

720
(07)
I57
v.5
pt.2

Federal Housing Administration
Library

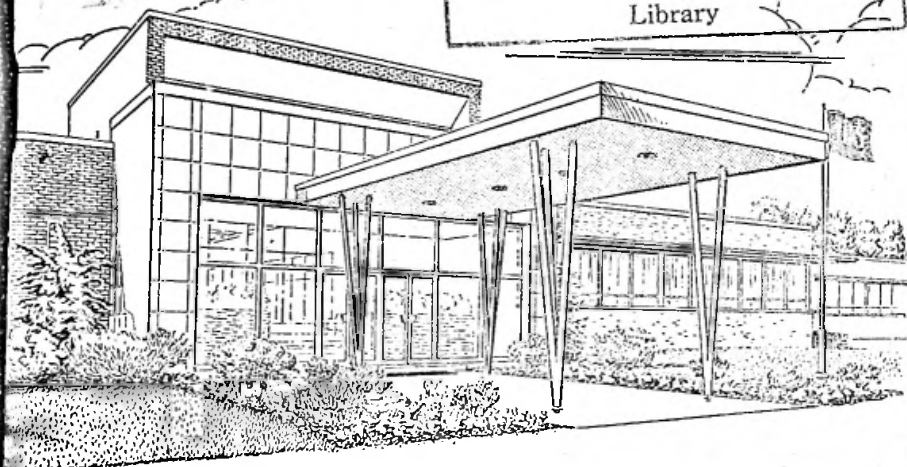

International Correspondence Schools, Scranton, Pa.

Floor, Wall, and Ceiling Coverings

Prepared Especially for Home Study

By

DURWARD E. NICHOLSON

Technical Writer

International Correspondence Schools

and

Director, School of Architecture and the Building Trades

International Correspondence Schools

Member, American Institute of Architects

and

The Construction Specifications Institute

6239B

Part 2

Edition 1

International Correspondence Schools, Scranton, Pennsylvania

International Correspondence Schools, Canadian, Ltd., Montreal, Canada

Architecture home study course

Floor, Wall, and Ceiling Coverings,

V. 5 PART 2

By

DURWARD E. NICHOLSON

Technical Writer
International Correspondence Schools

and

DAVID T. JONES, B. Arch.

Director, School of Architecture and the Building Trades

International Correspondence Schools

Member, American Institute of Architects

and

The Construction Specifications Institute

Serial 6239B

© 1959 by INTERNATIONAL TEXTBOOK COMPANY

Printed in the United States of America

All rights reserved

*"The higher men climb, the longer
their working day. And to keep at the
top is harder, almost, than to get there.
There are no 'office hours' for leaders."*

—Cardinal Gibbons

But for the man who has found the job he loves, work is no longer "labor." And learning more about that job becomes a thrilling, exciting adventure.



International Correspondence Schools,

c. f.

Scranton, Pennsylvania

International Correspondence Schools Canadian, Ltd.

Montreal, Canada

What This Text Covers . . .



1. SELECTION OF WALL AND CEILING COVERINGS ----- Pages 1 to 3
Factors determining the selection of wall and ceiling coverings are discussed here. Many materials used for floor coverings can also be used for wall and ceiling coverings.
2. NATURAL STONES, CAST STONE, AND CONCRETE BLOCKS ----- Pages 4 to 19
Natural stones, cast stones, and concrete blocks and their finishes are discussed in this section. Methods of setting natural and cast stones and concrete blocks are described.
3. BRICK, STRUCTURAL-CLAY FACING TILE, AND CERAMIC VENEER ----- Pages 20 to 31
Various types of glazed and unglazed units are described. Clear glazes and opaque colored glazes are discussed. Also, the sizes of the different units available are given.
4. GLASS, TILE, AND TERRAZZO ----- Pages 32 to 45
Attractive and easily cleaned wall coverings can be had with glass, tile, or terrazzo. Glass is used in the form of blocks, sheets, and plates. Tile can be given many attractive finishes.
5. PLASTER AND ACOUSTICAL MATERIALS ----- Page 46 to 53
Plaster is more widely used than any other wall and ceiling covering. You will be interested in the use of acoustical plaster and acoustical tile for sound-reduction purposes.
6. WOOD, WALLBOARDS, AND PLASTICS ----- Pages 54 to 65
Rare and expensive veneers can be obtained in plywoods. Such plywoods are frequently used to form wall and ceiling coverings. Types, sizes, and applications of wallboard are discussed. Plastic-coated wallboards, opaque and transparent plastic sheets, and their uses are discussed.
7. PAINTING AND WOOD FINISHING ----- Pages 66 to 74
Materials for finishing—oil paints, enamels, lacquers, stains, varnishes, and waxes—are discussed. The preparation of the undersurface is described.
8. WALLPAPERS, FABRICS, AND PLASTIC-COATED COVERINGS ----- Pages 75 to 82
A wide variety of wallpapers and fabrics are available for application to walls and ceilings. Most of these coverings are applied over a plaster base.
9. MISCELLANEOUS COVERINGS ----- Pages 83 to 91
Linoleums make durable, washable wall coverings. Metals such as stainless steel, aluminum, and enameled sheet metal have applications as wall coverings.

720
(07)
157
V. 5
pt. 2

Floor, Wall, and Ceiling Coverings

PART 2

Selection of Wall and Ceiling Coverings

Factors That Determine Selection

1. The problem of selecting wall and ceiling coverings differs from the problem of selecting floor coverings, even when the materials for wall and ceiling coverings are of the same basic composition as those for floor coverings. Wear, design, and cost are important factors for both types of covering, but resistance to wear is usually not as essential in wall and ceiling coverings as it is in floor coverings.

Due to differences in use and application, you can usually obtain the materials for walls and ceilings in larger sizes than those for floors. And since there is no direct stress on the materials, such as is caused by walking or vehicular traffic, you can use thinner sections.

Plaster can be applied to walls and ceilings in large areas and without joints, resulting in continuous surfaces readily adaptable for painting. Some fabricated materials for walls and ceilings, such as tile, are of a slightly different composition than the corresponding materials for floors, since resistance to direct wear is not a factor. Thus, some of these materials are not suitable for floor coverings. A highly glazed wall tile, for instance, would scratch if used as a floor covering. Wall tile, therefore, not limited by wear resistance, offer a larger variety of sizes and finishes than floor tile. Certain types of materials, such as acoustic tile, cannot be satisfactorily used for floors because they are too soft, but can be adapted for wall and ceiling coverings.

Physical Limitations

2. In selecting materials for wall and ceiling coverings, you must always keep in mind the physical limitations of the materials. Most natural materials, such as wood and marble, can be made into panels or moldings. This is also true of plaster, of cast artificial materials such as cast stone and terrazzo, and of those materials that are run in molds, like the metals. Many fabricated materials, such as wallboard and linoleum, are too thin to be used other than as plain surfaces or as panels without moldings. Other fabricated materials, such as tile, are available with moldings.

Utility and Wear

3. If walls or ceilings are to be purely utilitarian, your selection of materials is based primarily upon the utilitarian property desired. Design, color, and surface texture are secondary considerations. If sound absorption, for instance, is the property desired, the selection narrows down to materials that have that property and to the surface textures and colors in which these materials can be obtained. If sanitary wall surfaces are desired, materials that can be easily cleaned and that will withstand wear will receive your consideration.

Design

4. When design is a prime consideration, your selection of wall and ceiling coverings is governed by the architectural effect desired — including the texture and coloring desired — and the adaptability of the materials to the structural conditions. No material is restricted to one architectural style, so the designer has a variety of materials to select from. His selection is restricted only by the use of the room, the degree of ornamentation, the color desired, and the amount that the owner can spend.

As in the case of floor coverings, materials for wall and ceiling coverings should be honestly used. Each material should show itself to be what it is and not try to be anything else.

Color

5. Color may be a deciding factor in your selection of wall and ceiling coverings, since all materials are not available in the same range of colors.

Up until a few years ago, color selection depended primarily on personal opinion and preference. This is still true and desirable in many instances. But today a new science has been developed in which color is used to meet definite needs and problems. In industrial plants good visibility and relief from eyestrain are essential. In hospitals a cheerful, restful atmosphere for convalescents is necessary. Schools require an atmosphere of quiet that aids concentration. Color can fill all these needs.

Considerable research has been done in regard to the most suitable colors for use in rooms intended for specific purposes. Successful practice in the use of color has been checked against the recommendations of specialists in human vision and in illumination. As a result, much scientific information on the use of color can be obtained from the research institutes of various manufacturers.

Cost

6. Cost often affects both design and utility. If the selection of wall and ceiling coverings must depend largely upon the amount of money available, the list of materials from which you may choose will usually be restricted.

In many cases, however, as in school corridors and hospital operating rooms, it is not so much a question of first cost as of the expense of continuous maintenance and repair which must be considered. Over a period of years, good materials usually pay for themselves.

Summary

7. Usually, more factors will enter into your selection of wall and ceiling coverings than into your selection of floor coverings. Wear is still an important factor, but not as im-

portant as it is for floor coverings. Cost is usually an important factor, but remember that the initial cost of a material should be weighed against the life of the material. The dominant factor in the selection of wall and ceiling coverings will vary with the requirements of use. In selecting wall coverings for toilet rooms, for instance, the dominant factor will be utility. Where design is the dominant factor, you should keep in mind that an honest use of materials is the keynote of good design.

Many materials that are used for floor coverings — such as stone, marble, and wood — are also used for walls and, in some cases, ceilings. In addition, there are available many other interesting materials, such as ceramic veneer, plaster, wall-board, glass, and plastic.

Natural Stones, Cast Stones, and Concrete Blocks

Uses of Stone

8. You have studied the general characteristics of various natural stones in Part I. The same kinds of stones that are used as floor coverings are often used for wall coverings. Stones are seldom used on ceilings due to their weight and to the expense and difficulty of installation.

Some stones are more widely used for wall coverings than others. Limestone, travertine, and marble, for instance, are employed more frequently than granite and slate.

Whatever stone is used for a wall covering, the finish selected should conform to the requirements of use and to the methods of manufacturing the stone, and should show to advantage the color, veining, and natural texture of the stone.

Finishes for Stone

9. Where granite, marble, travertine, and some kinds of soapstone are used for wall coverings, the polished finish is the most desirable, since it brings out the color and the irregular veinings and formations, is more resistant to dirt, and is readily cleaned. Honed finishes and sand-rubbed finishes are

sometimes used where subdued effects are desired and cleaning is secondary.

For slate, sandstone, limestone, and the general run of soapstone, the honed finish is the finest finish used in wall work. Flagstones and similar stones are usually given a fine sand-rubbed finish where the natural split faces are not desired. In modern interiors there is an ever increasing use of stone in broken-range patterns with sawed and split finishes.

Granite

10. Granite for interior use is usually given a polished finish. Due to its dense composition and resistance to wear, polished granite makes a beautiful and serviceable wall covering. It is much used as a base below other wall-covering materials, especially where the floor has to be constantly washed. For wall coverings, it is usually used in slabs 2" (inches) thick. However, due to the cost of production and installation, the use of granite as a wall covering is more or less restricted to lobbies and monumental rooms.

Slate and Flagstone

11. Slate is sometimes used as a wainscot in vestibules and corridors, or in washrooms, when a hard surface is desired. The most commonly used finishes are fine sand-rubbed and honed finishes. Whatever the finish, the surface should be protected by a coat of boiled linseed oil, rubbed in well. Slate allows a certain absorption of moisture, which must be taken into consideration in its use. Slate is occasionally given a baked or sprayed-on enamel finish in color; slate with such a finish forms an economical and sanitary wall covering highly resistant to wear and to dampness.

Flagstones do not take a polish, but they are frequently given a sand-rubbed or honed finish, which provides them with an excellent wear-resistant surface. Flagstones are widely used also in split and sawed finishes for interior walls and for fireplaces.

Limestone

12. For interior use, limestone usually has a sand-rubbed or planed finish, which gives a smooth surface. Limestone can be laid in large slabs or in small pieces in regular courses, or it can be laid in broken range as shown in Fig. 1. Here the stone is Alabama veined limestone. In Fig. 1, where both sawed and split textures have been used, the stones have been laid up with a raked joint.

Limestone is quarried much like granite, but limestone, since it is a softer stone, is more readily worked into thinner slabs and into varying sizes. Care must be taken in setting limestone to avoid discoloration by using nonstaining mortar.

Limestone is much used in monumental rooms, where the spaces are large enough to permit proper design and where the light-gray or buff color of the stone can be used to advantage. An excellent example of the use of limestone is in the interior of the library shown in Fig. 2.

Limestone will discolor and is hard to clean. You must be careful not to expose the stone to rough usage.

Sandstone

13. Sandstone is composed chiefly of quartz hardened into a solid mass by a natural cementing material such as silica or calcium carbonate. It is used in much the same manner as limestone, and generally has the same color variations and characteristics, except that it is available in darker shades.

Marble

14. Marble is a beautiful and distinguished material, and is the most widely used of all natural stones for wall facing. In large buildings it is used for lobbies, stair halls, and toilet rooms. Recent years have seen a revival of the use of marble as a home finishing material for vestibules, living rooms, kitchens, and bathrooms. Its richness as a decorative material is responsible for its wide use for such focal points as fireplaces. As a fireplace material, it resists deterioration from

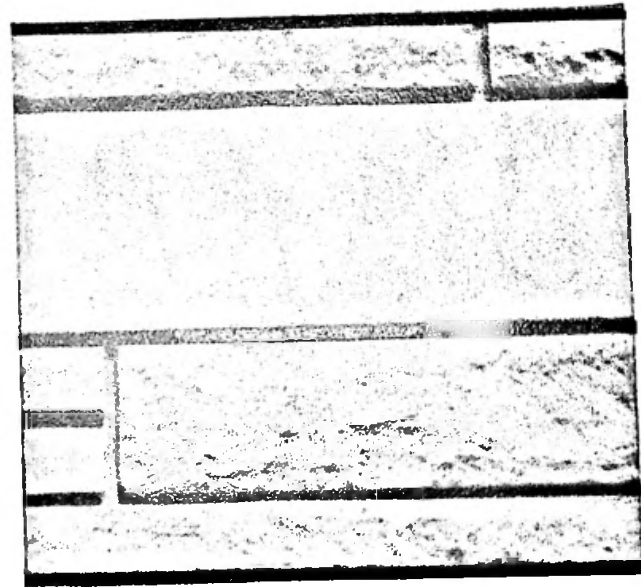
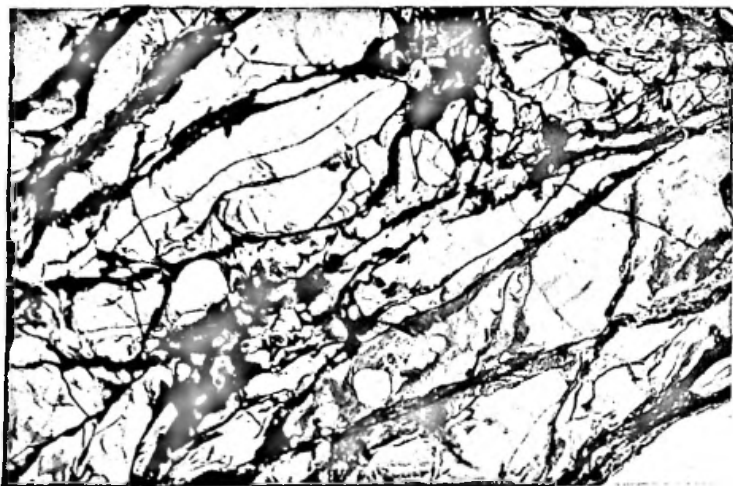
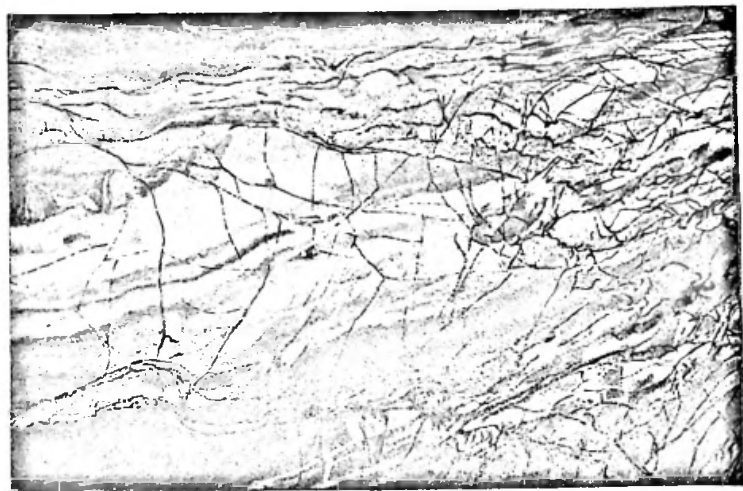

FIG. 1. ALABAMA VEINED LIMESTONE



(a)



(c)

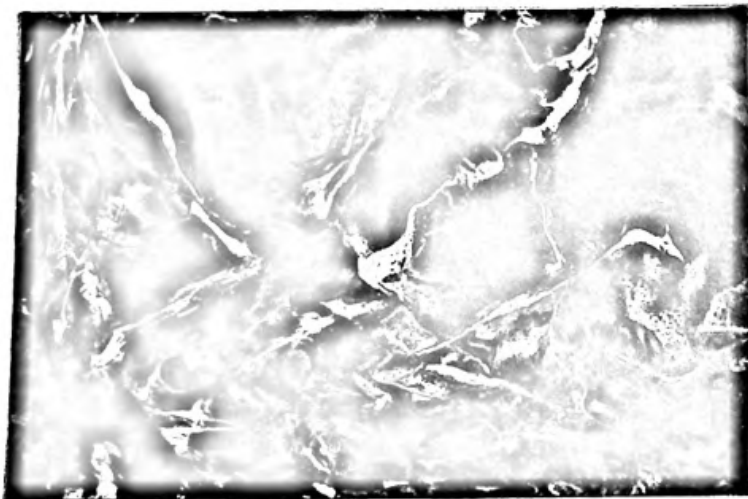

(b)

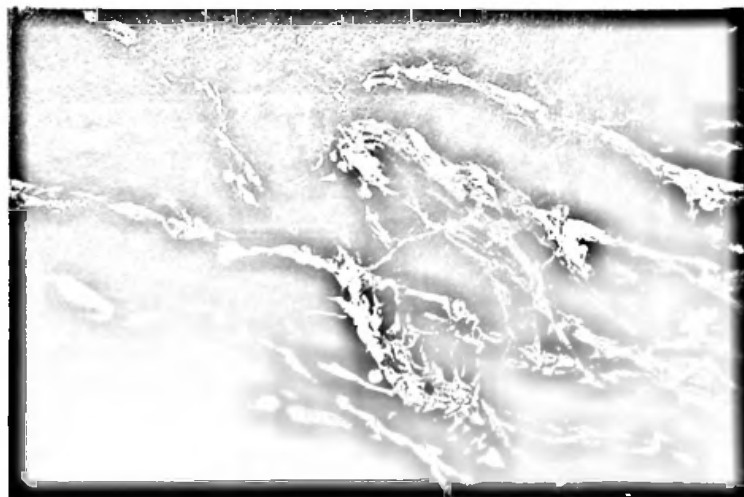

(d)

(a) Pavonazzo marble
(b) Red Numidian marble

(c) Dark Siena marble
(d) Alps green marble

FIG. 3. COLORED MARBLES WITH POLISHED FINISH

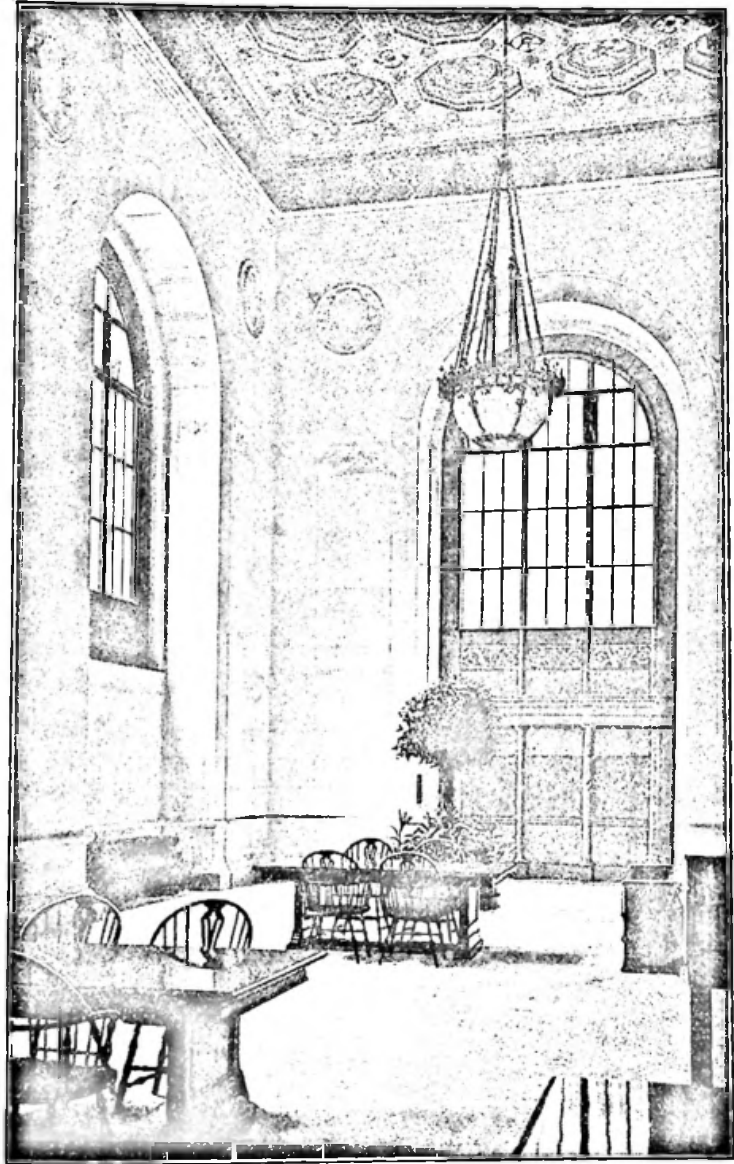

FIG. 2. LIMESTONE SIDE WALLS IN LIBRARY

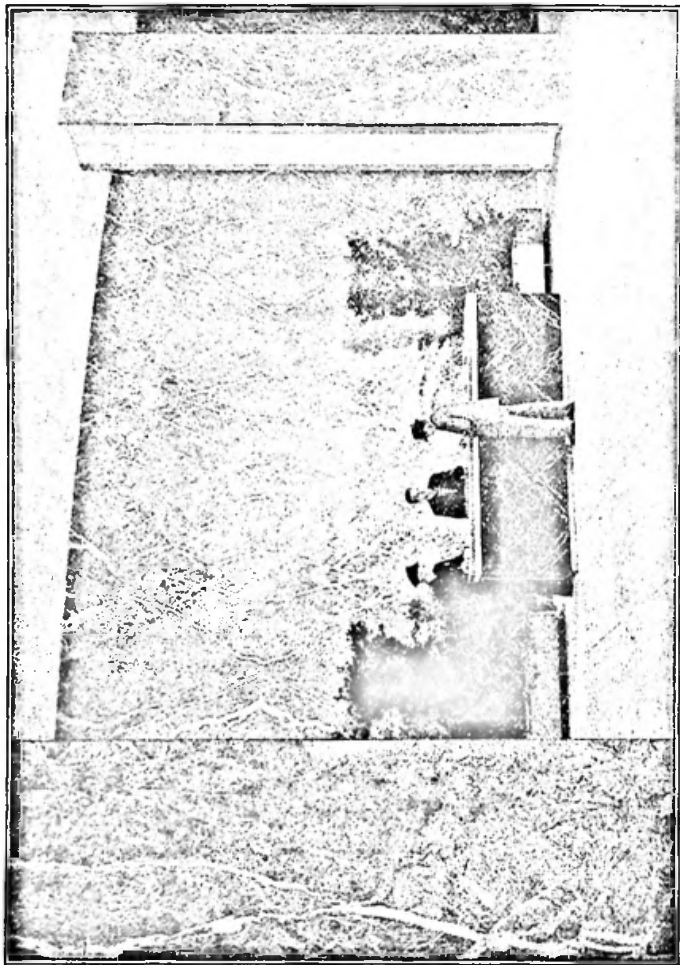

FIG. 4. MARBLE WALLS IN LOBBY OF OFFICE BUILDING

rapid changes in temperature and provides a surface that is easily cleaned.

You learned something about the physical characteristics of the various groups of marble and the finishes of marble in Part 1 of this text series. Some of the softer marbles or those too fragile for use in floors are often suitable for use as wall coverings. Some of the decorative marbles, such as those shown in Fig. 3, lend themselves to interesting designs in a full range of colors.

Marbles used for practical purposes should be carefully selected. For rooms having hard usage and requiring constant washing, the marbles listed in Part 1 under Group A are recommended, although some of Group B will give good service. For corridor walls, bathrooms, and similar spaces in private houses where the usage is less hard, any of the Group A or Group B marbles may be used safely.

For spaces where color and design are the most important factors and where ease of cleaning is more or less incidental, you may select any of the marbles in Groups A to D inclusive. Choice depends upon the color and effect desired, but you must give consideration to the size and installation limitations of those marbles in Groups C and D that require much sticking, waxing, or filling.

Interesting effects can be secured by matching the veinings in marble slabs, as was done in the lobby of the office building shown in Fig. 4. The size of the block from which the slabs are cut will limit such matchings, and all the slabs will vary due to natural formation. Certain types of marbles can be secured in slabs as long as 8' (feet); therefore, a wall can be wainscoted with a minimum number of joints or panels according to design. In most cases, interior wall slabs are from $\frac{3}{4}$ " to 1" in thickness, with molded members having greater thickness. Details for the installation of marble wainscots are shown in Figs. 5 and 6.

Instead of marble slabs, marble tile may be used for wall

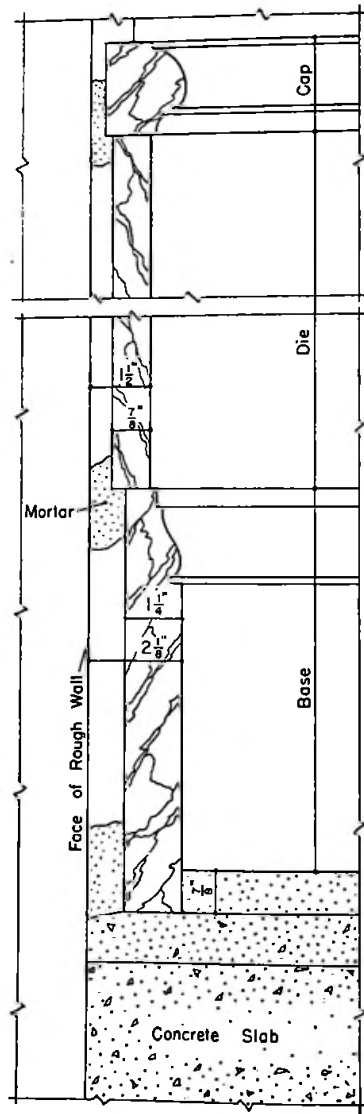
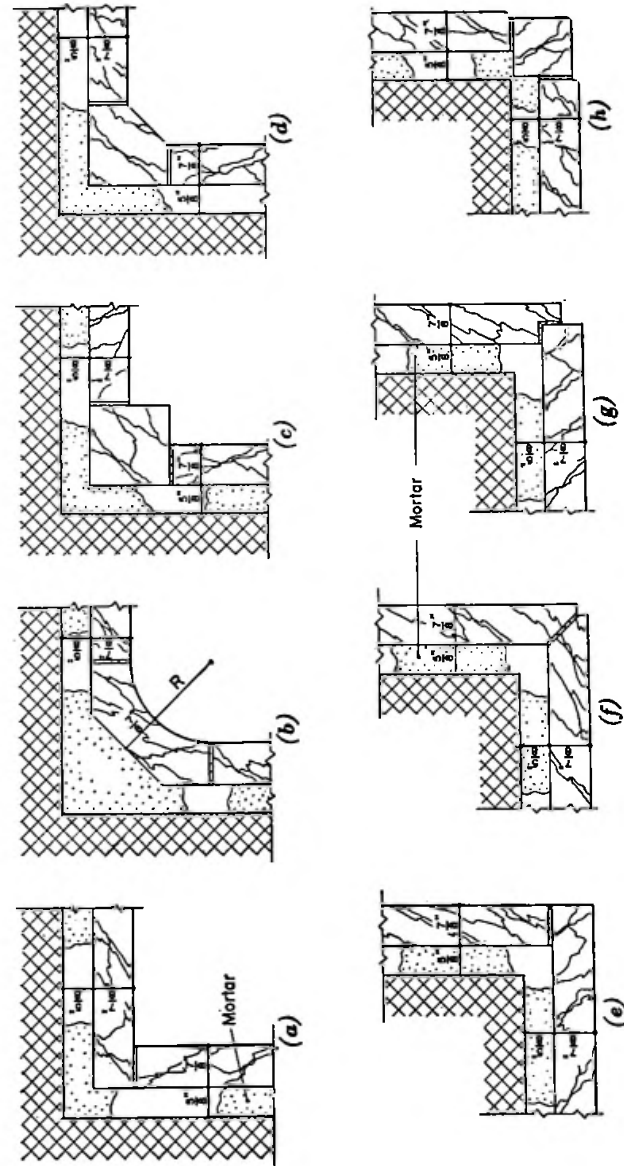

FIG. 5. SECTION AT MARBLE WAJNSCOT



(a), (b), (c), (d) Interior corners
 (e), (f), (g), (h) Exterior corners
 FIG. 6. INTERIOR AND EXTERIOR CORNERS FOR MARBLE WAJNSCOTS

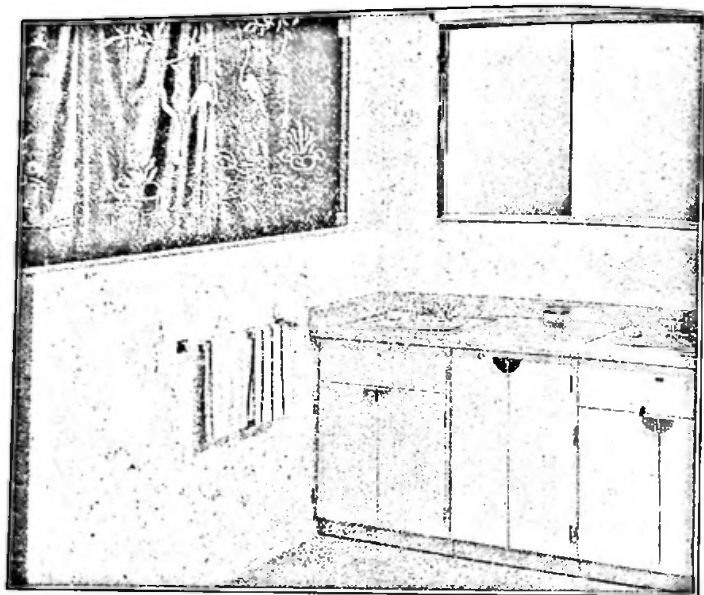

FIG. 7. MARBLE TILE IN BATHROOM

coverings. The tile are usually $\frac{1}{2}$ " thick and can be obtained in various sizes. An installation of marble tile in a bathroom is shown in Fig. 7.

Marble, when used as a wall covering, is almost always polished. The polished finish brings out the color and beauty of the markings; it serves also a practical purpose by resisting absorption and staining, and making the marble easier to clean.

Travertine and Similar Stones

15. Closely related to the marbles are travertines and such stones as buff Missouri stone. Like marble, these stones take an excellent polished finish, and where their characteristic mottled buff or brown color is desired or where the voids in the travertine do not affect design or use, they are an excellent selection for corridor or lobby walls. Travertine, when used with a sand-rubbed finish, gives an unusually soft effect.

Composition and Use of Cast Stone

16. The use of white or gray portland cement in combination with various aggregates and colors has brought about the development of many synthetic materials that resemble natural stones in color and effect, although the markings and veinings of materials such as marble are difficult to imitate. These artificial stones are cast in molds, the surfaces are either troweled to the texture desired and the blocks allowed to cure, or the surfaces are finished in those types requiring honing or polishing, after curing. Some cast stones are difficult to distinguish in color and texture from the natural stones for which they are substitutes. Most cast stones, however, lose their resemblance to natural stone when they are wet, and as a rule they do not weather like natural stones.

Artificial stones are generally used in the same way as natural stones. If properly made, they have similar physical properties. They can be made in very dense form to give high resistance to wear; they can be produced in almost any reasonable size and thickness and can be adjusted to suit irregular construction at the building.

Precast Concrete

17. Precast masonry units of reinforced concrete may be used to face exterior and interior walls; in practice, however, they have been used mostly for exterior work. The units are 2" thick and faced with an exposed aggregate which may be of crushed graded quartz, granite, or vitreous bodies. Units in sizes as large as 20 to 60 sq ft (square feet) can be manufactured. The units are strong, dense, and highly resistant to moisture, and have a compressive strength of approximately 7500 psi (pounds per square inch).

Slabs or blocks with a cement base are produced without any attempt to imitate other materials. In the making of these slabs, advantage is taken of the possibilities of colored mixes of cement, sand, and other ingredients, to produce effects

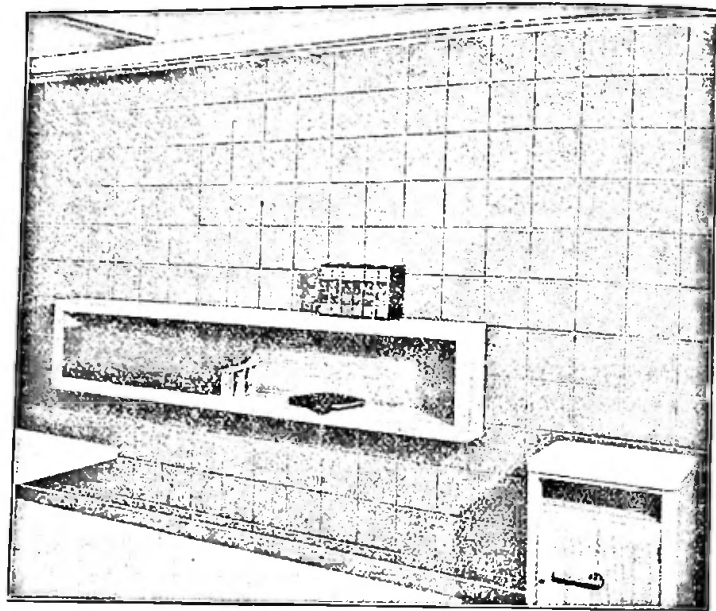

FIG. 8. CONCRETE BLOCK IN OFFICE

which sometimes have a high decorative value. The surfaces of these slabs generally have a fine sand finish, but a stippled or heavily sanded effect can be obtained, as well as troweled-stucco or rough-cast textures.

Concrete Blocks

18. Concrete blocks are composed of portland cement, sand, and usually an aggregate of stone, cinders, or gravel. They are either hollow or solid, to meet structural requirements. Originally, they were made for use in structural walls only. Their use as a wall finish has increased as a better block with a finer surface has been produced. While concrete blocks are available mostly in units of 8" x 16", there are variations in size to permit the use of these blocks in securing design effects.

Concrete blocks can be laid in different bonds to achieve



FIG. 9. CONCRETE BLOCK IN CHANCEL

interesting effects. In Fig. 8 is shown the use of 8" x 8" units in a stack bond. The use of blocks to form a curved chancel wall is shown in Fig. 9. Here the blocks are stacked on end.

As a rule, you will give the blocks a painted finish. Either an oil paint, a water paint, or a cement-base paint can be used. Since concrete blocks are quite porous, heavy applications of paint are necessary.

As better concrete blocks have been produced, there has been a growing use of such blocks in finished interior walls.

Setting of Stone and Concrete Block

19. Certain stones such as granite and limestone, when over 4" thick, can be used as self-supporting walls. When less than 4" thick and used solely as wall coverings, these stones are generally attached to structural walls by a mortar setting bed and by galvanized-iron or copper wall ties. The ties are spaced to enter into the horizontal joints and are bent down and fitted into notches in the stones. Grooves or holes are cut in the top edges of the stone slabs to receive the turned-down portions of the ties.

Marbles, travertines, slates, and sandstones $\frac{1}{8}$ " or more in thickness are also secured to structural walls in this way. The slabs are set before the ties are placed, generally by what is known as the spotting method, shown in Fig. 5, which illustrates a recommended method of erecting marble base, wainscot, and cap. The setting space, which is the distance from the rough-wall backing to the finished face of the marble, is normally $1\frac{1}{2}$ " for $\frac{3}{4}$ " thick marble. Spots of mortar, either of plaster of Paris or stainless portland cement, are put on the wall around the edges and on the back of each slab; the slabs are set and pressed into position. Since plaster of Paris is soluble in the presence of moisture, it is not suitable for spotting or jointing on exterior veneer, in shower stalls, or wherever dampness may be present. Portland cement with a shrinkage-reducing accelerator can be used instead of plaster of Paris where moisture is a factor. The ties are then placed. These ties hold the slabs in position until the mortar has set. Then the combination of mortar setting bed and ties holds the slabs firmly in place. The joints, which are usually $\frac{1}{16}$ " to $\frac{1}{8}$ " wide, are pointed with a stainless cement or lime mortar, or a nonstaining pointing mastic, cleaned off, and washed. This method of erection is applicable to most thin stones.

20. Marble should be kept free of grease, oil, rust, or similar stains. When cleaned, it should be washed with pure

soap and softened water and then washed again with soft water. Special preparations are available for cleaning marble without danger of staining.

Cast artificial stones, when used for wainscoting, are set in the same manner as natural stones, usually with $\frac{1}{4}$ " joints. The thicker types are set as self-supporting walls, while the thinner types are set as a veneer in the same manner as marble slabs. All require rigid foundations or bases, and every precaution should be taken against shrinkage or settling.

Mortars used in laying stone and concrete blocks are the same as those used for other masonry units, such as brick and structural-clay tile. But such stones as marble and limestone require that the mortar be made with nonstaining portland cement. A discussion of mortars is contained in the section of this text devoted to brick, structural-clay tile, and ceramic veneer.

Concrete blocks are laid in the same manner as masonry units, usually with $\frac{1}{2}$ " to $\frac{3}{4}$ " joints.

Maintenance of Stone

21. The chief characteristics of stone are hardness and permanence. But even stone wall coverings must be treated properly and cleaned regularly.

In general, avoid use of acids and wire brushes, and on marble avoid the use of oil or any other material that will stain the marble. As a rule, you can use water and a mild soap powder for washing, rinsing with clear water. Detailed instructions for the maintenance of stone and marble can be obtained from such agencies as the Marble Institute of America and the Indiana Limestone Institute.

Summary

22. Many of the natural stones, in a variety of finishes, can be used for wall facings. The polished finish is best suited to bringing out the natural beauty of stones such as marble and granite. Stone facing, depending on its thickness, may be self-

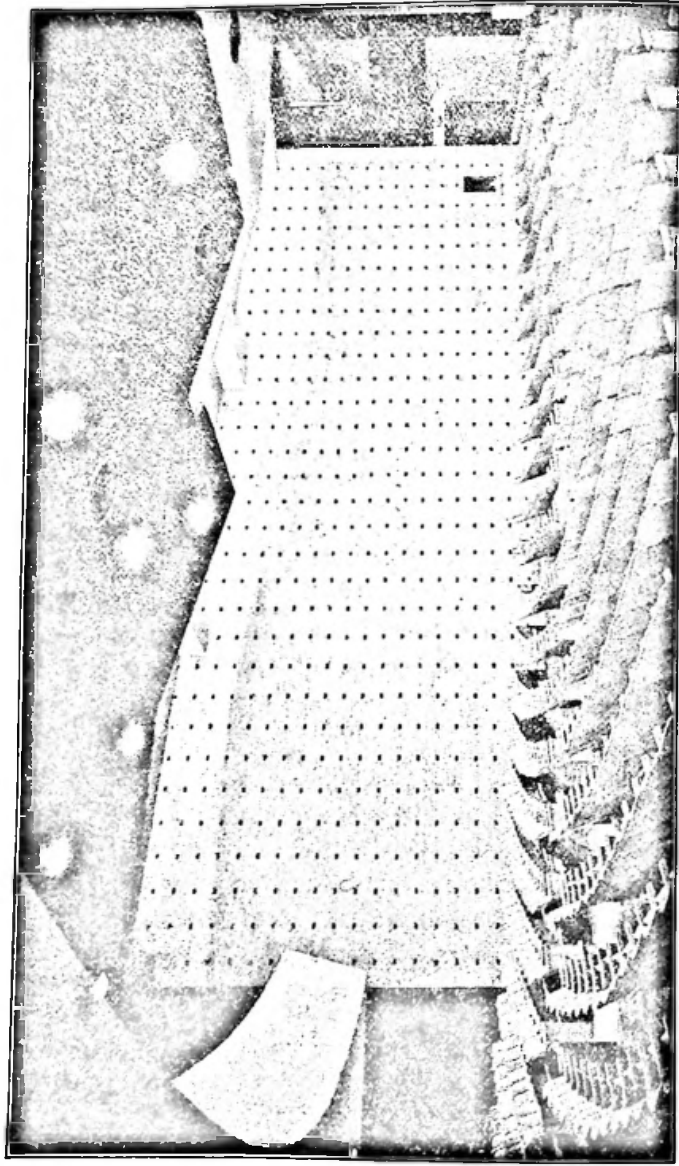

FIG. 10. LIGHT BRICK WITH DARK HEADERS IN AUDITORIUM WALL

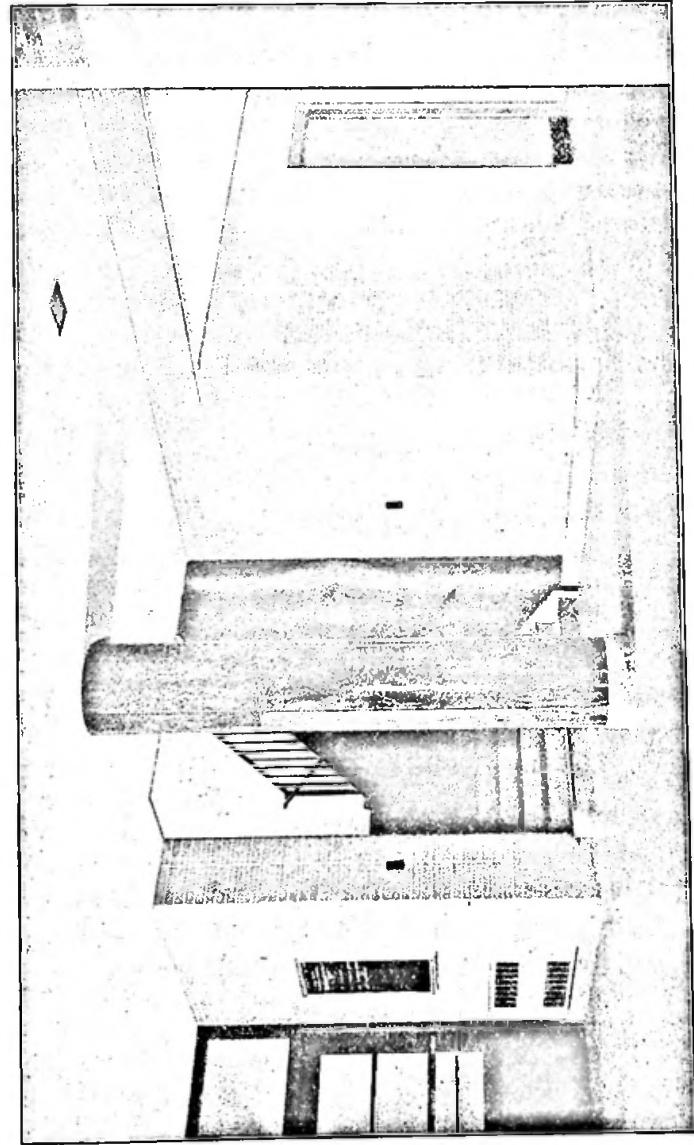

FIG. 11. GLAZED BRICK IN LOBBY OF SCHOOL BUILDING

supporting or attached to the backing by a mortar setting bed and metal ties.

Artificial stones resemble natural stones in physical characteristics and methods of installation. Where molded work is involved, cast stone can usually be produced more economically than can natural stone. In most cases, cast stone does not successfully duplicate the weathering characteristics of natural stone.

Brick, Structural-Clay Facing Tile, and Ceramic Veneer

Use of Brick

23. Brick, structural-clay facing tile, and ceramic veneer are all burned masonry units that are used for interior wall coverings. Each type of masonry unit has its advantages as a wall covering under specific requirements of use. For instance, some units are larger than others and require less time and labor to install. Some units are more impervious than others and more resistant to acids. Some units weigh less than others.

The same brick used for facing exterior walls may be used for facing interior walls and often provide interesting contrasts in texture with adjoining walls and ceilings of other materials. In Fig. 10, notice the auditorium wall of light-colored brick with dark headers. These brick are comparatively smooth. In most cases, the smoother brick are preferred for interior work because they are easier to clean. For certain locations glazed brick are desirable. A lobby of a school building with walls of light-green glazed Norman brick is shown in Fig. 11.

Glazed Brick

24. Glazed brick are produced by giving a coat of glaze to hard-clay or shale brick. The glazed surface is hard, impervious, and resistant to grease, dirt, and practically all acids.

Glazed brick are produced especially for facing interior

walls. They are much used in places where reflection of light and cleanliness are desired, as in dairies, laboratories, gymnasiums, cafeterias, and operating rooms in hospitals.

Sizes of Glazed Brick

25. The standard size of glazed brick is the same as that of other types of brick, namely, $2\frac{1}{4}'' \times 3\frac{3}{4}'' \times 8''$. This size is gradually being changed to dimensions based upon a 4" module. The brick is either a solid unit or a cored unit with a series of round holes extending from top to bottom. The brick can be glazed not only on the face but also on the ends, so that a wall can be laid with all the exposed ends glazed. Glazed brick are also available in special shapes, such as coves, rounded interior and exterior angles, caps, and so forth.

Surfaces and Colors of Glazed Brick

26. Various clear and opaque glazes can be applied to brick in the same manner as described for tile in Part 1 and for structural-clay facing tile later in this section of the text. The usual colors for the opaque glazes are cream, buff, ivory, tan, green, and gray. You can also obtain white and black by order. Variations in colors include mottled and stippled effects.

In selecting glazed brick, you should stipulate the particular quality desired, since glazed brick are available in several standard grades.

Laying Glazed Brick

27. Glazed brick are laid in the same manner as other types of clay brick, except that the mortar is usually kept back from the face of the brick. The joints are then pointed after the brick are laid. For pointing, a nonstaining cement mortar is used. The mortar is colored when a joint of a particular color is desired.

Uses of Structural-Clay Facing Tile

28. Structural-clay facing tile consist of finely pulverized and screened fire clays or shales. Mineral pigments may be

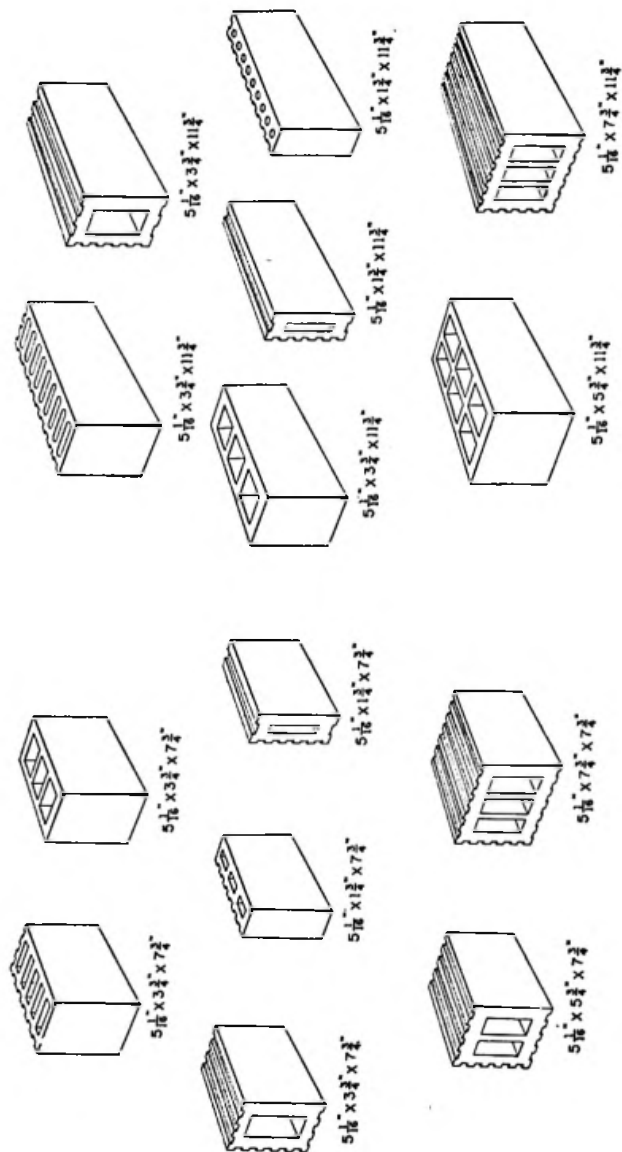

FIG. 12. MODULAR SIZES OF STRUCTURAL-CLAY FACING TILE

TABLE 1
NOMINAL MODULAR SIZES OF STRUCTURAL FACING TILE

THICKNESS INCHES	FACE DIMENSION IN WALL	
	Height Inches	Length Inches
2, 4, 6, and 8	4	8 and 12
2, 4, 6, and 8	5½	8 and 12
2, 4, 6, and 8	6	12
2, 4, 6, and 8	8	12 and 16

added to obtain different color effects. Glazed surfaces may be obtained by one of several methods.

The tile are generally made by a stiff-mud process, extruded into blocks, dried, and burned in kilns at a high temperature. They are hollow, and the thicknesses of the web and facings are all standardized for use under various conditions of load and fire resistance as a result of tests by the industry and the American Society for Testing Materials. The tile units are divided into unglazed and glazed wall units. The glazed units are divided again into units with clear glazes and units with opaque glazes.

Structural-clay facing tile combine both wall finish and structural strength. You can obtain them in either load-bearing tile or in a lighter and thinner tile to be used as wall-finishing material or in nonbearing partitions.

Sizes and Classes of Structural-Clay Facing Tile

29. Structural-clay facing tile can be secured in nominal 2", 4", 6", and 8" thicknesses. For facing interior walls where the tile becomes a part of the wall, the 4" thickness is used; in other cases the 2" thickness is used for facing the wall. Face sizes vary with each type.

The common face sizes were originally 5" x 8" and 5" x 12", but dimensions are being changed to conform to modular

coordination and to sizes of $5\frac{1}{2}'' \times 12''$, $5\frac{1}{2}'' \times 8''$, and $4'' \times 12''$, which fit into dimensions of 4" or multiples thereof. These sizes include the joint thickness. Some modular sizes are shown in Fig. 12. Additional sizes are listed in Table 1. Shapes and fittings are available for finishing corners, caps, and bases.

In Fig. 12, notice that in some tile the coring is vertical; in others the coring is horizontal. Types and directions of coring and scoring are optional with the manufacturer. Generally, a manufacturer standardizes in either horizontal or vertical coring and does not use both.

Unglazed Tile

30. Unglazed tile consist of the natural clay body finished in one burning. Surfaces can be smooth- or rough-textured, wire-cut with vertical or horizontal markings, or speckled with iron or manganese spots. Usually, the tile have a mat, or dull, surface with a fine, medium, or coarse texture. Colors range from pearl gray or cream to buff, dark brown, red, purple, and gun-metal black, all with or without spots. In fact, you will find unglazed tile available in most of the colors and textures obtainable in facing brick.

The unglazed surface is hard and nonporous, and will withstand considerable rough wear. The burning sometimes produces a slight unevenness in the surface, which is not objectionable. Usually, the joints must be at least $\frac{1}{4}''$ wide to allow for uneven edges on the tile.

Glazed Facing Tile

31. Glazed facing tile are of two types: those having an opaque ceramic glaze and those having a clear glaze. The clear glaze may be a ceramic glaze or a salt glaze.

The opaque ceramic glaze is compounded of metallic oxides, clays, and chemicals ground together and sprayed upon the previously burned body. It is then burned at high temperatures until the glaze is fused to the body. The opaque ceramic glaze gives the tile a highly glazed colored surface.

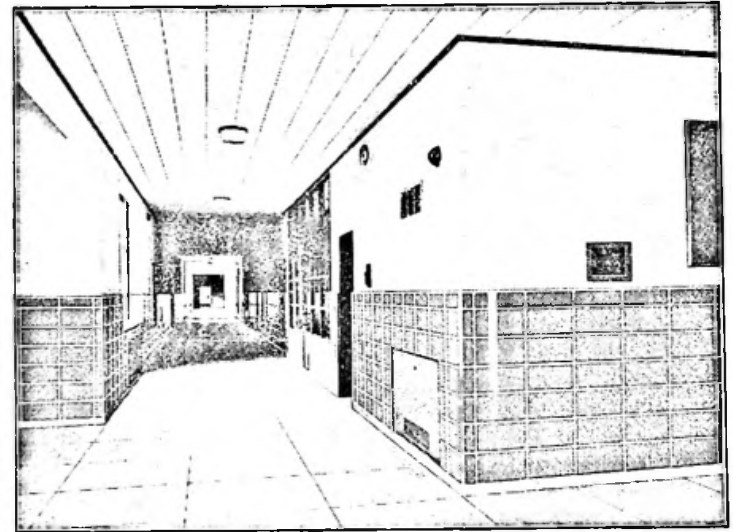

FIG. 13. CERAMIC-GLAZED FACING TILE IN CORRIDOR

Opaque ceramic-glazed tile comes in a bright satin or glossy finish and you can secure it in either a plain or mottled surface. The plain surface comes in white, cream, buff, and light green. The mottled surface comes in any shade, or gradation, of the plain colors. Trim, caps, and bases come in brown and black as well as in the plain colors just listed. Tile with an opaque ceramic glaze are shown in the photograph of the school corridor in Fig. 13. Large rectangular tile are placed horizontally in the wainscot.

Clear ceramic-glazed tile is obtained by spraying the glaze upon the previously burned unit and then reburning until the glaze is fused to the body. The color is the same as the body of the unglazed unit, although it has a tendency to darken somewhat under the glaze.

32. The salt glaze is obtained by introducing common salt and other chemicals into the kiln box near the end of the burn. The vapor from the salt, coming into contact with the surfaces

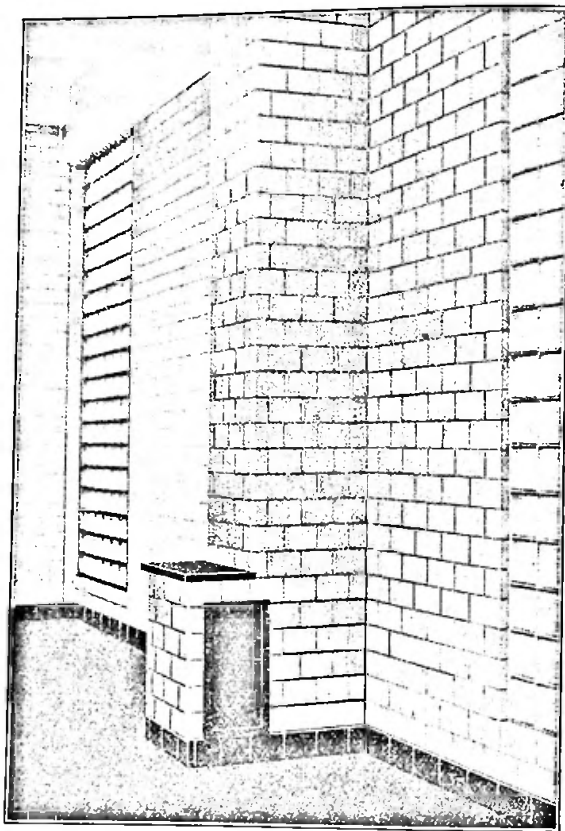

FIG. 14. SALT-GLAZED FACING TILE IN TELEPHONE BUILDING

of the units at high temperatures, forms a glossy coating. The salt glaze produces a hard, fairly smooth, wear-resistant surface. The glaze does not change the color of the original body, and the glazed units are therefore generally obtainable only in ranges of light buff or cream.

The salt-glazed-surface type of tile is especially suited to locations where cleanliness at low cost is important. You can see an example of salt-glazed tile in the interior of the telephone building shown in Fig. 14.

TABLE 2
MORTAR PROPORTIONS BY VOLUME

Mortar Type	Portland Cement Cubic Feet	Masonry Cement (ASTM C-91-) Cubic Feet	Hydrated Lime or Lime Putty Cubic Feet	Aggregate Measured in Damp, Loose Condition Cubic Feet
M	1	None	$\frac{1}{4}$	Not less than $2\frac{1}{2}$,
	1	1 of Type II	None	and not more
S	1	None	Over $\frac{1}{4}$ up to $\frac{1}{2}$	than 3, times the
	$\frac{1}{2}$	1 of Type II	None	sum of the vol-
N	1	None	Over $\frac{1}{2}$ up to $1\frac{1}{2}$	umes of cement
	None	1 of Type II	None	and lime used
O	1	None	Over $1\frac{1}{2}$ up to $2\frac{1}{2}$	
	None	1 of Type I or II	None	

Mortar for Setting Masonry Units

33. Structural-clay tile are masonry units and they are set in the same general manner as brickwork. The setting mortar used with structural-clay units may be any of the four types (M, S, N, or O) listed in Table 2. For the purposes of the specifications in the table, the weight of one cubic foot of the respective materials used is considered as follows:

Portland cement	94 lb
Masonry cement	Weight printed on bag
Hydrated lime	40 lb
Lime putty (quicklime)	80 lb
Sand, damp and loose	80 lb of dry sand

The type of mortar you select should be in accordance with job requirements. Load-bearing partitions, for instance, require a stronger mortar than do partitions that are not load bearing. Masonry cements are not recommended in mortars for use in reinforced brick masonry. For units laid with $\frac{1}{4}$ " joints, all aggregate should pass a No. 16 sieve.

Setting Structural-Clay Tile

34. When thin units of structural-clay tile are laid as

wainscoting, wall ties of galvanized iron should be built into the structural wall from 18" to 2' apart. Where the units are 4" or more in thickness, they are self-supporting, but if tile are used as a veneer they should still be tied to the backup.

In setting thin units, a coat of mortar is generally first applied to the structural wall, and the back of each unit is buttered before the unit is placed. This assures good construction and permanent adhesion.

The joints should be filled well as the units are laid, and the mortar should be struck smooth at the surface of the wall. When stainless white cement or colored joints are desired, or when mastic-filled joints are used for acid or water protection, the mortar is kept about 1" back from the face of the wall, and the joint is filled after the wall is completed.

If desired, glazed tile can be set with a very close joint, but the unglazed types require at least a $\frac{1}{4}$ " joint to take up unevenness.

Ceramic Veneer

35. Ceramic veneer is a machine-made form of architectural terra cotta in which the plastic clay is extruded through dies. Since ceramic veneer can be obtained with large plane areas, in various textures, and in an almost unlimited range of colors, it is widely used as a facing material. Because of the high temperatures at which it is fired and its impervious surface, ceramic veneer provides a durable facing material when applied properly. The ceramic colors are permanent, and so will neither fade nor change color. Some idea of the flexibility obtainable in the use of ceramic veneer can be obtained from Fig. 15.

You can obtain ceramic veneer in two types, the adhesion type and the anchored type. Adhesion-type veneer is commonly called "thin" ceramic veneer, and the overall thickness of a slab is not over $1\frac{1}{8}$ ".

The maximum face areas of individual slabs of adhesion-

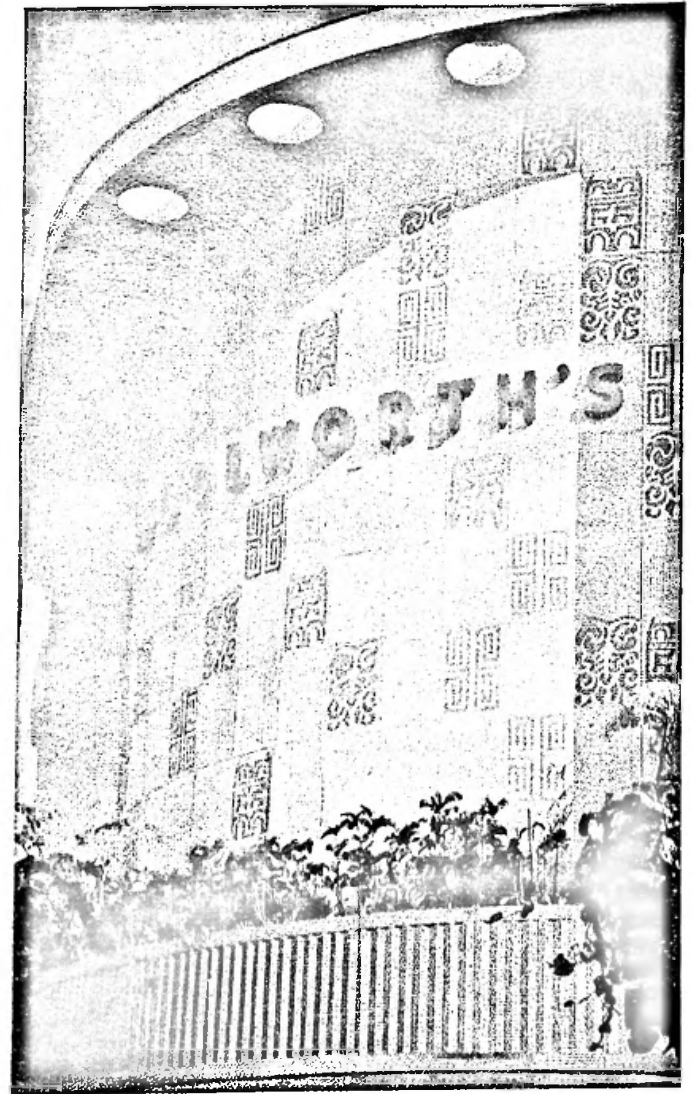
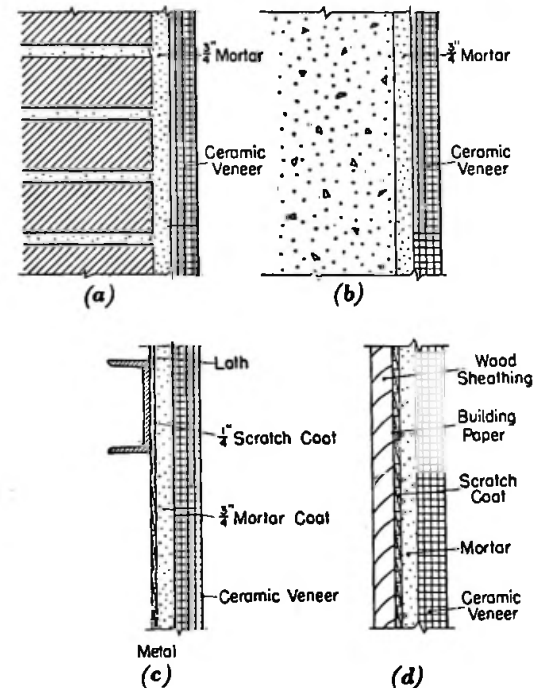

FIG. 15. EXAMPLE OF VERSATILITY OF CERAMIC VENEER



(a) Brick backing (c) Metal-lath-and-plaster backing
 (b) Concrete backing (d) Wood-sheathing-and-plaster backing

FIG. 16. DETAILS OF APPLICATION OF ADHESION-TYPE CERAMIC VENEER

type ceramic veneer do not exceed 540 sq in. (square inches). Typical overall face dimensions are 18" x 30" or 20" x 27". This type of veneer requires no metal anchors, but is held in place by the adhesion of the mortar to the unit and to the backing. The overall thickness from the face of the veneer to the face of the backing will be only 1 $\frac{1}{4}$ " to 3". Details of application of adhesion-type veneer are shown in Fig. 16.

The mortar recommended for adhesion-type ceramic veneer consists of 1 part portland cement, $\frac{1}{2}$ part high-calcium lime putty and 4 parts sand, by volume. For waterproofing purposes ammonium stearate is sometimes added in proportions

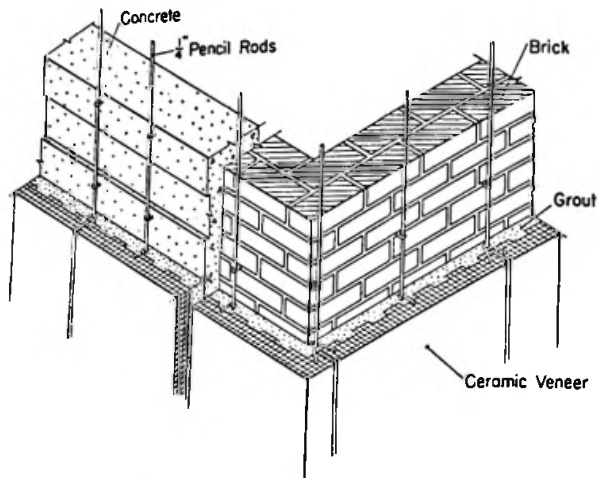

FIG. 17. DETAILS OF ANCHORED-TYPE CERAMIC VENEER

recommended by the manufacturer of the veneer. The usual joint is $\frac{1}{4}$ " wide.

The "thin" or adhesion type of ceramic veneer is mostly used for interior wall covering.

36. The anchored-type ceramic veneer is used where a slab larger than can be obtained in the "thin" veneer is desired. Ribs or scoring are provided on the back of each slab and the overall slab thickness ranges from 2" to approximately $2\frac{1}{2}$ ". A total of 3" to $4\frac{1}{2}$ " is required from rough wall to finished veneer surface to provide adequate grout space between the veneer and the backing. You can obtain anchored-type veneer in slabs as large as 36" x 52", with returns as wide as 14". Bed edges of the slabs are provided with anchor holes for the installation of loose wire anchors, which are fastened to pencil rods anchored to the backing as shown in Fig. 17. The grout used should consist of 1 part portland cement, 1 part sand, and 5 parts graded pea gravel passing a $\frac{1}{4}$ " sieve. Sufficient water should be used to make the mixture flow rapidly.

Setting Ceramic Veneer

37. Before the adhesion type of ceramic veneer is set, the slabs should be soaked in water for at least 1 hr (hour). The wall surface also should be damp at the time of setting. Immediately before setting, the wall surface and the back of the ceramic-veneer slab should be given a brush coat of portland cement and water. One half of the mortar used in setting should be spread on the wall space to be covered; the other half should be spread on the back of the slab to be set. Sufficient mortar should be used to eliminate air pockets and fill all voids so that a slight excess of mortar will be forced out at the joints as the slab is set, leveled, and tapped into place. To maintain the proper joint at the bottom of the slab, wood wedges should be used. After the mortar has its initial set, the wedges are removed and the face joints are raked out and pointed with the same type mortar used for setting or a finer mortar. The final step is to wash down the surface of the wall with clean water.

Before setting the anchored type of ceramic veneer, you should see that the unit and the backing wall are thoroughly soaked with clean water, as is done for the adhesion type. But since the space between the slabs is to be grouted, no brush coat of neat cement mortar is required on either the unit or the backing.

Once the slabs in a horizontal course are set in place with wood wedges and secured to the pencil rods with wire anchors, grout is poured into the space between the veneer and the backing. As it is poured, it should be thoroughly "puddled" to eliminate all voids and air pockets. After the grout has achieved its initial set, the wedges are removed, the joints are pointed, and the wall is washed down in the same manner as for the adhesion-type veneer.

Maintenance of Brick, Facing Tile, and Ceramic Veneer

38. You may clean interior brick walls by washing them

down, using clean water and stiff fiber brushes. The same treatment may be given to structural-clay facing tile and ceramic veneer. Glazed facing tile and ceramic veneer lend themselves to easy cleaning.

Summary

39. Masonry units of brick, structural-clay facing tile, and ceramic veneer may be laid up in mortar to form walls and wall facings that satisfy various requirements of use.

Both glazed brick and structural-clay facing tile combine strength and wall finish. Glazed brick are available in the same sizes as standard brick. The usual sizes of structural-clay facing tile are approximately 5" x 12" and 5" x 8". You may obtain larger sizes in ceramic veneer which lend themselves to the production of large areas of smooth wall surface.

Glazed masonry units are widely used in areas that require combined fire protection, attractive appearance, and cleanliness.

Glass, Tile, and Terrazzo

Use of Glass, Tile, and Terrazzo

40. Glass, tile, and terrazzo provide attractive wall coverings that are easy to clean. Terrazzo is not widely used for walls, since the vertical surfaces are hard to grind. But glass and tile are employed extensively in bathrooms, kitchens, cafeterias, and the like.

Forms of Glass

41. Glass for walls and wall coverings is produced in different forms. Some forms of glass are opaque; some are transparent; others are transparent and colored; and still others, such as glass block, are translucent. While almost every manufacturer has a specific trade name for his product, you will find that, in general, most products fall under certain broad classifications.



BB 279 5375

FIG. 18. STRUCTURAL-GLASS WALLS IN BATHROOM

Courtesy of the Pittsburgh Plate Glass Co.

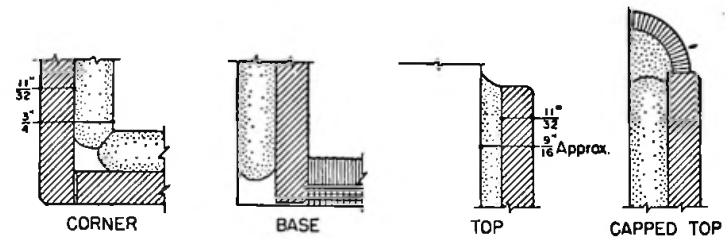

FIG. 19. INSTALLATION DETAILS OF STRUCTURAL GLASS

Structural Glass

42. "Structural glass" is the term commonly applied to glass that is used for wall coverings. The glass is dense, nonabsorbent, opaque, homogeneous, and uniform in structure. Metallic oxides give the glass its opacity and color. It is strong and durable and is impervious to grease, chemicals, oils, and all forms of dirt. It will not check, craze, stain, or change color with age, but retains its luster. A mat finish can be obtained, but a polished finish is more commonly used and is easily cleaned. For bonding purposes, the backs of structural glass slabs are generally roughened. Structural glass may be used for either interior or exterior work, and because of its tight joints and nonabsorbent surface, it forms a highly sanitary wall covering. In Fig. 18 is shown a bathroom lined from floor to ceiling with structural glass.

Structural-glass slabs come in many colors, including green, ivory, white, pink, gray, black, wine, blue, and beige. The sizes and thicknesses used depend upon the application. For interior wall paneling, thicknesses from $\frac{1}{4}$ " to $\frac{3}{4}$ " are generally used; for standing partitions, such as toilet stalls, $\frac{1}{2}$ " to $1\frac{1}{4}$ " are the usual thicknesses. Slabs up to 25 or 30 sq ft in area can be obtained; but for paneling, slabs over 15 sq ft are not recommended. Usually the slabs are cut to size and have the edges ground before delivery to the building where they are to be used.

Structural glass can be installed over almost any firm, true



FIG. 20. PARTITION OF CLEAR PLATE GLASS WITH ETCHED DESIGNS

subwall. You should not install it directly over a wood backing. Structural glass is set with mastic compounds furnished by the manufacturer. Joints are very narrow, about $\frac{1}{16}$ " , and are usually filled with a pointing compound of either a matching or a complimentary color. Setting details are shown in Fig. 19.

Clear plate glass with etched designs can be used for partitions as shown in Fig. 20. You can use such partitions to separate two floor areas while each area is still visible from the other.

Patterned Glass

43. Patterned glass is from $\frac{1}{4}$ " to $\frac{1}{2}$ " in thickness, and has

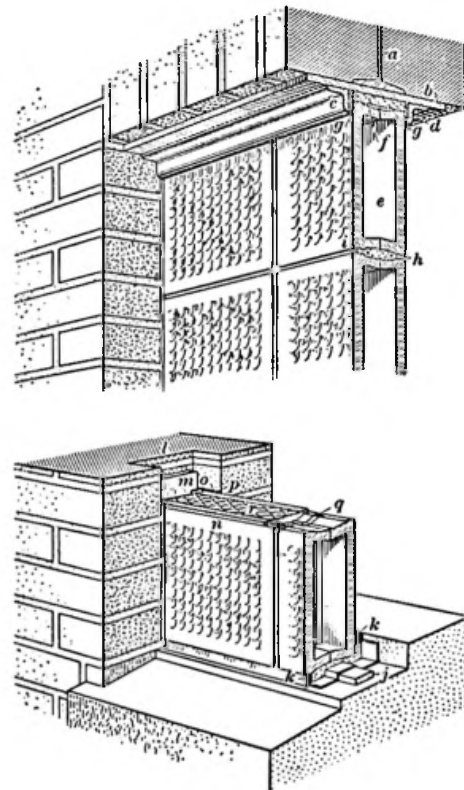

- | | |
|--------------------------------|--------------------------|
| <i>a.</i> steel I beam | <i>i.</i> expanded metal |
| <i>b.</i> steel plate | <i>j.</i> iron bar |
| <i>c, d.</i> steel angles | <i>l.</i> recess |
| <i>e, n.</i> glass blocks | <i>o.</i> oakum |
| <i>f, m.</i> expansion joints | <i>q.</i> vertical joint |
| <i>g, k, p.</i> calking mastic | <i>r.</i> wall tie |
| <i>h.</i> horizontal joint | |

FIG. 21. METHOD OF SETTING GLASS BLOCKS

a ribbed, hammered, fluted, or corrugated surface. It is translucent and is used as wainscoting or for walls where light transmission without full vision is desired. Generally, you may obtain patterned glass in sizes up to 30' x 72". The glass must be cut to size at the factory to fit the spaces in which it is to

be erected. Patterned glass is usually installed in a wood frame.

Glass Blocks

44. The term "glass blocks" refers to square blocks of pressed glass made at high temperatures by pressing together two halves and fusing them into a single unit. A gritty coating is applied at the edges for mortar bond.

Glass blocks commonly come in $5\frac{3}{4}$ ", $7\frac{3}{4}$ ", and $11\frac{3}{4}$ " squares, $3\frac{3}{8}$ " thick. They are translucent, with ribbed, fluted, rippled, and other surface treatments. Setting is similar to the setting of other masonry units, with mortar and wall ties being used as shown in Fig. 21. In setting glass blocks, allowance is usually made for expansion at the jambs and head to prevent the blocks from cracking.

You can use glass blocks for interesting wall treatments in all types of rooms where transmission of light without vision is desired. Glass blocks are frequently used for office partitions.

Flexglass

45. Flexglass consists of small pieces of glass bonded to a fabric backing. It usually comes in sheets $19\frac{1}{2}$ " square. The pieces of glass are cut in the shape of small rectangles or triangles, from $\frac{1}{2}$ " x 2" to 4" x 4" in area and with a nominal thickness of $\frac{1}{16}$ ". Sheets with glass pieces under 2" x 4" may be bent around corners to create curved effects. Colors may be fired on the under side of the glass.

Flexglass offers many possibilities for decorative and mirrorlike effects.

Photomurals

46. Photomurals are used for wall treatment, usually as special features in such places as restaurants and hotel lobbies. A photomural is formed by mounting a color photographic transparency between two sheets of plate glass. By placing lights behind the glass, you can illuminate the photomural.

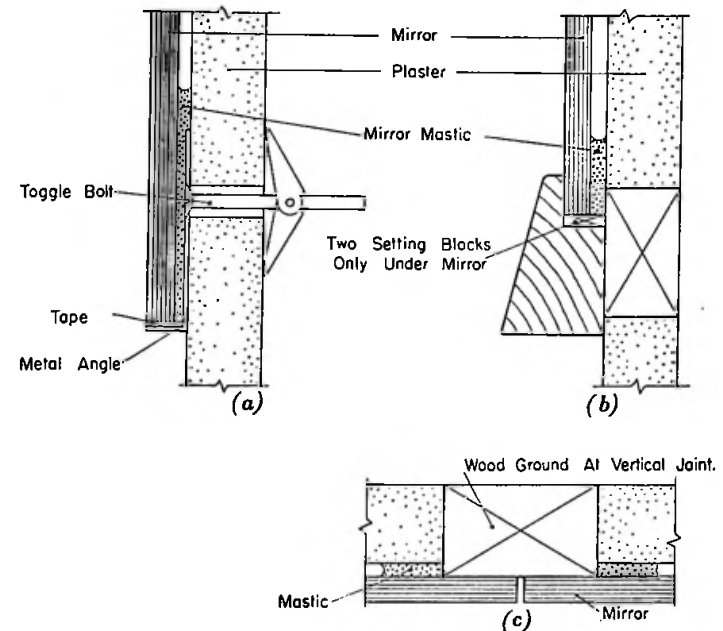

(a) Section showing mirror with metal edge
 (b) Section showing mirror with wood trim
 (c) Plan showing joint between mirrors

FIG. 22. INSTALLATION OF MIRRORS

Plate Glass

47. Tempered plate glass has approximately four to five times the strength of regular plate glass of equal thickness. It is more resistant to impact and pressure and more flexible under strain than normal plate glass. Various decorative treatments can be obtained by sandblasting, by fusing on colored designs, and by applying materials. Tempered plate glass comes in $\frac{3}{4}$ " and $\frac{7}{8}$ " thicknesses and is used for doors and screens.

Large mirrors are often used as decorative wall coverings, especially where it is desirable to enlarge the apparent size of a room. Polished plate glass $\frac{1}{4}$ " thick is used for mirrors. The best mirrors are copper-backed. Several methods of installing mirrors are shown in Fig. 22.

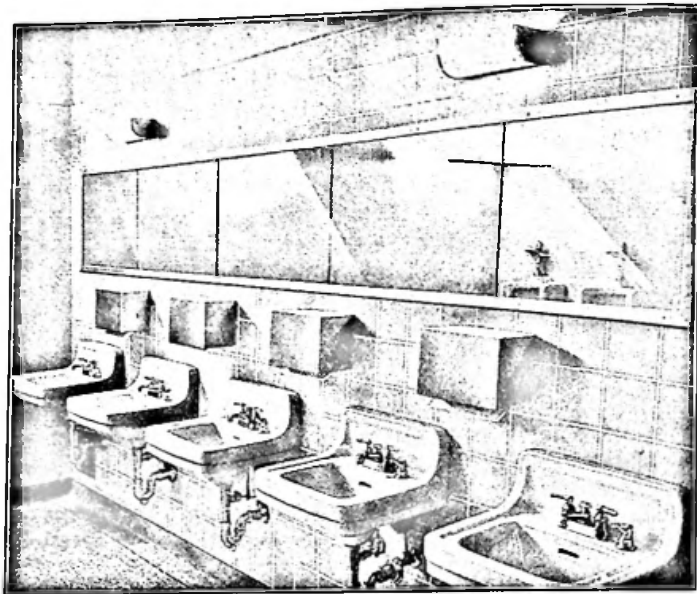

FIG. 23. TILE WALLS IN WASHROOM

Uses of Wall Tile

48. Tile as a wall covering is especially suitable for use in such rooms as kitchens, bathrooms, lavatories, washrooms, locker rooms, corridors, and spaces where cleanliness and resistance to wear are important. The glazes on wall tile are such that it is difficult to scratch them. Glazed wall tile are suitable in rooms used by the public and in places where there is a possibility of water being splashed on walls or floors. Note the use of tile in the washroom in Fig. 23.

As a purely ornamental or decorative material, you can use tile in almost every kind of room, from the simplest and most informal den or vestibule to the most elaborate monumental room, living room, museum, or library.

Sizes and Shapes of Wall Tile

49. The sizes, grades, methods of production, and classifications of clay tile have been fully described in Part 1. Most

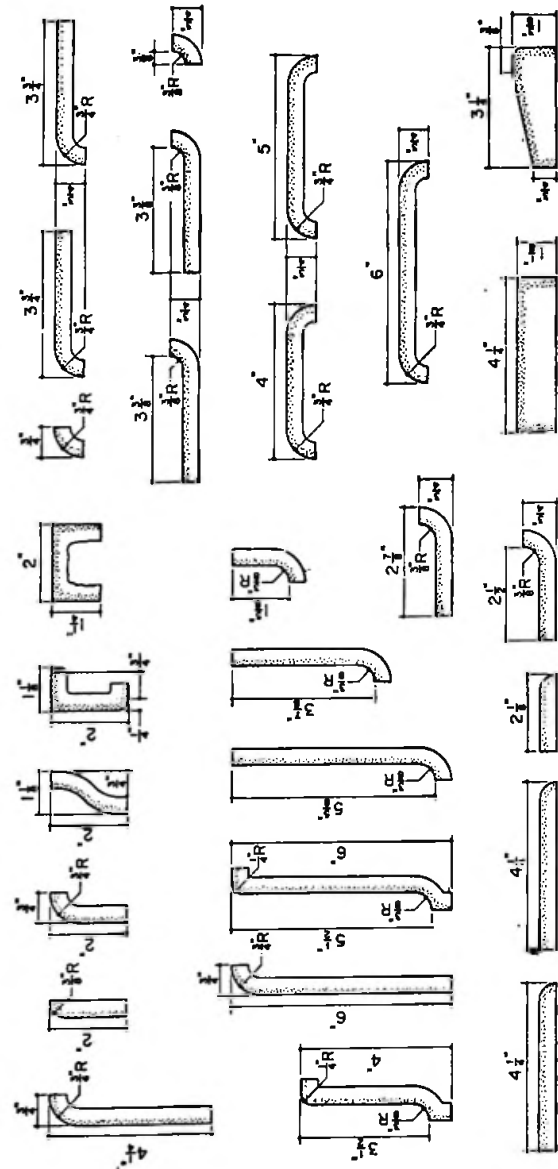

FIG. 24. STANDARD TRIMMERS FOR GLAZED WALL TILE

of the types of tile that you studied in Part 1 may be used for wall as well as floor coverings. But certain kinds, such as quarry tile, pavers, and unglazed ceramic mosaics, are used almost entirely on floors. Glazed wall tile, which are made with a glaze applied on a nonvitreous body, are used exclusively for walls.

The standard sizes and shapes of tile and their applications are given in Tables 3 and 4. Many special sizes and shapes are available, however. This is especially true of the handmade types of tile, such as faience tile, which can be produced in sizes and shapes to suit any design, including patterns on individual glazed tiles.

Special forms of tile that are used as the bases and caps of wainscoting, as trim around openings, for panel treatment, and for similar features are called trimmers. They are used extensively in wall work. For buildings such as hospitals, sanitary coves and plain trim with rounded corners are extremely practical and can be cleaned easily.

Tile manufacturers, in cooperation with the National Bureau of Standards, have adopted simplified-practice recommendations, which include standard sizes and shapes of trimmers for glazed wall tile. These are illustrated in Fig. 24, which shows the standard types of coves, bullnoses, and rounded corners. Individual manufacturers also make special molds and ornamental pieces from which you can make selections.

Faience Tile

50. For an unusual wall treatment, some of the faience or handmade glazed tile are often used. With these, many colors and effects can be obtained, owing to their hand-patted irregular faces and edges and their shading in tone. The tile may be laid in patterns with wide joints, and the joints filled after the tile are set, or they may be set with close joints and the joints grouted.

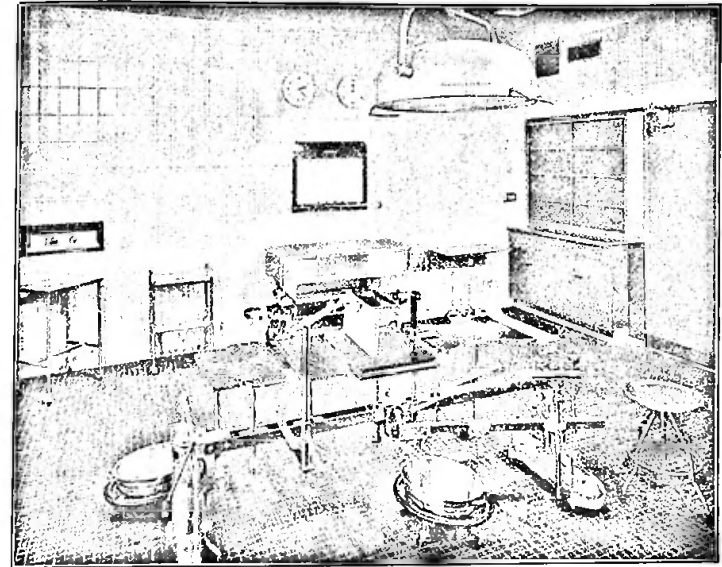

FIG. 25. OPERATING ROOM WITH GLAZED-TILE SIDE WALLS AND CONDUCTIVE-TILE FLOOR

Glazed Interior Tile

51. Of the tile for wall use, glazed interior tile, known also as wall tile, having glazed surfaces on nonvitreous bodies, are in by far the greatest demand. Since the edges of this type of tile are fairly smooth, the tile can be laid with either close or wide joints. The color range of these tile is extensive, including shades of almost every color, and mottled, stippled, and crackled effects. These tile are made in the types listed in Table 3. They are much used in bathrooms, kitchens, and lavatories in all types of homes. They are also used in such places as corridors, cafeterias, laboratories, hospitals, and similar locations where sanitation is essential. Glazed tile on the side walls of a hospital operating room are shown in Fig. 25. The floor is of conductive tile. An extensive use of wall tile is shown in Fig. 26. The floor of the patio is set with quarry tile.

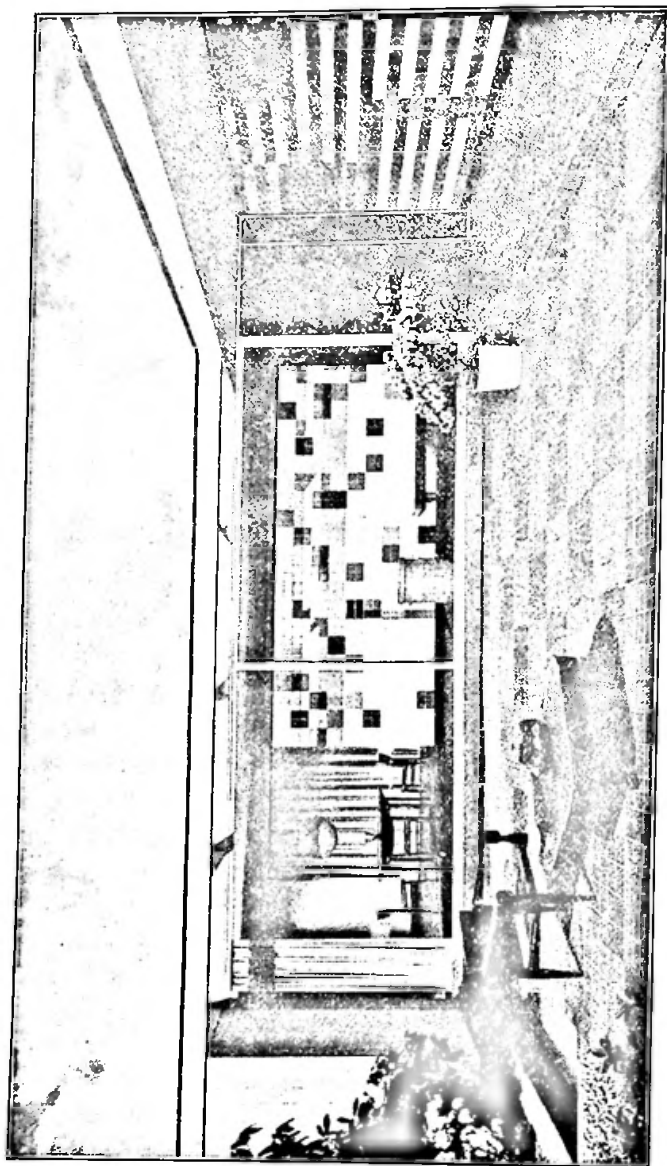

FIG. 26. TILE IN LIVING ROOM AND PATIO

Tile Combinations

52. Different types of tile can be used in the same room, and advantage can be taken of different colors and sizes to develop interesting combinations. Some examples of the ways in which the different types of tile can be combined are shown in the various illustrations.

Installation of Wall Tile

53. You may apply wall tile over either masonry or frame construction. Where the tile are to be applied over wood construction, metal lath is securely fastened to the wood studs or furring strips. A scratch coat of 1 part cement to $2\frac{1}{2}$ or 3 parts of sand is then troweled well on the lath and leveled off at the proper distance behind the face of the finished tile. While wet, the first coat is well scratched with a trowel to give a key for the next coat. It must not be less than $\frac{1}{4}$ " thick and should be applied not less than 24, nor more than 48, hr before the setting bed is applied.

When the scratch coat is placed directly on masonry, without the use of lath, the vertical face of the masonry should be reasonably true and sufficiently rough to form a good key to hold the mortar. Over such materials as gypsum block, cork, or other forms of insulating material, a layer of waterproof paper must first be attached and metal lath used as overfurring, since the cement mortar used for the scratch coat will not properly adhere to such materials.

Plumb Coat

54. In cases where the wall is out of plumb and cannot be brought to a true surface with the scratch coat, you must apply a second coat, of the same composition as the scratch coat. This is called the plumb coat. It should not be over $\frac{1}{4}$ " thick in order to adhere properly, and should be scratched on the surface, ready for the next operation — the setting of the tile.

Methods of Setting Tile

55. After the scratch or plumb coat is ready, the tile are generally set by either the floating or the buttering method. In the buttering method, dabs of mortar, called screeds, are placed on the scratch coat and flattened. These screeds give the level to which the finished surfaces of the tile are set. The screeds are removed and replaced by the tile as the wall is finished. After the scratch coat is thoroughly moistened, it is ready to receive the tile.

A thin coat of rich mortar, called the setting mortar, is spread, or buttered, on the back of each tile. The tile are then placed on the wall and pressed and tamped into place so as to be level with the top of the mortar screed. When the setting mortar is dry, the tile are ready for pointing.

In the floating method also, the scratch coat is thoroughly moistened. The setting mortar is spread evenly over the scratch coat, being brought to the level at which the back of the tile will be set, allowing for the finished thickness. Then a very thin skim coat is spread either over the setting mortar or on the back of the tile. The tile are then placed on the wall and pressed or tamped into position.

Whichever setting method is used, the tile, except the types having impervious, nonabsorbent bodies, must be thoroughly soaked in water before they are set. This soaking prevents the tile from absorbing water from the wet mortar and thus spoiling the adhesion by drying the mortar too fast.

Mortars

56. The setting mortar used in the buttering and the floating methods consists of from $\frac{1}{2}$ to 1 part of lime putty, 1 part of portland cement, and from 3 to 4 parts of sand. The skim coat is neat portland cement mixed with water. You must see that the tile are placed before the setting mortar has its initial set. Hollows in the back of the tile, particularly trimmers, must be completely filled with mortar before setting.

Filling Joints

57. After the setting-mortar bed has hardened sufficiently to hold the tile firmly in place, the tile should be thoroughly washed with water and the joints filled. The joints are filled by grouting with a cement-and-sand mortar in the case of close joints, and pointing with a stiffer mixture in the case of wide joints. In Part 1, you studied the joint widths that are recommended for the various types of tile in floor work. These joint widths apply also to wall work.

After the joints are filled, the wall is again washed clean. Unglazed tile are sometimes given a thin coat of linseed oil, applied with a rag and wiped off, to bring out the color.

Whether you should use close or wide joints depends in a great measure on the need for wall protection. In kitchens, washrooms, and so forth, the joints should be close, so that the walls can be easily cleaned. Where design is a first consideration, advantage can be taken of the interesting effects obtained by using a wider joint filled with mortar of a contrasting color.

Terrazzo Wall Covering

58. Terrazzo used as a wall covering is usually precast in the shop, ground and polished, and then installed in the same manner as marble. If the terrazzo is installed over a stud partition, it is necessary to place metal lath and a scratch coat of plaster over the wood studs.

You can obtain the same color variations in precast wall coverings as in floor work, with colorful marbles forming the basis for selection.

Summary

59. Glass, tile, and terrazzo provide sanitary and attractive wall coverings. Glass may be used in various forms, colors, and degrees of transparency for partitions and wall coverings. Structural glass is uniform and homogeneous in structure, and comes with a polished surface that can be cleaned easily.

Tile offers a wide range of sizes and patterns for covering wall surfaces.

Terrazzo can be used to form a colorful wall covering, but it is not used too widely because of the labor involved in grinding and polishing.

Plaster and Acoustical Materials

Uses of Plaster

60. The finishing material used most frequently on walls and ceilings is plaster. The plaster may provide the finished surface, or it may be covered with paint, wallpaper, wood paneling, or other materials.

The usual plastering procedures are described in the text on plastering. In this text, you will study some of the special plaster finishes and treatments.

Special Plaster Surfaces

61. Used as a base for other finishing materials, plaster is generally applied so that the surface is hard, white, and smooth. When a hard, smooth finish is not desired, the finishing coat of plaster may be applied in a rougher texture. A sand finish, for instance, has a stippled texture secured by the admixture of more and coarser sand than is used for a white coat.

Plaster can also be stippled by using a float to make the stippling either light or heavy. Or the plaster finish coat can be given a troweled surface by allowing the sweep of the trowel to remain. A hand finish can also be secured by working the finished coat in such a manner that the surface has the effect of light waves and irregularities, but without trowel or float marks showing.

Keene's Cement

62. Where hard plaster surfaces are required to resist wear and dampness, as in washrooms and kitchens, the finish is

frequently provided by Keene's cement. This is a finely ground gypsum cement produced in varying grades of fineness and with various setting times. It is pure white and takes a hard, polished finish. It is used in areas subject to heavy usage, and in special plaster finishes.

Stone and Marble Effects

63. Plaster is sometimes used in producing effects imitative of natural stones. You may obtain these effects by using either of two methods.

One method is to use two coats of cement plaster base, made of either Keene's cement or nonstaining portland cement. On this base a finishing coat is applied in the same manner as the usual final plaster coat, and troweled or floated to the desired surface texture. The final coat is usually composed of the stone or marble to be imitated — ground fine — mixed with white portland cement. When the surface is to be jointed, the joints are cut in after the coat is dry and are filled with cement as in real stonework.

In the second method, the plaster is cast in molds, forming separate slabs. The slabs are then laid in the same manner as natural stone. This method can be used only for interiors, as the slabs are thin and quite porous. In either method, the surface should be treated to protect it from dirt and to make it more readily cleanable.

64. Caen stone, a natural stone found in France, ground to a powder, is the base for the imitation Caen-stone finish. The ground Caen stone, when combined with sand and cement, gives the plaster the proper color and texture. When the plaster surface is dry, it is sandpapered smooth to represent a sand-rubbed surface; or, before it is dry, it is combed with a tool to resemble a tooled surface. Joints are usually cut in the finishing coat and are filled with white mortar.

Generally, no protective material is applied after the surface texture has been obtained, but occasionally it has been

found desirable to brush on a liquid binder to prevent the fine sand from rubbing off. Such a binder may be a thin skim milk or a weak tea or coffee solution. Before applying this binder, you should experiment on a small area having a similar surface.

The method used in imitating Caen stone is used also in imitating limestones and granite colors and textures. The finished plaster in such cases consists of a cement rather than a lime base plus ground limestone or granite granules, and is applied like plaster.

65. *Scagliola* is the name given to imitation marbles made on a plaster base. You can imitate almost any marble in scagliola. Scagliola may be cast in molds in the shop or it may be applied at the building like plaster.

Scagliola is composed largely of white nonstaining cement or Keene's cement, sand, and finely ground marble or mineral pigments in the colors desired. When the material has been finished and is thoroughly dry, it is buffed to a polished surface.

Scagliola, when cast separately, is set in the same manner as marble, but because of its fragility extreme care must be exercised to avoid chipping. You must protect it against dampness and the possibility of staining.

Scagliola is used where the construction does not permit the use of heavier natural stone and where the natural stone might be prohibitive in cost. You should use scagliola only on interior surfaces.

Use of Acoustical Materials

66. A present-day problem in rooms where there is considerable noise is to find a satisfactory wall and ceiling covering that will absorb and deaden sound. Such a ceiling covering is especially important. Acoustical materials are commonly employed in auditoriums, theaters, kitchens, corridors, res-

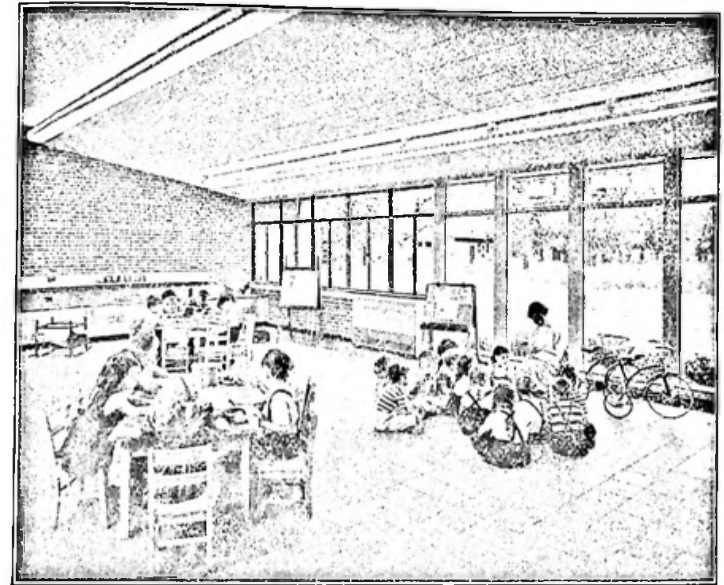

FIG. 27. ACOUSTICAL-TILE CEILING

taurants, offices, and stores. An acoustical-tile ceiling in a classroom is shown in Fig. 27.

The acoustical properties of any material can be scientifically determined in a laboratory. Different materials have different coefficients of sound absorption. Your selection of any acoustical material should be made only after a careful study of the properties of the material and the requirements of use.

Acoustical materials are commonly available in the form of acoustical plaster, panels, or tile.

Acoustical Plaster

67. Acoustical plaster is made by mixing wood chips, fibers, asbestos, or similar materials with gypsum or lime plaster. Acoustical plaster has a loose, open texture. The pores and open spaces absorb sound and prevent its reflection. You may apply acoustical plaster to walls or ceilings

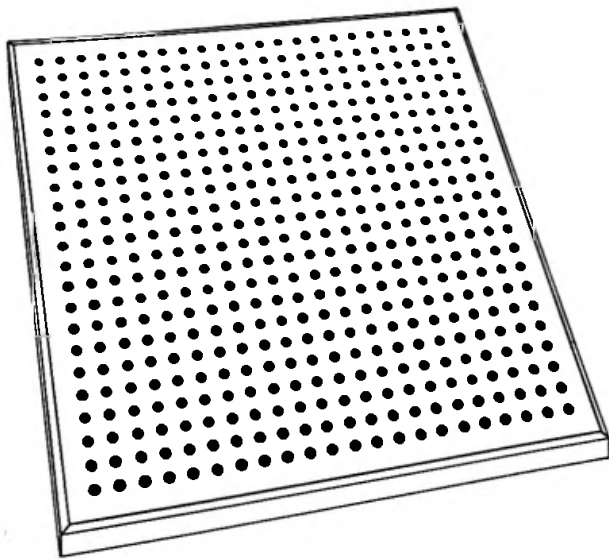

FIG. 28. TYPICAL ACOUSTICAL TILE

Acoustical plaster is generally applied in two finishing coats over a scratch coat of ordinary plaster. It is troweled to a level surface, care being taken not to destroy the texture. In cast form this material is used as acoustical tile.

Acoustical plaster is suitable when you wish to obtain a continuous surface, unbroken by joints. You can paint acoustical plaster, but the paint used should be the type recommended by the manufacturer of the material, since most oil paints fill the voids in the plaster and destroy its acoustical value.

Acoustical Tile

68. Acoustical tile is the most commonly used form of acoustical material for sound absorption. It can also be used for decorative effects.

The materials most frequently used as a base for sound- and noise-absorbing tile are wood or cane fiber, asbestos, wood pulp, gypsum, magnesite, cork, and metal. These

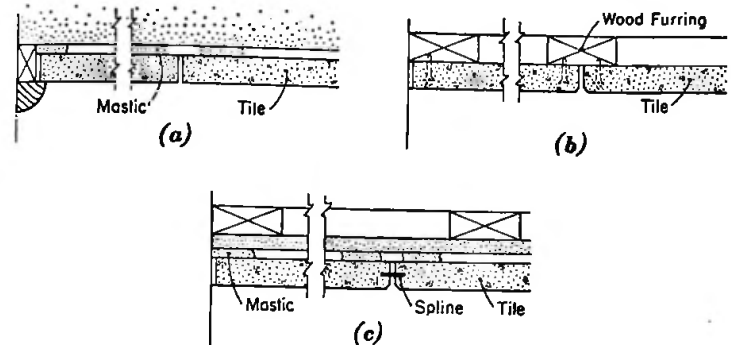

- (a) Tile cemented with mastic to plaster
 (b) Tile nailed to wood furring strips
 (c) Tile cemented with mastic to gypsum lath

FIG. 29. INSTALLATION OF ACOUSTICAL CEILING TILE

materials are generally compressed in forms into tile sizes ranging from 12" to 24" square, or into correspondingly sized rectangles. Various surface finishes are available.

Some acoustical tile have a fine-grained, close texture; some simulate travertine in surface and color; others have a series of holes on the surface; while still others have a very coarse, porous surface. A typical acoustical tile is shown in Fig. 28. The thicknesses, sizes, and other characteristics of various acoustical tile are given in Table 5.

Acoustical tile are applied either by nailing to wood supports, by clipping to metal furring strips, or by securing to concrete, masonry, or gypsum lath by the use of special adhesives. Several methods of applying acoustical ceiling tile are shown in Fig. 29.

You can secure some types of tile with finished colored surfaces; other types can be painted after application. Usually the paint must be of a special composition developed for the material on which it is to be used.

Metal Acoustical Tile

69. Excellent sound absorption can be obtained by use of a

combination of perforated metal tile or panels and blankets of glass fiber or mineral wool. In the usual installations, the metal tile are suspended from the ceiling and they in turn support the sound-absorbing blanket. Or the blanket may be fastened to the ceiling and the panels suspended at a lower level. Metal acoustical tile may be of corrugated aluminum with a natural or a painted finish, or of fabricated metal with a baked-enamel finish.

The tile are usually supported on inverted T sections suspended from above by galvanized wire or metal straps. However, the sound-insulating blanket may be cemented directly to the existing ceiling or wall if the ceiling or wall is tight. The metal panels are then fastened over the blanket with metal strips screwed to the ceiling or to furring strips.

Acoustical panels are designed to cover large areas where long ceiling spans of up to 8' are desirable. On side walls, panels up to 12' long can be used. Widths of panels vary from 24" to 34½". The sound-absorbing blanket may be from ½" to 1½" thick, depending on the degree of noise control desired.

This type of ceiling covering not only absorbs annoying sound, but is moisture resistant, fire resistant, and serves as insulation against the passage of heat.

Acoustical Slabs and Boards

70. You can obtain roof slabs of acoustical materials in thicknesses of 2" and 3" and in sizes up to 24" x 96". The slabs are usually nailed in place over wood supports and may be brush- or spray-painted without loss in sound absorption.

Various perforated hardboards may be used as acoustical tile in sizes that range from 12" x 12" up to 48" x 48". The extent to which they provide sound absorption depends on the type of absorptive backing that is used. These hardboards may be brush- or spray-painted without loss in sound absorption.

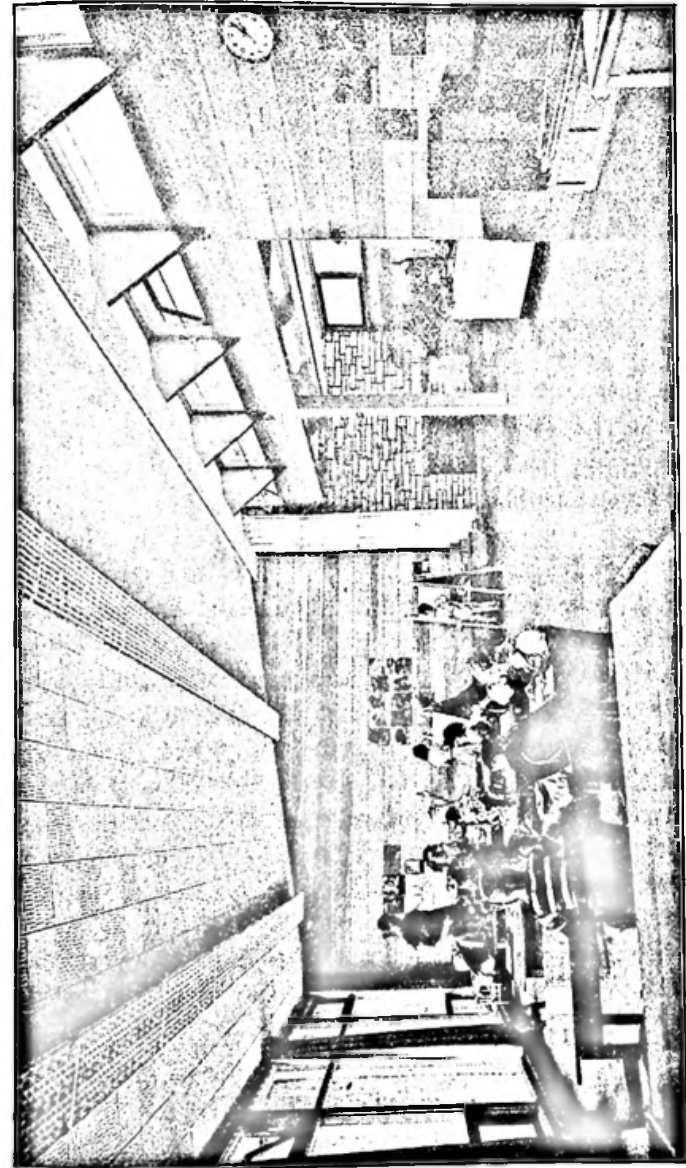

FIG. 30. WALLS OF WOOD BOARDING

Summary

71. More walls and ceilings are finished in plaster than in any other material. Often, plaster provides a base for other finishing materials such as paint, wallpaper, and wood paneling. Sometimes plaster is used as a base to imitate more expensive materials, such as stone or marble. As a rule, you should avoid such imitations. One of the fundamentals of architectural design is the honest use of materials.

Sound reduction, which is an increasingly important consideration of modern living, may be accomplished by the use of various acoustical materials.

Wood Coverings, Wallboards, and Plastics

Uses of Wood

72. Wood has been used since early times as a covering for floors and ceilings. In its simplest form, wood is available as boards of different widths. These may be used with or without covering over the joints. Plain boards, without covering over the joints, have been used in the classroom shown in Fig. 30. The ceiling in this classroom is of acoustical tile. Wood may be used to form panels of various designs, from the simplest rectangular form to elaborate designs using moldings and carved ornaments.

When the surface of the wood is to be painted or enameled, you can use softwoods, such as white pine, poplar, or basswood. Many of the softwoods can be stained to produce interesting effects.

Most of the hardwoods have pleasing grains and markings, which can be emphasized or modified by using transparent stains. Such woods include oak, mahogany, walnut, maple, birch, gum, cherry, and chestnut.

Cutting

73. Each wood has a distinctive growth formation. Variations in grain, coloring, and marking can be secured by the

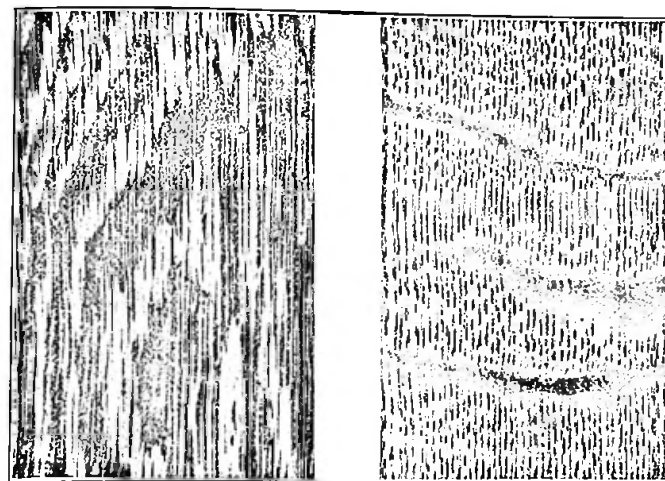

(a) Flat-grain (plain-sawn) surface
(b) Edge-grain (quarter-sawn) surface

FIG. 31. GRAIN OF OAK WOOD

method of cutting employed. The wood may be cut either with or across the grain.

Wood cut parallel with the grain is known as plain-sawn, or flat-grain, wood. When cut across the grain, exposing the edges of the annual rings, it is known as quarter-sawn, or edge-grain, wood. The plain-sawn, or flat-grain, effect in oak is shown in Fig. 31 (a); in (b) is shown the quarter-sawn effect. The quarter-sawn surface is more resistant to wear and more beautiful in appearance than the plain-sawn.

Veneers

74. Up until modern times, the materials used for finished woodwork consisted of solid thicknesses of wood. This restricted the size of the panels obtainable, due to the widths of boards and the practical maximum width in which the wood could be used without excessive shrinkage.

Today, many problems of size and shrinkage have been overcome by the use of veneers. The veneers consist of very

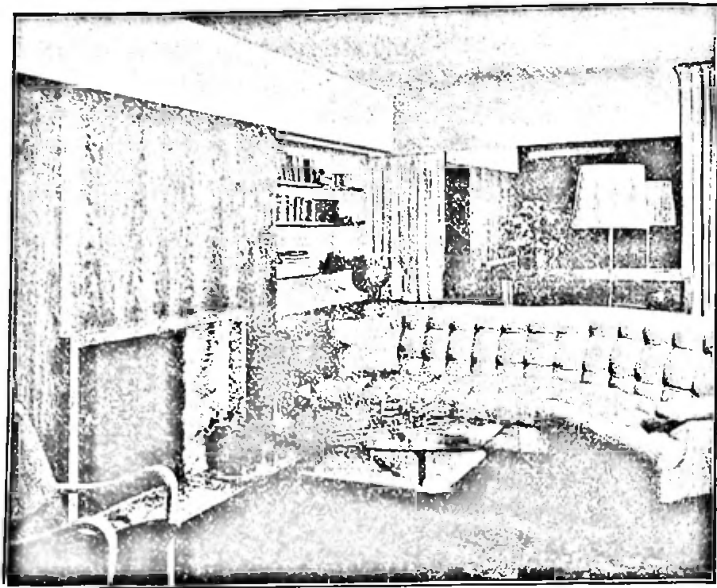

FIG. 32. WALL TREATMENT USING PLYWOOD

thin pieces, usually rotary cut around the log, mounted on a wood backing of from 3 to 7 layers. Wood in this form is known as plywood. Plywoods make it possible for you to employ many rare and exotic woods which otherwise could not be used economically. Among domestic woods used as veneers are aspen, holly, myrtle, butternut, and curly and rock maple. Imported varieties include such woods as crotch walnut, ebony, hawthorn, mahogany, lacewood, English oak, rosewood, satinwood, teak, and zebrawood.

Not all veneers are full rotary cut. Some are quartered, some flat cut, and some half round, depending upon the type of wood and the size of logs secured from the tree. In selecting plywoods, you should always consider samples for color, grain, and markings, and obtain exact information as to the sizes available.

Plywoods or veneered woods are usually $\frac{1}{8}$ " to $\frac{3}{4}$ " in thickness. Plywoods $\frac{1}{8}$ " thick employ very thin veneers and

must be handled carefully. Plywoods can be obtained in striated and other textured surfaces. Very often these textured plywoods are installed in 12", 16", and 24" squares. Some plywoods are made in plank widths and are installed with overlapping joints.

Plywoods are excellent for flat surfaces or panels, but for moldings, base boards, chair rails, trims or cornices, it is usually necessary to use solid wood. To obtain uniformity of color you must take care to obtain the same markings and colors in both plywood and solid wood.

Plywoods in large sheets are particularly useful in broad, flat wall treatments like the one illustrated in Fig. 32.

Shrinkage

75. Woods shrink in varying degrees, depending on the direction of the grain and the density of the wood. Solid woods usually shrink more than plywoods. In assembling woodwork you must take care to allow for the shrinkage of different woods. The sizes of the pieces must be adjusted to the characteristics of the wood used.

Erecting Woodwork

76. Wood wainscoting is generally applied after the wall construction is finished and after all plastering has dried out. However, during the construction of the wall, you must make preparation for receiving the woodwork.

Where wood paneling is to be installed against a masonry wall, lead plugs *a*, Fig. 33, are built into the masonry joints as the wall goes up, and vertical furring strips *b* are nailed to the plugs to receive the covering. The furring strips are usually 1" x 2" or 2" x 3" rough lumber. The furring strips are spaced properly to receive the lath for plastering if plaster is to be used, or to receive the wood wainscoting.

If the wall is to be plastered first, grounds *c*, consisting of wood strips, are fastened to the furring strips at the proper places to receive the base *d*, rails *e*, and cap *f*, which are nailed

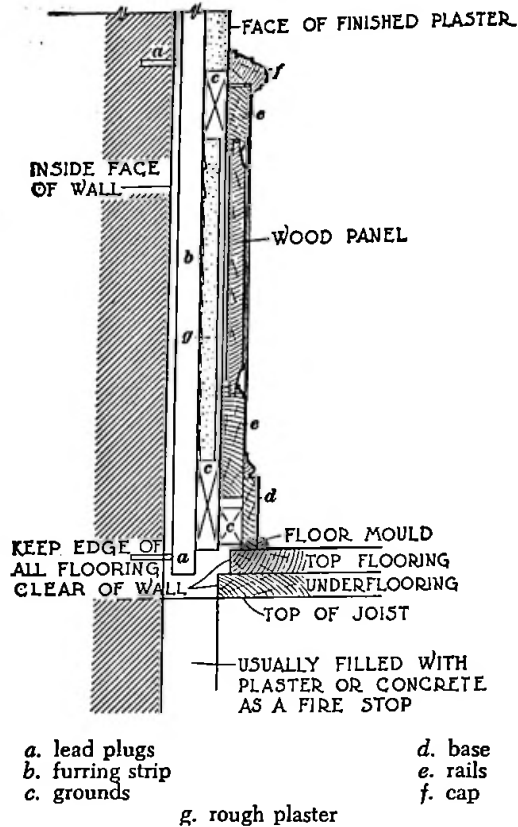

FIG. 33. CROSS SECTION THROUGH WOOD PANELING

to them. The wood panel shown in Fig. 33 is a raised panel necessitating either solid wood or heavy veneers.

When the wall behind the wainscoting is to be plastered, as is done in the best practice, the white coat is omitted and the face of the brown coat is kept back of the face of the grounds, so that there will be no contact between the plaster *g* and the wood.

Millwork

77. Finished woodwork that is cut into proper sizes and

molds at a planing mill and then sent to the building in varying lengths and sizes for fitting and erection by carpenters working at the job is called millwork, and the erection is called carpentry. Wood wall coverings and simple paneling are usually prepared as finished woodwork.

78. More elaborate woodwork that is cut, fitted, and partly or wholly assembled at the mill or shop before delivery is called cabinetwork. More precise fitting is made possible by using shop facilities and tools. In this method, door trim, complete panels with stiles and rail attached, and sometimes even the entire sides of rooms are completely assembled and then erected in large sections at the building. Shop assembly is usually employed when rare or exotic woods or woods with unusual grains or markings are desired.

Kinds of Wallboards

79. Various materials are used in the production of wallboards that are used as wall and ceiling coverings. One group of wallboards is made of vegetable fibers such as wood, sugar-cane, or cornstalk fibers. The fibers are pressed and cemented together to form sheets in thicknesses ranging from $\frac{1}{8}$ " to $\frac{3}{4}$ ". Another type of wallboard is made of wood fibers and chips bonded under pressure with phenolic resins. These wallboards have no grain and can be cut or sawed in any direction.

An asbestos-cement mixture is used to form wallboards in sheets $\frac{1}{2}$ " and $\frac{3}{4}$ " thick. Gypsum wallboard and gypsum lath consist of a sheet of gypsum plaster encased in a paper covering. The paper usually covers only the finished surface and the two longest edges of the sheet. The usual thicknesses of the sheets are $\frac{1}{4}$ " and $\frac{3}{8}$ ".

80. Hardboards are similar to fiber wallboards but are thinner, usually being $\frac{1}{8}$ " to $\frac{1}{4}$ " thick. They are made by pressing the material into sheets in a hydraulic press under

considerable pressure and are much stronger and harder than ordinary wallboards.

Prefinished wallboards provide a finished surface that permits you to omit lath and plaster, thereby avoiding the delay, moisture, and dirt that always accompany plastering. Since you can readily apply wallboards in a short time, you can use them to advantage in finishing attics or other unfinished spaces in homes that are already built.

Wallboard Finishes

81. Wallboards can be secured in a great variety of finishes. Each manufacturer produces a wide range of special types, surfaces, and effects.

The very plain wallboards, such as the gypsum boards, often have the joints filled or taped and can be covered with wallpaper or painted.

Prefinished wallboards may be secured in natural-wood effects and in plain painted or stippled finishes; they may be enameled or, in the case of the insulating types made of wood, cane, and similar fibers, they may have a somewhat irregular surface caused by the type of material used in their manufacture.

Some of the hardboards are divided into squares to resemble tile with depressed white or colored joints. These hardboards are used in bathrooms and kitchens where they give satisfactory service if wear is not too heavy.

Wallboards can be applied as simple boards, or they can be readily cut and fitted into panels. Base, chair-rail, and simple flat moldings may be obtained in some of the wallboard types.

Uses of Wallboards

82. The great variety of designs and surfaces available make prefinished wallboards useable in most types of rooms except, perhaps, those in industrial or commercial establish-

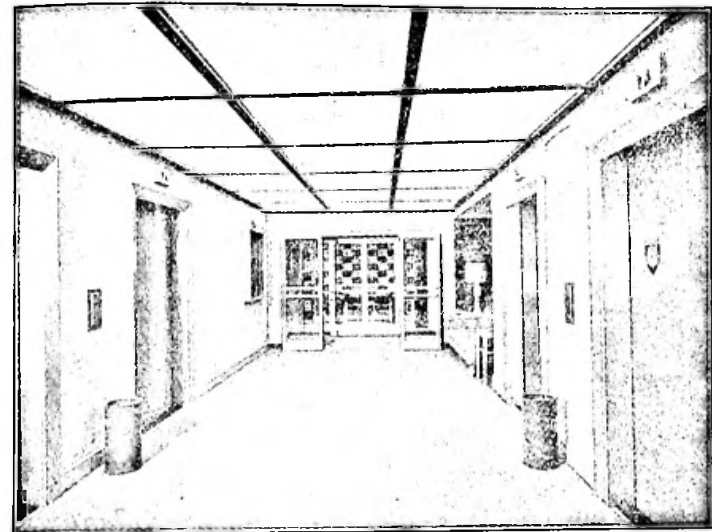

FIG. 34. ILLUMINATED PLASTIC CEILING

ments where heavy wear may be encountered. Most of the fiber boards have insulation value in varying degrees and are useful in keeping out cold in winter and heat in summer.

In selecting wallboards, you must be careful to secure hard surfaces for spaces having wear or requiring cleaning.

Sizes of Wallboards

83. Wallboards are generally made in various widths up to 48" to accommodate studding placed 12" or 16" on centers. When planks are used, the studding must be placed to receive the width of boards used.

The thickness of boards made from wood fiber is from $\frac{1}{8}$ " to $\frac{1}{4}$ ". Gypsum boards are $\frac{1}{4}$ " to $\frac{3}{8}$ " thick and Compo boards are about $\frac{1}{4}$ " thick. Pressed wood is from $\frac{1}{8}$ " to $\frac{1}{4}$ " thick for the thinner types.

The lengths of the boards are from 4' to 16', so that they can be obtained to fit the height of any ordinary room without cutting.

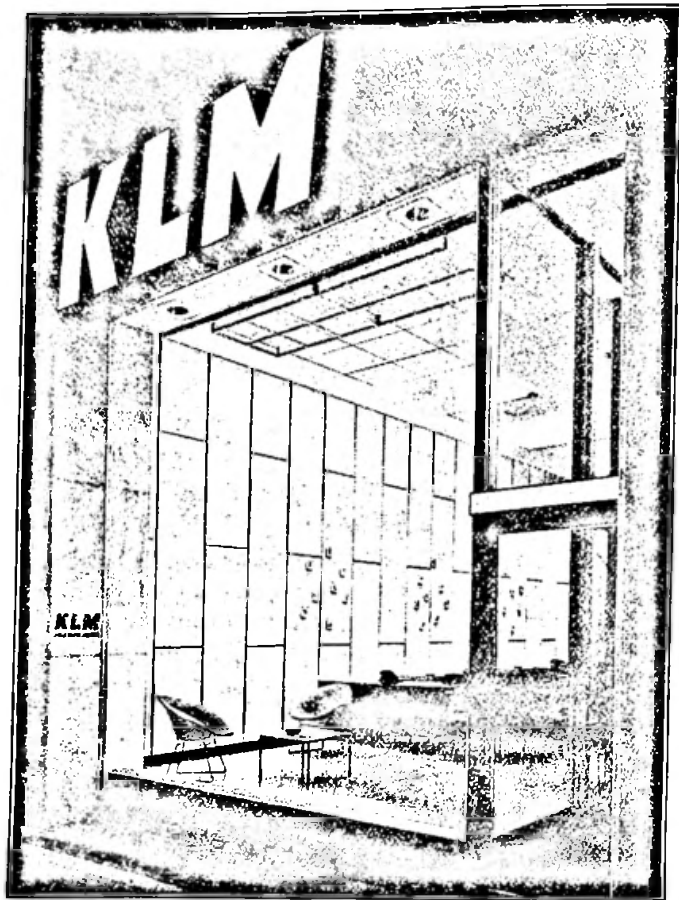

Courtesy of United States Plywood Corp.

FIG. 35. LAMINATED-PLASTIC WALL COVERING IN SHOWROOM

Application of Wallboards

84. Wallboards are generally placed vertically on the walls of a room, except when the design calls for some other treatment. When covering ceilings with the boards, a design should be laid out and the boards placed according to the design. The joints are frequently covered with strips of wood called battens, or molds.

The normal stud spacing of 16" on centers may not always lend itself to the paneled treatment desired, and additional studs may have to be added to provide satisfactory nailing for the boards. Nailing grounds for horizontal rails in the paneling must be nailed between the studs where the rails are to occur; this holds true also for wainscoting caps, plate rails, cornices, and other horizontal features of the finish of a room.

Use of Plastics

85. Plastics may be used in various forms as coverings for walls and ceilings. Clear or translucent plastic sheets serve instead of glass for window openings, as partitions between rooms and as ceilings. Illumination above the plastic ceiling, as shown in Fig. 34, gives the effect of a completely luminous ceiling.

Laminated plastics are used for wall panels, for table tops, and for work surfaces in kitchens and bathrooms. They can be set off by metal bands in contrast to the material itself, as shown in Fig. 35. A striped effect in a stairway is shown in Fig. 36. The plastic surface has a smooth finish and is resistant to heavy wear, moisture, and the effects of frequent cleaning.

Plastic Sheets

86. Single sheets of plastic are made of either vinyl plastic or acrylic plastic. These sheets can be flat or corrugated. The plain flat sheets may be clear or colored and may have a glossy, mat, ribbed, or patterned surface. Plastic sheets may be had in black opaque, white translucent, and standard-color transparent types. A partition of corrugated translucent plastic is shown in Fig. 37.

Plastic sheets are produced in various sizes from 12" x 36" to 5'-0" x 8'-6", and from 0.06" to 4" in thickness. The regular plastic sheets are classified as slow burning, but special plastics are available that are classified as flame resistant or self-extinguishing.

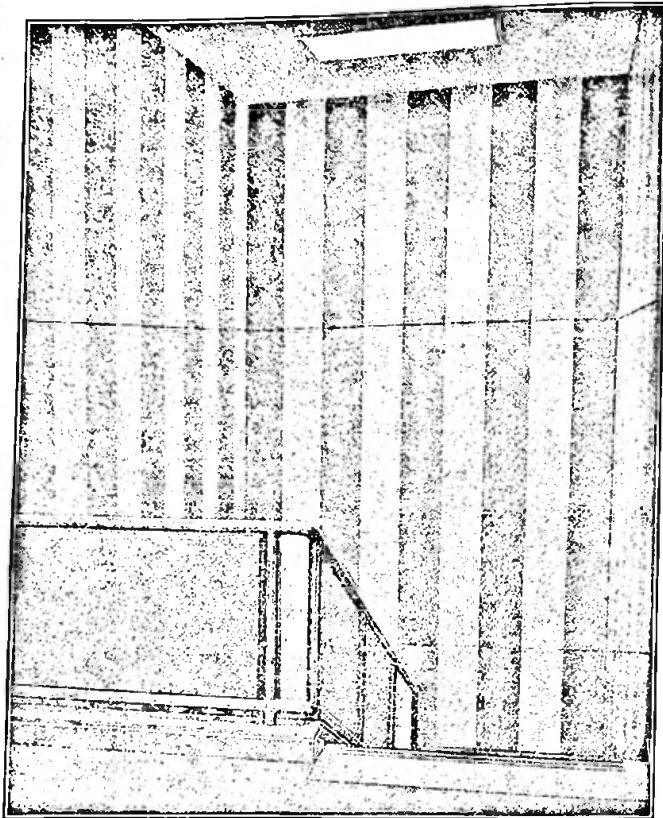

Courtesy of Formica Corporation

FIG. 36. LAMINATED-PLASTIC WALL COVERING IN STAIRWELL

Plastic sheets can be cut with ordinary band saws, circular saws, or jigsaws, and can be drilled at moderate speeds and light pressure. Sheets can be joined together by using cements which are solvents and which soften the surface of the plastic. The softened surfaces, when pressed together, intermingle, and as the solvent evaporates, a hard joint is formed.

Plastic sheets may be sprung into a curved frame without heating if the radius of curvature is very large. When heated to about 300 F (degrees Fahrenheit), the sheets can be formed

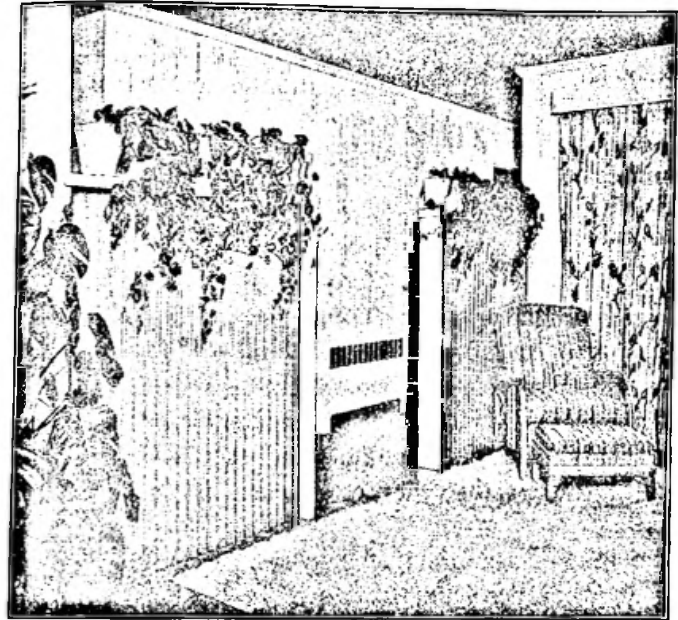

Courtesy of Rohm & Haas Company

FIG. 37. CORRUGATED TRANSLUCENT PLASTIC IN DWARF PARTITION

to almost any shape; the shape is retained when the plastic cools.

Laminated Plastics

87. Laminated plastics usually consist of three parts: a core of layers of kraft paper impregnated with phenolic resin and bonded together under heat and pressure; a printed decorative sheet or a thin wood veneer saturated with melamine resin; and a tough, clear surfacing sheet, also saturated with melamine resin. The surface may have either a glossy or a satin finish. The decorative middle sheet is printed in various patterns and colors. Some of these patterns simulate marble, leather, wood, or textiles.

These laminated sheets are available in sizes ranging from 24" x 36" to 8'-0" x 10'-0", and in thicknesses of $\frac{1}{16}$ ", $\frac{1}{8}$ ",

and $\frac{1}{16}$ ". The sheets can be applied directly to a smooth wall or ceiling surface or they can be first laminated to a backing of hardboard or plywood. Laminated plastics are known by trade names such as Formica, Micarta, and Textolite.

Summary

88. Wood may be used as a wall and ceiling covering either in the form of boards or as plywoods.

Cutting the wood in different directions produces variations in grain, color, and markings.

In erecting woodwork you should always make allowance for the shrinkage of the wood.

Wallboards are made in various materials, such as gypsum between sheets of felt, wood fiber, and asbestos. An advantage of wallboards is that they often make it possible to omit plastering.

Plastics in sheet form may be clear, translucent, or opaque. The clear plastics lend themselves to locations that would ordinarily employ glass. Laminated plastics may be used for wall coverings and for table and counter tops.

Painting and Wood Finishing

Uses of Painting and Wood Finishing

89. "Wood finishing," as the name implies, is the process of finishing woods so as to make them more durable and attractive. Painted finishes also may be given to wood and to many other materials, such as metal and plaster. Painted finishes are often used not only to protect a surface, but also to give it color. Painted plaster, for instance, is the most common wall and ceiling covering.

The subjects of painting and wood finishing are covered extensively in the text *Painting*, Parts 1 and 2.

Painted Finishes

90. In painted work, the first coat is called the priming

coat. For woodwork, this coat should be applied at the mill before delivery to the job, to protect the surface of the wood. You can further protect wood against dampness by giving the back of the woodwork a coat of pure white lead in linseed oil, aluminum paint, or asphalt-base paint. This coating is known as back painting.

Paint is applied to woodwork in two or more coats, depending on the kind of wood used and the type of finish desired. A minimum of three coats, including the priming coat, is generally recommended for oil paints. If the final coat is to have color, it is usual to tint the priming coat with color similar to that of the final coat in order to form a tinted base. If there are any knots in the wood to be painted, they should be covered with shellac before being primed, since paint does not adhere naturally to a knotty surface. In better work, the entire surface of the wood is given a coat of shellac over the priming coat. This gives a firm, hard surface which takes a fine finish.

The second coat usually contains enough oil to form a good body. This gives a firm, hard base to receive the final coat or coats. If the final coat is to be enamel, a small amount of enamel should be mixed with the second coat. When more than three coats are used, the coats can be thinned and brushed out more, giving a finer finish.

Generally, there are five basic types of paint: oil paint, enamel, casein paint, water-base paint, and texture paint.

Preparation of Surface

91. Millwork usually comes to the job ready for finishing. But sometimes the wood surface is marred in handling the wood and nailing it in place. Before any finish is applied, therefore, the surface should be thoroughly cleaned of all dirt and then sandpapered to remove rough spots and hammer marks. All nailheads should be driven at least $\frac{1}{8}$ " below the surface of the wood.

Sometimes the wood is first wet to raise the loose grain so that the wood can be sandpapered to a smoother face. As each coat of paint is applied, finer-grained sandpaper is used, and more care is taken to avoid cutting through the coats already applied. Sandpapering is as important as the application of the paint or stain. The smoother the surface, the better the paint will adhere, and the less brushing will be required to give a satisfactory surface.

If knots, sap, or sap streaks appear on the surface of the wood, you should apply a thin coat of alcohol shellac over the defects before applying the first coat of paint, to prevent the sap from working through the paint and discoloring it. Sometimes a coat of shellac is given to all of the woodwork, if it is of a sappy nature and a fine job is desired.

Oil-Base Paint

92. The most commonly used paint is the paint that has oil as a vehicle. Oil paints may be secured ready-mixed, in white or in color, or they may be mixed on the job.

Oil-base paints are flat paints which, when applied, flatten to a dull finish. You may obtain a slight, or eggshell, gloss by the addition of enamel.

Oil paints are applied in two or more coats. In two-coat work, each coat must be heavy to cover and protect the backing. Three-coat work is better, as it can be built up with thinner coats, giving better coverage and protection. You can use oil paints to finish almost any kind of room.

The surface finish may be either brushed smooth so that there are no irregularities, or it may be specially treated in the finishing coat.

Enamels

93. Enamel employs varnish instead of oil as a vehicle; you might consider enamel to be a pigmented varnish. Compared with the pigmentation in paints, which is high, the pigmen-

tion in enamels is relatively low. Combinations of basic pigments — chiefly zinc oxide, lithopone, or titanium — are used with the varnish vehicle. For enamels that will be subjected to exterior weather conditions, you should use a varnish with a high percentage of oil.

Enamels provide a finish that is harder than paint and has more gloss. Dull, or mat-finish, enamels give the finish of hand-rubbed surfaces without rubbing. You can clean an enameled finish more easily than you can a painted finish. When a colored enamel finish is desired, colors ground in oil may be added.

High-gloss enamel finishes are usually employed for locations where much cleaning will be necessary and where grease will be present, as in kitchens. A dull, or eggshell, finish is suitable for most other locations.

Stippled Surface

94. You can secure a stippled finish in flat oil paints or in enameled work by tapping the last coat of paint with a large brush, about 4" x 10" in size, with fine or coarse bristles, depending on the effect desired. This gives a slightly irregular surface from which all sheen has been eliminated, giving in enameled work all the advantages of the protective coating of enamel without any gloss.

Overstaining Painted Woodwork

95. Antique effects on painted woodwork are obtained by overstaining. A very thin coat of clear varnish or oil stain, tinted to the depth desired, is brushed thinly over the woodwork, and then wiped off the high surfaces with a rag. You can remove the stain until the desired effect is obtained.

When the stain is applied over moldings and is wiped off only on those portions with the greatest projection, leaving the stain color in the recesses in the molds, the process is known as high lighting. Shadows on the moldings are accentuated, as though the woodwork had aged gradually.

Casein Paint

96. Casein paint is a water-thinned paint in which the vehicle is a milk protein called casein. The pigments used in this type of paint include whiting and lithopone as well as those pigments required to give the desired color. Normally, the paint is clear white, but you can obtain it in almost any color. It comes in either paste or powder form and is mixed with water on the job and applied with a brush.

Casein paint usually comes only with a flat or mat finish. It may be brushed smooth, stippled, or textured. Where walls are subject to considerable wear and need to be refinished at frequent intervals, as in apartments, casein paint has given considerable satisfaction.

In applying casein paints, your first coat should be a primer recommended by the manufacturer of the paint to close the pores of the plaster, masonry, wallboard, or other material on which it is applied. Casein is a very quick drying material and must be carefully applied to avoid overlapping sections. This paint has the advantage of permitting the use of the room only a short time after the paint is brushed on.

Water-Base Paints

97. Water-base paints are of two types: those which can be mixed with cold water and those which must be mixed with hot or boiling water. The latter, as a rule, are called calcimine paints.

Both types usually have an admixture of lime in some form, sometimes combined with gypsum or other ingredients. The most common form of cold-water paint is whitewash, which consists of lime and water to which salt and finely ground ingredients are sometimes added to give better coverage and longer life.

Water-base paints are generally applied in flat coats which have a mat finish. While sometimes used in finished rooms, water-base paints are more suitable for factories, stores, and

meeting rooms, where they can be advantageously used to secure clean, light-reflecting walls, especially over masonry units. You can obtain water-base paints in a limited range of colors. Some of the water-base paints can be applied directly over wallpaper.

Cement Paints

98. Cement-water paints are used on interior and exterior walls of brick, concrete, and cement plaster. The chief component of these paints is portland cement, which, for best durability, should make up at least 60 per cent of the solids. Other ingredients include hydrated lime, fine inert particles such as silica or limestone, hygroscopic salts, water repellents, and pigments. You should not apply cement paints to concrete or stucco until the concrete or stucco has had a chance to cure for at least three weeks.

Texture Paint

99. Texture paint is made with a heavy body, with either an oil or water base, combined with finely ground minerals to produce a thick paint. You can apply texture paints with either brush or trowel. Surfaces may be stippled, textured, or finished like extremely rough plaster.

Texture paints can be colored as desired, and several colors can be combined and worked on the wall to secure a variegated effect. In using texture paints, you should always follow carefully the manufacturer's recommendations.

Wood Finishing

100. No matter what kind of wood is used, or in what location it is used, you will find that it is usually necessary to protect the wood with some surface treatment or finish. If the wood is not to be covered with an oil paint or enamel, it may be stained, varnished, bleached, or lacquered, using one of the many methods that have proved satisfactory. The general

process of covering a wood with transparent or semitransparent finishes is called wood finishing.

Stained Finish

101. Staining is the process of applying a liquid preparation, called a stain, to a wood surface in order to develop or change the color of that surface, and to bring out the figure or grain of the wood. Stain affects a wood irregularly, acting strongly or weakly on different parts of the surface. The grain is emphasized accordingly.

Stains are often used to produce an imitation of a rarer or more expensive wood, as by staining birch to represent mahogany. Stains are also used to give richer tones to a wood than it possesses naturally, as is often done with oak and mahogany.

The principal stains are oil stains, aniline stains, water stains, spirit stains, acid stains, and varnish stains. Each type of stain is applicable to certain kinds of wood, and each is used to obtain certain color effects. Stains may be obtained in prepared form, or mixed by a skillful painter.

After the stain has dried, a coat of transparent filler may be applied to fill up any minute holes that exist in the surface of the wood. The stain and filler are often put on at the same time. This produces a flat, even surface of the desired color.

Woodwork that is given a stained finish is usually protected by a coating of wax, or one or two coats of varnish or shellac.

Rare and exotic woods are rarely stained, since the beauty of the wood can often be brought out better by using a coat of paste filler thinned with naphtha. The filler should be rubbed in, allowed to dry thoroughly, sandpapered lightly, and protected by two coats of clear lacquer or wax, depending upon the finish desired. As a rule, paste fillers are applicable to open-grained woods, such as oak, chestnut, and walnut. A fine-grained wood may require a liquid filler.

Bleached Finishes

102. You can secure unusual finishes on woods such as oak, mahogany, and walnut by bleaching them with such agents as peroxide or ammonia. Care must be exercised in using a bleached finish, since it tends to lighten the wood and may be spotty in appearance if not well done. The finish is protected with a coat of clear, colorless wax or lacquer.

Varnishing

103. Varnish is a solution of certain gums or resins in linseed oil, turpentine, alcohol, or some other liquid. What is known as shellac is a spirit varnish made by dissolving gum lac in alcohol. Varnish forms a hard, tough, transparent film, or coating, over the surface of the wood. The coating has a permanent gloss.

Varnish is usually applied as the finish to woodwork that has been stained, filled, and sanded smooth. Two coats of varnish are applied to most wood surfaces. For very fine work, a third coat is sometimes given to some open-grained woods, such as oak. Varnish is applied as it comes from the manufacturer's container. If it has thickened, you may thin it with turpentine.

Waxing

104. Wax can be used as a protective coating over a stained and filled wood surface, or it may be applied over a coating of varnish or shellac. One coat of wax is generally sufficient for all surfaces except floors. Two or three coats will give more satisfactory protection on wood floors, or other types of floor coverings. Waxes are often colored to match the color of the stain that has been used on the wood that is to be waxed.

Lacquers

105. Most lacquers have as a base nitrocellulose, which is a chemically processed cellulose. The term "lacquer" refers to cellulose coatings which dry by solvent evaporation.

To the cellulose base are added certain gums or resins. The solvents may be alcohol, esters, or ketones, or a combination of these. A plasticizer is added to prevent the film from becoming too hard or brittle.

Lacquers may be either clear or pigmented and may be used for both exterior and interior finishes. Lacquers are used widely for finishing furniture and automobiles, and for coating linoleum, floor tile, and ornamental metalwork.

To obtain the proper film thickness and appearance, a lacquer finish requires several more coats than are needed for an oil-type finish. The need for more coats partly offsets the advantage offered by the fast-drying property of lacquer. Most lacquers dry hard in one hour, which permits you to apply several coats of lacquer to the same surface in a day. A lacquered finish is extremely hard and durable.

Summary

106. Paint is a common finish for wood, plaster, and some metals. Water-based paints can be applied over wallpaper. Texture paint has a heavy body and can be used to cover minor irregularities in the surface to which it is applied.

Where you wish to retain the natural beauty of a wood, instead of using opaque paints, you should use stains and varnishes.

More detailed information on painting and wood finishing is contained in the text *Painting*, Parts 1 and 2.

Wallpapers, Fabrics, and Plastic-Coated Coverings

Composition of Wallpaper

107. Most wallpaper consists of about 75 per cent ordinary wood pulp and 25 per cent sulfite. Sulfite is a wood pulp that has been treated to remove all but cellulose fibers. To this combination, clay is added to render the paper opaque and to give it a suitable surface. Some papers are reinforced with kraft fibers to provide additional strength.

You can obtain wallpapers in plain colors or in simple or elaborate patterns. Costly hand-painted effects that include reproductions of paintings can be secured.

The basic pigment used in printing wallpaper designs is an opaque, grayish-white powder, or clay. Pigments that are insoluble in water are used in combination with the clay to produce the required colors. Transparent adhesives, or sizes, are used to bind the pigments to the surface of the paper. If inks are used instead of pigments in printing the designs, specially treated sulfite paper stock with extra sizing is required.

The colors for a full production run of a particular pattern are mixed at one time. When another run of this pattern is to be made, another mixing of colors is necessary. There is always the possibility of a variation in color from the original batch. For this reason, each color run is given a different number. When purchasing a supply of paper for a room, you should be sure that all rolls carry the same run number so that the colors in all the rolls will match exactly.

The unit of measurement for wallpaper is a roll containing 36 sq ft. Narrow papers 18" or 20½" wide come in double rolls, while papers 28" or 30" wide come in triple rolls. The three general classes of wallpaper are water-sensistive, or nonwashable; water-resistant; and plastic. To determine whether or not your wallpaper is water-resistant, try dabbing at an inconspicuous spot with a damp cloth.

Uses of Wallpaper

108. Records indicate that wallpaper was used in China as early as 200 B.C. The old Chinese papers were hand-painted on rice paper and included beautiful designs of birds, flowers, and landscapes. These early papers were made in small sections about 12" square. The Chinese papers were imported into England and France in the sixteenth century, but the popular use of wallpaper dates from the eighteenth century. Many of today's wallpapers are either copies or adaptations of older designs.

The invention of wallpaper permitted people of small means to enrich their walls with gay patterns — a decoration which before had been possible only for those who could afford expensive mural paintings and fabrics. Today, wallpaper still provides an economical wall and ceiling covering that is available in an infinite variety of designs.

Wallpaper can be selected to fit any type of room. Its warmth and texture make it especially desirable for living spaces and for bedrooms. You may use wallpaper for the full height of a wall from the top of the base to the ceiling or you may use it above a chair rail or dado only. Or you may use it for one wall of a room where the other walls are painted. It is much used for the ceilings of rooms even when the walls are finished with some other material.

Preparation of Surface

109. Wallpaper should be applied only to a smooth surface that is thoroughly hard and dry and not subject to shrinkage or movement. The common base for wallpaper is plaster. Wallboard is sometimes used as a base, but the joints must be carefully taped and the heads of nails covered or pointed to prevent their showing through the paper.

Whatever the base, you should see that it is properly prepared to receive the wallpaper. If the walls and ceilings are of plaster, any cracks should be filled with quick-drying plaster

or spackling compound. The walls and ceilings should then be sanded and given a coat of glue size. The size seals the pores of the plaster and gives a better bond to the paste that holds the paper.

Walls and ceilings that are newly plastered should be neutralized by washing them with a solution consisting of 2 lb (pounds) of zinc sulfate per gallon of water. The walls should be thoroughly dry before the sizing is applied.

Glossy painted walls should be sanded, washed with a strong solution of paint cleaner, and rinsed before sizing. Flat oil-painted walls require no treatment other than sizing.

Water paint, such as calcimine or casein paint, should be removed by scrubbing the walls with a special remover available for this purpose, or with a strong solution of paint cleaner. Then the walls should be rinsed and sized.

While it is usually safe to install new paper over one or two layers of old paper, provided that the old layers are tightly bonded to the wall, you can secure better results by removing all old paper. The wall should then be rinsed and sized. After the application of the size, the wallpaper can be hung. It is important that you select the proper adhesive for hanging wallpaper.

Adhesives

110. Most stores that sell wallpapers also carry prepared pastes and adhesives. For locations where extreme moisture is encountered, water-resistant pastes are available.

Where a job-prepared paste is desired, you may use the following formula, using parts by weight:

- 42 parts of flour or potato starch
- 4 parts of powdered caustic soda or potash
- 4 parts of ammonium sulfate

Grind all the ingredients to a fine powder and mix thoroughly. To make into a paste, use lukewarm water, add the

powder slowly while stirring, and heat until a smooth mass of the proper consistency is formed. Keep the powder in a dry place.

Some papers can be purchased prepasted. You can obtain instructions for preparing and applying prepasted wallpapers from the manufacturer. These instructions should be carefully followed.

Application of Wallpaper

111. After the wall or ceiling surface has been properly prepared, the next step is to apply the paste evenly to the back of the wallpaper. The paper is then spread on the wall and flattened into place with a wide brush. A roller is run over the joints to make them tight. In paper with a continuous design, the edges must be carefully matched so that the design will fit together properly.

If the wallpaper is nonwashable, avoid using excess paste and keep the surface free of paste. When washable paper is hung, the entire surface of the paper should be sponged with clear water after each strip is hung, to remove excess paste and possible finger marks.

Overstaining

112. You can overstain some papers to secure an antique effect. Overstaining is done after the paper has been applied and is thoroughly dry; a clear, thinned stain or shellac is used, and is brushed or wiped lightly over the paper. An overstained finish produces an interesting effect and makes the paper more resistant to wear and especially to dampness.

Cleaning Soiled Wallpaper

113. Water-sensitive, or nonwashable, wallpapers require great care in cleaning. One of the best cleaners is a puttylike material that is rubbed lightly over the paper. Since the surface of this cleaner picks up the dirt, the cleaner should be

kneaded frequently in the hand to expose fresh portions to the soiled surface of the paper.

Water-resistant wallpaper can be cleaned with a synthetic, nonabrasive type of washing powder dissolved in lukewarm water. The entire surface is washed with this solution, using a cloth or sponge and long, free strokes. Do not scrub the paper. Rinse with clear water. Commercial cleaners are also available at wallpaper dealers.

Impregnated or plastic-coated wallpapers are resistant to many kinds of stains, spots, grease, and dirt. They may be washed frequently and scrubbed with soaps or cleaning solutions. The wallpaper manufacturer's instructions should be followed carefully.

Plastic-Coated Coverings

114. Plastic-coated coverings usually consist of a special high-strength paper or treated cotton fabric sealed in with clear vinyl-plastic coatings. The plastic coatings lock the colors to the backing, are impervious to grease, liquids, and stains, and are highly resistant to abrasion. When soiled, the coverings can be quickly scrubbed and restored to their original freshness, since the plastic coatings render the designs fade-proof.

These wall coverings are tough, durable, washable, and crack-resistant. You can use them in bathrooms and kitchens since they are unaffected by steam or splashing water. They are available in a wide variety of designs and colors; some types can be had in embossed textures.

You can apply plastic wall coverings in the same manner as wallpaper, using standard adhesives. Greater care must be taken, however, especially with the embossed types of plastic wall coverings, to fill all low spots on the wall before the covering is applied, and to eliminate all air pockets during application. After the wall covering is hung, the surface should be washed with clean water to ensure that all paste has been removed.

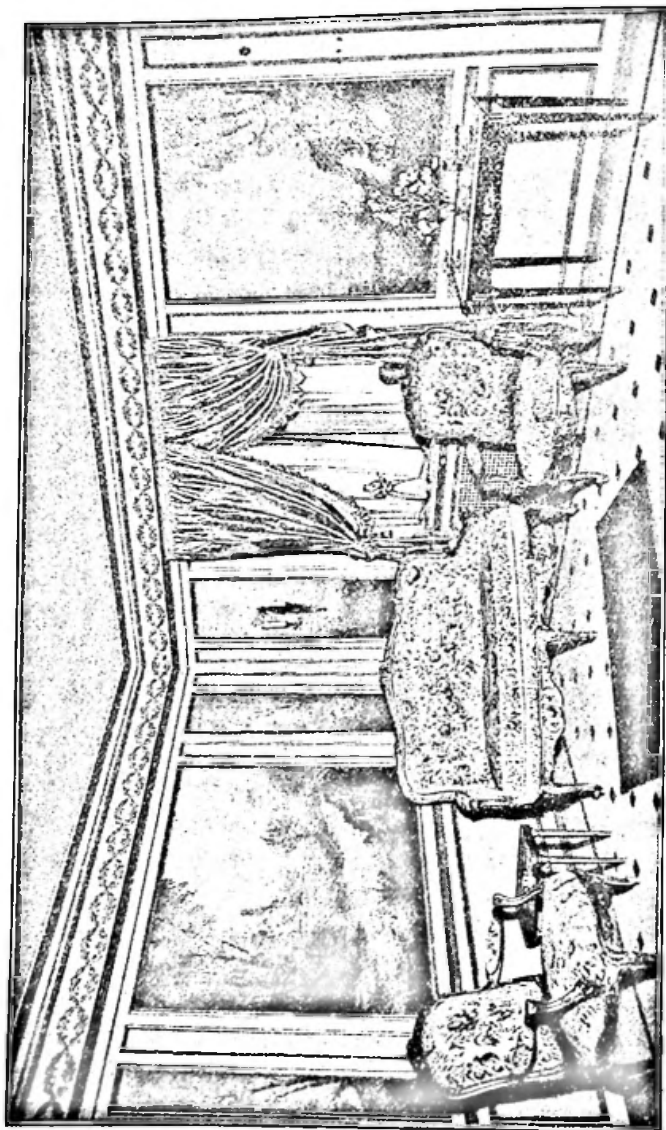

FIG. 38. PICTURES BUILT IN AS WALL PANELS

Kinds of Fabrics

115. Fabrics, in general, consist of materials with a woven base. They include materials such as silk, damask, linen, or cotton; various combinations such as Saran and nylon, linen and viscose; and linen and rayon; also leather, and very thin wood veneers glued to a fabric base. They are produced in many different ways and are applied in the same general manner as wallpapers.

Silks, Satins, Tapestries, and Pictures

116. Silk and satin wall coverings are sometimes used when especially elegant effects are desired — for instance, in rooms styled in imitation of certain periods of French architecture. They are applied mostly in panels, between wood or plaster stiles and rails. Since they are very delicate materials, they should be mounted on a stretcher frame before being placed on the wall, so that they will not come in direct contact with the plaster.

Tapestries are either machine-woven in continuous designs or hand-woven in separate panels. Because they normally belong to definite architectural periods, they are used mostly in rooms of special design.

Pictures in oils, water colors, and other media can be used in the same manner as tapestries. Or they can be built into wall panels as shown in Fig. 38.

Leather

117. Leather is a serviceable material and is used in such rooms as libraries, dens, lounges, and playrooms. Leather generally comes in tones of brown, red, blue, and black, but you can also secure it in light tones, such as gray or white. Often it can be tooled or it can have designs pressed into the material. Since it is a heavy material, it exerts a very strong pull on the wall, and the plaster or backing must have no loose spots.

Wood Veneer

118. Wood-veneer coverings consist of very thin sheets of natural wood cemented under pressure to a backing of linen or cotton. The sheets are flexible and are applied to the wall in the same manner as wallpaper. These coverings have all of the beauty of the wood from which the veneer is made, but, since the veneers are extremely thin, the coverings cannot take as heavy usage as plywood coverings can.

Wood-veneer coverings are especially suitable for executing designs in contemporary style when the walls are to be covered, at a minimum cost, with continuous wood graining. In some cases, wood moldings are applied on the veneer surface to form stiles and rails and to give a paneled effect to the walls of the room.

Canvas

119. In addition to the fabrics that present finished surfaces and those that are used as a base for plastic coverings, there are other fabrics, such as canvas, that are used as a base for paint. The canvas used in this way is a fine cotton duck that is applied to the wall with a paste and forms a firm, level base for paint. It provides a more elastic body than plaster, and plaster cracks will not show through the final coats of paint.

You can obtain canvas in a very smooth texture, and also in rough textures that give stippled effects.

Fire-Resistant Materials

120. Most wall fabrics can be treated with chemicals in such a manner that they become resistant to fire. It takes intense heat of some duration to make such treated fabrics burn. The chemical treatment is especially desirable when the fabrics are to be used in places of public assembly, such as theaters. You should carefully study reports of the tests made on the various materials before making your selection.

Summary

121. Wallpapers provide economical and decorative wall and ceiling coverings. Fabrics such as silk, damask, linen, cotton cloth, and thin wood veneers with cloth backings are used in the same manner as wallpapers. Plastic-coated coverings are extremely strong and durable.

*Miscellaneous Coverings***Other Coverings**

122. In addition to the wall and ceiling coverings that you have studied thus far, there are other materials used under various conditions and for various requirements of use to provide attractive wall and ceiling coverings. Among these are linoleum, stainless steel, and enameled sheet metal.

Linoleum Wall Coverings

123. Where a durable, washable surface is required, you will find that linoleum provides a suitable wall covering. It is readily adaptable to the renovation of rooms in old buildings.

The linoleums used for wall coverings have the same composition and general character as the thin gages of plain linoleum described in Part 1. They are usually made about $\frac{1}{16}$ " thick for use on walls. The surfaces, however, are finished to provide a texture that is more suitable for walls.

You can secure wall linoleums in plain or mottled colors, in tile effects, in striated colors as in jaspé linoleum, and in marbled and wood-grained effects.

Application of Linoleum

124. The walls that receive linoleum should be of plaster or of a hard, compressed type of wallboard such as gypsum, asbestos, or compressed wood, in order to hold the paste used in attaching the linoleum.

Your first step is to apply a water-solvent adhesive to the wall. The linoleum is then hung and rolled out so that it is

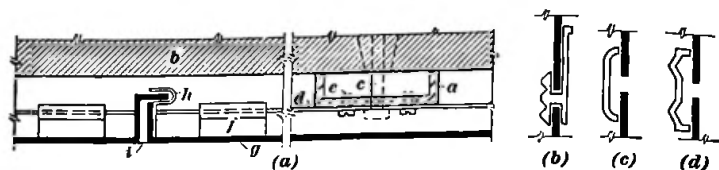

- | | |
|--------------------|--------------------|
| a. channel furring | f. horizontal clip |
| b. wall | g. metal sheet |
| c. expansion bolt | h. vertical clip |
| d. metal bar | i. mastic |
| e. screw | |

- (a) Concealed mounting
 (b) Extruded slotted batten
 (c) Extruded smooth batten
 (d) Extruded indented batten

FIG. 39. SHEET-METAL INSTALLATION

in continuous contact with the adhesive and the wall, and so that the surface is perfectly smooth.

When the linoleum is rolled smooth, the joints are filled with a waterproof glue and rolled. All excess material is removed from the wall, and the linoleum is cleaned. Generally, no finish is applied, but in some of the effects, like wood veneer, a thin coat of wax can be used. The wax is well rubbed so that it will not remain tacky.

On outside corners and at edges, linoleum wall covering is sometimes protected by using metal moldings.

Metal Wall Coverings

125. The use of metal wall coverings for interiors has increased as the possibilities of aluminum, stainless steel, and porcelain-enameled sheet metal have become better understood. Since metals are extremely flexible and subject only to restrictions in size depending on the process of manufacture, their use offers considerable freedom to the designer.

Sheet metal is furnished in different materials and types, and is applied according to the individual manufacturer's instructions. The most common type is that secured to the wall supports or to metal or wooden grounds by means of screws.

Another method of securing sheet metal is to interlock all joints by use of strips of aluminum, stainless steel, or a similar nonferrous metal; these strips are left exposed and form a part of the finished design. A typical method of sheet-metal installation is shown in Fig. 39.

Channel furring *a*, in view (a), is held to the wall *b* by means of expansion bolts like the one at *c*. Metal bars, as at *d*, are held to the channel by means of self-supporting screws, as at *e*. Clips, like the one at *f*, are attached to the metal sheet *g* and are bent over the bar *d* to hold the sheet in the required position. Other clips, like the one at *h*, hold the sheet at the vertical joints. These joints are usually filled with mastic *i*.

In Fig. 39, views (b), (c), and (d), are shown three forms of extruded aluminum battens. The form shown in (b) is made with slots on the sides which hold to the sheets rigidly. The forms shown in (c) and (d) cover the joint and are held in place by bolts extending through the joint and into the backing. The joint usually is filled with mastic.

In another type, the sheet metal is backed with concrete after the color has been applied to the exposed surface. This forms a concrete slab, which is set in the same manner as cast stone. For interior use, the slabs are made about 1" thick, and they are secured to vertical or horizontal grounds by wires. The joints are then filled with stainless, light-colored mastic. Or strips of other materials can be used at the joints to form designs.

Still another type of metal wall covering is produced in small sizes like individual tile. The tile are enameled on the exposed face, and on the edges, which are formed by turning the material back. A special asphalt-treated wallboard is first nailed to the wall. Grooves spaced so as to receive the metal tile have been cut in this board. The tile are pressed into the grooves and the joints are then filled with a mastic compound or a cement-and-lime-putty mortar; thus the finished appearance is very similar to tile. These tile have a bright, glazed

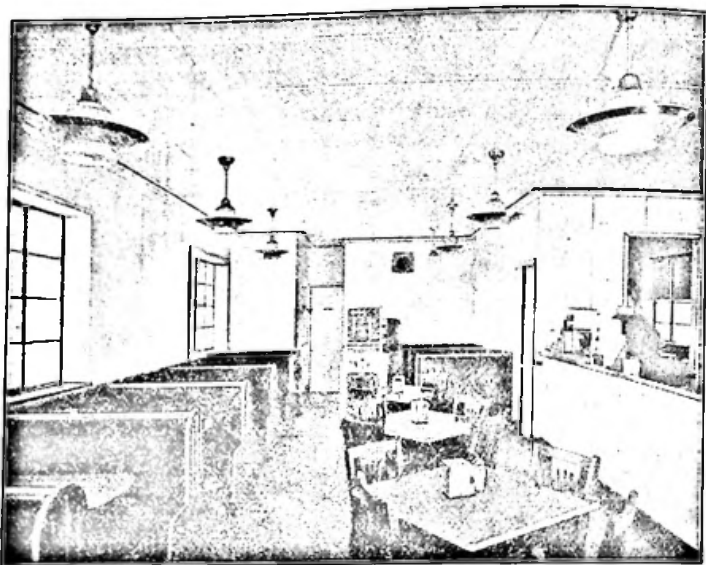

FIG. 40. PORCELAIN-ENAMEL WALL AND CEILING COVERING

surface and can be obtained in almost any color. They are used in kitchens, bathrooms, corridors, and similar areas.

Porcelain Enamel

126. Ferrous sheet metal has long been used for practical building purposes. Before the advent of porcelain enamel, this metal was generally painted after erection.

Porcelain enamel is a vitreous inorganic coating bonded to rust-proofed metal by fusion, at temperatures above 800 F. At these temperatures the metal base and the surface material permanently combine, providing a product with the hardness of glass and the strength of the base metal. In fact, for all practical purposes, you may consider porcelain enamel as a glass surface supported by a rigid metal base. The surface will resist weathering, dirt, and grease, and all but the strongest acids. You can obtain porcelain enamel in many colors and in embossed, corrugated, mottled, pebbled, and other textural finishes.

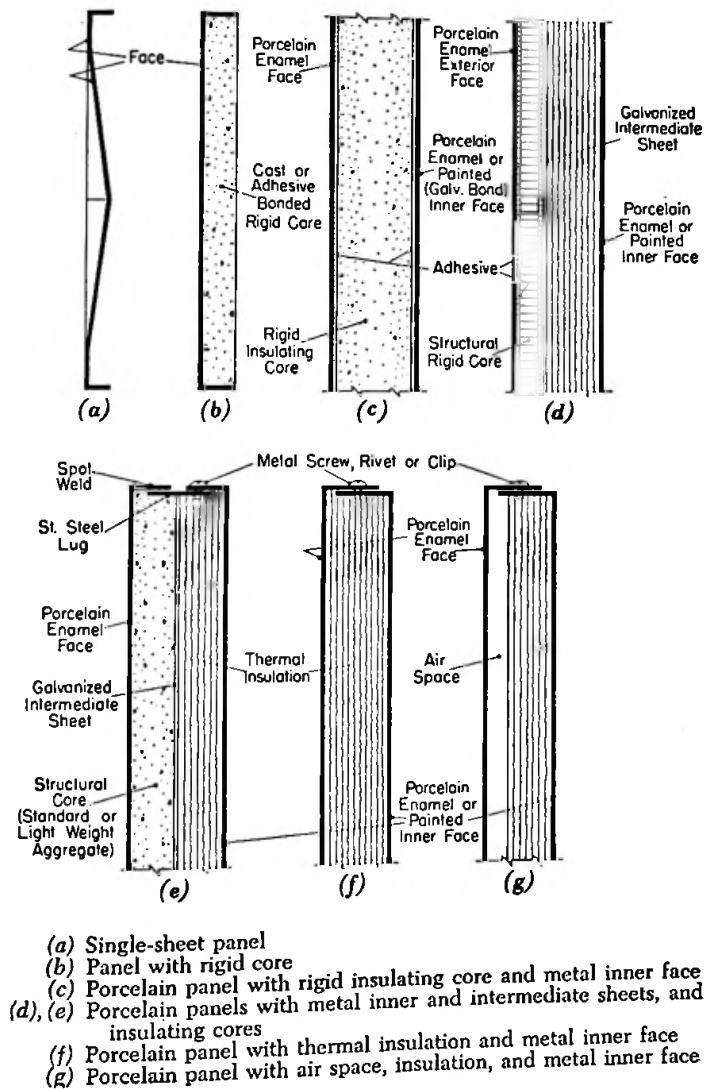

- (a) Single-sheet panel
 (b) Panel with rigid core
 (c) Porcelain panel with rigid insulating core and metal inner face
 (d), (e) Porcelain panels with metal inner and intermediate sheets, and insulating cores
 (f) Porcelain panel with thermal insulation and metal inner face
 (g) Porcelain panel with air space, insulation, and metal inner face

FIG. 41. PORCELAIN-ENAMEL PANELS

Porcelain enamel is widely used for exterior curtain walls and for interior partitions and screens. The use of porcelain enamel as the wall and ceiling covering in a small restaurant is shown in Fig. 40.

Porcelain-enamel panels can be obtained as single sheets, as adhesive-laminated panels, or as mechanically assembled panels. These types are shown in section in Fig. 41. The gage of the metal used will depend on the type and size of the porcelain-enamel panel. Heavier gages will have less tendency to distort during the firing process. Where the panel has a strong backing, the metal may be of a lighter weight.

Aluminum

127. Aluminum is strong, durable, easily workable, attractive in appearance, and highly resistant to corrosion; also, it is the lightest in weight of all the metals used for building construction. It is suited to exterior or interior use.

Aluminum products are either "wrought" or "cast," depending upon whether their shape results from mechanically working solid metal or from molding molten metal. Special alloys have been produced for each method of manufacture. When used as wall and ceiling coverings, aluminum is usually used in sheets that have been produced by rolling, together with extruded shapes that have been forced through metal dies. Ornamental designs are usually pressed or cast. Some embossed sheets in which the pattern on one side is raised and the same pattern indented on the reverse side are shown in Fig. 42. The embossed sheet is stiffer than the regular flat sheet.

The thickness of the metal sheets varies to a considerable extent, depending on the form in which it is employed. Sheets usually range in thickness from 0.030" to 0.250". Sheets may be flat, ribbed, corrugated, or embossed in different patterns. The sheets can be satisfactorily joined by welding or adhesive bonding, or by means of a variety of mechanical fastenings.

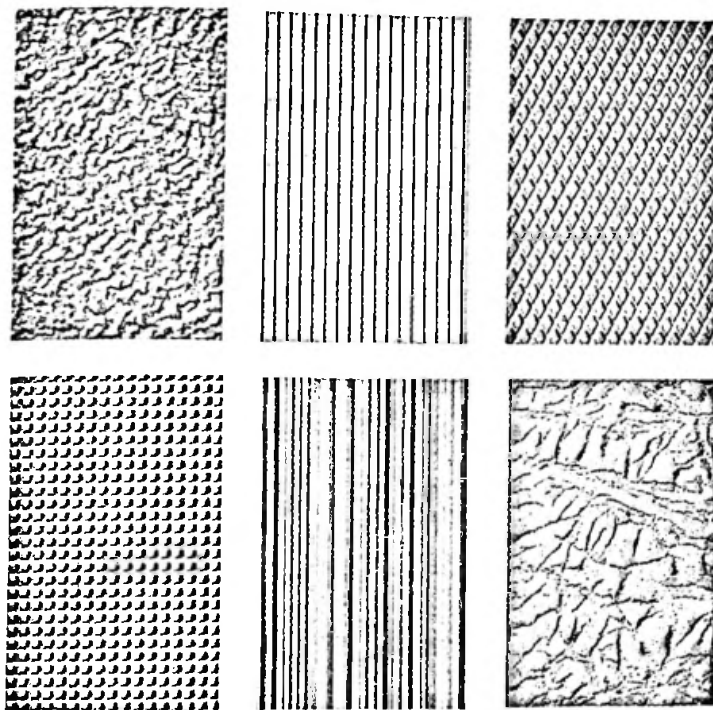

FIG. 42. FINISHES ON ALUMINUM SHEETS

The natural color of aluminum is a distinctive, warm gray. The aluminum surface can be given a fine sand finish, which gives a stippled effect showing the grain of the metal; or it can be buffed to a satin finish, which gives a smooth, semi-polished effect.

Changes in the natural color can be secured by applying an oxidized finish, which turns the material dark gray or almost black. This color can be lightened slightly by buffing. The finish, in any case, varies slightly depending on whether cast or rolled metal is used. Usually, the finish on cast material is slightly darker and coarser than on rolled metal.

A method by which color can be applied to the surface of aluminum has been developed. Originally, the colors available

were confined to red and black, but other colors are now available.

For protection, aluminum is given an anodic treatment in a special electrolyte so as to secure a dense coating of aluminum oxide. This anodized finish is less susceptible to wear than the natural finish and prevents darkening or discoloration.

Stainless Steel

128. Stainless steel is a corrosion-resisting steel characterized by hardness, brilliance of luster, and resistance to dampness.

Normally, stainless steel is of a steel-gray color, and, when finished, has a semipolished surface. It can, however, like aluminum, have color applied on the surface. You can also secure stainless steel with a black sand-finished surface.

Stainless steel generally comes in sheets. It cannot be molded or extruded, and any shapes must be formed on a press with dies. For that reason, its use is limited to a certain extent.

In setting stainless steel, you must make special provision to erect substantial supports, usually steel shapes, to which the stainless steel can be bolted.

Stainless steel has long been used in commercial establishments for counters, bars, and kitchen equipment, and in similar places requiring a metal that has a long life and can be cleaned easily. Because it can be colored, stainless steel is now being used also in the creation of decorative wall designs, either by itself or in combination with other metals.

Wrought Iron

129. Heavy, solid wrought-iron plates are used where protection against extremely hard usage is required. Such plates are generally available only in large sizes, not less than $\frac{1}{4}$ " thick, and are bolted to steel channels or to masonry walls. Typical uses are in workrooms of post offices or industrial

buildings where there is considerable trucking and where the wall is frequently hit by moving objects.

Summary

130. Linoleum forms a durable, washable wall covering. When you use linoleum as a wall covering, you should apply it to a hard, smooth undersurface of plaster or wallboard.

Porcelain enamel may be considered as a glazed surface supported by a rigid metal base. It provides a hard, colorful, sanitary wall covering.

Metal wall coverings are chosen to fill special design requirements.

This completes your study of Part 2 of *Floor, Wall, and Ceiling Coverings*. You have learned that floor, wall, and ceiling coverings include a wide variety of materials and that each material has its advantages under certain requirements of use. New materials are being developed each year. You must study constantly to keep abreast of the advances in the field of floor, wall, and ceiling coverings.

Pronunciation Hints

Sometimes it is very difficult to indicate exactly how a letter or a combination of letters in a certain word in the English language should be pronounced. Moreover, some of the words are pronounced somewhat differently in different localities. To help you pronounce correctly several words in this text, we have respelled the words here. Also, we have underlined the accented syllable of each word.

CORRECT SPELLING

acoustic

casein

opaque

pavonazzo

scagliola

PRONUNCIATION

uh-koos-tik

ka-see-in, or kay-seen

oh-pake

pa-voh-not-so

skal-yo-luh

Appendix

Standards for Wall and Ceiling Coverings

Standard specifications for various items used in the covering of floors and walls have been prepared by the American Society for Testing Materials. Each of these standards is available in pamphlet form for a small charge. A few of the standards available are listed below:

DESIGNATION NUMBER	TITLE
C-7	<i>Specifications for Paving Brick</i>
C-36	<i>Specifications for Gypsum Wallboard</i>
C-55	<i>Specifications for Concrete Building Brick</i>
C-61	<i>Specifications for Keene's Cement</i>
C-126	<i>Specifications for Ceramic-Glazed Facing Brick</i>
C-208	<i>Specifications for Structural Insulating Board Made from Vegetable Fibers</i>
C-209	<i>Specifications for Aluminum and Aluminum- Alloy Sheet and Plate</i>
C-212	<i>Specifications for Structural-Clay Facing Tile</i>
C-279	<i>Specifications for Chemical-Resistant Masonry Units</i>

These and other standards can be obtained from the American Society for Testing Materials, 1916 Race Street, Philadelphia 3, Pennsylvania.

Glossary of Terms

For your convenience, various terms used frequently in describing floor, wall, and ceiling coverings are explained here. Because the primary purpose of this Glossary is to explain terms rather than words, the terms are arranged alphabetically according to the first word of the term.

acrylic plastics Transparent synthetic resins made from petroleum. They are stable in the presence of sunlight, have dimen-

sional stability, and are weather resistant. They are commonly used for skylights and screens.

aggregate The material which, added to cement and water, makes concrete. Aggregate is said to be fine or coarse according to whether it consists of sand or larger pieces of stone or gravel.

boiled linseed oil Raw linseed oil that has been heated in the presence of metallic drying compounds.

bond(of brick) The overlapping of joints in successive courses and the employment of units that project laterally into adjacent courses or through the wall.

bushhammer A tool used by stonemasons for dressing the surface of stones. It is made of steel plates bolted together, with channels between the cutting edges.

buttered Spread with a layer of mortar. Said of a masonry unit that is to be set in place in a wall or floor.

crazing The developing of minute surface cracks, as in pottery, stucco, tile, or concrete.

filler A pigmented composition in liquid or paste form, used for filling the pores or irregularities in surfaces of open-grained woods, preparatory to application of other finishes. Also used to fill natural flaws in fine stones such as marble.

filling The operation of repairing defects, such as cracks or pockets in marble blocks, by inserting gum shellac or small pieces of marble in the openings of the stone.

grout A concrete mortar with fine aggregate and a heavy liquid consistency, capable of flowing to fill small joints or cracks.

hard-burned brick Brick that have been well burned in the kiln as compared to those that have been underburned.

marble liners Slabs or strips of sound material used to back up unsound slabs of marble. Usually fastened to the marble slabs with plaster of Paris or cement.

module A 4" unit of measurement used as the basis for a grid permitting the coordination of two or more different materials in a building.

nonstaining mortar A mortar made from white nonstaining portland cement.

pigments Fine solid particles used in the preparation of paint and substantially insoluble in the vehicle.

screed A guide strip commonly used to establish the proper thickness of a plaster or concrete surface.

TABLE 3. TYPES, SIZES, AND USES OF GLAZED TILE

TYPE OF TILE	DESCRIPTION							BASIC SHAPE AND SIZE INCHES	THICKNESS INCHES	RECOMMENDED JOINT SIZES INCHES	USAGE	
	Outer Finish			Body								
	Bright	Semimat	Mat	Crystalline	Impervious	Vitreous	Semivitreous					Nonvitreous
Glazed interior	A	A	A	A	A	A	Hexagon 3 and 4 Half hexagon 3 and 4 6 x 9; 6 x 12	$\frac{1}{4}$ to $\frac{1}{2}$ Average $\frac{3}{8}$ $\frac{1}{2}$	$\frac{1}{8}$ to $\frac{1}{4}$	Glazed tile are used where an impervious, nonstaining, nonfading surface is desired	Glazed interior tile used for bathrooms, showers, operating rooms, corridors, lunchrooms, locker rooms, wash-rooms, closets, and powder rooms	
Extra-duty subject to wear		C	C	A	A	$2\frac{1}{2} \times 2\frac{1}{2}$; $2\frac{1}{2} \times 2\frac{1}{2}$ Triangular half $2\frac{1}{2}$ $4\frac{1}{2} \times 4\frac{1}{2}$; $4\frac{1}{2} \times 6$	$\frac{1}{2}$ to $\frac{3}{4}$	$\frac{1}{8}$ to $\frac{1}{4}$	Bright and semimat finishes for walls and ceilings; never used on floors	Extra-duty tile used for bulkheads, store fronts, exterior decoration, subway entrances, light-traffic floors, vestibules, fountains, and drainboards		
Extra-duty subject to freezing	A	A	A	A	A	C	Triangular half $4\frac{1}{2}$ 3×3 ; 3×6 ; 6×6 Triangular half 3 and 6	Average $\frac{3}{8}$		Mat finish for walls, ceilings, and sometimes counter tops and residential floors subject to a minimum of wear		
Ceramic-mosaic	A	A	A	A	A	A	$1\frac{1}{2} \times 1\frac{1}{2}$; $1\frac{1}{2} \times 2\frac{1}{2}$; $2\frac{1}{2} \times 2\frac{1}{2}$ Triangular half $1\frac{1}{2}$ and $2\frac{1}{2}$ $2\frac{1}{2} \times 2\frac{1}{2}$; $2\frac{1}{2} \times 3\frac{1}{2}$; $3\frac{1}{2} \times 3\frac{1}{2}$ Triangular half $1\frac{1}{2}$ and $2\frac{1}{2}$ $3\frac{1}{2} \times 3\frac{1}{2}$; $3\frac{1}{2} \times 4\frac{1}{2}$; $4\frac{1}{2} \times 4\frac{1}{2}$ 2×2 ; 2×1 ; 1×1 ; $1 \times \frac{1}{2}$ $\frac{1}{2} \times \frac{1}{2}$ Triangular half 2 and 1 $2\frac{1}{2} \times 2\frac{1}{2}$; $2\frac{1}{2} \times 1\frac{1}{2}$ $1\frac{1}{2} \times 1\frac{1}{2}$ Triangular half $2\frac{1}{2}$ and $1\frac{1}{2}$ $1\frac{1}{2} \times 2\frac{1}{2}$; $2\frac{1}{2} \times 3\frac{1}{2}$ Hexagonal 1, $1\frac{1}{2}$, and 2 Half hexagonal 1, $1\frac{1}{2}$, and 2	$\frac{1}{2}$	$\frac{1}{8}$ to $\frac{1}{4}$ Paper mounted average $\frac{3}{8}$	Crystalline finish for walls, ceilings, counter tops, and residential floors subject to light wear; never on a commercial floor	Ceramic-mosaic, faience, and faience-mosaic tile used for exterior and interior surface where glazed tile are suitable	
Faience (handmade)	Made as desired in special sizes, shapes, patterns, and colors; consult manufacturer for information									Tile with impervious body can be used anywhere		
Faience-mosaic (handmade)	Made as desired in special sizes, shapes, patterns, and colors; consult manufacturer for information									Tile with non-vitreous body cannot be used where subject to freezing and thawing		
Special-purpose	Made to any specifications as to size, thickness, shape, color, or decoration, keys or lugs on back or edges; has unusual resistance to absorption, alkali, acid, thermal shock or physical impact; has high coefficient of friction, or electrical properties								As specified $\frac{1}{8}$ to $\frac{1}{4}$		Special-purpose tile specified to meet special requirements in any location	

A — available.
C — available if certified by manufacturer.

Floor, Wall, and Ceiling Coverings

PART 2
Serial 6239B

© 1959 by INTERNATIONAL TEXTBOOK COMPANY
Printed in the United States of America
All rights reserved

TABLE 4
TYPES, SIZES, AND USES OF UNGLAZED TILE

Tables 3, 4, and 5

TYPE OF TILE	DESCRIPTION								SIZE INCHES	THICKNESS INCHES	RECOMMENDED JOINT SIZE INCHES	USAGE
	Outer Finish			Body				Edge				
	Admixture	Grooved	Smooth Surface	Impervious	Vitreous	Semivitreous	Nonvitreous	Cushion				
Ceramic-mosaic	A	A	A	A	A	A	A	A	Same as glazed ceramic-mosaic			Especially adapted to floors and other heavy-duty applications, both indoors and outdoors, and to working surfaces, drainboards, bathrooms, kitchens, corridors, operating rooms, delivery rooms, entrances, stables, recreation rooms, porches, dairies, packing houses, power and industrial plants, swimming pools, snack bars, and grease rooms
Faience Faience-mosaic	Made as desired in special sizes, shapes, patterns, and colors; consult manufacturers for information											Impervious and vitreous tile resist staining
Paver	A	A	A	A	A	A	A	A	3×3 3×6 4×4 $4\frac{1}{2} \times 4\frac{1}{2}$ 6×6	$\frac{1}{2}$ to $\frac{3}{4}$	For tile up to $4\frac{1}{2} \times 4\frac{1}{2}$, $\frac{1}{2}$ to $\frac{3}{4}$ For tile 6×6 and over, $\frac{3}{8}$ to $\frac{1}{2}$	Semivitreous may or may not resist staining
Quarry	A	A	A	A	A	A	A	A	$2\frac{1}{2} \times 2\frac{1}{2}$; 4×4 $6 \times 2\frac{1}{2}$; 6×6 6×9 ; $8 \times 3\frac{1}{2}$ 8×4 ; 8×8 9×9	$\frac{1}{2}$ to $\frac{3}{4}$ $1\frac{1}{2}$ to $1\frac{1}{2}$	$\frac{1}{2}$ to $\frac{3}{4}$	Nonvitreous tile will not resist staining
Ship or galley	A	A	A	A	A	A	A	A	6×6	$\frac{1}{2}$ to $\frac{3}{4}$	$\frac{1}{2}$ to $\frac{3}{4}$	Used on ship decks and galley floors
Conductive		A	A	A	A	A	A	A	$1\frac{1}{2} \times 1\frac{1}{2}$ $1\frac{1}{2} \times 1\frac{1}{2}$	$\frac{1}{2}$	Paper-mounted $\frac{3}{8}$ average	Nonvitreous should not be subject to freezing and thawing

A — available.

TABLE 5. ACOUSTICAL MATERIALS

Product	Thicknesses Inches	Sizes Inches	Type Edge	Installation Methods	Finish	Flame Resistance	Maintenance	Efficiency (Noise Reduction Coefficient)	Relative Cost	Special Features
Fissured wood-fiber tile	$\frac{3}{8}$	12 x 12	Beveled	Cementing or nailing	Washable warm white	Federal specifications SS-A-118b Class C	May be vacuum- cleaned or brush- or spray-painted without appreciable loss of absorption	0.60 to 0.70, depending on thickness and method of installation	Low, comparable with popular thicknesses of perforated fiber tile	Beauty with economy and efficiency
	$\frac{1}{2}$	12 x 12	Beveled or square edged, kerfed and rabbeted	Cementing, nailing, or mechanical suspension						
		12 x 23 $\frac{1}{2}$	Beveled, kerfed, and rabbeted long edges	Exposed Z or T systems						
Perforated wood-fiber tile, standard drilled	$\frac{1}{4}$	12 x 12	Beveled	Cementing, nailing, or mechanical suspension systems	Washable white	Federal specifications SS-A-118b Class C or Class D	Washable, may be painted repeatedly without loss of absorption	0.60 to 0.75, depending on thickness and method of installation	Low	Economy with maximum paintability and efficiency
	$\frac{3}{8}$	12 x 24								
	1	24 x 24								
Perforated wood-fiber tile, scatter drilled	$\frac{1}{2}$	12 x 12	Beveled	Cementing, nailing, or mechanical suspension systems	Washable white	Federal specifications SS-A-118b Class C or Class D	Washable, may be painted repeatedly without loss of absorption	0.55 to 0.70, depending on thickness and method of installation	Low	Minimizes tile lines and mechanical pattern
	$\frac{3}{8}$	24 x 24								
	1									
Fissured mineral tile	$\frac{3}{4}$	12 x 12	Beveled or square edged	Cementing or mechanical suspension systems	Washable white	Federal specifications SS-A-118b Class A (incombustible)	May be vacuum- cleaned or brush- or spray-painted without appreciable loss of absorption	0.70 to 0.80, depending on method of installation	Moderate	Beauty with fire safety and efficiency
	$\frac{1}{2}$	12 x 23 $\frac{1}{2}$	Beveled long edges	Exposed Z or T systems						
Metal acoustical units	$2\frac{1}{2}$ (Overall)	12 x 24	Beveled and center scored	Mechanical suspension system	White enamel	Federal specifications SS-A-118b Class A (incombustible)	May be washed or painted repeatedly without loss of absorption	0.85	High	Maximum accessibility to utility space above ceiling
Acoustical roof slab	2 3	24 x 96	Long edges beveled; vapor-barrier type has rubber end gasket	Nailed over wood beams	White	Federal specifications SS-A-118b Class C	May be brush- or spray-painted repeatedly without loss of absorption	0.55	Low when compared with materials offering comparable insulating, structural and acoustical values	Ideal for low-cost, one-story construction
Perforated cement asbestos board	$\frac{1}{2}$	12 x 12 12 x 24 24 x 24 24 x 48 48 x 48	Beveled or square edge	Nailing or screwing to wood framework or on mechanical suspension systems	Unpainted	Federal specifications SS-A-118b Class A (incombustible)	May be brush- or spray-painted repeatedly without loss of absorption	Depends on absorptive backing	Moderate to high	Ideal facing material offering maximum flexibility in absorption
Perforated hardboard	$\frac{1}{2}$ $\frac{3}{8}$	12 x 12 12 x 24 24 x 24 24 x 48 48 x 48	Beveled	Nailing or screwing to wood framework or on mechanical suspension systems	Unpainted	Federal specifications SS-A-118b Class D	May be brush- or spray-painted repeatedly without loss of absorption	Depends on absorptive backing	Moderate to high	Good facing material offering maximum flexibility in absorption

seal To apply a transparent liquid coating containing a pigment to a porous surface of wood or plaster for the purpose of filling the pores.

shellac Purified lac resin, especially in thin layers or flakes. Also, a type of varnish consisting of lac carried in alcohol as a solvent. Lac resin is deposited on trees by an insect native to India.

spalling The breaking off of small pieces of stone caused by the weather or by stresses in the stone.

sticking The operation of mending a natural break in a marble slab, in which operation the broken edges are heated and joined together with melted shellac, sometimes with the addition of brass dowels.

stratified stone Stone formed in beds or layers.

texture of stone The character, arrangement, and mode of aggregation of the fragments, particles, or crystals that compose the stone.

thinner A liquid added to paint to make it flow more easily, which evaporates completely as the paint dries.

troweled Worked over with a trowel to give either a smooth or patterned surface.

vehicle The liquid portion of a paint.

vinyl plastics Synthetic resins made from coal, salt, air, water, and natural gas. They are used in the manufacture of floor coverings. They are impervious to oils, have dimensional stability, and are available in a wide range of colors.

vitrification The process of converting into, or causing to resemble, glass, or a glassy substance, by the application of heat.

waxing The process of finishing the surface of a defect in marble so that it blends with the original stone. The wax is a mixture of zinc white, white shellac, and a suitable pigment such as pulverized marble of the same type as the block. Also, the process of applying wax to the surface of wood floors or wood finishes.

Floor, Wall, and Ceiling Coverings

Serial 6239B

PART 2

Edition 1

Examination Questions

Notice to Students.—Study this instruction text thoroughly before you answer the following questions. Read each question carefully and be sure you understand it; then write the best answer you can. When you complete your work, examine it closely, correct all the errors you can find, and see that every question is answered; then mail your work to us. DO NOT HOLD IT until another examination is ready.

1. Explain the following terms: high lighting, back painting, eggshell finish, spotting method, salt glaze, adhesion type, anodized, cored, shellac, and scagliola.
2. You are building a fine house that is nearing completion. The plastering is finished but not yet painted. Numerous small cracks have appeared in the plaster, indicating that the subframe was not properly seasoned and that more cracks will appear. What provision will you make to ensure that no cracks will mar the finished painted surfaces?
3. Explain how marble finish may be secured to rough masonry walls.
4. a) What is the common thickness for linoleum wall coverings?
b) Name three surface finishes that may be obtained in structural-clay facing tile.
5. What are the advantages of structural glass as a wall covering?

6. *a)* Under what circumstances would you use varnish as a vehicle?
b) When is a milk protein used as a vehicle?
c) In connection with wood finishing, when would you use ammonia?
7. Name the finish you would specify for the following applications:
a) The marble side walls in a public space.
b) An elaborate hammered and high-lighted ornamental wrought-iron screen on the exterior of a building.
c) A piece of hardwood furniture that is to be used as soon as possible.
d) A white-pine wainscot in a waiting room where the traffic is heavy and the quality of the wood is such that an opaque covering is recommended.
8. What are the advantages and disadvantages of cast stone?
9. What are the respective merits of glazed brick, glazed structural-clay facing tile, and ceramic veneer?
10. *a)* What would be your procedure in selecting a paint to be applied to an acoustical-plaster ceiling?
b) What type of acoustical tile would you apply to a ceiling when the maximum in noise reduction is desired?

le
f
ber

720 (07) I57 v.5 pt.2

International Correspondence
Schools, Scranton, Pa.
Architecture home study
course. v.5 pt.2.

DATE	ISSUED TO

pa
ls
pa
ru
al

gh

gh

I O S