

RECEIVERS: USRP2, YE'OLD AM RADIO

TRANSMITTER:
XYZ EMBEDDED DEVICE + RF Funtenna Payload

FUNTENNA

Noun:

- 1: Software payload that intentionally causes its host hardware to act as an improvised RF transmitter using existing hardware, which are typically not designed for electromagnetic emanation.
- 2: Software which intentionally causes compromising emanation.

www.funtenna.org

PoC code to be released on 7.8.2015 11:30 PDT

Ang Cui, PhD
a@redballoonsecurity.com

About me,

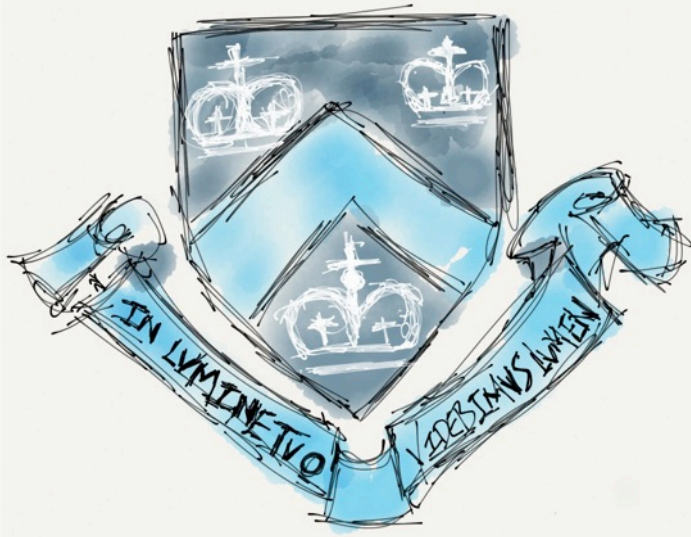

Columbia University

About me,

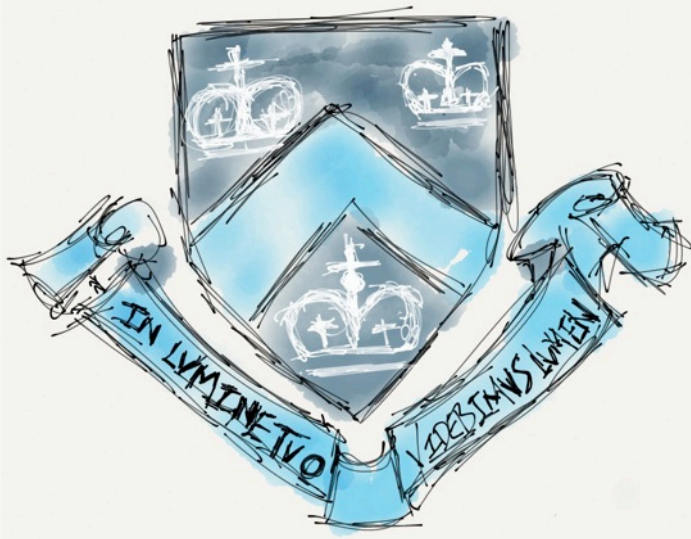

Columbia University

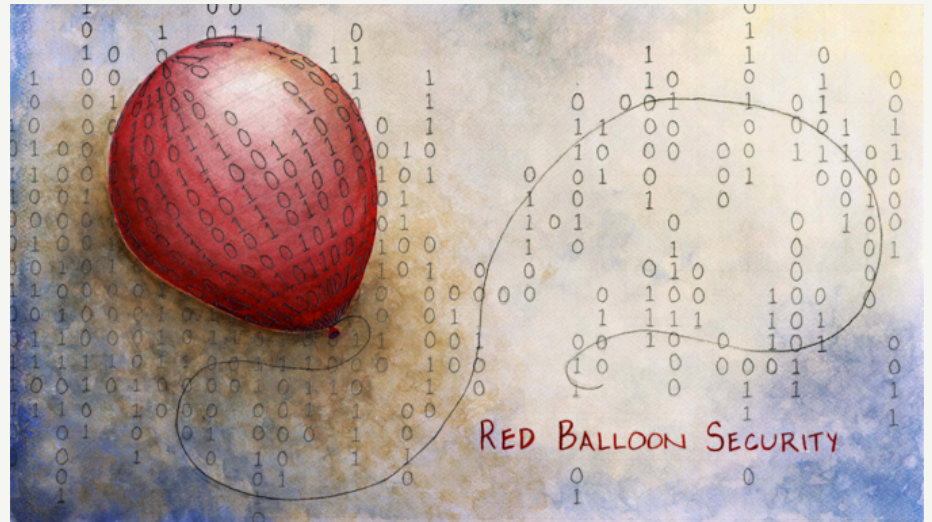

Red Balloon Security

Disclaimer

1. Research presented in this talk not funded by any government sources or Columbia University.

Disclaimer

1. Research presented in this talk not funded by any government sources or Columbia University.
2. Research presented not related to Red Balloon Security.

Disclaimer

1. Research presented in this talk not funded by any government sources or Columbia University.
2. Research presented not related to Red Balloon Security.
3. I only pretend to know how electricity works.

BOSS Hardware

You are doing **real science** when you are using...

Boss Hardware ☺

You are doing **real science** when you are using...



You purchased this item on July 16, 2013.

[View this order](#)



Roll over image to zoom in

Geo-Phone Paranormal Research Tool

by Gen-EI

★★★★☆ ▾ 11 customer reviews

List Price: \$59.95

Price: **\$49.49** + \$5.50 shipping

You Save: **\$10.46** (17%)

Note: Not eligible for Amazon Prime.

In Stock.

Ships from and sold by [General Electromagnetics](#).

Estimated Delivery Date: Aug. 6 - 11 when you choose Standard at checkout.

- Ultrasensitive vibration detector

Boss Hardware ☺

You are doing **real science** when you are using...



Customer Questions & Answers

Have a question? Ask the owners here

Ask

Don't see what you're looking for? Submit your question to our community by clicking the 'Ask' button above.

▲
0
votes
▼

Geo pone converts noise into voices? have I got that right, and these voices are they Alive humans like your neighbors that you hear?

A: It hears through vibrations, you have to set it down on something and then hook either a recorder or headphones to it to hear anything. I thought it was something else when I bought it. I didn't want to have to hook something up to it to hear sounds. as for voices, I only tried it once and I think it picked up everything.

Sandra Labella answered on April 17, 2014

Boss Hardware ☺

You are doing **real science** when you are using...

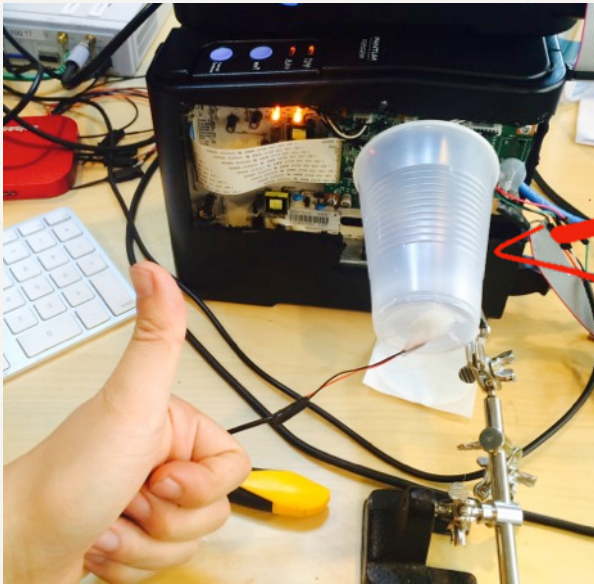

Homemade dog whistle **detector**
(in a cup)

Boss Hardware ☺

You are doing **real science** when you are using...



Roll over image to zoom in



Anti-Radiation Shield Women Maternity Briefs Panties Protection Medium 8900651M
[Be the first to review this item](#)

List Price: \$99.98
Price: **\$75.98** ✓Prime & Free Returns. [Details](#)
You Save: **\$24.00 (24%)**

Only 1 left in stock.
Sold by [OurSure](#) and [Fulfilled by Amazon](#). Gift-wrap available.

Want it Tuesday, Aug. 4? Order within **28 hrs 58 mins** and choose **One-Day Shipping** at checkout. [Details](#)

- 100% Silver-Nylon Blend
- 100% silver blend fabric provides super RF radiation shield effectiveness up to 60 dBin the frequency range from 10 MHz to 3 GHz and beyond, let you take advantage to prevent your baby from RF radiation
- Silky feel, light stretch, comfort woman briefs offer full front and back coverage following the natural leg curve
- Breathable and comfortable

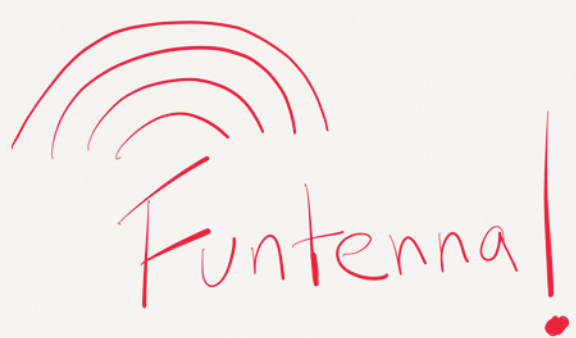

Noun:

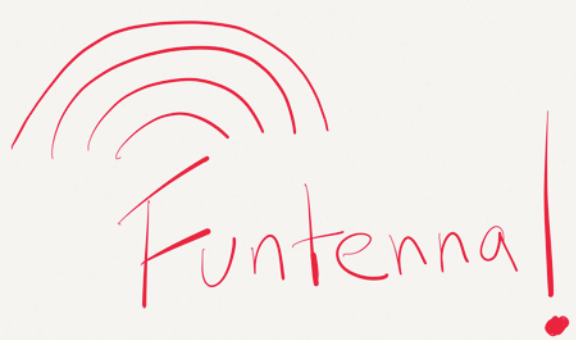

Noun:

1: Malware that intentionally causes compromising emanation.



Noun:

1: Malware that intentionally causes compromising emanation.

2: Software payload that intentionally causes its host hardware to act as an improvised RF transmitter using existing hardware, which are typically not designed for electromagnetic emanation.



xyz
Thing



xyz

Thing

Laptop



xyz

Thing

Laptop, Server,



xyz

Thing

Laptop, Server, phone,



xyz

Thing

Laptop, Server, phone,
router



xyz

Thing

Laptop, Server, phone,
router, printer,



xyz

Thing

Laptop, Server, phone,
router, printer, TV, car, building_ etc



+ Funtenna
payload

xyz
Thing



xyz
Thing

+

Funtenna
payload

(tiny malware)



xyz
Thing

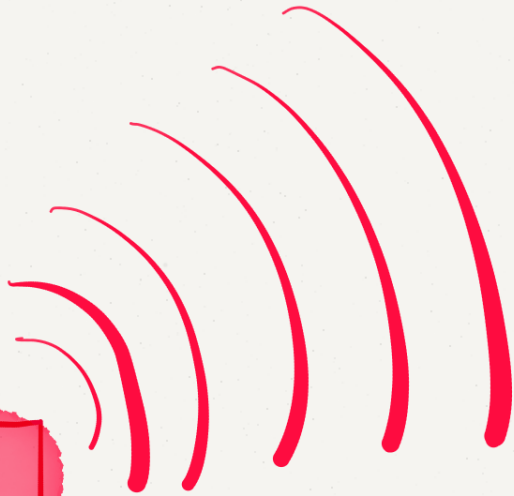

xyz
Thing



Attacker



↓
Attacker



xyz
Thing



xyz
Thing



receiver
Attacker

xyz
Thing



Monitored
Transmission
mediums



xyz
Thing



Monitored
Transmission
mediums



xyz
Thing





Transmission medium of
the **attacker's** choosing





Transmission medium of
the attacker's choosing

Where you **don't monitor**





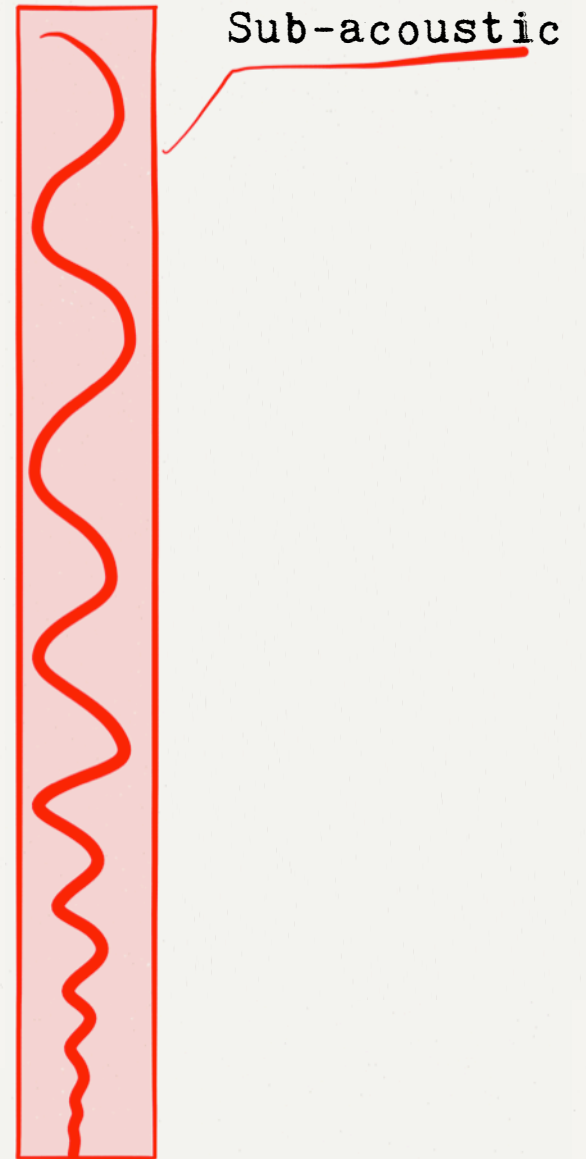

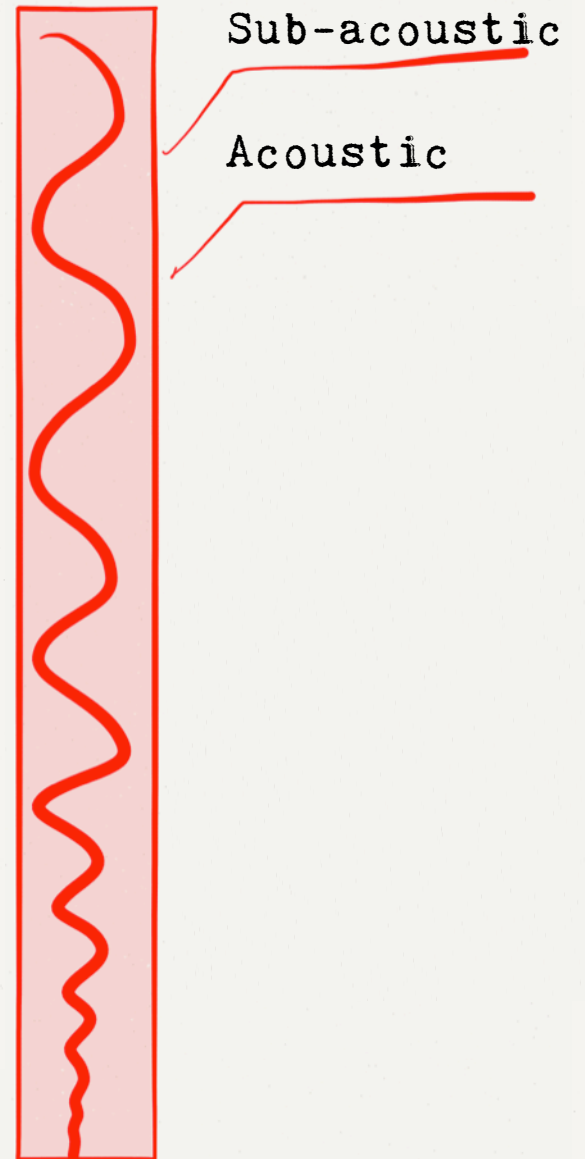

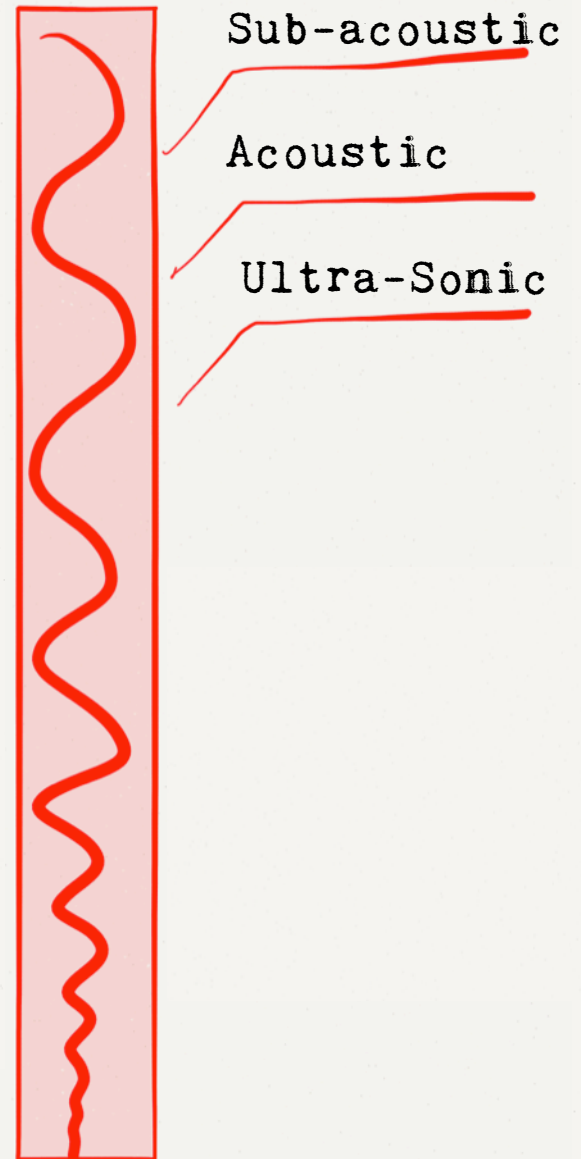

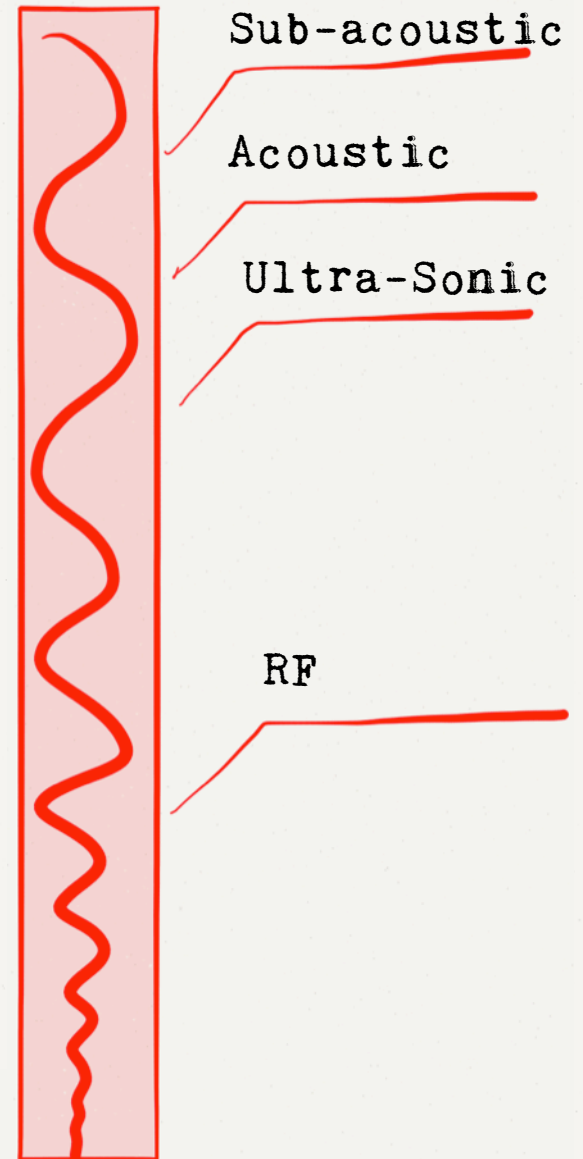

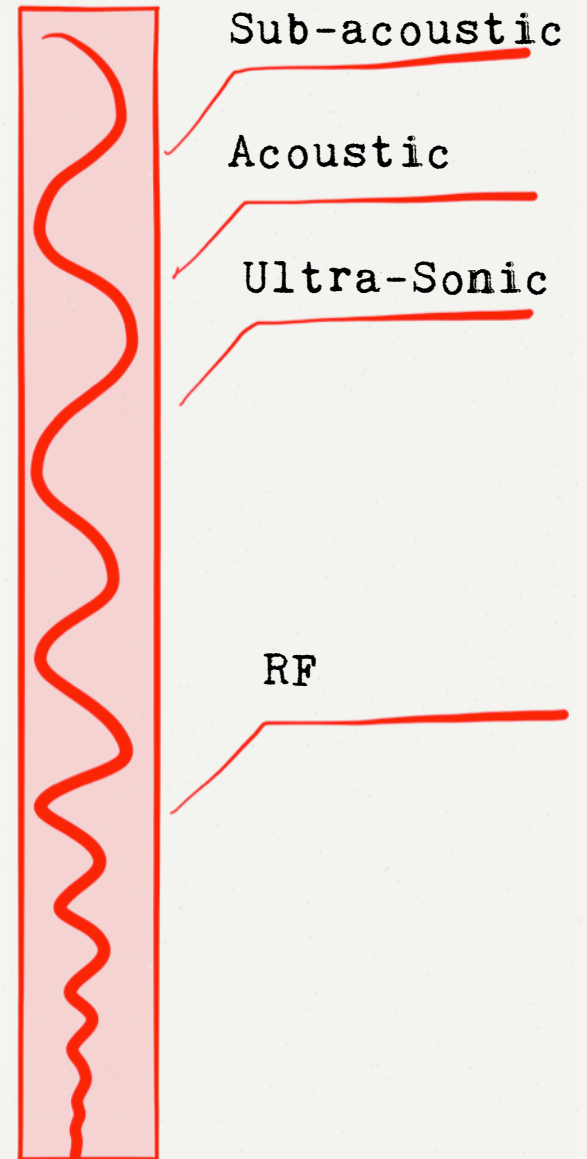

Why?

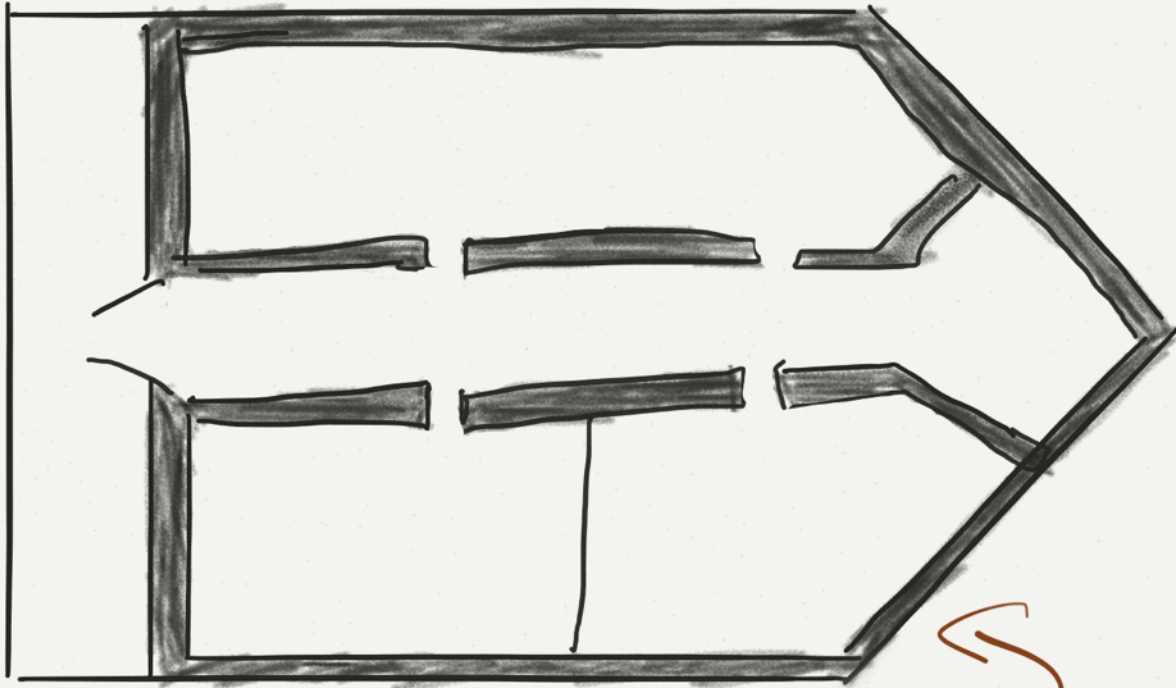

Super Secret Fort!

Internet!

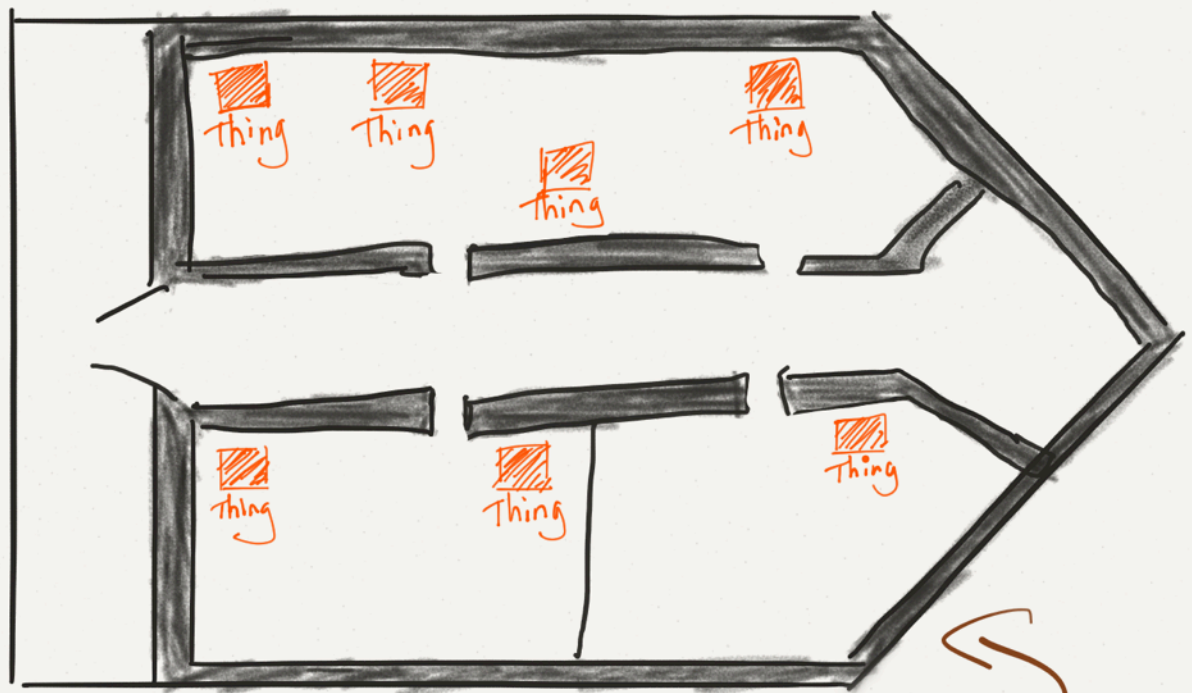

Super Secret Fort!

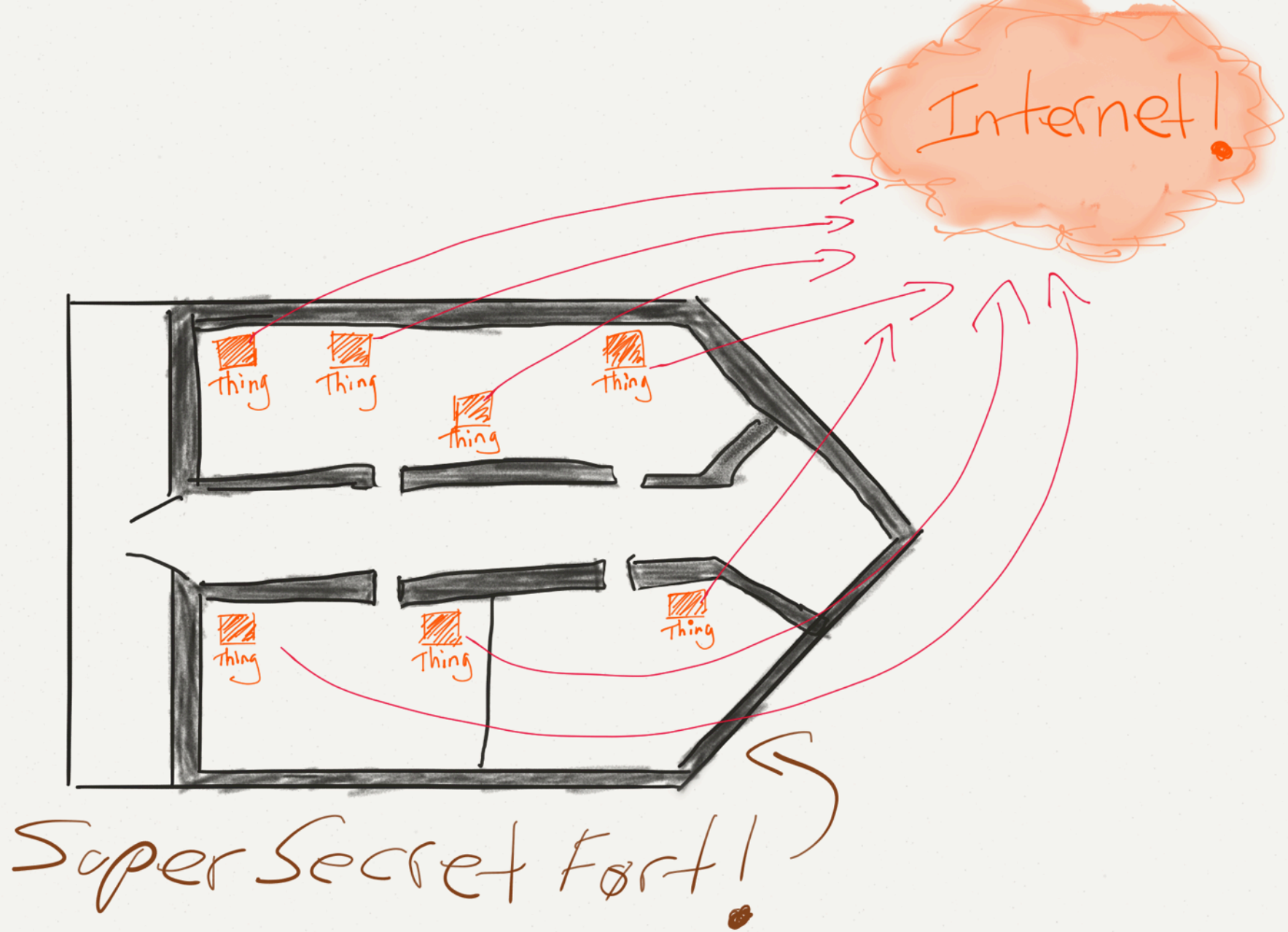

Too Obvious =(

Internet!

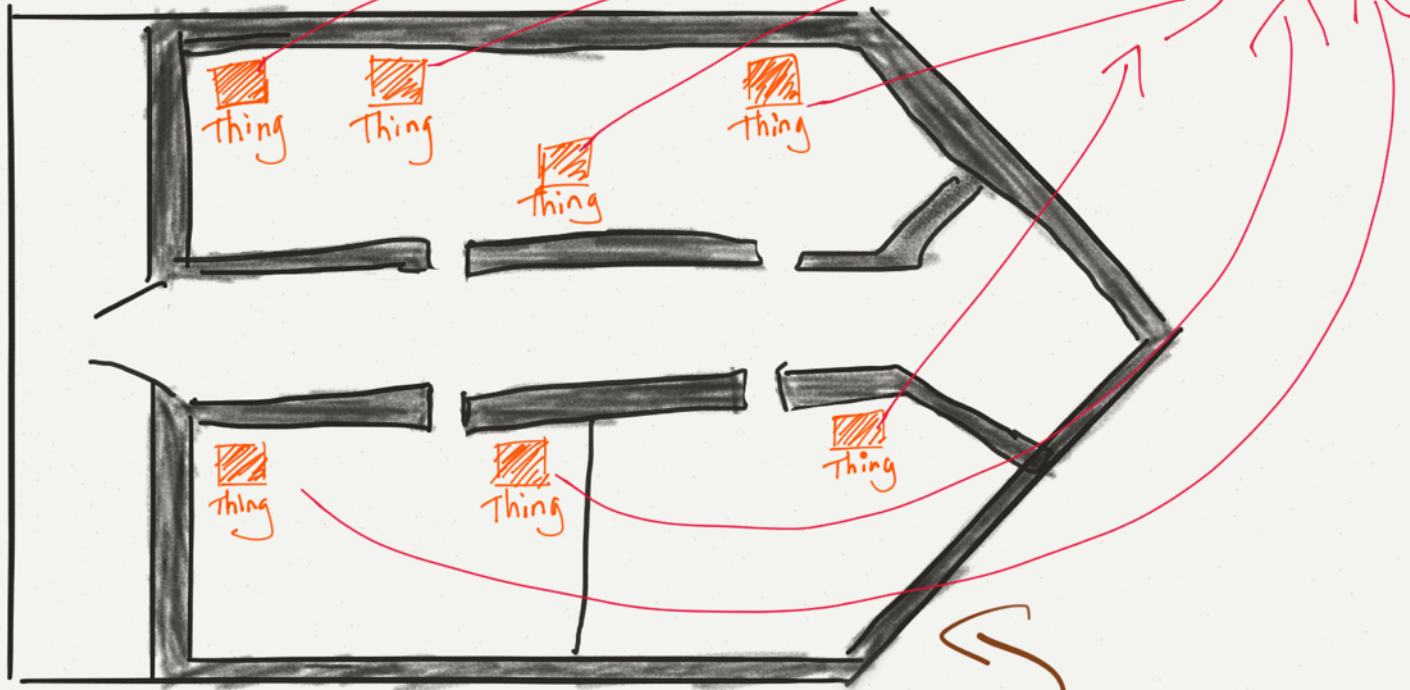

Super Secret Fort!

Internet!

AIR GAP!

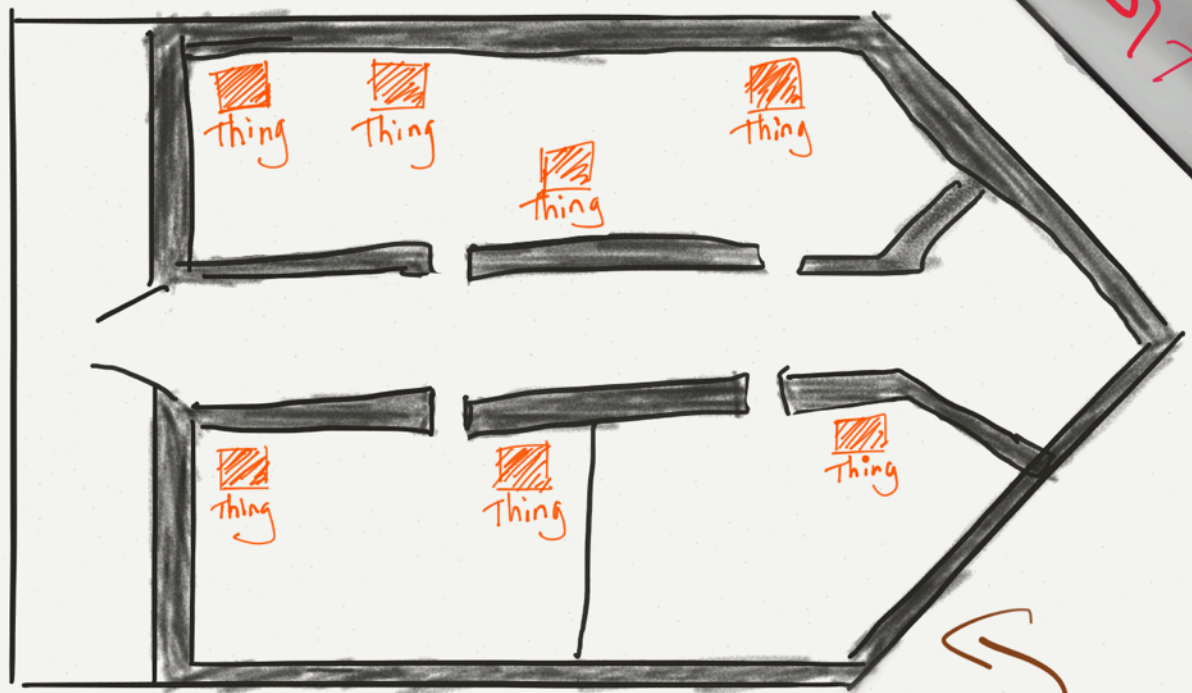

Super Secret Fort!

Anti: Super Secret Fort Technology

Anti: Super Secret Fort Technology



Amazing Ninja Tech

Anti: Super Secret Fort Technology



Amazing Ninja Tech

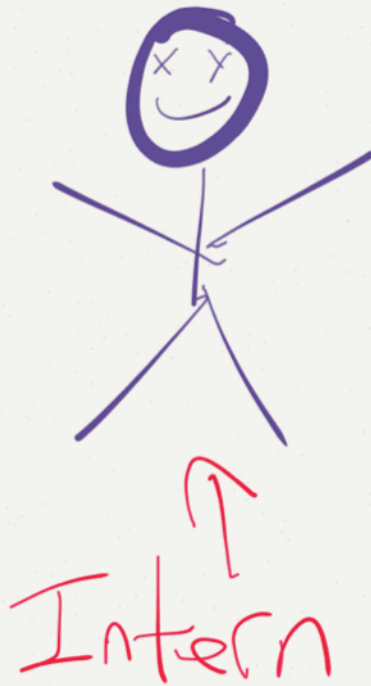

Anti: Super Secret Fort Technology



Amazing Ninja Tech

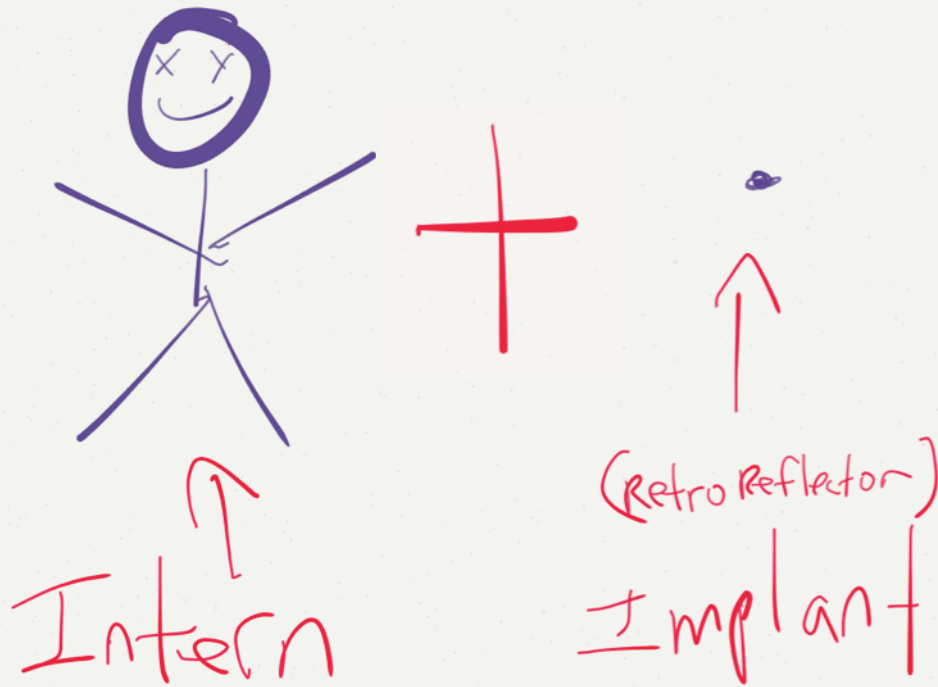

Anti: Super Secret Fort Technology



Amazing Ninja Tech

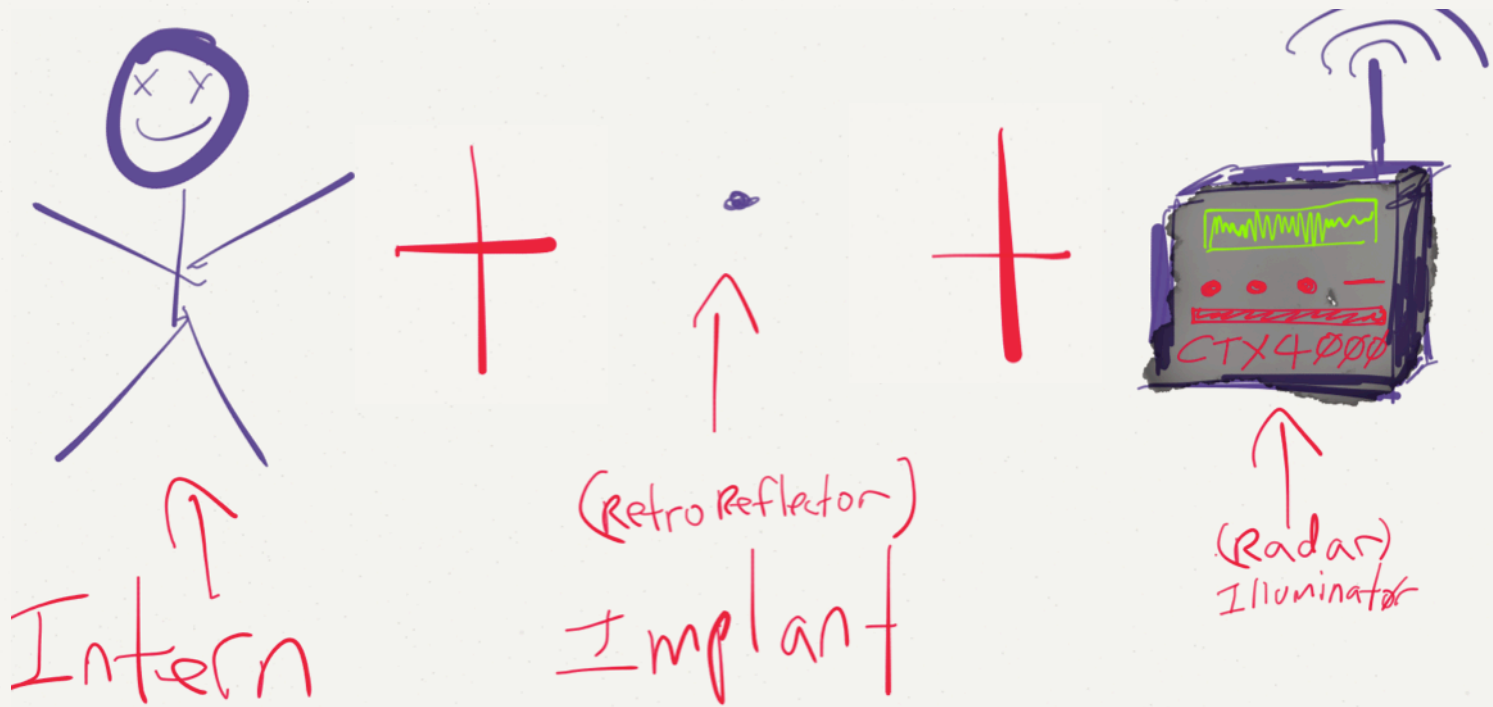

Step 1: Intern sneaks into
secret fort

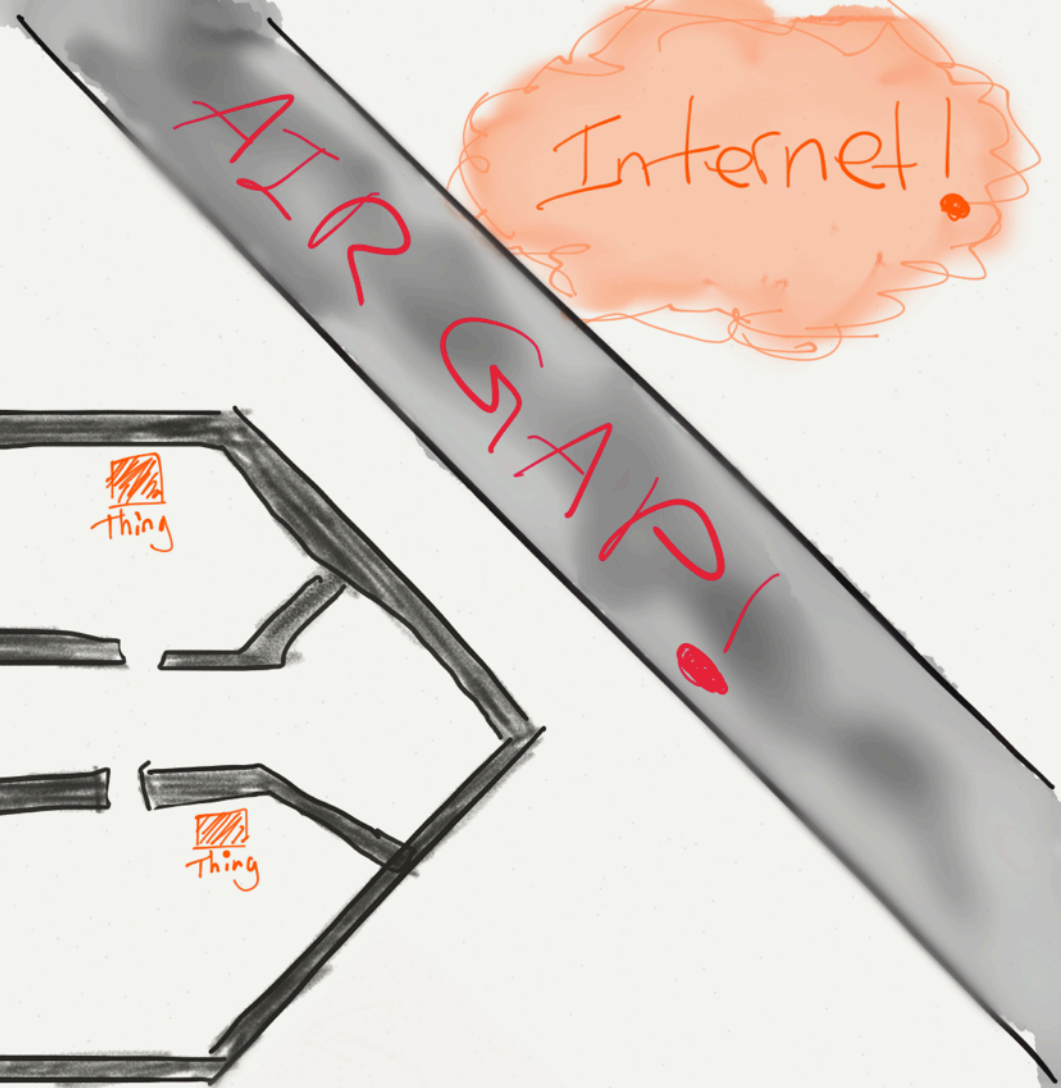
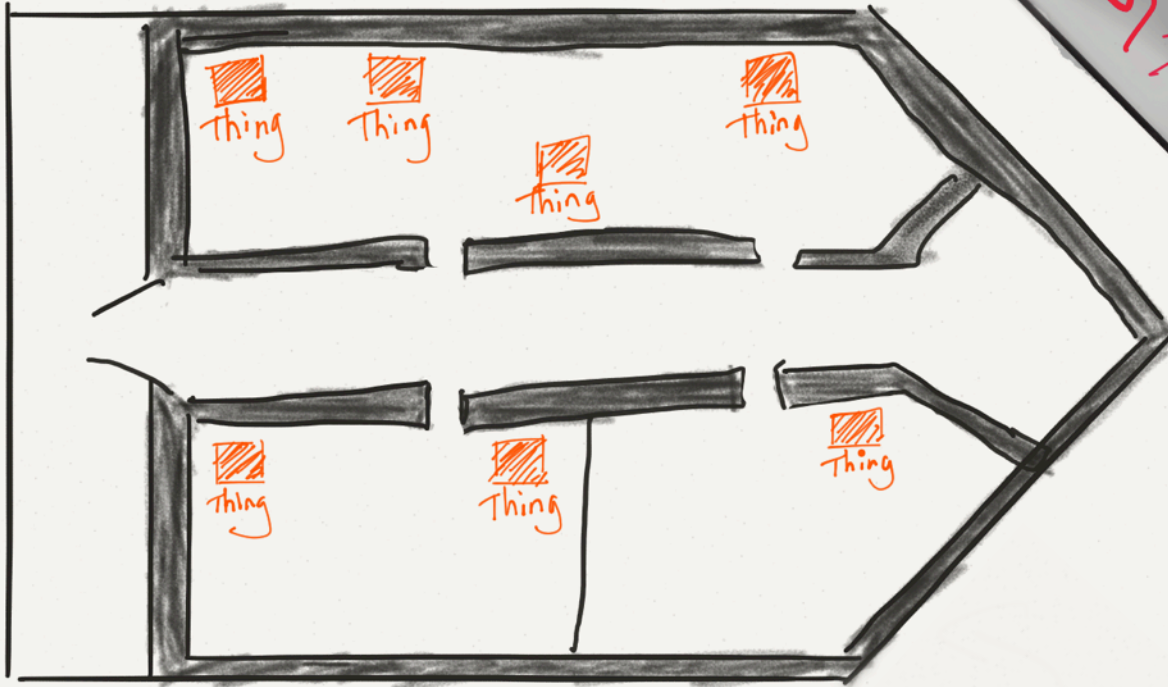

Step 1: Intern sneaks into
secret fort

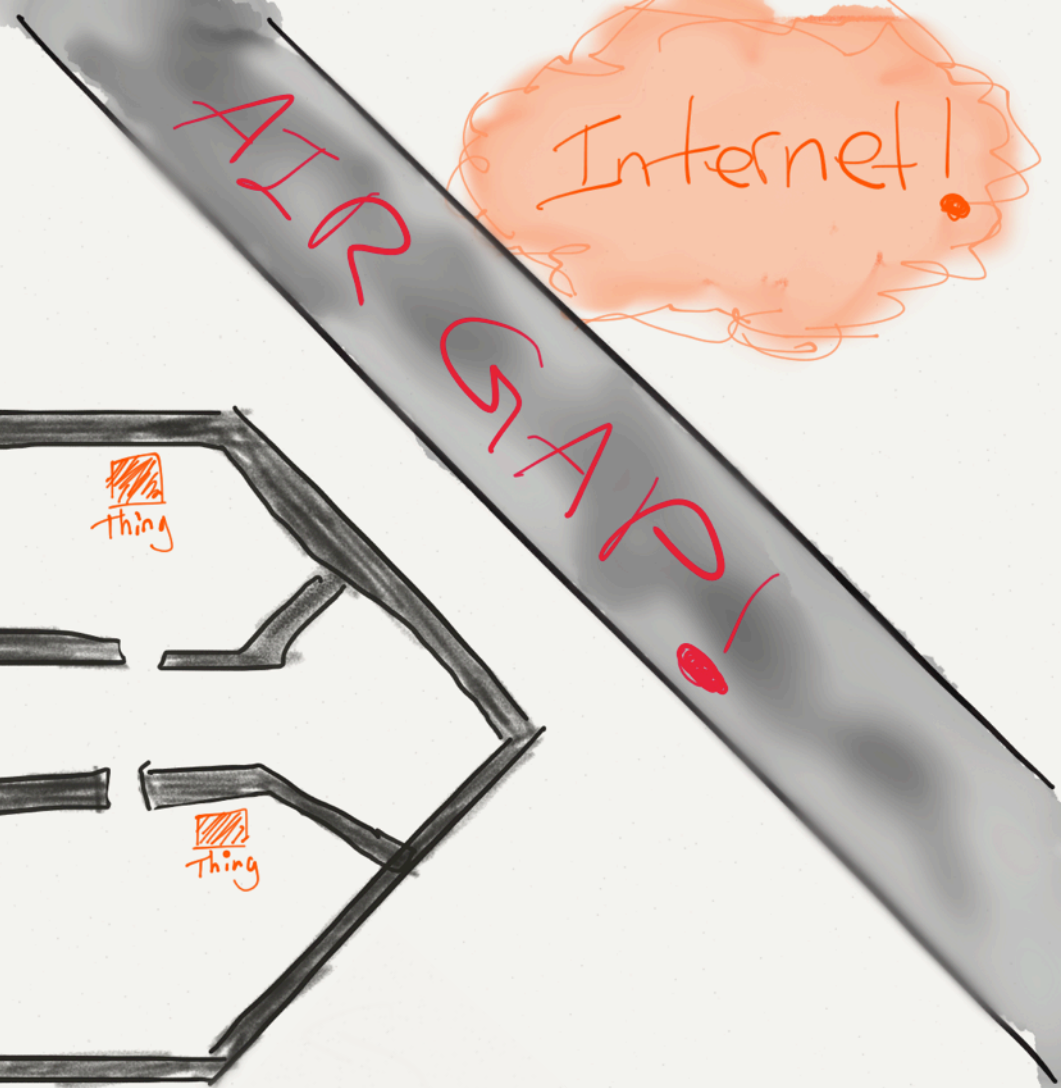
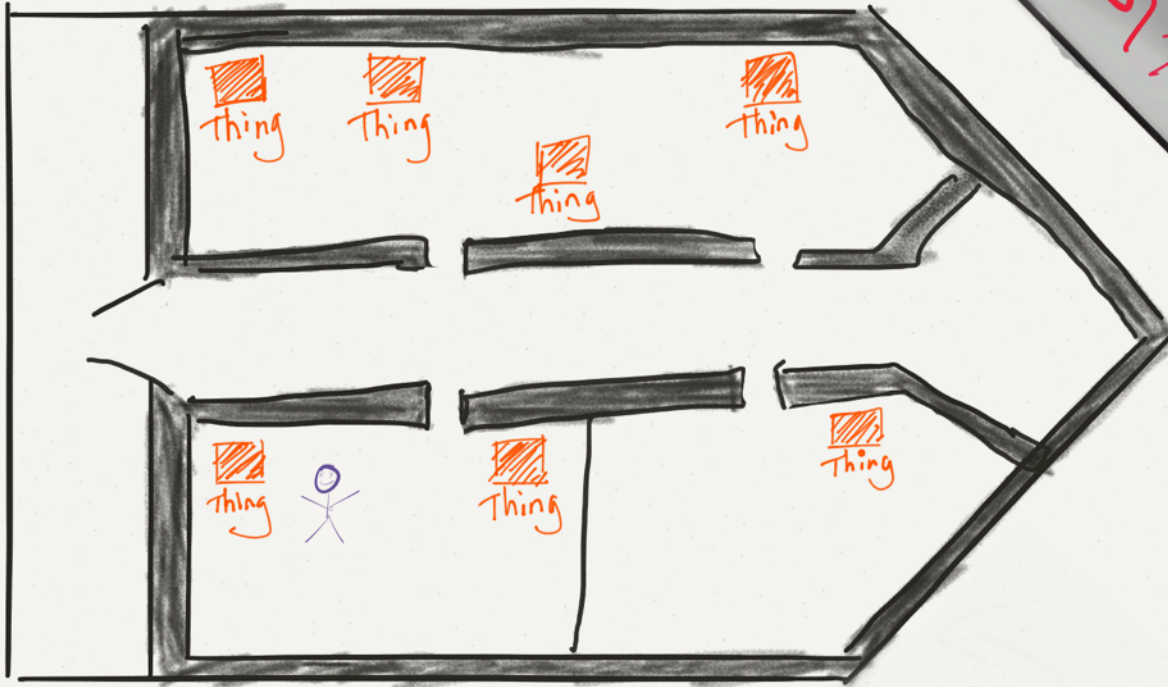

Step 1: Intern sneaks into
secret fort

Step 2: Intern physically implants
target thing with
retro-reflector

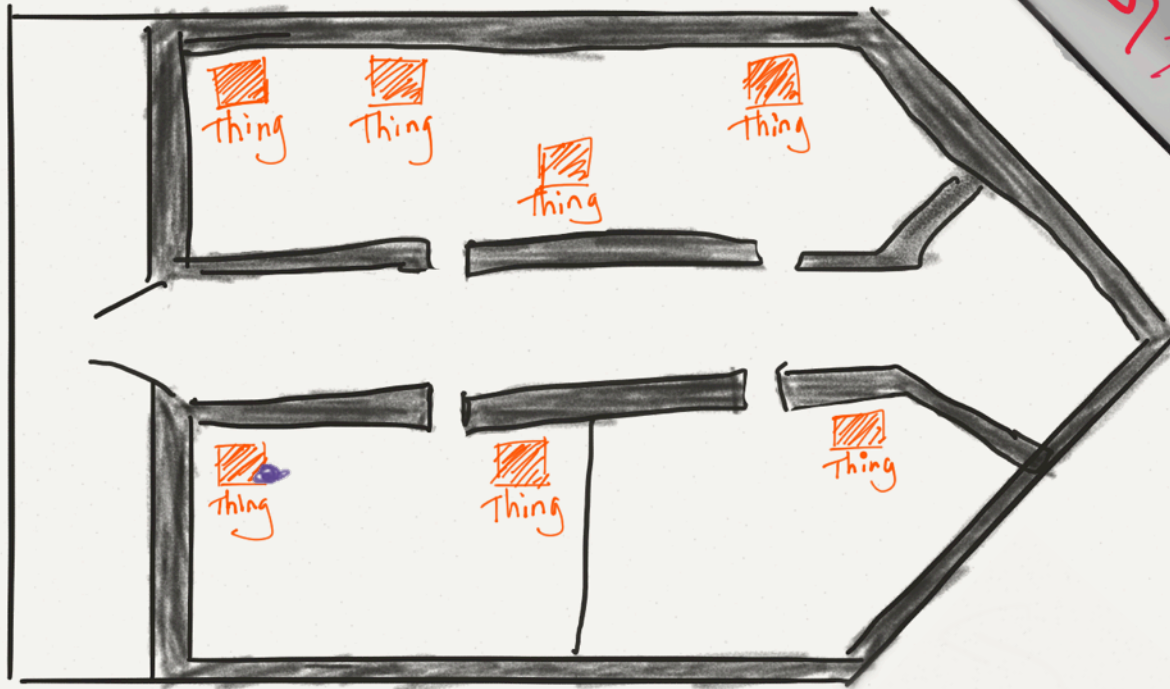

Step 1: Intern sneaks into
secret fort

Step 2: Intern physically implants
target thing with
retro-reflector

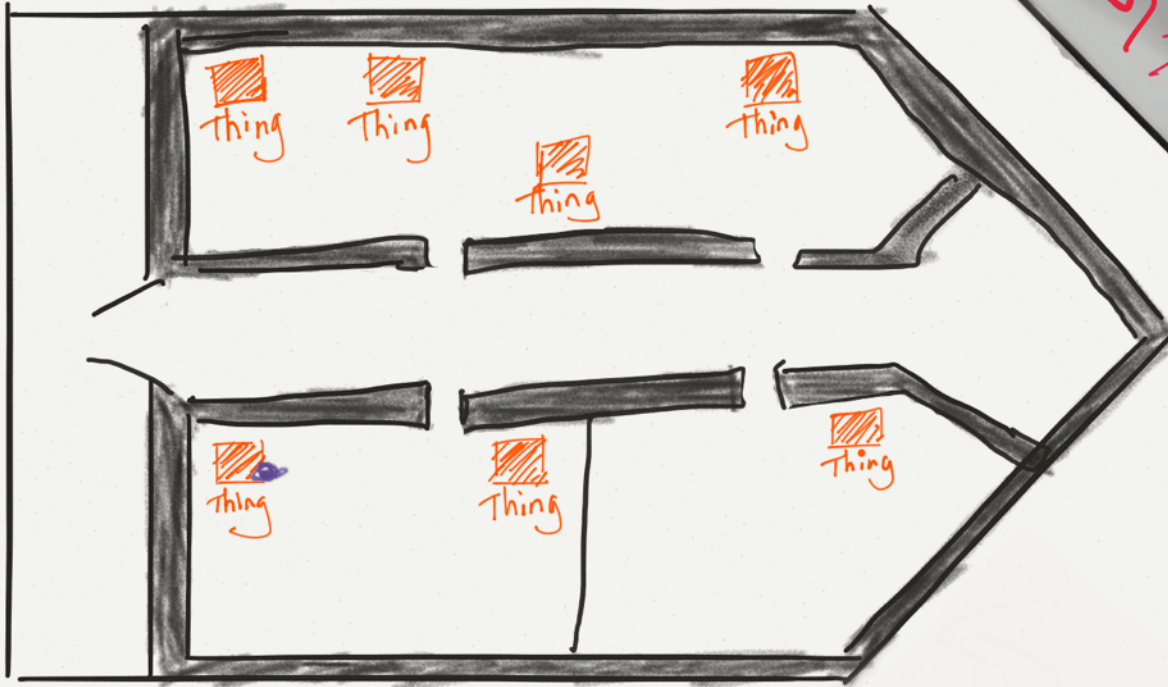

Step 3: Continuous RF Illumination (CTX4k, etc)
into secret fort

Step 1: Intern sneaks into
secret fort

Step 2: Intern physically implants
target thing with
retro-reflector

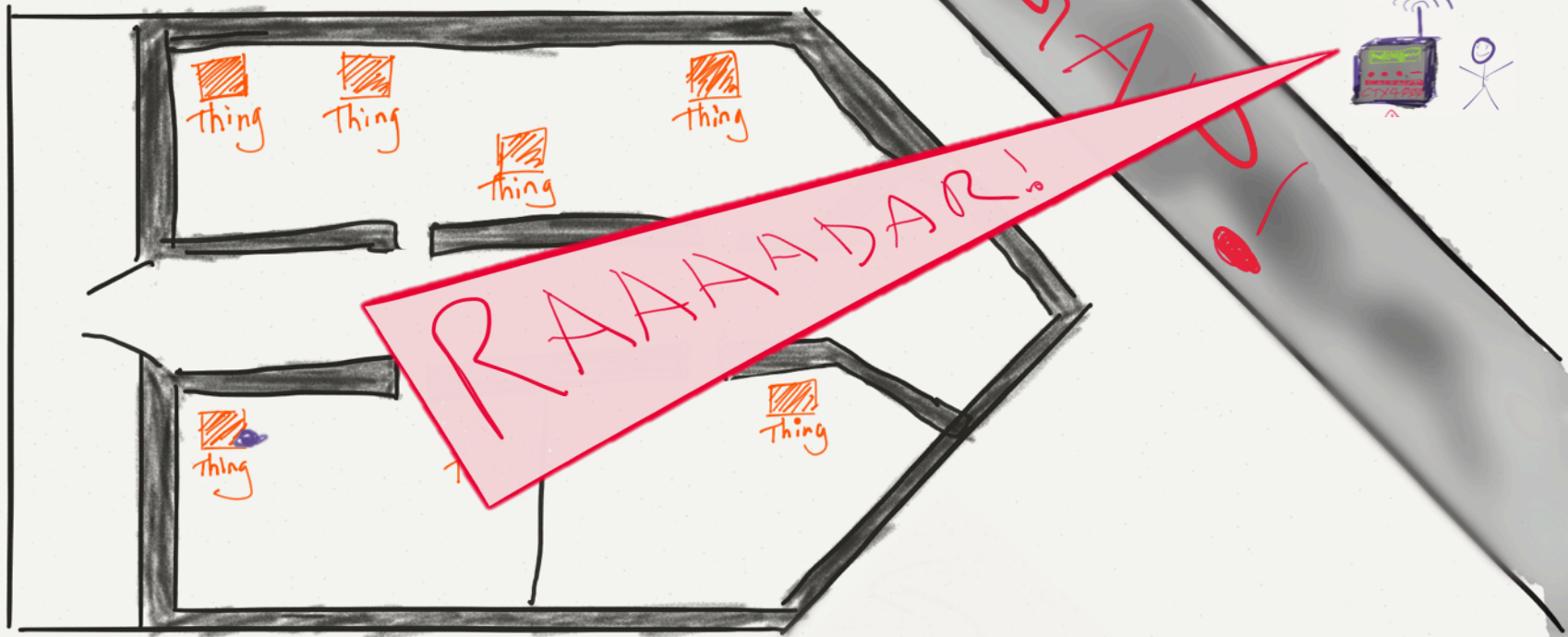

Step 3: Continuous RF Illumination (CTX4k, etc)
into secret fort, secret data comes out

Step 1: Intern sneaks into
secret fort

Step 2: Intern physically implants
target thing with
retro-reflector

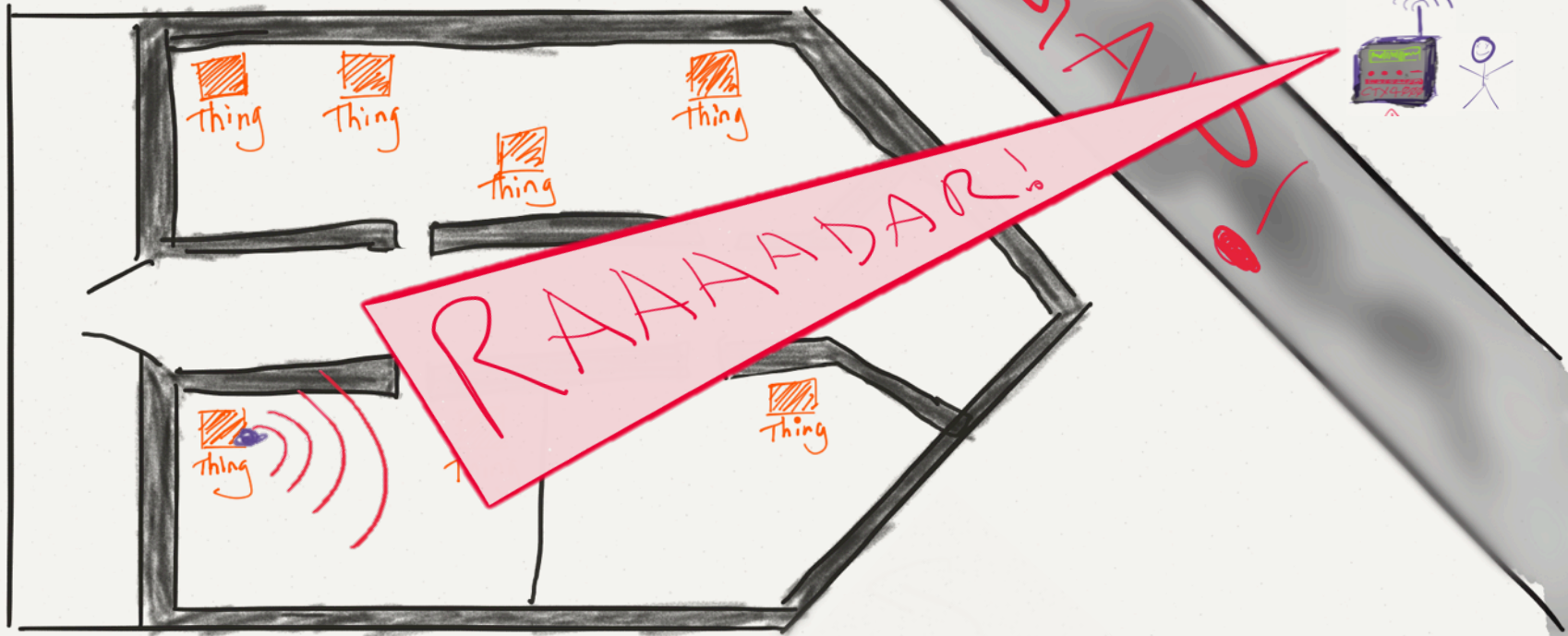

Step 3: Continuous RF Illumination (CTX4k, etc)
into secret fort, secret data comes out

Good idea if...

Good idea if...

1: Infinite Interns

Good idea if...

1: Infinite Interns

2: Not worried about **leaving evidence behind**
(see #1)

Retroreflector Technology

Retroreflector Technology

In Historical Context...

"The Thing"

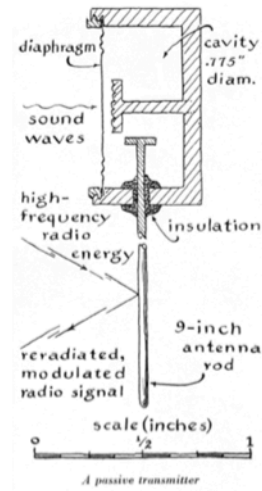
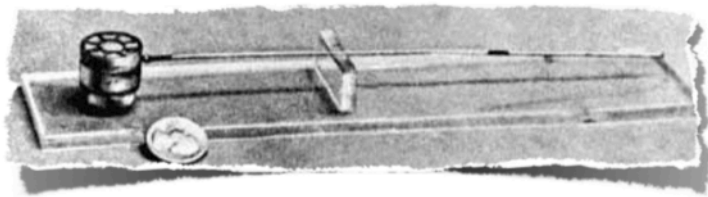

(from Scientific American, 1968)

sites.apam.columbia.edu/courses/apph4903x/Great_Seal_Bug.pdf

Retroreflector In Historical Context...

Way back when...

Retroreflector In Historical Context...



Phone

Designed for this

Retroreflector In Historical Context...



Phone



phone

Deployed in the
age of **this**

Retroreflector In Historical Context...



office

Designed for this

Retroreflector In Historical Context...



office



office

Deployed in the
age of **this**

The Difference?



The Difference?

~ 50 Million Transistors



8/10/15

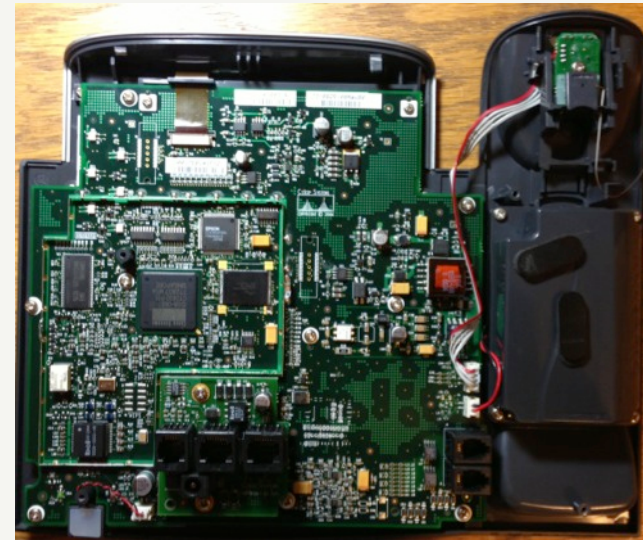

Blackhat USA 2015

The Difference?

~ 50 Million Transistors
~ 1 Million Lines of Code



8/10/15

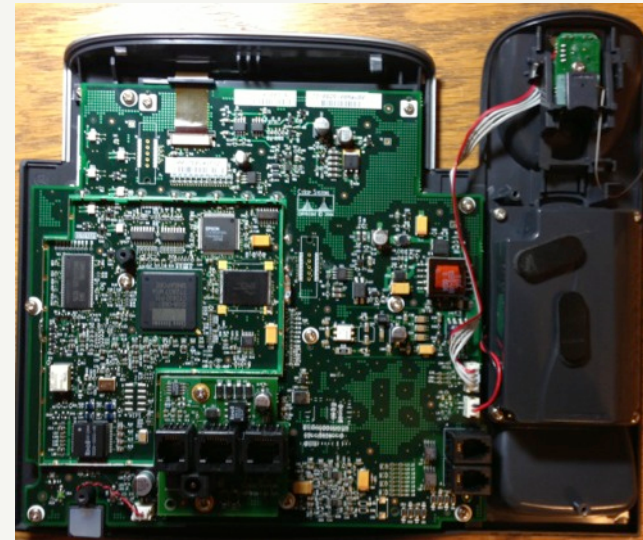

Blackhat USA 2015

The Difference?

~ 50 Million Transistors
~ 1 Million Lines of Code

All-purpose computing hardware
Inside special-purpose packaging



8/10/15

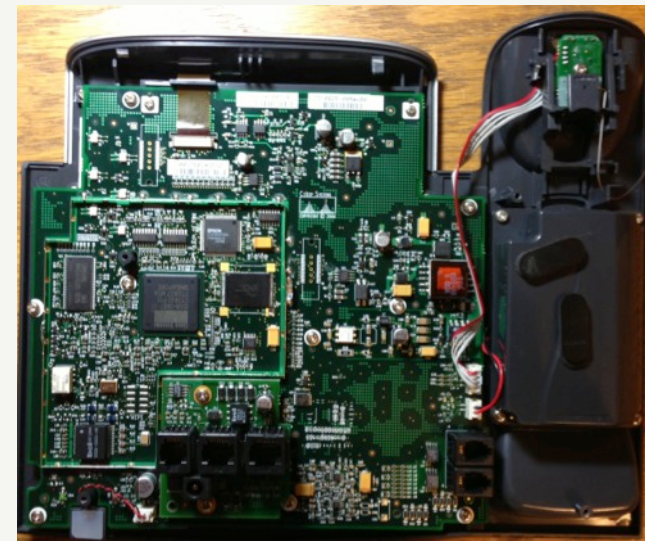

Blackhat USA 2015

Leverage This Difference



~ 50 Million Transistors
~ 1 Million Lines of Code

All-purpose computing hardware
Inside special-purpose packaging

And...

↳ Emanate like a "

~~Scrub~~

 BOSS!

Leverage This Difference

And...

1. Exfiltrate using **only software**

Leverage This Difference

And...

1. Exfiltrate using only software
2. Exfiltrate using **all the things**

Leverage This Difference

And...

1. Exfiltrate using only software
2. Exfiltrate using all the things
3. Exfiltrate using arbitrary frequency range

Leverage This Difference

And...

1. Exfiltrate using only software
2. Exfiltrate using all the things
3. Exfiltrate using arbitrary frequency range
4. **Evaporate** when done

Part I

Compromising Emanations!

Part I

Compromising Emanations!

Part II

Firmware Shenanigans

PRIOR ART

350 MHz center frequency, 50 MHz bandwidth, 16 (1) frames averaged, 3 m distance



magnified image section



Fig. 1. Eavesdropped Linux boot screen visible on the LCD of a Toshiba 440CDX laptop (log-periodic antenna, vertical polarization).



Electromagnetic Eavesdropping Risks of Flat-Panel Displays

Markus G. Kuhn

University of Cambridge, Computer Laboratory,
15 JJ Thomson Avenue, Cambridge CB3 0FD, United Kingdom
<http://www.cl.cam.ac.uk/~mgk25/>

PRIOR ART

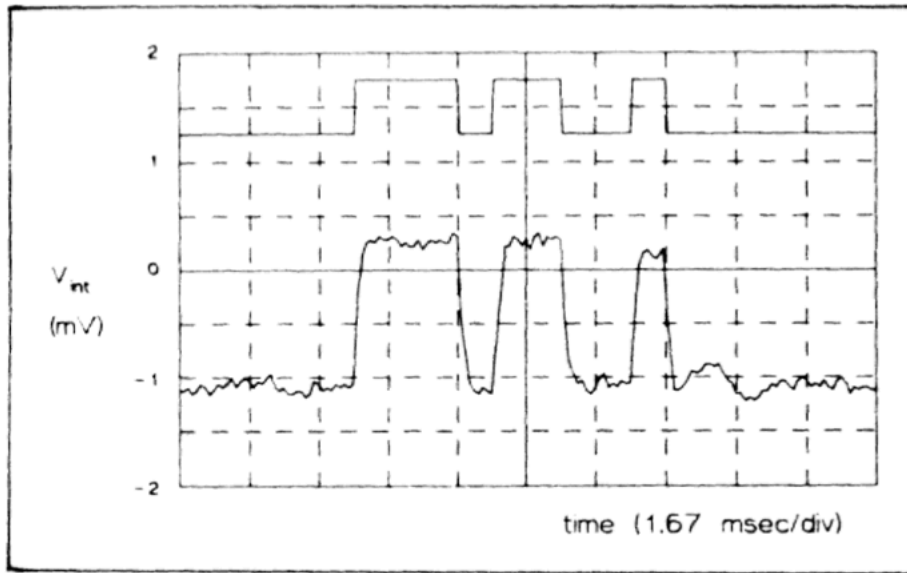

Fig. 4. Original and intercepted data signal at 7 m and 98 MHz (FM band).

**The Threat of
Information Theft
by Reception of
Electromagnetic
Radiation from
RS-232 Cables**

Peter Smulders

Example: Acoustic Crypto-Analysis

Genkin, Shamir, Tromer

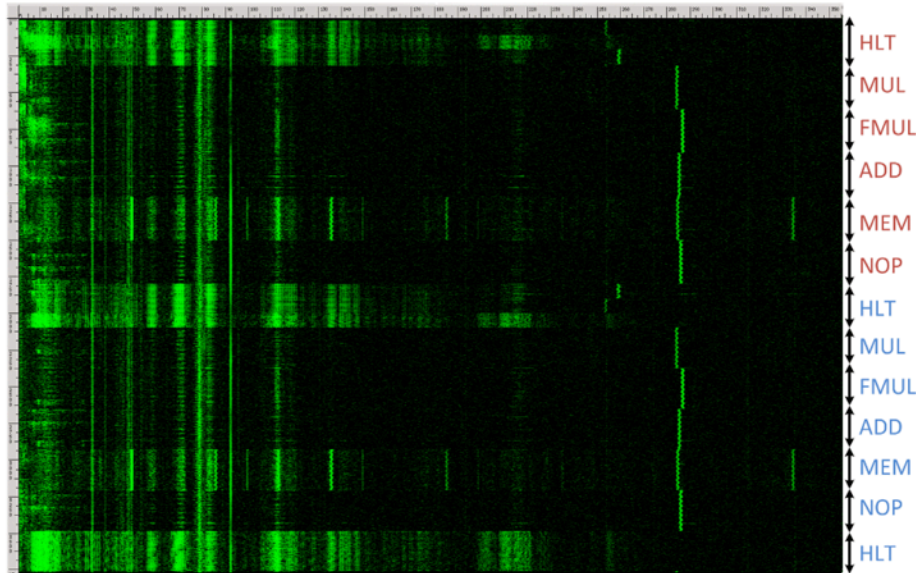

Figure 7: Acoustic measurement frequency spectrogram of a recording of different CPU operations using the Brüel&Kjær 4939 microphone capsule. The horizontal axis is frequency (0–310 kHz), the vertical axis is time (3.7 sec), and intensity is proportional to the instantaneous energy in that frequency band.

RSA Key Extraction via Low-Bandwidth Acoustic Cryptanalysis*

Daniel Genkin

Technion and Tel Aviv University
danielg3@cs.technion.ac.il

Adi Shamir

Weizmann Institute of Science
adi.shamir@weizmann.ac.il

Eran Tromer

Tel Aviv University
tromer@cs.tau.ac.il

Example: Acoustic Crypto-Analysis

Genkin, Shamir, Tromer

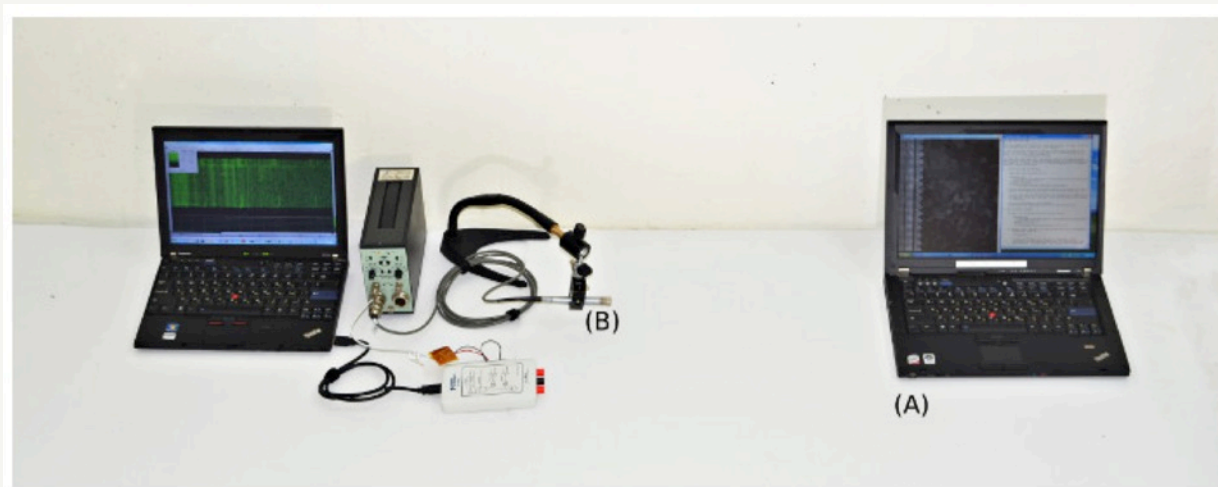

4 Meters!

RSA Key Extraction via Low-Bandwidth Acoustic Cryptanalysis*

Daniel Genkin

Technion and Tel Aviv University
danielg3@cs.technion.ac.il

Adi Shamir

Weizmann Institute of Science
adi.shamir@weizmann.ac.il

Eran Tromer

Tel Aviv University
tromer@cs.tau.ac.il

Majority of Compromising Emanations Research

Majority of Compromising Emanations Research

Faint, accidentally
Leaked signal

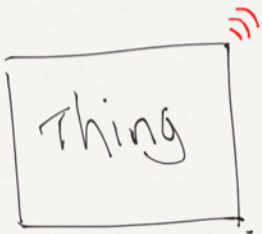

Majority of Compromising Emanations Research

Faint, accidentally
Leaked signal

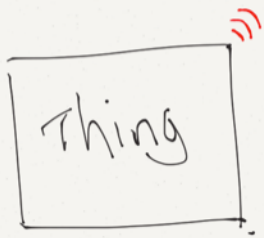

Big powerful receiver



What if...

Faint, accidentally
Leaked signal

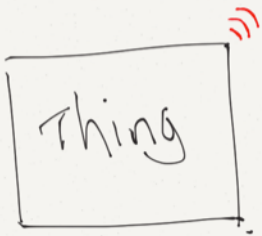

Big powerful receiver



What if...

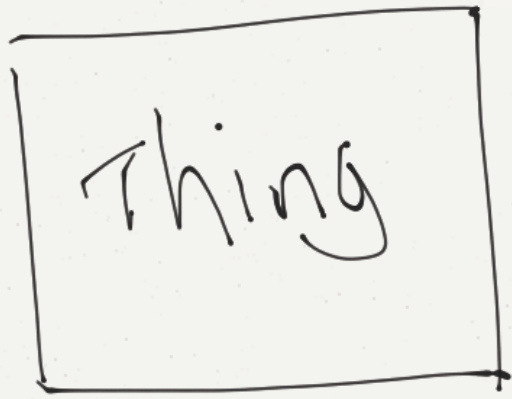

Loud, intentionally
generated compromising emanation

Big powerful receiver

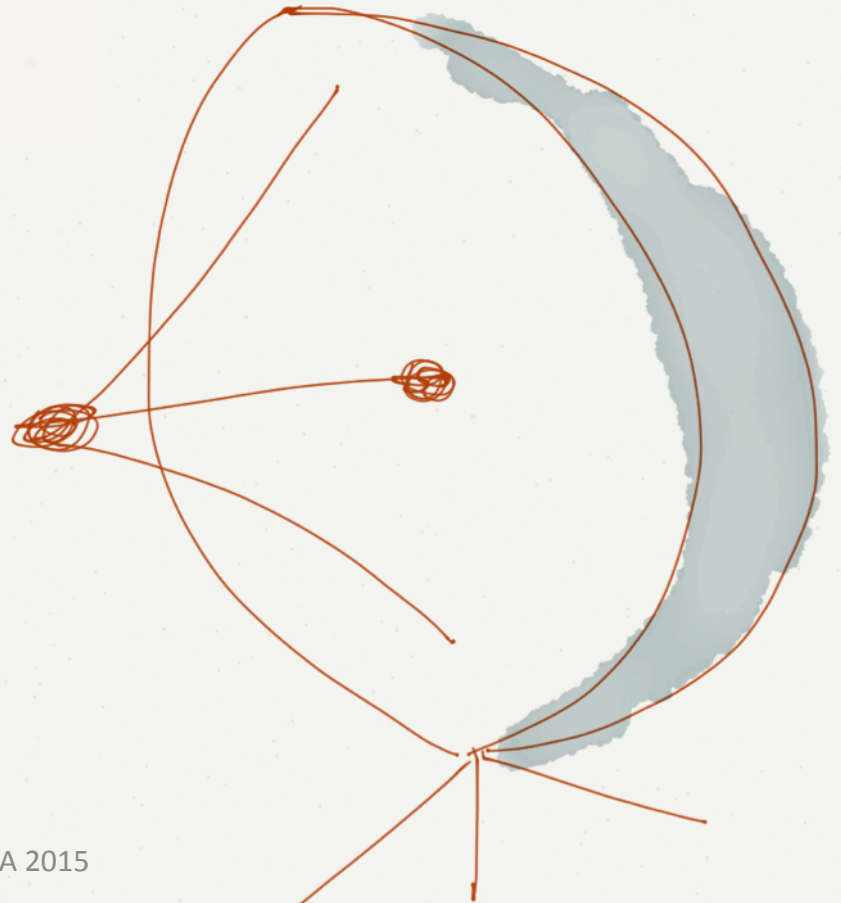

DEMO 1: Acoustic Funtenna Emanation

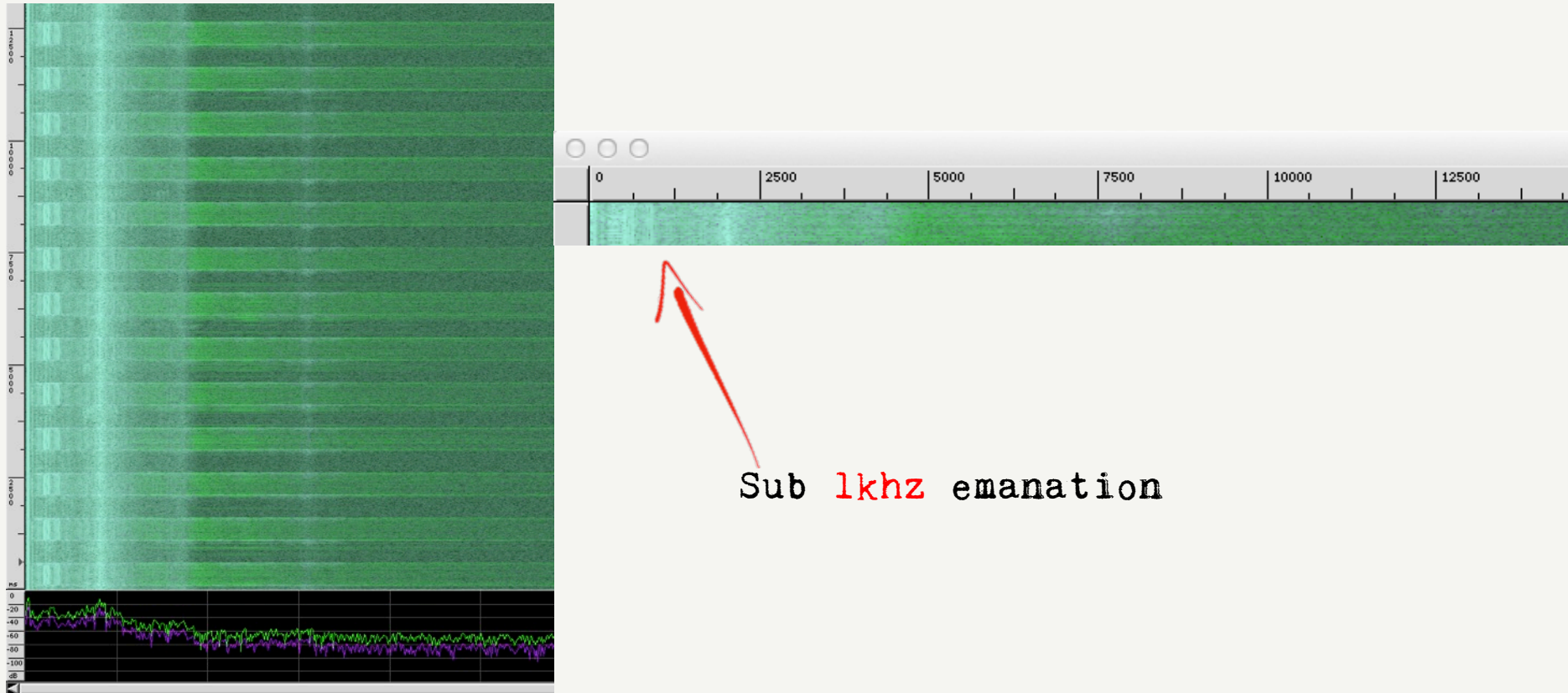

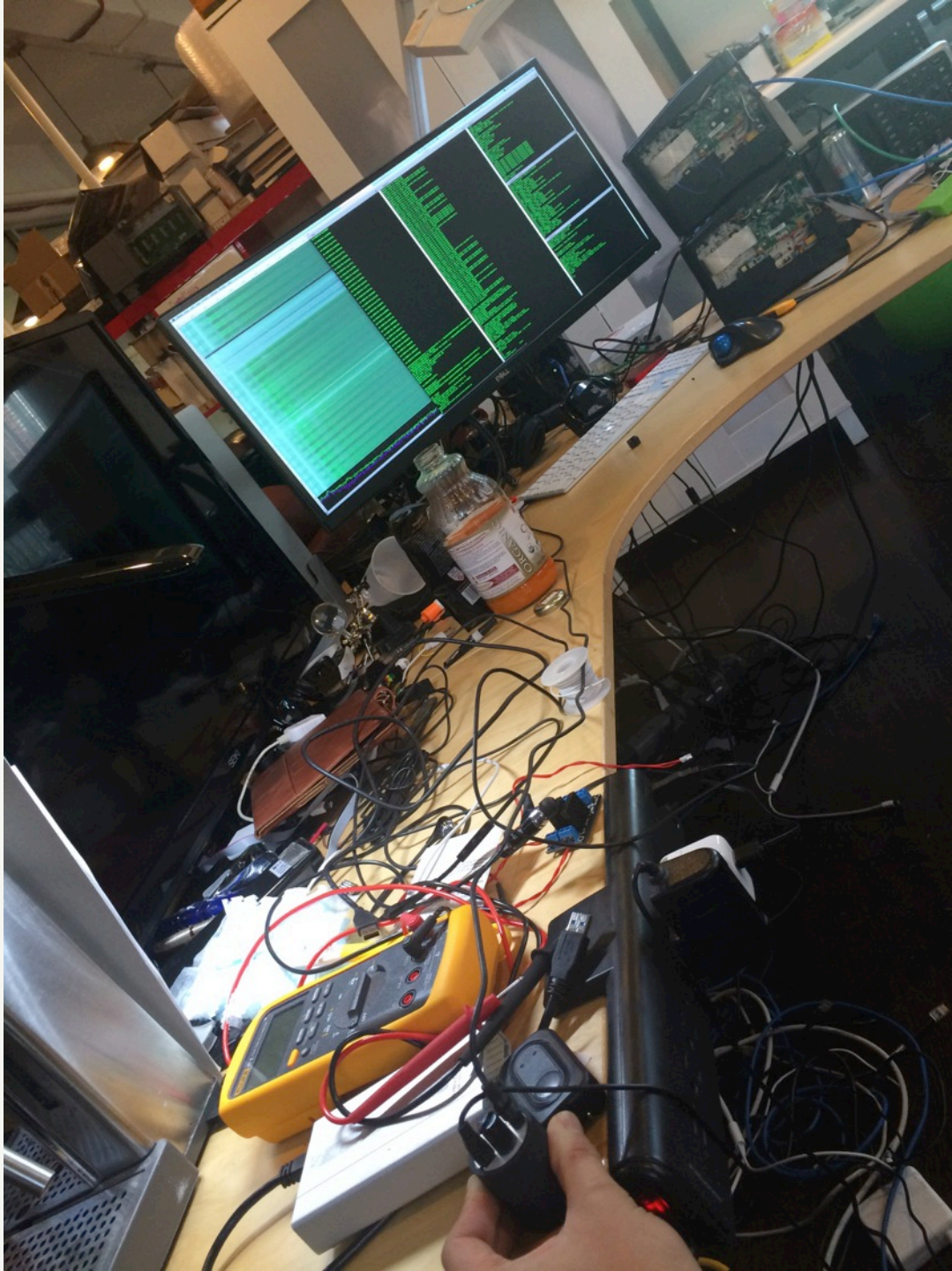

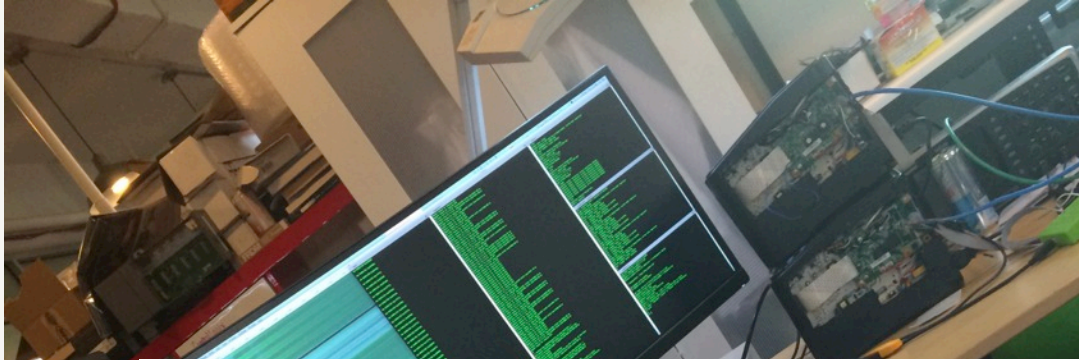

Customer Questions & Answers

Have a question? Ask the owners here

Ask

Don't see what you're looking for? Submit your question to our community by clicking the 'Ask' button above.

▲
0
votes
▼

Geo pone converts noise into voices? have I got that right, and these voices are they Alive humans like your neighbors that you hear?

A: It hears through vibrations, you have to set it down on something and then hook either a recorder or headphones to it to hear anything. I thought it was something else when I bought it. I didn't want to have to hook something up to it to hear sounds. as for voices, I only tried it once and I think it picked up everything.

Sandra Labella answered on April 17, 2014



No, not like Alive humans

DEMO 1.5: Ultrasonic Funtenna Emanation

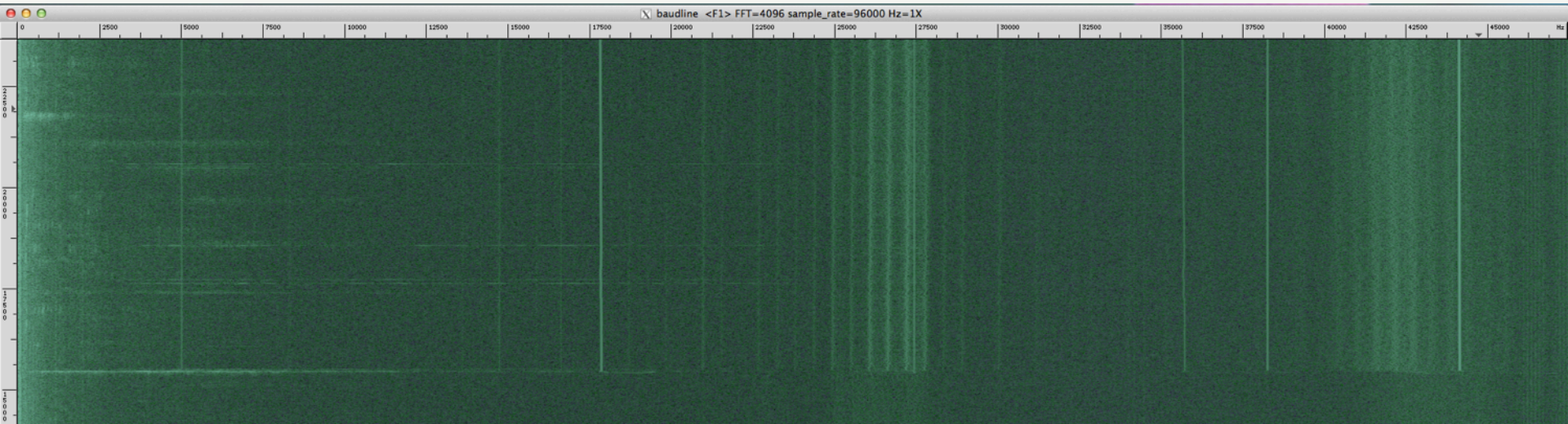

DEMO 1.5: Ultrasonic Funtenna Emanation

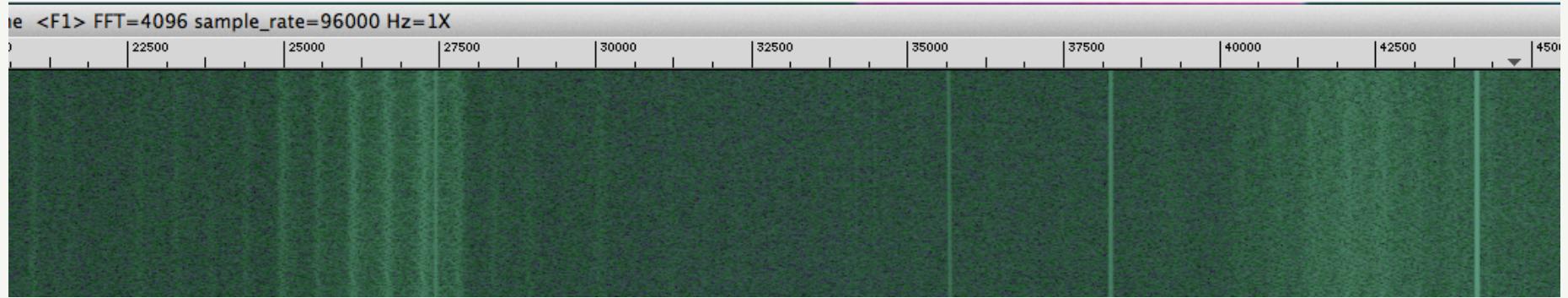

~27 Khz

~42 Khz

Soft Tempest: Hidden Data Transmission Using Electromagnetic Emanations

Markus G. Kuhn* and Ross J. Anderson

University of Cambridge, Computer Laboratory, New Museums Site,
Pembroke Street, Cambridge CB2 3QG, United Kingdom
{mgk25,rja14}@cl.cam.ac.uk

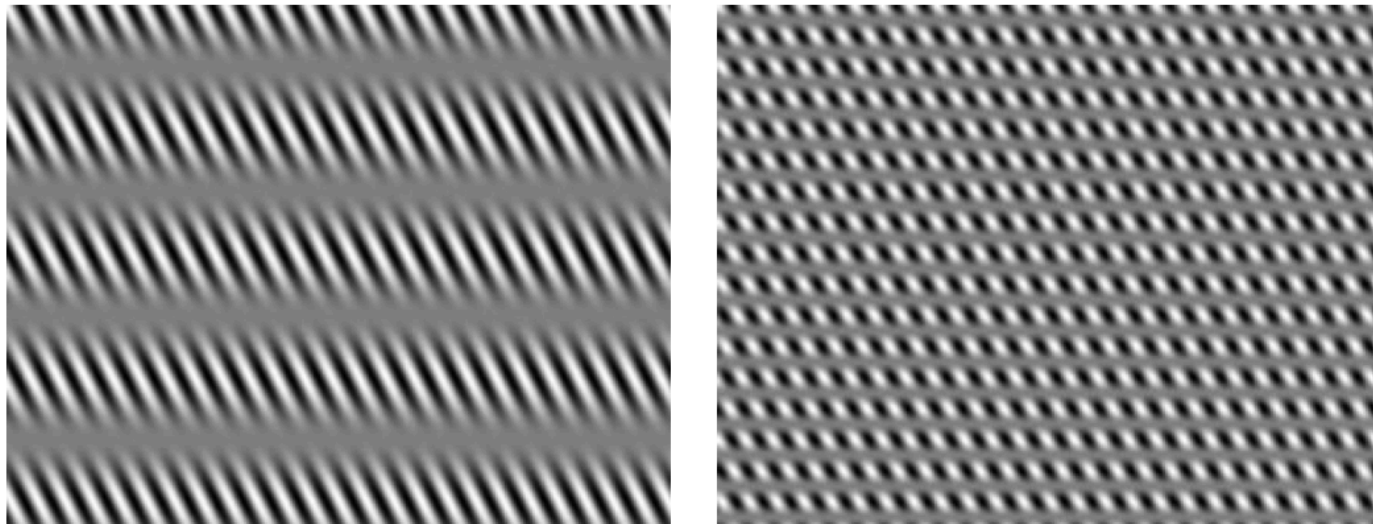

Fig. 1. Example screen contents that cause the authors' computer monitor to broadcast an $f_t = 300$ Hz (left) and 1200 Hz tone (right) on an $f_c = 2.0$ MHz carrier in amplitude modulation.

```
ModeLine "1152x900" 95 1152 1152 1192 1472 900 900 931 939
```

Soft Tempest: Hidden Data Transmission Using Electromagnetic Emanations

Markus G. Kuhn and Ross J. Anderson
Computer Laboratory



**UNIVERSITY OF
CAMBRIDGE**

<http://www.cl.cam.ac.uk/~mgk25/ih98-tempest-slides.pdf>

***Soft Tempest: Hidden Data Transmission
Using Electromagnetic Emanations***

Markus G. Kuhn and Ross J. Anderson
Computer Laboratory



<http://www.cl.cam.ac.uk/~mgk25/08-tempest-slides.pdf>

Conclusions

→ Interesting field of study, mostly unexplored in the open literature

Probably not a new idea

But not discussed "in the open"

A decade later...

BitWhisper: Covert Signaling Channel between Air-Gapped Computers using Thermal Manipulations

Guri, Monitz, Mirski, Elovici

Distance: 40cm

Data Rate: 1-8 bits per hour

On Covert Acoustical Mesh Networks In Air

Hanspach & Goetz

Distance: 19.7 M

Data Rate: 20 bits per second

AirHopper: Bridging the Air-Gap Between Isolated Networks and Mobile Phones Using Radio Frequencies

Guri, Kedma, Kachlon, Elovici

Distance: 7 M

Data Rate: 60 bits per second

The next steps

The next steps

1. Generalize and Unify Methodology

The next steps

1. Generalize and Unify Methodology
2. Minimize hardware dependencies

Funtenna ~~101~~

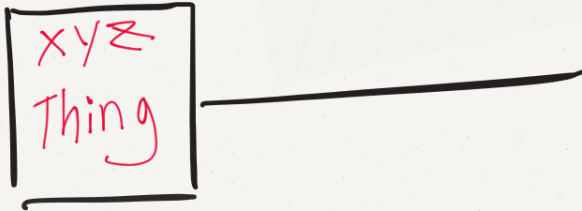

Funtenna 101

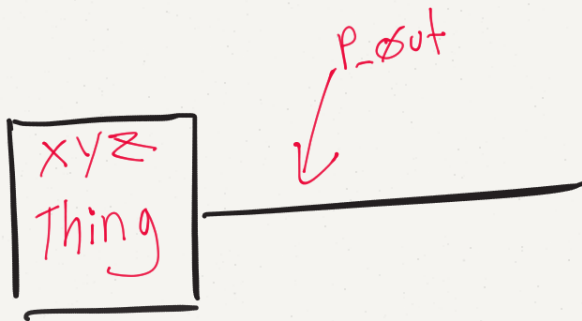

Funtenna ~~101~~

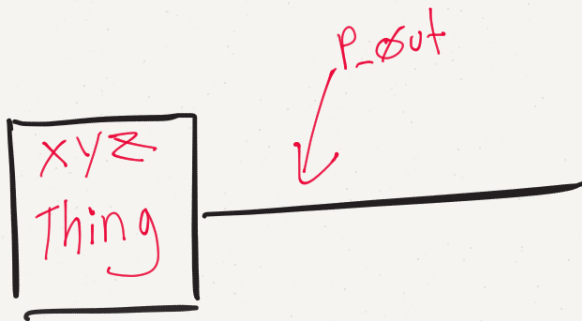

P_out: 0 1 0 1 0 1 0 1



Funtenna ~~101~~

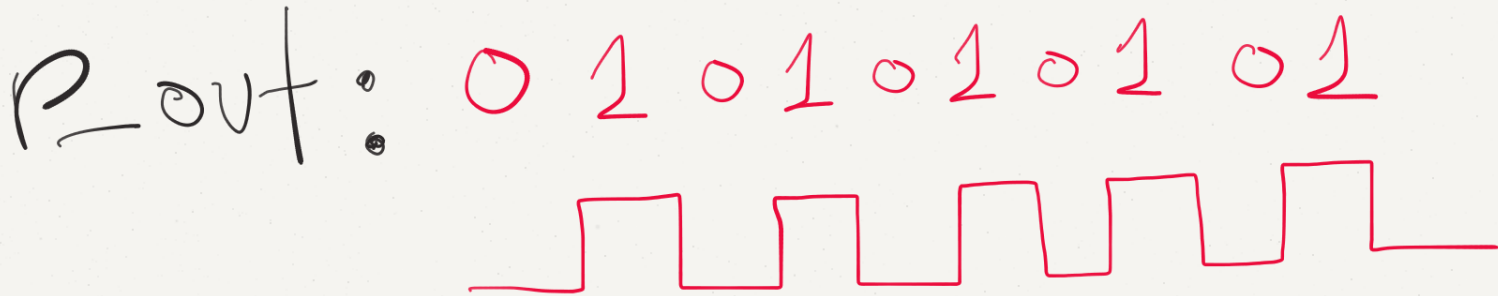
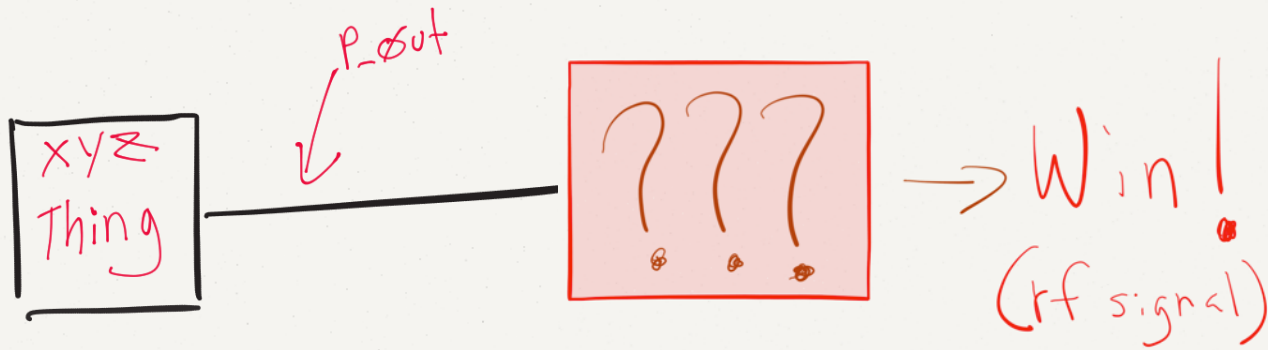









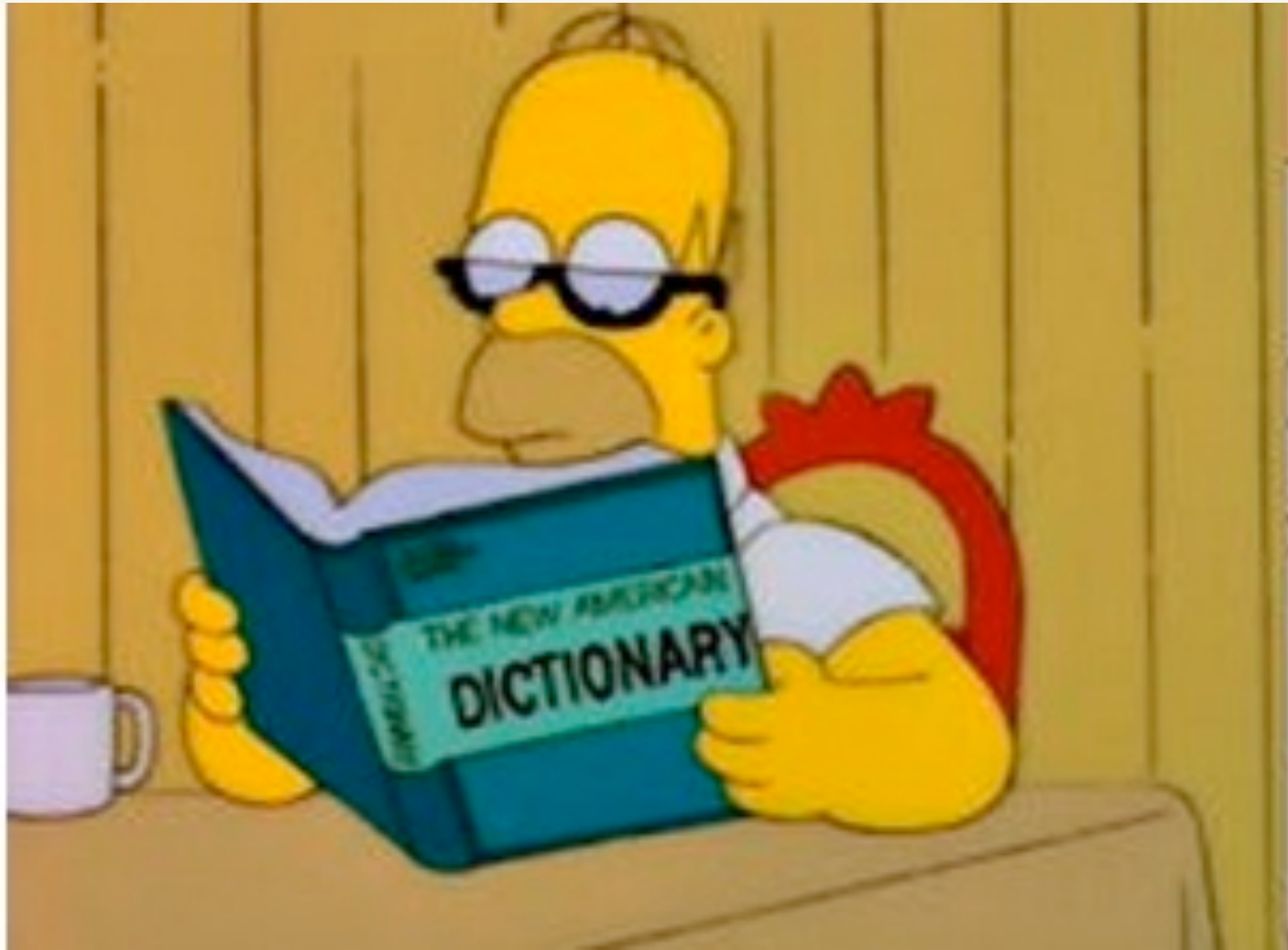

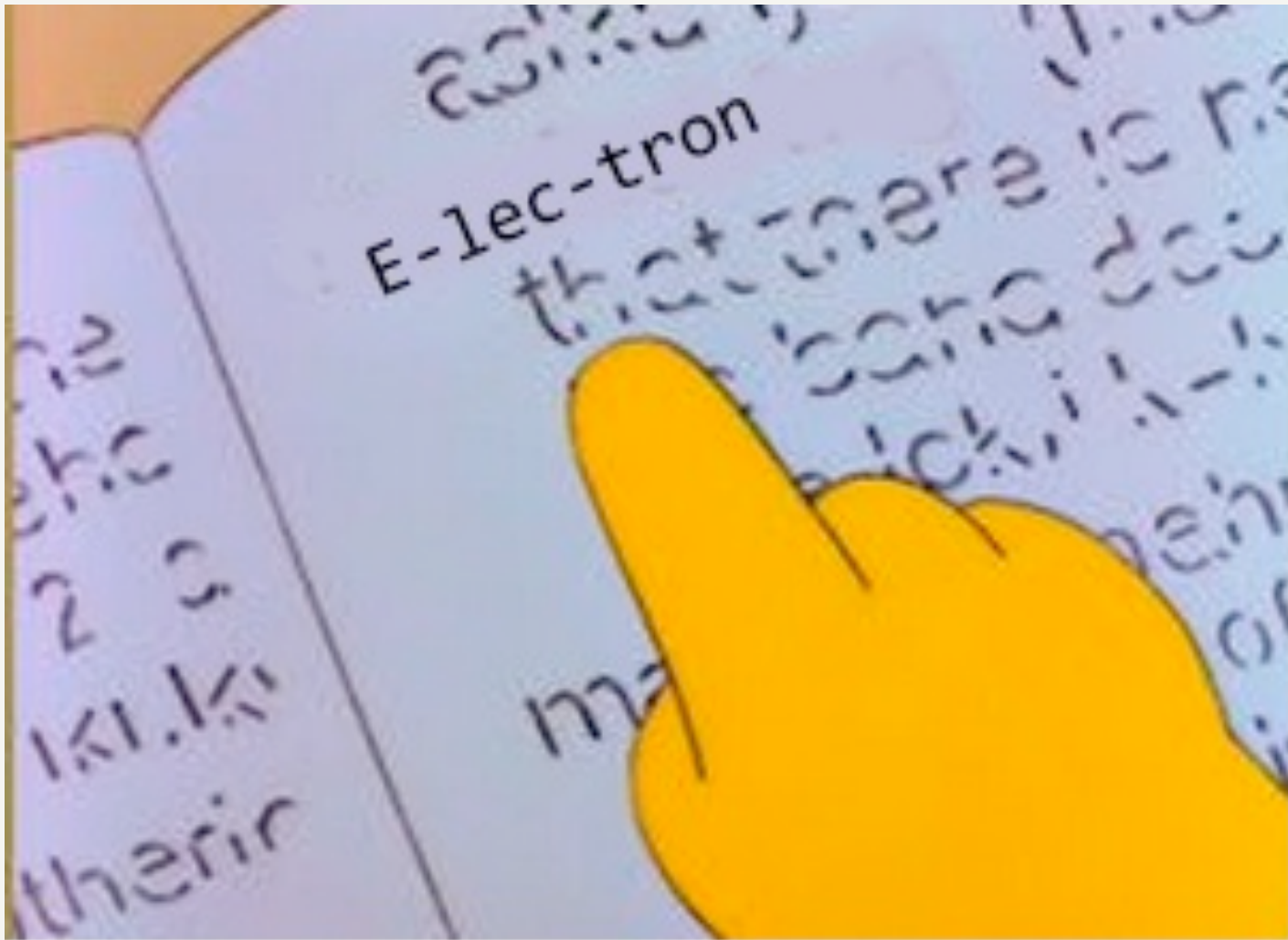

$$\nabla \times \mathbf{E} = \frac{\partial \mathbf{B}}{\partial t}$$

$$\nabla \times \mathbf{H} = \frac{\partial \mathbf{D}}{\partial t}$$

$$\nabla \cdot \mathbf{D} = \phi$$

$$\nabla \cdot \mathbf{B} = \phi$$

Maxwell's
equations

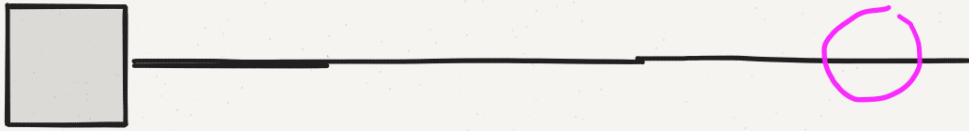

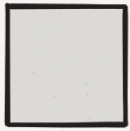



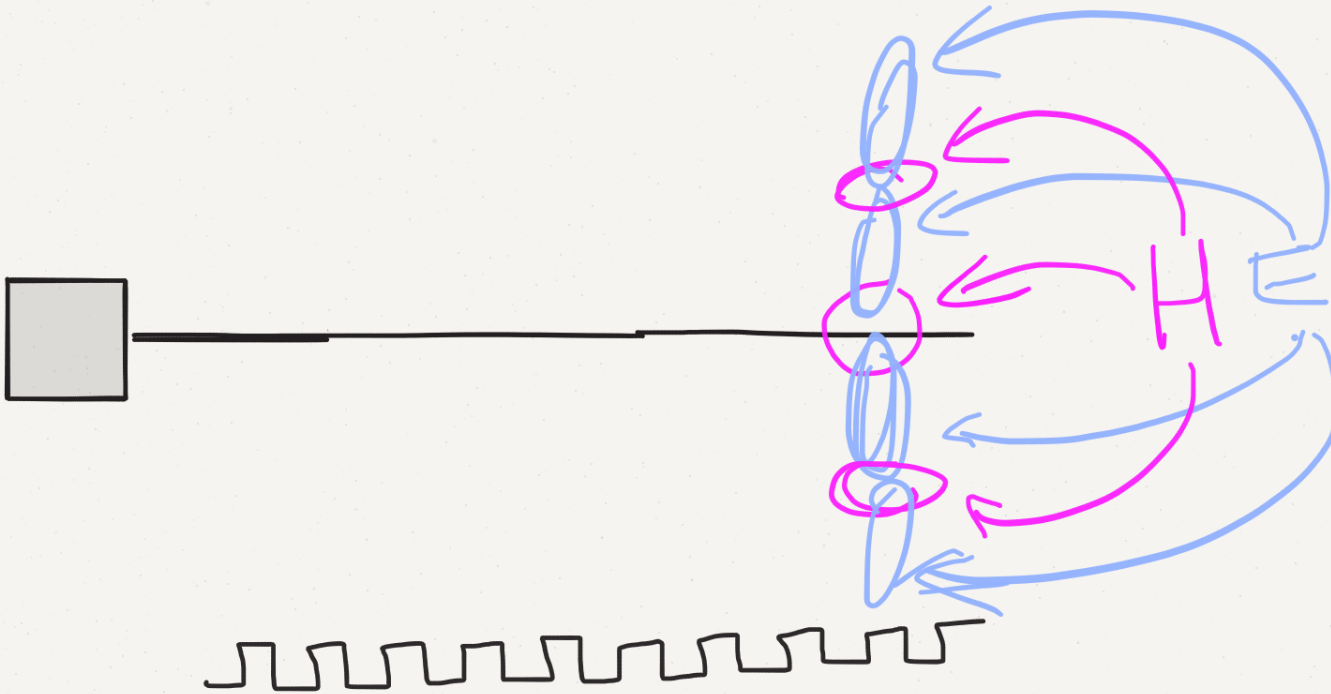

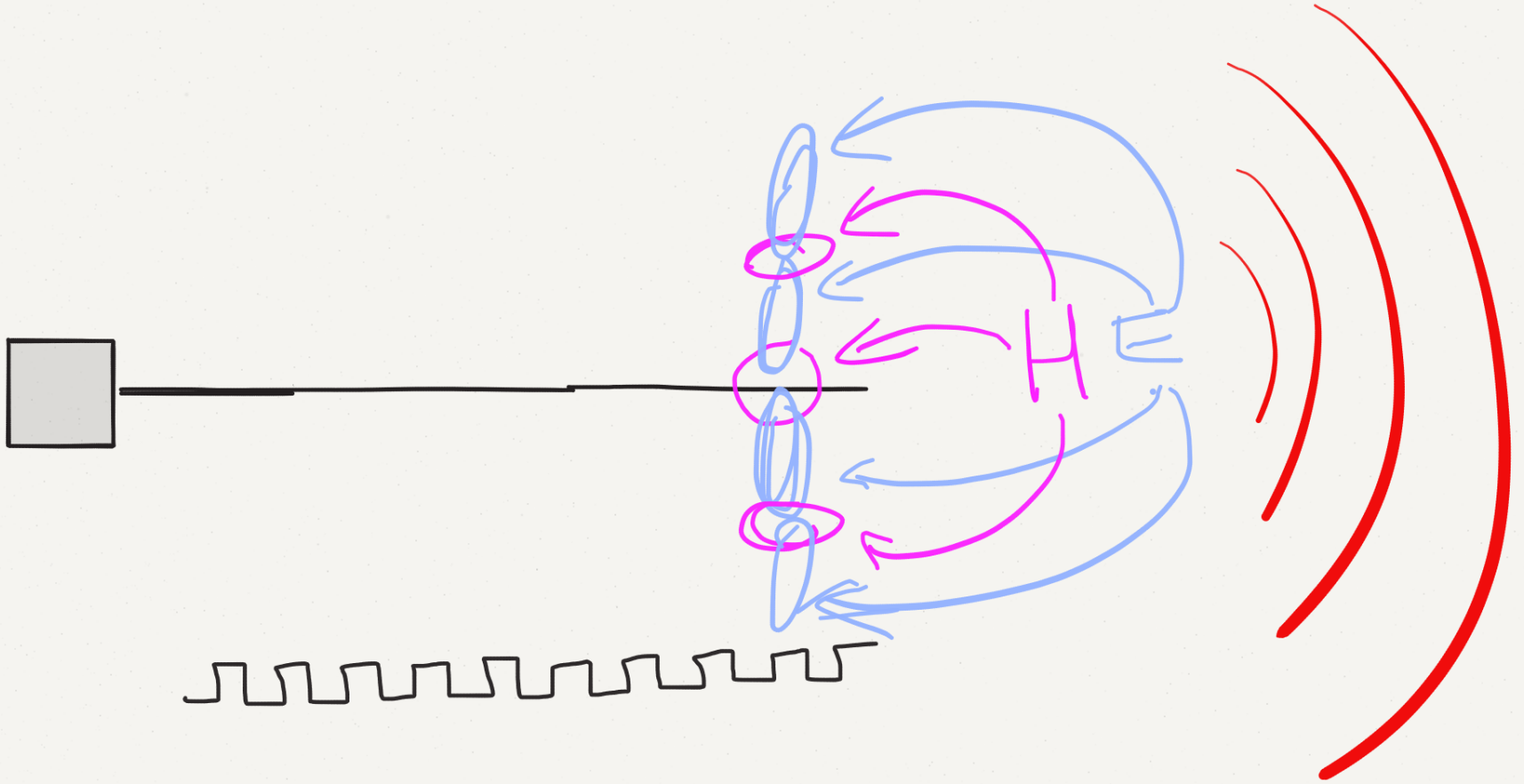

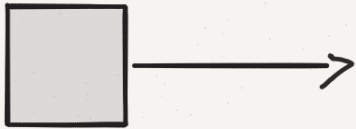

$$f = \chi$$
$$H$$

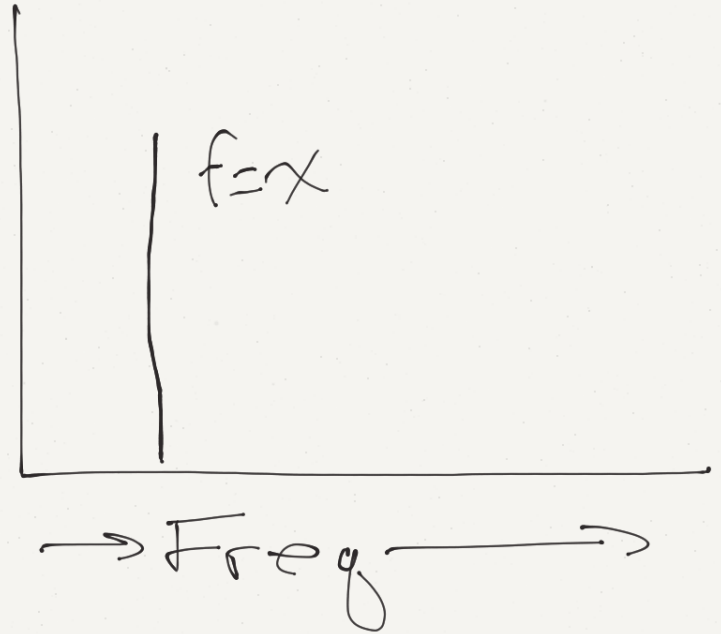

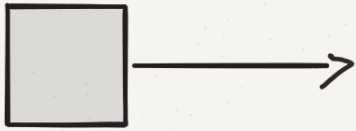

$f = x$
H

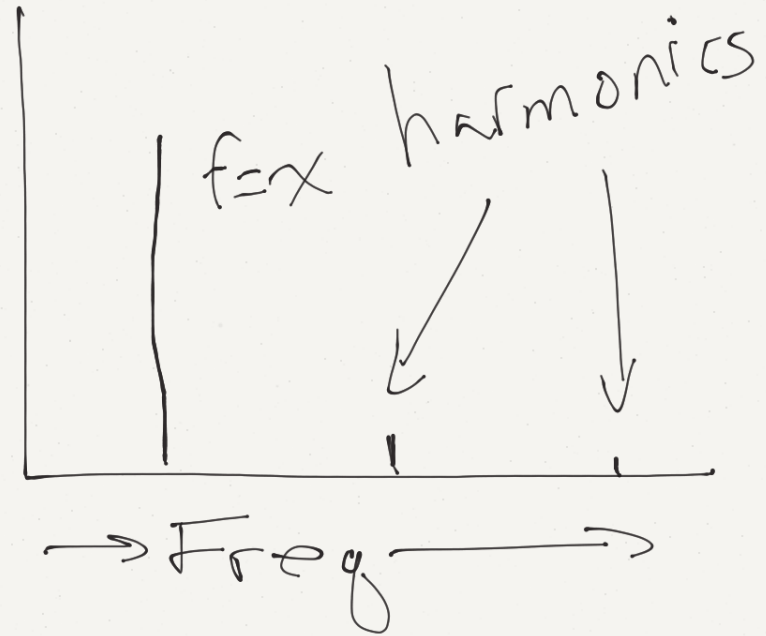

Funtenna 102

Common Output Pins

- PWM (Pulse Width Modulation)
- GPIO (General Purpose Input Output)
- UART (Universal Asynchronous Receive Transmit)

Funtenna

102

Science!

Funtenna

102

Science!

For each

- PWM
- GPIO
- UART

Funtenna

102

Science!

For each

- PWM
- GPIO
- UART

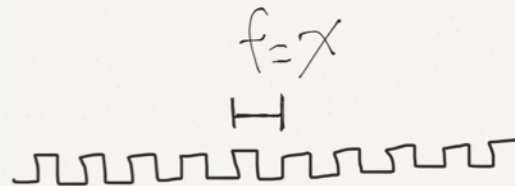

Funtenna 102

Science!

For each

- PWM
- GPIO
- UART

1. Possible values for **f**
2. Optimal values for **f**

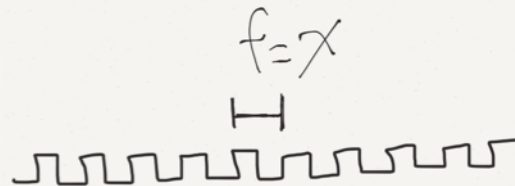

Funtenna 1Ø2

Science!

For each

- PWM
- GPIO
- UART

1. Possible values for f
2. Optimal values for f

For each radiator length

- 0cm
- 15cm
- 30cm

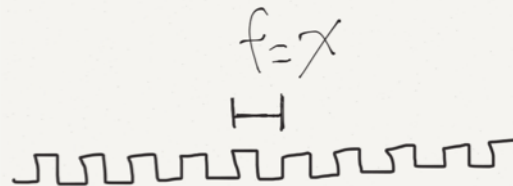

Experimental Setup

- "Faraday" Cage
- Buspirate (transmitter)
- USRP2 & BasicRX Board (receiver)



For example,

30cm radiator, $f=500\text{kHz}$, harmonic signal @ 2.5MHz

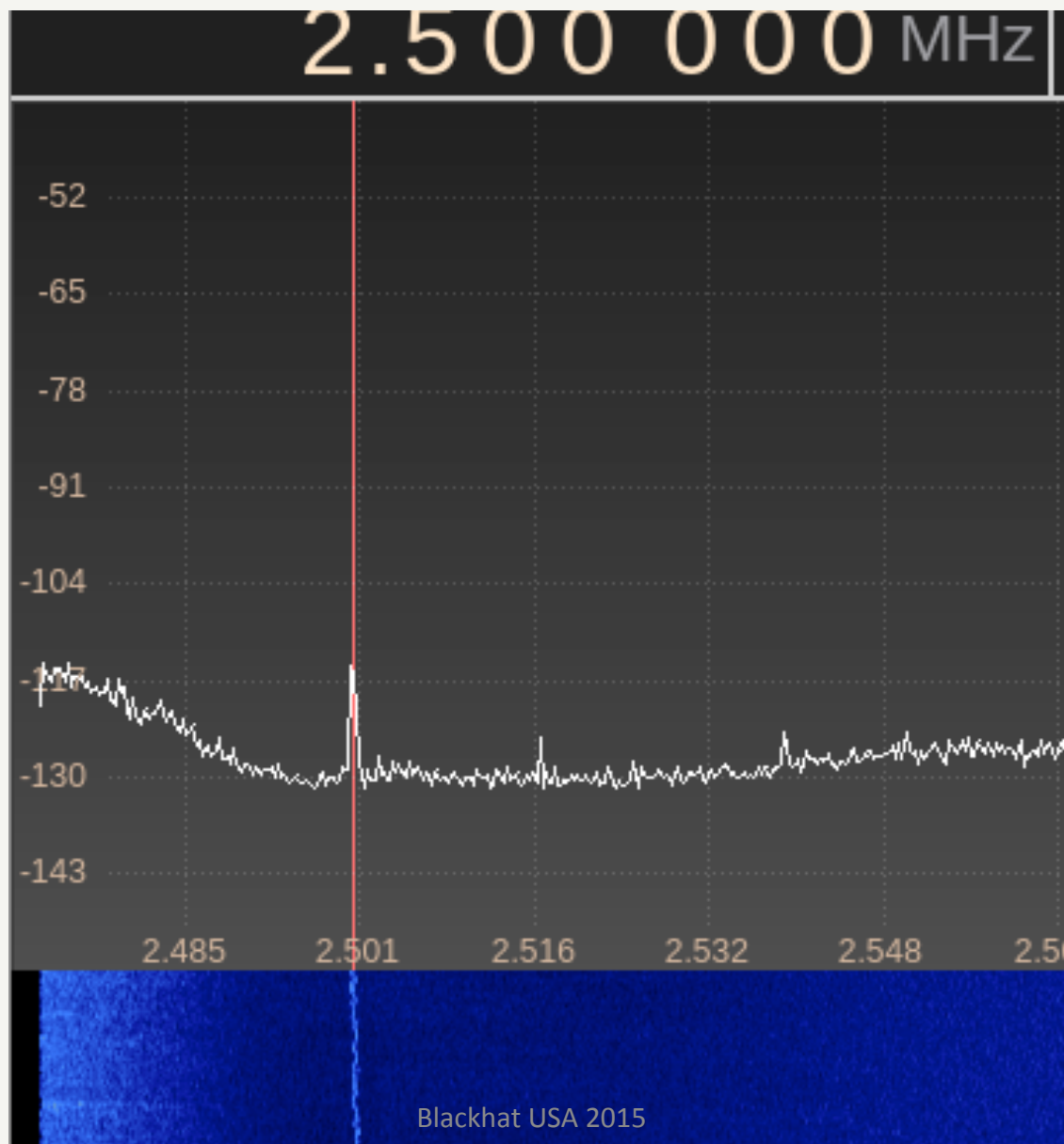

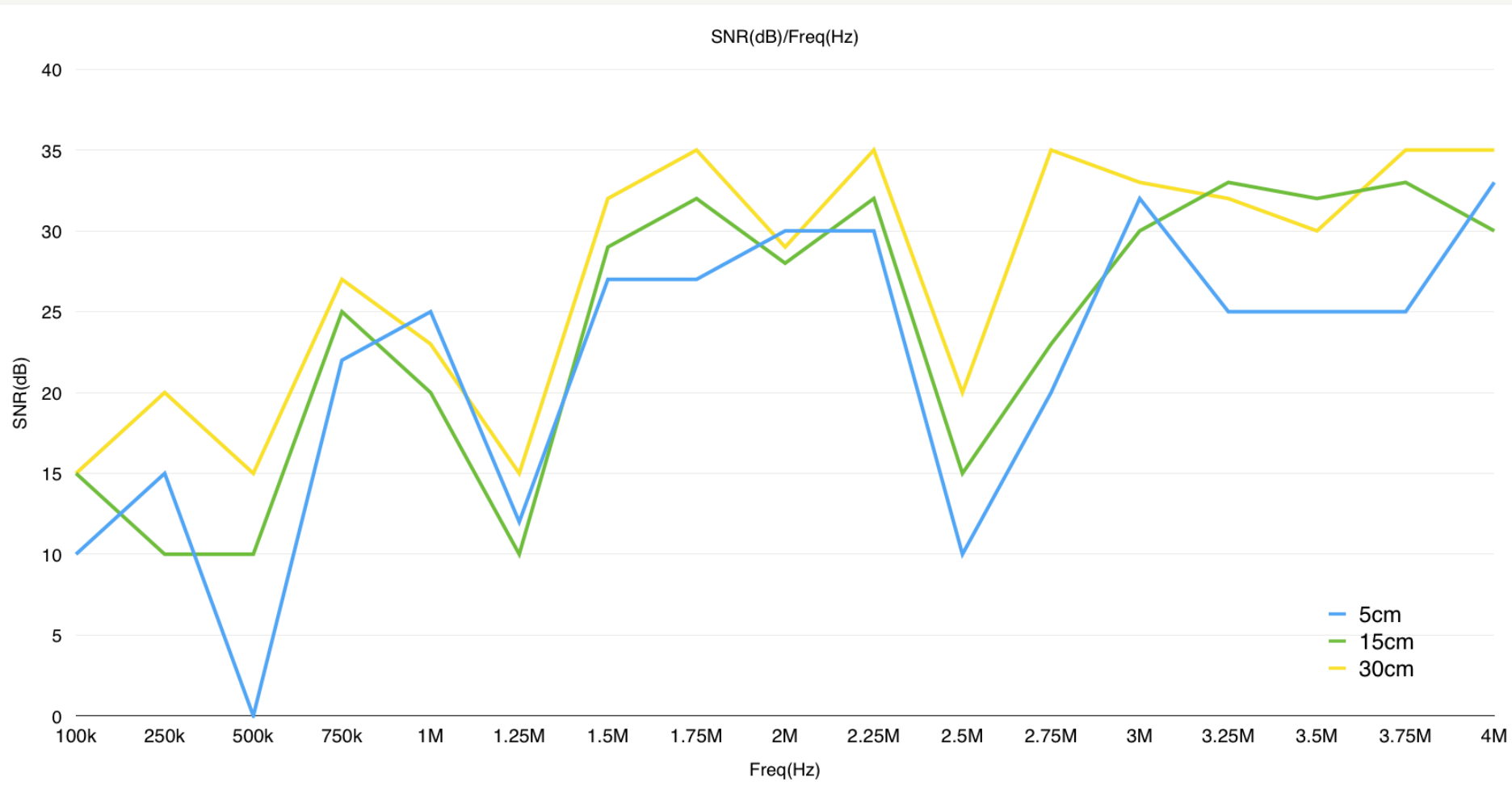

Full raw dataset available at www.funtenna.org

Funtenna

102

Data Analysis...

Possible values for **f**

Optimal values for **f**

Optimal length of radiator

Funtenna

102

Data Analysis...

Optimal length of radiator

Anything > 0 , longer better...

Funtenna

102

Data Analysis...

Possible values for **f**

PWM: 10khz - 4mhz

GPIO: 10khz - 5mhz

UART: 10khz - 4mhz

Funtenna 102

Data Analysis...

Possible values for f

PWM: 10khz - 4mhz

GPIO: 10khz - 5mhz

UART: 10khz - 4mhz

Optimal values for f

120Mhz - 205Mhz

Internet!

AIR GAP!

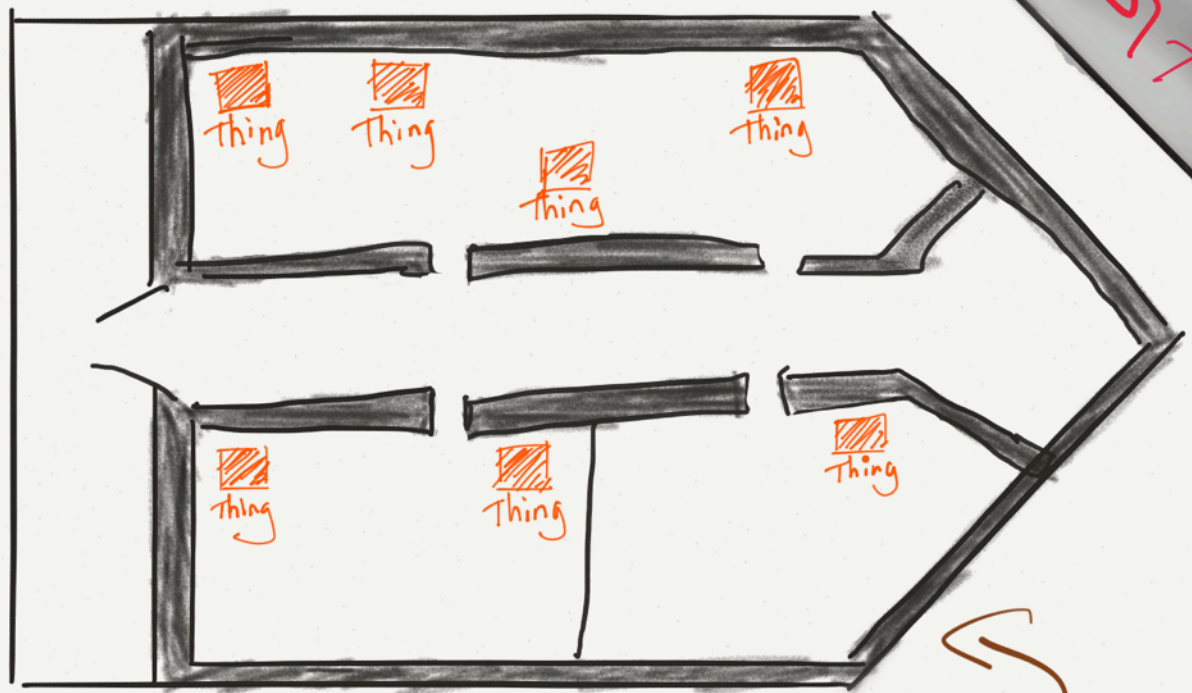

Super Secret Fort!

AIR

Internet!

AD!

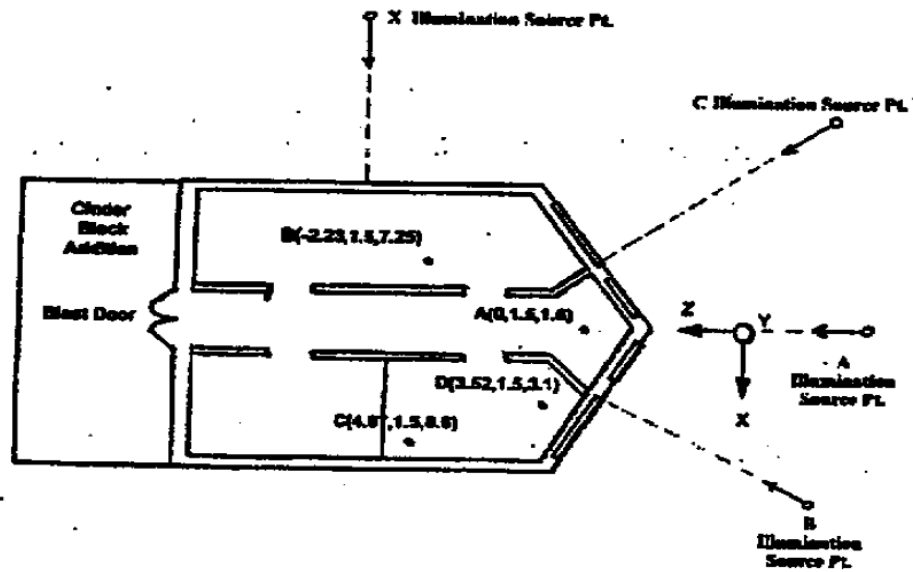

Figure 2. Diagram of Building 12500 at the A-15A Site on Elgin Air Force Base,

Super Secret Fort!

Measurement of RF Propagation into Concrete Structures over the Frequency Range 100 MHz to 3 GHz

by

Clayborne D. Taylor
Samuel J. Gutierrez
Steven L. Langdon
Kenneth L. Murphy
William A. Walton, III

Phillips Laboratory/WSM
3550 Aberdeen Ave. SE
Kirtland AFB, NM 87117-5776

ISBN 9781461378617

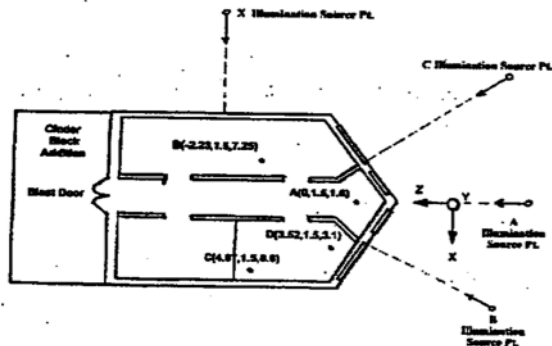

Figure 2. Diagram of Building 12500 at the A-15A Site on Elgin Air Force Base,

Say you wanted to Funtenna out of a
2-ft reinforced concrete structure

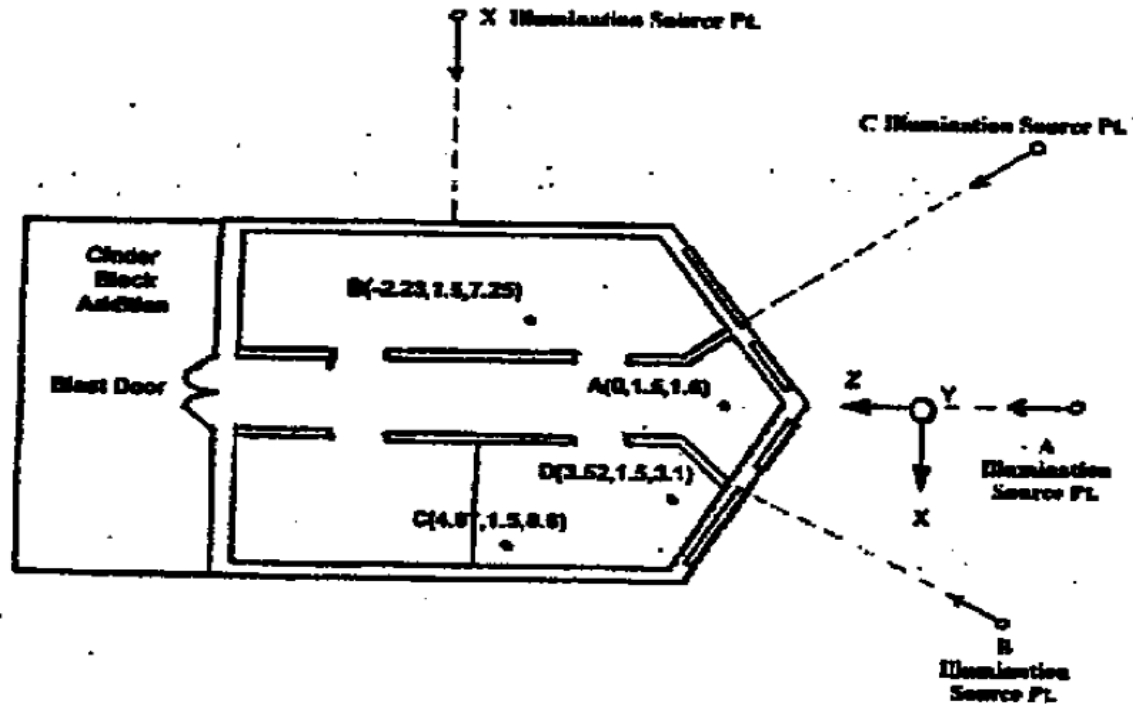

Figure 2. Diagram of Building 12500 at the A-15A Site on Elgin Air Force Base,

ISBN 9781461378617

Say you wanted to Funtenna out of a
2-ft reinforced concrete structure

ISBN 9781461378617

structures. For two-feet thick concrete walls, the measured attenuation above 200 MHz appears to increase with an increase in frequency. And for frequencies near and below 100 MHz, rebar attenuation becomes significant and seems to affect the magnetic field more than the electric field penetration. In the frequency range between 120 and 205 MHz the attenuation is often less than 20 dB. For four-inch and eight-inch thick walls the attenuation is much less (see Table 3).

$F \leq 100\text{MHz}$, bad for magnetic field penetration

$F \geq 200\text{MHz}$, bad for electric field penetration

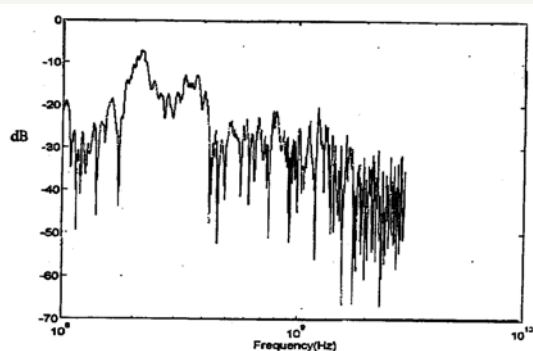

Figure 5. The internal electric field (E_z) at measurement point B relative to the incident electric field for illuminating source point X.

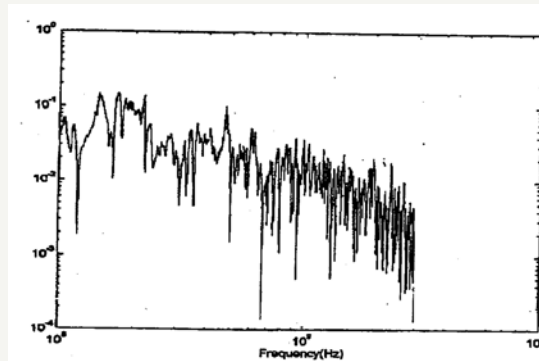
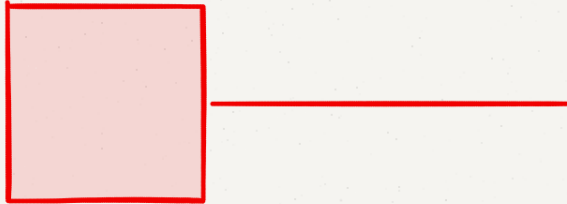

Figure 4. The internal magnetic field (H_z) at measurement point B relative to the incident magnetic field for illumination source point X.

Generalized Funtenna Algorithm



Generalized Funtenna Algorithm

$P_{out} \rightarrow 1$
Delay(\star)
 $P_{out} \rightarrow \emptyset$
Delay(\star)

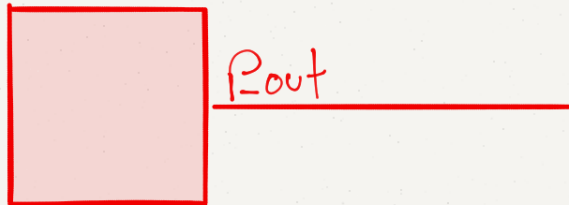

Generalized Funtenna Algorithm

$P_{out} \rightarrow 1$
Delay(\star)
 $P_{out} \rightarrow \emptyset$
Delay(\star)

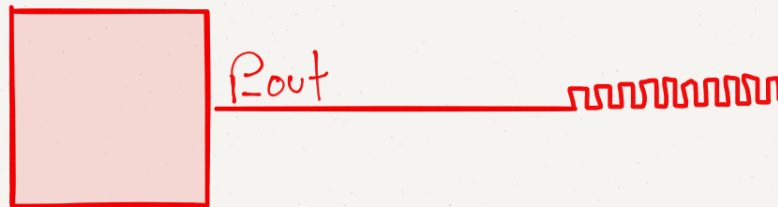

Generalized Funtenna Algorithm

$$\left. \begin{array}{l} P_{out} \rightarrow 1 \\ \text{Delay}(d_r) \\ P_{out} \rightarrow \emptyset \\ \text{Delay}(d_i) \end{array} \right] f = X$$

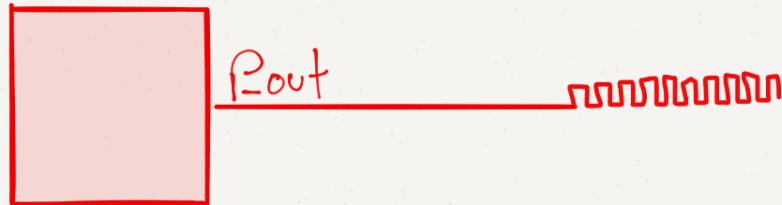

Generalized Funtenna Algorithm

Do "Symbol Duration" Times

$\left. \begin{array}{l} P_{out} \rightarrow 1 \\ \text{Delay}(d_r) \\ P_{out} \rightarrow \emptyset \\ \text{Delay}(d_i) \end{array} \right] f = X$



Generalized Funtenna Algorithm

- ASK (Amplitude Shift Keying)
- FSK (Frequency Shift Keying)
- OOK (On-Off Keying)

Generalized Funtenna Algorithm Amplitude-Shift Keying

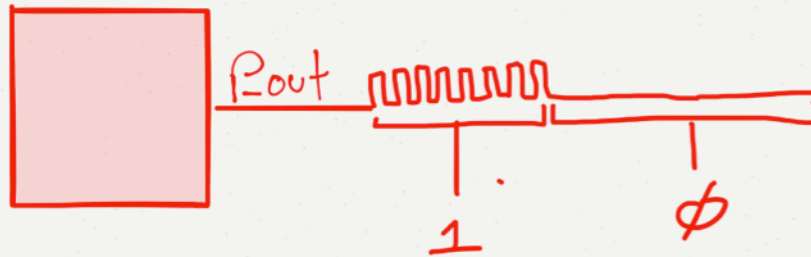

Generalized Funtenna Algorithm Amplitude-Shift Keying

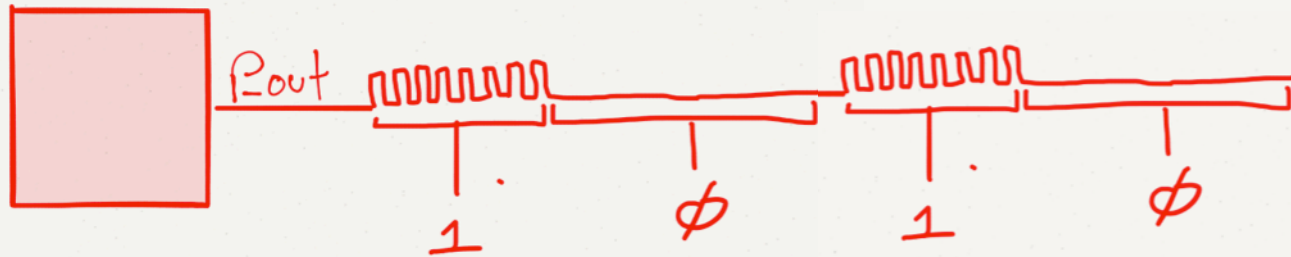

Generalized Funtenna Algorithm Amplitude-Shift Keying

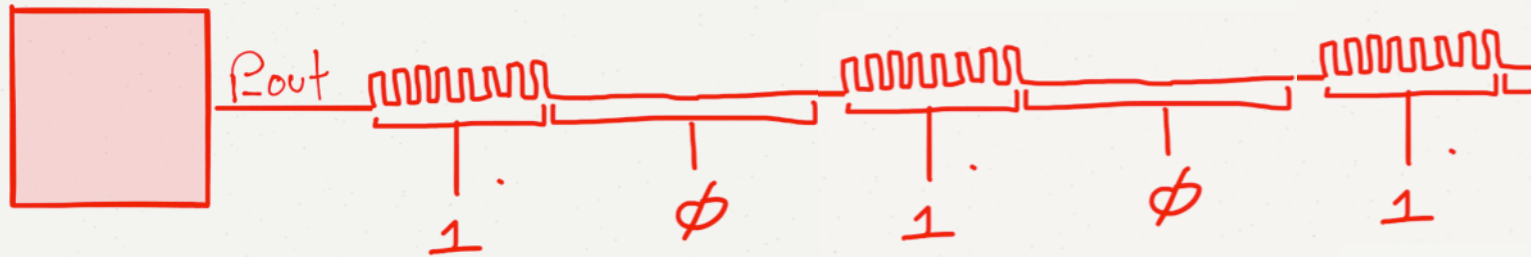

Generalized Funtenna Algorithm Frequency-Shift Keying (sort of)

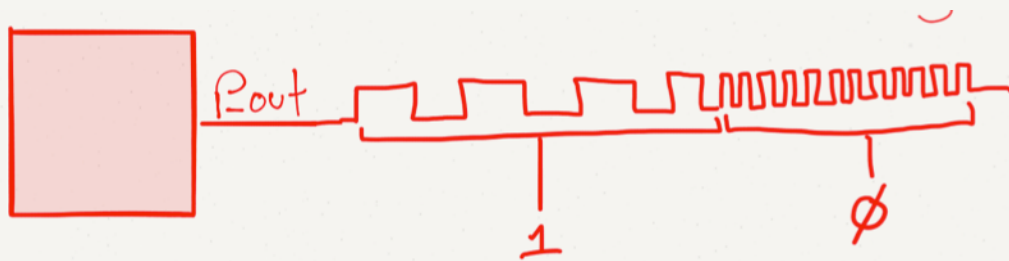

Generalized Funtenna Algorithm Frequency-Shift Keying (sort of)



Generalized Funtenna Algorithm

On-Off Keying



Generalized Funtenna Algorithm On-Off Keying

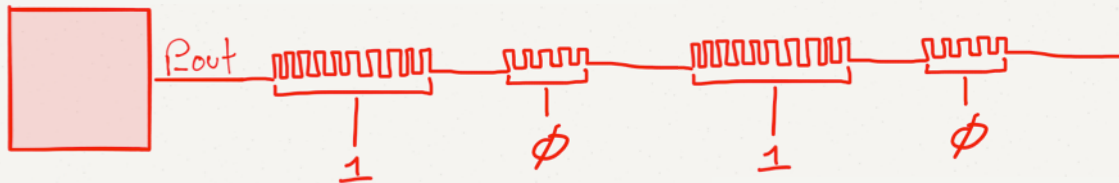

Generalized Funtenna Algorithm On-Off Keying

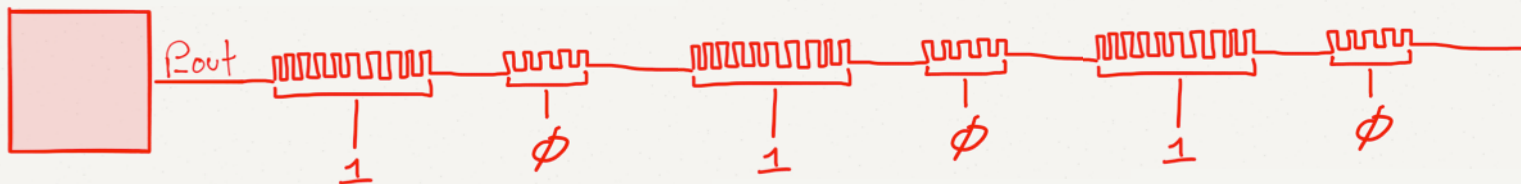

Funtenna In Practice

Funtenna In Practice

Pantum P2502W Wireless Monochrome Laser Printer

★★★★★ 113 reviews



Stores

[Newegg.com](#)

Free shipping, no tax - **\$39.99**

[eBay](#)

Free shipping, no tax - **\$53.00**

[View all stores and prices »](#)

Funtenna In Practice

Pantum P2502W Wireless Monochrome
Laser Printer

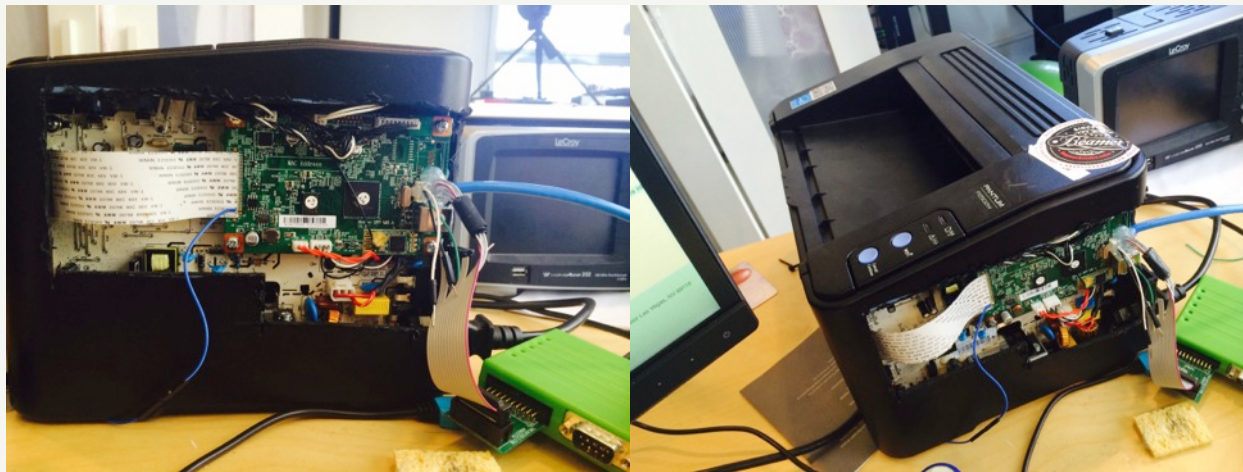

1. Cheap
2. Typical ARM SoC
3. GPIO (lots)
4. PWM
5. UART
6. JTAG

Funtenna In Practice

Pantum P2502W Wireless Monochrome
Laser Printer

The Controller Board

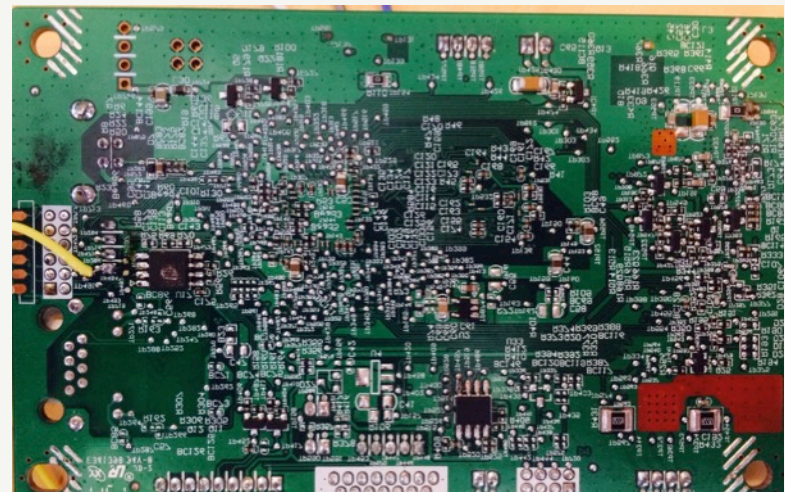
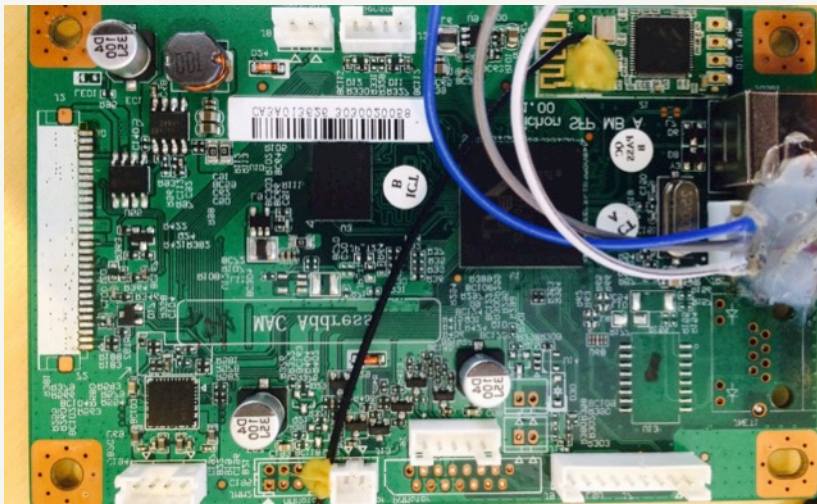

Funtenna In Practice

Pantum P2502W Wireless Monochrome
Laser Printer

The SoC



Marvell 88PA6110

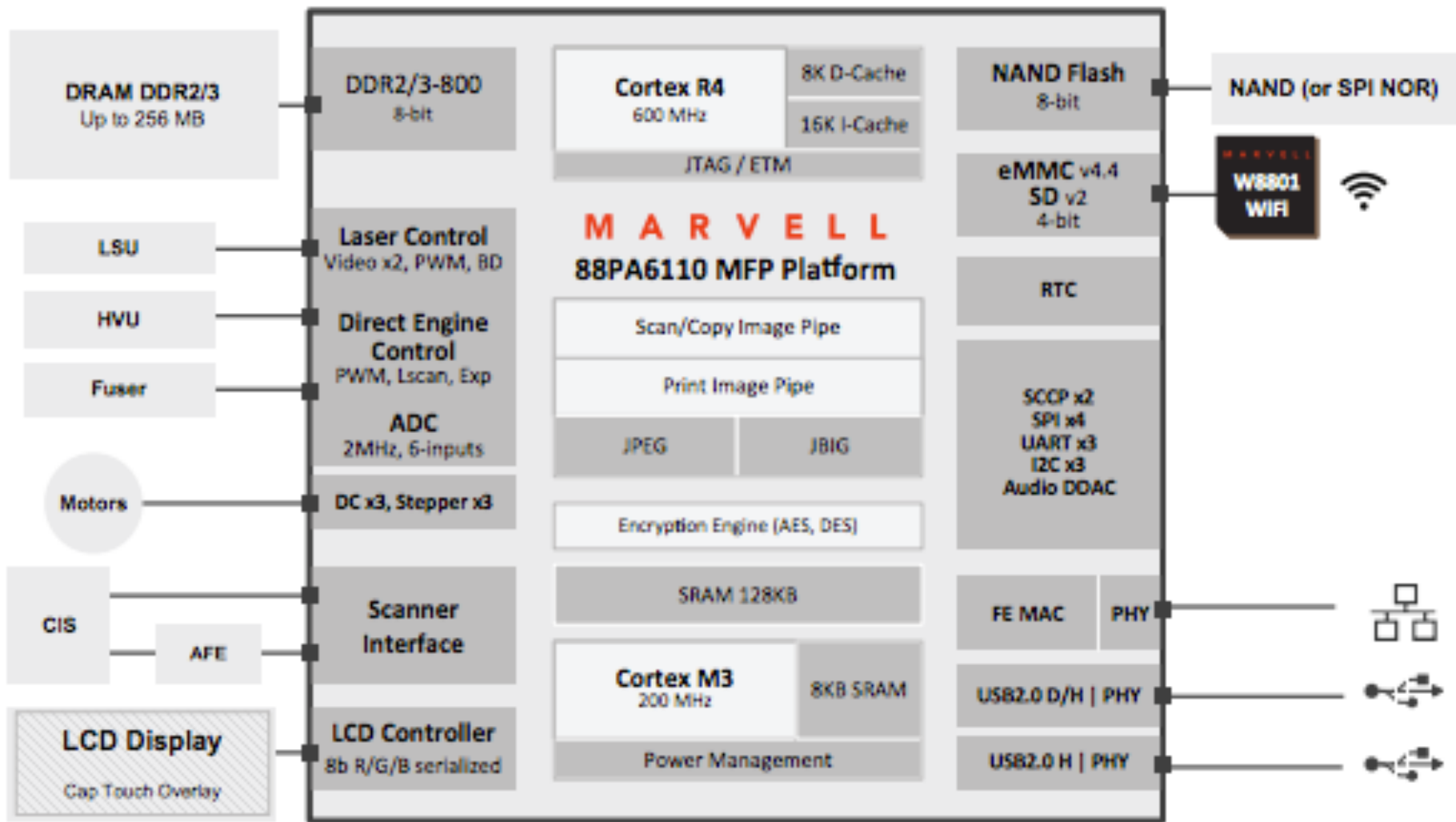

Funtenna In Practice

Pantum P2502W Wireless Monochrome
Laser Printer

Hardware Triage



Funtenna In Practice

Pantum P2502W Wireless Monochrome
Laser Printer

Hardware Triage

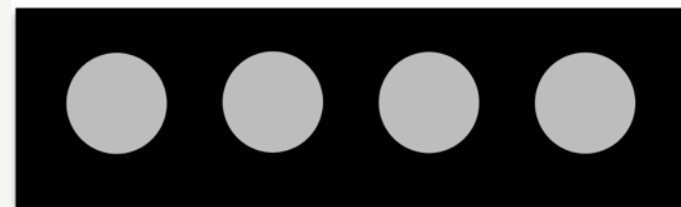

VCC

RX

GND

TX

Funtenna In Practice

Pantum P2502W Wireless Monochrome
Laser Printer

Hardware Triage

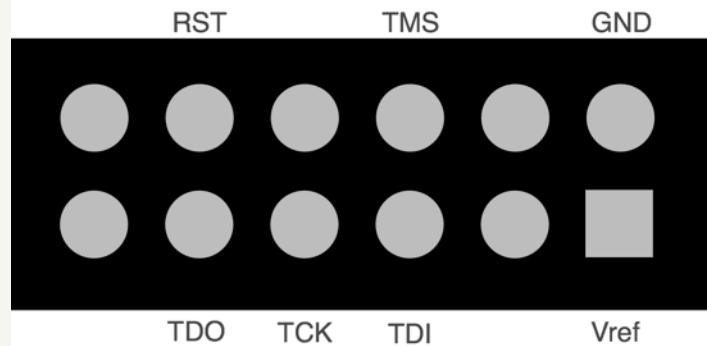
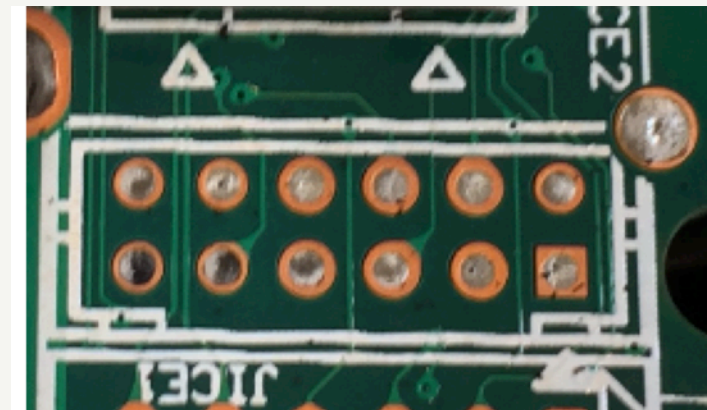
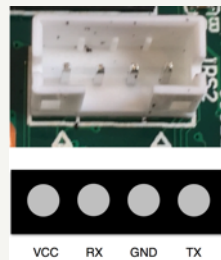

Funtenna In Practice (PWM)

Pantum P2502W Wireless Monochrome
Laser Printer



13Khz PWM

Funtenna In Practice (PWM)

Pantum P2502W Wireless Monochrome
Laser Printer



13Khz PWM

No love -(

Funtenna In Practice (GPIO)

4 GPIO Banks, 121 pins in all

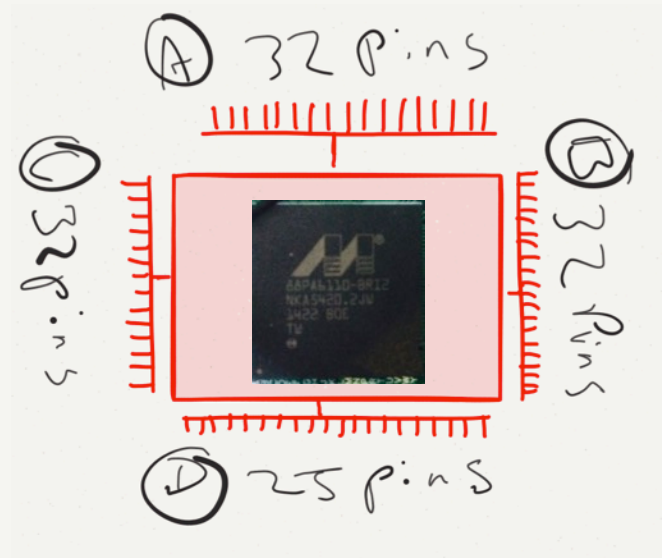

Funtenna In Practice (GPIO)

Input pins: Buttons, few sensors, switches



Funtenna In Practice (GPIO)



Output pins: LEDs, Engine Control, Power Control, Fuser Control, Toner Control and lots more!

Funtenna In Practice (GPIO)

Which pin to flip?



↳ Emanate like a "

~~Scrub~~

 BOSS!

Funtenna In Practice (GPIO)

Which pin to flip? **Every pin, at the same time!**



Funtenna In Practice (GPIO)

OFF On

Which pin to flip? **Every pin, at the same time!**

FD040000	8021D3FB	8005058	80407C08	8021D3FB	..l.xP... @...l.
FD040010	00000300	00000000	FFFE3C07	00000000<.....
FD040020	00000000	00000000	00000000	00000000
FD040030	00000000	00000000	00000000	00000000
FD040040	00000000	00000000	00000000	00000000
FD040050	00000000	00000000	00000000	00000000
FD040060	00000000	00000000	00000000	00000000
FD040070	00000000	00000000	00000000	00000000

0x20 - Pin **OFF**
0x24 - Pin **On**

GPIO Bank A – Memory Mapped Control Registers

Funtenna In Practice (GPIO)

```
.equ all_p1mp, 0xffffffff
.equ gpio_bank_a_off_addr, 0xFD040020
.equ gpio_bank_b_off_addr, 0xF8040020
.equ gpio_bank_c_off_addr, 0xF8041020
.equ gpio_bank_d_off_addr, 0xF8042020
_loopy:
    LDR    R5, =all_p1mp
    LDR    R1, =gpio_bank_a_off_addr
    LDR    R2, =gpio_bank_b_off_addr
    LDR    R3, =gpio_bank_c_off_addr
    LDR    R4, =gpio_bank_d_off_addr
```

Funtenna In Practice (GPIO)

```
.equ all_p1mp, 0xffffffff
.equ gpio_bank_a_off_addr, 0xFD040020
.equ gpio_bank_b_off_addr, 0xF8040020
.equ gpio_bank_c_off_addr, 0xF8041020
.equ gpio_bank_d_off_addr, 0xF8042020
_loopy:
  LDR    R5, =all_p1mp
  LDR    R1, =gpio_bank_a_off_addr
  LDR    R2, =gpio_bank_b_off_addr
  LDR    R3, =gpio_bank_c_off_addr
  LDR    R4, =gpio_bank_d_off_addr
```



```
STR    R5, [R1, #0x4]
STR    R5, [R2, #0x4]
STR    R5, [R3, #0x4]
STR    R5, [R4, #0x4]
```

All Pins **on**

Funtenna In Practice (GPIO)

```
.equ all_p1mp, 0xffffffff
.equ gpio_bank_a_off_addr, 0xFD040020
.equ gpio_bank_b_off_addr, 0xF8040020
.equ gpio_bank_c_off_addr, 0xF8041020
.equ gpio_bank_d_off_addr, 0xF8042020
_loopy:
  LDR    R5, =all_p1mp
  LDR    R1, =gpio_bank_a_off_addr
  LDR    R2, =gpio_bank_b_off_addr
  LDR    R3, =gpio_bank_c_off_addr
  LDR    R4, =gpio_bank_d_off_addr
```



```
STR    R5, [R1, #0x4]
STR    R5, [R2, #0x4]
STR    R5, [R3, #0x4]
STR    R5, [R4, #0x4]
```



```
STR    R5, [R1]
STR    R5, [R2]
STR    R5, [R3]
STR    R5, [R4]
```

All Pins **off**

Funtenna In Practice (GPIO)

```
.equ all_p1mp, 0xffffffff
.equ gpio_bank_a_off_addr, 0xFD040020
.equ gpio_bank_b_off_addr, 0xF8040020
.equ gpio_bank_c_off_addr, 0xF8041020
.equ gpio_bank_d_off_addr, 0xF8042020
_loopy:
LDR    R5, =all_p1mp
LDR    R1, =gpio_bank_a_off_addr
LDR    R2, =gpio_bank_b_off_addr
LDR    R3, =gpio_bank_c_off_addr
LDR    R4, =gpio_bank_d_off_addr
```

```
STR    R5, [R1, #0x4]
STR    R5, [R2, #0x4]
STR    R5, [R3, #0x4]
STR    R5, [R4, #0x4]
```

All Pins **on**

```
STR    R5, [R1]
STR    R5, [R2]
STR    R5, [R3]
STR    R5, [R4]
```

Funtenna In Practice (GPIO)

```
.equ all_p1mp, 0xffffffff
.equ gpio_bank_a_off_addr, 0xFD040020
.equ gpio_bank_b_off_addr, 0xF8040020
.equ gpio_bank_c_off_addr, 0xF8041020
.equ gpio_bank_d_off_addr, 0xF8042020
_loopy:
LDR    R5, =all_p1mp
LDR    R1, =gpio_bank_a_off_addr
LDR    R2, =gpio_bank_b_off_addr
LDR    R3, =gpio_bank_c_off_addr
LDR    R4, =gpio_bank_d_off_addr
```

```
STR    R5, [R1, #0x4]
STR    R5, [R2, #0x4]
STR    R5, [R3, #0x4]
STR    R5, [R4, #0x4]
```

All Pins **on**

F = Approx **5mhz**

```
STR    R5, [R1]
STR    R5, [R2]
STR    R5, [R3]
STR    R5, [R4]
```

Funtenna In Practice (GPIO)

F = Approx 5mhz

And things get really interesting

Funtenna In Practice

Funtenna Demo 2: ALL GPIO Funtenna - On Off Keying

Funtenna Demo 2: ALL GPIO Funtenna - On Off Keying

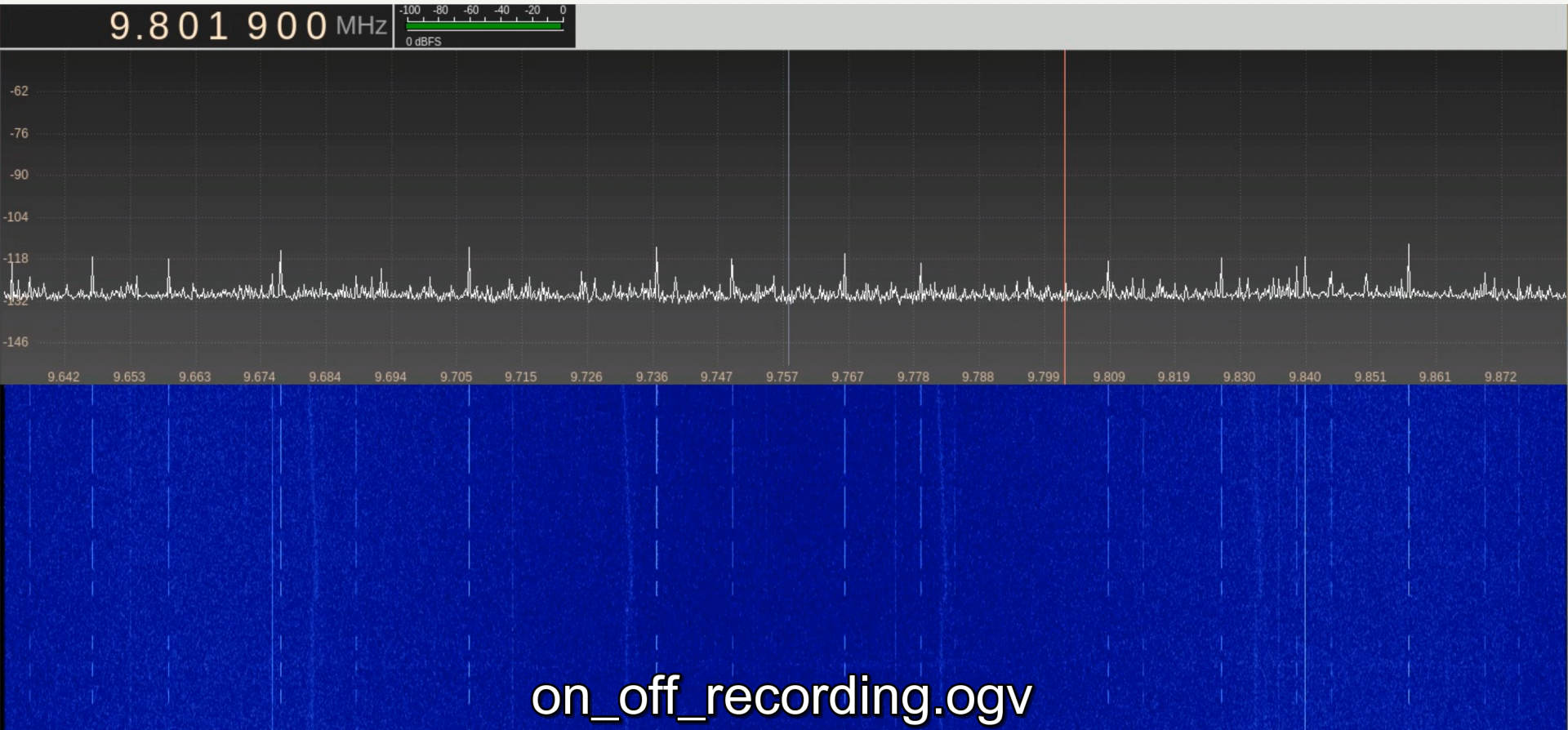

Funtenna In Practice

Funtenna Demo 2: ALL GPIO Funtenna - Freq Shift Keying (sort of)

Funtenna Demo 2: ALL GPIO Funtenna - Freq Shift Keying (sort of)

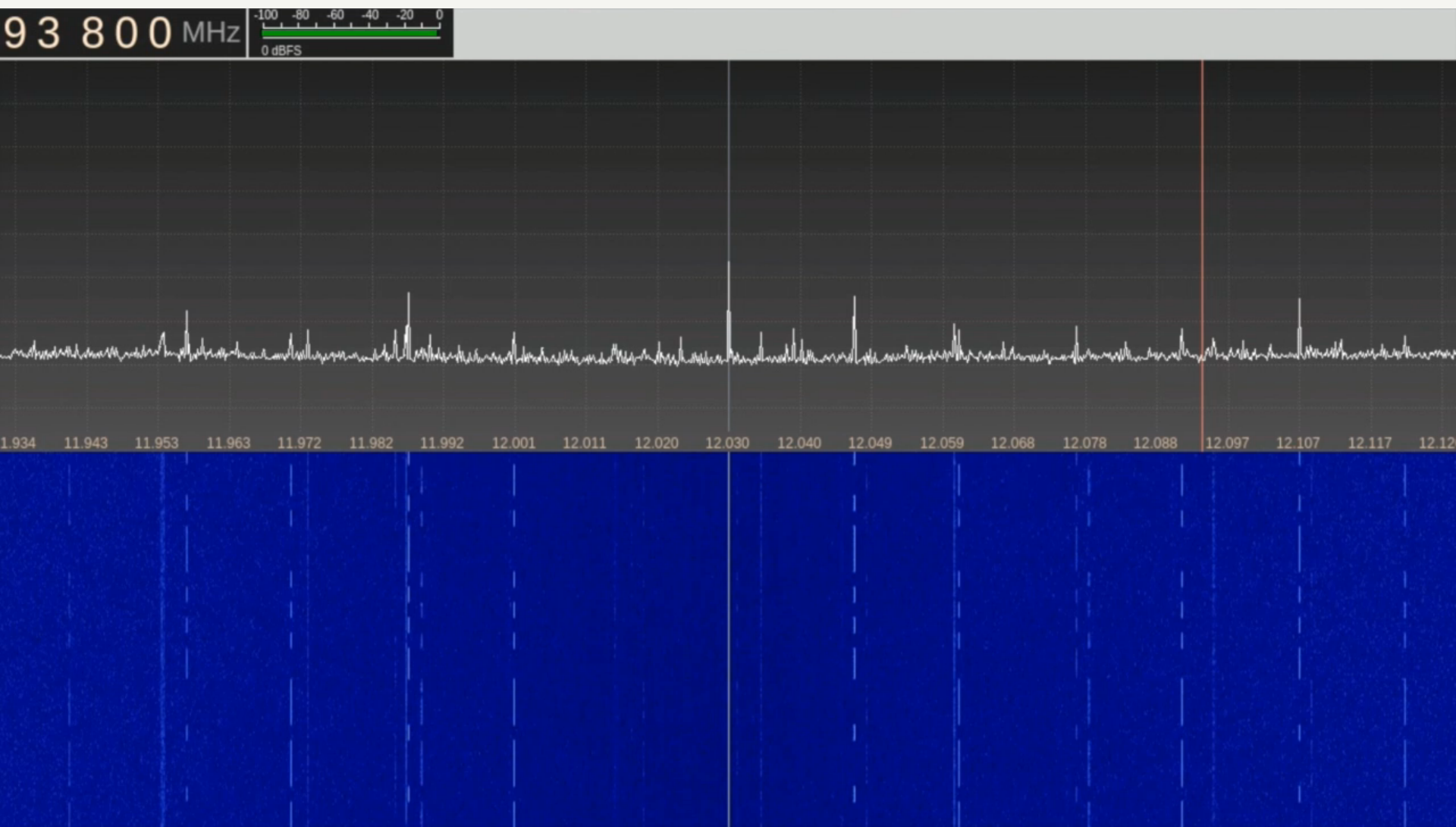

Funtenna In Practice

Pantum P2502W Wireless Monochrome
Laser Printer

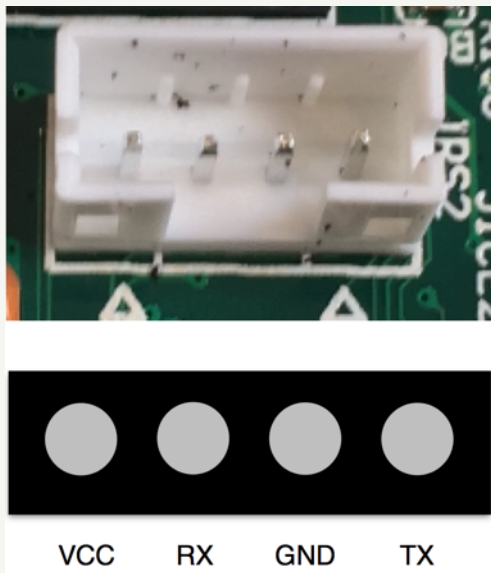

UART Funtenna

UART FUNTENNA 460800 BAUD

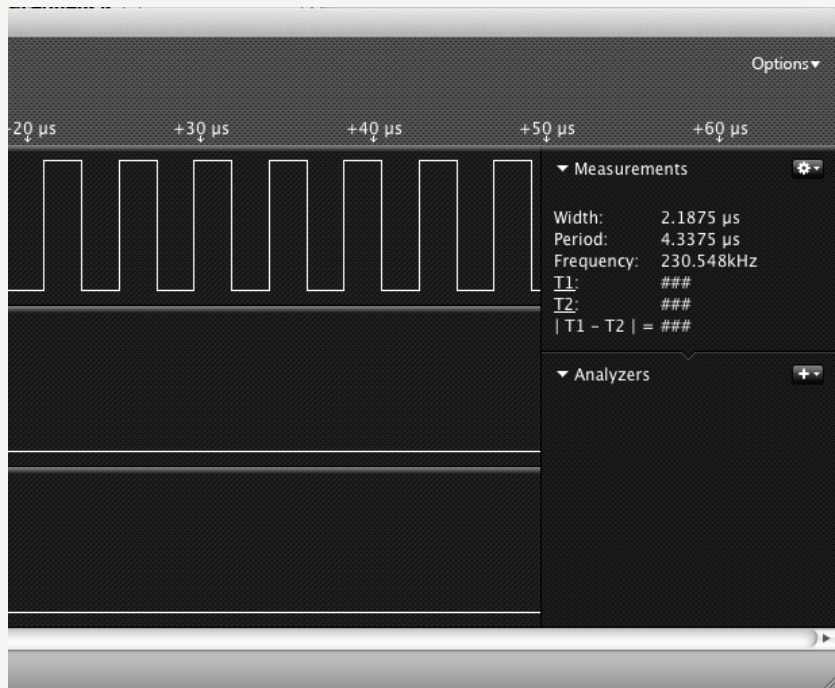

“UUUUUUUUUUUUUUUUUUUU”

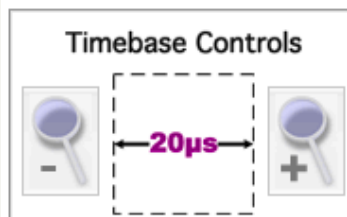

UART FUNTENNA 460800 BAUD

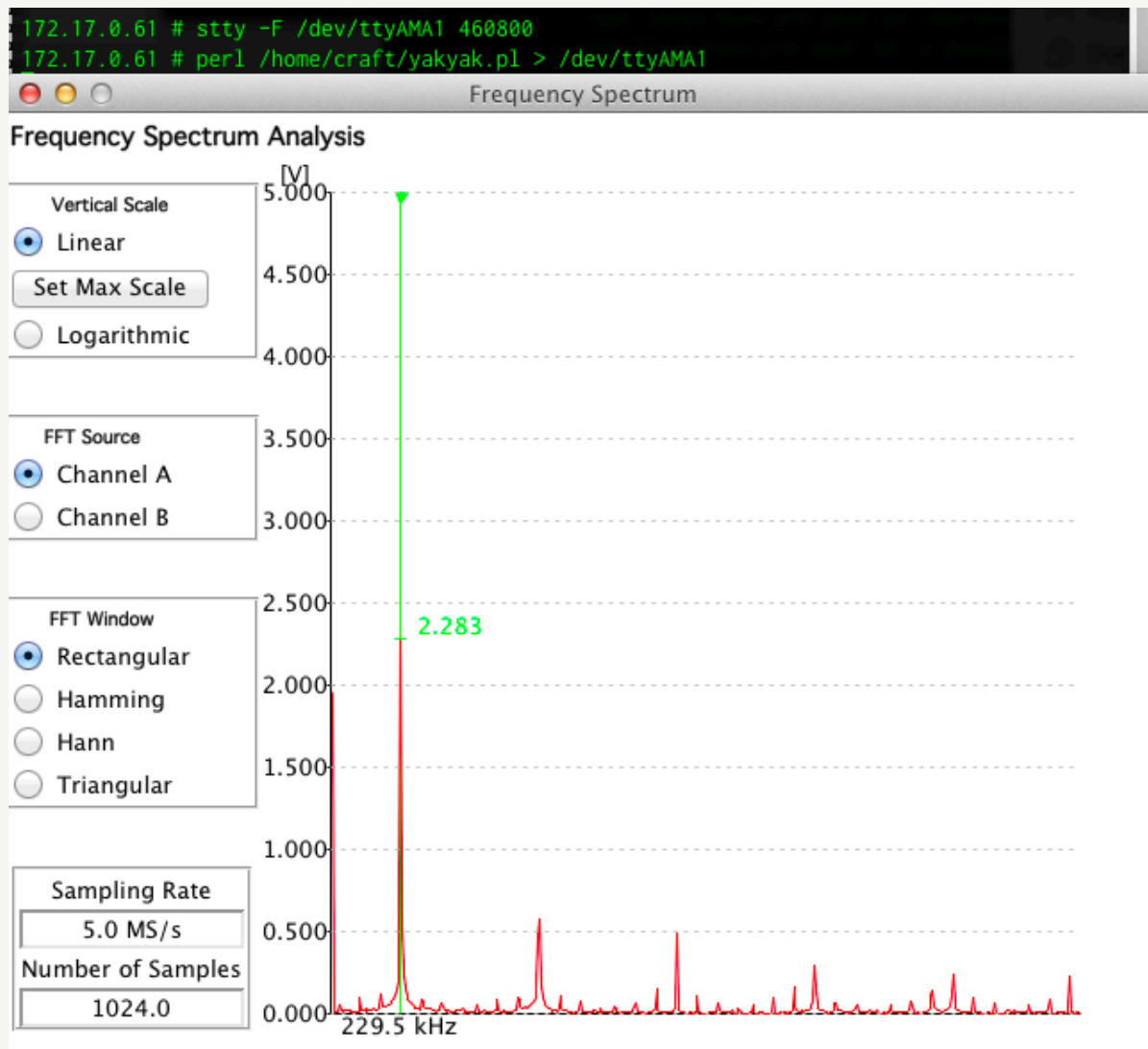

Funtenna In Practice

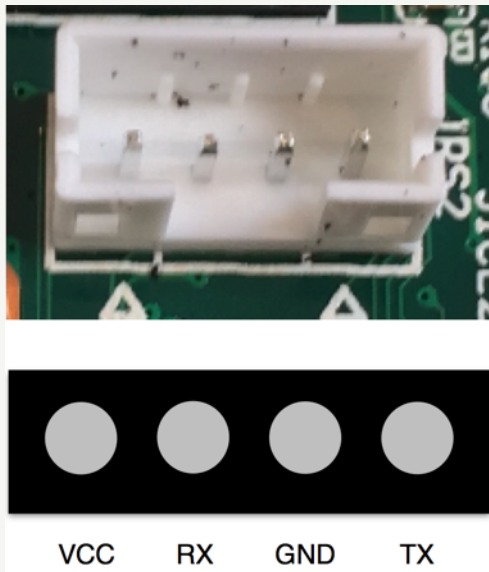

Let's be more sneaky...

Funtenna In Practice

```
LDR      R3, =asc_1121944 ; "/home/lihaixiong/source/common/devices/"...
BL       sub_49F668
MOV      R3, R0
MOV      R2, R3
LDR      R3, =dword_EC6
STR      R2, [R3]
asc_1121944 DCB "/home/lihaixiong/source/common/dev"
            DCB "ices/uart/dwapb/src/dw_apb_uart.c",0
```

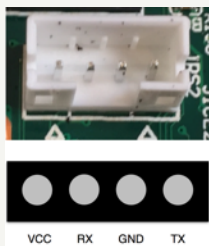

dw_apb_uart.c

Funtenna In Practice

SYNOPSYS[®]

DesignWare DW_apb_uart Databook

DesignWare Synthesizable Components for AMBA 2
DW_apb_uart

dw_apb_uart.c

Funtenna In Practice

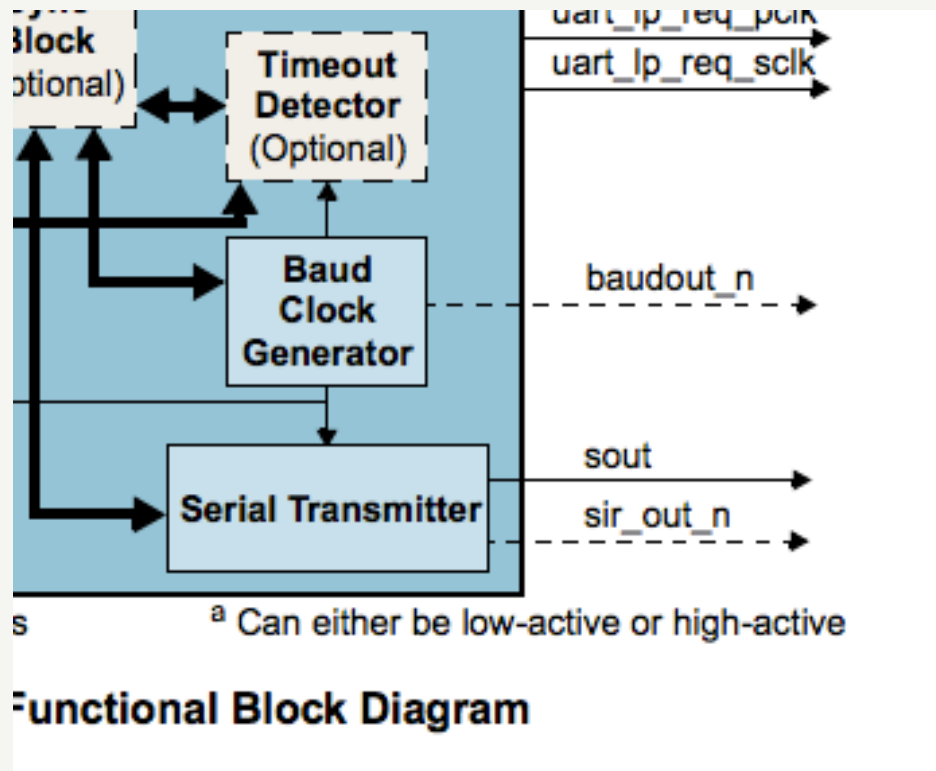
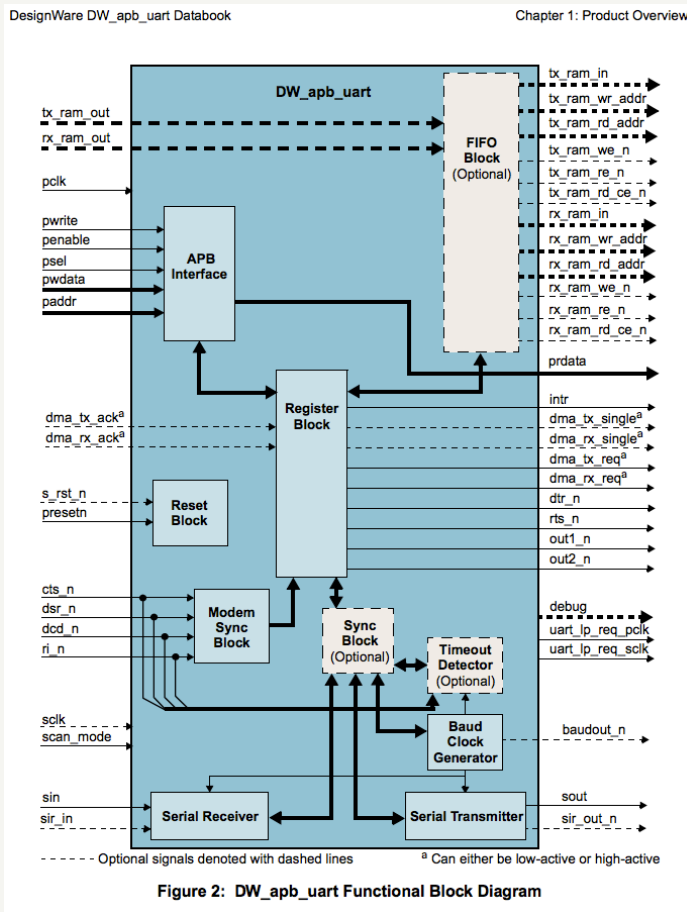

FLIP **sout** pin

Step 1: UART Break-Ctrl Bit -> 1

LCR

- Name: Line Control Register
- Size: 32 bits
- Address Offset: 0x0C
- Read/write access: read/write

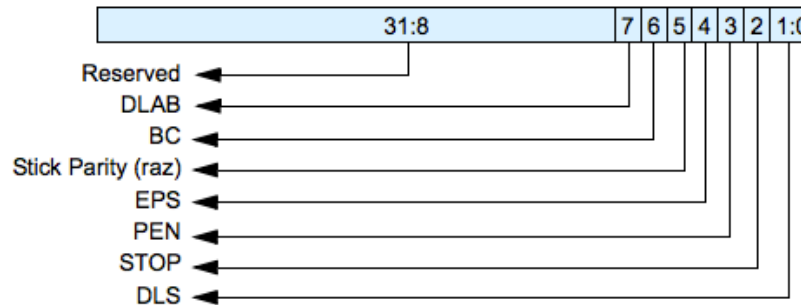

6	Break (or BC)	R/W	Break Control Bit. This is used to cause a break condition to be transmitted to the receiving device. If set to one the serial output is forced to the spacing (logic 0) state. When not in Loopback Mode, as determined by MCR[4], the <code>sout</code> line is forced low until the Break bit is cleared. If <code>SIR_MODE == Enabled</code> and active (MCR[6] set to one) the <code>sir_out_n</code> line is continuously pulsed. When in Loopback Mode, the break condition is internally looped back to the receiver and the <code>sir_out_n</code> line is forced low. Reset Value: 0x0
---	---------------	-----	--

FLIP **sout** pin

Step 2: UART Loopback bit -> 1

MCR

- **Name:** Modem Control Register
- **Size:** 32 bits
- **Address Offset:** 0x10
- **Read/write access:** read/write

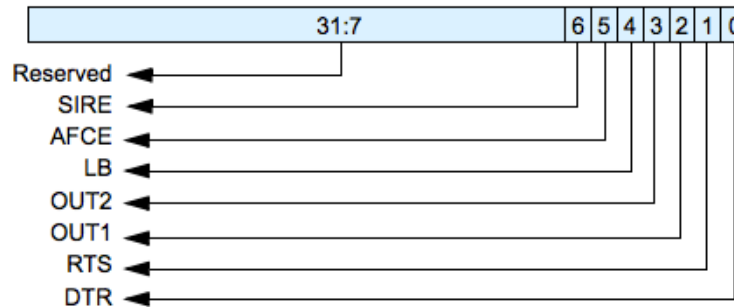

4	LoopBack (or LB)	R/W	<p>LoopBack Bit. This is used to put the UART into a diagnostic mode for test purposes.</p> <p>If operating in UART mode (<code>SIR_MODE != Enabled</code> or not active, <code>MCR[6]</code> set to zero), data on the <code>sout</code> line is held high, while serial data output is looped back to the <code>sin</code> line, internally. In this mode all the interrupts are fully functional. Also, in loopback mode, the modem control inputs (<code>dsr_n</code>, <code>cts_n</code>, <code>ri_n</code>, <code>dcd_n</code>) are disconnected and the modem control outputs (<code>dtr_n</code>, <code>rts_n</code>, <code>out1_n</code>, <code>out2_n</code>) are looped back to the inputs, internally.</p> <p>If operating in infrared mode (<code>SIR_MODE == Enabled AND active</code>, <code>MCR[6]</code> set to one), data on the <code>sir_out_n</code> line is held low, while serial data output is inverted and looped back to the <code>sir_in</code> line.</p> <p>Reset Value: 0x0</p>
---	------------------	-----	--

FLIP **sout** pin

Step 3: UART Loopback bit -> 0

MCR

- **Name:** Modem Control Register
- **Size:** 32 bits
- **Address Offset:** 0x10
- **Read/write access:** read/write

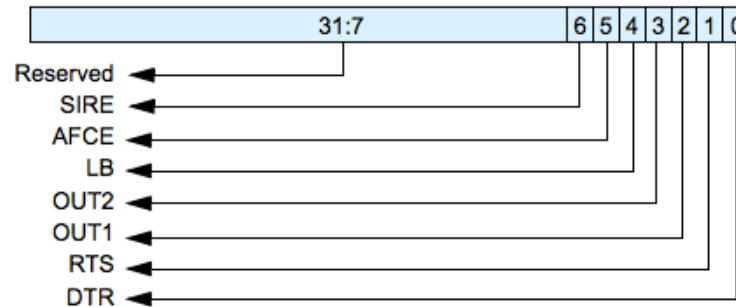

4	LoopBack (or LB)	R/W	<p>LoopBack Bit. This is used to put the UART into a diagnostic mode for test purposes.</p> <p>If operating in UART mode (<code>SIR_MODE != Enabled</code> or not active, <code>MCR[6]</code> set to zero), data on the <code>sout</code> line is held high, while serial data output is looped back to the <code>sin</code> line, internally. In this mode all the interrupts are fully functional. Also, in loopback mode, the modem control inputs (<code>dsr_n</code>, <code>cts_n</code>, <code>ri_n</code>, <code>dcd_n</code>) are disconnected and the modem control outputs (<code>dtr_n</code>, <code>rts_n</code>, <code>out1_n</code>, <code>out2_n</code>) are looped back to the inputs, internally.</p> <p>If operating in infrared mode (<code>SIR_MODE == Enabled AND active</code>, <code>MCR[6]</code> set to one), data on the <code>sir_out_n</code> line is held low, while serial data output is inverted and looped back to the <code>sir_in</code> line.</p> <p>Reset Value: 0x0</p>
---	------------------	-----	--

FLIP **sout** pin

Funtenna In Practice (UART)

```
equ uart_conf_reg, 0xFD060000  
@ set BREAK bit to force SOUT to low  
MOV    R1, #0x43  
LDR    R2, =uart_conf_reg  
STR    R1, [R2, #0xc]  
MOV    R1, #0x23  
MOV    R3, #0x33
```



```
STR    R1, [R2, #0x10]
```

Uart_sout -> 1

Funtenna In Practice (UART)

```
equ uart_conf_reg, 0xFD060000  
@ set BREAK bit to force SOUT to low  
MOV    R1, #0x43  
LDR    R2, =uart_conf_reg  
STR    R1, [R2, #0xc]  
MOV    R1, #0x23  
MOV    R3, #0x33
```



```
STR    R1, [R2, #0x10]
```

Uart_sout -> 1



```
STR    R3, [R2, #0x10]
```

Uart_sout -> 0

Funtenna In Practice (UART)

```
equ uart_conf_reg, 0xFD060000  
@ set BREAK bit to force SOUT to low  
MOV    R1, #0x43  
LDR    R2, =uart_conf_reg  
STR    R1, [R2, #0xc]  
MOV    R1, #0x23  
MOV    R3, #0x33
```

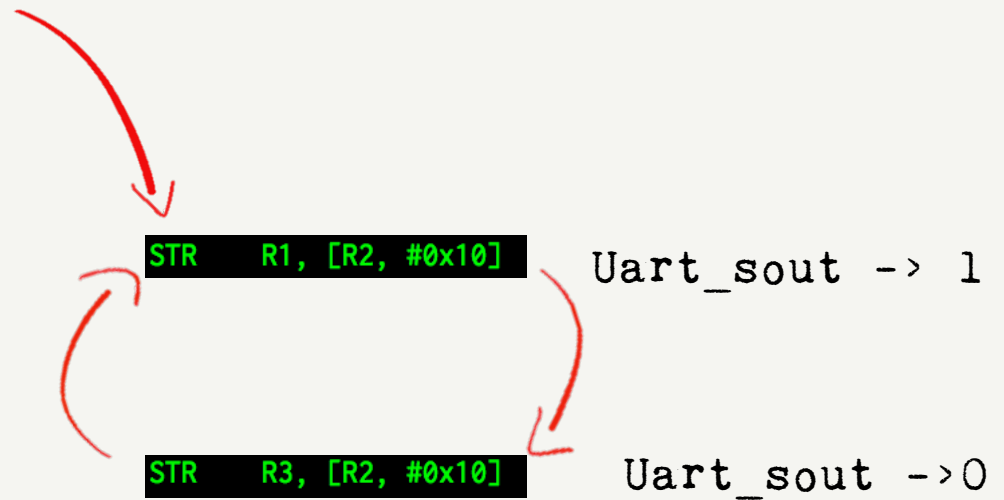

Funtenna In Practice (UART)

```
equ uart_conf_reg, 0xFD060000  
  
@ set BREAK bit to force SOUT to low  
MOV    R1, #0x43  
LDR    R2, =uart_conf_reg  
STR    R1, [R2, #0xc]  
MOV    R1, #0x23  
MOV    R3, #0x33
```

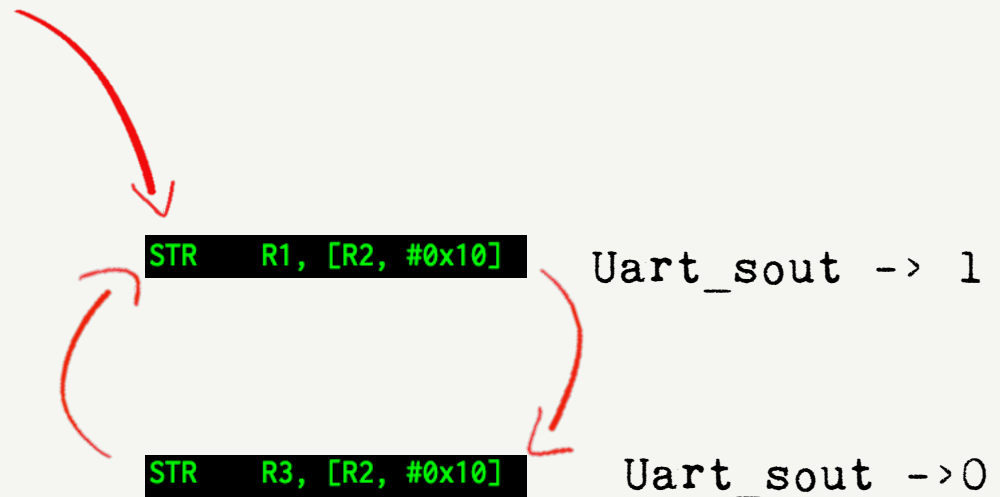

F = Approx 500khz

Funtenna In Practice

Funtenna Demo 2: UART, On Off Keying

UART Pin, 10 feet of console cable

Funtenna Demo 2: UART FUNTENNA DEMOD

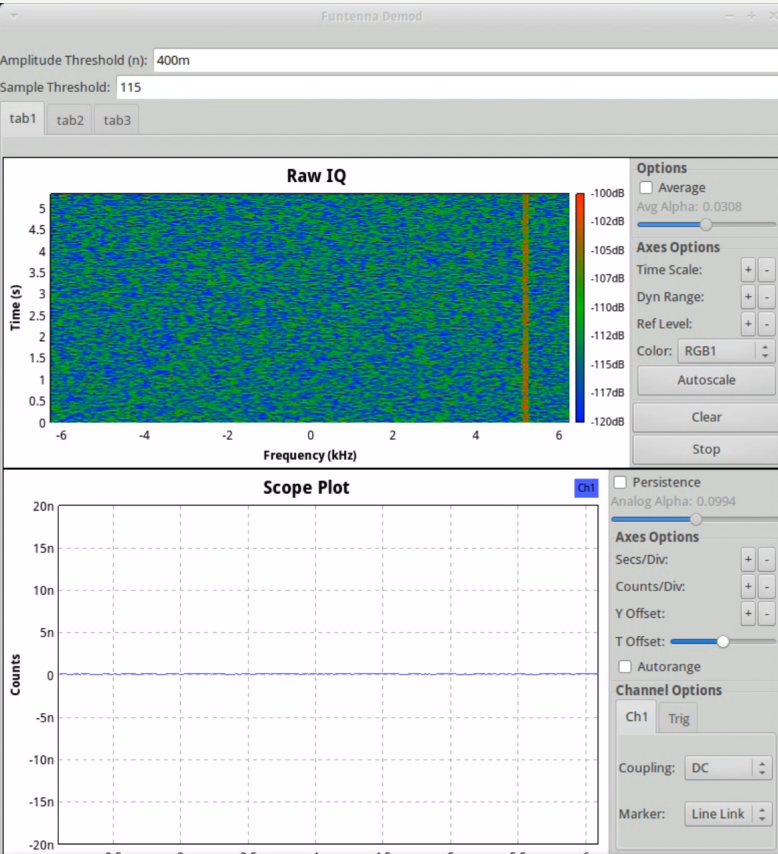

```
Terminal - panda@panda-XPS-15-9530:~/src/funtenna
Edit View Terminal Tabs Help
panda@panda-XPS-15-9530:~/src/funtenna$ python funtenna_demod.py |python slowprinter.py
```

```
Terminal - panda@panda-XPS-15-9530:~/pantum
File Edit View Terminal Tabs Help
target halted in ARM state due to debug-request, current mode: Supervisor
cpsr: 0x80000013 pc: 0x002e620c
D-Cache: enabled, I-Cache: enabled
Info : dropped 'telnet' connection
```

```
Terminal - panda@panda-XPS-15-9530:~
File Edit View Terminal Tabs Help
panda@panda-XPS-15-9530:~$
panda@panda-XPS-15-9530:~$
panda@panda-XPS-15-9530:~$
panda@panda-XPS-15-9530:~$
panda@panda-XPS-15-9530:~$
panda@panda-XPS-15-9530:~$
```

Take Away

- Funtenna works
- Network IDS is no substitute for host-based defense
- Host-based embedded defense important!

Big Thanks!

Chris Evans



Big Thanks!

Joseph Pantoga



Big Thanks!

Kang-Wei Chang



www.funtenna.org

Ang Cui, PhD
a@redballoonsecurity.com

Backup slides

Funtenna In Practice (GPIO)

Which pin to flip? **Every pin, at the same time!**

Memory Mapped Registers

0x1600D58 <- Contains GPIO Bank & Register List

GPIO bank A - 0x1600DA8 MEMREG 0xFD040000

GPIO bank B - 0x16011B8 MEMREG 0xF8040000

GPIO bank C - 0x16015C8 MEMREG 0xF8041000

GPIO bank D - 0x16019D8 MEMREG 0xF8042000

Funtenna In Practice (GPIO)

Which pin to flip? **Every pin, at the same time!**

Memory Mapped Registers

0x1600D58 <- Contains GPIO Bank & Register List

01600D58	00B315AC	01600DA8	FD040000	00B315C4
01600D68	016011B8	F8040000	00B315DC	016015C8
01600D78	F8041000	00B315F4	016019D8	F8042000

GPIO bank A - 0x1600DA8 MEMREG 0xFD040000

GPIO bank B - 0x16011B8 MEMREG 0xF8040000

GPIO bank C - 0x16015C8 MEMREG 0xF8041000

GPIO bank D - 0x16019D8 MEMREG 0xF8042000

Funtenna In Practice (GPIO)

Which pin to flip? **Every pin, at the same time!**

Memory Mapped Registers

0x1600D58 <- Contains GPIO Bank & Register List

```
01600D58 00B315AC 01600DA8 FD040000 00B315C4
01600D68 016011B8 F8040000 00B315DC 016015C8
01600D78 F8041000 00B315F4 016019D8 F8042000
```

GPIO bank A - 0x1600DA8 MEMREG 0xFD040000

GPIO bank B - 0x16011B8 MEMREG 0xF8040000

GPIO bank C - 0x16015C8 MEMREG 0xF8041000

GPIO bank D - 0x16019D8 MEMREG 0xF8042000

```
01600DA8 4750494F 01600D58 CDCDCD00 FD040080 OIPGX.~
01600DB8 CDCDCD00 00000000 00000000 CDCDCDCD .....
01600DC8 4750494F 01600D58 CDCDCD00 FD040084 OIPGX.~
01600DD8 CDCDCD00 00000001 00000000 CDCDCDCD .....
01600DE8 4750494F 01600D58 CDCDCD00 FD040088 OIPGX.~
01600DF8 CDCDCD00 00000002 00000000 CDCDCDCD .....
01600E08 4750494F 01600D58 CDCDCD01 FD04008C OIPGX.~
01600E18 CDCDCD00 00000003 00000000 CDCDCDCD .....
01600E28 4750494F 01600D58 CDCDCD01 FD040090 OIPGX.~
01600E38 CDCDCD00 00000004 00000000 CDCDCDCD .....
01600E48 4750494F 01600D58 CDCDCD00 FD040094 OIPGX.~
01600E58 CDCDCD00 00000005 00000000 CDCDCDCD .....
01600E68 4750494F 01600D58 CDCDCD01 FD040098 OIPGX.~
01600E78 CDCDCD00 00000006 00000001 00000000 .....
01600E88 4750494F 01600D58 CDCDCD00 FD04009C OIPGX.~
```

GPIO Bank A