

Ceiling Air-conditioner

Installation & Operation Instruction Manual

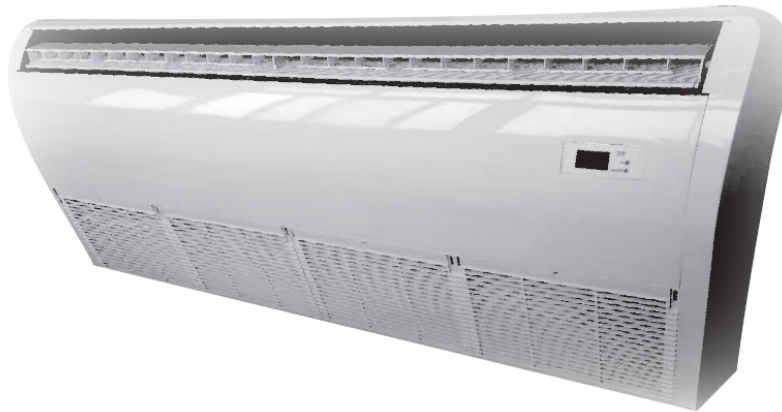

Model:

30K 30000BTU(Cooling Only)

36K 36000BTU(Cooling Only)

42K 42000BTU(Cooling Only)

48K 48000BTU(Cooling Only)

60K 60000BTU(Cooling Only)

In order to operate and use this product correctly and safely, this instruction manual should be read carefully before operation. Keep it in a safe place after reading, for future reference.

Contents

Safety Precautions

1.Component Name and Funcion	1
2.USE Method of Remote Control.	2
3.Operation Instruction.	5
4.Optimum Operation Methods	5
5.Repairing and Maintenance.	5
6.Troubleshooting	6
7.Location of installation.	7
8.Machine Installation	8
9.Pipes Installation	9
10.Electric wire installation	11
11.Error code analysis	12

Installation and Operation Instruction manual

1. Components Name and Function

● Indoor unit

42K/48K/60K series

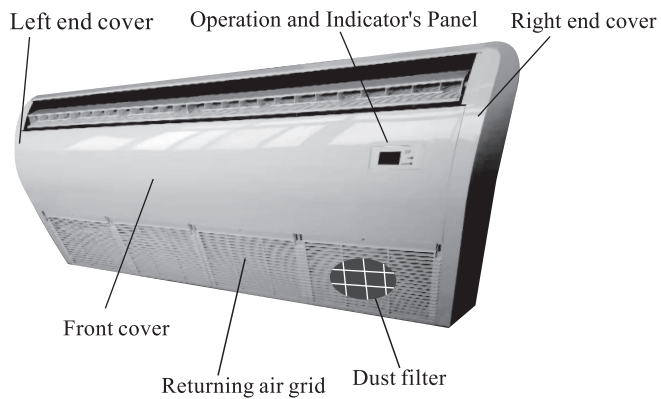

30K/36K Series

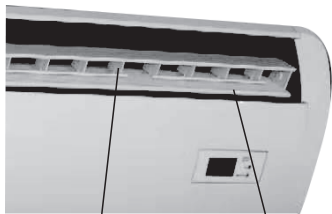
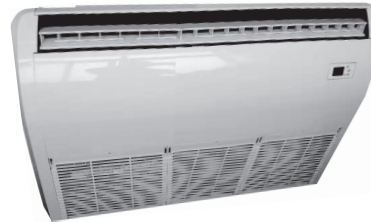

Left/Right air swing plate Up/Down air swing plate

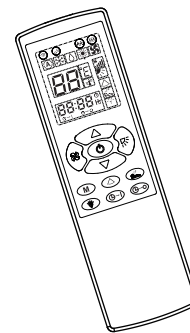

Remote controller

● Outdoor unit

30K/36K/42K/48K series

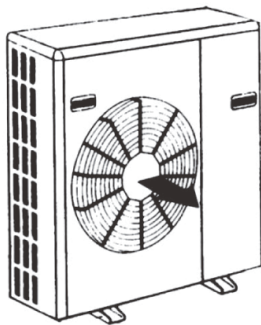

60K series

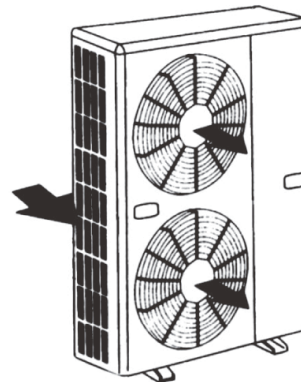

● Dimensions of the machine

Type	Indoor			Outdoor		
	Length	Wide	Length	Length	Wide	Length
30K	1288	673	243	917	330	820
36K	1288	673	243	917	330	820
42K	1672	673	243	917	330	940
48K	1672	673	243	917	330	940
60K	1672	673	243	917	330	1240

Installation and Operation Instruction manual

2. USE Method of Remote Control

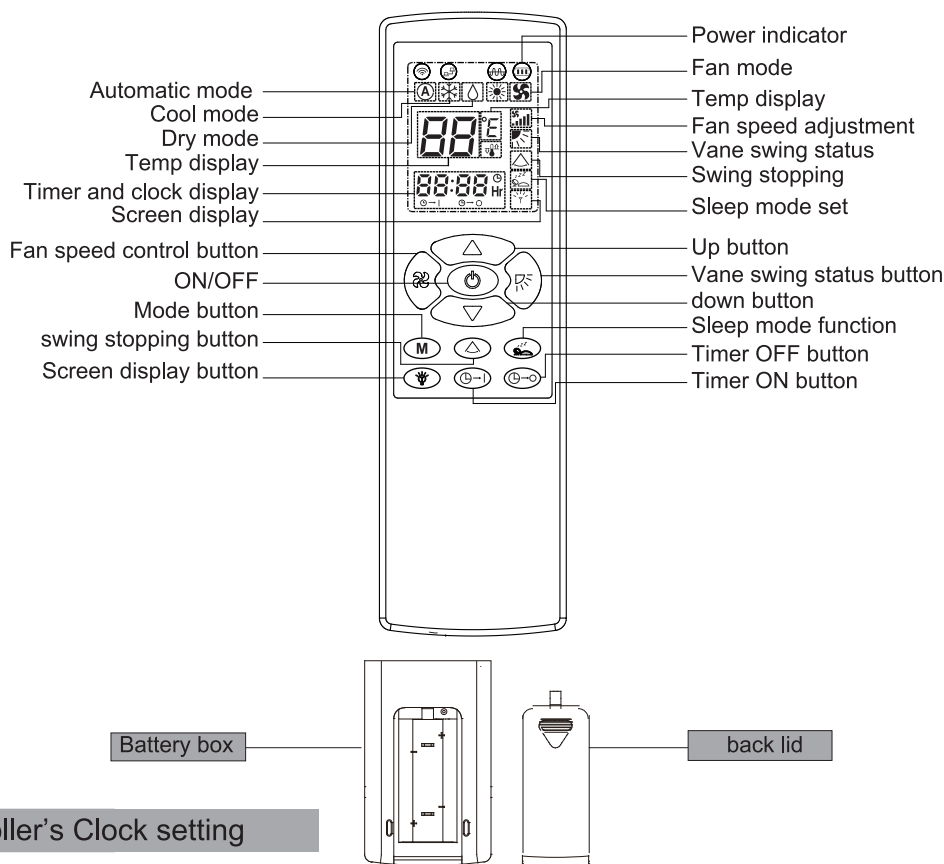

Remote controller's Clock setting

1.Remove the back lid and install two batteries.

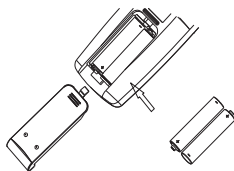

(please pay attention to the battery electrodes)

2.Pressing clock setting button

The first time to install batteries,all LCD displaying,then LCD shows power indicator and the clock shows: **00:00**°.

3.Clock function setting button

When LCD shows **00:00**° at fist time,press the clock setting button(press timer on button and timer off button at the same time), **00:00**° start to twinkle,then setting the clock.Press “up” button to setting hour,and press “down” button to set Min,it is finish setting When LCD display twinkles five times or press “up” and “down” at the same time.

(It is the same way to revised time in the days after)

Operate automatically

When the operation starts according to the room temperature,the operation mode is automatically select among cooling,Dry .However ,when operation start again within two hours after the operation is stopped,the same operation mode before is is stopped is selected.The room temperature will not be influenced once the operate is selected.

Room temp when starts	Running Mode
Approximately 25 C or higher	Cool
21 C ~ 25 C	Dry(Fan)

To start operation

- 1.The signal transmitting section of the remote controller should be pointed at the receiving section.
- 2.Press the **ON/OFF** to start air-conditioner.
- 3.To select the Auto mode, each time the button is pressed, the operation **MODE** is changed in sequence from.

AUTO — COOL — DRY

To stop operation

Press the **ON/OFF** button.







While too warm or cool

When about 3-15 min passes, after operation start, if you feel slightly warm or cool.

- 1.Press the **▲** button to raise the temperature, One press raises the temperature by about 1 C .
- 2.Press the **▼** button to lower the temperature, One press lowers the temperature by about 1 C

Installation and Operation Instruction manual

To Select The“COOL”,“DRY”, “FAN”, “ON/OFF” Mode

- 1.Press  to start machine.
- 2.Press  to select running mode. The running mode is change in sequence after pressing the , from AUTO-COOL-DRY .(For example)To select the cool operate mode,Press Mode button continuously until“cool”is shown on display screen.
- 3.press the  button to select fan speed.
- 4.Press  to select air flow blowing direction.
- 5.Press the  button to stop machine.

Note

Once the operation mode has been selected, the same operation mode will start after the ON/OFF button pressed on.

Temperature adjustment

To lower the temperature, Press the  button, One press lowers the temperature by about 1℃.

To raises the temperature, Press the  button, One press raise the temprature by about 1℃.

In “DRY”operation

When Dry operation starts,The air conditioner running under low speed of fan,and it cannot be changed, Con-trolled by the microprocessor, the fans in the outdoor and indoor unit operate occasionally for “DRY”opera-tion. The room temperature is slightly lowered in this operation mode,the “DRY” function can not be done when the room temperature is 13℃ or lower.





Air Flow velocity adjustment

Press the button  to adjust the air flow velocity. Each time the button is pressed, fan speed is changed as follows: AUTO-LOW-MEDIUM-HIGH.





Adjust horizontal direction of wind

Please don't use hand to adjust the horizontal of vane swing.The vane swing will adjust the direction from up to down and left to right by freely under running. please be careful in case to harm your hand.

Swing up and down to supply air

- 1.Swing supply air:Please press the button ,Vane swing freely in horizontal direction,supplying air from corner to corner of room.Press the button  again, The vane stop to swing.
- 2.Fixed angle to supply air: Please press the button , the vane will swing to your wanted angle to supply air.
- 3.Please press  button to adjust the up and down direction of vane,Each time the button is pressed, air supply direction is changed as follows:



- 1.Please select  at ordinary times.
- 2.Please select  under “COOL”and “DRY” mode.
- 3.When the  symbol on the position , press  button to stop the vane on your wanted place.

Note

Please use remote controller to adjust the direction of vane, otherwise will cause error if you use hand to change the direction of vane directly.











Screen display

The screen display shows  after power on. It means the air conditioner is working under current mode.For example,if the screen display too bright when you are in sleep, it will hide the display content after you pressing the screen display button. And reset display if you press any button.

Notice:This remote controller is the latest type,and some types don't have above function.

Installation and Operation Instruction manual

To set timer on/off function

Press the timer on button , the  appears in the display and begins to glitter. The glitter will last on 1 min, it prompts you that you can start to set the timer on function. It will be canceled if you press the timer button  again. Press  the timer off button when the unit is on, or press timer off button after pressing  timer on button to set the timer, the  appears in the display and begins to glitter, and it will last on 1 min, it prompts you that you can starts to set the timer off function. The function will be canceled if you press timer off button again. Press  and  to set timer on and timer off function which you need. Each press of the , the set time will increase by 1 hour. Each press of the . the set time will decrease by 1 min.

To use the timer on/off function together

Press the timer on button to set the timer on function first, and then press the timer off button to set the timer off function. the timer on/off functions are use together at this time.

Notice

Please confirm whether the electronic clock is set right or not before setting the timer on/off function. If the current time is the time of the timer on/off, and the state of the machine is the same as the requirement of the time set, the operating mode will not be changed.

Set the comfortable sleep mode function

1. The air condition unit is power on.
2. Press the sleep button  to enter the operation of sleep mode function.

Sleep function

1. The fan motor indoor changes to the Auto speed.
2. In cool operation, each hour the temperature will raise by 1°C, but the changing range is only 2°C.
3. In dry operation, the room temperature often does not change.



To cancel the sleep mode function



The function can be canceled as below:

1. Press the sleep mode  set button again.
2. Press the on/off button or stop the machine auto-matically.

Notice:

This remote controller is the latest type.

Please according to this instruction if the instruction has difference from the object. If this remote controller is used together with the cabinet type,  button control the horizontal direction and  button control the vertical direction.

There is not swing function if the remote controller is used for some air conditioner units such as portable,  and  button does not work.

Working condition of unit

Mode	Cool
Room Temperature	16°C ~ 31°C

Notes:

1. The efficiency of unit will be worse under condition except above.
2. If you select "COOL" mode under wet weather (Relative humidity higher than 80%). It will appear condensation water on indoor panel, at this time, it will be better if select high wind mode.

Installation and Operation Instruction manual

3. Operation Instruction

● Remote Controller Mode or Key Control Mode

For more details, please see the Remote Controller Operation Instruction Manual or Key Controller Operation Instruction Manual.

⚠ Note

There is no sleep setup for this product

⚠ Note

1. This remote controller can be commonly used in both the cooling/heating types and the cooling type air-conditioner products. For cooling-only products, the heating mode will be spare.
2. In the room with fluorescent lamp, because of the effect of periodic on/off of its high voltage pulse regulator or electronic regulator, sometime it may happen that the indoor unit can not properly receive the signal transmitted by the remote controller.

● Emergency mode

When the battery of the remote controller is out off or the controller itself malfunctions, there is an emergency pushbutton which can control the machine.

Every time when this pushbutton is pushed.

the air-conditioner responses in the following sequence:

Action	Temperature Setting	Wind Speed	Wind Direction Plate
Cooling	24°C	Auto	Swinging

(Cooling): Emergency cooling → Stop

In emergency operation set the temperature, wind speed and wind direction plate to the state in the right table.

Displays the room temperature, when set temperature, it display the set one.

Remote control receiving window

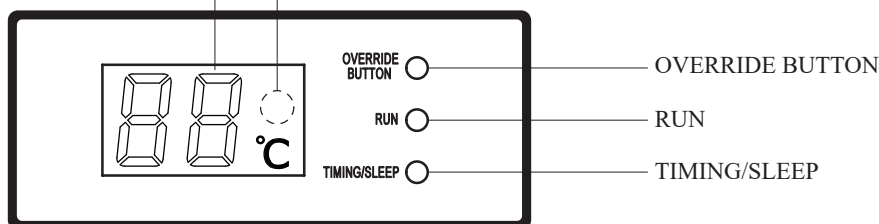

4. Optimum Operation Methods

- The temperature in the room should be set so that it is comfortable in it.
 - └ When cooling, it should be comfortable if the difference of temperature between in-door and out-door is less than 5°C.
 - └ When cooling, every 1°C you increase the temperature setting, about 10% of the power consumption will be saved.
 - └ It is harmful for your health, and power wasting if you set the temperature too low.
- When cooling, do not let sun light get into the room.
 - └ When cooling, the window facing the sun should be covered with curtain, to minimize the heat of sunlight getting into the room. In addition, minimize the times of opening and closing the door.
- Periodically clean the dust filter
 - └ Filter blockage will reduce the recycled air volume, which will affect the efficiency of cooling and even cause air-conditioner malfunction. If the air conditioner has stopped for a long term, clean the filter before starting it In the environment with lots of dust, the filter should be cleaned even more often.

5. Repairing and Maintenance

Shut down the power supply before repairing or maintenance.

1).Dust filter

- Dismantle the returning air grid, and take out the dust filter.

Installation and Operation Instruction manual

- Lightly clap the filter or clean the filter with dust collector. If there is too much dust on the filter, clean it with warm water containing a small amount of neutral scour, and then rinse it with clean water, and dry it.
Install the filter and the grid back in sequence reverse to the dismantling sequence.

ⓘ **Note:**

- Do not dry the filter by exposing it to sunshine or an oven, and avoid deforming the filter.
- Do not clean the filter with warm water higher than 50 degree, and avoid deforming the filter

2).Body

- Sweep the body surface with soft cloths. If there are oil dirties or finger prints on the body surface, clean it with domestic-use neutral detergent.
- Do not clean it with volatile oil, gasoline, dilutes, abrasive powder, non-neutral detergents, etc.

3).Before putting it into use seasonally.

- Make sure that there is no blockage materials at the exhaust of the indoor unit and the outdoor unit.
- Make sure that the protection cover on the outdoor unit has been removed.
- Make sure that the ground wire has been properly connected.
- Make sure that there is no condition as bending, lifting, or blocking in the drainage flexible pipe.
- Make sure that the filter has been properly installed (If the air conditioner runs without this filter, dust or other things may get into it and cause troubles).

4).After seasonal use.

- Shut down the power supply of the air conditioner.
- Properly clean and maintain the dust filter and other parts of the air conditioner.
- Cover the outdoor unit with plastic cloth, to avoid dust or garbage getting in.

6.Troubleshooting

- If you suspect that the air conditioner may malfunction, before you contact the local service agency, please read the following list

Trouble	Phenomenon	Causes	Handling methods
The air conditioner does not run	When pushing the on button, there is no indication on the indication part	The power supply is out	Push the ON button when power supply is normal
		The power supply is out turned on	Turn on the power supply
		The fuse burns	Replace the burnt fuse
		The leakage switch is shut down	Turn on the leakage switch
There is wind blowing out but it is neither warm nor cool	The indication is normal. and there is wind blowing out and the wind is neither warm nor cool	The temperature setting is too high when cooling, or the setting is too low when heating	Lower or increase the temperature setting.
		There is too much dust or other things, which block the filter.	Clean the filter
		There is obstacle at the path of exhaust or suction intake of the in-door unit or the out-door unit.	Clear the obstacle
		The door or the windows of the room is open.	Close the door or the windows

- If the above trouble remains after checking and handling it according to the above list, shut down the power supply and talk the trouble to a local service agency.

Installation and Operation Instruction manual

① **Note:**When the air conditioner is running, some situations may occur as following:

- **Odor:**The air conditioner may emit odor sometime, which may be caused by residual in the air-conditioner of flavors as cigarette and cosmetics in the roombeing blew out from it.

Noise:When the machine is running or just stopped, refrigeration agent inside may make some noise as “swoosh” “swoosh” ,After cooling/heating begins or stops,the parts such as covers will expand or shrink because of temperature change,which may cause friction with noise as crack.

- When the indoor humidity is higher, there could be water drop around the air outlet and brim, which is normal.

7.Location of installation

●Indoor unit

- The place to accommodate the machine should be good with ventilation conditions.
- The wall or ceiling to install the machine should be strong and firm enough.
- The place should be convenient to conduct water drainage.
- Avoid installing the machine at a place exposed to sunlight or high temperature.
- Avoid installing the machine at a place exposed to oil fog, steam and flammable gas.
- The distance between the machine and TV and Audio System should be more than 1 meter.
- Keep it as far as away from equipment emitting high frequency signal, such as fluorescent lamp and flashing lamp.

There are two kinds of location which are possible to install the indoor unit.

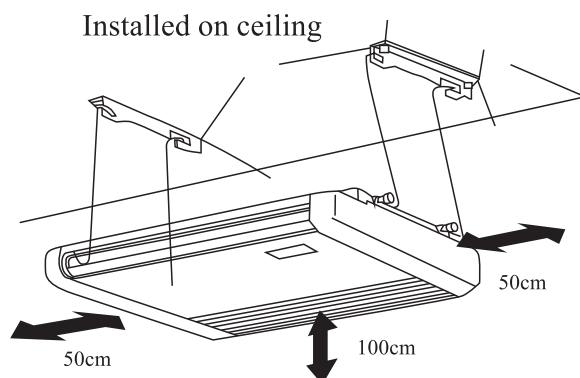

Location of installation of out door unit(at the same time, please ask for opinions of the customer)

- Avoid sunlight directly shining upon it (Shield it with sunlight shielding cover)
- Prevent it from effect of strong wind.
- Keep it away from flammable gas.
- The place should be convenient in pinping and wiring between the indoor unit and the outdoor unit.
- Avoid noise of the unit interfering your neighbor.
- Avoid installing it on top of a frame or platform where may exaggerate the noise and vibration.
- Install it high enough from the ground, and fix firmly the foot nuts.
- When heating, please notify that there is condensing water drained from the unit bottom.

(Unit: mm)

When front (air outlet) side is open

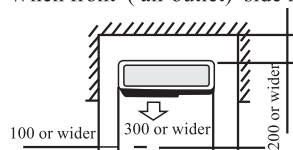

When the rear, two ends and top sides are open

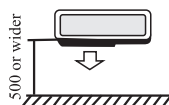

Installation and Operation Instruction manual

8. Machine Installation

1). Indoor unit installation

- (1). Choose installation location.
Determine the specific position of installation for the indoor unit..
- (2). Install the expanding bolts.
Install the expanding bolts at the right location.

ⓘ Note: The users should prepare the required expanding bolts by themselves.

- (3). Install the left/right frames.
 - A. Dismantle the air inlet grid kit.
 - B. Dismantle the left /right cover.
 - C. Take down the left/right frames from the unit.
 - D. Fix the left/right frames onto the expanding bolts, and tight the nuts.

ⓘ Note: After installing, the left/right frames should keep horizontal,the installation direction of which are shown on the right side pictures.

- (4). Fix the indoor unit
 - A. Suspend the unit onto the frames.
 - B. Tight the screws.
 - C. Install back the left/right covers.
 - D. Install back the air inlet grid kit.

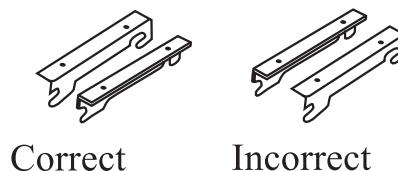

2). Outdoor unit

Installation Requirement

When installing the outdoor unit,use bolts to fix its feet. (The users or the authorized local service will provide the bolts by themselves).

The installation should be strong enough.to withstand windstorm or earthquake.

Note:

Try as hard as you can to deliver the air conditioner with original package to installation location. Because the center of gravity of the outdoor unit is not at the center axis of it,be careful when slinging the unit.
When delivering, do not tilt the unit more than 45 degree (Do not lay the unit sidelong).

Installation and Operation Instruction manual

9. Pipes Installation

⚠ Caution: Choose isolation pipe thicker than 9 mm, to isolate the copper pipe and avoid condensing on it.

⚠ Caution: When installing the drainage pipe, isolate it with isolation pipe thicker than 6 mm, to avoid condensing on it.

1). Material and size of the refrigeration pipe and drainage pipe.

Measurement of refrigerant pipe/drainage hose			
Capacity		30K/36K/42K/48K	60K
Refrigerant Type		R410A	R410A
Refrigerant liquid pipe		9.52	9.52
Refrigerant gas pipe		15.88	19.05
Drainage hose	PVC pipe: diameter 20		

2). Location of Refrigeration Agent Pipes and Drainage Pipe of Indoor Unit.

The pipes connected with indoor unit should be connected as shown following.

(1). When the pipes are led out from rear side of the indoor unit.

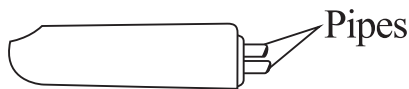

(2). When the pipes are led out from bottom of the indoor unit.

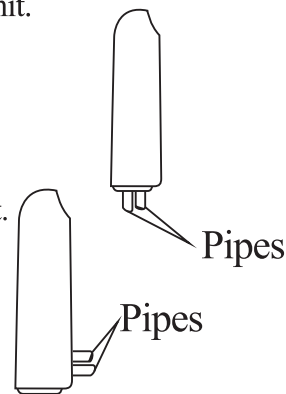
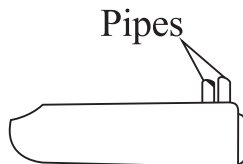

ⓘ Note: The mode of pipes leading out is related to installation mode of indoor unit.

3). Connection of refrigeration agent pipes.

(1). Dismantle the air inlet grid kit of indoor unit.

(2). Keep the original status of closing of the gas valve and liquid valve of the outdoor unit.

Respectively dismantle the nuts, anti-dust cap and piping screw plugs from the indoor and outdoor pipes, and quickly complete connection of the horns of the pipes (Avoid dust, moisture, and other things getting into the pipes and causing troubles.)

- Smear a thin layer of seal lil on the matching surface of the horns and the connectors before fix the horn nuts.

- When tightening the nuts, firstly push the horn onto the cone surface of the connector, and keep the leading pipe and the connector in the same axis, then gradually turn the cone nuts clockwise tightly with hands, and then tighten it with a wrench.

When tightening the nuts with wrench, apply torque according to the right list, If it is not tightened enough, leakage of rfrigeration agent may happen, but if it is fixed too tight, the horn surface may be damaged

Outer Dameter of Copper Pipe(mm)	Turning Torque (N M)
Φ 9.52	35-40
Φ 15.88	73-78
Φ 19.05	98-130

Installation and Operation Instruction manual

- (3). Complete the horns connection in sequence, to finish connection of all the refrigeration agent pipes.
 - The bending angle of the pipes should not be smaller than 90 degree, bending radius should not be less than 100 mm, and bending times should not be more than 3 times.
 - After finishing connection of all the pipes, use a tester of soap water to check whether there is leakage in the pipes or not.
 - The connection part of the pipes should be covered with isolation sleeves, to avoid water condensing at these positions, offsetting the isolation sleeves for gas and liquid pipes.
- (4). Suction the air out from the maintenance opening of the pipe by a vacuum pump, to form vacuum inside the pipes.
- (5). After finishing the above operation, open both the gas valve and the liquid valve to let the indoor and outdoor pipes openly connected.
- 4). Refrigeration agent quantity control
 - ⚠ Caution: Do not try to exhaust the air inside the pipes by the refrigeration agent in the outdoor unit.
 - ⚠ Caution: When compensating refrigeration agent, please use the filling port on the gas valve of the outdoor unit.
 - Allow a maximum length of the pipes(Single way) 6 m. When the pipe length is less than 6 m, it is necessary to compensate agent; When the pipe is longer than 6 m, please compensate agent according to the following list:

Capacity	Outer dia of pipe		Rated	Max	Extra Refrigerent
	liquid	gas			
30K/36K/42K/48K/60K	9.52	19.05 15.88	6m	30m	20gm/m

- 5). Installation of drainage pipe of the indoor unit.
 - The pipe should tilt downwardly from the indoor unit, and make sure there is no water accumulation inside it.
 - The connection part of the pipe should be tightened so that there is no leakage of water occurring.
 - Do not put the pipe onto the sewage pitch with sulphuration gas or odor.
- 6). Acknowledgement of water draining of the indoor unit
 - When the drainage pipe is installed, make sure that whether there is water drained from this pipe and whether there is water leakage happening.
 - When pouring water into the indoor unit to check the pipe, fill the water into the unit from side plate of the heat exchanger.

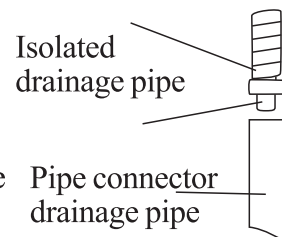

Note:

- Ⓢ For the cooling/heating type, because when heating there is condensed water produced in the out-door unit, install a drainage pipe at it's pipe at it's bottom cover by: push the drainage pipe connector onto the drainage port at the bottom of the out-door unit, with the direction that the bigger end of the connector towards the drainage pipe onto the smaller end of the conector. (Note: the connector is placed in package tray of the outdoor unit, the drainage pipes should be prepared by the customer himself).

Installation and Operation Instruction manual

10. Electric wire installation

10.1 Caution:

- Please install the special power and the creepage switch.
- Please check the unit's voltage and electric wire before connection.
- The electric wire should be installed according with the requirement. Screw down the bolt.
- The unit's signal part can't be connected to the power of 220V, otherwise malfunction can be caused.
- Because signal board has the polarity, so please connect it by the correct number. If the connection is wrong, the compressor will not work.

10.2 The sketch of elements connection.

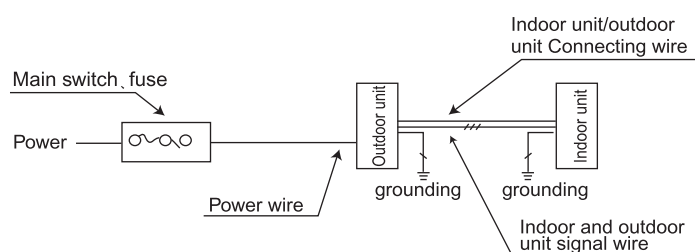

10.3 Connection specification

Type		30K/36K/42K/48K/60K(Only Cooling Outdoor PCB)	
Power supply		3N~ 50Hz, 380V	
Input current (main switch/fuse) (A)		30	
Electric wire	Outdoor unit electric wire	Quantity of electric wire	5(Greenish-yellow is ground wire)
		Core wire section(mm ²)	4x2.5+1x1.5
	Indoor and outdoor connection wire	Quantity of electric wire	4(Greenish-yellow is ground wire)
		Core wire section(mm ²)	4x1.5

Caution:

- When you install the electric wire, please consider the circumstance (temperature, sunlight, directly, rain)
- Both the indoor and outdoor unit should have the ground wire connected
- The installation should comply with the local's standard

Error code analysis

Error code analysis

1. Room temperature sensor (RT) damage-----E0
2. Indoor coil temperature sensor (IPT) damage-----E1
3. System malfunction(lack of refrigerant and others)-----E8
4. Connection malfunction (high voltage/low voltage protection , exhaust air temperature too high and others; only suitable for 42K/48K/60K unit)-----E7

Error code analysis

11.Error code analysis

- Room temperature sensor (RT) damage-----E0
- Indoor coil temperature sensor (IPT) damage-----E1
- System malfunction(lack of refrigerant and others)-----E8
- Connection malfunction (high voltage/low voltage protection , exhaust air temperature too high and others ; only suitable for 42K/48K/60K unit)-----E7