

# CASSETTE TYPE AIR CONDITIONER

BEFORE USE

---

## OPERATION AND INSTALLATION INSTRUCTIONS

USE AND MAINTANANCE

### Model:

30K 30000BTU(Cooling Only)

36K 36000BTU(Cooling Only)

42K 42000BTU(Cooling Only)

48K 48000BTU(Cooling Only)

60K 60000BTU(Cooling Only)

INSTALLATION

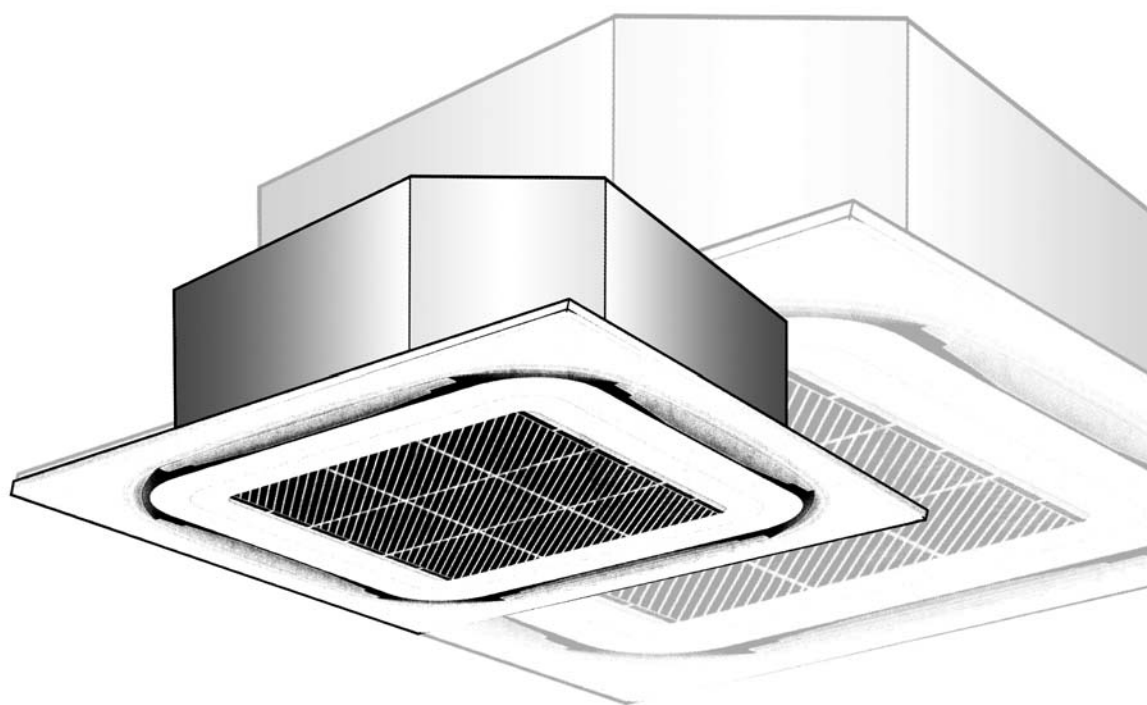

# CONTENTS

## BEFORE USE

SAFETY PRECAUTIONS ..... 1

NAME OF EACH PART ..... 3

## USE AND MAINTENANCE

USE METHOD OF REMOTE CONTROLLER ..... 4

HOW TO GET THE BEST EFFICIENCY ..... 7

MAINTENANCE ..... 7

MALFUNCTION CHECK ..... 8

ERROR CODE ANALYSIS ..... 9

## INSTALLATION

INSTALLATION PLACE ..... 10

INSTALLING THE INDOOR UNIT ..... 12

INSTALLING THE OUTDOOR UNIT ..... 14

INSTALLING THE ELECTRIC WIRE ..... 16

INSTALLING PANEL AND TRIAL OPERATION ..... 17

PLEASE READ THE OPERATION AND INSTALLATION INSTRUCTIONS CAREFULLY BEFORE YOU USE THE UNIT, AND KEEP IT PROPERLY.

# SAFETY PRECAUTIONS

For your safety, please read the following contents carefully before you use the unit.

Safety sign

⊘ Prohibition

⚠ Control according with indicator

⚡ Must joint the ground wire

Please don't install, repair and move the unit by yourself.

Please ask the professional installation man to repair and move the air conditioner, otherwise maybe caused the fire electric shock or drop.

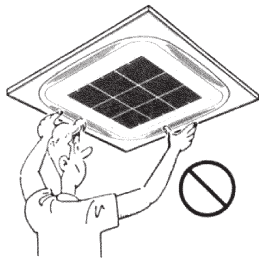

Install the unit according to the stipulation

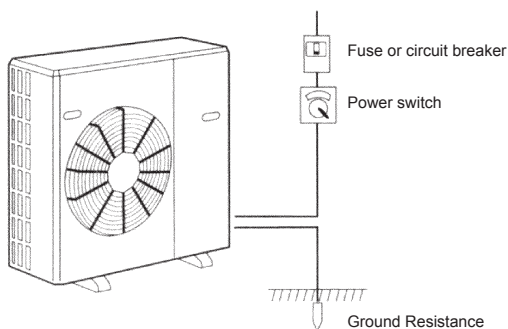
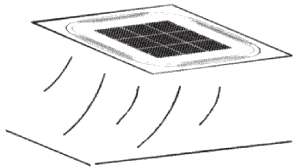

Drain water should be fully drained.

If the drainage is incomplete, water may drop from the unit. It may wet and spoil furniture.

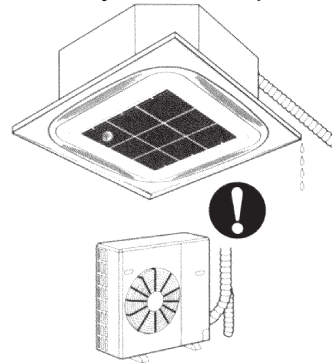

Please don't install the unit where flammable gas could leak or atrocious

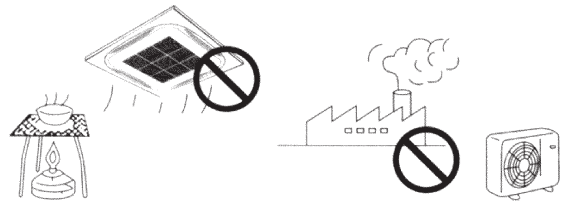

Caution before trial operation

Check all the panel, fan guard and other protection sets whether installed correctly or not; If touch the running, heater or high voltage part, maybe caused damage.

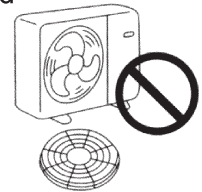

Never insert stick or foreign object in air inlet or outlet. Touching rotating or fans can be hazardous.

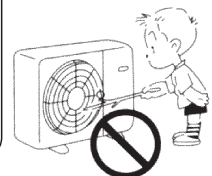

Please insure the air outlet and inlet without obstruction.

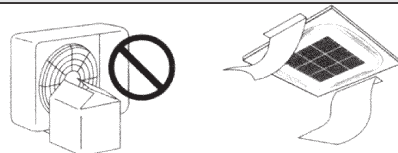

# SAFETY PRECAUTIONS

Please don't press the remote controller button with spiculate object.



Don't place propagation at the location of direct air flow.



Please stop running the unit and switch off As soon as the abnormality appears(burnt smell)

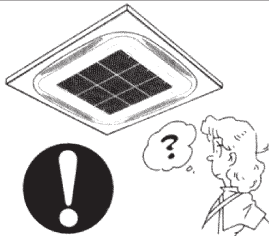

The unit can't be wet;  
Touch it by wet hand is prohibited.

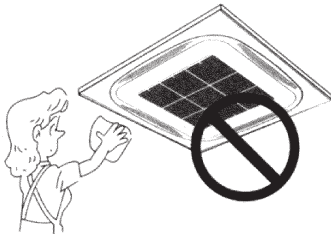

Do not put a pet or house plant where will be exposed to direct airflow.

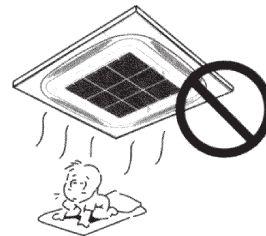

Don't step on the outdoor unit and don't put anything on it.

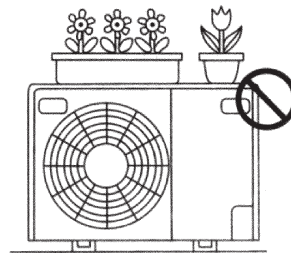

Allow fresh air into room occasionally.

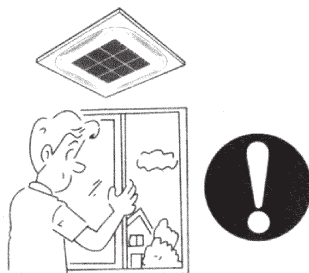

Do not apply an insecticide or flammable spray.

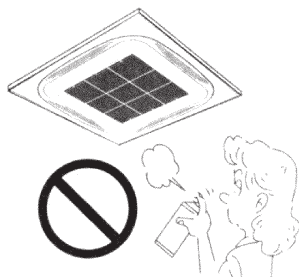

Don't deal with the unit by yourself.



# NAME OF EACH PART

## 1. Indoor unit

- A. Air inlet
- B. 4-way air outlet
- C. Adjustment vanes
- D. Air filter
- E. Panel
- F. Remote controller

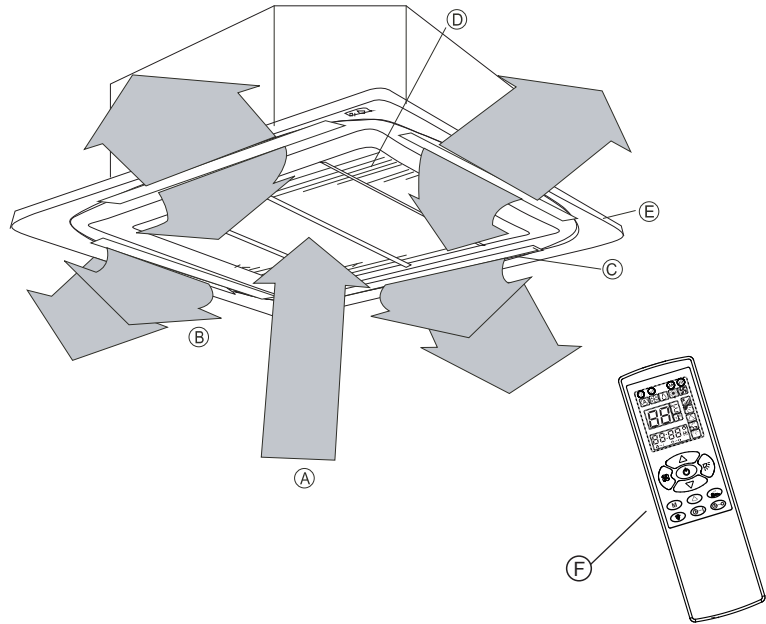

## 2. Outdoor unit

- A. Air outlet
- B. Air inlet

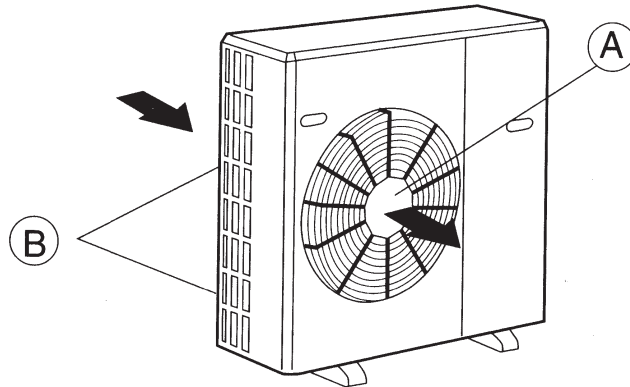

Before Use

# USE METHOD OF REMOTE CONTROLLER

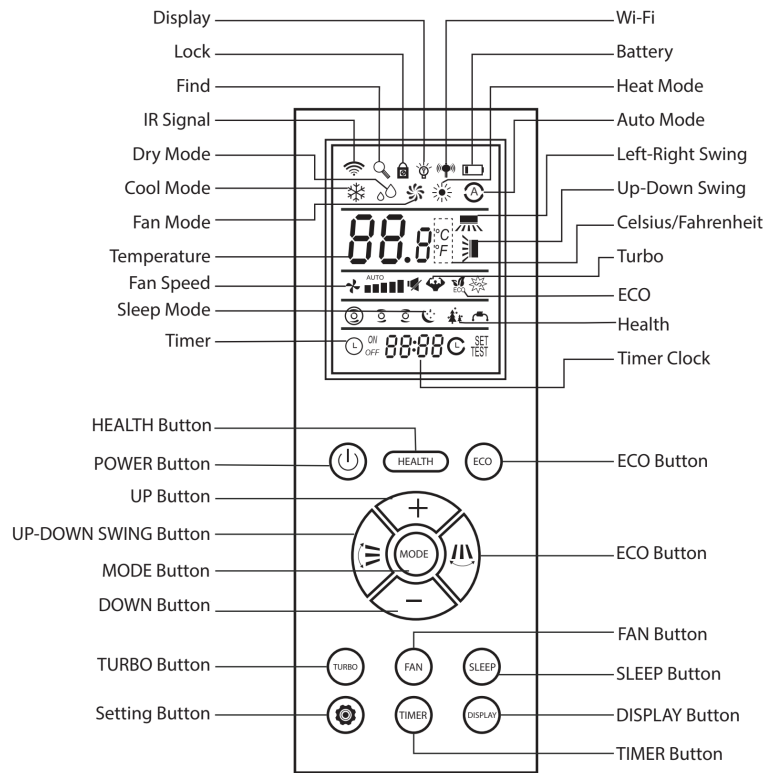

## Remote controller's Clock setting

1.Remove the back lid and install two batteries.

2.Pressing clock setting button

The first time to install batteries,all LCD displaying,then LCD shows power indictor and the clock shows: **00:00<sup>°</sup>**.

3.Clock function setting button

When LCD shows **00:00<sup>°</sup>** at fist time,press the clock setting button(press timer on button and timer off button at the same time), **00:00<sup>°</sup>** start to twinkle,then setting the clock.Press "up" button to setting hour,and press "down" button to set Min,it is finish setting When LCD display twinkles five times or press "up" and "down" at the same time.

(It is the same way to revised time in the days after)

## Operate automatically

When the operation starts according to the room temperature,the operation mode is automatically select among cooling,Dry .However ,when operation start again within two hours after the operation is stopped,the same operation mode before is is stopped is selected.The room temperature will not be influenced once the operate is selected.

Room temp when starts	Running Mode
Approximately 25 C or higher	Cool
21 C ~ 25 C	Dry(Fan)

## To start operation

- 1.The signal transmitting section of the remote controller should be pointed at the receiving section.
- 2.Press the **ON/OFF** to start air-conditioner.
- 3.To select the Auto mode, each time the button is pressed, the operation **MODE M** is changed in sequence from.

AUTO — COOL — DRY

## To stop operation

Press the **ON/OFF** button.







## While too warm or cool

When about 3-15 min passes, after operation start, if you feel slightly warm or cool.

- 1.Press the **▲** button to raise the temperature, One press raises the temperature by about 1 C .
- 2.Press the **▼** button to lower the temperature, One press lowers the temperature by about 1 C .

# USE METHOD OF REMOTE CONTROLLER



## To Select The“COOL”,“DRY”, “FAN”, “ON/OFF” Mode

- 1.Press  to start machine.
- 2.Press  to select running mode. The running mode is change in sequence after pressing the  button, from AUTO-COOL-DRY .(For example)To select the cool operate mode,Press Mode button continuously until“cool”is shown on display screen.
- 3.press the  button to select fan speed.
- 4.Press  to select air flow blowing direction.
- 5.Press the  button to stop machine.

### Note

Once the operation mode has been selected, the same operation mode will start after the ON/OFF button pressed on.

## Temperature adjustment

To lower the temperature, Press the  button, One press lowers the temprature by about 1C.  
To raises the temperature, Press the  button, One press raise the temprature by about 1C.

## In “DRY”operation

When Dry operation starts,The air conditioner running under low speed of fan,and it cannot be changed, Con-trolled by the microprocessor, the fans in the outdoor and indoor unit operate occasionally for “DRY”opera-tion. The room temperature is slightly lowered in this operation mode,the “DRY” function can not be done when the room temperature is 13℃ or lower.





## Air Flow velocity adjustment

Press the button  to adjust the air flow velocity. Each time the button is pressed, fan speed is changed as follows: AUTO-LOW-MEDIUM-HIGH.

## Adjust horizontal direction of wind

Please don't use hand to adjust the horizontal of vane swing.The vane swing will adjust the direction from up to down and left to right by freely under running. please be careful in case to harm your hand.

## Swing up and down to supply air

- 1.Swing supply air:Please press the button ,Vane swing freely in horizontal direction,supplying air from corner to corner of room.Press the button  again, The vane stop to swing.
- 2.Fixed angle to supply air: Please press the button , the vane will swing to your wanted angle to supply air.
- 3.Please press  button to adjust the up and down direction of vane,Each time the button is pressed, air supply direction is changed

### Note

Please use remote controller to adjust the direction of vane, otherwise will cause error if you use hand to change the direction of vane directly.











## Screen display

The screen display shows  after power on. It means the air conditioner is working under current mode.For example,if the screen display too bright when you are in sleep, it will hide the display content after you pressing the screen display button. And reset display if you press any button.

Notice:This remote controller is the latest type,and some types don't have above function.

# USE METHOD OF REMOTE CONTROLLER

## To set timer on/off function

Press the timer on button , the  appears in the display and begins to glitter. The glitter will last on 1 min, it prompts you that you can start to set the timer on function. It will be canceled if you press the timer button  again. Press  the timer off button when the unit is on, or press timer off button after pressing  timer on button to set the timer, the  appears in the display and begins to glitter, and it will last on 1 min, it prompts you that you can starts to set the timer off function. The function will be canceled if you press timer off button again. Press  and  to set timer on and timer off function which you need. Each press of the , the set time will increase by 1 hour. Each press of the . the set time will decrease by 1 min.

## To use the timer on/off function together

Press the timer on button to set the timer on function first, and then press the timer off button to set the timer off function. the timer on/off functions are use together at this time.

### Notice

Please confirm whether the electronic clock is set right or not before setting the timer on/off function. If the current time is the time of the timer on/off, and the state of the machine is the same as the requirement of the time set, the operating mode will not be changed.

## Set the comfortable sleep mode function

1. The air condition unit is power on.
2. Press the sleep button  to enter the operation of sleep mode function.

## Sleep function

1. The fan motor indoor changes to the Auto speed.
2. In cool operation, each hour the temperature will raise by 1 °C, but the changing range is only 2 °C.
3. In dry operation, the room temperature often does not change.



## To cancel the sleep mode function



The function can be canceled as below:

1. Press the sleep mode  set button again.
2. Press the on/off button or stop the machine automatically.

### Notice:

This remote controller is the latest type.

Please according to this instruction if the instruction has difference from the object. If this remote controller is used together with the cabinet type,  button control the horizontal direction and  button control the vertical direction.

There is not swing function if the remote controller is used for some air conditioner units such as portable,  and  button does not work.

## Working condition of unit

Mode	Cool
Room Temperature	16 °C ~ 31 °C

### Notes:

1. The efficiency of unit will be worse under condition except above.
2. If you select "COOL" mode under wet weather (Relative humidity higher than 80%). It will appear condensation water on indoor panel, at this time, it will be better if select high wind mode.



# HOW TO GET THE BEST EFFICIENCY

- Clean the air filter frequently.

Dirty or blocked filter will influence the efficiency.

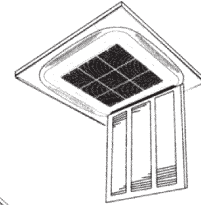

- Set the reasonable temperature

Cooling (Heating) is more efficient when the difference between room and out door temperature is less than 5 °C.

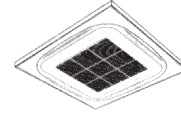

- Block sources of outside heat

Use curtains to cover windows subject to direct sunlight during cooling. Avoid opening doors often unless necessary.

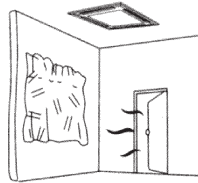

- Allow fresh air into room occasionally

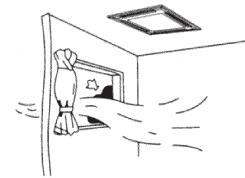

## MAINTENANCE

- ⚠ When clean the air conditioner, you must turn off the power.

- Clean air filter and indoor unit.  
Clean air filter Step: 1, take out air filter

2, clean it with vacuum cleaner or water.

3, after clean it with water, please dry it, don't parch it.

Clean indoor unit.

Method 1: clean it with a clean and soft cloth.

Method 2: clean out blotch with neuter house use cleanser

- Maintenance for season finish (when the unit is not going to be used for a long time).

- Switch on air conditioner, set fan mode; keep it running for 3-4 hours to dry the spare parts.
- Switch off air conditioner, cut off the power supply.
- Clean air filter and indoor unit drastically.
- Take out the battery.

- Maintenance for season start.

- Check outdoor unit and grounding wire whether installed correctly or not.
- Check the unit's air inlet and outlet whether blocked or not.
- Check the drainage hose whether blocked or not, the inner whether normal or not.
- Check the installation of air cleaner whether installed correctly or not.

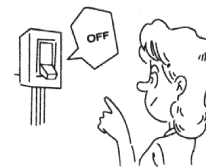
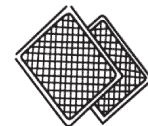
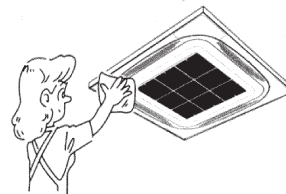

# MALFUNCTION CHECK

Problem	Phenomenon	Cause	Remedy
Unit does not operate at all	After press the ON/OFF button, can't hear the "Beep" from the unit, the operation lamp doesn't light	Power outage	Press ON/OFF button after power restored
		Main power not on	Turn main power on
		Main power fuse blown	Replace fuse
		Ground leakage greaker open	Reset ground leakage breaker
		The remote controller is out of the operation range	Use the remote control inside the operation range
		The battery finish	Replace the new battery
The unit can't start immediately	The remote controller displays the unit is in operation	The unit is driving the restart protection procedure, wait 3 minutes before the unit restart	The unit has the restart protection procedure to protect the compressor, please wait for 3 minutes.
After start for a while, the unit stop running		The outlet or inlet was blocked	Clean the stem
		The air filter was blocked or dirty	Clean the filter
Air is blown out but is not cooled or heated.	The remote controller displays the unit is in operation	Improper temperature Setting	Check the temperature setting on remote controller display and reset the appropriate temperature.
		Air filter clogged	Clean air filter
		Inlet or outlet of indoor or outdoor unit blocked	Remove obstruction
		Window or door open	Close window or door

1、 Once the unit stop caused by the power cut, even if the power come back, the unit can't restart; If you want to restart it , Press the "ON/OFF" button on the remote controller.

2、 If there water leakage, maybe the drainage hose was blocked, please replace it.

The following are not malfunctions.

- Water flowing sound is heard during operation. This is the sound of refrigerant flowing inside the air conditioner.
- Air from air conditioner may sometimes carry odors. It is not a malfunction for air conditioner itself. Clean the air filters at once.

# ERROR CODE ANALYSIS

## Error code analysis

SN	Fault protection definition	Yellow timing indicator	(Red) White sleep indicator
1	Indoor coil failure sensor failure	Flash 4 times, turn off for 3 seconds	
2	Indoor ambient temperature sensor failure	Flash 5 times, turn off for 3 seconds	
3	Drain or float failure	Flash 8 times, turn off for 3 seconds	
4	Indoor and outdoor communication failure	Flash 9 times, turn off for 3 seconds	
5	Compressor startup abnormality (phase loss, reverse rotation)	Flash 12 times, turn off for 3 seconds	
6	Discharge temperature sensor failure	Flash 16 times, turn off for 3 seconds	
7	Outdoor coil temperature sensor failure	Flash 18 times, turn off for 3 seconds	
8	Discharge temperature overheating protection		Flash 8 times, turn off for 3 seconds
9	High pressure switch protection		Flash 14 times, turn off for 3 seconds
10	Low pressure switch protection		Flash 15 times, turn off for 3 seconds

# INSTALLATION PLACE

## 1. Select the installation location

### 1.1 Indoor unit

- Install in a roof or frame which is strong enough.
- Install in a location where the outflow air will reach all parts of the room.
- Install in a location where the air inlet and outlet are swimmingly.
- Avoid a location where can communicate with the outside.
- Avoid a location where there is a danger that inflammable gas will be generated, inflow, accumulate or leakage.
- Apart from the high frequency equipment.
- Avoid a location where the air flow to the fire annunciator.(when heating, the hot air maybe spring the annunciator)
- Avoid a location where should use the acidic solution or sulfur frequently.
- Secure adequate space for installation and servicing. Please refer to the follows:

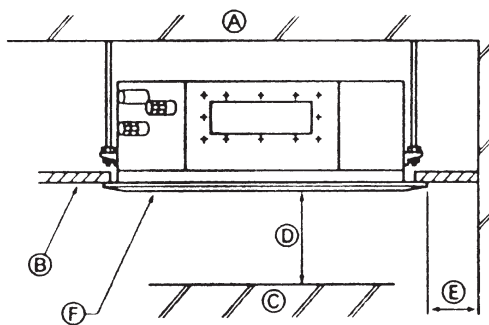

- A. Roof
- B. Ceiling
- C. Fraise
- D. More than 1 meter
- E. More than 50 cm
- F. Panel

### 1.2 Outdoor unit

- Install in location unexposed to direct sunlight or other radiated heat. Install a sunshade to protect the outdoor unit from the sun or the rain.
- Avoid the strong wind.
- Avoid the flammable gas.
- Select location permitting easy wiring and piping to power source and indoor unit.
- Select locating from which noise emitted by unit will not inconvenience neighbors.
- Make sure the installation stand firmly anchored.

# INSTALLATION PLACE

## 1.3 Adequate space for installation and service for outdoor unit.

### 1. One unit:

(1) When fraise on the above

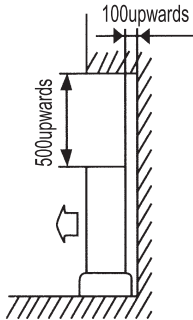

(2) When face (air outlet) open

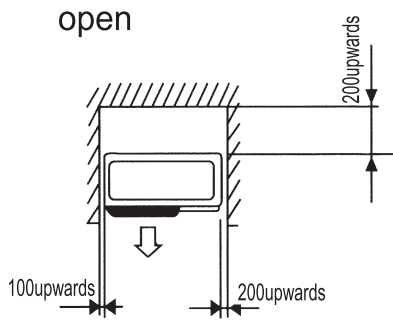

(3) When fraise only at the face. At the moment, keep the back, both sides and above opening.

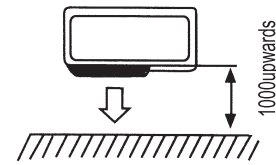

(4) When fraise on both face and back.

Please do not use the measurement  
As follows, please refer to the (5)

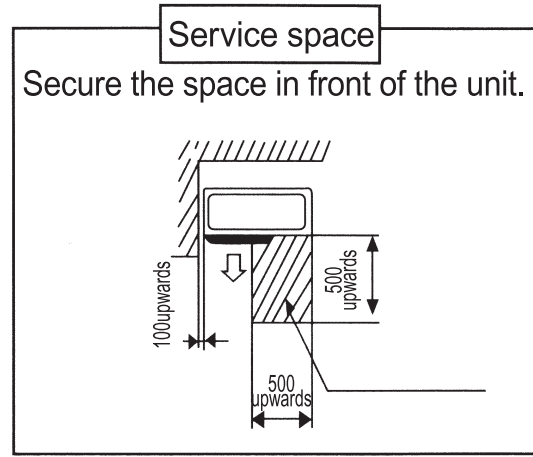
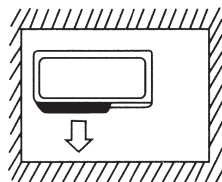
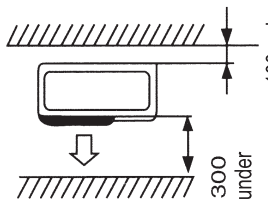

(unit: mm)

(5) When four sides all fraise.

Although the above is open, but because of four sides all fraise, so it can't install here.

### 2. many units:

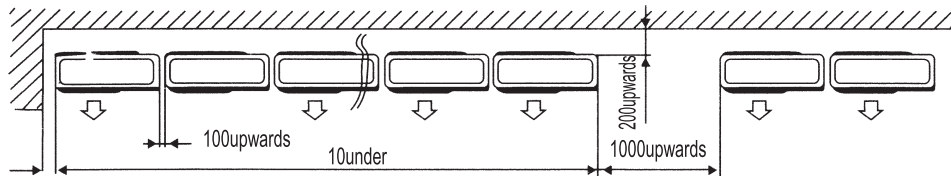

### 3. When collocate front and back

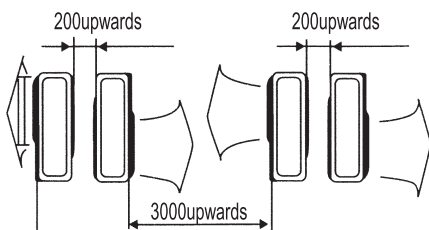

When do not use the outdoor exhaust oriented board

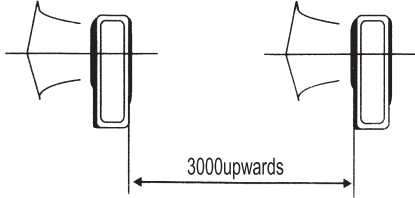

### 4. When install the unit on the roof or other location where has much wind:

- When install the outdoor unit on the roof or other location where has no building around, avoid the strong wind blows the air outlet directly. Otherwise the heat exchanger maybe influence the cooling or heating efficiency because of influence the deficient airflow.

- When the air outlet influenced by the strong wind and wind direction, please change the location of outdoor unit, let the air outlet and wind direction be a right angle.

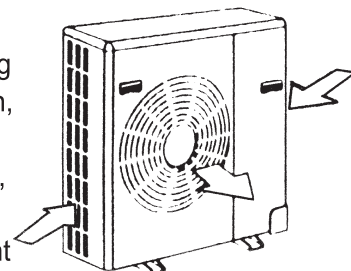

# INSTALLING THE INDOOR UNIT

## 1. Installing the indoor unit

### 1.1 Installation measurement of ceiling hatch and pothook.

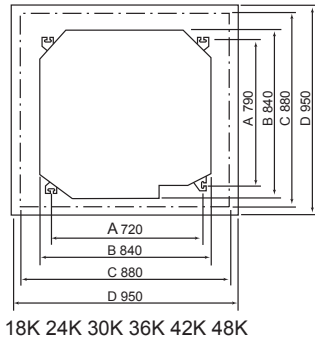

### 1.2 Measurement of indoor unit

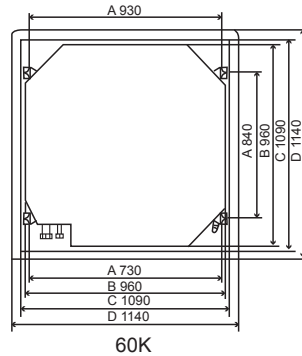

A. Distance of pothook bolt.

B. Exterior measurement of the unit.

C. Measurement of ceiling hatch.

D. Exterior measurement of the panel

I. Measurement of pipe connection.

K. Panel.

L. Ceiling paneling

M. Pothook bolt.

Caution: Please insure the distance of 10-15 mm between ceiling and top of the unit.

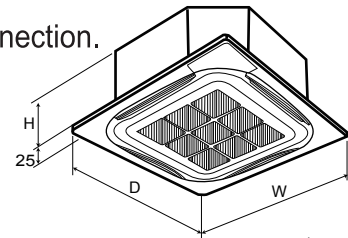

Indoor unit: (mm)

Capacity	W	D	H
30K/36K	950	950	240
42K/48K	950	950	285
60K	960	960	295

Installation

### 1.3 Hanging

Caution:

- For safety, the hanger place should be strong enough. Please install the unit on the horizontal ceiling, if the ceiling is gradient; please add some underlay to insure the level. Please refer to the installation sketch. (Right)

1) Install the unit on the beton ceiling.

- Please install expand bolt J refer to the sketch(1).
- Fixup installation bracket on the expand bolt J, install the pothook bolt A refer to the sketch(2).

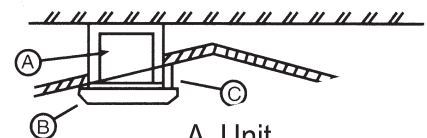

A. Unit  
B. Panel  
C. Underlay

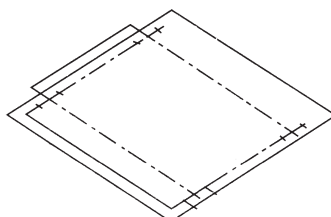

Installation splint  
Sketch (1) Look up

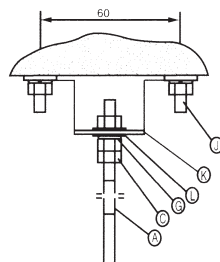

Sketch(2)

A. Pothook bolt

C. Nut

G. Spring gasket

J. Expand bolt

K. Installation bracket (by in local)

L. Flat gasket

# INSTALLING THE INDOOR UNIT

2) Install the unit on the wooden ceiling.

- Install by the rafter.
- The rafter should be strong enough.  
Requirement: The distance between rafter and rafter should within 50 cm, the rafter's width should be 6 cm at least; When width should be 9 cm at least. The diameter of bolt should be 11 mm.

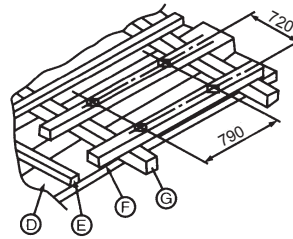

- D. Ceiling paneling
- E. Girder
- F. Rafter
- G. Top girder

## 1.4 The step of hang unit.

- 1) Every pothook bolt should be installed by one nut(M10)、two gasket、two nut.
- 2) Lift the unit at the proper location.  
Note: If the unit can't aim at the ceiling installation hole, you may adjust the runner on the installation piece.  
Refer to sketch at the right:

- A. Pothook bolt
- B. Ceiling paneling
- C. Nut(M10)
- E. Installation piece
- F. Gasket
- I. At least 30 mm

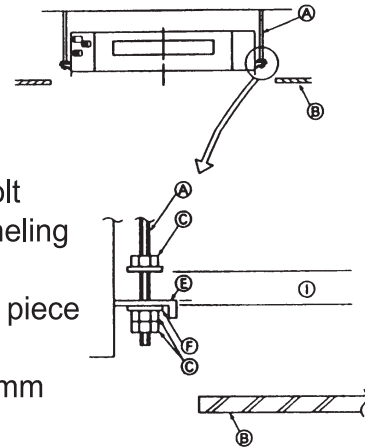

## 1.5 Fixup the unit.

- Adjust the unit to be horizontal by gradienter, (adjust the two nuts). Insure there is no space between ceiling paneling and panel, unit and panel.
- Insure that the unit is in the middle of ceiling hatch by tape measure.
- After insure the location, tighten the screws, fixup the unit.

## 1.6 Installation location of indoor refrigerant pipe and drainage hose.(mm)

- A. Drainage hose tie-in
- B. Ceiling paneling
- C. Panel
- D. Refrigerant liquid pipe tie-in
- E. Refrigerant gas pipe tie-in

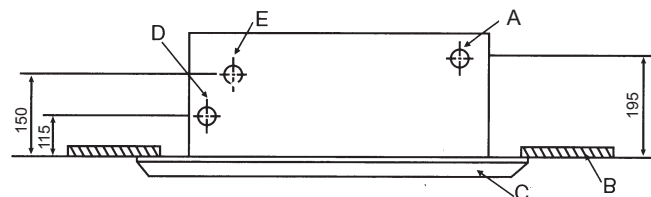

Note: The measurement in the parentheses is for 24000BTU

## 1.7 Installation of drainage hose.

- Connect the drainage, one end with unit water outlet, one end with PVC pipe (diameter is 20mm, please buy in local).
- The drainage hose should be installed for a gradient at least 1/100.
- Buy the heat preservation bushing to bind the PVC pipe, prevent the conensate separates out.

- The tie-in should be binded tightly to prevent water drop.

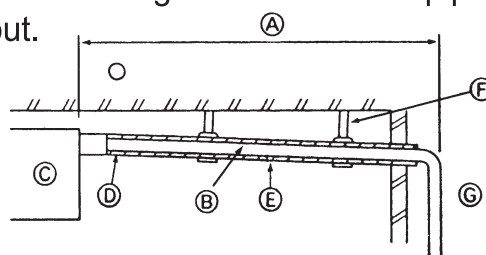

- A. Max.20m
- B. Drainage hose
- C. Indoor unit
- D. Heat preservation material (thickness bigger than 9mm)
- E. Gradient at least 1/100
- F. Metal underprop

# INSTALLING THE OUTDOOR UNIT

## 1. Installing the outdoor unit

- Better carry the unit by the original carton box to the location.
- Because the unit's barycenter is in the center, please take care when you sling it.
- The Gradient can't bigger than 45°C during the transportation.(Decumbence is prohibited)
- When install the outdoor unit, please fixup the underside by bolt. Caution: The length of underside Bolt should be shorter than 25 mm.
- Please install it firmly.
- Please refer to the sketch when install on the beton.

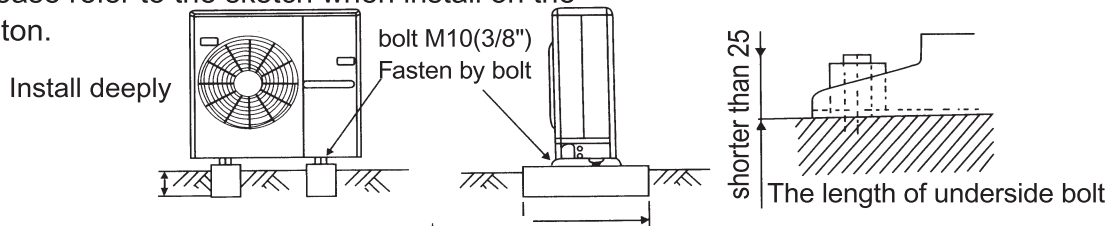

## 2.Measurement of outdoor unit.

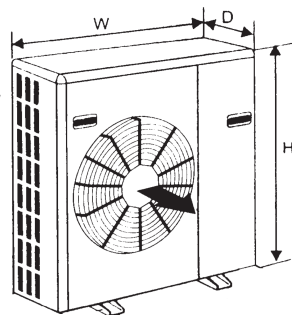

Capacity	W	D	H
30K/36K	917	330	840
42K/48K	917	330	960
60K	917	330	1260

Installation

## 3.Connect the pipe

- If you want to buy the pipe, please choose the heat preservation bushing that the heat preservation layer is thick than 9mm and the function should be good.
- When you use the lengthen PVC drainage hose, please choose the heat preservation layer is thicker than 6mm bind the hose.
- The measurement of refrigerant pipe and drainage hose, please refer to the drainage hose, please refer to the diagram on the right.

Measurement of refrigerant pipe/drainage hose			
Capacity	30K/36K	42K/48K	60K
		410A	410A
Refrigerant liquid pipe	9.52	9.52	9.52
Refrigerant gas pipe	15.88	15.88	19.00
Drainage hose	PVC pipe: diameter 20		

### 3.1 Connecting the indoor and outdoor refrigerant pipe.

1)Keep the outdoor check valve the original, tear down the indoor and outdoor pipe nut, dustproof screw cap and bolt, connect these quickly(avoid the dust, water, and other object come into the pipe caused the malfunction)

Before screw down the nut, please coat the tie-in with the putty.

When you connect the pipe, please use two wrenches, refer to the following diagram.

Refer to the screw moment when using the wring wrench; Refer to the screw angle when without wring wrench; When screw down the nut, please stop when the screw moment raise sharply, then refer to the following sketch to turn the angel.



# INSTALLING THE OUTDOOR UNIT

Screw moment standard:

Copper tube diameter(mm)	Screw down wring(Newton/m)	Tightening angle
9.52	35-40	60°-90°
15.88	73-78	30°-60°
19.05	98-130	20°-35°

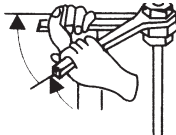

2) Connection in sequence, connect the entire refrigerant pipe.

- After connect the pipe, you should fill air to keep the pressure, and check whether leak or not by leakage equipment or suds.

3) Take out the vacuum from check valve maintenance's port by vacuum pump.

4) After finishing the above steps, unscrew the gas liquid valve by inner 6-angle wrench; thereout the refrigerant loop is connected.

3.2 Adjustment of refrgerant

- Bell-mouth joint and copper bared is prohibited, bind the bare part with heat preservation bushing, and fix it up.

3.3 Adjustment of refrigerant

- When the pipeis longer than 6m, add the refrigerant. The superaddition should calculate by the following expressions:  $\text{superaddition(g)} = 20\text{g/m} \times (A-6)$  A means length of pipe (m)
- Please use vacuum pump take out the refrigerant.

# INSTALLING THE ELECTRIC WIRE

## 1. Electric wire installation

### 1.1 Caution:

- Please install the special power and the creepage switch.
- Please check the unit's voltage and electric wire before connection.
- The electric wire should be installed according with the requirement. Screw down the bolt.
- The unit's signal part can't be connected to the power of 220V, otherwise malfunction can be caused.
- Because signal board has the polarity, so please connect it by the correct number. If the connection is wrong, the compressor will not work.

### 1.2 The sketch of elements connection.

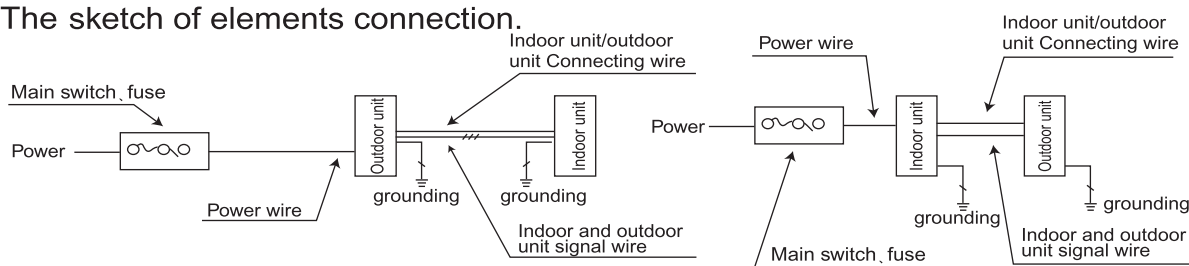

### 1.3 Connection specification

Type		30K/36K/42K/48K/60K	
Power Supply		3N~50Hz, 380V	
Input current (Main Switch/Fuse) (A)		30	
Electric Wire	Outdoor unit electric wire	Quantity of electric wire	5(Greenish-Yellow is ground wire)
		Core wire section(mm <sup>2</sup> )	4 x 3.0 + 1 x 1.5
	Indoor and outdoor connection wire	Quantity of electric wire	4(Greenish-Yellow is ground wire)
		Core wire section(mm <sup>2</sup> )	4 x 1.5

Installation

### Caution:

- When you install the electric wire, please consider the circumstance (temperature, sunlight, directly, rain)
- Both the indoor and outdoor unit should have the ground wire connected
- The installation should comply with the local's standard

# INSTALLING PANEL AND TRIAL OPERATION

## 1. Install the panel

### 1.1 Installation of panel

1. Take down the air inlet grill, take out air filter;

Undraw the air inlet grill in the direction of arrow (1), take down the orientation axes in the direction of arrow (3) and (4), take down the air filter in the direction of (5).

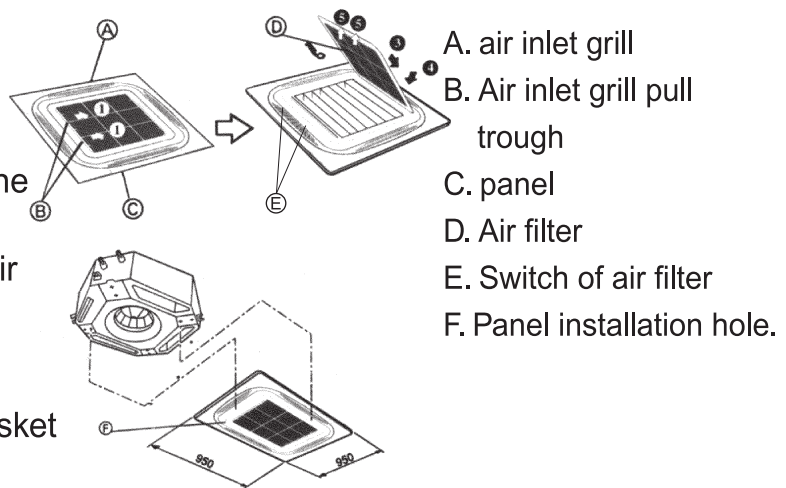

### 2. Orientation

Hang the panel G on the unit's gasket bolt correctly.

### 3. Fixup the panel

Tighten the screws; don't leave the space between panel and ceiling.



### 4. Circuitry connection

Connect the two tie-ins of unit and panel, the tie-in should be firm.

## 2. Trial operation

### 1.1 Confirmation before trial operation

- After install the indoor/outdoor unit, joint the pipe and connection, confirm again that there is no refrigerant leakage, the power wire、signal wire connect firmly and correctly.

### 1.2 Try operation

1) Turn on main switch.

2) Press the "ON/OFF" button on the remote control, if you heard the "beep", it means the remote control is ok, then press the other button:

Press Mode button, select Cooling mode, and check whether there is cool air blows out.

Press Mode button, Select Heating mode, and check whether there is hot air blows out.

Press (Fan speed) button, select "High" mode, and check whether there is strong air blows out.

Press Swing button, check whether the vane is swinging and then press it again to stop it.

3) Press the "ON/OFF" button again to stop the operation.

### 1.3 Check the drainage set.

After installation finished, you should check the drainage set.

When trial operation, the water must be drain out and the tie-in should not be leakage.

1) Before install the panel, debus the water inlet window at the side of unit, and then fill around 1000ml water into the water plate by water supply pump. Please install the water inlet window back after fill.

2) Turn on the unit, when cooling mode, please check where there is water leakage.