

ELECTRONIC TECHNICIAN

Including 16 pages of
Circuit Digests



**INDUSTRIAL ELECTRONICS
AND COMMUNICATIONS**

50¢

You are more apt to get the volume control you need from **your IRC distributor** than from any other source

Whether you need a special exact duplicate control or a standard replacement carbon or wire-wound control, you are almost sure to find it at your IRC Distributor.

He carries the most versatile line of controls in the industry. He offers you better, more complete replacement coverage. He can supply an almost endless variety of combinations of resistance elements and shafts.

He can take care of your needs far more frequently than any other source.

And you can depend upon IRC quality and dependable performance. Exact duplicate TV and Auto Set controls (over 850 of them) are specified to manufacturers' procurement prints—they will fit and operate without modification.

Make your IRC Distributor Your Volume Control Headquarters.

**BIGGEST
BARGAIN IN
VOLUME
CONTROL
COVERAGE IN
THE INDUSTRY**

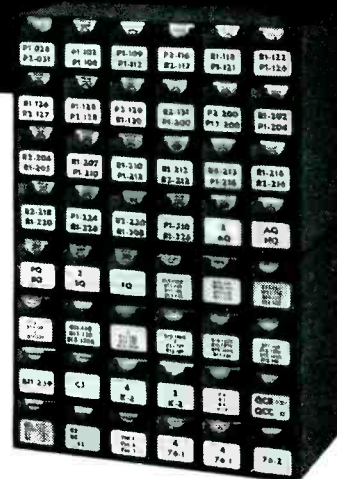

New IRC Dealer Parts Stocks No. 21 and No. 22 afford you amazing coverage of not only exact duplicate controls but also standard carbon and wire-wound control coverages. As much as \$1245 coverage for an amazingly low investment! See your IRC Distributor today!

Wherever the Circuit Says



INTERNATIONAL RESISTANCE CO.

Dept. 574, 401 N. Broad St., Phila. 8, Pa.

In Canada: International Resistance Co., Ltd.
Toronto, Licensee

ELECTRONIC TECHNICIAN

Including
Circuit Digests

TELEVISION • ELECTRONIC • RADIO • AUDIO • INDUSTRIAL

JANUARY, 1957

ALBERT J. FORMAN *Editor*
M. CLEMENTS *Publisher*
O. H. CALDWELL *Editorial Consultant*
ROBERT CORNELL *Technical Editor*
A. O'ROURKE *Assistant Editor*
CHARLES F. DREYER *Art Director*

Address all mail to
480 Lexington Ave., New York 17, N. Y.
Telephone Plaza 9-7880

BUSINESS DEPARTMENT

H. A. REED *General Sales Manager*
BERNARD BLOCK *District Manager*
N. McALLISTER *Production Manager*
A. H. POND *Controller*
W. W. SWIGERT *Credit Manager*
M. RUBIN *Circulation Manager*
S. Ja MACCHIA *Asst. Circulation Mgr.*
P. H. DEMPERS *District Manager*
5010 Howard St., Skokie, Ill.
Chicago Telephone RAndolph 6-9225

CHRIS DUNKLE & ASSOCIATES
California Representative
3527 W. 6th Street, Los Angeles 5, Calif.
Telephone DUUnkirk 7-6149

BERNIE EDSTROM *District Manager*
2169 Eldred Ave., Cleveland 7, Ohio
Academy 1-7082



ELECTRONIC TECHNICIAN & Circuit Digests, Jan. 1957. Vol. 65, No. 1. \$5.00 a copy. Published monthly by Electronic Technician, Inc., an affiliate of Caldwell-Clements Co. Publication office, Emmett St., Bristol, Conn. Editorial, advertising and executive offices, 480 Lexington Avenue, New York 17. Telephone Plaza 9-7880.

Entered as second class matter at the Post Office at Bristol, Conn., June 10, 1954. Subscription rates: United States and Canada, \$4.00 for one year; \$6.00 for two years; \$8.00 for three years. Pan-American and foreign countries; \$7.00 for one year; \$10.00 for two years; \$14.00 for three years. Copyright 1957 by Electronic Technician, Inc., New York. M. Clements, Chairman of the Board; H. Reed, President; A. Farman, Executive Vice-President. Title registered in U. S. Patent Office. Reproduction or reprinting prohibited except by written authorization of publisher. Printed in U.S.A. by Hildreth Press, Bristol, Conn.

FRONT COVER

Industrial electronics is becoming increasingly important in manufacturing plants, offering new opportunities for electronic technicians. Shown are electronic motor controls, audio paging and factory music system, induction heater, photoelectric conveyor controls, and electronic temperature-pressure control for boilers. Communication antenna atop building transmits to two-way radio equipped cars and trucks.

FEATURES and ARTICLES

What's Ahead for '57! (Editorial)	25
"Tuning in the Picture"	26
Servicing Industrial Electronic Equipment	J. Darr 28
Problems Encountered In Sweep-Alignment Jobs ..	R. G. Middleton 30
Build Customer Good Will	R. T. Oelrich 32
"Tough Dog" Corner	F. Grumann, W. M. Parsons 33
A Practical View of What Audio Distortion Matters	N. H. Crowhurst 34
Make Blanking Bars Talk	B. Eldridge 36
1956 TV-Electronic Industry Statistics	37
Suppressing Noise In 2-Way Radio Equipped Vehicles	W. S. Loeb 38
Improve the Vertical Response of Your Scope	W. J. Smith 40
Dynamic Demagnetizing of Tape Recorder Heads ..	J. A. McRoberts 41
Shop Hints	L. Holder, L. Lounsbury, E. Kesgen, C. Goldstein 42
New Audio Products	43
New Antennas & Accessories	44
New Tubes & Components	45
Latest Test Instruments	46
RCA Service Flat-Rate Plan	50

DEPARTMENTS

Letters to the Editor	4	News of the Industry	20
Editor's Memo	10	Reps & Distributors	22
Audio Newsletter	12	Calendar of Coming Events	27
New Books	14	New Products	43
Catalogs & Bulletins	18	Employment	47
Association News	54		

CIRCUIT DIGESTS

65

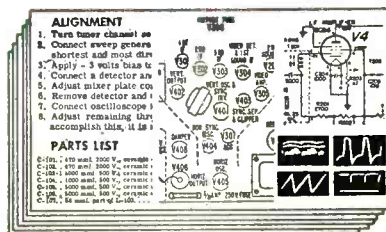

IN THIS ISSUE

(16 pp. latest schematics—see last page)
Cumulative Index Addenda 53
ADMIRAL: Color TV Chassis 2921
BOGEN: Hi-Fi Tuner, Model R660
GE: Portable TV Chassis "MM" series
MOTOROLA: TV Chassis 539 series
OLYMPIC: TV Chassis CT, CU, CW, CX
PILOT: Audio Amplifier & Preamp. Model
AA-903B

ROHN

Give what the buyer
WANTS

**HOT
DIPPED
GALVANIZED**

**LIFETIME
OF
DEPENDABLE
PERFORMANCE**

**UNEQUALLED
DESIGN!**

These 3 BIG sales features are ROHN Exclusives... features that have been proved positively. Sell—recommend—install ROHN... the world's largest manufacturer of this type of tower... you have the BEST by far!

ROHN Manufacturing Co.

116 Limestone, Bellevue Peoria, Illinois Ph: 4-9156

MAIL THIS COUPON FOR FREE LITERATURE

Rohn Manufacturing Company
116 Limestone, Bellevue
Peoria, Illinois

Gentlemen: Please rush me complete details on the full line of Rohn Towers and Accessories.

Firm _____

Name _____ Title _____

Address _____

City _____ State _____

towers

the
"Magic
Triangle"*

*pat. pending

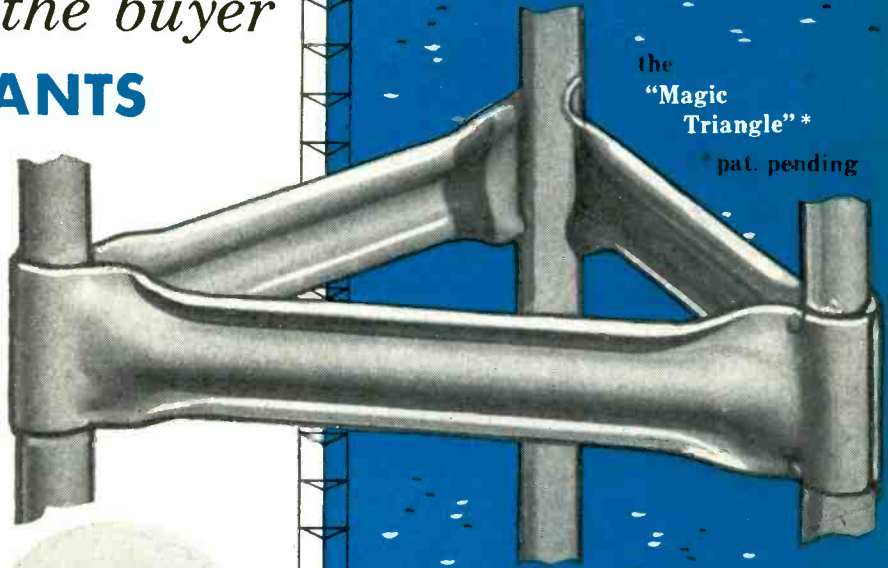

The popular ROHN No. 6 Tower (and ROHN Package Towers) feature the exclusive "Magic Triangle"... the machine produced triangular tower bracing that adds ruggedness, sturdiness and dependability far above any other similar tower!

And, speaking of "similar" towers, there are NONE in existence. ROHN "Superior Design" Towers are far ahead with more exclusive features... with more research... with greater acceptance than any other tower!

See a ROHN Representative or Authorized Distributor for the FULL Rohn Story... it's one you should know!

All models of Rohn Towers are suitable for home TV installations... makes possible elimination of guy wires to give a self-supporting installation of gleaming galvanized steel!



Communication towers, heavy duty towers fold over towers are also available. The Rohn catalog shows a complete line including all types installation equipment, bases, roof towers, tubing and dozens of accessories.



PROUDLY DISPLAY THE NEW DECAL

Colorful new Rohn window decals are available for authorized Rohn Distributors, Dealers and Servicemen. Get yours today and display it proudly!

IT'S NOW WORTH YOUR WHILE TO SELL *Collaro* RECORD CHANGERS

For Original Installations and Replacements



Here's Why:

- New Collaro distribution is made to order for the serviceman. Dealer net prices allow you a full profit margin on every unit.
- Audiophile acceptance and approval have made Collaro record changers the fastest growing in hi-fi popularity.
- Leading phonograph manufacturers have adopted and now feature Collaro record changers in their high quality consoles.
- Millions of Americans now know about Collaro through national advertising, promotion and word of mouth.

Make your next installation or replacement with a Collaro 4-speed record changer and treat your customer to all of these hi-fi features:

4-Speeds • 4-pole motor • Low noise • Accurate speeds and pitch • Jam Proof operation • Automatic Intermix plus Manual Operation • Rapid change cycle independent of record speed • Automatic 'shut-off' after last record • Idler disengages at 'shut-off' • Simple one-knob speed selection.

Write for complete specifications, prices, distributor details and service manual to Dept. YA-22

ROCKBAR CORPORATION 650 Halstead Avenue, Mamaroneck, N. Y.

... another
MALLORY
service-engineered
product



Etched Cathode stops costly "call-backs"

Some capacitors develop hum after a few weeks' service. The reason is loss of capacitance—caused by build-up of cathode oxide film.

This can't happen in Mallory FP capacitors . . . because they have *etched cathode* construction. Standard in all FP's and also in popular Mallory tubular electrolytics, etched cathode prevents gradual capacitance loss that can lead to annoying hum and costly call-backs. And you get this extra value in Mallory capacitors *without premium price*.

See your Mallory distributor for full facts about what etched cathode does for capacitors. It's another good reason why you're always sure of top performance when you use Mallory!

- Capacitors
- Controls
- Vibrators
- Switches
- Resistors
- Rectifiers
- Power Supplies
- Filters
- Mercury and Zinc-Carbon Batteries

P. R. MALLORY & CO. Inc.
MALLORY

P. R. MALLORY & CO. Inc., INDIANAPOLIS 6, INDIANA

LETTERS To the Editor

Factory Service Is No Improvement

Editor, ELECTRONIC TECHNICIAN:

On page 30 of your October issue you report that the set makers claim the primary aim of factory service is to bolster their product reputation, not gather servicing business for its own sake. In spite of this, one manufacturer flooded our area with letters about their repair service, saying they have parts for radio and TV sets up to 15 years old. All this after their representative had assured us during a meeting that their service department was only to take care of chronic complaints.

Factory servicemen are local recruits, and quite often ones who could not make a go of the service business themselves. In our city of 127,000 people, since the first of the year we received seven complaints from the Better Business Bureau, five concerning non-members and two about our members. Our members took care of the complaints immediately. Factory service can do no better than this.

MICHAEL E. TOTH
Secretary

Radio Servicemen's Assoc.
Trenton, N.J.

Who Designed It?

Editor, ELECTRONIC TECHNICIAN:

Among the servicing instructions one set manufacturer offers is this gem: To gain access to "all small components, including the power line fuse, face the front of the cabinet . . . the chassis must be completely removed. This requires removing the yoke and the picture tube accessories . . . when it becomes necessary to service the chassis, the need for a new concept of servicing becomes apparent."

This company is an excellent manufacturer of refrigerators. Are the same people designing the TV sets?

JULIO B. ARROYO
New York, N.Y.

Binder Finder

Editor, ELECTRONIC TECHNICIAN:

Where can I purchase a book binder for Circuit Digests?

N. A. DESMOND
Maywood, Ill.

• For a description of binders for *Circuit Digests*, see page 58.—Ed.

Ready for High School

Editor, ELECTRONIC TECHNICIAN:

After reading "Power Transformer Checks" in your November issue, I'd like to remind you that we left first grade and are at least ready for high school. Let's keep ELECTRONIC TECHNICIAN for the technicians, and let other

publications carry the articles directed to hobbyists and beginners.

HOWARD E. CARROLL

Iowa City, Iowa

Techmanship Accomplishment

Editor, ELECTRONIC TECHNICIAN:

Congratulations for the lucid and authoritative statements concerning the Techmanship movement that appeared in your October issue. I question whether Mr. Potter would entirely concur with your views on complexity, but on the whole you have sensitively captured his noble philosophical spirit, and may well be on the glorious road to momentous accomplishment. Who can tell but that you may lead the way to world peace, a third party, landlord-tenant harmony, or even to a rise in circulation!

J. J. HILL

Maspeth, N.Y.

• *Circulation, shmirculation . . . as long as you subscribe to the magazine.*—Ed.

Employment Opportunities

Editor, ELECTRONIC TECHNICIAN:

I received my recent copy with great delight as always. However, I have been wondering why you don't devote some space to employment opportunities. I would like to go to California, Texas or Arizona. Can't I place an ad, even at a fee?

T. ZIER

Brooklyn, N.Y.

• *Just turn to page 47. Not only will you find the start of a new section advertising employment opportunities, but you will note the announcement of a free "position wanted" service we plan to start for our readers.*—Ed.

Are Rebuilt Pix Tubes New

Editor, ELECTRONIC TECHNICIAN:

We have used rebuilt pix tubes from a number of small manufacturers with varying degrees of success. We have also purchased big name tubes through regular suppliers that have been re-nicked at the factory. We do not wish to misrepresent a tube to our customers, nor do we wish to lose the extra profit gained by using rebuilt tubes. If we find a rebuilt brand that is satisfactory, can we sell this as a new tube?

LARRY CRITCHLOW

Rockland Assoc. of
TV & Electronic Services
Pearl River, N.Y.

• *Rebuilt pix tubes cannot be sold legitimately as new. Leading manufacturers supply completely new tubes to set makers, but their replacements sometimes employ recovered glass bulbs. So these responsible producers class them as "Glass may or may not be new." Their gun, screen, etc., are new. However, there is little standardization among small producers; some rebuild completely, some leave the old screen, and some just rejuvenate it by flashing.*—Ed.

(Continued on page 8)

... another
MALLORY
service-engineered
product

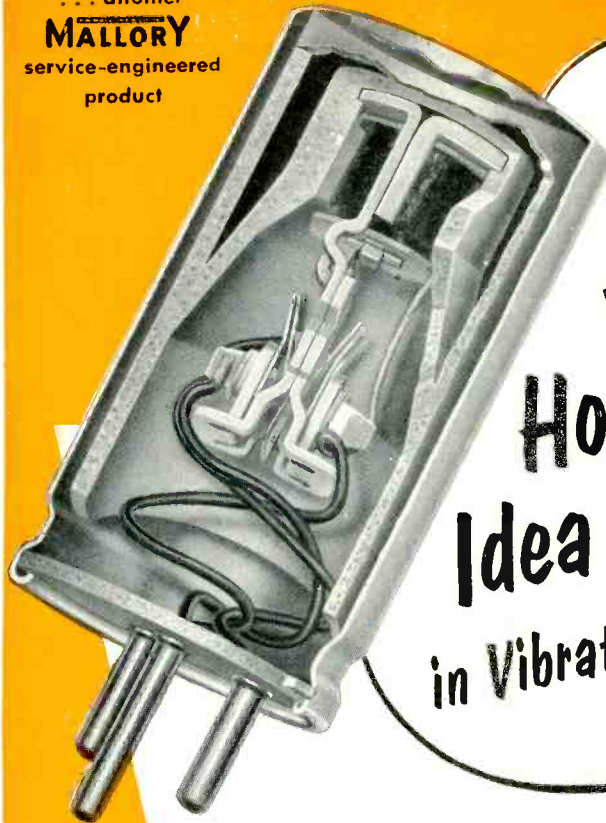

the
**Hottest
Idea Ever**
in Vibrator design!

Look inside the brand new Mallory 1600 series vibrator. There are no contact buttons!

This completely new approach to vibrator design means a big advance in performance. The extra-large spring-leaf contact area gives you up to 100% longer life than ever before . . . reduces arc erosion.

Sticking of contacts is eliminated, to assure you positive starts. The simpler design makes possible absolute uniformity of every vibrator. And thanks to lighter vibrating mass and noise-stopping design, they're the quietest vibrators you've ever installed.

Be sure to get your stock of the new Mallory 1600 vibrators from your distributor. He carries them in ratings for all auto radios . . . at the same price you would pay for an ordinary vibrator.

P. R. MALLORY & CO. Inc.
MALLORY

P. R. MALLORY & CO. Inc., INDIANAPOLIS 6, INDIANA

- Capacitors
- Controls
- Vibrators
- Switches
- Resistors
- Rectifiers
- Power Supplies
- Filters
- Mercury and Zinc-Carbon Batteries

Simplify Rectifier Servicing

with *Federal's*

miniaturized

HI-DENSITY

Selenium Rectifiers



JUST 5 TYPES

handle 90%
of all Radio-TV
replacements!

ACTUAL SIZE
New vs. Old

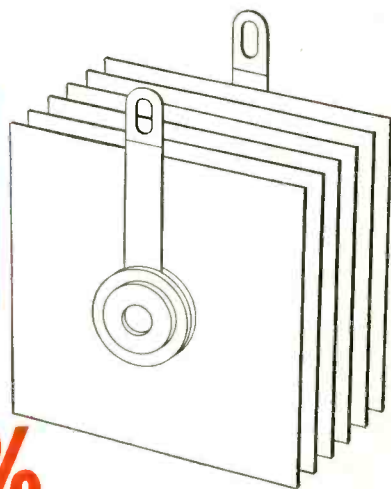

UNIT SIZE REDUCED NEARLY **50%**

—by unique, time-tested production process!

Federal's HI-DENSITY Rectifiers mark one of the most significant advances in miniaturized types since Federal originated them in 1946!

Manufactured by an entirely new, exclusive-with-Federal process, the efficiency, dependability and long life of these lighter, smaller-plate, high-temperature rectifiers have been proved-in by the most rugged service testing.

Just 5 types ranging from 65-100 MA to 600 MA handle 9 out of 10 radio-TV replacements.

Call your Federal Distributor today about Federal's specially-processed Hi-Density rectifiers... simplify rectifier servicing... get the same top profits with fewer types and less bother...!

Smaller size permits packaging that saves up to 50% in shelf space:



ONE dozen Hi-Density rectifiers occupy 1/2 the shelf space of one dozen former types!

Now there's no need to carry a big variety of rectifier types to meet today's replacement requirements.

Federal's Hi-Density rectifiers make servicing simpler than ever... save shelf, bench and kit space... save time on calls... make calls more profitable... all with just FIVE types...!

Order Federal's Hi-Density Rectifiers today through your Federal Distributor!

Federal Selenium Rectifiers are listed in Howard W. Sam's Counter-Facts and Photo Facts

Federal

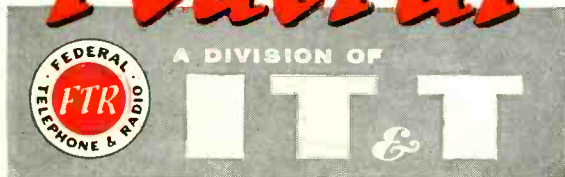

Federal Telephone and Radio Company

A Division of INTERNATIONAL TELEPHONE AND TELEGRAPH CORPORATION
COMPONENTS DIVISION • 100 KINGSLAND ROAD • CLIFTON, N. J.

In Canada: Standard Telephones and Cables Mfg. Co. (Canada) Ltd., Montreal, P. Q.
Export Distributors: International Standard Electric Corp., 67 Broad St., New York

GUIDE

AUTRONIC-EYE[®]

TRAINING COURSES

MEAN MORE

BUSINESS FOR YOU!



Courses for experienced service technicians provide latest repair information—enable you to do the job faster and more efficiently.

Quick, accurate circuit diagnosis and repair to factory specifications boosts your profits. That's why so many qualified auto technicians attend these Guide training courses at no cost other than transportation and living expenses.

The Guide Lamp diploma, awarded only to those who successfully complete the course, is proof that you're equipped to give more and better service to more people—and that means business.

If you're an auto radio service dealer, come yourself, or send your technicians. There's one of 30 GM Training Centers near you. Apply through your local United Motors Service Division Distributor or write

GUIDE LAMP DIVISION • GENERAL MOTORS CORP. • ANDERSON, INDIANA

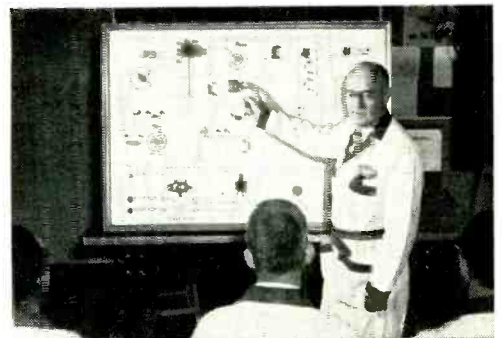

Jumbo-size operational panel of Guide's Autronic-Eye Circuit puts all parts out front for better, more efficient instruction.



Thirty modern GM Training Centers offer newest equipment and latest service techniques. There's one nearby . . . no matter where you live.

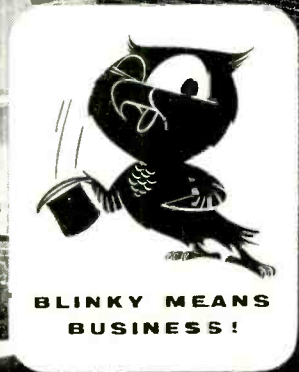

AT LAST . . . one tester that does the whole job!

Faster—Easier—Better

**NO OTHER
QUICK-TEST
TUBE CHECKER
IS SO
COMPLETE**



The Advanced, Improved,

ANKO

TELETEST

TV and RADIO TUBE CHECKER

with the Exclusive Anko "Grid-Snooper"

that spotlights troubles

**CHECKS MULTI-SECTION TUBES—
UP TO 4 SECTIONS—
ONE SECTION AT A TIME—
WITHOUT ADDITIONAL
SWITCHING!**

A Necessity for Profitable Operation

The Anko-Teletest is so advanced in design that it not only accurately tests over 300 tubes in use today, but also has 10 spare sockets for new tubes that cannot be tested on presently wired sockets, so that it will fill your needs for years to come.

Tells the "inside story" of every set quickly and reliably—speeds bench work, pleases customers on service calls.

Simple to Use

No special skill or experience required—anyone can operate with speed and efficiency. A model of simplicity in spite of its advanced design.

Costs Little More But Worth It

You can own the all-inclusive Anko-Teletest for just a few dollars more than partial, inadequate testers, and have the benefit of top quality, serviceable equipment for years to come.

**Ask Your Jobber for
a Free Bench
Demonstration on
Your Toughest
Problem!**

1. Checks for shorts from any element to any adjacent element—requires no additional set-up. Special tests for gas, grid emission and grid shorts on all one and two section tubes.

2. Quick-test feature eliminates roll chart and multiple switching. Tests an entire set of tubes in minutes.

3. Dynamic loaded test puts tubes under fully loaded conditions.

4. Long life case—so light it can be carried anywhere, easily. Heavy duty wood case is covered with imported fabric that resists scratches and scuffing. Trimmed with genuine leather. Detachable hinged cover with firm holding catch.

**Fully Guaranteed.
90 day warranty on
all defective material
and workmanship.**

**ANKO MANUFACTURING
COMPANY, INC.**

5042 W. State St., Milwaukee 8, Wis.

(Letters continued from page 5)

Detaching Circuit Digests

Editor, **TECHNICIAN**:

In your August issue H. K. Brown suggests you insert the schematics so they are more easily removed. I find the magazine is held together by two staples. I just straighten the staples, lift out the schematics and rebend them. Result—neat schematics and no damage to magazine.

MARVIN KEOWN

Marvin's Service Center
Clinton, Ind.

Hint on Shop Hint

Editor, **ELECTRONIC TECHNICIAN**:

Regarding the October Shop Hint on fusing the plate of the horizontal output tube . . . don't do it. If people would turn their sets off immediately when the picture goes black the idea would be fine. But they often leave it on and listen to the sound. If the oscillator went bad and the poor output tube had to struggle with no drive, the screen would do all the suffering. Take the time to hunt up the B plus lead that supplies the horizontal output, break the circuit, and insert your fuse.

FRITZ C. HOFFMAN

Kewaunee, Wis.

• Roger. Plate fusing would protect the flyback, but B supply fusing protects the output tube as well.—Ed.

Info Wanted

Editor, **TECHNICIAN**:

I have a "Panarama" 16" TV console with a Lytle tuner having FM band at one end. Chassis is similar to RCA 721TCS. I need an alignment chart for it. Can your readers help?

B. A. COHENOUR

Cohenour's Refrigeration Service
407 S. Division St.
Mount Union, Pa.

Schematics for New Shop

Editor, **TECHNICIAN**:

I am planning to open a TV-radio shop in the near future, and will need a considerable number of schematics. While attending school, I had to refer to your Circuit Digests at various times and found they were the best. How do I go about obtaining your schematics from past issues?

IRA J. GUNTER

Philadelphia, Pa.

• The complete 16-page Circuit Digests section as published in any issue, generally containing five to seven different manufacturers' series, may be obtained from **ELECTRONIC TECHNICIAN** for 50¢ postpaid. Cumulative Circuit Digests index was published in the Nov. 1956 issue.—Ed.



NOW... EXTRA PROFIT

ON EVERY Portable... Table... Console TV SALE!

Add a  **OUT-OF-SIGHT** indoor antenna...
TO EVERY TV SALE...
BEEF UP PROFIT MARGIN!

OPENS HUGE NEW PROFIT FIELD

Every portable table or console TV buyer is a prospect. Put them out and watch them go! Sell them like an appliance — and get a full profit on the extra sale. JFD Out-of-Sight TV Antennas are easy to sell with the sets... make them work better... are ideal as a sell-up feature that's easily demonstrated. Thousands of service-dealers are cashing in — so can you!

FOR EVERY TV

There's a JFD Tuk-A-Tenna or Periscope-Tenna for every TV set... regardless of size or make. Compactly built, handsomely styled, available in a wide variety of sell-on-sight decorator colors. Promotionally priced for mass market volume, quick profits — at your distributor now.

JOIN THE SWING THAT'S ELIMINATING TOP-OF-THE-SET INDOOR ANTENNAS!

1 Out of Every 4 TV Sets Built This Year May Be A Portable!
—RETMA

DEALERS CASH-IN SELLING PORTABLE TV ANTENNAS
—RETAILING DAILY



TUK-A-TENNA MODELS

Less Cover
TA142, TA143, TA442
With Cover
TA242, TA243, TA342

Recommended for portable TV makes listed below:
**Dumont • General Electric • Hoffman
Hotpoint • Olympic • Philco • Setchell-
Carlson • Sonora • Sylvania • Zenith**

PERISCOPE-TENNA MODELS



**TA154, TA155, TA156,
TA254, TA255, TA355,
TA356, TA454, TA455**

Recommended for portable TV makes listed below:
**Admiral • Dumont • Emerson
General Electric • Hoffman • Hotpoint
Magnavox • Motorola • Olympic • Philco
RCA • Setchell-Carlson • Sonora
Sylvania • Westinghouse • Zenith**



ELECTRONICS INC., BROOKLYN 4, N. Y.
JFD CANADA LTD. • 51 McCormack Street, Toronto 14, Ontario
JFD INTERNATIONAL • 15 Moore Street, N. Y. C.

Available in dipole lengths ranging from 29" to 48" to suit city, suburban or country signal areas. Write for complete descriptive literature.

Editor's Memo

Building up a name or a trademark is a slow process, but once it has achieved substantial public acceptance, it's a terrific asset.

For example, take Lana or Marilyn (there are quite a few fellows who wouldn't be adverse to the idea). Though the names are tagged on many girls, I doubt if many people would first think of their maiden aunts, Lana Ziltch and Marilyn Krumpedink. No, these fairly ordinary names have become trademarks of sorts.

In manufacturing, the reverse is often true; a trademark becomes a household name and is used in a generic sense to describe all such products. This is particularly applicable to leaders in the field. Back in the days when more people owned ice boxes than refrigerators, my grandfather bought a Frigidaire. Now, several decades later, at the still spry age of 90 or thereabouts, he still refers to his refrigerator as a Frigidaire despite the fact that General Motors never laid a finger on it.

More than once have I heard folks refer to their phonographs as Victrolas even though those record players were made by RCA's competitors. More often than not this is done by older people who were conditioned to the brand before the day of mass advertising media.

Perhaps the classic exhibit is the petroleum jelly made by Chesebrough. Their brand is Vaseline, and two-to-one you call it that regardless of who the manufacturer is.

Other well known trademarks are Motorola's Handie-Talkie, Bakelite, Band-Aid and Deepfreeze to name a few.

Don't think there aren't opportunities for local shop names. Out our way there's a TV shop run by two technicians whose first names, and consequently their shop name, happen to coincide with the comedy team of Bob & Ray.

There's an insurance broker whose company name is The Insurance Man. There's a juvenile furniture store called the Lilliputian Shoppe.

Sometimes names are chosen to get the best listing in the phone book. For TV servicing here in town we have AA, AAA and AAAA, the latter being listed first. Is AAAAA next? There's also Do-Right Radio & TV Service, Golden Rule, Sav-On Television Service, and Stardust TV & Radio.

Interesting, but not as colorful as The Forget-Me-Knots Shopping Service.

But regardless of the name or trademark selected, the most important thing is to make sure your product or service is the real McCoy . . . like Lana and Marilyn.

Al Forman

LOOKING?

for the right dual-control replacement

You'll find it's
ALWAYS IN STOCK at your
Centralab Fastatch®
distributor

- With Centralab's unique Fastatch system, your distributor can afford to carry a *complete line* of dual-concentric replacements for all popular TV, radio, and auto sets.
- Each Fastatch control unit is factory assembled, tested, and guaranteed.
- Ask your Centralab distributor's salesman or counterman about Fastatch duals. Or send coupon for bulletin 42-218.

Centralab

A DIVISION OF GLOBE-UNION INC.

902A East Keefe Avenue, Milwaukee 1, Wisconsin 8-5622

Send me Fastatch bulletin 42-218.

Name _____

Company _____

Address _____

City _____ Zone _____ State _____

*...for faster, more profitable
servicing of RCA products*



ALWAYS USE **RCA** SERVICE PARTS

One simple formula sums up success in your business . . . faster service equals more profits!

Here are a few of the many thousands of RCA SERVICE PARTS available through your RCA Distributor. Like all of their kind, they are identical mechanical and electrical duplicates of original parts used in RCA Victor TV, Radios and Phonographs. Factory-Tailored, they fit exactly right. This means faster replacement, less time on the bench, and restored top performance. RCA SERVICE PARTS are distinguished by the name your customers know, respect, and trust to do the job right!

Next time you "call" for an RCA Victor TV, Radio, or Phonograph . . . contact your RCA Distributor for Factory-Tailored, RCA SERVICE PARTS —and keep your servicing on the go—profitably!



SERVICE PARTS

Radio Corporation of America, Components Division, Camden, N.J.

RCA PRODUCTS AND RCA SERVICE PARTS — made for each other!

BETTER and FASTER ALIGNMENT *is Easy.*

(Monochrome or Color TV and FM)

...with the **PRECISION Model 220**



MARKER-ADDER

An accessory instrument for improving the accuracy and versatility of the conventional sweep generator, signal-marker generator and 'scope.

- ◆ Greatly increases the accuracy and speed of RF and IF alignment of color and monochrome TV, as well as FM.
- ◆ Permits use of large-size, highly visible markers, without distorting the sweep response curve.
- ◆ Eliminates the need to connect the marker signal generator to the tuned circuits of the receiver.

- ◆ Makes the marker pip fully visible in traps and at other zero response points. Simplifies and speeds adjustments at these critical points.
- ◆ Prevents marker signal from overloading the receiver tuned circuits... preserves the true shape of the sweep response curve.

Model 220: In attractive, rugged, blue-grey, ripple-finished steel cabinet. Size: 5 $\frac{7}{8}$ " x 7 $\frac{3}{4}$ " x 3 $\frac{1}{2}$ ". Complete with 4 connecting cables and comprehensive manual. Ready to operate. 115 volts 50/60 cycles.

Code: Nymph

Shipping Weight: 7 lbs.

Net Price: **\$52⁵⁰**

...and the **PRECISION Model 230**
(voltage regulated)

MULTI-BIAS SUPPLY

A valuable, time-saving accessory instrument for single and multiple bias substitution in color and monochrome TV alignment (AVC, AGC, Chroma).

- ◆ Provides four simultaneous bias voltages. Each output is individually adjustable and well filtered from a voltage-regulated source.
- Three controls for 0 to -15 volts... One control for 0 to -150 volts.
- ◆ Eliminates all need for makeshift battery hook-ups and other cumbersome temporary bias supply arrangements.

Model 230: In custom-molded phenolic case with satin-brushed aluminum panel. Complete with all connecting leads, VR tube and manual. Size: 5 $\frac{3}{8}$ " x 7" x 2 $\frac{1}{4}$ ". Ready to operate. 115 volts 50/60 cycles. Shipping Weight: 4 lbs.

Code: Naomi

Net Price: **\$27⁵⁰**

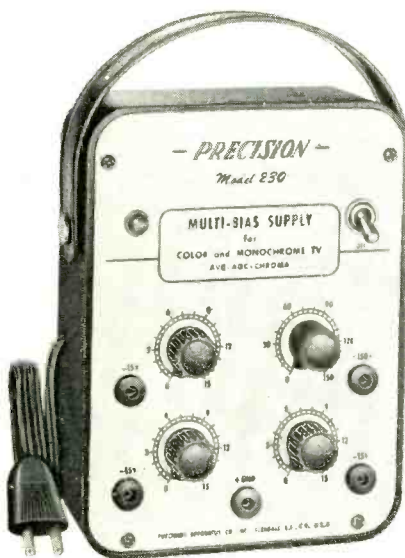

See the complete **PRECISION** line of signal generators, cathode-ray oscillographs, vacuum-tube voltmeters, volt-ohm-milliammeters, tube testers and accessories for all phases of electronics, radio communications, color and monochrome TV, etc.

On display at leading electronic parts distributors

PRECISION Apparatus Company, Inc.

70-31 84th Street, Glendale 27, L. I., N. Y.

Export: 458 Broadway, New York 13, N.Y., U.S.A. • Cables: MORHANEX
Canada: Atlas Radio Corp. Ltd. • 50 Wingold Ave., Toronto 10, Ontario



Recent survey of TV-electronic technicians by University Loudspeakers shows 58.8% sell hi-fi, 38.2% sell public address, and only 16.1% sell none.

The 1957 Los Angeles High Fidelity and Music Show, which will be held at the Ambassador Hotel, Feb. 6-9, expects to contract for 100 rooms. The San Francisco show will be held Feb. 15-18 at the Hotel Whitcomb.

"Humanation"—the human factors of production—are receiving increasing attention. Muzak exec vp reports background music relieves worker tension.

"Baffles Unbaffled" is the title of a technical pamphlet on speaker enclosures available free from Rockbar Corp., 650 Halstead Ave., Mamaroneck, N.Y.

Philco has entered the tape recorder field with a \$199.95 unit, and a \$219.95 stereophonic playback.

Walco has announced a new Record Accessory Gift Kit for \$4.95. It includes can of Stati-Clean, anti-static spray, record brush, sleeves, cloth, turntable level and stylus pressure gauge.

You can buy Fairchild's XP-2 experimental hand-constructed moving coil cartridge for \$60.

The passing of several key executives in the audio field is noted with deepest regret. James Philip Quam, 76, Chairman of the Board of Quam-Nichols, passed away on Dec. 15. His widow, Helen Staniland Quam, is treasurer and distributor sales manager of the firm.

Dec. 15 also witnessed the death of Morton Lee, 46, product sales manager of British Industries, and a technical audio expert.

Charles F. Fenton, president of the firm bearing his name, died early in Dec. at the age of 51. He was treasurer of the Institute of High Fidelity Manufacturers.



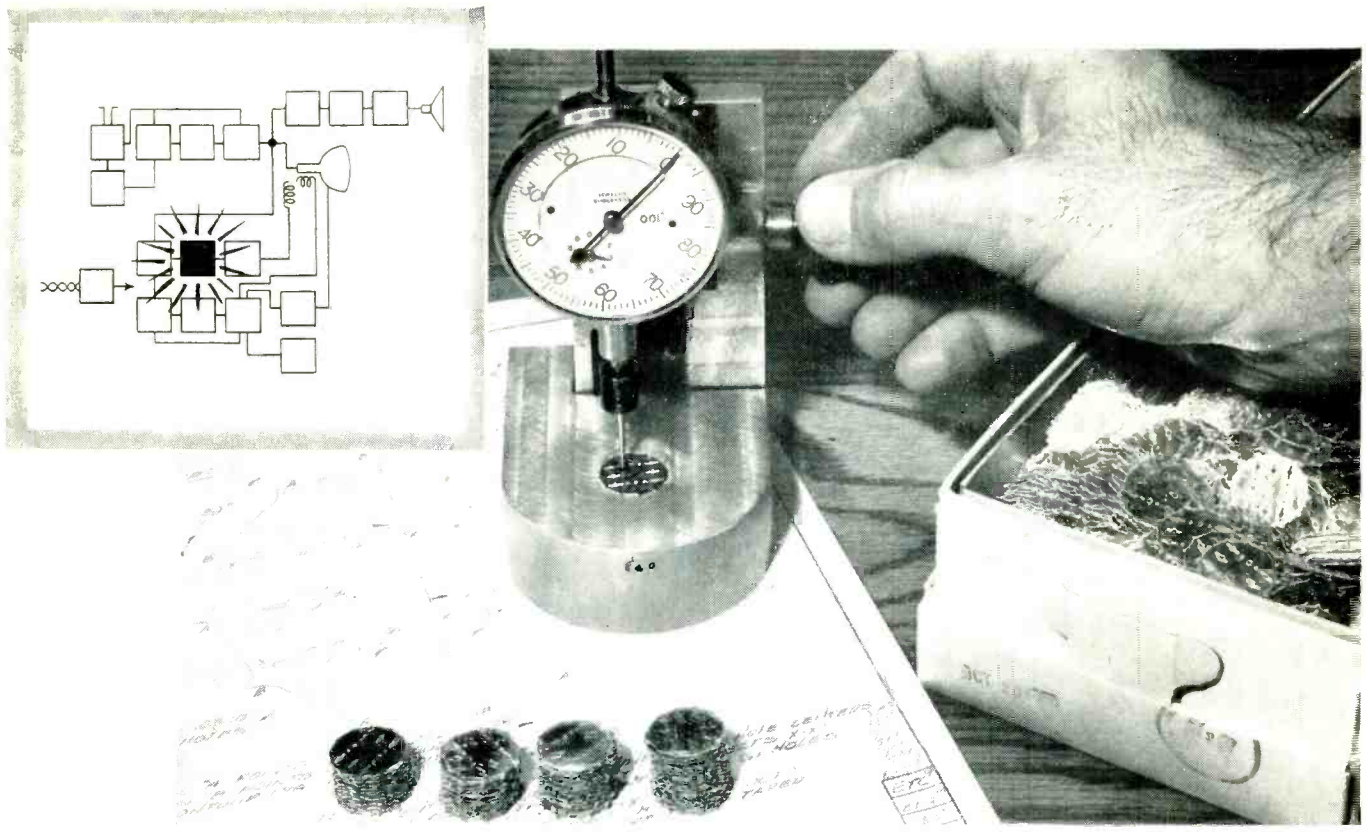

Close mica specifications of G-E vertical-sweep tubes cut microphonics, help prevent picture "jitter"!

THE tapered-pin micro-gage above, shown checking the diameter of a grid side rod aperture in a G-E tube mica, helps you to service TV sets with increased assurance of owner satisfaction. Within .0005 inch the mica aperture must meet exact size requirement, in order that General Electric grids, once inserted, will fit tightly, have minimum microphonics.

TV owners see microphonics in vertical-oscillator-and-output tubes—as image-jitter on their screens. General Electric keeps down your call-backs from this cause by holding to the industry's most rigid standards of mica measurement on 6CM7's, 6BL7-GT's, and other vertical-sweep tubes... by precision-building and micro-checking the grids and other parts, and by

a final tube test for low microphonic properties.

In many other ways, General Electric vertical-sweep tubes are better built for a superior job in your customers' sets. Careful checking for zero-bias plate current, plus improved plate design and other advancements, reduce sharply the risk of picture foldover, short sweep, and top stretch. The tubes receive a special sensitive test for tap shorts, and life-rack performance must show electrical stability at all times.

For every socket in the sets you service, there is a General Electric tube with quality as outstanding as that of G-E vertical-sweep types. See your G-E tube distributor! *Electronic Components Division, General Electric Company, Schenectady 5, New York.*

Progress Is Our Most Important Product

GENERAL  **ELECTRIC**

161-1A1

New Books

TRANSISTOR TECHNIQUES. Prepared and published by Gernsback Library Inc., 154 W. 14 St., New York 11, N.Y. 96 pages. Paper cover. \$1.50.

Here's a handy and informative book on transistor construction, testing, performance, measurements, oscillators, dc transformers, controls and geiger counters. It provides an interesting addition to your technical library for transistor servicing and experimenting.

PICTORIAL MICROWAVE DICTIONARY. By V. J. Young and M. W. Jones. Published by John F. Rider Publisher, Inc., 116 W. 14 St., New York 11, N.Y. 116 pages. Paper cover. \$2.95.

With more and more electronic technicians entering or getting interested in the commercial communications field, a volume such as this is most welcome. Current microwave terminology is clearly defined, and explanatory text with illustrations provide an easily used reference. It starts with "admittance," goes through "K-scan Poyting's theorem" and a host of others. It ends with "work" and microwaves can be attractive work for electronic technicians.

SERVICING TV AFC SYSTEMS. By John Russell, Jr. Published by John F. Rider Publisher, Inc., 116 W. 14 St., New York 11, N.Y. 128 pages. Paper cover. \$2.70.

Automatic Frequency Control circuits are essential elements in practically all TV receivers, and the servicing of this section can be difficult. In this very useful book the author has directed his explanations of circuit functions, diagnosis, waveforms and adjustments to the practical technician. He discusses horizontal frequency discriminators, horizontal phase detectors, the pulse-width system, the Gruen system and other AFC systems, including the color receiver type. Over 75 illustrations supplement the text material. Almost every TV troubleshooter can benefit from the information in this book.

THE OSCILLOSCOPE AT WORK. By A. Haas and R. W. Hallows. Published by Philosophical Library, Inc., 15 E. 40 St., New York 16, N.Y. 171 pages. Hard cover. \$10.

Using the oscilloscope and interpreting waveforms are extensively discussed in this excellent book for the intermediate and advanced electronic technician. Scope circuits, scope adjustments and scope repair are also covered. The text is divided scope application for different types of circuits: audio amplifiers, r-f amplifiers, oscillators, rectifiers, modulators, and wave shaping circuits. One chapter briefly covers TV, although most of entire text is applicable as well. It's a solid grounding for getting the most out of this valuable test instrument.

ELECTRONICS. By A. W. Keen. Published by Philosophical Library, Inc., 15 E. 40 St., New York 16, N.Y. 256 pages. Hard cover. \$7.50.

Aptly subtitled "The Science of Electrons in Action," this fine reference work offers extremely broad coverage of the field, but without going into any one phase in great depth. In addition to discussion of the usual circuits, theory, and components, the text covers audio, radio navigation, broadcasting, computing, and industrial applications, among others. It provides an enlightening broad understanding of the electronic industry.

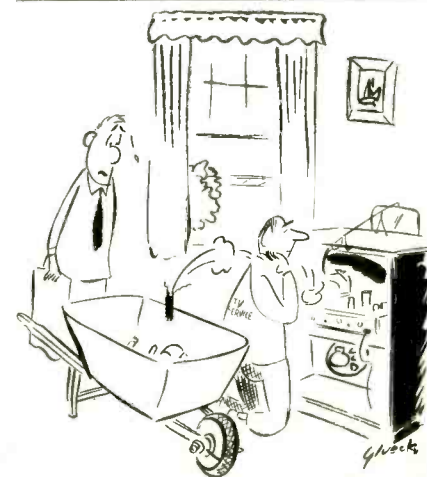

FREE!
FOR THE
ASKING

the **NEW**
INDISPENSABLE

1957

STANCOR

TV

**TRANSFORMER
REPLACEMENT
GUIDE**

to every
serviceman



The most complete, up-to-date TV transformer replacement guide published:

- 72 pages of valuable information
- Easy-to-read, easy-to-find listings, indexed alphabetically by manufacturer, model and chassis numbers
- Easy-to-find exact replacement flyback listing of manufacturer and manufacturer's part number
- Schematic diagrams of all flybacks
- Complete specifications on 260 Stancor TV transformers and related components

Get the new Stancor Replacement Guide from your Stancor distributor or by writing to Chicago Standard... NOW!

JUST RELEASED: 8 new exact replacement flybacks for Raytheon, G.E., RCA, Sentinel, Philco, and Admiral



CHICAGO STANDARD TRANSFORMER CORPORATION
3513 ADDISON STREET • CHICAGO 18, ILLINOIS

EXPORT SALES: Roburn Agencies, Inc., 431 Greenwich St., New York 13, N.Y.



AR-22



TR-2



TR-4



CDR ROTORS



TR 11 and 12



AR 1 and 2

5-star feature...

- 1 **the best color TV picture**
the growth of color TV means an even greater demand for CDR Rotors for pin-point accuracy of antenna direction.
- 2 **a better picture on more stations**
CDR Rotors add to the pleasure of TV viewing because they line up the antenna perfectly with the transmitted TV signal giving a BETTER picture . . . and making it possible to bring in MORE stations.

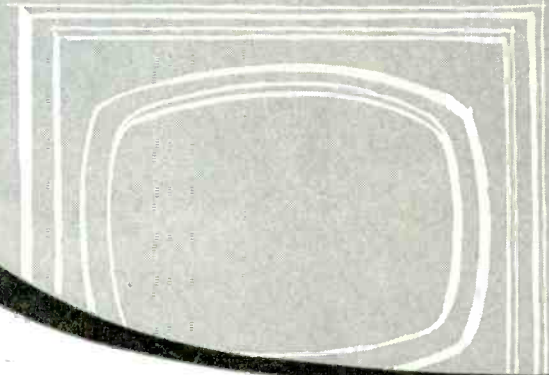

- 3 **tested and proven dependable**
thousands and thousands of CDR Rotors have proven their dependability over years of unflinching performance in installations everywhere in the nation. Quality and engineering you know you can count on.
- 4 **pre-sold to your customers**
the greatest coverage and concentration of full minute spot announcements on leading TV stations is working for YOU . . . pre-selling your customers.
- 5 **the complete line**
a model for every need . . . for every application. CDR Rotors make it possible for you to give your customer exactly what is needed . . . the right CDR Rotor for the right job.

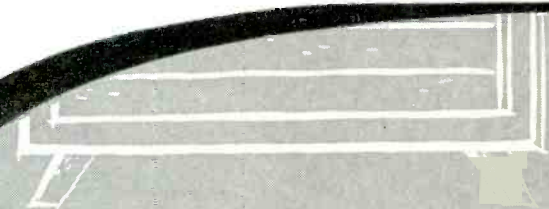

CORNELL-DUBILIER
SOUTH PLAINFIELD, N. J.



THE RADIART CORP.
CLEVELAND 13, OHIO

(Continued from page 14)

RCA TRANSMITTING TUBES, (Technical Manual TT-4). Published by Tube Div., Radio Corp. of America, Harrison, N.J. 256 pages. Paper cover. \$1.00.

This authoritative manual contains data on 112 types of power tubes with plate-input ratings up to 4 kv, and 13 associated rectifier tubes. The first 77 pages offer material applicable to any power tube, including discussion of fundamentals and materials, circuit design considerations, installation requirements, rectifier types and filters. This is a basic and practical reference for technicians servicing the communications field.

WIRELESS SERVICING MANUAL. By W. T. Cocking. Published for "Wireless World" by Iliffe & Sons Limited, Books Dept., Dorset House, Stamford St., London S.E. 1, England. 268 pages. \$2.46 plus postage.

This ninth edition of a book from England, which has been widely read by radio techs since 1936, provides an authoritative guide to repair and adjustment of modern receivers. Among the subjects covered by the text and 128 illustrations are test gear, valves (tubes in the U.S.), hum, superhets, whistles, short wave, speakers, afc, amplifiers and many other topics of primary interest to American, as well as British service techs.

RADIO VALVE DATA. Prepared by staff of "Wireless World." Published by Iliffe & Sons Ltd., Dorset House, Stamford St., London S.E.1, England. 126 pages. Paper cover. 4 shillings, 6 pence.

This fifth edition contains operating data on over 2500 British and U.S. valves (tubes), 37 transistors and 300 crt's. Some 19 British manufacturers are represented, along with U.S. type numbers. The value of this reference takes on increased importance in view of the growing number of foreign electronic products entering this country.

TELEVISION SERVICING COURSE. By M. N. Beitman. Published by Supreme Publications, 1760 Balsam Rd., Highland Park, Ill. 192 pages. Paper cover. \$3.00.

Designed as a practical home study course, this text compresses much informative material into its pages. Included are sections on pix patterns, antennas, crt's, TV circuits, UHF, test equipment, alignment and advanced troubleshooting. Of interest to beginners and old pros alike.

Time for Replacement?

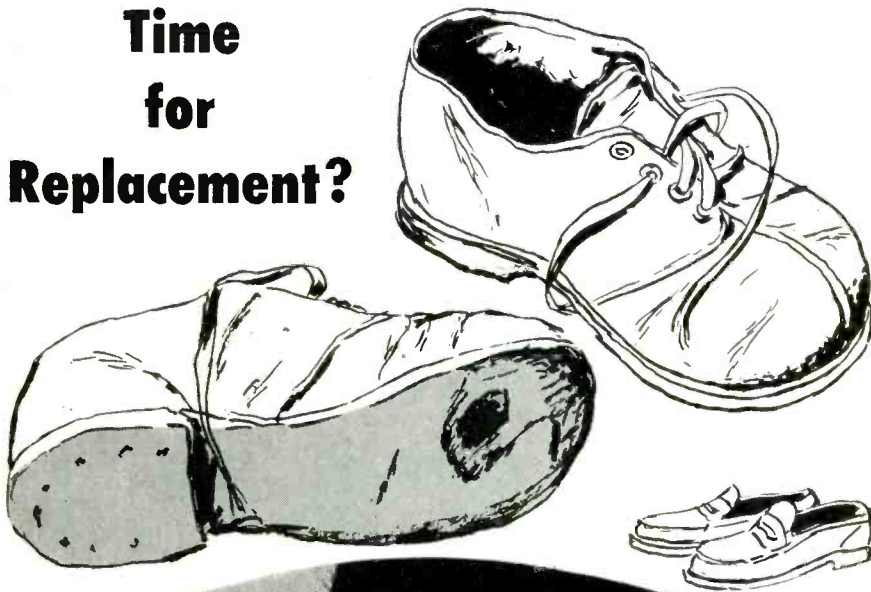

Specify

OXFORD SPEAKERS

"Put the right shoe on the right foot" by demanding the most exact replacement speakers . . . OXFORD. Proven for replacement and preferred for original equipment, OXFORD offers you the best from 2" to 15" . . . a streamlined, complete line of speakers constantly improved over more than twenty-five years of speaker leadership.

TIME for REPLACEMENT . . . specify OXFORD SPEAKERS . . . you'll be glad you did.

OXFORD Components, Inc.

Subsidiary of Oxford Electric Corp.

556 West Monroe Street • Chicago 6, Illinois

In Canada: Atlas Radio Corp., Ltd., Toronto

Export: Roburn Agencies, New York City



Cartoon Promotion

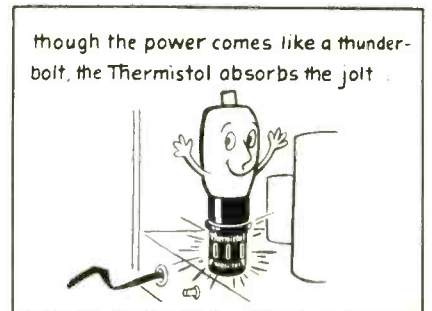
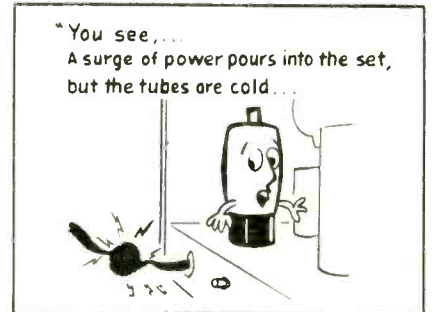
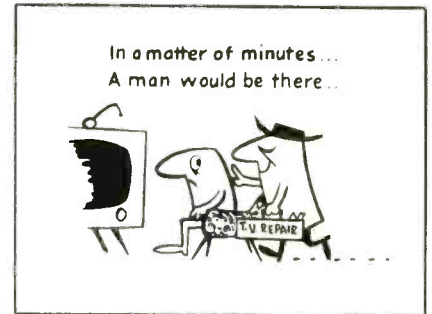

Three of a series of cartoons explaining reasons for having technician install Workman TV's Thermistol. Unit extends tube life by reducing heater surge voltage.

ASTRON *"Staminized"* CAPACITORS HAVE . . .

long life

**NO CALL-BACK CONSTRUCTION
ASSURED BY 10 INDIVIDUAL
PRODUCTION TESTS**

plus **100% FINAL INSPECTION**

Long life in capacitors is important to you as a serviceman. Complete confidence in the components you use is a necessity, because your business is built on reputation.

Astron considers the serviceman's reputation to be prime importance. That is why each capacitor is manufactured under Astron's "Staminized" system.

Astron's "Selected Purchasing" guarantees that only the very finest of raw materials are chosen. Astron's special production techniques are supplemented by continuous inspection under strict quality controls. Production tests are made right on the production line . . . 10 separate tests in all. **A 100% final inspection is made before any capacitor can be shipped.**

You can put your trust in Astron . . . your assurance of top performance . . . every time.

There is an Astron "Staminized" Capacitor built especially to fill the specific, exacting replacement requirements of any job you tackle.

Remember, your reputation is our business, too. Build it, guard it, protect it . . . Buy Astron!

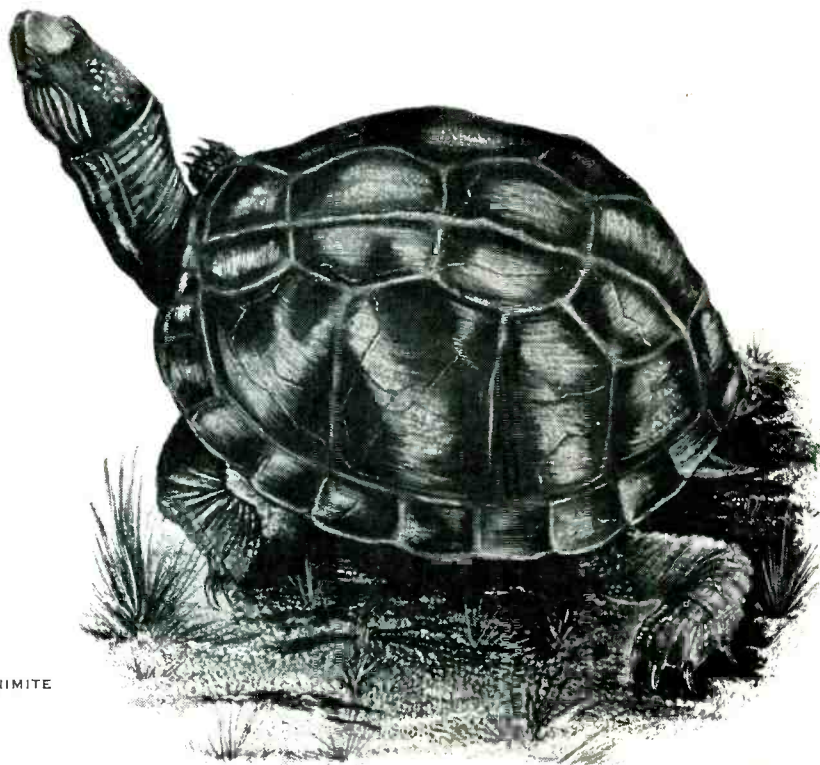

*Trade-Mark

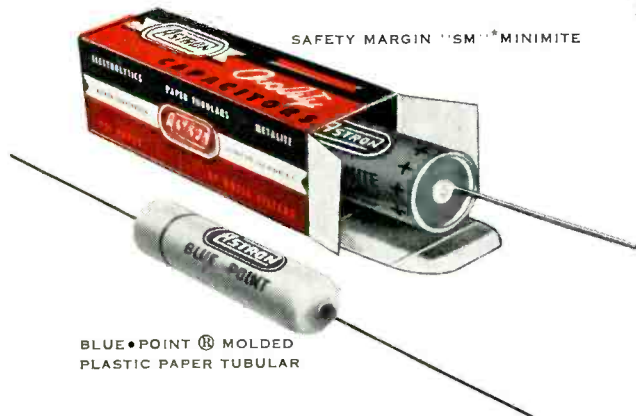

BLUE-POINT® MOLDED
PLASTIC PAPER TUBULAR

Free Servicing Aid . . .

Save time, use handy Astron pocket-sized Replacement Catalog and Pricing Guide (AC-4D) . . . Write today!



ASTRON

C O R P O R A T I O N

255 GRANT AVENUE

EAST NEWARK, N. J.

Export Division: Rocke International Corp., 13 East 40th St., N. Y., N. Y. . . In Canada: Charles W. Pointon, 6 Alcina Ave., Toronto 10, Ontario

"SURE, I use **CLEAR BEAM** **Antenna Kits**...they've doubled my installation business!"

Using Clear Beam Antenna Kits makes sense right from the start! Attractive packaging and do-it-yourself label creates customer interest in a new or replacement antenna—makes it a cinch to sell complete installations.

Servicemen installing Clear Beam Antenna Kits have eliminated "loose stock" inventory problems and are now able to price installation jobs accurately and profitably due to fixed material costs!

Start doubling your installation business with Clear Beam Antenna Kits now. Display them in your shop—show them from your service truck—let Clear Beam's self-selling antenna kits clinch extra installation sales for you!



Kits for Conicals, Arrows, Yagis, Dipoles, UHF, VHF
complete with mast, lead-in and all necessary hardware ready to install!



CLEAR ANTENNA CORP.,
BEAM CANOGA PARK, CALIF.

Warehouses in Seattle, Portland, San Francisco, Honolulu, Dallas, Kansas City, Detroit, Baltimore

Catalogs & Bulletins

MOLDED DEPOSITED CARBON RESISTORS: Catalog data bulletin B-9 (4 pages) gives comprehensive data on construction, applications, types, tolerance, resistance element, terminals, insulation, dimensions, performance, characteristics, etc. International Resistance Co., 401 N. Broad St., Philadelphia, Penna. (ELECTRONIC TECHNICIAN No. B1-1)

ELECTRONIC KITS: 1956 Fall flyer, 24 pages including two handy order blanks, describes and illustrates four new kits, plus the regular line of Heathkits. A time payment plan is also presented. Heath Co., Benton Harbor, Mich. (ELECTRONIC TECHNICIAN No. B1-2)

DOOR OPENER: Automatic radio and electronic garage door openers described in this illustrated bulletin. Price list also furnished. Richards-Wilcox Mfg., Aurora, Ill. (ELECTRONIC TECHNICIAN No. B1-3)

ALL-BAND ANTENNA: Data sheets describing several types of AM & FM radio antennas and a master antenna system installation. Another fact sheet tells about couplers. Electronic Specialties Mfg., Worcester, Mass. (ELECTRONIC TECHNICIAN No. B1-4)

TV REMOTE CONTROL: Folder and fact sheet describes the advantages of "IT" a control that can be installed by anyone without tools. Alliance Mfg., Alliance, Ohio. (ELECTRONIC TECHNICIAN No. B1-6)

SPEAKERS: Catalog 1070 contains 24 pages of definitive information on all equipment in the Professional Series line including the Hypex projectors new lifetime drivers, rectangular horns, transformers, Speech Master, high fidelity, Weather Master and Viking lines. Jensen Mfg. Co., Chicago, Ill. (ELECTRONIC TECHNICIAN No. B1-7)

FILAMENT RESISTORS: 2 data sheets tell about the Thermistol, which protects radio and TV filament strings, and extends their life, and the Erectohm Model E 10, a long-life filament dropping resistor. Workman TV Inc., Teaneck, N.J. (ELECTRONIC TECHNICIAN No. B1-8)

UTILITY TESTER: A 4 page bulletin describes this multi-purpose tester, and illustrates some of its many uses. Moss Electronic Dist., Inc., New York, N.Y. (ELECTRONIC TECHNICIAN No. B1-9)

GARAGE DOOR: Fact sheet and folder tells about a power door opener that is electronically controlled. Perma-Power Co., Chicago, Ill. (ELECTRONIC TECHNICIAN No. B1-10)

(Continued on page 58)

Something new in
EMPLOYMENT OPPORTUNITIES!
See pages 47 and 48

**"I cut testing time in half"
... "doubled our tube sales" ***



"Adds to my income and saves me unprofitable call-backs."

"We have two... one for the shop and one for house calls."

"Paid for itself several times. Really indispensable."

"Best tube tester I've ever owned. Simple to operate. Saves time."

"Makes lots of money for us. Wonderful instrument."

"Serves my purpose best for speed and dependability."



B&K MODEL 500
DYNA-QUIK

DYNAMIC MUTUAL CONDUCTANCE TUBE TESTER

FASTEST SELLING TUBE TESTER IN THE WORLD

Tests over 95% OF ALL POPULAR TV TUBES — IN SECONDS

- Accurately makes each tube test in seconds. Checks average TV set in minimum minutes.
- Tests each tube for shorts, grid emission, gas content, leakage, and dynamic mutual conductance.
- Ingenious life test detects tubes with short life expectancy.
- One switch tests everything. No multiple switching. No roll charts.
- Shows tube condition on "Good-Bad" scale and in micromhos. Large 4½-inch plastic meter has two highly accurate scales calibrated 0-6000 and 0-18,000 micromhos.
- Automatic line compensation is maintained by a special bridge that continuously monitors line voltage.
- Built-in 7 pin and 9-pin straighteners are mounted on the panel.

* NAMES ON REQUEST



Makers of Dyna-Quik, CRT, Dyna-Scan and Calibrator

B & K MANUFACTURING CO.
3726 N. Southport Ave. • Chicago 13, Illinois

One extra tube sale on each of 5 calls a day pays for the Model 500 in 30 days

Enthusiastic comments like those above* come from servicemen all over the country. *Actual experience shows an average of close to 2 additional tube sales per call.*

Instead of the "trial and error" method of substitution testing, the Dyna-Quik 500 quickly detects weak or inoperative tubes. Cuts servicing time, saves costly call-backs, shows each customer the true condition and life expectancy of the tubes in the set, and makes more on-the-spot tube sales. Helps keep customer good-will, give a better service guarantee, and make more profit.

The B&K Dyna-Quik 500 measures *true dynamic mutual conductance*. Completely checks tubes with laboratory accuracy under actual operating conditions right in the home... in a matter of seconds. Saves time and work in the shop, too. Simple to operate. Easily portable in luggage-type case. Weighs only 12 lbs. **NET, \$109.95**

See Your B&K Distributor or Write for Bulletin No. 500-T



Model 1000 DYNA-SCAN
Picture and Pattern Video Generator Complete Flying Spot Scanner. Net, \$199.95



Model 400 CRT
Cathode Rejuvenator Tester. Tests and repairs TV picture tubes. Net, \$54.95



Model 750 CALIBRATOR
Designed to check and adjust test instruments with laboratory accuracy. Net, \$54.95

News of the Industry

TELEX announces the appointment of **L. H. JOSEFSON** as General Manager of its Industrial Electronics Div.

ALLEN B. DUMONT LABS. has promoted **PETER G. BUTTACAVOLI** to the position of National Service Manager of the Receiver Div.

GENERAL ELECTRIC has appointed **I. D. Daniels** as General Manager of the receiving tube department.

THE YOUNG PRESIDENTS ORGANIZATION has announced that **ROBERT G. WALCUTT**, Pres. of

ELECTROVOX CO., has been elected a member of the youthful executive's organization.

SIMPSON ELECTRIC CO. has appointed **WILLIAM R. JOHANSEN** to the post of Asst. Sales Manager.

STACKPOLE CARBON CO. elected **H. S. CONRAD** President, to succeed **LYLE G. HALL**; and **J. HALL STACKPOLE** was re-elected Chairman of the Board of Directors.

DELMAH F. ORE has been appointed Sales Coordinator for Semiconductors for **CBS-HYTRON**.

LOUIS W. SELSOR has been appointed to the post of General Sales Manager of **ELECTRO-VOICE, INC.**

JOSEPH P. JATIS has been named Manager of Two-way Radio Service

Training, as announced by Motorola's Communications and Electronics Div.

WALTER E. PEEK was appointed General Sales Manager of **CENTRAL-LAB**, div. **GLOBE UNION INC.**

WILLIAM J. NAGY has been appointed Advertising and Promotion Manager of **PHILCO CORP.** Accessory Div., as announced by **RAYFORD E. NUGENT**, General Manager of Accessory Div.

ALLIANCE MFG. CO., INC. announces the appointment of **THOMAS L. DOWELL** to the position of Jobber Sales Manager.

ROBERT BEEBE has been named Acting Sales Manager of Commercial Product Sales for the Electronics Div. of **THOMPSON PRODUCTS, INC.**

ERIE RESISTOR CORP. announced the appointment of **WESLEY M. HAGUE, JR.** to head the New England District Sales Office for its Electronics, Electro-Mechanical, and Plastics Divs.

RAYTHEON MFG. CO. has formed a new electronics laboratory at Maynard, Mass. with primary responsibility to design and develop airborne electronics equipment.

CBS-HYTRON, electron tube manufacturing div. of **COLUMBIA BROADCASTING SYSTEM, INC.**, has been commended as a leading supporter of independent radio and television service-dealers by the **NATIONAL ALLIANCE OF TELEVISION & ELECTRONIC SERVICE ASSOCIATIONS**.

TRIPLETT ELECTRICAL INSTRUMENT CO. is building a 10,000 square foot subsidiary plant to be constructed in Oceanside, Calif.

HERB BOWDEN, president of **SERVICE INSTRUMENTS CORP.**, Addison, Ill., announces that the firm has changed its trade name to **SENCOR**.

DUMONT TUBE DIV. offers expanded picture tube line was announced by **ROBERT G. SCOTT**, General Sales Manager of the Cathode-Ray Tube Div.

TV TREND is a new magazine designed for the store owner to give out as his own advertising piece simply by placing his name on the front cover plus any special message of his own inside. Booklet contains 3 pages of illustrated TV sales and service advertising, highlights of coming TV programs for 30 days and photos of popular TV stars. All exclusively in your own territory. **TV Trend**, 4950-T Marine Drive, Chicago 40, Ill.

MULLARD, Britain's largest manufacturer of electronic tubes, has recently introduced a blue-plastic pin protector which guards **MULLARD'S** miniature tubes against the possibility of damage in transit.

ELECTRONIC CHEMICAL CORP., Jersey City, N. J., has introduced a new corrugated display carton, enabling dealers to display twelve cans of **No-Noise Volume Control** and **Contact Restorer** together with twelve cans of the **No-Noise Tuner Tonic** in one compact arrangement.

(Continued on page 22)

Something new in
EMPLOYMENT OPPORTUNITIES!
See pages 47 and 48

You'll find that Quam speakers are heavier than other speakers of equivalent size and magnet weight—because they are built of stronger, finer quality materials.

Quam speakers have heavier gauge metal baskets . . . larger and more efficient magnetic structures . . . more insulating and impregnating materials.

The result is a more rugged, longer lasting speaker that is sure to be in perfect operating condition when you take it out of its factory package. Quam speakers are always shipped in individual protective cartons . . . never in bulk!

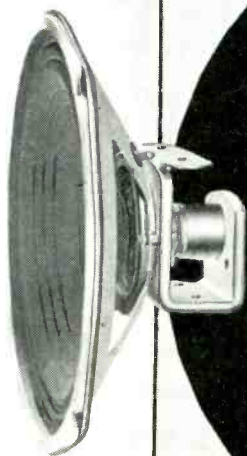

**COMPARE
THE WEIGHT
of a**

QUAM
Adjust-a-Cone®
SPEAKER

**QUAM-NICHOLS
COMPANY**

226 EAST MARQUETTE ROAD
CHICAGO 37, ILLINOIS

ask for QUAM, the quality line, for all your speaker needs



for the expanding independent service-dealer

More and more independent service-dealers are strengthening their competitive position by broadening their activities. They are adding to radio and television service: Marine, mobile and citizen radio . . . sound systems . . . industrial equipment . . . special electronic devices . . . etc.

These forward-looking independent service-dealers are discovering expanded lines of CBS industrial tubes and semiconductors ready to help

them in their profitable new fields. New PA-5 and PA-17 reference guides describe respectively over 200 CBS industrial receiving, power and special-purpose tubes . . . and a wide line of CBS crystal diodes, transistors and silicon power rectifiers.

Both guides are free . . . from CBS Tube distributors or direct. Just ask for Bulletins PA-5 and PA-17.



tubes • semiconductors

Reliable products through Advanced-Engineering

CBS-HYTRON

Danvers, Massachusetts

A Division of Columbia Broadcasting System, Inc.

Reps & Distributors

The name of **SAMUEL SIEGEL CO.**, mfrs. reps for electrical and electronic material, has been changed to **YARBROUGH SALES CO.**

JOHN J. KELLEY has been appointed General Manager of **PHILCO DISTRIBUTORS, INC.**

WELLER ELECTRIC CORP. placed insertions in six leading consumer magazines to reach the big 1956 Yule gift market for **WELLER** power tools designed for the mass market.

CBS-HYTRON has opened a new sales office and warehouse in Seattle under the direction of **LEO McCABE.**

1957 ELECTRONIC PARTS DISTRIBUTORS SHOW applications are 35 per cent over this time last year, as reported by **KENNETH C. PRINCE**, general manager of the show. The 1957 show will be held at the Conrad Hilton Hotel, Chicago, May 20-23. Drawings for space on Dec. 5th were based on the seniority system initiated last year, designed to give preference to companies which have exhibited longest.

CONTINENTAL MFG., INC. manufacturers of the **CONTROLA-TONE** remote volume control, has announced the appointment of the following reps: **R. W.**

FARRIS CO., INC., RAY RIPLEY, WALTER F. MARSH, WAYNE BEITEL CO., R. G. SIDNELL & CO., HARRISON J. BLIND & CO., FRED GROSS & CO., WOLFE-MARSEY SALES, KAELBER & MACK, PAUL W. NIEF ASSOC., PARK & GOODMAN, PAUL HAYDEN ASSOC., WM. B. GOLLIHER.

FEDERATED PURCHASER, INC., Mountainside, N. J., offers free time-saving self-calculator, called **FEDISC**. Various formulae such as Ohm's Law, Voltage or Current vs. decibels, capacitive reactance vs. frequency, and inductive reactance vs. frequency, are covered in turn by the calculator.

The electronics industry paid tribute to **AARON LIPPMAN**, **NATIONAL ELECTRONIC DISTRIBUTORS ASSOCIATION'S** Board Chairman Emeritus at a testimonial dinner in his honor in the Grand Ballroom of the Hotel Roosevelt, New York on December 4th.

ARGOS PRODUCTS CO., Genoa, Ill., has been appointed exclusive sales representative for the electronic and electrical field for **PLASTI-KOTE** spray paints and other pressure products.

UNIVERSITY LOUDSPEAKERS, White Plains, N. Y., announces the appointment of **LEON S. BUSH CO.**, Salt Lake City, to represent its products in the Rocky Mountain territory.

SNYDER MFG. CO. has appointed the following new reps for its Antenna and Electronics Divisions: **J. W. LEHNER CO.; HARRY HALINTON, Engineers; LE ROY & MCGUIRE, INC.**

RADIO MERCHANDISE SALES, INC. announces the appointment of **ED MARTIN** as its rep in Va.

ART CERF ORGANIZATION, established in 1939 to give electronics firms knowledgeable, productive sales representation, has issued a booklet introducing each member of its organization along with a brief biography of each person.

TODD-TRAN CORP., Mt. Vernon, N. Y., announces the appointment of three new jobber sales reps: **ERDE HAVILAND, Malverne, N. Y., R. L. STONE SALES CO., Beverly Hills, Calif., and KENNETH L. BROWN, Brookline, Mass.**

Quickly Spots and Corrects TV Picture Tube Troubles Without Removing Tube From the Set

TESTS the picture tube for all the important factors which determine the quality of the tube.

RESTORES emission and brightness.

REPAIRS inter-element shorts and open circuits. Stops leakage.

LIFE TEST checks gas content and predicts remaining useful life of the picture tube.

GRID CUT-OFF reading indicates the picture quality customer can expect.

QUALITY DESIGN makes it easy to use. Provides quick reading at a glance.

CRT 400 PROVES REAL MONEY-MAKER

Here's what **Joe Driscoll** of **TV Trouble Shooters, St. Paul, Minnesota** says: "It has made more money for us than any other instruments, with the possible exception of tube checkers. We make an additional charge each time we use the instrument in the home to check or correct picture tube conditions. We have been able to convince customers much easier that their old tubes need replacing and have enjoyed a nice profitable business from the sale of new picture tubes without leaving any doubt whatever in the customer's mind that he needed a new tube."

This is typical of the experience of thousands of servicemen using the **CRT 400**. It cuts service-operating costs...brings new profits...builds customer good-will...quickly pays for itself. Also saves money on TV set trade-in reconditioning. Has 4 1/2-inch plastic meter. Easily portable. **NET \$54.95**

See Your Distributor today or Write for Bulletin No. 400-T

Makers of **CRT, DYNA-QUIK, DYNA-SCAN** and **CALIBRATOR**

B & K MANUFACTURING CO.
3726 N. Southport Ave. • Chicago 13, Illinois



"Not sliced egg sandwiches, again?"

Westinghouse casts a vote of confidence for the independent service dealer!

Westinghouse
ELECTRIC CORPORATION

ELECTRONIC TUBE DIVISION

P.O. BOX 254
ELMIRA, NEW YORK

TO: INDEPENDENT RADIO-TELEVISION SERVICE DEALERS

A great deal of written and verbal discussion has been going on in our industry just recently on the subject of "factory service" for television and radio sets. This discussion has been of considerable importance to Westinghouse from both the tube and set viewpoint; and, after lengthy consultation with Mr. E. J. Kelly, General Manager of the Radio & Television Division, Westinghouse does not contemplate going into factory service operation for Westinghouse sets.

We have confidence in the independent service dealers to supply replacement parts and render the necessary service for television sets in our very rapidly expanding industry that is forecast to double in size again in the next ten years.

We presently feel that the best interests of the ultimate consumer are served by the continued utilization of the vast coverage and experience of the independent service dealers. The Westinghouse Tube Division has supported independent servicemen in the past and this support will be continued in the future.

May I take this opportunity to congratulate you and your independent service organization on the vital role you have played so well in the television industry.

Cordially,



R. T. Orth
Vice-President

YOU CAN BE SURE...IF IT'S Westinghouse

YOU CAN BE SURE...IF IT'S Westinghouse



Answers Independent Service Dealers' Questions About "Captive Service"

What is "Captive Service"?

It is the repair work done by service companies owned by set manufacturers — companies established by them to handle the profitable TV and radio set maintenance on receivers of their own manufacture — work that otherwise would be handled by Independent Service Dealers.

Will "Captive Service" affect my volume of business as an Independent Service Dealer?

A conservative estimate by service association spokesmen indicates that in 1957 Captive Service Companies could do close to \$250,000,000 worth of TV and radio repair work.

Does Raytheon compete with me through a "Captive Service" organization?

No, indeed! Raytheon does not have a captive TV-Radio service organization — does not now manufacture TV or radio receivers.

Raytheon believes service is your business — servng you is Raytheon's.

How can I compete with the "Captive Service" organizations of big national companies?

Raytheon helps you do this. If you can qualify as a RAYTHEON Bonded ELECTRONIC TECHNICIAN, your service and parts guarantee is backed by a bond — a bond issued through Continental Casualty Company, one of the country's largest insurance companies. Here is real prestige for you. What's more, your work on all makes and models of sets is *bonded*.

Will becoming a Raytheon Bonded Dealer mean I'll lose my "independence"?

Not at all. You become one of a group of TV-radio technicians known from coast-to-coast as the best in the business, yet you retain your own "independence." The Raytheon Bonded Program is nothing new. It's a proven program Raytheon has provided for more than 11 years — that has successfully helped build premium customer business for Independent "Bonded" Service Dealers. It's Raytheon's investment in your future.

How does being a Raytheon Bonded Dealer help me compete with "Captive Service" companies?

- (1) Your TV-radio repair service is nationally advertised by Raytheon in TV Guide Magazine.
- (2) Western Union "Operator 25" is retained in 23,000 cities and towns by Raytheon to send customers to Raytheon Bonded Dealers.
- (3) You are *bonded* to service *all* makes and models of sets — a big advantage.

Will I have other advantages over "Captive Service" organizations?

Yes, you'll be using Raytheon TV and Radio Tubes. They are perfect for your replacement work because Raytheon Tubes are designed to give quality performance in all Television and Radio sets.

How do I get the whole story on the Raytheon Bonded Program?

Ask your nearest Raytheon Sponsoring Bonded Tube Distributor.



RAYTHEON MANUFACTURING COMPANY

Receiving and Cathode Ray Tube Operations

Newton, Mass. • Chicago, Ill. • Atlanta, Ga. • Los Angeles, Calif.

Raytheon makes } Receiving and Picture Tubes, Reliable Subminiature and Miniature Tubes,
all these } Semiconductor Diodes and Transistors, Nucleonic Tubes, Microwave Tubes.



ELECTRONIC TECHNICIAN

Including
Circuit Digests

What's Ahead for '57!

Watch for a continued rise in electronic servicing volume for 1957. More radios, TV sets, audio equipment and commercial electronic products in use will result in an annual retail repair bill of \$2.4 billion for labor and parts.

Parts sales may be expected to climb. Our predictions for specific products are:

TELEVISION: TV receiver sales should run about 7,300,000, including about 300,000 color sets. Manufacturer competition will remain strong, and profit margin low. A few set makers currently in the red may give up this phase of their business. Compact sets with 110° pix tubes are practically a certainty. Anticipate announcements of transistor sets, but no substantial production.

RADIO: Good business in radio sets, well over 13,000,000, is expected. Good car sales should hypo auto radios. Portables, particularly transistor types, should move briskly.

AUDIO: Phonograph sales should be about 4,500,000 units, and tape recorders over 500,000. Hi-Fi equipment of various types should top the \$135,000,000 mark for the year. PA will offer even more sales and service attractions than the past year. Four out of five technicians will sell some audio item.

TUBES: Receiving tube production will pass a record half-billion mark, and TV picture tubes should come close to 12,000,000.

1957 will be a year of opportunity for service work, mixed with a certain amount of concern and confusion about captive service, licensing and labor union activities in the field. In addition to the growing TV-radio-audio repair business, electronic technicians should become increasingly interested in the

excellent potential of one other phase of electronic activities. . . .

Industrial Electronics & Communications

In the communications field, such as police and taxi two-way mobile radio, many independent service shops are earning enviable incomes. There is a strong demand for still more qualified technicians.

In-plant electronic devices, such as photoelectric devices and motor controllers, are maintained for the most part by factory employees or factory authorized representatives. As industrial electronic applications have spread, the need for local service has made itself more evident. There is a huge reservoir of untapped opportunities here. Of course, electronic manufacturers are constantly seeking electronic technicians as well.

How do you make the first step in the direction of industrial electronic and communications servicing? Well, there are several approaches. Various schools offer excellent training courses. Much can be learned by joining professional technical societies such as the Institute of Radio Engineers, in addition to your local service association. Direct contact with various manufacturers can be most informative.

If you are currently engaged in such work and desire more business, or if you would like to get started in this field, **ELECTRONIC TECHNICIAN** editors will help you. Just write to us, describing your interests, experience and facilities, and we will put you in touch with just the right people.

If you are interested, write to us now. It can make the difference of a new electronic horizon for you in the coming months.

Tuning In the

CARRIER PIGEONS are one of the casualties of the electronic age. The Army has retired these gallant birds in favor of radio communications.

TALLEST MAN-MADE STRUCTURE will be the 1610-ft. TV tower being constructed for KSWs-TV in Roswell, N.M. It will surpass the 1572-ft. tower of Oklahoma City's KWTv.

EMPHASIS ON NEW IDEAS and developments in monochrome TV sets, which would obsolete present sets, are what is needed to return the TV business to a profitable level, notes H. Leslie Hoffman. In other words, let's take a lesson from the automobile manufacturers.

PRAISE AND CRITICISM were heaped on the TV networks by the Sylvania Television Award judges. In particular, the pat on the back went for political convention coverage; the rap went for the inadequate attention given the United Nations proceedings in the recent Middle East and Hungarian crises.

MILITARY AUDIO development by Cook Research Labs consists of an air-ground loudspeaker system capable of being dropped from airplanes flying at 60,000 ft. It is designed to deliver three to five-minute tape recorded messages to a ground area during the parachute-braked final phase of its descent.

ULTRASONIC SOLDERING

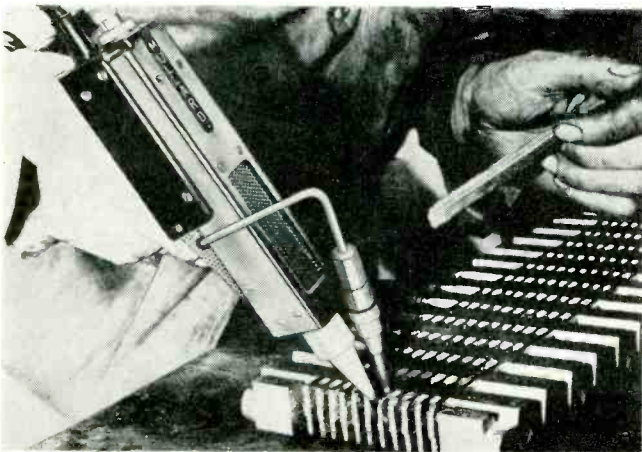

Ultrasonic soldering iron applies power to aluminum surface through molten solder. Cavitation effects in solder remove oxide film without flux. Unit developed by Mullard and marketed by Acoustica is one of many industrial applications of "silent sound." Others include drilling hard materials, degreasing, sterilizing, flaw detection and medical treatment.



"All those in favor of making the IF's in our receivers 32 KC's in honor of our 32nd anniversary, say AYE."

WHAT'S YOUR WATTS? The experts say that when a person sits still he generates 100 watts, or enough to bring a quart of water to boil in one hour. This "boiling point" time would be shortened to 15 minutes by a running person.

LOW-VOLTAGE PIX TUBE developed by Westinghouse requires only 110 volts on grid 2, instead of the 300 volts commonly required.

SILICON RECTIFIERS for TV are moving along briskly. Sarkes-Tarzian reports their cartridge unit is being produced at the rate of 20,000 to 25,000 daily, about half of them being purchased by technicians for field replacements. Big Long Island, N.Y., distributor sold out his complete allotment quickly, and has reordered. Among benefits of silicon replacements for selenium are higher output voltage, smaller size, greater temperature range, and easy snap-in installation.

QUOTABLE QUOTE. "Lack of mental capital accounts for more business failures than lack of working capital."—Joseph A. DeMambro, President, National Electronic Distributors Association.

TV AROUND THE WORLD. Buenos Aires has 70,000 sets. TV receiver production in France this year will run about 300,000 compared to 185,000 in 1955. Italy has 340,000 sets in use. Broadcasting has started in Australia and Spain, and plans are completed in Norway. Info courtesy DuMont.

Picture



RETMA ADVANCED TRAINING. Industry is providing the means to help practicing TV technicians learn the new techniques and acquire the added skills made necessary by the rapid technological progress and extensive changes in the service field. Local industry advisory committees are being formed to help technical and vocational schools institute the course in advanced TV servicing techniques. The course lays the groundwork for successful training in color TV.

The scope and activity of local committees may be illustrated by the Greater N.Y. Electronic Industry Advisory Committee for Education. This committee was formed recently to help provide evening school facilities for accreditation to TV technicians in metropolitan N.Y., Westchester, Nassau and Suffolk Counties. Under the guidance of this committee, East Meadow High School, in Long Island, is equipping a service laboratory patterned after that in the N.Y. Trade School.

INDUSTRIAL TV is being used by GE to convey the latest servicing techniques to independent authorized service station personnel who specialize in the maintenance and installation of two-way radio.

NATIONAL ELECTRICAL WEEK, Feb. 10-16, 1957, will be heavily promoted to make consumers aware of the need for proper electrical practices and adequate installations. Some attention is focused on radio and TV sets, mentioning cord wear, ventilation and lightning protection.

CALENDAR OF COMING EVENTS

- Jan. 14-16: Third National Symposium on Reliability and Quality Control in Electronics, Hotel Statler, Washington, D. C.
- Feb. 6-9: Los Angeles High Fidelity Show. Ambassador Hotel.
- Feb. 6-9: San Francisco High Fidelity Show. Hotel Whitcomb.
- Mar. 3-6: 1957 Annual Convention of National Education Assoc., Dept. of Audio-Visual Instruction, Sheraton Park Hotel, Washington, D. C.
- Mar. 18-21: IRE National Convention, New York Coliseum and Waldorf-Astoria Hotel, New York, N. Y.
- May 20-23: 1957 Electronic Parts Distributors Show, Conrad Hilton Hotel, Chicago, Ill.

Something new in
EMPLOYMENT OPPORTUNITIES!
See pages 47 and 48

TECHNICIANS TALK BACK. Newspapers often carry stories pointing the accusing finger at TV repairmen. Rarely is there the opportunity to present the servicer's viewpoint. One of these rare occasions was a story by the economic columnist Sylvia Porter. The article quoted technicians who stated, among other things: "If the repairman is a thief, the customer has taught him to be one . . . I've had a lot of training. My business expenses go into my price. Then the customer says 'you charged me \$12 JUST for! . . . Something goes wrong with the TV picture. We fix it. Next week something makes the picture look the same. The customer screams 'you knew it would happen again.'"

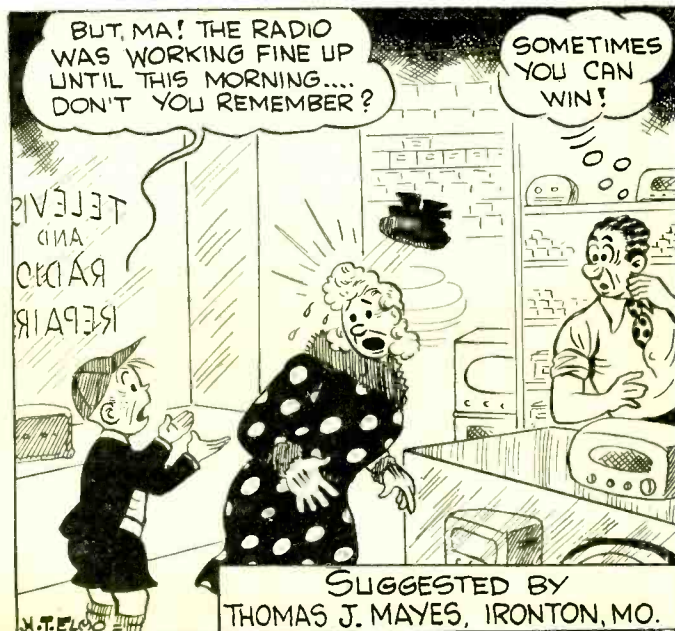

Servicing Industrial Electronic

Photo-electric cells • Electronic timers • Capacity detectors •

JACK DARR

• Industry, from the smallest factory to the largest plant, has taken electronics to its bosom. The speed, accuracy, and usefulness of electronic control and operation systems have made them a must in many operations. This offers an ever-increasing opportunity to the trained electronics technician. Because of his specialized knowledge, he already understands the operating principles, and can make the needed repairs.

The basic requirements are a working knowledge of electronics, mechanical ability to do radio or TV work, and a standard assortment of tools and test equipment. Along with these, you'll need the ability to look at a gadget, study it and the instruction books, and then be able to tell just what the thing is supposed to do. If you can do that, it won't be too much trouble to find out just why it isn't functioning properly. This procedure should be pretty simple for the average radio-TV serviceman; he does it many times every day.

The major application of electronics is in the control mechanism. For instance, a gas-fired boiler, in the heating plant of a hospital, has a photo-electric cell, an electric timer, several pressure-switches, thermo-

stats, and relays. To a man used to the bewildering complexity of TV circuitry, these functions will seem absurdly simple; do not make things unnecessarily complicated. Most of the devices have only one function. All of the machinery thus controlled is fully automatic. The cycle is started by pressing a button, and the machine takes it from there. The cycle can also be started or stopped by signals from control devices, thermostats, pressure switches, and so on. Therefore, all of the mechanical control functions of the machine must be electrical; valves are opened by heavy solenoids, switches are replaced by relays, and mechanical functions require the use of electric motors. Pressure-switches, float-switches, photocells, and other sensing-devices are used to give the signals.

Float Switch

The float-switch is probably the simplest type, and the oldest. The float is mounted on the end of an arm. The position of the arm determines whether the switch contacts attached to the other end are open or closed. Thus, it may be used to indicate the liquid level in a tank, and to start and stop a pump whenever this level reaches certain limits.

The pressure-switch is quite com-

mon. Basically it is a diaphragm or bellows with the switch actuating arm linked to it. The pressure applied to the diaphragm determines the position of the arm. Low pressure-switches may work on a pressure of as little as 8 ounces, and high pressure types can handle hundreds of pounds. Millions of them are in use, in refrigerators, water pumps, and air-conditioners.

The thermostat is another device just as common. A temperature-sensitive element is arranged so that variations in the temperature cause mechanical movement. This can be a bimetal strip, or any of several other types. A change in temperature causes the coupled switch to open or close. Adjustments permit setting the device to open and close contacts within certain given limits.

Photocells are used in switching circuits in many ways. Basically, all applications are alike. They utilize the small change in the cell current, caused by a change in the light falling upon it, to send a signal through the accompanying amplifier and then to the control circuits themselves.

Magnetic fields are also used for control purposes. The presence of a metallic object can be detected by using a magnetic pickup-coil. The object causes a change in the coil's magnetic field, and causes varying control currents to flow.

Fig. 1—The thermostat senses a demand for heat and starts the timing motor; which operates the blower and ignites the pilot light. A

photo-electric cell sees the light and causes the main-gas valve to open. If water level and gas pressure are correct the boiler will fire.

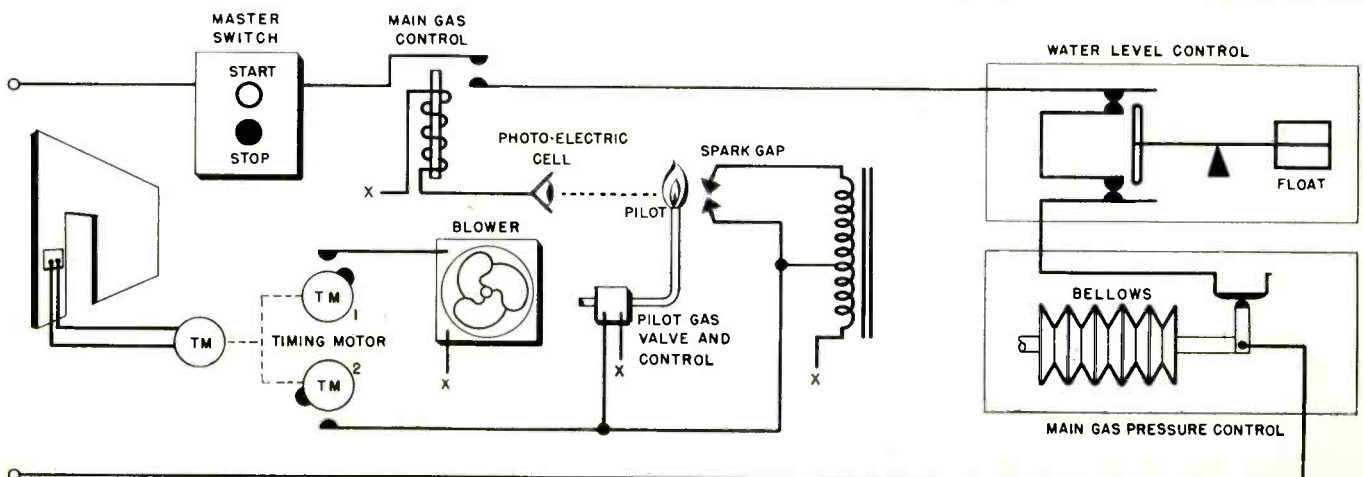

Controls & Equipment

Pressure switches • Float switches • Thermostats • Relays

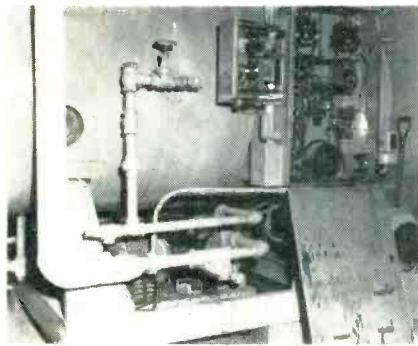

Fig. 2—Electronic timer & boiler control.

Capacity-detectors are used in some applications. The presence of an object is detected by a change in capacity of the pickup. Probably the most common circuit is the one familiar to experimenters; where the pickup is a part of the tank circuit of an oscillator. Changes in capacity cause either a change in frequency, or a stoppage of oscillation, thus sending the necessary signal to the control circuits.

Simplest of all is the limit-switch, used to stop mechanical movement. These are usually microswitches, operated by flexible arms. They are used to shut off motors, and to prevent parts of machinery from traveling too far.

Fail Safe

Automatic controls used in industry are merely combinations of these devices. Enough units of the required types are connected to the machine to make it perform its assigned task automatically. Another vital function of this type of control system, is the prevention of accidents. If anything out of the ordinary happens to the machine, which might possibly cause trouble, the whole system will be quickly and safely shut off.

The gas boiler uses just such a combination of devices. It is controlled by thermostats in the building, which determine the demand for heat. Pressure-operated switches on the boiler control steam pressure. Another pressure switch permits the boiler to operate only when the pressure in the main gas line is

within limits. (8 oz. to 15 oz.) The water level in the boiler is maintained by a floating switch control. The whole system is "fail-safe"; if water and gas pressures are not right, the safety switches are open, and the boiler cannot start.

To start the furnace an electrically timed rotary switch control causes the following sequence of actions: starts a blower to remove any unburnt gas from the combustion chamber; lights the pilot light by opening its electrically controlled gas valve and a spark from a high-voltage transformer ignites the gas; the light from the pilot flame falls on a photocell which closes a relay. (Unless the PE cell sees fire the cycle is stopped, and the boiler will not light); finally, a solenoid opens the main gas valve.

Another simple device is used in dairies to control the filling of waxed-paper milk containers. As they are opaque, it isn't possible to do this visually. So, an electronically

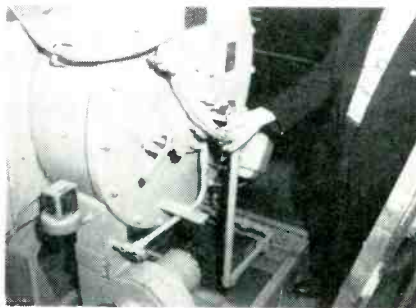

Fig. 3—Hand on photo-electric-cell holder. 2 ignition spark plugs located above hand.

timed, solenoid controlled, valve is used on the main tank. This is similar to the photo-timers used by photographers. A condenser is charged, then discharged through a resistance. The voltage across the condenser is applied to the grid of a tube which has a relay in its plate circuit. When the signal voltage reaches a given value, the tube conducts, and closes the relay. By varying the size of the resistance and the condensers, any time constant can be obtained. In this case, the cycle is started when the empty bottle is pushed against an actuating

arm, with a microswitch, on the filling table. This opens the solenoid valve, milk flows until the bottle is

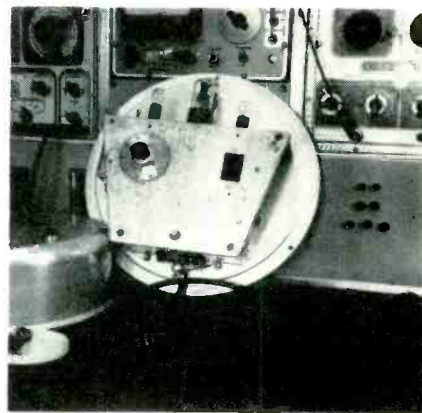

Fig. 4—Electronic timer used to fill bottles. Calibrated dial adjusts timing.

filled to a preset point, the timer shuts off the valve, and resets itself for the next one.

These are only a very few of the many applications of electronics in industry. One point to remember is the way in which all controls are interlocked, to get the fail-safe feature. In the case of the boiler mentioned, much trouble has been found in other controls; gas pressure, water level, etc., and very little actual trouble in the electronic circuits themselves. So, when checking, be sure that all external devices are in the proper condition before blaming the trouble on the electronic circuits. Automatic door-openers are on the increase, and are in use in hotels, shopping centers, in private garages, and other busy entrance-ways. They are triggered by radio control, remote control, contact, electric eye, and magnetic induction. Fire alarms, smoke control, speed control, quality control, smoke control, and countless other applications, make use of the above mentioned devices. For the technician who wants to develop in this field, it is only a short hop into servomechanisms, ultrasonics, and electronic welding. Most of this business can be quite easy, and highly profitable; all you've got to do is go after it. •

Problems Encountered In

Understand Test Equipment and Procedure. Obtaining

ROBERT G. MIDDLETON
SIMPSON ELECTRIC CO.

• Field engineering activity soon discloses that the best intentions of the instrument manufacturer are sometimes defeated, and that a sweep-alignment job, may not be satisfactorily completed, because the operator does not have a working knowledge of the test arrangement.

This lack of working knowledge is due to several factors, chief among which is the instruction manual which accompanies the equipment, and the practical utility of supplementary instruction now generally provided at service meetings and in trade-magazine articles. However, improvement and progress are being made constantly in these projects.

Certainly, no conscientious test-equipment manufacturer chooses to ignore this situation, and force the instrument user to fend for himself. In matter of fact, the larger equipment manufacturers set aside respectable budgets, and devote considerable time to provide the application data which the instrument user requires in his work.

Queries sometimes arise concerning horizontal deflection of the scope utilized in sweep-alignment work. At the outset, it should be recognized that 60-cycle sawtooth deflection voltage is *not* used to any appreciable extent today in sweep-alignment work. Phasable 60-cycle sine-wave deflection voltage is now utilized almost universally, for two reasons:

Fig. 1—Variable phase control.

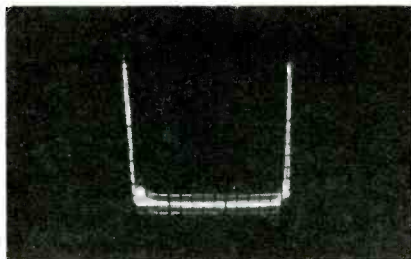
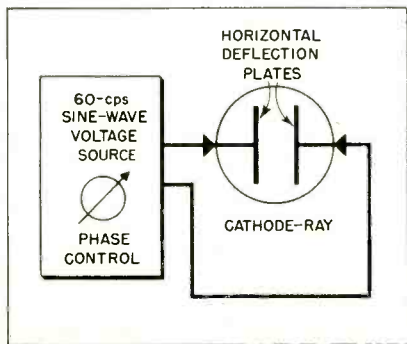

Fig. 2—Phase control misadjusted.

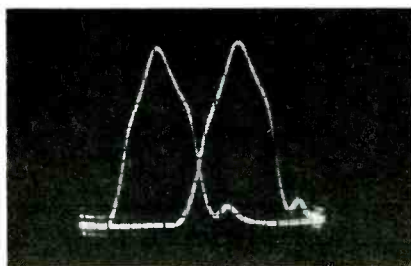

Fig. 3—Improved phase adjustment.

- 1) Improved stability of the pattern is realized, inasmuch as there is no synchronizing problem when 60-cycle sine-wave deflection is used.
- 2) Better control of the display results from independence of the horizontal control settings.

When sweeping wide-band circuits, better horizontal linearity is also noted in the pattern when 60-cycle sine-wave horizontal deflection is utilized, due to the fact that the high-frequency sweep modulator in the generator is also energized by a 60-cycle sine-wave source. The improved linearity of display is observed particularly at the ends of the pattern.

Fig. 1 shows the basic arrangement utilized for horizontal deflection of the scope beam in sweep-alignment applications. There is a possible source of confusion in this arrangement which should be carefully noted: the phasable sine-wave deflection voltage is usually provided in the sweep generator, instead of the scope—hence, a cable must be run from the horizontal-output connector of the generator to the horizontal-input terminals of the scope. This arrangement, of course, means

that the phasing of the pattern is accomplished by a control on the panel of the generator, instead of the scope. However, once the arrangement is brought to the operator's attention, no confusion results.

Phase Adjustment

It is helpful to observe the change which occurs in the display as the phase of the horizontal deflection voltage is varied. Fig. 2 shows an i-f response curve, with the phasing control far out of adjustment—the trace and retrace are widely separated and appear compressed to spikes at the ends of the display. This pattern can be brought to standard form by proper adjustment of the horizontal phasing control.

Fig. 3 shows the same display when the phasing control is adjusted to bring the phase of horizontal deflection nearer to the phase of the sweep signal voltage. Now the trace and retrace become recognizable as response curves. Trace and retrace are brought together and merged to form a single curve display by suit-

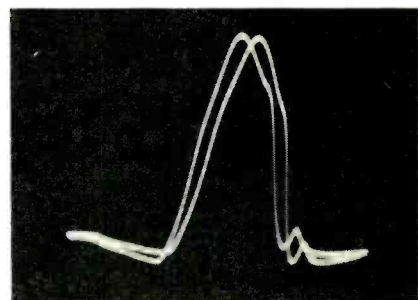
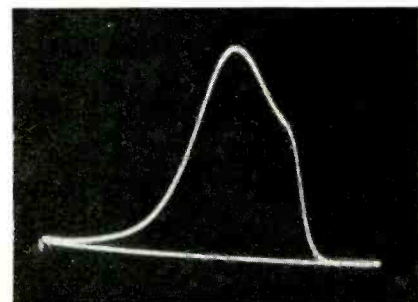

Fig. 4—Trace and retrace almost merged. Control close to proper setting.

Fig. 5—Retrace becomes reference line.



Sweep-Alignment Jobs

Zero-Volt Reference and Horizontal Deflection Adjustments.

able adjustment of the phasing control. Fig. 4 shows a trace and retrace almost merged.

Modern sweep generators are provided with a blanking control, which converts the return trace in such patterns into a zero-volt reference line. Fig. 5 shows an i-f response curve, in which trace and retrace have been merged by suitable adjustment of the horizontal phasing control, after which the blanking switch of the generator has been turned on, thereby converting the return trace into a zero-volt reference line.

It is desirable to eliminate the retrace from the pattern in some such manner, since minor distortions such as small hum voltages, circuit reactance, and residual inaccuracies in instrument characteristics, often cause trace and retrace to have slightly different shapes which are of no consequence in practical work, but which prevent identical layover of trace and retrace. This lack of complete identity in trace and retrace produces a double-image appearance in the pattern upon occasion, to which the operator may find

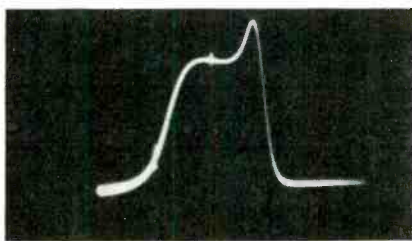

Fig. 6—Retrace blanked.

Fig. 7—Curve incompletely swept.

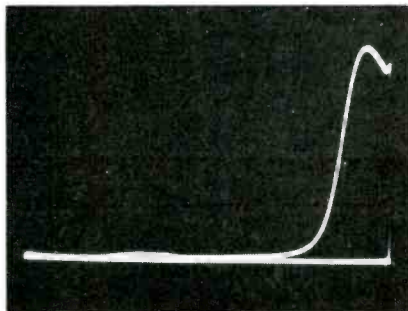
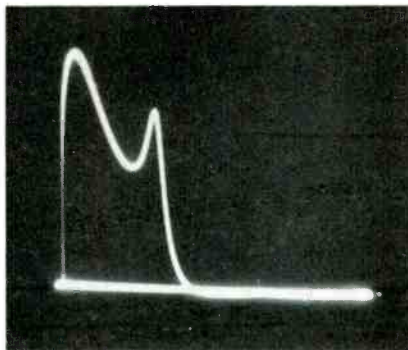
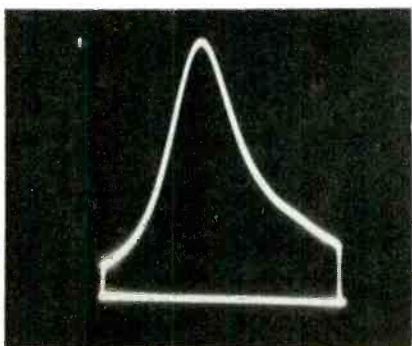

Fig. 8—Curve "walking" the base line.

objection—hence the need for retrace elimination.

Eight or ten years ago, the prevailing thought on the subject was to blank out the retrace by application of a suitable 60-cycle blanking voltage to the intensity-modulation post of the scope (Z axis), producing a clean single curve display as illustrated in Fig. 6.

Zero-volt Reference

While this technique is quite satisfactory for display of relatively narrow-band response curves, such as i-f patterns, there is something left to be desired when wide-band responses, such as r-f patterns are under observation. In such cases, the bandwidth of the circuit under test may exceed the sweep-width capabilities of the sweep generator, with the result that the curve is incompletely swept, as shown in Fig. 7.

Incomplete sweeping of the curve leaves the location of the actual base line (zero-volt level) in doubt, unless a zero-volt reference line is provided in the display. In Fig. 7, it

is observed that although the generator does not sweep the curve all the way down to the base line, the location of the base line is nevertheless explicit, since the return trace has been converted into a zero-volt reference line. The practical advantage of such indication is obvious.

Centering the Curve

Beginners sometimes make the mistake of trying to adjust the center frequency of the sweep generator with extreme accuracy to some specified frequency. This is an error, because the sweep generator provides an F.M. signal, which is *deviated* to either side of center frequency. When adjusting the sweep-generator tuning control the operator is not primarily concerned with the frequency indication on the tuning dial, but is concerned rather with the centering of the curve on the base line of the scope display.

Fig. 8 shows how a response curve "walks" from one end of the base line to the other end, as the sweep-generator tuning control is turned. The beginner's error is understandable, inasmuch as service manuals often specify a particular center frequency in setting the dial of the sweep generator. However, due to line-voltage waveform errors, differences in settings of the sweep-width control, and differences in instrument characteristics from one manufacturer to another, the technician soon learns to utilize the frequency indications on the sweep tuning dial *only as a guide*, and to

(Continued on page 53)

Fig. 9—Trap centered on base line.

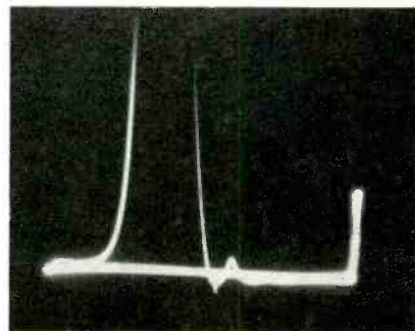



Build Customer Good Will

Itemize Your Bill to Preserve Your Profits

R. T. OELRICH

• Nobody buys service unless it is needed to restore or maintain the value of a set they have already bought and paid for. To most of the public, service is a negative value and they resent the fact that they require it. This resentment is what frequently causes set owners to be-

lieve they are being "gypped" even though they have received full value for their money. Because they are looking for an outlet for their resentment, they will often direct it toward the servicer, if he gives them the slightest reason for doing so. If a set owner voices his resentment, the service dealer has the opportunity of explaining the job in detail

to eliminate this resentment. But set owners who do not voice their resentment cannot be set straight verbally, because they don't ask for an explanation and to attempt to give one voluntarily, puts a dealer in a defensive position.

Service Ticket

The best practical way to acquaint the set owner with the technical details of the repair is by means of the service ticket or receipt, which tells a comprehensive story, itemizes, and describes the various elements of the repair job. The set owner will then have a much better idea of what his service dollars were paid for. People, in general, want to believe they are being treated fairly, but they do not place their confidence in anyone, unless they have a reason for doing so. If a dealer is highly recommended by someone whose opinion is respected, or if a dealer performs service in such a way that he conveys the fact that he is honest and capable, he will gain customer confidence and keep that customer coming to him as long as he continues to make a favorable impression. A clearly stated and itemized repair bill goes a long way to impress customers because it makes an accounting of the items charged for and recognizes that a customer is entitled to know what he is paying for. Incomplete, or poorly written or amateurish receipts, or no receipts at all, tend to give the impression that the dealer's technical skill is on a par with the quality of his receipt, or he is purposely being evasive by not supplying complete information on the repair job.

The need for explanation of service performed varies in ratio to the

29351

TV SERVICE SHOP REPORT

MAKE: _____ MODEL: _____ CONTRACT: _____

DEFECT TO BE CORRECTED: NO BRIGHTNESS NO PICTURE VERTICAL WHITE LINE

REPAIRED BY: HOME SHOP

FOR NO. _____ DATE _____ No. _____

SET OWNER: _____ SET PHONE: _____

ADDRESS: _____ CITY: _____ STATE: _____ ZIP: _____

ANTENNA: BUILT IN EXTERNAL

ESTIMATE: _____ BROUGHT BY: _____ DATE RECEIVED: _____

WARRANTY: _____

DETAIL OF CHARGES

CHARGE	PRICE
PARTS, TUBES, MATERIALS	
LABOR	
TAX	
TOTAL CHARGE	

MINOR SERVICE CHARGE \$ _____

MINOR SERVICE: Check and adjust the following controls:

FINAL INSPECTION:

DETAILS OF MAJOR LABOR

SET OWNER PLEASE NOTE: THE ABOVE CHARGES COVER THIS SPECIFIC REPAIR JOB ONLY. WE GUARANTEE ALL PARTS INSTALLED BY US FOR NINETY DAYS AFTER DATE OF REPAIR. BUT DO NOT GUARANTEE OR PRETEND TO GUARANTEE OTHER PARTS IN YOUR SET. IF NEW REPAIRS BECOME NECESSARY IN THE FUTURE THEY ARE SUBJECT TO OUR REGULAR RATES.

TELEVISION SERVICE ENGINEER SET TO PROPER WORKING CONDITION.

NOT RESPONSIBLE FOR SETS LEFT OVER THIRTY DAYS.

(Continued on page 52)

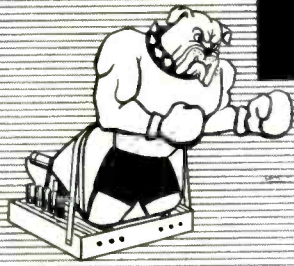

"Tough Dog"

Corner



Difficult Service Jobs Described by Readers

AGC Blocks

We recently had a repair job in the shop which had us baffled. It was a Sylvania model 1-533-1 chassis. It would produce a normal picture and sound for only 3 or 4 seconds during the warm-up period, and then block. The AGC voltage dropping to 20 or 30 volts negative. All the components in the AGC circuit checked normal. After much sweating and swearing, I decided to go over the rest of the set, looking for abnormal voltages. At the cathode of the 1st sound IF amplifier,

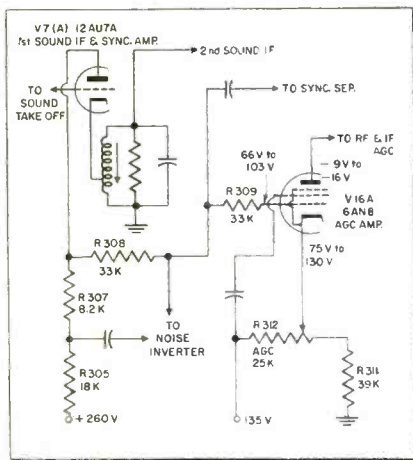

Sylvania model 1-533-1 chassis AGC circuit

a positive voltage was found. This stage is cathode loaded with a 4.5 mc tuned circuit. The coil was open at the ground end due to a poor solder joint. The open cathode circuit caused the tube to draw little or no current. The plate load resistor R307 also forms part or the plate load for the noise inverter tube. The AGC amplifier tube derives its grid voltage from this network and the plate of the noise inverter. With the sound IF amplifier drawing no current,

these voltages were above normal, resulting in excessive negative voltage in the AGC line. As these voltages are all subject to variation, depending on signal strength, a check of the voltages in the AGC and noise inverter circuits gave no clue as to the actual trouble. Resistance readings weren't of much help either. Who would think of looking for AGC trouble in the sound IF coil. *Felix Grumann, Laona, Wisconsin.*

Intermittent Sound & Picture

I was recently called in to service a GE 21C151, which had been in service for about a year. The complaint was that the picture and sound were normal for a time and then everything went out. I removed the back, plugged in my cheater cord, turned the set on and prepared to watch the results. The picture and sound came on normal, and played for about 10 minutes. Then the sound began to get weaker, and the picture started fading. The raster was now apparently normal with no sound and no picture. I said to myself that this was a simple case of an intermittent filament in the IF strip. While checking the filaments to see if everything was lit, I noticed the raster getting narrower and dimmer until it was gone. I began to think that a second fault had developed when the customer informed me that it had been doing this, and also would I check and see why the picture was snowy at times.

Since the filaments (in parallel) appeared normal, and it is a transformer chassis, with a 5U4 rectifier, I decided that my trouble was in the B+ supply. I changed the rectifier tube, tested all the tubes and turned the set on. The tubes all lit and the set played normal. It was probably fixed so I began packing my gear;

leaving the back off till the last minute, just in case. The sound and picture faded and pretty soon the raster narrowed and went out. My old trouble. I inspected all the filaments a little closer, hoping maybe I would catch one "winking." They all seemed to have the same brightness, but possibly a little dimmer than usual. The late afternoon sun was going down behind me so I overlooked this point. After all, how could anything be wrong with the filaments? They were all lit. I pulled the chassis and after connecting the appropriate extension cables and jumpers and finding the B+ voltages correct at the power supply, I proceeded to check the plate and screen voltages. I began in the IF strip and worked to the front end. The readings were pretty close to normal when the set was working. When it started to fade, the plate voltages began to increase to the full 140 volts of the divider. I checked the power supply again and finding it normal, began to reason why the tubes were not drawing any current. I couldn't blame the AGC because it wasn't involved in some of the points checked.

As I squatted there thinking, staring blankly at the filaments, something in the back of my mind kept saying check that d--- filament voltage. The 5 volt rectifier filament was heating correctly because the rectifier was functioning properly, and so was eliminated. I traced the 6.3 volt winding from the transformer and found that the filament return lead along with a couple of other grounds were pushed up through a sort of ferrule riveted to the chassis and apparently dip soldered from the top. With one probe of my multimeter connected to the

(Continued on page 52)

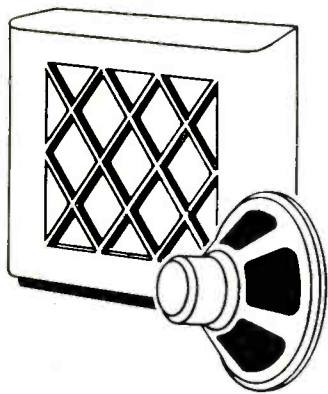

NORMAN H. CROWHURST

• The answer to this question cannot be given in terms of a simple number, .5% for example. Nor can it be answered by specifying either a harmonic or an intermodulation figure. The question that most people want to know is how the different degrees and kinds of distortion effect the sound so they will know what to listen for in an amplifier. The amount of distortion of any particular kind, that can be heard, depends entirely upon how it effects the program material.

HARMONIC DISTORTION

This is still the kind most commonly stated in amplifier specifications. Usually a single figure is given, for example, .5% at 25 watts. Occasionally figures are given for two different power levels, while some manufacturers do us really proud and give a complete curve of distortion as at Fig. 1. This last presentation is much more useful for making an engineering comparison of amplifier performance, but an engineering comparison does not tell us how the two amplifiers will compare on a listening test.

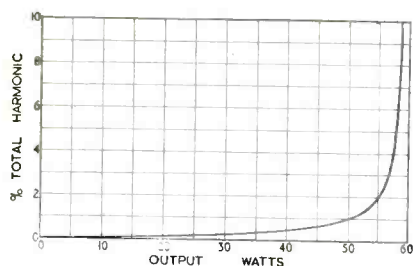

Fig. 1—Typical harmonic distortion curve.

One would assume that, if one amplifier had a curve that showed consistently less distortion than another amplifier's curve at all levels, the first one should sound the best, but even this conclusion is not necessarily true. The reason is that the kinds of distortion we hear do not bear any direct relationship to the kinds usually measured in engineer-

A Practical View of

What Distortion Can Be Heard? Distortion,



ing data. Not only do musical instruments generate their own harmonics but our ears have been proven to generate harmonics, particularly at higher levels. Another peculiarity of hearing is that the ears frequency response changes with intensity of sound. These two effects combined explain why the quality of reproduced sound changes as the gain control is adjusted. Amplifiers that keep distortion down to .5%—or even 5%—are not producing as much harmonic as that generated by the ear at high intensity, or as much as that generated by the individual instruments themselves. Consequently this amount of distortion will not be audible in itself. What can be heard, however, is when any amplifier is turned up to overload point, then it sounds loud, regardless whether it is producing 5 watts or 45 watts. This explains why some people do not consider an amplifier to be loud enough until they can hear distortion!

The fact that analysis on the basis of harmonics generated is rather uninformative, led to the specification of amplifier distortion in terms of intermodulation. Unless the distortion is very severe, it is not the effect on single tones that matters, the harmonics added will be insufficient to make the tone detectably different from the original.

INTERMODULATION DISTORTION

The difference that we notice much more readily is due to the effect produced by a distorting amplifier on a combination of tones. When two or more tones are reproduced through an amplifier with any distortion at all, they will generate spurious tones that are not harmonically related to either of the tones individually, but to the relationship between them.

This simple statement of fact is not new or very satisfying. What we really want to know is, what do the effects of intermodulation (IM) sound like? Different methods of testing, using different types of instruments, can give different figures for the same amplifier, so it is not surprising if a listening comparison should produce a different conclusion. *Four different ways of noticing intermodulation distortion* will be mentioned here. They are each due to a different combination of tones producing a spurious effect.

EFFECT NO. 1

The first type we shall consider is also the basis of one method of measuring IM distortion. When a relatively low frequency is played, the wave occupies a large amplitude, which will be accompanied with a certain amount of harmonic distortion. The harmonic distortion itself probably will not be noticeable for the reason already discussed. But the harmonic distortion is accompanied by a change of amplification. The higher frequencies present will be amplified by varying amounts during the low frequency wave.

This effect can very definitely be heard by listening. For example, the reproduction of organ music, where low frequency tones are reproduced at high level. Listen carefully to the reproduction of higher frequencies present at the same time as the very low tones. If intermodulation distortion is present, you will notice a definitely dithery (trembling, shivering or quivering) effect on the reproduction of the higher frequencies, as if the low frequency is at the same time modulating the higher frequencies. This is the most important reason why the lower frequencies should be distortion free. Low frequency distortion will have a tendency to modulate other frequencies.

This kind of distortion is measured by using a definite low frequency, such as 60 cycles, with a high frequency, such as 2000 cycles, in a specified ratio. Usually the low fre-

What Audio Distortion Matters

what it is, what to listen for & what to do about it.

quency is four times the amplitude of the higher one. The output from the amplifier under test is first passed through a high pass filter that removes the 60 cycles, leaving the 2000 cycles. This should not be modulated. If it is, it will be just like a modulated radio wave, with 1940 and 2060 cycles in addition to the original 2000 cycles. It can, like the radio wave, be detected, or demodulated, and filtered, to measure the 60 cycle modulation. An IM test set includes all the necessary filters to perform this operation, as well as the two tone sources.

One solution is to handle the low frequencies separately from the highs. In a loudspeaker system, use of a separate woofer prevents this modulation from occurring in the unit handling the middle and upper frequencies.

EFFECT NO. 2

The next form of IM, that is also fairly easy to spot, is the generation of a low tone by two higher tones. Suppose, for example, two tones are played having a frequency relationship of approximately 1.26 to 1. If IM distortion takes place, there will be, among other extra tones a frequency whose numerical value is the

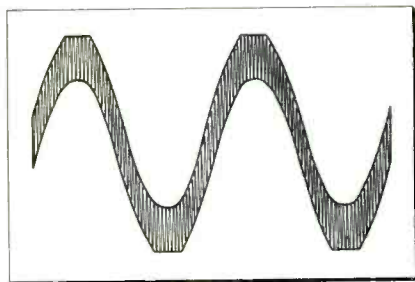

Fig. 2—High tone modulated by low tone.

difference between the two tones played. If the original two tones played are in the lower or middle part of the audio spectrum, it is doubtful whether the low tone generated will be even audible, but if the original tones are higher up in the spectrum, the interference tone will definitely become audible. These

spurious low tones tend to sound like low buzzing, or a general "muddiness."

Where this distortion occurs it cannot be cured by separating the offending frequencies, as with the first type, because they are too close together. The only thing to do is to start looking for the cause of distortion, such as non-linearity in the amplifier, pickup, loudspeaker, and eliminate it, either by suitable circuit adjustments, or by replacing the offending component.

EFFECT NO. 3

One that is considerably overlooked particularly in modern feedback amplifiers. This is due to the amplifier clipping on overload. An extraordinary thing, not generally realized, is that a very small percentage of clipping distortion, measured by conventional methods, is both audible and also visible on an oscilloscope screen.

The waveform shown in Fig. 2, represents an output from an amplifier using the first method of IM distortion test. However, the distortion does not take the form usually described in the theory generally related with this method of testing. It is a clipping; due to the fact that at a certain point in the excursion of the amplifier amplification abruptly ceases. The clipping is quite visible in the oscilloscope screen.

If the same amplifier were tested by harmonic measurement, it would also be equally visible as shown at Fig. 3 and likewise quite audible. Yet harmonic or intermodulation measurements of these waveforms will show up as a distortion figure well below 1%.

This is because the reading is averaged over the complete period of the signal and does not measure the extent of the clipping just at the point where it occurs. Unfortunately, however, our hearing presents a story very similar to the picture on the oscilloscope screen.

What we hear in this kind of reproduction is a sound like knocking,

as if the voice coil in the loudspeaker were hitting some kind of end stops. In a modern high damping amplifier this virtually is what is happening. The driving voltage abruptly reaches an "end stop" determined by the characteristics of the amplifier. Because the amplifier is equipped with a high damping factor, this flattening abruptly stops the movement of the voice coil as well.

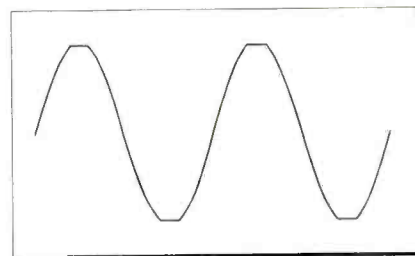

Fig. 3—Clipping distortion.

It becomes evident as a knocking sound identified with the lower frequency tone, but not a part of it. Modern amplifiers usually exhibit much more of this kind of distortion at maximum level than they do either of the other kinds. At levels below maximum, the distortion measured is principally of the kinds previously discussed. Where this effect is noticed, careful output measurements should be made, to see whether the amplifier is delivering its rated power. Best look at the output waveform, as at Fig. 3, to see when clipping commences. If the amplifier proves to be seriously below its rated output, start looking for wrong operating voltages and defective components.

EFFECT NO. 4

Even when the types so far discussed measure low, sometimes an amplifier will produce distortion that is quite audible on certain kinds of program material. This effect is particularly pronounced in some of the amplifiers that have been designed to have unnecessarily wide frequency response—say from 2 to 200,000 cycles.

(Continued on page 57)

Fig. 1—Blanking bar, sync pulse and video.

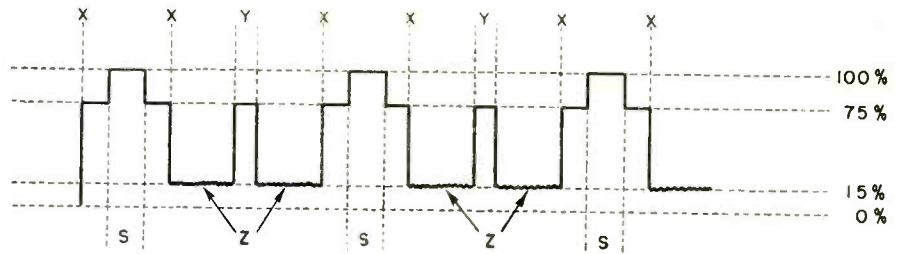

Make Blanking Bars Talk

Simplifies Trouble Shooting Procedure & Picture Adjustment

BOB ELDRIDGE

• The useful indications which are offered by the vertical and horizontal blanking bars, and the "blacker-than-black" pulses visible within them, if the controls are suitably adjusted, are often overlooked. The blanking bars can be used to good advantage not only for preliminary observations before actual troubleshooting, but also for setting up the receiver for correct operating conditions and therefore the best obtainable picture. Most viewers adjust their set with too high a contrast level, to produce a "nice black and white picture," and do not realize that by so doing not only is the detail in the shadow areas completely blacked out, and electrical interference and snow grossly exaggerated, but their eyes suffer from the sharply contrasted shades. The video amplifier tube is running full blast with little or no bias, and the crt is pumping out millions more electrons than is necessary. A mere cautionary, "keep the contrast down a bit," is not effective. Imagine what would happen if the traffic signs just said, "go slower" instead of "limit

25 m.p.h." A complicating factor is the fact that no amount of examination of the picture itself can give a true guide to the correctness of the contrast and brightness settings, unless the contrast values of the transmitted picture are known, as on a test pattern. When the contrast control is set to produce black at the darkest part of the picture, it is only correct if the transmitted picture contains blacks, which is by no means always the case. This is where the vertical blanking bar comes in.

Video Modulation

It can tell you and the viewer, when he has been suitably instructed, exactly how to set the contrast level irrespective of the contrast quality of the film being transmitted at the moment. Before we cover this point practically, let us digress into a little theory on picture modulation. Fig. 1, shows the amplitude modulation waveform of a signal consisting of a single thick black bar across the center of the screen. The higher the amplitude modulation the blacker the picture. The portion at Z is white, 15%

total amplitude, and Y is black, 75% of total amplitude. The region X-X is the vertical blanking bar, which is fixed at 75% of total amplitude. At S, the vertical sync pulse group, represents 100% modulation. The purpose of the vertical blanking bar is to make the picture tube face black during the short time needed for the spot to retrace before starting a new series of lines. If the picture tube is not completely blacked out at this time, the retrace lines may be visible. The blackness of the bar is governed by bias, brightness control setting, and the amplitude of the signal fed to the crt, contrast control setting.

If the bias is increased, less signal voltage is necessary to cut off the tube and thereby produce black in the picture. So for each setting of the brightness control there is just one contrast control setting which will make the blanking bar "just" black.

Now to go back to practical cases. Adjust the vertical hold control to make the blanking bar visible. The picture can be rolling slowly or stationary, as long as the bar can be seen. If the sync pulse is visible, as

Fig. 2—Contrast control adjustment, too low.

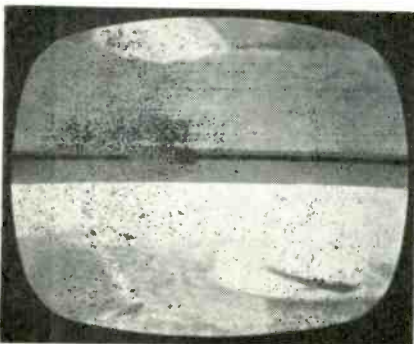

Fig. 3—Just black enough to obscure pulse.



Fig. 4—Ghosts or ringing are easily visible.

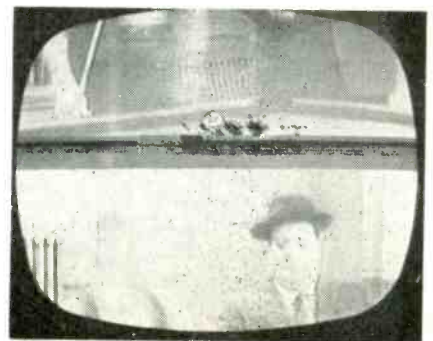



Fig. 5—Narrow blanking shows compression.

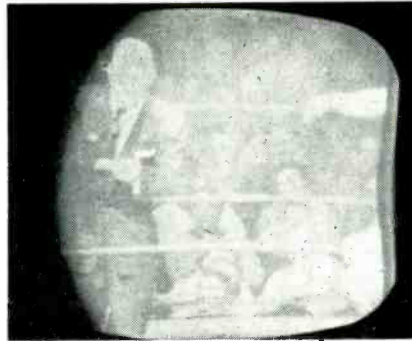

Fig. 6—Hum in picture, but not in raster.

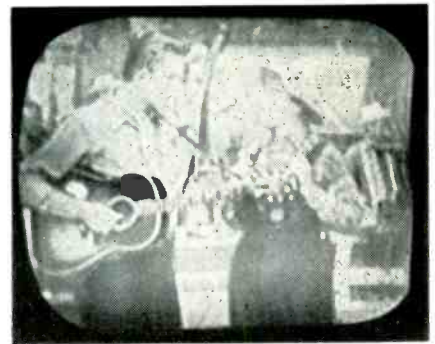

Fig. 7—Hum is in both picture and raster.

in Fig. 2, the bar is not dark enough for effective blanking, and the picture material will be "washed-out." To blacken the bar, turn the contrast UP, or the brightness DOWN, until the bar darkens just enough to obscure the pulse. In viewers' language, "just hide the little hammer." We now have a correct range of gray scale in the picture; but the overall brightness may be too high or too low. The important thing to note now is that in order to preserve this correct balance we must simultaneously turn both controls UP or DOWN, for a brighter or a dimmer picture.

Having produced a blanking bar

which is just black and no blacker, Fig. 3, the controls are set correctly and if there is no black in the picture itself, none is being sent at this moment.

The vertical pulse can also be used to good advantage for spotting ghosts. The transmitted picture material is often relatively fuzzy and usually in motion and of confusing make-up; making it difficult to determine whether there is ghosting on the signal or not, but in the gray peace and tranquility of the blanking bar, the ghosts of the blacker pulse (if they exist) can be counted at leisure, as in Fig. 4. If very severe ghosting is present, the "handle" of

the left "hammer" may apparently carry right on through into the head of the right one. In cases of intermittent uncontrollable rolling it is very effective to explain this effect to the customer, saying in effect, "If you see the handle smearing right through the gap between the hammers, you cannot expect the set to lock tightly, so if it rolls under those conditions it is the antenna which needs the loving care, not the set. Or move to a better location!" One person in particular who previously complained continuously that his set did not lock correctly, having now been thoroughly briefed (Continued on page 56)

1956 TV-Electronic Industry Statistics

TELEVISION

New sets	7,300,000
\$ volume at retail	\$1,241,000,000
Discount to dealer from list	26%
Sets scrapped	2,500,000

TELEVISION SETS IN USE

U.S. homes* with b & w sets	37,000,000
Secondary sets in above homes	3,800,000
Sets in business places, institutions	2,900,000
Color sets	200,000
Total TV sets in U.S.	43,900,000

RADIO

New sets	14,000,000
\$ volume at retail	\$495,000,000

RADIO SETS IN USE

U.S. homes* with sets	52,000,000
Secondary sets in above homes	4,200,000
Sets in business places, institutions	11,000,000
Automobile sets	38,100,000
Total radio sets in U.S.	145,300,000

* Includes all dwellings such as apartment hotels, etc.

ANNUAL RETAIL BILL FOR SERVICING

176,000,000 replacement receiving tubes	\$ 310,000,000
3,300,000 replacement picture tubes	\$ 130,000,000
Antennas, components, parts, instruments	\$ 695,000,000
Labor	\$ 960,000,000
Total servicing bill	\$2,100,000,000

TV-ELECTRONIC TECHNICIANS

Major service outlets	62,000
Parts jobber business accounted for	69%

Median weekly income	\$80
Average work week	50 hrs.

TUBES MANUFACTURED

Picture Tubes	
Number made	11,400,000
Total manufacturer value	\$231,000,000
% used for replacement	29.0%
Receiving Tubes	
Number made	475,000,000
Total manufacturer value	\$370,000,000
% used for replacement	37.1%

TELEVISION STATISTICS 1946-1956

Year	Sets Manufactured	Total Sets in Use	TV Stations on Air
1946	10,000	8,000	5
1947	250,000	230,000	20
1948	1,000,000	1,000,000	44
1949	3,000,000	3,800,000	100
1950	7,500,000	10,500,000	107
1951	5,600,000	15,750,000	108
1952	6,300,000	21,800,000	123
1953	7,300,000	28,000,000	350
1954	7,300,000	33,000,000	415
1955	7,800,000	39,000,000	465
1956	7,300,000	43,900,000	495

AUDIO

Phonographs sold	4,200,000
Phonographs \$ volume at retail	\$142,800,000
Phonographs in U.S.	32,400,000
Tape recorders sold	445,000
Tape recorder \$ volume at retail	\$ 82,100,000
Commercial audio equipment	\$ 60,000,000
Audio replacement components	\$ 14,000,000
Hi-Fi audio \$ volume	\$125,000,000

Suppressing Noise In Two-

Bonding, Shielding, and Bypassing to Eliminate

W. S. LOEB

HUNTSVILLE RADIO
MOTOROLA SERVICE STATION

• Although FM radios are considered to be static free, electrical noise generated in the vehicle equipped with FM two-way radio can affect reception. This "ignition noise," as it is commonly called, can be suppressed by various methods, depending upon the source of noise and the minimum signal strength received in the area in which the vehicles operate. In very few vehicles will satisfactory radio operation be obtained without some type of suppression. Many problems can be avoided by being careful in installing the radio equipment. A hurriedly made, haphazard installation invites trouble. A good installation is not only an excellent way of avoiding interference and eliminating trouble calls, but it will also create good customer relations.

Start by planning the location of every part before you even lift the drill and begin punching holes. Keep in mind the fact that the set and its accessories will require service from time to time. Mount fuse blocks, relays, etc., and route cables as far from the ignition wiring as

possible. Particular care should be given to the routing of the antenna transmission line. Keep the cabling out of the engine compartment as much as possible. When mounting the antenna, scrape the paint from around the hole so that a good ground connection is obtained. This precaution applies to the mounting of all parts—the set housing, control head, relays, junction boxes and cable shields. The need for good grounds cannot be over-emphasized.

In today's highly selective FM receivers, impulse noise from the ignition system can frequently be minimized during the alignment process by the following procedure: First, check overall receiver alignment to be sure that the set is operating at maximum sensitivity. Then install the set in the vehicle and allow it to warm up. Connect a VTVM or a special test set such as the Motorola P-8501-A test set to the grid of the first limiter stage in order to read relative sensitivity. Radiate a signal on the frequency of the receiver by means of a signal generator, another transmitter, or the Motorola test set equipped with the appropriate crystal. The signal should be just strong enough to produce receiver quieting. For this use, the signal generator has the advantages of producing a steadier

signal and having an attenuator. Then, with the engine running and the receiver volume turned up to a normal usable level, use an insulated alignment tool to adjust one or all of the first IF coils for minimum audible ignition noise. This should be a minor adjustment and should not decrease the meter reading by more than .5 microampere. Should there be any appreciable change in sensitivity at the null point, check receiver alignment completely.

The Ignition System

The ignition system itself is by far the greatest source of noise and is also the most troublesome because the noise it produces exhibits its greatest strength as a vertically polarized signal such as our present day communications systems use. Ignition noise is indicated by a regular popping sound which varies in frequency with engine speed and disappears when the ignition is switched off. A check for ignition noise should be made with the engine running and while receiving a weak signal, preferably one which causes not less than 10 db or more than 20 db noise quieting. In most vehicles, a carbon or wire wound suppressor in series with the high tension lead from the spark coil to the distributor will eliminate some of this noise. The suppressor should be mounted as close to the distributor as is possible. Should this step fail to eliminate the popping noise, suppressors should be tried on each spark plug, or plugs with built-in suppressors can be installed.

Shielding & Bonding

Other preventive measures succeed by shielding the ignition system. Bonding the hood with short pieces of flexible braid to the chassis ground is sometimes helpful. Similarly, bonding of the motor block, steering column and main body to the chassis ground may suppress or eliminate noise. Noise is sometimes caused by the low voltage breaker on the distributor. How-

Two-way radio provides latest road and traffic information, and emergency service.



Way Radio Equipped Vehicles

Electrical, Ignition and Static Discharge Interference.

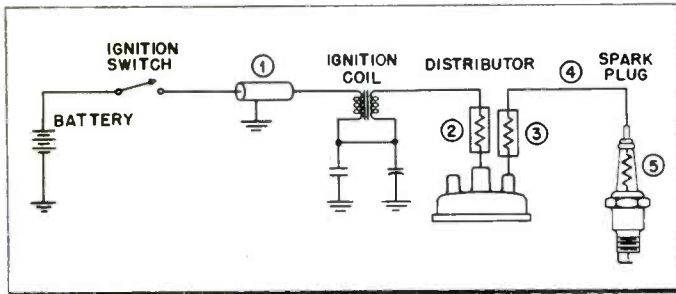

Ignition, and electrical-system noise-suppression remedies: 1. coaxial capacitor, .1 μf ; 2. resistor, 10,000 ohms; 3. resistor, 5,000 ohms;

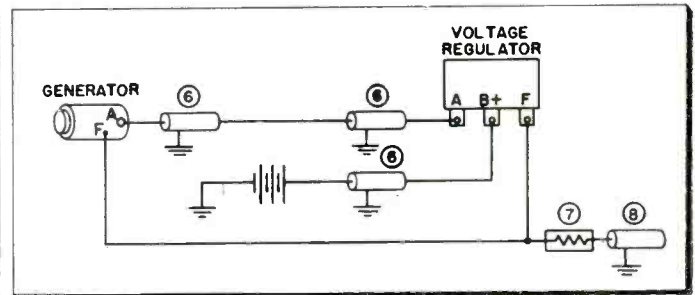

4. steel-wire ignition harness; 5. resistor spark plug; 6. coaxial capacitor, .5 μf ; 7. carbon resistor, 4 ohms; and 8. capacitor, .002 μf .

ever, consult the auto manufacturer's instruction book or a reliable mechanic before by-passing the breaker points with a condenser to be sure that this action will not be harmful. In extreme cases, it may be necessary to replace a Bakelite encased ignition coil with one in a metal container or use special ignition harnesses to eliminate noise.

The Charging System

Offenders in the charging system include the generator, regulator and ammeter. Generator noise is indicated by a steady grinding siren-like noise when the motor is running and the generator is charging. A .5 mfd. metal clad condenser with a mounting tab connected from the armature terminal to ground on the generator is often sufficient to correct this noise. Be sure that you do not connect the by-pass condenser to the field terminal or you will damage the voltage regulator. The armature terminal is usually the largest terminal on the generator. The wire from it can be traced to the voltage regulator terminal which is usually labeled "ARM." Do not determine which lug is the armature by shorting it to ground with the screwdriver. Some manufacturers even mark the field terminal with a red tag marked "Do not connect radio condenser to this terminal." If the commutator bars have high or pitted points, if the armature is unbalanced, or if the brushes are excessively worn causing excessive sparking, generator noise may be difficult to suppress. Dirty com-

mutator bars can be dressed with a piece of very fine sandpaper. Do not use a file or emerycloth, as the small particles may short out segments of the commutator.

A low-pass filter is often very helpful. One can be purchased or one can be made simply by using 15 turns of No. 10 enamelled wire in series with the generator armature lead and bypassed on each end with a .5 mfd condenser. Any form of an inch to an inch and a half in diameter that will stand the strain and stress of use in the car can be used as a foundation for the filter. The regulator may be bypassed at the armature terminal if necessary but not on any other except on competent advice. There are also cases where shielding the armature lead in its entirety has been found necessary but since this is quite a job it is best to avoid it if at all possible. The regulator itself is not often an offender but by no means overlook it in a stubborn case. Have a me-

chanic substitute another one and note the results.

There is no set procedure to follow in locating many of the noises encountered in the present day installation but a spark of any kind between metallic parts may be heard in the radio as noise. If there is a difference of potential between parts of the vehicle that are close to each other, a small spark is created when these parts touch due to vibration of the car. To avoid this sparking, the parts can be bonded together with a flexible wire or braid. Some of the most frequent sources of this type of noise are listed below: Muffler and Tail Pipe, Fenders, Brake Cables, Chrome Trimwork, Speedometer Cable, Hood Latch, Doors, Mud Guards, Choke and Throttle Cables, and Motor Block. The wheels are also a common offender. A special grounding spring is available which can be used inside the grease cup to ground the rotating wheel to the axle. Noise from the tires can be effectively suppressed by injecting a small amount of graphite powder in each tube. The gages on the instrument panel can be checked for noise by disconnecting them one at a time. A by-pass condenser will usually clear up any gage noise.

Satisfactory operation can be had in most vehicles without going to the extremes mentioned above. Usually a condenser on the generator and a suppressor on the distributor will be sufficient on most new cars; however, the older cars may need more attention due to wear and loosening of parts. •

Metal-clad condenser with a mounting tab.

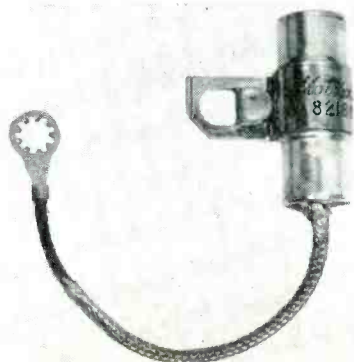

Improve the Vertical Response

Simple input circuit modification eliminates distortion.

WARREN J. SMITH

• A simple circuit modification can increase the versatility and usefulness of most moderately priced oscilloscopes.

The majority of such scopes on the market, including nearly all kits, employ a simple potentiometer attenuation circuit as a means of controlling vertical input signal level. Due to the presence of resistance and distributed capacitance, the simple potentiometer arrangement is frequency sensitive and adequate frequency response is usually obtained only when the gain control is advanced to some optimum setting.

Fig. 1 is an illustration of such an attenuation circuit. Distributed capacitance is to be found across the circuit as a whole and across that section which is delivering the signal voltage to the input circuit of the tube. Varying the position of the potentiometer arm along the resistance element changes the constants of the circuit, i.e., the resistance and capacitance. The result is frequency distortion that is introduced on both sides of an optimum setting somewhere between the maximum and zero signal positions of the gain control.

Frequency Distortion

The effects of such frequency distortion are shown in Fig. 2. These traces illustrate the performance of an oscilloscope using the simple

Fig. 1—Original vertical input circuit of author's scope. The simple potentiometer attenuator is frequency sensitive. See text.

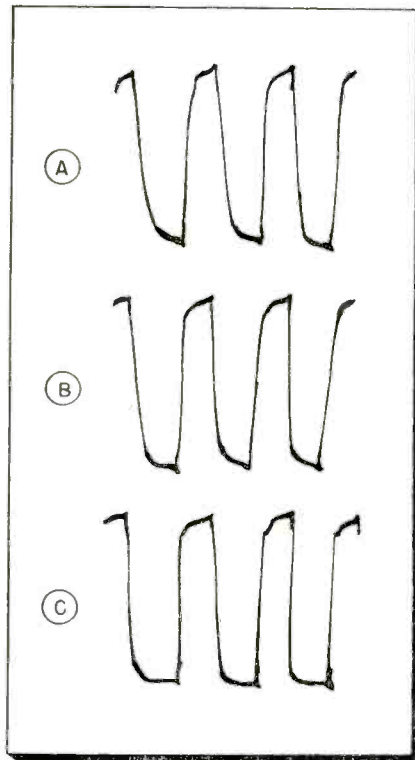
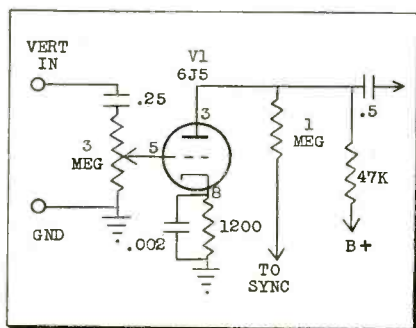

Fig. 2—Distortion of 20,000-cps square waves at various gain control settings; (A) shows the trace with near-zero gain, (B) at full gain, and (C) at the optimum position of the gain control.

potentiometer attenuation circuit shown in Fig. 1 when a 20,000-cps square wave was fed to the vertical input. Although it may be said that too much was expected of the scope because of its relatively limited frequency rating, the differences in pattern configuration using this high frequency best illustrates the manner in which the simple potentiometer attenuator affects the reproduction. Trace (A) was made with the gain control near its zero signal position; trace (B) with the gain control set at maximum; trace (C) with the gain control set at its optimum position, i.e., the setting which resulted in a trace that most closely resembled the square wave input signal.

Because the frequency discrimination described above is more frequently true of simple potentiometer attenuators of high resistance value

than those of low value, scope owners often attempt to improve the vertical response by lowering the potentiometer's resistance or substituting another control. This reduces the overall vertical gain and loads circuits under test excessively; such a change should not be considered if genuine improvement is the aim.

Modifying Input Stage

Fortunately, there is a fairly simple answer to the problem of poor frequency response in low-cost oscilloscopes. It lies in the fact that nearly all of these scopes use a triode as the vertical input amplifier stage. By modifying this input stage to receive a dual-triode, a cathode-follower with a frequency-compensated three-step attenuator in the input circuit and a continuously variable gain control in the output can be placed ahead of the first vertical amplifier. The need for step attenuation in addition to the continuous variation arises from a condition that must be satisfied and cannot be accomplished by means of a single potentiometer. The range of signal voltages encountered in oscillography is very broad, but smooth control over relatively small increments of signal level is required. This is not possible with a single control.

The modified version of the vertical input circuit illustrated in Fig. 1 is shown in Fig. 3. While the circuit is neither completely original nor unique, the advantages of adding the circuit to an existing scope are readily apparent, especially when Figs. 2 and 4 are compared. The compensated three-step attenuator presents a high impedance to the input, approximately 2.2-megohms—39- μ f., and the overall frequency response, regardless of the gain or attenuator control setting, depends entirely upon the limits imposed by the scope's original vertical circuits.

While the layout and wiring of the circuit is not too critical, the usual precautions concerning high frequency circuit construction should be observed. The components used

of Your Scope

Frequency compensated step attenuator

need not be of the instrument type, but they should all be of fairly close tolerance, say 5%. Mounting the attenuator and gain controls on the scope panel may be somewhat of a problem in itself since most scope panels are crowded to start with. The new gain control can easily be mounted in place of the original, but finding a mounting location for the attenuator may require considerable thought and maneuvering. In any case it should be located as close to the vertical input circuit as practicable, thereby reducing the possibility of stray or spurious pickup.

Attenuator Adjustment

Adjustment of the completed attenuator is fairly simple; the only equipment required is a square wave generator and polystyrene alignment tool. The generator is adjusted to give an output of 2,000 cps and the attenuator set to the "X 100" switch

Parts List for Input Circuit (Fig. 3)

- R1, R3, R5—3 megohms, 1/2 W
- R2—300 K ohms, 1/2 W
- R4—30 K ohms, 1/2 W
- R6—51 K ohms, 1 W
- R7—3 K ohm carbon, linear taper
- R8—3 K ohms, 1/2 W
- R9—1 megohm, 1/2 W
- R10—50 ohms, 1/2 W
- C1—.25 μ f, 600 V (in original circuit)
- C2, C4—2.8-50 μ f trimmer
- C3—100 μ f, 600 V ceramic
- C5—.001 μ f, 600 V ceramic
- C6—10 μ f, 450 V electrolytic
- C7—.005 μ f, 600 V ceramic
- C8—40 μ f, 150 V electrolytic
- C9—.47 μ f, 200 V
- V1—6SN7-GT
- S1—SP3T ceramic

Fig. 3—Modified input circuit. V1-b replaces the original triode; rewire accordingly.

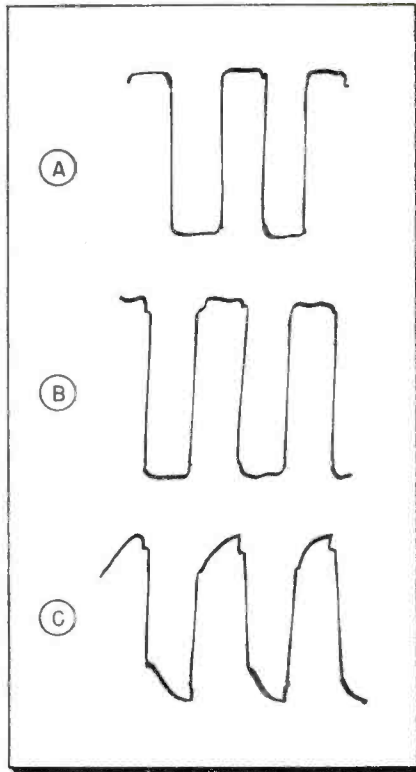
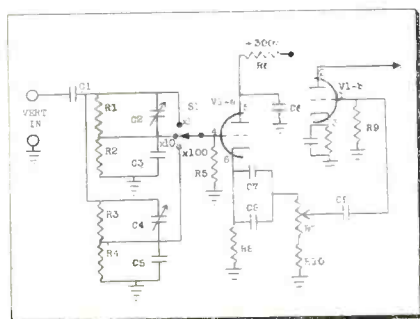

Fig. 4—The effects of attenuator adjustment; (A) the trace of a square wave fed directly to the deflection plates, (B) the trace of the same square wave when the attenuator is properly adjusted, and (C) the trace from an improperly adjusted attenuator.

step. The output of the square wave generator is applied to the vertical input of the scope and the trimmer C4 adjusted for a flat-top trace on the scope screen. The vertical gain is then reduced, the attenuator control set to the direct (XI) switch step and the trace observed. If the attenuator is properly adjusted, the trace resulting in this position will closely match, except for greater amplitude, the trace obtained on the "X 100" setting. See Fig. 4. The attenuator control is then switched to the "X 10" step and the procedure repeated.

The presence of compensation in the step attenuator is not meant to imply that all variations in circuit constants have been removed, but rather that a suitable compromise has been accomplished which mini-

(Continued on page 62)

Dynamic Demagnetizing of Tape Recorder Heads



JAMES A. McROBERTS

• Demagnetizing tape recorders with an ac operated demagnetizer is a routine chore if a demagnetizer is available. Shields must be removed from the heads to permit the demagnetizing flux to saturate the head's magnetic structure. Shield removal is time consuming and may be tricky in some recorders and a demagnetizer may not be handy.

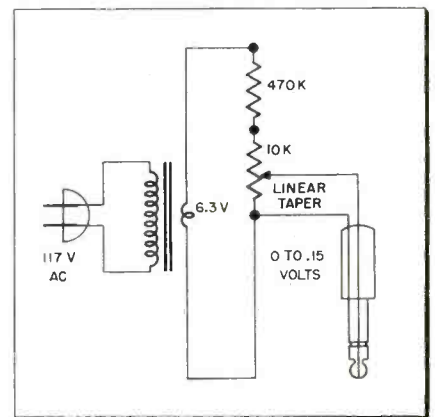

Fig. 1 Tape recorder head demagnetizer.

Many recorders employ a single head for both recording and playback. By proper application of a pure ac voltage to the coil, the head may be demagnetized without a demagnetizer. The most convenient place to apply such a voltage is at the microphone input jack. The recording amplifier delivers the ac demagnetizing voltage to the recording head coil.

The rig shown in the sketch comprises a resistor in series with a potentiometer forming a voltage divider network across the secondary of a 6.3-volt transformer. However, any convenient source of 6.3-volts ac may be used, such as a tube checker, or the heater supply of the recorder. The fixed resistor limits the voltage across the potentiometer

(Continued on page 60)

SHOP HINTS



Tips for Home and Bench Service by Readers

Cheater Cord

It wasn't until I had lost a half dozen cheater cords, by leaving them plugged into sockets, in customers living rooms, that I hit upon this idea. Take a standard 2 prong lamp adaptor, drill a 1/4" hole in the side, where there is a gap for the lamp center pin connection, cut the plug from the cheater cord and insert

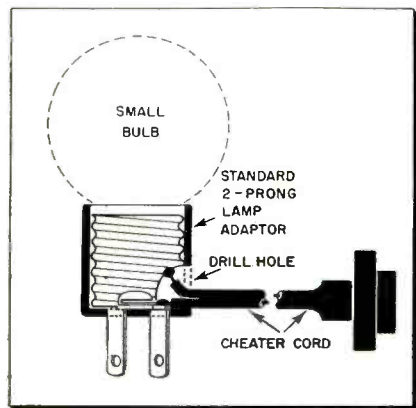

Cheater cord and line voltage indicator.

in the hole, solder one wire to the center and one to the screw part of the lamp holder. This gimmick acts as an indication as to whether the customers socket is OK, plus the fact that a light will always be noticed. I haven't lost a cheater cord since. *Lewis Holder, Sethbridge, Alta, Canada.*

Auxiliary Power Supply

An external power supply can often be used to track down leaks and short circuits in TV and radio B+ supply lines, especially when seleniums and fuses are used and are bound to "pop." Disconnect the B+ lead from the cathode of the rectifier and connect the auxiliary power supply, observing proper polarity. Note, just before connecting the external supply, with the load disconnected, it is possible to plug in the set to check the transformer or selenium rectifier and other primary circuit components. Having ascertained that the trouble exists elsewhere, then proceed. The voltage should be monitored. The safest way

to conduct this test without causing undue damage is to connect one lead at a time until an unusual voltage drop occurs. Tracing out the line that is causing this drop, will lead to the defective component. Since there is no filament voltage supplied, the tubes are not conducting. There are times when excessive voltage drop occurs across a power amplifier tube due to an upset in grid bias, or a shorted tube. Unfortunately this substitute power supply will not help in such a situation. However it is still worthwhile having. It can be constructed from "junk-box" parts. A professional looking piece of equipment, with meters, may be obtained from the test instrument manufacturers. *Clifford H. Goldstein, Jackson Heights, N.Y.*

Stripping Flat Transmission Line

All that is needed for a neat and efficient stripping job on flat transmission line, without nicking a few

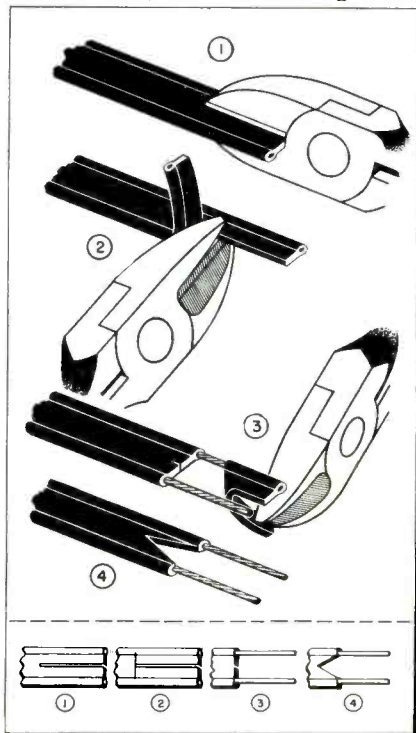

Diagonals used to strip transmission line.

strands of wire, is a pair of side-cutters. Cut the insulation down the center. At the end of the slot thus formed cut 2 right angles, one to the right, and one to the left, as close the wires as possible, without cutting into them. Grasp the tabs, thus formed, with the cutters, one at a time, and peel back towards the open end. Trim to shape. *Lewis Lounsbury, Stone Ridge, N. Y.*

Formula Shy

If you are in a hurry, and have no desire to fuss with the reciprocal of the sums of reciprocals, or the $R_1 \times R_2$ divided by $R_1 + R_2$ formula, to determine the size of a shunt resistor; paste this table on your resistor-bin.

1% 90	8% 11.5
1.5 66.7	9 10
2 50	10 9.1
2.5 40	15 5.6
3 33.3	20 4
4 26.5	25 3
5 20	30 2.33
6 15.6	40 1.5
7 13.3	50 1

Example: To parallel a 100 ohm resistor to arrive at 95 ohms, which is 5% less, multiply 100 by 20. This indicates that a 2000 ohm resistor should be used. *Maury Kerr, Redondo Beach, Calif.*

• Another reader has submitted the following item dealing with this same subject.—Ed.

For those technicians who want to feel safe and make use of the 2 resistors in parallel, formula here is another form of the $R_1 \times R_2$ divided by $R_1 + R_2$ rule. Let R_1 equal any resistor larger than the one desired and R_D equal to the desired resistance. R_x will be equal to the resistor needed to shunt R_1 in the following formula:

$$R_x = \frac{R_1 \times R_D}{R_1 - R_D}$$

E. W. Kesgen, E. Rutherford, N. J.

New Audio Products

Rye EARSETS

The earsets, are designed to fit each important make of transistor radio on the market. A special earset with a hearing-aid-quality magnetic receiver, non-toxic plastic earloop, cord and molded jack has been designed to fit each of the following type radios: Zenith, Regency, RCA, GE, Motorola, Westinghouse, Magnavox, Philco, Bulova, Roland, Raytheon-Admiral, Traveler, DeWald, Emerson, Revere, Sonora, Arvin and others. List is \$6.95. Rye Sound Corp., 21 Rye Road, Rye, N.Y. (ELECTRONIC TECHNICIAN 1-12)

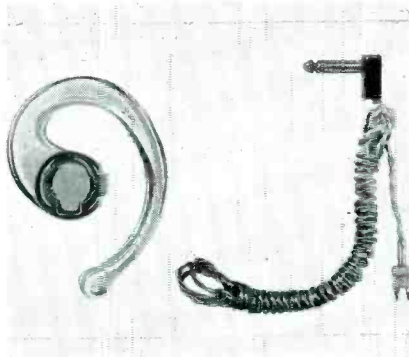

Kay AUDIOLATOR

A fully-transistorized beat frequency audio oscillator designed for field service, industrial, commercial and domestic hi-fi, and military applications. The Audiolator is powered by long-life mercury or penlight batteries. A single sweep of the dial covers the audio range of 50 cycles to 15 kc. Features constant output, built-in stability, no hum and flat output constant with frequency, within 1 db. Dimensions 6" x 2" x 3 3/4". Catalog No. 1000. Kay Electric Co., 14 Maple Ave., Pine Brook, N.J. (ELECTRONIC TECHNICIAN 1-8)

University POWRPAGE

The two models, Portable Powrpage, PP-1, and Pistolgrip Powrpage, PP-2, fill every practical application of outdoor and indoor soundcasting for self-contained equipment. Both models are powered by flashlight batteries, are extremely efficient and feature a built-in Powsaver switch which conserves battery current when full output is not needed, and also overcomes reverberation problems when used indoors. University Loudspeakers, Inc., 80 S. Kensico Ave., White Plains, N.Y. (ELECTRONIC TECHNICIAN 1-10)

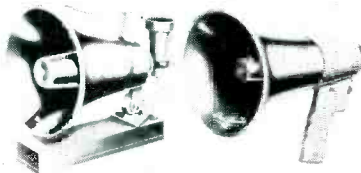

Ronette PHONO CARTRIDGE

New phonograph cartridge of advanced design features greatly simplified stylus replacement, without tools. Frequency response to over 20,000 cps, with less than 1% IM distortion, and with a greater compliance than heretofore known, is claimed. Ronette Acoustical Corp., 135 Front St., New York, N.Y. (ELECTRONIC TECHNICIAN 1-14)

Granco FM-AM TUNER

The new tuner is designed for use with phonographs, tape recorders, TV, and high-fidelity systems. It is easily connected to any of these instruments. The exclusive coaxial tuning assures drift-free reception. Features, built-in FM and AM antennas, 6 tubes, and a selenium rectifier. Frequency response is 20 to 15,000 cps. Model T-270, retails for \$54.95. Granco Products, Inc., Long Island City, N.Y. (ELECTRONIC TECHNICIAN 1-15)

Jensen TRANSFORMERS

The type ZC Constant-Voltage transformers are designed expressly for constant-voltage systems. They are engineered to draw a predetermined amount of power from a 70-volt line, and are equipped with a terminal board featuring a handy pin-jack adjustment. Heavy-duty screw terminals are provided for speaker and line connection. The transformers are impregnated for operation in outdoor and industrial atmospheres. Jensen Mfg. Co., 6601 S. Laramie Ave., Chicago, Ill. (ELECTRONIC TECHNICIAN 1-11)

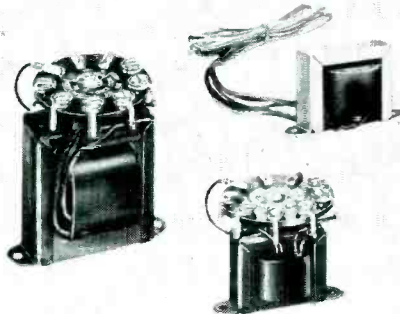

Ould TRANSISTORIZED P.A.

A new, self-powered, portable public address system with a fully transistorized 10-watt amplifier, complete with an 8" loudspeaker, batteries and press-to-talk microphone are housed in one portable case. There is nothing to hook up. The user simply flicks a switch, and speaks into the microphone. Tone and volume controls are provided, together with terminals for additional speakers. John Ould U.S.A. Ltd., 519 S. Fifth Ave., Mount Vernon, N.Y. (ELECTRONIC TECHNICIAN 1-16)

MF MICAMP

The completely transistorized Micamp, is a self-contained and self-powered miniature impedance-matching preamplifier. One mercury cell will last approximately 2,500 hours. Features, 30 db gain at an absolutely zero hum level, distortion is immeasurable at the average operating level, and the frequency response is 20 to 20,000 cycles within 1.5 db. The input impedance is 100 ohms and the output is 18,000 ohms. Madison Fielding Corp., 863 Madison St., Brooklyn, N.Y. (ELECTRONIC TECHNICIAN 1-13)



Tru-Sonic MICROPHONE

Actually a miniature FM transmitter, the unit is designed for high fidelity pickup in stage, nightclub, radio and TV, motion-picture, industrial and law-enforcement applications. The transmitter is slightly smaller than a package of cigarettes, weighs about 4 ounces, and is easily concealed. Stephens Tru-Sonic Inc., Culver City, Calif. (ELECTRONIC TECHNICIAN 1-17)

New Antennas & Accessories

Channel Master SHOWMAN →

The addition of a UHF dipole has extended the range of the new indoor antenna to all channels, 2-83. On UHF, the Showman operates as a folded dipole and reflector antenna, with the VHF elements functioning as parasitic reflectors. It is equipped with separate VHF and UHF leads, for direct connection to most all-channel sets. This saves the cost of filters. Performance claims on the model 3905 are supported by a full money-back guarantee. Channel Master Corp., Ellenville, N.Y. (ELECTRONIC TECHNICIAN 1-20)

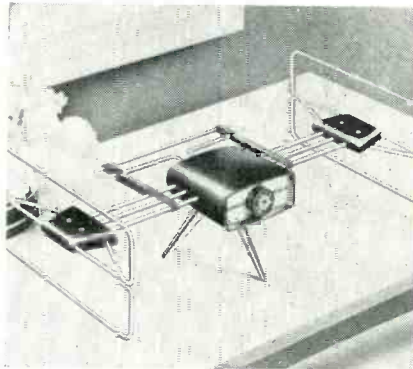

Brach HIDE-AWAY ANTENNA

The "TV Compact," is a smartly styled portable antenna, in a gleaming plastic case, has five-section triple-plated chrome elements which may be fully depressed into the antenna case. It has omnidirectional tuning and full frequency response. Model No. 5608S lists for \$6.95. Brach Mfg. Corp., 200 Central Ave., Newark, N.J. (ELECTRONIC TECHNICIAN 1-23)

Saxton TRANSMISSION LINE

300 ohm, 450 ohm, and a new 600 ohm, 2-inch spaced, open line transmission wire has hi-gain, and lo-loss. The latest addition is primarily intended for use in ham or community TV installations. It is made of 12 gauge hard-drawn Copperweld and is random spaced to avoid tuned-trap circuits. These lines transfer the maximum amount of energy from antenna to receiver; thereby improving reception. Available is 250 or 500 foot spools. Saxton Products, 1661 Boone Ave., New York, N.Y. (ELECTRONIC TECHNICIAN 1-22)

Starbeam PORTABLE ANTENNA

The antenna employs a new principle of eight-twisted aluminum elements arranged in a star pattern on each end of a 34", two-piece aluminum beam, and weighs only 9½ ounces. It is easily assembled or disassembled and may be used indoors and out. Suggested retail price is \$9.95. Starbeam Co., Box 5087, Waco, Texas. (ELECTRONIC TECHNICIAN 1-24)

Midwest INDOOR ANTENNA

The "Decor-Tenna" is fashioned in a gleaming black and gold ensemble, in a metallic floral arrangement. New rotary tuning eliminates ghosts and snow, and provides extra power on all channels, including UHF. Has minimized tuning, no switches, no knobs, etc., to adjust. Also available in black and silver. List price \$14.95. Midwest Naturlite Co., 6651 N. Clark St., Chicago, Ill. (ELECTRONIC TECHNICIAN 1-25)

Fretco TRANSMISSION LINE

A ready made heavy duty high frequency open wire transmission line, which up until now has been made up in the field, is now being made available in a variety of sizes to meet exacting impedance and capacitance requirements. Fretco Inc., 406 N. Craig St., Pittsburgh, Pa. (ELECTRONIC TECHNICIAN 1-26)

Trio GROUND MASTER →

A completely new idea in TV antennas, looks like an attractive aluminum trellis and is installed just as simply, however, it is in reality a powerful antenna that will give fine reception. The Ground-Master has the advantage over indoor antennas in that it is not affected by interference from metal sheathing, insulation, wire screens and appliances in the home. A special covering used on active elements makes it impervious to moisture and growing objects. 36" x 72". Trio Mfg. Co., Griggsville, Ill. (ELECTRONIC TECHNICIAN 1-21)

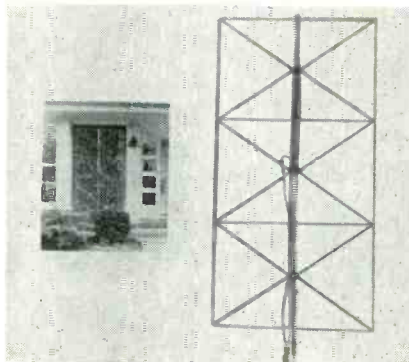

Winegard MINUTE MOUNT →

A new long-range, high-performing outdoor TV antenna is especially designed for both fringe and primary areas where reception is unsatisfactory. Complete package includes 10 foot aluminum tower, antenna with factory-attached lead-in and insulators, ground wire, ground rod, and lightning arrester. Opens like an umbrella, and mounts quickly on any roof angle from 0° to 45°. Features all-12-channel high sensitivity and the patented "Electro-Lens." Winegard Co., Burlington, Iowa. (ELECTRONIC TECHNICIAN 1-19)

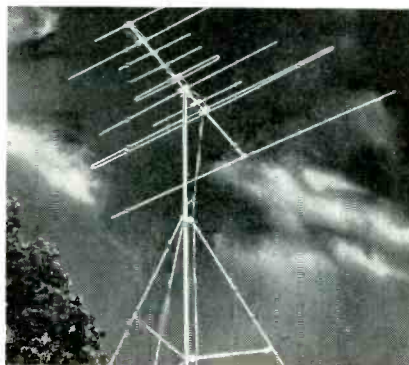

FOR MORE TECHNICAL INFORMATION ON NEW PRODUCTS OR BULLETINS

use this convenient coupon. Enter below the reference numbers for all items desired.

New Products Editor
ELECTRONIC TECHNICIAN
480 Lexington Ave.
New York 17, N. Y.

Please send me more information on the following items:

My company letterhead or business card is enclosed.

Name

Address

Firm My position

City State

Business address (if different from above)

New Tubes & Components

CD DISC-CERAMICS

Three new ceramic-disc capacitors, Types JA, JB, and JC, are designed for applications requiring minimum change in capacitance at any temperature within their operating ranges. They are insulated with phenolic and high-temperature wax vacuum impregnation. Insulation resistance characteristics is; initial, 30,000 megohms; after humidity, 5,000 megohms. Working voltage is 600-volts DC. They are ideal for printed wiring. Cornell-Dubilier Electric Corp., South Plainfield, N.J. (ELECTRONIC TECHNICIAN 1-41)

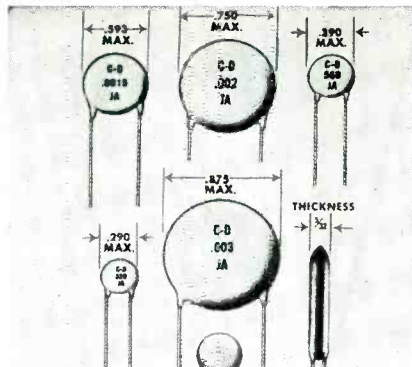

Rogers FLYBACK

Model EFG 137, is a new TV-flyback transformer. This unit is an exact replacement for Bendix Parts numbers NH265051-1, -2, and TSOHO5, as used in 26 different chassis and models. It is packaged in a hermetically sealed plastic container, which extends shelf life indefinitely and reduces failures by excluding moisture and dirt. Comes complete with mounting board, socket and associated components, less tube. Rogers Electronic Corp., 49 Bleeker St., New York 12, N.Y. (ELECTRONIC TECHNICIAN 1-43)

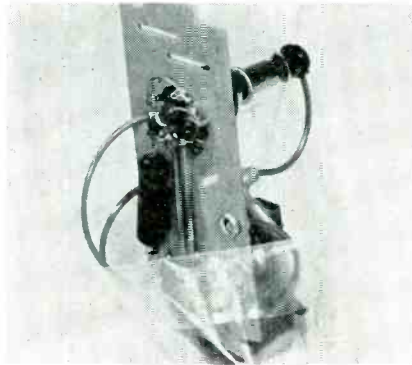

Mallory VIBRATOR

A completely new kind of vibrator construction is featured in the new Series 1600. The new design eliminates the usual button contacts. The vibrating reed and side arms themselves, made of special contact alloy, act as the contacting elements, and affords far greater contact area than previously possible. Life is increased by 50 to 100%. Sticking of contacts is eliminated, and wear is distributed over a larger surface. P. R. Mallory & Co., 3029 E. Washington St., Indianapolis, Indiana. (ELECTRONIC TECHNICIAN 1-30)

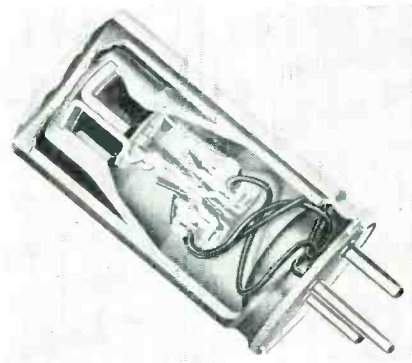

Pyramid PYRA-PAK KIT

A special Pyra-Pak kit contains an assortment of electrolytic capacitors. It consists of a combination of the most popular and frequently used electrolytic capacitors, both tubular and twist-mount; and are packed in a metal tool box; which, also contains a tool-kit, a TM Twist-Mount catalog, and an interchangeability guide. Parts and tools in one place save time. This kit was assembled after a nation-wide survey was made. Pyramid Electric Co., 1445 Hudson Blvd., Chicago, Ill. (ELECTRONIC TECHNICIAN 1-40)

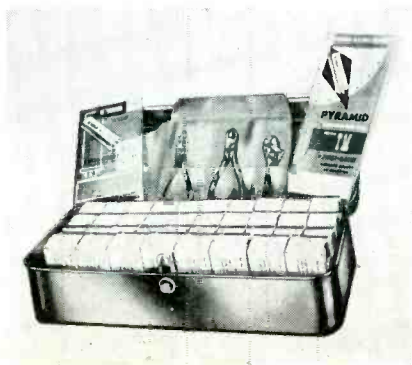

RCA TUBES

Fifteen new tubes having 450-ma, controlled warm-up heaters, have been announced. Except for heater design, they correspond electrically and mechanically to their prototypes. As follows: 4AU6, 4CB6, 4DT6, 5BQ7-A, 6AM8-A, 6AQ5-A, 6AT8-A, 6CG8-A, 6U8-A, 8AW8-A, 8CG7, 8CM7, 17AX4-GT, 17BQ6-GTB, and 17DQ6-A. Also announced were the following 9-pin miniature tubes: The 6CZ5, is a high-perveance beam-power amplifier; the 6CQ8, contains a medium- μ triode and a sharp-cutoff tetrode; the 6AW8-A, is a medium- μ triode, sharp-cutoff pentode. The 5725, is a 7-pin miniature, "Premium" sharp-cutoff pentode. The new 21CEP4, has a 110°-deflection angle and is approximately 5½" shorter than the 90°-deflection CRT. Features electrostatic-focus and magnetic deflection; ion-trap is not required. RCA Tube Division, Harrison, N.J. (ELECTRONIC TECHNICIAN 1-50)

GE GERMANIUM RECTIFIERS

A new line of germanium rectifiers specifically designed for TV-set power supplies, priced competitively with other types of dry rectifiers, is comprised of three types designated as the 1N573, 1N575, and 1N581. The 1N573 and 1N575 are half-wave units and are designed for 250 ma, and 350 ma DC output, respectively. Type 1N581 consists of two germanium rectifiers connected in a voltage-doubler configuration and has a DC output rating of 250 ma. The voltage drop for the 1N573 and 1N581 is rated at 0.15 volts maximum, and 0.30 for the 1N575. General Electric Co., Syracuse, N.Y. (ELECTRONIC TECHNICIAN 1-51)

CAPACITORS

New miniaturized ceramic capacitors make replacements much easier on crowded transistorized chassis. Small as they are, the new capacitors are just as tough and dependable in bypass and coupling applications as conventional styles. Available in the five most popular values of capacitance from .005 to .1 μ fd, rated at 50-volts DC. Sprague Products Co., North Adams, Mass., (ELECTRONIC TECHNICIAN 1-52)

Clarostat RESISTORS

Square-body Greenohm Jr., miniature power resistors, Series C7GL, and C10GL, have been announced. Axial pigtail leads provide connections and also support for the resistor in point-to-point wiring. Available in 7-watt, and 10-watt, to 11,000 ohms. Clarostat Mfg., Inc., Dover, N.H. (ELECTRONIC TECHNICIAN 1-42)

Latest Test Instruments

Hickok AM Generator →

New AM generator features high speed and low cost for radio servicing. This equipment provides an accurate and very stable source of RF power for alignment of AM broadcast receivers. Five preset calibrated frequencies, is available; modulated or unmodulated, the output is variable from 2 to 200 microvolts. Audio output is 400 cps. If desired, crystal accuracy may be obtained. Model 290X, is priced under \$45.00. Hickok Electrical Instrument Co., 10550 Dupont Av., Cleveland, Ohio. (ELECTRONIC TECHNICIAN 1-1)

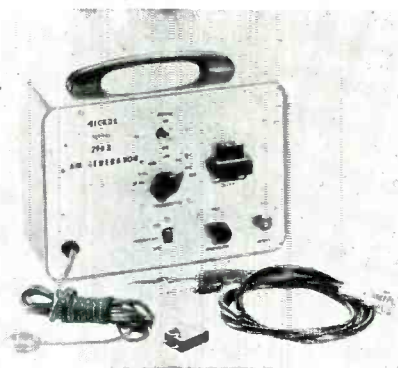

ASD PICTURE GENERATOR

Low priced, broadcast-quality test pattern and picture generator, model TV-10, generates a 525 line fully interlaced picture or test pattern with a usable frequency response of over 4½ megacycles. It contains a multiplier-type photo tube, with its high voltage power supply, video amplifier and high frequency compensator, and a modulator operating on the standard low band TV channels. This unit is the second half of a flying spot TV system. The first half of the system is any used 10" or 12" TV set. The price is \$64.50. American Scientific Development Co., 336 S. Main St., Ft. Atkinson, Wisconsin. (ELECTRONIC TECHNICIAN 1-5)

Jerrold SWEEP GENERATORS →

Two rugged, portable, wide-band sweep generators, designed for testing and aligning RF circuits in the frequency spectrum from 22 mc to 216 mc; contain an all-electronic sweep circuit, of the saturable reactor type. The RF output of both models is held constant by a highly effective AGC circuit. The sweep generators are used in production-line testing, laboratories, service shops, and in the field. Models 95, and 220, sell for \$375.00. Jerrold Electronics Corp., 23rd and Chestnut St., Phila., Pa. (ELECTRONIC TECHNICIAN 1-3)

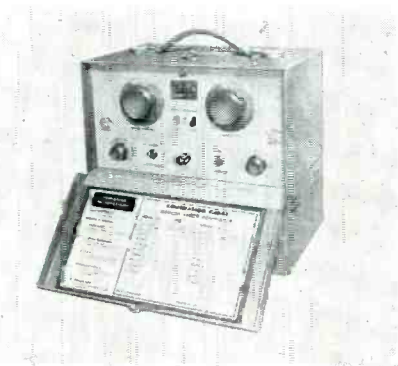

Telematic TELECHECK

New 1956 model of the Telecheck, is a CRT tube and yoke assembly permitting quick and accurate checks of CRT and yoke faults in the home or on the bench. It consists of an 8-AXP-4 tube, requiring no ion trap; a universal yoke, wired and fused to eliminate the possibility of damage to the set; service extension leads for the CRT anode, and yoke; a plastic mask and yoke support; and an attractive case. It is self-focusing. A deluxe model CR-118-S, includes a universal test speaker, for use on sets with or without a transformer. Telematic Industries Inc., 16 Howard Ave., Brooklyn, N.Y. (ELECTRONIC TECHNICIAN 1-6)

Seco TUBE TESTER →

A new portable tester provides all three of the most important vacuum tube checks; namely, grid-circuit test, dynamic mutual conductance test, and cathode emission test. Tedious set-up normally encountered in a dynamic check is eliminated, as test voltages are pre-wired to individual sockets. Only filament voltage and load setting is necessary. "Flip-chart" operates like a telephone index. Completely wired and tested. Model No. 107 is \$139.50 net. Seco Mfg. Co., Minneapolis, Minn. (ELECTRONIC TECHNICIAN 1-4)



Knight-Kit RF SWEEP GENERATOR

High accuracy and reliability at low cost. It is designed for use wherever coils or circuits must be accurately adjusted for resonance and proper bandpass. An electro-mechanical wobulator system is used to provide extreme sweep linearity. Frequency range is 300 kc to 250 mc on four fundamental ranges and sweep is fully variable from 0 to 13 mc on any frequency within this range. An AGC circuit keeps output voltage constant within 1 db. A built-in crystal-controlled marker accommodating any two crystals is included. Stock No. 83 YX 123, price is \$44.75. Allied Radio Corp., Chicago, Ill. (ELECTRONIC TECHNICIAN 1-7)

Heathkit CALIBRATOR →

A new voltage calibrator produces near-perfect square wave signals of known amplitude. Precision 1% attenuator resistors assure accurate output amplitude, and a multivibrator circuit guarantees good, sharp square waves, as distinguished from clipped-sine waves. Output frequency is approximately 1000 cps. The model VC-3 will also double as a square-wave generator for determining gain, frequency response, or phase-shift characteristics of amplifiers. Heath Co., Benton Harbor, Mich. (ELECTRONIC TECHNICIAN 1-2)



(CORRECTION)

INCORRECTLY NOTED IN THE DECEMBER ISSUE AS SELLING FOR \$49.95. SHOULD READ \$9.95. AS FOLLOWS:

Barjay CAPACITEST

Checks all types of capacitors and selenium rectifiers. The new compact series 11 capacitest, 4" x 4" x 2" with two test leads and instruction sells for \$9.95. Barjay Co., 145 W. 40th St., New York, N.Y. (ELECTRONIC TECHNICIAN 1-9)

EMPLOYMENT OPPORTUNITIES

for electronic technicians

For further information about employment openings advertised in this section, write directly to address noted in advertisement, or to:

Personnel Dept.
ELECTRONIC TECHNICIAN
480 Lexington Avenue
New York 17, N.Y.

Free Employment Service

for ELECTRONIC TECHNICIAN readers.

Starting soon, we will list announcements of readers who are seeking new jobs or the opportunity to buy a service business. There will be no charge for this service. Within the limits of space available, announcements will be published on a first-come first-served basis at the discretion of the Personnel Dept.

While names of technicians seeking positions will be withheld on request, we reserve the right to furnish such names to prospective employers; or in the case of someone seeking to buy a business, to such prospective sellers.

HOW TO OBTAIN YOUR FREE LISTING

Simply write to the Personnel Dept., ELECTRONIC TECHNICIAN, 480 Lexington Ave., New York 17, N.Y., briefly stating the following:

1. Your name, address and phone number.
2. Your experience and training, giving number of years.
3. Area in which you wish to locate. Will you relocate?
4. Optional: Salary requirements, age and marital status.

If you are interested, DO IT TODAY!

More information on next page.

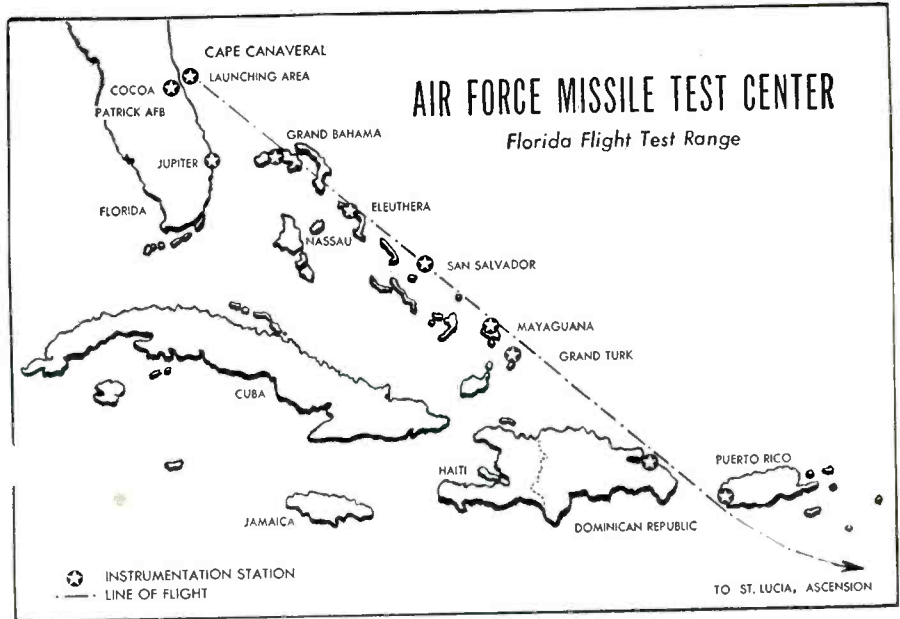

RCA

ANNOUNCES OPPORTUNITIES

In Guided Missile Test Instrumentation For Electronic Technicians

At the following locations

PATRICK AIR FORCE BASE, FLORIDA

Engineering development technicians
Radar
Communications
Test Equipment

CAPE CANAVERAL

Radar
Radio
Telemetry

Timing
Telephone
Optics

Enjoy pleasant Florida living and working at these locations.
Liberal company benefits. Relocation assistance.

INTERESTING DOWN-RANGE ASSIGNMENTS

Radar
Radio

Telemetry
Timing

Telephone
Optics

These positions are located on the Islands shown on the map above. Salary, 30% differential, meals and lodging furnished. Return to U.S. every 3 months.



For information and arrangements for personal interview, send complete resume to:

Mr. H. C. Laur
Technical Employment, Dept. N-35A
Missile Test Project
RCA Service Co., Inc.
P.O. Box 1226, Melbourne, Florida



RADIO CORPORATION of AMERICA

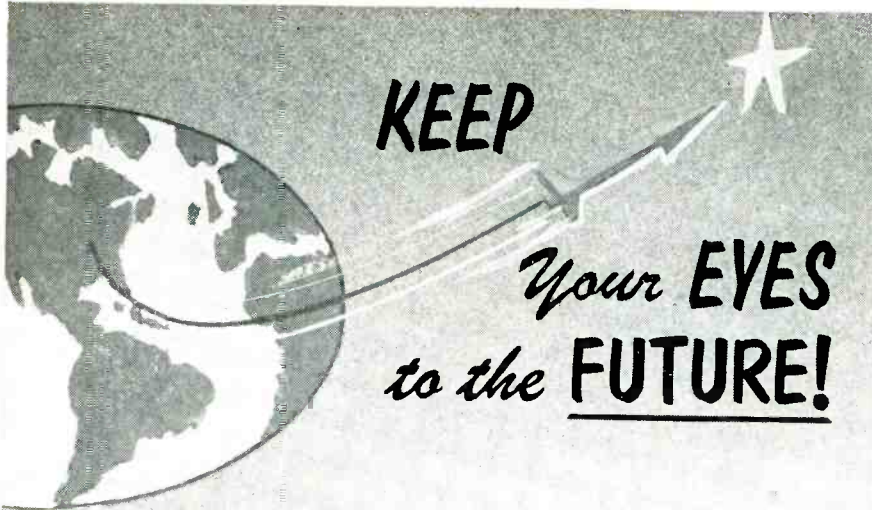

KEEP
Your EYES
to the FUTURE!

Do YOU Know

... the field of ELECTRONICS is the most advanced and fastest growing in the world, offering the largest range of jobs for technicians and engineers in history?

Do YOU Know

... PHILCO TechRep is the world's largest Field Service organization and because of this leadership can offer you—

- unlimited advancement
- opportunity to work any place in the world
- experience in the most advanced fields of electronics and guided missiles
- personal security, real challenge, top salary and compensation for your skills

Do YOU Know

- Philco electronic experts help prepare you for your TechRep Service career
- Philco's especially written Home Study Course keeps you posted on latest electronic techniques, including radar, guided missiles and transistors
- Philco provides financial assistance to continue your education

Do YOU Know

... Philco not only will help you select the position in Electronics best suited to you but can and will provide you with periodic reports as to the openings in our world-wide organization for which you may be qualified.

Get The FACTS About Your Future With Philco:

Send Now to Dept. 18A

for The Complete Story on What Makes The Philco TechRep Division —

"First In Employment Opportunities"
PHILCO TECHREP DIVISION
22nd & LEHIGH AVE., PHILADELPHIA 32, PA.

EMPLOYMENT OPPORTUNITIES

for electronic technicians

For further information about employment openings advertised in this section, write directly to address noted in advertisement, or to:

Personnel Dept.

ELECTRONIC TECHNICIAN

480 Lexington Avenue

New York 17, N.Y.

"Help Wanted" and "Business For Sale"

Service for

TV-Electronic Shops

Starting soon, special paid "Help Wanted" and "Business for Sale" sections will be started by ELECTRONIC TECHNICIAN to aid small shops in obtaining qualified personnel or selling their business. This section is not open to manufacturers.

Cost for an announcement in this section is 25¢ per word, with numbers and address words counted. Remittance must accompany insertion order.

Those service shops wishing to have a box number listing instead of including their names and address may have one assigned for an extra charge of \$2. All inquiries directed to such box numbers will be routed directly to the shop inserting the announcement.

If you are looking for technician personnel or a buyer for your business, write the announcement, add the cost at 25¢ per word (plus \$2 for box number, if any), and send payment along with announcement to:

Personnel Dept.

ELECTRONIC TECHNICIAN

480 Lexington Avenue

New York 17, N.Y.

New Products

B-T LIGHT COMPENSATOR

Widest range automatic light compensator (ALC) for TV cameras is now available. The all-electronic unit compensates for light variations as great as 150 to 1. Eliminates the need for manual or remote resetting of the TV-camera-lens iris or control generator.



With the ALC a constant, high-definition picture is assured regardless of any sharp or sudden changes in the light source. It is especially suited for use out of doors. Blonder-Tongue Laboratories, Inc., Westfield, N.J. (ELECTRONIC TECHNICIAN 1-31)

ATR BATTERY CHARGERS

Portable automobile plug-in type battery chargers for operation with 6 or 12-volt, storage-battery systems, in 4, 6, and 10 ampere capacities, are available. Rugged construction and long life are built into these units. Completely equipped with both the power-line cord



and the charging-line cord. Features easy charging by simply plugging into the cigarette-lighter receptacle, and the 117-volt, AC-house line. List prices as low as \$14.95. American Television & Radio Co., 300 E. 4th St., St. Paul, Minn. (ELECTRONIC TECHNICIAN 1-32)

More New Products on pp. 59, 61

NOW — for your protection...

ONLY ROGERS YOKES & FLYBACKS

**ARE HERMETICALLY SEALED
IN PLASTIC CONTAINERS!**

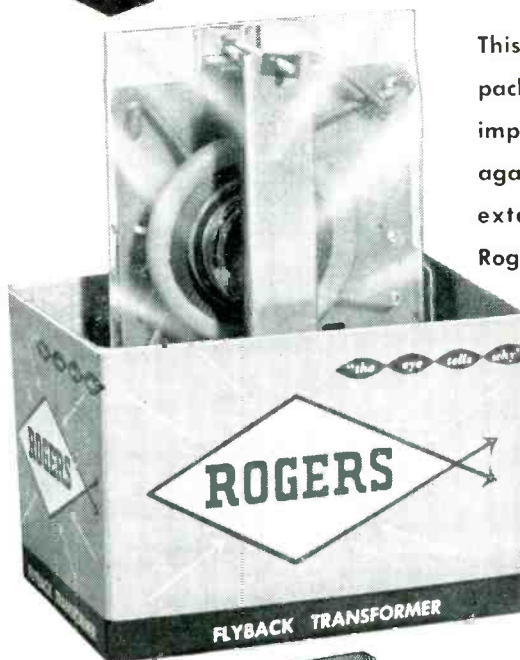

This exclusive moisture-free, dirt-free packaging... in addition to built-in impregnation and sealing... protects against failure, reduces callbacks and extends shelf-life indefinitely. It's Rogers for the complete line of high quality TV replacements!



Often called the "Bible for TV Replacements," the giant Rogers Exact Replacement Manual cross references over 11,000 sets and 7,000 parts! 71 pages, with supplemental inserts issued periodically to keep it up to date. It's free to TV Service Technicians from Rogers jobbers, or 75¢ from the manufacturer.

Write for name of your Rogers jobber



ROGERS ELECTRONIC CORP. 43-49 Bleeker Street
New York 12, N. Y.

SERVICE MEN KNOW THERE IS JUST ONE

HUSH

Reg. U.S. Pat. Off.

Chemically engineered for tuners and switching mechanism



Hush comes in a 6 oz. pressure can with sufficient pressure to reach all contacts to wash-away that dirt, leaving clean and positive contacts, protected with a lasting lubricant film.

\$2.25 net

Hush also available in 2 oz., 8 oz. and 32 oz. containers.

EVER-QUIET

Reg. U.S. Pat. Off. Pend.

Since 1949 the Original Volume Control and Contact Restorer

EVER-QUIET is a free-flowing liquid that leaves no powder residue. Scientifically designed to seep around the shaft and penetrate the control or potentiometer, cleaning the contacts and leaving a safe protecting film. Harmless to metals, wire or carbon. Will not affect inductance, capacitance or resistance.

2-Ounce Bottle with Handy Dispenser (32 oz. sizes available)

only 59c



See your distributor or write to

CHEMICAL ELECTRONIC ENGINEERING, INC. Matawan, New Jersey

BEST BUILT



YET

That's our claim—backed up by a solid majority of independent set makers who use them. Built to one standard of quality—Blue Chip Quality—Magic Mirror Aluminized Picture Tubes mirror twice the light to create a picture twice as bright. Tell your supplier you'd rather have Tung-Sol!

Blue Chip Quality

TUNG-SOL®

Magic Mirror Aluminized
PICTURE TUBES

TUNG-SOL ELECTRIC INC., Newark 4, N. J. Sales Offices: Atlanta, Ga., Columbus, Ohio, Culver City, Calif., Dallas, Tex., Denver, Colo., Detroit, Mich., Irvington, N. J., Melrose Park, Ill., Newark, N. J., Seattle, Wash.

RCA Service Flat-Rate Plan

• RCA Service Co., is experimenting with a flat-rate plan in a few limited areas. It is not generally advertised, but their customers are notified by direct mail and telephone contact. The basic charge of \$3.95 is for at-home diagnosis only, and does not include any repairs. This does not represent a cut in the overall pricing structure. Only occasionally is the bill less than \$6.95. It is an attempt to derive a practical pricing scale, and to let the customer know exactly what he is paying for by itemizing the actual work performed.

The accumulated charges resulting from this procedure may very easily exceed the Company's regular service tab of \$6.95. As an example, let us consider the case of a set suffering from loss of vertical sweep. The servicer was able to effect a quick repair by replacing two tubes, and adjusting the vertical height and linearity controls. The bill might read as follows:

Basic diagnosis	\$3.95
Install 2 tubes	\$2.00
Adjust vertical height & linearity controls .	\$2.00
<hr/>	
Total labor	\$7.95
Plus parts	2 tubes

In this case, assuming work was completed in less than ½ hour, the customer actually paid \$1.00 more than the regular \$6.95 call! It is too early to tell how this flat-rate pricing arrangement will be accepted by consumers.

It should be noted that various TV manufacturers have published similar flat-rate schedules in previous years. Reprinted below are two experimental "Standard Service Labor Rates" on RCA antennas and receivers. While these prices reflect current thinking, they are expected to be modified in the light of practical experience. •

STANDARD SERVICE LABOR RATES RCA ANTENNAS

Basic Charge	10 ft. height	\$ 3.50
	20 ft. height	7.00
	30 ft. height	7.00
Replace Lead In	10 ft. height	10.00
	20 ft. height	15.00
	30 ft. height	15.00
Replace Guy Wire	10 ft. height	12.00
	20 ft. height	15.00
	30 ft. height	15.00
Replace Antenna Single Bay	10 ft. height	10.00
	20 ft. height	15.00
	30 ft. height	15.00
Overhaul Antenna Complete Accessories	10 ft. height	15.00
	20 ft. height	20.00
	30 ft. height	20.00
Service Rotor	10 ft. height	15.00
	20 ft. height	15.00
	30 ft. height	20.00
Remove Antenna	10 ft. height	7.50
	20 ft. height	10.00
	30 ft. height	10.00
Reinstall Antenna	10 ft. height	10.00
	20 ft. height	15.00
	30 ft. height	20.00
Orient Antenna	10 ft. height	12.50
	20 ft. height	12.50
	30 ft. height	12.50
Two Set Coupler All Mast Sizes		10.00

(Continued in next column)

**Something new in
EMPLOYMENT OPPORTUNITIES!**

See pages 47 and 48

(RCA Service Flat-Rate Plan cont.)

NORTHEAST PHILA. BRANCH

STANDARD SERVICE LABOR RATES—RCA VICTOR TELEVISION RECEIVERS

BASIC CHARGE.....\$3.95

ADJUSTMENTS

Set up Syncrokod or Syncroguide Circuit.....	2.50
Rear Panel Adjustments (Single).....	1.50
Additional Adjustments (Each).....	.50
Adjust Ion Trap.....	1.50
All Adjustments (Special Job).....	6.00
Re-Set Kinescope.....	2.00
RF Unit Tracking and Adjustment.....	3.00
Remove Old Kine, Install New Kine and Adjust Set.....	13.75
Air Check.....	3.00
AGC Adjustment.....	1.50
Phono. Landing Adjustment.....	1.00
Phono. Cycling Adjustment.....	3.50

REPAIRS

Install Receiving Tube (includes rectifiers).....	1.50
Install Additional Receiving Tubes (ea.).....	.50
Resolder Picture Tube Socket Connections.....	1.70
Replace Resistor (ea.) (different circuits).....	1.40
Replace Additional Resistor in Same Circuit.....	.40
Replace Capacitor (ea.).....	1.40
Replace Transformer.....	4.00
Replace Power Transformer.....	6.50
Install Selenium Rectifier.....	4.00
Damper Modification (MP Line Only).....	4.00
Replace Tube Socket.....	6.00
Clean RF Unit Contacts (Home Job).....	2.00
Replace Detent Shaft.....	3.50
Replace Yoke where Wired In.....	5.00
Replace Yoke—Plug Type.....	3.00
Replace Fuse.....	1.40
Replace Pilot Light.....	1.00
Replace Tuning Cord.....	3.20
Install Hi-Pass Filter.....	2.50
Replace Printed Circuit.....	4.00
Repair Printed Circuit.....	7.00
Replace Speaker.....	3.50
Replace Coil.....	2.70
Replace Tuning Knobs (ea.).....	1.00
Replace Escutcheon Plate.....	1.00
Replace Tuning Control.....	4.50
Replace AC Interlock.....	4.00
Replace Fine Tuning Belt.....	1.00
Replace Crystal Detector.....	2.00
Replace Radio-Phono Switch.....	4.00
Replace Power Cord.....	3.00
Replace RF Unit.....	17.50
Replace Safety Glass.....	3.00
Replace Kinescope (No Adjustments).....	7.75
Clean Controls (ea.).....	1.00
Replace Sound Transformer and Align Sound Circuit.....	5.00
Install Adjacent Channel Trap.....	1.50
Clean & Lubricate Phono. Motor.....	3.00
Repair Phono. Pick-up.....	3.00
Circuit Modification Minor.....	2.50
Circuit Modification Major.....	4.50
Align Sound Transformer.....	1.00
Repair Loose Connectors on Converter (VHF Only).....	2.40

CIRCUIT ANALYSIS

Locate and Clear Short.....	4.50
Locate and Correct Arcing.....	2.70
Locate and Correct Loose Connection.....	6.40
Additional for Locating Intermittent or Defective Component.....	5.00
Complete Instrument Alignment (Shop Work).....	10.50

ACCESSORIES

Clean Kinescope and/or Safety Glass and Install Sealer.....	2.50
---	------

ADDITIONAL FOR SHOP WORK & DELIVERY.....7.50

Metal Whiskers Cause Short Circuits

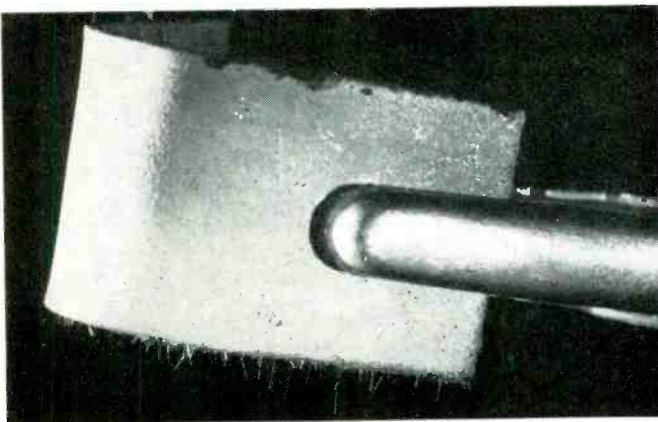

Whiskers which grew from tin-plated metal in a jar for three years at Bell Labs are type which cause telephone short circuits. Sample is 0.5" wide. Atomic radiation speeds up crystal whisker growing process.

**BEST
FOR**



**EVERY
SET**

All Tung-Sol radio, TV or Hi Fi tubes are engineered to one standard of quality—Blue Chip Quality. Whether they're for famous set makers or leading service dealers, Tung-Sol Tubes are identical in design and performance. Tell your supplier you'd rather have Tung-Sol!

Blue Chip Quality

**TUNG-SOL®
RECEIVING TUBES**

TUNG-SOL makes All-Glass Sealed Beam Lamps, Miniature Lamps Signal Flashers, Picture Tubes, Radio, TV and Special Purpose Electron Tubes and Semiconductor Products.

Customer Good Will

(Continued from page 32)

amount of money involved in the repair. The customer doesn't see the work done and must take the dealer's word that certain repairs were necessary and that these repairs were satisfactorily performed.

A service dealer can acquaint the customer with complete job details by presenting him with a comprehensive invoice that breaks the job down into its separate operations,

itemizing both parts and labor. Comprehensive forms designed for this purpose are available from most electronic parts jobbers at a very nominal cost.

Many service dealers have found that spending a few extra minutes to write up shop jobs on these types of forms has materially decreased price complaints, the need for lengthy explanations, and has markedly increased customer satisfaction. Remember, Mrs. Set Owner invariably has to justify the repair bill to her husband, (or vice versa) and a completely detailed service bill is a tremendous help to her in that respect.

No bill, an incomplete bill, or a poorly written bill, often leads to dissatisfaction, and results in a, "Next time let me handle it," situation. Mr. Set Owner is forced to call some other service dealer the next time service is needed in order to justify his griping on the previous job. Comprehensive shop forms also aid the dealer to do better work, because he is reminded of many minor parts as he checks them on the form, and he will have less tendency to overlook items, such as slipping dial cables, dirty dial windows, noisy controls, improper picture adjustment, etc. that could easily give the customer the impression that the work was sloppily done.

For some purely psychological reasons a printed form instills a feeling of confidence, and seeing spaces for additional charges, helps condition the customer to the fact that maybe that is the way it is supposed to be after all. Another very great advantage to be gained in itemizing a bill is that the customer who complains about the total price, which may seem very large to him, can be asked to pick on any single item in the bill which he thinks is not as it should be. This narrows the dispute down. If compromise is indicated, the bulk of the bill is still pretty much left intact. Everyone likes to feel that he is getting his money's worth, so let your customer know and appreciate the service you render by using comprehensive shop forms, so that he too can feel the pleasant glow of satisfaction, resulting from money well spent on a job well done. •

How to increase your income

- ▶ Two-way radio
- ▶ Microwave relay
- ▶ Home electronics
- ▶ Industrial electronics
- ▶ Radar

Find out how you can increase your monthly income by installing and maintaining the types of electronic devices listed above.

Anyone now in the radio-television servicing field can qualify. A Commercial FCC license will open the door to new profit areas . . . and the work is interesting.

Don't limit yourself to receiver servicing. Prepare yourself to handle the more profitable jobs in electronics. Fill out the coupon below and mail it TODAY. The information is free!



Cleveland Institute of Radio Electronics
Desk T4, 4900 Euclid Bldg., Cleveland 3, Ohio

Please rush the Free booklets to

Name

Address

City

Member National Home Study Council

"Tough Dog"

(Continued from page 33)

high side and the other probe on the chassis the voltage measured 4.6 volts. I checked the voltage across the winding by putting the probe directly to the wire going into the ferrule. It was 6.3 volts. The leads were well soldered in the ferrule, but there was 1.7 volt drop between the ferrule and the chassis. By soldering the ferrule to the chassis the trouble was eliminated and the customer has not complained since. Wilbur M. Parsons, Stockton, Calif.

• Many letters have been received describing this difficulty. Parsons letter had the earliest post date. Ed.

Something new in
EMPLOYMENT OPPORTUNITIES!

See pages 47 and 48

Sweep Alignment Jobs

(Continued from page 31)

make the final tuning adjustment of the sweep generator in such manner as to center the curve on the base line.

Actually, readjustment of the sweep tuning control is required during some alignment procedures. Consider, e.g., the problem of marking a trap. As shown in Fig. 9, the sweep generator is tuned to bring

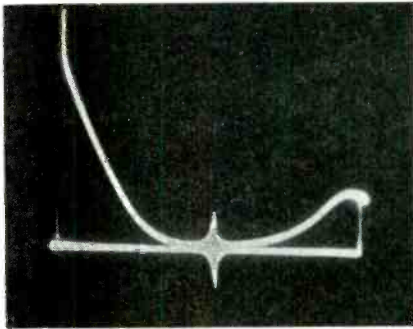

Fig. 10—Marker in trap.

the trap to center-screen. The sweep-width control is reduced in setting, the vertical-gain control of the scope is advanced, and the marker then becomes clearly visible in the trap, Fig. 10. If the sweep tuning control were not readjusted to a suitable center frequency in this procedure, the reduction in setting of the sweep-width control would throw the trap display off the end of the base line. •

Circuit Digests Index

Cumulative Index Addenda
beginning Dec. 1956

December, 1956

Circuit Digest No.

- CROSLLEY** 310
Chassis 489: Models BT-12M, BT-12MZ, BT-12BZ, BC-12M, BC-12MZ, BC-12BZ, BC-14M Chassis 490: Models BT-13M, BT-13B, BC-13M, BC-13B, BC-15M
- GENERAL ELECTRIC** 311
Chassis "ST" line: Models 21C133, 21C134, 21C135, 21C136, 21C140, 21C-141, 21C142
- MAGNAVOX** 314
Chassis 73 series: Models V/U73-01-AA, V/U73-02AA
- MOTOROLA** 312
Auto radio Model 79MS, Ford FEJ-18806-C

RCA-VICTOR 313

Transistorized portable Chassis RC-1156A: Model 8-BT-10K

WESTINGHOUSE 315

Chassis V-2311, V-2321, V-2370, V-2380: Models 14T170, 14T171, 14T172, 14TU170, 14TU171, 14TU172

January, 1957

Circuit Digest No.

ADMIRAL 316

COLOR TV Chassis 29Z1, 29Z1B, 29SZ1, 29SZ1B: Models C322C2, C322C2, C322C3, CS322C3, C322C16, CS322C16, C322C17, CS322C17, C322C26, CS322C26, C322C27, CS322C27, LC322C36, LCS322C36, LC322C37, LCS322C37, LC322C39, LCS322C39

BOGEN 317

High Fidelity AM-FM Tuner, Model R660

GENERAL ELECTRIC 321

Portable TV Chassis "MM" series: Models 17T025, 17T026

MOTOROLA 320

Chassis 539, 539Y series (TTS, TS, WTS, VTS prefix): Models 21C5, 21F6, 21K54, 56-63, 21T33, 35, 36; 24K14, 15; 24T6 (A, YA prefix)

OLYMPIC 318

Chassis CT, CU, CW, CX

PILOT 319

Audio Amplifier & Preamplifier Model AA-903B

DON'T PASS UP PRINTED CIRCUIT REPAIRS!

EVERYTHING YOU NEED IS IN THE...



PRINTED CIRCUIT REPAIR KIT

Now you can repair any printed circuits or printed circuit wiring. This kit contains silicone resin and solvent, pure silver print, solder and tools... plus the G-C Printed Circuit Service Manual. Used and recommended by leading set manufacturers. Ask for G-C No. 680.



ALWAYS USE THESE G-C CHEMICAL SERVICE AIDS!

G-C RADIO-TV SERVICE CEMENT No. 30-2	G-C PLI-O-BOND CEMENT No. 43-2	G-C RADIO SERVICE SOLVENT No. 31-2	G-C SPRU-KOAT ACRYLIC SPRAY No. 8665	G-C DE-OX-ID CONTACT CLEANER No. 19-1	G-C SPRU-KLEEN CLEANER-LUBRICANT No. 8666	G-C CREME-O-WAX POLISH No. 95-2	G-C SPRU-KOAT RUF-KOAT No. 60-12



GENERAL CEMENT MFG. CO.

Division of Textron Inc. • 400 South Wyman Street • Rockford, Illinois

Send 10c for Your G-C Printed Circuit Service Manual... PLUS G-C CATALOG

for service and lab. work

Heathkit PRINTED CIRCUIT OSCILLOSCOPE KIT FOR COLOR TV!

① Check the outstanding engineering design of this modern *printed circuit* Scope. Designed for color TV work, ideal for critical Laboratory applications. Frequency response essentially flat from 5 cycles to 5 Mc down only 1½ db at 3.58 Mc (TV color burst sync frequency). Down only 5 db at 5 Mc. New sweep generator 20-500,000 cycles, 5 times the range usually offered. Will sync wave form display up to 5 Mc and better. Printed circuit boards stabilize performance specifications and cut assembly time in half. Formerly available only in costly Lab type Scope. Features horizontal trace expansion for observation of pulse detail — retrace blanking amplifier — voltage regulated power supply — 3 step frequency compensated vertical input — low capacity nylon bushings on panel terminals — plus a host of other fine features. Combines peak performance and fine engineering features with low kit cost!



MODEL
0-10
\$6950
Shpg. Wt.
27 lbs.



MODEL
TS-4
\$4950
Shpg. Wt.
16 lbs.

Heathkit TV

SWEEP GENERATOR KIT ELECTRONIC SWEEP SYSTEM

② A new Heathkit sweep generator covering all frequencies encountered in TV service work (color or monochrome). FM frequencies too! 4 Mc — 220 Mc on fundamentals, harmonics up to 880 Mc. Smoothly controllable all-electronic sweep system. Nothing mechanical to vibrate or wear out. Crystal controlled 4.5 Mc fixed marker and separate variable marker 19-60 Mc on fundamentals and 57-180 Mc on calibrated harmonics. Plug-in crystal included. Blanking and phasing controls — automatic constant amplitude output circuit — efficient attenuation — maximum RF output well over .1 volt — vastly improved linearity. Easily your best buy in sweep generators.



Association News

L.I. Guild Nominations

To carry out a progressive platform of advanced ideas for advertising and publicity, for the general benefit of the Radio And Television Guild, nominations, to fill the executive positions during 1957, were accepted at the last business meeting. Since 1936, when it was first organized, the Guild has compiled an outstanding record of accomplishments within the electronics service industry. Highlighting this span of activity was the Electronics Fair conducted at the Farmingdale Agricultural and Technical Institute, December 6th to 8th. In its early stages of organization, the Guild met, in the shops of its members, to discuss mutual problems.

NATESA Files Charges

The National Alliance of Television Electronics Service Associations have filed charges with the Justice Department alleging unfair trade practices by various TV-set manufacturers in operating service branches offering extended parts warranties, etc. In an article in Retailing Daily, the Justice Department states that from time-to-time they have received complaints from individual firms about franchise agreements and factory service arrangements, but that up to now they have been unable to establish an industry-wide pattern. However the outline developed by NATESA, covering every facet of the general situation, was so complete and comprehensive that not only the Justice Department decided to go into the captive service deal, but the Senate Judiciary Subcommittee on Anti-Trust and monopoly and the Senate Small Business Committee are both considering a probe of the entire radio-TV industry.

TSDA Color Course

The Television Service Dealers Assn., of San Mateo County, California, report making arrangements with San Mateo College for a color-TV course, to be held twice a week from January to May. Dealers in neighboring counties have raised their rates to \$6.00, minimum, for a house service call. (As we had done in the past.) We have found the revised schedule of charges necessary to meet increasing costs of labor and of doing business.

SELENIUMS: Bulletin 237 describes flat selenium rectifiers which offer space saving advantages. Radio Receptor Co., Semiconductor Div., 240 Wythe Ave., Brooklyn, N.Y. (ELECTRONIC TECHNICIAN B1-20)

KITS: 56-page catalog, Heathkits for 1957, presents pictures and data on complete line of test instruments, hi-fi and ham equipment. Heath Co., Benton Harbor, Mich. (ELECTRONIC TECHNICIAN B1-21)

All From One Source

These four quality lines of Electronic Components may be obtained quickly and conveniently from Distributors who stock **ERIE RESISTOR CORPORATION** products.



ERIE Electronic Components enjoy the reputation of having the highest quality and make up the most complete line of Ceramic Replacement Capacitors. Distributor Stock items are representative of the most common types used by dealers, servicemen, experimenters, amateurs, laboratories, project engineers, and industrials.



CORNING Glass Electronic Components include the complete line of Fixed Glass Capacitors, Direct Traverse and Midget Rotary Glass Trimmer Capacitors, and various types of Low Power, Precision and High Power Glass Resistors.



ERIE-Chemelec Teflon Electronic Components are made of the most nearly perfect insulating material available, and are ideally suited to withstand high humidity, high or low temperatures, high altitudes, high voltages, and high frequency operation. It is serviceable at any temperature from -110° to 550°F for long periods with negligible change in critical electrical characteristics.



GRIGSBY-ALLISON Switches are known throughout the industry for dependable quality and smooth performance. They include a complete variety of styles for all types of applications.

ORDER NOW
From Your
ERIE
DISTRIBUTOR



ERIE ELECTRONICS DISTRIBUTOR DIVISION
ERIE RESISTOR CORPORATION
Main Offices: ERIE, PA.
Factories: ERIE, PA. • LONDON, ENGLAND • TRENTON, ONTARIO



ADELCO

Degaussing Coil

\$14.95
NET

The Adelco Degaussing Coil is for use in the degaussing of metal envelope color TV picture tubes. This unit is enclosed in a high impact plastic case with built-in slide switch.

ADVANCE ELECTRONICS CO.

8510 North End Avenue

Oak Park, Michigan

Your Best Business Builder

A TV Magazine of Your Own
At Surprisingly Low Cost



- with Your Name on the Cover
- with 3 pages of well-illustrated, hard-hitting TV sales & service advertising, and space for any special message of your own
- with Highlights of coming TV programs that keep magazine in home for 30 days
- with Double-Page Photo of a popular TV Star—ideal for scrapbooks

ALL EXCLUSIVELY YOUR OWN IN YOUR TERRITORY

*Send Your Name Now for Free Particulars
on this Powerful Business Builder!*

TV TREND, 4950-T Marine Drive, Chicago 40, Ill.

IMPORTANT NOTICE TO SUBSCRIBERS

Changes of address require four weeks' notice. Notify your Postmaster and ELECTRONIC TECHNICIAN Circulation Department, 480 Lexington Ave., New York 17, N.Y., at the earliest possible moment.

When ordering change, please INCLUDE IMPRINTED LABEL showing exactly how magazine is now addressed. This will enable us to put the change into effect with a minimum of delay.

YOU CAN REST EASY ...

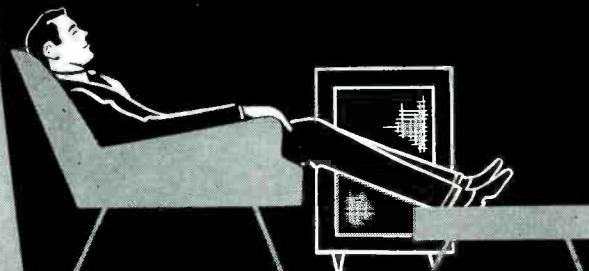

**WHEN YOU INSTALL
UTAH REPLACEMENT SPEAKERS**

Yes, you can rest easy whenever you install a Utah pre-tested replacement speaker, because you know your customer will be satisfied.

Every service man knows he must be sure that the replacement speaker he uses will perform superbly and reflect favorably on his reputation as a highly skilled technician.

The name Utah on a speaker signifies the finest quality in design, engineering, production and performance that money can buy.

You can rest easy when you install a Utah. Because of customer satisfaction—repeat sales are assured with Utah.

All leading jobbers handle Utah—because Utah has the widest line of speakers available to the trade—Utah is your one complete speaker source.

UTAH YOUR ONE COMPLETE SPEAKER SOURCE

**AUTO • REAR DECK KITS
STANDARD REPLACEMENT
TELEVISION • PUBLIC
ADDRESS • HIGH FIDELITY
OUTDOOR • INTER-COMM
WOOD AND METAL BAFFLES**

Get your FREE copy of the latest Utah Catalog S-156 listing over 100 replacement speakers.

Available at your distributors or from

RADIO PRODUCTS CORP.

HUNTINGTON, INDIANA

KESTER

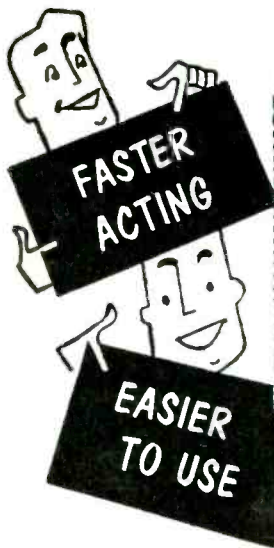

Absolutely non-corrosive and non-conductive, KESTER "RESIN-FIVE" CORE SOLDER contains an activated type of resin that gives you that fast, positive action on all your jobs . . . including the most difficult.



KESTER SOLDER COMPANY
4264 Wrightwood Avenue • Chicago 39, Illinois
Newark 5, New Jersey • Brantford, Canada



SOLDER

Make Blanking Bars Talk

(Continued from page 37)

on the technique of pulse watching, is apparently quite content, and we believe in our shop that he welcomes an occasional roll when he has company so that he can impart to his guests his newly found knowledge of electronics and propagation.

The relative blackness of the pulse compared to that of the bar is a guide to the presence or absence of compression or clipping in the tuner, I.F., or video stages of the receiver. A note of warning here though—if the picture tube is getting old, remember that its cut-off characteristic may be below par.

If the pulse is missing altogether, obviously there is severe clipping, and there is no future in digging around in the sync portions of the set.

Another use of the vertical bar is commonly known, but is included here for the sake of completeness. In the absence of a test pattern, the vertical linearity and height controls can be pretty well set up by observation of the bar as it rolls down the screen. If linearity is good, the bar should remain the same width all the way; if the picture is stretched at the top or bottom of the screen, the bar will be wider as it reaches that point in its travels. See Fig. 5.

The horizontal blanking bar is somewhat more limited in application, but there are two extremely useful ways in which it can be put to good use in servicing. Phasing the picture upon the raster. If the brightness and contrast controls are adjusted to produce a gray blanking bar, the picture can be phased by direct observation of the picture

Learn at Home to Fix Electric Appliances

Better Pay—More Opportunities

Get into a field where there is important work, good pay, a good future for the trained man. Today's automatic electric appliances need expert service. Up to 10 million are sold each year. Owners pay well to have them fixed properly.

A Way To Extra Money

This is your opportunity for a better job, extra earnings or a business of your own. Soon after starting you can earn many extra dollars fixing toasters, clocks, fans, vacuum cleaners, etc. for your neighbors, friends. Keep your job while learning. The record, reputation and 40 years experience of NRI back up this course. It's the training you need to learn Appliance Servicing at home in your spare time.

Tester Furnished

With this NRI course you get parts to build professional type Appliance Tester. It takes guess work out of servicing at home. Get started toward this profitable career now. Mail coupon for Sample Lesson and Book FREE. Address: Electric Appliance Training, NRI, Dept. E8A7, Washington 9, D. C.



MAIL—Lesson and Book—FREE

NATIONAL RADIO INSTITUTE

Dept. E8A7, Washington 9, D. C.
Send me Lesson and Book Free. No Salesman will call.

Name _____ Age _____
Address _____
City _____ Zone _____ State _____
My occupation or job title is _____
ACCREDITED MEMBER NATIONAL HOME STUDY COUNCIL



REPUTATION

is what you make it. It will be the "best-in-town" if you read CORNELL-DUBILIER'S pocket-size monthly magazine chock full of reputation building service aids. Mailed FREE to your home every month for the asking—just use the coupon below.

CORNELL-DUBILIER ELECTRIC CORP.
DEPT. RT-17, SOUTH PLAINFIELD, N. J.
OK! Send me "The Capacitor"—Free

Name _____ Please Print!
Address _____
City _____ Zone _____ State _____
My occupation or job title is _____



"I can't understand it. Business seems to have stopped."

tube. This is particularly applicable to sets with Synchroguide circuitry, and adjustment methods were covered in detail in an article in the July 1956 issue of "Electronic Technician." Determining whether 60 or 120 cycle hum is present in the picture or on the raster. If the picture is pushed off center, and the blanking bar is made visible it can easily be seen whether the whole raster is weaving, or whether the raster is straight but has a weaving picture displayed on it. Figs. 6 and 7. This observation will quickly rule out trouble in either the sweep department or the signal and sync sections. The vertical and horizontal blanking bars were not put there for the convenience of the technician, but we can sure use them to good advantage. •

Audio Distortion

(Continued from page 35)

Normal test signals are periodic—of sine, square, or other repetitious waveform, and symmetrical-negative-going excursions are identical with positive-going ones. But program material contains much that does not fall in this category, and this can sometimes cause distortion not found by regular tests.

For example, the clash of a cymbal may excite more than one supersonic transient in such an amplifier. But difference tones from the supersonic frequencies stimulated will be audible—and spoil the effect of the cymbal. It will lose its crispness and sound more like pieces of galvanized iron being clanked together.

Another example occurs with tones that are not symmetrical, such as a trumpet, or a plucked string bass. In this case the fault is subsonic. The amplifier is disturbed at a very low frequency—around 1 or 2 cycles, which is not itself audible, but produces "warbling" IM tones not evident on other program material or normal test methods.

Because of the very nature of these defects, they cannot be found by normal test methods—they show up by comparison between amplifiers. It is usually due to faulty design, so is beyond the scope of the average tech to remedy. The only thing to do is look for a better amplifier (not necessarily a more expensive one!)

The foregoing discussion has

(Continued on page 59)

The RADIO ENGINEERING SHOW

moves to the COLISEUM! MARCH 18-21 • NEW YORK CITY

SO BIG it takes all 4 floors of New York City's Coliseum to hold this year's great annual IRE Radio Engineering Show. For 4 phenomenal days the largest show ever assembled will open its doors to more than 41,000* engineers just 4 minutes from Times Square.

IS IT TOO BIG—not for a 12 billion dollar and still growing industry! More than 200 papers presented by 22 professional groups at the Convention's 55 technical sessions will summarize all that's new in radio-electronics research and development... the 834 exhibitors will also represent over 80% of the productive capacity of the industry. Not by a long shot is this show too big for what will soon be our nation's largest industry. Plan now to be at this vitally important radio-electronics show!

*41,017 engineers and businessmen from coast to coast and in every field of radio-electronics attended the 1956 Radio Show... the forecast for 1957 is even higher!

Registration:
IRE Members \$1.00
Non-Members \$3.00

OVER 800 NEW IDEAS
IN RADIO-ELECTRONICS
ENGINEERING
PRESENTED BY MORE THAN
800 EXHIBITORS!

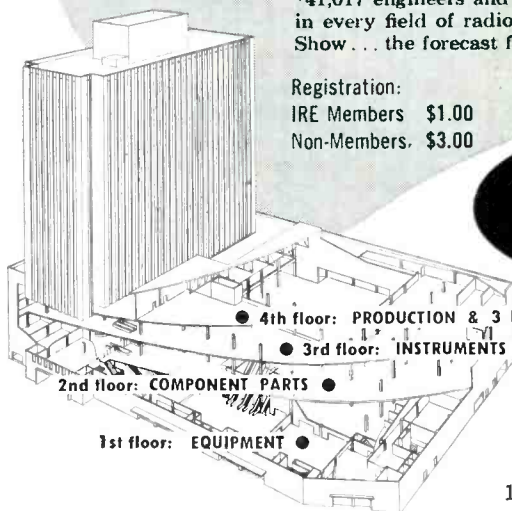

The
Institute of
Radio
Engineers

1 East 79th Street, New York 21, N. Y.

SAVE

TIME!
MONEY!
CUSTOMERS!

INCREASE

SALES!
PROFITS!
GOOD WILL!

DECREASE LOSSES... ERRORS... COMPLAINTS... with

OELRICH Business Forms & Sales Aids



DESIGNED SPECIFICALLY FOR RADIO-TV SERVICE

Twenty-Eight items that can earn extra profits, organize business FOR YOU while at the same time favorably impressing your customers and eliminating misunderstandings. You can't afford to be without them. Buy in small quantities at low cost. Ask your jobber about them today!

OVER 800 JOBBERS TO SERVE YOU!...

Our products are distributed coast to coast... look for our big red display unit on your jobber's sales floor. Solve many of your business problems by including our forms and sales aids in your business plans.

SEND FOR FREE CATALOG

OELRICH PUBLICATIONS
4308 N. MILWAUKEE AVE. • CHICAGO 41, ILL.
 PLEASE SEND FREE CATALOG

Name _____
Address _____
City _____ Zone _____ State _____

AMERICAN TELEVISION &
RADIO CO. ST. PAUL, MINN.

For those who
want the finest!



*Full Door Console
Receiving Sets*

UNSURPASSED
IN BEAUTY

UNEQUALLED
IN PERFORMANCE

UNMATCHED IN
QUALITY
CONSTRUCTION

exclusive
profitable
TV TECHNICIAN
franchises
now available

*designed
with the
Serviceman
in mind
... easy to
get at*

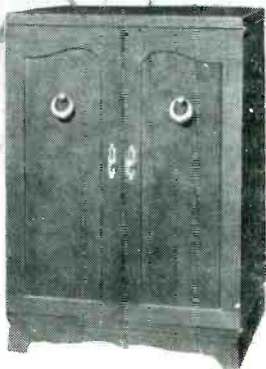

WRITE TODAY FOR COLORFUL
BROCHURE SHOWING THE
NEW LINE OF ATR TV SETS

ALSO MANUFACTURERS OF DC-AC INVERTERS,
"A" BATTERY ELIMINATORS, AUTO RADIO VIBRATORS

ATR AMERICAN TELEVISION & RADIO CO.
Quality Products Since 1931
SAINT PAUL 1, MINNESOTA-U.S.A.

(Continued from page 18)

MIKES & PICKUPS: Catalog 56 is a 12-page booklet of microphones, phono pickups and other audio components. Shure Bros., Inc., 222 Hartrey, Evanston, Ill. (ELECTRONIC TECHNICIAN B1-11)

CAPACITORS: 16-page electrolytic reference on type TM twist-mount capacitors provides working specs and prices. Pyramid Electric Co., 1445 Hudson Blvd., North Bergen, N.J. (ELECTRONIC TECHNICIAN B1-12)

SEMICONDUCTORS: Characteristics of over 80 transistors and diodes in this useful booklet. 5 pages of easy-reading type. Raytheon Mfg. Co., Receiving & CRT Operations, 55 Chapel St., Newton 58, Mass. (ELECTRONIC TECHNICIAN B1-13)

ELECTRONIC STUDY: "Your Future in the New World of Electronics" is title of 44-page booklet describing home courses in many advanced subjects such as radar, communications, broadcasting, computers and other opportunities for technicians. Capitol Radio Engineering Institute, 3224 16th St. NW, Washington 10, D.C. (ELECTRONIC TECHNICIAN B1-14)

APPLIANCE SERVICING: "How to Learn Servicing Electrical Appliances," a 30-plus page booklet specifically describing home study courses for repairing toasters, heaters, motors, mixers, vacuum cleaners, ranges, washing machines, etc. National Radio Institute, 16 & U Sts. NW, Washington 9, D.C. (ELECTRONIC TECHNICIAN B1-15)

ANTENNAS: Colorful literature on Colorceptor TV antenna, with range to 150 miles, "Minute Mount" antenna, and booklet on "Operation Team-Up" promotional program to aid technician sales. Winegard Co., 3000 Scotten Blvd., Burlington, Iowa. (ELECTRONIC TECHNICIAN B1-16)

DC SUPPLY: 4-page stuffer tells story of what is reportedly the first DC power supply designed to service transistor auto radios. For 12 and 6 volt systems. R. C. Crossley, Electro Products Labs., 4500 N. Ravenswood, Chicago 40, Ill. (ELECTRONIC TECHNICIAN B1-18)

TV TRANSFORMERS: Supplement sheet to Exact Replacement Manual cross references yoke, flyback, transformer and coil replacements for Bendix receivers. Rogers Electronic Corp., 49 Bleeker St., New York 12, N.Y. (ELECTRONIC TECHNICIAN B1-17)

CAPACITORS: Complete line of replacement capacitors, catalog C-455, is made up in wall-calendar style for easy technician reference. Free from Sprague distributors, or 10¢ from Sprague Products Co., 65 Marshall St., North Adams, Mass. (ELECTRONIC TECHNICIAN B1-19)

CONTROLS: Data sheet on wirewound controls and Radiohms cover 5-watt and 1/4-watt sizes respectively. Centralab Div., Globe Union Inc., 902 E. Keefe Ave., Milwaukee 1, Wis. (ELECTRONIC TECHNICIAN B1-22)

BEST BUY IN SCOPES



new!
Simpson
COLORSCOPE
MODEL 458

Compare the new Simpson Colorscope Model 458 with any oscilloscope on the market. It is an advanced, seven-inch, high-gain, wide-band scope especially designed for color-TV service. Ideal for black and white, too.

100% RESPONSE at 3.58 mc color-burst!

DUAL bandwidth—narrow or wide!
FLAT FREQUENCY RESPONSE, within 1 db to 4.5 mc!

RISE TIME less than 0.05 microsecond (wide band)!

FULL RANGE compensated vertical attenuator!

Price complete with shielded input cable and Operators' Manual.

\$229⁹⁵

Four accessory probes are available to provide the Simpson Colorscope with still greater utility.

See your distributor for details or write—

SIMPSON Electric Company

WORLD'S LARGEST MANUFACTURER
OF ELECTRONIC TEST EQUIPMENT

5200 W. Kinzie St., Chicago 44, Illinois
Phone: ESTebrook 9-1121

In Canada: Bach-Simpson Ltd., London, Ont.

**the modern serviceman
reads RIDER books
on theory and servicing
... his future depends on
electronic knowledge**

NEW BOOKS

**HOW TO INSTALL & SERVICE
INTERCOMMUNICATION SYSTEMS**

by Jack Darr

Covers the entire field of commercial intercommunication enabling the reader to install and service this equipment. Discusses basic amplifiers, special speakers, switching arrangements, a-c and a-c/d-c systems, wireless systems, cabling networks, all-call systems, paging systems, remote and master systems, one and 2-way intercom systems, home and industrial installation, outdoor wiring, system requirements for particular applications. Test equipment and tools needed for troubleshooting, numerous illustrations of test setups included. Design techniques covered. #189, soft cover, approx. 152 pp., \$3.00.

REPAIRING TELEVISION RECEIVERS

by Cyrus Glickstein

The most modern completely practical book, written by an expert in TV receiver repair. Devoted to troubleshooting and repair techniques that are modern, yet down-to-earth. Covers the use of simple as well as elaborate test equipment. Profusely illustrated. Not a theory book, it is a guide for every TV technician because it explains step-by-step procedures. #191, soft cover, 212 pp., \$4.40.

SERVICING TV AFC SYSTEMS

by John Russell, Jr.

Troubles in the AFC systems of TV receivers are difficult to diagnose and correct. This book discusses the trouble, location, and repair of the major types of AFC circuits used today... as well as some of the less common AFC systems the technician may encounter. The theory, waveforms, components, common faults, and their diagnosis in these systems are presented in a manner that affords the reader a thorough understanding of AFC circuits and their behavior. Supplemented by more than 75 illustrations, it makes it easy for the technician to locate and correct troubles. #192, soft cover, 128 pp., illus., \$2.70.

TV TUBE LOCATION & TROUBLE GUIDE (RCA)

by Rider Lab. Staff

This book shows the tube locations, key voltages, signal paths and common troubles in all RCA receivers produced between 1947 and 1956. #194, soft cover, 56 pp., \$1.25.

OBTAINING & INTERPRETING TEST SCOPE TRACES

by John F. Rider. #146, soft cover, 190 pp., \$2.40.

SERVICING TV VERTICAL & HORIZONTAL OUTPUT SYSTEMS

by Harry Thomas. #150, soft cover, 176 pp., \$2.40.

HANDBOOK OF 630-TYPE TV RECEIVERS

by Miller & Bierman. #174, soft cover, 200 pp., \$3.50.

PICTURE BOOK OF TV TROUBLES

by Rider Lab. Staff

Vol. 1: Horizontal AFC-Oscillator Circuits. #168, 80 pp., \$1.35.

Vol. 2: Vertical Sweep-Deflection Circuits. #168-2, 96 pp., \$1.80.

Vol. 3: Video I-F & Video Amplifier Circuits. #168-3, 96 pp., \$1.80.

Vol. 4: Automatic Gain Control Circuits. #168-4, 96 pp., \$1.80.

Vol. 5: Horizontal Output & H-V Circuits. #168-5, 108 pp., \$1.80.

Vol. 6: Horizontal & Vertical Sync Circuits. #168-6, 120 pp., \$1.80.

Vol. 7: Sound Circuits & L-V Power Supplies. #168-7, 64 pp., \$1.50.

TV REPAIR QUESTIONS & ANSWERS

by Sidney Platt

#173, Front Ends: 128 pp., \$2.10.

#173-2, Video Circuits: 128 pp., \$2.10.

#173-3, Sync & Sweep Circuits: 140 pp., \$2.10.

#173-4, Deflection & H-V Circuits: 128 pp., \$2.10.

#173-5, Sound & L-V Circuits: 120 pp., \$2.10.

These RIDER books and manuals and many others are available at your Parts Jobber—Look for the RIDER BOOKSELLER. If these RIDER books are not available, order direct by checking books desired in this ad. Add state and city taxes where applicable. Canadian prices 5% higher.

JOHN F. RIDER PUB., INC.
116 West 14th St., New York 11, N. Y.



(Continued from page 57)

shown that no form of specification, giving simple numbers or a simple graph can give an adequate picture of what the distortion will sound like. The answer to the question, "What distortion matters?" must finally be answered by listening to the equipment.

A further factor that was deliberately kept out of the discussion is that most measurements of the amplifier are made working into a resistance load—which is not listened to. A loudspeaker does not provide resistance termination for the amplifier, because it has a much more complex impedance. Comparative measurements indicate distortion figures are often higher than those in a resistance load. The currently available methods for measuring distortion are very valuable to engineers in producing better amplifiers, because they provide a method of comparison to see whether one circuit is inherently better than another. But as far as the final performance is concerned the final and best arbiter is the listening test. •

New Products

Califone SOUND SYSTEM

The "Commander," is a deluxe, powerful sound system with built-in performance, power, quality, and reliability. Features a high fidelity amplifier with an output of 25-watts undistorted, and 40-watts peak, frequency response within 2 db, from 30 to 20,000 cycles. Two heavy-duty speakers can handle the full 40 watts. A center-drive continuously-variable speed, cork-covered turntable having a range of 16 to 84 rpm with a strobe-selector control for exact setting of four speeds. Model 40V-7, is \$214.50 net. Califone Corp., 1041 N. Sycamore Ave., Hollywood, Calif. (ELECTRONIC TECHNICIAN 1-18)

Motorola CONELRAD MONITOR

The conelrad-monitor receiver requires both carrier brake and 1000 cps tone to activate an alarm. It is designed to eliminate nuisance alarms caused by carrier break alone. A front panel switch permits the speaker to be muted for silent monitoring until an alert signal is received. Reception of the alert signal activates the front speaker (if muted), an alert indicator lamp and a pair of contacts for an external alarm device. The alarm remains activated until manually reset, assuring the operator cognizance that an alert signal has been received. Motorola Inc., 4501 W. Augusta Blvd., Chicago 51, Ill. (ELECTRONIC TECHNICIAN 1-37)

(Continued on page 61)

Now Available ...

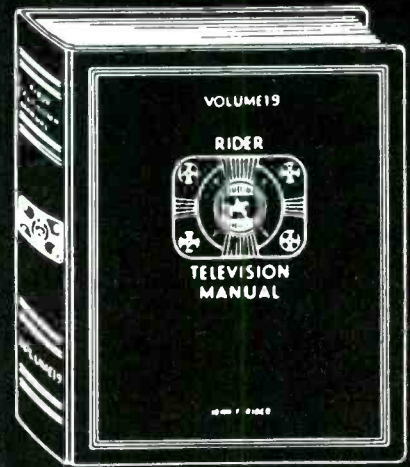

RIDER'S TV 19!

only \$19.80

LIMITED PRINTING

**IF YOU WANT THE BEST
IN TV SERVICE INFORMATION**

ON
R C A EMERSON
PHILCO MOTOROLA
ADMIRAL CROSLEY
G E ZENITH
SYLVANIA WESTINGHOUSE
HOFFMAN PACKARD-BELL

... YOU CAN GET IT FROM
YOUR JOBBER IN

RIDER'S NEW

S D O

("single diagram only")

SERVICE

**ONLY 50¢ PER CHASSIS
FACTORY-ACCURATE ...
DEPENDABLE!**

JOHN F. RIDER Publisher, Inc.

116 West 14th St., New York 11, N. Y.

**You're Ready
for any Service Job**

with

JACKSON

*"Service Engineered"
Test Equipment*



**TVG-2
Sweep
Marker
Generator**

Dealer Net \$259.95

A complete TV generator plus crystal calibrator. Sweep 30KC through 216MC. Width adjustable from 0 through 18MC. Accurate Marker 4MC through 216MC. Crystal oscillator for frequencies to 20MC. Provision for Video Modulation

**CRO-2
Wide Band
High Sensitivity
5-inch Scope**

Dealer Net \$225.00



Flat within 1 db from 20 cycles through 4.5MC. Sensitivity from 0.18RMS volts per inch. Positive or Negative internal horizontal sync. Saw tooth sweep 20 cycles through 50KC. Many accessories including low capacity probes.



**Model 655
Wide Range
Audio Oscillator**

Dealer Net \$135.00

Highly stable RC sine wave generator. Range 20 cycles to 200 kc in 4 steps. Up to 500 milliwatt output at impedances of 10, 250, 500, 5000 ohms or HiZ. Frequency characteristic 1db. 30 to 15k cycles Accuracy 3% or 1 cycle.

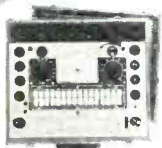

**Model 648A
Dynamic®
Tube Tester**

Dealer
Net \$129.95

Fastest tester on the market—and featuring famous Jackson Dynamic Circuit Meter calibrated in Good-Bad, as well as percent Transconductance. Correct test voltage for all tubes including latest 600-mil types. Line Voltage Indicator.

JACKSON
ELECTRICAL INSTRUMENT CO.

World's largest exclusive makers of
factory-built service test equipment.

16-18 S. Patterson Boulevard • Dayton 2, Ohio
In Canada: The Canadian Marconi Co.

Tape Recorders

(Continued from page 41)

to approximately 1/50 of the supply voltage, which permits a maximum of about 0.13 volts in this instance. This voltage is enough to saturate the recording head with normal settings of the record level control on the recorder. It will overload the recording amplifier in most machines but is not harmful.

The recorder is set up for normal recording but without a tape in place. The plug from the test rig is inserted into the microphone jack. The arm of the potentiometer should lead to the "hot" terminal. Start at minimum and turn up the potentiometer, applying more voltage to the recorder input, until the record level indicator shows a heavy overload, at least one and half times the normal recording level. The magnetic structure is saturated by this voltage. Leave the voltage applied for about 30 seconds, then start decreasing the voltage very slowly. Take about a minute to turn the potentiometer down to zero. Do not slow up, or stop and then start again. The reduction of voltage must be uniform to insure slow and steady reduction of the flux. (Such action simulates the action of the demagnetizer accessory. The demagnetizer is left near the head for a minute or less and then is slowly withdrawn.)

When the voltage on the microphone input has been lowered to zero, shut off the tape recorder. Then turn off the voltage on the test rig. Remove the plug. Do not reverse this turning-off procedure; lest an undesirable transient occur, and remagnetize the head. •



**WHEN
PERFORMANCE
IS
AFFECTED BY
LOW VOLTAGE
CONDITIONS**

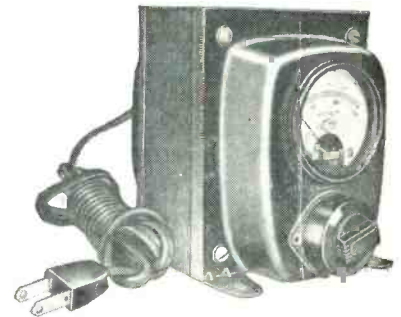

**SELL THIS
ACME ELECTRIC
VOLTAGE
ADJUSTER**

TV sets are designed to operate best when voltage holds closely to 115-117 volts. Overloaded supply lines (the power industries greatest problem) may result in a voltage drop of 10 to 15% at certain times of day. Usually the TV set will function in a fashion under such low voltage conditions but with a great strain on its components. For example; narrowing of picture, output stage tube life shortened, frequent burn-out of filaments, fuzzy focus have been traced to lack of proper voltage.

These conditions can be corrected with an Acme Electric T-8394M Voltage Adjuster. Simply plug-in to convenient outlet. Plug-in television set cord into female receptacle built into adjuster. Voltmeter indicates output voltage. If voltage is incorrect turn regulating control until proper voltage is reached for best performance. Voltage range 95 to 125 volts. Tell your supply dealer you want the Acme Electric T-8394M. No other so compact, practical, inexpensive.

ACME ELECTRIC CORPORATION
881 WATER ST. CUBA, NEW YORK

Acme Electric
TRANSFORMERS



Easy Does it WITH Winegard

Most Winegard antennas are so easy to install that you can put them up in minutes. Without a helper, too! All of which means more time for you to put in on skilled service instead of on rooftops.

Only Winegard makes a *complete*, factory-assembled antenna installation. You get the whole package—*nothing else to buy! Not a kit*, but a completely assembled unit that opens easily as an umbrella. No loose parts. Nothing to put together. Nothing to attach. Fold it open—nail it up. (Special screw-type nails included!) Clip lead-in to terminals... and you're done!

There's a Winegard model for every area and every customer.

Nationally advertised in **SATURDAY EVENING POST** and other leading magazines.

"Minute-Mount" Model

for fringe areas. A high-gain antenna with patented "Electro Lens" focusing and 10' aluminum fold-out tower. Factory-assembled and ready for installation. Complete, including lead-in, insulators, lightning arrester, ground wire and ground rod — \$44.95 retail.

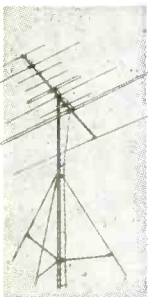

See your Jobber, or write:

Winegard Co.

3000 Scotten Blvd., Burlington, Iowa

*Pat. No. 2700105

New Products

Adelco **DEGAUSSING COIL**

The Adelco degaussing coil is for use in the degaussing of metal envelope color or B&W TV-picture tubes. A must for color-TV work. If unable to accomplish convergence, the use of the degaussing coil may be the solution. TV-

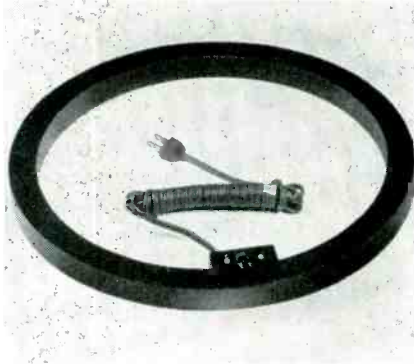

set manufacturers specify that color tubes be demagnetized before installation. This unit is enclosed in a high-impact-plastic case with a built-in slide switch, and is equipped with a 9 foot cord. \$14.95. Advance Electronics Co., 8510 N. End Ave., Oak Park, Mich. (ELECTRONIC TECHNICIAN 1-33)

James **POWER SUPPLY**

A new marine and aircraft communications vibrator power supply has been developed. Designed to operate from any 24 and 32-volt DC source. Will serve any mobile or field power supply function, such as communications, special test equipment, etc. User's price \$65.95. James Vibrapowr, 4050 N. Rockwell St., Chicago 18, Ill. (ELECTRONIC TECHNICIAN 1-34)

Altron **TUBE GUIDE**

The guide eliminates the arduous task of replacing 7 and 9-pin miniature tubes. It is held fast to the chassis by a new type magnet, which offers perfect alignment, and will not deviate from position while inserting new tubes. Altron Products. POB 9038, Long Beach, Calif. (ELECTRONIC TECHNICIAN 1-35)

Atlas **MICROPHONE SUPPORT**

The new model SB-1, mike support, can be conveniently positioned. A flexible 12" chrome-plated goose-neck arm is mounted on a spring-loaded swivel. A feed-through hole at the mike end of the goose-neck allows the mike cable to be concealed within the arm. To prevent forward tipping, the heavy, functionally-designed base casting is rear-loaded, and rests on rubber bumpers. Atlas Sound Corp., 1451 39th St., Brooklyn 18, N.Y. (ELECTRONIC TECHNICIAN 1-36)

BINDERS

for your

CIRCUIT DIGESTS . . .

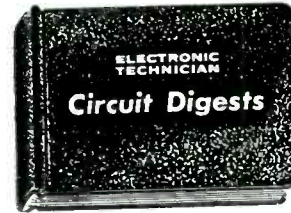

10¾"
X
14¼"

. . . are now available to

ELECTRONIC TECHNICIAN
subscribers!

These sturdy spring-type (no holes to punch) binders are bound in dark red, hard bookcover material

. . . they hold 24 monthly issues of **CIRCUIT DIGESTS** plus other reference literature.

. . . and are embossed in gold on the front and the back binding.

Another **ELECTRONIC TECHNICIAN** service—to help you preserve and get more convenient use out of your valuable **CIRCUIT DIGESTS!**

\$2.95 each—Postpaid

ELECTRONIC TECHNICIAN

480 Lexington Ave.
New York 17, N. Y.

Please ship "CIRCUIT
DIGEST Binders." I enclose \$. . .

(please print)

Name

Street & No.

City Zone . . . State . . .

157

HQ for the 5 TOP-QUALITY brands of

STANDARD BRAND TUBES

AT SENSIBLE PRICES!

- 90-day RETMA guarantee • First quality only
 - Brand new • Individually boxed
 - No rebrands, rejects, or reworked "bargains"
- WRITE FOR LATEST HANDY RECEIVING & TV TUBE PRICE SHEET/ORDER BLANK, FREE!

5" DUMONT SCOPE MODEL 274A AT LESS THAN HALF PRICE!

Genuine Dumont model 274A, 5" oscilloscopes, regularly sold for \$150 now available for LESS THAN HALF PRICE! Look at these features: Frequency response within 50% from 20 to 200,000 cps with recurrent sweep from 8 to 30,000 cps. Similar X and Y amplifiers and provision for intensity modulation. Portable, light weight, ship. wt. only 35 lb. Used, clean, checked out and guaranteed. F.O.B. N.Y.C. **\$65.00** SPECIAL!

UHF SIGNAL GENERATOR GENERAL RADIO TYPE 804

(Worth Over \$800.00)
7.5 to 330 mcs. Made by G.E. & Federal Engineering. Used, clean, checked out and guaranteed. Special! **\$99.50** F.O.B. N.Y.C.

- ABSORPTION WAVEMETER, GEN'L. Radio type 758A 55-400 MCS. (Worth \$40.00) NEW... \$12.50
5" OSCILLOSCOPE, Dumont 274A, Vy. good... 65.00
5" OSCILLOSCOPE, Dumont 208B, Vy. good... 95.00
5" OSCILLOSCOPE, RCA W0-88A, Vy. good... 85.00
TV XTAL 13 CHANNEL MARKER, Kay "Mega-marker" incl. all 13 xtals. Vy. good... \$49.50
SIGNAL GENERATOR, Measurements Corp. model 78FM, 86-110 Mcs. 30 Kc. deviation, Excellent condition... \$175.00
LM-7 FREQ. METER, w/orig. book & xtal, Exc. \$100.00
POWER SUPPLY (115v. 60cy. AC) for above L.N. \$35.00
INTERCONNECTING CABLE for LM & Pow. Supply \$5.00
12 VOLT DC MALLORY VIBRAPACK 250 Volts DC @ 100 MA. output L.N. \$9.95
6 VOLT DC MALLORY VIBRAPACK 300 Volts DC @ 100 MA output L.N. \$9.95
12 VOLT DC DYNAMOTOR, 420 VDC @ 160 MA. cont. (250 MA.INT.) output, new, boxed... \$9.95

OIL FILLED CONDENSERS

(50 MFD @ 1,000 VDC (330 VAC)

BRAND NEW... by the pair... \$2.50 ea. (singles... \$2.95 ea.)

TUBE STACKERS

Miniature or GT

Holds 10 Tubes in Cartons

SPECIAL! Per 100 **\$125**

\$10.00 Per Case of 1000 FOB NYC.

2 COLOR TUBE CARTONS

Keeps your tube stock neat. New safety partition prevents tube breakage. Distinctively lithographed in glossy red and black. The most distinctive tube carton available today. Minimum quantity: 100 for any one size. Write for case lot prices.

SIZE FOR TUBE PER 100
Miniature 6AU6, etc. \$1.00
GT... 6SN7, etc. 1.25
Large GT... 1B3 etc. 1.50
Large G... 5U4G, etc. 2.00

WHITE GLOSSY BOXES

Completely blank. No printing or color. Otherwise same as above. Same high quality, same low prices. Specify "WHITE" when ordering. When color is not stated, 2 color cartons will be shipped.

TUBE STACKERS

White glossy only. Ministacker holds 10 Mini. tube cartons; "GT" stacker holds 10 "GT" cartons.

SIZE PER EACH
Ministacker... 1 1/2 c
GT... .02



TV Sweep Generators

RCA Model WR-59A

SPECIAL! Excel. \$75 Cond.

TV SWEEP GENERATOR, RCA WR-59B, Vy. gd. 125.00

TV SWEEP GENERATOR, RCA WR-59C, Vy. gd. 150.00

WRITE FOR "BARRY'S GREEN SHEET" FREE LISTS!

TERMS: 25% deposit with order, balance C.O.D. All merchandise guaranteed. F.O.B. N.Y.C.

BARRY ELECTRONICS CORP.

512 Broadway, Dept. ET, N.Y. 12, N.Y.
Phone: Walker 5-7000

Improve Vertical Response

(Continued from page 41)

mizes distortion in reproduction to a point where it does not seriously impair the utility of the instrument. Such compensation must be fairly accurate and it is entirely possible that after a period of use some changes will take place, either in the adjustment of the trimmers or in the circuit constants. In either case, periodical response checks will make known any changes.

In conclusion, the simple circuit modification outlined here is applicable to practically any low-cost scope, and the little time and money involved in the change-over definitely makes it worth while. The versatility and usefulness of the instrument is increased considerably while the cost of components and the small amount of work required for rewiring is negligible in comparison.

Something new in
EMPLOYMENT OPPORTUNITIES!
See pages 47 and 48

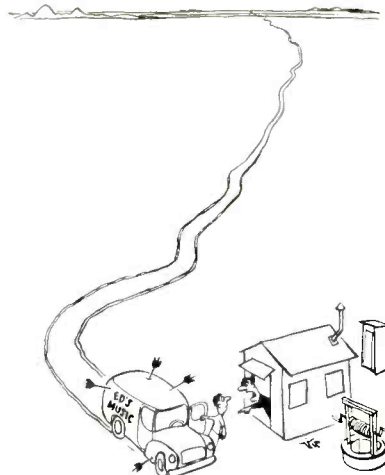

"Listen! If you don't have
JENSEN NEEDLES,
just forget I called!"



Opens Garage Doors
AUTO-matically

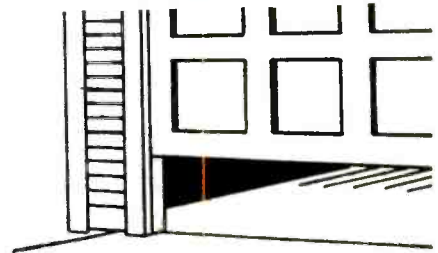

At All Distributors



new Rye Sound earsets
for transistor radios
spark profitable sales

Transistor radio sales are booming. Every transistor radio sale paves the way for a profitable earset sale. Now Rye Sound offers the only complete line of transistor radio earsets to fit each of the following brands:

- Zenith Regency RCA GE Motorola
- Westinghouse Magnavox
- Philco Bulova Roland Dewald
- Raytheon-Admiral Emerson
- Trav-Ler Sonora Revere Arvin and others.

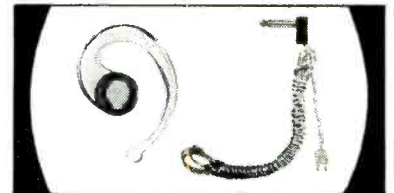

There's a real profit in each sale. Suggested list of \$6.95 incorporates full distributor and dealer profit margin. Fast turnover — A NEW YORK distributor sold more than \$10,000 worth of Rye Sound earsets in a 5 week period.

Check these Rye Sound features:

- only line that covers every popular model.
- individually packed in sales producing clear plastic box. Labeled to indicate the brand radio it fits.
- each set contains one hearing aid-quality magnetic receiver with non-toxic earloop for use on either ear, cord, molded jack.

Servicemen:

—Contact your local jobber, or write direct.

Rye Sound Corp. • 21 Rye Road • Rye, N. Y.
Phone MAMaroneck 9-7010

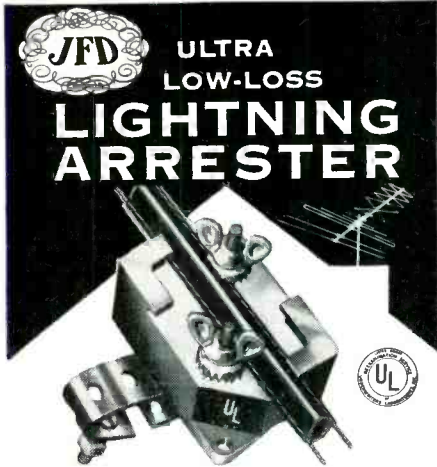

Ultra low-loss performance on VHF-UHF frequencies.
 Patented strain-relief retaining lips prevent tearing or ripping of wire.
 Universal design takes all transmission lines.

NO.	LIST
AT110	\$1.50
(wall mounting)	
AT110S	1.75
(stainless steel strap)	

"World's largest manufacturer of TV Lightning Arresters"



MANUFACTURING CO., Inc.
 BROOKLYN 4, NEW YORK

ALERT SERVICEMAN BECOMES SUCCESSFUL SALESMAN

Direct-from-the factory product information is the key . . .

he finds it faster in the MASTER!



1546 pages
 World's Largest Electronic Parts Catalog

The MASTER describes, illustrates, lists specifications of over 125,000 items necessary to radio-TV servicing. What's more—it offers thousands of other products that can lead to extra income in Hi-Fi, sound and industrial servicing. You can buy, sell and bill direct from The MASTER. It shows list prices! 1546 pages of current, direct-from-the-factory product information, systematically arranged for quick, easy reference.

Get the NEW
1957 Radio-Electronic MASTER

(21st edition)
 at your parts distributor today.

ONLY \$2.⁹⁵

The Radio-Electronic MASTER
 60 Madison Ave. Hempstead, N. Y.

ADVERTISING INDEX

January 1957

Acme Electric Corp.	60
Advance Electronics Co.	55
Allied Radio Corp.	63
American Television and Radio Co.	58
Anko Manufacturing Co., Inc.	8
Astron Corporation	17
B & K Manufacturing Co.	19, 22
Barry Electronics Corp.	62
CBS-Hytron	21
Centralab, Div. of Globe-Union, Inc.	10
Chemical Electronic Engineering, Inc.	49
Chicago Standard Transformer Corp.	14
Clear Beam Antenna Corp.	18
Cleveland Institute of Radio Electronics	52
Cornell-Dubilier Electric Corp.	15, 56
Eico	63
Electronic Technician, Inc.	55, 61
Erie Resistor Corp.	54
Federal Telephone & Radio Co.	6
General Cement Mfg. Co.	53
General Electric Co.	13
General Motors Corp., Guide Lamp Division	7
Heath Co.	54
Institute of Radio Engineers	57
International Resistance Co.	Cover II
Jackson Electrical Instrument Co.	60
Jensen Industries, Inc.	62
JFD Manufacturing Co., Inc.	9, 63
Kester Solder Co.	56
Mallory & Co., Inc., P. R.	4, 5
Merit Coil & Transformer Corp.	64
National Radio Institute	56
Oelrich Publications	57
Oxford Components, Inc.	16
Perma-Power Co.	62
Philco TechRep Division	48
Precision Apparatus Co., Inc.	12
Quam-Nichols Co.	20
Radiart Corp.	15, 56
Radio Corporation of America	11, 47, Cover IV
Raytheon Manufacturing Co.	24
Rider Publisher, John F.	59
Rockbar Corp.	3
Rogers Electronic Corp.	49
Rohn Manufacturing Co.	2
Rye Sound Corp.	62
Simpson Electric Co.	58
Sprague Products Co.	Cover III
Tungsol Electric, Inc.	50, 51
TV Trend	55
United Catalog Publishers, Inc.	63
Utah Radio Products Corp.	55
Westinghouse Electric Corp.	23
Winegard Co.	61

While every precaution is taken to insure accuracy, we cannot guarantee against the possibility of an occasional change or omission in the preparation of this index.

EICO 84 Withers St., Brooklyn 11, N. Y. T-1

SAVE ME 50% on precision instruments—
 send FREE CATALOG on EICO's 46 models
 in factory-wired and kit form.

My Name.....
 Address.....
 City..... Zone..... State.....

NEW! COLOR
 and Black-&White
 DC to 5 MC LAB & TV
 5" OSCILLOSCOPE

#460
 Factory-wired
 and tested. \$129⁵⁰
 Also available as Kit \$79⁹⁵

• Features DC Amplifiers!

Flat from DC-4.5 mc, usable to 10 mc. VERT. AMPL.: sens. 25 rms mv/in; Z 3 megs; direct-coupled & push-pull thruout; K-follower coupling bet. stages; 4-step freq-compensated attenuator up to 1000:1. SWEEP: perfectly linear 10 cps-100 kc (ext. cap. for range to 1 cps); pre-set TV V & H positions (30 & 7875 cps); auto. sync. ampl. & lim. PLUS: direct or cap. coupling; bal. or unbal. inputs; edge-lit engraved lucite graph screen; dimmer; filter; bezel fits std photo equipt. High intensity trace CRT. 0.06 usec rise time. Push-pull hor. ampl., flat to 400 kc, sens. 0.6 rms mv/in. Built-in volt. calib. Z-axis mod. Sawtooth & 60 cps outputs. Astig. control. Retrace blanking. Phasing control.

BEFORE you buy ANY instruments—get the FACTS on the money-saving, high-precision EICO line. Fill in coupon for FREE catalog & name of your nearby distributor.

EICO 84 Withers St., Brooklyn 11, N. Y.
 Prices 5% higher on West Coast

BUILD YOUR OWN
NEW knight-kit
FLYBACK CHECKER KIT
 Helps You Earn More

Race through TV deflection circuit repairs—boost your profits! This new Flyback and Yoke Tester checks all standard types of horizontal output transformers, deflection yokes, linearity and width coils. Positively indicates shorted turns for any coil with "Q" greater than 1, and inductance between .003 and 2 henries. Determines continuity of any circuit with resistance from zero to .5 meg. Checks much wider range of inductances than any other unit. Big 4 1/2" meter; 6S4-A pulsed oscillator circuit. Complete with case, all parts and test leads. Shpg. wt., 5 1/2 lbs.
 Model 83 Y 118. Net only \$19.50
 Net F.O.B. Chicago

FREE
356-PAGE ALLIED CATALOG
 Lists dozens of other low-cost quality Knight-Kit test instruments, plus the world's largest selection of parts and equipment for service work. Write for FREE copy.

ALLIED RADIO

ALLIED RADIO, Dept. 25-A-7
 100 N. Western Ave., Chicago 80, Ill.

Send Kit No. 83 Y 118. \$ enclosed
 Send FREE 356-Page ALLIED Catalog.

Name.....
 Address.....

products of the month . . .



ONLY
MERIT
FIRST
WITH
THE
LATEST
exact
replacement.

. . . and only Merit designs, engineers, manufactures completely within wholly owned facilities. This accounts for Merit's famed quality—known to exceed original equipment specifications. This is why Merit products can be relied upon to do a perfect exact replacement job; no hacking, drilling or rewiring . . . and no call-backs!

Smart jobbers appreciate maximum quality—minimum back-order!



MERIT COIL AND TRANSFORMER CORP.
4427 North Clark Street, Chicago 40, Illinois

M E R I T M E R I T
 R I T M E R I T
 E R I T M E R I T
 M E R I T M E R I T
 R I T M E R I T
 E R I T M E R I T
 M E R I T M E R I T
 R I T M E R I T
 E R I T M E R I T
 M E R I T M E R I T
 R I T M E R I T
 E R I T M E R I T
 M E R I T M E R I T
 R I T M E R I T
 E R I T M E R I T
 M E R I T M E R I T

 HVO-66 replaces Motorola parts 24K736488

 MDF-84 replaces G.E. parts RLD-025

 MDF-80 replaces Motorola parts 24C70295B, 24C703260, 24C703260B, 24C711217, 24K71126B, 24K711584

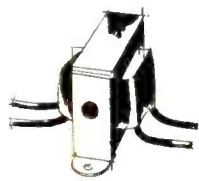
 P.2964 filament transformer, 6.3 at 0.5 amps, for amateur, amplifier, industrial

 HVO-62 replaces part 360580-1, 360604-1, 360610-1

 BC-349 sub-miniature IF output transformer for battery radios—455KC

 BC-356 miniature IF input transformer for printed circuits—455KC

 MDF-82 replaces Dumont parts 21011061, 21011062, 21011742, 89012702, 89013321

 MDF-85 replaces G.E. parts RLD-041, RLD-045

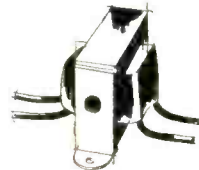
 A-3009 driver transformer, turn ratio 2.5:1, for mobile or portable radio

 BC-357 miniature IF output transformer for printed circuits—455KC

 BC-348 sub-miniature IF input transformer for battery radios—455KC

Reputation Builder #1: it pays to get along with everybody

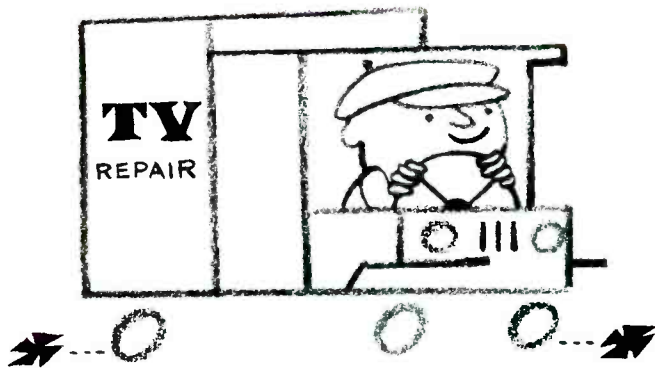

- Only 13% of your customers chose you because you were nearby

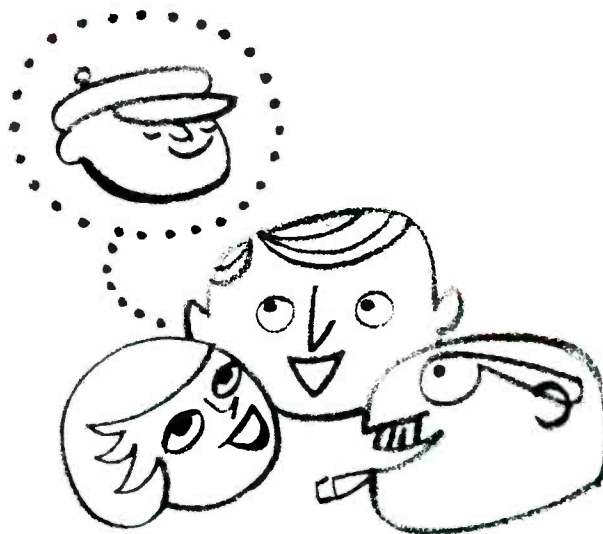

- But ... more than 40% picked you because they liked you ... or knew someone else who did

it pays to replace with Sprague Black Beauty® Telecaps®



- Another way to build and hold a reputation is to insist on top quality replacement parts. Callbacks due to replacement failures not only cost you *money* ... they also cost you customers! Replace with less than the best and you place your reputation at stake. In capacitors, the best is *Sprague*.

- Take the Telecap molded tubular, for example. It's the most imitated capacitor Sprague ever introduced. But you get Sprague *performance* only when you insist on Sprague Telecaps. They're the first choice of *reputation-conscious* manufacturers and servicemen ... yet they cost no more.

- Get your copy of Sprague's latest radio and TV service catalog, C-455. Write Sprague Products Co.*, 65 Marshall Street, North Adams, Mass.
*Distributors' Division of Sprague Electric Company

don't be vague...insist on

SPRAGUE®

world's largest capacitor manufacturer

SPRAGUE RESEARCH IS CONSTANTLY PRODUCING NEW AND BETTER CAPACITORS FOR YOU

IT TAKES TWO:

RCA and YOU

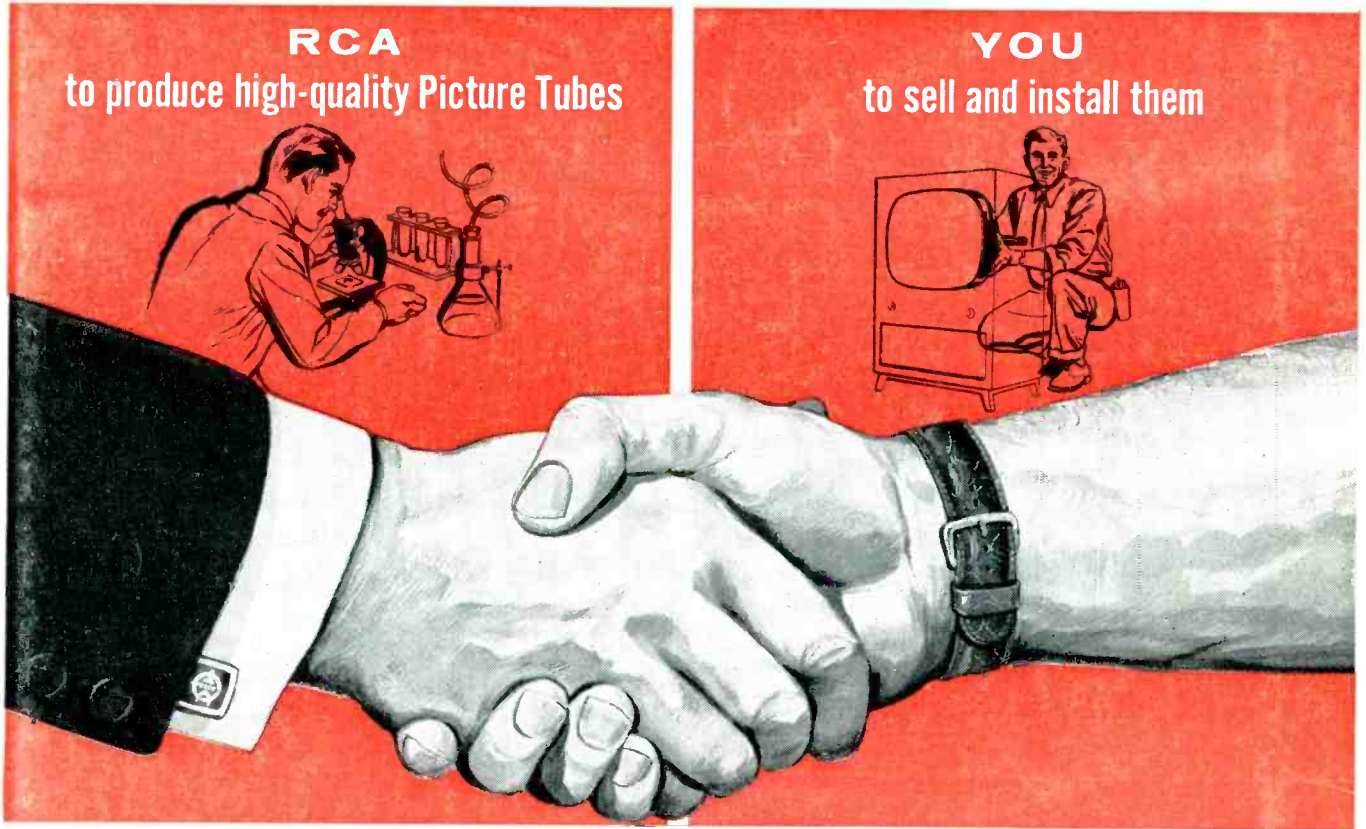

When the customer says, "Why?", "What?", "How Much?", don't just talk tubes, talk:

- QUALITY** Tell them how an RCA picture tube must pass well over 100 careful inspections before it's good enough for you—or your customer.
- ACCEPTANCE** Remind them that more people view TV shows on RCA picture tubes than on any other brand.
- BRAND NAME** Emphasize RCA—the name that's first in electronics.
- WARRANTY** The Warranty Card you give your customers says the tube is an RCA tube; it says it's factory-fresh; above all it says: "warranted for a year."



Today, your customers are well-informed TV viewers who demand the best in picture tube performance. These are the people who, week in and week out, read the RCA Silverama story in Life, TV Guide, the Saturday Evening Post. These are the people who see and hear the RCA Silverama quality story on NBC's network radio and TV shows. And these are the very customers who say "yes" to RCA. So, team-up with RCA. You'll know the difference, and your customers will see it—big and bright as life.

Silverama



PICTURE TUBES

RADIO CORPORATION OF AMERICA

Tube Division • Harrison, N. J.

TMK(S)®