



z/Architecture

Principles of Operation



z/Architecture

Principles of Operation

Note:

Before using this information and the product it supports, be sure to read the general information under "Notices" on page xvii.

Softcopy Note:

The reader should be aware of the fact that this publication contains many symbols, such as superscripts, that may not display correctly with any given hardware or software. The definitive version of this publication is the hardcopy version.

| Thirteenth Edition (September, 2019)

| This edition obsoletes and replaces *z/Architecture Principles of Operation, SA22-7832-11*.

This publication is provided for use in conjunction with other relevant IBM publications, and IBM makes no warranty, express or implied, about its completeness or accuracy. The information in this publication is current as of its publication date but is subject to change without notice.

Additional copies of this and other IBM publications may be ordered or downloaded from the IBM publications web site at <http://www.ibm.com/support/documentation>.

| Please direct any comments on the contents of this publication to:

IBMLink™ (United States customers only): IBMUSM10(MHVRCFS)
Internet e-mail: mhvrcfs@us.ibm.com

When you send information to IBM, you grant IBM a non-exclusive right to use or distribute the information in any way it believes appropriate without incurring any obligation to you.

| © Copyright International Business Machines Corporation 2000, 2019. All rights reserved.

US Government Users Restricted Rights — Use, duplication or disclosure restricted by GSA ADP Schedule Contract with IBM Corp.

Contents

Notices	xxv
Trademarks	xxv

Preface	xxvii
Size and Number Notation	xxviii
Bytes, Characters, and Codes	xxix
Other Publications	xxix
Summary of Changes in Thirteenth Edition	xxx
Summary of Changes in Twelfth Edition	xxxii
Summary of Changes in Eleventh Edition	xxxvi
Summary of Changes in Tenth Edition	xxxix
Summary of Changes in Ninth Edition	xli
Summary of Changes in Eighth Edition	xlili
Summary of Changes in Seventh Edition	xlili
Summary of Changes in Sixth Edition	xlv
Summary of Changes in Fifth Edition	xlvi
Summary of Changes in Fourth Edition	xlix
Summary of Changes in Third Edition	l
Summary of Changes in Second Edition	lii

Chapter 1, Introduction	1-1
Highlights of Original z/Architecture	1-2
General Instructions for 64-Bit Integers	1-3
Other New General Instructions	1-3
Floating-Point Instructions	1-5
Control Instructions	1-5
Trimodal Addressing	1-5
Modal Instructions	1-5
Effects on Bits 0-31 of a General Register	1-6
Input/Output	1-6
Additions to z/Architecture	1-7
ASN-and-LX-Reuse Facility	1-7
CMPSC-Enhancement Facility	1-7
Compare-and-Swap-and-Store Facility	1-8
Compare-and-Swap-and-Store Facility 2	1-8
Conditional-SSKE Facility	1-8
Configuration-Topology Facility	1-8
Configuration-z/Architecture-Architectural-Mode Facility	1-8
Constrained-Transactional-Execution Facility	1-8
DAT-Enhancement Facility 1	1-8
DAT-Enhancement Facility 2	1-9
Decimal-Floating-Point Facility	1-9
Decimal-Floating-Point Packed-Conversion Facility	1-9
Decimal-Floating-Point-Rounding Facility	1-9
Decimal-Floating-Point Zoned-Conversion Facility	1-9
DEFLATE-Conversion Facility	1-9

Distinct-Operands Facility	1-9
Enhanced-DAT Facility 1	1-10
Enhanced-DAT Facility 2	1-10
Enhanced-Monitor Facility	1-11
Entropy Encoding Compression Facility	1-11
ESA/390-Compatibility-Mode Facility	1-11
ETF2-Enhancement Facility	1-11
ETF3-Enhancement Facility	1-11
Execute-Extensions Facility	1-12
Execution-Hint Facility	1-12
Extended-Immediate Facility	1-12
Extended-I/O-Measurement-Block Facility	1-12
Extended-I/O-Measurement-Word Facility	1-12
Extended-Translation Facility 2	1-13
Extended-Translation Facility 3	1-13
Extract-CPU-Time Facility	1-13
Fast-BCR-Serialization Facility	1-13
Fibre-Channel Extensions (FCX)	1-13
FCX-Bidirectional-Data-Transfer Facility	1-14
Floating-Point Extension Facility	1-14
Floating-Point-Support-Sign- Handling Facility	1-15
FPR-GR-Transfer Facility	1-15
General-Instructions-Extension Facility	1-15
Guarded-Storage Facility	1-16
HFP Multiply-and-Add/Subtract Facility	1-16
HFP-Unnormalized-Extensions Facility	1-16
High-Word Facility	1-16
IEEE-Exception-Simulation Facility	1-17
Insert-Reference-Bits-Multiple Facility	1-17
Instruction-Execution-Protection Facility	1-17
Interlocked-Access Facility 1	1-17
Interlocked-Access Facility 2	1-17
IPTE-Range Facility	1-17
List-Directed Initial Program Load	1-17
Load-and-Trap Facility	1-18
Load-and-Zero-Rightmost-Byte Facility	1-18
Load/Store-on-Condition Facility 1	1-18
Load/Store-on-Condition Facility 2	1-18
Local-TLB-Clearing Facility	1-18
Long-Displacement Facility	1-18
Message-Security Assist	1-19
Message-Security-Assist Extension 1	1-19
Message-Security-Assist Extension 2	1-19
Message-Security-Assist Extension 3	1-19
Message-Security-Assist Extension 4	1-20
Message-Security-Assist Extension 5	1-21
Message-Security-Assist Extension 6	1-21
Message-Security-Assist Extension 7	1-22
Message-Security-Assist Extension 8	1-22
Message-Security-Assist Extension 9	1-22
Miscellaneous-Instruction-Extensions Facility 1	1-23
Miscellaneous-Instruction-Extensions Facility 2	1-23

Miscellaneous-Instruction-Extensions	
Facility 3	1-23
Modified CCW Indirect Data Addressing	
Facility	1-23
Move-Page-and-Set-Key Facility	1-24
Move-With-Optional-Specifications Facility	1-24
Multiple-Epoch Facility	1-24
Multiple-Subchannel-Set Facility	1-24
Multithreading Facility	1-25
Nonquiescing Key-Setting Facility	1-25
Parsing-Enhancement Facility	1-25
PER-3 Facility	1-25
PER-Storage-Key-Alteration Facility	1-26
PER Zero-Address-Detection Facility	1-26
PFPO Facility	1-26
Population-Count Facility	1-26
Processor-Assist Facility	1-26
Reset-Reference-Bits-Multiple Facility	1-26
Restore-Subchannel Facility	1-26
Server-Time-Protocol Facility	1-26
Side-Effect-Access Facility	1-27
Store-Clock-Fast Facility	1-27
Store-Facility-List-Extended Facility	1-27
Test-Pending-External-Interrupt Facility	1-27
TOD-Clock-Steering Facility	1-27
Transactional-Execution Facility	1-27
Vector-Enhancements Facility 1	1-27
Vector-Enhancements Facility 2	1-28
Vector Facility for z/Architecture	1-28
Vector Packed-Decimal Facility	1-28
Vector-Packed-Decimal-Enhancement	
Facility	1-29
Warning-Track Interruption Facility	1-29
The ESA/390 Base	1-29
The ESA/370 and 370-XA Base	1-34
System Program	1-36
Compatibility	1-36
Compatibility among z/Architecture Systems	1-36
Compatibility between z/Architecture and	
ESA/390	1-37
Control-Program Compatibility	1-37
Problem-State Compatibility	1-37
Availability	1-37
Chapter 2, Organization	2-1
Main Storage	2-2
Expanded Storage	2-2
CPU	2-2
CPU Types	2-3
Multithreading	2-3
PSW	2-4
General Registers	2-4
Floating-Point Registers	2-4

Floating-Point-Control Register	2-5
Vector Registers	2-5
Control Registers	2-6
Access Registers	2-6
Cryptographic Facility	2-7
External Time Reference	2-7
I/O	2-7
Channel Subsystem	2-7
Channel Paths	2-7
I/O Devices and Control Units	2-8
Operator Facilities	2-8

Chapter 3, Storage	3-1
Storage Addressing	3-2
Information Formats	3-3
Integral Boundaries	3-3
Address Types and Formats	3-4
Address Types	3-4
Absolute Address	3-4
Real Address	3-4
Virtual Address	3-5
Primary Virtual Address	3-5
Secondary Virtual Address	3-5
AR-Specified Virtual Address	3-5
Home Virtual Address	3-5
Logical Address	3-5
Instruction Address	3-5
Effective Address	3-5
Address Size and Wraparound	3-6
Address Wraparound	3-7
Storage Key	3-9
Protection	3-10
Key-Controlled Protection	3-11
Storage-Protection-Override Control	3-12
Fetch-Protection-Override Control	3-13
Access-List-Controlled Protection	3-13
DAT Protection	3-13
Low-Address Protection	3-14
Instruction-Execution Protection	3-14
Suppression on Protection	3-15
Reference Recording	3-19
Change Recording	3-20
Prefixing	3-21
Prefixing in the z/Architecture Architectural	
Mode	3-22
Prefixing in the ESA/390-Compatibility Mode	3-22
Common Prefixing Attributes	3-22
Address Spaces	3-23
Changing to Different Address Spaces	3-23
Address-Space Number	3-23
ASN-Second-Table-Entry Sequence Number	3-24
ASN-Second-Table-Entry Instance Number	
and ASN Reuse	3-25

ASN Translation	3-30	Assigned Storage Locations in the ESA/390-Compatibility Mode	3-83
ASN-Translation Controls	3-30		
Control Register 14	3-30		
ASN-Translation Tables	3-31		
ASN-First-Table Entries	3-31		
ASN-Second-Table Entries	3-31		
ASN-Translation Process	3-33		
ASN-First-Table Lookup	3-33		
ASN-Second-Table Lookup	3-34		
Recognition of Exceptions during ASN Translation	3-35		
ASN Authorization	3-35		
ASN-Authorization Controls	3-35		
Control Register 4	3-35		
ASN-Second-Table Entry	3-35		
Authority-Table Entries	3-36		
ASN-Authorization Process	3-36		
Authority-Table Lookup	3-36		
Recognition of Exceptions during ASN Authorization	3-38		
Dynamic Address Translation	3-38		
Translation Control	3-40		
Translation Modes	3-40		
Control Register 0	3-41		
Control Register 1	3-42		
Control Register 7	3-44		
Control Register 13	3-45		
Translation Tables	3-45		
Region-Table Entries	3-46		
Segment-Table Entries	3-49		
Page-Table Entries	3-51		
Translation Process	3-52		
Inspection of Real-Space Control	3-54		
Inspection of Designation-Type Control	3-54		
Lookup in a Table Designated by an Address-Space-Control Element	3-57		
Lookup in a Table Designated by a Region-Table Entry	3-59		
Page-Table Lookup	3-61		
Formation of the Real and Absolute Addresses	3-62		
Recognition of Exceptions during Translation	3-62		
Translation-Lookaside Buffer	3-62		
TLB Structure	3-63		
Formation of TLB Entries	3-63		
Use of TLB Entries	3-65		
Modification of Translation Tables	3-67		
Address Summary	3-70		
Addresses Translated	3-70		
Handling of Addresses	3-71		
Assigned Storage Locations	3-73		
Assigned Storage Locations in the z/Architecture Architectural Mode	3-73		
		Chapter 4, Control	4-1
		CPU States	4-2
		Stopped State	4-2
		Operating State	4-3
		Load State	4-3
		Check-Stop State	4-3
		Program-Status Word	4-4
		Program-Status-Word Format	4-5
		Short PSW Format	4-8
		Control Registers	4-8
		Tracing	4-12
		Implicit Tracing	4-12
		Branch Tracing	4-12
		ASN Tracing	4-13
		Mode Tracing	4-13
		Explicit Tracing	4-14
		Control-Register Allocation	4-15
		Trace Entries	4-15
		Trace Operation	4-25
		Program-Event Recording	4-26
		PER Instruction-Fetching Nullification	4-26
		Control-Register Allocation and Address-Space-Control Element	4-26
		PER Operation	4-29
		Identification of Cause	4-30
		Priority of Indication	4-33
		Storage-Area Designation	4-35
		PER Events	4-36
		Successful Branching	4-36
		Instruction Fetching	4-37
		Storage Alteration	4-37
		Store Using Real Address	4-38
		Zero-Address Detection	4-38
		Transaction End	4-39
		Storage-Key Alteration	4-40
		Indication of PER Events Concurrently with Other Interruption Conditions	4-40
		Indication of PER Events and Guarded-Storage Events	4-44
		Breaking-Event-Address Recording	4-45
		Breaking-Event-Address Register	4-46
		Execution-Break Instructions	4-46
		Timing	4-47
		Time-of-Day Clock and Epoch Index	4-47
		Format	4-47
		States	4-48
		Changes in Clock State	4-49
		Setting and Inspecting the Clock	4-50
		TOD Programmable Register	4-52
		TOD-Clock Synchronization	4-54

Timing Mode	4-54	CPU Reset	4-86
Timing State	4-54	Set Prefix	4-86
STP Clock Source State	4-55	Store Status at Address	4-87
TOD-Clock Steering	4-55	Store Extended Status at Address	4-88
Offset-Based TOD-Clock Steering		Set Architecture	4-89
Overview	4-56	Conditional Emergency Signal	4-91
Hardware-Based TOD-Clock-Steering		Sense Running Status	4-92
Overview	4-56	Set Multithreading	4-92
TOD-Offset-Update Events	4-57	Store Additional Status at Address	4-93
Episodes	4-57	Conditions Determining Response	4-95
TOD-Clock-Steering Registers	4-57	Conditions Precluding Interpretation of the	
UTC Information Block (UIB)	4-58	Order Code	4-95
Clock Comparator	4-60	Status Bits	4-96
CPU Timer	4-63	Facility Indications	4-99
Guarded-Storage Facility	4-65		
Guarded-Storage-Facility Registers	4-65	Chapter 5, Program Execution	5-1
Control Register 2	4-65	Instructions	5-3
Guarded-Storage-Designation (GSD)		Operands	5-3
Register	4-66	Instruction Formats	5-3
Guarded-Storage-Section-Mask (GSSM)		Register Operands	5-7
Register	4-66	Immediate Operands	5-8
Guarded-Storage-Event Parameter-		Storage Operands	5-9
List-Address (GSEPLA) Register	4-67	Address Generation	5-10
Guarded-Storage Control Block (GSCB)	4-67	Trimodal Addressing	5-10
Guarded-Storage-Event Parameter List		Sequential Instruction-Address Generation	5-10
(GSEPL)	4-67	Operand-Address Generation	5-11
Guarded-Storage Facility Operation	4-70	Formation of the Intermediate Value	5-11
Guarded-Storage-Event Detection	4-70	Formation of the Operand Address	5-12
Guarded-Storage-Event Processing	4-71	Branch-Address Generation	5-12
Externally Initiated Functions	4-74	Formation of the Intermediate Value	5-12
Resets	4-74	Formation of the Branch Address	5-13
CPU Reset	4-78	Instruction Execution and Sequencing	5-14
Initial CPU Reset	4-79	Decision Making	5-14
Subsystem Reset	4-80	Loop Control	5-14
Clear Reset	4-80	Subroutine Linkage without the Linkage Stack	5-14
Power-On Reset	4-81	Simple Branch Instructions	5-14
Initial Program Loading	4-81	Other Linkage Instructions	5-17
CCW-Type IPL	4-82	Interruptions	5-22
Store Status	4-82	Types of Instruction Ending	5-22
Multiprocessing	4-83	Completion	5-22
Shared Main Storage	4-84	Suppression	5-22
CPU-Address Identification	4-84	Nullification	5-23
CPU-Address Expansion	4-84	Termination	5-23
CPU-Address Contraction	4-85	Interruptible Instructions	5-24
CPU Signaling and Response	4-85	Point of Interruption	5-24
Signal-Processor Orders	4-85	Unit of Operation	5-24
Sense	4-85	Execution of Interruptible Instructions	5-24
External Call	4-85	Condition-Code Alternative to	
Emergency Signal	4-86	Interruptibility	5-25
Start	4-86	Exceptions to Nullification and Suppression	5-26
Stop	4-86	Modification of DAT-Table Entries	5-27
Restart	4-86	Trial Execution for Editing Instructions and	
Stop and Store Status	4-86	Translate Instruction	5-27
Initial CPU Reset	4-86		

Authorization Mechanisms	5-27	Obtaining the Effective Access-List Designation	5-62
Mode Requirements	5-28	Access-List Lookup	5-62
Extraction-Authority Control	5-28	Locating the ASN-Second-Table Entry	5-63
PSW-Key Mask	5-28	Authorizing the Use of the Access-List Entry	5-63
Secondary-Space Control	5-29	Checking for Access-List-Controlled Protection	5-64
Subsystem-Linkage Control	5-29	Obtaining the Address-Space-Control Element from the ASN-Second-Table Entry	5-64
ASN-Translation Control	5-29	Recognition of Exceptions during Access-Register Translation	5-64
Authorization Index	5-29	ART-Lookaside Buffer	5-64
Instructions and Controls Related to ASN-and-LX Reuse	5-30	ALB Structure	5-64
PC-Number Translation	5-33	Formation of ALB Entries	5-64
PC-Number Translation Control	5-34	Use of ALB Entries	5-65
Control Register 0	5-35	Modification of ART Tables	5-66
Control Register 5	5-35	Subspace Groups	5-66
PC-Number Translation Tables	5-36	Subspace-Group Tables	5-66
Linkage-Table Entries	5-36	Subspace-Group Dispatchable-Unit Control Table	5-66
Linkage-First-Table Entries	5-36	Subspace-Group ASN-Second-Table Entries	5-68
Linkage-Second-Table Entries	5-37	Subspace-Replacement Operations	5-70
Entry-Table Entries	5-37	Linkage-Stack Introduction	5-70
Table Summary	5-38	Summary	5-71
PC-Number-Translation Process	5-39	Linkage-Stack Functions	5-71
Obtaining the Linkage-Table or Linkage- First-Table Designation	5-42	Transferring Program Control	5-71
Linkage-Table Lookup	5-42	Branching Using the Linkage Stack	5-73
Linkage-First-Table Lookup	5-42	Adding and Retrieving Information	5-74
Linkage-Second-Table Lookup	5-43	Testing Authorization	5-74
Linkage-Second-Table-Entry-Sequence- Number Comparison	5-43	Program-Problem Analysis	5-75
Entry-Table Lookup	5-43	Linkage-Stack Entry-Table Entries	5-75
Recognition of Exceptions during PC-Number Translation	5-44	Linkage-Stack Operations	5-76
Home Address Space	5-44	Linkage-Stack-Operations Control	5-78
Access-Register Introduction	5-45	Control Register 0	5-78
Summary	5-45	Control Register 15	5-78
Access-Register Functions	5-46	Linkage Stack	5-79
Access-Register-Specified Address Spaces	5-46	Entry Descriptors	5-79
Access-Register Instructions	5-52	Header Entries	5-80
Access-Register Translation	5-53	Trailer Entries	5-81
Access-Register-Translation Control	5-53	State Entries	5-81
Control Register 2	5-53	Stacking Process	5-84
Control Register 5	5-54	Locating Space for a New Entry	5-84
Control Register 8	5-54	Forming the New Entry	5-85
Access Registers	5-54	Updating the Current Entry	5-86
Access-Register-Translation Tables	5-55	Updating Control Register 15	5-86
Dispatchable-Unit Control Table and Access-List Designations	5-55	Recognition of Exceptions during the Stacking Process	5-86
Access-List Entries	5-56	Unstacking Process	5-86
ASN-Second-Table Entries	5-57	Locating the Current Entry and Processing a Header Entry	5-87
Access-Register-Translation Process	5-59	Checking for a State Entry	5-88
Selecting the Access-List-Entry Token	5-62		
Obtaining the Primary or Secondary Address-Space-Control Element	5-62		
Checking the First Byte of the ALET	5-62		

Restoring Information	5-88
Updating the Preceding Entry	5-89
Updating Control Register 15	5-89
Recognition of Exceptions during the Unstacking Process	5-89
Transactional-Execution Facility	5-89
Transactional-Execution Terminology	5-89
Transactional-Execution Facility Controls	5-92
Control Register Bits	5-92
Transaction-Diagnostic-Block Address (TDBA)	5-93
Transaction-Abort PSW (TAPSW)	5-93
Transaction Nesting Depth (TND)	5-93
Transaction Diagnostic Block (TDB)	5-93
Transactional-Execution Facility Instructions	5-97
Restricted Instructions	5-97
Transactional-Execution Facility Operation	5-99
Transaction Initiation	5-99
Execution in the Transactional-Execution Mode	5-99
Normal Transaction Ending	5-99
Transaction Abort Conditions	5-100
Transaction Abort Processing	5-102
Program-Interrupt Filtering on a Transaction Abort	5-104
Priority of Abort Conditions	5-107
Constrained Transaction	5-107
Monitor-Event Counting	5-109
ESA/390-Compatibility-Mode Facility	5-111
Sequence of Storage References	5-113
Conceptual Sequence	5-113
Overlapped Operation of Instruction Execution	5-114
Divisible Instruction Execution	5-115
Interlocks for Virtual-Storage References	5-115
Interlocks between Instructions	5-116
Interlocks within a Single Instruction	5-116
Instruction Fetching	5-118
ART-Table and DAT-Table Fetches	5-119
Storage-Key Accesses	5-120
Storage-Operand References	5-123
Storage-Operand Fetch References	5-123
Storage-Operand Store References	5-123
Storage-Operand Update References	5-124
Storage-Operand Consistency	5-125
Single-Access References	5-125
Multiple-Access References	5-125
Block-Concurrent References	5-127
Relation between Operand Accesses	5-129
Storage Operand References in the Transactional-Execution Mode	5-129
Other Storage References	5-130
Relation between Storage-Key Accesses	5-130
Serialization	5-130

CPU Serialization	5-130
Specific-Operand Serialization	5-132
Channel-Program Serialization	5-133
Quiescing	5-133

Chapter 6, Interruptions 6-1

Interruption Action	6-2
Interruption Code	6-5
Enabling and Disabling	6-6
Handling of Floating Interruption Conditions	6-6
Instruction-Length Code	6-7
Zero ILC	6-7
ILC on Instruction-Fetching Exceptions	6-8
Exceptions Associated with the PSW	6-9
Early Exception Recognition	6-9
Late Exception Recognition	6-10
External Interruption	6-11
Clock Comparator	6-12
CPU Timer	6-12
Emergency Signal	6-13
External Call	6-13
Interrupt Key	6-13
Malfunction Alert	6-13
Measurement Alert	6-14
Service Signal	6-14
Timing Alert	6-14
ETR-Timing-Alert Condition	6-14
STP-Timing-Alert Condition	6-14
Warning Track	6-15
I/O Interruption	6-15
Machine-Check Interruption	6-16
Program Interruption	6-16
Data-Exception Code (DXC)	6-17
Priority of Program Interruptions for Data Exceptions	6-17
Vector-Exception Code	6-20
Program-Interruption Conditions	6-20
Addressing Exception	6-20
AFX-Translation Exception	6-22
ALEN-Translation Exception	6-22
ALE-Sequence Exception	6-22
ALET-Specification Exception	6-22
ASCE-Type Exception	6-22
ASTE-Instance Exception	6-23
ASTE-Sequence Exception	6-23
ASTE-Validity Exception	6-24
ASX-Translation Exception	6-24
Crypto-Operation Exception	6-24
Data Exception	6-25
Decimal-Divide Exception	6-26
Decimal-Overflow Exception	6-26
Execute Exception	6-26
EX-Translation Exception	6-26

Extended-Authority Exception	6-27	Binary Arithmetic.	7-5
Fixed-Point-Divide Exception.	6-27	Signed Binary Arithmetic.	7-5
Fixed-Point-Overflow Exception	6-27	Addition and Subtraction.	7-5
HFP-Divide Exception	6-28	Fixed-Point Overflow.	7-5
HFP-Exponent-Overflow Exception.	6-28	Unsigned Binary Arithmetic.	7-6
HFP-Exponent-Underflow Exception.	6-28	Signed and Logical Comparison.	7-7
HFP-Significance Exception	6-28	Instructions	7-7
HFP-Square-Root Exception	6-29	ADD	7-25
LFX-Translation Exception	6-29	ADD IMMEDIATE	7-26
LSTE-Sequence Exception	6-29	ADD HALFWORD.	7-27
LSX-Translation Exception	6-29	ADD HALFWORD IMMEDIATE	7-28
LX-Translation Exception.	6-30	ADD HIGH	7-28
Monitor Event.	6-30	ADD IMMEDIATE HIGH	7-29
Operand Exception	6-31	ADD LOGICAL	7-29
Operation Exception	6-31	ADD LOGICAL IMMEDIATE.	7-29
Page-Translation Exception.	6-32	ADD LOGICAL HIGH	7-30
PC-Translation-Specification Exception . .	6-32	ADD LOGICAL WITH CARRY	7-30
PER Event	6-32	ADD LOGICAL WITH SIGNED IMMEDIATE .	7-31
Primary-Authority Exception	6-33	ADD LOGICAL WITH SIGNED IMMEDIATE	
Privileged-Operation Exception	6-33	HIGH.	7-32
Protection Exception	6-34	AND	7-32
Region-First-Translation Exception	6-35	AND IMMEDIATE	7-34
Region-Second-Translation Exception . . .	6-36	AND WITH COMPLEMENT	7-34
Region-Third-Translation Exception	6-36	BRANCH AND LINK	7-35
Secondary-Authority Exception	6-37	BRANCH AND SAVE	7-36
Segment-Translation Exception.	6-37	BRANCH AND SAVE AND SET MODE	7-36
Space-Switch Event.	6-37	BRANCH AND SET MODE	7-37
Special-Operation Exception	6-38	BRANCH INDIRECT ON CONDITION.	7-38
Specification Exception	6-40	BRANCH ON CONDITION	7-39
Stack-Empty Exception	6-44	BRANCH ON COUNT	7-40
Stack-Full Exception	6-45	BRANCH ON INDEX HIGH	7-41
Stack-Operation Exception	6-45	BRANCH ON INDEX LOW OR EQUAL	7-41
Stack-Specification Exception	6-45	BRANCH PREDICTION PRELOAD	7-42
Stack-Type Exception	6-45	BRANCH PREDICTION RELATIVE	
Trace-Table Exception.	6-45	PRELOAD.	7-42
Transaction-Constraint Exception	6-46	BRANCH RELATIVE AND SAVE	7-45
Transactional-Execution-Aborted Event . .	6-46	BRANCH RELATIVE AND SAVE LONG	7-45
Translation-Specification Exception.	6-46	BRANCH RELATIVE ON CONDITION.	7-46
Vector Processing Exception.	6-47	BRANCH RELATIVE ON CONDITION LONG	7-46
Collective Program-Interruption Names. . . .	6-47	BRANCH RELATIVE ON COUNT	7-47
Recognition of Access Exceptions.	6-47	BRANCH RELATIVE ON COUNT HIGH	7-47
Multiple Program-Interruption Conditions . .	6-51	BRANCH RELATIVE ON INDEX HIGH	7-47
Access Exceptions.	6-53	BRANCH RELATIVE ON INDEX LOW OR	
ASN-Translation Exceptions	6-55	EQUAL	7-47
Subspace-Replacement Exceptions	6-56	CHECKSUM	7-49
Trace Exceptions	6-56	CIPHER MESSAGE	7-52
Restart Interruption	6-56	CIPHER MESSAGE WITH CHAINING.	7-52
Supervisor-Call Interruption.	6-57	CIPHER MESSAGE WITH	
Priority of Interruptions	6-57	AUTHENTICATION	7-77
Chapter 7, General Instructions	7-1	CIPHER MESSAGE WITH CIPHER	
Data Format.	7-4	FEEDBACK.	7-91
Binary-Integer Representation.	7-4	CIPHER MESSAGE WITH COUNTER.	7-106
		CIPHER MESSAGE WITH OUTPUT	
		FEEDBACK.	7-119

COMPARE	7-133	CONVERT UTF-8 TO UTF-16.	7-243
COMPARE IMMEDIATE	7-133	CONVERT UTF-8 TO UNICODE	7-243
COMPARE RELATIVE LONG	7-134	CONVERT UTF-8 TO UTF-32.	7-247
COMPARE AND BRANCH	7-134	COPY ACCESS	7-251
COMPARE AND BRANCH RELATIVE	7-134	DIVIDE	7-251
COMPARE IMMEDIATE AND BRANCH	7-135	DIVIDE LOGICAL	7-252
COMPARE IMMEDIATE AND BRANCH RELATIVE	7-135	DIVIDE SINGLE	7-253
COMPARE AND FORM CODEWORD	7-136	EXCLUSIVE OR	7-253
COMPARE AND SWAP	7-143	EXCLUSIVE OR IMMEDIATE.	7-255
COMPARE DOUBLE AND SWAP.	7-143	EXECUTE	7-255
COMPARE AND SWAP AND STORE.	7-145	EXECUTE RELATIVE LONG	7-255
COMPARE AND TRAP	7-148	EXTRACT ACCESS	7-256
COMPARE IMMEDIATE AND TRAP.	7-148	EXTRACT CPU ATTRIBUTE	7-256
COMPARE HALFWORD	7-149	EXTRACT CPU TIME	7-259
COMPARE HALFWORD IMMEDIATE	7-149	EXTRACT PSW	7-260
COMPARE HALFWORD RELATIVE LONG	7-149	EXTRACT TRANSACTION NESTING DEPTH	7-260
COMPARE HIGH.	7-150	FIND LEFTMOST ONE.	7-261
COMPARE IMMEDIATE HIGH	7-150	INSERT CHARACTER	7-261
COMPARE LOGICAL	7-151	INSERT CHARACTERS UNDER MASK.	7-261
COMPARE LOGICAL IMMEDIATE	7-151	INSERT IMMEDIATE	7-262
COMPARE LOGICAL RELATIVE LONG.	7-152	INSERT PROGRAM MASK.	7-263
COMPARE LOGICAL AND BRANCH	7-153	LOAD.	7-263
COMPARE LOGICAL AND BRANCH RELATIVE	7-153	LOAD IMMEDIATE	7-263
COMPARE LOGICAL IMMEDIATE AND BRANCH	7-153	LOAD RELATIVE LONG.	7-263
COMPARE LOGICAL IMMEDIATE AND BRANCH RELATIVE	7-153	LOAD ACCESS MULTIPLE	7-264
COMPARE LOGICAL AND TRAP.	7-154	LOAD ADDRESS	7-265
COMPARE LOGICAL IMMEDIATE AND TRAP	7-155	LOAD ADDRESS EXTENDED	7-265
COMPARE LOGICAL CHARACTERS UNDER MASK.	7-156	LOAD ADDRESS RELATIVE LONG.	7-266
COMPARE LOGICAL HIGH	7-156	LOAD AND ADD	7-267
COMPARE LOGICAL IMMEDIATE HIGH	7-157	LOAD AND ADD LOGICAL.	7-267
COMPARE LOGICAL LONG	7-157	LOAD AND AND	7-268
COMPARE LOGICAL LONG EXTENDED.	7-159	LOAD AND EXCLUSIVE OR.	7-268
COMPARE LOGICAL LONG UNICODE	7-162	LOAD AND OR	7-269
COMPARE LOGICAL STRING	7-165	LOAD AND TEST	7-269
COMPARE UNTIL SUBSTRING EQUAL	7-166	LOAD AND TRAP	7-270
COMPRESSION CALL	7-169	LOAD AND ZERO RIGHTMOST BYTE	7-270
COMPUTE INTERMEDIATE MESSAGE DIGEST	7-187	LOAD BYTE	7-271
COMPUTE LAST MESSAGE DIGEST	7-200	LOAD BYTE HIGH	7-271
COMPUTE MESSAGE AUTHENTICATION CODE.	7-218	LOAD COMPLEMENT	7-271
CONVERT TO BINARY	7-229	LOAD COUNT TO BLOCK BOUNDARY	7-272
CONVERT TO DECIMAL.	7-230	LOAD GUARDED	7-273
CONVERT UTF-16 TO UTF-32.	7-230	LOAD LOGICAL AND SHIFT GUARDED	7-273
CONVERT UTF-16 TO UTF-8.	7-233	LOAD GUARDED STORAGE CONTROLS	7-274
CONVERT UNICODE TO UTF-8.	7-233	LOAD HALFWORD.	7-275
CONVERT UTF-32 TO UTF-16.	7-237	LOAD HALFWORD IMMEDIATE	7-275
CONVERT UTF-32 TO UTF-8.	7-240	LOAD HALFWORD RELATIVE LONG	7-275
		LOAD HALFWORD HIGH.	7-276
		LOAD HALFWORD IMMEDIATE ON CONDITION	7-276
		LOAD HALFWORD HIGH IMMEDIATE ON CONDITION	7-276
		LOAD HIGH.	7-277
		LOAD HIGH AND TRAP	7-277

LOAD LOGICAL	7-277	PERFORM CRYPTOGRAPHIC	
LOAD LOGICAL RELATIVE LONG	7-277	COMPUTATION	7-316
LOAD LOGICAL AND TRAP	7-278	PERFORM LOCKED OPERATION	7-337
LOAD LOGICAL AND ZERO RIGHTMOST		PERFORM PROCESSOR ASSIST	7-351
BYTE	7-278	PERFORM RANDOM NUMBER	
LOAD LOGICAL CHARACTER	7-278	OPERATION	7-352
LOAD LOGICAL CHARACTER HIGH	7-279	POPULATION COUNT	7-365
LOAD LOGICAL HALFWORD	7-279	PREFETCH DATA	7-365
LOAD LOGICAL HALFWORD RELATIVE		PREFETCH DATA RELATIVE LONG	7-366
LONG	7-279	ROTATE LEFT SINGLE LOGICAL	7-367
LOAD LOGICAL HALFWORD HIGH	7-280	ROTATE THEN AND SELECTED BITS	7-368
LOAD LOGICAL IMMEDIATE	7-280	ROTATE THEN EXCLUSIVE OR	
LOAD LOGICAL THIRTY ONE BITS	7-280	SELECTED BITS	7-368
LOAD LOGICAL THIRTY ONE BITS AND		ROTATE THEN OR SELECTED BITS	7-368
TRAP	7-281	ROTATE THEN INSERT SELECTED BITS	7-369
LOAD MULTIPLE	7-281	ROTATE THEN INSERT SELECTED BITS	
LOAD MULTIPLE DISJOINT	7-282	HIGH	7-371
LOAD MULTIPLE HIGH	7-282	ROTATE THEN INSERT SELECTED BITS	
LOAD NEGATIVE	7-282	LOW	7-371
LOAD ON CONDITION	7-283	SEARCH STRING	7-372
LOAD HIGH ON CONDITION	7-283	SEARCH STRING UNICODE	7-374
LOAD PAIR DISJOINT	7-284	SELECT	7-376
LOAD PAIR FROM QUADWORD	7-285	SELECT HIGH	7-376
LOAD POSITIVE	7-286	SET ACCESS	7-377
LOAD REVERSED	7-286	SET ADDRESSING MODE	7-377
MONITOR CALL	7-287	SET PROGRAM MASK	7-378
MOVE	7-288	SHIFT LEFT DOUBLE	7-378
MOVE INVERSE	7-289	SHIFT LEFT DOUBLE LOGICAL	7-379
MOVE LONG	7-289	SHIFT LEFT SINGLE	7-379
MOVE LONG EXTENDED	7-293	SHIFT LEFT SINGLE LOGICAL	7-380
MOVE LONG UNICODE	7-296	SHIFT RIGHT DOUBLE	7-381
MOVE NUMERICS	7-300	SHIFT RIGHT DOUBLE LOGICAL	7-381
MOVE RIGHT TO LEFT	7-300	SHIFT RIGHT SINGLE	7-382
MOVE STRING	7-301	SHIFT RIGHT SINGLE LOGICAL	7-383
MOVE WITH OFFSET	7-302	STORE	7-383
MOVE ZONES	7-303	STORE RELATIVE LONG	7-384
MULTIPLY	7-304	STORE ACCESS MULTIPLE	7-384
MULTIPLY HALFWORD	7-305	STORE CHARACTER	7-385
MULTIPLY HALFWORD IMMEDIATE	7-305	STORE CHARACTER HIGH	7-385
MULTIPLY LOGICAL	7-306	STORE CHARACTERS UNDER MASK	7-385
MULTIPLY SINGLE	7-307	STORE CLOCK	7-386
MULTIPLY SINGLE IMMEDIATE	7-307	STORE CLOCK FAST	7-386
NAND	7-308	STORE CLOCK EXTENDED	7-387
NEXT INSTRUCTION ACCESS INTENT	7-309	STORE FACILITY LIST EXTENDED	7-389
NONTRANSACTIONAL STORE	7-310	STORE GUARDED STORAGE CONTROLS	7-390
NOR	7-311	STORE HALFWORD	7-390
NOT EXCLUSIVE OR	7-311	STORE HALFWORD RELATIVE LONG	7-391
OR	7-312	STORE HALFWORD HIGH	7-391
OR IMMEDIATE	7-313	STORE HIGH	7-391
OR WITH COMPLEMENT	7-314	STORE MULTIPLE	7-392
PACK	7-314	STORE MULTIPLE HIGH	7-392
PACK ASCII	7-315	STORE ON CONDITION	7-392
PACK UNICODE	7-316	STORE HIGH ON CONDITION	7-393
		STORE PAIR TO QUADWORD	7-393

STORE REVERSED	7-394
SUBTRACT	7-394
SUBTRACT HALFWORD	7-395
SUBTRACT HIGH	7-396
SUBTRACT LOGICAL	7-396
SUBTRACT LOGICAL IMMEDIATE	7-397
SUBTRACT LOGICAL HIGH	7-397
SUBTRACT LOGICAL WITH BORROW	7-398
SUPERVISOR CALL	7-398
TEST ADDRESSING MODE	7-399
TEST AND SET	7-399
TEST UNDER MASK (TEST UNDER MASK HIGH, TEST UNDER MASK LOW)	7-400
TRANSACTION ABORT	7-401
TRANSACTION BEGIN (TBEGIN)	7-401
TRANSACTION BEGIN (TBEGINC)	7-406
TRANSACTION END	7-408
TRANSLATE	7-408
TRANSLATE AND TEST	7-409
TRANSLATE AND TEST EXTENDED	7-410
TRANSLATE AND TEST REVERSE EXTENDED	7-410
TRANSLATE AND TEST REVERSE	7-415
TRANSLATE EXTENDED	7-415
TRANSLATE ONE TO ONE	7-418
TRANSLATE ONE TO TWO	7-418
TRANSLATE TWO TO ONE	7-418
TRANSLATE TWO TO TWO	7-418
UNPACK	7-423
UNPACK ASCII	7-423
UNPACK UNICODE	7-424
UPDATE TREE	7-425
Protection of Cryptographic Keys	7-431
Protection of DES Keys	7-432
Protection of AES Keys	7-434
Protection of ECC Keys	7-436

Chapter 8, Decimal Instructions 8-1

Decimal-Number Formats	8-1
Zoned Format	8-1
Packed-Decimal Formats	8-1
Signed-Packed-Decimal Format	8-2
Unsigned-Packed-Decimal Format	8-2
Decimal Codes	8-2
Decimal Operations	8-3
Decimal-Arithmetic Instructions	8-3
Editing Instructions	8-4
Execution of Decimal Instructions	8-4
Other Instructions for Decimal Operands	8-4
General-Operand Data Exception	8-5
Instructions	8-5
ADD DECIMAL	8-6
COMPARE DECIMAL	8-7

DIVIDE DECIMAL	8-7
EDIT	8-8
EDIT AND MARK	8-11
MULTIPLY DECIMAL	8-12
SHIFT AND ROUND DECIMAL	8-12
SUBTRACT DECIMAL	8-13
TEST DECIMAL	8-14
ZERO AND ADD	8-14

Chapter 9, Floating-Point Overview and Support Instructions 9-1

Sign Bit	9-2
Finite Floating-Point Numbers	9-2
Infinities	9-2
Not-A-Number (NaN)	9-2
Signaling and Quiet NaNs	9-2
Payload	9-2
Propagation of NaNs	9-3
Default QNaN	9-3
Floating-Point Number Representations	9-3
Hexadecimal-Floating-Point (HFP)	9-3
Binary Floating-Point (BFP)	9-4
Decimal Floating-Point (DFP)	9-4
Canonical DFP Data	9-4
Comparison of Floating-Point Number Representations	9-4
Floating-Point Number Ranges	9-4
Equivalent Floating-Point Number Representations	9-5
Effective Width	9-7
Floating-Point Data in Storage	9-8
Registers And Controls	9-8
Floating-Point Registers	9-8
Additional Floating-Point (AFP) Registers	9-9
Valid Floating-Point-Register Designations	9-9
Floating-Point-Control (FPC) Register	9-9
IEEE Masks and Flags	9-10
FPC DXC Byte	9-10
Operations on the FPC Register	9-10
AFP-Register-Control Bit	9-11
IEEE Computational Operations	9-11
Intermediate Values	9-12
Precise Intermediate Value	9-12
Precision-Rounded Value	9-12
Denormalized Value	9-12
Functionally-Rounded Value	9-12
Rounded Intermediate Value	9-12
Scaled Value	9-12
Scale Factor (Ψ)	9-12
Unsigned Scaling Exponent (α)	9-12
Signed Scaling Exponent (Ω)	9-13
IEEE Rounding	9-13
Permissible Set	9-13

Selection of Candidates	9-13	COMPARE AND SWAP AND PURGE	10-21
Ties	9-13	DIAGNOSE	10-23
Voting Digit and Common-Rounding- Point View	9-13	EXTRACT AND SET EXTENDED AUTHORITY	10-24
Rounding Methods	9-14	EXTRACT PRIMARY ASN	10-24
Explicit Rounding Methods	9-17	EXTRACT PRIMARY ASN AND INSTANCE	10-24
Summary of Rounding Action	9-17	EXTRACT SECONDARY ASN	10-24
IEEE Exceptions	9-18	EXTRACT SECONDARY ASN AND INSTANCE	10-25
Concurrent IEEE Exceptions	9-18	EXTRACT STACKED REGISTERS	10-25
IEEE Invalid Operation	9-19	EXTRACT STACKED STATE	10-26
IEEE Division-By-Zero	9-19	INSERT ADDRESS SPACE CONTROL	10-29
IEEE Overflow	9-19	INSERT PSW KEY	10-30
IEEE Underflow	9-20	INSERT REFERENCE BITS MULTIPLE	10-30
IEEE Inexact	9-20	INSERT STORAGE KEY EXTENDED	10-30
Quantum Exception	9-21	INSERT VIRTUAL STORAGE KEY	10-31
Suppression of Certain IEEE Exceptions	9-23	INVALIDATE DAT TABLE ENTRY	10-32
IEEE Same-Radix Format Conversion	9-23	INVALIDATE PAGE TABLE ENTRY	10-37
IEEE Comparison	9-24	LOAD ADDRESS SPACE PARAMETERS	10-41
Condition Codes for IEEE Instructions	9-24	LOAD CONTROL	10-50
Instructions	9-24	LOAD PAGE TABLE ENTRY ADDRESS	10-50
CONVERT BFP TO HFP	9-27	LOAD PSW	10-54
CONVERT HFP TO BFP	9-28	LOAD PSW EXTENDED	10-55
COPY SIGN	9-30	LOAD REAL ADDRESS	10-56
EXTRACT FPC	9-30	LOAD USING REAL ADDRESS	10-60
LOAD	9-31	MODIFY STACKED STATE	10-61
LOAD COMPLEMENT	9-31	MOVE PAGE	10-62
LOAD FPC	9-31	MOVE TO PRIMARY	10-65
LOAD FPC AND SIGNAL	9-32	MOVE TO SECONDARY	10-65
LOAD FPR FROM GR	9-34	MOVE WITH DESTINATION KEY	10-67
LOAD GR FROM FPR	9-34	MOVE WITH KEY	10-67
LOAD NEGATIVE	9-34	MOVE WITH OPTIONAL SPECIFICATIONS	10-69
LOAD POSITIVE	9-34	MOVE WITH SOURCE KEY	10-72
LOAD ZERO	9-35	PAGE IN	10-73
PERFORM FLOATING-POINT OPERATION	9-35	PAGE OUT	10-74
SET BFP ROUNDING MODE	9-47	PERFORM CRYPTOGRAPHIC KEY MANAGEMENT OPERATION	10-75
SET DFP ROUNDING MODE	9-47	PERFORM FRAME MANAGEMENT FUNCTION	10-80
SET FPC	9-47	PERFORM TIMING FACILITY FUNCTION	10-83
SET FPC AND SIGNAL	9-48	PERFORM TOPOLOGY FUNCTION	10-92
STORE	9-48	PROGRAM CALL	10-93
STORE FPC	9-49	PROGRAM RETURN	10-106
Summary of All Floating-Point Instructions	9-49	PROGRAM TRANSFER	10-110
Impacts on ESA/390 and ESA/390-Compatibility Mode	9-52	PROGRAM TRANSFER WITH INSTANCE	10-110
Impacts of the Decimal-Floating-Point Facility	9-52	PURGE ALB	10-119
Impacts of the Floating-Point Extension Facility	9-53	PURGE TLB	10-119
Chapter 10, Control Instructions	10-1	RESET REFERENCE BIT EXTENDED	10-119
BRANCH AND SET AUTHORITY	10-7	RESET REFERENCE BITS MULTIPLE	10-120
BRANCH AND STACK	10-11	RESUME PROGRAM	10-120
BRANCH IN SUBSPACE GROUP	10-13	SET ADDRESS SPACE CONTROL	10-123
COMPARE AND REPLACE DAT TABLE ENTRY	10-17	SET ADDRESS SPACE CONTROL FAST	10-123
		SET CLOCK	10-124
		SET CLOCK COMPARATOR	10-125

SET CLOCK PROGRAMMABLE FIELD	10-126
SET CPU TIMER	10-126
SET PREFIX	10-126
SET PSW KEY FROM ADDRESS	10-127
SET SECONDARY ASN	10-128
SET SECONDARY ASN WITH INSTANCE	10-128
SET STORAGE KEY EXTENDED	10-133
SET SYSTEM MASK	10-136
SIGNAL PROCESSOR	10-136
STORE CLOCK COMPARATOR	10-138
STORE CONTROL	10-138
STORE CPU ADDRESS	10-139
STORE CPU ID	10-139
STORE CPU TIMER	10-141
STORE FACILITY LIST	10-141
STORE PREFIX	10-142
STORE REAL ADDRESS	10-142
STORE SYSTEM INFORMATION	10-143
STORE THEN AND SYSTEM MASK	10-167
STORE THEN OR SYSTEM MASK	10-167
STORE USING REAL ADDRESS	10-168
TEST ACCESS	10-168
TEST BLOCK	10-170
TEST PENDING EXTERNAL INTERRUPTION	10-172
TEST PROTECTION	10-173
TRACE	10-176
TRAP	10-177

Chapter 11, Machine-Check

Handling	11-1
Machine-Check Detection	11-2
Correction of Machine Malfunctions	11-2
Error Checking and Correction	11-2
CPU Retry	11-2
Effects of CPU Retry	11-3
Checkpoint Synchronization	11-3
Handling of Machine Checks during Checkpoint Synchronization	11-4
Checkpoint-Synchronization Operations	11-4
Checkpoint-Synchronization Action	11-4
Channel-Subsystem Recovery	11-5
Unit Deletion	11-5
Handling of Machine Checks	11-5
Validation	11-6
Invalid CBC in Storage	11-7
Programmed Validation of Storage	11-7
Invalid CBC in Storage Keys	11-7
Invalid CBC in Registers	11-9
Check-Stop State	11-9
System Check Stop	11-10
Machine-Check Interruption	11-10
Exigent Conditions	11-10

Repressible Conditions	11-10
Interruption Action	11-11
Interruption Action in the z/Architecture Architectural Mode	11-11
Interruption Action in the ESA/390-Compatibility Mode	11-12
Interruption Action: Common Actions	11-13
Point of Interruption	11-14
Machine-Check-Interruption Code	11-14
Subclass	11-15
System Damage	11-15
Instruction-Processing Damage	11-15
System Recovery	11-15
Timing-Facility Damage	11-16
External Damage	11-16
Degradation	11-16
Warning	11-17
Channel Report Pending	11-17
Service-Processor Damage	11-17
Channel-Subsystem Damage	11-17
Subclass Modifiers	11-17
Backed Up	11-17
Delayed Access Exception	11-17
Ancillary Report	11-18
Synchronous Machine-Check-Interruption Conditions	11-18
Processing Backup	11-18
Processing Damage	11-19
Storage Errors	11-19
Storage Error Uncorrected	11-19
Storage Error Corrected	11-19
Storage-Key Error Uncorrected	11-19
Storage Degradation	11-19
Indirect Storage Error	11-20
Machine-Check Interruption-Code Validity Bits	11-20
PSW-MWP Validity	11-20
PSW Mask and Key Validity	11-20
PSW Program-Mask and Condition-Code Validity	11-21
PSW-Instruction-Address Validity	11-21
Failing-Storage-Address Validity	11-21
Vector Register Validity	11-21
External-Damage-Code Validity	11-21
Floating-Point-Register Validity	11-21
General-Register Validity	11-21
Control-Register Validity	11-21
Storage Logical Validity	11-21
Access-Register Validity	11-21
Guarded-Storage-Registers Validity	11-22
TOD-Programmable-Register Validity	11-22
Floating-Point-Control-Register Validity	11-22
CPU-Timer Validity	11-22
Clock-Comparator Validity	11-22

Machine-Check Extended Interruption Information	11-22
Register-Save Areas	11-23
External-Damage Code	11-23
Failing-Storage Address	11-24
Machine-Check Extended Save Area (MCESA)	11-24
Machine-Check Extended Save Area in the z/Architecture Architectural Mode	11-24
Machine-Check Extended Save Area in the ESA/390 Compatibility Mode	11-25
Handling of Machine-Check Conditions	11-25
Floating Interruption Conditions	11-25
Floating Machine-Check-Interruption Conditions	11-26
Floating I/O Interruptions	11-26
Machine-Check Masking	11-26
Channel-Report-Pending Subclass Mask	11-26
Recovery Subclass Mask	11-26
Degradation Subclass Mask	11-27
External-Damage Subclass Mask	11-27
Warning Subclass Mask	11-27
Machine-Check Logout	11-27
Summary of Machine-Check Masking	11-27

Chapter 12, Operator Facilities 12-1

Manual Operation	12-1
Basic Operator Facilities	12-1
Address-Compare Controls	12-1
Alter-and-Display Controls	12-2
Architectural-Mode Indicator	12-2
Architectural-Mode-Selection Controls	12-3
Check-Stop Indicator	12-3
CPUs-per-Core Indicator	12-3
IML Controls	12-3
Interrupt Key	12-3
Load Indicator	12-3
Load-Clear Key	12-4
Load-Clear-List-Directed Key	12-4
Load-Normal Key	12-4
Load-with-Dump Key	12-4
Load-Unit-Address Controls	12-4
Manual Indicator	12-4
Power Controls	12-4
Rate Control	12-5
Restart Key	12-5
Start Key	12-5
Stop Key	12-5
Store-Status Key	12-5
System-Reset-Clear Key	12-6
System-Reset-Normal Key	12-6
Test Indicator	12-6
TOD-Clock Control	12-6

Wait Indicator	12-6
Multiprocessing Configurations	12-6
Multithreading Considerations	12-7

Chapter 13, I/O Overview 13-1

Input/Output (I/O)	13-1
The Channel Subsystem	13-1
Subchannel Sets	13-2
Subchannels	13-2
Attachment of Input/Output Devices	13-3
Channel Paths	13-3
Control Units	13-4
I/O Devices	13-5
I/O Addressing	13-5
Subchannel-Set Identifier	13-5
Channel-Path Identifier	13-5
Subchannel Number	13-5
Device Number	13-6
Device Identifier	13-6
Fibre-Channel Extensions	13-6
I/O-Command Words	13-7
Transport Command Word (TCW)	13-7
Channel Program Organization	13-7
CCW Channel Program	13-7
TCW Channel Program	13-7
Execution of I/O Operations	13-8
Start-Function Initiation	13-8
Subchannel Operation Modes	13-9
Path Management	13-9
Channel-Program Execution	13-9
Conclusion of I/O Operations	13-10
Chaining When Using a CCW Channel Program	13-11
Chaining When Using a TCW Channel Program	13-11
Premature Conclusion of I/O Operations	13-12
I/O Interruptions	13-12

Chapter 14, I/O Instructions 14-1

I/O-Instruction Formats	14-1
I/O-Instruction Execution	14-2
Serialization	14-2
Operand Access	14-2
Condition Code	14-2
Program Exceptions	14-2
Instructions	14-2
CANCEL SUBCHANNEL	14-3
CLEAR SUBCHANNEL	14-5
HALT SUBCHANNEL	14-6
MODIFY SUBCHANNEL	14-7
RESET CHANNEL PATH	14-9
RESUME SUBCHANNEL	14-10
SET ADDRESS LIMIT	14-12

SET CHANNEL MONITOR	14-13	Transport-Command DCW	15-42
START SUBCHANNEL	14-15	Transfer-CBC-Offset-Block DCW	15-43
STORE CHANNEL PATH STATUS	14-16	CBC-Offset Block	15-44
STORE CHANNEL REPORT WORD	14-17	Transfer-TCA-Extension DCW	15-44
STORE SUBCHANNEL	14-18	Transport-Command-Area Extension	15-45
TEST PENDING INTERRUPTION	14-19	Interrogate TCCB	15-46
I/O-Interruption Code	14-20	Interrogate DCW	15-46
TEST SUBCHANNEL	14-21	Interrogate Data	15-46
Chapter 15, Basic I/O Functions	15-1	Transport Status Block	15-48
Control of Basic I/O Functions	15-1	Transport-Status Header (TSH)	15-48
Subchannel-Information Block	15-2	I/O-Status TSA	15-49
Path-Management-Control Word	15-2	Device-Detected-Program-Check TSA	15-50
Subchannel-Status Word	15-9	Interrogate TSA	15-56
Model-Dependent Area/Measurement		Command Code	15-57
Block Address	15-9	Designation of Storage Area	15-58
Summary of Modifiable Fields	15-10	CCW Channel Program Chaining	15-60
Channel-Path Allegiance	15-12	Data Chaining	15-61
Working Allegiance	15-12	Command Chaining	15-63
Working Allegiance for Subchannels		TCW Channel Program Chaining	15-63
Operating in Command Mode	15-12	Skipping	15-64
Working Allegiance for Subchannels		Program-Controlled Interruption	15-64
Operating in Transport Mode	15-12	Indirect-Storage Designator (ISD)	15-66
Active Allegiance	15-13	CCW Indirect Data Addressing	15-66
Dedicated Allegiance	15-13	Modified CCW Indirect Data Addressing	15-68
Channel-Path Availability	15-13	Transport Indirect Data Addressing	15-70
Control-Unit Type	15-14	Suspension of CCW Channel-Program	
Clear Function	15-14	Execution	15-73
Clear-Function Path Management	15-14	Commands and Flags for CCWs	15-75
Clear-Function Subchannel Modification	15-15	Branching in CCW Channel Programs	15-76
Clear-Function Signaling and Completion	15-15	Transfer in Channel	15-77
Halt Function	15-16	Command Retry	15-77
Halt-Function Path Management	15-16	Concluding I/O Operations before Initiation	15-77
Halt-Function Signaling and Completion	15-17	Concluding I/O Operations during Initiation	15-78
Start Function and Resume Function	15-20	Immediate Conclusion of Command-Mode I/O	
Start-Function and Resume-Function Path		Operations	15-78
Management	15-20	Concluding I/O Operations During Data	
Interrogate Function	15-22	Transfer	15-79
Interrogate-Function Path Management	15-22	Channel-Path-Reset Function	15-80
Interrogate TCCB Transportation and		Channel-Path-Reset-Function Signaling	15-81
Completion	15-22	Channel-Path-Reset-Function-Completion	
Execution of I/O Operations	15-23	Signaling	15-81
Blocking of Data	15-24	Chapter 16, I/O Interruptions	16-1
Operation-Request Block	15-24	Interruption Conditions	16-2
Command-Mode ORB	15-25	Intermediate Interruption Condition	16-4
Transport-Mode ORB	15-30	Primary Interruption Condition	16-4
Channel-Command Word	15-31	Secondary Interruption Condition	16-5
Transport Control Word	15-33	Alert Interruption Condition	16-5
Transport-Command-Control Block	15-36	Priority of Interruptions	16-5
Transport-Command-Area Header	15-37	Interruption Action	16-6
Transport-Command Area	15-37	Interruption-Response Block	16-6
Device-Command Word	15-38	IRB Format	16-6
Transport-Command-Area Trailer	15-40	Subchannel-Status Word	16-7

Command-Mode SCSW	16-8	FCX-Status Field	16-44
Subchannel Key	16-9	Subchannel-Extended-Status Field	16-44
Suspend Control (S)	16-9	Extended-Status Word	16-47
Extended-Status-Word Format (L)	16-9	Extended-Status Format 0	16-47
Deferred Condition Code (CC)	16-9	Subchannel Logout	16-47
CCW Format (F)	16-11	Extended-Report Word	16-51
Prefetch (P)	16-11	Failing-Storage Address	16-53
Initial-Status-Interruption Control (I)	16-12	Extended-Subchannel-Logout Descriptor (ESLD)	16-53
Address-Limit-Checking Control (A)	16-12	Secondary-CCW Address	16-53
IRB-Format Control (X)	16-12	Extended-Status Format 1	16-53
Suppress-Suspended Interruption (U)	16-12	Extended-Status Format 2	16-54
Subchannel-Control Field	16-12	Extended-Status Format 3	16-55
Zero Condition Code (Z)	16-12	Extended-Control Word	16-56
Extended Control (E)	16-12	Extended-Measurement Word	16-56
Path Not Operational (N)	16-13		
Function Control (FC)	16-13		
Activity Control (AC)	16-14		
Status Control (SC)	16-17		
CCW-Address Field	16-19		
Device-Status Field	16-24		
Subchannel-Status Field	16-24		
Program-Controlled Interruption	16-24		
Incorrect Length	16-24		
Program Check	16-25		
Protection Check	16-28		
Channel-Data Check	16-28		
Channel-Control Check	16-29		
Interface-Control Check	16-29		
Chaining Check	16-30		
Count Field	16-31		
Transport-Mode SCSW	16-34		
Subchannel Key	16-35		
Reserved	16-35		
Extended-Status-Word Format (L)	16-35		
Deferred Condition Code (CC)	16-35		
Format (FMT)	16-35		
IRB-Format Control (X)	16-35		
Interrogate Complete (Q)	16-35		
Subchannel-Control Field	16-35		
Extended Control (E)	16-35		
Path Not Operational (N)	16-35		
Function Control (FC)	16-35		
Activity Control (AC)	16-36		
Status Control (SC)	16-36		
TCW Address Field	16-36		
Device-Status Field	16-39		
Subchannel-Status Field	16-39		
Incorrect Length	16-39		
Program Check	16-40		
Protection Check	16-42		
Channel-Data Check	16-42		
Channel-Control Check	16-43		
Interface-Control Check	16-43		
Channel-Subsystem Retry Failed	16-44		

Chapter 17, I/O Support Functions . . 17-1

Channel-Subsystem Monitoring	17-1
Channel-Subsystem Timing	17-2
Channel-Subsystem Timer	17-2
Measurement-Block Update	17-2
Measurement Block	17-3
Measurement-Block Format	17-7
Measurement-Block Origin	17-7
Measurement-Block Address	17-7
Measurement-Block Key	17-8
Measurement-Block Index	17-8
Measurement-Block-Update Mode	17-8
Measurement-Block-Format Control	17-8
Measurement-Block-Update Enable	17-9
Control-Unit-Queuing Measurement	17-9
Control-Unit-Defer Time	17-9
Device-Active-Only Measurement	17-9
Initial-Command-Response Measurement	17-9
Time-Interval-Measurement Accuracy	17-9
Device-Connect-Time Measurement	17-10
Device-Connect-Time-Measurement Mode	17-10
Device-Connect-Time-Measurement Enable	17-10
Extended Measurement Word	17-11
Extended-Measurement-Word Enable	17-11
Signals and Resets	17-11
Signals	17-11
Halt Signal	17-12
Clear Signal	17-12
Reset Signal	17-12
Resets	17-13
Channel-Path Reset	17-13
I/O-System Reset	17-13
Externally Initiated Functions	17-16
Initial Program Loading	17-16
CCW-type IPL	17-17

List-Directed IPL	17-19
IPL Information Report Block	17-21
IPL Signature Certificate List	17-22
IPL Signature Certificate Entry	17-22
Reconfiguration of the I/O System	17-25
Status Verification	17-26
Address-Limit Checking	17-26
Configuration Alert	17-27
Incorrect-Length-Indication Suppression	17-27
Concurrent Sense	17-27
Channel-Subsystem Recovery	17-27
Channel Report	17-28
Channel-Report Word	17-29
Restore-Subchannel Facility	17-31
Extended-Subchannel-Logout Facility	17-32
Channel-Subsystem-I/O-Priority Facility	17-32
Number of Channel-Subsystem-Priority Levels	17-33
Multiple-Subchannel-Set Facility	17-33

Chapter 18, Hexadecimal-Floating-Point Instructions 18-1

HFP Arithmetic	18-1
HFP Number Representation	18-1
Normalization	18-2
HFP Data Formats	18-2
HFP Short Format	18-4
HFP Long Format	18-4
HFP Extended Format	18-4
Instructions	18-5
ADD NORMALIZED	18-8
ADD UNNORMALIZED	18-9
COMPARE	18-10
CONVERT FROM FIXED	18-11
CONVERT TO FIXED	18-11
DIVIDE	18-12
HALVE	18-13
LOAD AND TEST	18-13
LOAD COMPLEMENT	18-14
LOAD FP INTEGER	18-15
LOAD LENGTHENED	18-15
LOAD NEGATIVE	18-16
LOAD POSITIVE	18-16
LOAD ROUNDED	18-17
MULTIPLY	18-17
MULTIPLY AND ADD	18-19
MULTIPLY AND SUBTRACT	18-19
MULTIPLY AND ADD UNNORMALIZED	18-20
MULTIPLY UNNORMALIZED	18-22
SQUARE ROOT	18-23
SUBTRACT NORMALIZED	18-24
SUBTRACT UNNORMALIZED	18-25

Chapter 19, Binary-Floating-Point

Instructions	19-1
Binary-Floating-Point Facility	19-1
Floating-Point-Control (FPC) Register	19-2
BFP Arithmetic	19-2
BFP Data Formats	19-2
BFP Short Format	19-2
BFP Long Format	19-2
BFP Extended Format	19-2
Biased Exponent	19-2
Significand	19-3
Values of Nonzero Numbers	19-3
Classes of BFP Data	19-4
Zeros	19-4
Subnormal Numbers	19-4
Normal Numbers	19-4
Infinities	19-4
Signaling and Quiet NaNs	19-4
BFP-Format Conversion	19-5
BFP Rounding	19-5
BFP Comparison	19-5
Remainder	19-5
IEEE Exceptions	19-7
Summary of Rounding And Range Actions	19-8
Result Figures	19-9
Data-Exception Codes (DXC) and Abbreviations	19-10
Instructions	19-11
ADD	19-15
COMPARE	19-17
COMPARE AND SIGNAL	19-18
CONVERT FROM FIXED	19-19
CONVERT FROM LOGICAL	19-21
CONVERT TO FIXED	19-22
CONVERT TO LOGICAL	19-25
DIVIDE	19-27
DIVIDE TO INTEGER	19-28
LOAD AND TEST	19-31
LOAD COMPLEMENT	19-31
LOAD FP INTEGER	19-32
LOAD LENGTHENED	19-33
LOAD NEGATIVE	19-34
LOAD POSITIVE	19-35
LOAD ROUNDED	19-35
MULTIPLY	19-37
MULTIPLY AND ADD	19-38
MULTIPLY AND SUBTRACT	19-38
SQUARE ROOT	19-40
SUBTRACT	19-40
TEST DATA CLASS	19-41

Chapter 20, Decimal-Floating-Point

Instructions	20-1
Decimal-Floating-Point Facility	20-1
DFP Arithmetic	20-2
Finite Floating-Point Number	20-2
Cohort	20-2
Quantum	20-2
Preferred Quantum	20-2
Scaled Preferred Quantum	20-3
Delivered Quantum	20-3
Special Quantum-Handling Operations	20-3
DFP Data Formats	20-3
DFP Short Format	20-3
DFP Long Format	20-3
DFP Extended Format	20-4
Sign	20-4
Combination	20-4
Encoded Trailing Significand	20-5
Values of Finite Numbers	20-5
Significand	20-5
DFP Significant Digits	20-5
Canonical Decls	20-6
DFP Canonical Data	20-6
Classes of DFP Data	20-6
Zeros	20-6
Subnormal Numbers	20-6
Normal Numbers	20-7
Infinities	20-7
Signaling and Quiet NaNs	20-7
Canonicalization	20-7
DFP-Format Conversion	20-7
DFP Rounding	20-7
DFP Comparison	20-7
DFP Formatting Instructions	20-8
Signed-Packed-Decimal Format	20-8
Unsigned-Packed-Decimal Format	20-8
Zoned-Decimal Format	20-9
IEEE Exceptions	20-9
Summary of Preferred Quantum	20-10
Summary of Rounding And Range Actions	20-10
Result Figures	20-15
Data-Exception Codes (DXC) and Abbreviations	20-15
Instructions	20-16
ADD	20-19
COMPARE	20-22
COMPARE AND SIGNAL	20-23
COMPARE BIASED EXPONENT	20-23
CONVERT FROM FIXED	20-24
CONVERT FROM LOGICAL	20-25
CONVERT FROM PACKED	20-26
CONVERT FROM SIGNED PACKED	20-28
CONVERT FROM UNSIGNED PACKED	20-28

CONVERT FROM ZONED	20-29
CONVERT TO FIXED	20-29
CONVERT TO LOGICAL	20-32
CONVERT TO PACKED	20-33
CONVERT TO SIGNED PACKED	20-35
CONVERT TO UNSIGNED PACKED	20-35
CONVERT TO ZONED	20-36
DIVIDE	20-37
EXTRACT BIASED EXPONENT	20-39
EXTRACT SIGNIFICANCE	20-39
INSERT BIASED EXPONENT	20-40
LOAD AND TEST	20-41
LOAD FP INTEGER	20-42
LOAD LENGTHENED	20-45
LOAD ROUNDED	20-46
MULTIPLY	20-47
QUANTIZE	20-49
REROUND	20-52
SHIFT SIGNIFICAND LEFT	20-54
SHIFT SIGNIFICAND RIGHT	20-54
SUBTRACT	20-55
TEST DATA CLASS	20-56
TEST DATA GROUP	20-57
Densely Packed Decimal (DPD)	20-58
Decimal-to-DPD Mapping	20-58
DPD-to-Decimal Mapping	20-58

Chapter 21, Vector Overview and Support Instructions

Support Instructions	21-1
Overview	21-1
Vector Registers and Controls	21-1
Vector Enablement Control	21-2
Vector Storage Accesses	21-2
Saturating Arithmetic	21-2
Instructions	21-2
VECTOR BIT PERMUTE	21-4
VECTOR GATHER ELEMENT	21-5
VECTOR GENERATE BYTE MASK	21-5
VECTOR GENERATE MASK	21-6
VECTOR LOAD	21-6
VECTOR LOAD AND REPLICATE	21-7
VECTOR LOAD BYTE REVERSED ELEMENT	21-7
VECTOR LOAD BYTE REVERSED ELEMENT AND REPLICATE	21-8
VECTOR LOAD BYTE REVERSED ELEMENT AND ZERO	21-8
VECTOR LOAD BYTE REVERSED ELEMENTS	21-9
VECTOR LOAD ELEMENT	21-9
VECTOR LOAD ELEMENT IMMEDIATE	21-10
VECTOR LOAD ELEMENTS REVERSED	21-10
VECTOR LOAD GR FROM VR ELEMENT	21-11

VECTOR LOAD LOGICAL ELEMENT AND ZERO	21-12
VECTOR LOAD MULTIPLE	21-12
VECTOR LOAD RIGHTMOST WITH LENGTH	21-13
VECTOR LOAD TO BLOCK BOUNDARY	21-14
VECTOR LOAD VR ELEMENT FROM GR	21-14
VECTOR LOAD VR FROM GRS DISJOINT	21-15
VECTOR LOAD WITH LENGTH	21-15
VECTOR MERGE HIGH	21-15
VECTOR MERGE LOW	21-16
VECTOR PACK	21-16
VECTOR PACK SATURATE	21-17
VECTOR PACK LOGICAL SATURATE	21-18
VECTOR PERMUTE	21-18
VECTOR PERMUTE DOUBLEWORD IMMEDIATE	21-19
VECTOR REPLICATE	21-19
VECTOR REPLICATE IMMEDIATE	21-20
VECTOR SCATTER ELEMENT	21-20
VECTOR SELECT	21-21
VECTOR SIGN EXTEND TO DOUBLEWORD	21-21
VECTOR STORE	21-21
VECTOR STORE BYTE REVERSED ELEMENT	21-22
VECTOR STORE BYTE REVERSED ELEMENTS	21-22
VECTOR STORE ELEMENT	21-23
VECTOR STORE ELEMENTS REVERSED	21-24
VECTOR STORE MULTIPLE	21-24
VECTOR STORE RIGHTMOST WITH LENGTH	21-25
VECTOR STORE WITH LENGTH	21-26
VECTOR UNPACK HIGH	21-26
VECTOR UNPACK LOGICAL HIGH	21-26
VECTOR UNPACK LOW	21-27
VECTOR UNPACK LOGICAL LOW	21-27

Chapter 22, Vector Integer

Instructions	22-1
Instructions	22-1
VECTOR ADD	22-3
VECTOR ADD COMPUTE CARRY	22-4
VECTOR ADD WITH CARRY	22-4
VECTOR ADD WITH CARRY COMPUTE CARRY	22-5
VECTOR AND	22-5
VECTOR AND WITH COMPLEMENT	22-5
VECTOR AVERAGE	22-6
VECTOR AVERAGE LOGICAL	22-6
VECTOR CHECKSUM	22-6
VECTOR ELEMENT COMPARE	22-7

VECTOR ELEMENT COMPARE LOGICAL	22-7
VECTOR COMPARE EQUAL	22-7
VECTOR COMPARE HIGH	22-8
VECTOR COMPARE HIGH LOGICAL	22-9
VECTOR COUNT LEADING ZEROS	22-10
VECTOR COUNT TRAILING ZEROS	22-10
VECTOR EXCLUSIVE OR	22-11
VECTOR GALOIS FIELD MULTIPLY SUM	22-11
VECTOR GALOIS FIELD MULTIPLY SUM AND ACCUMULATE	22-12
VECTOR LOAD COMPLEMENT	22-12
VECTOR LOAD POSITIVE	22-12
VECTOR MAXIMUM	22-13
VECTOR MAXIMUM LOGICAL	22-13
VECTOR MINIMUM	22-13
VECTOR MINIMUM LOGICAL	22-14
VECTOR MULTIPLY AND ADD LOW	22-14
VECTOR MULTIPLY AND ADD HIGH	22-15
VECTOR MULTIPLY AND ADD LOGICAL HIGH	22-15
VECTOR MULTIPLY AND ADD EVEN	22-15
VECTOR MULTIPLY AND ADD LOGICAL EVEN	22-15
VECTOR MULTIPLY AND ADD ODD	22-16
VECTOR MULTIPLY AND ADD LOGICAL ODD	22-16
VECTOR MULTIPLY HIGH	22-16
VECTOR MULTIPLY LOGICAL HIGH	22-17
VECTOR MULTIPLY LOW	22-17
VECTOR MULTIPLY EVEN	22-18
VECTOR MULTIPLY LOGICAL EVEN	22-18
VECTOR MULTIPLY ODD	22-18
VECTOR MULTIPLY LOGICAL ODD	22-18
VECTOR MULTIPLY SUM LOGICAL	22-19
VECTOR NAND	22-20
VECTOR NOR	22-20
VECTOR NOT EXCLUSIVE OR	22-20
VECTOR OR	22-20
VECTOR OR WITH COMPLEMENT	22-21
VECTOR POPULATION COUNT	22-21
VECTOR ELEMENT ROTATE LEFT LOGICAL	22-21
VECTOR ELEMENT ROTATE AND INSERT UNDER MASK	22-22
VECTOR ELEMENT SHIFT LEFT	22-23
VECTOR ELEMENT SHIFT RIGHT ARITHMETIC	22-23
VECTOR ELEMENT SHIFT RIGHT LOGICAL	22-24
VECTOR SHIFT LEFT	22-25
VECTOR SHIFT LEFT BY BYTE	22-25
VECTOR SHIFT LEFT DOUBLE BY BIT	22-25
VECTOR SHIFT LEFT DOUBLE BY BYTE	22-26
VECTOR SHIFT RIGHT ARITHMETIC	22-26

VECTOR SHIFT RIGHT ARITHMETIC BY BYTE	22-26
VECTOR SHIFT RIGHT DOUBLE BY BIT	22-26
VECTOR SHIFT RIGHT LOGICAL	22-27
VECTOR SHIFT RIGHT LOGICAL BY BYTE	22-27
VECTOR SUBTRACT	22-27
VECTOR SUBTRACT COMPUTE BORROW INDICATION	22-28
VECTOR SUBTRACT WITH BORROW INDICATION	22-28
VECTOR SUBTRACT WITH BORROW COMPUTE BORROW INDICATION	22-29
VECTOR SUM ACROSS DOUBLEWORD	22-29
VECTOR SUM ACROSS QUADWORD	22-30
VECTOR SUM ACROSS WORD	22-30
VECTOR TEST UNDER MASK	22-31

Chapter 23, Vector String

Instructions	23-1
Vector String Facility	23-1
Instructions	23-1
VECTOR FIND ANY ELEMENT EQUAL	23-2
VECTOR FIND ELEMENT EQUAL	23-3
VECTOR FIND ELEMENT NOT EQUAL	23-4
VECTOR ISOLATE STRING	23-5
VECTOR STRING RANGE COMPARE	23-6
VECTOR STRING SEARCH	23-8

Chapter 24, Vector Floating-Point

Instructions	24-1
IEEE Exception Handling	24-1
Result Figures	24-1
Instructions	24-2
VECTOR FP ADD	24-4
VECTOR FP COMPARE SCALAR	24-7
VECTOR FP COMPARE AND SIGNAL SCALAR	24-8
VECTOR FP COMPARE EQUAL	24-9
VECTOR FP COMPARE HIGH	24-11
VECTOR FP COMPARE HIGH OR EQUAL	24-13
VECTOR FP CONVERT FROM FIXED	24-15
VECTOR FP CONVERT FROM LOGICAL	24-17
VECTOR FP CONVERT TO FIXED	24-18
VECTOR FP CONVERT TO LOGICAL	24-20
VECTOR FP DIVIDE	24-22
VECTOR LOAD FP INTEGER	24-24
VECTOR FP LOAD LENGTHENED	24-26
VECTOR FP LOAD ROUNDED	24-27
VECTOR FP MAXIMUM	24-28
VECTOR FP MINIMUM	24-34
VECTOR FP MULTIPLY	24-40
VECTOR FP MULTIPLY AND ADD	24-42

VECTOR FP MULTIPLY AND SUBTRACT	24-42
VECTOR FP NEGATIVE MULTIPLY AND ADD	24-42
VECTOR FP NEGATIVE MULTIPLY AND SUBTRACT	24-42
VECTOR FP PERFORM SIGN OPERATION	24-44
VECTOR FP SQUARE ROOT	24-45
VECTOR FP SUBTRACT	24-46
VECTOR FP TEST DATA CLASS IMMEDIATE	24-47

Chapter 25, Vector Decimal

Instructions	25-1
Vector-Packed-Decimal Facility	25-1
Vector Decimal Control	25-1
Vector Decimal Registers	25-1
Decimal Digits and Signs	25-2
Instructions	25-2
VECTOR ADD DECIMAL	25-3
VECTOR COMPARE DECIMAL	25-5
VECTOR CONVERT TO BINARY	25-5
VECTOR CONVERT TO DECIMAL	25-7
VECTOR DIVIDE DECIMAL	25-8
VECTOR LOAD IMMEDIATE DECIMAL	25-10
VECTOR MULTIPLY DECIMAL	25-10
VECTOR MULTIPLY AND SHIFT DECIMAL	25-12
VECTOR PACK ZONED	25-13
VECTOR PERFORM SIGN OPERATION DECIMAL	25-14
VECTOR REMAINDER DECIMAL	25-16
VECTOR SHIFT AND DIVIDE DECIMAL	25-18
VECTOR SHIFT AND ROUND DECIMAL	25-19
VECTOR SUBTRACT DECIMAL	25-21
VECTOR TEST DECIMAL	25-22
VECTOR UNPACK ZONED	25-22

Chapter 26, Specialized-Function-

Assist Instructions	26-1
Instructions	26-1
COMPUTE DIGITAL SIGNATURE AUTHENTICATION	26-2
DEFLATE CONVERSION CALL	26-16

Appendix A, Number Representation and Instruction-Use Examples A-1

Number Representation	A-2
Binary Integers	A-2
Signed Binary Integers	A-2
Unsigned Binary Integers	A-3
Decimal Integers	A-4
Hexadecimal-Floating-Point Numbers	A-5

Conversion Example	A-6	MOVE STRING (MVST)	A-27
Instruction-Use Examples	A-7	MOVE WITH OFFSET (MVO).	A-27
Machine Format	A-7	MOVE ZONES (MVZ)	A-28
Assembler-Language Format.	A-7	MULTIPLY (M, MR)	A-28
Addressing Mode in Examples.	A-7	MULTIPLY HALFWORD (MH)	A-29
General Instructions	A-7	OR (O, OC, OI, OR)	A-29
ADD HALFWORD (AH)	A-8	OI Example	A-29
AND (N, NC, NI, NR)	A-8	PACK (PACK)	A-29
NI Example.	A-8	ROTATE THEN EXCLUSIVE OR SELECTED	
Linkage Instructions (BAL, BALR, BAS, BASR,		BITS	A-30
BASSM, BSM)	A-8	ROTATE THEN INSERT SELECTED BITS .	A-30
Other BALR and BASR Examples	A-10	ROTATE THEN OR SELECTED BITS	A-30
BRANCH AND STACK (BAKR)	A-10	SEARCH STRING (SRST)	A-31
BAKR Example 1	A-11	SRST Example 1	A-31
BAKR Example 2	A-11	SRST Example 2	A-31
BAKR Example 3	A-11	SHIFT LEFT DOUBLE (SLDA)	A-31
BRANCH ON CONDITION (BC, BCR)	A-12	SHIFT LEFT SINGLE (SLA)	A-32
BRANCH ON COUNT (BCT, BCTR)	A-12	STORE CHARACTERS UNDER MASK	
BRANCH ON INDEX HIGH (BXH).	A-12	(STCM)	A-32
BXH Example 1	A-12	STORE MULTIPLE (STM).	A-32
BXH Example 2	A-13	TEST UNDER MASK (TM)	A-33
BRANCH ON INDEX LOW OR EQUAL		TRANSLATE (TR)	A-33
(BXLE)	A-13	TRANSLATE AND TEST (TRT)	A-34
BXLE Example 1	A-14	UNPACK (UNPK)	A-35
BXLE Example 2	A-14	UPDATE TREE (UPT).	A-36
COMPARE AND FORM CODEWORD (CFC) A-14		Decimal Instructions	A-36
COMPARE HALFWORD (CH).	A-14	ADD DECIMAL (AP)	A-36
COMPARE LOGICAL (CL, CLC, CLI, CLR) .	A-15	COMPARE DECIMAL (CP).	A-36
CLC Example.	A-15	DIVIDE DECIMAL (DP).	A-37
CLI Example.	A-15	EDIT (ED)	A-37
CLR Example.	A-16	EDIT AND MARK (EDMK).	A-38
COMPARE LOGICAL CHARACTERS		MULTIPLY DECIMAL (MP).	A-39
UNDER MASK (CLM)	A-16	SHIFT AND ROUND DECIMAL (SRP)	A-39
COMPARE LOGICAL LONG (CLCL).	A-16	Decimal Left Shift	A-39
COMPARE LOGICAL STRING (CLST)	A-18	Decimal Right Shift	A-39
CONVERT TO BINARY (CVB)	A-18	Decimal Right Shift and Round	A-40
CONVERT TO DECIMAL (CVD)	A-19	Multiplying by a Variable Power of 10	A-40
DIVIDE (D, DR)	A-19	ZERO AND ADD (ZAP).	A-41
EXCLUSIVE OR (X, XC, XI, XR)	A-20	Hexadecimal-Floating-Point Instructions.	A-41
XC Example	A-20	ADD NORMALIZED (AD, ADR, AE, AER,	
XI Example	A-21	AXR)	A-41
EXECUTE (EX)	A-21	ADD UNNORMALIZED (AU, AUR, AW,	
FIND LEFTMOST ONE (FLOGR)	A-22	AWR)	A-42
INSERT CHARACTERS UNDER MASK		COMPARE (CD, CDR, CE, CER)	A-42
(ICM)	A-23	DIVIDE (DD, DDR, DE, DER)	A-42
LOAD (L, LR)	A-23	HALVE (HDR, HER)	A-43
LOAD ADDRESS (LA)	A-23	MULTIPLY (MD, MDR, MDE, MDER, MXD,	
LOAD HALFWORD (LH)	A-24	MXDR, MXR).	A-43
MOVE (MVC, MVI).	A-24	Hexadecimal-Floating-Point-Number	
MVC Example	A-24	Conversion	A-44
MVI Example	A-25	Fixed Point to Hexadecimal Floating Point	A-44
MOVE INVERSE (MVCIN).	A-25	Hexadecimal Floating Point to Fixed Point	A-44
MOVE LONG (MVCL)	A-26	Multiprogramming and Multiprocessing	
MOVE NUMERICS (MVN).	A-26	Examples.	A-45

Example of a Program Failure Using OR	
Immediate	A-45
Conditional Swapping Instructions (CS, CDS)	A-46
Setting a Single Bit	A-46
Updating Counters	A-47
Bypassing Post and Wait	A-47
Lock/Unlock	A-47
Lock/Unlock with LIFO Queuing for	
Contentions	A-48
Lock/Unlock with FIFO Queuing for	
Contentions	A-49
Free-Pool Manipulation	A-50
PERFORM LOCKED OPERATION (PLO)	A-51
Sorting Instructions	A-53
Tree Format	A-53
Example of Use of Sort Instructions	A-55

Appendix B, Lists of Instructions. . . . B-1

Instructions Arranged by Name	B-5
Instructions Arranged by Mnemonic	B-29
Instructions Arranged by Operation Code	B-53

Appendix C, Condition-Code Settings C-1

Appendix D, Compression Call

Facility	D-1
Introduction to Compression Call Facility	D-1
Compression and Expansion Dictionaries	D-1
Compression-Dictionary Entries	D-1
Compression Process	D-2
Child and Sibling Characters	D-2

Child and Extension-Character Combinations	D-3
Restriction on Identical Child and Sibling	
Characters	D-3
Expansion-Dictionary Entries	D-6
Expansion Process	D-6
Compressed-Data Symbol Size	D-7
Symbol Translation	D-8
Order Preservation	D-8
Entropy Encoding	D-9
Results of Dictionary Errors	D-10
Dictionary Formats	D-10
Notation	D-10
Compression Dictionary	D-11
Format-0 Sibling Descriptor	D-11
Format-1 Sibling Descriptor	D-12
Expansion Dictionary	D-12
Character Entry	D-12
Format-1 Sibling Descriptor	D-13

Appendix G, Table of Powers of 2 . . . G-1

Appendix H, Hexadecimal Tables . . . H-1

Appendix I, EBCDIC and ISO-8 Codes .I-1

Control Character Representations	I-2
Formatting Character Representations	I-2
Additional ISO-8 Control Character	
Representations	I-2

Index X-1

Notices

References in this publication to IBM® products, programs or services do not imply that IBM intends to make these available in all countries in which IBM operates. Any reference to an IBM product, program, or service is not intended to state or imply that only IBM's product, program, or service may be used. Any functionally equivalent product, program, or service that does not infringe any of IBM's intellectual property rights may be used instead of the IBM product, program, or service. Evaluation and verification of operation in conjunction with other products, except those expressly designated by IBM, is the user's responsibility.

IBM may have patents or pending patent applications covering subject matter in this document. The furnishing of this document does not give you any license to these patents. You can send license inquiries, in writing, to the IBM Director of Licensing, IBM Corporation, North Castle Drive, Armonk, NY, 10504-1785 USA.

Trademarks

The following terms are trademarks or registered trademarks of the International Business Machines Corporation in the United States, other countries, or both:

AIX/ESA
BookMaster
CICS
DB2
Enterprise Systems Architecture/370
Enterprise Systems Architecture/390
Enterprise Systems Connection Architecture
ESA/370
ESA/390
FICON
IBM
IBM Z
IBM Z family
IBM z13
IBM z13s
IBM z14
IBM z15
IBM zSystems
IBMLink
ibm.com
MVS/ESA
OS/390
Processor Resource/Systems Manager
PR/SM
Sysplex Timer
System z
System z9
System z10
System/370
VM/ESA
z/Architecture
zEnterprise
z/OS
zPDT
z Systems
z/VM
z9
z10
z13
z14
z15

ANSI is a registered trademark of the American National Standards Institute in the United States, other countries, or both.

IEEE is a trademark of the Institute of Electrical and Electronics Engineers, Inc. in the United States, other countries, or both.

Java and all Java-based marks are trademarks or registered trademarks of Oracle America Inc. in the United States and other countries.

Linux is a registered trademark of Linus Torvalds in the United States, other countries or both.

Unicode is a registered trademark of Unicode, Incorporated in the United States, other countries, or both.

UNIX is a registered trademark of The Open Group in the United States and other countries.

Other trademarks and registered trademarks are the properties of their respective companies.

Preface

This publication provides, for reference purposes, a detailed z/Architecture™ description.

The publication applies only to systems operating as defined by z/Architecture. For systems operating in accordance with the Enterprise Systems Architecture/390® (ESA/390™) definition, Reference [1.] on page xxix should be consulted.

The publication describes each function at the level of detail needed to prepare an assembler-language program that relies on that function. It does not, however, describe the notation and conventions that must be employed in preparing such a program, for which the user must instead refer to the appropriate assembler-language publication.

The information in this publication is provided principally for use by assembler-language programmers, although anyone concerned with the functional details of z/Architecture will find it useful.

This publication is written as a reference and should not be considered an introduction or a textbook. It assumes the user has a basic knowledge of data-processing systems.

All facilities discussed in this publication are not necessarily available on every model. Furthermore, in some instances the definitions have been structured to allow for some degree of extendibility, and therefore certain capabilities may be described or implied that are not offered on any model. Examples of such capabilities are the use of a 16-bit field in the subsystem-identification word to identify the subchannel number, the size of the CPU address, and the number of CPUs sharing main storage. The allowance for this type of extendibility should not be construed as implying any intention by IBM to provide such capabilities. For information about the characteristics and availability of facilities on a specific model, see the functional characteristics publication for that model.

Largely because this publication is arranged for reference, certain words and phrases appear, of necessity, earlier in the publication than the principal discussions explaining them. The reader who encounters a problem because of this arrangement should refer to the index, which indicates the location of the key description.

The information presented in this publication is grouped in 26 chapters and several appendices:

Chapter 1, Introduction, highlights the major facilities of z/Architecture.

Chapter 2, Organization, describes the major groupings within the system — main storage, expanded storage, the central processing unit (CPU), the external time reference (ETR), and input/output — with some attention given to the composition and characteristics of those groupings.

Chapter 3, Storage, explains the information formats, the addressing of storage, and the facilities for storage protection. It also deals with dynamic address translation (DAT), which, coupled with special programming support, makes the use of a virtual storage possible.

Chapter 4, Control, describes the facilities for the switching of system status, for special externally initiated operations, for debugging, and for timing. It deals specifically with CPU states, control modes, the program-status word (PSW), control registers, tracing, program-event recording, timing facilities, resets, store status, and initial program loading.

Chapter 5, Program Execution, explains the role of instructions in program execution, looks in detail at instruction formats, and describes briefly the use of the program-status word (PSW), of branching, and of interruptions. It contains the principal description of the advanced address-space facilities that were introduced in ESA/370™. It also details the aspects of program execution on one CPU as observed by other CPUs and by channel programs.

Chapter 6, Interruptions, details the mechanism that permits the CPU to change its state as a result of conditions external to the system, within the system, or within the CPU itself. Six classes of interruptions are identified and described: machine-check interruptions, program interruptions, supervisor-call interruptions, external interruptions, input/output interruptions, and restart interruptions.

Chapter 7, General Instructions, contains detailed descriptions of logical and binary-integer data formats and of most of the unprivileged instructions.

Other unprivileged instructions are described in chapters 8-10 and 18-25.

Chapter 8, Decimal Instructions, describes in detail decimal data formats and the decimal instructions.

Chapter 9, Floating-Point Overview and Support Instructions, includes an introduction to the floating-point operations, detailed descriptions of those instructions common to binary-floating-point, decimal-floating-point, and hexadecimal-floating-point operations, and summaries of all floating-point instructions.

Chapter 10, Control Instructions, contains detailed descriptions of all of the semiprivileged and privileged instructions except for the I/O instructions.

Chapter 11, Machine-Check Handling, describes the mechanisms for detecting, correcting, and reporting machine malfunctions.

Chapter 12, Operator Facilities, describes the basic manual functions and controls available for operating and controlling the system.

Chapters 13-17 of this publication provide a detailed definition of the functions performed by the channel subsystem and the logical interface between the CPU and the channel subsystem.

Chapter 13, I/O Overview, provides a brief description of the basic components and operation of the channel subsystem.

Chapter 14, I/O Instructions, contains the description of the I/O instructions.

Chapter 15, Basic I/O Functions, describes the basic I/O functions performed by the channel subsystem, including the initiation, control, and conclusion of I/O operations.

Chapter 16, I/O Interruptions, covers I/O interruptions and interruption conditions.

Chapter 17, I/O Support Functions, describes such functions as channel-subsystem usage monitoring, resets, initial-program loading, reconfiguration, and channel-subsystem recovery.

Chapter 18, Hexadecimal-Floating-Point Instructions, contains detailed descriptions of the hexadecimal-

floating-point (HFP) data formats and the HFP instructions.

Chapter 19, Binary-Floating-Point Instructions, contains detailed descriptions of the binary-floating-point (BFP) data formats and the BFP instructions.

Chapter 20, Decimal-Floating-Point Instructions, contains detailed descriptions of the decimal-floating-point (DFP) data formats and the DFP instructions.

Chapter 21, Vector Overview and Support Instructions, describes the vector facility support instructions.

Chapter 22, Vector Integer Instructions, describes the vector facility integer instructions.

Chapter 23, Vector String Instructions, describes the vector facility string instructions.

Chapter 24, Vector Floating-Point Instructions, describes the vector facility floating-point instructions.

Chapter 25, Vector Decimal Instructions, describes the vector decimal instructions.

Chapter 26, Specialized-Function-Assist Instructions, describes the specialized-function-assist instructions.

The *Appendices* include:

- Appendix A: Information about number representation and instruction-use examples
- Appendix B: Lists of the instructions arranged in several sequences
- Appendix C: A summary of the condition-code settings
- Appendix D: Additional information on the compression-call (CMPSC) facility, including processes, dictionary formats, entropy encoding, and order preservation.
- Appendix G: A table of the powers of 2
- Appendix H: Tabular information helpful in dealing with hexadecimal numbers
- Appendix I: A table of EBCDIC and other codes.

Size and Number Notation

In this publication, the letters K, M, G, T, P, and E denote the multipliers 2^{10} , 2^{20} , 2^{30} , 2^{40} , 2^{50} , and 2^{60} ,

respectively. Although the letters are borrowed from the decimal system and stand for kilo (10^3), mega (10^6), giga (10^9), tera (10^{12}), peta (10^{15}), and exa (10^{18}), they do not have the decimal meaning but instead represent the power of 2 closest to the corresponding power of 10. Their meaning in this publication is as follows:

Symbol	Value
K (kilo)	$1,024 = 2^{10}$
M (mega)	$1,048,576 = 2^{20}$
G (giga)	$1,073,741,824 = 2^{30}$
T (tera)	$1,099,511,627,776 = 2^{40}$
P (peta)	$1,125,899,906,842,624 = 2^{50}$
E (exa)	$1,152,921,504,606,846,976 = 2^{60}$

The following are some examples of the use of K, M, G, T, and E:

- 2,048 is expressed as 2K.
- 4,096 is expressed as 4K.
- 65,536 is expressed as 64K (not 65K).
- 2^{24} is expressed as 16M.
- 2^{31} is expressed as 2G.
- 2^{42} is expressed as 4T.
- 2^{53} is expressed as 8P.
- 2^{64} is expressed as 16E.

When the words “thousand” and “million” are used, no special power-of-2 meaning is assigned to them.

All numbers in this publication are in decimal unless they are explicitly noted as being in binary or hexadecimal (hex).

Bytes, Characters, and Codes

Although the System/360 architecture was originally designed to support the Extended Binary-Coded-Decimal Interchange Code (EBCDIC), the instructions and data formats of the architecture are for the most part independent of the external code which is to be processed by the machine. For most instructions, all 256 possible combinations of bit patterns for a particular byte can be processed, independent of the character which the bit pattern is intended to represent. For instructions which use the zoned format, and for those few instructions which are dependent

on a particular external code, the various TRANSLATE instructions may be used to convert data from one code to another code. Thus, a machine operating in accordance with z/Architecture can process EBCDIC, ASCII, or any other code which can be represented in eight or fewer bits per character.

In this publication, unless otherwise specified, the value given for a byte is the value obtained by considering the bits of the byte to represent a binary code. Thus, when a byte is said to contain a zero, the value 00000000 binary, or 00 hex, is meant, and not the value for an EBCDIC character “0,” which would be F0 hex.

Other Publications

1. The IBM ESA/390 architectural mode is described in *IBM Enterprise Systems Architecture/390 Principles of Operation*, SA22-7201.
2. The parallel-I/O interface is described in the publication *IBM System/360 and System/370 I/O Interface Channel to Control Unit Original Equipment Manufacturers' Information*, GA22-6974.
3. The parallel-I/O channel-to-channel adapter is described in the publication *IBM Enterprise Systems Architecture/390 Channel-to-Channel Adapter for the System/360 and System/370 I/O Interface*, SA22-7091.
4. The Enterprise Systems Connection Architecture[®] (ESCON[®]) I/O interface, referred to in this publication along with the FICON I/O interface as the serial-I/O interface, is described in the publication *IBM Enterprise Systems Architecture/390 ESCON I/O Interface*, SA22-7202.
5. The FICON I/O interface is described in the ANSI[®] standards document *Fibre Channel - Single-Byte Command Code Sets-2 (FC-SB-2)*.
6. The channel-to-channel adapter for the serial-I/O interface is described in the publication *IBM Enterprise Systems Architecture/390 ESCON Channel-to-Channel-Adapter*, SA22-7203.
7. The commands, status, and sense data that are common to all I/O devices that comply with z/Architecture are described in the publication *IBM Enterprise Systems Architecture/390 Common I/O-Device Commands and Self Description*, SA22-7204.

8. The compression facility is described in the publication *IBM Enterprise Systems Architecture/390 Data Compression*, SA22-7208. The z/Architecture form of the COMPRESSION CALL instruction is described in this publication.
9. The interpretive-execution facility is described in the publication *IBM 370-XA Interpretive Execution*, SA22-7095.
10. The load-program-parameter and CPU-measurement facilities are described in the publication *The Load-Program-Parameter and CPU-Measurement Facilities*, SA23-2260.
11. The store-hypervisor-information facility is described in the publication *z/VM CP Programming Services* (SC24-6179).
12. The IBM Enterprise Systems Architecture/Extended Configuration (ESA/XC) virtual-machine architecture is described in *Enterprise Systems Architecture/Extended Configuration Principles of Operation*, SC24-6192.
13. The data-encryption algorithm is described in the publication *Data Encryption Standard*, Federal Information Processing Standards (FIPS) publication 46-3, October 25, 1999.
14. The advanced encryption standard is described in *Advanced Encryption Standard*, FIPS publication 197, November 26, 2001.
15. The secure hash algorithm is described in the publication *Secure Hash Standard*, FIPS publication 180-4, March, 2012.
16. The cipher-feedback (CFB), output-feedback (OFB), and counter (CTR) modes of encryption and decryption are described in *Recommendation for Block Cipher Modes of Operation*, National Institute of Standards and Technology (NIST) Special Publication 800-38A, December, 2001.
17. The Galois/counter mode (GCM) multiplication operation is described in *Recommendation for Block Cipher Modes of Operation: Galois/Counter Mode (GCM) and GMAC*, NIST special publication 800-38D, November, 2007.
18. Pseudorandom number generation is described in *Recommendation for Random Number Generation Using Deterministic Random Bit Generators*, NIST special publication 800-90A, January, 2012.
19. Entropy sources for random number generation are described in *Recommendation for the Entropy Sources Used for Random Bit Generation*, NIST DRAFT Special Publication 800-90B, August, 2012.
20. Binary floating point is described in *IEEE Standard for Floating-Point Arithmetic*, Institute of Electrical and Electronics Engineers publication IEEE 754-2008.
21. The SHA-3 standard is described in *SHA-3 Standard: Permutation-Based Hash and Extendable-Output Functions*, FIPS publication 202, August, 2015.
22. The extensible-markup language (XML) is described in *Extensible Markup Language (XML) 1.0 (Fifth Edition)*, published by the World Wide Web Consortium.
23. The DEFLATE compressed-data format is described in *DEFLATE Compressed Data Format Specification version 1.3*, Internet Engineering Task Force (IETF), Request For Comments (RFC) 1951, May, 1996.
24. *Digital Signature Standard (DSS)*, National Institute of Standards and Technology (NIST) July 2013, <http://nvlpubs.nist.gov/nist-pubs/FIPS/NIST.FIPS.186-4.pdf>
25. *Edwards-Curve Digital Signature Algorithm (EdDSA)*, Internet Research Task Force (IRTF), RFC-8032, January 2017, <https://tools.ietf.org/html/rfc8032>.
26. *Ed448-Goldilocks, a new elliptic curve*, Mike Hamburg, Cryptology ePrint Archive, Report 2015/624, 2015, <https://eprint.iacr.org/2015/625.pdf>
27. *ANSI X9.62-1998: Public Key Cryptography for the Financial Services Industry: the Elliptic Curve Digital Signature Algorithm (ECDSA)*. September 20, 1998. Working Draft.
28. *ANSI X9.63-2011: Public Key Cryptography for the Financial Services Industry: the Elliptic Curve Key Agreement and Key Transport Using Elliptic Curve Cryptography*. December 21, 2011. Working Draft.
29. *ANSI/IEEE Std 1363a-2004: IEEE Standard Specifications for Public-Key Cryptography - Amendment 1: Additional Techniques*. July 22, 2004.

30. *Recommendation for Pair-Wise Key Establishment Schemes Using Discrete Logarithm Cryptography*, NIST Special Publication 800-56A, Revision 2, May 2013, <http://dx.doi.org/10.6028/NIST.SP.800-56Ar2>.
31. *Elliptic Curve Cryptography (ECC) Cipher Suites for Transport Layer Security (TLS)*, Network Working Group, RFC-4492, May 2006, <https://tools.ietf.org/html/rfc4492>.
32. *Elliptic Curve Cryptography Subject Public Key Information*, Network Working Group, RFC-5480, March 2009, <https://www.ietf.org/rfc/rfc5480.txt.pdf>.
33. *SEC 2: Recommended Elliptic Curve Domain Parameters*, Standards for Efficient Cryptography, Certicom Research, Sept. 2000, <http://www.secg.org/SEC2-Ver-1.0.pdf>.
34. *SEC 1: Elliptic Curve Cryptography*, Standards for Efficient Cryptography, Certicom Research, May 2009, <http://www.secg.org/sec1-v2.pdf>.
35. *Recommendation for Key Management, Part 1: General*, National Institute of Standards and Technology (NIST) Jan. 2016, <http://nvlpubs.nist.gov/nistpubs/SpecialPublications/NIST.SP.800-57pt1r4.pdf>.
36. *Secure Hash Standard (SHS)*, National Institute of Standards and Technology (NIST) Aug. 2015, <http://nvlpubs.nist.gov/nistpubs/FIPS/NIST.FIPS.180-4.pdf>
37. *Use of Elliptic Curve Cryptography (ECC) Algorithms in Cryptographic Message Syntax (CMS)*, Internet Engineering Task Force (IETF), RFC-5753, January 2010, <https://tools.ietf.org/html/rfc5753>.
38. *The Transport Layer Security (TLS) Protocol Version 1.3*, Network Working Group, Internet Engineering Task Force (IETF), draft-ietf-tls-tls13-20, April 28, 2017, <https://tools.ietf.org/pdf/draft-ietf-tls-tls13-20.pdf>.
39. *The Advanced Encryption Standard (AES) Key Wrap with Padding Algorithm*, Network Working Group, IETF, RFC-5649, August, 2009, <https://tools.ietf.org/pdf/rfc5649.pdf>
40. *Elliptic Curves for Security*, Internet Research Task Force (IRTF), RFC-7748, January 2016, <https://tools.ietf.org/html/rfc7748>.

Summary of Changes in Thirteenth Edition

The thirteenth edition of this publication differs from the previous edition principally by containing the definitions of the following facilities:

- DEFLATE-conversion facility
- Message-security-assist extension 9
- Miscellaneous-instruction-extensions facility 3
- Move-page-and-set-key facility
- PER-storage-key-alteration facility
- PPA-in-order facility
- Vector-enhancements facility 2
- Vector-packed-decimal-enhancement facility

The thirteenth edition also contains the following significant changes relative to the previous edition:

- In the Preface (this section):
 - A summary of Chapter 26 is added.
 - The list of other publications is extended to include additional documents referenced by this document.
- In Chapter 1, “Introduction,” a summary of the new facilities is presented.
- In Chapter 4, “Control”:
 - Descriptions of the short-format PSW and set-architecture order of SIGNAL PROCESSOR when the CPU is in the ESA/390-compatibility mode are amended.
 - Bits 0-8 of control register 2 have been reserved for IBM use.
- In Chapter 5, “Program Execution”:
 - Amendments are made to the sections “Multiple-Access References” and “Block-Concurrent References” to account for existing implementations of the LOAD REVERSED and STORE REVERSED instructions.
- In Chapter 7, “General Instructions”:
 - Programming notes which state the storage-operand references of LOAD REVERSED and STORE REVERSED may be multiple-access references are removed.

- Clarification is made to the descriptions of BRANCH AND SAVE AND SET MODE and BRANCH AND SET MODE when the CPU is in the ESA/390-compatibility mode.
- In Chapter 10, “Control Instructions”:
 - The description of SYSIB 1.1.1 for the STORE SYSTEM INFORMATION instruction is amended to account for additional IBM uses.
 - Clarification is made to the descriptions of LOAD PAGE TABLE ENTRY ADDRESS, LOAD PSW, and LOAD PSW EXTENDED when the CPU is in the ESA/390-compatibility mode.
- Chapter 26, “Specialized-Function-Assist Instructions” is added.
- Numerous other minor clarifications and corrections are included.
- A summary of Chapter 25 is added.
- The list of other publications is extended to include additional documents referenced by this document.
- In Chapter 1, “Introduction,” a summary of the new facilities is presented.
- In Chapter 2, “Organization”:
 - The description of CPU registers is extended to include the guarded-storage-facility registers and the epoch index.
 - The description of general and control registers is amended to account for the ESA/390-compatibility-mode facility.
- In Chapter 3, “Storage”:
 - The sections “Address Types,” “Low-Address Protection,” “Prefixing,” “Address Spaces,” “ASN Translation,” “ASN Authorization,” “Dynamic Address Translation,” and “Assigned Storage Locations” are amended to account for the ESA/390 compatibility mode.
 - The sections “Storage Keys” and “Address Summary” are amended to account for the INSERT REFERENCE BITS MULTIPLE facility.
 - The sections “Protection,” “Suppression on Protection,” “Dynamic Address Translation,” and “Assigned Storage Locations” are amended to account for instruction-execution protection. As a result, the section on “Suppression on Protection” is complete rewritten, introducing the side-effect-access facility.
 - Clarification is made to the “Change Recording” section.

Summary of Changes in Twelfth Edition

The twelfth edition of this publication differs from the previous edition principally by containing the definitions of the following facilities:

- Configuration-z/Architecture-architectural-mode (CZAM) facility
- ESA/390-compatibility-mode (ESA/390CM facility)
- Guarded-storage facility
- Insert-reference-bits-multiple facility
- Instruction-execution-protection facility
- Message-security-assist extension 6
- Message-security-assist extension 7
- Message-security-assist extension 8
- Miscellaneous-instruction-extensions facility 2
- Multiple-epoch facility
- Side-effect-access facility
- Test-pending-external-interruption facility
- Vector-enhancements facility 1
- Vector packed-decimal facility

The twelfth edition also contains the following significant changes relative to the previous edition:

- In the Preface (this section):

- sor Orders” to account for the ESA/390-compatibility-mode facility.
 - Other amendments and clarifications are made to the “Program Event Recording” section.
 - Amendments are made to the section “Tracing” and “Timing” to account for the multiple-epoch facility. Additionally, a new leap second is defined in the section “Timing.”
 - The section “Guarded-Storage Facility” is added.
 - The section “Facility Indications” is amended to describe new facility-indication bits.
- In Chapter 5, “Program Execution”:
 - Amendments are made to the sections “Instruction Formats” and “Block-Concurrent References” to account for the vector-enhancements facility 1 and the vector-packed-decimal facility.
 - The section “Formation of the Intermediate Value” is amended to account for the BRANCH INDIRECT ON CONDITION instruction.
 - The sections “Condition-Code Alternative to Interruptibility” and “Multiple-Access References” are amended to account for the message-security-assist extension 8.
 - Clarification is made to the section “Exceptions to Nullification and Suppression.”
 - The section “Transactional-Execution Facility” is updated to account for the guarded-storage facility. Other clarifications and corrections are also included in the description of the transactional-execution facility.
 - Amendments are made to the section “Monitor-Event Counting.”
 - The ESA/390 compatibility mode is described in a new section.
 - Amendments are made to the section “Relation between Storage-Key Accesses” to account for the insert-reference-bits-multiple facility.
- In Chapter 6, “Interruptions”:
 - Multiple sections are amended to account for the ESA/390-compatibility-mode facility.
 - Various subsections of the section “Program-Interruption Conditions” are amended to account for the guarded-storage, instruction-execution-protection, message-security-assist extension 6, message-security-assist extension 8, and vector-packed-decimal facilities.
 - Various other clarifications are made to the sections “Instruction-Length Code” and “Exceptions Associated with the PSW.”
- In Chapter 7, “General Instructions”:
 - The instructions of the guarded-storage facility, miscellaneous-instruction-extensions facility 2, and message-security-assist extension 8 are described. (Of necessity, the original miscellaneous-instruction-extensions facility is now called the miscellaneous-instruction-extensions facility 1.)
 - New functions are defined for the KIMD, KLMD, and PRNO instructions in support of the message-security-assist extensions 6 and 7.
 - Numerous other clarifications are made to the descriptions of each of the message-security-assist instructions and to the section “Protection of Cryptographic Keys. All of the figures in these sections have been redrawn.
 - The descriptions of multiple instructions are amended to account for the ESA/390-compatibility-mode facility.
 - Clarification is made to the description of the COMPARE AND FORM CODEWORD instruction.
 - Clarification is made to the description of the CONVERT UTF-16 TO UTF-32, CONVERT UTF-16 TO UTF-8, CONVERT UTF-32 TO UTF-16, and CONVERT UTF-32 TO UTF-8 instructions.
 - The description of the EXTRACT CPU ATTRIBUTE instruction is extended to provide CPU attributes.
 - A programming note is added to all instructions having a query function, advising of the proper use of the function.

- The descriptions of STORE CLOCK, STORE CLOCK EXTENDED, and STORE CLOCK FAST are amended to account for the multiple-epoch facility and the addition of a new leap second.
- In Chapter 8, “Decimal Instructions”:
 - Clarification is made to the introductory material and to the sections “Decimal Codes,” “Other Instructions for Decimal Operands,” and “General-Operand Data Exception.”
 - In the description of EDIT and EDIT AND MARK, clarification is made to the setting of condition code 2.
 - In the description of TEST DECIMAL, clarification is made to the description of condition codes 1 and 2.
- In Chapter 9, “Floating-Point Overview and Support Instructions”:
 - Clarification is made to the section “Hexadecimal-Floating-Point (HFP).”
 - Clarification is made to the section “IEEE Computational Operations” and to the description of the PERFORM FLOATING POINT OPERATION instruction with regards to subnormal numbers and exception handling.
 - The section “Impacts on ESA/390” is extended to account for the ESA/390-compatibility-mode facility.
 - Item 1 in the section “Impacts of the Floating-Point Extension Facility” is corrected.
- In Chapter 10, “Control Instructions”:
 - Descriptions of the INSERT REFERENCE BITS MULTIPLE, and TEST PENDING EXTERNAL INTERRUPTION instructions are added.
 - The descriptions of BRANCH AND SET AUTHORITY, EXTRACT STACKED STATE, INVALIDATE PAGE TABLE ENTRY, LOAD ADDRESS SPACE PARAMETERS, LOAD CONTROL, LOAD PSW, LOAD PSW EXTENDED, LOAD REAL ADDRESS, RESUME PROGRAM, SET PREFIX, SET SYSTEM MASK, STORE PREFIX, STORE REAL ADDRESS, STORE THEN OR SYS-TEM MASK, and TEST ACCESS instructions are amended to account for the ESA/390-compatibility-mode facility
 - Various clarifications are made to the description of the PERFORM FRAME MANAGEMENT FUNCTION instruction.
 - New function codes are described for the PERFORM TIMING FACILITY FUNCTION instruction in support of the multiple-epoch facility. Additionally, the 27th leap second is described.
 - A programming note is added to the description of the SET CLOCK instruction in support of the multiple-epoch facility.
 - The description of the STORE CPU ID instruction is complete rewritten.
 - Various changes are made to the description of the STORE SYSTEM INFORMATION instruction, including a new field in the SYSIB 1.1.1, corrections to the descriptions of the adjustment factors in the SYSIB 1.2.2, the addition of the virtual-server ID and virtual-server name in the SYSIB 2.2.2, and the addition of the extended-VM-name field in the SYSIB 3.2.2.
 - The description of the TEST PROTECTION instruction is amended to account for the instruction-execution-protection facility.
 - The description of the TRACE instruction is amended to account for the multiple-epoch facility.
- In Chapter 11, “Machine-Check Handling”:
 - The section “Effects of CPU Retry” is amended to account for the addition of the message-security-assist extension 8.
 - The sections “Validation” and “Invalid CBC in Registers” are amended, simplifying the description of register validation.
 - The sections “Interrupt Action,” “Machine-Check-Interrupt Code,” “Machine-Check Extended Interruption Information,” and “Machined-Check Extended Save Area (MCESA)” are amended to account for the addition of the guarded-storage facility and the ESA/390-compatibility-mode facility.

- In Chapter 12, “Operator Facilities,” various sections are amended to account for the addition of the ESA/390-compatibility-mode facility.
- In Chapter 14, “I/O Instructions”:
 - Clarification is made to the Figure 14-1, “Summary of I/O Instructions.”
- In Chapter 15, “Basic I/O Functions”:
 - In the section “Command-Mode ORB”, a correction is made to the description of the prefetch control.
 - In the section “CCW Channel Program Chaining”, a correction is made to the figure “Subchannel Chaining Action.”
- In Chapter 16, “I/O Interruptions, in the section “Extended-Status Word,” the illustration of the subchannel logout is corrected.
- In Chapter 17, “I/O Support Functions”:
 - In the section “Externally Initiated Functions,” the descriptions of CCW-type IPL and List-Directed IPL are amended to account for the ESA/390-compatibility-mode (ESA/390CM) and configuration-z/Architecture-architectural-mode (CZAM) facilities, and clarification is made to the contents of the ORB used by a CCW-type IPL.
- In Chapter 19, “Binary-Floating-Point Instructions”:
 - Terminology has been updated to conform to that of Reference [20.] on page xxx.
 - In the figure “Summary of BFP Instructions,” clarification is made to the applicability of the symbols Xi, Xo, Xu, Xx, and Xz (they are data exceptions, as opposed to the same symbols in Chapter 24, where they are vector-processing exceptions).
- In Chapter 20, “Decimal-Floating-Point Instructions,” in the figure “Summary of DFP Instructions”:
 - The instruction format is corrected for CONVERT FROM ZONED and CONVERT TO ZONED.
- Clarification is made to the applicability of the symbols Xi, Xo, Xu, Xx, and Xz (they are data exceptions, as opposed to the same symbols in Chapter 24, where they are vector-processing exceptions).
- In Chapter 21, “Vector Overview and Support Instructions”:
 - The instructions and instruction enhancements added by the vector-enhancements facility 1 are described. The instructions added by the vector-packed-decimal facility are described.
 - An optional alignment-hint operand is added to the VECTOR LOAD, VECTOR LOAD MULTIPLE, VECTOR STORE, and VECTOR STORE MULTIPLE.
- In Chapter 22, “Vector Integer Instructions”:
 - The instructions added by the vector-enhancements facility 1 are described.
 - The description of the VECTOR POPULATION COUNT instruction is extended to accommodate multiple element sizes.
- In Chapter 24, “Vector Floating-Point Instructions”:
 - In the section “IEEE Exception Handling,” clarification is made to the contents of the VXC.
 - The mnemonics for VECTOR FP LOAD LENGTHENED and VECTOR FP LOAD ROUNDED are changed to VFLL and VFLLR, respectively. The former mnemonics VLDE and VLED, respectively, are deprecated but retained for compatibility purposes.
 - The instructions and instruction enhancements added by the vector-enhancements facility 1 are described.
- Chapter 25, “Vector Decimal Instructions” is added.
- Appendix D, “Compression Call Facility” is added.

Summary of Changes in Eleventh Edition

The eleventh edition of this publication differs from the previous edition principally by containing the definitions of the following facilities:

- Decimal-floating-point packed-conversion facility
- FCX-bidirectional-data-transfer facility
- Load-and-zero-rightmost-byte facility
- Load/store-on-condition facility 2
- Message-security-assist extension 5
- Multithreading facility
- Vector facility for z/Architecture

The eleventh edition also contains the following significant changes relative to the previous edition:

- In the Preface:
 - Summaries of Chapters 21-24 are added.
 - The list of other publications is extended to include additional documents referenced by this document.
- In Chapter 1, “Introduction,” a summary of the new facilities is presented.
- In Chapter 2, “Organization”:
 - New sections are added, describing CPU types, multithreading, and vector registers.
 - Clarification is made as to the contents of bit positions 0-31 of general registers while the CPU is in the ESA/390 mode.
- In Chapter 3, “Storage”:
 - Clarification is made as to the applicability of key-controlled protection’s to the program-interruption TDB.
 - Clarification is made as to the applicability of DAT to certain instructions and events.
 - Bits 62-63 of the format-1 RTTE and STE are made available for programming.
 - The vector-exception code and machine-check-extended-save-area address are added to the assigned-storage locations.

- Because of their pervasive use by z/OS, three additional assigned-storage locations are made available for use by programming.
- In Chapter 4, “Operation”:
 - Additional constraints are placed on the use of CPU address-compare controls is program-event recording is used.
 - Additional bits are defined in control registers 0 and 2.
 - Applicability of VRV-format instructions (used by the vector facility) are added to the description of PER zero-address detection.
 - In the section “Timing”:
 - Numerous clarifications are made to the section “Setting and Inspecting the Clock.”
 - Leap second 26 is documented.
 - Descriptions of hardware-based and off-set-based TOD-clock steering are added.
 - Description of the UTC-information block (UIB) is added.
 - Clarification is made to the description of the CPU timer.
 - The descriptions of various reset operations are updated to account for the addition of the multithreading and vector facilities.
 - Clarification is made to the description of CCW-based IPL.
 - In the section “Multiprocessing,” the process of CPU-address expansion and contraction is described.
 - In the section “CPU Signaling and Response,” various changes are described in support of the multithreading facility:
 - The SIGP set-multithreading order is described.
 - Various changes are made to other SIGP orders in support of multithreading.
 - New facility indications are described.
- In Chapter 5, “Program Execution”:

- Instruction formats are added, most in support of vector-facility for z/Architecture instructions.
- Clarification is made to the description of instruction nullification and suppression.
- The section “Condition-Code Alternative to Interruptibility” is updated to account for new instructions.
- Clarification is added to the description of the TBEGIN-specified TDB.
- The TDB is updated to include the vector-exception code (VXC).
- A programming note is added, describing the proper use of branch instructions following a TRANSACTION BEGIN.
- The section “Multiple-Access References” is updated to account for added instructions.
- The section “Block-Concurrent References” is updated to account for the vector-facility for z/Architecture instructions.
- A programming note is added to the section “Storage-Key Accesses”, describing behavior of the nonquiescing key-setting operation.
- In Chapter 6, “Interruptions”:
 - The vector-processing interruption is described.
 - STP timing-alert interruptions are defined to be floating interruptions.
 - Clarification is made to the section “Exceptions Associated with the PSW.”
 - Clarification is made to the description of external interruptions.
 - Clarification is made to the description of the warning-track interruption.
 - Because it is used for other instructions besides decimal instructions, data-exception code 0 is renamed *general-operand data exception* (it was formerly *decimal-operand data exception*).
 - Descriptions of the vector-exception code, vector-instruction data exception code, and the vector-processing exception are added.
- The descriptions of various program-interruption codes are updated to account for new instructions.
- In Chapter 7, “General Instructions”:
 - A programming note is added to the BRANCH PREDICTION PRELOAD and BRANCH PREDICTION RELATIVE PRELOAD instructions.
 - The CIPHER MESSAGE WITH CFB and CIPHER MESSAGE WITH OFB instructions are renamed to the more descriptive CIPHER MESSAGE WITH CIPHER FEEDBACK and CIPHER MESSAGE WITH OUTPUT FEEDBACK, respectively. The mnemonics for these instructions are unchanged.
 - Instructions for the following facilities are described:
 - Load-and-zero-rightmost-byte facility
 - Load/store-on-condition facility 2 (note, the former load/store-on-condition facility is renamed load-store-on-condition facility 1)
 - Message-security-assist extension 5
 - Vector facility for z/Architecture (the LOAD COUNT TO BLOCK BOUNDARY is the only general instruction in this facility; the remaining instructions appear in Chapters 21-24)
 - Numerous clarifications and corrections are made to the descriptions of the message-security instructions: CIPHER MESSAGE, CIPHER MESSAGE WITH CHAINING, CIPHER MESSAGE WITH CIPHER FEEDBACK, CIPHER MESSAGE WITH COUNTER, CIPHER MESSAGE WITH OUTPUT FEEDBACK, COMPUTE INTERMEDIATE MESSAGE DIGEST, COMPUTE LAST MESSAGE DIGEST, COMPUTE MESSAGE AUTHENTICATION CODE, and PERFORM CRYPTOGRAPHIC COMPUTATION. Additional clarification is made to the section “Protection of Cryptographic Keys.”
 - Clarification is made to the description of access exception for instructions of the interlocked-access facility 1. Also, additional

extended mnemonics are described for the instructions of the facility.

- A programming note is added to the description of PERFORM LOCKED OPERATION.
- Programming notes are added to the SHIFT LEFT SINGLE LOGICAL and SHIFT RIGHT SINGLE LOGICAL instructions.
- Clarification is added to programming note 5 for STORE CLOCK and STORE CLOCK FAST.
- Leap second 26 is documented.
- Various changes and clarifications are made to the description of TRANSACTION BEGIN.
- In Chapter 8, “General Instructions”:
 - The description of the signed-packed-decimal format is amended to accommodate the addition of the DFP-packed-conversion facility.
 - The term *general-operand data exception* replaces the former *decimal-operand data exception*.
- In Chapter 9, “Floating-Point Overview and Support Instructions”:
 - References to the ANSI/IEEE binary-floating-point standard are updated.
 - Numerous clarifications are made to the description of the PERFORM FLOATING POINT OPERATION instruction and affiliated text.
- In Chapter 10, “Control Instructions”:
 - In the description of BRANCH AND SET AUTHORITY, clarification is made to the discussion of special conditions.
 - In the description of LOAD PAGE TABLE ENTRY ADDRESS, a correction is made to programming notes 2 and 3.
 - Clarification is provided in the description of the LOAD REAL ADDRESS instruction.
 - In the description of PERFORM TIMING FACILITY FUNCTION:
 - New functions are added.
- Numerous other clarifications are made to the instruction description.
- Leap second 26 is documented.
- The description of SIGNAL PROCESSOR is changed to accommodate the vector facility for z/Architecture and multithreading facility.
- The description of STORE SYSTEM INFORMATION is updated to accommodate the multithreading facility.
- The description of TEST PROTECTION is updated to account for the EDAT-2 facility.
- In Chapter 11, “Machine-Check Handling”:
 - Various sections are updated to accommodate the addition of the vector facility for z/Architecture.
 - The vector-register-validity bit is added to the MCIC.
 - The machine-check extended save area is described.
- In Chapter 12, “Operator Facilities”:
 - Various constraints are put on the use of address-compare controls with using the program-event-recording (PER) facility.
 - Alter-and-display controls accommodate the vector registers.
 - A CPUs-per-core indicator is added in support of the multithreading facility.
 - The section “Multithreading Considerations” is added.
- In Chapter 13, “I/O Overview,” the bidirectional-data-transfer facility and transfer-control-area extension (TCAX) are described.
- In Chapter 15, “Basic I/O Functions”:
 - Description of the bidirectional-data-transfer operations is added to the various transport-mode I/O control structures.
 - Description of the transport-control-area extension (TCAX) is added.
 - Description of the transfer-TCA-Extension (TTE) DCW is added.

- In Chapter 16, “I/O Interruptions,” program-check conditions for bidirectional-data-transfer operations are added.
- In Chapter 19, “Binary-Floating-Point Instructions,” references to the ANSI/IEEE binary-floating-point standard are updated.
- In Chapter 20, “Decimal-Floating-Point Instructions”:
 - The instructions of the DFP-packed-conversion facility are described.
 - The term *general-operand data exception* replaces the former *decimal-operand data exception*.
 - In the description of the CONVERT TO ZONED instruction, clarification is made to the description of the zone control.
- Chapters 21-24 are added, describing the instructions of the vector facility for z/Architecture.
- Numerous other minor clarifications and corrections are included.

Summary of Changes in Tenth Edition

The tenth edition of this publication differs from the previous edition principally by containing the definitions of the following facilities:

- Decimal-floating-point zoned-conversion facility
- Enhanced-DAT facility 2
- Execution-hint facility
- Interlocked-access facility 2
- Load-and-trap facility
- Local-TLB-clearing facility
- Miscellaneous-instruction-extensions facility 1
- PER zero-address-detection facility
- Processor-assist facility
- Side-effect-access facility
- Transactional-execution facility
- Warning-track-interruption facility

The tenth edition contains the following significant changes relative to the previous edition:

- In Chapter 1, “Introduction,” a summary of the new facilities is presented.

- In Chapter 3, “Storage:”
 - Changes introduced by the enhanced-DAT facility 2 are added.
 - Changes introduced by the execution-hint facility are added.
 - Changes introduced by the side-effect-access facility are described.
 - Changes introduced by the transactional-execution facility are added.
- In Chapter 4, “Control:”
 - Changes introduced by the enhanced-DAT facility 2 are added.
 - Changes introduced by the execution-hint facility are added.
 - Changes introduced by the PER zero-address-detection facility are added.
 - Changes introduced by the transactional-execution facility are added.
 - Leap second 25 is documented.
 - Facility indications for the new facilities are added.
- In Chapter 5, “Program Execution:”
 - New instruction formats are defined.
 - Changes introduced by the enhanced-DAT facility 2 are added.
 - Changes introduced by the execution-hint facility are added.
 - Changes introduced by the interlocked-access facility 2 are added.
 - Changes introduced by the transactional-execution facility are added.
 - Clarification is made to the access-register-translation process.
 - Clarification is made to the handling of PER events in the enhanced-monitor counting array.
- In Chapter 6, “Interruptions:”
 - Changes introduced by the load-and-trap facility are added.

- Changes introduced by the transactional-execution facility are added.
- Changes introduced by the warning-track-interruption facility are added.
- Clarification is made to the description of the measurement-alert external interruption.
- In Chapter 7, “General Instructions:”
 - Changes introduced by the execution-hint facility are added.
 - Changes introduced by the interlocked-access facility 2 are added. The original interlocked-access facility is now called the interlocked-access facility 1.
 - Changes introduced by the load-and-trap facility are added.
 - Changes introduced by the miscellaneous-instruction-extension facility are added.
 - Changes introduced by the processor-assist facility are added.
 - Changes introduced by the transactional-execution facility are added.
 - Changes introduced by the PER zero-address-detection facility are added.
 - The EXTRACT CACHE ATTRIBUTE instruction is renamed EXTRACT CPU ATTRIBUTE.
- In Chapter 8, “Decimal Instructions:”
 - Changes introduced by the decimal-floating-point zoned-conversion facility are added.
 - Changes introduced by the transactional-execution facility are added.
- In Chapter 9, “Floating-Point Overview and Support Instructions:”
 - Changes introduced by the transactional-execution facility are added.
 - Miscellaneous corrections are made to Figure 9-21.
 - Miscellaneous clarifications and corrections are made to the description of PERFORM FLOATING POINT OPERATION.
- In Chapter 10, “Control Instructions:”
 - Changes introduced by the enhanced-DAT facility 2 are added.
 - Changes introduced by the local-TLB-clearing facility are added.
 - Changes introduced by the transactional-execution facility are added.
 - Changes introduced by the PER zero-address-detection facility are added.
 - Clarification is made to the description of EXTRACT STACKED STATE.
 - Clarification is made to the description of STORE CPU ID and STORE SYSTEM INFORMATION.
- In Chapter 12, “Operator Facilities,” clarification is made to the description of the load-unit-address controls.
- In Chapter 13, “I/O Overview:”
 - Clarification is made to the description of the device number.
- In Chapter 14, “I/O Instructions:”
 - Changes introduced by the transactional-execution facility are added.
- In Chapter 15, “Basic I/O Functions:”
 - Various clarifications are made to the description of the output-count field of the transport-control word.
 - Various clarifications and changes are made to the device-command word, including the description of the suppress-length-indication flag.
 - The transport-command DCW is described.
 - Clarifications are made to the description of the Transfer-CBC-offset-block DCW.
- In Chapter 16, “I/O Interruptions:”
 - The incorrect-length subchannel-status indication is described.
- In Chapter 17, “I/O Support Functions:”
 - The interrupt-delay-time and I/O-priority-delay-time fields are described in the measurement block.

- In Chapter 18, “Hexadecimal-Floating-Point Instructions:”
 - Changes introduced by the transactional-execution facility are added.
 - Clarifications are made to the description of CONVERT TO FIXED.
- In Chapter 19, “Binary-Floating-Point Instructions:”
 - Changes introduced by the transactional-execution facility are added.
 - Clarifications and corrections are made to the description of CONVERT TO FIXED.
 - Clarifications and corrections are made to the description of CONVERT TO LOGICAL.
- In Chapter 20, “Decimal-Floating-Point Instructions:”
 - Changes introduced by the decimal-floating-point zoned-conversion facility are added.
 - Changes introduced by the transactional-execution facility are added.

The tenth edition also contains numerous minor corrections and clarifications.

Summary of Changes in Ninth Edition

The ninth edition of this publication differs from the previous edition principally by containing the definitions of the following facilities:

- CMPSC-enhancement facility
- Distinct-operands facility
- Enhanced-monitor facility
- Fast-BCR-serialization facility
- Floating-point extension facility
- High-word facility
- Interlocked-access facility 1
- IPTe-range facility
- Load/store-on-condition facility
- Message-security-assist extension 3
- Message-security-assist extension 4
- Nonquiescing key-setting facility
- Population-count facility
- The Reset-reference-bits-multiple facility

The ninth edition contains the following significant changes relative to the previous edition:

- In Chapter 3, “Storage:”
 - Changes introduced by the reset-reference-bits-multiple are added to various sections.
 - Changes introduced by the enhanced-monitor facility are added.
 - Changes introduced by the access-exception-fetch/store-indication facility are added.
 - Clarification is added to the description of the translation-exception identification.
- In Chapter 4, “Control:”
 - Changes introduced by the enhanced-monitor facility are added.
 - Clarification is made to the description of the PER ASCE identification (AI) and PER access identification (PAID).
 - Changes introduced by the high-word facility are added.
 - Descriptions of the new facility indications are added.
- In Chapter 5, “Program Execution:”
 - A significant editorial change has been made to the description of the instruction formats. Instruction formats having variations in assembler syntax or field content are designated by an alphabetic suffix which is also reflected in the instruction descriptions in chapters 7-10, 14, and 18-24.
 - Changes introduced by the enhanced-monitor facility are added.
 - Clarification is made to the description of suppression.
 - Changes introduced by the message-security assist extensions 3 and 4 are added.
 - Changes introduced by the nonquiescing-key-setting facility are added, including the description of quiescing.
 - Changes introduced by the interlocked-access facility are added, including the description of an interlocked-fetch reference and specific-operand serialization.

- In Chapter 6, “Interruptions:”
 - Changes introduced by the enhanced-monitor facility are added.
 - Changes introduced by the floating-point extension facility are added.
 - Clarification is provided regarding the handling of data exceptions resulting from the compare-and-trap instructions.
- In Chapter 7, “General Instructions:”
 - Clarification is made as to the content of the chapter.
 - Changes introduced by the distinct-operands facility are added.
 - Changes introduced by the high-word facility are added.
 - Changes introduced by the interlocked-access facility are added.
 - Changes introduced by the load/store-on-condition facility are added.
 - Changes introduced by the message-security-assist extension 3 are added, including a new section on the protection of cryptographic keys.
 - Changes introduced by the message-security-assist extension 4 are added.
 - Changes introduced by the population-count facility are added.
 - Changes introduced by the instruction-format clarifications are added.
 - Clarifications are made to the description of COMPARE AND SWAP AND STORE.
 - Changes introduced by the CMPSC-enhancement facility are added.
 - Extended assembler mnemonics are defined for the ROTATE THEN AND SELECTED BITS, ROTATE THEN OR SELECTED BITS, and ROTATE THEN EXCLUSIVE OR SELECTED BITS instructions.
 - Clarification is made to the descriptions of the SEARCH STRING and SEARCH STRING UNICODE instructions.
- In Chapter 8, “Decimal Instructions:”
 - Changes introduced by the instruction-format clarifications are added.
 - Clarification is made to the description of the EDIT and EDIT AND MARK instructions.
- In Chapter 9, “Floating-Point Overview and Support Instructions:”
 - Changes introduced by the instruction-format clarifications are added.
 - Changes introduced by the floating-point-extension facility are added.
- In Chapter 10, “Control Instructions:”
 - Clarification is made as to the content of the chapter; specifically, the chapter also contains the description of certain nonprivileged instructions.
 - Changes introduced by the instruction-format clarifications are added.
 - Changes introduced by the IPTE-range facility are added.
 - Changes introduced by the message-security-assist extension 3 are added.
 - Changes introduced by the nonquiescing key-setting facility are added.
 - Changes introduced by the reset-reference-bits-multiple facility are added.
 - Changes are made to the STORE SYSTEM INFORMATION instruction with regards to topology information returned.
- In Chapter 14, “Basic I/O Functions,” the CBC-offset block is added for the fibre-channel-extensions facility.
- In Chapter 18, “Hexadecimal-Floating Instructions,” changes introduced by the instruction-format clarifications are added.
- In Chapter 19, “Binary-Floating-Point Instructions:”
 - Changes introduced by the instruction-format clarifications are added.
 - Changes introduced by the floating-point-extension facility are added.
- In Chapter 20, “Decimal-Floating-Point Instructions:”
 - Changes introduced by the instruction-format clarifications are added.

- Changes introduced by the instruction-format clarifications are added.
- Changes introduced by the floating-point-extension facility are added.

The ninth edition also contains numerous minor corrections and clarifications.

Summary of Changes in Eighth Edition

The eighth edition of this publication differs from the previous edition principally by containing the definitions of the following facility:

- Fibre-channel-extensions (FCX) facility

The eighth edition contains the following significant changes relative to the previous edition:

- In Chapter 1, “Introduction,” a summary of the fibre-channel-extensions facility is added.
- In Chapter 4, “Control,” the clock setting for the leap second on January 1, 2009 is added to the section “Timing.”
- In Chapter 7, “General Instructions,” the clock setting for the leap second on January 1, 2009 is added to the description of STORE CLOCK EXTENDED.
- In Chapter 13, “I/O Overview,” changes introduced by the fibre-channel-extensions facility are added to various sections.
- In Chapter 14, “I/O Instructions,” changes introduced by the fibre-channel-extensions facility are added to various sections.
- In Chapter 15, “Basic I/O Functions,” changes introduced by the fibre-channel-extensions facility are added to various sections.
- In Chapter 16, “I/O Interruptions,” changes introduced by the fibre-channel-extensions facility are added to various sections.
- In Chapter 17, “I/O Support Functions,” changes introduced by the fibre-channel-extensions facility are added to various sections.

The eighth edition also contains numerous minor corrections and clarifications.

Summary of Changes in Seventh Edition

The seventh edition of this publication differs from the previous edition principally by containing the definitions of the following facilities:

- Compare-and-swap-and-store facility 2
- Configuration-topology facility
- Enhanced-DAT facility
- Execute-extensions facility
- General-instructions-extension facility
- Message-security-assist extension 2
- Move-with-optional-specifications facility
- Parsing-enhancement facility
- Restore-subchannel facility

The seventh edition contains the following significant changes relative to the previous edition:

- In Chapter 3, “Storage:”
 - Changes introduced by the enhanced-DAT facility are added to various sections.
 - Changes introduced by the enhanced suppression-on-protection function are added
 - Changes introduced by the execute-extensions facility are added to various sections.
 - Changes introduced by the general-instructions-extension facility are added to the section “Assigned Storage Locations.”
 - Changes introduced by the move-with-optional-specifications facility are added to the section “Protection.”
- In Chapter 4, “Control:”
 - Changes introduced by the enhanced-DAT facility are added to various sections.
 - Changes introduced by the execute-extensions facility are added to various sections.
 - Changes introduced by the general-instructions-extension facility are added to various sections.

- New facility bits for the compare-and-swap-and-store facility 2, configuration-topology facility, enhanced-DAT facility, execute-extensions facility, general-instructions-extension facility, move-with-optional-specifications facility, and parsing-enhancement facility are added to the section “Facility Indications.”
- In Chapter 5, “Program Execution:”
 - In the section “Instruction Formats,” the RIS, RRS, and SIL formats are added. Four new versions of the RIE instruction format and one new version of the RXY format are added.
 - Changes introduced by the enhanced-DAT facility are added to various sections.
 - Changes introduced by the execute-extensions facility are added to various sections.
 - Changes introduced by the general-instructions-extension facility are added to various sections.
 - Changes introduced by the move-with-optional-specifications facility are added to various sections.
 - Changes introduced by the parsing-enhancement facility are added to the section “Multiple-Access References.”
- In Chapter 6, “Interruptions:”
 - Changes introduced by the compare-and-swap-and-store facility 2 are added to the section “Specification Exception.”
 - Changes introduced by the enhanced-DAT facility are added to various sections.
 - Changes introduced by the execute-extensions facility are added to various sections.
 - Changes introduced by the general-instructions-extension facility are added to various sections.
 - Changes introduced by the move-with-optional-specifications facility are added to various sections.
 - Changes introduced by the parsing-enhancement facility are added to section “Specification Exception.”
- In Chapter 7, “General Instructions:”
 - For various instruction descriptions in which multiple instruction formats are present, headings have been added to distinguish one format from another.
 - Changes introduced by the compare-and-swap-and-store facility 2 are added to the description of the COMPARE AND SWAP AND STORE instruction.
 - Changes introduced by the message-security-assist extension 2 are added to the descriptions of the CIPHER MESSAGE, CIPHER MESSAGE WITH CHAINING, COMPUTE INTERMEDIATE MESSAGE DIGEST and COMPUTE LAST MESSAGE DIGEST instructions.
 - Programming notes are added to the description of the UTF conversion instructions (CU12, CU14, CU21, CU24, CU41, and CU42) indicating that the instructions support big-endian encoding only.
 - Changes introduced by the execute-extensions facility are added to various sections, including the description of the EXECUTE RELATIVE LONG instruction.
 - Changes introduced by the general-instructions-extension facility are added to various sections, including the descriptions of the facility’s 72 new instructions.
 - The description of the MOVE LONG UNICODE instruction is amended such that an odd length specification is permitted.
 - Changes introduced by the parsing-enhancement facility are added to various sections, including the descriptions of the TRANSLATE AND TEST EXTENDED and TRANSLATE AND TEST REVERSE EXTENDED instructions.
- In Chapter 10, “Control Instructions:”
 - Changes introduced by the move-with-optional-specifications facility are added to various sections, including the description of the MOVE WITH OPTIONAL SPECIFICATIONS instruction.
 - Changes introduced by the enhanced-DAT facility are added to various sections, including the description of the PERFORM FRAME MANAGEMENT FUNCTION instruction.

- Changes introduced by the configuration-topology facility are added to various sections, including the description of the PERFORM TOPOLOGY FUNCTION instruction and enhancements to the STORE SYSTEM INFORMATION instruction.
- Changes introduced by the execute-extensions facility are added to various sections.
- The STORE SYSTEM INFORMATION instruction is enhanced to include the following:
 - Additional information returned in SYSIB 1.1.1.
 - The definition of SYSIB 15.1.2 in support of the configuration-topology facility.
- In Chapter 11, “Machine-Check Handling:”
 - Changes introduced by the enhanced-DAT facility are added to various sections.
 - Changes introduced by the execute-extensions facility are added to various sections.
- In Chapter 13, “I/O Overview,” changes introduced by the multiple-subchannel set facility are described.
- In Chapter 14, “I/O Instructions,” changes introduced by the multiple-subchannel set facility are described.
- In Chapter 17, “I/O Support Functions,” changes introduced by the multiple-subchannel set facility are described.

The seventh edition also contains numerous minor corrections and clarifications.

Summary of Changes in Sixth Edition

The sixth edition of this publication differs from the previous edition principally by containing the definitions of the following facilities:

- Compare-and-swap-and-store facility
- Conditional-SSKE facility
- Decimal-floating-point facility
- Decimal-floating-point-rounding facility
- Extract-CPU-time facility

- Floating-point-support-sign-handling facility
- FPR-GR-transfer facility
- IEEE-exception-simulation facility
- PFPO facility

The sixth edition contains the following significant changes relative to the previous edition:

- In Chapter 3, “Storage”:
 - Changes introduced by the conditional-SSKE facility are added to various sections.
 - In the “Assigned Storage Locations” section, the descriptions of the various fields now include hexadecimal as well as decimal locations.
 - Clarification is made to the definition of the exception access identification and PER access identification at locations 160 and 161, respectively.
- In Chapter 4, “Control”:
 - Changes introduced by the extract-CPU-time facility are added to the section “CPU Timer.”
 - New facility bits for the compare-and-swap-and-store facility, decimal-floating-point facility, decimal-floating-point performance, extract-CPU-time facility, floating-point-support-enhancement facilities (FPR-GR-transfer, FPS-sign-handling, and DFP-rounding), and PFPO (PERFORM FLOATING-POINT OPERATION) facility are added to the section “Facility Indications.”
- In Chapter 5, “Program Execution”:
 - In the section “Instruction Formats”, the RRR and SSF formats are added.
 - Changes introduced by the compare-and-swap-and-store facility are added to various sections.
 - Changes introduced by the extract-CPU-time facility are added to the “Consistency Specification” section.
 - Previous restrictions on storing into the instruction stream in the access-register or home address-space-control modes are removed.
- In Chapter 6, “Interruptions”:

- Changes introduced by the simulated IEEE exception (IXS) are added to the various sections.
- Changes introduced by the compare-and-swap-and-store facility are added to various sections.
- The descriptions of the special-operation and specification program interruptions are updated and rearranged.
- Clarification is added to the section “Multiple Program-Interruption Conditions.”
- In Chapter 7, “General Instructions”:
 - The descriptions of the COMPARE AND SWAP AND STORE and EXTRACT CPU TIME instructions are added.
 - Programming notes for COMPARE LOGICAL LONG UNICODE and MOVE LONG UNICODE are amended to account for the long-displacement facility.
 - A programming note clarifying the setting of the condition code is added to AND IMMEDIATE, EXCLUSIVE OR IMMEDIATE, and OR IMMEDIATE.
- In Chapter 9, “Floating-Point Overview and Support Instructions”:
 - The concepts of “views” and “quantum” are introduced.
 - The name of the instruction SET ROUNDING MODE is changed to SET BFP ROUNDING MODE and is moved from Chapter 19 to Chapter 9.
 - The following instructions operating on the floating-point-control (FPC) register are moved from Chapter 19 to Chapter 9: EXTRACT FPC, LOAD FPC, SET FPC, and STORE FPC.
 - The FPR-GR-transfer facility instructions, LOAD FPR FROM GR and LOAD GR FROM FPR, are added.
 - The four instructions making up the floating-point-support-sign-handling facility are added: COPY SIGN, LOAD COMPLEMENT, LOAD NEGATIVE, and LOAD POSITIVE.
- The decimal-floating-point-rounding facility is added. This includes a 3-bit DFP rounding mode field in the floating-point control (FPC) register and the instruction SET DFP ROUNDING MODE.
- The IEEE-exception-simulation facility is added, including the instructions SET FPC AND SIGNAL and LOAD FPC AND SIGNAL.
- The instruction PERFORM FLOATING-POINT OPERATION (PFPO) is added.
- In Chapter 10, “Control Instructions”, changes introduced by the conditional-SSKE facility are added to the description of SET STORAGE KEY EXTENDED.
- In Chapter 11, “Machine-Check Handling”, changes introduced by the conditional-SSKE facility are added.
- In Chapter 12, the operator rate control is now defined to be model dependent.
- In Chapter 14, clarification is added to the section “Modified CCW Indirect Data Addressing”.
- In Chapter 18, “Hexadecimal-Floating-Point Instructions”: The names of two of the rounding methods used by the instruction CONVERT TO FIXED are changed from “biased round to nearest” and “round to nearest” to “round to nearest with ties away from 0” and “round to nearest with ties to even”, respectively.
- In Chapter 19, “Binary-Floating-Point Instructions”: This chapter is updated extensively to be consistent with Chapter 20. This includes the following:
 - The terms “normal” and “subnormal”, referring to BFP data classes, replace the obsolete terms “normalized”, and “denormalized”, respectively.
 - The name of the instruction SET ROUNDING MODE is changed to SET BFP ROUNDING MODE and is moved from Chapter 19 to Chapter 9.
 - The following instructions operating on the floating-point-control (FPC) register are moved from Chapter 19 to Chapter 9: EXTRACT FPC, LOAD FPC, SET FPC, and STORE FPC.

- The section “Floating-Point-Control (FPC) Register” is moved to Chapter 9.
- The sections “BFP Rounding”, “BFP Comparison”, “Condition Codes for BFP Instructions”, and “IEEE Exception Conditions” are renamed and moved to Chapter 9.
- In Chapter 20, “Decimal-Floating-Point Instructions”: This chapter is new, and describes the decimal-floating-point (DFP) facility.

The sixth edition also contains numerous minor corrections and clarifications.

Summary of Changes in Fifth Edition

The fifth edition of this publication differs from the previous edition principally by containing the definitions of the following facilities:

- DAT-enhancement facility 2
- ETF2-enhancement facility
- ETF3-enhancement facility
- Extended-immediate facility
- HFP-unnormalized-extensions facility
- Message-security-assist extension 1
- Modified-CCW-indirect-data-addressing facility
- PER-3 facility
- Server-time-protocol facility
- Store-clock-fast facility
- Store-facility-list-extended facility:
- TOD-clock-steering facility

The fifth edition contains minor clarifications and corrections and also the following significant changes relative to the previous edition:

- In Chapter 3, “Storage”:
 - In the “Information Formats” section, the length of a storage-operand field that is implied by the instruction now includes a 16-byte operand.
 - Changes introduced by the modified-CCW-indirect-data-addressing facility are added to various sections.
 - Changes introduced by the DAT-enhancement facility 2 are added to various sections.
- In Chapter 4, “Control”:
 - Changes introduced by the PER-3 facility are added to the section “Assigned Storage Locations.”
 - Changes introduced by the store-facility-list-extended facility are added to section “Assigned Storage Locations.”
 - Changes introduced by the store-clock-fast facility are added to various sections.
 - Changes introduced by the PER-3 facility, including breaking-event-address recording and PER instruction-fetch nullification, are added to various sections.
 - Changes introduced by the server-time protocol (STP) facility are added to various sections.
 - Changes introduced by the TOD-clock-steering facility are added to various sections.
 - The conditional-emergency-signal and sense-running-status orders are added to the section “Signal-Processor Orders.”
 - The location in which the PSW that is preserved as a result of switching from the *z/Architecture* to the ESA/390 architectural mode is formally named the *Captured z/Architecture PSW register*.
 - The description of all facility-indication bits has been moved to a new section at the end of the chapter.
- In Chapter 5, “Program Execution”:
 - The instructions of the message-security assist are added to the section “Condition Code Alternative to Interruptibility.”
 - Changes introduced by the DAT-enhancement facility 2 are added to various sections.
 - Changes introduced by the store-clock-fast facility are added to various sections.
 - Changes introduced by the modified-CCW-indirect-data-addressing facility are added to the section “Channel-Program Serialization.”
- In Chapter 6, “Interruptions”:
 - Changes introduced by the PER-3 facility are added to the various sections.

- Changes introduced by the server-time protocol (STP) facility are added to various sections.
- Changes introduced by the TOD-clock-steering facility are added to various sections.
- Changes introduced by the DAT-enhancement facility 2 are added to various sections.
- Changes introduced by the extended-immediate facility are added to the description of the specification exception program interruption.
- In Chapter 7, “General Instructions”:
 - A note is added to the “Instructions” section indicating that, for certain new or modified instructions, an operand may be optional.
 - Descriptions of thirty-four new instructions introduced by the extended-immediate facility are added.
 - A description of the STORE CLOCK FAST instruction is added.
 - A description of the STORE FACILITY LIST EXTENDED instruction is added.
 - Changes introduced by the TOD-clock-steering facility are added to the STORE CLOCK, STORE CLOCK FAST, and STORE CLOCK EXTENDED instructions.
 - Descriptions of new functions introduced by the message-security-assist extension 1 are added to the CIPHER MESSAGE, CIPHER MESSAGE WITH CHAINING, COMPUTE INTERMEDIATE MESSAGE DIGEST, and COMPUTE LAST MESSAGE DIGEST instructions.
 - Changes introduced by the ETF-2 enhancement facility are added to the TRANSLATE ONE TO ONE, TRANSLATE ONE TO TWO, TRANSLATE TWO TO ONE, and TRANSLATE TWO TO TWO instructions.
 - Changes introduced by the ETF-3 enhancement are added to the CONVERT UTF-16 TO UTF-32, CONVERT UTF-16 TO UTF-8, CONVERT UTF-8 TO UTF-16, and CONVERT UTF-8 TO UTF-32 instructions.
- In Chapter 10, “Control Instructions”:
 - A description of the LOAD PAGE-TABLE-ENTRY ADDRESS instruction, introduced by the DAT-enhancement facility 2, is added.
 - A description of the PERFORM TIMING FACILITY FUNCTION instruction, introduced by the TOD-clock-steering facility, is added.
 - Changes introduced by the TOD-clock-steering facility are added to the description of the SET CLOCK instruction.
 - The description of all facility-indication bits are moved to Chapter 4 (they are removed from the description of the STORE FACILITY LIST instruction).
 - A model-dependent field is defined in the SYSIB 2.2.2 operand stored by the STORE SYSTEM INFORMATION instruction.
 - Changes introduced by the store-clock-fast facility are added to the description of the TRACE instruction.
- In Chapter 11, “Machine-Check Handling”:
 - Changes introduced by the store-clock-fast facility are added to the section “CPU Retry.”
 - Changes introduced by the modified-CCW-indirect-data-addressing facility are added to the section “Invalid CBC in Storage”.
 - Changes introduced by the TOD-clock-steering facility are added to the section “Timing-Facility Damage.”
 - Changes introduced by the server-time-protocol facility are added to the section “External-Damage Code.”
- In Chapter 13, “I/O Overview”, changes introduced by the modified-CCW-indirect-data-address facility are added to the section “Channel-Program Execution”.
- In Chapter 15, “Basic I/O Functions”:
 - Changes introduced by the modified-CCW-indirect-data-addressing facility are added which include:
 - The modified-indirect-data-address word (MIDAW) is defined.
 - Bit 25 of word 1 of the operation-request block (ORB) is defined as the modified-CCW-indirect-data-addressing control.

- Bit 7 of the flags field in the channel-command word (CCW) is defined as the modified-indirect-data-addressing flag.
- In Chapter 16, “I/O Interruptions“:
 - Changes introduced by the modified-CCW-indirect-data-address facility are added to the sections “Subchannel-Status Word” and “Extended-Status Word”.
 - Changes are introduced to the section “Interface-Control Check” to support retrying a CCW-type IPL when an interface-control check is detected during the execution of the IPL channel program.
- In Chapter 17, “I/O Support Functions“:
 - Changes are introduced to the section “CCW-Type IPL” to support retrying a CCW-type IPL when an interface-control check is detected during the execution of the IPL channel program.
 - Changes are introduced to the section “List-Directed IPL” to support storing of the sub-system-identification word (SID) for the IPL-device during list-directed IPL, if a subchannel is associated with the IPL-device.
- In Chapter 18, “Hexadecimal-Floating-Point Instructions”, descriptions of the twelve instructions introduced by the HFP-unnormalized-extensions facility are added.
- In Appendix I, character representations of EBCDIC code pages 81C, 94C, 500, and 1047, IBM-PC, and BookMaster symbols are removed. Only the commonly used EBCDIC code page 037 and ISO-8 characters are shown.
- Changes introduced by the ASN-and-LX-reuse facility are added, including changes to the “Address Spaces” and “ASN Translation” sections.
- A programming note is added to the “Dynamic Address Translation” section, describing implications in using common segments.
- The ATMID and AI fields are corrected in the “Assigned Storage Locations” figure.
- In Chapter 4, “Control“:
 - Changes introduced by the ASN-and-LX-reuse facility are added, including changes to the “Trace” section.
 - The list-directed IPL function is added to the “Initial Program Load” section.
 - In the “Trace” section, serialization requirements for instructions that implicitly store into the trace table or linkage stack are relaxed.
- In Chapter 5, “Program Execution“:
 - A new RI and SS instruction format are included.
 - Changes introduced by the ASN-and-LX-reuse facility are added, including changes to the “Authorization Mechanisms”, “PC-Number Translation”, and “Linkage-Stack Operations” sections.
 - The instructions of the extended-translation facility 3 (except TRANSLATE AND TEST REVERSED) are added to the sections “Condition-Code Alternative to Interruptibility” and “Multiple-Access References.”
 - Serialization requirements for instructions that implicitly store into the trace table or linkage stack are relaxed.

Summary of Changes in Fourth Edition

The fourth edition of this publication differs from the previous edition principally by containing the definitions of the extended-translation facility 3 and the ASN-and-LX-reuse facility. The fourth edition contains minor clarifications and corrections and also the following significant changes relative to the previous edition:

- In Chapter 3, “Storage“:
 - Changes introduced by the ASN-and-LX-reuse facility include the new LFX translation, LSX translation, LSTE sequence, and ASTE instance exceptions.
 - An additional condition for TRAP is added to the list of instructions that can cause a special-operation exception to be recognized.

- SEARCH STRING UNICODE, a part of the extended-translation facility 3, is added to the list of instructions that can cause a specification exception to be recognized.
- In Chapter 7, “General Instructions”:
 - Six new instructions provided by the extended-translation facility 3 are added. The instructions CONVERT UNICODE TO UTF-8 (CUUTF) and CONVERT UTF-8 TO UNICODE (CUTFU) are renamed to CONVERT UTF-16 TO UTF-8 (CU21) and CONVERT UTF-8 TO UTF-16 (CU12), respectively. The old mnemonics continue to be recognized.
 - The instruction-format illustrations for STAMY and STMY are corrected.
- In Chapter 10, “Control Instructions”:
 - Changes introduced by the ASN-and-LX-reuse facility include the following:
 - Four new instructions provided by the facility are added.
 - The definitions of BRANCH AND STACK, BRANCH IN SUBSPACE GROUP, EXTRACT PRIMARY ASN, EXTRACT SECONDARY ASN, LOAD ADDRESS SPACE PARAMETERS, PROGRAM CALL, PROGRAM RETURN, PROGRAM TRANSFER, and SET SECONDARY ASN are updated to account for the facility.
 - New facility bits for the ASN-and-LX-reuse facility and the extended-translation facility 3 are added to STORE FACILITY LIST.
 - New fields are added to the system-information block (SYSIB) returned by STORE SYSTEM INFORMATION.
 - Serialization requirements for instructions that implicitly store into the trace table or linkage stack are relaxed, including PROGRAM CALL, PROGRAM RETURN, PROGRAM TRANSFER (WITH INSTANCE), SET SECONDARY ASN (WITH INSTANCE), and TRACE.
 - Corrections and clarifications are made to TRAP.
- In Chapter 12, “Operator Facilities”: Changes introduced by the list-directed IPL function are added, including the load-clear-list-directed key and the load-with-dump key.
- In Chapter 14, “I/O Instructions”, Clarifications are added to programming note 1 of the CANCEL SUBCHANNEL instruction description.
- In Chapter 16, “I/O Interruptions”:
 - Bit 1 of the extended-report word (ERW) is defined as the request-logging-only (L) bit.
 - Bit 2 of the ERW is defined as the extended-subchannel-logout-pending (E) bit.
 - Words 2-3 of the format-0 extended-status word (ESW) are defined as the failing-storage address when the failing-storage-address-validity (F) bit, bit 6 of the ERW, is one and as the extended-subchannel-logout descriptor (ESLD) when the extended-subchannel-logout-pending (E) bit, bit 2 of the ERW, is one. The E-bit is always zero when the F-bit is one, and the F-bit is always zero when the E-bit is one.
- In Chapter 17, “I/O Support Functions”, list-directed IPL is added to support initial-program loading (IPL) from devices that are not accessed by CCWs. IPL from devices that are accessed by CCWs is designated CCW-type IPL.
- In Appendix C, “Condition-Code Settings”: The instructions of the extended-translation facility 3 are added.

Summary of Changes in Third Edition

The third edition of this publication differs from the previous edition principally by containing the definitions of the DAT-enhancement, HFP-multiply-add/subtract, and long-displacement facilities and the message-security assist. The third edition contains minor clarifications and corrections and also the following significant changes relative to the previous edition:

- In Chapter 3, “Storage”:
 - Clarifications are added to the description of dynamic-address-translation process.

- The primary address-space-control element (ASCE) in control register 1 is an attaching ASCE even when the CPU is in the home-space mode, and the home ASCE in control register 13 is an attaching ASCE even when the CPU is in the secondary-space mode.
- The illustration of the PER code in Figure 3-19 is corrected.
- In Chapter 4, “Control”:
 - The relationships between ETR time (TOD-clock time), UTC, and International Atomic Time are described in programming note 3 on page 4-52.
 - Code 0 of the SIGNAL PROCESSOR set-architecture order, and also a CPU reset due to activation of the load normal key, are changed to save the current z/Architecture PSW when switching to the ESA/390 architectural mode. Also, code 2 of the order is added, and this restores, for CPUs other than the one executing SIGNAL PROCESSOR, the saved PSW when switching to the z/Architecture architectural mode, provided that the saved PSW has not been set to all zeros by certain resets.
- In Chapter 5, “Program Execution”:
 - The I format, the RI format with a M_1 operand, and the SS format with the I_3 operand are added.
 - The RSY, RXY, and SIY instruction formats are added, and the RSE format is deleted. (All instructions that were of format RSE are now referred to as being of format RSY.)
 - The formation of an operand address using the 20-bit signed displacement of instructions of formats RSY, RXY, and SIY is described.
 - The results when a PER instruction-fetching event occurs along with certain exceptions or exception conditions are clarified. See “Indication of PER Events Concurrently with Other Interruption Conditions” on page 4-40
 - The fetch of the address-space-control element from the ASN-second-table entry during access-register translation is doubleword concurrent as observed by other CPUs.
- The change bit is not necessarily set to one currently with the related storage reference, as observed by other CPUs; it may be set to one before or after the reference, within certain limits. See “Storage-Key Accesses” on page 5-120 for a detailed description of when the change bit is set.
- The five instructions of the message-security assist are added to the list of instructions having multiple-access references.
- In Chapter 6, “Interruptions,” the list of conditions causing a specification exception to be recognized is extended to include those caused by the message-security assist instructions.
- In Chapter 7, “General Instructions”:
 - Thirty-nine instructions provided by the long-displacement facility are added. With the exception of the new LOAD BYTE instruction, the instructions added by the long-displacement facility have names and functions that are the same as existing instructions (but the mnemonics and opcodes are new). The new instructions are of formats RSY, RXY, and SIY and have a 20-bit signed displacement instead of a 12-bit unsigned displacement.
 - All previously existing format-RSE and format-RXE instructions are changed to be of formats RSY and RXY, respectively, by use of a previously unused byte in the instructions. These changes are not marked by a bar in the margin.
 - Five instructions provided by the message-security assist are added.
 - The instruction format of SUPERVISOR CALL is changed to I.
- In Chapter 9, “Floating-Point Overview and Support Instructions,” four instructions provided by the long-displacement facility are added. These are the LOAD (long and short) and STORE (long and short) instructions.
- In Chapter 10, “Control Instructions”:
 - The COMPARE AND SWAP AND PURGE (CSPG) and INVALIDATE DAT TABLE ENTRY instructions provided by the DAT-enhancement facility are added. CSPG operates on a doubleword operand in storage.

- The definition of LOAD ADDRESS SPACE PARAMETERS is clarified.
- The LOAD REAL ADDRESS (LRAY) instruction provided by the long-displacement facility is added.
- All previously existing format-RSE instructions are changed to be of format RSY by use of a previously unused byte in the instructions. These changes are not marked by a bar in the margin.
- The description of the bits set by STORE FACILITY LIST is clarified, and new bits are assigned.
- In Chapter 14, “I/O Instructions”:
 - The definition of MODIFY SUBCHANNEL is modified.
 - The definition of SET CHANNEL MONITOR is modified.
- In Chapter 15, “Basic I/O Functions,” the following changes are made to the subchannel-information-block (SCHIB):
 - Bit 29 of word 6 of the path-management-control word (PMCW) is defined as the measurement-block-format control.
 - Bit 30 of word 6 of the PMCW is defined as the extended-measurement-word-mode enablement bit.
 - The definition of words 10-11 (words 0-1 of the model-dependent area) are changed to contain a measurement-block address, when the extended-I/O-measurement-block facility is installed.
- In Chapter 16, “I/O Interruptions”, the interruption-response block (IRB) is extended to include the extended-measurement word.
- In Chapter 17, “I/O Support Functions”:
 - The requirement that the measurement block be updated when secondary status is accepted is clarified.
 - The extended-measurement-block facility is added.
 - The extended-measurement-word facility is added.

- In Chapter 18, “Hexadecimal-Floating-Point Instructions,” the MULTIPLY AND ADD (four instructions) and MULTIPLY AND SUBTRACT (four instructions) instructions provided by the HFP-multiply-add/subtract facility are added.

The above changes may affect other chapters besides the ones listed. All technical changes to the text or to an illustration are indicated by a vertical line to the left of the change.

Summary of Changes in Second Edition

The second edition of this publication differs from the previous edition mainly by containing clarifications and corrections. The significant changes are as follows:

- In Chapter 1, “Introduction”:
 - Summaries of DIVIDE LOGICAL and MULTIPLY LOGICAL, TEST ADDRESSING MODE, the set-architecture order of SIGNAL PROCESSOR, and STORE FACILITY LIST are added or improved.
 - An extensive summary of the input/output enhancements placed in z/Architecture is added.
- In Chapter 3, “Storage”:
 - Definitions of absolute locations 0-23 are deleted since they pertain only to an ESA/390 initial program load.
 - The definition of real locations 200-203, stored in by STORE FACILITY LIST, is corrected to state that bit 16 indicates the extended-translation facility 2.
- In Chapter 4, “Control,” a description of unassigned fields in the PSW is corrected to state that bit 4 is unassigned and bit 31 is assigned.
- In Chapter 5, “Program Execution,” the RSL format and an RIL format with an M_1 field are added.
- In Chapter 7, “General Instructions”:
 - The definition of BRANCH AND SET MODE is corrected to state that bit 63 of the R_1 gen-

eral register remains unchanged in the 24-bit or 31-bit addressing mode; the bit is not set to zero.

- The definitions of PACK ASCII, PACK UNICODE, UNPACK ASCII, and UNPACK UNICODE are clarified.
- It is clarified that the following instructions perform multiple-access references to their storage operands:
 - CHECKSUM
 - COMPARE AND FORM CODEWORD
 - CONVERT UNICODE TO UTF-8
 - CONVERT UTF-8 TO UNICODE
- It is clarified that the following instructions do not necessarily process their storage operands left to right as observed by other CPUs: MOVE LONG, MOVE LONG EXTENDED, and MOVE LONG UNICODE. Special padding characters of MOVE LONG and MOVE LONG EXTENDED specify whether left-to-right processing should be performed, as observed by other CPUs, and whether the data being moved should or should not be placed in the cache for availability for subsequent processing.
- In Chapter 10, “Control Instructions,” it is clarified that the following instructions perform multiple-access references to their storage operands:
 - LOAD ADDRESS SPACE PARAMETERS
 - RESUME PROGRAM
 - STORE SYSTEM INFORMATION

Chapters 13-17 contain many clarifying changes, all indicated by a vertical line in the margin, in addition to the significant changes listed below.

- In Chapter 13, “I/O Overview,” statements about the suspend flag in a CCW are clarified to describe the flag being specified as a one and being valid because of a one value of the suspend control in the associated ORB.

- In Chapter 14, “I/O Instructions,” the results of MODIFY SUBCHANNEL when the device-number-valid bit at the designated subchannel is zero are corrected.
- In Chapter 15, “Basic I/O Functions”:
 - It is clarified that unlimited prefetching of data and IDAWs associated with the current and prefetched CCWs is allowed independent of the value of the prefetch control in the associated ORB.
 - A specified control-unit-priority number is ignored if the channel-subsystem-I/O-priority facility is not operational due to an operator action.
 - It is clarified that address-limit checking applies to data locations and not to locations containing a CCW or IDAW.
- In Chapter 16, “I/O Interruptions,” the form of the address stored in the failing-storage-address field is described in terms of the format-2-IDAW control instead of an addressing mode.
- In Chapter 17, “I/O Support Functions”:
 - The introduction to the channel-subsystem monitoring facilities is clarified.
 - References to the measurement block by the measurement-block-update facility are single-access references and appear to be word concurrent as observed by CPUs. They do not appear to be block concurrent.
 - The description of the channel-subsystem-I/O-priority facility is corrected by including mention of control-unit priority for fibre-channel-attached control units.

The above changes may affect other chapters besides the ones listed.

Chapter 1. Introduction

Highlights of Original z/Architecture	1-2	General-Instructions-Extension Facility	1-15
General Instructions for 64-Bit Integers	1-3	Guarded-Storage Facility	1-16
Other New General Instructions	1-3	HFP Multiply-and-Add/Subtract Facility	1-16
Floating-Point Instructions	1-5	HFP-Unnormalized-Extensions Facility	1-16
Control Instructions	1-5	High-Word Facility	1-16
Trimodal Addressing	1-5	IEEE-Exception-Simulation Facility	1-17
Modal Instructions	1-5	Insert-Reference-Bits-Multiple Facility	1-17
Effects on Bits 0-31 of a General Register	1-6	Instruction-Execution-Protection Facility	1-17
Input/Output	1-6	Interlocked-Access Facility 1	1-17
Additions to z/Architecture	1-7	Interlocked-Access Facility 2	1-17
ASN-and-LX-Reuse Facility	1-7	IPTE-Range Facility	1-17
CMPSC-Enhancement Facility	1-7	List-Directed Initial Program Load	1-17
Compare-and-Swap-and-Store Facility	1-8	Load-and-Trap Facility	1-18
Compare-and-Swap-and-Store Facility 2	1-8	Load-and-Zero-Rightmost-Byte Facility	1-18
Conditional-SSKE Facility	1-8	Load/Store-on-Condition Facility 1	1-18
Configuration-Topology Facility	1-8	Load/Store-on-Condition Facility 2	1-18
Configuration-z/Architecture-Architectural-Mode Facility	1-8	Local-TLB-Clearing Facility	1-18
Constrained-Transactional-Execution Facility	1-8	Long-Displacement Facility	1-18
DAT-Enhancement Facility 1	1-8	Message-Security Assist	1-19
DAT-Enhancement Facility 2	1-9	Message-Security-Assist Extension 1	1-19
Decimal-Floating-Point Facility	1-9	Message-Security-Assist Extension 2	1-19
Decimal-Floating-Point Packed-Conversion Facility	1-9	Message-Security-Assist Extension 3	1-19
Decimal-Floating-Point-Rounding Facility	1-9	Message-Security-Assist Extension 4	1-20
Decimal-Floating-Point Zoned-Conversion Facility	1-9	Message-Security-Assist Extension 5	1-21
DEFLATE-Conversion Facility	1-9	Message-Security-Assist Extension 6	1-21
Distinct-Operands Facility	1-9	Message-Security-Assist Extension 7	1-22
Enhanced-DAT Facility 1	1-10	Message-Security-Assist Extension 8	1-22
Enhanced-DAT Facility 2	1-10	Message-Security-Assist Extension 9	1-22
Enhanced-Monitor Facility	1-11	Miscellaneous-Instruction-Extensions Facility 1	1-23
Entropy Encoding Compression Facility	1-11	Miscellaneous-Instruction-Extensions Facility 2	1-23
ESA/390-Compatibility-Mode Facility	1-11	Miscellaneous-Instruction-Extensions Facility 3	1-23
ETF2-Enhancement Facility	1-11	Modified CCW Indirect Data Addressing Facility	1-23
ETF3-Enhancement Facility	1-11	Move-Page-and-Set-Key Facility	1-24
Execute-Extensions Facility	1-12	Move-With-Optional-Specifications Facility	1-24
Execution-Hint Facility	1-12	Multiple-Epoch Facility	1-24
Extended-Immediate Facility	1-12	Multiple-Subchannel-Set Facility	1-24
Extended-I/O-Measurement-Block Facility	1-12	Multithreading Facility	1-25
Extended-I/O-Measurement-Word Facility	1-12	Nonquiescing Key-Setting Facility	1-25
Extended-Translation Facility 2	1-13	Parsing-Enhancement Facility	1-25
Extended-Translation Facility 3	1-13	PER-3 Facility	1-25
Extract-CPU-Time Facility	1-13	PER-Storage-Key-Alteration Facility	1-26
Fast-BCR-Serialization Facility	1-13	PER Zero-Address-Detection Facility	1-26
Fibre-Channel Extensions (FCX)	1-13	PFPO Facility	1-26
FCX-Bidirectional-Data-Transfer Facility	1-14	Population-Count Facility	1-26
Floating-Point Extension Facility	1-14	Processor-Assist Facility	1-26
Floating-Point-Support-Sign- Handling Facility	1-15	Reset-Reference-Bits-Multiple Facility	1-26
FPR-GR-Transfer Facility	1-15		

Restore-Subchannel Facility	1-26
Server-Time-Protocol Facility	1-26
Side-Effect-Access Facility	1-27
Store-Clock-Fast Facility	1-27
Store-Facility-List-Extended Facility	1-27
Test-Pending-External-Interruption Facility . .	1-27
TOD-Clock-Steering Facility	1-27
Transactional-Execution Facility	1-27
Vector-Enhancements Facility 1	1-27
Vector-Enhancements Facility 2	1-28
Vector Facility for z/Architecture	1-28
Vector Packed-Decimal Facility	1-28

Vector-Packed-Decimal-Enhancement Facility	1-29
Warning-Track Interruption Facility	1-29
The ESA/390 Base	1-29
The ESA/370 and 370-XA Base	1-34
System Program	1-36
Compatibility	1-36
Compatibility among z/Architecture Systems .	1-36
Compatibility between z/Architecture and ESA/390	1-37
Control-Program Compatibility	1-37
Problem-State Compatibility	1-37
Availability	1-37

This publication provides, for reference purposes, a detailed description of z/Architecture.™

The architecture of a system defines its attributes as seen by the programmer, that is, the conceptual structure and functional behavior of the machine, as distinct from the organization of the data flow, the logical design, the physical design, and the performance of any particular implementation. Several dissimilar machine implementations may conform to a single architecture. When the execution of a set of programs on different machine implementations produces the results that are defined by a single architecture, the implementations are considered to be compatible for those programs.

Highlights of Original z/Architecture

z/Architecture is the next step in the evolution from the System/360 to the System/370™, System/370 extended architecture (370-XA), Enterprise Systems Architecture/370™ (ESA/370™), and Enterprise Systems Architecture/390® (ESA/390™). z/Architecture includes all of the facilities of ESA/390 except for the asynchronous-pageout, asynchronous-data-mover, program-call-fast, and ESA/390 vector facilities. z/Architecture also provides significant extensions, as follows:

- Sixty-four-bit general registers and control registers.
- A 64-bit addressing mode, in addition to the 24-bit and 31-bit addressing modes of ESA/390, which are carried forward to z/Architecture.

Both operand addresses and instruction addresses can be 64-bit addresses. The program-status word (PSW) is expanded to 16 bytes to contain the larger instruction address. The PSW also contains a newly assigned bit that specifies the 64-bit addressing mode.

- Up to three additional levels of dynamic-address-translation (DAT) tables, called region tables, for translating 64-bit virtual addresses.

A virtual address space may be specified either by a segment-table designation as in ESA/390 or by a region-table designation, and either of these types of designation is called an address-space-control element (ASCE). An ASCE may alternatively be a real-space designation that causes virtual addresses to be treated simply as real addresses without the use of DAT tables.

- An 8 K-byte prefix area for containing larger old and new PSWs and register save areas.
- A SIGNAL PROCESSOR order for switching between the ESA/390 and z/Architecture architectural modes.

Initial program loading sets the ESA/390 architectural mode. The new SIGNAL PROCESSOR order then can be used to set the z/Architecture mode or to return from z/Architecture to ESA/390. This order causes all CPUs in the configuration always to be in the same architectural mode.

- Many new instructions, many of which operate on 64-bit binary integers

Some of the new instructions that do not operate on 64-bit binary integers have also been added to ESA/390.

All of the ESA/390 instructions, except for those of the four facilities named above, are included in z/Architecture.

The bit positions of the general registers and control registers of z/Architecture are numbered 0-63. An ESA/390 instruction that operates on bit positions 0-31 of a 32-bit register in ESA/390 operates instead on bit positions 32-63 of a 64-bit register in z/Architecture.

z/Architecture was announced in October, 2000. The remainder of this section summarizes the original contents of z/Architecture. Subsequent additions are described in “Additions to z/Architecture” on page 1-7.

General Instructions for 64-Bit Integers

The 32-bit-binary-integer instructions of ESA/390 have new analogs in z/Architecture that operate on 64-bit binary integers. There are two types of analogs:

- Analogs that use two 64-bit binary integers to produce a 64-bit binary integer. For example, the ESA/390 ADD instruction (A for a storage-to-register operation or AR for a register-to-register operation) has the analogs AG (adds 64 bits from storage to the contents of a 64-bit general register) and AGR (adds the contents of a 64-bit general register to the contents of another 64-bit general register). These analogs are distinguished by having “G” in their mnemonics.
- Analogs that use a 64-bit binary integer and a 32-bit binary integer to produce a 64-bit binary integer. The 32-bit integer is either sign-extended or extended on the left with zeros, depending on whether the operation is signed or unsigned, respectively. For example, the ESA/390 ADD (A or AR) instruction has the analogs AGF (adds 32 bits from storage to the contents of a 64-bit general register) and AGFR (adds the contents of bit positions 32-63 of a 64-bit general register to the contents of another 64-bit general register). These analogs are distinguished by having “GF” in their mnemonics.

Other New General Instructions

The other additional or significantly enhanced general instructions of z/Architecture are highlighted as follows:

- ADD LOGICAL WITH CARRY and SUBTRACT LOGICAL WITH BORROW operate on either 32-bit or 64-bit unsigned binary integers and include a carry or borrow, as represented by the leftmost bit of the two-bit condition code in the PSW, in the computation. This can improve the performance of operating on extended-precision integers (integers longer than 64 bits).
- AND IMMEDIATE and OR IMMEDIATE combine a two-byte immediate operand with any of the two bytes on two-byte boundaries in a 64-bit general register.
- BRANCH AND SAVE AND SET MODE and BRANCH AND SET MODE are enhanced so that they set bit 63 of the R₁ general register to one if the current addressing mode is the 64-bit mode, and they set the 64-bit addressing mode if bit 63 of the R₂ general register is one. This allows “pointer-directed” linkages between programs in different addressing modes, including any of the 24-bit, 31-bit, and 64-bit modes.
- BRANCH RELATIVE AND SAVE LONG and BRANCH RELATIVE ON CONDITION LONG are like the BRANCH RELATIVE AND SAVE and BRANCH RELATIVE ON CONDITION instructions of ESA/390 except that the new instructions use a 32-bit immediate field. This increases the target range available through relative branching.
- COMPARE AND FORM CODEWORD is enhanced so that, in the 64-bit addressing mode, the comparison unit is six bytes instead of two and the resulting codeword is eight bytes instead of four. UPDATE TREE is enhanced so that, in the 64-bit addressing mode, a node is 16 bytes instead of eight and the codeword in a node is eight bytes instead of four. This improves the performance of sorting records having long keys.
- DIVIDE LOGICAL uses a 64-bit or 128-bit unsigned binary dividend and a 32-bit or 64-bit unsigned binary divisor, respectively, to produce a 32-bit or 64-bit quotient and remainder, respectively. MULTIPLY LOGICAL uses a 32-bit or 64-bit unsigned binary multiplicand and multiplier

to produce a 64-bit or 128-bit product, respectively.

- **DIVIDE SINGLE** divides a 64-bit dividend by a 32-bit or 64-bit divisor and produces a 64-bit quotient and remainder. **MULTIPLY SINGLE** is enhanced so it can multiply a 64-bit multiplicand by a 32-bit or 64-bit multiplier and produce a 64-bit product.
- **EXTRACT PSW** extracts bits 0-63 of the current PSW to allow determination of the current machine state, for example, determination of whether the CPU is in the problem state or the supervisor state.
- **INSERT IMMEDIATE** inserts a two-byte immediate operand into a 64-bit general register on any of the two-byte boundaries in the register. **LOAD LOGICAL IMMEDIATE** does the same and also clears the remainder of the register.
- **LOAD ADDRESS RELATIVE LONG** forms an address relative to the current (unupdated) instruction address by means of a signed 32-bit immediate field.
- **LOAD LOGICAL THIRTY ONE BITS** places the rightmost 31 bits of either a general register or a word in storage, with 33 zeros appended on the left, in a general register.
- **LOAD MULTIPLE DISJOINT** loads the leftmost 32 bits of each register in a range of general registers from one area in storage and the rightmost 32 bits of each of those registers from another area in storage. This is for use in place of a **LOAD MULTIPLE HIGH** instruction and a 32-bit **LOAD MULTIPLE** instruction when one of the storage areas is addressed by one of the registers loaded.
- **LOAD MULTIPLE HIGH** and **STORE MULTIPLE HIGH** load or store the leftmost 32 bits of each register in a range of general registers, allowing augmentation of existing programs that load or store the rightmost 32 bits by means of **LOAD MULTIPLE** and **STORE MULTIPLE**. (Sixty-four-bit forms of **LOAD MULTIPLE** and **STORE MULTIPLE** also are provided.)
- **LOAD PAIR FROM QUADWORD** and **STORE PAIR TO QUADWORD** operate between an even-odd pair of 64-bit general registers and a quadword in storage (16 bytes aligned on a 16-byte boundary). These instructions provide quadword consistency (all bytes appear to be loaded or stored concurrently in a multiple-CPU system). (Only the 64-bit form of **COMPARE DOUBLE AND SWAP** also provides quadword consistency.)
- **LOAD REVERSED** and **STORE REVERSED** load or store a two-byte, four-byte, or eight-byte unit in storage with the left-to-right sequence of the bytes reversed. **LOAD REVERSED** also can move a four-byte or eight-byte unit between two general registers. These operations allow conversion between “little-endian” and “big-endian” formats.
- **PERFORM LOCKED OPERATION** is enhanced with two more sets of function codes, with each set providing six different operations. One of the additional sets provides operations on 64-bit operands in 64-bit general registers, and the other provides operations on 128-bit operands in a parameter list.
- **ROTATE LEFT SINGLE LOGICAL** obtains 32 bits or 64 bits from a general register, rotates them (the leftmost bit replaces the rightmost bit), and places the result in another general register (a nondestructive rotate).
- **SET ADDRESSING MODE** can set any of the 24-bit, 31-bit, and 64-bit addressing modes.
- **SHIFT LEFT SINGLE**, **SHIFT LEFT SINGLE LOGICAL**, **SHIFT RIGHT SINGLE**, and **SHIFT RIGHT SINGLE LOGICAL** are enhanced with 64-bit forms that obtain the source operand from one general register and place the result operand in another general register (a nondestructive shift).
- **TEST ADDRESSING MODE** sets the condition code to indicate whether bits 31 and 32 of the current PSW specify the 24-bit, 31-bit, or 64-bit addressing mode.
- **TEST UNDER MASK HIGH** and **TEST UNDER MASK LOW**, which are ESA/390 instructions, are given the alternative name **TEST UNDER MASK**, and two additional forms are added so that a two-byte immediate operand can be used to test the bits of two bytes located on any of the two-byte boundaries in a 64-bit general register. (The ESA/390 instruction **TEST UNDER MASK**, which uses a one-byte immediate operand to test a byte in storage, continues to be provided.)

Floating-Point Instructions

The z/Architecture floating-point instructions are the same as in ESA/390 except that instructions are added for converting between 64-bit signed binary integers and either hexadecimal or binary floating-point data. These new instructions have “G” in their mnemonics.

Control Instructions

The new or enhanced control instructions of z/Architecture are highlighted as follows:

- **EXTRACT AND SET EXTENDED AUTHORITY** is a privileged instruction for changing the extended authorization index in a control register. This enables real-space designations to be used more efficiently by means of access lists.
- **EXTRACT STACKED REGISTERS** is enhanced to extract optionally all 64 bits of the contents of one or more saved general registers.
- **EXTRACT STACKED STATE** is enhanced to extract optionally the entire contents of the saved PSW, including a 64-bit instruction address.
- **LOAD CONTROL** and **STORE CONTROL** are enhanced for operating optionally on 64-bit control registers.
- **LOAD PSW** uses an eight-byte storage operand as in ESA/390 and expands this operand to a 16-byte z/Architecture PSW.
- **LOAD PSW EXTENDED** directly loads a 16-byte PSW.
- **LOAD REAL ADDRESS** in its ESA/390 form and in the 24-bit or 31-bit addressing mode operates as in ESA/390 if the translation is successful and the obtained real address has a value less than 2G bytes. **LOAD REAL ADDRESS** in its ESA/390 form and in the 64-bit addressing mode, or in its enhanced z/Architecture form in any addressing mode, loads a 64-bit real address.
- **LOAD USING REAL ADDRESS** and **STORE USING REAL ADDRESS** are enhanced to have optionally 64-bit operands.
- **SIGNAL PROCESSOR** has a new order that can be used to switch all CPUs in the configuration either from the ESA/390 architectural mode to

the z/Architecture architectural mode or from z/Architecture to ESA/390. (A system that is to operate using z/Architecture must first be IPLed in the ESA/390 mode.)

- **STORE FACILITY LIST** is a privileged instruction that stores at real location 200 an indication of whether z/Architecture is installed and of whether it is active. This instruction is added also to ESA/390 and also stores an indication of whether the new z/Architecture instructions that have been added to ESA/390 are available. Real location 200 has previously contained all zeros in most systems and normally can be examined by a problem-state program whether or not **STORE FACILITY LIST** is installed. The information stored at real location 200 also indicates whether the extended-translation facility 2 is installed.
- **STORE REAL ADDRESS** is like **LOAD REAL ADDRESS** except that **STORE REAL ADDRESS** stores the resulting address instead of placing it in a register.
- **TRACE** is enhanced to record optionally the contents of 64-bit general registers.

Trimodal Addressing

“Trimodal addressing” refers to the ability to switch between the 24-bit, 31-bit, and 64-bit addressing modes. This switching can be done by means of:

- The old instructions **BRANCH AND SAVE AND SET MODE** and **BRANCH AND SET MODE**. Both of these instructions set the 64-bit addressing mode if bit 63 of the R_2 general register is one. If bit 63 is zero, the instructions set the 24-bit or 31-bit addressing mode if bit 32 of the register is zero or one, respectively.
- The new instruction **SET ADDRESSING MODE** (**SAM24**, **SAM31**, and **SAM64**). The instruction sets the 24-bit, 31-bit, or 64-bit addressing mode as determined by the operation code.

Modal Instructions

Trimodal addressing affects the general instructions only in the manner in which logical storage addresses are handled, except as follows.

- The instructions **BRANCH AND LINK**, **BRANCH AND SAVE**, **BRANCH AND SAVE AND SET MODE**, **BRANCH AND SET MODE**, and

BRANCH RELATIVE AND SAVE place information in bit positions 32-39 of general register R_1 as in ESA/390 in the 24-bit or 31-bit addressing mode or place address bits in those bit positions in the 64-bit addressing mode. The new instruction BRANCH RELATIVE AND SAVE LONG does the same.

- The instructions BRANCH AND SAVE AND SET MODE and BRANCH AND SET MODE place a one in bit position 63 of general register R_1 in the 64-bit addressing mode. In the 24-bit or 31-bit mode, BRANCH AND SAVE AND SET MODE sets bit 63 to zero, and BRANCH AND SET MODE leaves it unchanged.
- Certain instructions leave bits 0-31 of a general register unchanged in the 24-bit or 31-bit addressing mode but place or update address or length information in them in the 64-bit addressing mode. These are listed in programming note 1 on page 7-8 and are sometimes called modal instructions.

Effects on Bits 0-31 of a General Register

Bits 0-31 of general registers are changed by two types of instructions. The first type is a modal instruction (see the preceding section) when the instruction is executed in the 64-bit addressing mode. The second type is an instruction having, independent of the addressing mode, either a 64-bit result operand in a single general register or a 128-bit result operand in an even-odd general-register pair.

Most of the instructions of the second type are indicated by a “G,” either alone or in “GF,” in their mnemonics. The other instructions that change or may change bits 0-31 of a general register regardless of the current addressing mode are listed in programming note 2 on page 7-8. All of the instructions of the second type are sometimes referred to as “G-type” instructions.

If a program is not executed in the 64-bit addressing mode and does not contain a G-type instruction, it cannot change bits 0-31 of any general register.

Input/Output

Additional I/O functions and facilities are provided when z/Architecture is installed. They are provided in both the ESA/390 and the z/Architecture architectural mode and are as follows:

- Indirect data addressing is enhanced by the provision of a doubleword format-2 IDAW that is intended to allow operations on data at or above the 2 G-byte absolute-address boundary in z/Architecture. The previously existing IDAW, a word containing a 31-bit address, is now called a format-1 IDAW. The format-2 IDAW contains a 64-bit address. A bit in the operation-request block (ORB) associated with a channel program specifies whether the program uses format-1 or format-2 IDAWs. A further enhancement is the ability of all format-2 IDAWs of a channel program to specify either 2 K-byte or 4 K-byte data blocks, as determined by another bit in the ORB. The use of 4 K-byte blocks improves the efficiency of data transfers.
- The *FICON[®]-channel facility* provides the capabilities of attaching FICON-I/O-interface and FICON-converted-I/O-interface channel paths and of fully utilizing these channel-path types. FICON channel paths can significantly enhance overall data throughput by providing increased data-transfer rates in comparison to ESCON channel paths and by allowing multiple commands and associated data to be “streamed” to control units, thus further improving performance. The facility supports the following additional control mechanisms:
 - The modification-control bit in the ORB allows the program to optimize the performance of FICON channel paths when dynamically modifying channel programs.
 - The synchronization-control bit in the ORB ensures data integrity along with maximum channel-path performance by delaying the execution of a write command until the completion of an immediately preceding read command when performing unlimited prefetching of CCWs and when the data to be written may be the data read.
 - The streaming-mode-control bit in the ORB allows the program to prevent command streaming in cases that require such prevention.
 - The secondary-CCW-address field in the extended-status word assists in the recovery of channel programs that terminate abnormally when command streaming to a control unit is being performed. The field identifies a CCW that failed at the control unit.

- The *ORB-extension facility* expands the size of the ORB from three words to eight words. This makes fields available for use by the channel-subsystem-I/O-priority facility.
- The *channel-subsystem-I/O-priority facility* allows the program to establish a priority relationship among subchannels that have pending I/O operations. The priority relationship specifies the order in which I/O operations are initiated by the channel subsystem. Additionally, for fibre-channel-attached control units, the facility allows the program to specify the priority in which I/O operations pending at the control unit are performed.

The input/output enhancements are further highlighted below by describing how they affect the I/O chapters.

- In Chapter 13, “I/O Overview,” FICON and FICON-converted I/O interfaces and the frame-multiplex mode are introduced.
- In Chapter 14, “I/O Instructions”:
 - The CANCEL SUBCHANNEL instruction is described.
 - TEST PENDING INTERRUPTION, when the second-operand address is zero, stores a three-word I/O-interruption code at real locations 184-195. The new third word contains an interruption-identification word that further identifies the source of the I/O interruption.
- In Chapter 15, “Basic I/O Functions”:
 - The ORB is extended to eight words and newly contains a streaming-mode control, modification control, synchronization control, format-2-IDAW control, 2K-IDAW control, ORB-extension control, channel-subsystem priority, and control-unit priority.
 - A doubleword format-2 IDAW and 4 K-byte data blocks optionally designated by format-2 IDAWs are added.
- In Chapter 16, “I/O Interruptions”:
 - A secondary-CCW-address-validity bit and failing-storage-address-format bit are added to the extended-report word.
 - A two-word failing-storage address and a secondary-CCW address are added to the format-0 extended-status word.

- In Chapter 17, “I/O Support Functions”:
 - Control-unit-defer time is added. This has an effect on the device-connect time and device-disconnect time in the measurement block.
 - References to the measurement block by the measurement-block-update facility are single-access references and appear to be word concurrent as observed by CPUs.
 - Device-active-only time is added to the measurement block.
 - The channel-subsystem-I/O-priority facility, providing channel-subsystem priority and control-unit priority, is added.

Additions to z/Architecture

z/Architecture was announced in October, 2000. Any extension added subsequently is summarized below and has the date of its announcement at the end of its summary.

ASN-and-LX-Reuse Facility

The *ASN-and-LX-reuse facility* may be available on a model implementing z/Architecture. The facility provides the means by which an address-space number (ASN) that is used in certain space-switching linkage instructions may be safely reused. The facility also adds a 32-bit program-call (PC) number, and it also provides the means by which the linkage index that is used in PC-number translation may be safely reused. The facility provides the following instructions:

- EXTRACT PRIMARY ASN AND INSTANCE
- EXTRACT SECONDARY ASN AND INSTANCE
- PROGRAM TRANSFER WITH INSTANCE
- SET SECONDARY ASN WITH INSTANCE

(May, 2004)

CMPSC-Enhancement Facility

The *CMPSC-enhancement facility* may be available on a model implementing z/Architecture. The facility provides performance improvements for the COMPRESSION CALL instruction. (August, 2010)

Compare-and-Swap-and-Store Facility

The *compare-and-swap-and-store facility* may be available on a model implementing z/Architecture. The facility performs compare-and-swap operations on 4- or 8-byte operands using interlocked update. If the operands are equal, a subsequent store operation of 1, 2, 4, or 8 bytes is performed. The facility provides the COMPARE AND SWAP AND STORE instruction. (April, 2007)

Compare-and-Swap-and-Store Facility 2

The *compare-and-swap-and-store facility 2* may be available on a model implementing z/Architecture. The facility extends the compare-and-swap-and-store facility by providing a 16-byte compare-and-swap function and a 16-byte store operation. (February, 2008)

Conditional-SSKE Facility

The *conditional-SSKE facility* may be available on a model implementing z/Architecture. The facility provides performance improvements for the SET STORAGE KEY EXTENDED instruction. (April, 2007)

The *conditional-SSKE facility* also provides performance improvements for the PERFORM FRAME MANAGEMENT FUNCTION instruction which was introduced with the enhanced-DAT facility. (February, 2008)

Configuration-Topology Facility

The *configuration-topology facility* may be available on a model implementing z/Architecture. The facility provides additional topology awareness to the program such that certain optimizations can be performed to improve cache hit ratios and thereby improve overall performance. The facility provides:

- The PERFORM TOPOLOGY FUNCTION (PTF) control instruction.
- A new system-information block (SYSIB 15.1.2) stored by the STORE SYSTEM INFORMATION instruction.

(February, 2008)

Configuration-z/Architecture-Architectural-Mode Facility

The *configuration-z/Architecture-architectural-mode (CZAM) facility* may be present on a model implementing z/Architecture. When the facility is installed in a configuration, the configuration is reset into the z/Architecture architectural mode (rather than into the ESA/390 architectural mode), and the configuration cannot be switched into the ESA/390 architectural mode.

The facility may be installed in a configuration operating in a logical partition and in a configuration operating as a guest of a logical partition. (September, 2017)

Constrained-Transactional-Execution Facility

The *constrained-transactional-execution facility* may be available on a model in which the transactional-execution facility is installed. The constrained-transactional-execution facility ensures that – in the absence of repeated interruptions or conflicts with other CPUs or the I/O subsystem – transactional execution will eventually complete; thus, an abort-handler routine is not required. The facility provides the TRANSACTION BEGIN (TBEGINC) general instruction. (September, 2012)

DAT-Enhancement Facility 1

The *DAT-enhancement facility 1* may be available on a model implementing z/Architecture. The facility provides the following instructions:

- COMPARE AND SWAP AND PURGE (CSPG)
- INVALIDATE DAT TABLE ENTRY

COMPARE AND SWAP AND PURGE (CSPG) provides function similar to that of COMPARE AND SWAP AND PURGE (CSP), but CSPG has 64-bit operands whereas CSP has 32-bit operands.

INVALIDATE DAT TABLE ENTRY provides the means by which one or more region-table and segment-table entries in storage may be invalidated, and the corresponding TLB entries may be purged. The

instruction provides an invalidation-and-clearing operation which invalidates and clears entries based on a specified virtual address, or a clear-by-ASCE operation which clears TLB entries based on the specified ASCE. (June, 2003)

DAT-Enhancement Facility 2

The *DAT-enhancement facility 2* may be available on a model implementing z/Architecture. When the DAT-enhancement facility 2 is installed, the LOAD PAGE-TABLE-ENTRY ADDRESS instruction is available. Given a virtual address, the LOAD PAGE-TABLE-ENTRY ADDRESS instruction returns the 64-bit real address of the corresponding page-table entry. The address-space-control mode used by the dynamic-address-translation process is specified in the M_4 field of the instruction. (September, 2005)

Decimal-Floating-Point Facility

The *decimal-floating-point facility* supports three decimal-floating-point (DFP) data formats and provides 54 new instructions to operate on data in these formats. The formats: 32-bit (short), 64-bit (long), and 128-bit (extended), were developed in collaboration with the IEEE floating-point working group. (April, 2007)

Decimal-Floating-Point Packed-Conversion Facility

The *decimal floating point packed-conversion facility* may be available on models implementing the DFP facility. The facility includes the following instructions:

- CONVERT FROM PACKED (CDPT)
- CONVERT FROM PACKED (CXPT)
- CONVERT TO PACKED (CPDT)
- CONVERT TO PACKED (CPXT)

(March, 2015)

Decimal-Floating-Point-Rounding Facility

The *decimal-floating-point-rounding facility* provides a 3-bit DFP rounding mode field in the floating-point control (FPC) register, and the instruction SET DFP ROUNDING MODE, which may be used to set this

field. The DFP rounding mode can specify any of eight rounding methods, including the five required by the IEEE floating-point working group.

The DFP rounding mode is used by PFPO and the decimal-floating-point instructions. (April, 2007)

Decimal-Floating-Point Zoned-Conversion Facility

The *decimal floating point zoned-conversion facility* may be available on models implementing the DFP facility. The facility includes the following features and instructions:

1. In Chapter 8, “Decimal Instructions,” the zoned format is defined to include the ASCII zone value (0011 binary).
2. In Chapter 20, “Decimal-Floating-Point Instructions,” the following instructions are defined:
 - CONVERT FROM ZONED (CDZT)
 - CONVERT FROM ZONED (CXZT)
 - CONVERT TO ZONED (CZDT)
 - CONVERT TO ZONED (CZXT)

(September, 2012)

DEFLATE-Conversion Facility

The *DEFLATE-conversion facility* may be available on models implementing z/Architecture. The facility provides a means to compress and uncompress data using the DEFLATE compressed-data format. The facility includes the DEFLATE CONVERSION CALL instruction.

(September, 2019)

Distinct-Operands Facility

The *distinct-operands facility* may be available on a model implementing z/Architecture. The facility provides alternate forms of selected arithmetic and logical instructions in which the result register may be different from either of the source registers. The facility provides alternate forms for the following instructions.

- ADD

- ADD IMMEDIATE
- ADD LOGICAL
- ADD LOGICAL WITH SIGNED IMMEDIATE
- AND
- EXCLUSIVE OR
- OR
- SHIFT LEFT SINGLE
- SHIFT LEFT SINGLE LOGICAL
- SHIFT RIGHT SINGLE
- SHIFT RIGHT SINGLE LOGICAL
- SUBTRACT
- SUBTRACT LOGICAL

(August, 2010)

Enhanced-DAT Facility 1

The *enhanced-DAT facility 1* may be available on models implementing z/Architecture. When the facility is installed and enabled, DAT translation may produce either a page-frame real address or a segment-frame absolute address, determined by the STE-format control in the segment-table entry.

When the facility is installed in a configuration, a new bit in control register 0 enables the facility.

Note: The term *EDAT-1 applies* is used pervasively in this document to describe the condition of when the enhanced-DAT facility 1 is installed in the configuration and enabled by control register 0. See “Enhanced-DAT Terminology:” on page 3-41 for details on this terminology.

When EDAT-1 applies, the following function is available in the DAT process:

- Region-table entries include a DAT-protection bit, providing function similar to the DAT-protection bits in the segment- and page-table entries.
- The segment-table entry includes a STE-format control. When the STE-format control is zero, DAT proceeds as if EDAT-1 does not apply.
- When the STE-format control is one, the segment-table entry also contains the following:
 - A segment-frame absolute address (rather than a page-table origin) specifying the absolute storage location of the 1 M-byte block.

- Access-control bits and a fetch-protection bit which optionally may be used instead of the corresponding bits in the segment’s individual storage keys
- A bit which determines the validity of the access-control bits and a fetch-protection bit in the segment-table entry

The facility adds the PERFORM FRAME MANAGEMENT FUNCTION control instruction. The facility includes enhancements or changes to the following control instructions:

- LOAD PAGE-TABLE-ENTRY ADDRESS
- MOVE PAGE
- SET STORAGE KEY EXTENDED
- TEST PROTECTION

(February, 2008)

Enhanced-DAT Facility 2

The *enhanced-DAT facility 2* may be available on models implementing z/Architecture. When the facility is installed and enabled, DAT translation may produce either a page-frame real address, a segment-frame absolute address, or a region-frame absolute address, determined by format controls in the region-third-table entry (if any) and the segment-table entry (if any).

Note: The term *EDAT-2 applies* is used pervasively in this document to describe the condition of when the enhanced-DAT facility 2 is installed in the configuration and enabled by control register 0. See “Enhanced-DAT Terminology:” on page 3-41 for details on this terminology.

When EDAT-2 applies, the following function is available in the DAT process:

- EDAT-1 applies.
- The region-third-table entry includes a RTTE-format control. When the RTTE-format control is zero, DAT proceeds as is the case for when EDAT-1 applies.
- When the RTTE-format control is one, the region-third-table entry also contains the following:

- A region-frame absolute address (rather than a segment-table origin) specifying the absolute storage location of the 2 G-byte block.
- Access-control bits and a fetch-protection bit which optionally may be used in lieu of the corresponding bits in the region’s individual storage keys
- A bit which determines the validity of the access-control bits and a fetch-protection bit in the region-third-table entry

The enhanced-DAT facility 2 adds the COMPARE AND REPLACE DAT TABLE entry instruction, providing for the dynamic replacement of valid, attached DAT-table entries, and the selective clearing of any TLB entries created from the replaced entry.

The enhanced-DAT facility 2 also includes enhancements or changes to the following control instructions:

- INVALIDATE DAT TABLE ENTRY
- LOAD PAGE-TABLE-ENTRY ADDRESS
- MOVE PAGE
- PERFORM FRAME MANAGEMENT FUNCTION
- TEST PROTECTION

When the enhanced-DAT facility 2 is installed, the enhanced-DAT facility 1 is also installed. (September, 2012)

Enhanced-Monitor Facility

The *enhanced-monitor facility* may be available on a model implementing z/Architecture. The facility provides the means by which executions of the MONITOR CALL instruction may be counted in CPU-specific counter arrays where each entry in the array represents a different monitor code.

The enhanced-monitor facility is controlled by the enhanced-monitor masks in control register 8. The enhanced-monitor masks work in conjunction with the monitor masks in CR8. Existing programs that use the MONITOR CALL instruction continue to operate compatibly when the enhanced-monitor masks are zero; the enhanced counting operation is only provided when a monitor mask bit *and* its corresponding enhanced-monitor mask bit are both ones. (August, 2010)

Entropy Encoding Compression Facility

The *entropy-encoding-compression facility* may be available on models implementing z/Architecture. When the facility is installed an additional entropy encoding/decoding step may be performed as part of COMPRESSION CALL. (September, 2017)

ESA/390-Compatibility-Mode Facility

The *ESA/390-compatibility-mode (390-CM) facility* may be available on a model implementing z/Architecture. A configuration operating in the ESA/390-compatibility mode provides an environment supporting a subset of DAT-off ESA/390 programs in a hybrid architectural mode. See “ESA/390-Compatibility-Mode Facility” on page 5-111 for details. (September, 2017)

ETF2-Enhancement Facility

The *ETF2-enhancement facility* may be available on a model implementing z/Architecture. The facility includes modifications to the following instructions:

- New function is added to the TRANSLATE ONE TO ONE, TRANSLATE ONE TO TWO, TRANSLATE TWO TO ONE, and TRANSLATE TWO TO TWO instructions, allowing the test-character comparison to be bypassed.
- For TRANSLATE TWO TO ONE and TRANSLATE TWO TO TWO, the alignment requirements for the translate table are relaxed.

(September, 2005)

ETF3-Enhancement Facility

The *ETF3-enhancement facility* may be available on a model implementing z/Architecture. The facility provides improved well-formedness checking for the following instructions:

- CONVERT UTF-16 TO UTF-32
- CONVERT UTF-16 TO UTF-8
- CONVERT UTF-8 TO UTF-16
- CONVERT UTF-8 TO UTF-32

(September, 2005)

Execute-Extensions Facility

The *execute-extensions facility* may be available on a model implementing z/Architecture. The facility provides the EXECUTE RELATIVE LONG instruction. (February, 2008)

Execution-Hint Facility

The *execution-hint facility* may be available on a model implementing z/Architecture. The facility provides the means by which the program can provide hints which the CPU may take into consideration when deciding what information to maintain and use for storage-operand accesses and branch prediction. The facility provides the following instructions.

- BRANCH PREDICTION PRELOAD (BPP)
- BRANCH PREDICTION RELATIVE PRELOAD (BPRP)
- NEXT INSTRUCTION ACCESS INTENT (NIAI)

Additionally, new prefetch-intent codes are defined for PREFETCH DATA (PFD) and PREFETCH DATA RELATIVE LONG (PFDRL). (September, 2012)

Extended-Immediate Facility

The *extended-immediate facility* may be available on models implementing z/Architecture. The facility provides 32-bit immediate-operand versions of the following instructions:

- ADD IMMEDIATE
- ADD LOGICAL IMMEDIATE
- AND IMMEDIATE
- COMPARE IMMEDIATE
- COMPARE LOGICAL IMMEDIATE
- EXCLUSIVE OR IMMEDIATE
- INSERT IMMEDIATE
- LOAD IMMEDIATE
- LOAD LOGICAL IMMEDIATE
- OR IMMEDIATE
- SUBTRACT LOGICAL IMMEDIATE

Other new instructions added as a part of the extended-immediate facility include the following:

- FIND LEFTMOST ONE
- LOAD AND TEST (32-bit and 64-bit RXY format)
- LOAD BYTE (RRE format)
- LOAD HALFWORD (RRE format)
- LOAD LOGICAL CHARACTER (64-bit RRE format, and 32-bit RXY and RRE formats)
- LOAD LOGICAL HALFWORD (64-bit RRE format, and 32-bit RXY and RRE formats)

(September, 2005)

Extended-I/O-Measurement-Block Facility

The *extended-I/O-measurement-block facility* may be available on models implementing z/Architecture. The facility includes the following features:

- A new format of the channel-measurement block. The new measurement block, termed a format-1 channel-measurement block, is expanded to 64 bytes and is addressed using a separate measurement-block address for each subchannel. The new measurement-block format provides additional measurement information and the flexibility to store the measurement blocks in non-contiguous, real storage.
- The previously existing channel-measurement block is termed a format-0 channel-measurement block. A device-busy-time field is added to the format-0 channel-measurement block.

(June, 2003)

Extended-I/O-Measurement-Word Facility

The *extended-I/O-measurement-word facility* may be available on models implementing z/Architecture. The extended-measurement-word (EMW) is an extension to the interruption-response block (IRB) and allows channel-measurement data to be provided on an I/O operation basis. This reduces program overhead by alleviating the previous requirement that the program fetch the measurement block before and after an operation and calculate the difference between the respective measurement data values. (June, 2003)

Extended-Translation Facility 2

The *extended-translation facility 2* may be available on a model implementing z/Architecture. The facility performs operations on double-byte, ASCII, and decimal data. The double-byte data may be Unicode® data – that is, data that uses the binary codes of the Unicode Worldwide Character Standard and enables the use of characters of most of the world's written languages. The facility provides the following instructions:

- COMPARE LOGICAL LONG UNICODE
- MOVE LONG UNICODE
- PACK ASCII
- PACK UNICODE
- TEST DECIMAL
- TRANSLATE ONE TO ONE
- TRANSLATE ONE TO TWO
- TRANSLATE TWO TO ONE
- TRANSLATE TWO TO TWO
- UNPACK ASCII
- UNPACK UNICODE

The extended-translation facility 2 is called facility 2 since an extended-translation facility, now called facility 1, was introduced in ESA/390. Facility 1 is standard in z/Architecture. Facility 1 provides the instructions:

- CONVERT UNICODE TO UTF-8
- CONVERT UTF-8 TO UNICODE
- TRANSLATE EXTENDED

For when either or both of facility 1 and facility 2 are not installed on the machine, both facilities are simulated by the MVS CSRUNIC macro instruction, which is provided in OS/390® Release 10 and z/OS®.

OS/390 MVS Assembler Services Reference, GC28-1910-10, contains programming requirements, register information, syntax, return codes, and examples for the CSRUNIC macro instruction.

When CSRUNIC is used, the program exceptions listed in this publication do not cause program interruptions; instead, the exception conditions are indicated by CSRUNIC by means of return codes, as described in GC28-1910-10. (October, 2000)

Extended-Translation Facility 3

The *extended-translation facility 3* may be available on a model implementing z/Architecture. The facility performs operations on Unicode and Unicode-transformation-format (UTF) characters; it also includes a right-to-left TRANSLATE AND TEST operation. The facility provides the following instructions:

- CONVERT UTF-16 TO UTF-32
- CONVERT UTF-32 TO UTF-16
- CONVERT UTF-32 TO UTF-8
- CONVERT UTF-8 TO UTF-32
- SEARCH STRING UNICODE
- TRANSLATE AND TEST REVERSE

(May, 2004)

Extract-CPU-Time Facility

The *extract-CPU-time facility* may be available on a model implementing z/Architecture. The facility adds the general instruction EXTRACT CPU TIME. This instruction provides an efficient means by which a problem-state program can determine the amount of CPU time consumed, without requiring a supervisor-state service routine. (April, 2007)

Fast-BCR-Serialization Facility

The *fast-BCR-serialization facility* may be available on a model implementing z/Architecture. When the facility is installed, the execution of BRANCH ON CONDITION with the M_1 field containing 1110 binary and the R_2 field containing 0000 binary causes serialization without checkpoint synchronization. (August, 2010)

Fibre-Channel Extensions (FCX)

The *fibre-channel-extensions (FCX) facility* may be available on models implementing z/Architecture. The facility includes enhancements and performance extensions that provide the program a means to transport lists of commands to an I/O device for processing without the channel overhead of fetching and decoding each command.

Use of the FCX facility may be restricted to devices accessible by certain channel path types.

The FCX facility includes the following:

- Changes to the operation-request block (ORB), interruption-response block (IRB), and subchannel-information block (SCHIB).
- A form of a channel program that consists of a transport-control word (TCW) that designates a transport-command-control block (TCCB) and transport-status block (TSB). The TCCB includes a transport-command area (TCA) which contains a list of up to 30 I/O commands that are in the form of device-command words (DCWs). The TSB contains completion status and other information related to the TCW channel program that is complementary to the completion information contained in the IRB.

A TCW may specify the transfer of either input data or output data.

- The ability to directly or indirectly designate any or all of the TCCB, the input data storage area, and the output data storage area. When a storage area is designated directly, the TCW specifies the location of a single, contiguous block of storage. When a storage area is designated indirectly, the TCW designates the location of a list of one or more transport-indirect-data-address words (TIDAWs). TIDAW lists and the storage area designated by each TIDAW in a list are restricted from crossing 4 K-byte boundaries.
- An interrogate operation which may be initiated by CANCEL SUBCHANNEL to determine the state of an I/O operation.

(February, 2009)

FCX-Bidirectional-Data-Transfer Facility

The *FCX-bidirectional-data-transfer facility* may be available on a model implementing fibre-channel extensions. When the facility is installed and an attached device supports bidirectional-data transfer, transport-mode channel programs may specify the transfer of both input and output data. (September, 2012)

Floating-Point Extension Facility

The *floating-point extension facility* may be available on models implementing the DFP facility. The extension includes the following features and instructions:

Additions to Chapter 9, “Floating-Point Overview and Support Instructions:”

- A new floating-point-support instruction, SET BFP ROUNDING MODE (SRNMB), is added.
- A new exception, the quantum exception, is defined for DFP computational operations.
- Bit 5 of the floating-point-control (FPC) register is assigned to the quantum-exception mask
- Bit 13 of the FPC register is assigned to the quantum-exception flag.
- Data-exception code (DXC) 04 (hex) is assigned to the quantum exception.
- DXC 07 (hex) is assigned to the simulated quantum exception.
- The BFP-rounding-mode field in the FPC register is changed to 3 bits to support one additional BFP rounding mode, round to prepare for shorter precision.
- One new value of the effective rounding method field is assigned to support the round to prepare for shorter precision rounding method for CONVERT HFP TO BFP.
- For PFPO with a DFP result, bit 58 of general register 0 is assigned to be the DFP quantum-permission control.

Additions to Chapter 19, “Binary-Floating-Point Instructions:”

- The following new BFP instructions are added:
 - CONVERT FROM LOGICAL (CXLFB, CDLFB, CELFB, CXLGB, CDLGB, and CELGB).
 - CONVERT TO LOGICAL (CLFXB, CLFDB, CLFEB, CLGX, CLGDB, and CLGEB)
- One new value of the effective rounding method field is assigned to support the round to prepare for shorter precision rounding method for CONVERT TO FIXED, DIVIDE TO INTEGER, and LOAD FP INTEGER
- An IEEE-inexact-exception control (XxC) is added to CONVERT TO FIXED and LOAD FP INTEGER.

- An effective rounding method field and an IEEE-inexact-exception control (XxC) are added to CONVERT FROM FIXED and LOAD ROUNDED.

Additions to Chapter 20, “Decimal-Floating-Point Instructions:”

- The following new DFP instructions are added:
 - CONVERT FROM FIXED (CXFTR, CDFTR)
 - CONVERT FROM LOGICAL (CXLGTR, CDLGTR, CXLFTR, CDLFTR)
 - CONVERT TO FIXED (CFXTR, CFDTR)
 - CONVERT TO LOGICAL (CLGXTR, CLGDTR, CLFXTR, CLFDTR)
- All reserved values in the effective rounding method field and a quantum-exception control (XqC) are assigned for LOAD FP INTEGER, LOAD ROUNDED, QUANTIZE, and REROUND.
- All reserved values in the effective rounding method field are assigned for CONVERT TO FIXED.
- An IEEE-inexact-exception control (XxC) is added to CONVERT TO FIXED and LOAD ROUNDED.
- An effective rounding method field and a quantum-exception control (XqC) are added to ADD, DIVIDE, MULTIPLY, and SUBTRACT.
- An effective rounding method field, an IEEE-inexact-exception control (XxC), and a quantum-exception control (XqC) are added to CONVERT FROM FIXED.

(August, 2010).

Floating-Point-Support-Sign-Handling Facility

The *floating-point-support-sign-handling* facility includes four instructions: COPY SIGN, LOAD COMPLEMENT, LOAD NEGATIVE, and LOAD POSITIVE. These instructions operate on a 64-bit (long) floating-point datum independent of the radix and do not set the condition code. (April, 2007)

FPR-GR-Transfer Facility

The *FPR-GR-transfer* facility includes the following two instructions:

- LOAD FPR FROM GR
- LOAD GR FROM FPR

These instructions provide the means to move a 64-bit (long) floating-point datum between a floating-point register and a general register. (April, 2007)

General-Instructions-Extension Facility

The *general-instructions-extension* facility may be available on a model implementing z/Architecture. The facility provides the following new instructions:

- ADD LOGICAL WITH SIGNED IMMEDIATE
- COMPARE AND BRANCH
- COMPARE AND BRANCH RELATIVE
- COMPARE AND TRAP
- COMPARE HALFWORD RELATIVE LONG
- COMPARE IMMEDIATE AND BRANCH
- COMPARE IMMEDIATE AND BRANCH RELATIVE
- COMPARE IMMEDIATE AND TRAP
- COMPARE LOGICAL AND BRANCH
- COMPARE LOGICAL AND BRANCH RELATIVE
- COMPARE LOGICAL AND TRAP
- COMPARE LOGICAL IMMEDIATE AND BRANCH
- COMPARE LOGICAL IMMEDIATE AND BRANCH RELATIVE
- COMPARE LOGICAL IMMEDIATE AND TRAP
- COMPARE LOGICAL RELATIVE LONG
- COMPARE RELATIVE LONG
- EXTRACT CPU ATTRIBUTE
- LOAD HALFWORD RELATIVE LONG
- LOAD LOGICAL HALFWORD RELATIVE LONG
- LOAD LOGICAL RELATIVE LONG
- LOAD RELATIVE LONG
- MULTIPLY SINGLE IMMEDIATE
- PREFETCH DATA
- PREFETCH DATA RELATIVE LONG
- ROTATE THEN AND SELECTED BITS
- ROTATE THEN EXCLUSIVE OR SELECTED BITS
- ROTATE THEN INSERT SELECTED BITS
- ROTATE THEN OR SELECTED BITS
- STORE HALFWORD RELATIVE LONG
- STORE RELATIVE LONG

Additionally, the following instructions have been enhanced to include additional formats:

- ADD IMMEDIATE
- COMPARE HALFWORD
- COMPARE HALFWORD IMMEDIATE

- COMPARE LOGICAL IMMEDIATE
- LOAD ADDRESS EXTENDED
- LOAD AND TEST
- MOVE
- MULTIPLY
- MULTIPLY HALFWORD

(February, 2008)

Guarded-Storage Facility

The *guarded-storage facility* may be available on a model implementing z/Architecture. The facility provides a means by which a problem-state program can designate an area of logical storage comprising guarded-storage sections. The facility includes the following instructions:

- LOAD GUARDED (LGG)
- LOAD LOGICAL AND SHIFT GUARDED (LLGFSG)
- LOAD GUARDED STORAGE CONTROLS (LGSC)
- STORE GUARDED STORAGE CONTROLS (STGSC)

When the facility is installed in the configuration, enabled by the control program, and the second operand of the LOAD GUARDED or LOAD LOGICAL AND SHIFT GUARDED designates a guarded-storage section, a guarded-storage event is recognized, and control is passed to a guarded-storage event handler. Otherwise, the respective instructions simply perform their defined load operations.

The guarded-storage facility is intended to be used by various programming languages that implement storage-reclamation techniques commonly referred to as *garbage collection*. All other instructions that access a range of guarded storage are unaffected by the facility, only the LGG and LLGFSG instructions are capable of generating a guarded-storage event. (September, 2017)

HFP Multiply-and-Add/Subtract Facility

The *HFP-multiply-and-add/subtract facility* provides instructions for improved processing of hexadecimal floating-point numbers. The MULTIPLY AND ADD (or SUBTRACT) instruction is intended to be used in

place of MULTIPLY followed by ADD (or SUBTRACT) NORMALIZED. (June, 2003)

HFP-Unnormalized-Extensions Facility

The *HFP-unnormalized-extension facility* may be available on a model implementing z/Architecture. The facility provides instructions for improved processing of unnormalized hexadecimal floating-point numbers. It extends the capabilities of the HFP-multiply-and-add/subtract facility, by providing the following instructions that operate on unnormalized operands:

- MULTIPLY UNNORMALIZED
- MULTIPLY AND ADD UNNORMALIZED

(September, 2005)

High-Word Facility

The *high-word facility* may be available on a model implementing z/Architecture. For selected 32-bit instructions, the high-word facility effectively provides sixteen additional 32-bit registers by utilizing bits 0-31 of the sixteen 64-bit general registers. The facility provides the following instructions.

- ADD HIGH
- ADD IMMEDIATE HIGH
- ADD LOGICAL HIGH
- ADD LOGICAL WITH SIGNED IMMEDIATE HIGH
- BRANCH RELATIVE ON COUNT HIGH
- COMPARE HIGH
- COMPARE IMMEDIATE HIGH
- COMPARE LOGICAL HIGH
- COMPARE LOGICAL IMMEDIATE HIGH
- LOAD BYTE HIGH
- LOAD HALFWORD HIGH
- LOAD HIGH
- LOAD LOGICAL CHARACTER HIGH
- LOAD LOGICAL HALFWORD HIGH
- ROTATE THEN INSERT SELECTED BITS HIGH
- ROTATE THEN INSERT SELECTED BITS LOW
- STORE CHARACTER HIGH
- STORE HALFWORD HIGH
- SUBTRACT HIGH
- SUBTRACT LOGICAL HIGH

(August, 2010)

IEEE-Exception-Simulation Facility

The *IEEE-exception-simulation facility* includes the instructions SET FPC AND SIGNAL and LOAD FPC AND SIGNAL. These instructions provide a means to simulate a data exception program interruption. (April, 2007)

Insert-Reference-Bits-Multiple Facility

The *insert-reference-bits-multiple facility* may be available on a model implementing z/Architecture. The facility provides the means by which the reference bits for 64 contiguous blocks of storage can be inspected in a single instruction. (September, 2017)

Instruction-Execution-Protection Facility

The *instruction-execution-protection facility* may be available on a model implementing z/Architecture. When the facility is installed and enabled, and an instruction is fetched from the primary or home address space, an instruction-execution-protection control in the leaf DAT-table entry used in the translation determines whether instructions may or may not be executed from the frame mapped by the entry.

The facility may be used by a control program to better segregate instructions from data. Improved system reliability and integrity may be realized by preventing the execution of instructions from storage locations intended to contain only data. For example, erroneously or maliciously modified data in a program stack can be prevented from being executed. (September, 2017)

Interlocked-Access Facility 1

The *interlocked-access facility 1* may be available on a model implementing z/Architecture. The facility provides the means by which a load, update, and store operation can be performed with interlocked update in a single instruction (as opposed to using a compare-and-swap type of update). The facility also provides an instruction to attempt to load from two distinct storage locations in an interlocked-fetch manner. The facility provides the following instructions.

- LOAD AND ADD
- LOAD AND ADD LOGICAL
- LOAD AND AND
- LOAD AND EXCLUSIVE OR
- LOAD AND OR
- LOAD PAIR DISJOINT

Additionally, when the interlocked-access facility 1 is installed, the storage-operand update reference for the following instructions appears to be an interlocked-update reference as observed by other CPUs and channel programs when the first operand is aligned on an integral boundary corresponding to its size:

- ADD IMMEDIATE (ASI and AGSI)
- ADD LOGICAL WITH SIGNED IMMEDIATE

(August, 2010)

Interlocked-Access Facility 2

The *interlocked-access facility 2* may be available on a model. When installed, the storage-operand update reference for the following instructions appears to be an interlocked-update as observed by other CPUs and channel programs.

- AND (NI, NIY)
- OR (OI, OIY)
- EXCLUSIVE OR (XI, XIY)

(September, 2012)

IPTE-Range Facility

The *IPTE-range facility* may be available on a model implementing z/Architecture. The facility provides performance improvements for the INVALIDATE PAGE TABLE ENTRY instruction. (August, 2010)

List-Directed Initial Program Load

The *list-directed initial-program-load* (IPL) function may be available on a model. List-directed IPL, also known as SCSI IPL in other System Library publications, provides the means by which a program can be loaded from an I/O device other than a classical channel-attached device (ESCON or FICON). Facilities are also provided for loading a stand-alone dump program using list-directed IPL. (May, 2004)

Load-and-Trap Facility

The *load-and-trap facility* may be available on a model implementing z/Architecture. The facility adds instructions that can be used to assist the program in determining when a value of all zeros (an address for example) has been loaded into a designated register. The facility provides the following instructions:

- LOAD AND TRAP (LAT and LGAT)
- LOAD HIGH AND TRAP (LFHAT)
- LOAD LOGICAL AND TRAP (LLGFAT)
- LOAD LOGICAL THIRTY ONE BITS AND TRAP (LLGTAT)

(September, 2012)

Load-and-Zero-Rightmost-Byte Facility

The *load-and-zero-rightmost-byte facility* may be available on a model implementing z/Architecture. The facility instructions of the facility load a value into a register from storage and zero the rightmost eight bits of the register. The facility provides the following instructions:

- LOAD AND ZERO RIGHTMOST BYTE (LZRF, LZRG)
- LOAD LOGICAL AND ZERO RIGHTMOST BYTE (LLZRGF)

(March, 2015)

Load/Store-on-Condition Facility 1

The *load/store-on-condition facility 1* may be available on a model implementing z/Architecture. The facility provides the means by which selected operations may be executed only when a condition-code-mask field of the instruction matches the current condition code in the PSW. The facility provides the following instructions.

- LOAD ON CONDITION
- STORE ON CONDITION

(August, 2010)

Load/Store-on-Condition Facility 2

The *load/store-on-condition facility 2* may be available on a model implementing z/Architecture. The facility provides six load-immediate operations, two load-high operations, and one store-high operation; all of which are executed only when a condition-code-mask field of the instruction matches the current condition code in the PSW. The facility includes the following instructions.

- LOAD HALFWORD HIGH IMMEDIATE ON CONDITION (LOCHHI)
- LOAD HALFWORD IMMEDIATE ON CONDITION (LOCHI, LOCGHI)
- LOAD HIGH ON CONDITION (LOCFHR, LOCFH)
- STORE HIGH ON CONDITION (STOCFH)

(March, 2015)

Local-TLB-Clearing Facility

The *local-TLB-clearing facility* may be available on a model implementing z/Architecture. The facility may provide performance improvements for the INVALIDATE DAT TABLE ENTRY and INVALIDATE PAGE TABLE ENTRY instructions by allowing the program to specify whether TLB clearing should be done in all CPUs of the configuration or only in the CPU executing the instruction. (September, 2012)

Long-Displacement Facility

The *long-displacement facility* provides a 20-bit signed-displacement field in 69 previously existing instructions (by using a previously unused byte in the instructions) and 44 new instructions. A 20-bit signed displacement allows relative addressing of up to 524,287 bytes beyond the location designated by a base register or base-and-index-register pair and up to 524,288 bytes before that location. The enhanced previously existing instructions generally are ones that handle 64-bit binary integers. The new instructions generally are new versions of instructions for 32-bit binary integers. The new instructions also include (1) a LOAD BYTE instruction that sign-extends a byte from storage to form a 32-bit or 64-bit result in a general register and (2) new floating-point LOAD and STORE instructions. The long-displacement facility provides register-constraint relief by reducing the need for base registers, code size

reduction by allowing fewer instructions to be used, and additional improved performance through removal of possible address-generation interlocks. (June, 2003)

Message-Security Assist

The *message-security assist* (MSA) may be available on a model implementing z/Architecture. The MSA basic facility includes the following instructions:

- CIPHER MESSAGE
- CIPHER MESSAGE WITH CHAINING
- COMPUTE INTERMEDIATE MESSAGE DIGEST
- COMPUTE LAST MESSAGE DIGEST
- COMPUTE MESSAGE AUTHENTICATION CODE

Also included are five query functions and two functions for generating a message digest based on the secure-hash algorithm (SHA-1). The five query functions, one for each instruction, are used to determine the additional installed MSA facilities, which may include the following.

MSA Data-Encryption-Algorithm (DEA) Facility:

The *MSA DEA facility* consists of nine functions for ciphering messages, with or without chaining, and for generating a message-authentication code (MAC) using a 56-bit, 112-bit, or 168-bit cryptographic key.¹ All of these functions are based on the DEA algorithm. (June, 2003)

Message-Security-Assist Extension 1

The *message-security-assist extension 1* may be available on models implementing the message-security assist. The extension provides the following functions:

MSA SHA-256 Facility: This facility consists of two functions, one for generating an intermediate message digest and another for generating a final message digest.

MSA Advanced-Encryption-Standard (AES-128) Facility: This facility consists of two functions for

ciphering messages, with or without chaining, using the AES-128 algorithm.

MSA Pseudo-Random-Number Generation (PRNG) Facility: This facility consists of a function for generating a multiple of 64-bit pseudo-random numbers using the ANSI[®] X9.17 pseudo-random-number algorithm.

(September, 2005)

Message-Security-Assist Extension 2

The *message-security-assist extension 2* may be available on models implementing the message-security assist. The extension provides the following functions:

MSA AES-192 Facility: This facility consists of two functions for ciphering a message, with or without chaining, using the AES-192 algorithm.

MSA AES-256 Facility: This facility consists of two functions for ciphering a message, with or without chaining, using the AES-256 algorithm.

MSA SHA-512 Facility: This facility consists of two functions, one for generating an intermediate message digest and another for generating a final message digest, using the SHA-512 algorithm.

(February, 2008)

Message-Security-Assist Extension 3

The *message-security-assist extension 3* provides a means to protect user cryptographic keys by encrypting them under machine-generated wrapping keys. When this extension is installed, two wrapping keys are provided for each configuration: one for protecting user DEA keys and another for protecting user AES keys. The wrapping keys reside in the machine so that, with an appropriate setting of controls, no clear value of user cryptographic keys is observed any where in the system by any program.

1. These key lengths reflect the cryptographic strength. In subsequent chapters, they are referred to as 64-bit, 128-bit, or 192-bit, respectively, to include the DEA-key-parity bits.

The message-security-assist extension 3 may be available on models implementing the message-security assist. The extension provides the following features:

- A 256-Bit AES Wrapping-Key Register: The register contents are used to protect user AES keys.
- A 256-Bit AES Wrapping-Key Verification-Pattern Register: The register contents are used to identify the version of the AES wrapping key.
- A 192-Bit DEA Wrapping-Key Register: The register contents are used to protect user DEA keys.
- A 192-Bit DEA Wrapping-Key Verification-Pattern Register: The register contents are used to identify the version of the DEA wrapping key.
- The following functions under the CIPHER MESSAGE instruction:
 - Encrypted DEA
 - Encrypted TDEA 128
 - Encrypted TDEA 192
 - Encrypted AES 128
 - Encrypted AES 192
 - Encrypted AES 256

These functions use an encrypted cryptographic key.

- The following functions under the CIPHER MESSAGE WITH CHAINING instruction:
 - Encrypted DEA
 - Encrypted TDEA 128
 - Encrypted TDEA 192
 - Encrypted AES 128
 - Encrypted AES 192
 - Encrypted AES 256

These functions use an encrypted cryptographic key.

- The following functions under the COMPUTE MESSAGE AUTHENTICATION CODE instruction:
 - Encrypted DEA
 - Encrypted TDEA 128
 - Encrypted TDEA 192

These functions use an encrypted cryptographic key.

- The PERFORM CRYPTOGRAPHIC KEY MANAGEMENT OPERATION instruction with the following functions:

- Query
- Encrypt DEA Key
- Encrypt TDEA 128 Key
- Encrypt TDEA 192 Key
- Encrypt AES 128 Key
- Encrypt AES 192 Key
- Encrypt AES 256 Key

These functions provide a means for importing clear cryptographic keys.

(August, 2010)

Message-Security-Assist Extension 4

The *message-security-assist extension 4* provides the support for the CFB (cipher feedback) mode, the OFB (output feedback) mode, and the CTR (counter) mode. In addition, a number of primitives are provided to facilitate the support for the CMAC (cipher-based message authentication code) mode, the CCM (counter with cipher block chaining – message authentication code) mode, the GCM (Galois/counter mode), and the XTS mode.

The message-security-assist extension 4 may be available on models implementing the message-security assist. The extension provides the following instructions and functions:

- The CIPHER MESSAGE WITH CIPHER FEEDBACK, CIPHER MESSAGE WITH COUNTER, and CIPHER MESSAGE WITH OUTPUT FEEDBACK instructions. Each of these instructions includes the following functions:
 - Query
 - DEA
 - TDEA 128
 - TDEA 192
 - Encrypted DEA
 - Encrypted TDEA 128
 - Encrypted TDEA 192
 - AES 128
 - AES 192
 - AES 256
 - Encrypted AES 128
 - Encrypted AES 192

- Encrypted AES 256
- The PERFORM CRYPTOGRAPHIC COMPUTATION instruction with the following functions:
 - Query
 - Compute Last Block CMAC Using DEA
 - Compute Last Block CMAC Using TDEA 128
 - Compute Last Block CMAC Using TDEA 192
 - Compute Last Block CMAC Using Encrypted DEA
 - Compute Last Block CMAC Using Encrypted TDEA 128
 - Compute Last Block CMAC Using Encrypted TDEA 192
 - Compute Last Block CMAC Using AES 128
 - Compute Last Block CMAC Using AES 192
 - Compute Last Block CMAC Using AES 256
 - Compute Last Block CMAC Using Encrypted AES 128
 - Compute Last Block CMAC Using Encrypted AES 192
 - Compute Last Block CMAC Using Encrypted AES 256
 - Compute XTS Parameter Using AES 128
 - Compute XTS Parameter Using AES 256
 - Compute XTS Parameter Using Encrypted AES 128
 - Compute XTS Parameter Using Encrypted AES 256
- The following functions under the CIPHER MESSAGE instruction:
 - XTS AES 128
 - XTS AES 256
 - XTS Encrypted AES 128
 - XTS Encrypted AES 256
- The following function under the COMPUTE INTERMEDIATE MESSAGE DIGEST instruction:
 - GHASH
- The following functions under the COMPUTE MESSAGE AUTHENTICATION CODE instruction:
 - AES 128
 - AES 192
 - AES 256
 - Encrypted AES 128
 - Encrypted AES 192
 - Encrypted AES 256

The message-security-assist extension 4 requires the message-security-assist extension 3 as a prerequisite. (August, 2010)

Message-Security-Assist Extension 5

The *message-security-assist extension 5* provides support for deterministic pseudorandom-number seeding and generation that conforms to the National Institute of Standards and Technology (NIST) special publication 800-90A. The message-security-assist extension 5 may be available on models implementing the z/Architecture architectural mode. The extension provides the following instruction:

- PERFORM RANDOM NUMBER OPERATION (PRNO)

The PERFORM RANDOM NUMBER OPERATION instruction provides the following functions:

- PRNO-Query
- PRNO-SHA-512-DRNG

The message-security-assist extension 5 requires the secure-hash-algorithm (SHA-512) capabilities of the message-security-assist extension 2 as a prerequisite. (March, 2015)

Note: The PERFORM RANDOM NUMBER OPERATION instruction was formerly named PERFORM PSEUDORANDOM NUMBER OPERATION. With the addition of the message-security-assist extension 7, the same instruction is also capable of generating true random numbers, hence the name change. The former mnemonic PPNO is deprecated, but is still retained.

Message-Security-Assist Extension 6

The *message-security-assist extension 6* may be available on models implementing the message-security assist. The extension provides the following additional functions for the COMPUTE INTERMEDIATE MESSAGE DIGEST and COMPUTE LAST MESSAGE DIGEST instructions.

MSA SHA-3 Hash Facility: This facility consists of the following four functions for generating message

digests having a length of 224, 256, 384, and 512 bits, using the respective SHA-3 functions defined in Reference [21.] on page xxx.

- KIMD-SHA3-224
- KIMD-SHA3-256
- KIMD-SHA3-384
- KIMD-SHA3-512
- KLMD-SHA3-224
- KLMD-SHA3-256
- KLMD-SHA3-384
- KLMD-SHA3-512

MSA SHA-3 Extendable-Output Facility: This facility consists of the following functions for producing message digests having any desired length using the SHAKE-128 and SHAKE-256 functions described in Reference [21.] on page xxx.

- KIMD-SHAKE-128
- KIMD-SHAKE-256
- KLMD-SHAKE-128
- KLMD-SHAKE-256

(September,2017)

Message-Security-Assist Extension 7

The *message-security-assist extension 7* may be available on models implementing the message-security-assist extension 5. The extension provides the following additional functions to the PERFORM RANDOM NUMBER OPERATION (PRNO) instruction related to true random number generation:

- PRNO-TRNG-Query-Raw-to-Conditioned Ratio
- PRNO-TRNG

(September,2017)

Message-Security-Assist Extension 8

The *message-security-assist extension 8* may be available on models implementing the z/Architecture architectural mode. The message-security-assist extension 8 provides support for both ciphering and authentication of a message, and the authentication of additional data (other than the message). The

message-security-assist extension 8 provides the following instruction:

- CIPHER MESSAGE WITH AUTHENTICATION (KMA)

The CIPHER MESSAGE WITH AUTHENTICATION instruction provides support for the Galois-counter-mode (GCM) of ciphering, as described in Reference [17.] on page xxx. Functions provided by the instruction include the following:

- KMA-Query
- KMA-GCM-AES-128
- KMA-GCM-AES-192
- KMA-GCM-AES-256
- KMA-GCM-encrypted-AES-128
- KMA-GCM-encrypted-AES-192
- KMA-GCM-encrypted-AES-256

(September, 2017)

Message-Security-Assist Extension 9

The *message-security-assist extension 9* may be available on models implementing the z/Architecture architectural mode. The message-security-assist extension 9 provides support for elliptic curve cryptography authentication of a message, and the generation of elliptic curve keys, and scalar multiplication. The message-security-assist extension 9 provides the following instruction:

- COMPUTE DIGITAL SIGNATURE AUTHENTICATION (KDSA)

The COMPUTE DIGITAL SIGNATURE AUTHENTICATION (KDSA) instruction provides support for the signing and verification of elliptic curves as described in References [24.] through [40.] on page xxx. Functions provided by the instruction include the following:

- KDSA-Query
- KDSA-ECDSA-Verify-P256
- KDSA-ECDSA-Verify-P384
- KDSA-ECDSA-Verify-P521
- KDSA-ECDSA-Sign-P256
- KDSA-ECDSA-Sign-P384
- KDSA-ECDSA-Sign-P521
- KDSA-Encrypted-ECDSA-Sign-P256
- KDSA-Encrypted-ECDSA-Sign-P384

- KDSA-Encrypted-ECDSA-Sign-P521
- KDSA-EdDSA-Verify-Ed25519
- KDSA-EdDSA-Verify-Ed448
- KDSA-EdDSA-Sign-Ed25519
- KDSA-EdDSA-Sign-Ed448
- KDSA-Encrypted-EdDSA-Sign-Ed25519
- KDSA-Encrypted-EdDSA-Sign-Ed448

Additionally, PERFORM CRYPTOGRAPHIC COMPUTATION instruction is modified to add functions for elliptic curves of scalar multiplication. Here is a list of the added functions:

- PCC-Scalar-Multiply-P256
- PCC-Scalar-Multiply-P384
- PCC-Scalar-Multiply-P521
- PCC-Scalar-Multiply-Ed25519
- PCC-Scalar-Multiply-Ed448
- PCC-Scalar-Multiply-X25519
- PCC-Scalar-Multiply-X448

Also, the PERFORM CRYPTOGRAPHIC COMPUTATION (PCKMO) instruction is modified to add key generation for elliptic curves. Here is a list of the added functions:

- PCKMO-Encrypt-ECC-P256-Key
- PCKMO-Encrypt-ECC-P384-Key
- PCKMO-Encrypt-ECC-P521-Key
- PCKMO-Encrypt-ECC-Ed25519-Key
- PCKMO-Encrypt-ECC-Ed448-Key

(September, 2019)

Miscellaneous-Instruction-Extensions Facility 1

The *miscellaneous-instruction-extensions facility 1* may be available on a model implementing the z/Architecture. The facility provides additional instruction formats for the following instructions:

- COMPARE LOGICAL AND TRAP (CLT and CLGT)
- ROTATE THEN INSERT SELECTED BITS (RISBGN)

(September, 2012)

Miscellaneous-Instruction-Extensions Facility 2

The *miscellaneous-instruction-extensions facility 2* may be available on a model implementing the z/Architecture. The facility provides the following additional instructions:

- ADD HALFWORD (AGH)
- BRANCH INDIRECT ON CONDITION
- MULTIPLY (MG, MGRK)
- MULTIPLY HALFWORD (MGH)
- MULTIPLY SINGLE (MSC, MSGC, MSGRKC, MSRKC)
- SUBTRACT HALFWORD (SGH)

(September, 2017)

Miscellaneous-Instruction-Extensions Facility 3

The *miscellaneous-instruction-extensions facility 3* may be available on a model implementing z/Architecture. The facility provides the following additional instructions:

- AND WITH COMPLEMENT (NCRK, NCRK)
- MOVE RIGHT TO LEFT
- NAND (NNRK, NNGRK)
- NOT EXCLUSIVE OR (NXRK, NXGRK)
- NOR (NORK, NOGRK)
- OR WITH COMPLEMENT (OCRK, OGRK)
- SELECT (SEL, SELGR)
- SELECT HIGH (SELFHR)

In addition, POPULATION COUNT includes a control in an M_3 field for counting the number of one bits in each byte or the entire 64-bit register.

(September, 2019)

Modified CCW Indirect Data Addressing Facility

The *modified-CCW-indirect-data-addressing (MIDA) facility* may be available on models implementing z/Architecture and provides the program an alternate means to transfer large amounts of data that spans noncontiguous blocks in main storage without the overhead of data chaining and without the strict

boundary and count restrictions imposed by CCW indirect data addressing (IDA). Modified CCW indirect data addressing permits a single channel-command word to control the transfer of up to 65,535 bytes of data that spans noncontiguous blocks in main storage. Each block of main storage to be transferred may be specified on any boundary and length up to 4K bytes, provided the specified block does not cross a 4 K-byte boundary.

Use of modified CCW indirect data addressing may be restricted to devices accessible by certain channel-path types.

When modified CCW indirect data addressing is used, the CCW data address is not used to directly address data. Instead, the address points to a contiguous list of up to 256 quadwords called the modified-indirect-data-address list (MIDAL). Each quadword in the MIDAL is called a modified-indirect-data-address word (MIDAW) that describes a block of storage to be transferred and contains flags, a byte count, and a 64-bit address designating a data area in absolute storage. When modified CCW indirect data addressing is used, transfer of control from one MIDAW to the next is made when the count of bytes specified by the MIDAW count field has been transferred and the total count of bytes transferred does not yet equal the count specified by the CCW. This is dissimilar to indirect data addressing where the transfer of control from one IDAW to the next is made when a program-specified 2K or 4K boundary is reached and the total count of bytes transferred does not yet equal the count specified in the CCW.

In addition to the MIDAW, the ORB modified-CCW-indirect-data-addressing-control bit and the CCW modified-indirect-data-address flag are added. (September, 2005)

Move-Page-and-Set-Key Facility

The *move-page-and-set-key facility* may be available on a model implementing z/Architecture. The facility provides additional functionality for the MOVE PAGE (MVPG) instruction. It may also provide improved performance for the PERFORM FRAME MANAGEMENT FUNCTION (PFMF) instruction when it is issued with specific options.

(September, 2019)

Move-With-Optional-Specifications Facility

The *move-with-optional-specifications facility* may be available on a model implementing z/Architecture. The facility adds the semiprivileged MOVE WITH OPTIONAL SPECIFICATIONS instruction. This instruction provides the means of moving from a source operand to a destination operand using different address-space-control modes and different keys for each operand. (February, 2008)

Multiple-Epoch Facility

The *multiple-epoch facility* may be available on a model implementing z/Architecture. The facility provides the means by which a nonzero epoch index may be stored in byte 0 of the operand of the STORE CLOCK EXTENDED instruction and in bits 9-15 of the trace entry formed by the TRACE (TRACG) instruction.

The multiple-epoch facility also provides four additional functions for the PERFORM TIMING FACILITY FUNCTION (PTFF) instruction:

- Query steering information extended
- Query TOD offset user extended
- Set TOD offset extended
- Set TOD offset user extended

Additionally, the multiple-epoch facility provides the clock-comparator sign control, allowing the comparisons of the clock comparator to be either signed or unsigned.

When the multiple-epoch facility is installed, the store-clock-fast and TOD-clock-steering facilities are also installed. (September,2017)

Multiple-Subchannel-Set Facility

The *multiple-subchannel-set (MSS) facility* may be available on a model implementing z/Architecture and increases the maximum number of subchannels that can be configured to a program. When the MSS facility is not installed, a single set of subchannels, in the range 0-65,535, may be provided. When the MSS facility is installed, a maximum of four sets of subchannels may be provided for a program. Each sub-

channel set provides from one to 64K subchannels in the range 0 to-65,535. (February, 2008)

Multithreading Facility

The *multithreading (MT) facility* may be available on models implementing z/Architecture. The facility provides the means by which more efficient utilization of a configuration's resources may be realized. The facility introduces the architectural concept of a core, which, when multithreading is enabled, comprises a group of CPUs (sometimes called threads). The CPU comprises all of the architected resources available to the program such as the program-status word, registers, timing facilities, and so forth. When the multithreading facility is not enabled, a core consists of a single CPU.

When the multithreading facility is enabled, the CPUs within a core may share certain hardware resources such as execution units or caches. When one CPU in a core is waiting for other hardware resources (typically, while waiting for a storage access), other CPUs in the core can utilize the shared resources in the core rather than have them remain idle. (March, 2015)

Nonquiescing Key-Setting Facility

The *nonquiescing key-setting facility* may be available on a model implementing z/Architecture. The facility provides performance improvements for the PERFORM FRAME MANAGEMENT FUNCTION and SET STORAGE KEY EXTENDED instruction. (August, 2010)

Order Preserving Compression Facility

The *order-preserving-compression facility* may be available on models implementing z/Architecture. When the facility is installed the ordering of compressed symbols is the same as the ordering of uncompressed data when compression is performed by COMPRESSION CALL. (September, 2017)

Parsing-Enhancement Facility

The *parsing-enhancement facility* may be available on a model implementing z/Architecture. The facility adds the following instructions:

- TRANSLATE AND TEST EXTENDED
- TRANSLATE AND TEST REVERSE EXTENDED

These instructions perform functions similar to those of the TRANSLATE AND TEST and TRANSLATE AND TEST REVERSE instructions, respectively, but provide the capability of processing either single-byte or double-byte argument characters, returning either 8-bit or 16-bit function codes. (February, 2008)

PER-3 Facility

The *PER-3 facility* may be available on a model implementing z/Architecture. When the facility is installed, the following two functions are available for use by the program:

Breaking-Event Address Register: The breaking-event-address register is a 64-bit CPU register that is updated with the address of any instruction that causes a break in sequential instruction execution (that is, the instruction address in the PSW is replaced, rather than incremented by the length of the instruction). When the PER-3 facility is installed and a program interruption occurs, whether or not PER is indicated, the contents of the breaking-event-address register are stored in real storage locations 272-279. This can be used as a debugging assist for wild-branch detection.

PER Instruction-Fetching Nullification: Bit 39 of control register 9, when one, specifies that PER instruction-fetching events force nullification. Bit 39 of control register 9 is meaningful only when bit 33 of control register 9, the instruction-fetching PER-event mask, is also one. When the PER-3 facility is not installed, or when bit 39 of control register 9 is zero, nullification is not forced for PER instruction-fetching events (called a PER instruction-fetching basic event).

(September, 2005)

PER-Storage-Key-Alteration Facility

The *PER-storage-key-alteration facility* may be available on a model implementing z/Architecture. The facility provides for program-event recording to detect alteration of storage keys made by the SET STORAGE KEY EXTENDED, PERFORM FRAME MANAGEMENT FUNCTION, MOVE PAGE, and TEST BLOCK instructions.

(September, 2019)

PER Zero-Address-Detection Facility

The *PER zero-address-detection facility* may be available on a model implementing z/Architecture. When the facility is installed and enabled, a PER zero-address-detection event is caused by execution of an instruction that accesses storage using an operand address formed from a general register containing zero. (August, 2010)

PFPO Facility

The *PFPO facility* provides the instruction PERFORM FLOATING-POINT OPERATION. This instruction, designed for future expansion, currently provides 54 conversion functions (from any of nine floating-point data formats to any of the six formats in another floating-point radix) using any of eight rounding methods. All conversions are correctly rounded. (April, 2007)

Population-Count Facility

The *population-count facility* may be available on a model implementing z/Architecture. The facility provides the POPULATION COUNT instruction which provides a count of one bits in each byte of a general register. (August, 2010)

Processor-Assist Facility

The *processor-assist facility* may be available on a model implementing z/Architecture. The facility pro-

vides the means by which the program can request that the processor perform an assist function. The program specifies which assist function is to be performed in an immediate (M_3) field of the instruction.

The facility provides the following general instruction:

- PERFORM PROCESSOR ASSIST

The processor-assist functions provided include the following:

- Transaction-abort assist

(September, 2012)

Reset-Reference-Bits-Multiple Facility

The *reset-reference-bits-multiple facility* may be available on a model implementing z/Architecture. The facility provides performance improvements for the inspection and resetting of reference bits by means of the RESET REFERENCE BITS MULTIPLE instruction. (August, 2010)

Restore-Subchannel Facility

The *restore-subchannel facility* may be available on a model implementing z/Architecture. The facility provides the means for the channel subsystem to recover a damaged subchannel and report the recovery to the program by means of a CRW. (February, 2008)

Server-Time-Protocol Facility

The *server-time-protocol facility* may be available on a model implementing z/Architecture. The facility provides the means by which the time-of-day (TOD) clocks in various systems can be synchronized using message links. STP operates in conjunction with the TOD-clock-steering facility, providing a new timing mode, new timing states, a new STP-timing-alert external interruption, and a new STP-sync-check machine-check conditions. (September, 2005)

Side-Effect-Access Facility

The *side-effect-access facility* may be available on a model implementing z/Architecture. When the facility is installed, the translation-exception identification (TEID) stored at real locations 168-175 during certain access exceptions contains an indication that the access was a side-effect access. A side-effect access is an implied access not directly associated with a storage operand of an instruction, is not an instruction fetch, is not a fetch of table information during ART or DAT, and is not a store of a trace entry. Additionally, when the side-effect-access facility is installed, an enhanced three-bit protection code is stored in the TEID. (September, 2017)

Store-Clock-Fast Facility

The *store-clock-fast facility* may be available on a model implementing z/Architecture. The facility provides a means by which an eight-byte time-of-day clock value may be stored without any artificial delay to ensure uniqueness. When the facility is installed, the TOD-clock bits stored by TRACE (TRACE and TRACG) are subject to additional control by a bit in control register 0. The facility provides the STORE CLOCK FAST instruction. (September, 2005)

Store-Facility-List-Extended Facility

The *store-facility-list-extended facility* may be available on a model implementing z/Architecture. The facility extends the function provided by the STORE FACILITY LIST (STFL) instruction. Whereas STFL is a control instruction that can store an indication of 32 facilities at real location 200, the new STORE FACILITY LIST EXTENDED (STFLE) instruction is a general instruction that can store an indication of up to 16,384 facilities at a program-specified location. (September, 2005)

Test-Pending-External-Interruption Facility

The *test-pending-external-interruption facility* may be available on a model implementing z/Architecture. The facility provides the means by which a control program can determine whether one or more of a subset of external interruptions is pending in the

CPU. The facility provides the TEST PENDING EXTERNAL INTERRUPTION instruction. (September, 2017)

TOD-Clock-Steering Facility

The *TOD-clock-steering facility* may be available on a model implementing z/Architecture. The facility provides a means by which apparent stepping rate of the time-of-day clock may be altered without changing the physical hardware oscillator which steps the physical clock. The facility adds the semiprivileged PERFORM TIMING FACILITY FUNCTION (PTFF) instruction which provides the means by which the program can query various timing-related parameters, and, optionally, the means by which an authorized timing-control program can influence certain of these parameters. (September, 2005)

Transactional-Execution Facility

The *transactional-execution facility* may be available on a model implementing z/Architecture. The facility provides the means by which a program can issue multiple instructions, the storage accesses of which either (a) appear to occur as a single concurrent operation or (b) do not appear to occur, as observed by other CPUs and by the channel subsystem.

The facility provides the following general instructions:

- EXTRACT TRANSACTION NESTING DEPTH
- NONTRANSACTIONAL STORE
- TRANSACTION ABORT
- TRANSACTION BEGIN (TBEGIN)
- TRANSACTION END

(September, 2012)

Vector-Enhancements Facility 1

The *vector-enhancements facility 1* may be available on models implementing the vector facility for z/Architecture. The facility adds support for the following features and functions:

The facility also includes the following new instructions:

- VECTOR BIT PERMUTE
- VECTOR MULTIPLY SUM LOGICAL

- VECTOR NOT EXCLUSIVE OR
- VECTOR NAND
- VECTOR OR WITH COMPLEMENT
- VECTOR FP MAXIMUM
- VECTOR FP MINIMUM

The facility adds support for halfword, word, and doubleword elements to VECTOR POPULATION COUNT

The facility adds support for BFP short format and BFP extended format elements to most instructions in chapter 24.

(September, 2017)

Vector-Enhancements Facility 2

The *vector-enhancements facility 2* may be available on a model implementing the z/Architecture. The facility extends the *vector-enhancements facility 1*. It provides performance improvements for algorithms working with elements or arrays of elements stored in the little endian format, shifting vectors, and performing substring search. In addition conversion support for short-format arithmetic has been added.

The facility includes the following instructions:

- VECTOR LOAD BYTE REVERSED ELEMENTS (VLBR)
- VECTOR LOAD ELEMENTS REVERSED (VLER)
- VECTOR LOAD BYTE REVERSED ELEMENT AND ZERO (VLLEBRZ)
- VECTOR LOAD BYTE REVERSED ELEMENT (VLEBRH, VLEBRF, VLEBRG)
- VECTOR LOAD BYTE REVERSED ELEMENT AND RELOCATE (VLBRREP)
- VECTOR STORE BYTE REVERSED ELEMENTS (VSTBR)
- VECTOR STORE ELEMENTS REVERSED (VSTER)
- VECTOR STORE BYTE REVERSED ELEMENT (VSTEBRH, VSTEBRF, VSTEBRG)
- VECTOR SHIFT LEFT DOUBLE BY BIT (VSLD)
- VECTOR SHIFT RIGHT DOUBLE BY BIT (VSRD)
- VECTOR STRING SEARCH (VSTRS)

The facility provides alternate forms for the following instructions:

- VECTOR SHIFT LEFT (VSL)
- VECTOR SHIFT RIGHT ARITHMETIC (VSRA)
- VECTOR SHIFT RIGHT LOGICAL (VSRL)
- VECTOR FP CONVERT FROM FIXED (VCFPS)
- VECTOR FP CONVERT FROM LOGICAL (VCFPL)
- VECTOR FP CONVERT TO FIXED (VCSFP)
- VECTOR FP CONVERT TO LOGICAL (VCLFP)

(September, 2019)

Vector Facility for z/Architecture

The *vector facility for z/Architecture* may be available on models implementing z/Architecture. When the facility is installed and enabled, vector instructions are available, having access to 32 128-bit registers. The instructions are described in four chapters:

- Chapter 21 describes the vector facility support instructions
- Chapter 22 describes the vector facility integer instructions
- Chapter 23 describes the vector facility string instructions
- Chapter 24 describes the vector facility floating-point instructions.

Note: ESA/390 provided an optional vector facility, however this facility was never available on any processor capable of the z/Architecture architectural mode. The vector facility for z/Architecture differs from the ESA/390 vector facility in instruction and register definitions. (March, 2015)

Vector Packed-Decimal Facility

The *vector-packed-decimal facility* may be available on models implementing z/Architecture. When the facility is installed and enabled, vector decimal instructions are available, allowing operations on packed data in vector registers. The facility provides the following instructions:

- VECTOR ADD DECIMAL
- VECTOR COMPARE DECIMAL
- VECTOR CONVERT TO BINARY
- VECTOR CONVERT TO DECIMAL
- VECTOR DIVIDE DECIMAL
- VECTOR LOAD IMMEDIATE DECIMAL
- VECTOR LOAD RIGHTMOST WITH LENGTH
- VECTOR MULTIPLY DECIMAL

- VECTOR MULTIPLY AND SHIFT DECIMAL
- VECTOR PACK ZONED
- VECTOR PERFORM SIGN OPERATION DECIMAL
- VECTOR REMAINDER DECIMAL
- VECTOR SHIFT AND DIVIDE DECIMAL
- VECTOR SHIFT AND ROUND DECIMAL
- VECTOR STORE RIGHTMOST WITH LENGTH
- VECTOR SUBTRACT DECIMAL
- VECTOR TEST DECIMAL
- VECTOR UNPACK ZONED

(September, 2017)

Vector-Packed-Decimal-Enhancement Facility

The *vector-packed-decimal-enhancement facility* may be available on models implementing the z/Architecture. The facility extends the vector packed-decimal facility. It provides performance improvements for common code constructs as well as the ability to suppress the decimal exception on an overflow condition and handle the overflow case when needed locally based on the condition code.

The facility provides alternate forms for the following instructions:

- VECTOR ADD DECIMAL (VAP)
- VECTOR CONVERT TO BINARY (VCVB, VCVBG)
- VECTOR CONVERT TO DECIMAL (VCVF, VCVDG)
- VECTOR DIVIDE DECIMAL (VDP)
- VECTOR MULTIPLY AND SHIFT DECIMAL (VMSP)
- VECTOR MULTIPLY DECIMAL (VMP)
- VECTOR PERFORM SIGN OPERATION DECIMAL (VPSOP)
- VECTOR REMAINDER DECIMAL (VRP)
- VECTOR SHIFT AND DIVIDE DECIMAL (VSDP)
- VECTOR SHIFT AND ROUND DECIMAL (VSRP)
- VECTOR SUBTRACT DECIMAL (VSP)

(September, 2019)

Warning-Track Interruption Facility

The *warning-track-interruption facility* may be available on a model implementing the z/Architecture.

The facility provides the means by which a warning-track external interruption can be presented to a CPU in a configuration with shared-CPU resources, such as a logical partition. The control program can use the warning-track external interruption as the signal to make the currently-executing dispatchable unit dispatchable on a different CPU of the configuration. (September, 2012)

The ESA/390 Base

z/Architecture includes all of the facilities of ESA/390 except for the asynchronous-pageout, asynchronous-data-mover, program-call-fast, and ESA/390 vector facilities. This section briefly outlines most of the remaining facilities that were additions in ESA/390 as compared to ESA/370.

ESA/390 is described in Reference [1.] on page xxix.

The CPU-related facilities that were new in ESA/390 are summarized below. ESA/390 was announced in September, 1990. Any extension added subsequently has the date of its announcement in parentheses at the end of its summary.

The following extensions are described in detail in SA22-7201 and in this publication:

- *Access-list-controlled protection* allows store-type storage references to an address space to be prohibited by means of a bit in the access-list entry used to access the space. Thus, different users having different access lists can have different capabilities to store in the same address space.
- The *program-event-recording facility 2 (PER 2)* is an alternative to the original PER facility, which is now named PER 1. (Neither of the names PER 1 and PER 2 is used in z/Architecture; only “PER” is used.) PER 2 provides the option of having a successful-branching event occur only when the branch target is within the designated storage area, and it provides the option of having a storage-alteration event occur only when the storage area is within designated address spaces. The use of these options improves performance by allowing only PER events of interest to occur. PER 2 deletes the ability to monitor for general-register-alteration events.

PER 2 includes extensions that provide additional information about PER events. The extensions were described in detail beginning in the fourth edition of SA22-7201.

- *Concurrent sense* improves performance by allowing sense information to be presented at the time of an interruption due to a unit-check condition, thus avoiding the need for a separate I/O operation to obtain the sense information.
- *Broadcasted purging* provides the COMPARE AND SWAP AND PURGE instruction for conditionally updating tables associated with dynamic address translation and access-register translation and clearing associated buffers in multiple CPUs. This is described in detail beginning in the eighth edition of SA22-7201.
- *Storage-protection override* provides a new form of subsystem storage protection that improves the reliability of a subsystem executed in an address space along with possibly erroneous application programs. When storage-protection override is made active by a control-register bit, fetches and stores by the CPU are permitted to storage locations having a storage key of 9 regardless of the access key used by the CPU. If the subsystem is in key-8 storage and is executed with a PSW key of 8, for example, and the application programs are in key-9 storage and are executed with a PSW key of 9, accesses by the subsystem to the application-program areas are permitted while accesses by the application programs to the subsystem area are denied. (September, 1991)
- *Move-page facility 2* extends the MOVE PAGE instruction introduced in ESA/370 by allowing use of a specified access key for either the source or the destination operand, by allowing improved performance when the destination operand will soon be referenced, and by allowing improved performance when an operand is invalid in both main and expanded storage. The ESA/370 version of MOVE PAGE is now called move-page facility 1 and is in Chapter 7, "General Instructions." MOVE PAGE of move-page facility 2 is in Chapter 10, "Control Instructions." Some details about the means for control-program support of MOVE PAGE are not provided. (September, 1991) (The z/Architecture MOVE PAGE instruction is described only in Chapter 10 of this publication. MOVE PAGE no longer can

move data to or from expanded storage, and all details about MOVE PAGE are provided.)

- The *square-root facility* consists of the SQUARE ROOT instruction and the square-root exception. The instruction extracts the square root of a floating-point operand in either the long or short format. The instruction is the same as that provided on some models of the IBM 4341, 4361, and 4381 Processors. (September, 1991)
- The *cancel-I/O facility* allows the program to withdraw a pending start function from a designated subchannel without signaling the device, which is useful in certain error-recovery situations. (September, 1991)

The cancel-I/O facility provides the CANCEL SUBCHANNEL instruction and is described in detail beginning in the eighth edition of SA22-7201.

- The *string-instruction facility* (or *logical string assist*) provides instructions for (1) moving a string of bytes until a specified ending byte is found, (2) logically comparing two strings until an inequality or a specified ending byte is found, and (3) searching a string of a specified length for a specified byte. The first two instructions are particularly useful in a C program in which strings are normally delimited by an ending byte of all zeros. (June, 1992)
- The *suppression-on-protection facility* causes a protection exception due to page protection to result in suppression of instruction execution instead of termination of instruction execution, and it causes the address and an address-space identifier of the protected page to be stored in low storage. This is useful in performing the AIX/ESA[®] copy-on-write function, in which AIX/ESA causes the same page of different address spaces to map to a single page frame of real storage so long as a store in the page is not attempted and then, when a store is attempted in a particular address space, assigns a unique page frame to the page in that address space and copies the contents of the page to the new page frame. (February, 1993)
- The *set-address-space-control-fast facility* consists of the SET ADDRESS SPACE CONTROL FAST (SACF) instruction, which possibly can be used instead of the previously existing SET ADDRESS SPACE CONTROL (SAC) instruction, depending on whether all of the SAC functions

are required. SACF, unlike SAC, does not perform the serialization and checkpoint-synchronization functions, nor does it cause copies of prefetched instructions to be discarded. SACF provides improved performance on some models. (February, 1993)

- The *subspace-group facility* includes the BRANCH IN SUBSPACE GROUP instruction, which can be used to give or return control from one address space to another in a group of address spaces called a subspace group, with this giving and returning of control being done with better performance than can be obtained by means of the PROGRAM CALL and PROGRAM RETURN or PROGRAM TRANSFER instructions. One address space in the subspace group is called the base space, and the other address spaces in the group are called subspaces. It is intended that each subspace contain a different subset of the storage in the base space, that the base space and each subspace contain a subsystem control program, such as CICS[®], and application programs, and that each subspace contain the data for a single transaction being processed under the subsystem control program. The placement of the data for each transaction in a different subspace prevents the processing of a transaction from erroneously damaging the data of other transactions. The data of the control program can be protected from the transaction processing by means of the storage-protection-override facility. (April, 1994)
- The *virtual-address enhancement of suppression on protection* provides that if dynamic address translation (DAT) was on when a protection exception was recognized, the suppression-on-protection result is indicated, and the address of the protected location is stored, only if the address is one that was to be translated by DAT; the suppression-on-protection result is not indicated if the address that would be stored is a real address. This enhancement allows the stored address to be translated reliably by the control program to determine if the exception was due to page protection as opposed to key-controlled protection. The enhancement extends the usefulness of suppression on protection to operating systems like MVS/ESA[™] that use key-controlled protection. (September, 1994)
- The *immediate-and-relative-instruction facility* includes 13 new instructions, most of which use a halfword-immediate value for either signed-binary arithmetic operations or relative branching. The facility reduces the need for general registers, and, in particular, it eliminates the need to use general registers to address branch targets. As a result, the general registers and access registers can be allocated more efficiently in programs that require many registers. (September, 1996)
- The *compare-and-move-extended facility* provides new versions of the COMPARE LOGICAL LONG and MOVE LONG instructions. The new versions increase the size of the operand-length specifications from 24 bits to 32 bits, which can be useful when objects larger than 16M bytes are processed through the use of 31-bit addressing. The new versions also periodically complete to allow software polling in a multiprocessing system. (September, 1996)
- The *checksum facility* consists of the CHECKSUM instruction, which can be used to compute a 16-bit or 32-bit checksum in order to improve Transmission-Control Protocol/Internet Protocol (TCP/IP) performance. (September, 1996)
- The *called-space-identification facility* improves serviceability by further identifying the called address space in a linkage-stack state entry formed by the PROGRAM CALL instruction. (September, 1996)
- The *branch-and-set-authority facility* consists of the BRANCH AND SET AUTHORITY instruction, which can be used to improve the performance of linkages within an address space by replacing PROGRAM CALL, PROGRAM TRANSFER, and SET PSW KEY FROM ADDRESS instructions. (June, 1997)
- The *perform-locked-operation facility* consists of the unprivileged PERFORM LOCKED OPERATION instruction, which appears to provide concurrent interlocked-update references to multiple storage operands. A function code of the instruction can specify any of six operations: compare and load, compare and swap, double compare and swap, compare and swap and store, compare and swap and double store, and compare and swap and triple store. The function code further specifies either word or doubleword operands. The instruction can be used to avoid the use of programmed locks in a multiprocessing system. (June, 1997)

- Four additional floating-point facilities improve the hexadecimal-floating-point (HFP) capability of the machine and add a binary-floating-point (BFP) capability. The facilities are:

- *Basic floating-point extensions*, which provides 12 additional floating-point registers to make a total of 16 floating-point registers. This facility also includes a floating-point-control register and means for saving the contents of the new registers during a store-status operation or a machine-check interruption.
- *Floating-point-support (FPS) extensions*, which provides eight new instructions, including four to convert data between the HFP and BFP formats.
- *Hexadecimal-floating-point (HFP) extensions*, which provides 26 new instructions to operate on data in the HFP format. All of these are counterparts to new instructions provided by the BFP facility, including conversion between floating-point and fixed-point formats, and a more complete set of operations on the extended format.
- *Binary floating-point (BFP)*, which defines short, long, and extended binary-floating-point (BFP) data formats and provides 87 new instructions to operate on data in these formats. The BFP formats and operations provide everything necessary to conform to the IEEE standard (ANSI/IEEE Standard 754-2008, as defined in Reference [20.] on page xxx) except for conversion between binary-floating-point numbers and decimal strings, which must be provided in software.

(May, 1998)

- The *resume-program facility* consists of the RESUME PROGRAM instruction, which restores, from a specified save area, the instruction address and certain other fields in the current PSW and also the contents of an access-and-general-register pair. RESUME PROGRAM allows a problem-state interruption-handling program to restore the state of an interrupted program and return to that program despite that a register is required for addressing the save area from which the state is restored. (May, 1998)
- The *trap facility* provides the TRAP instructions (a two-byte TRAP2 instruction and a four-byte

TRAP4 instruction) that can overlay instructions in an application program to give control to a program that can perform fix-up operations on data being processed, such as dates that may be a “Year-2000” problem. RESUME PROGRAM can be used to return from the fix-up program. TRAP and RESUME PROGRAM can improve performance by avoiding program interruptions that would otherwise be needed to give control to and from the fix-up program. (May, 1998)

- The *extended-TOD-clock facility* includes (1) an extension of the TOD clock from 64 bits to 104 bits, allowing greater resolution; (2) a TOD programmable register, which contains a TOD programmable field that can be used to identify the configuration providing a TOD-clock value in a sysplex; (3) the SET CLOCK PROGRAMMABLE FIELD instruction, for setting the TOD programmable field in the TOD programmable register; and (4) the STORE CLOCK EXTENDED instruction, which stores both the longer TOD-clock value and the TOD programmable field. STORE CLOCK EXTENDED can be used in the future when the TOD clock is further extended to contain time values that exceed the current year-2042 limit (when there is a carry out of the current bit 0 of the TOD clock). (August, 1998)
- The *TOD-clock-control-override facility* provides a control-register bit that allows setting the TOD clock under program control, without use of the manual TOD-clock control of any CPU. (August, 1998)
- The *store-system-information facility* provides the privileged STORE SYSTEM INFORMATION instruction, which can be used to obtain information about a component or components of a virtual machine, a logical partition, or the basic machine. (January, 1999)
- The *extended-translation facility*, now called the extended-translation facility 1, includes the CONVERT UNICODE TO UTF-8, CONVERT UTF-8 TO UNICODE, and TRANSLATE EXTENDED instructions, all of which can improve performance. TRANSLATE EXTENDED can be used in place of a TRANSLATE AND TEST instruction that locates an escape character, followed by a TRANSLATE instruction that translates the bytes preceding the escape character. (April, 1999)

The following extensions are described in detail in other publications:

- The *Enterprise Systems Connection Architecture*[®] (*ESCON*[®]) introduces a new type of channel that uses an optical-fiber communication link between channels and control units. Information is transferred serially by bit, at 200 million bits per second, up to a maximum distance of 60 kilometers. The optical-fiber technology and serial transmission simplify cabling and improve reliability. See the publication *IBM Enterprise Systems Architecture/390 ESCON I/O Interface*, SA22-7202.
- The *ESCON channel-to-channel adapter (ESCON CTCA)* provides the same type of function for serial channel paths as is available for the parallel-I/O-interface channel paths. See the publication *IBM Enterprise Systems Architecture/390 ESCON Channel-to-Channel Adapter*, SA22-7203.
- *I/O-device self-description* allows a device to describe itself and its position in the I/O configuration. See the publication *IBM Enterprise Systems Architecture/390 Common I/O-Device Commands and Self Description*, SA22-7204.
- The *compression facility* performs a Ziv-Lempel type of compression and expansion by means of static (nonadaptive) dictionaries that are to be prepared by a program before the compression and expansion operations. Because the dictionaries are static, the compression facility can provide good compression not only for long sequential data streams (for example, archival or network data) but also for randomly accessed short records (for example, 80 bytes). See the publication *IBM Enterprise Systems Architecture/390 Data Compression*, SA22-7208. (February, 1993) (The *z/Architecture COMPRESSION CALL* instruction is described in this publication. However, introductory information and information about dictionary formats still is provided only in SA22-7208.)
- Usability of the cryptographic facility is extended to virtual-machine environments, which allows the facility to be used by MVS/ESA being executed under VM/ESA[®], which in turn may be executed either under another VM/ESA or in a logical partition. (September, 1991)
- The *external-time-reference facility* provides a means to initiate and maintain the synchronization of TOD clocks to an external time reference (ETR). Synchronization tolerance of a few microseconds can be achieved, and the effect of leap seconds is taken into account. The facility consists of an ETR sending unit (Sysplex Timer[®]), which may be duplexed, two or more ETR receiving units, and optical-fiber cables. The cables are used to connect the ETR sending unit, which is an external device, to ETR receiving units of the configuration. CPU instructions are provided for setting the TOD clock to the value supplied by the ETR sending unit.
 - The *ETR automatic-propagation-delay-adjustment* function adjusts the time signals from the ETR to the attached processors to compensate for the propagation delay on the cables to the processors, thus allowing the cables to be of different lengths. (September, 1991)
 - The *ETR external-time-source* function synchronizes the ETR to a time signal received from a remote location by means of a telephone or radio. (September, 1991)
- *Extended sorting* provides instructions that improve the performance of the DB2[®] sorting function.
- Other *PER extensions*, besides those described beginning in the fourth edition of this publication, are an augmentation of PER 2 that provide additional PER function in the interpretive-execution mode.
- *Channel-subsystem call* provides various functions for use in the management of the I/O configuration. Some of the functions acquire information about the configuration from the accessible elements of the configuration, while others dynamically change the configuration.
- The *operational extensions* are a number of other improvements that result in increased availability and ease of use of the system, as follows:

The remaining extensions of ESA/390, for which detailed descriptions are not provided, are as follows:

- The integrated *cryptographic facility* provides a number of instructions to protect data privacy, to support message authentication and personal identification, and to facilitate key management. The high-performance cipher capability of the facility is designed for financial-transaction and bulk-encryption environments, and it complies with the Data Encryption Standard (DES).

- *Automatic-reconfiguration* permits an operating system in an LPAR partition to declare itself willing to be terminated suddenly, usually to permit its storage and CPU resources to be acquired by an adjacent partition that is dynamically absorbing the work load of another system that has failed. Other functions deactivate and reset designated participating partitions.
- A new *storage-reconfiguration* command decreases the time needed to reconfigure storage by allowing multiple requests for reconfiguration to be made by means of a single communication with the service processor.
- *SCP-initiated reset* allows a system control program (SCP) to reset its I/O configuration prior to entering the disabled wait state following certain check conditions.
- *Console integration* simplifies configuration requirements by reducing by one the number of consoles required by MVS.
- The *processor-availability facility* enables a CPU experiencing an unrecoverable error that will cause a check stop to save its state and alert the other CPUs in the configuration. This allows, in many cases, another CPU to continue execution of the program that was in execution on the failing CPU. The facility is applicable in both the ESA/390 mode and the LPAR mode. (April, 1991)
- *Extensions for virtual machines* are a number of improvements to the interpretive-execution facility, as follows:
 - The *VM-data-space facility* provides for making the ESA/390 access-register architecture more useful in virtual-machine applications. The facility improves the ability to address a larger amount of data and to share data. For information on how VM/ESA uses the VM-data-space facility, see the publication *VM/ESA CP Programming Services*, SC24-5520.
 - A new *storage-key function* improves performance by removing the need for the previously used RCP area.
 - Other improvements include an optional special-purpose lookaside for some of the guest-

state information and greater freedom in certain implementation choices.

- The *ESCON-multiple-image facility (EMIF)* allows multiple logical partitions to share ESCON channels (and FICON channels) and optionally to share any of the control units and associated I/O devices configured to these shared channels. This can reduce channel requirements, improve channel utilization, and improve I/O connectivity. (June, 1992)
- *PR/SM LPAR mode* is enhanced to allow up to 10 logical partitions in a single-image configuration and 20 in a physically-partitioned configuration. The previous limits were seven and 14, respectively. (June, 1992)

Coincident with z/Architecture, PR/SM LPAR mode allows 15 logical partitions, and physical partitioning is not supported.

- The *coupling facility* enables high-performance data sharing among MVS/ESA systems that are connected by means of the facility. The coupling facility provides storage that can be dynamically partitioned for caching data in shared buffers, maintaining work queues and status information in shared lists, and locking data by means of shared lock controls. MVS/ESA services provide access to and manipulation of the coupling-facility contents. (April, 1994)

The ESA/370 and 370-XA Base

ESA/390 includes the complete set of facilities of ESA/370 as its base. This section briefly outlines most of the facilities that were additions in 370-XA as compared to System/370 and that were additions in ESA/370 as compared to 370-XA.

The CPU-related facilities that were new in 370-XA are as follows:

- *Bimodal addressing* provides two modes of operation: a 24-bit addressing mode for the execution of old programs and a 31-bit addressing mode.
- *31-bit logical addressing* extends the virtual address space from the 16M bytes addressable with 24-bit addresses to 2G bytes (2,147,483,648 bytes).
- *31-bit real and absolute addressing* provides addressability for up to 2G bytes of main storage.

- The 370-XA *protection* facilities include key-controlled protection on only 4 K-byte blocks, page protection, and, as in System/370, low-address protection for addresses below 512. Fetch-protection override eliminates fetch protection for locations 0-2047.
- The *tracing* facility assists in the determination of system problems by providing an ongoing record in storage of significant events.
- The COMPARE AND FORM CODEWORD and UPDATE TREE instructions facilitate sorting applications.
- The *interpretive-execution facility* allows creation of virtual machines that may operate according to several architectures and whose performance is enhanced because many virtual-machine functions are directly interpreted by the machine rather than simulated by the program. This facility is described in the publication *IBM 370-XA Interpretive Execution*, SA22-7095.
- The *service-call-logical-processor (SCLP) facility* provides a means of communicating between the control program and the service processor for the purpose of describing and changing the configuration. This facility is not described.

The I/O-related differences between 370-XA and System/370 result from the 370-XA *channel subsystem*, which includes:

- *Path-independent addressing* of I/O devices, which permits the initiation of I/O operations without regard to which CPU is executing the I/O instruction or how the I/O device is attached to the channel subsystem. Any I/O interruption can be handled by any CPU enabled for it.
- *Path management*, whereby the channel subsystem determines which paths are available for selection, chooses a path, and manages any busy conditions encountered while attempting to initiate I/O processing with the associated devices.
- *Dynamic reconnection*, which permits any I/O device using this capability to reconnect to any available channel path to which it has access in order to continue execution of a chain of commands.
- *Programmable interruption subclasses*, which permit the programmed assignment of I/O-interruption requests from individual I/O devices to any one of eight maskable interruption queues.
- An *additional CCW format* for the direct use of 31-bit addresses in channel programs. The new CCW format, called format 1, is provided in addition to the System/370 CCW format, now called format 0.
- *Address-limit checking*, which provides an additional storage-protection facility to prevent data access to storage locations above or below a specified absolute address.
- *Monitoring facilities*, which can be invoked by the program to cause the channel subsystem to measure and accumulate key I/O-resource usage parameters.
- *Status-verification facility*, which reports inappropriate combinations of device-status bits presented by a device.
- A set of 13 *I/O instructions*, with associated control blocks, which are provided for the control of the channel subsystem.

The facilities that were new in ESA/370 are as follows:

- Sixteen *access registers* permit the program to have immediate access to storage operands in up to 16 2 G-byte address spaces, including the address space in which the program resides. In a dynamic-address-translation mode named *access-register mode*, the instruction B field, or for certain instructions the R field, designates both a general register and an access register, and the contents of the access register, along with the contents of protected tables, specify the operand address space to be accessed. By changing the contents of the access registers, the program, under the control of an authorization mechanism, can have fast access to hundreds of different operand address spaces.
- A *linkage stack* is used in a functionally expanded mechanism for passing control between programs in either the same or different address spaces. This mechanism makes use also of the previously existing PROGRAM CALL instruction, an extended entry-table entry, and a new PROGRAM RETURN instruction. The mechanism saves various elements of status, including access-register and general-register contents, during a calling linkage, provides for

changing the current status during the calling linkage, and restores the original status during the returning linkage. The linkage stack can also be used to save and restore access-register and general-register contents during a branch-type linkage performed by the new instruction BRANCH AND STACK.

- A translation mode named *home-space mode* provides an efficient means for the control program to obtain control in the address space, called the home address space, in which the principal control blocks for a dispatchable unit (a task or process) are kept.
- The semiprivileged MOVE WITH SOURCE KEY and MOVE WITH DESTINATION KEY instructions allow bidirectional movement of data between storage areas having different storage keys, without the need to change the PSW key.
- The privileged LOAD USING REAL ADDRESS and STORE USING REAL ADDRESS instructions allow the control program to access data in real storage more efficiently.
- The *private-space facility* allows an address space not to contain any common segments and causes low-address protection and fetch-protection override not to apply to the address space.
- The unprivileged MOVE PAGE instruction allows the program to move a page of data between main and expanded storage, provided that the source and destination pages are both valid. Some details about the means for control-program support of MOVE PAGE are not provided. The ESA/370 version of MOVE PAGE is now called move-page facility 1.
- The *Processor Resource/Systems Manager™ (PR/SM™)* feature provides support for multiple preferred guests under VM/XA and provides the logically partitioned (LPAR) mode, with the latter providing flexible partitioning of processor resources among multiple logical partitions. Certain aspects of the LPAR use of PR/SM are described in the publication *IBM ES/3090 Processor Complex Processor Resource/Systems Manager Planning Guide*, GA22-7123.
- The COMPARE UNTIL SUBSTRING EQUAL instruction provides improved performance of the compression of IMS log data sets and can be useful in other programs also.

System Program

z/Architecture is designed to be used with a control program that coordinates the use of system resources and executes all I/O instructions, handles exceptional conditions, and supervises scheduling and execution of multiple programs.

Compatibility

Compatibility among z/Architecture Systems

Although systems operating as defined by z/Architecture may differ in implementation and physical capabilities, logically they are upward and downward compatible. Compatibility provides for simplicity in education, availability of system backup, and ease in system growth. Specifically, except as noted below, any program written for z/Architecture gives identical results on any z/Architecture implementation, provided that the program:

1. Is not time-dependent.
2. Does not depend on system facilities (such as storage capacity, I/O equipment, or optional facilities) being present when the facilities are not included in the configuration.
3. Does not depend on system facilities being absent when the facilities are included in the configuration. For example, the program must not depend on interruptions caused by the use of operation codes or command codes that are not installed in some models. Also, it must not use or depend on fields associated with uninstalled facilities. For example, data should not be placed in an area used by another model for fixed-logout information. Similarly, the program must not use or depend on unassigned fields in machine formats (control registers, instruction formats, etc.) that are not explicitly made available for program use.
4. Does not depend on results or functions that are defined to be unpredictable or model-dependent or are identified as undefined. This includes the requirement that the program should not depend

on the assignment of device numbers and CPU addresses.

5. Does not depend on results or functions that are defined in the functional-characteristics publication for a particular model to be deviations from the architecture.
6. Takes into account any changes made to the architecture that are identified as affecting compatibility.
7. Does not depend on the installation of a facility which provides any of the specialized-function-assist instructions.

However, the following operations may not generate reproducible results:

- DEFLATE CONVERSION CALL functions DFLTCC-GDHT and DFLTCC-CMPR may generate different results from the same input data. However, all results comply to the standard described in Reference [23.] on page xxx and all compressed-data symbols generated using these functions can be decoded to the original (uncompressed) form of the data by any decoder which complies to the same standard. Refer to programming note 9 on page 26-59 for further details.

Compatibility between z/Architecture and ESA/390

Control-Program Compatibility

Control programs written for ESA/390 cannot be directly transferred to systems operating as defined by z/Architecture. This is because the general-register and control-register sizes, PSW size, assigned storage locations, and dynamic address translation are changed.

Problem-State Compatibility

A high degree of compatibility exists at the problem-state level in going forward from ESA/390 to z/Architecture. Because the majority of a user's applications are written for the problem state, this problem-state compatibility is useful in many installations.

A problem-state program written for ESA/390 operates with z/Architecture, provided that the program:

1. Complies with the limitations described in "Compatibility among z/Architecture Systems".
2. Is not dependent on privileged facilities which are unavailable on the system.

Programming Note: This publication assigns meanings to various operation codes, to bit positions in instructions, channel-command words, registers, and table entries, and to fixed locations in the low 512 bytes and bytes 4096-8191 of storage. Unless specifically noted, the remaining operation codes, bit positions, and low-storage locations are reserved for future assignment to new facilities and other extensions of the architecture.

To ensure that existing programs operate if and when such new facilities are installed, programs should not depend on an indication of an exception as a result of invalid values that are currently defined as being checked. If a value must be placed in unassigned positions that are not checked, the program should enter zeros. When the machine provides a code or field, the program should take into account that new codes and bits may be assigned in the future. The program should not use unassigned low-storage locations for keeping information since these locations may be assigned in the future in such a way that the machine causes the contents of the locations to be changed.

Availability

Availability is the capability of a system to accept and successfully process an individual job. Systems operating in accordance with z/Architecture permit substantial availability by (1) allowing a large number and broad range of jobs to be processed concurrently, thus making the system readily accessible to any particular job, and (2) limiting the effect of an error and identifying more precisely its cause, with the result that the number of jobs affected by errors is minimized and the correction of the errors facilitated.

Several design aspects make this possible.

- A program is checked for the correctness of instructions and data as the program is executed, and program errors are indicated separate from equipment errors. Such checking and reporting assists in locating failures and isolating effects.

- The protection facilities, in conjunction with dynamic address translation and the separation of programs and data in different address spaces, permit the protection of the contents of storage from destruction or misuse caused by erroneous or unauthorized storing or fetching by a program. This provides increased security for the user, thus permitting applications with different security requirements to be processed concurrently with other applications.
- Dynamic address translation allows isolation of one application from another, still permitting them to share common resources. Also, it permits the implementation of virtual machines, which may be used in the design and testing of new versions of operating systems along with the concurrent processing of application programs. Additionally, it provides for the concurrent operation of incompatible operating systems.
- The use of access registers allows programs, data, and different collections of data to reside in different address spaces, and this further reduces the likelihood that a store using an incorrect address will produce either erroneous results or a system-wide failure.
- Multiprocessing and the channel subsystem permit better use of storage and processing capabilities, more direct communication between CPUs, and duplication of resources, thus aiding in the continuation of system operation in the event of machine failures.
- MONITOR CALL, program-event recording, and the timing facilities permit the testing and debugging of programs without manual intervention and with little effect on the concurrent processing of other programs.
- On most models, error checking and correction (ECC) in main storage, CPU retry, and command retry provide for circumventing intermittent equipment malfunctions, thus reducing the number of equipment failures.
- An enhanced machine-check-handling mechanism provides model-independent fault isolation, which reduces the number of programs impacted by uncorrected errors. Additionally, it provides model-independent recording of machine-status information. This leads to greater machine-check-handling compatibility between models and improves the capability for loading and operating a program on a different model when a system failure occurs.
- A small number of manual controls are required for basic system operation, permitting most operator-system interaction to take place *via* a unit operating as an I/O device and thus reducing the possibility of operator errors.
- The logical partitions made available by the PR/SM feature allow continued reliable production operations in one or more partitions while new programming systems are tested in other partitions. This is an advancement in particular for non-VM installations.
- The operational extensions and channel-subsystem-call facility of ESA/390 and z/Architecture improve the ability to continue execution of application programs in the presence of system incidents and the ability to make configuration changes with less disruption to operations.

Chapter 2. Organization

Main Storage	2-2	Control Registers	2-6
Expanded Storage	2-2	Access Registers	2-6
CPU	2-2	Cryptographic Facility	2-7
CPU Types	2-3	External Time Reference	2-7
Multithreading	2-3	I/O	2-7
PSW	2-4	Channel Subsystem	2-7
General Registers	2-4	Channel Paths	2-7
Floating-Point Registers	2-4	I/O Devices and Control Units	2-8
Floating-Point-Control Register	2-5	Operator Facilities	2-8
Vector Registers	2-5		

Logically, a system consists of main storage, one or more central processing units (CPUs), operator facilities, a channel subsystem, and I/O devices. I/O devices are attached to the channel subsystem through control units. The connection between the channel subsystem and a control unit is called a channel path.

A channel path employs either a parallel-transmission protocol or a serial-transmission protocol and, accordingly, is called either a parallel or a serial channel path. A serial channel path may connect to a control unit through a dynamic switch that is capable of providing different internal connections between the ports of the switch.

Expanded storage may also be available in the system, a cryptographic unit may be included in a CPU, and an external time reference (ETR) may be connected to the system.

The physical identity of the above functions may vary among implementations, called “models”. Figure 2-1 depicts the logical structure of a two-CPU multiprocessing system that includes expanded storage and a cryptographic unit and that is connected to an ETR.

Specific processors may differ in their internal characteristics, the installed facilities, the number of subchannels, channel paths, and control units which can be attached to the channel subsystem, the size of main and expanded storage, and the representation of the operator facilities.

A system viewed without regard to its I/O devices is referred to as a configuration. All of the physical equipment, whether in the configuration or not, is referred to as the installation.

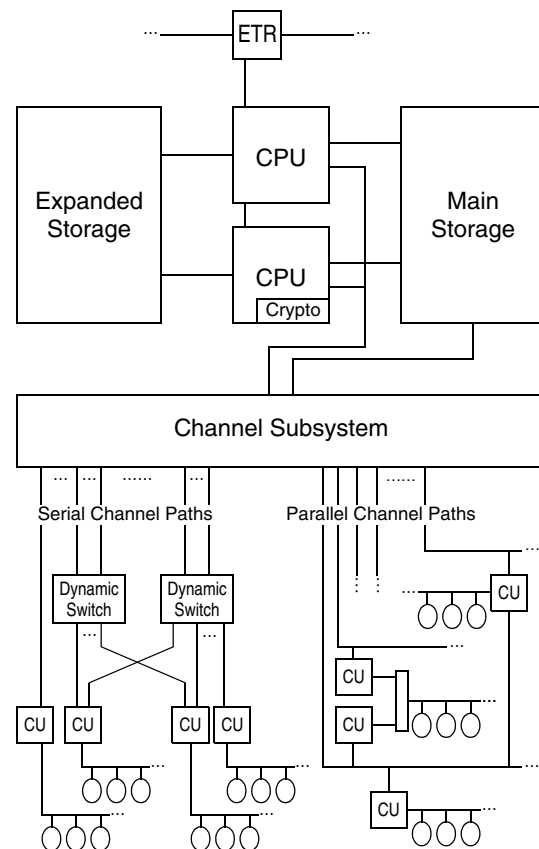

Figure 2-1. Logical Structure of a z/Architecture System with Two CPUs

Model-dependent reconfiguration controls may be provided to change the amount of main and expanded storage and the number of CPUs and channel paths in the configuration. In some instances, the reconfiguration controls may be used to partition a single configuration into multiple config-

urations. Each of the configurations so reconfigured has the same structure, that is, main and expanded storage, one or more CPUs, and one or more sub-channels and channel paths in the channel subsystem.

Each configuration is isolated in that the main and expanded storage in one configuration is not directly addressable by the CPUs and the channel subsystem of another configuration. It is, however, possible for one configuration to communicate with another by means of shared I/O devices or a channel-to-channel adapter. At any one time, the storage, CPUs, sub-channels, and channel paths connected together in a system are referred to as being in the configuration. Each CPU, subchannel, channel path, main-storage location, and expanded-storage location can be in only one configuration at a time.

Main Storage

Main storage, which is directly addressable, provides for high-speed processing of data by the CPUs and the channel subsystem. Both data and programs must be loaded into main storage from input devices before they can be processed. The amount of main storage available in the system depends on the model, and, depending on the model, the amount in the configuration may be under control of model-dependent configuration controls. The storage is available in multiples of 4 K-byte blocks. At any instant, the channel subsystem and all CPUs in the configuration have access to the same blocks of storage and refer to a particular block of main-storage locations by using the same absolute address.

Main storage may include a faster-access buffer storage, sometimes called a cache. Each CPU may have an associated cache. The effects, except on performance, of the physical construction and the use of distinct storage media are not observable by the program.

Expanded Storage

Expanded storage may be available on some models. Expanded storage, when available, can be accessed by all CPUs in the configuration by means of instructions that transfer 4 K-byte blocks of data from expanded storage to main storage or from main

storage to expanded storage. These instructions are the PAGE IN and PAGE OUT instructions, described in "PAGE IN" on page 10-73 and "PAGE OUT" on page 10-74.

Each 4 K-byte block of expanded storage is addressed by means of a 32-bit unsigned binary integer called an expanded-storage block number.

CPU

The central processing unit (CPU) is the controlling center of the system. It contains the sequencing and processing facilities for instruction execution, interruption action, timing functions, initial program load- ing, and other machine-related functions.

The physical implementation of the CPU may differ among models, but the logical function remains the same. The result of executing an instruction is the same for each model, providing that the program complies with the compatibility rules.

The CPU, in executing instructions, can process binary integers and floating-point numbers (binary, decimal, and hexadecimal) of fixed length, decimal integers of variable length, and logical information of either fixed or variable length. Processing may be in parallel or in series; the width of the processing elements, the multiplicity of the shifting paths, and the degree of simultaneity in performing the different types of arithmetic differ from one model of CPU to another without affecting the logical results.

Instructions which the CPU executes fall into fourteen classes: general, decimal, floating-point-support (FPS), binary-floating-point (BFP), decimal-floating-point (DFP), hexadecimal-floating-point (HFP), vector support, vector integer, vector string, vector floating point, vector decimal, specialized-function assist, control, and I/O instructions. The general instructions are used in performing binary-integer-arithmetic operations and logical, branching, and other nonarithmetic operations. The decimal instructions operate on data in the decimal format. The BFP, DFP, and HFP instructions operate on data in the BFP, DFP, and HFP formats, respectively, while the FPS instructions operate on floating-point data independent of the format or convert from one format to another. The privileged control instructions and the I/O instructions can be executed only when the CPU is in the supervisor state; the semiprivileged control instructions

can be executed in the problem state, subject to the appropriate authorization mechanisms.

The CPU provides registers which are available to programs but do not have addressable representations in main storage, as follows:

- Access registers
- Breaking-event-address register
- Clock comparator
- Control registers
- CPU timer
- Current program-status word (PSW)
- Floating-point-control register
- Floating-point registers
- General registers
- Guarded-storage-control registers
- Prefix register
- TOD-programmable register
- Vector registers

This set of registers is sometimes referred to as the CPU's *architected register context*.

Each CPU in an installation provides access to a time-of-day (TOD) clock and epoch index, which are shared by all CPUs in the installation. The instruction operation code determines which type of register is to be used in an operation. See Figure 2-2 on page 2-5 for the format of the control, access, general, and floating-point registers.

CPU Types

Each CPU has a type attribute that indicates whether it provides the full complement of functions and facilities (called a general CPU), or whether it is intended to process specific types of workloads. A primary CPU is either a general CPU or a CPU having the same type as the CPU started following the last IPL operation (the IPL CPU). A secondary CPU is any CPU other than a general CPU, and whose CPU type differs from that of the IPL CPU.

Programming Note: CPUs intended to process specific types of workloads include those used by the integrated facility for Linux (IFL), the internal coupling facility (ICF), and the IBM z Integrated Information Processor (zIIP). Machines prior to the IBM z13 may have also included the IBM zEnterprise Application-Assist Processors (zAAPs) for specific types of workloads.

Multithreading

When the multithreading (MT) facility is installed, it may be enabled by execution of the set-multithreading SIGP order (see “Set Multithreading” on page 4-92 for details). The following terms are applicable when the MT facility is installed:

Core: When the multithreading facility is enabled, the following applies:

- The number of CPUs in the configuration is increased by a multiple, the value of which is determined by a program-specified maximum thread identification (thread ID, or simply TID). The number of CPUs in a core is one more than the program-specified maximum thread identification.
- A number of CPUs corresponding to this multiple are grouped into a *core*.
- Each core has the same number of CPUs. Each CPU within a core is of the same CPU type; however, based on the model and CPU type, some CPUs within a core may not be operational.

When the multithreading facility is not installed, or the facility is installed but not enabled, a core comprises a single CPU, and the term CPU is generally used in favor of the term core.

Thread: When the multithreading facility is installed, a *thread* is synonymous with a CPU that is a member of a core. When the multithreading facility is not installed, or when the facility is installed but not enabled, the term thread is not applicable.

A control program must explicitly enable multithreading in order for it to be usable, as described in “Set Multithreading” on page 4-92. However, an application program is generally unaware of whether multithreading has been enabled.

When multithreading is enabled, the CPU addresses of all CPUs in the configuration are adjusted to include a core identification (or core ID) in the leftmost bits of the address and a thread identification (thread ID, or TID) in the rightmost bits of the address. See “CPU-Address Identification” on page 4-84 for details on the core-ID and thread-ID fields of the CPU address.

CPUs within a core may share certain hardware facilities such as execution units or lower-level caches,

thus execution within one CPU of a core may affect the performance of other CPUs in the core.

PSW

The program-status word (PSW) includes the instruction address, condition code, and other information used to control instruction sequencing and to determine the state of the CPU. The active or controlling PSW is called the current PSW. It governs the program currently being executed.

The CPU has an interruption capability, which permits the CPU to switch rapidly to another program in response to exceptional conditions and external stimuli. When an interruption occurs, the CPU places the current PSW in an assigned storage location, called the old-PSW location, for the particular class of interruption. The CPU fetches a new PSW from a second assigned storage location. This new PSW determines the next program to be executed. When it has finished processing the interruption, the program handling the interruption may reload the old PSW, making it again the current PSW, so that the interrupted program can continue.

There are six classes of interruption: external, I/O, machine check, program, restart, and supervisor call. Each class has a distinct pair of old-PSW and new-PSW locations permanently assigned in real storage.

General Registers

Instructions may designate information in one or more of 16 general registers. The general registers may be used as base-address registers and index registers in address arithmetic and as accumulators in general arithmetic and logical operations. Each register contains 64 bit positions. The general registers are identified by the numbers 0-15 and are designated by a four-bit R field in an instruction. Some instructions provide for addressing multiple general registers by having several R fields. For some instructions, the use of a specific general register is implied rather than explicitly designated by an R field of the instruction.

For some operations, either bits 32-63 or bits 0-63 of two adjacent general registers are coupled, providing a 64-bit or 128-bit format, respectively. In these operations, the program must designate an even-numbered register, which contains the leftmost (high-order) 32 or 64 bits. The next higher-numbered register contains the rightmost (low-order) 32 or 64 bits.

In addition to their use as accumulators in general arithmetic and logical operations, 15 of the 16 general registers are also used as base-address and index registers in address generation. In these cases, the registers are designated by a four-bit B field or X field in an instruction. A value of zero in the B or X field specifies that no base or index is to be applied, and, thus, general register 0 cannot be designated as containing a base address or index.

While in the ESA/390 architectural mode, the contents of bit positions 0-31 of the 64-bit general registers of all CPUs in the configuration cannot be altered by any instruction.

In the ESA/390-compatibility mode, unless stated otherwise, it is unpredictable whether instructions that are unique to the z/Architecture architectural mode result in an operation exception or in execution as defined in z/Architecture. Therefore, it is possible that bits 0-31 of a 64-bit general register may be altered by a z/Architecture instruction that is executed in the ESA/390-compatibility mode.

Floating-Point Registers

All floating-point instructions (FPS, BFP, DFP, and HFP) use the same set of floating-point registers. The CPU has 16 floating-point registers. The floating-point registers are identified by the numbers 0-15 and are designated by a four-bit R field in floating-point instructions. Each floating-point register is 64 bits long and can contain either a short (32-bit) or a long (64-bit) floating-point operand. As shown in Figure 2-2 on page 2-5, pairs of floating-point registers can be used for extended (128-bit) operands. Each of the eight pairs is referred to by the number of the lower-numbered register of the pair.

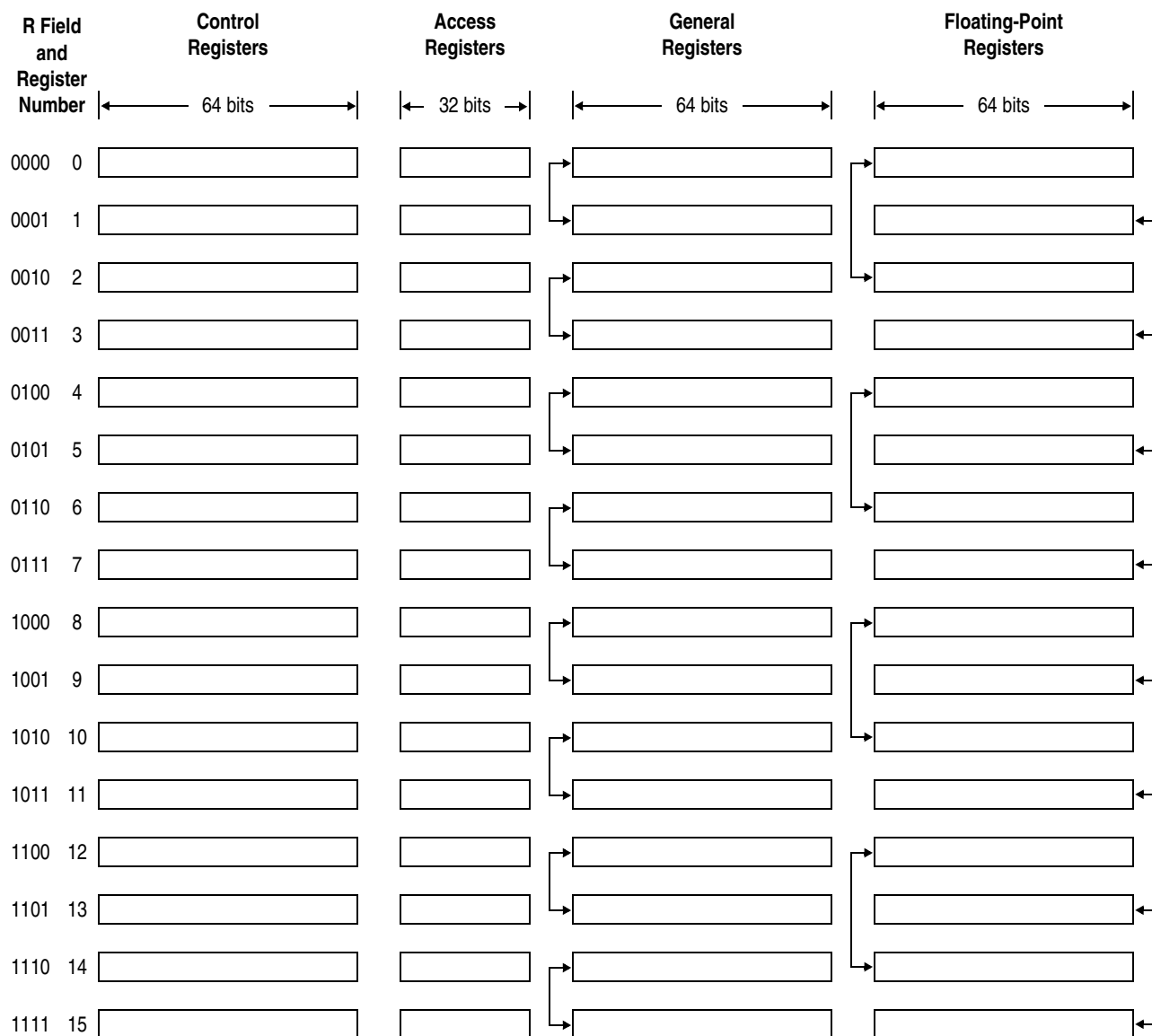

Note: The arrows indicate that the two registers may be coupled as a double-register pair, designated by specifying the lower-numbered register in the R field. For example, the floating-point register pair 13 and 15 is designated by 1101 binary in the R field.

Figure 2-2. Control, Access, General, and Floating-Point Registers

Floating-Point-Control Register

The floating-point-control (FPC) register is a 32-bit register that contains mask bits, flag bits, a data-exception code, and rounding-mode bits. The FPC register is described in the section “Floating-Point-Control (FPC) Register” on page 9-9.

Vector Registers

All vector instructions use the same set of 32 vector registers identified by the numbers 0-31 and are designated by the concatenation of a single register number extension bit with a four-bit field. Each vector register is 128 bits long and can contain from one to sixteen equal sized elements. When there are multi-

ple elements in the register the elements are indexed from left to right starting at element zero.

The floating-point registers overlay the vector registers as shown in Figure 2-3 on page 2-6. Bits 0-63 of vector registers 0-15 correspond to floating-point registers 0-15. Whenever a floating-point instruction or floating point support instruction writes to a floating point register, or a floating point instruction that reads a register pair reads from floating-point registers, bits 64-127 of the corresponding vector register are unpredictable. Any use of vector registers 0-15 by a vector instruction, except for VECTOR LOAD ELEMENT specifying an element not in bits 0-63 of the vector register will cause the data in the floating point register to be overwritten as well.

0	FPR 0 or VR 0 (bits 0-63)	VR 0 (bits 64-127)
1	FPR 1 or VR 1 (bits 0-63)	VR 1 (bits 64-127)
2	FPR 2 or VR 2 (bits 0-63)	VR 2 (bits 64-127)
3	FPR 3 or VR 3 (bits 0-63)	VR 3 (bits 64-127)
4	FPR 4 or VR 4 (bits 0-63)	VR 4 (bits 64-127)
5	FPR 5 or VR 5 (bits 0-63)	VR 5 (bits 64-127)
6	FPR 6 or VR 6 (bits 0-63)	VR 6 (bits 64-127)
7	FPR 7 or VR 7 (bits 0-63)	VR 7 (bits 64-127)
8	FPR 8 or VR 8 (bits 0-63)	VR 8 (bits 64-127)
9	FPR 9 or VR 9 (bits 0-63)	VR 9 (bits 64-127)
10	FPR 10 or VR 10 (bits 0-63)	VR 10 (bits 64-127)
11	FPR 11 or VR 11 (bits 0-63)	VR 11 (bits 64-127)
12	FPR 12 or VR 12 (bits 0-63)	VR 12 (bits 64-127)
13	FPR 13 or VR 13 (bits 0-63)	VR 13 (bits 64-127)
14	FPR 14 or VR 14 (bits 0-63)	VR 14 (bits 64-127)
15	FPR 15 or VR 15 (bits 0-63)	VR 15 (bits 64-127)
16	VR 16	
17	VR 17	
18	VR 18	
19	VR 19	
20	VR 20	
21	VR 21	
22	VR 22	
23	VR 23	
24	VR 24	
25	VR 25	
26	VR 26	
27	VR 27	
28	VR 28	
29	VR 29	
30	VR 30	
31	VR 31	

Figure 2-3. Vector and Floating Point Registers

Control Registers

The CPU has 16 control registers, each having 64 bit positions. The bit positions in the registers are assigned to particular facilities in the system, such as program-event recording, and are used either to specify that an operation can take place or to furnish special information required by the facility.

The control registers are identified by the numbers 0-15 and are designated by four-bit R fields in the instructions LOAD CONTROL and STORE CONTROL. Multiple control registers can be addressed by these instructions.

While in the ESA/390 architectural mode or the ESA/390-compatibility mode, the contents of bit positions 0-31 of the 64-bit control registers of all CPUs in the configuration cannot be altered by any instruction. If a configuration returns to the ESA/390-compatibility mode from the z/Architecture architectural mode, the contents of bit positions 0-31 of the 64-bit control registers are all set to zeros.

Access Registers

The CPU has 16 access registers numbered 0-15. An access register consists of 32 bit positions containing an indirect specification (not described here in detail) of an address-space-control element. An address-space-control element is a parameter used by the dynamic-address-translation (DAT) mechanism to translate references to a corresponding address space. When the CPU is in a mode called the access-register mode (controlled by bits in the PSW), an instruction B field, used to specify a logical address for a storage-operand reference, designates an access register, and the address-space-control element specified by the access register is used by DAT for the reference being made. For some instructions, an R field is used instead of a B field. Instructions are provided for loading and storing the contents of the access registers and for moving the contents of one access register to another.

Each of access registers 1-15 can designate any address space, including the current instruction space (the primary address space). Access register 0 always designates the current instruction space. When one of access registers 1-15 is used to designate an address space, the CPU determines which address space is designated by translating the con-

tents of the access register. When access register 0 is used to designate an address space, the CPU treats the access register as designating the current instruction space, and it does not examine the actual contents of the access register. Therefore, the 16 access registers can designate, at any one time, the current instruction space and a maximum of 15 other spaces.

Cryptographic Facility

Depending on the model, an integrated cryptographic facility may be provided as an extension of the CPU. When the cryptographic facility is provided on a CPU, it functions as an integral part of that CPU. A summary of the benefits of the cryptographic facility is given on page 1-33; the facility is otherwise not described.

External Time Reference

Depending on the model, an external time reference (ETR) may be connected to the configuration. A summary of the benefits of the ETR is given on page 1-33; the facility is otherwise not described.

I/O

Input/output (I/O) operations involve the transfer of information between main storage and an I/O device. I/O devices and their control units attach to the channel subsystem, which controls this data transfer.

Channel Subsystem

The channel subsystem directs the flow of information between I/O devices and main storage. It relieves CPUs of the task of communicating directly with I/O devices and permits data processing to proceed concurrently with I/O processing. The channel subsystem uses one or more channel paths as the communication link in managing the flow of information to or from I/O devices. As part of I/O processing, the channel subsystem also performs the path-management function of testing for channel-path availability, selecting an available channel path, and initiating execution of the operation with the I/O

device. Within the channel subsystem are subchannels.

One subchannel is provided for and dedicated to each I/O device accessible to the channel subsystem. Each subchannel contains storage for information concerning the associated I/O device and its attachment to the channel subsystem. The subchannel also provides storage for information concerning I/O operations and other functions involving the associated I/O device. Information contained in the subchannel can be accessed by CPUs using I/O instructions as well as by the channel subsystem and serves as the means of communication between any CPU and the channel subsystem concerning the associated I/O device. The actual number of subchannels provided depends on the model and the configuration; the maximum number of subchannels is 65,536.

Channel Paths

I/O devices are attached through control units to the channel subsystem via channel paths. Control units may be attached to the channel subsystem via more than one channel path, and an I/O device may be attached to more than one control unit. In all, an individual I/O device may be accessible to a channel subsystem by as many as eight different channel paths, depending on the model and the configuration. The total number of channel paths provided by a channel subsystem depends on the model and the configuration; the maximum number of channel paths is 256.

A channel path can use one of three types of communication links:

- System/360 and System/370 I/O interface, called the parallel-I/O interface; the channel path is called a parallel channel path
- ESCON I/O interface, called a serial-I/O interface; the channel path is called a serial channel path
- FICON I/O interface, also called a serial-I/O interface; the channel path again is called a serial channel path

Each parallel-I/O interface consists of a number of electrical signal lines between the channel subsystem and one or more control units. Eight control units can share a single parallel-I/O interface. Up to 256

I/O devices can be addressed on a single parallel-I/O interface. The parallel-I/O interface is described in the publication *IBM System/360 and System/370 I/O Interface Channel to Control Unit Original Equipment Manufacturers' Information*, GA22-6974.

Each serial-I/O interface consists of two optical-fiber conductors between any two of a channel subsystem, a dynamic switch, and a control unit. A dynamic switch can be connected by means of multiple serial-I/O interfaces to either the same or different channel subsystems and to multiple control units. The number of control units which can be connected on one channel path depends on the channel-subsystem and dynamic-switch capabilities. Up to 256 devices can be attached to each control unit that uses the serial-I/O interface, depending on the control unit. The ESCON I/O interface is described in the publication *ESA/390 ESCON I/O Interface*, SA22-7202. The FICON I/O interface is described in the ANSI standards document *Fibre Channel - Single-Byte Command Code Sets-2 (FC-SB-2)*.

I/O Devices and Control Units

I/O devices include such equipment as printers, magnetic-tape units, direct-access-storage devices, displays, keyboards, communications controllers, teleprocessing devices, and sensor-based equip-

ment. Many I/O devices function with an external medium, such as paper or magnetic tape. Other I/O devices handle only electrical signals, such as those found in displays and communications networks. In all cases, I/O-device operation is regulated by a control unit that provides the logical and buffering capabilities necessary to operate the associated I/O device. From the programming point of view, most control-unit functions merge with I/O-device functions. The control-unit function may be housed with the I/O device or in the CPU, or a separate control unit may be used.

Operator Facilities

The operator facilities provide the functions necessary for operator control of the machine. Associated with the operator facilities may be an operator-console device, which may also be used as an I/O device for communicating with the program.

The main functions provided by the operator facilities include resetting, clearing, initial program loading, start, stop, alter, and display.

Chapter 3. Storage

Storage Addressing	3-2	ASN-Second-Table Lookup	3-34
Information Formats	3-3	Recognition of Exceptions during ASN Translation	3-35
Integral Boundaries	3-3	ASN Authorization	3-35
Address Types and Formats	3-4	ASN-Authorization Controls	3-35
Address Types	3-4	Control Register 4	3-35
Absolute Address	3-4	ASN-Second-Table Entry	3-35
Real Address	3-4	Authority-Table Entries	3-36
Virtual Address	3-5	ASN-Authorization Process	3-36
Primary Virtual Address	3-5	Authority-Table Lookup	3-36
Secondary Virtual Address	3-5	Recognition of Exceptions during ASN Authorization	3-38
AR-Specified Virtual Address	3-5	Dynamic Address Translation	3-38
Home Virtual Address	3-5	Translation Control	3-40
Logical Address	3-5	Translation Modes	3-40
Instruction Address	3-5	Control Register 0	3-41
Effective Address	3-5	Control Register 1	3-42
Address Size and Wraparound	3-6	Control Register 7	3-44
Address Wraparound	3-7	Control Register 13	3-45
Storage Key	3-9	Translation Tables	3-45
Protection	3-10	Region-Table Entries	3-46
Key-Controlled Protection	3-11	Segment-Table Entries	3-49
Storage-Protection-Override Control	3-12	Page-Table Entries	3-51
Fetch-Protection-Override Control	3-13	Translation Process	3-52
Access-List-Controlled Protection	3-13	Inspection of Real-Space Control	3-54
DAT Protection	3-13	Inspection of Designation-Type Control	3-54
Low-Address Protection	3-14	Lookup in a Table Designated by an Address-Space-Control Element	3-57
Instruction-Execution Protection	3-14	Lookup in a Table Designated by a Region-Table Entry	3-59
Suppression on Protection	3-15	Page-Table Lookup	3-61
Reference Recording	3-19	Formation of the Real and Absolute Addresses	3-62
Change Recording	3-20	Recognition of Exceptions during Translation	3-62
Prefixing	3-21	Translation-Lookaside Buffer	3-62
Prefixing in the z/Architecture Architectural Mode	3-22	TLB Structure	3-63
Prefixing in the ESA/390-Compatibility Mode	3-22	Formation of TLB Entries	3-63
Common Prefixing Attributes	3-22	Use of TLB Entries	3-65
Address Spaces	3-23	Modification of Translation Tables	3-67
Changing to Different Address Spaces	3-23	Address Summary	3-70
Address-Space Number	3-23	Addresses Translated	3-70
ASN-Second-Table-Entry Sequence Number	3-24	Handling of Addresses	3-71
ASN-Second-Table-Entry Instance Number and ASN Reuse	3-25	Assigned Storage Locations	3-73
ASN Translation	3-30	Assigned Storage Locations in the z/Architecture Architectural Mode	3-73
ASN-Translation Controls	3-30	Assigned Storage Locations in the ESA/390-Compatibility Mode	3-83
Control Register 14	3-30		
ASN-Translation Tables	3-31		
ASN-First-Table Entries	3-31		
ASN-Second-Table Entries	3-31		
ASN-Translation Process	3-33		
ASN-First-Table Lookup	3-33		

This chapter discusses the representation of information in main storage, as well as addressing, protection, and reference and change recording. The aspects of addressing which are covered include the format of addresses, the concept of address spaces, the various types of addresses, and the manner in which one type of address is translated to another type of address.

A list of permanently assigned storage locations appears at the end of the chapter.

Main storage provides the system with directly addressable fast-access storage of data. Both data and programs must be loaded into main storage (from input devices) before they can be processed.

Main storage may include one or more smaller faster-access buffer storages, sometimes called caches. A cache is usually physically associated with a CPU or an I/O processor. The effects, except on performance, of the physical construction and use of distinct storage media are generally not observable by the program.

Separate caches may be maintained for instructions and for data operands. Information within a cache is maintained in contiguous bytes on an integral boundary called a cache block or cache line (or line, for short). A model may provide the EXTRACT CPU ATTRIBUTE instruction which returns various cache attributes such as line size, number of cache levels, and set associativity. A model may also provide any or all of the PREFETCH DATA, PREFETCH DATA RELATIVE LONG, and NEXT INSTRUCTION ACCESS INTENT instructions which affect the prefetching of storage into the data cache, the releasing of data from the cache, or indicating access intent of storage operands.

Fetching and storing of data by a CPU are not normally affected by any concurrent channel-subsystem activity or by a concurrent reference to the same storage location by another CPU. When concurrent requests to a main-storage location occur, access normally is granted in a sequence determined by the system. If a reference changes the contents of the location, any subsequent storage fetches obtain the new contents. However, when the transactional-execution facility is installed, a transaction executing on one CPU may be aborted due to conflicting fetches and stores by another CPU or by the channel subsystem.

Main storage may be volatile or nonvolatile. If it is volatile, the contents of main storage are not preserved when power is turned off. If it is nonvolatile, turning power off and then back on does not affect the contents of main storage, provided all CPUs are in the stopped state and no references are made to main storage when power is being turned off. In both types of main storage, the contents of storage keys are not necessarily preserved when the power for main storage is turned off.

Note: Because most references in this publication apply to virtual storage, the abbreviated term “storage” is often used in place of “virtual storage.” The term “storage” may also be used in place of “main storage,” “absolute storage,” or “real storage” when the meaning is clear. The terms “main storage” and “absolute storage” are used to describe storage which is addressable by means of an absolute address. The terms describe fast-access storage, as opposed to auxiliary storage, such as that provided by direct-access storage devices. “Real storage” is synonymous with “absolute storage” except for the effects of prefixing.

Programming Note: On models that implement separate caches for instructions and data operands, a significant delay may be experienced if the program stores into a cache line from which instructions are subsequently fetched, regardless of whether the store alters the instructions that are subsequently fetched.

Storage Addressing

Storage is viewed as a long horizontal string of bits. For most operations, accesses to storage proceed in a left-to-right sequence. The string of bits is subdivided into units of eight bits. An eight-bit unit is called a byte, which is the basic building block of all information formats.

Each byte location in storage is identified by a unique nonnegative integer, which is the address of that byte location or, simply, the byte address. Adjacent byte locations have consecutive addresses, starting with 0 on the left and proceeding in a left-to-right sequence. Addresses are unsigned binary integers and are 24, 31, or 64 bits. Addresses are described in “Address Size and Wraparound” on page 3-6.

Information Formats

Information is transmitted between storage and a CPU or the channel subsystem one byte, or a group of bytes, at a time. Unless otherwise specified, a group of bytes in storage is addressed by the leftmost byte of the group. The number of bytes in the group is either implied or explicitly specified by the operation to be performed. When used in a CPU operation, a group of bytes is called a field.

Within each group of bytes, bits are numbered in a left-to-right sequence. The leftmost bits are sometimes referred to as the “high-order” bits and the rightmost bits as the “low-order” bits. Bit numbers are not storage addresses, however. Only bytes can be addressed. To operate on individual bits of a byte in storage, it is necessary to access the entire byte.

The bits in a byte are numbered 0 through 7, from left to right.

The bits in an address may be numbered 8-31 or 40-63 for 24-bit addresses or 1-31 or 33-63 for 31-bit addresses; they are numbered 0-63 for 64-bit addresses. Within any other fixed-length format of multiple bytes, the bits making up the format are consecutively numbered starting from 0.

For purposes of error detection, and in some models for correction, one or more check bits may be transmitted with each byte or with a group of bytes. Such check bits are generated automatically by the machine and cannot be directly controlled by the program. References in this publication to the length of data fields and registers exclude mention of the associated check bits. All storage capacities are expressed in number of bytes.

When the length of a storage-operand field is implied by the operation code of an instruction, the field is said to have a fixed length, which can be one, two, four, eight, or sixteen bytes. Larger fields may be implied for some instructions.

When the length of a storage-operand field is not implied but is stated explicitly, the field is said to have a variable length. Variable-length operands can vary in length by increments of one byte.

When information is placed in storage, the contents of only those byte locations are replaced that are included in the designated field, even though the width of the physical path to storage may be greater than the length of the field being stored.

Integral Boundaries

Certain units of information must be on an integral boundary in storage. A boundary is called integral for a unit of information when its storage address is a multiple of the length of the unit in bytes. Special names are given to fields of 2, 4, 8, 16, and 32 bytes on an integral boundary. A halfword is a group of two consecutive bytes on a two-byte boundary and is the basic building block of instructions. A word is a group of four consecutive bytes on a four-byte boundary. A doubleword is a group of eight consecutive bytes on an eight-byte boundary. A quadword is a group of 16 consecutive bytes on a 16-byte boundary. An octoword is a group of 32 consecutive bytes on a 32-byte boundary. (See Figure 3-1 on page 3-4.)

When storage addresses designate halfwords, words, doublewords, quadwords, and octowords, the binary representation of the address contains one, two, three, four, or five rightmost zero bits, respectively.

Instructions must be on two-byte integral boundaries, and CCWs, IDAWs, MIDAWs, TIDAWs, and the storage operands of certain instructions must be on other integral boundaries. The storage operands of most instructions do not have boundary-alignment requirements.

Programming Notes:

1. For fixed-field-length operations with field lengths that are a power of 2, significant performance degradation is possible when storage operands are not positioned at addresses that are integral multiples of the operand length. To improve performance, frequently used storage operands should be aligned on integral boundaries.
2. Some vector instructions have an alignment-hint-control, whereby the program can notify the CPU of the alignment of an operand without the CPU

having to perform the address arithmetic to determine the alignment.

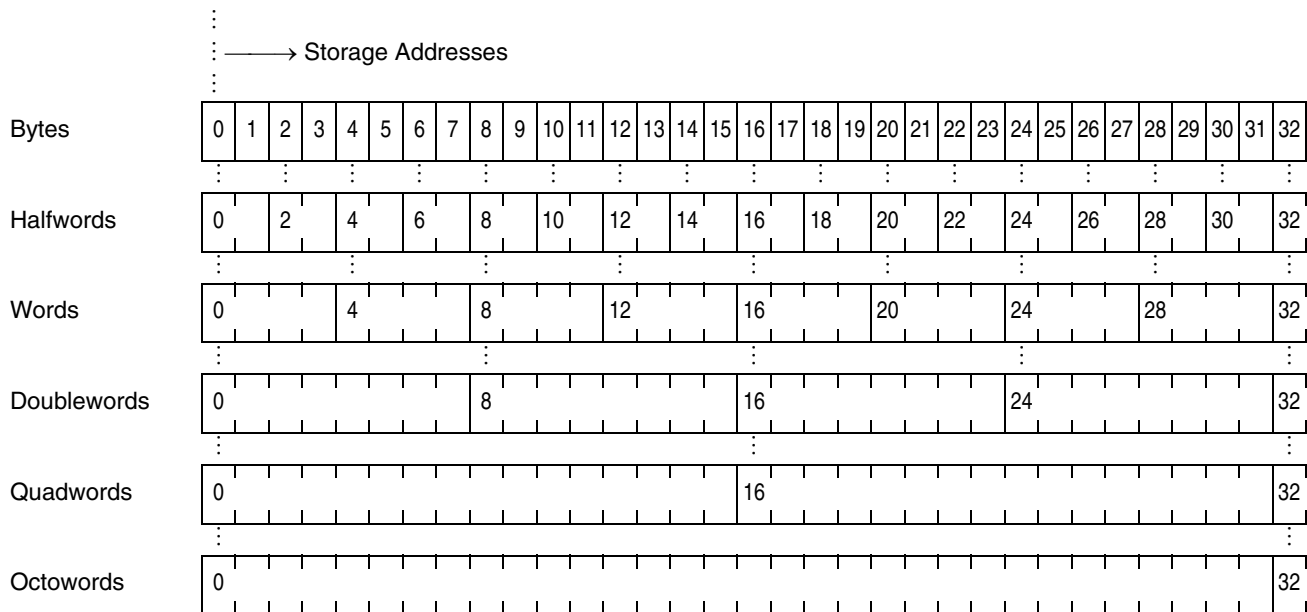

Figure 3-1. Integral Boundaries with Storage Addresses

Address Types and Formats

Address Types

For purposes of addressing main storage, three basic types of addresses are recognized: absolute, real, and virtual. The addresses are distinguished on the basis of the transformations that are applied to the address during a storage access. Address translation converts virtual to real, and prefixing converts real to absolute. In addition to the three basic address types, additional types are defined which are treated as one or another of the three basic types, depending on the instruction and the current mode.

In the ESA/390-compatibility mode, dynamic-address translation (DAT) is not supported, thus virtual addresses – including primary, secondary, AR-specified, and home virtual addresses – are not applicable. The ESA/390-compatibility mode may support absolute-storage address spaces as defined in Reference [12.] on page xxx by means of host access-register translation.

Absolute Address

An absolute address is the address assigned to a main-storage location. An absolute address is used

for a storage access without any transformations performed on it.

The channel subsystem and all CPUs in the configuration refer to a shared main-storage location by using the same absolute address. Available main storage is usually assigned contiguous absolute addresses starting at 0, and the addresses are always assigned in complete 4 K-byte blocks on integral boundaries. An exception is recognized when an attempt is made to use an absolute address in a block which has not been assigned to physical locations. On some models, storage-reconfiguration controls may be provided which permit the operator to change the correspondence between absolute addresses and physical locations. However, at any one time, a physical location is not associated with more than one absolute address.

Storage consisting of byte locations sequenced according to their absolute addresses is referred to as absolute storage.

Real Address

A real address identifies a location in real storage. When a real address is used for an access to main storage, it is converted, by means of prefixing, to an absolute address.

At any instant there is one real-address to absolute-address mapping for each CPU in the configuration. When a real address is used by a CPU to access main storage, it is converted to an absolute address by prefixing. The particular transformation is defined by the value in the prefix register for the CPU.

Storage consisting of byte locations sequenced according to their real addresses is referred to as real storage.

Virtual Address

A virtual address identifies a location in virtual storage. When a virtual address is used for an access to main storage, it is translated by means of dynamic address translation, either (a) to a real address which is then further converted by prefixing to an absolute address, or (b) directly to an absolute address.

Primary Virtual Address

A primary virtual address is a virtual address which is to be translated by means of the primary address-space-control element. Logical addresses are treated as primary virtual addresses when in the primary-space mode. Instruction addresses are treated as primary virtual addresses when in the primary-space mode, secondary-space mode, or access-register mode. The first-operand address of MOVE TO PRIMARY and the second-operand address of MOVE TO SECONDARY are always treated as primary virtual addresses.

Secondary Virtual Address

A secondary virtual address is a virtual address which is to be translated by means of the secondary address-space-control element. Logical addresses are treated as secondary virtual addresses when in the secondary-space mode. The second-operand address of MOVE TO PRIMARY and the first-operand address of MOVE TO SECONDARY are always treated as secondary virtual addresses.

AR-Specified Virtual Address

An AR-specified virtual address is a virtual address which is to be translated by means of an access-register-specified address-space-control element. Logical addresses are treated as AR-specified addresses when in the access-register mode.

Home Virtual Address

A home virtual address is a virtual address which is to be translated by means of the home address-space-control element. Logical addresses and instruction addresses are treated as home virtual addresses when in the home-space mode.

Logical Address

Except where otherwise specified, the storage-operand addresses for most instructions are logical addresses. Logical addresses are treated as real addresses in the real mode, as primary virtual addresses in the primary-space mode, as secondary virtual addresses in the secondary-space mode, as AR-specified virtual addresses in the access-register mode, and as home virtual addresses in the home-space mode. Some instructions have storage-operand addresses or storage accesses associated with the instruction which do not follow the rules for logical addresses. In all such cases, the instruction definition contains a definition of the type of address.

Instruction Address

Addresses used to fetch instructions from storage are called instruction addresses. Instruction addresses are treated as real addresses in the real mode, as primary virtual addresses in the primary-space mode, secondary-space mode, or access-register mode, and as home virtual addresses in the home-space mode. The following are instruction addresses:

- The instruction address in the current PSW
- The target address of execute-type instructions (EXECUTE and EXECUTE RELATIVE LONG)
- The instruction address in the transaction-abort PSW
- The aborted-transaction instruction address (in the transaction diagnostic block)

Effective Address

In some situations, it is convenient to use the term "effective address." An effective address is the address which exists before any transformation by dynamic address translation or prefixing is performed. An effective address may be specified directly in a register or may result from address arithmetic. Address arithmetic is the addition of the base and displacement or of the base, index, and displacement.

Address Size and Wraparound

An address size refers to the maximum number of significant bits that can represent an address. Three sizes of addresses are provided: 24-bit, 31-bit, and 64-bit. A 24-bit address can accommodate a maximum of 16,777,216 (16M) bytes; with a 31-bit address, 2,147,483,648 (2G) bytes can be

addressed; and, with a 64-bit address, 18,446,744,073,709,551,616 (16E) bytes can be addressed. The bits of a 24-bit, 31-bit, or 64-bit address produced by address arithmetic under the control of the current addressing mode are numbered 40-63, 33-63, and 0-63, respectively, corresponding to the numbering of base-address and index bits in a general register, as shown below:

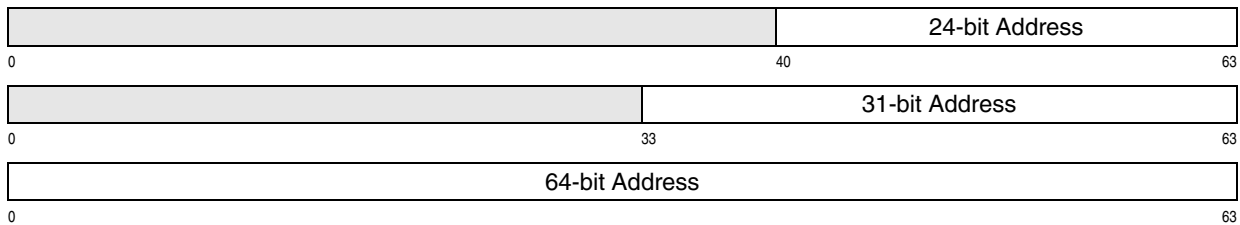

The byte and bit positions of a 64-bit address and corresponding power-of-two and numerical values are shown in Figure 3-2.

Byte	0								1								2								3								4								5								6								7																															
Bit Position	0	1	2	3	4	5	6	7	8	9	10	11	12	13	14	15	16	17	18	19	20	21	22	23	24	25	26	27	28	29	30	31	32	33	34	35	36	37	38	39	40	41	42	43	44	45	46	47	48	49	50	51	52	53	54	55	56	57	58	59	60	61	62	63																								
Power of 2	63	62	61	60	59	58	57	56	55	54	53	52	51	50	49	48	47	46	45	44	43	42	41	40	39	38	37	36	35	34	33	32	31	30	29	28	27	26	25	24	23	22	21	20	19	18	17	16	15	14	13	12	11	10	9	8	7	6	5	4	3	2	1	0																								
Value	8	4	2	1	5	2	1	6	3	1	8	4	2	5	2	1	6	3	1	8	4	2	5	2	1	6	3	1	8	4	2	5	2	1	6	3	1	8	4	2	5	2	1	6	3	1	8	4	2	5	2	1	6	3	1	8	4	2	5	2	1	6	3	1	8	4	2	5	2	1	6	3	1	8	4	2	5	2	1	6	3	1	8	4	2	5	2	1

Figure 3-2. 64-Bit Address Attributes

The bits of an address that is 31 bits regardless of the addressing mode are numbered 1-31, and, when a 24-bit or 31-bit address is contained in a four-byte field in storage, the bits are numbered 8-31 or 1-31, respectively:

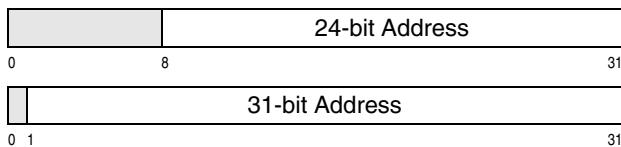

A 24-bit or 31-bit virtual address is expanded to 64 bits by appending 40 or 33 zeros, respectively, on the left before it is translated by means of the DAT process, and a 24-bit or 31-bit real address is similarly expanded to 64 bits before it is transformed by prefixing. A 24-bit or 31-bit absolute address is expanded to 64 bits before main storage is accessed. Thus, the 24-bit address always designates a location in the first 16 M-byte block of the 16 E-byte storage addressable by a 64-bit address, and the 31-bit

address always designates a location in the first 2 G-byte block.

Unless specifically stated to the contrary, the following definition applies in this publication: whenever the machine generates and provides to the program a 24-bit or 31-bit address, the address is made available (placed in storage or loaded into a general register) by being imbedded in a 32-bit field, with the leftmost eight bits or one bit in the field, respectively, set to zeros. When the address is loaded into a general register, bits 0-31 of the register remain unchanged.

The size of effective addresses is controlled by bits 31 and 32 of the PSW, the extended-addressing-mode bit and the basic-addressing-mode bit, respectively. When bits 31 and 32 are both zero, the CPU is in the 24-bit addressing mode, and 24-bit operand and instruction effective addresses are specified. When bit 31 is zero and bit 32 is one, the CPU is in the 31-bit addressing mode, and 31-bit operand and instruction effective addresses are specified. When

bits 31 and 32 are both one, the CPU is in the 64-bit addressing mode, and 64-bit operand and instruction effective addresses are specified (see “Address Generation” on page 5-10).

The sizes of the real or absolute addresses used or yielded by the ASN-translation, ASN-authorization, PC-number-translation, and access-register-translation processes are always 31 bits regardless of the current addressing mode. Similarly, the sizes of the real or absolute addresses used or yielded by the DAT, stacking, unstacking, and tracing processes are always 64 bits.

The size of the data address in a CCW is under control of the CCW-format-control bit in the operation-request block (ORB) designated by a START SUBCHANNEL instruction. The CCWs with 24-bit and 31-bit addresses are called format-0 and format-1 CCWs, respectively. Format-0 and format-1 CCWs are described in “Basic I/O Functions” on page 15-1. Similarly, the size of the data address in an IDAW is under control of the IDAW-format-control bit in the ORB. The IDAWs with 31-bit and 64-bit addresses are called format-1 and format-2 IDAWs, respectively. MIDAWs contain 64-bit data addresses. IDAWs and MIDAWs are described in Chapter 15, “Basic I/O Functions.”

Address Wraparound

The CPU performs address generation when it forms an operand or instruction address or when it generates the address of a table entry from the appropriate table origin and index. It also performs address generation when it increments an address to access successive bytes of a field. Similarly, the channel subsystem performs address generation when it increments an address (1) to fetch a CCW, (2) to fetch an IDAW, (3) to fetch a MIDAW, (4) to transfer

data, or (5) to compute the address of an I/O measurement block.

When, during the generation of the address, an address is obtained that exceeds the value allowed for the address size ($2^{24} - 1$, $2^{31} - 1$, or $2^{64} - 1$), one of the following two actions is taken:

1. The carry out of the high-order bit position of the address is ignored. This handling of an address of excessive size is called *wraparound*.
2. An interruption condition is recognized.

The effect of wraparound is to make an address space appear circular; that is, address 0 appears to follow the maximum allowable address. Address arithmetic and wraparound occur before transformation, if any, of the address by DAT or prefixing.

Addresses generated by the CPU that may be virtual addresses always wrap. Wraparound also occurs when the linkage-stack-entry address in control register 15 is decremented below 0 by PROGRAM RETURN. For CPU table entries that are addressed by real or absolute addresses, it is unpredictable whether the address wraps or an addressing exception is recognized.

For channel-program execution, when the generated address exceeds the value for the address size (or, for the read-backward command is decremented below 0), an I/O program-check condition is recognized.

Figure 3-3 on page 3-7 identifies what limit values apply to the generation of different addresses and how addresses are handled when they exceed the allowed value.

Address Generation for	Address Type	Handling when Address Would Wrap
Instructions and operands when EAM and BAM are zero	L,I,R,V	W24
Successive bytes of instructions and operands when EAM and BAM are zero	I,L,V ¹	W24
Instructions and operands when EAM is zero and BAM is one	L,I,R,V	W31
Successive bytes of instructions and operands when EAM is zero and BAM is one	I,L,V ¹	W31
Instructions and operands when EAM and BAM are one	L,I,R,V	W64

Figure 3-3. Address Wraparound (Part 1 of 3).

Address Generation for	Address Type	Handling when Address Would Wrap
Successive bytes of instructions and operands when EAM and BAM are one	I,L,V ¹	W64
DAT-table entries when used for implicit translation or for LPTEA, LRA, LRA, or STRAG	A or R ²	X64
ASN-second-table, authority-table (during ASN authorization), linkage-table, linkage-first-table, linkage-second-table, and entry-table entries	R	X31
Authority-table (during access-register translation) and access-list entries	A or R ²	X31
Linkage-stack entry	V	W64
I/O measurement block	A	P31
For a channel program with format-0 CCWs:		
Successive CCWs	A	P24
Successive IDAWs	A	P24
Successive MIDAWs	A	P24
Successive bytes of I/O data (without IDAWs and MIDAWs)	A	P24
Successive bytes of I/O data (with format-1 IDAWs)	A	P31
Successive bytes of I/O data (with format-2 IDAWs)	A	P64
Successive bytes of I/O data (with MIDAWs)	A	P64
For a channel program with format-1 CCWs:		
Successive CCWs	A	P31
Successive IDAWs	A	P31
Successive MIDAWs	A	P31
Successive bytes of I/O data (without IDAWs and MIDAWs)	A	P31
Successive bytes of I/O data (with format-1 IDAWs)	A	P31
Successive bytes of I/O data (with format-2 IDAWs)	A	P64
Successive bytes of I/O data (with MIDAWs)	A	P64

Figure 3-3. Address Wraparound (Part 2 of 3).

Address Generation for		Address Type	Handling when Address Would Wrap
Explanation:			
1	Real addresses do not apply in this case since the instructions which designate operands by means of real addresses cannot designate operands that cross boundary 2^{24} , 2^{31} , 2^{64} .		
2	It is unpredictable whether the address is absolute or real.		
A	Absolute address.		
BAM	Basic-addressing-mode bit in the PSW.		
EAM	Extended-addressing-mode bit in the PSW.		
I	Instruction address.		
L	Logical address.		
P24	An I/O program-check condition is recognized when the address exceeds $2^{24} - 1$ or is decremented below zero.		
P31	An I/O program-check condition is recognized when the address exceeds $2^{31} - 1$ or is decremented below zero.		
P64	An I/O program-check condition is recognized when the address exceeds $2^{64} - 1$ or is decremented below zero.		
R	Real address.		
V	Virtual address.		
W24	Wrap to location 0 after location $2^{24} - 1$ and vice versa.		
W31	Wrap to location 0 after location $2^{31} - 1$ and vice versa.		
W64	Wrap to location 0 after location $2^{64} - 1$ and vice versa.		
X31	When the address exceeds $2^{31} - 1$, it is unpredictable whether the address wraps to location 0 after location $2^{31} - 1$ or whether an addressing exception is recognized.		
X64	When the address exceeds $2^{64} - 1$, it is unpredictable whether the address wraps to location 0 after location $2^{64} - 1$ or whether an addressing exception is recognized.		

Figure 3-3. Address Wraparound (Part 3 of 3).

Storage Key

A storage key is associated with each 4 K-byte block of main storage that is available in the configuration. The storage key has the following format:

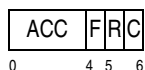

The bit positions in the storage key are allocated as follows:

Access-Control Bits (ACC): If a reference is subject to key-controlled protection, the four access-control bits, bits 0-3, are matched with the four-bit access key when information is stored and when information is fetched from a location that is protected against fetching.

Fetch-Protection Bit (F): If a reference is subject to key-controlled protection, the fetch-protection bit, bit 4, controls whether key-controlled protection applies to fetch-type references: a zero indicates that only store-type references are monitored and that fetching

with any access key is permitted; a one indicates that key-controlled protection applies to both fetching and storing. No distinction is made between the fetching of instructions and of operands.

Reference Bit (R): The reference bit, bit 5, normally is set to one each time a location in the corresponding storage block is referred to either for storing or for fetching of information.

Change Bit (C): The change bit, bit 6, is set to one each time information is stored at a location in the corresponding storage block.

Storage keys are not part of addressable storage. The entire storage key may be set by SET STORAGE KEY EXTENDED and inspected by INSERT STORAGE KEY EXTENDED. INSERT REFERENCE BITS MULTIPLE provides a means of inspecting the reference bits of 64 contiguous 4 K-byte blocks. RESET REFERENCE BIT EXTENDED provides a means of inspecting the reference and change bits and of setting the reference bit to zero. RESET REFERENCE BITS MULTIPLE provides a means of inspecting the reference bits of 64 contiguous 4 K-byte blocks and setting the reference bits to zero.

Bits 0-4 of the storage key are inspected by the INSERT VIRTUAL STORAGE KEY instruction. The contents of the storage key are unpredictable during and after the execution of the usability test of the TEST BLOCK instruction. When the conditional SSKE facility is installed, SET STORAGE KEY EXTENDED may be used to set all or portions of a storage key based on program-specified criteria. When the enhanced-DAT facility is installed, the SET STORAGE KEY EXTENDED, PERFORM FRAME MANAGEMENT FUNCTION, or MOVE PAGE instructions may be used to set all or portions of one or more storage keys based on program-specified criteria.

When EDAT-1 applies,¹ the invalid bit of the segment-table entry used in the translation is zero, and the STE-format-control is one, the following additional conditions are in effect:

- Bit position 47 of the segment-table entry contains the ACCF-validity control. The ACCF-validity control determines the validity of the access-control and fetch-protection bits in the STE. When the ACCF-validity control is zero, key-controlled protection uses the access-control and fetch-protection bits in the storage key for the 4 K-byte block corresponding to the address.
- When the ACCF-validity control is one, bit positions 48-52 of the segment-table entry contain the access-control bits and the fetch-protection bit for the segment. When determining accessibility to a storage operand, it is unpredictable whether bits 48-52 of the STE or bits 0-4 of the individual storage keys for the 4 K-byte blocks composing the segment are examined. See “Translation Process” on page 3-52 for further details.

When EDAT-2 applies¹, the invalid bit of the region-third-table entry (RTTE) used in the translation is zero, and the RTTE-format-control is one, the following conditions are in effect:

- Bit position 47 of the RTTE contains the ACCF-validity control. The ACCF-validity control determines the validity of the access-control and fetch-protection bits in the RTTE. When the ACCF-validity control is zero, key-controlled protection uses the access-control and fetch-protection bits in the storage key for the 4 K-byte block corresponding to the address.

1. See “Enhanced-DAT Terminology:” on page 3-41 for an explanation of EDAT applicability.

- When the ACCF-validity control is one, bit positions 48-52 of the RTTE contain the access-control bits and the fetch-protection bit for the region. When determining accessibility to a storage operand, it is unpredictable whether bits 48-52 of the RTTE or bits 0-4 of the individual storage keys for the 4 K-byte blocks composing the segment are examined. See “Translation Process” on page 3-52 for further details.

Programming Note: When EDAT-1 applies, and both the ACCF-validity control and the STE-format control (bits 47 and 53 of the segment-table entry, respectively) are one, bits 48-52 of the STE contain access-control and fetch-protection bits which may be used in lieu of the corresponding bits in the storage keys. In this case, the program is responsible for ensuring that the access-control and fetch-protection bits in the STE are identical to the corresponding bits in each of the 256 storage keys for the segment.

Similarly, when EDAT-2 applies, and both the ACCF-validity control and the RTTE-format control (bits 47 and 53 of the region-third-table entry, respectively) are one, bits 48-52 of the RTTE contain access-control and fetch-protection bits which may be used in lieu of the corresponding bits in the storage keys. In this case, the program is responsible for ensuring that the access-control and fetch-protection bits in the RTTE are identical to the corresponding bits in each of the 524,288 storage keys for the region.

See “Modification of Translation Tables” on page 3-67 for restrictions on (a) modifying the STE or the storage keys when the STE-format control is one or (b) modifying the RTTE or the storage keys when the RTTE-format control is one.

Protection

Five protection facilities are provided to protect the contents of main storage from destruction or misuse by programs that contain errors or are unauthorized:

- Key-controlled protection
- Access-list-controlled protection
- DAT protection
- Low-address protection
- Instruction-execution protection (when installed)

Key-Controlled Protection

When key-controlled protection applies to a storage access, a store is permitted only when the storage key matches the access key associated with the request for storage access; a fetch is permitted when the keys match or when the fetch-protection bit of the storage key is zero.

Key-controlled protection affords protection against improper storing or against both improper storing and fetching, but not against improper fetching alone.

The keys are said to match when the four access-control bits of the storage key are equal to the access key, or when the access key is zero.

The protection action is summarized in Figure 3-4.

Conditions		Is Access to Storage Permitted	
Fetch-Protection Bit of Storage Key	Key Relation	Fetch	Store
0	Match	Yes	Yes
0	Mismatch	Yes	No
1	Match	Yes	Yes
1	Mismatch	No	No

Explanation:

Match The four access-control bits of the storage key are equal to the access key, or the access key is zero.

Yes Access is permitted.

No Access is not permitted. On fetching, the information is not made available to the program; on storing, the contents of the storage location are not changed.

Figure 3-4. Summary of Protection Action

When the access to storage is initiated by the CPU and key-controlled protection applies, the PSW key is the access key, except that the access key is specified in a general register for the first operand of MOVE TO SECONDARY and MOVE WITH DESTINATION KEY, for the second operand of MOVE TO PRIMARY, MOVE WITH KEY, and MOVE WITH SOURCE KEY, and for either the first or the second operand of MOVE PAGE. The access key may be the PSW key or the key specified in an operand-access control for either operand of MOVE WITH OPTIONAL SPECIFICATIONS. The PSW key occupies bit positions 8-11 of the current PSW.

When the access to storage is for the purpose of channel-program execution, the subchannel key associated with that channel program is the access key. The subchannel key for a channel program is specified in the operation-request block (ORB). When, for purposes of channel-subsystem monitoring, an access to the measurement block is made, the measurement-block key is the access key. The measurement-block key is specified by the SET CHANNEL MONITOR instruction. Even when the enhanced-DAT facility 1 is installed, channel subsystem accesses continue to reference the storage keys for each 4 K-byte block; because channel subsystem accesses are not subject to dynamic address translation, the access-control bits and fetch-protection bit in the segment-table entry are not used by the channel subsystem.

When a CPU access is prohibited because of key-controlled protection, the execution of the instruction is terminated, and a program interruption for a protection exception takes place. However, the unit of operation or the execution of the instruction may be suppressed, as described in the section "Suppression on Protection" on page 3-15. When a channel-program access is prohibited, the start function is ended, and the protection-check condition is indicated in the associated interruption-response block (IRB). When a measurement-block access is prohibited, the I/O measurement-block protection-check condition is indicated.

When a store access is prohibited because of key-controlled protection, the contents of the protected location remain unchanged. When a fetch access is prohibited, the protected information is not loaded into a register, moved to another storage location, or provided to an I/O device. For a prohibited instruction fetch, the instruction is suppressed, and an arbitrary instruction-length code is indicated.

Key-controlled protection is independent of whether the CPU is in the problem or the supervisor state and, except as described below, does not depend on the type of CPU instruction or channel-command word being executed.

Except where otherwise specified, all accesses to storage locations that are explicitly designated by the program and that are used by the CPU to store or fetch information are subject to key-controlled protection.

Key-controlled protection does not apply when the storage-protection-override control is one and the value of the four access-control bits of the storage key is 9. Key-controlled protection for fetches may or may not apply when the fetch-protection-override control is one, depending on the effective address and the private-space control.

The storage-protection-override control and fetch-protection-override control do not affect storage references made by the channel subsystem.

Accesses to the second operand of TEST BLOCK are not subject to key-controlled protection.

All storage accesses by the channel subsystem to access the I/O measurement block, or by a channel program to fetch a CCW, IDAW, or MIDAW or to access a data area designated during the execution of a CCW, are subject to key-controlled protection. However, if a CCW, an IDAW, a MIDAW, or output data is prefetched, a protection check is not indicated until the CCW, IDAW, or MIDAW is due to take control or until the data is due to be written.

Key-controlled protection is not applied to accesses that are implicitly made for any of such sequences as:

- An interruption
- CPU logout
- Fetching of table entries for access-register translation, dynamic-address translation, PC-number translation, ASN translation, or ASN authorization
- Tracing
- A store-status function
- Storing in real locations 184-191 when TEST PENDING INTERRUPTION has an operand address of zero
- Initial program loading
- Storing in real locations 6,144-6,399 when transactional execution is aborted due to an unfiltered program-exception condition

Similarly, protection does not apply to accesses initiated via the operator facilities for altering or displaying information. However, when the program explicitly designates these locations, they are subject to protection.

Storage-Protection-Override Control

Bit 39 of control register 0 is the storage-protection-override control. When this bit is one, storage-protection override is active. When this bit is zero, storage-protection override is inactive. When storage-protection override is active, key-controlled storage protection is ignored for storage locations having an associated storage-key value of 9. When storage-protection override is inactive, no special action is taken for a storage-key value of 9.

Storage-protection override applies to instruction fetch and to the fetch and store accesses of instructions whose operand addresses are logical, virtual, or real. It does not apply to accesses made for the purpose of channel-program execution or for the purpose of channel-subsystem monitoring.

Storage-protection override has no effect on accesses which are not subject to key-controlled protection.

Programming Notes:

1. Storage-protection override can be used to improve reliability in the case when a possibly erroneous application program is executed in conjunction with a reliable subsystem, provided that the application program needs to access only a portion of the storage accessed by the subsystem. The technique for doing this is as follows. The storage accessed by the application program is given storage key 9. The storage accessed by only the subsystem is given some other nonzero storage key, for example, key 8. The application is executed with PSW key 9. The subsystem is executed with PSW key 8 (in this example). As a result, the subsystem can access both the key-8 and the key-9 storage, while the application program can access only the key-9 storage.
2. Storage-protection override affects the accesses to storage made by the CPU and also affects the result set by TEST PROTECTION. However, those instructions which, in the problem state, test the PSW-key mask to determine if a particular key value may be used are not affected by whether storage-protection override is active. These instructions include, among others, MOVE WITH KEY and SET PSW KEY FROM ADDRESS. To permit these instructions to use an access key of 9 in the problem state, bit 9 of the PSW-key mask must be one.

Fetch-Protection-Override Control

Bit 38 of control register 0 is the fetch-protection-override control. When the bit is one, key-controlled fetch protection is ignored for locations at effective addresses 0-2047. An effective address is the address which exists before any transformation by dynamic address translation or prefixing. However, key-controlled fetch protection is not ignored if the effective address is subject to dynamic address translation and the private-space control, bit 55, is one in the address-space-control element used in the translation.

Fetch-protection override applies to instruction fetch and to the fetch accesses of instructions whose operand addresses are logical, virtual, or real. It does not apply to fetch accesses made for the purpose of channel-program execution or for the purpose of channel-subsystem monitoring. When this bit is set to zero, fetch protection of locations at effective addresses 0-2047 is determined by the state of the fetch-protection bit of the storage key associated with those locations.

Fetch-protection override has no effect on accesses which are not subject to key-controlled protection.

Programming Note: The fetch-protection-override control allows fetch protection of locations at addresses 2048-4095 along with no fetch protection of locations at addresses 0-2047.

Access-List-Controlled Protection

In the access-register mode, bit 6 of the access-list entry, the fetch-only bit, controls which types of operand references are permitted to the address space specified by the access-list entry. When the entry is used in the access-register-translation part of a reference and bit 6 is zero, both fetch-type and store-type references are permitted; when bit 6 is one, only fetch-type references are permitted, and an attempt to store causes a protection exception to be recognized and the execution of the instruction to be suppressed.

The fetch-only bit is included in the ALB access-list entry. A change to the fetch-only bit in an access-list entry in main storage does not necessarily have an immediate, if any, effect on whether a protection exception is recognized. However, this change to the

bit will have an effect immediately after PURGE ALB or a COMPARE AND SWAP AND PURGE instruction that purges the ALB is executed.

TEST PROTECTION takes into consideration access-list-controlled protection when the CPU is in the access-register mode. A violation of access-list-controlled protection causes condition code 1 to be set, except that it does not prevent condition code 2 or 3 from being set when the conditions for those codes are satisfied.

Programming Note: A violation of access-list-controlled protection always causes suppression. A violation of any of the other protection types may cause termination.

DAT Protection

The DAT-protection function² controls access to virtual storage by using the DAT-protection bit in each page-table entry and segment-table entry, and, when the enhanced-DAT facility is installed, in each region-table entry. It provides protection against improper storing.

The DAT-protection bit, bit 54 of the page-table entry, controls whether storing is allowed into the corresponding 4 K-byte page. When the bit is zero, both fetching and storing are permitted; when the bit is one, only fetching is permitted. When an attempt is made to store into a protected page, the contents of the page remain unchanged, the unit of operation or the execution of the instruction is suppressed, and a program interruption for protection takes place.

The DAT-protection bit, bit 54 of the segment-table entry, controls whether storing is allowed into the corresponding 1 M-byte segment, as follows:

- When EDAT-1 does not apply, or when EDAT-1 applies and the STE-format control is zero, the DAT-protection bit of the segment-table entry is treated as being ORed into the DAT-protection-bit position of each entry in the page table designated by the segment-table entry. Thus, when the segment-table-entry DAT-protection bit is one, the effect is as if the DAT-protection bit were one in each entry in the designated page table.
- When EDAT-1 applies and the STE-format control is one, the DAT-protection bit of the segment-

2. Prior to the enhanced-DAT facility, the DAT-protection function was known as the page-protection facility.

table entry controls whether storing is allowed into the corresponding 1 M-byte segment. When the bit is zero, both fetching and storing are permitted; when the bit is one, only fetching is permitted. When an attempt is made to store into a protected segment, the contents of the segment remain unchanged, the unit of operation or the execution of the instruction is suppressed, and a program interruption for protection takes place

When EDAT-1 applies, the DAT-protection bit, bit 54 of the region-table entry, controls whether storing is allowed into the corresponding region(s). The DAT-protection bit in a region-table entry is treated as being ORed into the DAT-protection bit position of any subsequent region-table entry and segment-table entry that is used in the translation. When the STE-format control is zero, the DAT-protection bit is further propagated to the page-table entry, as described above.

DAT protection applies to all store-type references that use a virtual address.

Low-Address Protection

The low-address-protection facility provides protection against the destruction of main-storage information used by the CPU during interruption processing. In the z/Architecture architectural mode, this is accomplished by prohibiting instructions from storing with effective addresses in the ranges 0 through 511 and 4096 through 4607 (the first 512 bytes of each of the first and second 4 K-byte effective-address blocks). In the ESA/390-compatibility mode, low-address protection is limited to effective addresses in the range of 0-511 (the first 512 bytes of the first 4 K-byte effective-address block). The range criterion is applied before address transformation, if any, of the address by dynamic address translation or prefixing. However, the range criterion is not applied, with the result that low-address protection does not apply, if the effective address is subject to dynamic address translation and the private-space control, bit 55, is one in the address-space-control element used in the translation. Low-address protection does not apply if the address-space-control element to be used is not available due to another type of exception.

Low-address protection is under control of bit 35 of control register 0, the low-address-protection-control bit. When the bit is zero, low-address protection is off; when the bit is one, low-address protection is on.

If an access is prohibited because of low-address protection, the contents of the protected location remain unchanged, the execution of the instruction is terminated, and a program interruption for a protection exception takes place. However, the unit of operation or the execution of the instruction may be suppressed, as described in the section “Suppression on Protection” on page 3-15.

Any attempt by the program to store by using effective addresses in the range 0 through 511 is subject to low-address protection. In the z/Architecture architectural mode, any attempt to store by using effective addresses in the range of 4096 through 4607 is also subject to low-address protection. Low-address protection is applied to the store accesses of instructions whose operand addresses are logical, virtual, real, or absolute. Low-address protection is also applied to the trace table.

Low-address protection is not applied to accesses made by the CPU or the channel subsystem for such sequences as interruptions, CPU logout, the storing of the I/O-interruption code in real locations 184-195 by TEST PENDING INTERRUPTION, the storing of the results of STORE FACILITY LIST in real locations 200-203, and the initial-program-loading and store-status functions, nor is it applied to data stores during I/O data transfer. When the enhanced-monitor facility is installed, low-address protection is not applied when a monitor-event counting operation results in the updating the enhanced-monitor exception count in real locations 268-271. However, explicit stores by a program at any of these locations are subject to low-address protection.

Instruction-Execution Protection

The instruction-execution-protection (IEP) facility may be available on a model implementing z/Architecture. The IEP facility is installed in a configuration when facility indication 130, as stored by the STORE FACILITY LIST EXTENDED instruction, is one. When the IEP facility is installed, the access-exception-fetch/store-indication and side-effect-access facilities and the enhanced suppression-on-protection facility 2 are also installed. When installed, the IEP facility is enabled in a CPU when the instruction-execution-protection-enablement (IEPE) control, bit 43 of control register 0, is one.

When the facility is enabled, and an instruction is fetched from the primary or home address space, an

instruction-execution-protection control in the DAT leaf-table entry used in the translation determines whether instructions in the frame mapped by the entry may or may not be executed. Instruction-execution protection applies to both an instruction designated directly by the PSW instruction address and to an instruction that is the target of an execute-type instruction.

The facility may be used by a control program to better segregate instructions from data. Improved system reliability and integrity may be realized by preventing instructions from being executed in storage locations intended to contain only data. For example, erroneously or maliciously modified data in a program stack can be prevented from being executed.

When the instruction-execution-protection facility is enabled, the instruction-execution-protection control, bit 55 of a format-1 region-third-table entry, a format-1 segment-table entry, or a page-table entry, controls whether instructions in the respective region, segment, or page are allowed to be executed. When the bit is zero, the execution of instructions in the respective region, segment, or page is permitted; when the bit is one, the execution of instructions in the respective region, segment, or page is suppressed, and a protection exception is recognized with an arbitrary instruction-length code indicated.

When two DAT leaf-table entries are required to fetch an instruction, an instruction-execution-protection exception is recognized if bit 55 is one in either or both of the leaf-table entries used to translate the instruction's address.

When a protection exception is recognized due to instruction-execution protection, the protection code in bits 56, 60, and 61 of the translation-exception identification (TEID) at real locations 168-175 contain 101 binary, and it is unpredictable whether the bit positions 0-51 of the TEID contain the virtual address of the instruction or zeros.

Further details on the instruction-execution-protection facility may be found in the section "Dynamic Address Translation" on page 3-38.

Programming Notes:

1. Low-address protection and key-controlled protection apply to the same store accesses, except that:
 - a. Low-address protection does not apply to storing performed by the channel subsystem, whereas key-controlled protection does.
 - b. Key-controlled protection does not apply to tracing, the second operand of TEST BLOCK, or instructions that operate specifically on the linkage stack, whereas low-address protection does.
2. Because fetch-protection override and low-address protection do not apply to an address space for which the private-space control is one in the address-space-control element, locations 0-2047 and, in the z/Architecture architectural mode, locations 4096-4607 in the address space are usable the same as the other locations in the space.

Suppression on Protection

The suppression-on-protection facilities provide the means by which a control program can effectively determine whether a protection exception resulted in suppression, and if so, whether the exception was due to DAT protection – without having to unnecessarily scan DAT-table entries to determine if DAT protection was not the cause. Determining whether a protection exception was caused by DAT protection is necessary for the implementation of the POSIX fork function, discussed in programming notes below.

Depending on the model, one of three types of suppression-on-protection facility is installed:

- Basic suppression-on-protection (SOP) facility (without the side-effect access facility)
- Enhanced suppression-on-protection facility 1 (ESOP-1; without the side-effect access facility)
- Enhanced suppression on protection facility 2 (ESOP-2; with the side-effect access facility)

Whether or not a protection exception is suppressing depends on both the type of suppression-on-protec-

tion facility that is installed and the protection exception that is recognized, as shown below in Figure 3-5.

Protection Exception Recognized	Type of Suppression-on-Protection Facility Installed		
	SOP	ESOP-1	ESOP-2
Access-List-Controlled	✓	✓	✓
DAT	✓	✓	✓
Instruction-Execution	—	—	✓
Key-Controlled	?	?	☑
Low-Address	?	?	☑
Explanation:			
✓	Exception is suppressing.		
☑	Exception is suppressing when the protection code in bits 56, 60, and 61 of the translation-exception identification is nonzero.		
—	Not applicable		
?	Unpredictable whether the exception results in suppression or termination		
ESOP	Enhanced suppression on protection (facility -1 or -2)		
SOP	Basic suppression on protection		

Figure 3-5. Suppression Attributes for Protection Exceptions

Regardless of which suppression-on-protection facility is installed, the following applies:

- When multiple protection-exception conditions apply to the same reference, the exceptions are recognized in the order described in Figure 6-9, “Priority of Access Exceptions” on page 6-54. When (a) low-address protection applies to a reference, and (b) any of access-list-controlled protection, DAT protection, or key-controlled protection also apply to the same reference, it is unpredictable whether the former or latter is indicated.
- Information identifying the cause of the protection exception is stored in the translation-exception identification (TEID) at real locations 168-175. The extent of information stored in the TEID depends on both type of suppression-on-protection facility that is installed and the type of protection exception. The TEID stored during a protection exception is further described in the section “Translation-Exception Identification for Protection Exceptions” on page 3-77.

Depending on the type of suppression-on-protection facility installed and the type of protection exception, additional information may be stored in the exception-access identification (EAID) at real location 160. The EAID is further described in the section “Exception Access Identification (EAID): During a program interruption due to an ASCE-type, region-first-translation, region-second-translation, region-third-translation, segment-translation, or page-translation exception, an indication of the address space to which the exception applies may be stored at location 160, as follows:” on page 3-74.

The following describes the fundamental differences between the three types of suppression-on-protection facilities.

Basic Suppression-on-Protection Facility

When TEID bit 61 is zero, the operation is either suppressed or terminated, and the remainder of the TEID and the EAID are unpredictable. TEID bit 61 is zero if DAT was on, but the effective address causing the exception was either real or absolute.

When TEID bit 61 is one, the following applies:

- The operation is suppressed.
- TEID bit positions 0-51 contain the effective address that caused the protection exception.
- TEID bits 52-59 are unpredictable.
- If DAT was on, the following applies:
 - The effective address that caused the protection exception is a virtual address.
 - When TEID bit 60 is zero, access-list-controlled protection is not the cause of the exception. When TEID bit 60 is one, access-list-controlled protection is the cause of the exception.
 - TEID bit positions 62 and 63 and the EAID contain additional information identifying the address space.

If DAT was off, TEID bits 60 and 62-63 and the EAID are unpredictable.

The results of basic suppression on protection are summarized in Figure 3-6.

Exception Conditions				Presented Fields		
LAP or KCP	DAT	ALCP or DATP	Effective Address	Bit 61	If Bit 61 is One	
					Bits 62, 63 and Loc. 160	Bit 60
No	On	Yes	Log.	1	P	1A
Yes	On	Yes	Log.	U1	P	1A
Yes	Off	No	Log.	U2	U3	U3
Yes	Off	No	R/A	U2	U3	U3
Yes	On	No	Log.	U2	P	0
Yes	On	No	R/A	0R	–	–

Explanation:

- Immaterial or not applicable.
- 0R Zero because effective address is real.
- 1A One if bit 61 is set to one because of access-list-controlled protection; zero otherwise.
- ALCP Access-list-controlled protection.
- DATP DAT protection.
- KCP Key-controlled protection.
- LAP Low-address protection.
- Log. Logical.
- P Predictable.
- R/A Real or absolute
- U1 Unpredictable because low-address or key-controlled protection may be recognized instead of access-list-controlled or DAT protection.
- U2 Unpredictable because bit 61 is only required to be set to one for access-list-controlled or DAT protection.
- U3 Unpredictable because DAT is off.

Figure 3-6. Basic Suppression-on-Protection Results

Programming Note: When the basic suppression-on-protection facility is installed, the information provided in the TEID can be used to determine that DAT protection *was not* the cause of the exception, but it cannot be used directly to determine that DAT protection *was* the cause.

Enhanced Suppression-on-Protection Facility 1

The enhanced suppression-on-protection facility 1 (ESOP-1) provides additional function over that of the basic suppression-on-protection facility. When

ESOP-1 is installed, the side-effect-access facility is not installed. Characteristics of ESOP-1 are described in this section.

The operation is always suppressed, regardless of the contents of TEID bit 61.

When TEID bit 61 is zero, the exception is due to either key-controlled protection or low-address protection, and the remainder of the TEID and the EAID are unpredictable.

When TEID bit 61 is one, the following applies:

- The exception is due to either access-list-controlled protection or DAT protection, as determined by TEID bit 60. When TEID bit 60 is zero, DAT protection is the cause of the exception. When TEID bit 60 is one, access-list-controlled protection is the cause of the exception.
- TEID bit positions 0-51 contain the virtual address that caused the protection exception.
- When the access-exception-fetch/store-indication facility is installed, TEID bit positions 52-53 contain the access-exception fetch/store indication.
- TEID bit positions 54-59 are unpredictable.
- TEID bit positions 62 and 63 and the EAID contain additional information identifying the address space.

Figure 3-7 summarizes the results of a protection exception when the enhanced suppression-on-protection facility 1 is installed.

Exception Type	DAT	Bits 0-51	Bits 52-53	Bit 60	Bit 61	Bits 62, 63 and Loc. 160
LAP	–	–	–	–	0	–
KCP	–	–	–	–	0	–
ALCP	Yes	A	FS	1	1	AS
DATP	Yes	A	FS	0	1	AS

Explanation:

- Undefined.
- A Bits 0-51 of the effective address that caused the exception (This must be a virtual address).
- ALCP Access-list-controlled protection.

Figure 3-7. Enhanced Suppression-on-Protection Facility 1 Results

AS	Identifies the address space containing the effective address that caused the exception.
DAT	Dynamic address translation is performed.
DATP	DAT protection.
FS	Access-exception fetch/store indicator if the facility is installed, otherwise unpredictable.
KCP	Key-controlled protection.
LAP	Low-address protection.

Figure 3-7. Enhanced Suppression-on-Protection Facility 1 Results (Continued)

Enhanced Suppression-on-Protection Facility 2

The enhanced suppression-on-protection facility 2 (ESOP-2) provides additional function over that of ESOP-1. When ESOP-2 is installed, the side-effect-access facility is also installed. Characteristics of ESOP-2 are described in this section.

The contents of TEID bit positions 56, 60, and 61 form a three-bit binary code that identifies the cause of the protection exception. When the protection code is zero, the remainder of the TEID and the EAID are unpredictable. When the protection code is non-zero, the following applies:

- The three-bit code identifies the cause of the protection exception, as follows:

Code Meaning

000	Key-controlled or low-address protection
001	DAT protection
010	Key-controlled protection
011	Access-list-controlled protection
100	Low-address protection
101	Instruction-execution-protection (when the instruction-execution-protection facility is installed).

- When the protection code is not 000 binary, the operation is always suppressed (regardless of the contents of TEID bit 61).
- Except as noted below, TEID bits position 0-51 contain the effective address that caused the protection exception. For access-list-controlled-protection, DAT-protection, and instruction-execution-protection exceptions, the effective address is virtual. The effective address may be

virtual for key-controlled-protection and low-address-protection exceptions when DAT is on; otherwise, it is real or absolute.

For key-controlled-protection or instruction-execution-protection exceptions recognized when fetching an instruction, it is unpredictable whether bit positions 0-51 of the TEID contain the address of the instruction or zeros.

- TEID bit positions 52-53 contain the access-exception fetch/store indication.
- TEID bit position 54 contains the side-effect-access indication.
- Bit 55 is unpredictable.
- TEID bits 57-59 are unpredictable.
- TEID bit positions 62 and 63 and the EAID contain additional information identifying the address space.

Figure 3-8 summarizes the TEID for a protection exception when the enhanced suppression-on-protection facility 2 is installed.

Exception Type	DAT	Addr Type	TEID Bit Positions (168-175)						62, 63, and Loc. 160
			0-51	52-53	54	Protection Code			
						56	60	61	
KCP or LAP ¹	–	–	–	–	–	0	0	0	–
DATP	Yes	V	@	FS	S	0	0	1	AS
KCP	No	R/A	@ ²	FS	S	0	1	0	– ³
	Yes	V	@ ²	FS	S	0	1	0	AS
ALCP	Yes	V	@	FS	S	0	1	1	AS
LAP	No	R/A	@	FS	S	1	0	0	– ³
	Yes	V	@	FS	S	1	0	0	AS
IEP	Yes	V	@ ²	FS	0	1	0	1	AS

Explanation:

- ¹ Presented if TEID details are not available.
- ² For an instruction fetch, zeros may be stored instead of the translation-exception address.
- ³ Address type cannot be determined from TEID.
- @ Bits 0-51 of the address that caused the exception.
- A Absolute address.
- ALCP Access-list-controlled protection.
- AS Identifies the address space containing the effective address that caused the exception.

Figure 3-8. Enhanced Suppression-on-Protection Facility 2 Results

DAT	Dynamic address translation is performed.
DATP	DAT protection.
E	Effective address.
FS	Access-exception fetch/store indicator.
IEP	Instruction-execution protection.
KCP	Key-controlled protection.
LAP	Low-address protection.
R	Real address.
S	Side-effect-access indicator.
V	Virtual address.
–	Undefined, unpredictable.
Protection codes 110-111 binary are reserved.	

Figure 3-8. Enhanced Suppression-on-Protection Facility 2 Results (Continued)

Facility indication 131, when one, indicates that the enhanced-suppression-on-protection facility 2 and the side-effect-access facility are both installed.

Programming Notes: Except as noted, the following program notes are applicable regardless of which suppression-on-protection facility is installed.

1. The suppression-on-protection function is useful in performing the POSIX fork function, which causes a duplicate address space to be created. The following discussion pertains to (a) when EDAT-1 does not apply, (b) when EDAT-1 applies but the STE-format-control in the segment-table entry is zero, or (c) when EDAT-2 applies but the RTTE-format control in the region-third-table entry is zero.

The duplicate address space is initially created by making a copy of the DAT tables mapping the original address space, but marking each page-table entry in the duplicate address space as DAT protected. Fetch accesses in the duplicate address space use the same common page frame as that of the original address space. However, when a store is attempted in the duplicate address space, the control program recognizes the DAT-protection exception, assigns a unique page frame for this page in the duplicate address space, and copies the contents of the original block into the duplicate address space's block (a process known as the copy-on-write function). The control program may initially set the DAT-protection bit to one in a higher-level DAT-table entry to detect an attempt to store anywhere in the blocks mapped by lower-level DAT-table entries.

When EDAT-1 applies, and the STE-format control in the segment-table entry is one, a similar technique may be used to map a single segment frame of absolute storage. Similarly, when EDAT-2 applies, and the RTTE-format control in the region-third-table entry is one, this technique may be used to map a single region frame of absolute storage.

2. For the basic suppression-on-protection facility, when DAT is on, TEID bit 61 being one indicates that the address that caused a protection exception is virtual, and TEID bit 60 being zero indicates that the exception was not caused by access-list-controlled protection. These indications allow programmed forms of access-register translation and dynamic address translation to be performed to locate the DAT-table entries used in the translation, and determine whether the exception was due to DAT protection (as opposed to low-address or key-controlled protection).

For the enhanced-suppression-on-protection facility 1, TEID bits 60 and 61 being 01 binary indicate that DAT protection was the cause of the exception. For the enhanced-suppression-on-protection facility 2, TEID bits 56, 60, and 61 being 001 binary indicate that DAT protection was the cause of the exception.

However, regardless of which suppression-on-protection-exception facility applies, the control program must still locate the appropriate DAT-table entries to effect a copy-on-write function.

Reference Recording

Reference recording provides information for use in selecting pages for replacement. Reference recording uses the reference bit, bit 5 of the storage key. The reference bit is set to one each time a location in the corresponding storage block is referred to either for fetching or for storing information, regardless of whether DAT is on or off.

Reference recording is always active and takes place for all storage accesses, including those made by any CPU, any operator facility, or the channel subsystem. It takes place for implicit accesses made by the

machine, such as those which are part of interruptions and I/O-instruction execution.

Reference recording does not occur for operand accesses of the following instructions since they directly refer to a storage key without accessing a storage location:

- INSERT REFERENCE BITS MULTIPLE
- INSERT STORAGE KEY EXTENDED
- RESET REFERENCE BIT EXTENDED (reference bit is set to zero)
- RESET REFERENCE BITS MULTIPLE (reference bits of 64 consecutive 4 K-byte blocks are set to zero)
- PERFORM FRAME MANAGEMENT FUNCTION, SET STORAGE KEY EXTENDED and MOVE PAGE (reference bit may be set to a specified value)

The record provided by the reference bit is substantially accurate. The reference bit may be set to one by fetching data or instructions that are neither designated nor used by the program, and, under certain conditions, a reference may be made without the reference bit being set to one. Under certain unusual circumstances, a reference bit may be set to zero by other than explicit program action.

When the CPU is in the transactional-execution mode, it is unpredictable whether the reference bit is set coincident with the transaction's storage accesses or at the end of the transaction. Reference bits that are set during the execution of a transaction may remain set if the transaction is aborted.

Change Recording

Change recording provides information as to which pages have to be saved in auxiliary storage when they are replaced in main storage. Change recording uses the change bit, bit 6 of the storage key.

The change bit is set to one each time a store access causes the contents of the corresponding storage block to be changed. A store access that does not change the contents of storage may or may not set the change bit to one.

The change bit is not set to one for an attempt to store if the access is prohibited. In particular:

1. For the CPU, a store access is prohibited whenever an access exception exists for that access, or whenever an exception exists which is of higher priority than the priority of an access exception for that access.
2. For the channel subsystem, a store access is prohibited whenever a key-controlled-protection violation exists for that access.

Change recording is always active and takes place for all store accesses to storage, including those made by any CPU, any operator facility, or the channel subsystem. It takes place for implicit references made by the machine, such as those which are part of interruptions.

Change recording does not take place for the operands of the following instructions since they directly modify a storage key without modifying a storage location:

- RESET REFERENCE BIT EXTENDED
- RESET REFERENCE BITS MULTIPLE
- SET STORAGE KEY EXTENDED, PERFORM FRAME MANAGEMENT FUNCTION, and MOVE PAGE (change bit may be set to a specified value)

Change bits which have been changed from zeros to ones are not necessarily restored to zeros on CPU retry (see "CPU Retry" on page 11-2). See "Exceptions to Nullification and Suppression" on page 5-26 for a description of the handling of the change bit in certain unusual situations. It is possible that the change bit may be over-indicated for any storage which is referenced before execution of the first instruction that sets or extracts a storage key, sets the PSW key to a non-zero value or uses a non-zero alternate key for storage access.

When the condition specified by the M_3 field of a STORE ON CONDITION instruction is not met, it is model dependent whether the change bit is set for the storage location designated by the second operand.

When the CPU is in the transactional-execution mode, it is unpredictable whether the change bit is set coincident with the transaction's store accesses or at the end of the transaction. Change bits that are set during the execution of a transaction may remain set if the transaction is aborted.

Prefixing

Prefixing provides the ability to assign the block of real addresses containing assigned storage locations to a different block in absolute storage for each CPU, thus permitting more than one CPU sharing main storage to operate concurrently with a minimum of interference, especially in the processing of interruptions.

In the z/Architecture architectural mode, prefixing causes real addresses in the range 0-8191 to correspond one-for-one to the block of 8 K-byte absolute addresses (the prefix area) identified by the value in bit positions 0-50 of the prefix register for the CPU, and the block of real addresses identified by that value in the prefix register to correspond one-for-one to absolute addresses 0-8191.

In the ESA/390-compatibility mode, prefixing causes real addresses in the range 0-4,095 to correspond one-for-one to the block of 4 K-byte absolute addresses (the prefix area) identified by the value in bit positions 0-51 of the prefix register for the CPU, and the block of real addresses identified by that value in the prefix register to correspond one-for-one to absolute addresses 0-4,095.

The remaining real addresses are the same as the corresponding absolute addresses. This transformation allows each CPU to access all of main storage, including the first 8K bytes and the locations designated by the prefix registers of other CPUs.

The relationship between real and absolute addresses is graphically depicted in Figure 3-9 on page 3-21.

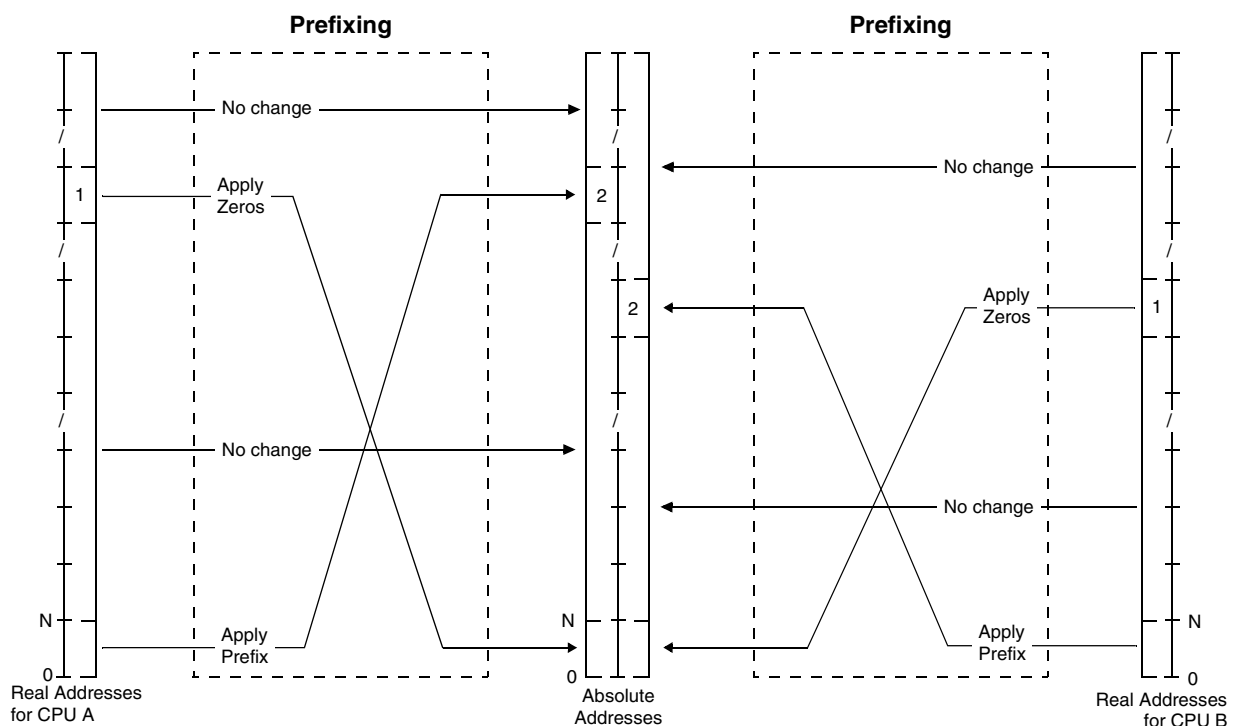

Explanation:

- N In the z/Architecture architectural mode, N is 8,192. In the ESA/390-compatibility mode, N is 4,096.
- 1 In the z/Architecture architectural mode, real addresses in which bits 0-50 are equal to bits 0-50 of the prefix for this CPU (A or B). In the ESA/390-compatibility mode, real addresses in which bits 0-51 are equal to bits 0-51 of the prefix for this CPU (A or B).
- 2 Absolute addresses of the block that contains for this CPU (A or B) the real locations 0 through (N-1)

Figure 3-9. Relationship between Real and Absolute Addresses

Prefixing in the z/Architecture Architectural Mode

In the z/Architecture architectural mode, the prefix is a 51-bit quantity contained in bit positions 0-50 of the prefix register. Figure 3-10 illustrates the prefix register in the z/Architecture architectural mode.

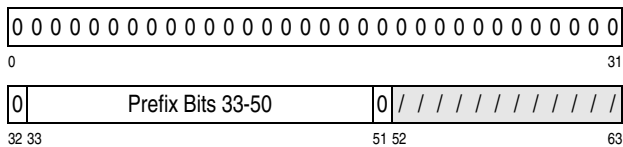

Figure 3-10. z/Architecture Prefix Register

Bits 33-50 of the register can be set and inspected by the privileged instructions SET PREFIX and STORE PREFIX, respectively.

SET PREFIX sets bits 33-50 of the prefix register with the value in bit positions 1-18 of a word in storage, and it ignores the contents of bit positions 0 and 19-31 of the word. STORE PREFIX stores the value in bit positions 33-50 of the prefix register in bit positions 1-18 of a word in storage, and it stores zeros in bit positions 0 and 19-31 of the word.

When prefixing is applied, the real address is transformed into an absolute address by using one of the following rules, depending on bits 0-50 of the real address:

1. Bits 0-50 of the address, if all zeros, are replaced with bits 0-50 of the prefix.
2. Bits 0-50 of the address, if equal to bits 0-50 of the prefix, are replaced with zeros.
3. Bits 0-50 of the address, if not all zeros and not equal to bits 0-50 of the prefix, remain unchanged.

Bit 51 of the prefix register is always set to zero and does not participate in the prefixing process.

Prefixing in the ESA/390-Compatibility Mode

In the ESA/390-compatibility mode, the prefix is a 52-bit quantity contained in bit positions 0-51 of the

prefix register. Figure 3-11 illustrates the prefix register in the ESA/390-compatibility mode.

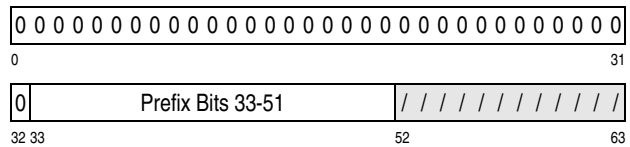

Figure 3-11. ESA/390-Compatibility Mode Prefix Register

Bits 33-51 of the register can be set and inspected by the privileged instructions SET PREFIX and STORE PREFIX, respectively.

SET PREFIX sets bits 33-51 of the prefix register with the value in bit positions 1-19 of a word in storage, and it ignores the contents of bit positions 0 and 20-31 of the word. STORE PREFIX stores the value in bit positions 33-51 of the prefix register in bit positions 1-19 of a word in storage, and it stores zeros in bit positions 0 and 20-31 of the word.

When prefixing is applied, the real address is transformed into an absolute address by using one of the following rules, depending on bits 0-51 of the real address:

1. Bits 0-51 of the address, if all zeros, are replaced with bits 0-51 of the prefix.
2. Bits 0-51 of the address, if equal to bits 0-51 of the prefix, are replaced with zeros.
3. Bits 0-51 of the address, if not all zeros and not equal to bits 0-51 of the prefix, remain unchanged.

Common Prefixing Attributes

Bits 0-32 of the prefix register are always all zeros. When the contents of the prefix register are changed, the change is effective for the next sequential instruction.

Only the address presented to storage is translated by prefixing. The contents of the source of the address remain unchanged.

The distinction between real and absolute addresses is made even when the prefix register contains all zeros, in which case a real address and its corresponding absolute address are identical.

Address Spaces

Note: In the ESA/390-compatibility mode, ASN translation and dynamic address translation are not supported, however absolute-storage address spaces may be supported, as described in Reference [12.] on page xxx.

An address space is a consecutive sequence of integer numbers (virtual addresses), together with the specific transformation parameters which allow each number to be associated with a byte location in storage. The sequence starts at zero and proceeds left to right.

When a virtual address is used by a CPU to access main storage, it is first converted, by means of dynamic address translation (DAT), to a real address, and then, by means of prefixing, to an absolute address. DAT may use from five to two levels of tables (region first table, region second table, region third table, segment table, and page table) as transformation parameters. The designation (origin and length) of the highest-level table for a specific address space is called an address-space-control element, and it is found for use by DAT in a control register or as specified by an access register. Alternatively, the address-space-control element for an address space may be a real-space designation, which indicates that DAT is to translate the virtual address simply by treating it as a real address and without using any tables.

DAT uses, at different times, the address-space-control elements in different control registers or specified by the access registers. The choice is determined by the translation mode specified in the current PSW. Four translation modes are available: primary-space mode, secondary-space mode, access-register mode, and home-space mode. Different address spaces are addressable depending on the translation mode.

At any instant when the CPU is in the primary-space mode or secondary-space mode, the CPU can translate virtual addresses belonging to two address spaces — the primary address space and the secondary address space. At any instant when the CPU is in the access-register mode, it can translate virtual addresses of up to 16 address spaces — the primary address space and up to 15 AR-specified address spaces. At any instant when the CPU is in the home-

space mode, it can translate virtual addresses of the home address space.

The primary address space is identified as such because it consists of primary virtual addresses, which are translated by means of the primary address-space-control element (ASCE). Similarly, the secondary address space consists of secondary virtual addresses translated by means of the secondary ASCE, the AR-specified address spaces consist of AR-specified virtual addresses translated by means of AR-specified ASCEs, and the home address space consists of home virtual addresses translated by means of the home ASCE. The primary and secondary ASCEs are in control registers 1 and 7, respectively. The AR-specified ASCEs are in control registers 1 and 7 and in table entries called ASN-second-table entries. The home ASCE is in control register 13.

Changing to Different Address Spaces

A program can cause different address spaces to be addressable by using the semiprivileged SET ADDRESS SPACE CONTROL or SET ADDRESS SPACE CONTROL FAST instruction to change the translation mode to the primary-space mode, secondary-space mode, access-register mode, or home-space mode. However, SET ADDRESS SPACE CONTROL and SET ADDRESS SPACE CONTROL FAST can set the home-space mode only in the supervisor state. The program can cause still other address spaces to be addressable by using unprivileged instructions to change the contents of the access registers and by using semiprivileged or privileged instructions to change the address-space-control elements in control registers 1 and 7. The semiprivileged instructions are ones that cause linkage from one address space to another and are the BRANCH IN SUBSPACE GROUP, PROGRAM CALL, PROGRAM RETURN, PROGRAM TRANSFER, PROGRAM TRANSFER WITH INSTANCE, SET SECONDARY ASN, and SET SECONDARY ASN WITH INSTANCE instructions. The privileged instructions are the LOAD ADDRESS SPACE PARAMETERS and LOAD CONTROL instructions. Only LOAD CONTROL is available for changing the home address-space-control element in control register 13.

Address-Space Number

An address space may be assigned an address-space number (ASN) by the control program. The ASN designates, within a two-level table structure in

main storage, an ASN-second-table entry containing information about the address space. If the ASN-second-table entry is marked as valid, it contains the address-space-control element that defines the address space.

Under certain circumstances, the semiprivileged instructions which place a new address-space-control element in control register 1 or 7 fetch this element from an ASN-second-table entry. Some of these instructions use an ASN-translation mechanism which, given an ASN, can locate the designated ASN-second-table entry.

The 16-bit unsigned binary format of the ASN permits 64K unique ASNs.

The ASNs for the primary and secondary address spaces are assigned positions in control registers. The ASN for the primary address space, called the primary ASN, is assigned bits 48-63 in control register 4, and that for the secondary address space, called the secondary ASN, is assigned bits 48-63 in control register 3. Bits 48-63 of these registers have the following formats:

Control Register 4

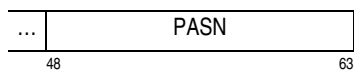

Control Register 3

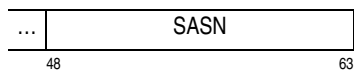

A semiprivileged instruction that loads the primary or secondary address-space-control element into the appropriate control register also loads the corresponding ASN into the appropriate control register.

The ASN for the home address space is not assigned a position in a control register.

An access register containing the value 0 or 1 specifies the primary or secondary address space, respectively; and the address-space-control element specified by the access register is in control register 1 or 7, respectively. An access register containing any other value designates an entry in a table called an access list. The designated access-list entry contains the real address of an ASN-second-table entry for the address space specified by the access register. The address-space-control element specified by the access register is in the ASN-second-table entry.

Translating the contents of an access register to obtain an address-space-control element for use by DAT does not involve the use of an ASN.

Note: Virtual storage consisting of byte locations ordered according to their virtual addresses in an address space is usually referred to as “storage.”

Programming Note: Because an ASN-second-table entry is located from an access-list entry by means of its address instead of by means of its ASN, the ASN-second-table entries designated by access-list entries can be “pseudo” ASN-second-table entries, that is, entries which are not in the two-level structure able to be indexed by means of the ASN-translation process. The number of unique pseudo ASN-second-table entries can be greater than the number of unique ASNs and is limited only by the amount of storage available to be occupied by the ASN-second-table entries. Thus, in a sense, there is no limit on the number of possible address spaces.

ASN-Second-Table-Entry Sequence Number

The ASN-second-table entry contains an ASN-second-table-entry sequence number (ASTESN) that may be used to control storage references to the related address space by means of an access register or through use of the SET SECONDARY ASN, SET SECONDARY ASN WITH INSTANCE, or LOAD ADDRESS SPACE PARAMETERS instruction and that may be used to control linkages to or back to the address space by means of the BRANCH IN SUBSPACE GROUP, PROGRAM CALL, PROGRAM TRANSFER, PROGRAM TRANSFER WITH INSTANCE, and PROGRAM RETURN instructions. These uses of the ASTESN are described below.

When any instruction uses an access register to designate an access-list entry, which in turn designates an ASN-second-table entry, to perform a storage reference to the address space specified by the ASN-second-table entry, an ASTESN in the access-list entry is compared to the ASTESN in the ASN-second-table entry, and these ASTESNs must be equal; otherwise, an ASTE-sequence exception is recognized. This use of the ASTESN allows an access-list entry to be made unusable if some authorization policy is changed or the designated ASN-second-table entry is reassigned to specify a conceptually different address space. The entry can be made unusable by

changing the ASTESN in the ASN-second-table entry. The use is further described in “Revoking Accessing Capability:” on page 5-51.

The ASTESN is used in connection with subspace groups as follows:

- When BRANCH IN SUBSPACE GROUP uses an access register to designate an access-list entry, which in turn designates an ASN-second-table entry, to transfer control to the subspace specified by the ASN-second-table entry, an ASTESN in the access-list entry is compared to the ASTESN in the ASN-second-table entry, and these ASTESNs must be equal.
- When BRANCH IN SUBSPACE GROUP uses, in an access register, an access-list-entry token with the value 00000001 hex to transfer control to the subspace specified by the subspace-ASN-second-table-entry origin in the current dispatchable-unit control table (designated by control register 2), a subspace-ASN-second-table-entry sequence number (SSASTESN) in the dispatchable-unit control table is compared to the ASTESN in the ASN-second-table entry for the subspace, and the SSASTESN and ASTESN must be equal.
- When LOAD ADDRESS SPACE PARAMETERS, PROGRAM CALL, PROGRAM RETURN, PROGRAM TRANSFER, PROGRAM TRANSFER WITH INSTANCE, SET SECONDARY ASN, or SET SECONDARY ASN WITH INSTANCE sets the primary address-space-control element in control register 1 or the secondary address-space-control element in control register 7 with bits of the address-space-control element in the ASN-second-table entry for a subspace, the SSASTESN is compared to the ASTESN in the ASN-second-table entry for the subspace, and the SSASTESN and ASTESN must be equal.

Otherwise, in all of the above three cases, an ASTE-sequence exception is recognized, except that LOAD ADDRESS SPACE PARAMETERS sets condition code 1 or 2 depending on whether the subspace is the primary address space or the secondary address space, respectively. These uses of the ASTESN allow an access-list entry and the subspace-ASN-second-table-entry origin in the current dispatchable-unit control table to be made unusable when the ASN-second-table entry either of them designates is reassigned to specify a conceptually different

address space. The access-list entry and subspace-ASN-second-table-entry origin can be made unusable by changing the ASTESN in the ASN-second-table entry. The uses are further described in “Subspace Groups” on page 5-66.

Programming Note: The above operations use an ASN-second-table-entry origin in either an access-list entry or the dispatchable-unit control table; they do not use an ASN. The designated ASN-second-table entry is normally a pseudo ASN-second-table entry (one not in the structure able to be indexed by means of an ASN).

ASN-Second-Table-Entry Instance Number and ASN Reuse

The ASN-and-LX-reuse facility may be installed on the model. If this facility is installed, the ASN-second-table entry contains an ASN-second-table-entry instance number (ASTEIN), and certain new definitions related to the ASTEIN and to a new linkage-second-table-entry sequence number (LSTESN) apply. The definitions related to the ASTEIN are summarized below and also given in the appropriate sections of this publication.

- The ASN-and-LX-reuse facility includes the following new instructions:
 - EXTRACT PRIMARY ASN AND INSTANCE
 - EXTRACT SECONDARY ASN AND INSTANCE
 - PROGRAM TRANSFER WITH INSTANCE
 - SET SECONDARY ASN WITH INSTANCE
- The facility also includes the following new control bits:
 - The ASN-and-LX-reuse control (R), bit 44 of control register 0
 - The controlled-ASN bit (CA), bit 30 of word 1 of the ASN-second-table entry
 - The reusable-ASN bit (RA), bit 31 of word 1 of the ASN-second-table entry

The three control bits are shown as follows:

Control Register 0



Word 1 of ASN-Second-Table Entry

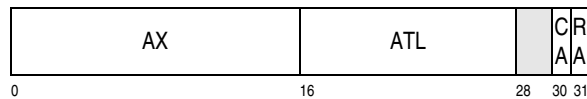

- The facility also includes the primary ASTEIN in bit positions 0-31 of control register 4 and the secondary ASTEIN in bit positions 0-31 of control register 3. The primary ASTEIN is a copy of the ASTEIN in the ASN-second-table entry for the current primary address space specified by the PASN in control register 4, and the secondary ASTEIN is a copy of the ASTEIN in the ASN-second-table entry for the current secondary address space specified by the SASN in control register 3. The complete formats of control registers 3 and 4 are as follows:

Control Register 3

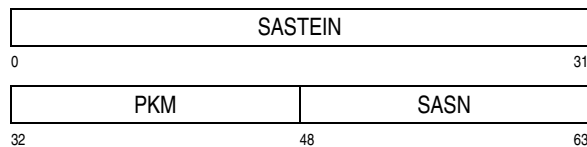

Control Register 4

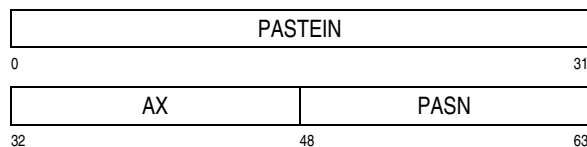

- The following operations are performed if the ASN-and-LX-reuse control, bit 44 of control register 0, is one. When LOAD ADDRESS SPACE PARAMETERS, PROGRAM CALL, PROGRAM RETURN, PROGRAM TRANSFER, or SET SECONDARY ASN (1) sets the primary ASN in control register 4 or the secondary ASN in control register 3 equal to a specified ASN and (2) sets the primary address-space-control element in control register 1 or the secondary address-space-control element in control register 7, respectively, with the value of an address-space-control element obtained from an ASN-second-table entry located by means of ASN translation of the specified ASN (or located, by PROGRAM CALL only, by means of an ASTE address), the instruction also sets the primary ASTEIN in control register 4 or secondary ASTEIN in control register 3, respectively, with the value of the ASTEIN in the ASN-second-table entry. However, PROGRAM TRANSFER and

SET SECONDARY ASN, which are performing their space-switching operations, recognize a special-operation exception if the reusable-ASN bit, bit 31 of word 1, in the ASN-second-table entry is one.

When the ASN-and-LX-reuse control is one and any of the instructions named above or BRANCH IN SUBSPACE GROUP sets the secondary ASN and secondary address-space-control element equal to the primary ASN (in the space-switching stacking PROGRAM CALL operation, this may be the old or the new primary ASN, as determined by a bit in the entry-table entry used) and primary address-space-control element, respectively, it also sets the secondary ASTEIN in control register 3 equal to the primary ASTEIN in control register 4 (again, in the space-switching stacking PROGRAM CALL case, this may be the old or the new primary ASTEIN). Since this function does not include the accessing of an ASN-second-table entry, it is not affected by a reusable-ASN bit.

PROGRAM TRANSFER WITH INSTANCE and SET SECONDARY ASN WITH INSTANCE operate as described above except (1) independent of the value of the ASN-and-LX-reuse control (they always update the primary ASTEIN and secondary ASTEIN as described above), (2) without recognizing an exception due to the reusable-ASN bit (they ignore the bit), and (3) in their space-switching forms and the problem state at the beginning of the operation, by recognizing a special-operation exception if the controlled-ASN bit, bit 30 of word 1, is one in the ASN-second-table entry located by ASN translation. PROGRAM TRANSFER WITH INSTANCE and SET SECONDARY ASN WITH INSTANCE ignore the controlled-ASN bit if the CPU is in the supervisor state at the beginning of the operation. (PROGRAM TRANSFER WITH INSTANCE may switch the CPU from the supervisor state to the problem state.)

- PROGRAM TRANSFER WITH INSTANCE and SET SECONDARY ASN WITH INSTANCE operate the same as PROGRAM TRANSFER and SET SECONDARY ASN, respectively, except as described in the preceding item and except as follows.

Independent of the ASN-and-LX-reuse control and the reusable-ASN bit, but not of the controlled-ASN bit, each of PROGRAM TRANSFER

WITH INSTANCE with space switching and SET SECONDARY ASN WITH INSTANCE with space switching, after it has used the ASN in the R_1 general register to locate an ASN-second-table entry, compares an ASTEIN in bit positions 0-31 of general register R_1 to the ASTEIN in the entry. The two ASTEINs must be equal; otherwise, an ASTE-instance exception is recognized. This comparison is performed in both the problem and the supervisor state.

- The following operations are performed if the ASN-and-LX-reuse control is one. Each of stacking PROGRAM CALL and BRANCH AND STACK places the current primary ASTEIN in bytes 180-183 of the linkage-stack state entry that it forms, and it places the current secondary ASTEIN, bits 0-31 of control register 3, in bytes 176-179 of the state entry.

Note: There is not a test of an ASTEIN related to the ASN in the entry-table entry used by PROGRAM CALL. There may be a test of a linkage-second-table-entry sequence number related to the linkage index used to locate the entry-table entry, as summarized in “ASN-and-LX-Reuse Control:” on page 5-30.

- The following operations are performed if the ASN-and-LX-reuse control is one. PROGRAM RETURN with space switching, after it has used the PASN in bytes 134 and 135 of the linkage-stack program-call state entry to locate an ASN-second-table entry (because that PASN is not equal to the current PASN in control register 4), compares the primary ASTEIN in bytes 180-183 of the state entry to the ASTEIN in the ASN-second-table entry. PROGRAM RETURN to current primary or with space switching, if it uses the SASN in bytes 130 and 131 of the state entry to locate an ASN-second-table entry (because that SASN is not equal to the new PASN), compares the secondary ASTEIN in bytes 176-179 of the state entry to the ASTEIN in the ASN-second-table entry. The one or two comparisons of ASTEINs must each give equal results; otherwise, an ASTE-instance exception is recognized. These operations occur independent of the controlled-ASN and reusable-ASN bits in the ASN-second-table entry. PROGRAM RETURN does not compare ASTEINs when it unstacks a branch state entry.
- The following format applies, and the operations are performed, if the ASN-and-LX-reuse control

is one. The first operand of LOAD ADDRESS SPACE PARAMETERS is two consecutive doublewords having the following format:

First Operand of LOAD ADDRESS SPACE PARAMETERS

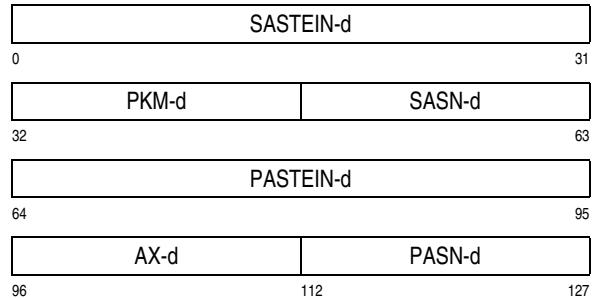

If PASN translation is performed to locate an ASN-second-table entry, PASTEIN-d is compared to the ASTEIN in the ASN-second-table entry, and they must be equal; otherwise, condition code 1 is set. If SASN translation is performed to locate an ASN-second-table entry, SASTEIN-d is compared to the ASTEIN in the ASN-second-table entry, and they must be equal; otherwise, condition code 2 is set. These operations are performed independent of the controlled-ASN and reusable-ASN bits in the ASN-second-table entries.

- Independent of the ASN-and-LX-reuse control, EXTRACT PRIMARY ASN AND INSTANCE places the current primary ASN, bits 48-63 of control register 4, in bit positions 48-63 of general register R_1 ; places the current primary ASTEIN, bits 0-31 of control register 4, in bit positions 0-31 of the general register; and places zeros in bit positions 32-47 of the general register. EXTRACT SECONDARY ASN AND INSTANCE operates the same except that it obtains the secondary ASN and secondary ASTEIN in control register 3 for placement in the general register.
- Independent of the ASN-and-LX-reuse control, a new code, code 5, of the EXTRACT STACKED STATE instruction is valid. Code 5 causes the saved secondary ASTEIN, bytes 176-179 of the state entry, to be placed in bit positions 0-31 of the R_1 general register and the saved primary ASTEIN, bytes 180-183 of the state entry, to be placed in bit positions 0-31 of general register $R_1 + 1$. Bits 32-63 of the general registers remain unchanged.

These uses of the ASTEIN allow, in all cases except one, an ASN associated with a particular ASTEIN to be made unusable when the ASN and the ASN-second-table entry it designates are reassigned to specify a conceptually different address space. The ASN-and-ASTEIN combination can be made unusable by (1) setting to one the reusable-ASN bit in the ASN-second-table entry, which prevents the use of PROGRAM TRANSFER and SET SECONDARY ASN, and (2) changing the ASTEIN in the ASN-second-table entry, which prevents the use of LOAD ADDRESS SPACE PARAMETERS, PROGRAM TRANSFER WITH INSTANCE, PROGRAM RETURN, and SET SECONDARY ASN WITH INSTANCE. The uncovered case is that of an ASN (and the corresponding ASN-second-table-entry address) in an entry-table entry, and this case should be handled by means of deletion, by the control program, of the entry-table entry. However, if the control program then reforms the entry-table entry (forms an entry-table entry located by means of the same PC number, used by PROGRAM CALL, as was the deleted entry-table entry), a PC number that was used to link to the conceptually deleted address space will then be usable to link to a different (different ASN) or conceptually different (same ASN but different contents) address space, and this error should be avoided by using the linkage-second-table-entry sequence number as described in “ASN-and-LX-Reuse Control:” on page 5-30.

Programming Notes:

1. The reusable-ASN bit of the ASN-and-LX-reuse facility provides reliability, availability, and serviceability. Most importantly, it provides availability since it allows ASNs to be reused. However it does not provide system integrity since the ASTEIN in the general register used by PROGRAM TRANSFER WITH INSTANCE or SET SECONDARY ASN WITH INSTANCE is provided by the program. (The authorization index used by those instructions normally provides system integrity but may fail to do so if an ASN authorized by an unchanged authorization index is reused.) The controlled-ASN bit provides system integrity since, if the CPU is in the problem state at the beginning of the operation, PROGRAM TRANSFER WITH INSTANCE and SET SECONDARY ASN WITH INSTANCE are unable to proceed successfully after accessing an ASN-second-table entry in which the controlled-ASN bit is one. When the calling program and called program are both executed in the problem state,

a program in an address space for which the controlled-ASN bit is one should perform linkages to programs in other address spaces only by means of stacking PROGRAM CALL. If that is done, the return by means of PROGRAM RETURN will always be successful, or will fail appropriately when the ASN of the first address space has been changed, because of the comparison to the saved primary ASTEIN in the linkage-stack state entry.

2. A program given control by a basic PROGRAM CALL operation can use EXTRACT SECONDARY ASN AND INSTANCE to obtain the ASTEIN to be used by PROGRAM TRANSFER WITH INSTANCE to return to the calling program or by SET SECONDARY ASN WITH INSTANCE to restore its secondary address space after a change of that space. This EXTRACT SECONDARY ASN AND INSTANCE instruction should be executed while the original secondary space remains continuously the secondary space; otherwise, depending on actions by the control program, EXTRACT SECONDARY ASN AND INSTANCE may return an ASTEIN that allows return to or use of a conceptually incorrect secondary space for which the ASTEIN has been changed.
3. A summary of the functions related to ASN reuse is given in Figure 3-12 on page 3-29.
4. There are certain programming errors, or situations that are not necessarily errors, that will not be detected. These cases are described in the definitions of the named instructions and are as follows:
 - In LOAD ADDRESS SPACE PARAMETERS:
 - SASN translation is performed only when, but not necessarily when, SASN-d is not equal to PASN-d. When SASN-d is equal to PASN-d, SASCE-new and SASTEIN-new are set equal to PASCE-new and PASTEIN-new, respectively. In this case, there is not a test of whether SASTEIN-d is equal to PASTEIN-d; SASTEIN-d is ignored.
 - When SASN-d is not equal to PASN-d and is equal to SASN-old, bit 61 (force ASN translation) is zero, and bit 63 (skip SASN authorization) is one, SASN translation is not performed, and SASCE-old and SASTEIN-old become SASCE-new

and SASTEIN-new, respectively. In this case, there is not a test of whether SAS-TEIN-d is equal to SASTEIN-old; SAS-TEIN-d is ignored.

- In PROGRAM RETURN, if the new SASN is equal to the new PASN, the SASCE in control register 7 is set equal to the new PASCE in control register 1. The SASTEIN, PKM, and SASN in control register 3 remain as restored from the state entry. In this case, there is not a test of whether the new SAS-TEIN is equal to the new PASTEIN. (There has already been a test of whether the PASTEIN saved in the entry, which becomes the new PASTEIN, equals the ASTEIN in the new PASTE.)
- In the PROGRAM TRANSFER WITH INSTANCE to-current-primary operation, there is not a test of whether the current PASTEIN equals the ASTEIN specified in bit positions 0-31 of general register R₁; the ASTEIN is ignored.
- In the SET SECONDARY ASN WITH INSTANCE to-current-primary operation, there is not a test of whether the current PASTEIN (to which the SASTEIN is set equal) equals the ASTEIN specified in bit positions 0-31 of general register R₁; the ASTEIN is ignored.

Function	Required Bit Value		
	R	CA	RA
LASP, PC, and PR update PASTEIN or SASTEIN in a control register after accessing an ASN-second-table entry	1	–	–
PT and SSAR update PASTEIN or SASTEIN in a control register after accessing an ASN-second-table entry	1	–	0 ¹
BSG, LASP, PC, PR, PT, and SSAR set SASTEIN equal to PASTEIN	1	–	–
PTI and SSAIR update PASTEIN or SASTEIN in a control register after accessing an ASN-second-table entry	–	0 ²	–
PTI and SSAIR set SASTEIN equal to PASTEIN	–	–	–

Figure 3-12. Summary of Functions Related to ASN Reuse (Part 1 of 2)

Function	Required Bit Value		
	R	CA	RA
PTI and SSAIR after accessing an ASN-second-table entry, compare ASTEIN in general register R ₁ to ASTEIN in the entry	–	0 ²	–
Stacking PC and BAKR copy PASTEIN and SASTEIN from control registers to state entry	1	–	–
PR, after accessing an ASN-second-table entry, compares PASTEIN or SASTEIN in the state entry to ASTEIN in the ASN-second-table entry ³	1	–	–
LASP, after accessing an ASN-second-table entry, compares PASTEIN-d or SASTEIN-d to ASTEIN in the entry ⁴	1	–	–
EPAIR copies PASTEIN and PASN from control register 4 to general register R ₁	–	–	–
ESAIR copies SASTEIN and SASN from control register 3 to general register R ₁	–	–	–
ESTA code 5 copies PASTEIN and SASTEIN from state entry to general registers	–	–	–

Explanation:

- Bit is ignored or not applicable to the operation.
- ¹ A special-operation exception is recognized if the bit is one.
- ² A special-operation exception is recognized if the bit is one and the CPU is in the problem state at the beginning of the operation.
- ³ An ASTE-instance exception is recognized if the ASTEINs are not equal.
- ⁴ Condition code 1 (if PASTEIN comparison) or 2 (if SASTEIN comparison) is set if the ASTEIN is not equal.
- CA Controlled-ASN bit, bit 30 of word 1 of ASN-second-table entry.
- R ASN-and-LX-reuse control, bit 44 of control register 0.
- RA Reusable-ASN bit, bit 31 of word 1 of ASN-second-table entry.

Figure 3-12. Summary of Functions Related to ASN Reuse (Part 2 of 2)

ASN Translation

Note: The ASN-translation concepts described in following section are applicable only to the z/Architecture architectural mode where dynamic address translation is supported. ASN translation is not supported in the ESA/390-compatibility mode.

ASN translation is the process of translating a 16-bit ASN to locate the ASN-second-table entry designated by the ASN. ASN translation is performed as part of PROGRAM TRANSFER with space switching (PT-ss) PROGRAM TRANSFER WITH INSTANCE with space switching (PTI-ss), SET SECONDARY ASN with space switching (SSAR-ss), and SET SECONDARY ASN WITH INSTANCE with space switching (SSAIR-ss), and it may be performed as part of LOAD ADDRESS SPACE PARAMETERS. For PT-ss and PTI-ss the ASN which is translated replaces the primary ASN in control register 4. For SSAR-ss and SSAIR-ss, the ASN which is translated replaces the secondary ASN in control register 3. These two translation processes are called primary ASN translation and secondary ASN translation, respectively, and both can occur for LOAD ADDRESS SPACE PARAMETERS. The ASN-translation process is the same for both primary and secondary ASN translation; only the uses of the results of the process are different.

ASN translation may also be performed as part of PROGRAM RETURN. Primary ASN translation is performed as part of PROGRAM RETURN with space switching (PR-ss). Secondary ASN translation is performed if the secondary ASN restored by PROGRAM RETURN (PR-ss or PROGRAM RETURN to current primary) does not equal the primary ASN restored by PROGRAM RETURN.

PROGRAM CALL with space switching (PC-ss) performs the equivalent of primary ASN translation by obtaining a primary ASN and the address of the corresponding ASN-second-table entry from an entry-table entry.

The ASN-translation process uses two tables, the ASN first table and the ASN second table. They are used to locate the ASN-second-table entry and a third table, the authority table, which is used when ASN authorization is performed.

For the purposes of this translation, the 16-bit ASN is considered to consist of two parts: the ASN-first-table index (AFX) is the leftmost 10 bits of the ASN, and the ASN-second-table index (ASX) is the six rightmost bits. The ASN has the following format:

ASN

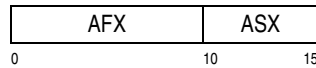

The AFX is used to select an entry from the ASN first table. The origin of the ASN first table is designated by the ASN-first-table origin in control register 14. The ASN-first-table entry contains the origin of the ASN second table. The ASX is used to select an entry from the ASN second table.

As a result of primary ASN translation and during the operation of PROGRAM CALL with space switching, the address of the located ASN-second-table entry (ASTE) is placed in control register 5 as the new primary-ASTE origin (PASTE0).

ASN-Translation Controls

ASN translation is controlled by the ASN-translation-control bit and the ASN-first-table origin, both of which reside in control register 14.

Control Register 14

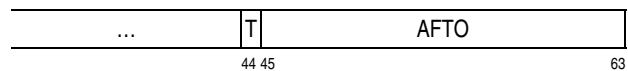

ASN-Translation Control (T): Bit 44 of control register 14 is the ASN-translation-control bit. This bit provides a mechanism whereby the control program can indicate whether ASN translation can occur while a particular program is being executed, and also whether the execution of PROGRAM CALL with space switching is allowed. Bit 44 must be one to allow completion of these instructions:

- LOAD ADDRESS SPACE PARAMETERS
- PROGRAM CALL with space switching
- PROGRAM RETURN with space switching or when the restored SASN does not equal the restored PASN
- PROGRAM TRANSFER with space switching
- PROGRAM TRANSFER WITH INSTANCE with space switching
- SET SECONDARY ASN

- SET SECONDARY ASN WITH INSTANCE

Otherwise, a special-operation exception is recognized. The ASN-translation-control bit is examined in both the problem and the supervisor states.

ASN-First-Table Origin (AFTO): Bits 45-63 of control register 14, with 12 zeros appended on the right, form a 31-bit real address that designates the beginning of the ASN first table.

ASN-Translation Tables

The ASN-translation process consists in a two-level lookup using two tables: an ASN first table and an ASN second table. These tables reside in real storage.

ASN-First-Table Entries

An entry in the ASN first table has the following format:

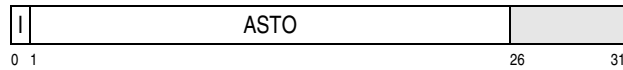

The fields in the entry are allocated as follows:

AFX-Invalid Bit (I): Bit 0 controls whether the ASN second table associated with the ASN-first-table entry is available. When bit 0 is zero, ASN translation proceeds by using the designated ASN second table. When the bit is one, the ASN translation cannot continue.

ASN-Second-Table Origin (ASTO): Bits 1-25, with six zeros appended on the right, are used to form a 31-bit real address that designates the beginning of the ASN second table.

ASN-Second-Table Entries

The ASN-second-table entry has a length of 64 bytes, with only the first 48 bytes currently in use. Bytes 0-47 of the entry have the following format:

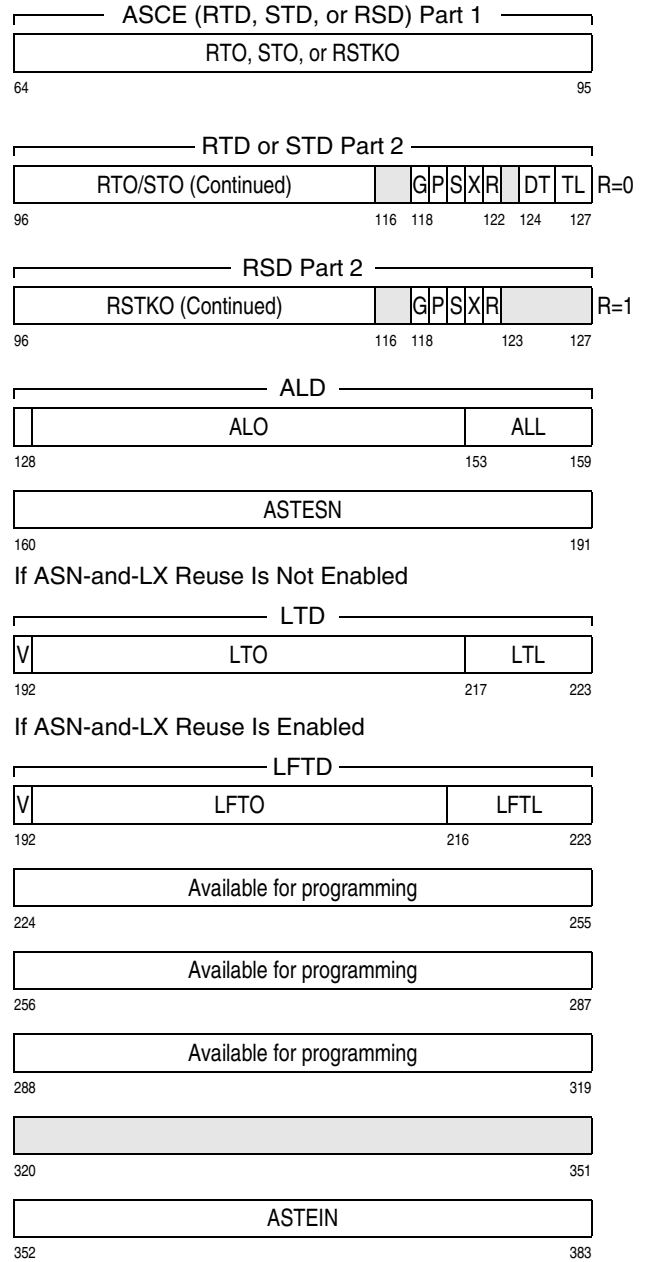
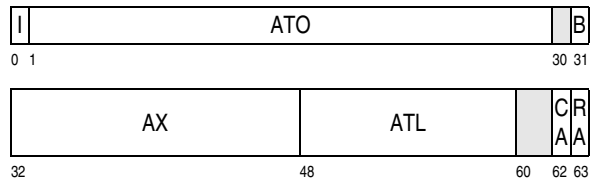

The fields in bytes 0-47 of the ASN-second-table entry are allocated as follows. Only the fields that are used in or as a result of ASN translation or PROGRAM CALL with space switching are described in detail.

ASX-Invalid Bit (I): Bit 0 controls whether the address space associated with the ASN-second-table entry is available. When bit 0 is zero, ASN translation proceeds. When the bit is one, the ASN translation cannot continue.

Authority-Table Origin (ATO): Bits 1-29, with two zeros appended on the right, are used to form a 31-bit real address that designates the beginning of the authority table.

Base-Space Bit (B): Bit 31 specifies, when one, that the address space associated with the ASN-second-table entry is the base space of a subspace group. Bit 31 is further described in “Subspace-Group ASN-Second-Table Entries” on page 5-68.

Authorization Index (AX): Bits 32-47 are used in ASN authorization as an index to locate the authority bits in the authority table. The AX field is used as a result of primary ASN translation by PROGRAM RETURN, PROGRAM TRANSFER, PROGRAM TRANSFER WITH INSTANCE, and, possibly, LOAD ADDRESS SPACE PARAMETERS. It is also used by PROGRAM CALL with space switching. The AX field is ignored after secondary ASN translation.

Authority-Table Length (ATL): Bits 48-59 specify the length of the authority table in units of four bytes, thus making the authority table variable in multiples of 16 entries. The length of the authority table, in units of four bytes, is one more than the ATL value. The contents of the ATL field are used to establish whether the entry designated by a particular AX falls within the authority table.

Controlled-ASN Bit (CA): PROGRAM TRANSFER WITH INSTANCE with space switching and SET SECONDARY ASN WITH INSTANCE with space switching recognize a special-operation exception if bit 62 is one and the CPU is in the problem state at the beginning of the operation. Bit 62 is ignored in the supervisor state.

Reusable-ASN Bit (RA): If the ASN-and-LX-reuse facility is installed and is enabled by a one value of the ASN-and-LX-reuse control, bit 44 of control register 0, PROGRAM TRANSFER with space switching and SET SECONDARY ASN with space switching recognize a special-operation exception if bit 63 is one in the problem or the supervisor state.

Address-Space-Control Element (ASCE): Bits 64-127 are an eight-byte address-space-control element (ASCE) that may be a region-table designation (RTD), a segment-table designation (STD), or a real-space designation (RSD). (The term “region-table designation” is used to mean a region-first-table designation, region-second-table designation, or region-third-table designation.) The ASCE field is used as a

result of ASN translation or in PROGRAM CALL with space switching to replace the primary ASCE (PASCE) or the secondary ASCE (SASCE). For PROGRAM CALL with space switching, the ASCE field replaces the PASCE, bits 0-63 of control register 1. For SET SECONDARY ASN, and SET SECONDARY ASN WITH INSTANCE, the ASCE field replaces the SASCE, bits 0-63 of control register 7. Each of these actions may occur independently for LOAD ADDRESS SPACE PARAMETERS. For PROGRAM TRANSFER, and PROGRAM TRANSFER WITH INSTANCE, the ASCE field replaces both the PASCE and the SASCE. For PROGRAM RETURN, as a result of primary ASN translation, the ASCE field replaces the PASCE, and, as a result of secondary ASN translation, the ASCE field replaces the SASCE. The contents of the entire ASCE field are placed in the appropriate control registers without being inspected for validity.

The subspace-group-control bit (G), bit 118 of the ASCE field, indicates, when one, that the ASCE specifies an address space that is the base space or a subspace of a subspace group. The bit is further described in “Subspace-Group ASN-Second-Table Entries” on page 5-68.

Bit 121 (X) of the ASCE field is the space-switch-event-control bit. When, in the space-switching operations of PROGRAM CALL, PROGRAM RETURN, and PROGRAM TRANSFER, and PROGRAM TRANSFER WITH INSTANCE, this bit is one in control register 1 either before or after the execution of the instruction, a program interruption for a space-switch event occurs after the execution of the instruction is completed. A space-switch-event program interruption also occurs after the completion of a SET ADDRESS SPACE CONTROL, SET ADDRESS SPACE CONTROL FAST, or RESUME PROGRAM instruction that changes the translation mode either to or from the home-space mode when this bit is one in either control register 1 or control register 13. When, in LOAD ADDRESS SPACE PARAMETERS, this bit is one during primary ASN translation, this fact is indicated by the condition code.

The real-space-control bit (R), bit 122 of the ASCE field, indicates, when zero, that the ASCE is a region-table or segment-table designation or, when one, that the ASCE is a real-space designation.

When bit 122 is zero, the designation-type-control bits (DT), bits 124 and 125 of the ASCE field, indicate the designation type of the ASCE. A value 11, 10, 01,

or 00 binary of bits 124 and 125 indicates a region-first-table designation, region-second-table designation, region-third-table designation, or segment-table designation, respectively.

The other fields in the ASCE (RTO, STO, P, S, TL, and RSTKO) are described in “Control Register 1” on page 3-42.

Access-List Designation (ALD): The access-list-designation (ALD) field is described in “ASN-Second-Table Entries” on page 5-57.

ASN-Second-Table-Entry Sequence Number (ASTESN): The ASTE-sequence-number (ASTESN) field is described in “ASN-Second-Table Entries” on page 5-57.

Linkage-Table Designation (LTD) or Linkage-First-Table Designation (LFTD): The linkage-table-designation (LTD) or linkage-first-table designation (LFTD) field in the ASN-second-table entry is described in “PC-Number Translation Control” on page 5-34.

ASN-Second-Table-Entry Instance Number (ASTEIN): When the ASN-and-LX-reuse facility is installed and is enabled by a one value of the ASN-and-LX-reuse control in control register 0, bits 352-383 are compared to an ASTEIN specified along with an ASN for use by PROGRAM RETURN or LOAD ADDRESS SPACE PARAMETERS. The ASTEINs must be equal; otherwise, an ASTE-instance exception is recognized by PROGRAM RETURN or condition code 1 or 2 is set by LOAD ADDRESS SPACE PARAMETERS. This comparison and the exception result also occur in the operations of PROGRAM TRANSFER WITH INSTANCE and SET SECONDARY ASN WITH INSTANCE except independent of the ASN-and-LX-reuse control.

Bits 224-319 in the ASN-second-table entry are available for use by programming.

Programming Note: All unused fields in the ASN-second-table entry, including the unused fields in bytes 0-31 and all of bytes 40-43 and 48-63 should be set to zeros. These fields are reserved for future extensions, and programs which place nonzero values in these fields may not operate compatibly on future machines.

ASN-Translation Process

This section describes the ASN-translation process as it is performed during the execution of the space-switching forms of PROGRAM RETURN, PROGRAM TRANSFER, PROGRAM TRANSFER WITH INSTANCE, SET SECONDARY ASN, and SET SECONDARY ASN WITH INSTANCE, and also in PROGRAM RETURN when the restored secondary ASN does not equal the restored primary ASN. ASN translation for LOAD ADDRESS SPACE PARAMETERS is the same except that AFX-translation and ASX-translation exceptions do not occur; such conditions are instead indicated by the condition code. Translation of an ASN is performed by means of two tables, an ASN first table and an ASN second table, both of which reside in main storage.

The ASN first index is used to select an entry from the ASN first table. This entry designates the ASN second table to be used.

The ASN second index is used to select an entry from the ASN second table.

If the I bit is one in either the ASN-first-table entry or the ASN-second-table entry, the entry is invalid, and the ASN-translation process cannot be completed. An AFX-translation exception or ASX-translation exception is recognized.

Whenever access to main storage is made during the ASN-translation process for the purpose of fetching an entry from an ASN first table or ASN second table, key-controlled protection does not apply.

The ASN-translation process is shown in Figure 3-13 on page 3-34.

ASN-First-Table Lookup

The AFX portion of the ASN, in conjunction with the ASN-first-table origin, is used to select an entry from the ASN first table.

The 31-bit real address of the ASN-first-table entry is obtained by appending 12 zeros on the right to the AFT origin contained in bit positions 45-63 of control register 14 and adding the AFX portion with two rightmost and 19 leftmost zeros appended. This addition cannot cause a carry into bit position 0. The 31-bit address is formed and used regardless of whether the current PSW specifies the 24-bit, 31-bit, or 64-bit addressing mode.

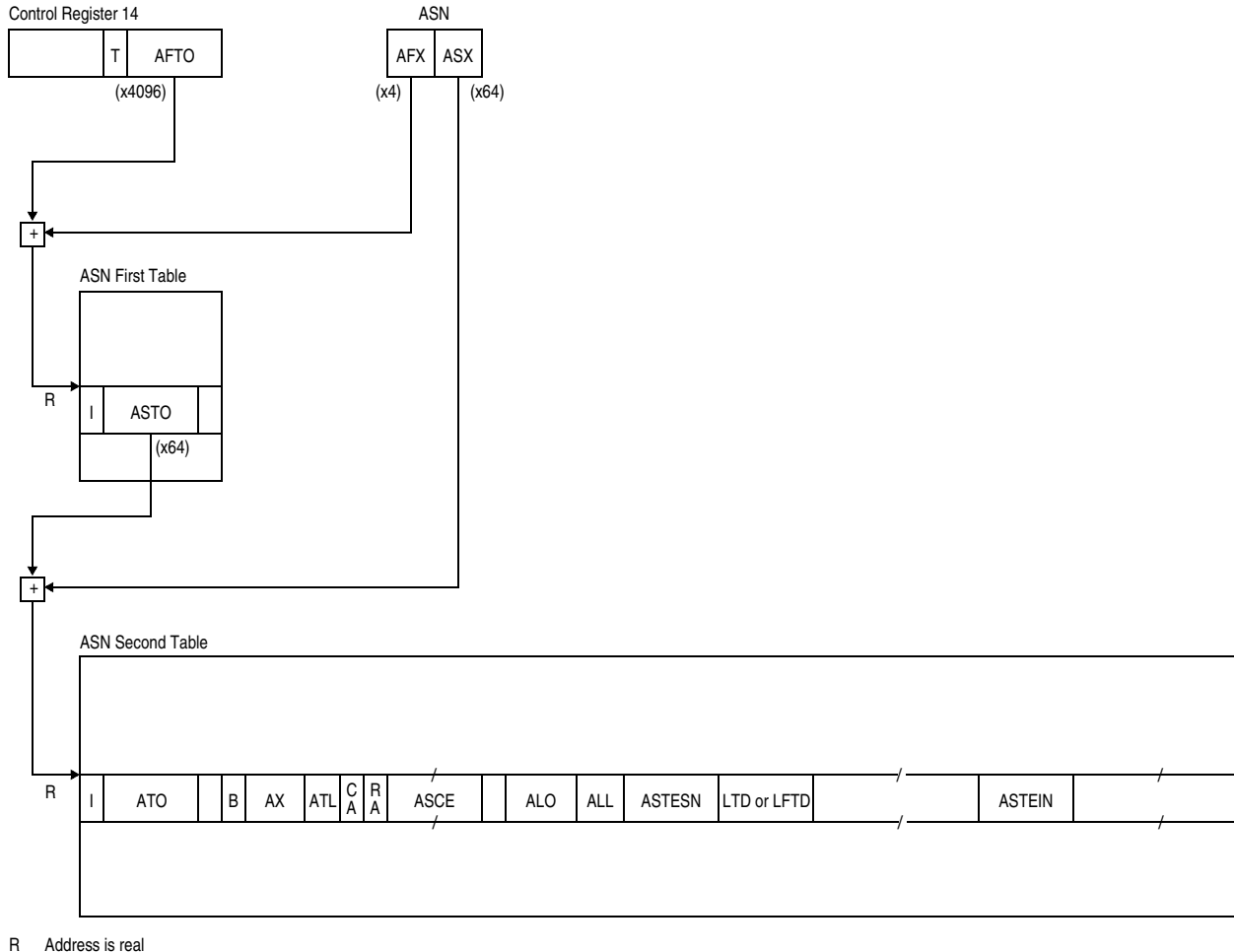

Figure 3-13. ASN Translation

All four bytes of the ASN-first-table entry appear to be fetched concurrently as observed by other CPUs. The fetch access is not subject to protection. When the storage address which is generated for fetching the ASN-first-table entry designates a location which is not available in the configuration, an addressing exception is recognized, and the operation is suppressed.

Bit 0 of the four-byte AFT entry specifies whether the corresponding AST is available. If this bit is one, an AFX-translation exception is recognized. The entry fetched from the AFT is used to access the AST.

ASN-Second-Table Lookup

The ASX portion of the ASN, in conjunction with the ASN-second-table origin contained in the ASN-first-table entry, is used to select an entry from the ASN second table.

The 31-bit real address of the ASN-second-table entry is obtained by appending six zeros on the right to bits 1-25 of the ASN-first-table entry and adding the ASX with six rightmost and 19 leftmost zeros appended. When a carry into bit position 0 occurs during the addition, an addressing exception may be recognized, or the carry may be ignored, causing the table to wrap from $2^{31} - 1$ to zero. The 31-bit address is formed and used regardless of whether the current PSW specifies the 24-bit, 31-bit, or 64-bit addressing mode.

The fetch of the 64 bytes of the ASN-second-table entry appears to be word concurrent as observed by other CPUs, with the leftmost word fetched first. The order in which the remaining 15 words are fetched is unpredictable. The fetch access is not subject to protection. When the storage address which is generated for fetching the ASN-second-table entry

designates a location which is not available in the configuration, an addressing exception is recognized, and the operation is suppressed.

Bit 0 of the ASN-second-table entry specifies whether the address space is accessible. If this bit is one, an ASX-translation exception is recognized.

Recognition of Exceptions during ASN Translation

The exceptions which can be encountered during the ASN-translation process are collectively referred to as ASN-translation exceptions. A list of these exceptions and their priorities is given in Chapter 6, "Interruptions".

ASN Authorization

Note: The ASN-authorization concepts described in following section are applicable only to the z/Architecture architectural mode where dynamic address translation is supported. ASN authorization is not supported in the ESA/390-compatibility mode.

ASN authorization is the process of testing whether the program associated with the current authorization index is permitted to establish a particular address space. The ASN authorization is performed as part of PROGRAM TRANSFER with space switching (PT-ss), PROGRAM TRANSFER WITH INSTANCE with space switching (PTI-ss), SET SECONDARY ASN with space switching (SSAR-ss), and SET SECONDARY ASN WITH INSTANCE with space switching (SSAIR-ss), and may be performed as part of LOAD ADDRESS SPACE PARAMETERS. ASN authorization is performed after the ASN-translation process for these instructions.

ASN authorization is also performed as part of PROGRAM RETURN when the restored secondary ASN does not equal the restored primary ASN. ASN authorization of the restored secondary ASN is performed after ASN translation of the restored secondary ASN.

When performed as part of PT-ss or PTI-ss, the ASN authorization tests whether the ASN can be established as the primary ASN and is called primary-ASN authorization. When performed as part of LOAD ADDRESS SPACE PARAMETERS, PROGRAM RETURN, SSAR-ss, or SSAIR-ss, the ASN authori-

zation tests whether the ASN can be established as the secondary ASN and is called secondary-ASN authorization.

The ASN authorization is performed by means of an authority table in real storage which is designated by the authority-table-origin and authority-table-length fields in the ASN-second-table entry.

ASN-Authorization Controls

ASN authorization uses the authority-table origin and the authority-table length from the ASN-second-table entry, together with an authorization index.

Control Register 4

For PT-ss, PTI-ss, SSAR-ss, and SSAIR-ss, the current contents of control register 4 include the authorization index. For LOAD ADDRESS SPACE PARAMETERS and PROGRAM RETURN, the value which will become the new contents of control register 4 is used. The register has the following format:

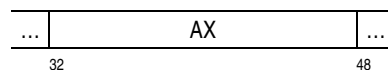

Authorization Index (AX): Bits 32-47 of control register 4 are used as an index to locate the authority bits in the authority table.

ASN-Second-Table Entry

The ASN-second-table entry which is fetched as part of the ASN translation process contains information which is used to designate the authority table. An entry in the ASN second table has the following format:

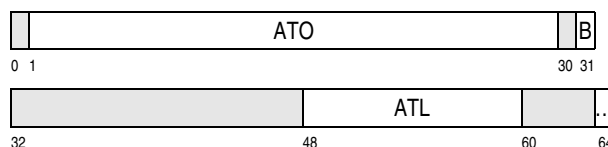

Authority-Table Origin (ATO): Bits 1-29, with two zeros appended on the right, are used to form a 31-bit real address that designates the beginning of the authority table.

Authority-Table Length (ATL): Bits 48-59 specify the length of the authority table in units of four bytes, thus making the authority table variable in multiples of 16 entries. The length of the authority table, in units of four bytes, is equal to one more than the ATL

value. The contents of the length field are used to establish whether the entry designated by the authorization index falls within the authority table.

Authority-Table Entries

The authority table consists of entries of two bits each; accordingly, each byte of the authority table contains four entries in the following format:

The fields are allocated as follows:

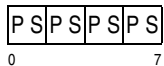

Primary Authority (P): The left bit of an authority-table entry controls whether the program with the authorization index corresponding to the entry is permitted to establish the address space as a primary address space. If the P bit is one, the establishment is permitted. If the P bit is zero, the establishment is not permitted.

Secondary Authority (S): The right bit of an authority-table entry controls whether the program with the corresponding authorization index is permitted to establish the address space as a secondary address space. If the S bit is one, the establishment is permitted. If the S bit is zero, the establishment is not permitted.

The authority table is also used in the extended-authorization process, as part of access-register translation. Extended authorization is described in “Authorizing the Use of the Access-List Entry” on page 5-63.

ASN-Authorization Process

This section describes the ASN-authorization process as it is performed during the execution of PROGRAM TRANSFER with space switching, PROGRAM TRANSFER WITH INSTANCE with space switching, SET SECONDARY ASN with space switching, and SET SECONDARY ASN WITH INSTANCE with space switching. For these two instructions, the ASN-authorization process is performed by using the authorization index currently in control register 4. Secondary authorization for PROGRAM RETURN, when the restored secondary ASN does not equal the restored primary ASN, and for LOAD ADDRESS SPACE PARAMETERS is the

same, except that the value which will become the new contents of control register 4 is used for the authorization index. Also, for LOAD ADDRESS SPACE PARAMETERS, a secondary-authority exception does not occur. Instead, such a condition is indicated by the condition code.

The ASN-authorization process is performed by using the authorization index, in conjunction with the authority-table origin and length from the AST entry, to select an authority-table entry. The entry is fetched, and either the primary- or the secondary-authority bit is examined, depending on whether the primary- or secondary-ASN-authorization process is being performed. The ASN-authorization process is shown in Figure 3-14.

Authority-Table Lookup

The authorization index, in conjunction with the authority-table origin contained in the ASN-second-table entry, is used to select an entry from the authority table.

The authorization index is contained in bit positions 32-47 of control register 4.

Bit positions 1-29 of the AST entry contain the leftmost 29 bits of the 31-bit real address of the authority table (ATO), and bit positions 48-59 contain the length of the authority table (ATL).

The 31-bit real address of a byte in the authority table is obtained by appending two zeros on the right to the authority-table origin and adding the 14 leftmost bits of the authorization index with 17 zeros appended on the left. When a carry into bit position 0 occurs during the addition, an addressing exception may be recognized, or the carry may be ignored, causing the table to wrap from $2^{31} - 1$ to zero. The 31-bit address is formed and used regardless of whether the current PSW specifies the 24-bit, 31-bit, or 64-bit addressing mode.

As part of the authority-table-entry-lookup process, bits 0-11 of the authorization index are compared against the authority-table length. If the compared portion is greater than the authority-table length, a primary-authority exception or secondary-authority exception is recognized for PT-ss, PTI-ss, SSAR-ss, or SSAIR-ss, respectively. For LOAD ADDRESS SPACE PARAMETERS, when the authority-table length is exceeded, condition code 2 is set.

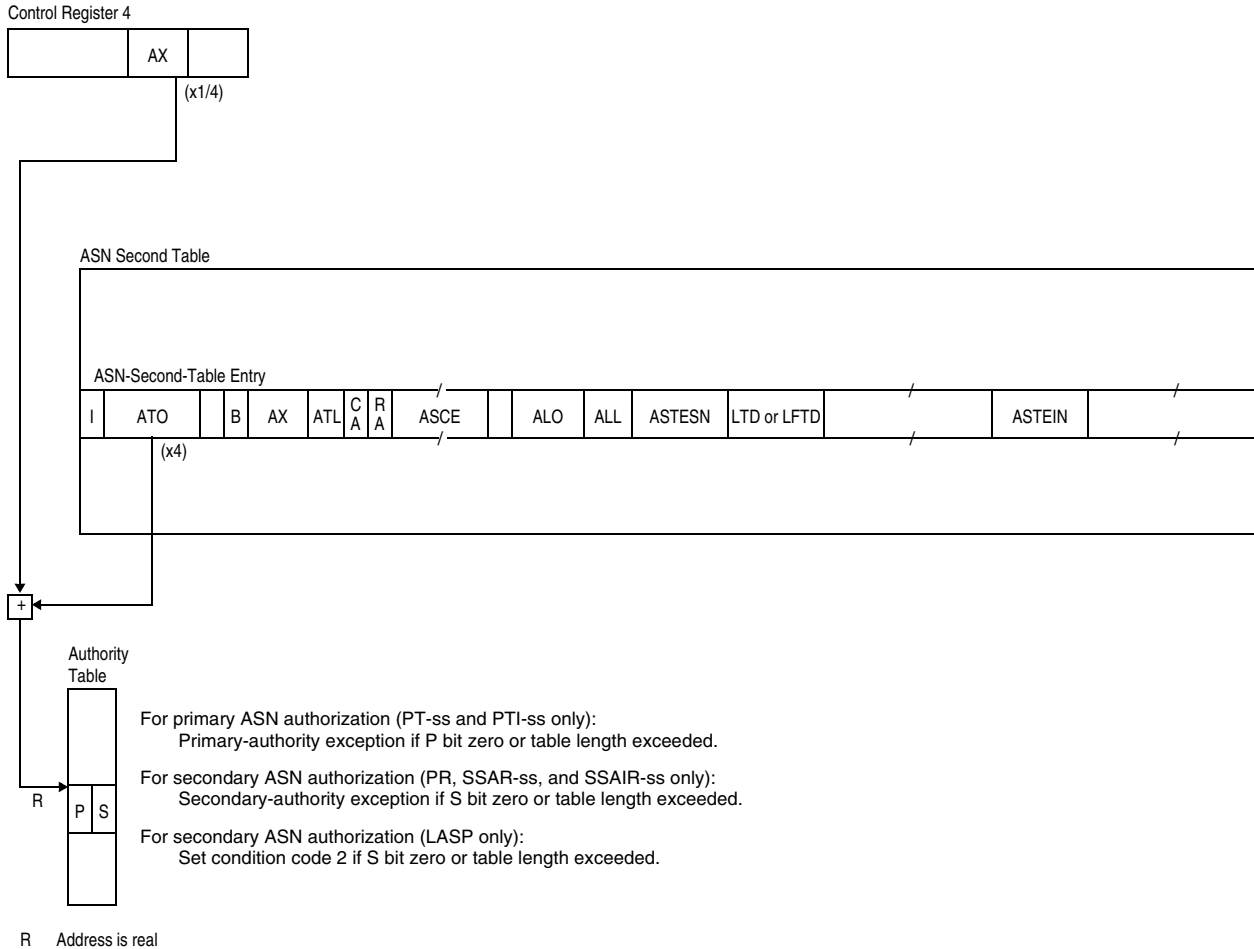

Figure 3-14. ASN Authorization

The fetch access to the byte in the authority table is not subject to protection. When the storage address which is generated for fetching the byte designates a location which is not available in the configuration, an addressing exception is recognized, and the operation is suppressed.

The byte contains four authority-table entries of two bits each. The rightmost two bits of the authorization index, bits 46 and 47 of control register 4, are used to select one of the four entries. The left or right bit of the entry is then tested, depending on whether the authorization test is for a primary ASN or a secondary ASN. The following table shows the bit which is selected from the byte as a function of bits 46 and 47 of the authorization index and the instruction PT-ss,

PTI-ss, SSAR-ss, SSAIR-ss, PROGRAM RETURN, or LOAD ADDRESS SPACE PARAMETERS.

Authorization-Index Bits		Bit Selected from Authority-Table Byte for Test	
		P Bit (PT-ss and PTI-ss)	S Bit (SSAR-ss, SSAIR-ss, PR, or LASP)
0	0	0	1
0	1	2	3
1	0	4	5
1	1	6	7

If the selected bit is one, the ASN is authorized, and the appropriate fields in the AST entry are loaded into the appropriate control registers. If the selected bit is zero, the ASN is not authorized, and a primary-authority exception is recognized for PT-ss or PTI-ss, or a secondary-authority exception is recognized for SSAR-ss, SSAIR-ss, or PROGRAM RETURN. For

LOAD ADDRESS SPACE PARAMETERS, when the ASN is not authorized, condition code 2 is set.

Recognition of Exceptions during ASN Authorization

The exceptions which can be encountered during the primary- and secondary-ASN-authorization processes and their priorities are described in the definitions of the instructions in which ASN authorization is performed.

Programming Note: The primary- and secondary-authority exceptions cause nullification in order to permit dynamic modification of the authority table. Thus, when an address space is created or “swapped in,” the authority table can first be set to all zeros and the appropriate authority bits set to one only when required.

Dynamic Address Translation

Note: The dynamic-address translation concepts described in following section are applicable only to the z/Architecture architectural mode where DAT is supported. DAT is not supported in the ESA/390-compatibility mode.

Dynamic address translation (DAT) provides the ability to interrupt the execution of a program at an arbitrary moment, record it and its data in auxiliary storage, such as a direct-access storage device, and at a later time return the program and the data to different main-storage locations for resumption of execution. The transfer of the program and its data between main and auxiliary storage may be performed piecemeal, and the return of the information to main storage may take place in response to an attempt by the CPU to access it at the time it is needed for execution. These functions may be performed without change or inspection of the program and its data, do not require any explicit programming convention for the relocated program, and do not disturb the execution of the program except for the time delay involved.

With appropriate support by an operating system, the dynamic-address-translation facility may be used to provide to a user a system wherein storage appears to be larger than the main storage which is available in the configuration. This apparent main storage is referred to as virtual storage, and the addresses

used to designate locations in the virtual storage are referred to as virtual addresses. The virtual storage of a user may far exceed the size of the main storage which is available in the configuration and normally is maintained in auxiliary storage. The virtual storage is considered to be composed of blocks of addresses, called pages. Only the most recently referred-to pages of the virtual storage are assigned to occupy blocks of physical main storage. As the user refers to pages of virtual storage that do not appear in main storage, they are brought in to replace pages in main storage that are less likely to be needed. The swapping of pages of storage may be performed by the operating system without the user’s knowledge.

The sequence of virtual addresses associated with a virtual storage is called an address space. With appropriate support by an operating system, the dynamic-address-translation facility may be used to provide a number of address spaces. These address spaces may be used to provide degrees of isolation between users. Such support can consist of a completely different address space for each user, thus providing complete isolation, or a shared area may be provided by mapping a portion of each address space to a single common storage area. Also, instructions are provided which permit a semiprivileged program to access more than one such address space. Dynamic address translation provides for the translation of virtual addresses from multiple different address spaces without requiring that the translation parameters in the control registers be changed. These address spaces are called the primary address space, secondary address space, and AR-specified address spaces. A privileged program can also cause the home address space to be accessed.

In the process of replacing blocks of main storage by new information from an external medium, it must be determined which block to replace and whether the block being replaced should be recorded and preserved in auxiliary storage. To aid in this decision process, a reference bit and a change bit are associated with the storage key.

Dynamic address translation may be specified for instruction and data addresses generated by the CPU but is not available for the addressing of data and of CCWs, IDAWs, and MIDAWs in I/O operations. The CCW-indirect-data-addressing facility and modified-CCW-indirect-data-addressing facilities are provided to aid I/O operations in a virtual-storage environment.

Address computation can be carried out in the 24-bit, 31-bit, or 64-bit addressing mode. When address computation is performed in the 24-bit or 31-bit addressing mode, 40 or 33 zeros, respectively, are appended on the left to form a 64-bit address. Therefore, the resultant logical address is always 64 bits in length. The real or absolute address that is formed by dynamic address translation, and the absolute address that is then formed by prefixing, are always 64 bits in length.

Dynamic address translation is the process of translating a virtual address during a storage reference into the corresponding real or absolute address. The virtual address may be a primary virtual address, secondary virtual address, AR-specified virtual address, or home virtual address. These addresses are translated by means of the primary, the secondary, an AR-specified, or the home address-space-control element, respectively. After selection of the appropriate address-space-control element, the translation process is the same for all of the four types of virtual address. An address-space-control element may be a segment-table designation specifying a 2 G-byte address space, a region-table designation specifying a 4 T-byte, 8 P-byte, or 16 E-byte space, or a real-space designation specifying a 16 E-byte space. (The letters K, M, G, T, P, and E represent kilo, 2^{10} , mega, 2^{20} , giga, 2^{30} , tera, 2^{40} , peta, 2^{50} , and exa, 2^{60} , respectively.) A segment-table designation or region-table designation causes translation to be performed by means of tables established by the operating system in real or absolute storage. A real-space designation causes the virtual address simply to be treated as a real address, without the use of tables in storage.

In the process of translation when using a segment-table designation or a region-table designation, three types of units of information are recognized—regions, segments, and pages. A region is a block of sequential virtual addresses spanning 2G bytes and beginning at a 2 G-byte boundary. A segment is a block of sequential virtual addresses spanning 1M bytes and beginning at a 1 M-byte boundary. A page is a block of sequential virtual addresses spanning 4K bytes and beginning at a 4 K-byte boundary.

The virtual address, accordingly, is divided into four principal fields. Bits 0-32 are called the region index (RX), bits 33-43 are called the segment index (SX), bits 44-51 are called the page index (PX), and bits

52-63 are called the byte index (BX). The virtual address has the following format:

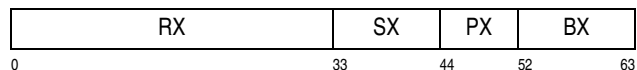

As determined by its address-space-control element, a virtual address space may be a 2 G-byte space consisting of one region, or it may be up to a 16 E-byte space consisting of up to 8G regions. The RX part of a virtual address applying to a 2 G-byte address space must be all zeros; otherwise, an exception is recognized.

The RX part of a virtual address is itself divided into three fields. Bits 0-10 are called the region first index (RFX), bits 11-21 are called the region second index (RSX), and bits 22-32 are called the region third index (RTX). Bits 0-32 of the virtual address have the following format:

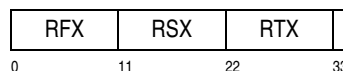

A virtual address in which the RTX is the leftmost significant part (a 42-bit address) is capable of addressing 4T bytes (2K regions), one in which the RSX is the leftmost significant part (a 53-bit address) is capable of addressing 8P bytes (4M regions), and one in which the RFX is the leftmost significant part (a 64-bit address) is capable of addressing 16E bytes (8G regions).

A virtual address in which the RX is always zero can be translated into real addresses by means of one or two translation tables, as follows:

- When enhanced DAT does not apply, or when enhanced DAT applies but the STE-format control, bit 53 of the segment-table entry, is zero, the virtual address can be translated by means of a segment table and a page table.
- When enhanced DAT applies and the STE-format control of the segment-table entry is one, the virtual address can be translated by means of a segment table only.

If the RX may be nonzero, from one to three additional translation tables are required, as follows. If the RFX may be nonzero, a region first table, region second table, and region third table are required. If the RFX is always zero but the RSX may be nonzero, a

region second table and region third table are required. If the RFX and RSX are always zero but the RTX may be nonzero, a region third table is required. An exception is recognized if the address-space-control element for an address space does not designate the highest level of table (beginning with the region first table and continuing downward to the segment table) needed to translate a reference to the address space.

A region first table, region second table, or region third table is sometimes referred to simply as a region table. Similarly, a region-first-table designation, region-second-table designation, or region-third-table designation is sometimes referred to as a region-table designation.

The region, segment, and, when applicable, page tables reflect the current assignment of real or absolute storage.

When EDAT-1 does not apply, or when EDAT-1 applies but the STE-format control, bit 53 of the segment-table entry, is zero, the assignment of real storage occurs in units of pages, the real locations being assigned contiguously within a page. The pages need not be adjacent in real storage even though assigned to a set of sequential virtual addresses.

When EDAT-1 applies and the STE-format control of the segment-table entry is one, the assignment of real storage occurs in units of segments, the absolute locations being assigned contiguously within a segment. The segments need not be adjacent in absolute storage even though assigned to a set of sequential virtual addresses.

Similarly, when EDAT-2 applies and the RTTE-format control of the region-third-table entry is one, the assignment of real storage occurs in units of regions, the absolute locations being assigned contiguously within a region. The regions need not be adjacent in absolute storage even though assigned to a set of sequential virtual addresses.

To improve performance, translation normally is performed by means of table copies maintained in a special buffer called the translation-lookaside buffer (TLB). The TLB may also contain entries that provide the virtual-equals-real translation specified by a real-space designation.

Translation Control

Address translation is controlled by three bits in the PSW and by a set of bits referred to as the translation parameters. The translation parameters are in control registers 0, 1, 7, and 13. Additional controls are located in the translation tables.

Additional controls are provided as described in Chapter 5, "Program Execution." These controls determine whether the contents of each access register can be used to obtain an address-space-control element for use by DAT.

Translation Modes

The three bits in the PSW that control dynamic address translation are bit 5, the DAT-mode bit, and bits 16 and 17, the address-space-control bits. When the DAT-mode bit is zero, then DAT is off, and the CPU is in the real mode. When the DAT-mode bit is one, then DAT is on, and the CPU is in the translation mode designated by the address-space-control bits: 00 designates the primary-space mode, 01 designates the access-register mode, 10 designates the secondary-space mode, and 11 designates the home-space mode.

For certain instructions such as LOAD PAGE TABLE ENTRY ADDRESS, LOAD REAL ADDRESS and STORE REAL ADDRESS, and for monitor-event counting operations, dynamic address translation is performed even when the DAT-mode bit in the PSW is off.

The various modes are shown in Figure 3-15, along with the handling of addresses in each mode.

PSW Bit				DAT	Mode	Handling of Addresses	
5	16	17	Instruction Addresses			Logical Addresses	
0	0	0	Off	Real mode	Real	Real	
0	0	1	Off	Real mode	Real	Real	
0	1	0	Off	Real mode	Real	Real	
0	1	1	Off	Real mode	Real	Real	
1	0	0	On	Primary-space mode	Primary virtual	Primary virtual	
1	0	1	On	Access-register mode	Primary virtual	AR-specified virtual	
1	1	0	On	Secondary-space mode	Primary virtual	Secondary virtual	

Figure 3-15. Translation Modes

PSW Bit			DAT	Mode	Handling of Addresses	
5	16	17			Instruction Addresses	Logical Addresses
1	1	1	On	Home-space mode	Home virtual	Home virtual

Figure 3-15. Translation Modes

Control Register 0

Bit 37 is provided in control register 0 for use in controlling dynamic address translation. When the enhanced-DAT facility is installed, bit 40 is also provided for use in controlling dynamic-address translation. The bit assignments are as follows:

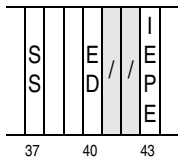

Secondary-Space Control (SS): Bit 37 of control register 0 is the secondary-space-control bit. When this bit is zero and execution of MOVE TO PRIMARY, MOVE TO SECONDARY, or SET ADDRESS SPACE CONTROL is attempted, a special-operation exception is recognized. A special-operation exception is also recognized when this bit is zero, execution of MOVE WITH OPTIONAL SPECIFICATIONS is attempted, and the operand-access control for either operand designates the secondary space. When this bit is one, it indicates that the region table or segment table designated by the secondary address-space-control element has been established.

Enhanced-DAT-Enablement Control (ED): When the enhanced-DAT facility 1 is installed, bit 40 of control register 0 is the enhanced-DAT-enablement control. When this bit is zero, dynamic address translation proceeds as though the enhanced-DAT facility was not installed. When the bit is one, the following conditions apply:

- The DAT-protection bit is defined in bit position 54 of each region-table entry.
- The STE-format control is defined in bit position 53 of the segment-table entry. When the STE-format control is zero, bits 0-52 of the segment-table entry are used to locate the page table (as occurs when the enhanced-DAT facility 1 is not installed or enabled)

When the STE-format control is one, the following apply:

- Bits 0-43 of the segment-table entry form the segment-frame absolute address. There is no designation of a page table, and no page-table entries are used.
- Bit 47 of the segment-table entry determines the validity of the access-control bits and fetch-protection bit (in bits 48-52 of the STE).
- Bits 48-52 of the segment-table entry contain access-control bits and a fetch-protection bit for the segment.

When the enhanced-DAT facility 1 is not installed, bit 40 of control register 0 is reserved and should contain zero; otherwise, the program may not operate compatibly in the future.

When the enhanced-DAT-facility 2 is installed, and the enhanced-DAT-enablement control is one, the RTTE-format control is defined in bit position 53 of the region-third-table entry. When the RTTE-format control is zero, bits 0-51 of the region-third-table entry are used to locate the segment table (as occurs when the enhanced-DAT facility 2 is not installed). When the RTTE-format control is one, the following apply:

- Bits 0-32 of the region-third-table entry form the region-frame absolute address. There is no designation of a segment table, and no segment-table entries are used.
- Bit 47 of the region-third-table entry determines the validity of the access-control bits and fetch-protection bit (in bits 48-52 of the RTTE).
- Bits 48-52 of the region-third-table entry contain access-control bits and a fetch-protection bit for the region.

When the enhanced-DAT facility 2 is installed, the enhanced-DAT facility 1 is also installed.

Enhanced-DAT Terminology: For the purpose of brevity, the following terms are used in conjunction with the enhanced-DAT facilities:

- The term “*EDAT-1 applies*” refers to the case where all of the following are true:
 - The enhanced-DAT facility 1 is installed.

- The enhanced-DAT-enablement control, bit 40 of control register 0, is one.
- The address is translated by means of DAT-table entries.
- The term “*EDAT-2 applies*” refers to the case where both of the following are true:
 - The enhanced-DAT facility 2 is installed.
 - EDAT-1 applies.
- The term “*EDAT-1 does not apply*” refers to the case where any of the following are true:
 - The enhanced-DAT facility 1 is not installed.
 - The enhanced-DAT facility 1 is installed, but the enhanced-DAT-enablement control is zero.
 - The address is not translated by means of DAT-table entries (that is, DAT is off and is not being used implicitly; DAT is on, but the ASCE designates a real space; or the instruction uses a real address such as LOAD USING REAL ADDRESS or STORE USING REAL ADDRESS).
 - A real address is implicitly used, for example in the handling of an interruption, CPU logout, or fetching of table entries for ART, ASN translation, ASN authorization, DAT, or PC-number translation.
- The term “*EDAT-2 does not apply*” refers to the case where either of the following is true:
 - EDAT-1 does not apply
 - The enhanced-DAT facility 2 is not installed.

Instruction-Execution-Protection-Enablement

(IEPE) Control: When the instruction-execution-protection facility is installed, bit 43 of control register 0 is the instruction-execution-protection-enablement control. When the instruction-execution-protection facility is not installed, or when the facility is installed and this bit is zero, instruction-execution protection does not apply.

When the instruction-execution-protection facility is installed, the IEPE control is one, and instructions are fetched using an ASCE in which the real-space control is zero, the execution of instructions is subject to the instruction-execution-protection (IEP) control in the leaf table entry used in the translation. (See “Translation Tables” on page 3-45 for a definition of “leaf.”)

Programming Notes:

1. Before DAT is enabled or implicitly performed (such as in LOAD REAL ADDRESS), the program should ensure that the enhanced-DAT-enablement control is consistent with the enhanced-DAT-enablement control in any other CPU in the configuration that may be performing DAT for the same address space.
2. DAT should be disabled before altering the enhanced-DAT-enablement control, and the TLB of the CPU should be purged before re-enabling DAT.

Failure to follow these rules may result in unpredictable results, including the possibility of a delayed-access machine-check condition being recognized.

Control Register 1

Control register 1 contains the primary address-space-control element (PASCE). The register has one of the following two formats, depending on the real-space-control bit (R) in the register:

Primary Region-Table or Segment-Table Designation (R=0)

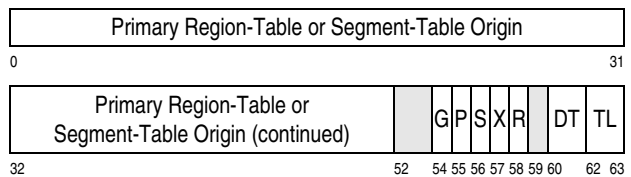

Primary Real-Space Designation (R=1)

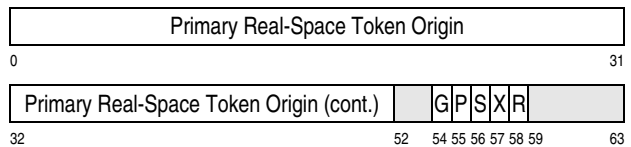

The fields in the primary address-space-control element are allocated as follows:

Primary Region-Table or Segment-Table Origin:

Bits 0-51 of the primary region-table or segment-table designation in control register 1, with 12 zeros appended on the right, form a 64-bit address that designates the beginning of the primary region table or segment table. It is unpredictable whether the address is real or absolute. This table is called the primary region table or segment table since it is used

to translate virtual addresses in the primary address space.

Primary Subspace-Group Control (G): Bit 54 of control register 1, when one, indicates that the address space specified by the PASCE is the base space or a subspace of a subspace group. When bit 54 is zero, the address space is not in a subspace group.

Primary Private-Space Control (P): If bit 55 of control register 1 is one, then (1) a one value of the common-segment bit in a translation-lookaside-buffer (TLB) representation of a segment-table entry prevents the entry and any TLB page-table copy it designates from being used when translating references to the primary address space, even with a match between the table or token origin in control register 1 and the table origin in the TLB entry, (2) low-address protection and fetch-protection override do not apply to the primary address space; and (3) a translation-specification exception is recognized if a reference to the primary address space is translated by means of a segment-table entry in storage and the common-segment bit is one in the entry. Item 2 in the above list applies even when the contents of control register 1 are a real-space designation.

When EDAT-2 applies and bit 55 of control register 1 is one, then (1) a one value of the common-region bit in a translation-lookaside-buffer (TLB) representation of a region-third-table entry prevents the entry and any TLB segment- and page-table copy it designates from being used when translating references to the primary address space, even with a match between the table or token origin in control register 1 and the table origin in the TLB entry, (2) low-address protection and fetch-protection override do not apply to the primary address space; and (3) a translation-specification exception is recognized if a reference to the primary address space is translated by means of a region-third-table entry in storage and the common-region bit is one in the entry. Item 2 in the above list applies even when the contents of control register 1 are a real-space designation.

Programming Note: With respect to item 1 in the above lists, when the contents of control register 1 are a real-space designation, a one value of the common-segment bit in a TLB representation of a segment-table entry prevents the entry and any TLB page-table copy it designates from being used regardless of the value of the private-space control in the real-space designation. Similarly, when EDAT-2

applies and the contents of control register 1 are a real-space designation, a one value of the common-region bit in a TLB representation of a region-third-table entry prevents the entry and any TLB segment- and page-table copies it designates from being used regardless of the value of the private-space control in the real-space designation.

Primary Storage-Alteration-Event Control (S): When the storage-alteration-space control in control register 9 is one, bit 56 of control register 1 specifies, when one, that the primary address space is one for which storage-alteration events can occur. Bit 56 is examined when the PASCE is used to perform dynamic-address translation for a storage-operand store reference. Bit 56 is ignored when the storage-alteration-space control is zero.

Primary Space-Switch-Event Control (X): When bit 57 of control register 1 is one:

- A space-switch-event program interruption occurs when execution of the space-switching form of PROGRAM CALL (PC-ss), PROGRAM RETURN (PR-ss), or PROGRAM TRANSFER (PT-ss) is completed. The interruption occurs if bit 57 is one either before or after the operation.
- A space-switch-event program interruption occurs upon completion of a RESUME PROGRAM, SET ADDRESS SPACE CONTROL, or SET ADDRESS SPACE CONTROL FAST instruction that changes the address space from which instructions are fetched either to or from the home address space; that is, when instructions are fetched from the home address space either before or after the operation but not both before and after the operation.
- Condition code 3 is set by LOAD ADDRESS SPACE PARAMETERS.

Primary Real-Space Control (R): If bit 58 of control register 1 is zero, the register contains a region-table or segment-table designation. If bit 58 is one, the register contains a real-space designation. When bit 58 is one, a one value of the common-segment bit in a translation-lookaside-buffer (TLB) representation of a segment-table entry prevents the entry and any TLB page-table copy it designates from being used when translating references to the primary address space, even with a match between the token origin in control register 1 and the table origin in the TLB entry. Similarly, when EDAT-2 applies and bit 58 is

one, a one value of the common-region bit in a translation-lookaside-buffer (TLB) representation of a region-third-table entry prevents the entry and any TLB segment- and page-table copies it designates from being used when translating references to the primary address space, even with a match between the token origin in control register 1 and the table origin in the TLB entry.

Primary Designation-Type Control (DT): When R is zero, the type of table designation in control register 1 is specified by bits 60 and 61 in the register, as follows:

Bits 60 and 61	Designation Type
11	Region-first-table
10	Region-second-table
01	Region-third-table
00	Segment-table

When R is zero, bits 60 and 61 must be 11 binary when an attempt is made to use the PASCE to translate a virtual address in which the leftmost one bit is in bit positions 0-10 of the address. Similarly, bits 60 and 61 must be 11 or 10 binary when the leftmost one bit is in bit positions 11-21 of the address, and they must be 11, 10, or 01 binary when the leftmost one bit is in bit positions 22-32 of the address. Otherwise, an ASCE-type exception is recognized.

Primary Region-Table or Segment-Table Length (TL): Bits 62 and 63 of the primary region-table designation or segment-table designation in control register 1 specify the length of the primary region table or segment table in units of 4,096 bytes, thus making the length of the region table or segment table variable in multiples of 512 entries. The length of the primary region table or segment table, in units of 4,096 bytes, is one more than the TL value. The contents of the length field are used to establish whether the portion of the virtual address (RFX, RSX, RTX, or SX) to be translated by means of the table designates an entry that falls within the table.

Primary Real-Space Token Origin: Bits 0-51 of the primary real-space designation in control register 1, with 12 zeros appended on the right, form a 64-bit address that may be used in forming and using TLB entries that provide a virtual-equals-real translation for references to the primary address space. Although this address is used only as a token and is not used to perform a storage reference, it still must

be a valid address; otherwise, an incorrect TLB entry may be used when the contents of control register 1 are used.

The following bits of control register 1 are not assigned and are ignored: bits 52, 53, and 59 if the register contains a region-table designation or segment-table designation, and bits 52, 53 and 59-63 if the register contains a real-space designation.

Control Register 7

Control register 7 contains the secondary address-space-control element (SASCE). The register has one of the following two formats, depending on the real-space-control bit (R) in the register:

Secondary Region-Table or Segment-Table Designation (R=0)

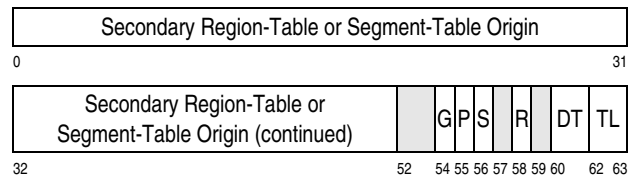

Secondary Real-Space Designation (R=1)

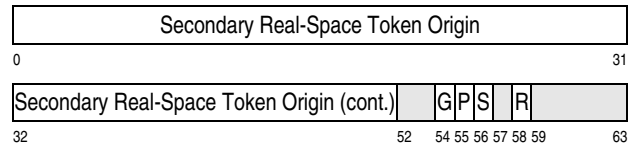

The secondary region-table origin, secondary segment-table origin, secondary subspace-group control (G), secondary private-space control (P), secondary storage-alteration-event control (S), secondary real-space control (R), secondary designation-type control (DT), secondary region-table or segment-table length (TL), and secondary real-space token origin in control register 7 are defined the same as the fields in the same bit positions in control register 1, except that control register 7 applies to the secondary address space.

The following bits of control register 7 are not assigned and are ignored: bits 52, 53, 57, and 59 if the register contains a region-table designation or segment-table designation, and bits 52, 53, 57, and 59-63 if the register contains a real-space designation.

Control Register 13

Control register 13 contains the home address-space-control element (HASCE). The register has one of the following two formats, depending on the real-space-control bit (R) in the register:

Home Region-Table or Segment-Table Designation (R=0)

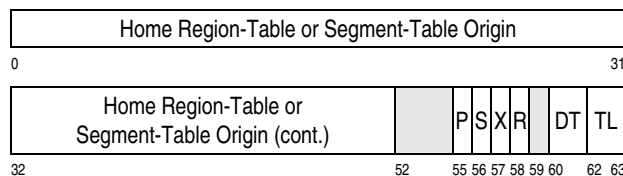

Home Real-Space Designation (R=1)

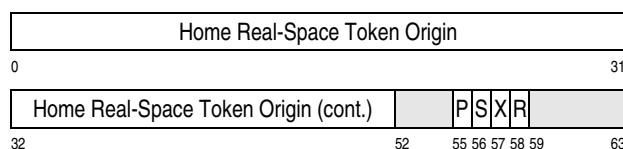

Home Space-Switch-Event Control (X): When bit 57 of control register 13 is one, a space-switch-event program interruption occurs upon completion of a RESUME PROGRAM, SET ADDRESS SPACE CONTROL, or SET ADDRESS SPACE CONTROL FAST instruction that changes the address space from which instructions are fetched either to or from the home address space; that is, when instructions are fetched from the home address space either before or after the operation but not both before and after the operation.

The home region-table origin, home segment-table origin, home private-space control (P), home storage-alteration-event control (S), home real-space control (R), home designation-type control (DT), home region-table or segment-table length (TL), and home real-space token origin in control register 13 are defined the same as the fields in the same bit positions in control register 1, except that control register 13 applies to the home address space.

The following bits of control register 13 are not assigned and are ignored: bits 52-54 and 59 if the register contains a region-table designation or segment-table designation, and bits 52-54 and 59-63 if the register contains a real-space designation.

Programming Notes:

1. The validity of the information loaded into a control register, including that pertaining to dynamic address translation, is not checked at the time the register is loaded. This information is checked and the program exception, if any, is indicated at the time the information is used.
2. The information pertaining to dynamic address translation is considered to be used when an instruction is executed with DAT on, or when the enhanced-monitor counting array is accessed, or when COMPARE AND REPLACE DAT TABLE ENTRY, INVALIDATE DAT TABLE ENTRY, INVALIDATE PAGE TABLE ENTRY, LOAD PAGE-TABLE-ENTRY ADDRESS, LOAD REAL ADDRESS, or STORE REAL ADDRESS is executed. The information is not considered to be used when the PSW specifies translation but an I/O, external, restart, or machine-check interruption occurs before an instruction is executed, or when the PSW specifies the wait state.

Translation Tables

When the address-space-control element (ASCE) used in a translation is a region-first-table designation, the translation process consists in a five-level lookup using five tables: a region first table, a region second table, a region third table, a segment table, and a page table. These tables reside in real or absolute storage. When the ASCE is a region-second-table designation, region-third-table designation, or segment-table designation, the lookups in the levels of tables above the designated level are omitted, and the higher-level tables themselves are omitted.

Notes:

1. The terms *higher* and *lower* are used to describe the level of DAT tables or table entries, either in storage or in the translation-lookaside buffer. A higher-level table entry maps a larger portion of virtual storage than a lower-level table entry. Thus, a region-first-table entry is the highest level of DAT-table entries, and a page-table entry is the lowest level.
2. Higher DAT-table entries (if any) may be referred to as *limb*-table entries. Limb-table entries comprise region-first-table entries, region-second-table entries, region-third-table entries in which

the format control is zero, and segment-table entries in which the format control is zero.

The lowest (or only) DAT-table entry used in a translation is referred to as a *leaf*-table entry. Leaf-table entries comprise region-third-table entries and segment-table entries in which the format control is one, and page-table entries.

Region-Table Entries

The term “region-table entry” means a region-first-table entry, region-second-table entry, or region-third-table entry.

The entries fetched from the region first table, region second table, and region third table have the following formats. The level (first, second, or third) of the table containing an entry is identified by the table-type (TT) bits in the entry.

Region-First-Table Entry (TT=11)

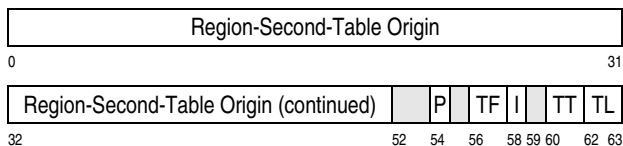

Region-Second-Table Entry (TT=10)

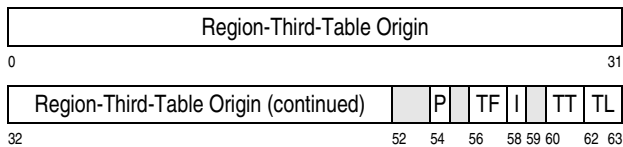

Region-Third-Table Entry (TT=01, FC=0)

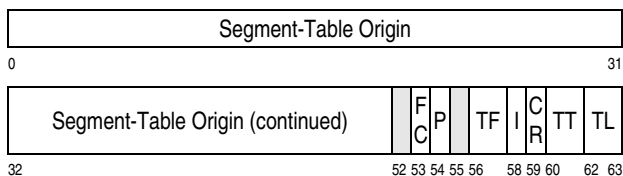

Region-Third-Table Entry (TT=01, FC=1)

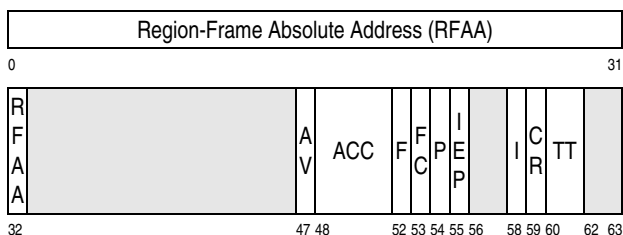

The fields in the three levels of region-table entries are allocated as follows:

Region-Second-Table Origin, Region-Third-Table Origin, and Segment-Table Origin: A region-first-table entry contains a region-second-table origin. A region-second-table entry contains a region-third-table origin. When EDAT-2 does not apply, or when EDAT-2 applies and the RTTE-format control in the region-third table entry is zero, a region-third-table entry contains a segment-table origin. The following description applies to each of the three origins. Bits 0-51 of the entry, with 12 zeros appended on the right, form a 64-bit address that designates the beginning of the next-lower-level table. It is unpredictable whether the address is real or absolute.

Region-Frame Absolute Address (RFAA): When EDAT-2 applies and the RTTE-format control is one, bits 0-32 of the entry, with 31 zeros appended on the right, form the 64-bit absolute address of the region.

ACCF-Validity Control (AV): When EDAT-2 applies and the RTTE-format control is one, bit 47 is the access-control-bits and fetch-protection bit (ACCF) validity control. When the AV control is zero, bits 48-52 of the region-third-table entry are ignored. When the AV control is one, bits 48-52 are used as described below.

Access-Control Bits (ACC): When EDAT-2 applies, and both the RTTE-format control and the AV control in the region-third-table-entry are one, bits 48-51 of the entry contain the access-control bits that may be used for any key-controlled access checking that applies to the address. It is unpredictable whether the CPU uses these bits or the access-control bits in the storage key of the 4 K-byte block corresponding to the address.

Fetch-Protection Bit (F): When EDAT-2 applies, and both the RTTE-format control and the AV control in the region-third-table-entry are one, bit 52 of the entry contains the fetch-protection bit that may be used for any key-controlled access checking that applies to the address. It is unpredictable whether the CPU uses this bit or the fetch-protection bit in the storage key of the 4 K-byte block corresponding to the address.

Format Control (FC): When EDAT-2 applies, bit 53 of the region-third table entry is the RTTE-format control for the entry, as follows:

- When the FC bit is zero, bits 0-51 of the entry form the segment-table origin, and bits 52 and 55 are reserved.
- When the FC bit is one, bits 0-32 of the entry form the region-frame absolute address, bit 47 is the ACCF-validity control, bits 48-51 are the access-control bits, bit 52 is the fetch-protection bit, and bits 56-57, and 62-63 are reserved. When the instruction-execution-protection facility is enabled (that is, bit 43 of control register 0 is one), bit 55 of the format-1 RTTE is the instruction-execution-protection control; otherwise bit 55 of the format-1 RTTE is reserved.

When EDAT-2 does not apply, bit 53 of the region-third table entry is reserved. Bit 53 is reserved in region-first- and region-second-table entries.

DAT-Protection Bit (P): When EDAT-1 applies, bit 54 is treated as being ORed with the DAT-protection bit in each subsequent region-table entry, and, when applicable, segment-table entry, and page-table entry used in the translation. Thus, when the bit is one, DAT protection applies to the entire region or regions specified by the region-table entry.

When the enhanced-DAT facility 1 is not installed, or when the facility is installed but the enhanced-DAT-enablement control is zero, bit 54 of the region-table entry is ignored.

Instruction-Execution-Protection (IEP) Control: When the instruction-execution-protection facility is enabled, and the RTTE-format control is one, bit 55 of the RTTE is the instruction-execution-protection control. When the IEP control is zero, instruction-execution protection does not apply to instructions executed in the region frame. When the IEP control is one, instruction-execution protection applies to the region frame; in the absence of higher-priority exception conditions, any attempt to execute instructions from the region frame causes a protection exception to be recognized.

Region-Second-Table Offset, Region-Third-Table Offset, and Segment-Table Offset (TF): A region-first-table entry contains a region-second-table offset. A region-second-table entry contains a region-third-table offset. When EDAT-2 does not apply, or when EDAT-2 applies but the RTTE-format control in the region-third table entry is zero, a region-third-table entry contains a segment-table offset. The following description applies to each of the three off-

sets. Bits 56 and 57 of the entry specify the length of a portion of the next-lower-level table that is missing at the beginning of the table, that is, the bits specify the location of the first entry actually existing in the next-lower-level table. The bits specify the length of the missing portion in units of 4,096 bytes, thus making the length of the missing portion variable in multiples of 512 entries. The length of the missing portion, in units of 4,096 bytes, is equal to the TF value. The contents of the offset field, in conjunction with the length field, bits 62 and 63, are used to establish whether the portion of the virtual address (RSX, RTX, or SX) to be translated by means of the next-lower-level table designates an entry that actually exists in the table.

When EDAT-2 applies and the RTTE-format-control of a region-third-table entry is one, bits 56-57 of the entry are reserved.

Region-Invalid Bit (I): Bit 58 in a region-first-table entry or region-second-table entry controls whether the set of regions associated with the entry is available. Bit 58 in a region-third-table entry controls whether the single region associated with the entry is available. When bit 58 is zero, address translation proceeds by using the region-table entry. When the bit is one, the entry cannot be used for translation.

When the region-invalid bit is one, all other bits in the region-table entry are available for use by programming.

Common-Region Bit (CR): When EDAT-2 applies, bit 59 controls the use of the translation-lookaside-buffer (TLB) copies of the region-third-table entry. When EDAT-2 applies but the RTTE-format control is zero, bit 59 also controls the use of the TLB copies of any segment table designated by the region-third-table entry, and any page table designated by the segment-table entry.

A zero identifies a private region; in this case, the region-third-table entry, and any lower-level table entries it designates may be used only in association with the region-third-table origin that designates the region-third table in which the region-third-table entry resides, except that on models that implement a TLB composite table entry that includes the region-third-table entry, the TLB composite table entry and any lower-level tables it designates may be used only when (a) the table origin in the TLB composite table entry matches the ASCE table origin or table origin of a higher-level region-table entry, and (b) the region

indices in the TLB composite table entry match the corresponding indices of the virtual address.

A one identifies a common region; in this case, the region-third-table entry and any lower-level tables it designates may continue to be used for translating addresses corresponding to the region-third index, even though a different region-third table is specified. However, TLB copies of the region-third-table entry and lower-level tables for a common region are not usable if the private-space control, bit 55, is one in the address-space-control element used in the translation or if that address-space-control element is a real-space designation. The common-region bit must be zero if the region-third-table entry is fetched from storage during a translation when the private-space control is one in the address-space-control element being used; otherwise, a translation-specification exception is recognized.

Bit 59 is ignored in the region-first- and region-second-table entries, and, when EDAT-2 does not apply, in the region-third-table entry.

Table-Type Bits (TT): Bits 60 and 61 of the region-first-table entry, region-second-table entry, and region-third-table entry identify the level of the table containing the entry, as follows:

Bits 60 and 61	Region-Table Level
11	First
10	Second
01	Third

Bits 60 and 61 must identify the correct table level, considering the type of table designation that is the address-space-control element being used in the translation and the number of table levels that have so far been used; otherwise, a translation-specification exception is recognized.

Region-Second-Table Length, Region-Third-Table Length, and Segment-Table Length (TL): A region-first-table entry contains a region-second-table length. A region-second-table entry contains a region-third-table length. When EDAT-2 does not apply, or when EDAT-2 applies but the RTTE-format control in the region-third table entry is zero, a region-third-table entry contains a segment-table length. The following description applies to each of the three lengths. Bits 62 and 63 of the entry specify the length of the next-lower-level table in units of 4,096 bytes, thus making the length of the table vari-

able in multiples of 512 entries. The length of the next-lower-level table, in units of 4,096 bytes, is one more than the TL value. The contents of the length field, in conjunction with the offset field, bits 56 and 57, are used to establish whether the portion of the virtual address (RSX, RTX, or SX) to be translated by means of the next-lower-level table designates an entry that actually exists in the table.

When EDAT-2 applies and the RTTE-format-control of a region-third-table entry is one, bits 62-63 of the entry are available for programming.

All other bit positions of the region-table entry are reserved for possible future extensions and should contain zeros; otherwise, the program may not operate compatibly in the future.

Programming Note: When the common-region (CR) bit is one in a valid region-third-table entry fetched from storage during dynamic-address translation for a non-private address space, that is, for an address space in which the private-space control is zero in the address-space-control element being used, then the following conditions apply:

1. The region-third-table entries corresponding to the same virtual address in all other non-private address spaces must be identical.

If the program alters such a region-third-table entry in one non-private address space, then it must also (a) identically alter all other region-third-table entries corresponding to the same virtual address in all other non-private address spaces, and (b) ensure that the affected entries are cleared from the TLBs of all CPUs in the configuration. Further information on clearing TLB entries may be found in "Modification of Translation Tables" on page 3-67.

2. The program must ensure that region-third-table entries in which the CR bit is set to one, and any region-first- and region-second-table entries used by the DAT process to locate such region-third-table entries, are consistent across all address spaces. That is, if the DAT process can successfully locate a region-third-table entry in which the CR bit is one in one non-private address space, then there must be no exception condition that prevents DAT from locating the region-third-table entry corresponding to the same virtual address in any other non-private address spaces.

If the program alters such a region-table entry in one non-private address space, then it must also (a) perform consistent alteration to all corresponding table entries in all other non-private address spaces, and (b) ensure that the affected entries are cleared from the TLBs of all CPUs in the configuration.

3. If the program fails to maintain consistent DAT table entries as described above, results are unpredictable and may include the presentation of a delayed-access-exception machine check, as described in “Delayed Access Exception” on page 11-17.

Segment-Table Entries

When EDAT-1 does not apply, or when enhanced DAT applies and the STE-format control, bit 53 of the segment-table entry is zero, the entry fetched from the segment table has the following format:

Segment-Table Entry (TT=00, FC=0)

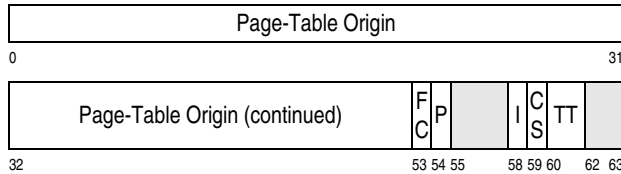

When EDAT-1 applies and the STE-format control is one, the entry fetched from the segment table has the following format:

Segment-Table Entry (TT=00, FC=1)

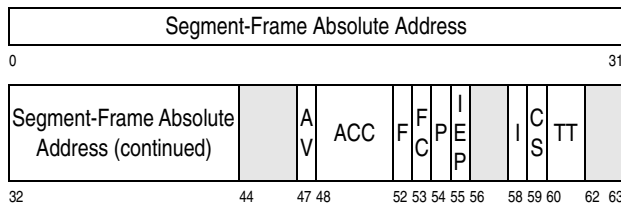

The fields in the segment-table entry are allocated as follows:

Page-Table Origin: When EDAT-1 does not apply, or when EDAT-1 applies but the STE-format control, bit 53 of the segment-table entry, is zero, bits 0-52, with 11 zeros appended on the right, form a 64-bit address that designates the beginning of a page table. It is unpredictable whether the address is real or absolute.

Segment-Frame Absolute Address (SFAA):

When EDAT-1 applies and the STE-format control is one, bits 0-43 of the entry, with 20 zeros appended on the right, form the 64-bit absolute address of the segment.

ACCF-Validity Control (AV):

When EDAT-1 applies and the STE-format control is one, bit 47 is the access-control-bits and fetch-protection bit (ACCF) validity control. When the AV control is zero, bits 48-52 of the segment-table entry are ignored. When the AV control is one, bits 48-52 are used as described below.

Access-Control Bits (ACC):

When EDAT-1 applies, and both the STE-format control and the AV control in the segment-table entry are one, bits 48-51 of the segment-table entry contain the access-control bits that may be used for any key-controlled access checking that applies to the address. It is unpredictable whether the CPU uses these bits or the access-control bits in the storage key of the 4 K-byte block corresponding to the address.

Fetch-Protection Bit (F):

When EDAT-1 applies, and both the STE-format control and the AV control in the segment-table entry are one, bit 52 of the segment-table entry contains the fetch-protection bit that may be used for any key-controlled access checking that applies to the address. It is unpredictable whether the CPU uses this bit or the fetch-protection bit in the storage key of the 4 K-byte block corresponding to the address.

STE-Format Control (FC):

When EDAT-1 applies, bit 53 is the format control for the segment-table entry, as follows:

- When the FC bit is zero, bits 0-52 of the entry form the page-table origin, and bit 55 is reserved.
- When the FC bit is one, bits 0-43 of the entry form the segment-frame absolute address, bit 47 is the ACCF-validity control, bits 48-51 are the access-control bits, and bit 52 is the fetch-protection bit. When the instruction-execution-protection facility is enabled, bit 55 of the STE is the instruction-execution-protection control; otherwise bit 55 of the STE is reserved.

When EDAT-1 does not apply, bit 53 is ignored.

DAT-Protection Bit (P): Bit 54, when one, indicates that DAT protection applies to the entire segment.

When EDAT-1 does not apply, bit 54 is treated as being ORed with the DAT-protection bit in the page-table entry used in the translation.

When EDAT-1 applies, the DAT-protection bit in any and all region-table entries used in the translation are treated as being ORed with the DAT-protection bit in the segment-table entry; when the STE-format control is zero, the DAT-protection bit in the STE is further treated as being ORed with the DAT-protection bit in the page-table entry.

Instruction-Execution-Protection (IEP) Control: When the instruction-execution-protection facility is enabled, and the STE-format control is one, bit 55 of the STE is the instruction-execution-protection control. When the IEP control is zero, instruction-execution protection does not apply to instructions executed in the segment frame. When the IEP control is one, instruction-execution protection applies to the segment frame; in the absence of higher-priority exception conditions, any attempt to execute instructions from the segment frame causes a protection exception to be recognized.

Segment-Invalid Bit (I): Bit 58 controls whether the segment associated with the segment-table entry is available. When the bit is zero, address translation proceeds by using the segment-table entry. When the bit is one, the segment-table entry cannot be used for translation.

When the segment-invalid bit is one, all other bits in the segment-table entry are available for use by programming.

Common-Segment Bit (CS): Bit 59 controls the use of the translation-lookaside-buffer (TLB) copies of the segment-table entry. When EDAT-1 does not apply or when EDAT-1 applies but the format control is zero, bit 59 also controls the use of the TLB copies of the page table designated by the segment-table entry.

A zero identifies a private segment; in this case, the segment-table entry and any page table it designates may be used only in association with the segment-table origin that designates the segment table in which the segment-table entry resides, except that

on models that implement a TLB composite table entry that includes the STE, the TLB composite table entry and any page table it designates may be used only when (a) the table origin in the TLB composite table entry matches the ASCE table origin or table origin of a higher-level region-table entry, and (b) the region and segment indices in the TLB composite table entry match the corresponding indices of the virtual address.

A one identifies a common segment; in this case, the segment-table entry and any page table it designates may continue to be used for translating addresses corresponding to the segment index, even though a different segment table is specified. However, TLB copies of the segment-table entry and any page table for a common segment are not usable if the private-space control, bit 55, is one in the address-space-control element used in the translation or if that address-space-control element is a real-space designation. The common-segment bit must be zero if the segment-table entry is fetched from storage during a translation when the private-space control is one in the address-space-control element being used; otherwise, a translation-specification exception is recognized.

When EDAT-2 applies, the effective value of the common-segment bit is the logical OR of bits 59 of the segment-table entry and any region-third-table entry designating the segment-table entry.

Table-Type Bits (TT): Bits 60 and 61 of the segment-table entry are 00 binary to identify the level of the table containing the entry. The meanings of all possible values of bits 60 and 61 in a region-table entry or segment-table entry are as follows:

Bits 60 and 61	Table Level
11	Region-first
10	Region-second
01	Region-third
00	Segment

Bits 60 and 61 must identify the correct table level, considering the type of table designation that is the address-space-control element being used in the translation and the number of table levels that have so far been used; otherwise, a translation-specification exception is recognized.

Bits 62-63 are available for programming.

All other bit positions of the segment-table entry are reserved for possible future extensions and should contain zeros; otherwise, the program may not operate compatibly in the future.

Programming Note: When the common-segment (CS) bit is one in a valid segment-table entry fetched from storage during dynamic-address translation for a non-private address space, that is, for an address space in which the private-space control is zero in the address-space-control element being used, then the following conditions apply:

1. The segment-table entries corresponding to the same virtual address in all other non-private address spaces must be identical.

If the program alters such a segment-table entry in one non-private address space, then it must also (a) identically alter all other segment-table entries corresponding to the same virtual address in all other non-private address spaces, and (b) ensure that the affected entries are cleared from the TLBs of all CPUs in the configuration. Further information on clearing TLB entries may be found in “Modification of Translation Tables” on page 3-67.

2. The program must ensure that segment-table entries in which the CS bit is set to one, and any region-table entries used by the DAT process to locate such segment-table entries, are consistent across all address spaces. That is, if the DAT process can successfully locate a segment-table entry in which the CS bit is one in one non-private address space, then there must be no exception condition that prevents DAT from locating the segment-table entry corresponding to the same virtual address in any other non-private address spaces.

If the program alters such a segment-table entry or region-table entry in one non-private address space, then it must also (a) perform consistent alteration to all corresponding table entries in all other non-private address spaces, and (b) ensure that the affected entries are cleared from the TLBs of all CPUs in the configuration.

3. If the program fails to maintain consistent DAT table entries as described above, results are unpredictable and may include the presentation of a delayed-access-exception machine check, as described in “Delayed Access Exception” on page 11-17.

Page-Table Entries

The entry fetched from the page table entry has the following format:

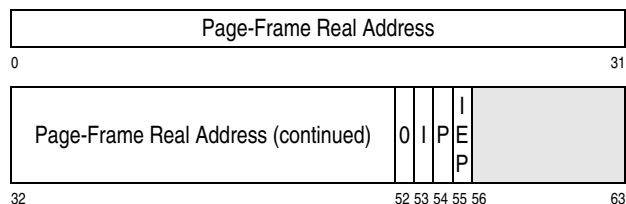

The fields in the page-table entry are allocated as follows:

Page-Frame Real Address (PFRA): Bits 0-51 provide the leftmost bits of a real storage address. When these bits are concatenated with the 12-bit byte-index field of the virtual address on the right, a 64-bit real address is obtained.

Page-Invalid Bit (I): Bit 53 controls whether the page associated with the page-table entry is available. When the bit is zero, address translation proceeds by using the page-table entry. When the bit is one, the page-table entry cannot be used for translation.

When the page-invalid bit is one, all other bits in the page-table entry are available for use by programming.

DAT-Protection Bit (P): Bit 54 controls whether store accesses can be made in the page. This protection mechanism is in addition to the key-controlled-protection and low-address-protection mechanisms. The bit has no effect on fetch accesses. If the bit is zero, stores are permitted to the page, subject to the following additional constraints:

- The DAT-protection bit being zero in the segment-table entry used in the translation,
- When EDAT-1 applies, the DAT-protection bit being zero in all region-table entries used in the translation,
- Other protection mechanisms

If the bit is one, stores are disallowed. When no higher priority exception conditions exist, an attempt to store when the DAT-protection bit is one causes a protection exception to be recognized. The DAT-protection bit in the segment-table entry is treated as being ORed with bit 54 when determining whether

DAT protection applies to the page. When EDAT-1 applies, the DAT-protection bits in any region-table entries used in translation are also treated as being ORed with bit 54 when determining whether DAT-protection applies.

Bit position 52 of the entry must contain zero; otherwise, a translation-specification exception is recognized as part of the execution of an instruction using that entry for address translation.

Instruction-Execution-Protection (IEP) Control: When the instruction-execution-protection facility is enabled, bit 55 of the PTE is the instruction-execution-protection control. When the IEP control is zero, instruction-execution protection does not apply to instruction executed in the page frame. When the IEP control is one, instruction-execution protection applies to the page frame; in the absence of higher-priority exception conditions, any attempt to execute instructions from the page frame causes a protection exception to be recognized.

When the instruction-execution-protection (IEP) facility is not installed in the configuration and EDAT-1 does not apply, it is unpredictable whether a translation-specification exception is recognized when bit 55 of the page-table entry is one. When the IEP facility is not installed in the configuration and EDAT-1 applies, or when the IEP facility is installed but disabled, bit 55 of the page-table entry is ignored.

Bit positions 56-63 are not assigned and are ignored.

Programming Note: Bit 55 of the format-1 region-third-table entry, format-1 segment-table entry, and page table entry was formerly defined to be the change-recording override (CO). The change-recording override was never implemented on any IBM processor, and this feature has been removed from the architecture. Bit 55 of the respective table entries is now defined to be the instruction-execution-protection control.

Architecture Notes:

Translation Process

This section describes the translation process as it is performed implicitly before a virtual address is used to access main storage. Explicit translation, which is the process of translating the operand address of LOAD PAGE-TABLE-ENTRY ADDRESS, LOAD

REAL ADDRESS, STORE REAL ADDRESS, and TEST PROTECTION, is the same, except that, for LOAD PAGE-TABLE-ENTRY ADDRESS, LOAD REAL ADDRESS and TEST PROTECTION, region-first-translation, region-second-translation, region-third-translation, and segment-translation exceptions are not recognized, and for LOAD REAL ADDRESS and TEST PROTECTION, page-translation exceptions are not recognized; such conditions are instead indicated by the condition code. Translation of the operand address of LOAD PAGE-TABLE-ENTRY ADDRESS, LOAD REAL ADDRESS and STORE REAL ADDRESS also differs in that the CPU may be in the real mode.

Translation of a virtual address is controlled by the DAT-mode bit and address-space-control bits in the PSW, by bits in control register 0, and by the address-space-control elements (ASCEs) in control registers 1, 7, and 13 and as specified by the access registers. When the ASCE used in a translation is a region-first-table designation, the translation is performed by means of a region first table, region second table, region third table, and, when applicable, a segment table and page table, all of which reside in real or absolute storage. When the ASCE is a lower-level type of table designation (region-second-table designation, region-third-table designation, or segment-table designation) the translation is performed by means of only the table levels beginning with the designated level, and the virtual-address bits that would, if nonzero, require use of a higher level or levels of table must be all zeros; otherwise, an ASCE-type exception is recognized. When the ASCE is a real-space designation, the virtual address is treated as a real address, and table entries in real or absolute storage are not used.

The address-space-control element (ASCE) used for a particular address translation is called the effective ASCE. Accordingly, when a primary virtual address is translated, the contents of control register 1 are used as the effective ASCE. Similarly, for a secondary virtual address, the contents of control register 7 are used; for an AR-specified virtual address, the ASCE specified by the access register is used; and for a home virtual address, the contents of control register 13 are used.

When the real-space control in the effective ASCE is zero, the designation-type control in the ASCE specifies the table-designation type of the ASCE: region-first-table designation, region-second-table designation, region-third-table designation, or segment-table

designation. The corresponding portion of the virtual address (region first index, region second index, region third index, or segment index) is checked against the table-length field in the designation, and it is added to the origin in the designation to select an entry in the designated table. If the selected entry is outside its table, as determined by the table-length field in the designation, or if the I bit is one in the selected entry, a region-first-translation, region-second-translation, region-third-translation, or segment-translation exception is recognized, depending on the table level specified by the designation. If the table-type bits in the selected entry do not indicate the expected table level, a translation-specification exception is recognized.

The table entry selected by means of the effective ASCE designates the next-lower-level table to be used. If the current table is a region first table, region second table, or region third table, the next portion of the virtual address (region second index, region third index, or, when applicable, segment index, respectively) is checked against the table-offset and table-length fields in the current table entry, and it is added to the origin in the entry to select an entry in the next-lower-level table. If the selected entry in the next table is outside its table, as determined by the table-offset and table-length fields in the current table entry, or if the I bit is one in the selected entry, a region-second-translation, region-third-translation, or, when applicable, segment-translation exception is recognized, depending on the level of the next table. If the table-type bits in the selected entry do not indicate the expected table level, a translation-specification exception is recognized.

Processing of portions of the virtual address continues by means of any successive table levels until a leaf table entry is reached. When EDAT-1 applies, the DAT-protection bit in any and all region-table entries used during the translation are treated as being ORed with the respective bit in any segment-table entry used in the translation.

When EDAT-2 applies, the region-third-table entry contains a common-region bit that controls the use of the TLB copies of any lower-level tables designated by the region-third-table entry. The common-region bit is logically ORed with the common-segment bit of any segment-table entry used in the translation.

When EDAT-2 applies and a region-third-table entry in which the RTTE-format control is one is selected,

the region-third-table entry is the leaf table entry, and the following conditions are in effect:

- The region-third-table entry contains the leftmost 33 bits of the absolute address that represents the translation of the virtual address.
- The segment-index, page-index and byte-index fields of the virtual address are used unchanged as the rightmost 31 bit positions of the real address.
- The region-third-table entry also contains the ACCF-validity control, the access-control bits, the fetch-protection bit, the DAT-protection bit, and the common-region bit that apply to the region. When the instruction-execution-protection facility is enabled, the region-third-table entry also contains the instruction-execution-protection control that applies to the region.

When EDAT-1 applies and a segment-table entry in which the STE-format control is one is selected, the segment-table entry is the leaf table entry, the following conditions are in effect:

- The segment-table entry contains the leftmost bits of the absolute address that represents the translation of the virtual address.
- The page-index and byte-index fields of the virtual address are used unchanged as the rightmost bit positions of the real address.
- The segment-table entry also contains the ACCF-validity control, the access-control bits, the fetch-protection bit, the DAT-protection bit, and common-segment bit that apply to the segment. When the instruction-execution-protection facility is enabled, the segment-table entry also contains the instruction-execution-protection control that applies to the segment.

When EDAT-1 does not apply, or when EDAT-1 applies but the STE-format control is zero, the following conditions are in effect:

- The segment-table entry contains a DAT-protection bit that applies to all pages in the specified segment; the segment-table entry also contains a common-segment bit that controls the use of the TLB copies of the page table designated by the segment-table entry.

- The segment-table entry designates the page table to be used, and the page-table entry is the leaf table entry.
- The page-index portion of the virtual address is added to the page-table origin in the segment-table entry to select an entry in the page table. If the I bit is one in the page-table entry, a page-translation exception is recognized. The page-table entry contains the leftmost bits of the real address that represents the translation of the virtual address, and it contains a DAT-protection bit that applies only to the page specified by the page-table entry. When the instruction-execution-protection facility is enabled, the page-table entry also contains the instruction-execution-protection control that applies to the page.
- The byte-index field of the virtual address is used unchanged as the rightmost bit positions of the real address.

In order to eliminate the delay associated with references to translation tables in real or absolute storage, the information fetched from the tables normally is also placed in a special buffer, the translation-lookaside buffer (TLB), and subsequent translations involving the same table entries may be performed by using the information recorded in the TLB. The TLB may also record virtual-equals-real translations related to a real-space designation. The operation of

the TLB is described in “Translation-Lookaside Buffer” on page 3-62.

Whenever access to real or absolute storage is made during the address-translation process for the purpose of fetching an entry from a region table, segment table, or page table, key-controlled protection does not apply.

The translation process, including the effect of the TLB, is shown graphically in Figure 3-16 on page 3-55.

Inspection of Real-Space Control

When the effective address-space-control element (ASCE) contains a real-space control, bit 58, having the value zero, the ASCE is a region-table or segment-table designation. When the real-space control is one, the ASCE is a real-space designation.

Inspection of Designation-Type Control

When the real-space control is zero, the designation-type control, bits 60 and 61 of the effective address-space-control element (ASCE), specifies the table-designation type of the ASCE. Depending on the type, some number of leftmost bits of the virtual address being translated must be zeros; otherwise, an ASCE-type exception is recognized. For each possible value of bits 60 and 61, the table-designa-

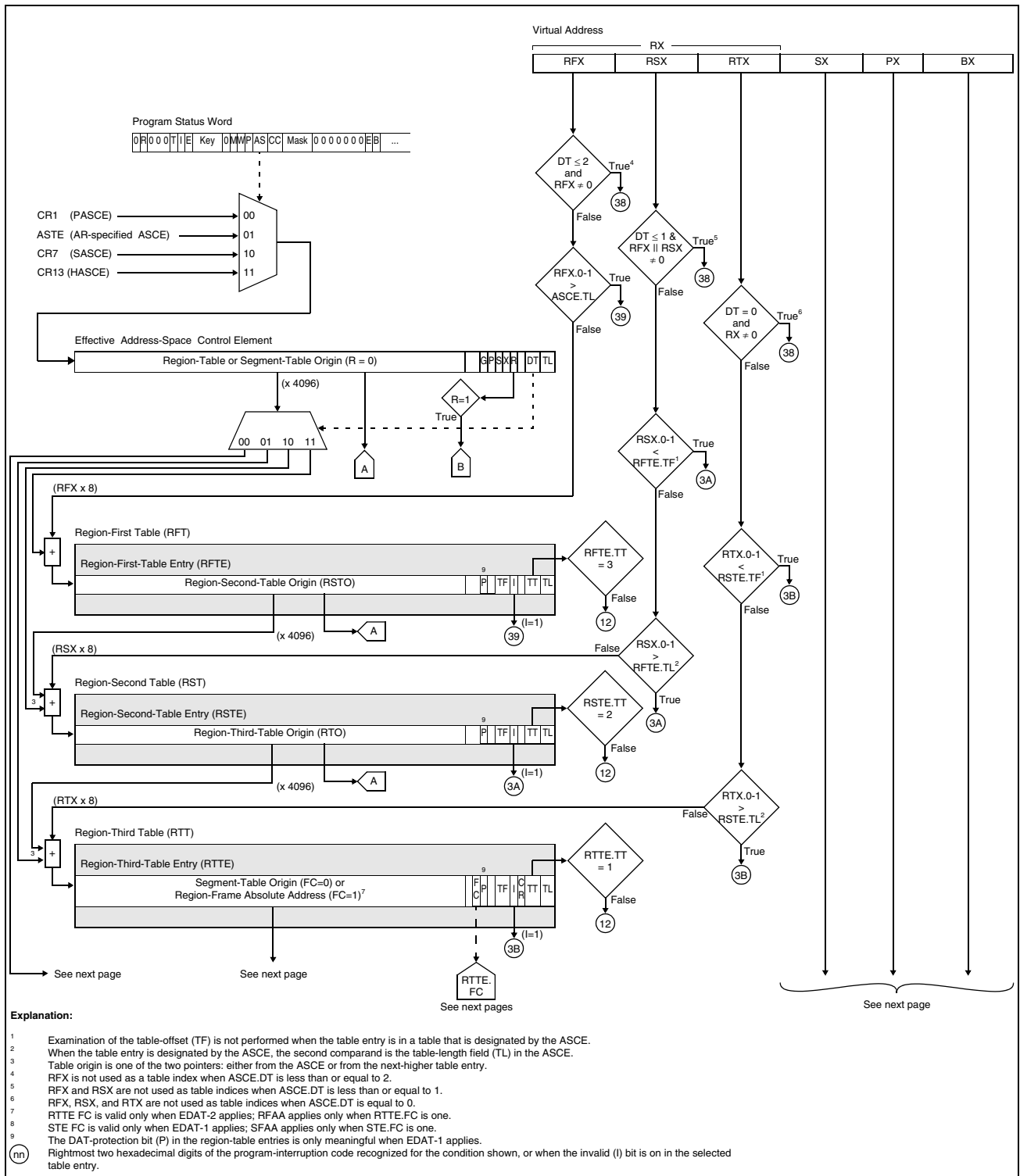

Figure 3-16. Translation Process (Part 1 of 3)

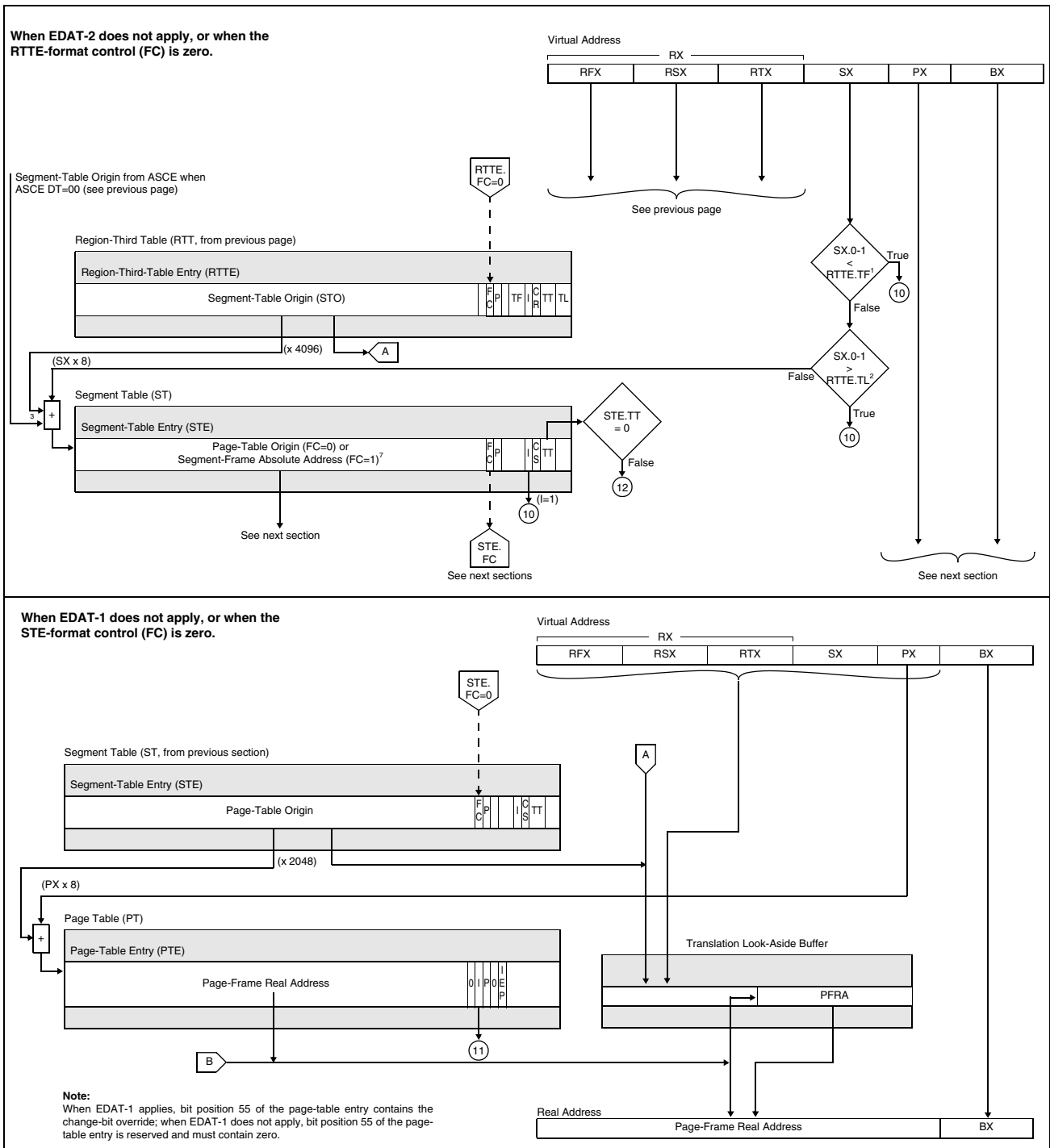

Figure 3-16. Translation Process (Part 2 of 3)

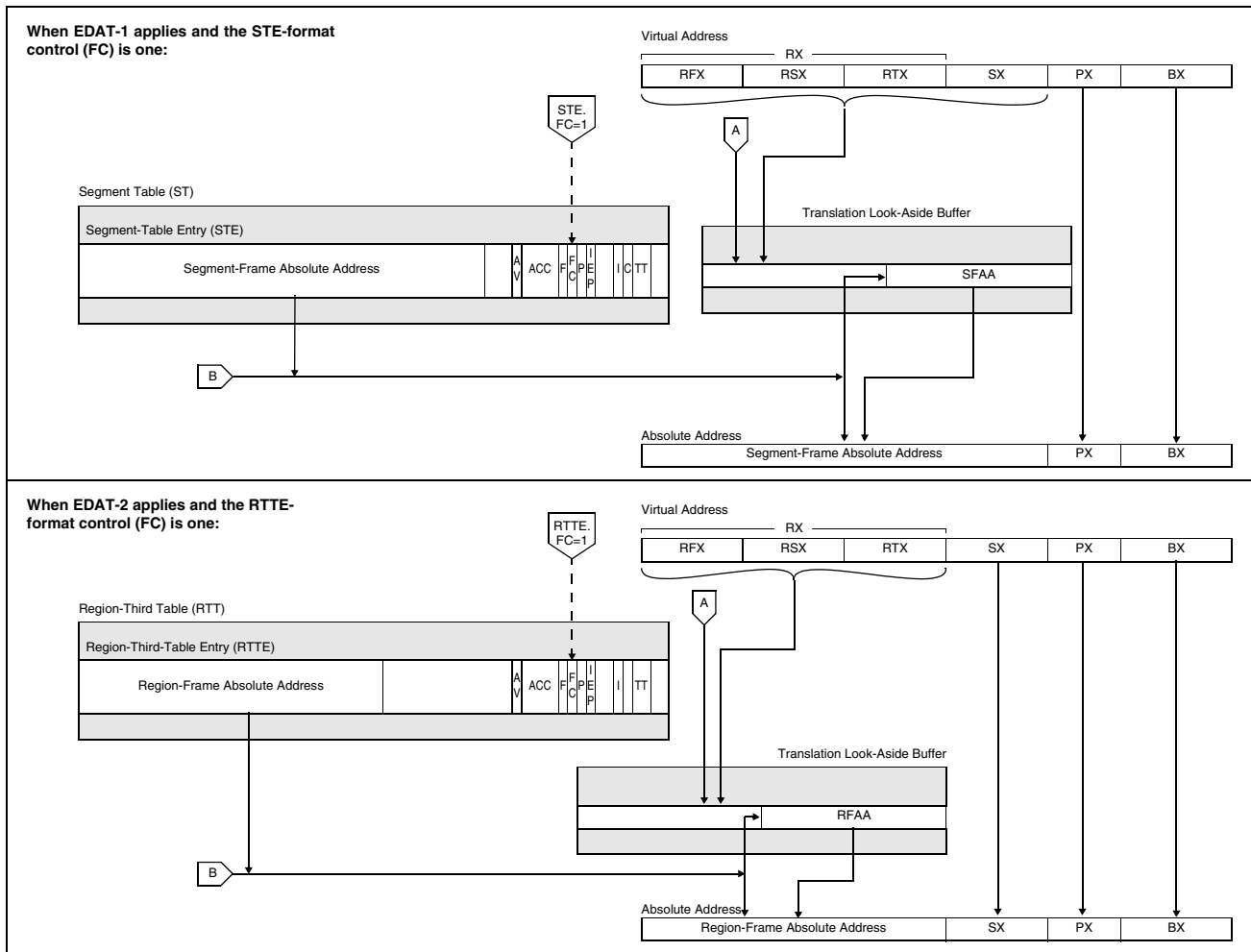

Figure 3-16. Translation Process (Part 3 of 3)

tion type and the virtual-address bits required to be zeros are as follows:

Bits 60 and 61	Designation Type	Virtual-Address Bits Required to be Zeros
11	Region-first-table	None
10	Region-second-table	0-10
01	Region-third-table	0-21
00	Segment-table	0-32

Lookup in a Table Designated by an Address-Space-Control Element

The designation-type control, bits 60 and 61 of the effective address-space-control element (ASCE), specifies both the table-designation type of the ASCE and the portion of the virtual address that is to be

translated by means of the designated table, as follows:

Bits 60 and 61	Designation Type	Virtual-Address Portion Translated by the Table
11	Region-first-table	Region first index (bits 0-10)
10	Region-second-table	Region second index (bits 11-21)
01	Region-third-table	Region third index (bits 22-32)
00	Segment-table	Segment index (bits 33-43)

Region-First-Table Lookup: When bits 60 and 61 have the value 11 binary, the region-first-index portion of the virtual address, in conjunction with the

region-first-table origin contained in the ASCE, is used to select an entry from the region first table.

The 64-bit address of the region-first-table entry in real or absolute storage is obtained by appending 12 zeros to the right of bits 0-51 of the region-first-table designation and adding the region first index with three rightmost and 50 leftmost zeros appended. When a carry out of bit position 0 occurs during the addition, an addressing exception may be recognized, or the carry may be ignored, causing the table to wrap from $2^{64} - 1$ to zero. All 64 bits of the address are used, regardless of whether the current PSW specifies the 24-bit, 31-bit, or 64-bit addressing mode. When forming the address of a region-first-, region-second-, region-third-, or segment-table entry, it is unpredictable whether prefixing, if any, is applied to the respective table origin contained in the ASCE before the addition of the table index value, or prefixing is applied to the table-entry address that is formed by the addition of the table origin and table index value.

As part of the region-first-table-lookup process, bits 0 and 1 of the virtual address (which are bits 0 and 1 of the region first index) are compared against the table length, bits 62 and 63 of the region-first-table designation, to establish whether the addressed entry is within the region first table. If the value in the table-length field is less than the value in the corresponding bit positions of the virtual address, a region-first-translation exception is recognized. The comparison against the table length may be omitted if the equivalent of a region-first-table entry in the translation-lookaside buffer is used in the translation.

All eight bytes of the region-first-table entry appear to be fetched concurrently as observed by other CPUs. The fetch access is not subject to protection. When the storage address generated for fetching the region-first-table entry designates a location which is not available in the configuration, an addressing exception is recognized, and the unit of operation is suppressed.

Bit 58 of the entry fetched from the region first table specifies whether the corresponding set of regions is available. This bit is inspected, and, if it is one, a region-first-translation exception is recognized.

A translation-specification exception is recognized if the table-type bits, bits 60 and 61, in the region-first-table entry do not have the same value as bits 60 and 61 of the ASCE.

When no exceptions are recognized in the process of region-first-table lookup, the entry fetched from the region first table designates the beginning and specifies the offset and length of the corresponding region second table.

Region-Second-Table Lookup: When bits 60 and 61 of the ASCE have the value 10 binary, the region-second-index portion of the virtual address, in conjunction with the region-second-table origin contained in the ASCE, is used to select an entry from the region second table. Bits 11 and 12 of the virtual address (which are bits 0 and 1 of the region second index) are compared against the table length in the ASCE. If the value in the table-length field is less than the value in the corresponding bit positions of the virtual address, a region-second-translation exception is recognized. The comparison against the table length may be omitted if the equivalent of a region-second-table entry in the translation-lookaside buffer is used in the translation. The region-second-table-lookup process is otherwise the same as the region-first-table-lookup process, except that a region-second-translation exception is recognized if bit 58 is one in the region-second-table entry. When no exceptions are recognized, the entry fetched from the region second table designates the beginning and specifies the offset and length of the corresponding region third table.

Region-Third-Table Lookup: When bits 60 and 61 of the ASCE have the value 01 binary, the region-third-index portion of the virtual address, in conjunction with the region-third-table origin contained in the ASCE, is used to select an entry from the region third table. Bits 22 and 23 of the virtual address (which are bits 0 and 1 of the region third index) are compared against the table length in the ASCE. If the value in the table-length field is less than the value in the corresponding bit positions of the virtual address, a region-third-translation exception is recognized. The comparison against the table length may be omitted if the equivalent of a region-third-table entry in the translation-lookaside buffer is used in the translation. When EDAT-2 applies, a translation-specification exception is recognized if (1) the private-space control, bit 55, in the ASCE is one and (2) the common-region bit, bit 59, in the entry fetched from the region-third table is one. The region-third-table-lookup process is otherwise the same as the region-first-table-lookup process, including the checking of the table-type bits in the region-third-table entry, except that a region-third-translation exception is recognized if bit 58 is one in the region-third-table entry.

When no exceptions are recognized, processing is as follows:

- When EDAT-2 does not apply, or when EDAT-2 applies but the RTTE-format control is zero, the entry fetched from the region third table designates the beginning and specifies the offset and length of the corresponding segment table.
- When EDAT-2 applies and the RTTE-format control is one, the entry fetched from the region-third table is a leaf-table entry and contains the left-most bits of the region-frame absolute address. In this case, if (a) the instruction-execution-protection facility is enabled, (b) the storage reference for which the translation is being performed is for instruction execution, and (c) the instruction-execution-protection control, bit 55, is one, then a protection exception is recognized.
- Regardless of the RTTE-format control, if (a) EDAT-2 applies, (b) the DAT-protection bit, bit 54, is one either in any region-table entry used in the translation, and (c) the storage reference for which the translation is being performed is a store, then a protection exception is recognized.

Segment-Table Lookup: When bits 60 and 61 of the ASCE have the value 00 binary, the segment-index portion of the virtual address, in conjunction with the segment-table origin contained in the ASCE, is used to select an entry from the segment table. Bits 33 and 34 of the virtual address (which are bits 0 and 1 of the segment index) are compared against the table length in the ASCE. If the value in the table-length field is less than the value in the corresponding bit positions of the virtual address, a segment-translation exception is recognized. The comparison against the table length may be omitted if the equivalent of a segment-table entry in the translation-lookaside buffer is used in the translation. A translation-specification exception is recognized if (1) the private-space control, bit 55, in the ASCE is one and (2) the common-segment bit, bit 59, in the entry fetched from the segment table is one. When EDAT-2 applies and the common-region bit is one in a region-third-table entry designating the segment table, then the common-segment bit is assumed to be one in all entries in the segment table. The segment-table-lookup process is otherwise the same as the region-first-table-lookup process, including the checking of the table-type bits in the segment-table entry, except that a segment-translation exception is recognized if

bit 58 is one in the segment-table entry. When no exceptions are recognized, processing is as follows:

- When EDAT-1 does not apply, or when EDAT-1 applies but the STE-format control is zero, the entry fetched from the segment table designates the beginning of the corresponding page table, and processing continues as described in “Page-Table Lookup”, below.
- When EDAT-1 applies and the STE-format control is one, the entry fetched from the segment table is a leaf-table entry and contains the left-most bits of the segment-frame absolute address. In this case, if (a) the instruction-execution-protection facility is enabled, (b) the storage reference for which the translation is being performed is for instruction execution, and (c) the instruction-execution-protection control, bit 55, is one, then a protection exception is recognized.
- Regardless of the STE-format control, if (a) EDAT-1 applies, (b) the DAT-protection bit, bit 54, is one either in any region-table entry used in the translation or in the segment-table entry, and (c) the storage reference for which the translation is being performed is a store, then a protection exception is recognized.

Lookup in a Table Designated by a Region-Table Entry

When the effective address-space-control element (ASCE) is a region-table designation, a region-table entry is selected as described in the preceding section. Then the contents of the selected entry and the next index portion of the virtual address are used to select an entry in the next-lower-level table, which may be another region table or a segment table.

Region-Second-Table Lookup: When the table entry selected by means of the ASCE is a region-first-table entry, the region-second-index portion of the virtual address, in conjunction with the region-second-table origin contained in the region-first-table entry, is used to select an entry from the region second table.

The 64-bit address of the region-second-table entry in real or absolute storage is obtained by appending 12 zeros to the right of bits 0-51 of the region-first-table entry and adding the region second index with three rightmost and 50 leftmost zeros appended. When a carry out of bit position 0 occurs during the addition, an addressing exception may be recog-

nized, or the carry may be ignored, causing the table to wrap from $2^{64} - 1$ to zero. All 64 bits of the address are used, regardless of whether the current PSW specifies the 24-bit, 31-bit, or 64-bit addressing mode. When forming the address of a region-second-, region-third-, or segment-table entry, it is unpredictable whether prefixing, if any, is applied to the respective table origin contained in the higher-level table entry before the addition of the table index value, or prefixing is applied to the table-entry address that is formed by the addition of the table origin and table index value.

As part of the region-second-table-lookup process, bits 11 and 12 of the virtual address (which are bits 0 and 1 of the region second index) are compared against the table offset, bits 56 and 57 of the region-first-table entry, and against the table length, bits 62 and 63 of the region-first-table entry, to establish whether the addressed entry is within the region second table. If the value in the table-offset field is greater than the value in the corresponding bit positions of the virtual address, or if the value in the table-length field is less than the value in the corresponding bit positions of the virtual address, a region-second-translation exception is recognized.

All eight bytes of the region-second-table entry appear to be fetched concurrently as observed by other CPUs. The fetch access is not subject to protection. When the storage address generated for fetching the region-second-table entry designates a location which is not available in the configuration, an addressing exception is recognized, and the unit of operation is suppressed.

Bit 58 of the entry fetched from the region second table specifies whether the corresponding set of regions is available. This bit is inspected, and, if it is one, a region-second-translation exception is recognized.

A translation-specification exception is recognized if the table-type bits, bits 60 and 61, in the region-second-table entry do not have a value that is one less than the value of those bits in the next-higher-level table.

When no exceptions are recognized in the process of region-second-table lookup, the entry fetched from the region second table designates the beginning and specifies the offset and length of the corresponding region third table.

Region-Third-Table Lookup: When the table entry selected by means of the ASCE is a region-second-table entry, or if a region-second-table entry has been selected by means of the contents of a region-first-table entry, the region-third-index portion of the virtual address, in conjunction with the region-third-table origin contained in the region-second-table entry, is used to select an entry from the region third table. Bits 22 and 23 of the virtual address (which are bits 0 and 1 of the region third index) are compared against the table offset and table length in the region-second-table entry. A region-third-translation exception is recognized if the table offset is greater than bits 22 and 23 or if the table length is less than bits 22 and 23. When EDAT-2 applies, a translation-specification exception is recognized if (1) the private-space control, bit 55, in the ASCE is one and (2) the common-region bit, bit 59, in the entry fetched from the region-third table is one. The region-third-table-lookup process is otherwise the same as the region-second-table-lookup process, including the checking of the table-type bits in the region-third-table entry, except that a region-third-translation exception is recognized if bit 58 is one in the region-third-table entry.

When no exceptions are recognized, processing is as follows:

- When EDAT-2 does not apply, or when EDAT-2 applies but the RTTE-format control is zero, the entry fetched from the region third table designates the beginning and specifies the offset and length of the corresponding segment table.
- When EDAT-2 applies and the RTTE-format control is one, the entry fetched from the region-third table is a leaf-table entry and contains the left-most bits of the region-frame absolute address. In this case, if (a) the instruction-execution-protection facility is enabled, (b) the storage reference for which the translation is being performed is for instruction execution, and (c) the instruction-execution-protection control, bit 55, is one, then a protection exception is recognized.
- Regardless of the RTTE-format control, if (a) EDAT-2 applies, (b) the DAT-protection bit, bit 54, is one either in any region-table entry used in the translation, and (c) the storage reference for which the translation is being performed is a store, then a protection exception is recognized.

Segment-Table Lookup: When (1) the table entry selected by means of the ASCE is a region-third-table entry, or a region-third-table entry has been selected by means of the contents of a region-second-table entry, and (2) EDAT-2 does not apply, or EDAT-2 applies but the RTTE-format control is zero, then the segment-index portion of the virtual address, in conjunction with the segment-table origin contained in the region-third-table entry, is used to select an entry from the segment table. Bits 33 and 34 of the virtual address (which are bits 0 and 1 of the segment index) are compared against the table offset and table length in the region-third-table entry. A segment-translation exception is recognized if the table offset is greater than bits 33 and 34 or if the table length is less than bits 33 and 34. A translation-specification exception is recognized if (1) the private-space control, bit 55, in the ASCE is one and (2) the common-segment bit, bit 59, in the entry fetched from the segment table is one. When EDAT-2 applies and the common-region bit is one in a region-third-table entry designating the segment table, then the common-segment bit is assumed to be one in all entries in the segment table. The segment-table-lookup process is otherwise the same as the region-second-table-lookup process, including the checking of the table-type bits in the segment-table entry, except that a segment-translation exception is recognized if bit 58 is one in the segment-table entry. When no exceptions are recognized, processing is as follows:

- When EDAT-1 does not apply, or when EDAT-1 applies but the STE-format control is zero, the entry fetched from the segment table designates the beginning of the corresponding page table, and processing continues as described in “Page-Table Lookup”, below.
- When EDAT-1 applies and the STE-format control is one, the entry fetched from the segment table is a leaf-table entry and contains the leftmost bits of the segment-frame absolute address. In this case, if (a) the instruction-execution-protection facility is enabled, (b) the storage reference for which the translation is being performed is for instruction execution, and (c) the instruction-execution-protection control, bit 55, is one, then a protection exception is recognized.
- Regardless of the STE-format control, if (a) EDAT-1 applies, (b) the DAT-protection bit, bit 54, is one either in any region-table entry used in the translation or in the segment-table entry, and

(c) the storage reference for which the translation is being performed is a store, then a protection exception is recognized.

Page-Table Lookup

When EDAT-1 does not apply, or when EDAT-1 applies but the STE-format control is zero, the page-index portion of the virtual address, in conjunction with the page-table origin contained in the segment-table entry, is used to select an entry from the page table.

The 64-bit address of the page-table entry in real or absolute storage is obtained by appending 11 zeros to the right of the page-table origin and adding the page index, with three rightmost and 53 leftmost zeros appended. A carry out of bit position 0 cannot occur. All 64 bits of the address are used, regardless of whether the current PSW specifies the 24-bit, 31-bit, or 64-bit addressing mode.

All eight bytes of the page-table entry appear to be fetched concurrently as observed by other CPUs. The fetch access is not subject to protection. When the storage address generated for fetching the page-table entry designates a location which is not available in the configuration, an addressing exception is recognized, and the unit of operation is suppressed.

The entry fetched from the page table is a leaf-table entry and indicates the availability of the page. If the page is available, the entry contains the leftmost bits of the page-frame real address.

- The page-invalid bit, bit 53, is inspected to establish whether the corresponding page is available. If this bit is one, a page-translation exception is recognized.
- If bit position 52 contains a one, a translation-specification exception is recognized.
- When EDAT-1 does not apply, and the instruction-execution-protection facility is not installed in the machine, a translation-specification exception is also recognized if bit position 55 contains a one. When EDAT-1 applies, but either the instruction-execution-protection facility is not installed in the machine, or the facility is installed but not enabled, bit 55 is ignored. Regardless of whether EDAT-1 applies, if (a) the instruction-execution-protection facility is enabled, (b) the storage reference for which the translation is being performed is for instruction execution, and

(c) the instruction-execution-protection control, bit 55, is one in the leaf-table entry, then a protection exception is recognized.

- If the DAT-protection bit, bit 54, is one either in the segment-table entry used in the translation, in the page-table entry, or, when EDAT-1 applies, in any region-table entry used during the translation, and the storage reference for which the translation is being performed is a store, a protection exception is recognized.

Formation of the Real and Absolute Addresses

When the effective address-space-control element (ASCE) is a real-space designation, bits 0-63 of the virtual address are used directly as the real storage address. The real address is then subjected to prefixing to form an absolute address.

When the effective ASCE is not a real-space designation and no exceptions in the translation process are encountered, the following conditions apply:

- When EDAT-2 applies and the RTTE-format control is one, the region-frame absolute address and the segment-index, page-index and byte-index portions of the virtual address are concatenated, left to right, respectively, to form the absolute address which corresponds to the virtual address.
- When EDAT-1 applies and the STE-format control is one, the segment-frame absolute address and the page-index and byte-index portions of the virtual address are concatenated, left to right, respectively, to form the absolute address which corresponds to the virtual address.
- When EDAT-1 does not apply, or when EDAT-1 applies but the STE format control is zero, the page-frame real address is obtained from the page-table entry. The page-frame real address and the byte-index portion of the virtual address are concatenated, with the page-frame real address forming the leftmost part. The result is the real storage address which corresponds to the virtual address. The real address is then subjected to prefixing to form an absolute address.

All 64 bits of the real and absolute addresses are used, regardless of whether the current PSW specifies the 24-bit, 31-bit, or 64-bit addressing mode.

Recognition of Exceptions during Translation

Invalid addresses and invalid formats can cause exceptions to be recognized during the translation process. Exceptions are recognized when information contained in table entries is used for translation and is found to be incorrect. When the storage reference for which the translation is being performed is a store, a protection exception can be recognized when the DAT-protection bit is on in the segment, or page-table entry, or, when EDAT-1 applies, in any region-table entry used in the translation. When the instruction-execution-protection facility is enabled, a protection exception can be recognized when the instruction-execution-protection control is one in the leaf-table entry used in the translation.

The information pertaining to DAT is considered to be used when an instruction is executed with DAT on, when the enhanced-monitor counting array is accessed, or when COMPARE AND REPLACE DAT TABLE ENTRY, INVALIDATE DAT TABLE ENTRY, INVALIDATE PAGE TABLE ENTRY, LOAD PAGE-TABLE-ENTRY ADDRESS, LOAD REAL ADDRESS, or STORE REAL ADDRESS is executed. The information is not considered to be used when the PSW specifies DAT on but an I/O, external, restart, or machine-check interruption occurs before an instruction is executed, or when the PSW specifies the wait state. Only that information required in order to translate a virtual address is considered to be in use during the translation of that address, and, in particular, addressing exceptions that would be caused by the use of an address-space-control element are not recognized when that address-space-control element is not the one actually used in the translation.

A list of translation exceptions, with the action taken for each exception and the priority in which the exceptions are recognized when more than one is applicable, is provided in "Recognition of Access Exceptions" on page 6-47.

Translation-Lookaside Buffer

To enhance performance, the dynamic-address-translation mechanism normally is implemented such that some of the information specified in the region tables, segment tables, and page tables is maintained in a special buffer, referred to as the translation-lookaside buffer (TLB). The CPU necessarily refers to a DAT-table entry in real or absolute storage only for the initial access to that entry. This informa-

tion may be placed in the TLB, and subsequent translations may be performed by using the information in the TLB. For consistency of operation, the virtual-equals-real translation specified by a real-space designation also may be performed by using information in the TLB. The presence of the TLB affects the translation process to the following extent:

1. A modification of the contents of a table entry in real or absolute storage does not necessarily have an immediate effect, if any, on the translation.
2. A region-first-table origin, region-second-table origin, region-third-table origin, segment-table origin, or real-space token origin in an address-space-control element (ASCE) may select a TLB entry that was formed by means of an ASCE containing a table or token origin of the same value even when the two origins were obtained from either (a) ASCEs having differing real-space controls or (b) ASCEs having differing designation-type controls (when the real-space controls are zero).
3. The comparison against the table length in an address-space-control element may be omitted if a TLB equivalent of the designated table is used. In a multiple-CPU configuration, each CPU has its own TLB.

Entries within the TLB are not explicitly addressable by the program.

Information is not necessarily retained in the TLB under all conditions for which such retention is permissible. Furthermore, information in the TLB may be cleared under conditions additional to those for which clearing is mandatory.

TLB Structure

The description of the logical structure of the TLB covers the implementation by all systems operating as defined by z/Architecture. The TLB entries are considered as being of six types: TLB region-first-table entries, TLB region-second-table entries, TLB region-third-table entries (collectively called TLB region-table entries), TLB segment-table entries, TLB page-table entries, and TLB real-space entries. A TLB region-table entry, TLB segment-table entry, or TLB page-table entry is considered as containing within it both the information obtained from the table entry in real or absolute storage and the attributes used to fetch this information from storage. A TLB

real-space entry is considered as containing a page-frame real address and the real-space token origin and region, segment, and page indexes used to form the entry.

Any applicable TLB region-table entries, the TLB segment-table entry, and the TLB page-table entry may be merged into a single entry called a TLB composite table entry. In a similar manner, an implementation may combine any contiguous subset of table levels. When this happens, the intermediate table origins, offsets, and lengths need not be buffered.

An equivalent to the TLB combined region-and-segment-table entry (CRSTE), described in previous versions of the architecture, may be formed which maps a table origin, region index, segment index, and common-segment bit to a segment-frame absolute address or page-table origin (and other designated fields).

The token origin in a TLB real-space entry is indistinguishable from the table origin in a TLB composite-, region-, or segment-table entry.

Note: The following sections describe the conditions under which information may be placed in the TLB, the conditions under which information from the TLB may be used for address translation, and how changes to the translation tables affect the translation process.

Formation of TLB Entries

The formation of TLB region-table entries, TLB segment-table entries and TLB page-table entries from table entries in real or absolute storage, and the effect of any manipulation of the contents of table entries in storage by the program, depend on whether the entries in storage are attached to a particular CPU and on whether the entries are valid.

The *attached* state of a table entry denotes that the CPU to which it is attached can attempt to use the table entry for implicit address translation, except that a table entry for the primary or home address space may be attached even when the CPU does not fetch from either of those spaces. A table entry may be attached to more than one CPU at a time.

The *valid* state of a table entry denotes that the region, segment, or page associated with the table entry is available. An entry is valid when the region-

invalid, segment-invalid, or page-invalid bit in the entry is zero.

A region-table entry, segment-table entry, or page-table entry may be placed in the TLB whenever the entry is attached and valid and would not cause a translation-specification exception if used for translation.

The region-table entries, if any, and the segment-table entry, if any, used to translate a virtual address are called a *translation path*. The highest-level table entry in a translation path is attached when it is within a table designated by an attaching address-space-control element (ASCE). “Within a table” means as determined by the origin and length fields in the ASCE. An ASCE is an attaching ASCE when all of the following conditions are met:

1. The current PSW specifies DAT on.
2. The current PSW contains no errors that would cause an early specification exception to be recognized.
3. The ASCE meets the requirements in a, b, c, or d, below.
 - a. The ASCE is the primary ASCE in control register 1.
 - b. The ASCE is the secondary ASCE in control register 7, and any of the following requirements is met:
 - The CPU is in the secondary-space mode or access-register mode.
 - The CPU is in the primary-space mode, and the secondary-space control, bit 37 of control register 0, is one.
 - The M_4 operand of LOAD PAGE TABLE ENTRY ADDRESS explicitly allows access to the secondary space or explicitly allows access-register translation.
 - Either operand’s operand-access control (OAC) of MOVE WITH OPTIONAL SPECIFICATIONS explicitly allows access to the secondary space or explicitly allows access-register translation.

For further explanation of the term “explicitly allows,” used in the above two items, see the programming note, below.

c. The ASCE is in either an attached and valid ASN-second-table entry (ASTE) or a usable ALB ASTE, and any of the following requirements is met:

- The CPU is in the access-register mode.
- The M_4 field of LOAD PAGE TABLE ENTRY ADDRESS explicitly allows access-register translation to be performed.
- Either operand’s OAC of MOVE WITH OPTIONAL SPECIFICATIONS explicitly allows access-register translation to be performed.

See the programming note, below, for further explanation. See “ART-Lookaside Buffer” on page 5-64 for the meaning of the terminology used here.

d. The ASCE is the home ASCE in control register 13.

Regardless of whether DAT is on or off, an ASCE is also an attaching ASCE when the current PSW contains no errors that would cause an early specification exception to be recognized, and any of the following conditions is met:

- The home ASCE is considered to be an attaching ASCE when a monitor-event counting operation occurs.

Each of the remaining table entries in a translation path is attached when it is within the table designated either by an attached and valid entry of the next higher level which would not cause a translation-specification exception if used for translation or by a usable TLB entry of the next higher level. “Within the table” means as determined by the origin, offset, and length fields in the next-higher-level entry. A usable TLB entry is explained in the next section.

A page-table entry is attached when it is within the page table designated by either an attached and valid segment-table entry that would not cause a translation-specification exception if used for translation or a usable TLB segment-table entry.

A region-table entry or segment-table entry causes a translation-specification exception if the table-type bits, bits 60 and 61, in the entry are inconsistent with the level at which the entry would be encountered

when using the translation path in the translation process. A segment-table entry also causes a translation-specification exception if the private-space-control bit is one in the address-space-control element used to select it and the common-segment bit is one in the entry. When EDAT-2 applies, a region-third-table entry also causes a translation-specification exception if the private-space-control bit is one in the address-space-control element used to select it and the common-region bit is one in the entry. A page-table entry causes a translation-specification exception if bit 52 in the entry is one. When EDAT-1 does not apply, a page-table entry also causes a translation-specification exception if bit 55 in the entry is one.

When the instruction-execution-protection facility is enabled, and the instruction-execution-protection control is one in the leaf table entry, a TLB entry or composite TLB entry of the appropriate level may be formed even if a protection exception is recognized. Alternatively, when an instruction-execution-protection exception is recognized, the formation of the TLB entry may be bypassed.

A TLB real-space entry may be formed whenever an attaching real-space designation exists. The entry is formed using the real-space token origin in the designation and any value of bits 0-51 of a virtual address.

Subject to the attached and valid constraints defined above, the CPU may form TLB entries in anticipation of future storage references or as a result of the speculative execution of instructions. See “Overlapped Operation of Instruction Execution” on page 5-114 for additional details.

Programming Note: In the above list of conditions for an ASCE to be attaching, item 3.b and 3.c use the term “explicitly allows ...”, as explained below:

- LPTEA explicitly allows access to the secondary space when the M_4 field is 0010 binary.
- LPTEA explicitly allows ART to be performed when the M_4 field is 0001 binary.
- Either operand of MVCOS explicitly allows access to the secondary space when bits 8-9 of the operand’s OAC are 10 binary, bit 15 of the OAC is one, and the secondary-space control, bit 37 of control register 0, is one.

- Either operand of MVCOS explicitly allows ART to be performed when bits 8-9 of the operand’s OAC are 01 binary, and bit 15 of the OAC is one.

Use of TLB Entries

The *usable* state of a TLB entry denotes that the CPU can attempt to use the TLB entry for implicit address translation. A usable TLB entry attaches the next-lower-level table, if any, and may be usable for a particular instance of implicit address translation.

With reference to a TLB entry, the term “current level” refers to the level of translation table (region first table, region second table, region third table, segment table, or page table) from which the TLB entry was formed. Likewise, the “current-level index” is that portion of the virtual address used as an index into the current level of translation table.

A TLB region- or segment-table entry is in the usable state when all of the following conditions are met:

1. The current PSW specifies DAT on.
2. The current PSW contains no errors that would cause an early specification exception to be recognized.
3. The TLB entry meets at least one of the following requirements:
 - a. The common-region bit is one in a TLB region-third-table entry.
 - b. The common-segment bit is one in a TLB segment-table entry.
 - c. The ASCE-table-origin (ASCETO) field in the TLB entry matches the table- or token-origin field in an attaching address-space-control element.
 - d. The TLB entry is a TLB region-second-table, region-third-table, or segment-table entry, and the current-level table-origin field in the TLB entry matches one of the following:
 - The table-origin field in an attaching ASCE which directly designates the current table level (as indicated by the R and DT bits)
 - The table-origin field in an attached region-table entry of the next higher level

- The table-origin field of the same level in a usable TLB region-table entry of the next higher level

A TLB region-table entry may be used for a particular instance of implicit address translation only when the entry is in the usable state, the current-level index field in the TLB entry matches the corresponding index field of the virtual address being translated, and any of the following conditions is met:

1. The ASCE-table-origin (ASCETO) field in the TLB entry matches the table- or token-origin field in the address-space-control element being used in the translation, and the portion of the virtual address being translated which is to the left of the current-level index matches the corresponding index fields in the TLB entry.
2. The address-space-control element being used in the translation designates a table of the current level, and the current-level table-origin field in the TLB entry matches the table origin in that address-space-control element.
3. The current-level table-origin field in the TLB entry matches the table origin of the same level in the next-higher-level table entry or TLB entry being used in the translation.
4. For a TLB region-third-table entry, the common-region bit is one in the TLB entry, and the region-first-index and region-second-index fields in the TLB entry matches those of the virtual address being translated.

However, when EDAT-2 applies, the TLB region-third-table entry is not used if the common-region bit is one in the entry and either the private-space-control bit is one in the address-space-control element being used in the translation or that address-space-control element is a real-space designation. In both these cases, the TLB entry is not used even if the ASCE-table-origin (ASCETO) field in the entry and the table- or token-origin field in the address-space-control element match.

A TLB segment-table entry may be used for a particular instance of implicit address translation only when the entry is in the usable state, the segment-index field in the TLB entry matches that of the virtual address being translated, and any of the following conditions is met:

1. The ASCE-table-origin (ASCETO) field in the TLB entry matches the table- or token-origin field in the address-space-control element being used in the translation, and the region-index field in the TLB entry matches that of the virtual address being translated.
2. The segment-table-origin field in the TLB entry matches the table-origin field in the address-space-control element being used in the translation, and that address-space-control element is a segment-table designation.
3. The segment-table-origin field in the TLB entry matches the segment-table-origin field in the region-third-table entry or TLB region-third-table entry being used in the translation.
4. The common-segment bit is one in the TLB entry, and the region-index field in the TLB entry matches that of the virtual address being translated.

However, the TLB segment-table entry is not used if the common-segment bit is one in the entry and either the private-space-control bit is one in the address-space-control element being used in the translation or that address-space-control element is a real-space designation. In both these cases, the TLB entry is not used even if the ASCE-table-origin (ASCETO) field in the entry and the table- or token-origin field in the address-space-control element match.

A TLB page-table entry may be used for a particular instance of implicit address translation only when the page-table-origin field in the entry matches the page-table-origin field in the segment-table entry or TLB segment-table entry being used in the translation and the page-index field in the TLB page-table entry matches the page index of the virtual address being translated.

A TLB real-space entry may be used for implicit address translation only when the token-origin field in the TLB entry matches the table- or token-origin field in the address-space-control element being used in the translation and the region-index, segment-index, and page-index fields in the TLB entry match those of the virtual address being translated

The operand addresses of LOAD PAGE-TABLE-ENTRY ADDRESS, LOAD REAL ADDRESS, and STORE REAL ADDRESS, and accesses to the enhanced-monitor counting array may be translated

with the use of the TLB contents whether DAT is on or off. However, for LOAD PAGE-TABLE-ENTRY ADDRESS, LOAD REAL ADDRESS, and STORE REAL ADDRESS, TLB entries still are formed only if DAT is on.

Programming Notes:

1. Although contents of a table entry may be copied into the TLB only when the table entry is both attached and valid, the copy may remain in the TLB even when the table entry itself is no longer attached or valid.
2. Except when translations are performed as a result of enhanced-monitor counting operations, no contents can be copied into the TLB when DAT is off because the table entries at this time are not attached. In particular, translation of the operand address of LOAD PAGE-TABLE-ENTRY ADDRESS, LOAD REAL ADDRESS and STORE REAL ADDRESS with DAT off does not cause entries to be placed in the TLB.

Conversely, when DAT is on, information may be copied into the TLB from all translation-table entries that could be used for address translation, given the current translation parameters, the setting of the address-space-control bits, and the contents of the access registers. The loading of the TLB does not depend on whether the entry is used for translation as part of the execution of the current instruction, and such loading can occur when the CPU is in the wait state.

3. More than one copy of contents of a table entry may exist in the TLB. For example, some implementations may cause a copy of contents of a valid table entry to be placed in the TLB for the table origin in each address-space-control element by which the entry becomes attached.

Modification of Translation Tables

When an attached and invalid table entry is made valid and no entry usable for translation of the associated virtual address is in the TLB, the change takes effect no later than the end of the current unit of operation. Similarly, when an unattached and valid table entry is made attached and no usable entry for the associated virtual address is in the TLB, the change takes effect no later than the end of the current unit of operation.

When a valid and attached table entry is changed, and when, before the TLB is cleared of entries that qualify for substitution for that entry, an attempt is made to refer to storage by using a virtual address requiring that entry for translation, unpredictable results may occur, to the following extent. The use of the new value may begin between instructions or during the execution of an instruction, including the instruction that caused the change. Moreover, until the TLB is cleared of entries that qualify for substitution for that entry, the TLB may contain both the old and the new values, and it is unpredictable whether the old or new value is selected for a particular access. If both old and new values of a higher-level table entry are present in the TLB, a lower-level table entry may be fetched by using one value and placed in the TLB associated with the other value. If the new value of the entry is a value that would cause an exception, the exception may or may not cause an interruption to occur. If an interruption does occur, the result fields of the instruction may be changed even though the exception would normally cause suppression or nullification.

Entries are cleared from the TLB in accordance with the following rules:

1. All entries are cleared from the TLB by the execution of PURGE TLB or SET PREFIX and by CPU reset.
2. All entries may be cleared from all TLBs in the configuration by the execution of COMPARE AND SWAP AND PURGE by any of the CPUs in the configuration, depending on a bit in a general register used by the instruction.
3. Selected entries are cleared from all TLBs in the configuration by the execution of COMPARE AND REPLACE DAT TABLE ENTRY, INVALIDATE DAT TABLE ENTRY or INVALIDATE PAGE TABLE ENTRY by any of the CPUs in the configuration when the local-TLB-clearing facility is not installed, or when the facility is installed but the instruction does not specify local clearing.

Only the entries in the TLB of the CPU executing COMPARE AND REPLACE DAT TABLE ENTRY, INVALIDATE DAT TABLE ENTRY or INVALIDATE PAGE TABLE ENTRY are cleared when the local-TLB-clearing facility is installed and the instruction specifies local clearing.

4. Some or all TLB entries may be cleared at times other than those required by the preceding rules.

Programming Notes:

1. Entries in the TLB may continue to be used for translation after the table entries from which they have been formed have become unattached or invalid. These TLB entries are not necessarily removed unless explicitly cleared from the TLB.

A change made to an attached and valid entry or a change made to a table entry that causes the entry to become attached and valid is reflected in the translation process for the next instruction, or earlier than the next instruction, unless a TLB entry qualifies for substitution for that table entry. However, a change made to a table entry that causes the entry to become unattached or invalid is not necessarily reflected in the translation process until the TLB is cleared of entries that qualify for substitution for that table entry.

2. Exceptions associated with dynamic address translation may be established by a pretest for operand accessibility that is performed as part of the initiation of instruction execution. Consequently, a region-first-translation, region-second-translation, region-third-translation, segment-translation, or page-translation exception may be indicated when a table entry is invalid at the start of execution even if the instruction would have validated the table entry it uses and the table entry would have appeared valid if the instruction was considered to process the operands one byte at a time.
3. A change made to an attached table entry, except to set the I bit to zero or to alter the rightmost byte of a page-table entry, may produce unpredictable results if that entry is used for translation before the TLB is cleared of all copies of contents of that entry. The use of the new value may begin between instructions or during the execution of an instruction, including the instruction that caused the change. When an instruction, such as MOVE (MVC), makes a change to an attached table entry, including a change that makes the entry invalid, and subsequently uses the entry for translation, a changed entry is being used without a prior clearing of the entry from the TLB, and the associated unpredictability of result values and of exception recognition applies.

Manipulation of attached table entries may cause spurious table-entry values to be recorded in a TLB. For example, if changes are made piece-

meal, modification of a valid attached entry may cause a partially updated entry to be recorded, or, if an intermediate value is introduced in the process of the change, a supposedly invalid entry may temporarily appear valid and may be recorded in the TLB. Such an intermediate value may be introduced if the change is made by an I/O operation that is retried, or if an intermediate value is introduced during the execution of a single instruction.

As another example, if a segment-table entry is changed to designate a different page table and used without clearing the TLB, the new page-table entries may be fetched and associated with the old page-table origin. In such a case, execution of INVALIDATE PAGE TABLE ENTRY designating the new page-table origin will not necessarily clear the page-table entries fetched from the new page table.

4. To facilitate the manipulation of page tables, the INVALIDATE PAGE TABLE ENTRY instruction is provided. This instruction sets the I bit in a page-table entry to one and clears one or more TLBs in the configuration of entries formed from those table entries as follows:
 - a. All TLBs in the configuration are cleared when the local-TLB-clearing facility is not installed, or when the facility is installed and the instruction specifies the clearing of all TLBs (that is, the local-clearing control in the instruction is zero).
 - b. Only the TLB in the CPU executing the INVALIDATE PAGE TABLE ENTRY instruction is cleared when the local-TLB-clearing facility is installed and the instruction specifies the clearing of only the local TLB (that is, the local-clearing control in the instruction is one).

The following aspects of the TLB operation should be considered when using INVALIDATE PAGE TABLE ENTRY. (See also the programming notes for INVALIDATE PAGE TABLE ENTRY.)

- a. INVALIDATE PAGE TABLE ENTRY should be executed before making any change to a page-table entry other than changing the rightmost byte; otherwise, the selective-clearing portion of INVALIDATE PAGE

TABLE ENTRY may not clear the TLB copies of the entry.

- b. Invalidation of all the page-table entries within a page table by means of INVALIDATE PAGE TABLE ENTRY does not necessarily clear the TLB of any segment-table entry designating the page table. When it is desired to invalidate and clear the TLB of a region- or segment-table entry, the rules in note 5 below must be followed.

Similarly, invalidation of all the lower-level table entries within a region or segment table by means of INVALIDATE DAT TABLE ENTRY does not necessarily clear the TLB of any higher-level table entry designating the lower-level table. When it is desired to invalidate and clear the TLB of a higher-level table entry, the rules in note 5 below must be followed.

- c. When a large number of page-table entries are to be invalidated at a single time, the overhead involved in using COMPARE AND SWAP AND PURGE (one that purges the TLB), INVALIDATE DAT TABLE ENTRY, or PURGE TLB and in following the rules in note 5 below may be less than in issuing INVALIDATE PAGE TABLE ENTRY for each page-table entry.
5. Manipulation of table entries should be in accordance with the following rules. If these rules are complied with, translation is performed as if the table entries from real or absolute storage were always used in the translation process.
 - a. A valid table entry must not be changed while it is attached to any CPU and may be used for translation by that CPU except to (1) invalidate the entry by using INVALIDATE PAGE TABLE ENTRY or INVALIDATE DAT TABLE ENTRY, (2) alter bits 56-63 of a page-table entry, (3) make a change by means of a COMPARE AND SWAP AND PURGE instruction that purges the TLB, or (4) replace an entry by using COMPARE AND REPLACE DAT TABLE ENTRY.
 - b. When any change is made to an invalid table entry in such a way as to allow intermediate valid values to appear in the entry, each CPU to which the entry is attached must be caused to purge its TLB after the change

occurs and prior to the use of the entry for implicit address translation by that CPU.

- c. When any change is made to an offset or length specified for a table, each CPU which may have a TLB entry formed from a table entry that no longer lies within its table must be caused to purge its TLB after the change occurs and prior to the use of the table for implicit translation by that CPU.

Note that when an invalid page-table entry is made valid without introducing intermediate valid values, the TLB need not be cleared in a CPU which does not have any TLB entries formed from that entry. Similarly, when an invalid region-table or segment-table entry is made valid without introducing intermediate valid values, the TLB need not be cleared in a CPU which does not have any TLB entries formed from that validated entry and which does not have any TLB entries formed from entries in a page table attached by means of that validated entry.

The execution of PURGE TLB, COMPARE AND SWAP AND PURGE, or SET PREFIX may have an adverse effect on the performance of some models. Use of these instructions should, therefore, be minimized in conformance with the above rules.

6. In addition to the constraints described in programming note 3 on page 3-68, the following considerations are in effect when EDAT-1 applies:
 - a. When the STE-format and ACCF-validity controls are both one, it is unpredictable whether the CPU inspects the access-control bits and the fetch-protection bit in the segment-table entry or in the storage key of the corresponding 4 K-byte block for any given key-controlled-protection check. Therefore, the program should ensure that the access-control bits and fetch-protection bit in the segment-table entry are identical to the respective fields in all 256 storage keys for the constituent 4 K-byte blocks of the segment, before setting the invalid bit in the STE to zero.
 - b. Prior to changing the ACCF-validity control, the access-control bits, or the fetch-protection bit in the segment-table entry, and prior to changing the access-control bits or fetch-protection bit in any of the segment's 256

storage keys, the program should first set the invalid bit to one in the segment-table entry and clear all entries in all TLBs in the configuration, as described previously in this section.

When EDAT-2 applies, the following additional considerations are in effect:

- a. When the RTTE-format control and ACCF-validity control are both one, it is unpredictable whether the CPU inspects the access-control bits and the fetch-protection bit in the region-third-table entry or in the storage key of the corresponding 4 K-byte block for any given key-controlled-protection check. Therefore, the program should ensure that the access-control bits and fetch-protection bit in the region-third-table entry are identical to the respective fields in all 524,288 storage keys for the constituent 4 K-byte blocks of the region, before setting the invalid bit in the RTTE to zero.
- b. Prior to changing the ACCF-validity control, the access-control bits, or the fetch-protection bit in the region-third-table entry, and prior to changing the access-control bits or fetch-protection bit in any of the region's 524,288 storage keys, the program should first set the invalid bit to one in the region-third-table entry and clear all entries in all TLBs in the configuration, as described previously in this section.

Failure to observe these procedures may lead to unpredictable results, possibly including a delayed-access-exception machine-check or failure to record a change.

Address Summary

Addresses Translated

Most addresses that are explicitly specified by the program and are used by the CPU to refer to storage are instruction or logical addresses and are subject to implicit translation when DAT is on. Analogously, the corresponding addresses indicated to the program on an interruption or as the result of executing an instruction are instruction or logical addresses. The operand address of LOAD PAGE TABLE ENTRY

ADDRESS, LOAD REAL ADDRESS, and STORE REAL ADDRESS is explicitly translated, regardless of whether the PSW specifies DAT on or off.

Translation is not applied to quantities that are formed from the values specified in the B and D fields of an instruction but that are not used to address storage. This includes operand addresses in EXTRACT CPU ATTRIBUTE, LOAD ADDRESS, LOAD ADDRESS EXTENDED, MONITOR CALL, the second operand address in LOAD ADDRESS SPACE PARAMETERS and SHIFT AND ROUND PACKED, and the shifting instructions. This also includes the addresses in control registers 10 and 11 designating the starting and ending locations for PER.

Except as noted below, the addresses explicitly designating storage keys (operand addresses in INSERT STORAGE KEY EXTENDED, PERFORM FRAME MANAGEMENT FUNCTION, RESET REFERENCE BIT EXTENDED, and SET STORAGE KEY EXTENDED) are real addresses.

- For INSERT VIRTUAL STORAGE KEY, the address designating the storage key is virtual.
- For INSERT REFERENCE BITS MULTIPLE, for PERFORM FRAME MANAGEMENT FUNCTION when the set-key control is 1 and the frame-size code is 1 or 2, for RESET REFERENCE BITS MULTIPLE, and for SET STORAGE KEY EXTENDED when the multiple-block control is one, the address designating the storage keys is absolute.
- For TEST PROTECTION, the address designating the block to be tested is logical.

The addresses implicitly used by the CPU for such sequences as interruptions are real addresses.

The addresses used by channel programs to transfer data and to refer to CCWs, IDAWs, or MIDAWs are absolute addresses.

The handling of storage addresses associated with DIAGNOSE is model-dependent.

The processing of addresses, including dynamic address translation and prefixing, is discussed in "Address Types" on page 3-4. Prefixing, when provided, is applied after the address has been translated by means of the dynamic-address-translation

facility. For a description of prefixing, see “Prefixing” on page 3-21.

Handling of Addresses

The handling of addresses is summarized in Figure 3-17. This figure lists all addresses that are encountered by the program and specifies the address type.

Virtual Addresses

- Address of storage operand for INSERT VIRTUAL STORAGE KEY
- Operand address in LOAD PAGE-TABLE-ENTRY ADDRESS, LOAD REAL ADDRESS, and STORE REAL ADDRESS
- Addresses of storage operands for MOVE TO PRIMARY, MOVE TO SECONDARY, and MOVE WITH OPTIONAL SPECIFICATIONS
- Address stored in the doubleword at real location 168 on a program interruption for ASCE-type, region-first-translation, region-second-translation, region-third-translation, segment-translation, or page-translation exception
- Linkage-stack-entry address in control register 15
- Backward stack-entry address in linkage-stack header entry
- Forward-section-header address in linkage-stack trailer entry
- Trap-control-block address in dispatchable-unit-control table
- Trap-save-area address and trap-program address in trap control block
- Address of the enhanced-monitor counter array in the doubleword at real location 256

Instruction Addresses

- Instruction address in PSW
- Branch address
- Target of EXECUTE and EXECUTE RELATIVE LONG
- Address stored in the doubleword at real location 152 on a program interruption for PER
- Address placed in general register by BRANCH AND LINK, BRANCH AND SAVE, BRANCH AND SAVE AND SET MODE, BRANCH AND STACK, BRANCH IN SUBSPACE GROUP, BRANCH RELATIVE AND SAVE, BRANCH RELATIVE AND SAVE LONG, and PROGRAM CALL
- Address used in general register by BRANCH AND STACK
- Address placed in general register by BRANCH AND SET AUTHORITY executed in reduced-authority state
- Addresses used by BRANCH PREDICTION PRELOAD and BRANCH PREDICTION RELATIVE PRELOAD
- Aborted-transaction instruction address (in the transaction diagnostic block)

Logical Addresses

- Addresses of storage operands for instructions not otherwise specified
- Address placed in general register 1 by EDIT AND MARK and TRANSLATE AND TEST
- Addresses in general registers updated by MOVE LONG, MOVE LONG EXTENDED, COMPARE LOGICAL LONG, and COMPARE LOGICAL LONG EXTENDED
- Addresses in general registers updated by CHECKSUM, COMPARE AND FORM CODEWORD, and UPDATE TREE
- Address for TEST PENDING INTERRUPTION when the second-operand address is nonzero
- Address of parameter list of RESUME PROGRAM
- Address of the TBEGIN-specified transaction-diagnostic block

Figure 3-17. Handling of Addresses (Part 1 of 3).

Real Addresses

- Address of storage key for INSERT STORAGE KEY EXTENDED, and RESET REFERENCE BIT EXTENDED
- Address of storage key for SET STORAGE KEY EXTENDED (when the enhanced-DAT facility is not installed, or when the enhanced-DAT facility is installed but the multiple-block control is zero)
- Address of second operand for PERFORM FRAME MANAGEMENT FUNCTION when frame-size code is 0.
- Address of storage operand for LOAD USING REAL ADDRESS, STORE USING REAL ADDRESS, and TEST BLOCK
- The translated address generated by LOAD REAL ADDRESS and STORE REAL ADDRESS
- Page-frame real address in page-table entry
- Trace-entry address in control register 12
- ASN-first-table origin in control register 14
- ASN-second-table origin in ASN-first-table entry
- Authority-table origin in ASN-second-table entry, except when used by access-register translation
- Linkage-table origin in primary ASN-second-table entry
- Entry-table origin in linkage-table entry
- Dispatchable-unit-control-table origin in control register 2
- Primary-ASN-second-table-entry origin in control register 5
- Base-ASN-second-table-entry origin and subspace-ASN-second-table-entry origin in dispatchable-unit control table
- ASN-second-table-entry address in entry-table entry and access-list entry

Permanently Assigned Real Addresses

- Address of the doubleword into which TEST PENDING INTERRUPTION stores when the second-operand address is zero
- Addresses of PSWs, interruption codes, and the associated information used during interruption
- Addresses used for machine-check logout and save areas
- Address of STORE FACILITY LIST operand

Addresses which Are Unpredictably Real or Absolute

- Region-first-table origin, region-second-table origin, region-third-table origin, or segment-table origin in control registers 1, 7, and 13, in access-register-specified address-space-control element, and in region-first-table entry, region-second-table entry, or region-third-table entry
- Page-table origin in segment-table entry and in INVALIDATE PAGE TABLE ENTRY
- Address of segment-table entry or page-table entry provided by LOAD REAL ADDRESS
- Address of region-first-table entry, region-second-table entry, region-third-table entry, segment-table entry, or page-table entry provided by LOAD PAGE-TABLE-ENTRY ADDRESS
- The dispatchable-unit or primary-space access-list origin and the authority-table origin (in the ASTE designated by the ALE used) used by access-register translation

Figure 3-17. Handling of Addresses (Part 2 of 3).

Absolute Addresses

- Prefix value
- Channel-program address in ORB
- Data address in CCW
- IDAW address in a CCW specifying indirect data addressing
- MIDAW address in a CCW specifying modified indirect data addressing
- CCW address in a CCW specifying transfer in channel
- Data address in IDAW
- Data address in MIDAW
- Measurement-block origin specified by SET CHANNEL MONITOR
- Address limit specified by SET ADDRESS LIMIT
- Addresses used by the store-status-at-address SIGNAL PROCESSOR order
- Address of storage key for INSERT REFERENCE BITS MULTIPLE and RESET REFERENCE BITS MULTIPLE
- Address of storage key for SET STORAGE KEY EXTENDED (when the enhanced-DAT facility is installed and the multiple-block control is one)
- Address of second operand for PERFORM FRAME MANAGEMENT FUNCTION when frame-size code is 1 or 2.
- Failing-storage address stored in the doubleword at real location 248
- CCW address in SCSW

Permanently Assigned Absolute Addresses

- Addresses used for the store-status function
- Addresses of PSW and first two CCWs used for initial program loading

Addresses Not Used to Reference Storage

- PER starting address in control register 10
- PER ending address in control register 11
- Address stored in the doubleword at real location 176 for a monitor event
- Address in shift instructions and other instructions specified not to use the address to reference storage
- Real-space token origin in real-space designation

Figure 3-17. Handling of Addresses (Part 3 of 3).

Assigned Storage Locations

Figure 3-19 on page 3-87 shows the format and extent of the assigned locations in storage in both the z/Architecture architectural mode and ESA/390-compatibility mode.

Assigned Storage Locations in the z/Architecture Architectural Mode

0-7 Absolute Address

IPL PSW: The first eight bytes read during a CCW-type initial-program-loading (IPL) initial-read operation are stored at locations 0-7. The list-directed IPL process also stores eight bytes at locations 0-7. The contents of these locations

are used to form the new PSW at the completion of the IPL operation. These locations may also be used for temporary storage at the initiation of the IPL operation.

When the configuration-z/Architecture-architectural-mode (CZAM) facility is not installed, the IPL new PSW has the format of an ESA/390 PSW. When the CZAM facility is installed, the IPL PSW has the short-PSW format, as shown in Figure 4-3 on page 4-8.

8-15 (08-0F hex) Absolute Address

CCW-Type IPL CCW1: Bytes 8-15 read during a CCW-type initial-program-loading (IPL) initial-read operation are stored at locations 8-15. The contents of these locations are ordinarily used as the next CCW in an IPL CCW chain after completion of the IPL initial-read operation.

16-23 (10-17 hex) Absolute Address

CCW-Type IPL CCW2: Bytes 16-23 read during a CCW-type initial-program loading (IPL) initial-read operation are stored at locations 16-23. The contents of these locations may be used as another CCW in the IPL CCW chain to follow IPL CCW1.

LD IPL Machine-Loader Execution-Space Size: During a list-directed initial-program loading (IPL) operation, the machine-loader execution-space size is stored at locations 16-19.

Available for Use by Programming: Locations 16-19 are available for use by programming after IPL.

LD IPL System-Parameter-Block Address: During a list-directed initial-program loading (IPL) operation, the absolute address of the first byte of the system-parameter block is stored at locations 20-23.

128-131 (80-83 hex) Real Address

External-Interrupt Parameter: During an external interruption due to service signal or timing alert, the parameter associated with the interruption is stored at locations 128-131.

132-133 (84-85 hex) Real Address

CPU Address: During an external interruption due to malfunction alert, emergency signal, or external call, the CPU address associated with the source of the interruption is stored at locations 132-133. For all other external-interruption conditions, zeros are stored at locations 132-133.

134-135 (86-87 hex) Real Address

External-Interrupt Code: During an external interruption, the interruption code is stored at locations 134-135.

136-139 (88-8B hex) Real Address

Supervisor-Call-Interrupt Identification: During a supervisor-call interruption, the instruction-length code is stored in bit positions 5 and 6 of location 137, and the interruption code is stored at locations 138-139. Zeros are stored at location 136 and in the remaining bit positions of location 137.

140-143 (8C-8F hex) Real Address

Program-Interrupt Identification: During a program interruption, the instruction-length code is stored in bit positions 5 and 6 of location 141, and the interruption code is stored at locations 142-143. Zeros are stored at location 140 and in the remaining bit positions of location 141.

When a transaction is aborted due to a program interruption, the instruction-length code is respective to the instruction at which the exception condition was detected.

144-147 (90-93 hex) Real Address

Data-Exception Code (DXC): During a program interruption due to a data exception, the data-exception code is stored at location 147, and zeros are stored at locations 144-146. The DXC is described in “Data-Exception Code (DXC)” on page 6-17.

Vector-Exception Code (VXC): During a program interruption due to a vector-processing exception, the vector-exception code is stored at location 147, and zeros are stored at locations 144-146. The VXC is described in “Vector-Exception Code” on page 6-20.

148-149 (94-95 hex) Real Address

Monitor-Class Number: During a program interruption due to a monitor event, the monitor-class number is stored at location 149, and zeros are stored at location 148.

150-151 (96-97 hex) Real Address

PER Code: During a program interruption due to a PER event the PER code is stored in bit positions 0-7 of locations 150-151, and other information is or may be stored as described in “Identification of Cause” on page 4-30.

152-159 (98-9F hex) Real Address

PER Address: During a program interruption due to a PER event, the PER address is stored at locations 152-159.

160 (A0 hex) Real Address

Exception Access Identification (EAID): During a program interruption due to an ASCE-type, region-first-translation, region-second-translation, region-third-translation, segment-translation, or page-translation exception, an indication

of the address space to which the exception applies may be stored at location 160, as follows:

- If the access was a storage-operand reference that used an AR-specified address-space-control element, the number of the access register used is stored in bit positions 4-7 of location 160, and zeros are stored in bit positions 0-3.
- If the CPU was in the access-register mode and either (a) the access was an instruction fetch, including a fetch of the target of an execute-type instruction (EXECUTE or EXECUTE RELATIVE LONG), or (b) the access was to the second operand of the relative-long form of COMPARE, COMPARE HALFWORD, COMPARE LOGICAL, COMPARE LOGICAL HALFWORD, LOAD, LOAD HALFWORD, LOAD LOGICAL, LOAD LOGICAL HALFWORD, STORE or STORE HALFWORD, then zeros are stored at location 160.

In either of the two cases described above, storing at location 160 occurs regardless of the value stored in bit positions 62 and 63 of the translation-exception identification (TEID) at real locations 168-175. Otherwise, the contents of location 160 are unpredictable.

During a program interruption due to a protection exception, the contents of real location 160 are dependent on both the type of suppression-on-protection facility installed and the type of protection exception recognized. In the following cases, the information stored in real location 160 is the same as that described above for a page-translation exception; otherwise, the contents of real location 160 are unpredictable.

Facility	Protection-Exception Conditions Producing EAID Identical to that of a Page-Translation Exception
SOP	TEID bit 61 is one, and PSW bit 5 is one.
ESOP-1	TEID bit 61 is one.
ESOP-2	The protection code in TEID bits 56, 60, and 61 is nonzero, and the address in TEID bits 0-51 is virtual.
Explanation:	
SOP	Basic suppression-on-protection
ESOP	Enhanced suppression-on-protection (facility 1 or 2)

During a program interruption due to an ALEN-translation, ALE-sequence, ASTE-validity, ASTE-sequence, or extended-authority exception recognized during access-register translation, the number of the access register used is stored in bit positions 4-7 of location 160, and zeros are stored in bit positions 0-3. During a program interruption due to an ASTE-validity or ASTE-sequence exception recognized during a sub-space-replacement operation, all zeros are stored at location 160.

During a program interruption due to an ASTE-instance exception recognized due to use of the ASN-and-LX-reuse facility, (1) a one is stored in bit position 2, and zeros are stored in bit positions 0, 1, and 3-7, if the exception was recognized after primary ASN translation in PROGRAM TRANSFER WITH INSTANCE or PROGRAM RETURN, or (2) a one is stored in bit position 3, and zeros are stored in bit positions 0-2 and 4-7, if the exception was recognized after secondary ASN translation in SET SECONDARY ASN WITH INSTANCE or PROGRAM RETURN.

161 (A1 hex) Real Address

PER Access Identification: During a program interruption due to a PER storage-alteration event or PER zero-address-detection event, an indication of the address space to which the event applies may be stored at location 161. If the access used an AR-specified address-space-control element, the number of the access register used is stored in bit positions 4-7 of location 161, and zeros are stored in bit positions 0-3. The contents of location 161 are unpredictable if the access did not use an AR-specified address-space-control element.

Programming Note: The PER ASCE identification may be inspected to determine whether the PER storage-alteration event or PER zero-address-detection event used an AR-specified ASCE. See “PER ASCE Identification (AI)” on page 4-31 for further details.

162 (A2 hex) Real Address

Operand Access Identification: When EDAT-1 does not apply, and a program interruption due to a page-translation exception is recognized by the MOVE PAGE instruction, the contents of the R₁ field of the instruction are stored in bit positions

0-3 of location 162, and the contents of the R_2 field are stored in bit positions 4-7. If the page-translation exception was recognized during the execution of an instruction other than MOVE PAGE, or if an ASCE-type, region-first-translation, region-second-translation, region-third-translation, or segment-translation exception was recognized, the contents of location 162 are unpredictable.

When EDAT-1 applies, and a program interruption due to a region-first-translation, region-second-translation, region-third-translation, segment-translation, or page-translation exception is recognized by the MOVE PAGE instruction, the contents of the R_1 and R_2 fields are stored in location 162 as described above. If any of the exceptions listed in the preceding sentence was recognized during the execution of an instruction other than MOVE PAGE, or if an ASCE-type exception was recognized, the contents of location 162 are unpredictable.

163 (A3 hex) Absolute Address

Store-Status Architectural-Mode Identification: During the execution of the store-status operation, zeros are stored in bit positions 0-6 of location 163, and a one is stored in bit position 7. A zero stored in bit position 7 indicates the ESA/390 architectural mode, and a one indicates the z/Architecture architectural mode.

163 (A3 hex) Real Address

Machine-Check Architectural-Mode Identification: During a machine-check interruption, zeros are stored in bit positions 0-6 of location 163, and a one is stored in bit position 7. A zero stored in bit position 7 indicates the ESA/390 architectural mode, and a one indicates the z/Architecture architectural mode.

168-175 (A8-AF hex) Real Address

Translation-Exception Identification (TEID): In the z/Architecture architectural mode, a translation-exception identification is stored at real locations 168-175 for various types of program interruptions, as described below.

Translation-Exception Identification for DAT Exceptions: During a program interruption due to an ASCE-type, region-first-translation, region-second-translation, region-third-translation, segment-translation, or page-translation exception,

bits 0-51 of the virtual address causing the exception are stored in bit positions 0-51 of locations 168-175. This address is sometimes referred to as the translation-exception address.

When the access-exception-fetch/store-indication facility is installed, bits 52 and 53 of locations 168-175 are set as described below.

Access-Exception Fetch/Store Indication (AEFSI): Bit positions 52-53 of locations 168-175 contain an indication of whether the exception was due to a fetch or a store operation, as follows:

Bit 52	Bit 53	Meaning
0	0	Could not determine whether the exception was due to a fetch or store
0	1	Exception was due to a store operation
1	0	Exception was due to a fetch operation
1	1	Reserved

When the access-exception-fetch/store-indication facility is not installed, bits 52 and 53 of locations 168-175 are unpredictable.

The access-exception fetch/store indication is also stored for access-list-controlled-protection and DAT-protection exceptions. When the enhanced suppression-on-protection facility 2 is installed, the access-exception fetch-store indication is also stored for key-controlled-protection and low-address-protection exceptions. When the instruction-execution-protection facility is installed, the access-exception fetch-store indication is also stored for instruction-execution-protection exceptions.

For DAT-protection and access-list-controlled-protection exceptions, the field indicates a store operation. For instruction-execution-protection exceptions, the field indicates a fetch operation. For a storage-operand update reference, it is unpredictable whether a fetch or store access is indicated. When multiple access-exception conditions exist — for one or more operands — the condition recognized is determined based on the discussion of “Multiple Program-Interruption Conditions” on page 6-51.

The enhanced-suppression-on-protection facility 1 is a prerequisite for the access-exception-fetch/store-indication and instruction-execution-protection facilities.

Side-Effect-Access Indication: When the side-effect-access facility is installed, bit position 54 of locations 168-175 contains an indication of whether the exception was due to a side-effect access or not, as follows:

Bit 54	Meaning
0	Recognized exception is not due to a side-effect access.
1	Recognized exception is due to a side-effect access.

A side-effect access is an implied access not directly associated with a storage operand of an instruction, is not an instruction fetch, is not a fetch of table information during ART or DAT, and is not a store of a trace entry. When the side-effect-access facility is not installed, bit 54 is unpredictable.

The location of a side-effect access is not specified by any operand of an instruction for which the exception is recognized. Instead, the location was established by previous loading of the relevant controls.

MOVE PAGE Indication: When EDAT-1 does not apply, and the exception was a page-translation exception that was recognized during the execution of MOVE PAGE, bit 61 of locations 168-175 is set to one. If the exception was a page-translation exception recognized during the execution of an instruction other than MOVE PAGE, bit 61 is set to zero. If the exception was an ASCE-type, region-first-translation, region-second-translation, region-third-translation, or segment-translation exception, bit 61 of locations 168-175 is unpredictable. See the definition of real location 162 for related information.

When EDAT-1 applies, and the exception was a region-first-, region-second, region-third-, segment-, or page-translation exception that was recognized during the execution of MOVE PAGE, bit 61 of locations 168-175 is set to one. If the exception was a region-first-, region-second, region-third-, segment-, or page-translation exception recognized during the execution of an instruction other than MOVE PAGE, bit 61 is set to zero. If the exception was an ASCE-type exception, bit 61 of locations 168-175 is unpredictable. See the definition of real location 162 for related information.

ASCE Identifier: Bits 62 and 63 of locations 168-175 are set to identify the address-space-control element (ASCE) used in the translation, as follows:

Bit 62	Bit 63	Meaning
0	0	Primary ASCE was used.
0	1	CPU was in the access-register mode, and either the access was an instruction fetch or it was a storage-operand reference that used an AR-specified ASCE (the access was not an implicit reference to the linkage stack). The exception access id, real location 160, can be examined to determine the ASCE used. However, if the primary, secondary, or home ASCE was used, bits 62 and 63 may be set to 00, 10, or 11, respectively, instead of 01.
1	0	Secondary ASCE was used.
1	1	Home ASCE was used (includes the case of an implicit reference to the linkage stack).

The CPU may avoid setting bits 62 and 63 to 01 by recognizing that the access was an instruction fetch, that access-list-entry token 00000000 or 00000001 hex was used, or that the access-list-entry token designated, through an access-list entry, an ASN-second-table entry containing an ASCE equal to the primary ASCE, secondary ASCE, or home ASCE.

Bits 55 and 57-59 are unpredictable.

Translation-Exception Identification for Protection Exceptions: The information stored in the TEID for a protection exception depends on which of the three suppression-on-protection facilities is installed, as described below.

Basic Suppression-on-Protection: When TEID bit 61 is zero, the remainder of the TEID is unpredictable. When TEID bit 61 is one, the following applies:

- TEID bit positions 0-51 contain the effective address that caused the protection exception.
- TEID bits 52-59 are unpredictable.
- If DAT was on, the following applies:
 - The effective address that caused the protection exception is a virtual address.
 - When TEID bit 60 is zero, access-list-controlled protection is not the cause of

the exception. When TEID bit 60 is one, access-list-controlled protection is the cause of the exception.

- TEID bit positions 62-63 contain information identifying ASCE used in the translation, as described in “ASCE Identifier: Bits 62 and 63 of locations 168-175 are set to identify the address-space-control element (ASCE) used in the translation, as follows:” on page 3-77.

If DAT was off, TEID bits 60, 62, and 63 are unpredictable.

Enhanced Suppression-on-Protection Facility 1: When TEID bit 61 is zero, the exception was due to either key-controlled protection or low-address protection, and the remainder of the TEID is unpredictable. When TEID bit position 61 is one, the following applies:

- The exception is due to either access-list-controlled protection or DAT protection, as determined by TEID bit 60.
- TEID bit positions 0-51 contain the virtual address that caused the protection exception.
- When the access-exception-fetch/store-indication facility is installed, TEID bit positions 52-53 contain the access-exception fetch/store indication as described in “Access-Exception Fetch/Store Indication (AEFSI): Bit positions 52-53 of locations 168-175 contain an indication of whether the exception was due to a fetch or a store operation, as follows:” on page 3-76.
- TEID bit 54-59 are unpredictable.
-
- When TEID bit 60 is zero, DAT protection is the cause of the exception. When TEID bit 60 is one, access-list-controlled-protection is the cause of the exception.
- TEID bit positions 62-63 contain information identifying ASCE used in the translation, as described in “ASCE Identifier: Bits 62 and 63 of locations 168-175 are set to identify the address-space-control element (ASCE) used in the translation, as follows:” on page 3-77.

Enhanced Suppression-on-Protection Facility 2: The contents of TEID bit positions 56, 60, and 61 form a three-bit binary code that identifies the cause of the exception. When the protection code is zero, the remainder of the TEID is unpredictable. When the protection code is nonzero, the following applies:

- The three-bit code identifies the cause of the protection exception, as follows:

Code	Meaning
000	Key-controlled or low-address protection
001	DAT protection
010	Key-controlled protection
011	Access-list-controlled protection
100	Low-address protection
101	Instruction-execution-protection (when the instruction-execution-protection facility is installed).

- Except as noted below, TEID bit positions 0-51 contain the effective address that caused the protection exception. For access-list-controlled-protection, DAT-protection, and instruction-execution-protection exceptions, the effective address is virtual. The effective address may be virtual for key-controlled-protection and low-address-protection exceptions.

For key-controlled-protection or instruction-execution-protection exceptions recognized when fetching an instruction, it is unpredictable whether bit positions 0-51 of the TEID contain the address of the instruction or zeros.

- TEID bits 52-53 are the access-exception fetch/store indication as described in “Access-Exception Fetch/Store Indication (AEFSI): Bit positions 52-53 of locations 168-175 contain an indication of whether the exception was due to a fetch or a store operation, as follows:” on page 3-76.
- TEID bit 54 is the side-effect-access indication, as described in “Side-Effect-Access Indication: When the side-effect-access facility is installed, bit position 54 of locations 168-175 contains an indication of whether the exception was due to a side-effect access or not, as follows:” on page 3-77.
- TEID bit 55 is unpredictable.

- TEID bits 57-59 are unpredictable.
- When DAT is on, TEID bit positions 62-63 contain information identifying ASCE used in the translation, as described in “ASCE Identifier: Bits 62 and 63 of locations 168-175 are set to identify the address-space-control element (ASCE) used in the translation, as follows:” on page 3-77. When DAT is off, or when DAT is on but the effective address is not virtual, TEID bits 62-63 are unpredictable.

Translation-Exception Identification for ASN-

Translation Exceptions: During a program interruption due to an AFX-translation, ASX-translation, primary-authority, or secondary-authority exception, the ASN being translated is stored at locations 174 and 175, zeros are stored at locations 172 and 173, and the contents of locations 168-171 remain unchanged.

Translation-Exception Identification for Space-Switch Events:

During a program interruption due to a space-switch event, an identification of the old instruction space is stored at locations 174 and 175, the old instruction-space space-switch-event-control bit is placed in bit position 0 and zeros are placed in bit positions 1-15 of locations 172 and 173, and the contents of locations 168-171 remain unchanged. The identification and bit stored are as follows:

- If the CPU was in the primary-space, secondary-space, or access-register mode before the operation, the old PASN, bits 48-63 of control register 4 before the operation, is stored at locations 174 and 175, and the old primary space-switch-event-control bit, bit 57 of control register 1 before the operation, is placed in bit position 0 of locations 172 and 173.
- If the CPU was in the home-space mode before the operation, zeros are stored at locations 174 and 175, and the home space-switch-event-control bit, bit 57 of control register 13, is placed in bit position 0 of locations 172 and 173.

Translation-Exception Identification During PC-Number Translation:

During a program interruption due to an EX-translation or LX-translation exception recognized by PROGRAM CALL when ASN-and-LX reuse is not installed or is not

enabled by a one value of the ASN-and-LX-reuse control in control register 0, bits 44-63 of the second-operand address used by PROGRAM CALL (a 20-bit PC number), with 12 zeros appended on the left, are stored at locations 172-175, and the contents of locations 168-171 remain unchanged.

During a program interruption due to an EX-translation, LFX-translation, LSTE-sequence, or LSX-translation exception recognized by PROGRAM CALL when ASN-and-LX reuse is enabled and bit 44 of the second-operand address used by PROGRAM CALL is zero, bits 44-63 of the second-operand address (a 20-bit PC number), with 12 zeros appended on the left, are stored at locations 172-175. If bit 44 of the second-operand address is one, bits 32-63 of the address (a 32-bit PC number) are stored at locations 172-175. In either of these cases, the contents of locations 168-171 remain unchanged.

176-183 (B0-B7 hex) Real Address

Monitor Code: During a program interruption due to a monitor event, the monitor code is stored at locations 176-183.

184-187 (B8-BB hex) Real Address

Subsystem-Identification Word: During an I/O interruption, the subsystem-identification word is stored at locations 184-187.

188-191 (BC-BF hex) Real Address

I/O-Interruption Parameter: During an I/O interruption, the interruption parameter from the associated subchannel is stored at locations 188-191.

192-195 (C0-C3 hex) Real Address

I/O-Interruption-Identification Word: During an I/O interruption, the I/O-interruption-identification word, which further identifies the source of the I/O interruption, is stored at locations 192-195.

200-203 (C8-CB hex) Real Address

STFL Facility List: The STORE FACILITY LIST instruction stores information at real locations 200-203. The information describes which facilities are provided by the configuration. The information stored is identical in format to the first 32 bits stored by the STORE FACILITY LIST EXTENDED instruction. Figure 4-36, “Assigned

Facility Bits” on page 4-99 shows the meanings of the assigned facility bits.

232-239 (E8-EF hex) Real Address

Machine-Check-Interruption Code: During a machine-check interruption, the machine-check-interruption code is stored at locations 232-239.

244-247 (F4-F7 hex) Real Address

External-Damage Code: During a machine-check interruption due to certain external-damage conditions, depending on the model, an external-damage code may be stored at locations 244-247.

248-255 (F8-FF hex) Real Address

Failing-Storage Address: During a machine-check interruption, a 64-bit failing-storage address may be stored at locations 248-255.

256-263 (100-107 hex) Real Address

Enhanced-Monitor Counter-Array Origin: Bits 0-60 of the doubleword at location 256, appended on the right with three binary zeros, form the 64-bit virtual address of the enhanced-monitor counter array in the home address space.

During the execution of the MONITOR CALL instruction when the enhanced-monitor facility is installed, both the monitor-mask bit and enhanced-monitor-mask bit in control register 8 corresponding to the monitor class are ones, and the monitor code derived from the first-operand address is less than the enhanced-monitor counter-array size in location 264, then the enhanced-monitor counter designated by the first-operand location is incremented by one.

Programming Note: It is recommended that the enhanced-monitor counter array be allocated on a cache-line boundary of the CPU’s first-level data cache. The cache line size may be determined by the EXTRACT CPU ATTRIBUTES (ECAG) instruction.

264-267 (108-10B hex) Real Address

Enhanced-Monitor Counter-Array Size: The word at location 264 contains a 32-bit unsigned binary value that is referenced during the execution of the MONITOR CALL instruction when the enhanced-monitor facility is installed, and both

the monitor-mask bit and enhanced-monitor-mask bit in control register 8 corresponding to the monitor class are both ones. In this case, if the monitor code derived from the first-operand address is less than the enhanced-monitor counter-array size in location 264, then the counter designated by the first-operand location is incremented by one; otherwise, the enhanced-monitor exception counter at location 268 is incremented.

268-271 (10C-10F hex) Real Address

Enhanced-Monitor Exception Count: The word at location 268 contains a 32-bit unsigned binary value that may be updated during the execution of the MONITOR CALL instruction when the enhanced-monitor facility is installed, and the monitor-class bit and corresponding enhanced-monitor-class bit in control register 8 are both ones. The word is updated in either of the following two cases:

- The monitor code derived from the first-operand address is greater than or equal to than the enhanced-monitor counter-array size in location 264.
- The counter designated by the first-operand location is inaccessible.

272-279 (110-117 hex) Real Address

Breaking-Event Address: If the PER-3 facility is installed, then, during a program interruption, the contents of the breaking-event-address register are stored in locations 272-279. If the breaking-event-address-recording facility is not installed, this location remains unchanged.

288-303 (120-12F hex) Real Address

Restart Old PSW: The current PSW is stored as the old PSW at locations 288-303 during a restart interruption.

304-319 (130-13F hex) Real Address

External Old PSW: The current PSW is stored as the old PSW at locations 304-319 during an external interruption.

320-335 (140-14F hex) Real Address

Supervisor-Call Old PSW: The current PSW is stored as the old PSW at locations 320-335 during a supervisor-call interruption.

336-351 (150-15F hex) Real Address

Program Old PSW: The current PSW is stored as the old PSW at locations 336-351 during a program interruption.

352-367 (160-16F hex) Real Address

Machine-Check Old PSW: The current PSW is stored as the old PSW at locations 352-367 during a machine-check interruption.

368-383 (170-17F hex) Real Address

Input/Output Old PSW: The current PSW is stored as the old PSW at locations 368-383 during an I/O interruption.

416-431 (1A0-1AF hex) Real Address

Restart New PSW: The new PSW is fetched from locations 416-431 during a restart interruption.

432-447 (1B0-1BF hex) Real Address

External New PSW: The new PSW is fetched from locations 432-447 during an external interruption.

448-463 (1C0-1CF hex) Real Address

Supervisor-Call New PSW: The new PSW is fetched from locations 448-463 during a supervisor-call interruption.

464-479 (1D0-1DF hex) Real Address

Program New PSW: The new PSW is fetched from locations 464-479 during a program interruption.

480-495 (1E0-1EF hex) Real Address

Machine-Check New PSW: The new PSW is fetched from locations 480-495 during a machine-check interruption.

496-511 (1F0-1FF hex) Real Address

Input/Output New PSW: The new PSW is fetched from locations 496-511 during an I/O interruption.

4528-4535 (11B0-11B7 hex) Real Address

Machine-Check-Extended-Save-Area Designation (MCESAD): During a machine check interruption, additional information may be stored at the absolute storage location designated by the doubleword at locations 4528-4535. The leftmost

bits of the doubleword, called the machine-check-extended-save-area origin (MCESAO), appended on the right with binary zeros, forms the address of the area.

When the guarded-storage facility is not installed, bit positions 0-53 of the doubleword form the MCESAO. The MCESAO, with 10 zeros appended on the right, is used as the absolute address of a 1,024-byte extended-save area. Bit positions 54-63 of the doubleword are reserved and should contain zeros.

When the guarded-storage facility is installed, bit positions 60-63 of the doubleword contain a length characteristic (LC) that specifies the size and alignment of the extended-save area as a power of two; an LC value of zero is treated as 10. Bits 0 through 63-LC of the doubleword form the MCESAO. The MCESAO, with LC zeros appended on the right, is used as the absolute address of a 2^{LC} -byte extended-save area on a 2^{LC} -byte boundary. Bit positions 64-LC through 59 of the doubleword are reserved and should contain zeros. Figure 3-18 shows the length-characteristic values and corresponding extended-save-area attributes. If a reserved LC value is specified, a machine-check extended save area is not stored.

LC	MCESA Attributes	
	MCESAO	Alignment & Size
0*	Bits 0-53	1,024 bytes
1-9†	N/A	0 bytes
10	Bits 0-53	1,024 bytes
11	Bits 0-52	2,048 bytes
12	Bits 0-51	4,096 bytes
13-15†	N/A	0 bytes

Explanation:

* An LC value of zero is treated as if a value of 10 was specified.

† LC values 1-9 and 13-15 are reserved.

N/A Not applicable; for reserved values, the MCESAO is treated as if all bits are zeros.

Figure 3-18. Machine-Check Extended-Save-Area Attributes based on Length Characteristic

When the value of the MCESAO is zero, storing is not performed in the extended save area.

The format of the machine-check extended save area is described in the section “Machine-Check Extended Save Area (MCESA)” on page 11-24.

4544-4607 (11C0-11FF hex) Real Address

Available for Programming: Locations 4544-4607 are available for use by programming.

4608-4735 (1200-127F hex) Absolute Address

Store-Status Floating-Point-Register Save Area: During the execution of the store-status operation, the contents of the floating-point registers are stored at locations 4608-4735.

4608-4735 (1200-127F hex) Real Address

Machine-Check Floating-Point-Register Save Area: During a machine-check interruption, the contents of the floating-point registers are stored at locations 4608-4735.

4736-4863 (1280-12FF hex) Absolute Address

Store-Status General-Register Save Area: During the execution of the store-status operation, the contents of the general registers are stored at locations 4736-4863.

4736-4863 (1280-12FF hex) Real Address

Machine-Check General-Register Save Area: During a machine-check interruption, the contents of the general registers are stored at locations 4736-4863.

4864-4879 (1300-130F hex) Absolute Address

Store-Status PSW Save Area: During the execution of the store-status operation, the contents of the current PSW are stored at locations 4864-4879.

4864-4879 (1300-130F hex) Real Address

Fixed-Logout Area: Depending on the model, logout information may be stored at locations 4864-4879 during a machine-check interruption.

4880-4887 (1310-1317 hex) Real Address

Assigned to IBM internal use.

4888-4891 (1318-131B hex) Absolute Address

Store-Status Prefix Save Area: During the execution of the store-status operation, the contents of the prefix register are stored at locations 4888-4891.

4892-4895 (131C-131F hex) Absolute Address

Store-Status Floating-Point-Control-Register Save Area: During the execution of the store-status operation, the contents of the floating-point control register are stored at locations 4892-4895.

4892-4895 (131C-131F hex) Real Address

Machine-Check Floating-Point-Control-Register Save Area: During a machine-check interruption, the contents of the floating-point control register are stored at locations 4892-4895.

4900-4903 (1324-1327 hex) Absolute Address

Store-Status TOD-Programmable-Register Save Area: During the execution of the store-status operation, the contents of the TOD programmable register are stored at locations 4900-4903.

4900-4903 (1324-1327 hex) Real Address

Machine-Check TOD-Programmable-Register Save Area: During a machine-check interruption, the contents of the TOD programmable register are stored at locations 4900-4903.

4904-4911 (1328-132F hex) Absolute Address

Store-Status CPU-Timer Save Area: During the execution of the store-status operation, the contents of the CPU timer are stored at locations 4904-4911.

4904-4911 (1328-132F hex) Real Address

Machine-Check CPU-Timer Save Area: During a machine-check interruption, the contents of the CPU timer are stored at locations 4904-4911.

4913-4919 (1331-1337 hex) Absolute Address

Store-Status Clock-Comparator Save Area: During the execution of the store-status operation, the contents of bit positions 0-55 of the clock comparator are stored at locations 4913-4919. When this store occurs, zeros are stored at location 4912.

4913-4919 (1331-1337 hex) Real Address

Machine-Check Clock-Comparator Save Area: During a machine-check interruption, the contents of bit positions 0-55 of the clock comparator are stored at locations 4913-4919. When this store occurs, zeros are stored at location 4912.

4928-4991 (1340-137F hex) Absolute Address

Store-Status Access-Register Save Area: During the execution of the store-status operation, the contents of the access registers are stored at locations 4928-4991.

4928-4991 (1340-137F hex) Real Address

Machine-Check Access-Register Save Area: During a machine-check interruption, the contents of the access registers are stored at locations 4928-4991.

4992-5119 (1380-13FF hex) Absolute Address

Store-Status Control-Register Save Area: During the execution of the store-status operation, the contents of the control registers are stored at locations 4992-5119.

4992-5119 (1380-13FF hex) Real Address

Machine-Check Control-Register Save Area: During a machine-check interruption, the contents of the control registers are stored at locations 4992-5119.

6144-6399 (1800-18FF hex) Real Address

Program-Interruption Transaction Diagnostic Block: During a program interruption while the CPU is in the transactional-execution mode, the transaction-diagnostic block is stored at locations 6,144-6,399. The format of the transaction-diagnostic block is described in "Transaction Diagnostic Block (TDB)" on page 5-93.

Assigned Storage Locations in the ESA/390-Compatibility Mode

0-7 Absolute Address

IPL PSW: The first eight bytes read during a CCW-type initial-program-loading (IPL) initial-read operation are stored at locations 0-7. The list-directed IPL process also stores eight bytes at locations 0-7. The contents of these locations are used to form the new PSW at the completion of the IPL operation. These locations may also be used for temporary storage at the initiation of the IPL operation.

The IPL PSW has the short-PSW format, as shown in Figure 4-3 on page 4-8.

0-7 Real Address

Restart New PSW: The new PSW is fetched from locations 0-7 during a restart interruption. The restart new PSW has the short-PSW format as shown in Figure 4-3 on page 4-8.

8-15 (08-0F hex) Absolute Address

CCW-Type IPL CCW1: Bytes 8-15 read during a CCW-type initial-program-loading (IPL) initial-read operation are stored at locations 8-15. The contents of these locations are ordinarily used as the next CCW in an IPL CCW chain after completion of the IPL initial-read operation.

8-15 (08-0F hex) Real Address

Restart Old PSW: The current PSW is stored as the old PSW at locations 288-303 during a restart interruption. The restart old PSW has the short-PSW format as shown in Figure 4-3 on page 4-8.

16-23 (10-17 hex) Absolute Address

CCW-Type IPL CCW2: Bytes 16-23 read during a CCW-type initial-program loading (IPL) initial-read operation are stored at locations 16-23. The contents of these locations may be used as another CCW in the IPL CCW chain to follow IPL CCW1.

LD IPL Machine-Loader Execution-Space Size: During a list-directed initial-program loading (IPL) operation, the machine-loader execution-space size is stored at locations 16-19.

Available for Use by Programming: Locations 16-19 are available for use by programming after IPL.

LD IPL System-Parameter-Block Address: During a list-directed initial-program loading (IPL) operation, the absolute address of the first byte of the system-parameter block is stored at locations 20-23.

24-31 (18-1F hex) Real Address

External Old PSW: The current PSW is stored as the old PSW at locations 24-31 during an external interruption. The external old PSW has the short-PSW format, as shown in Figure 4-3 on page 4-8.

32-39 (20-27 hex) Real Address

Supervisor-Call Old PSW: The current PSW is stored as the old PSW at locations 32-39 during a supervisor-call interruption. The supervisor-call old PSW has the short-PSW format, as shown in Figure 4-3 on page 4-8.

40-47 (28-2F hex) Real Address

Program Old PSW: The current PSW is stored as the old PSW at locations 40-47 during a program interruption. The program old PSW has the short-PSW format, as shown in Figure 4-3 on page 4-8.

48-55 (30-37 hex) Real Address

Machine-Check Old PSW: The current PSW is stored as the old PSW at locations 48-55 during a machine-check interruption. The machine-check old PSW has the short-PSW format, as shown in Figure 4-3 on page 4-8.

56-63 (38-3F hex) Real Address

Input/Output Old PSW: The current PSW is stored as the old PSW at locations 56-63 during an input/output interruption. The input/output old PSW has the short-PSW format, as shown in Figure 4-3 on page 4-8.

88-95 (58-5F hex) Real Address

External New PSW: The new PSW is fetched from locations 88-95 during an external interruption. The external new PSW has the short-PSW format, as shown in Figure 4-3 on page 4-8.

96-103 (60-67 hex) Real Address

Supervisor-Call New PSW: The new PSW is fetched from locations 96-103 during a supervisor-call interruption. The supervisor-call new PSW has the short-PSW format, as shown in Figure 4-3 on page 4-8.

104-111 (68-6F hex) Real Address

Program New PSW: The new PSW is fetched from locations 104-111 during a program interruption. The program new PSW has the short-PSW format, as shown in Figure 4-3 on page 4-8.

112-119 (70-77 hex) Real Address

Machine-Check New PSW: The new PSW is fetched from locations 112-119 during a

machine-check interruption. The machine-check new PSW has the short-PSW format, as shown in Figure 4-3 on page 4-8.

120-127 (78-7F hex) Real Address

Input/Output New PSW: The new PSW is fetched from locations 120-127 during an input/output interruption. The input/output new PSW has the short-PSW format, as shown in Figure 4-3 on page 4-8.

128-131 (80-83 hex) Real Address

External-Interruption Parameter: During an external interruption due to service signal or timing alert, the parameter associated with the interruption is stored at locations 128-131.

132-133 (84-85 hex) Real Address

CPU Address: During an external interruption due to malfunction alert, emergency signal, or external call, the CPU address associated with the source of the interruption is stored at locations 132-133. For all other external-interruption conditions, zeros are stored at locations 132-133.

134-135 (86-87 hex) Real Address

External-Interruption Code: During an external interruption, the interruption code is stored at locations 134-135.

136-139 (88-8B hex) Real Address

Supervisor-Call-Interruption Identification: During a supervisor-call interruption, the instruction-length code is stored in bit positions 5 and 6 of location 137, and the interruption code is stored at locations 138-139. Zeros are stored at location 136 and in the remaining bit positions of location 137.

140-143 (8C-8F hex) Real Address

Program-Interruption Identification: During a program interruption, the instruction-length code is stored in bit positions 5 and 6 of location 141, and the interruption code is stored at locations 142-143. Zeros are stored at location 140 and in the remaining bit positions of location 141.

144-147 (90-93 hex) Real Address

Data-Exception Code (DXC): During a program interruption due to a data exception, the data-

exception code is stored at location 147, and zeros are stored at locations 144-146. The DXC is described in “Data-Exception Code (DXC)” on page 6-17.

Protection-Exception Identification (PEID): Information may be stored at real locations 144-147 during a program interruption due to a protection exception. The information has the same format as bits 32-63 of the TEID stored at real locations 172-175 in z/Architecture architectural mode. See “Translation-Exception Identification (TEID)” on page 3-76 for details. See Reference [12.] on page xxx for further details on locations 144-147 in ESA/XC virtual machines.

148-149 (94-95 hex) Real Address

Monitor-Class Number: During a program interruption due to a monitor event, the monitor-class number is stored at location 149, and zeros are stored at location 148.

150-151 (96-97 hex) Real Address

PER Code: During a program interruption due to a PER event the PER code is stored in bit positions 0-7 of locations 150-151, and other information is or may be stored as described in “Identification of Cause” on page 4-30.

152-155 (98-9B hex) Real Address

PER Address: During a program interruption due to a PER event, the PER address is stored at locations 152-155.

156-159 (9C-9F hex) Real Address

Monitor Code: During a program interruption due to a monitor event, the monitor code is stored at locations 156-159.

160 (A0 hex) Real Address

Exception Access Identification (EAID): During a program interruption due to a protection exception, information is stored at location 160 as described in “Suppression on Protection” on page 3-15.

In ESA/XC virtual machines under z/VM, during a program interruption due to an ALEN-translation or addressing-capability exception, if the ALET being translated was obtained from an access register, the number of the access register used is stored in bit positions 4-7 of location 160, and zeros are stored in bit positions 0-3. If

the ALET being translated was not obtained from an access register, then zeros are stored at location 160. See Reference [12.] on page xxx for details.

161 (A1 hex) Real Address

PER Access Identification: During a program interruption due to a PER storage-alteration event or PER zero-address-detection event, the contents of location 161 are unpredictable.

163 (A3 hex) Absolute Address

Store-Status Architectural-Mode Identification: During the execution of the store-status operation, zeros are stored in location 163.

163 (A3 hex) Real Address

Machine-Check Architectural-Mode Identification: During a machine-check interruption, zeros are stored in location 163.

168-171 (A8-AB hex) Real Address

Exception ALET: In ESA/XC virtual machines under z/VM, during a program interruption due to an ALEN-translation or addressing-capability exception, the access-list-entry token used in the translation is stored at locations 168-171. See Reference [12.] on page xxx for details.

184-187 (B8-BB hex) Real Address

Subsystem-Identification Word: During an I/O interruption, the subsystem-identification word is stored at locations 184-187.

188-191 (BC-BF hex) Real Address

I/O-Interruption Parameter: During an I/O interruption, the interruption parameter from the associated subchannel is stored at locations 188-191.

192-195 (C0-C3 hex) Real Address

I/O-Interruption-Identification Word: During an I/O interruption, the I/O-interruption-identification word, which further identifies the source of the I/O interruption, is stored at locations 192-195.

200-203 (C8-CB hex) Real Address

STFL Facility List. The STORE FACILITY LIST instruction stores information at real locations

200-203. The information describes which facilities are provided by the configuration. The information stored is identical in format to the first 32 bits stored by the STORE FACILITY LIST EXTENDED instruction. Figure 4-36, "Assigned Facility Bits" on page 4-99 shows the meanings of the assigned facility bits.

212-215 (D4-D7 hex) Absolute Address

Store-Status Extended-Save-Area Address: During the execution of the store-status operation when the extended-save-area control, bit 34 of control register 14, is one, bits 1-19 of locations 212-215, with 33 zeros appended on the left and 12 zeros appended on the right, are used as the absolute address of a 4,096-byte extended save area. Bits 0 and 20-31 of the locations are reserved and should be zeros. They are ignored when forming the address of the extended save area. When bits 1-19 are all zeros, storing is not performed in the extended save area.

212-215 (D4-D7 hex) Real Address

Machine-Check Extended-Save-Area Address: During a machine-check interruption when the extended-save-area control, bit 34 of control register 14, is one, bits 1-19 of locations 212-215, with 33 zeros appended on the left and 12 zeros appended on the right, are used as the absolute address of a 4,096-byte extended save area. Bits 0 and 20-31 of the locations are reserved and should be zeros. They are ignored when forming the address of the extended save area. When bits 1-19 are all zeros, storing is not performed in the extended save area.

216-223 (D8-DF hex) Absolute Address

Store-Status CPU-Timer Save Area: During the execution of the store-status operation, the contents of the CPU timer are stored at locations 216-223.

216-223 (D8-DF hex) Real Address

Machine-Check CPU-Timer Save Area: During a machine-check interruption, the contents of the CPU timer are stored at locations 216-223.

224-231 (E0-E7 hex) Absolute Address

Store-Status Clock-Comparator Save Area: During the execution of the store-status operation,

the contents of the clock comparator are stored at locations 224-231.

224-231 (E0-E7 hex) Real Address

Machine-Check Clock-Comparator Save Area: During a machine-check interruption, the contents of the clock comparator are stored at locations 224-231.

232-239 (E8-EF hex) Real Address

Machine-Check-Interruption Code: During a machine-check interruption, the machine-check-interruption code is stored at locations 232-239.

244-247 (F4-F7 hex) Real Address

External-Damage Code: During a machine-check interruption due to certain external-damage conditions, depending on the model, an external-damage code may be stored at locations 244-247.

248-251 (F8-FB hex) Real Address

Failing-Storage Address: During a machine-check interruption, a 31-bit failing-storage address may be stored at locations 248-251.

256-263 (100-107 hex) Absolute Address

Store-Status PSW Save Area: During the execution of the store-status operation, the contents of the current PSW are stored at locations 256-263. The PSW has the short-PSW format, as shown in Figure 4-3 on page 4-8.

256-271 (100-10F hex) Real Address

Fixed-Logout Area: During a machine-check interruption, logout information may be stored at locations 256-271.

In ESA/XC virtual machines, a failing-storage address-space-identification token (ASIT) may be stored in locations 256-263 during a machine-check interruption. A failing-storage ASIT is stored whenever a failing-storage address is stored at locations 248-251. See Reference [12.] on page xxx for details.

264-267 (108-10B hex) Absolute Address

Store-Status Prefix Save Area: During the execution of the store-status operation, the contents of

the prefix register are stored at locations 264-267.

288-351 (120-15F hex) Absolute Address

Store-Status Access-Register Save Area: During the execution of the store-status operation, the contents of the access registers are stored at locations 288-351.

288-351 (120-15F hex) Real Address

Machine-Check Access-Register Save Area: During a machine-check interruption, the contents of the access registers are stored at locations 288-351.

352-367 (160-17F hex) Absolute Address

Store-Status Floating-Point-Register Save Area: During the execution of the store-status operation, the contents of floating-point registers 0, 2, 4, and 6 are stored at locations 352-367.

352-367 (160-17F hex) Real Address

Machine-Check Floating-Point-Register Save Area: During a machine-check interruption, the contents of floating-point registers 0, 2, 4, and 6 are stored at locations 352-367.

384-447 (180-1BF hex) Absolute Address

Store-Status General-Register Save Area: During the execution of the store-status operation, the contents of the general registers are stored at locations 384-447.

384-447 (180-1BF hex) Real Address

Machine-Check General-Register Save Area: During a machine-check interruption, the contents of the general registers are stored at locations 384-447.

448-511 (1C0-1FF hex) Absolute Address

Store-Status Control-Register Save Area: During the execution of the store-status operation, the

contents of the control registers are stored at locations 448-511.

448-511 (1C0-1FF hex) Real Address

Machine-Check Control-Register Save Area: During a machine-check interruption, the contents of the control registers are stored at locations 448-511.

Programming Notes:

1. When the CPU is in the access-register mode, some instructions, such as MVCL, which address operands in more than one address space, may cause a storage-alteration PER event in one address space concurrently with a region-translation, segment-translation, or page-translation exception in another address space. The access registers used to cause these conditions in such a case are different. In order to identify both access registers, two access identifications, namely the exception access identification and the PER access identification, are provided.
2. The store-status and machine-check architectural-mode identifications at absolute and real locations 163, respectively, indicate that the CPU is in the z/Architecture architectural mode. When z/Architecture is installed on the CPU but the CPU is in the ESA/390 or ESA/390-compatibility mode, the store-status and machine-check-interruption operations store zero at location 163.
3. Figure 3-19 on page 3-87 illustrates assigned storage locations 0-511 in both the z/Architecture architectural mode and the ESA/390-compatibility mode. Figure 3-20 on page 3-90 illustrates assigned storage locations 512-8191 in the z/Architecture architectural mode. Locations marked [A] are absolute; all other locations are real.

Hex	Dec	z/Architecture Fields	ESA/390-Compatibility-Mode Fields
0	0	Initial-Program-Loading PSW (when CZAM installed) [A]	Initial-Program-Loading PSW [A]; Restart New PSW
4	4		
8	8	CCW-Type IPL CCW1 (when CZAM installed) [A]	CCW-Type IPL CCW1 [A]; Restart Old PSW
C	12		

Figure 3-19. Assigned Storage Locations 0–511 in the z/Architecture Architectural Mode and ESA/390-Compatibility Mode (Part 1 of 4)

Hex	Dec	z/Architecture Fields				ESA/390-Compatibility-Mode Fields					
10	16	CCW-Type IPL CCW2, bytes 0-3 (when CZAM installed) [A]; Machine-loader execution-space size [A]; Available for use by programming after IPL				CCW-Type IPL CCW2, bytes 0-3 [A]; Machine-loader execution-space size [A]; Available for use by programming after IPL					
14	20	CCW-Type IPL CCW2, bytes 4-7 (when CZAM installed) [A]; LD-IPL System-IPL Parameter-List Pointer [A]				CCW-Type IPL CCW2, bytes 4-7 [A]; LD-IPD System-IPL Parameter-List Pointer [A]					
18	24					External Old PSW					
1C	28					Supervisor-Call Old PSW					
20	32					Program Old PSW					
30	48					Machine-Check Old PSW					
34	52					Input / Output Old PSW					
38	56					External New PSW					
3C	60					Supervisor-Call New PSW					
40	64					Program New PSW					
44	68					Machine-Check New PSW					
70	112					Input / Output New PSW					
48	72	Available for Use by Programming									
4C	76										
50	80										
54	84										
58	88										
5C	92										
60	96										
64	100										
68	104										
6C	108										
70	112										
74	116										
78	120										
7C	124										
80	128	External-Interrupt Parameter				External-Interrupt Parameter					
84	132	CPU Address		External-Interrupt Code		CPU Address		External-Interrupt Code			
88	136	0 0 0 0 0 0 0 0 0 0 0 0 0 0 0 0		ILC	0	SVC-Interrupt Code		0 0 0 0 0 0 0 0 0 0 0 0 0 0 0 0			
8C	140	0 0 0 0 0 0 0 0 0 0 0 0 0 0 0 0		ILC	0	Program-Interrupt Code		0 0 0 0 0 0 0 0 0 0 0 0 0 0 0 0			
90	144	Data-Exception Code or Vector-Exception Code				Data-Exception Code or Translation-Exception Identification					
94	148	Monitor-Class Number		Per Code	ATMID	AI	Monitor-Class Number		Per Code	ATMID	SI
98	152	PER Address				PER Address					
9C	156					Monitor Code					
A0	160	Exception Access ID	PER Access ID	Operand Access ID	SS Arch. Mode ID [A]; MC Arch. Mode ID	Exception Access ID	PER Access ID		SS Arch. Mode ID [A]; MC Arch. Mode ID		
A4	164										
A8	168	Translation-Exception Identification									
AC	172										
B0	176	Monitor Code									
B4	180										

Figure 3-19. Assigned Storage Locations 0–511 in the z/Architecture Architectural Mode and ESA/390-Compatibility Mode (Part 2 of 4)

Hex	Dec	z/Architecture Fields	ESA/390-Compatibility-Mode Fields	
B8	184	Subsystem Identification Word	Subsystem Identification Word	
BC	188	I/O Interruption Parameter	I/O Interruption Parameter	
C0	192	I/O Interruption-Identification Word	I/O Interruption-Identification Word	
C4	196			
C8	200	STFL Facility List	STFL Facility List	
CC	204	Available for Use by Programming		
D0	208			
D4	212			Store-Status Extended-Save-Area Address [A]; Machine-Check Extended-Save-Area Address;
D8	216			Store-Status CPU-Timer Save Area [A]; Machine-Check CPU-Timer Save Area
DC	220			
E0	224			Store-Status Clock-Comparator Save Area [A]; Machine-Check Clock-Comparator Save Area
E4	228			
E8	232	Machine-Check Interruption Code	Machine-Check Interruption Code	
EC	236			
F0	240			
F4	244	External-Damage Code	External-Damage Code	
F8	248	Failing-Storage Address	Failing-Storage Address	
FC	252			
100	256	Enhanced-Monitor Counter-Array Origin	Store-Status PSW Save Area [A]; Machine-Check Fixed-Logout Area (Part 1)	
104	260			
108	264	Enhanced-Monitor Counter-Array Size	Store-Status Prefix Save Area [A]; Machine-Check Fixed-Logout Area (Part 2)	
10C	268	Enhanced-Monitor Exception Count	Machine-Check Fixed-Logout Area (Part 3)	
110	272	Breaking-Event Address		
114	276			
118	280			
11C	284			
120	288	Restart Old PSW	Store Status Access-Register Save Area [A]; Machine-Check Access-Register Save Area (64 bytes)	
124	292			
128	296			
12C	300			
130	304	External Old PSW		
134	308			
138	312			
13C	316			
140	320	Supervisor-Call Old PSW		
144	324			
148	328			
14C	332			
150	336	Program Old PSW		
154	340			
158	344			
15C	348			

Figure 3-19. Assigned Storage Locations 0–511 in the z/Architecture Architectural Mode and ESA/390-Compatibility Mode (Part 3 of 4)

Hex	Dec	z/Architecture Fields	ESA/390-Compatibility-Mode Fields
160	352	Machine-Check Old PSW	Store Status Floating-Point-Register 0, 2, 4, & 6 Save Area [A]; Machine-Check Floating-Point-Register 0, 2, 4, & 6 Save Area (32 bytes)
164	356		
168	360		
16C	364		
170	368	Input/Output Old PSW	
174	372		
178	376		
17C	380		
180	384		Store Status General-Register Save Area [A]; Machine-Check General-Register Save Area (64 bytes)
184	388		
188	392		
18C	396		
190	400		
194	404		
198	408		
19C	412		
1A0	416	Restart New PSW	
1A4	420		
1A8	424		
1AC	428		
1B0	432	External New PSW	
1B4	436		
1B8	440		
1BC	444		
1C0	448	Supervisor-Call New PSW	
1C4	452		
1C8	456		
1CC	460		
1D0	464	Program New PSW	Store Status Control-Register Save Area [A]; Machine-Check Control-Register Save Area (64 bytes)
1D4	468		
1D8	472		
1DC	476		
1E0	480	Machine-Check New PSW	
1E4	484		
1E8	488		
1EC	492		
1F0	496	Input/Output New PSW	
1F4	500		
1F8	504		
1FC	508		

Figure 3-19. Assigned Storage Locations 0–511 in the z/Architecture Architectural Mode and ESA/390-Compatibility Mode (Part 4 of 4)

Hex	Dec	z/Architecture Fields
200	512	
204	516	

Figure 3-20. Assigned Storage Locations 512–8191 in the z/Architecture Architectural Mode (Part 1 of 3)

Hex	Dec	z/Architecture Fields
:	:	
FF8	4088	
FFC	4092	
1000	4096	
:	:	
11AC	4524	
11B0	4528	Machine-Check Extended-Save-Area Address
11B4	4532	
11B8	4536	
11BC	4540	
11C0	4544	Available for Use by Programming (64 bytes)
11C4	4548	
:	:	
11F8	4600	
11FC	4604	
1200	4608	Store-Status Floating-Point-Register Save Area [A]; Machine-Check Floating-Point-Register Save Area (128 bytes)
1204	4612	
:	:	
1278	4728	
127C	4732	
1280	4736	Store-Status General-Register Save Area [A]; Machine-Check General-Register Save Area (128 bytes)
1284	4740	
:	:	
12F8	4856	
12FC	4860	
1300	4864	Store-Status PSW Save Area [A]; Machine-Check Fixed Logout Area
1304	4868	
1308	4872	
130C	4876	
1310	4880	Assigned to IBM internal use [POP ONLY]
1314	4884	
1318	4888	Store-Status Prefix Save Area [A]
131C	4892	Store-Status Floating-Point-Control-Register Save Area [A]; Machine-Check Floating-Point-Control-Register Save Area
1320	4896	
1324	4900	Store-Status TOD-Programmable-Register Save Area [A]; Machine-Check TOD-Programmable-Register Save Area
1328	4904	Store-Status CPU-Timer Save Area [A]; Machine-Check CPU-Timer Save Area
132C	4908	
1330	4912	Store-Status Clock-Comp. Bits 0-55 Save Area [A];
1334	4916	Machine-Check Clock-Comparator Bits 0-55 Save Area
1338	4920	
133C	4924	

Figure 3-20. Assigned Storage Locations 512–8191 in the z/Architecture Architectural Mode (Part 2 of 3)

Hex	Dec	z/Architecture Fields
1340	4928	Store-Status Access-Register Save Area [A]; Machine-Check Access-Register Save Area (64 bytes)
1344	4932	
:	:	
1378	4984	
137C	4988	
1380	4992	Store-Status Control-Register Save Area [A]; Machine-Check Control-Register Save Area (128 bytes)
1384	4996	
:	:	
13F8	5112	
13FC	5116	
1400	5120	
1404	5124	
:	:	
17F8	6136	
17FC	6140	
1800	6144	Program-Interruption Transaction Diagnostic Block (256 bytes)
1804	6148	
:	:	
18F8	6392	
18FC	6396	
1900	6400	
1904	6404	
:	:	
1FF8	8184	
1FFC	8188	

Figure 3-20. Assigned Storage Locations 512–8191 in the z/Architecture Architectural Mode (Part 3 of 3)

Chapter 4. Control

CPU States	4-2	Timing State	4-54
Stopped State	4-2	STP Clock Source State	4-55
Operating State	4-3	TOD-Clock Steering	4-55
Load State	4-3	Offset-Based TOD-Clock Steering	
Check-Stop State	4-3	Overview	4-56
Program-Status Word	4-4	Hardware-Based TOD-Clock-Steering	
Program-Status-Word Format	4-5	Overview	4-56
Short PSW Format	4-8	TOD-Offset-Update Events	4-57
Control Registers	4-8	Episodes	4-57
Tracing	4-12	TOD-Clock-Steering Registers	4-57
Implicit Tracing	4-12	UTC Information Block (UIB)	4-58
Branch Tracing	4-12	Clock Comparator	4-60
ASN Tracing	4-13	CPU Timer	4-63
Mode Tracing	4-13	Guarded-Storage Facility	4-65
Explicit Tracing	4-14	Guarded-Storage-Facility Registers	4-65
Control-Register Allocation	4-15	Control Register 2	4-65
Trace Entries	4-15	Guarded-Storage-Designation (GSD)	
Trace Operation	4-25	Register	4-66
Program-Event Recording	4-26	Guarded-Storage-Section-Mask (GSSM)	
PER Instruction-Fetching Nullification	4-26	Register	4-66
Control-Register Allocation and		Guarded-Storage-Event Parameter-List-	
Address-Space-Control Element	4-26	Address (GSEPLA) Register	4-67
PER Operation	4-29	Guarded-Storage Control Block (GSCB)	4-67
Identification of Cause	4-30	Guarded-Storage-Event Parameter List	
Priority of Indication	4-33	(GSEPL)	4-67
Storage-Area Designation	4-35	Guarded-Storage Facility Operation	4-70
PER Events	4-36	Guarded-Storage-Event Detection	4-70
Successful Branching	4-36	Guarded-Storage-Event Processing	4-71
Instruction Fetching	4-37	Externally Initiated Functions	4-74
Storage Alteration	4-37	Resets	4-74
Store Using Real Address	4-38	CPU Reset	4-78
Zero-Address Detection	4-38	Initial CPU Reset	4-79
Transaction End	4-39	Subsystem Reset	4-80
Storage-Key Alteration	4-40	Clear Reset	4-80
Indication of PER Events Concurrently with		Power-On Reset	4-81
Other Interruption Conditions	4-40	Initial Program Loading	4-81
Indication of PER Events and		CCW-Type IPL	4-82
Guarded-Storage Events	4-44	Store Status	4-82
Breaking-Event-Address Recording	4-45	Multiprocessing	4-83
Breaking-Event-Address Register	4-46	Shared Main Storage	4-84
Execution-Break Instructions	4-46	CPU-Address Identification	4-84
Timing	4-47	CPU-Address Expansion	4-84
Time-of-Day Clock and Epoch Index	4-47	CPU-Address Contraction	4-85
Format	4-47	CPU Signaling and Response	4-85
States	4-48	Signal-Processor Orders	4-85
Changes in Clock State	4-49	Sense	4-85
Setting and Inspecting the Clock	4-50	External Call	4-85
TOD Programmable Register	4-52	Emergency Signal	4-86
TOD-Clock Synchronization	4-54	Start	4-86
Timing Mode	4-54	Stop	4-86

Restart	4-86	Sense Running Status	4-92
Stop and Store Status	4-86	Set Multithreading	4-92
Initial CPU Reset	4-86	Store Additional Status at Address	4-93
CPU Reset	4-86	Conditions Determining Response	4-95
Set Prefix	4-86	Conditions Precluding Interpretation of the	
Store Status at Address	4-87	Order Code	4-95
Store Extended Status at Address	4-88	Status Bits	4-96
Set Architecture	4-89	Facility Indications	4-99
Conditional Emergency Signal	4-91		

This chapter describes in detail the facilities for controlling, measuring, and recording the operation of one or more CPUs.

CPU States

The stopped, operating, load, and check-stop states are four mutually exclusive states of the CPU. When the CPU is in the stopped state, instructions and interruptions, other than the restart interruption, are not executed. In the operating state, the CPU executes instructions and takes interruptions, subject to the control of the program-status word (PSW) and control registers, and in the manner specified by the setting of the operator-facility rate control. The CPU is in the load state during the initial-program-loading operation. The CPU enters the check-stop state only as the result of machine malfunctions.

A change between these four CPU states can be effected by use of the operator facilities or by acceptance of certain SIGNAL PROCESSOR orders addressed to that CPU. The states are not controlled or identified by bits in the PSW. The stopped, load, and check-stop states are indicated to the operator by means of the manual indicator, load indicator, and check-stop indicator, respectively. These three indicators are off when the CPU is in the operating state.

The CPU timer is updated when the CPU is in the operating state or the load state. The TOD clock is not affected by the state of any CPU.

Stopped State

The CPU changes from the operating state to the stopped state by means of the stop function. The stop function is performed when:

- The stop key is activated while the CPU is in the operating state.
- The CPU accepts a stop or stop-and-store-status order specified by a SIGNAL PROCESSOR instruction addressed to this CPU while it is in the operating state.
- The CPU has finished the execution of a unit of operation initiated by performing the start function with the rate control set to the instruction-step position.

When the stop function is performed, the transition from the operating to the stopped state occurs at the end of the current unit of operation. When the wait-state bit of the PSW is one, the transition takes place immediately, provided no interruptions are pending for which the CPU is enabled. In the case of interruptible instructions, the amount of data processed in a unit of operation depends on the particular instruction and may depend on the model.

Before entering the stopped state by means of the stop function, all pending allowed interruptions occur while the CPU is still in the operating state. They cause the old PSW to be stored and the new PSW to be fetched before the stopped state is entered. While the CPU is in the stopped state, interruption conditions remain pending.

The CPU is also placed in the stopped state when:

- CPU reset is completed. However, when the reset operation is performed as part of initial program loading for this CPU, then the CPU is placed in the load state and does not necessarily enter the stopped state.
- An address comparison indicates equality and stopping on the match is specified.

The execution of resets is described in “Resets” on page 4-74, and address comparison is described in “Address-Compare Controls” on page 12-1.

If the CPU is in the stopped state when a COMPARE AND REPLACE DAT TABLE ENTRY, INVALIDATE DAT TABLE ENTRY or INVALIDATE PAGE TABLE ENTRY instruction is executed on another CPU in the configuration and the instruction specifies the clearing of all TLBs in the configuration, the clearing of TLB entries is completed before the CPU leaves the stopped state.

Operating State

The CPU changes from the stopped state to the operating state by means of the start function or when a restart interruption (see “Restart Interruption” on page 6-56) occurs.

The start function is performed if the CPU is in the stopped state and (1) the start key associated with that CPU is activated or (2) that CPU accepts the start order specified by a SIGNAL PROCESSOR instruction addressed to that CPU. The effect of performing the start function is unpredictable when the stopped state has been entered by means of a reset.

When the rate control is set to the process position and the start function is performed, the CPU starts operating at normal speed. When the rate control is set to the instruction-step position and the wait-state bit is zero, one instruction or, for interruptible instructions, one unit of operation is executed, and all pending allowed interruptions occur before the CPU returns to the stopped state. When the rate control is set to the instruction-step position and the wait-state bit is one, the start function does not cause an instruction to be executed, but all pending allowed interruptions occur before the CPU returns to the stopped state.

Load State

The CPU enters the load state when the load-normal, load-with-dump, load-clear, or load-clear-list-directed key is activated. (See “Initial Program Loading” on page 4-81 and “Initial Program Loading” on page 17-16.)

When neither the configuration-z/Architecture-architectural-mode (CZAM) facility nor the ESA/390-com-

patibility-mode facility are installed, this sets the architectural mode to the ESA/390 mode. When the ESA/390-compatibility-mode facility is installed, this sets the architecture mode to the ESA/390-compatibility mode. When the CZAM facility is installed, the architectural mode is unchanged (that is, it remains in the z/Architecture architectural mode).

Programming Note: If a control program that operates in the z/Architecture architectural mode is loaded in a configuration where the CZAM facility may or may not be installed, then the program must be able to tolerate any of the ESA/390, ESA/390-compatibility, or z/Architecture architectural modes when execution begins.

- If the load operation places the configuration into the ESA/390 architectural mode or ESA/390 compatibility mode, then the program must issue the SIGP set-architecture order to switch to the z/Architecture architectural mode.
- If the load operation places the configuration into the z/Architecture mode, then the program must either not issue the SIGP set-architecture order, or be able to tolerate an invalid-parameter response from the SIGP instruction indicating that the configuration is already in the z/Architecture architectural mode.

Check-Stop State

The check-stop state, which the CPU enters on certain types of machine malfunction, is described in “Check-Stop State” on page 11-9. The CPU leaves the check-stop state when CPU reset is performed.

Programming Notes:

1. Except for the relationship between execution time and real time, the execution of a program is not affected by stopping the CPU.
2. When, because of a machine malfunction, the CPU is unable to end the execution of an instruction, the stop function is ineffective, and a reset function has to be invoked instead. A similar situation occurs when an unending string of interruptions results from a PSW with a PSW-format error of the type that is recognized early, or from a persistent interruption condition, such as one due to the CPU timer.

3. Pending I/O operations may be initiated, and active I/O operations continue to suspension or completion, after the CPU enters the stopped state. The interruption conditions due to suspension or completion of I/O operations remain pending when the CPU is in the stopped state.

control and status information is contained in control registers and permanently assigned storage locations.

The status of the CPU can be changed by loading a new PSW or part of a PSW.

Control is switched during an interruption of the CPU by storing the current PSW, so as to preserve the status of the CPU, and then loading a new PSW.

Program-Status Word

The current program-status word (PSW) in the CPU contains information required for the execution of the currently active program. The PSW is 128 bits in length and includes the instruction address, condition code, and other control fields. In general, the PSW is used to control instruction sequencing and to hold and indicate much of the status of the CPU in relation to the program currently being executed. Additional

Execution of LOAD PSW or LOAD PSW EXTENDED, or the successful conclusion of the initial-program-loading sequence, introduces a new PSW. The instruction address is updated by sequential instruction execution and replaced by successful branches. Other instructions are provided which operate on a portion of the PSW. Figure 4-1 on page 4-4 summarizes these instructions.

Instruction	System Mask (PSW Bits 0-7)		PSW Key (PSW Bits 8-11)		Problem State (PSW Bit 15)		Address-Space Control (PSW Bits 16-17)		Condition Code and Program Mask (PSW Bits 18-23)		(PSW Bit 24)		Basic Addressing Mode (PSW Bit 32)		Extended Addressing Mode (PSW Bit 31)	
	Saved	Set	Saved	Set	Saved	Set	Saved	Set	Saved	Set	Saved	Set	Saved	Set	Saved	Set
BRANCH AND LINK	-	-	-	-	-	-	-	-	24AM	-	-	-	31AM	-	-	-
BRANCH AND SAVE	-	-	-	-	-	-	-	-	-	-	-	-	BAM	-	-	-
BRANCH AND SAVE AND SET MODE ⁶	-	-	-	-	-	-	-	-	-	-	-	-	BAM	Yes ¹	Yes	Yes ¹
BRANCH AND SET AUTHORITY ⁷	-	-	Yes	Yes	Yes	Yes	-	-	-	-	-	-	BAM ²	BAM	-	-
BRANCH AND SET MODE ⁶	-	-	-	-	-	-	-	-	-	-	-	-	BAM ¹	Yes ¹	Yes ¹	Yes ¹
BRANCH AND STACK ⁷	Yes	-	Yes	-	Yes	-	Yes	-	Yes	-	Yes	-	BAM ³	-	Yes	-
BRANCH IN SUBSPACE GROUP ⁷	-	-	-	-	-	-	-	-	-	-	-	-	BAM ¹	BAM	-	-
BRANCH RELATIVE AND SAVE	-	-	-	-	-	-	-	-	-	-	-	-	BAM	-	-	-
BRANCH RELATIVE AND SAVE LONG	-	-	-	-	-	-	-	-	-	-	-	-	BAM	-	-	-
EXTRACT PSW	Yes	-	Yes	-	Yes	-	Yes	-	Yes	-	Yes	-	Yes	-	Yes	-
INSERT PROGRAM MASK	-	-	-	-	-	-	-	-	Yes	-	-	-	-	-	-	-
INSERT PSW KEY	-	-	Yes	-	-	-	-	-	-	-	-	-	-	-	-	-
INSERT ADDRESS SPACE CONTROL	-	-	-	-	-	-	Yes	-	-	-	-	-	-	-	-	-
Basic PROGRAM CALL ⁷	-	-	-	-	Yes	Yes	-	-	-	-	-	Yes	BAM	BAM	-	-
Stacking PROGRAM CALL ⁷	Yes	-	Yes	PKC	Yes	Yes	Yes	Yes	Yes	-	Yes	Yes	Yes	Yes	Yes	Yes
PROGRAM RETURN ⁷	-	Yes ⁴	-	Yes	-	Yes	-	Yes	-	Yes	-	Yes	-	Yes	-	Yes
PROGRAM TRANSFER ⁷	-	-	-	-	-	Yes ⁵	-	-	-	-	-	-	-	BAM	-	-
RESUME PROGRAM	-	-	-	-	-	-	-	Yes	-	Yes	-	Yes	-	Yes	-	Yes
SET ADDRESS SPACE CONTROL	-	-	-	-	-	-	-	Yes	-	-	-	-	-	-	-	-
SET ADDRESSING MODE ⁶	-	-	-	-	-	-	-	-	-	-	-	-	-	Yes	-	Yes
SET PROGRAM MASK	-	-	-	-	-	-	-	-	-	Yes	-	-	-	-	-	-
SET PSW KEY FROM ADDRESS	-	-	-	Yes	-	-	-	-	-	-	-	-	-	-	-	-
SET SYSTEM MASK ⁶	-	Yes	-	-	-	-	-	-	-	-	-	-	-	-	-	-
STORE THEN AND SYSTEM MASK	Yes	ANDs	-	-	-	-	-	-	-	-	-	-	-	-	-	-
STORE THEN OR SYSTEM MASK ⁶	Yes	ORs	-	-	-	-	-	-	-	-	-	-	-	-	-	-

Figure 4-1. Operations on PSW Fields.

Instruction	System Mask (PSW Bits 0-7)		PSW Key (PSW Bits 8-11)		Problem State (PSW Bit 15)		Address-Space Control (PSW Bits 16-17)		Condition Code and Program Mask (PSW Bits 18-23)		(PSW Bit 24)		Basic Addressing Mode (PSW Bit 32)		Extended Addressing Mode (PSW Bit 31)	
	Saved	Set	Saved	Set	Saved	Set	Saved	Set	Saved	Set	Saved	Set	Saved	Set	Saved	Set
TRAP ⁷	-	-	-	-	Yes	-	Yes	Yes	Yes	-	-	-	Yes	Yes	Yes	-
Explanation:																
-	No.															
1	The action takes place only if the associated R field in the instruction is nonzero.															
2	In the reduced-authority state, the action takes place only if the R _i field in the instruction is nonzero.															
3	The action also takes place in the 64-bit addressing mode if the R _i field in the instruction is zero.															
4	PROGRAM RETURN does not change the PER mask.															
5	PROGRAM TRANSFER does not change the problem-state bit from one to zero.															
6	Some restrictions apply in the ESA/390-compatibility mode; see instruction description.															
7	Not supported in the ESA/390-compatibility mode.															
BAM	The basic-addressing-mode bit is saved or set in the 24-bit or 31-bit addressing mode.															
ANDs	The logical AND of the immediate field in the instruction and the current system mask replaces the current system mask.															
ORs	The logical OR of the immediate field in the instruction and the current system mask replaces the current system mask.															
PKC	When the PSW-key-control bit, bit 131 of the entry-table entry, is zero, the PSW key remains unchanged. When the PSW-key-control bit is one, the PSW key is set with the entry key, bits 136-139 of the entry-table entry.															
24AM	The condition code and program mask are saved in the 24-bit addressing mode.															
31AM	The basic-addressing-mode bit is saved in the 31-bit addressing mode.															

Figure 4-1. Operations on PSW Fields. (Continued)

A new or modified PSW becomes active (that is, the information introduced into the current PSW assumes control over the CPU) when the interruption or the execution of an instruction that changes the PSW is completed. The interruption for PER associated with an instruction that changes the PSW occurs under control of the PER mask that is effective at the beginning of the operation.

Bits 0-7 of the PSW are collectively referred to as the system mask.

Programming Notes:

1. A summary of the operations which save or set the problem state, addressing mode, and instruction address is contained in "Subroutine Linkage without the Linkage Stack" on page 5-14.
2. In the ESA/390-compatibility mode, it is unpredictable whether LOAD PSW EXTENDED is supported. If not supported, attempted execution of LPSWE results in an operation exception being recognized.

Program-Status-Word Format

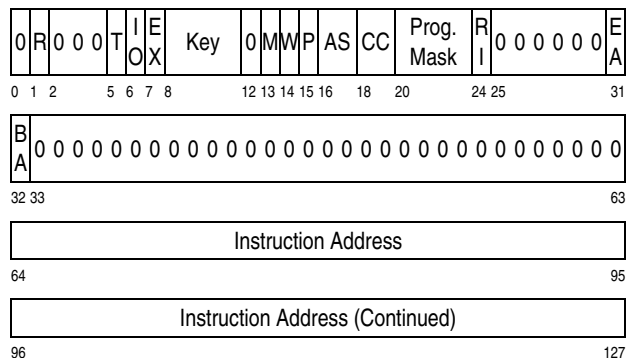

Figure 4-2. PSW Format

The following is a summary of the functions of the PSW fields. (See Figure 4-2.)

PER Mask (R): Bit 1 controls whether the CPU is enabled for interruptions associated with program-event recording (PER). When the bit is zero, no PER event can cause an interruption. When the bit is one, interruptions are permitted, subject to the PER-event-mask bits in control register 9.

Depending on the model, when bit position 1 of the PSW contains one, address-compare controls may be disabled and remain disabled, even if bit position

1 of the PSW transitions back to zero. See “Address-Compare Controls” on page 12-1 for details.

DAT Mode (T): Bit 5 controls whether implicit dynamic address translation of logical and instruction addresses used to access storage takes place. When the bit is zero, DAT is off, and logical and instruction addresses are treated as real addresses. When the bit is one, DAT is on, and the dynamic-address-translation mechanism is invoked.

In the ESA/390-compatibility mode, bit 5 of the PSW must be zero; otherwise, a specification exception is recognized.

I/O Mask (IO): Bit 6 controls whether the CPU is enabled for I/O interruptions. When the bit is zero, an I/O interruption cannot occur. When the bit is one, I/O interruptions are subject to the I/O-interruption subclass-mask bits in control register 6. When an I/O-interruption subclass-mask bit is zero, an I/O interruption for that I/O-interruption subclass cannot occur; when the I/O-interruption subclass-mask bit is one, an I/O interruption for that I/O-interruption subclass can occur.

External Mask (EX): Bit 7 controls whether the CPU is enabled for interruption by conditions included in the external class. When the bit is zero, an external interruption cannot occur. When the bit is one, an external interruption is subject to the corresponding external subclass-mask bits in control register 0; when the subclass-mask bit is zero, conditions associated with the subclass cannot cause an interruption; when the subclass-mask bit is one, an interruption in that subclass can occur.

PSW Key: Bits 8-11 form the access key for storage references by the CPU. If the reference is subject to key-controlled protection, the PSW key is matched with a storage key when information is stored or when information is fetched from a location that is protected against fetching. However, for one of the operands of each of MOVE TO PRIMARY, MOVE TO SECONDARY, MOVE WITH KEY, MOVE WITH SOURCE KEY, and MOVE WITH DESTINATION KEY, and for either or both operands of MOVE WITH OPTIONAL SPECIFICATIONS, an access key specified as an operand is used instead of the PSW key.

Bit 12: Bit 12 of the 16-byte current PSW must be zero; otherwise, a specification exception is recognized. This specification exception may be recognized either when the instruction that attempted to

load the PSW ends with suppression or when the newly-loaded PSW becomes active.

Programming Note: Bit 12 of an 8-byte short-format PSW in storage is inverted when the 16-byte current PSW is loaded from the following locations:

- An assigned storage location in the ESA/390-compatibility mode.
- The second operand of LOAD PSW (in the z/Architecture architecture mode and in the ESA/390-compatibility mode).
- The second operand of RESUME PROGRAM when the P bit in the parameter list is zero (in the z/Architecture architecture mode and in the ESA/390-compatibility mode).

Therefore, bit 12 of an 8-byte short-format PSW must be one; otherwise, a PSW-format error condition exists. See “Short PSW Format” on page 4-8.

Machine-Check Mask (M): Bit 13 controls whether the CPU is enabled for interruption by machine-check conditions. When the bit is zero, a machine-check interruption cannot occur. When the bit is one, machine-check interruptions due to system damage and instruction-processing damage are permitted, but interruptions due to other machine-check-subclass conditions are subject to the subclass-mask bits in control register 14.

Wait State (W): When bit 14 is one, the CPU is waiting; that is, no instructions are processed by the CPU, but interruptions may take place. When bit 14 is zero, instruction fetching and execution occur in the normal manner. The wait indicator is on when the bit is one.

Problem State (P): When bit 15 is one, the CPU is in the problem state. When bit 15 is zero, the CPU is in the supervisor state. In the supervisor state, all instructions are valid. In the problem state, only those instructions are valid that provide meaningful information to the problem program and that cannot affect system integrity; such instructions are called unprivileged instructions. The instructions that are never valid in the problem state are called privileged instructions. When a CPU in the problem state attempts to execute a privileged instruction, a privileged-operation exception is recognized. Another group of instructions, called semiprivileged instructions, are executed by a CPU in the problem state

only if specific authority tests are met; otherwise, a privileged-operation exception or some other program exception is recognized, depending on the particular requirement which is violated.

Address-Space Control (AS): In the z/Architecture architectural mode, bits 16 and 17, in conjunction with PSW bit 5, control the translation mode. See “Translation Modes” on page 3-40. In the ESA/390-compatibility mode, bits 16-17 may operate as defined in Reference [12.] on page xxx.

Condition Code (CC): Bits 18 and 19 are the two bits of the condition code. The condition code is set to 0, 1, 2, or 3, depending on the result obtained in executing certain instructions. Most arithmetic and logical operations, as well as some other operations, set the condition code. The instruction BRANCH ON CONDITION can specify any selection of the condition-code values as a criterion for branching. A table in Appendix C summarizes the condition-code values that may be set for all instructions which set the condition code of the PSW.

Program Mask: Bits 20-23 are the four program-mask bits. Each bit is associated with a program exception, as follows:

Program-Mask Bit	Program Exception
20	Fixed-point overflow
21	Decimal overflow
22	HFP exponent underflow
23	HFP significance

When the mask bit is one, the exception results in an interruption. When the mask bit is zero, no interruption occurs. The setting of the HFP-exponent-underflow-mask bit or the HFP-significance-mask bit also determines the manner in which the operation is completed when the corresponding exception occurs.

Bit 24 (RI): Bit 24 is reserved for IBM use. An early specification exception may be recognized when bit 24 of the operand of LPSW or LPSWE is one.

Extended Addressing Mode (EA): Bit 31 controls the size of effective addresses and effective-address generation in conjunction with bit 32, the basic-addressing-mode bit. When bit 31 is zero, the

addressing mode is controlled by bit 32. When bits 31 and 32 are both one, 64-bit addressing is specified.

In the ESA/390-compatibility mode, it is unpredictable whether a specification exception is recognized when bit 31 of the PSW is one.

Basic Addressing Mode (BA): Bits 31 and 32 control the size of effective addresses and effective-address generation. When bits 31 and 32 are both zero, 24-bit addressing is specified. When bit 31 is zero and bit 32 is one, 31-bit addressing is specified. When bits 31 and 32 are both one, 64-bit addressing is specified. Bit 31 one and bit 32 zero is an invalid combination that causes a specification exception to be recognized. The addressing mode does not control the size of PER addresses or of addresses used to access DAT, ASN, dispatchable-unit-control, linkage, entry, and trace tables or access lists or the linkage stack. See “Address Generation” on page 5-10 and “Address Size and Wraparound” on page 3-6. The control of the addressing mode by bits 31 and 32 of the PSW is summarized as follows:

PSW.31	PSW.32	Addressing Mode
0	0	24-bit
0	1	31-bit
1	1	64-bit

Instruction Address: Bits 64-127 of the PSW are the instruction address. This address designates the location of the leftmost byte of the next instruction to be executed, unless the CPU is in the wait state (bit 14 of the PSW is one).

Bit positions 0, 2-4, 25-30, and 33-63 are unassigned and must contain zeros. A specification exception is recognized when these bit positions do not contain zeros.

When bits 31 and 32 of the PSW specify the 24-bit addressing mode, bits 64-103 of the instruction address must be zeros, or, when bits 31 and 32 specify the 31-bit mode, bits 64-96 must be zeros. Otherwise, a specification exception is recognized. A specification exception is also recognized when bit 31 is one and bit 32 is zero or when bit position 12 does not contain a zero.

LOAD PSW EXTENDED has a 16-byte second operand, as shown in Figure 4-2 on page 4-5. The

instruction loads the operand unchanged and without examination as the current PSW.

Short PSW Format

Certain instructions are capable of loading the full 128-bit PSW, or portions thereof, from a shorter doubleword storage location, called a *short PSW*. The short PSW, shown in Figure 4-3, is similar to the ESA/390-format PSW in that bit 12 must be one. However, unlike the ESA/390-format PSW in which bit 31 must be zero, bit 31 of the short PSW may be either zero or one in the short PSW.

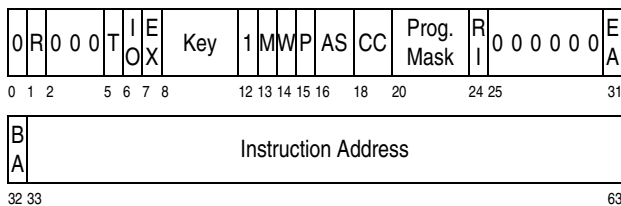

Figure 4-3. Short PSW Format

The bit positions of the short PSW and the corresponding bit positions in the full 128-bit PSW are shown in Figure 4-4.

PSW Bit Positions	Short-PSW Bit Positions
0-11	0-11
12 *	12 *
13-32	13-32
33-96	—
97-127	33-63

Explanation:

* Bit 12 must be zero in the full 128-bit current PSW and one in the short PSW. Bit 12 of the short PSW is inverted when loaded into the full 128-bit current PSW. While in the ESA/390 compatibility mode, bit 12 of the full 128-bit PSW is inverted in the old PSW stored during an interruption. The result placed in bit 44 of general register R₁ for EXTRACT PSW is based on the architectural mode and not on bit 12 of the current PSW. When execution of EXTRACT STACKED STATE with code 1 is completed in the z/Architecture architectural mode, the value of one is placed in bit 44 of general register R₁, for the purpose of placing the contents of a state entry into a pair of general registers, in the form of a short-format PSW.

— Zeros are placed in bit positions 33-96 of the full 128-bit PSW when a short PSW is loaded.

Figure 4-4. PSW and Short-PSW Bit Positions

LOAD PSW and the initial-program-loading (IPL) process translate a short PSW into the full 128-bit PSW, as shown in Figure 4-4. When the P control (bit 13) of the RESUME PROGRAM instruction's parameter list is zero, the instruction loads selected bits of a short PSW into the full 128-bit PSW.

In the ESA/390-compatibility mode, the PSW used in assigned storage locations and in the LOAD PSW and RESUME PROGRAM instructions has the same format as the short PSW except that when loading the PSW, (a) bit 5 must be zero, and (b) it is unpredictable whether bit 31 must be zero.

Depending on the model, either LOAD PSW (LPSW) recognizes a specification exception if bit 12 of its second operand is not one, or this error is indicated by an early specification exception after the completion of the execution of the LOAD PSW.

Note: The term short PSW refers only to the eight-byte entity in storage. The actual PSW used by the CPU is the 16-byte register illustrated in Figure 4-2.

Control Registers

The control registers provide for maintaining and manipulating control information outside the PSW. There are sixteen 64-bit control registers, however in the ESA/390-compatibility mode, bits 0-31 of each control register contains zeros.

The LOAD CONTROL (LCTLG) instruction causes all control-register bit positions within those registers designated by the instruction to be loaded from storage. In the ESA/390-compatibility mode, LCTLG is not supported; attempted execution of LCTLG results in an operation exception being recognized.

The LOAD CONTROL (LCTL) instruction loads only bit positions 32-63 of the control registers, and bits 0-31 of the registers remain unchanged. The instructions BRANCH AND SET AUTHORITY, BRANCH AND STACK, BRANCH IN SUBSPACE GROUP, EXTRACT AND SET EXTENDED AUTHORITY, LOAD ADDRESS SPACE PARAMETERS, PROGRAM CALL, PROGRAM RETURN, PROGRAM TRANSFER, PROGRAM TRANSFER WITH INSTANCE, SET SECONDARY ASN, and SET SECONDARY ASN WITH INSTANCE, provide special-

ized functions to place information into certain control-register bit positions.

Information loaded into the control registers becomes active (that is, assumes control over the system) at the completion of the instruction that causes the information to be loaded.

At the time the registers are loaded, the information is not checked for exceptions, such as an address designating an unavailable or protected location. The validity of the information is checked and the exceptions, if any, are indicated at the time the information is used.

The STORE CONTROL (STCTG) instruction causes the contents of all control-register bit positions, within those registers designated by the instruction, to be placed in storage. The STORE CONTROL (STCTL) instruction places the contents of bit positions 32-63 of the control registers in storage, and bits 0-31 of the registers are ignored. The instructions EXTRACT AND SET EXTENDED AUTHORITY, EXTRACT PRIMARY ASN, EXTRACT PRIMARY ASN AND

INSTANCE, EXTRACT SECONDARY ASN, EXTRACT SECONDARY ASN AND INSTANCE, and PROGRAM CALL provide specialized functions to obtain information from certain control-register bit positions.

Only the general structure of the control registers is described here; the definition of a particular control-register bit position appears in the description of the facility with which the position is associated. Figure 4-5 on page 4-10 shows the control-register bit positions which are assigned and the initial values of the positions upon execution of initial CPU reset. All control-register bit positions not listed in the figure are initialized to zero.

The following applies when the configuration is operating in the ESA/390-compatibility mode:

- Bits 0-31 of all control registers contain zeros.
- It is unpredictable whether any of bits 32-63 of a control register that are unique to z/Architecture features have any effect.

Control Register	Bits	Name of Field	Associated with	Initial Value
0	8	Transactional-execution control ⁵	Transactional execution	0
0	9	Transactional-execution program-interruption filtering override ⁵	Transactional execution	0
0	10	Clock-comparator sign control	Multiple-epoch facility	0
0	15	Measurement-counter-extraction-authorization control ⁵	CPU measurement ⁴	0
0	30	Warning-track subclass mask ⁵	Virtual machines	0
0	32	TRACE TOD-clock control ⁶	Tracing	0
0	33	SSM-suppression control	SET SYSTEM MASK	0
0	34	TOD-clock-sync control	TOD clock	0
0	35	Low-address-protection control	Low-address-protection	0
0	36	Extraction-authority control	Instruction authorization	0
0	37	Secondary-space control ⁵	Instruction authorization	0
0	38	Fetch-protection-override control	Key-controlled protection	0
0	39	Storage-protection-override control	Key-controlled protection	0
0	40	Enhanced-DAT-enablement control ⁵	Dynamic address translation	0
0	43	Instruction-execution-protection-enablement control ⁵	Instruction-execution protection	0
0	44	ASN-and-LX-reuse control ⁵	Instruction authorization	0
0	45	AFP-register control	Floating point	0
0	46	Vector enablement control	Vector facility for z/Architecture	0
0	48	Malfunction-alert subclass mask	External interruptions	0
0	49	Emergency-signal subclass mask	External interruptions	0
0	50	External-call subclass mask	External interruptions	0
0	52	Clock-comparator subclass mask	External interruptions	0
0	53	CPU-timer subclass mask	External interruptions	0
0	54	Service-signal subclass mask	External interruptions	0
0	56	Unused ¹		1
0	57	Interrupt-key subclass mask	External interruptions	1
0	58	Measurement-alert subclass mask	CPU measurement ⁴	1
0	59	Timing-alert subclass mask	External interruptions	0
0	61	Crypto control	Cryptography	0
1	0-51	Primary region-table origin ^{2,5}	Dynamic address translation	0
1	0-51	Primary segment-table origin ^{2,5}	Dynamic address translation	0
1	0-51	Primary real-space token origin ^{2,5}	Dynamic address translation	0
1	54	Primary subspace-group control ⁵	Subspace groups	0
1	55	Primary private-space control ⁵	Dynamic address translation	0
1	56	Primary storage-alteration-event ⁵	Program-event recording control	0
1	57	Primary space-switch-event control ⁵	Program interruptions	0
1	58	Primary real-space control ⁵	Dynamic address translation	0
1	60-61	Primary designation-type control ^{3,5}	Dynamic address translation	0
1	62-63	Primary table length ^{3,5}	Dynamic address translation	0
2	0-8	Reserved for IBM use	System controls	0
2	33-57	Dispatchable-unit-control-table origin	Access-register translation	0
2	59	Guarded-storage-facility enablement control ⁶	Guarded-storage facility	0
2	61	Transaction diagnostic scope ⁵	Transactional execution	0
2	62-63	Transaction diagnostic control ⁵	Transactional execution	0
3	0-31	Secondary ASN-second-table-entry instance number ⁵	Instruction authorization	0
3	32-47	PSW-key mask	Instruction authorization	0
3	48-63	Secondary ASN ⁵	Address spaces	0

Figure 4-5. Assignment of Control-Register Fields (Part 1 of 3)

Control Register	Bits	Name of Field	Associated with	Initial Value
4	0-31	Primary ASN-second-table-entry instance number ⁵	Instruction authorization	0
4	32-47	Authorization index ⁵	Instruction authorization	0
4	48-63	Primary ASN ⁵	Address spaces	0
5	33-57	Primary-ASN-second-table-entry origin ⁵	Access-register translation	0
6	32-39	I/O-interruption subclass mask	I/O interruptions	0
7	0-51	Secondary region-table origin ^{2,5}	Dynamic address translation	0
7	0-51	Secondary segment-table origin ^{2,5}	Dynamic address translation	0
7	0-51	Secondary real-space token origin ^{2,5}	Dynamic address translation	0
7	54	Secondary subspace-group control ⁵	Subspace groups	0
7	55	Secondary private-space control ⁵	Dynamic address translation	0
7	56	Secondary storage-alteration-event ⁵	Program-event recording control	0
7	58	Secondary real-space control ⁵	Dynamic address translation	0
7	60-61	Secondary designation-type control ^{3,5}	Dynamic address translation	0
7	62-63	Secondary table length ^{3,5}	Dynamic address translation	0
8	16-31	Enhanced-monitor masks ⁵	MONITOR CALL	0
8	32-47	Extended authorization index	Access-register translation	0
8	48-63	Monitor masks	MONITOR CALL	0
9	32	Successful-branching-event mask	Program-event recording	0
9	33	Instruction-fetching-event mask	Program-event recording	0
9	34	Storage-alteration-event mask	Program-event recording	0
9	35	Storage-key-alteration-event mask	Program-event recording	0
9	36	Store-using-real-address-event mask	Program-event recording	0
9	37	Zero-address-detection-event mask ⁶	Program-event recording	0
9	38	Transaction-end event mask ⁵	Program-event recording	0
9	39	Instruction-fetching-nullification-event mask ⁶	Program-event recording	0
9	40	Branch-address control	Program-event recording	0
9	41	Per-event-suppression control ⁵	Program-event recording	0
9	42	Storage-alteration-space control ⁵	Program-event recording	0
10	0-63	PER starting address ⁷	Program-event recording	0
11	0-63	PER ending address ⁷	Program-event recording	0
12	0	Branch-trace control ⁵	Tracing	0
12	1	Mode-trace control ⁵	Tracing	0
12	2-61	Trace-entry address ⁷	Tracing	0
12	62	ASN-trace control ⁵	Tracing	0
12	63	Explicit-trace control	Tracing	0
13	0-51	Home region-table origin ^{2,5}	Dynamic address translation	0
13	0-51	Home segment-table origin ^{2,5}	Dynamic address translation	0
13	0-51	Home real-space token origin ^{2,5}	Dynamic address translation	0
13	55	Home private-space control ⁵	Dynamic address translation	0
13	56	Home storage-alteration-event ⁵	Program-event recording control	0
13	57	Home space-switch-event control ⁵	Program interruptions	0
13	58	Home real-space control ⁵	Dynamic address translation	0
13	60-61	Home designation-type control ^{3,5}	Dynamic address translation	0
13	62-63	Home table length ^{3,5}	Dynamic address translation	0

Figure 4-5. Assignment of Control-Register Fields (Part 2 of 3)

Control Register	Bits	Name of Field	Associated with	Initial Value
14	32	Unused ¹		1
14	33	Unused ¹		1
14	34	Extended save-area control (ESA/390-compatibility mode only)	Floating point	0
14	35	Channel-report-pending subclass mask	I/O machine-check handling	0
14	36	Recovery subclass mask	Machine-check handling	0
14	37	Degradation subclass mask	Machine-check handling	0
14	38	External-damage subclass mask	Machine-check handling	1
14	39	Warning subclass mask	Machine-check handling	0
14	42	TOD-clock-control-override control	TOD clock	0
14	44	ASN-translation control ⁵	Instruction authorization	0
14	45-63	ASN-first-table origin ⁵	ASN translation	0
15	0-60	Linkage-stack-entry address ⁵	Linkage-stack operations	0

Explanation:

The fields not listed are unassigned. The initial value for all unlisted control-register bit positions is zero.

- ¹ This bit is not used but is initialized to one for consistency with the System/370 definition.
- ² The address-space-control element (ASCE) in the control register has one of three formats, depending on bit 58 of the register, the real-space control, and bits 60 and 61 of the register, the designation-type control. When bit 58 is zero, the ASCE is a region-table designation if bits 60 and 61 are 11, 10, or 01 binary, or it is a segment-table designation if bits 60 and 61 are 00 binary. When bit 58 is one, the ASCE is a real-space designation. Bits 0-51 are the region-table origin, the segment-table origin or the real-space token origin, depending on whether the ASCE is a region-table designation, a segment-table designation, or a real-space designation, respectively.
- ³ Bits 60-63 are assigned when the ASCE in the control register is a region-table designation or a segment-table designation.
- ⁴ See *The Load-Program-Parameter and CPU-Measurement Facilities (SA23-2260)* for details on these bits.
- ⁵ Not applicable in the ESA/390-compatibility mode.
- ⁶ It is unpredictable whether this bit has any effect in the ESA/390-compatibility mode.
- ⁷ In the ESA/390-compatibility mode, bits 0-31 of the register are all zeros. Results are unpredictable if bit 32 of the register is one.

Figure 4-5. Assignment of Control-Register Fields (Part 3 of 3)

Programming Notes:

1. The detailed definition of a particular control-register bit position can be located by referring to the entry “control-register assignment” in the Index.
2. To ensure that existing programs operate correctly if and when new facilities using additional control-register bit positions are installed, the program should load zeros in unassigned positions.

controllable functions which cause entries to be made in a trace table: branch tracing, ASN tracing, mode tracing, and explicit tracing.

Implicit Tracing

Branch tracing, ASN tracing, and mode tracing together are referred to as implicit tracing. In the ESA/390-compatibility mode, implicit tracing is not supported.

Tracing

Tracing assists in the determination of system problems by providing an ongoing record in storage of significant events. Tracing consists of four separately

Branch Tracing

When branch tracing is on, a branch trace entry is made in the trace table for each execution of certain branch instructions when they cause branching. The branch address is placed in the trace entry. The trace entry also indicates the following about the addressing mode in effect after branching and the branch

address: (1) the CPU is in the 24-bit addressing mode, (2) the CPU either is in the 31-bit addressing mode or is in the 64-bit addressing mode and bits 0-32 of the branch address are all zeros, or (3) the CPU is in the 64-bit addressing mode and bits 0-32 of the branch address are not all zeros. The branch instructions that are traced are:

- BRANCH AND LINK (BALR only) when the R_2 field is not zero
- BRANCH AND SAVE (BASR only) when the R_2 field is not zero
- BRANCH AND SAVE AND SET MODE when the R_2 field is not zero
- BRANCH AND SET AUTHORITY
- BRANCH AND STACK when the R_2 field is not zero
- BRANCH IN SUBSPACE GROUP
- RESUME PROGRAM
- TRAP

However, a branch trace entry is made for BRANCH IN SUBSPACE GROUP only if ASN tracing is not on.

If both branch tracing and mode tracing are on and BRANCH AND SAVE AND SET MODE or RESUME PROGRAM changes the extended-addressing-mode bit, PSW bit 31, a mode-switching-branch trace entry is made instead of a branch trace entry.

ASN Tracing

When ASN tracing is on, an entry named the same as the instruction is made in the trace table for each execution of the following instructions:

- BRANCH IN SUBSPACE GROUP
- PROGRAM CALL
- PROGRAM RETURN
- PROGRAM TRANSFER
- SET SECONDARY ASN

However, the entry for PROGRAM RETURN is made only when PROGRAM RETURN unstacks a linkage-stack state entry that was formed by PROGRAM CALL, not when PROGRAM RETURN unstacks an entry formed by BRANCH AND STACK.

When ASN tracing is on, a PROGRAM TRANSFER trace entry is also made for each execution of PROGRAM TRANSFER WITH INSTANCE, and a SET SECONDARY ASN trace entry is also made for each execution of SET SECONDARY ASN WITH

INSTANCE. In either case, a bit in the trace entry indicates whether the entry was made due to the without-instance or the with-instance instruction.

If both ASN tracing and mode tracing are on and PROGRAM CALL uses a 20-bit PC number and changes PSW bit 31, first a PROGRAM CALL trace entry is made, and then a mode-switch trace entry is made. In this case except when PROGRAM CALL uses a 32-bit PC number, only a PROGRAM CALL trace entry is made since it indicates the old and new values of the extended-addressing-mode bit, PSW bit 31. A 32-bit PC number may be used if the ASN-and-LX-reuse facility is installed and is enabled by a one value of the ASN-and-LX-reuse control, bit 44 of control register 0.

Mode Tracing

Mode tracing records a switch from a basic (24-bit or 31-bit) addressing mode to the extended (64-bit) addressing mode or from the extended mode to a basic mode.

When mode tracing is on, a mode-switch trace entry is made in the trace table for each execution of the following instructions if the execution changes PSW bit 31:

- BRANCH AND SAVE AND SET MODE
- BRANCH AND SET MODE
- PROGRAM CALL
- PROGRAM RETURN
- RESUME PROGRAM
- SET ADDRESSING MODE

However, a mode-switch trace entry is not made for PROGRAM RETURN if ASN tracing is on and PROGRAM RETURN unstacks a state entry formed by PROGRAM CALL; a PROGRAM RETURN trace entry is made instead, and it contains information about PSW bit 31.

BRANCH AND SAVE AND SET MODE and RESUME PROGRAM cause trace entries to be made as follows: a branch trace entry if only branch tracing is on, a mode-switching-branch trace entry if both branch tracing and mode tracing are on, or a mode-switch trace entry if only mode tracing is on.

The trace entries produced by implicit tracing are summarized in Figure 4-6.

Instruction	Implicit Tracing Enabled						
	Branch	ASN	Mode	Branch and ASN	Branch and Mode	ASN and Mode	All
	Trace Entries Made						
BAKR	B	–	–	B	B	–	B
BALR	B	–	–	B	B	–	B
BASR	B	–	–	B	B	–	B
BASSM	B	–	MS	B	B MSB	MS	B MSB
BSA	B	–	–	B	B	–	B
BSG	B	BSG	–	BSG	B	BSG	BSG
BSM	–	–	MS	–	MS	–	MS
PC-20	–	PC	MS	PC	MS	PC & MS	PC & MS
PC-32	–	PC	MS	PC	MS	PC	PC
PR-b	–	–	MS	–	MS	MS	MS
PR-pc	–	PR	MS	PR	MS	PR	PR
PT or PTI	–	PT	–	PT	–	PT	PT
RP	B	–	MS	B	B MSB	MS	B MSB
SSAR or SSAIR	–	SSAR	–	SSAR	–	SSAR	SSAR
SAM24/31/64	–	–	MS	–	MS	MS	MS
TRAP2/4	B	–	–	B	B	–	B

Explanation:

– None.

-20 The case when PROGRAM CALL uses a 20-bit PC number.

-32 The case when PROGRAM CALL uses a 32-bit PC number.

-b The case when PROGRAM RETURN unstacks a branch state entry.

-pc The case when PROGRAM RETURN unstacks a program-call state entry.

| OR.

& AND.

B Branch trace entry. Made only if the branch is taken and a mode-switching-branch trace entry is not made.

MS Mode-switch trace entry. Made only if PSW bit 31 is changed.

MSB Mode-switching-branch trace entry. Made only if PSW bit 31 is changed (which can occur only if the branch is taken).

Figure 4-6. Summary of Implicit Tracing

Explicit Tracing

Note: In the following discussion, the term “TRACE” by itself refers to the generic instruction name which includes the specific instructions having the mnemonics TRACE and TRACG. To avoid ambiguity, when a specific instruction is described, the generic name TRACE will be followed by the specific instruction’s mnemonic in parentheses.

When explicit tracing is on, execution of TRACE (TRACE or TRACG) causes an entry to be made in the trace table. The entry for TRACE (TRACE) includes bits 16-63 from the TOD clock, the second

operand of the TRACE instruction, and bits 32-63 of a range of general registers. The entry for TRACE (TRACG) is the same except that it includes bits 0-79 from the TOD clock and bits 0-63 of a range of general registers. When the multiple-epoch facility is installed, the entry for TRACE (TRACG) also includes bits 1-7 of the epoch index.

When the CPU is in the transactional-execution mode, an instruction that would otherwise cause tracing to occur is restricted. Attempted execution of such an instruction causes the transaction to be aborted with abort code 11, and the condition code is set to 3.

Control-Register Allocation

The information to control tracing is contained in control register 12 and has the following format:

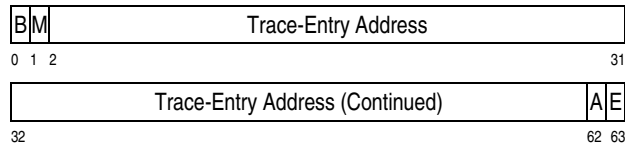

Branch-Trace-Control Bit (B): Bit 0 of control register 12 controls whether branch tracing is turned on or off. If the bit is zero, branch tracing is off; if the bit is one, branch tracing is on.

Mode-Trace-Control Bit (M): Bit 1 of control register 12 controls whether mode tracing is turned on or off. If the bit is zero, mode tracing is off; if the bit is one, mode tracing is on.

Trace-Entry Address: Bits 2-61 of control register 12, with two zero bits appended on the left and two on the right, form the real address of the next trace entry to be made.

In the ESA/390-compatibility mode, it is unpredictable whether bit 32 of the trace-entry address is treated as being zero.

ASN-Trace-Control Bit (A): Bit 62 of control register 12 controls whether ASN tracing is turned on or off. If the bit is zero, ASN tracing is off; if the bit is one, ASN tracing is on.

Explicit-Trace-Control Bit (E): Bit 63 of control register 12 controls whether explicit tracing is turned on or off. If the bit is zero, explicit tracing is off, which causes the TRACE instruction to be executed as a no-operation; if the bit is one, the execution of the TRACE instruction creates an entry in the trace table, except that no entry is made when bit 0 of the second operand of the TRACE instruction is one.

Programming Note: The following considerations apply to tracing in the ESA/390-compatibility mode:

- Bits 0-31 of control register 12 are always zero (the LCTLG instruction is not supported, thus there is no means by which bits 0-31 can be set to a nonzero value). This means that neither branch- nor mode-tracing can be performed.

- If bit 32 of control register 12 is one, it is unpredictable whether the bit is ignored and treated as zero, or the bit is treated as bit 32 of the trace-entry address. If bit 32 of the trace-entry address is one, then a trace entry may be formed between 2- and 4 G-bytes if the real storage is available; otherwise, an addressing exception may be recognized if the real storage is not available.
- Instructions that perform ASN tracing require that dynamic-address translation be enabled. DAT is not supported in the ESA/390-compatibility mode, thus the ASN-tracing control is ignored.

Trace Entries

Trace entries are of nine types, with most types having more than one detailed format. The types and numbers of formats are as follows:

- Branch (three formats)
- BRANCH IN SUBSPACE GROUP (two formats)
- Mode switch (three formats)
- Mode-switching branch (three formats)
- PROGRAM CALL (seven formats)
- PROGRAM RETURN (nine formats)
- PROGRAM TRANSFER (three formats)
- SET SECONDARY ASN (one format)
- TRACE (two formats)

Format-1 and format-2 PROGRAM CALL trace entries are made if the ASN-and-LX reuse facility is not enabled. Entries of formats 3-7 are made if the facility is enabled.

The PROGRAM TRANSFER trace entry is also made for PROGRAM TRANSFER WITH INSTANCE, and the SET SECONDARY ASN trace entry is also made for SET SECONDARY ASN WITH INSTANCE. In either case, bit 15 (N) of the entry is one if the entry was made because of execution of the with-instance instruction.

The entries are shown in Figure 4-7. In that figure, each entry is labeled with “Fn,” indicating a format number, to allow references to each format within a trace-entry type. Also, “Branch,” referring to the mnemonic of an instruction that causes a branch trace entry, refers to BAKR, BALR, BASR, BASSM, BSA, or BSG.

Figure 4-7 lists the trace entries in ascending order of values in bit fields that identify the entries.

F1 Branch (Branch, RP, or TRAP2/4 when Resulting Mode Is 24-Bit)

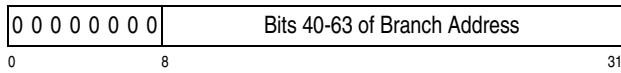

F2 Branch (Branch, RP, or TRAP2/4 when Resulting Mode Is 31-Bit, or when Resulting PSW Bit 31 is One (See Note) and Bits 0-32 of Branch Address Are All Zeros)

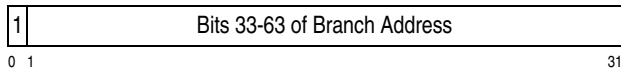

F3 Branch (Branch, RP, or TRAP2/4 when Resulting PSW Bit 31 Is One (See Note) and Bits 0-32 of Branch Address Are Not All Zeros)

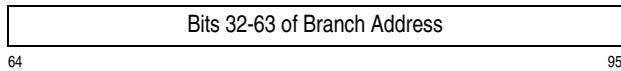
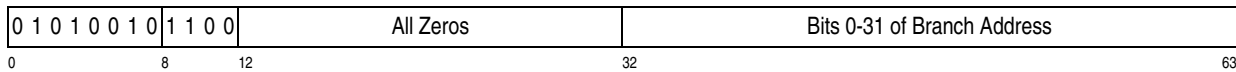

F1 BRANCH IN SUBSPACE GROUP (if ASN Is Tracing on, in 24-Bit or 31-Bit Mode)

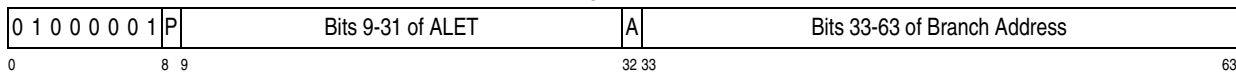

F2 BRANCH IN SUBSPACE GROUP (if ASN Is Tracing on, in 64-Bit Mode)

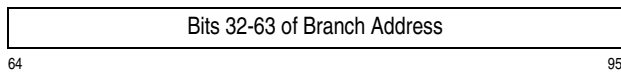
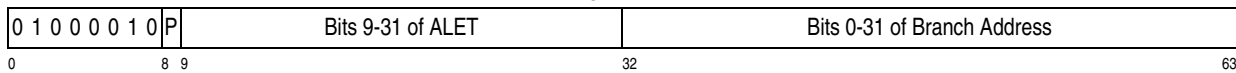

F1 Mode Switch (BASSM, BSM, PC, PR, RP, or SAM64 from 24-Bit or 31-Bit Mode when Resulting PSW Bit 31 is One (See Note))

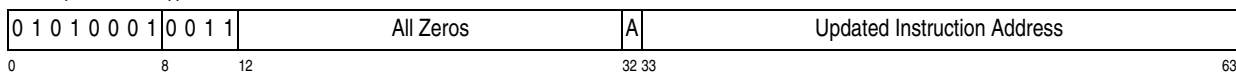

F2 Mode Switch (BASSM, BSM, PC, PR, RP, SAM24, or SAM31 from 64-Bit Mode to 24-Bit or 31-Bit Mode when Bits 0-31 of Updated Instruction Address Are All Zeros)

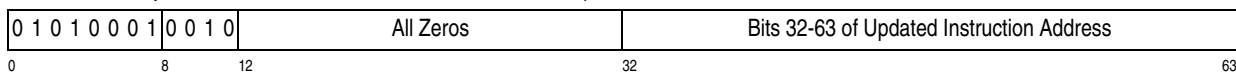
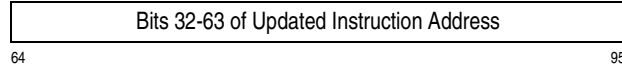
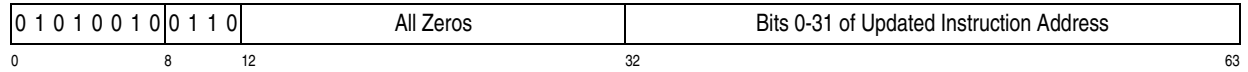
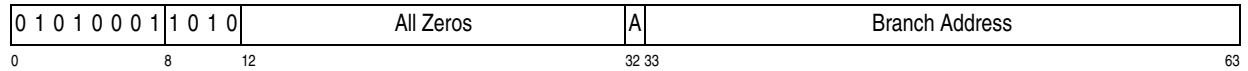

Figure 4-7. Trace Entries (Part 1 of 7)

F3 Mode Switch (BASSM, BSM, PC, PR, or RP from 64-Bit Mode to 24-Bit or 31-Bit Mode when Bits 0-31 of Updated Instruction Address Are Not All Zeros)



F1 Mode-Switching Branch (BASSM or RP from 64-Bit Mode to 24-Bit or 31-Bit Mode)



F2 Mode-Switching Branch (BASSM or RP from 24-Bit or 31-Bit Mode when Resulting PSW Bit 31 Is One (See Note) and Bits 0-31 of Branch Address Are All Zeros)

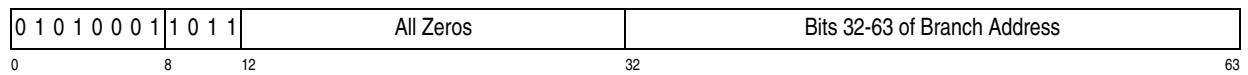

F3 Mode-Switching Branch (BASSM or RP from 24-Bit or 31-Bit Mode when Resulting PSW Bit 31 Is One (See Note) and Bits 0-31 of Branch Address Are Not All Zeros)

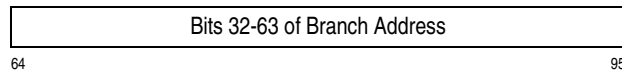
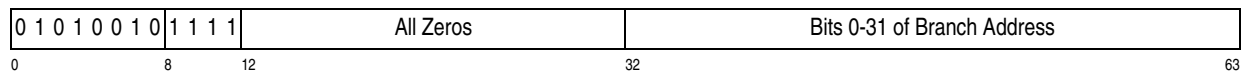

F1 PROGRAM CALL (in 24-Bit or 31-Bit Mode, Regardless of Resulting Mode, if ASN-and-LX Reuse Is Not Enabled)

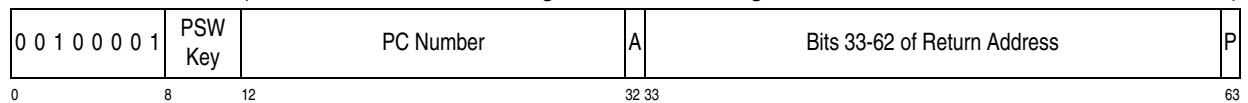

F2 PROGRAM CALL (in 64-Bit Mode, Regardless of Resulting Mode, if ASN-and-LX Reuse Is Not Enabled)

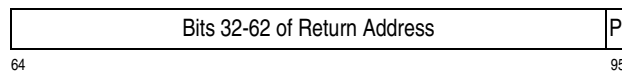
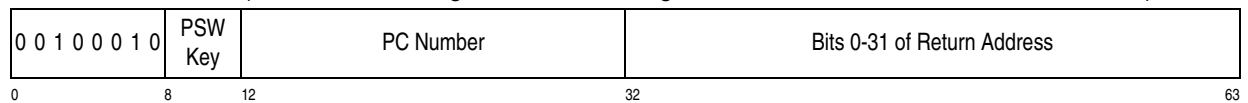

F3 PROGRAM CALL (in 24-Bit or 31-Bit Mode, Regardless of Resulting Mode, if ASN-and-LX Reuse Is Enabled and 20-Bit PC Number is Used)

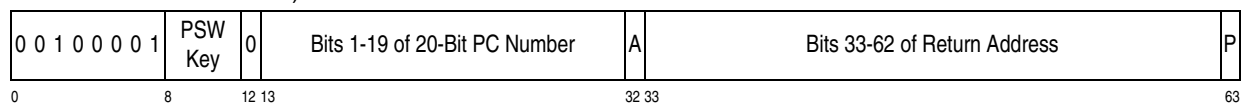
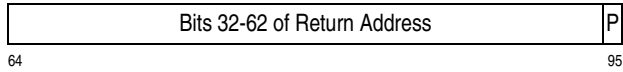
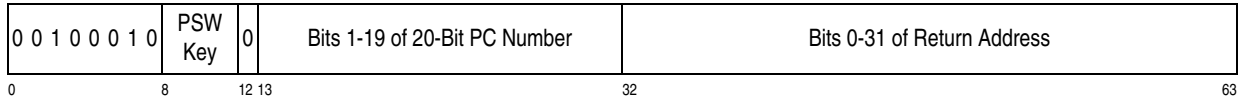
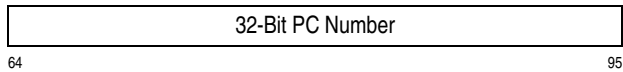
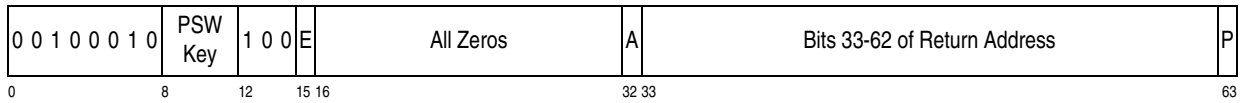

Figure 4-7. Trace Entries (Part 2 of 7)

F4 PROGRAM CALL (in 64-Bit Mode, Regardless of Resulting Mode, if ASN-and-LX Reuse Is Enabled and 20-Bit PC Number Is Used)



F5 PROGRAM CALL (in 24-Bit or 31-Bit Mode, Regardless of Resulting Mode, if ASN-and-LX Reuse Is Enabled and 32-Bit PC Number is Used)



F6 PROGRAM CALL (in 64-Bit Mode, Regardless of Resulting Mode, if ASN-and-LX Reuse Is Enabled, 32-Bit PC Number Is Used, and Bits 0-31 of Return Address Are All Zeros)

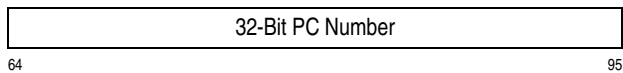
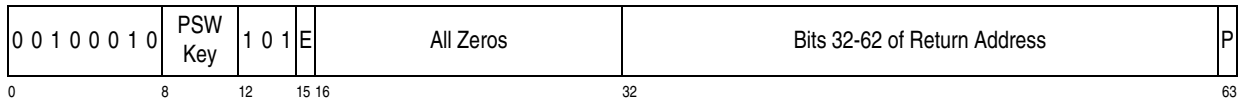

F7 PROGRAM CALL (in 64-Bit Mode, Regardless of Resulting Mode, if ASN-and-LX Reuse Is Enabled, 32-Bit PC Number Is Used, and Bits 0-31 of Return Address Are Not All Zeros)

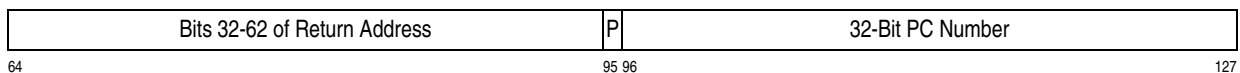
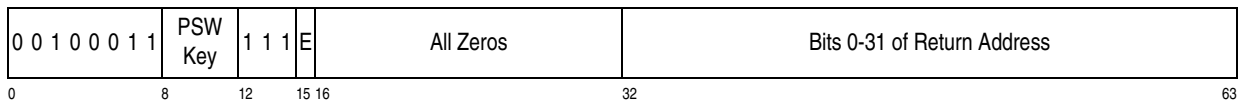
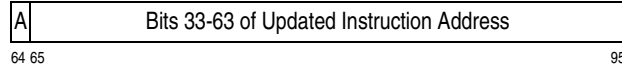
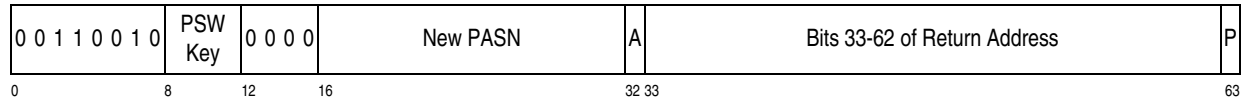
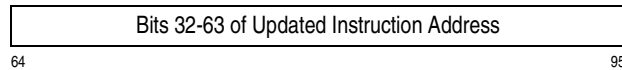
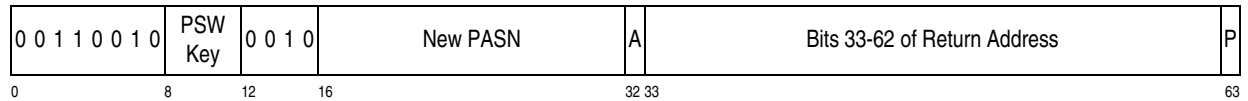

Figure 4-7. Trace Entries (Part 3 of 7)

F1 PROGRAM RETURN (in 24-Bit or 31-Bit Mode when Resulting Mode Is 24-Bit or 31-Bit)



F2 PROGRAM RETURN (in 64-Bit Mode when Bits 0-31 of Updated Instruction Address Are All Zeros and Resulting Mode Is 24-Bit or 31-Bit)



F3 PROGRAM RETURN (in 64-Bit Mode when Bits 0-31 of Updated Instruction Address Are Not All Zeros and Resulting Mode Is 24-Bit or 31-Bit)

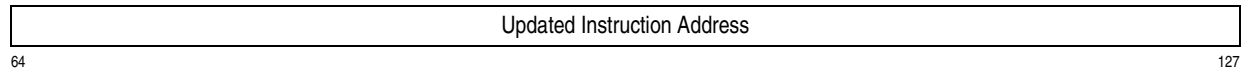
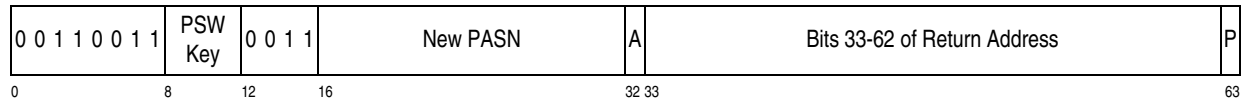

F4 PROGRAM RETURN (in 24-Bit or 31-Bit Mode when Resulting PSW Bit 31 Is One (See Note) and Bits 0-31 of Return Address Are All Zeros)

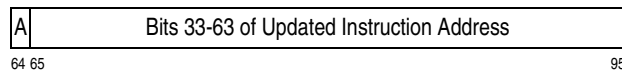
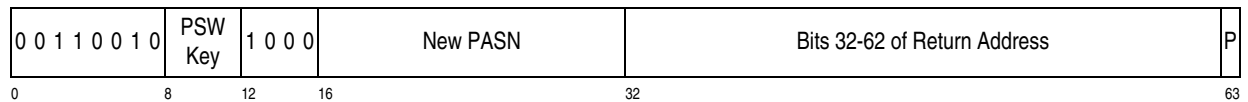

F5 PROGRAM RETURN (in 64-Bit Mode when Bits 0-31 of Updated Instruction Address Are All Zeros, Resulting PSW Bit 31 Is One (See Note), and Bits 0-31 of Return Address Are All Zeros)

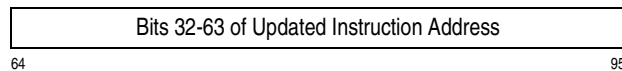
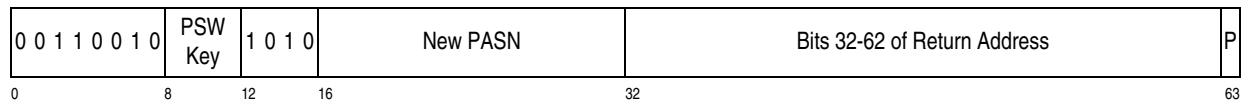
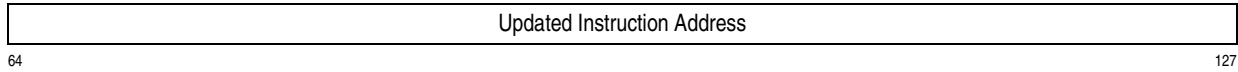
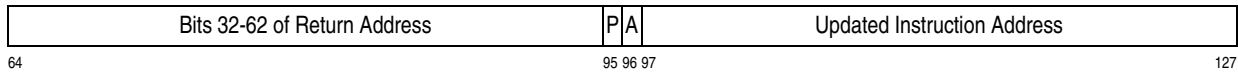
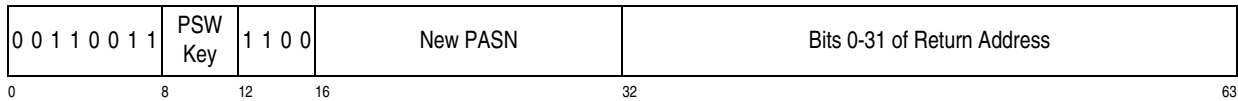

Figure 4-7. Trace Entries (Part 4 of 7)

F6 PROGRAM RETURN (in 64-Bit Mode when Bits 0-31 of Updated Instruction Address Are Not All Zeros, Resulting PSW Bit 31 Is One (See Note), and Bits 0-31 of Return Address Are All Zeros)



F7 PROGRAM RETURN (in 24-Bit or 31-Bit Mode when Resulting PSW Bit 31 Is One (See Note) and Bits 0-31 of Return Address Are Not All Zeros)



F8 PROGRAM RETURN (in 64-Bit Mode when Bits 0-31 of Updated Instruction Address Are All Zeros, Resulting PSW Bit 31 Is One (See Note), and Bits 0-31 of Return Address Are Not All Zeros)

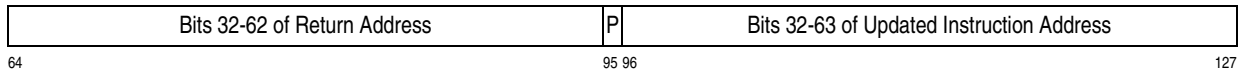
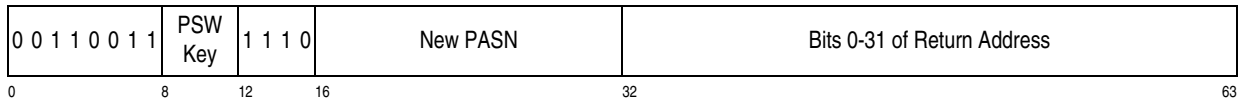

F9 PROGRAM RETURN (in 64-Bit Mode when Bits 0-31 of Updated Instruction Address Are Not All Zeros, Resulting PSW Bit 31 Is One (See Note), and Bits 0-31 of Return Address Are Not All Zeros)

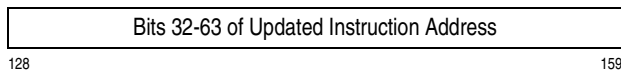
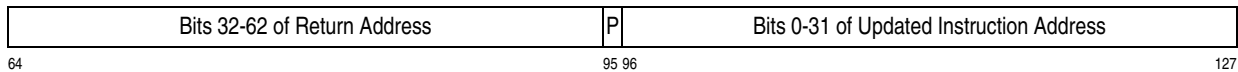
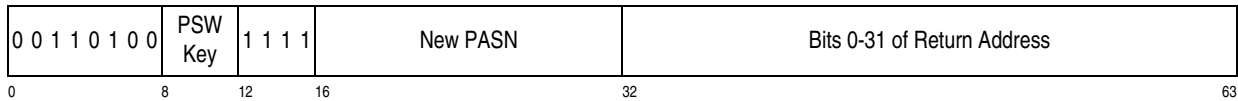
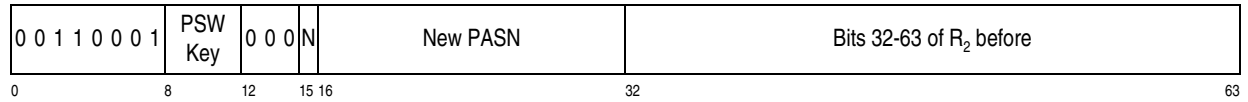
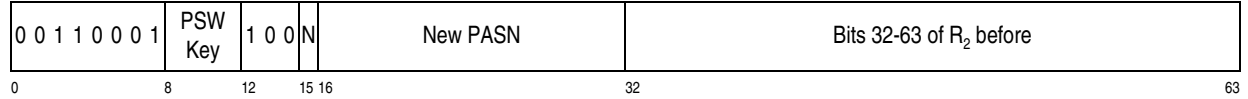

Figure 4-7. Trace Entries (Part 5 of 7)

F1 PROGRAM TRANSFER (WITH INSTANCE if N Is One) (in 24-Bit or 31-Bit Mode)



F2 PROGRAM TRANSFER (WITH INSTANCE if N Is One) (in 64-Bit Mode when Bits 0-31 of R₂ Are All Zeros)



F3 PROGRAM TRANSFER (WITH INSTANCE if N Is One) (in 64-Bit Mode when Bits 0-31 of R₂ Are Not All Zeros)

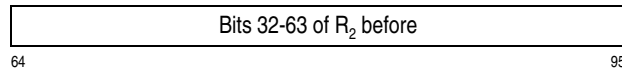
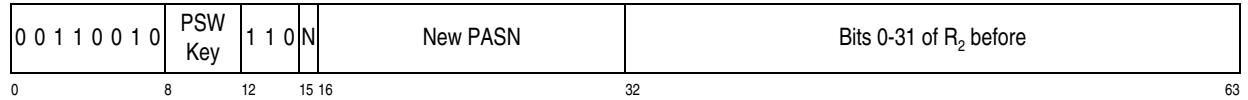

F1 SET SECONDARY ASN (WITH INSTANCE if N Is One)

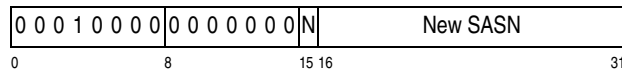

F1 TRACE (TRACE)

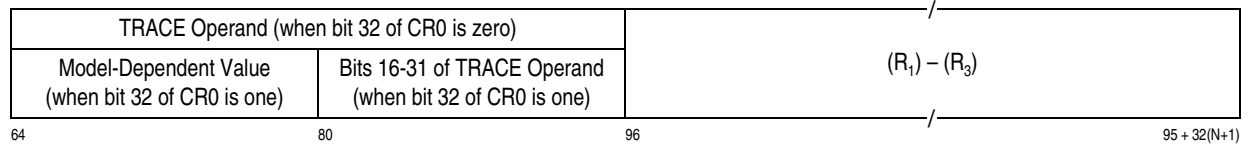
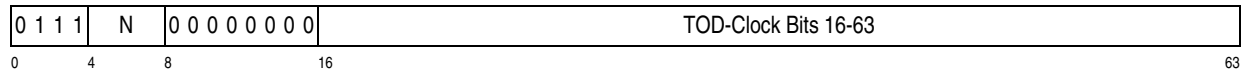

F2 TRACE (TRACG)

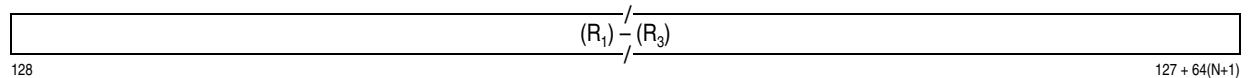
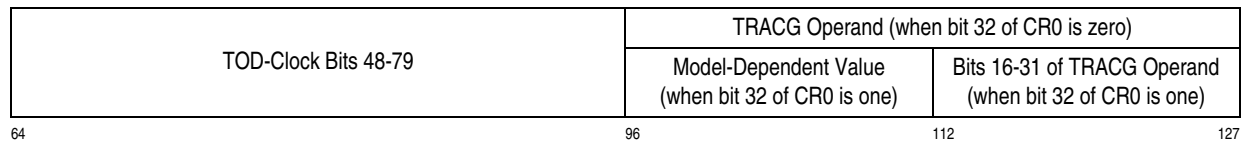
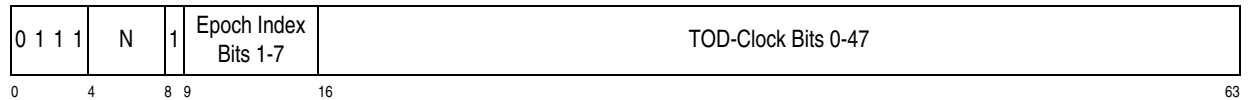

Figure 4-7. Trace Entries (Part 6 of 7)

Note: The terminology “when Resulting PSW Bit 31 Is One” is used instead of “when Resulting Mode Is 64-Bit” because, if the resulting PSW bit 32 is zero, an early specification exception will be recognized. PROGRAM RETURN can set PSW bit 31 to one and bit 32 to zero.

Figure 4-7. Trace Entries (Part 7 of 7)

The fields in the trace entries are defined as follows. The fields are described in the order in which they first appear in Figure 4-7 on page 4-16.

Branch Address: The branch address is the address of the next instruction to be executed when the branch is taken. In a branch trace entry made when the 24-bit addressing mode is in effect after branching (a format-1 entry), bit positions 8-31 contain bits 40-63 of the branch address. When the 31-bit addressing mode is in effect after branching or PSW bit 31 is one after branching and bits 0-32 of the branch address are all zeros, bit positions 1-31 of the trace entry (format 2) contain bits 33-63 of the branch address. When PSW bit 31 is one after branching and bits 0-32 of the branch address are not all zeros, bit positions 32-95 of the trace entry (format 3), contain bits 0-63 of the branch address.

In a BRANCH IN SUBSPACE GROUP trace entry made on execution in the 24-bit or 31-bit addressing mode, bit positions 33-63 of the trace entry (format 1) contain bits 33-63 of the branch address, or, in the 64-bit addressing mode, bit positions 32-95 of the trace entry (format 2) contain bits 0-63 of the branch address.

In a mode-switching-branch trace entry made on a switch from the 64-bit addressing mode to the 24-bit or 31-bit addressing mode, bit positions 33-63 of the entry (format 1) contain bits 33-63 of the branch address; or, on a switch from PSW bit 31 being off to the bit being on, bit positions 32-63 of the entry (format 2) contain bits 32-63 of the branch address if bits 0-31 of the branch address are zeros, or bits 32-95 of the entry (format 3) contain bits 0-63 of the branch address if bits 0-31 of the branch address are not all zeros.

Primary-List Bit (P) and Bits 9-31 of ALET: Bit position 8 of a BRANCH IN SUBSPACE GROUP trace entry contains bit 7 of the access-list-entry token (ALET) in the access register designated by the R_2 field of the instruction. Bit positions 9-31 of the trace entry contain bits 9-31 of the ALET.

Basic-Addressing-Mode Bit (A): Bit position 32 of a BRANCH IN SUBSPACE GROUP trace entry

made on execution in the 24-bit or 31-bit addressing mode (a format-1 entry) contains the basic-addressing-mode bit that replaces bit 32 of the PSW.

Bit position 32 of a mode-switch trace entry that indicates a switch from PSW bit 31 being off to the bit being on (a format-1 entry) contains the value of PSW bit 32 that existed before the mode-switch operation.

Bit position 32 of a mode-switching-branch trace entry that indicates a switch from the 64-bit addressing mode to the 24-bit or 31-bit addressing mode (a format-1 entry) contains the value that replaces PSW bit 32.

Bit position 32 of a PROGRAM CALL trace entry made on execution in the 24-bit or 31-bit addressing mode (regardless of the resulting addressing mode) (a format-1 entry) contains the basic-addressing-mode bit, bit 32, from the current PSW.

Bit position 32 of a PROGRAM RETURN trace entry made when the resulting addressing mode is the 24-bit or 31-bit mode (a format-1, format-2, or format-3 entry) contains the basic-addressing-mode bit that replaces bit 32 of the PSW.

Bit position 64 of a PROGRAM RETURN trace entry made in the 24-bit or 31-bit addressing mode when the return address occupies only one word in the entry, (a format-1 or format-4 entry), contains the value of PSW bit 32 that existed before the PROGRAM RETURN operation. When the return address occupies two words (a format-7 entry), bit position 96 contains that value of PSW bit 32.

Updated Instruction Address: Bit positions 33-63 of a mode-switch trace entry that indicates a switch from PSW bit 31 being off to the bit being on (a format-1 entry) contains bits 33-63 of the updated instruction address in the PSW (bits 97-127 of the PSW) before that address is replaced, if it is replaced, by the mode-switch operation. Bit positions 32-63 of a mode-switch trace entry (format 2) that indicates a switch from the 64-bit addressing mode to the 24-bit or 31-bit addressing mode contains bits 32-63 of the updated instruction address in the PSW

(bits 96-127 of the PSW) before that address is replaced, if it is replaced, by the mode-switch operation, if bits 0-31 of the updated instruction address are zeros; or bit positions 32-95 of the trace entry (format 3) contain bits 0-63 of that updated instruction address (bits 64-127 of the PSW) if bits 0-31 of the address are not all zeros.

The following description of a PROGRAM RETURN trace entry applies when the return address in the entry occupies only one word in the entry. Bit positions 65-95 of the trace entry made on execution in the 24-bit or 31-bit addressing mode (a format-1 or format-4 entry) contain bits 33-63 of the updated instruction address in the PSW (bits 97-127 of the PSW) before that address is replaced from the linkage-stack state entry; or, when the execution is in the 64-bit addressing mode, bit positions 64-95 of the trace entry (format 2 or 5) contain bits 32-63 of that updated instruction address (bits 96-127 of the PSW) if bits 0-31 of the address are zeros, or bit positions 64-127 of the trace entry (format 3 or 6) contain bits 0-63 of that updated instruction address (bits 64-127 of the PSW) if bits 0-31 of the address are not all zeros. If the return address in the PROGRAM RETURN trace entry occupies two words, the updated instruction address in the entry is moved one word to the right in the entry (formats 7-9).

PSW Key: Bit positions 8-11 of a PROGRAM CALL, PROGRAM TRANSFER, or PROGRAM RETURN trace entry contain the PSW key from the current PSW.

PC Number: Bit positions 12-31 of a PROGRAM CALL trace entry of format 1-4 contain the value of the rightmost 20 bits of the second-operand address. Bit positions 64-95 of a format-5 or format-6 PROGRAM CALL trace entry, or bit positions 96-127 of a format-7 entry, contain the value of the rightmost 32 bits of the second-operand address.

Return Address: Bit positions 33-62 of a PROGRAM CALL trace entry made on execution in the 24-bit or 31-bit addressing mode (a format-1, format-3, or format-5 entry) contain bits 33-62 of the updated instruction address in the PSW (bits 97-126 of the PSW) before that address is replaced from the entry-table entry; or, when the execution is in the 64-bit addressing mode, bit positions 32-94 of the trace entry (format 2, 4, or 7) contain bits 0-62 of that updated instruction address (bits 64-126 of the PSW), or, when bits 0-31 of the address are all zeros,

bit positions 32-62 of the trace entry (format 6) contain bits 32-62 of the address.

Extended-Addressing-Mode Bit (E): Bit position 15 of a PROGRAM CALL trace entry made using a 32-bit PC number (a format-5, format-6, or format-7 entry) contains the extended-addressing-mode bit that replaces bit 31 of the PSW.

Bit positions 33-62 of a PROGRAM RETURN trace entry made when the resulting addressing mode is the 24-bit or 31-bit mode (a format-1, format-2, or format-3 entry) contain bits 33-62 of the instruction address that replaces bits 64-127 of the PSW; or, when the resulting PSW bit 31 is one (which causes the addressing mode be the 64-bit mode unless the resulting PSW bit 32 is zero), bit positions 32-62 of the trace entry (formats 4-6) contain bits 32-62 of that instruction address if bits 0-31 of the address are zeros, or bit positions 32-94 of the trace entry (formats 7-9) contain bits 0-62 of that instruction address if bits 0-31 of the address are not all zeros.

Problem-State Bit (P): Bit position 63 of a PROGRAM CALL trace entry made on execution in the 24-bit or 31-bit addressing mode (regardless of the resulting mode) (a format-1, format-3, format-5, or format-6 entry), or bit position 95 of the entry (format 2, 4, or 7) made on execution in the 64-bit addressing mode, contains the problem-state bit from the current PSW.

Bit position 63 of a PROGRAM RETURN trace entry made when the resulting addressing mode is the 24-bit or 31-bit mode (a format-1, format-2, or format-3 entry) or when the resulting PSW bit 31 is one and bits 0-31 of the return address are zeros (formats 4-6) contains the problem-state bit that replaces bit 15 of the PSW. Bit position 95 of a PROGRAM RETURN trace entry made when the resulting PSW bit 31 is one and bits 0-31 of the return address are not all zeros (formats 7-9) contains that problem-state bit.

New PASN: Bit positions 16-31 a PROGRAM TRANSFER trace entry contain the new PASN (which may be zero) specified in bit positions 48-63 of general register R₁.

Bit positions 16-31 of a PROGRAM RETURN trace entry contain the new PASN that is restored from the linkage-stack state entry.

Bits 32-63 of R_2 before: Bit positions 32-63 of a PROGRAM TRANSFER trace entry made on execution in the 24-bit or 31-bit addressing mode (a format 1 entry) contain bits 32-63 of the general register designated by the R_2 field of the instruction. (Bits 32 and 33-62 of that register replace bits 32 and 97-126, respectively, of the PSW. Bit 63 of the register replaces the problem-state bit in the PSW.) When PROGRAM TRANSFER or PROGRAM TRANSFER WITH INSTANCE is executed in the 64-bit addressing mode, bit positions 32-63 of the trace entry (format 2) contain bits 32-63 of the R_2 general register if bits 0-31 of the register are zeros, or bit positions 32-95 of the trace entry (format 3) contain bits 0-63 of the register if bits 0-31 of the register are not all zeros.

New SASN: Bit positions 16-31 of a SET SECONDARY ASN trace entry contain the ASN value loaded into control register 3 by the instruction.

Number of Registers (N): Bits 4-7 of the trace entry for TRACE contain a value which is one less than the number of general registers which have been provided in the trace entry. The value of N ranges from zero, meaning the contents of one general register are provided in the trace entry, to 15, meaning the contents of all 16 general registers are provided.

Epoch Index Bits 1-7: When the multiple-epoch facility is installed in the configuration, bits 9-15 of the trace entry for TRACE (TRACG) are obtained from bit positions 1-7 of the epoch index, as would be provided by a single STORE CLOCK EXTENDED instruction executed at the time the TRACE instruction was executed (the single execution of which also provided bits 0-79 of the TOD clock)

When the multiple-epoch facility is not installed in the configuration, the following applies:

- When the TOD clock has not wrapped around to zeros, bits 9-15 of the trace entry for TRACE (TRACG) contain zeros.
- When the TOD clock has wrapped around to zeros, it is unpredictable whether bits 9-15 of the trace entry for TRACE (TRACG) contain zeros or bits 1-7 of the epoch index (as described above).

TOD-Clock Bits 16-63 or 0-79: When the store-clock-fast facility is not installed, or when the TRACE TOD-clock control in bit 32 of control register 0 is

zero, bits 16-63 of the trace entry for TRACE (TRACE) are obtained from bit positions 16-63 of the TOD clock, as would be provided by a STORE CLOCK instruction executed at the time the TRACE instruction was executed. When the store-clock-fast facility is installed and the TRACE TOD-clock control in bit 32 of control register zero is one, bits 16-63 of the trace entry for TRACE (TRACE) are obtained from bit positions 16-63 of the TOD clock, as would be provided by a STORE CLOCK FAST instruction executed at the time the TRACE instruction was executed.

Bits 16-95 of the trace entry for TRACE (TRACG) are obtained from bit positions 0-79 of the TOD clock, as would be provided by a STORE CLOCK EXTENDED instruction executed at the time the TRACE instruction was executed.

TRACE Operand: When the store-clock-fast facility is not installed, or when the TRACE TOD-clock control in bit 32 of control register 0 is zero, bit positions 64-95 of the trace entry for TRACE (TRACE) and bit positions 96-127 of the trace entry for TRACE (TRACG) contain a copy of the 32 bits of the second operand of the TRACE instruction for which the entry is made.

When the store-clock-fast facility is installed and the TRACE TOD-clock control in bit 32 of control register 0 is one, the trace-operand field in the trace entry is formed as follows:

- Bit positions 80-95 of the trace entry for TRACE (TRACE) and bit positions 112-127 of the trace entry for TRACE (TRACG) contain a copy of bits 16-31 of the second operand of the TRACE instruction for which the entry is made.
- The contents of bit positions 64-79 of the trace entry for TRACE (TRACE) and the contents of bit positions 96-111 for TRACE (TRACG) are set to a model-dependent value.

(R_1)-(R_3): The four-byte fields starting with bit 96 of the trace entry for TRACE (TRACE) contain the contents of bit positions 32-63 of the general registers whose range is specified by the R_1 and R_3 fields of the TRACE instruction. The general registers are stored in ascending order of register numbers, starting with general register R_1 and continuing up to and including general register R_3 , with general register 0 following general register 15. The eight-byte fields starting with bit 128 of the trace entry for TRACE

(TRACG) similarly contain the contents of bit positions 0-63 of those registers.

Programming Note: The size of the trace entry for TRACE (TRACE) in units of words is $3 + (N + 1)$. The maximum size of an entry is 19 words, or 76 bytes. For TRACE (TRACG), the size in units of words is $4 + 2(N + 1)$, and the maximum size is 36 words, or 144 bytes.

Trace Operation

When an instruction which is subject to tracing is executed and the corresponding tracing function is turned on, a trace entry of the appropriate type and format is made, except as noted below. The real address of the trace entry is formed by appending two zero bits on the left and two on the right to the value in bit positions 2-61 of control register 12. The address in control register 12 is subsequently increased by the size of the entry created.

In the ESA/390-compatibility mode, implicit tracing (that is, branch tracing, mode tracing, and ASN tracing) is not supported.

No trace entry is stored if the incrementing of the address in control register 12 would cause a carry to be propagated into bit position 51 (that is, if the trace-entry address would be in the next 4 K-byte block). If this would be the case for the entry to be made, a trace-table exception is recognized and the operation is nullified. When PROGRAM CALL is to form both a PROGRAM CALL trace entry and a mode-switch trace entry, neither entry is stored, and a trace-table exception is recognized, if either entry would cause a carry into bit position 51. For the purpose of recognizing the trace-table exception in the case of a TRACE instruction, the maximum length of 76 (TRACE) or 144 (TRACG) bytes is used instead of the actual length.

When the CPU is in the transactional-execution mode, an instruction that would otherwise cause tracing to occur is restricted. Attempted execution of such an instruction causes the transaction to be aborted with abort code 11, and the condition code is set to 3; no trace entry is made, and no trace-table exception condition (if any) is recognized.

The storing of a trace entry is not subject to key-controlled protection (nor, since the trace-entry address is real, is it subject to DAT protection), but it is subject

to low-address protection; that is, if the address of the trace entry due to be created is in the range 0-511 or 4096-4607 and bit 35 of control register 0 is one, a protection exception is recognized, and instruction execution is suppressed. If the address of a trace entry is invalid, an addressing exception is recognized, and instruction execution is suppressed.

The three exceptions associated with storing a trace entry (addressing, protection, and trace table) are collectively referred to as trace exceptions.

If a program interruption takes place for a condition which is not a trace-exception condition and for which execution of an instruction is not completed, it is unpredictable whether part or all of any trace entry due to be made for such an interrupted instruction is stored in the trace table. Thus, for a condition which would ordinarily cause nullification or suppression of instruction execution, storage locations may have been altered beginning at the location designated by control register 12 and extending up to the length of the entry that would have been created.

When PROGRAM RETURN unstacks a linkage-stack state entry that was formed by BRANCH AND STACK and ASN tracing is on, trace exceptions may be recognized, even though a trace entry is not made and no part of a trace entry is stored.

The order in which information is placed in a trace entry is unpredictable. Furthermore, as observed by other CPUs and by channel programs, the contents of a byte of a trace entry may appear to change more than once before completion of the instruction for which the entry is made.

The trace-entry address in control register 12 is updated only on completion of execution of an instruction for which a trace entry is made.

A serialization and checkpoint-synchronization function is performed before the operation begins and again after the operation is completed. However, it is unpredictable whether or not a store into a trace-table entry from which a subsequent instruction is fetched will be observed by the CPU that performed the store. Additionally, when the store-clock-fast facility is installed and the TRACE TOD-clock control in bit 32 of control register 0 is one, it is unpredictable whether explicit tracing causes serialization to be performed.

Program-Event Recording

The purpose of PER is to assist in debugging programs. It permits the program to be alerted to the following types of events:

- Execution of a successful branch instruction. The option is provided of having an event occur only when the branch-target location is within the designated storage area.
- Fetching of an instruction from the designated storage area.
- Alteration of the contents of the designated storage area. The option is provided of having an event occur only when the storage area is within designated address spaces.
- Execution of the STORE USING REAL ADDRESS instruction.
- Execution of the TRANSACTION END instruction.

The PER zero-address-detection facility may be available on a model implementing z/Architecture. When the zero-address-detection facility is installed in the machine, it is unpredictable whether the facility is installed in the ESA/390-compatibility mode. When this facility is installed, the program may be alerted to the following additional event:

- Execution of an instruction that accesses storage using an operand address formed from a general register containing zero.

The PER-storage-key-alteration facility may be available on a model implementing z/Architecture. When the PER-storage-key-alteration facility is installed in the machine, it is unpredictable whether the facility is installed in the ESA/390-compatibility mode. When this facility is installed, the program may be alerted to the following additional event:

- Execution of a SET STORAGE KEY EXTENDED, PERFORM FRAME MANAGEMENT FUNCTION, MOVE PAGE, or TEST BLOCK instruction that updates the storage key of the designated storage area.

The program can selectively specify that one or more of the above types of events be recognized, except that the event for STORE USING REAL ADDRESS can be specified only along with the storage-alteration event. The information concerning a PER event

is provided to the program by means of a program interruption, with the cause of the interruption being identified in the interruption code.

PER Instruction-Fetching Nullification

The PER-3 facility may be available on a model implementing z/Architecture. When the PER-3 facility is installed in the machine, it is unpredictable whether the facility is installed in the ESA/390-compatibility mode.

When this facility is installed, bit 39 of control register 9, when one, specifies that PER instruction-fetching events force nullification. Bit 39 is effective for this purpose only when bit 33 of control register 9, the instruction-fetching PER-event mask bit, is also one. When bit 33 is zero, PER instruction-fetching events are not recognized, and bit 39 has no effect. When the PER-3 facility is not installed or bit 39 is zero, PER instruction-fetching events do not force nullification. A PER instruction-fetching event that forces nullification is referred to as a PER instruction-fetching nullification event. A PER event that does not force nullification is referred to as a PER basic event.

When the PER-3 facility is installed, and bit 39 is one, the interruption caused by a PER instruction-fetching event occurs before the fetched instruction is executed, the PER instruction-fetching nullification event is indicated, no other PER events and no other program interruption conditions are reported, and execution of the instruction is nullified. When the PER-3 facility is not installed, or bit 39 is zero, nullification is not forced, the PER instruction-fetching basic event is indicated, other PER events and other program interruption conditions may be concurrently reported, and the execution of the instruction may be completed, terminated, suppressed, or nullified. In the absence of other conditions, the interruption caused by the PER instruction-fetching basic event occurs after execution of the fetched instruction, or units of operation thereof, are completed.

Control-Register Allocation and Address-Space-Control Element

The information for controlling PER resides in control registers 9, 10, and 11 and the address-space-control element.

Depending on the model, when any or all of control registers 9, 10, or 11 contain nonzero values, address-compare controls may be disabled and remain disabled even if all of control registers 9-11 transition back to zeros. See “Address-Compare Controls” on page 12-1 for details.

The information in the control registers has the following format:

Control Register 9

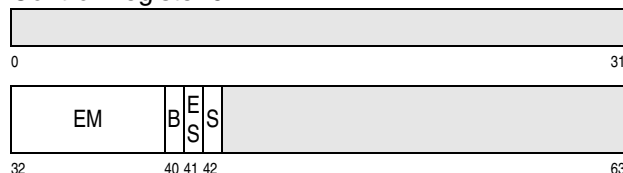

Control Register 10

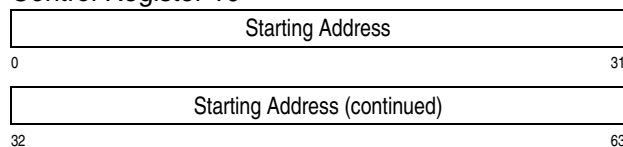

Control Register 11

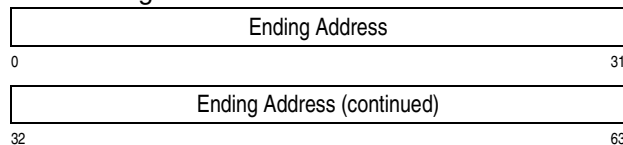

PER-Event Masks (EM): Bits 32-39 of control register 9 specify which types of events are recognized. Bits 32-34 and 36 are always available and control successful-branching events, instruction-fetching basic events, and storage-alteration events. When the PER-storage-key-alteration facility is installed, bit 35 of the PER-event masks is also used. When the PER zero-address-detection facility is installed, bit 37 of the PER-event masks is also used. When the transactional-execution facility is installed, bit 38 of the PER-event masks is also used. When the PER-3 facility is installed, bit 39 of the PER-event masks is also used. In the ESA/390-compatibility mode it is unpredictable whether the storage-key-alteration, zero-address-detection, instruction-fetching-nullification masks, bits 35, 37, and 39, respectively, are supported.

The bits are assigned as follows:

- Bit 32: Successful-branching event
- Bit 33: Instruction-fetching event
- Bit 34: Storage-alteration event
- Bit 35: Storage-key-alteration event
- Bit 36: Store-using-real-address event (bit 34 must also be one)
- Bit 37: Zero-address-detection event
- Bit 38: Transaction-end event
- Bit 39: Instruction-fetching nullification event (bit 33 must also be one)

Bits 32-34 and bit 36, when ones, specify that the corresponding types of events be recognized. However, bit 36 is effective for this purpose only when bit 34 is also one. When bit 34 is one, the storage-alteration event is recognized. When bits 34 and 36 are ones, both the storage-alteration event and the store-using-real-address event are recognized. When a bit is zero, the corresponding type of event is not recognized. When bit 34 is zero, both the storage-alteration event and the store-using-real-address event are not recognized.

When the PER-3 facility is not installed, bit 39 is ignored. Bit 39 is effective only when bit 33 is also one. When bit 33 is one, and the PER-3 facility is installed, and bit 39 is one, the PER instruction-fetching nullification event is recognized. When bit 33 is one and bit 39 is zero (or the PER-3 facility is not installed) the PER instruction-fetching basic event is recognized. When bit 33 is zero, neither the PER instruction-fetching basic event nor the PER instruction-fetching nullification event is recognized.

When the transactional-execution facility is not installed, or when the facility is installed and bit 38 is zero, transaction-end events are not recognized. When the transactional-execution facility is installed and bit 38 is one, a transaction-end event is recognized as a result of the completion of an outermost TRANSACTION END instruction. In the ESA/390-compatibility mode, bit 38 of control register 9 is ignored.

When the PER-storage-key-alteration facility is not installed, bit 35 is ignored. When bit 35 is one and the PER-storage-key-alteration facility is installed, a storage-key-alteration event is recognized when any of the following instructions executes and updates the ACC or F bits of the storage key associated with

a 4K-byte block of storage that lies within the designated area:

- MOVE PAGE when the move-page-and-set-key facility is installed and KFC (bits 51-53 of general register 0) contains a value of 4 or 5
- PERFORM FRAME MANAGEMENT FUNCTION when SK (bit 46 of general register R₁) is one
- SET STORAGE KEY EXTENDED
- TEST BLOCK, but only when the model's implementation actually updates the storage key

Branch-Address Control (B): Bit 40 of control register 9 specifies, when one, that successful-branching events occur only for branches that are to a location within the designated storage area. When bit 40 is zero, successful branching events occur regardless of the branch-target address.

Event-Suppression Control (ES): When the CPU is in the transactional-execution mode at the beginning of an instruction, bit 41 of control register 9 specifies, when one, that the PER event masks in bits 32-34, 36, 37, and 39 of the register are to be ignored and assumed to contain zeros. Except as noted below, when the CPU is not in the transactional-execution mode at the beginning of the instruction, or when bit 41 of the register is zero, all PER event masks operate as defined.

When (a) an outermost TRANSACTION BEGIN instruction is executed, (b) there are no concurrent program-exception conditions, and (c) the ES control is one, any PER storage-alteration or zero-address-detection event for the TBEGIN-specified TDB and any instruction-fetching basic event are suppressed; instruction-fetching nullification events are not suppressed in this case.

In the ESA/390-compatibility mode, the event-suppression control is ignored.

Architecture Notes:

Storage-Alteration-Space Control (S): Bit 42 of control register 9 specifies, when one, that storage-alteration events occur as a result of references to the designated storage area only within designated address spaces. An address space is designated as one for which storage-alteration events occur by means of the storage-alteration-event bit in the address-space-control element that is used to trans-

late references to the address space. Bit 42 is ignored when DAT is not in effect. When DAT is not in effect or bit 42 is zero, storage-alteration events are not restricted to occurring for only particular address spaces.

PER Starting Address: Bits 0-63 of control register 10 are the address of the beginning of the designated storage area. In the ESA/390-compatibility mode, it is unpredictable whether bit 32 of the PER starting address is treated as being zero.

PER Ending Address: Bits 0-63 of control register 11 are the address of the end of the designated storage area. In the ESA/390-compatibility mode, it is unpredictable whether bit 32 of the PER ending address is treated as being zero.

Storage-Alteration-Event Bit (S): When the storage-alteration-space control in control register 9 is one, bit 56 of the address-space control element (ASCE) specifies, when one, that the address space defined by the ASCE is one for which storage-alteration events can occur. See the sections "Control Register 1" on page 3-42, "Control Register 7" on page 3-44, and "Control Register 13" on page 3-45 for illustrations of the ASCE.

Bit 56 of the ASCE is examined when the ASCE is used to perform dynamic-address translation for a storage-operand store reference. The address-space-control element may be the PASCE, SASCE, or HASCE in control register 1, 7, or 13, respectively, or it may be obtained from an ASN-second-table entry during access-register translation. Instead of being obtained from an ASN-second-table entry in main storage, bit 56 of the ASCE may be obtained from an ASN-second-table entry in the ART-lookaside buffer (ALB). Bit 56 of the ASCE is ignored when the storage-alteration-space control is zero.

Programming Notes:

1. Models may operate at reduced performance while the CPU is enabled for PER events. In order to ensure that CPU performance is not degraded because of the operation of the PER facility, programs that do not use it should disable the CPU for PER events by setting either the PER mask in the PSW to zero or the PER-event masks in control register 9 to zero, or both. No degradation due to PER occurs when either of these fields is zero.

2. Some degradation may be experienced on some models every time control registers 9, 10, and 11 are loaded, even when the CPU is disabled for PER events (see the programming note under "Storage-Area Designation").
3. Enabling the CPU for PER instruction-fetching nullification may be used to determine the state of the CPU before execution of any instruction within the storage area designated by control registers 10 and 11. The instruction nullified could be the first instruction after a successful branch, after LOAD PSW, or after LOAD PSW EXTENDED; or it could be the target of an execute-type instruction or the leftmost instruction in the storage area and accessed in the process of sequential execution. After recording the desired information, in order to allow the CPU to execute this instruction, either the CPU must be disabled for instruction-fetching nullification or control registers 10 and 11 must be changed to designate a different storage area. This can be contrasted to enabling for PER successful branching within the same storage area, which causes a PER event to be reported only in the first case mentioned above, but does not require special action to continue.

PER Operation

PER is under control of bit 1 of the PSW, the PER mask. When the PER mask and a particular PER-event mask bit are all ones, the CPU is enabled for the corresponding type of event; otherwise, it is disabled. However, the CPU is enabled for the store-using-real-address event only when the storage-alteration mask bit and the store-using-real-address mask bit are both one.

The CPU is enabled for the PER instruction-fetching nullification event only when the PER-3 facility is installed, and then only when the instruction-fetching-event mask bit, the instruction-fetching-nullification-event mask bit, and the PER mask are all ones. An interruption due to a PER instruction-fetching nullification event causes the execution of the instruction causing the event to be nullified.

An interruption due to a PER basic event normally occurs after the execution of the instruction responsible for the event. The occurrence of the event does not affect the execution of the instruction, which may be completed, partially completed, terminated, sup-

pressed, or nullified. However, recognition of a storage-alteration event causes no more than 4K bytes to be stored to each operand location intersecting with the designated PER storage-area, beginning with the byte that caused the event.

The following applies to instructions performing an operation which may be suspended and subsequently resumed :

- When a storage-alteration PER event is recognized, the event is indicated by an interruption which may occur on completion of a unit of operation for an interruptible instruction, or may occur on completion of a CPU-determined amount of data for an instruction which has a condition-code alternative to interruptibility.
- When a zero-address-detection PER event is recognized, the event is indicated by an interruption which may occur on completion of a unit of operation for an interruptible instruction, or may occur on completion of a CPU-determined amount of data for an instruction which has a condition-code alternative to interruptibility.

When a storage-key-alteration event is detected on an instruction that updates the storage keys for multiple 4k-byte blocks, that instruction is interrupted immediately upon setting the storage key for the block where the event was detected. For MOVE PAGE, PERFORM FRAME MANAGEMENT FUNCTION and TEST BLOCK, the clearing or moving of data for that block are also completed before the interruption for the PER event.

An interruption for an instruction-fetching nullification event occurs before the instruction responsible for the event is executed, and the operation is nullified.

When a PER event is recognized while the CPU is in the transactional-execution mode, the transaction is aborted as described in "Transaction Abort Processing" on page 5-102, and bit 6 is set in the program-interruption code, indicating that the interruption occurred while the CPU was in the transactional-execution mode. For storage-alteration events that occur while the CPU is in the transactional-execution mode (except for those caused by NONTRANSACTIONAL STORE), the store is discarded even though the event results in a PER interruption.

A PER storage-alteration or zero-address-detection event is detected for the TBEGIN-specified transac-

tion diagnostic block during the execution of the outermost TRANSACTION BEGIN instruction rather than during transaction abort processing. It is unpredictable whether a PER storage-alteration or zero-address-detection event is detected for the TBEGIN-specified TDB during the execution of inner TBEGIN instructions.

When the CPU is disabled for a particular PER event at the time it occurs, either by the PER mask in the PSW or by the masks in control register 9, the event is not recognized.

A change to the PER mask in the PSW or to the PER control fields in control registers 9, 10, and 11 affects PER starting with the execution of the immediately following instruction. Thus, if, as a result of the change, an instruction-fetching nullification event applies to the immediately following instruction, execution of that instruction will be nullified and the instruction-fetching nullification event reported.

A change to the storage-alteration-event bit in an address-space-control element in control register 1, 7, or 13 also affects PER starting with the execution of the immediately following instruction. A change to the storage-alteration-event bit in an address-space-control element that may be obtained, during access-register translation, from an ASN-second-table entry in either main storage or the ALB does not necessarily have an immediate, if any, effect on PER. However, PER is affected immediately after either PURGE ALB or COMPARE AND SWAP AND PURGE that purges the ALB is executed.

If a PER basic event occurs during the execution of an instruction which changes the CPU from being enabled to being disabled for that type of event, that PER event is recognized.

PER basic events may be recognized in a trial execution of an instruction, and subsequently the instruction, DAT-table entries, and operands may be refetched for the actual execution. If any refetched field was modified by another CPU or by a channel program between the trial execution and the actual execution, it is unpredictable whether the PER events indicated are for the trial or the actual execution.

For special-purpose instructions that are not described in this publication, the operation of PER may not be exactly as described in this section.

Identification of Cause

A program interruption for PER sets bit 8 of the interruption code to one and places identifying information in real storage locations 150-159. When the PER event is a storage-alteration event or a zero-address-detection event, information is also stored in location 161. Additional information is provided by means of the instruction address in the program old PSW and the ILC.

Locations 150-151:

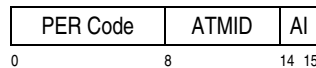

PER Code: The occurrence of PER events is indicated by ones in bit positions 0-7. The bit position in the PER code for a particular type of event is as follows:

Bit	PER Event
0	Successful-branching
1	Instruction-fetching
2	Storage-alteration
3	Storage-key-alteration
4	Store-using-real-address
5	Zero-address-detection
6	Transaction-end
7	Instruction-fetching nullification (PER-3)

A one in bit position 2 and a zero in bit position 4 of location 150 indicate a storage-alteration event, while ones in bit positions 2 and 4 indicate a store-using-real-address event. When a program interruption occurs, more than one type of PER basic event can be concurrently indicated. However, when a storage-alteration event and a zero-address-detection event are concurrently recognized, only the storage-alteration event is indicated. Additionally, if another program-interruption condition exists, the interruption code for the program interruption may indicate both the PER basic events and the other condition.

When a program interruption occurs for a PER instruction-fetching nullification event, bits 1 and 7 are set to one in the PER code. No other PER events are concurrently indicated.

When the transactional-execution facility is installed, and a program interruption occurs for a transaction-end event, bit 6 is set to one in the PER code. If an instruction-fetching basic event coincides with the transaction-end event, bit 1 is also set to one in the

PER code. No other PER events are concurrently indicated with a transaction-end event.

A zero is stored in bit position 3 of locations 150-151. When the PER zero-address-detection facility is not installed, zero is stored in bit position 5. When the transactional-execution facility is not installed, zero is stored in bit position 6. When PER-3 is not installed, zero is stored in bit position 7.

Addressing-and-Translation-Mode Identification (ATMID): During a program interruption when a PER event is indicated, bits 31, 32, 5, 16, and 17 of the PSW at the beginning of the execution of the instruction that caused the event may be stored in bit positions 8 and 10-13, respectively, of real locations 150-151. If bits 31, 32, 5, 16, and 17 are stored, then a one bit is stored in bit position 9 of locations 150-151. If bits 31, 32, 5, 16, and 17 are not stored, then zero bits are stored in bit positions 8-13 of locations 150-151.

Bits 8-13 of real locations 150-151 are named the addressing-and-translation-mode identification (ATMID). Bit 9 is named the ATMID-validity bit. When bit 9 is zero, it indicates that an invalid ATMID (all zeros) was stored.

The meanings of the bits of a valid ATMID are as follows:

Bit	Meaning
8	PSW bit 31
9	ATMID-validity bit
10	PSW bit 32
11	PSW bit 5
12	PSW bit 16
13	PSW bit 17

A valid ATMID is necessarily stored only if the PER event was caused by one of the following instructions:

- BRANCH AND SAVE AND SET MODE (BASSM)
- BRANCH AND SET AUTHORITY (BSA)
- BRANCH AND SET MODE (BSM)
- BRANCH IN SUBSPACE GROUP (BSG)
- LOAD PSW (LPSW)
- LOAD PSW EXTENDED (LPSWE)
- PROGRAM CALL (PC)
- PROGRAM RETURN (PR)
- PROGRAM TRANSFER (PT)
- PROGRAM TRANSFER WITH INSTANCE (PTI)

- RESUME PROGRAM (RP)
- SET ADDRESS SPACE CONTROL (SAC)
- SET ADDRESS SPACE CONTROL FAST (SACF)
- SET ADDRESSING MODE (SAM24, SAM31, SAM64)
- SET SYSTEM MASK (SSM)
- STORE THEN AND SYSTEM MASK (STNSM)
- STORE THEN OR SYSTEM MASK (STOSM)
- SUPERVISOR CALL (SVC)
- TRAP (TRAP2, TRAP4)

It is unpredictable whether a valid ATMID is stored if the PER event was caused by any other instruction. The value of the PER instruction-fetching-nullification-event mask bit does not affect the contents of the ATMID field.

PER ASCE Identification (AI): If the PER code contains an indication of a storage-alteration event (bit 2 is one and bit 4 is zero), or a zero-address detection event (bit 5 is one), and the event occurred when both PSW bit 5 was one and an ASCE was used to translate the reference that caused the event, bits 14 and 15 of locations 150-151 are set to identify the address-space-control element (ASCE) that was used to translate the reference that caused the event, as follows:

Bits	Meaning
00	Primary ASCE was used.
01	An AR-specified ASCE was used. The PER access ID, real location 161, can be examined to determine the ASCE used. Even when an AR-specified ASCE is used, if the contents of the AR designate the primary, secondary, or home ASCE, bits 14 and 15 may be set to 00, 10, or 11, respectively, instead of to 01.
10	Secondary ASCE was used.
11	Home ASCE was used.

The CPU may avoid setting bits 14 and 15 to 01 by recognizing that access-list-entry token (ALET) 00000000 or 00000001 hex was used or that the ALET designated, through an access-list entry, an ASN-second-table entry containing an ASCE equal to the primary ASCE, secondary ASCE, or home ASCE. When an ALE-designated ASCE was used, and the designated ASCE matches more than one of the primary ASCE, secondary ASCE, and home ASCE, it is unpredictable which of the matching ASCEs is indicated.

If the PER storage-alteration event occurred as a result of STORE HALFWORD RELATIVE LONG or STORE RELATIVE LONG, bits 14 and 15 correspond to the ASCE used to fetch the instruction: 00 when the CPU was in the primary-space mode, the secondary-space mode, or the access-register mode, and 11 when the CPU was in the home-space mode.

If either of the following is true, zeros are stored in bit positions 14 and 15 of locations 150-151.

- PSW bit 5 was zero, and an ASCE was not used to translate the reference that caused the event.
- The PER code indicates that neither a storage-alteration event nor a zero-address-detection event occurred.

The contents of the PER ASCE identification are unpredictable when any of the following is true:

- PSW bit 5 was zero, and an ASCE was used to translate the reference that caused the event.
- PSW bit 5 was one, and an ASCE was not used to translate the reference that caused the event.

Programming Note: Except for references to the enhanced-monitor counting array, an ASCE is not used to translate the reference when DAT is off or when the operand is defined to contain a real address (as is the case for LOAD USING REAL ADDRESS and STORE USING REAL ADDRESS). An ASCE is also not used to translate the reference when the operand is defined to contain a real or absolute address (as is the case for COMPARE AND REPLACE DAT TABLE ENTRY, INVALIDATE DAT TABLE ENTRY, INVALIDATE PAGE TABLE ENTRY, SET STORAGE KEY EXTENDED, and PERFORM FRAME MANAGEMENT FUNCTION).

PER Address: In the z/Architecture architectural mode, the PER-address field at locations 152-159 contains the instruction address used to fetch the

instruction responsible for the recognized PER event or events, as shown in Figure 4-8, below.

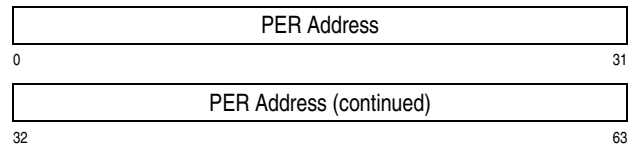

Figure 4-8. Locations 152-159 in the z/Architecture Architectural Mode

In the ESA/390-compatibility mode, the PER-address field at locations 152-155 contains bits 33-63 of the instruction address used to fetch the instruction responsible for the recognized PER event or events, as shown in Figure 4-9, below. Bit 0 of location 152 is stored as zero.

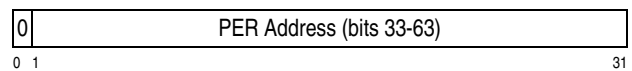
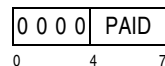

Figure 4-9. Locations 152-155 in the ESA/390-Compatibility Mode

When the instruction is the target of an execute-type instruction (EXECUTE or EXECUTE RELATIVE LONG), the instruction address used to fetch the execute-type instruction is placed in the PER-address field.

PER Access Identification (PAID): If a storage-alteration event or zero-address-detection event is indicated in the PER code, and the PER ASCE identification (AI, bits 14-15 of locations 150-151) contains 01 binary, an indication of the address space to which the event applies is stored at location 161, as shown below.

Location 161:



The number of the access register used is stored in bit positions 4-7 of location 161, and zeros are stored in bit positions 0-3. The contents of location 161 are unpredictable when the PER ASCE identification does not contain 01 binary.

Instruction Address: The instruction address in the program old PSW is the address of the instruction which would have been executed next, unless another program condition is also indicated, in which case the instruction address is that determined by the instruction ending due to that condition. When a

PER instruction-fetching nullification event is recognized, the instruction address in the program old PSW is the address of the instruction responsible for the event. This is the same address stored in the PER address field in real storage locations 152-159.

ILC: For PER instruction nullification events, the ILC is 0. For PER basic events, the ILC indicates the length of the instruction designated by the PER address, except when a concurrent specification exception for the PSW introduced by LOAD PSW, LOAD PSW EXTENDED, PROGRAM RETURN, or a supervisor-call interruption sets an ILC of 0.

Programming Notes:

1. PSW bit 31 is the extended-addressing-mode bit, and PSW bit 32 is the basic-addressing-mode bit. When PSW bit 31 and 32 are both one, they specify the 64-bit addressing mode. When PSW bit 31 is zero, PSW 32 specifies the 24-bit addressing mode if the bit is zero or the 31-bit addressing mode if the bit is one. PSW bit 5 is the DAT-mode bit, and PSW bits 16 and 17 are the address-space-control bits. For the handling of instruction and logical addresses in the different translation modes, see "Translation Modes" on page 3-40.
2. A valid ATMID allows the program handling the PER event to determine the address space from which the instruction that caused the event was fetched and also to determine which translation mode applied to the storage-operand references of the instruction, if any. Each of the instructions for which a valid ATMID is necessarily stored can change one or more of PSW bits 5, 16, and 17, with the result that the values of those bits in the program old PSW that is stored because of the PER event are not necessarily the values that existed at the beginning of the execution of the instruction that caused the event. The instructions for which a valid ATMID is necessarily stored are the only instructions that can change any of PSW bits 5, 16, and 17.
3. If a storage-alteration PER event or zero-address-detection event is indicated and DAT was on when the event occurred, an indication of the address-space-control element that was used to translate the reference that caused the event is given by the PER ASCE identification, bits 14 and 15 of real locations 150-151. If bits 14 and 15 indicate that an AR-specified address-

space-control element was used, the PER access identification in real location 161 can be used to determine the address space that was referenced. To determine if DAT was on, the program handling the PER event should first examine the ATMID-validity bit to determine whether a valid ATMID was stored and, if it was stored, then examine the DAT-mode bit in the ATMID. If a valid ATMID was not stored, the program should examine the DAT-mode bit in the program old PSW.

4. If a valid ATMID is stored, it also allows the program handling the PER event to determine the addressing mode (24-bit, 31-bit, or 64-bit) that existed for the instruction that caused the PER event. This knowledge of the addressing mode allows the program to determine, without any chance of error, the meaning of one bits in bit positions 0-39 of the addresses of the instruction and of the storage operands, if any, of the instruction and, thus, to determine accurately the locations of the instruction and operands. Note that the address of the instruction is not necessarily provided without error by the PER address in real locations 152-159 because that address may be the address of an execute-type instruction, with the address of the target instruction still to be determined from the fields that specify the second-operand address of the execute-type instruction. Also note that another possible source of error is that, in the 24-bit or 31-bit addressing mode, an instruction or operand may wrap around in storage by beginning just below the 16 M-byte or 2 G-byte boundary, respectively.
5. A valid ATMID is necessarily stored for all instructions that can change the addressing-mode bits. However, the ATMID mechanism does not provide complete assurance that the instruction causing a PER event and the instruction's operands can be located accurately because LOAD CONTROL and LOAD ADDRESS SPACE PARAMETERS can change the address-space-control element that was used to fetch the instruction.

Priority of Indication

When a PER instruction-fetching nullification event is recognized and other program interruption conditions exist, only the program interruption condition with the highest priority is indicated. See "Multiple Program-Interruption Conditions" on page 6-51 for a description of the priority of program interruption conditions.

When a PER instruction-fetching nullification event is indicated, no other PER events are indicated. When a PER instruction-fetching nullification event is not indicated, then more than one PER basic event may be recognized and reported. The remainder of this section applies to these cases.

When a program interruption for PER occurs and more than one PER basic event has been recognized, all recognized PER events are concurrently indicated in the PER code. However, when either a storage-alteration or store-using-real-address event is recognized concurrently with a zero-address-detection event, only the storage alteration or store-using-real-address event is indicated. Certain other program-interruption conditions may be concurrently indicated with a PER basic event as described in "Indication of PER Events Concurrently with Other Interruption Conditions" on page 4-40.

When a zero-address-detection event is recognized for more than one storage operand, it is unpredictable which operand's ASCE identification and AR number, if applicable, are stored in locations 150-151 and 161.

In the case of an instruction-fetching basic event for SUPERVISOR CALL, the program interruption occurs immediately after the supervisor-call interruption.

If a PER basic event is recognized during the execution of an instruction which also introduces a new PSW with the type of PSW-format error which is recognized early (see "Exceptions Associated with the PSW" on page 6-9), both the specification exception and PER are indicated concurrently in the interruption code of the program interruption. If the PSW-format error is of the type which is recognized late, only PER is indicated in the interruption code. In both cases, the invalid PSW is stored as the program old PSW.

Recognition of a PER basic event does not normally affect the ending of instruction execution. However, in the following cases, execution of an interruptible instruction is not completed normally:

1. When the instruction is due to be interrupted for an asynchronous condition (I/O, external, restart, or repressible machine-check condition), a program interruption for the PER event occurs first, and the other interruptions occur subsequently

(subject to the mask bits in the new PSW) in the normal priority order.

2. When the stop function is performed, a program interruption indicating the PER event occurs before the CPU enters the stopped state.
3. When any program exception is recognized, PER events recognized for that instruction execution are indicated concurrently.
4. Depending on the model, in certain situations, recognition of a PER event may appear to cause the instruction to be interrupted prematurely without concurrent indication of a program exception, without an interruption for any asynchronous condition, and without the CPU entering the stopped state. In particular, recognition of a storage-alteration event causes no more than 4K bytes to be stored beginning with the byte that caused the event, and recognition of a zero-address-detection event may occur on completion of a unit of operation.

In cases 1 and 2 above, if the only PER event that has been recognized is an instruction-fetching basic event and another unit of operation of the instruction remains to be executed, the event may be discarded, with the result that a program interruption does not occur. Whether the event is discarded is unpredictable.

Recognition of a PER instruction-fetching nullification event causes execution of the instruction responsible for the event to be nullified.

Programming Notes:

1. In the following cases, an instruction can both cause a program interruption for a PER basic event and change the value of fields controlling an interruption for PER events. The original field values determine whether a program interruption takes place for the PER event.
 - a. The instructions LOAD PSW, LOAD PSW EXTENDED, SET SYSTEM MASK, STORE THEN AND SYSTEM MASK, and SUPERVISOR CALL can cause an instruction-fetching event and disable the CPU for PER interruptions. Additionally, STORE THEN AND SYSTEM MASK can cause a storage-alteration event to be indicated. In all these cases, the program old PSW associated with the program interruption for the PER event may indi-

cate that the CPU was disabled for PER events.

- b. An instruction-fetching event or a zero-address-detection event may be recognized during execution of a LOAD CONTROL instruction that changes the value of the PER-event masks in control register 9 or the addresses in control registers 10 and 11 controlling indication of instruction-fetching events.
 - c. In the access-register mode, a storage-alteration event that is permitted by a one value of the storage-alteration-event bit in an address-space-control element in an ASN-second-table entry (designated by an access-list entry) may be caused by any store-type instruction that changes the value of the bit from one to zero.
2. When a PER interruption for a PER basic event occurs during the execution of an interruptible instruction, the ILC indicates the length of that instruction or execute-type instruction, as appropriate. When a PER interruption for a PER basic event occurs as a result of LOAD PSW, LOAD PSW EXTENDED, PROGRAM RETURN, or SUPERVISOR CALL, the ILC indicates the length of the instruction or of the execute-type instruction which designates the interrupted type of instruction as its target, as appropriate, unless a concurrent specification exception on LOAD PSW, LOAD PSW EXTENDED, or PROGRAM RETURN calls for an ILC of 0.
 3. When a PER interruption is caused by branching, the PER address identifies the branch instruction (or execute-type instruction, as appropriate), whereas the old PSW points to the next instruction to be executed. When the interruption occurs during the execution of an interruptible instruction, the PER address and the instruction address in the old PSW are the same.

Storage-Area Designation

Three types of PER events — instruction fetching, storage alteration, and storage-key alteration — always involve the designation of an area in storage. Successful-branching events may involve this designation. The storage area starts at the location designated by the starting address in control register 10 and extends up to and including the location design-

ated by the ending address in control register 11. The area extends to the right of the starting address.

An instruction-fetching event occurs whenever the first byte of an instruction or the first byte of the target of an execute-type instruction, as designated by the instruction address (before any address translation is applied), is fetched from the designated area.

A storage-alteration event occurs when a store access is made to the designated area by using an operand address that is defined to be a logical or a virtual address. However, when DAT is on and the storage-alteration-space control in control register 9 is one, a storage-alteration event occurs only when the storage area is within an address space for which the storage-alteration-event bit in the address-space-control element is one. A storage-alteration event does not occur for a store access made with an operand address defined to be a real address.

When the branch-address control in control register 9 is one, a successful-branching event occurs when the first byte of the branch-target instruction, as designated by the branch address (before any address translation is applied), is within the designated area.

A storage-key-alteration event occurs when any byte within the 4K-byte block associated with the updated storage key lies within the designated area. All bits of control registers 10 and 11, including the low-order 12 bits, participate in the determination of the designated area. The address is a real address for TEST BLOCK, real or absolute address for PERFORM FRAME MANAGEMENT FUNCTION and SET STORAGE KEY EXTENDED, and a logical address for MOVE PAGE.

The set of addresses designated for successful-branching, instruction-fetching, storage-alteration, and storage-key-alteration events wraps around at address $2^{64} - 1$; that is, address 0 is considered to follow address $2^{64} - 1$. When the starting address is less than the ending address, the area is contiguous. When the starting address is greater than the ending address, the set of locations designated includes the area from the starting address to address $2^{64} - 1$ and the area from address 0 to, and including, the ending address. When the starting address is equal to the ending address, only that one location is designated.

Address comparison for successful-branching, instruction-fetching, storage-alteration, and storage-key-alteration events is always performed using

64-bit addresses. This is accomplished in the 24-bit or 31-bit addressing mode by extending the virtual, logical, or instruction address on the left with 40 or 33 zeros, respectively, before comparing it with the starting and ending addresses.

Programming Note: In some models, performance of address-range checking is assisted by means of an extension to each page-table entry in the TLB. In such an implementation, changing the contents of control registers 10 and 11 when the successful-branching, instruction-fetching, or storage-alteration-event mask is one, or setting any of these PER-event masks to one, may cause the TLB to be cleared of entries. This degradation may be experienced even when the CPU is disabled for PER events. Thus, when possible, the program should avoid loading control registers 9, 10, or 11.

PER Events

Successful Branching

When the branch-address control in control register 9 is zero, a successful-branching event occurs independent of the branch-target address. When the branch-address control is one, a successful-branching event occurs only when the first byte of the branch-target instruction is in the storage area designated by control registers 10 and 11.

Subject to the effect of the branch-address control, a successful-branching event occurs whenever one of the following instructions causes branching:

- BRANCH AND LINK (BAL, BALR)
- BRANCH AND SAVE (BAS, BASR)
- BRANCH AND SAVE AND SET MODE (BASSM)
- BRANCH AND SET AUTHORITY (BSA)
- BRANCH AND SET MODE (BSM)
- BRANCH AND STACK (BAKR)
- BRANCH IN SUBSPACE GROUP (BSG)
- BRANCH INDIRECT ON CONDITION
- BRANCH ON CONDITION (BC, BCR)
- BRANCH ON COUNT (BCT, BCTR, BCTG, BCTGR)
- BRANCH ON INDEX HIGH (BXH, BXHG)
- BRANCH ON INDEX LOW OR EQUAL (BXLE, BXLEG)
- BRANCH RELATIVE AND SAVE (BRAS)
- BRANCH RELATIVE AND SAVE LONG (BRASL)
- BRANCH RELATIVE ON CONDITION (BRC)

- BRANCH RELATIVE ON CONDITION LONG (BRCL)
- BRANCH RELATIVE ON COUNT (BRCT, BRCTG)
- BRANCH RELATIVE ON COUNT HIGH (BRCTH)
- BRANCH RELATIVE ON INDEX HIGH (BRXH, BRXHG)
- BRANCH RELATIVE ON INDEX LOW OR EQUAL (BRXLE, BRXLG)
- COMPARE AND BRANCH (CRB, CGRB)
- COMPARE AND BRANCH RELATIVE (CRJ, CGRJ)
- COMPARE IMMEDIATE AND BRANCH (CIB, CGIB)
- COMPARE IMMEDIATE AND BRANCH RELATIVE (CIJ, CGIJ)
- COMPARE LOGICAL AND BRANCH (CLRB, CLGRB)
- COMPARE LOGICAL AND BRANCH RELATIVE (CLRJ, CLGRJ)
- COMPARE LOGICAL IMMEDIATE AND BRANCH (CLIB, CLGIB)
- COMPARE LOGICAL IMMEDIATE AND BRANCH RELATIVE (CLIJ, CLGIJ)
- RESUME PROGRAM (RP)
- TRAP (TRAP2, TRAP4)

Subject to the effect of the branch-address control, a successful-branching event also occurs whenever one of the following instructions causes branching:

- PROGRAM CALL (PC)
- PROGRAM RETURN (PR)
- PROGRAM TRANSFER (PT)
- PROGRAM TRANSFER WITH INSTANCE (PTI)

For PROGRAM CALL, PROGRAM RETURN, PROGRAM TRANSFER, and PROGRAM TRANSFER WITH INSTANCE, the branch-target address is considered to be the new instruction address that is placed in the PSW by the instruction.

When the guarded-storage facility is enabled, a successful-branching event is recognized as a result of a guarded-storage event caused by either of the following instructions:

- LOAD GUARDED (LGG)
- LOAD LOGICAL AND SHIFT GUARDED (LLGFSG)

When the branch-address control is one, the branch address is considered to be the contents of the

guarded-storage-event handler address (GSEHA) field in the guarded-storage-event parameter list (GSEPL).

A successful-branching event causes a PER successful-branching event to be recognized if bit 32 of the PER-event masks is one and the PER mask in the PSW is one.

A PER successful-branching event is indicated by setting bit 0 of the PER code to one.

Instruction Fetching

An instruction-fetching event occurs if the first byte of the instruction is within the storage area designated by control registers 10 and 11. An instruction-fetching event also occurs if the first byte of the target of an execute-type instruction is within the designated storage area.

Instruction-Fetching Basic Event: An instruction-fetching event causes a PER instruction-fetching basic event to be recognized if the PER mask in the PSW is one and bit 33 of the PER-event masks is one and either the PER-3 facility is not installed, or bit 39 of the PER-event masks is zero.

If an instruction-fetching basic event is the only PER event recognized for an interruptible instruction that is to be interrupted because of an asynchronous condition (I/O, external, restart, or repressible machine-check condition) or the performance of the stop function, and if a unit of operation of the instruction remains to be executed, the instruction-fetching event may be discarded, and whether it is discarded is unpredictable.

The PER instruction-fetching basic event is indicated by setting bit 1 of the PER code to one and bit 7 of the PER code to zero.

Instruction-Fetching Nullification Event: An instruction-fetching event causes a PER instruction-fetching nullification event to be recognized if the PER mask in the PSW is one and bit 33 of the PER-event masks is one and the PER-3 facility is installed and bit 39 of the PER-event masks is one.

It is unpredictable whether the PER-3 facility is installed in the ESA/390-compatibility mode.

The PER instruction-fetching nullification event is indicated by setting bits 1 and 7 of the PER code to one.

Storage Alteration

A storage-alteration event occurs whenever a CPU, by using a logical or virtual address, makes a store access without an access exception to the storage area designated by control registers 10 and 11. However, when DAT is on and the storage-alteration-space control in control register 9 is one, the event occurs only if the storage-alteration-event bit is one in the address-space-control element that is used by DAT to translate the reference to the storage location.

The contents of storage are considered to have been altered whenever the CPU executes an instruction that causes all or part of an operand to be stored within the designated storage area. Alteration is considered to take place whenever storing is considered to take place for purposes of indicating protection exceptions, except that recognition does not occur for the storing of data by a channel program. (See "Recognition of Access Exceptions" on page 6-47.) Storing constitutes alteration for PER purposes even if the value stored is the same as the original value. Additionally, the contents of a TBEGIN-specified TDB are considered to have been altered by the execution of an outermost TBEGIN instruction, regardless of whether the TDB is actually stored by a transaction being aborted; it is unpredictable whether a PER storage-alteration event is detected for the first-operand location of an inner TBEGIN instruction.

Implied locations that are referred to by the CPU are not monitored. Such locations include PSW and interruption-code locations, the program-interruption transaction diagnostic block, the enhanced-monitor exception counter, and the trace entry designated by control register 12. These locations, however, are monitored when information is stored there explicitly by an instruction. Similarly, monitoring does not apply to the storing of data by a channel program. Implied locations in the linkage stack, which are stored in by instructions that operate on the linkage stack, and enhanced-monitor-counting-array entries which are stored in by the MONITOR CALL instruction, are monitored.

The I/O instructions are considered to alter the second-operand location only when storing actually occurs.

Storage alteration does not apply to instructions whose operands are specified to have real or absolute addresses. Thus, storage alteration does not apply to COMPARE AND REPLACE DAT TABLE ENTRY, INVALIDATE DAT TABLE ENTRY (invalidation-and-clearing operation), INVALIDATE PAGE TABLE ENTRY, PAGE IN, PERFORM FRAME MANAGEMENT FUNCTION, RESET REFERENCE BIT EXTENDED, RESET REFERENCE BITS MULTIPLE, SET STORAGE KEY EXTENDED, STORE USING REAL ADDRESS, TEST BLOCK, and TEST PENDING INTERRUPTION (when the effective address is zero). Storage alteration does not apply to the store to real location 200 by STORE FACILITY LIST, nor does it apply to stores to the trace table by instructions that cause tracing to occur.

A storage-alteration event causes a PER storage-alteration event to be recognized if bit 34 of the PER-event masks is one and the PER mask in the PSW is one. Bit 36 of the PER-event masks is ignored when determining whether a PER storage-alteration event is to be recognized.

A PER storage-alteration event is indicated by setting bit 2 of the PER code to one and bit 4 of the PER code to zero.

Store Using Real Address

A store-using-real-address event occurs whenever the STORE USING REAL ADDRESS instruction is executed.

There is no relationship between the store-using-real-address event and the designated storage area.

A store-using-real-address event causes a PER store-using-real-address event to be recognized if bits 34 and 36 of the PER-event mask are ones and the PER mask in the PSW is one.

A PER store-using-real-address event is indicated by setting bits 2 and 4 of the PER code to one.

Zero-Address Detection

When the PER zero-address-detection facility is installed, a zero-address-detection event occurs whenever a CPU makes a storage access using an effective operand address formed from a general register, or subfield of a general register, containing zero. However, during execution of an RX-, RXE-, RXF-, RXY-, or VRX-format instruction, the event occurs only if the CPU makes a storage access using

an effective operand address formed under one of the following conditions:

1. The base register number is zero, the index register number is nonzero, and the index register contains zero.
2. The index register number is zero, the base register number is nonzero, and the base register contains zero.
3. When both the base register number and the index register number are nonzero, it is unpredictable which one of the following conditions causes the event:
 - (a) The base register contains zero.
 - (b) The sum of the contents of the base register and the index register is zero.

During the execution of a VRV-format instruction, it is unpredictable which one or more of the following conditions will cause the event to occur if the CPU makes a storage access:

1. The base register number is zero, and the value of the indexed element of the second operand is zero.
2. The base register number is non-zero and the base register contains zero
3. The sum of the contents of the base register and the value of the indexed element is zero.

Except as noted below, zero-address detection for an operand address is performed whenever a fetch, store, or update reference is made to storage using the address, and zero-address detection is performed only when an operand address is used to access storage.

Except for BRANCH INDIRECT ON CONDITION, zero-address detection is not performed on the branch address of branch-type instructions. For BRANCH INDIRECT ON CONDITION, zero-address detection is performed on the second-operand address but not on the branch address fetched from the second operand. For LOAD GUARDED and LOAD LOGICAL AND SHIFT GUARDED, zero-address detection is performed on the second-operand address of the instruction, even though these are considered to be branch-type instructions when a guarded-storage event is recognized.

Zero-address detection is also not performed on the target-instruction address of the EXECUTE instruction, and the contents of general register R_2 for the TEST BLOCK instruction.

For COMPRESSION CALL, CONVERT UTF-16 TO UTF-32, CONVERT UTF-16 TO UTF-8, CONVERT UTF-32 TO UTF-16, CONVERT UTF-32 TO UTF-8, CONVERT UTF-8 TO UTF-16, and CONVERT UTF-8 TO UTF-32, it is unpredictable whether a PER zero-address-detection event is recognized for any storage operand when the end of the first operand is reached, but the end of the second operand has not been reached.

Conditions for causing a zero-address-detection event are evaluated at the start of instruction execution. It is unpredictable if those conditions are reevaluated during instruction execution.

Except as noted below, the determination of whether a register's contents are zero is dependent upon the current addressing mode, as follows:

- In the 24- and 31-bit addressing modes, a register is considered to contain zero if bits 32-63 are all zeros.
- In the 64-bit addressing mode, a register is considered to contain zero if bits 0-63 are all zeros.

For COMPARE AND REPLACE DAT TABLE ENTRY, when bit position 59 of general register R_2 contains zero, general register R_2 is considered to contain zero if bits 0-52 are all zeros; when bit position 59 of general register R_2 contains one, general register R_2 is considered to contain zero if bits 0-51 are all zeros. For INVALIDATE DAT TABLE ENTRY, general register R_1 is considered to contain zero if bits 0-51 are all zeros, and for INVALIDATE PAGE TABLE ENTRY, general register R_1 is considered to contain zero if bits 0-52 are all zeros, regardless of the addressing mode.

Zero-Address-Detection Event: A zero-address-detection event causes a PER zero-address-detection event to be recognized if the PER mask in the PSW is one and bit 37 of the PER-event mask is one.

A PER zero-address-detection event is indicated by setting bit 5 of the PER code to one.

Programming Notes:

1. Following are examples of instructions and corresponding general register values that cause a zero-address-detection event:

LAM	3,4,8(7)	GR7=0
LG	1,8(0,3)	GR3=0
L	5,87(4,0)	GR4=0
LG	6,0(1,2)	GR2=0
MVCL	2,4	GR2=0 or GR4=0
MVCL	0,8	GR0=0 or GR8=0

The examples using the MVCL instructions will cause the event only if a nonzero second-operand length is specified in general register $R_2 + 1$; see Programming Note 3.

2. A zero-address-detection event may occur for normal programming situations. In particular, an instruction that intentionally accesses the prefix storage area or a data space with an origin of zero may use a base register containing zero in the formation of a storage operand address, and thus cause a zero-address-detection event to occur. If normal execution of a program frequently uses registers containing zero in the formation of storage addresses, then the PER zero-address-detection event will be of limited use in locating programming bugs involving the unintentional use of a general register containing zero in the formation of a storage address.
3. A PER zero-address-detection event is not recognized for an operand address that is not used to access storage. For example, when the MOVE LONG instruction is executed with a second-operand length of zero specified in general register $R_2 + 1$, a PER zero-address-detection event is not recognized when the second-operand address is zero.
4. Recognition of a PER zero-address-detection event is unpredictable for instructions where it is unpredictable whether access exceptions are recognized when the operand values allow the operation to complete without storage being accessed.

Transaction End

When the CPU is in the transactional-execution mode at the beginning of an outermost TRANSACTION END instruction, a transaction-end event occurs at the completion of the instruction.

There is no relationship between the transaction-end event and the designated storage area.

A transaction-end event causes a PER transaction-end event to be recognized if bit 38 of the PER-event mask is one and the PER mask in the PSW is one.

A PER transaction-end event is indicated by setting bit 6 of the PER code to one.

A transaction-end event is not recognized when a TRANSACTION END instruction is executed and the CPU is not in the transactional-execution mode.

Storage-Key Alteration

A storage-key-alteration event occurs whenever a CPU updates the ACC or F bits of a storage key, without an access exception, associated with a 4 K-byte block of storage within the storage area designated by control registers 10 and 11. Alteration of the R or C bits does not cause this event unless it also alters the ACC or F bits. Updating of the ACC or F bits is considered alteration for PER purposes even if the new value is the same as the original value.

Four instructions can cause a storage-key-alteration event if the 4K-byte block associated with the updated storage key lies within the designated area:

- Any execution of SET STORAGE KEY EXTENDED. When the conditional-SSKE facility is installed, either or both the MR and MC bits are one, and the access-control and fetch-protection bits are not required to be updated, then it is model-dependent if this is considered to be a storage-key-alteration event. In all cases that the access-control and fetch-protection bits are updated, a storage-key-alteration event occurs as long as the associated 4 K-byte block of storage lies within the designated area.
- PERFORM FRAME MANAGEMENT FUNCTION when SK (bit 46 of general register R₁) is one. When the conditional-SSKE facility is installed, the handling when either the MR or MC bits is non-zero, is the same as described above for SET STORAGE KEY EXTENDED.
- MOVE PAGE when the move-page-and-set-key facility is installed and KFC (bits 51-53 of general register 0) contains a value of 4 or 5.
- Any execution of TEST BLOCK, but only when the model's implementation actually updates the storage key.

A storage-key-alteration event causes a PER storage-key-alteration event to be recognized if bit 35 of the PER-event mask is one and the PER mask in the PSW is one.

A PER storage-key-alteration event is indicated by setting bit 3 of the PER code to one.

Indication of PER Events Concurrently with Other Interruption Conditions

When a PER instruction-fetching nullification event is reported, no other PER events and no other program interruption conditions other than transaction-abort exception (if applicable) are reported.

The following rules govern the indication of PER basic events caused by an instruction that also causes a program exception, a monitor event, a space-switch event, or a supervisor-call interruption.

1. The indication of an instruction-fetching basic event does not depend on whether the execution of the instruction was completed, terminated, suppressed, or nullified. However, special cases of suppression and nullification are as follows:
 - a. When the instruction is designated by an odd instruction address in the PSW, the instruction-fetching event is not indicated.
 - b. When an access exception applies to the first, second, or third halfword of the instruction designated by the PSW instruction address, and the PER-3 facility is installed, the instruction-fetching event is not indicated. However, if the PER-3 facility is not installed, it is unpredictable whether the instruction-fetching event is indicated.
 - c. When either (a) an access exception applies to the first, second, or third halfword of the target location of an execute-type instruction, or (b) the target address of an EXECUTE instruction is odd, the following applies:
 - 1) If the PER-3 facility is installed, then the following applies:
 - a) An instruction-fetching event is not indicated for the target location.

- b) It is unpredictable whether an instruction-fetching event is indicated for the execute-type instruction, including the case where the PER address range includes both the execute-type instruction and its target.
- 2) If the PER-3 facility is not installed, it is unpredictable whether the instruction-fetching event is indicated for either the execute-type instruction or the target location.
- 2. When the operation is completed or partially completed, the event is indicated, regardless of whether any program exception, space-switch event, or monitor event is also recognized.
- 3. Successful branching, zero-address detection, storage alteration, and store using real address are not indicated for an operation or, in case the instruction is interruptible, for a unit of operation that is suppressed or nullified.
- 4. When the execution of the instruction is terminated, storage alteration or zero-address detection is indicated whenever the event has occurred. A model may indicate the event if the event would have occurred had the execution of the instruction been completed, even if altering the contents of the result field is contingent on operand values. For purposes of this definition, the occurrence of those exceptions which permit termination (addressing, protection, and data) is considered to cause termination, even if no result area is changed.
- 5. When LOAD PSW, LOAD PSW EXTENDED, PROGRAM RETURN, SET SYSTEM MASK, STORE THEN OR SYSTEM MASK, or SUPERVISOR CALL causes a PER basic condition and at the same time introduces a new PSW with the type of PSW-format error that is recognized immediately after the PSW becomes active (called early exception recognition), the interruption code identifies both the PER basic condition and the specification exception.
- 6. When LOAD PSW, LOAD PSW EXTENDED, PROGRAM RETURN, or SUPERVISOR CALL causes a PER condition and at the same time introduces a new PSW with the type of PSW-format error that is recognized as part of the execution of the following instruction (called late exception recognition), the interruption code

identifies the PER basic condition and the introduced PSW is stored as the old PSW without the following instruction being fetched or executed and without the specification exception being recognized.

- 7. When an outermost TRANSACTION BEGIN instruction causes a PER basic event and a concurrent program exception, the event-suppression control does not apply.

When a PER event occurs while the CPU is in the transactional-execution mode, the transaction is aborted as described in "Transaction Abort Processing" on page 5-102, and bit 6 is set in the program-interruption code.

The indication of PER basic events concurrently with other program-interruption conditions for the same instruction, as described in cases 1-4 above, is summarized in Figure 4-10 on page 4-42. Cases 5 and 6 are shown in Figure 4-11 on page 4-44.

Programming Notes:

- 1. The execution of the interruptible instructions COMPARE AND FORM CODEWORD, COMPARE LOGICAL LONG, COMPARE UNTIL SUBSTRING EQUAL, COMPRESSION CALL, MOVE LONG, TEST BLOCK, and UPDATE TREE can cause events for instruction fetching and zero-address detection. The execution of the interruptible instructions PERFORM FRAME MANAGEMENT FUNCTION (when the enhanced-DAT facility is installed, and the frame-size code designates a 1 M-byte frame), SET STORAGE KEY EXTENDED (when the enhanced-DAT facility is installed, and the multiple-block control is one) and TEST BLOCK can cause events for instruction-fetching. Execution of COMPRESSION CALL, MOVE LONG, and UPDATE TREE can cause events for instruction-fetching, zero-address detection and storage-alteration.

Interruption of such an instruction may cause a PER basic event to be indicated more than once. It may be necessary, therefore, for a program to remove the redundant event indications from the PER data. The following rules govern the indication of the applicable events during execution of these instructions:

- a. The instruction-fetching basic event is indicated whenever the instruction is fetched for execution, regardless of whether it is the ini-

tial execution or a resumption, except that the event may be discarded (not indicated) if it is the only PER event to be indicated, the interruption is due to an asynchronous interruption condition or the performance of the stop function, and a unit of operation of the instruction remains to be executed.

- b. The storage-alteration event is indicated only when data has been stored in the designated storage area by the portion of the operation starting with the last initiation and ending with the last byte transferred before the interruption. No special indication is provided on premature interruptions as to whether the event will occur again upon the resumption of the operation. When the designated storage area is a single byte location, a storage-alteration event can be recognized only once in the execution of MOVE LONG or COMPRESSION CALL, but could be recognized more than once for UPDATE TREE.

2. The following is an outline of the general action a program must take to delete multiple entries for PER basic events in the PER data for an interruptible instruction so that only one entry for

each complete execution of the instruction is obtained:

- a. Check to see if the PER address is equal to the instruction address in the old PSW and if the last instruction executed was interruptible.
 - b. If both conditions are met, delete instruction-fetching events.
 - c. If both conditions are met and the event is storage alteration, delete the event if some part of the remaining destination operand is within the designated storage area.
3. An example of the indication of a PER instruction-fetching basic event caused by either a LOAD PSW (or LOAD PSW EXTENDED) instruction or the following instruction, in connection with an early PSW-format error or odd instruction address introduced by the LOAD PSW instruction, is shown in Figure 4-11 on page 4-44.

Notes on the Definition:

Concurrent Condition	Type of Ending	PER Basic Event						
		Branch	Instr. Fetch	Storage Alter.	STURA	TEND	Z-Addr Detect	Storage Key Alter.
Specification exception due to odd instruction address in the PSW:	S	–	No	–	–	–	–	–
Access exception fetching the instruction designated by the PSW instruction address								
Without PER-3	N or S	–	U	–	–	–	–	–
With PER-3	N or S	–	No	–	–	–	–	–
Specification exception due to the EXECUTE target address being odd:								
Without PER-3	S	–	U	–	–	–	–	–
With PER-3 (PER instruction-fetching-basic event detected only on the target instruction)	S	–	No	–	–	–	–	–
With PER-3 (PER instruction-fetching-basic event detected on the EXECUTE instruction)	S	–	U	–	–	–	–	–
Access exception fetching the target of an execute-type instruction:								
Without PER-3	N or S	–	U	–	–	–	–	–
With PER-3 (PER instruction-fetching-basic event detected only on the target instruction)	N or S	–	No	–	–	–	–	–

Figure 4-10. Indication of PER Basic Events with Other Concurrent Conditions (Part 1 of 2)

Concurrent Condition	Type of Ending	PER Basic Event						
		Branch	Instr. Fetch	Storage Alter.	STURA	TEND	Z-Addr Detect	Storage Key Alter.
With PER-3 (PER instruction-fetching-basic event detected on the execute-type instruction)	N or S	–	U	–	–	–	–	–
Other nullifying exceptions	N	–	Yes	No ¹	–	–	No ¹	No
Other suppressing exceptions	S	–	Yes	No ¹	–	–	No ¹	No
All terminating exceptions	T	No	Yes	Yes ²	–	–	U	–
All completing exceptions or events	C	Yes	Yes	Yes	–	–	Yes	Yes
Explanation:								
–	The PER event does not apply, or PER event applies but is prevented by the concurrent condition.							
U	It is unpredictable whether the PER event is indicated.							
¹	Although PER events of this type are not indicated for the current unit of operation of an interruptible instruction, PER events of this type that were recognized on completed units of operation of the interruptible instruction are indicated.							
²	This event may be indicated, depending on the model, if the event has not occurred but would have been indicated if execution had been completed.							
C	The operation or, in the case of the interruptible instructions, the unit of operation is completed.							
N	The operation or, in the case of the interruptible instructions, the unit of operation is nullified.							
No	The PER event is not indicated.							
S	The operation or, in the case of the interruptible instructions, the unit of operation is suppressed.							
T	The execution of the instruction is terminated.							
U	It is unpredictable whether the PER event is indicated.							
Yes	The PER event is indicated with the other program interruption condition if the event has occurred; that is, the instruction address in the PSW was replaced and the branch-address control and PER designated storage area allow the event occurrence, an attempt was made to execute an instruction whose first byte is located in the designated storage area, the contents of the designated storage area was altered, or a general register containing zero was used in the formation of an operand address used to reference storage.							

Figure 4-10. Indication of PER Basic Events with Other Concurrent Conditions (Part 2 of 2)

LPSW at 4000 Loads a PSW		Designated Storage Area Includes		Two-Byte Instruction Is at 6000			
PSW Has Early PSW-Format Error	Instruction Address in PSW	4000	6000-6001	Interruption Code	Address in Program Old PSW	ILC	PER Address
N	6000	N	N	None	-	-	-
N	6000	N	Y	P	6002	1	6000
N	6000	Y	-	P	6000	2	4000
N	6001	N	N	S	6001+J ¹	K ¹	None
N	6001	N	Y	S ²	6001+J ¹	K ¹	None
N	6001	Y	-	P ^{2 3}	6001 ^{2 3}	2	4000
Y	6000	N	-	S	6000	0 ⁴	None
Y	6000	Y	-	P,S ^{2 3}	6000 ^{2 3}	0 ⁴	4000
Y	6001	N	-	S	6001	0 ⁴	None
Y	6001	Y	-	P,S ^{2 3}	6001 ^{2 3}	0 ⁴	4000

Explanation:

- Immaterial or not applicable.
¹ See "ILC on Instruction-Fetching Exceptions" on page 6-8.
² See "Indication of PER Events Concurrently with Other Interruption Conditions" on page 4-40.
³ See "Priority of Indication" on page 4-33.
⁴ See "Zero ILC" on page 6-7.
J Unpredictably 2, 4, or 6.
K 1, 2, or 3 depending on whether J is 2, 4, or 6, respectively.
N No.
P PER instruction-fetching basic event.
S Specification exception.
Y Yes.

Figure 4-11. Example of Instruction-Fetching PER Basic Event and Early PSW-Format Error or Odd Instruction Address

Indication of PER Events and Guarded-Storage Events

For LOAD GUARDED or LOAD LOGICAL AND SHIFT GUARDED in which a guarded-storage event is recognized, any or all the following PER events are recognized coincident with the guarded-storage event (GSE):

- An instruction-fetch basic event
- A storage-alteration event (for the GSE parameter list)
- A successful-branching event (branching to the GSE handler)
- In the absence of a PER storage-alteration event, a PER zero-address-detection event

When a GSE coincides with a PER event, the following applies:

- The PER address contains the address of LOAD GUARDED or LOAD LOGICAL AND SHIFT GUARDED instruction, or, if the instruction was the target of an execute-type instruction, the PER address contains the address of the execute-type instruction.
- The instruction address of the program-old PSW is set as follows:
 - When the GSE parameter list (GSEPL) is accessible, the instruction address is set from the contents of the GSE handler-address (GSEHA) field. The GSEHA field is considered to be a branch address, thus the instruction address in the program-old PSW

is subject to the action described in “Formation of the Branch Address” on page 5-13.

- When the GSEPL is not accessible, the instruction address is set as follows:
 - If the CPU was not in the transactional-execution mode when the GSE was recognized, and the access exception results in nullification, then the instruction address points to the instruction causing the GSE (that is, the same as the PER address).
 - If the CPU was not in the transactional-execution mode when the GSE was recognized, and the access exception results in suppression or termination, then the instruction address points to the next-sequential instruction following the instruction that caused the GSE.
 - If the CPU was in the transactional-execution mode when the GSE was recognized, then the instruction address is set from the corresponding field of the transaction-abort PSW.
- The ILC indicates the length of the instruction designated by the PER address.

Programming Note: A GSE handler may adjust the contents of the second operand of the LGG or LLGFSG instruction such that a repeated execution of the instruction no longer results in a GSE being recognized. In this case, PER storage-alteration and successful-branching events are no longer applicable for the re-executed instruction. However, unless the program adjusts the PER controls, PER instruction-fetch-basic and zero-address-detection events that are recognized on the first execution of the instruction (that caused the GSE to be detected) will continue to be recognized when the instruction is re-executed, even though a GSE is not detected on the second execution.

Breaking-Event-Address Recording

When the PER-3 facility is installed, it provides the program with the address of the last instruction to cause a break in the sequential execution of the CPU. Breaking-event-address recording can be used as a debugging assist for wild-branch detection. This

facility provides a 64-bit register in the CPU, called the breaking-event-address register. Each time an instruction other than TRANSACTION ABORT causes a break in the sequential instruction execution (that is, the instruction address in the PSW is replaced, rather than incremented by the length of the instruction) the address of that instruction is placed in the breaking-event-address register. Whenever a program interruption occurs, whether or not PER is indicated, the current contents of the breaking-event-address register are placed in real storage locations 272-279.

Normally, operation of the CPU is controlled by instructions in storage that are executed sequentially, one at a time, left to right in an ascending sequence of storage addresses. This is called sequential instruction execution, and, as part of this operation, the instruction address in the PSW is incremented by the length of each instruction executed. The execution of some instructions cause the contents of the instruction address to be replaced, rather than incremented. The action to replace the instruction address is called a breaking event, and the instruction causing the action is called an execution-break instruction.

Programming Notes:

1. When the breaking-event-address register is physically installed in the machine, the full 64-bit value of the register is updated whenever a breaking event occurs. This occurs regardless of the architectural mode of the configuration

Although the breaking-event-address register is not stored in the ESA/390 architectural mode or ESA/390-compatibility mode, a breaking event that occurs in one of these modes may be visible if the configuration switches to the z/Architecture architectural mode. If (a) the CPU does not prevent a configuration operating in the ESA/390-compatibility mode from entering the 64-bit addressing mode, (b) the program enters the 64-bit addressing mode and executes above the 2 G-byte boundary, and (c) the program switches to the z/Architecture architectural mode, then a breaking-event address above the 2 G-byte boundary may be visible following the next program interruption.

2. The addressing mode and address space used to translate the instruction address are not preserved; therefore, breaking-event-address

recording is most effective for debugging code that does not contain address-space switches or addressing mode changes.

Breaking-Event-Address Register

When the PER-3 facility is installed, each CPU has a 64-bit register called the breaking-event-address register.

Each time execution of an instruction other than TRANSACTION ABORT replaces the instruction address in the PSW by any means other than sequential instruction execution, the instruction address used to fetch that instruction is placed in the breaking-event-address register. If the instruction causing the breaking event is the target of an execute-type instruction (EXECUTE or EXECUTE RELATIVE LONG), then the instruction address used to fetch the execute-type instruction is placed in the breaking-event-address register.

Each time a program interruption occurs, the contents of the breaking-event-address register are placed in real storage locations 272-279.

The contents of the breaking-event-address register are unpredictable after the SIGNAL PROCESSOR set-architecture order.

The contents of the breaking-event-address register are reset to a value of 0000000000000001 hex by initial CPU reset.

Execution-Break Instructions

A breaking event is considered to occur whenever one of the following instructions causes branching:

- BRANCH AND LINK (BAL, BALR)
- BRANCH AND SAVE (BAS, BASR)
- BRANCH AND SAVE AND SET MODE (BASSM)
- BRANCH AND SET MODE (BSM)
- BRANCH AND STACK (BAKR)
- BRANCH INDIRECT ON CONDITION
- BRANCH ON CONDITION (BC, BCR)
- BRANCH ON COUNT (BCT, BCTR, BCTG, BCTGR)
- BRANCH ON INDEX HIGH (BXH, BXHG)
- BRANCH ON INDEX LOW OR EQUAL (BXLE, BXLEG)
- BRANCH RELATIVE ON CONDITION (BRC)
- BRANCH RELATIVE ON CONDITION LONG (BRCL)

- BRANCH RELATIVE ON COUNT (BRCT, BRCTG)
- BRANCH RELATIVE ON COUNT HIGH (BRCTH)
- BRANCH RELATIVE ON INDEX HIGH (BRXH, BRXHG)
- BRANCH RELATIVE ON INDEX LOW OR EQUAL (BRXLE, BRXLG)
- COMPARE AND BRANCH (CRB, CGRB)
- COMPARE AND BRANCH RELATIVE (CRJ, CGRJ)
- COMPARE IMMEDIATE AND BRANCH (CIB, CGIB)
- COMPARE IMMEDIATE AND BRANCH RELATIVE (CIJ, CGIJ)
- COMPARE LOGICAL AND BRANCH (CLRB, CLGRB)
- COMPARE LOGICAL AND BRANCH RELATIVE (CLRJ, CLGRJ)
- COMPARE LOGICAL IMMEDIATE AND BRANCH (CLIB, CLGIB)
- COMPARE LOGICAL IMMEDIATE AND BRANCH RELATIVE (CLIJ, CLGIJ)

A breaking event is also considered to occur whenever one of the following instructions completes:

- BRANCH AND SET AUTHORITY (BSA)
- BRANCH IN SUBSPACE GROUP (BSG)
- BRANCH RELATIVE AND SAVE (BRAS)
- BRANCH RELATIVE AND SAVE LONG (BRASL)
- LOAD PSW (LPSW)
- LOAD PSW EXTENDED (LPSWE)
- PROGRAM CALL (PC)
- PROGRAM RETURN (PR)
- PROGRAM TRANSFER (PT)
- PROGRAM TRANSFER WITH INSTANCE (PTI)
- RESUME PROGRAM (RP)
- TRAP (TRAP2, TRAP4)

A breaking event is also considered to occur whenever a guarded-storage event is detected at the completion of the following instructions:

- LOAD GUARDED (LGG)
- LOAD LOGICAL AND SHIFT GUARDED (LLGFSG)

A breaking event is not considered to occur as a result of a transaction being aborted (either implicitly or as a result of the TRANSACTION ABORT instruction).

Timing

The timing facilities include three facilities for measuring time: the TOD clock, the clock comparator, and the CPU timer. A TOD programmable register is associated with the TOD clock. When the multiple-epoch facility is installed, the TOD-clock epoch index is also provided.

In a multiprocessing configuration, a single TOD clock is shared by all CPUs. Each CPU has its own clock comparator, CPU timer, and TOD programmable register.

Time-of-Day Clock and Epoch Index

The time-of-day (TOD) clock provides a high-resolution measure of real time suitable for the indication of date and time of day. The duration of the TOD clock, beginning with a value of zero and continuing until it wraps around to zero, is approximately 143 years; this duration is referred to as an *epoch*. A single TOD clock is shared by all CPUs in the configuration.

Format

The TOD clock is a 104-bit register.

For certain instructions, the TOD clock is considered to be extended to the left by an 8-bit *epoch index*. In a multiprocessing configuration, a single epoch index

is shared by all CPUs. When the multiple-epoch facility is not installed in the configuration, the epoch index contains zeros when the TOD clock has not wrapped around to zero; when the TOD clock has wrapped around to zeros, it is unpredictable whether or not the epoch index contains zeros. When the multiple-epoch facility is installed in the configuration, the epoch index extends the capacity of the monotonic sequence of clock values to approximately 36,534 years.

The TOD clock nominally is incremented by adding a one in bit position 51 every microsecond. In models having a higher or lower resolution, a different bit position is incremented at such a frequency that the rate of advancing the clock is the same as if a one were added in bit position 51 every microsecond. The resolution of the TOD clock is such that the incrementing rate is comparable to the instruction-execution rate of the model.

The stepping value of TOD-clock bit position 63, if implemented, is 2^{-12} microseconds, or approximately 244 picoseconds. This value is called a clock unit.

Figure 4-12 illustrates the format of the TOD clock and TOD-programmable field, and their relationship to the operands of the instructions that inspect or set them. Additionally, the PTF instruction may manipulate the TOD clock and epoch index, by means of fields in the instruction's parameter block that have the same resolution as the TOD clock (see "PER-

FORM TIMING FACILITY FUNCTION” on page 10-83).

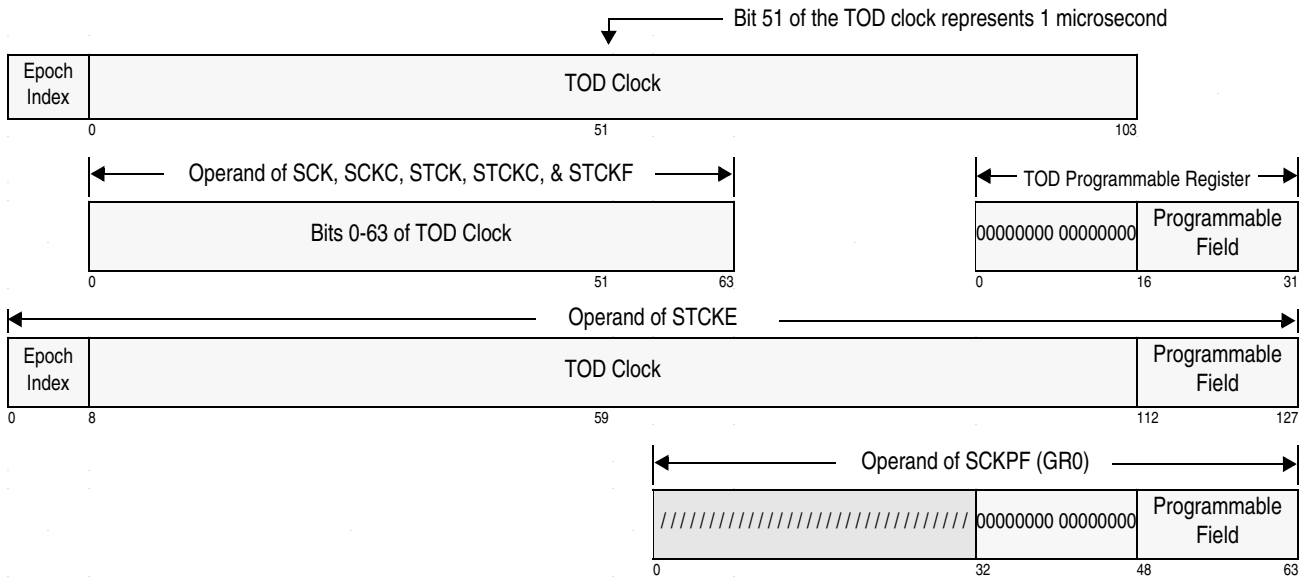

Figure 4-12. Format of the TOD Clock, Epoch Index, and TOD-Programmable Field as Set and Inspected by Various Instructions

When incrementing of the TOD clock causes a carry to be propagated out of bit position 0, the program is not alerted, and no interruption condition is generated as a result of the overflow. The handling of such a carry out of bit position 0 is as follows:

- The value of the TOD clock wraps around to zero.
- When the multiple-epoch facility is not installed in the configuration, it is unpredictable whether (a) the carry is ignored, and counting continues from zero, or (b) the carry causes the epoch index to be incremented by 1. Additionally, in case (b), above, the epoch index may revert to a value of zeros in future observations.
- When the multiple-epoch facility is installed in the configuration, the carry causes the epoch index to be incremented by 1. Any carry propagated out of the leftmost bit position of the epoch index is ignored.

The operation of the clock is not affected by any normal activity or event in the system. Incrementing of the clock does not depend on whether the wait-state bit of the PSW is one or whether the CPU is in the operating, load, stopped, or check-stop state. Its operation is not affected by CPU, initial-CPU, or clear resets or by initial program loading. Operation of the

clock is also not affected by the setting of the rate control or by an initial-machine-loading operation. Depending on the model and the configuration, the TOD clock may or may not be powered independent of the CPU.

States

The following states are distinguished for the TOD clock: set, not set, stopped, error, and not operational. The state determines the condition code set by execution of STORE CLOCK, STORE CLOCK EXTENDED, and STORE CLOCK FAST. The clock is incremented, and is said to be running, when it is in either the set state or the not-set state.

Not-Set State: When the power for the clock is turned on, the clock is set to zero, and the clock enters the not-set state. The clock is incremented when in the not-set state. When the TOD-clock-steering facility is installed, the TOD clock is never reported to be in the not-set state, as the TOD clock is placed in the set state as part of the initial-machine-loading (IML) process.

When the clock is in the not-set state, execution of STORE CLOCK, STORE CLOCK EXTENDED, or STORE CLOCK FAST causes condition code 1 to be set and the current value of the running clock to be stored.

Stopped State: The clock enters the stopped state when SET CLOCK is executed and the execution results in the clock being set. This occurs when SET CLOCK is executed without encountering any exceptions and either any manual TOD-clock control in the configuration is set to the enable-set position or the TOD-clock-control-override control, bit 42 of control register 14, is one. The clock can be placed in the stopped state from the set, not-set, and error states. The clock is not incremented while in the stopped state.

When the clock is in the stopped state, execution of STORE CLOCK, STORE CLOCK EXTENDED, or STORE CLOCK FAST causes condition code 3 to be set and the value of the stopped clock to be stored.

Set State: The clock enters the set state only from the stopped state. The change of state is under control of the TOD-clock-sync-control bit, bit 34 of control register 0, of the CPU which most recently caused the clock to enter the stopped state. If the bit is zero, the clock enters the set state at the completion of execution of SET CLOCK. If the bit is one, the clock remains in the stopped state until the bit is set to zero on that CPU or until another CPU executes a SET CLOCK instruction affecting the clock. If an external time reference (ETR) is installed, a signal from the ETR may be used to set the set state from the stopped state. When the system is not in the interpretive-execution mode, and an external time reference (ETR) is not attached to the configuration, the TOD-clock-sync control is treated as being zero, regardless of its actual value; in this case, the clock enters the set state and resumes incrementing upon completion of the instruction.

Programming Note: The STP facility does not provide a signal that will cause the clock to transition from the stopped state to the set state. If SET CLOCK is executed when the configuration is in STP-timing mode and bit 34 of control register 0 is one, the clock remains in the stopped state until the bit is set to zero on that CPU or until another CPU executes a SET CLOCK instruction affecting the clock.

Incrementing of the clock begins with the first stepping pulse after the clock enters the set state.

In the absence of an ETR, depending on the model, the clock may enter the set state from the stopped state without any programming action.

When the clock is in the set state, execution of STORE CLOCK, STORE CLOCK EXTENDED, or STORE CLOCK FAST causes condition code 0 to be set and the current value of the running clock to be stored.

Error State: The clock enters the error state when a malfunction is detected that is likely to have affected the validity of the clock value. It depends on the model whether the clock can be placed in this state. A timing-facility-damage machine-check-interruption condition is generated on each CPU in the configuration whenever the clock enters the error state. When the TOD-clock-steering facility is installed, the TOD clock is never reported to be in the error state. Errors in the TOD clock cause a system check stop.

When STORE CLOCK, STORE CLOCK EXTENDED, or STORE CLOCK FAST is executed and the clock is in the error state, condition code 2 is set, and the value stored is zero.

Not-Operational State: The clock is in the not-operational state when its power is off or when it is disabled for maintenance. It depends on the model whether the clock can be placed in this state. Whenever the clock enters the not-operational state, a timing-facility-damage machine-check-interruption condition is generated on each CPU in the configuration. When the TOD-clock-steering facility is installed, the TOD clock is never reported to be in the not-operational state.

When the clock is in the not-operational state, execution of STORE CLOCK, STORE CLOCK EXTENDED, or STORE CLOCK FAST causes condition code 3 to be set, and zero is stored.

Programming Note: When the TOD-clock-steering facility is installed, the TOD clock has only two states, the set state and the stopped state. Assuming proper operation by the operating system, problem programs are never dispatched while the TOD clock is in the stopped state. Thus, as observed by the problem program, the TOD clock is always in the set state and there is no need to test the condition code after issuing STORE CLOCK, STORE CLOCK EXTENDED, or STORE CLOCK FAST.

Changes in Clock State

When the TOD-clock-steering facility is not installed, and the TOD clock changes value because of the

execution of SET CLOCK or changes state, interruption conditions pending for the clock comparator and CPU timer may or may not be recognized for up to 1.048576 seconds (2^{20} microseconds) after the change.

When the TOD-clock-steering facility is installed and SET CLOCK is issued, interruption conditions for the clock comparator and CPU timer may or may not be recognized while the physical clock is in the stopped state. After the physical clock enters the set state, interruption conditions for the clock comparator are not necessarily recognized until one of the following instructions is issued: SET CLOCK COMPARATOR (SCKC), STORE CLOCK (STCK), or STORE CLOCK EXTENDED (STCKE). After the physical clock enters the set state, interruption conditions for the CPU timer are not necessarily recognized until SET CPU TIMER (SPT) is issued. If a CPU is in the wait state when the physical clock is set or changes state, the CPU does not necessarily recognize interruption conditions for the clock comparator or CPU timer until after it leaves the wait state and the appropriate aforementioned instruction is executed.

When the TOD-clock-steering facility is installed and the logical TOD clock is changed by PTF-ATO, PTF-STO, or PTF-STOE, interruption conditions for the clock comparator are not necessarily recognized until one of the following instructions is issued: SET CLOCK COMPARATOR (SCKC), STORE CLOCK (STCK), or STORE CLOCK EXTENDED (STCKE). If a CPU is in the wait state when the logical TOD clock is changed, the CPU may or may not recognize interruption conditions for the clock comparator until after it leaves the wait state and one of the aforementioned instructions is executed. The CPU timer and CPU-timer interruptions are not affected by PTF-ATO, PTF-STO and PTF-STOE.

The results of channel-subsystem-monitoring-facility operations may be unpredictable as a result of changes to the TOD clock.

Setting and Inspecting the Clock

When neither the TOD-clock-steering facility nor the multiple-epoch facility is installed, the clock can be set to a specified value by execution of SET CLOCK if the manual TOD-clock control of any CPU in the configuration is in the enable-set position or the TOD-clock-control-override control, bit 42 of control register 14, is one. SET CLOCK sets bits of the clock with the contents of corresponding bit positions of a dou-

bleword operand in storage. When either the TOD-clock-steering facility or the multiple-epoch facility is installed, the use of the SET CLOCK instruction is discouraged; rather, the PERFORM TIMING FACILITY FUNCTION instruction should be used to set the clock (see “TOD-Clock Steering” on page 4-55 for additional details).

Setting the clock replaces the values in all bit positions from bit position 0 through the rightmost position that is incremented when the clock is running. However, on some models, the rightmost bits starting at or to the right of bit 52 of the specified value are ignored, and zeros are placed in the corresponding positions of the clock. Zeros are also placed in positions to the right of bit position 63 of the clock.

The TOD clock can be inspected by executing STORE CLOCK or STORE CLOCK FAST, which causes bits 0-63 of the clock to be stored in an eight-byte operand in storage, or by executing STORE CLOCK EXTENDED, which causes bits 0-103 of the clock to be stored in bytes 1-13 of a 16-byte operand in storage. STORE CLOCK EXTENDED also stores the concurrently-obtained epoch index in byte 0 of its storage operand, and it obtains the TOD programmable field from bit positions 16-31 of the TOD programmable register and stores it in byte positions 14 and 15 of the storage operand. Figure 4-12 on page 4-48 shows the format of the operands stored by STORE CLOCK, STORE CLOCK EXTENDED, and STORE CLOCK FAST.

The following discussion of the results of STORE CLOCK, STORE CLOCK EXTENDED, and STORE CLOCK FAST assumes that the TOD clock is running and in the set state; TOD-clock values or portions thereof are considered to be unsigned binary integers.

- The values stored by any of the following sequence of instructions always correctly imply the sequence of execution of these instructions by one or more CPUs for all cases where the sequence can be discovered by the program:
 - Two executions of STORE CLOCK (assuming no wrap around of the TOD clock occurs between executions)
 - Two executions of STORE CLOCK EXTENDED (assuming no wrap around of the TOD clock occurs between executions when the multiple-epoch facility is not

installed in the configuration, and assuming no wrap around of the epoch index occurs when the multiple-epoch facility is installed in the configuration)

- An execution of STORE CLOCK followed by an execution of STORE CLOCK EXTENDED (assuming no wrap around of the TOD clock occurs between executions)
- An execution of STORE CLOCK EXTENDED followed by an execution of STORE CLOCK (assuming no wrap around of the TOD clock occurs between executions)

To ensure that unique values are obtained, non-zero values may be stored in positions to the right of the rightmost incremented bit position. When stored by STORE CLOCK EXTENDED, the value in bit positions 64-103 of the clock (bit positions 72-111 of the storage operand) is always nonzero; this ensures that values stored by STORE CLOCK EXTENDED are always unique when compared with values stored by STORE CLOCK, extended on the right with zeros.

For the purpose of establishing uniqueness and sequence of occurrence of the results of STORE CLOCK and STORE CLOCK EXTENDED, the 64-bit value provided by STORE CLOCK may be considered to be extended to a full 104-bit TOD value by appending 40 zeros on the right. As neither STORE CLOCK nor STORE CLOCK FAST store an epoch index, meaningful comparison between the results of these instruction with those of STORE CLOCK EXTENDED is possible only when the instructions are executed in the same epoch.

- Regardless of which instruction is executed first, STORE CLOCK and STORE CLOCK FAST executed on either the same or different CPUs do not necessarily return different values of the clock. The result of the second execution may be less than, equal to, or greater than that of the first execution.
- Two executions of STORE CLOCK FAST do not necessarily return different values of the clock. When executed on the same CPU, and in the absence of a carry out of bit position 0 of the TOD clock, the result of the second execution may be equal to or greater than that of the first execution. When executed on different CPUs in

the same configuration, the result of the second execution may be less than, equal to, or greater than that of the first execution.

- Regardless of which instruction is executed first, STORE CLOCK EXTENDED and STORE CLOCK FAST executed on either the same or different CPUs do not necessarily return different values for the common TOD-clock bit positions stored by the instructions (that is, the entire 64-bit result of STORE CLOCK FAST as compared with bit positions 8-71 of the result of STORE CLOCK EXTENDED). When executed on the same CPU, and in the absence of a carry out of bit position 0 of the TOD clock, the result of the second execution may be either equal to or greater than that of the first execution. When executed on different CPUs in the same configuration, the result of the second execution may be less than, equal to, or greater than that of the first execution.

Figure 4-13 summarizes the interdependencies of the results of STCK, STCKE, and STCKF described above, assuming no wrap-around of the TOD clock occurs between executions.

First Execution by:	Result of Second Execution by:		
	STCK	STCKE	STCKF
STCK	A: > ³	A: > ^{1,3}	A: <=>
STCKE	A: > ^{1,3}	A: >	S: => ^{2,3} D: <=> ²
STCKF	A: <=>	S: => ^{2,3} D: <=> ²	S: => ³ D: <=>
Explanation:			
¹	STCK results extended on the right with 40 binary zeros.		
²	STCKF results compared with bits 8-71 of STCKE results.		
<=>	Result of the second execution may be less than, equal to, or greater than that of the first execution.		
>	Result the second execution is greater than that of the first execution.		
=>	Result of the second execution is equal to or greater than that of the first execution.		
A:	First and second execution are on any CPU.		
D:	First and second execution on different CPUs.		
S:	First and second execution on the same CPU.		

Figure 4-13. Interdependencies of the Results of STCK, STCKE, and STCKF

In a configuration where more than one CPU accesses the clock, SET CLOCK is interlocked such that the entire contents appear to be updated concurrently; that is, if SET CLOCK instructions are executed simultaneously by two CPUs, the final result is

normally not valid as indications of the time of day. However, they permit elapsed-time measurements of high resolution.

7. The following chart shows the time interval between instants at which various bit positions of the TOD clock are stepped. This time value may also be considered as the weighted time value that the bit, when one, represents.

TOD-Clock Bit	Stepping Interval			
	Days	Hours	Min.	Seconds
51				0.000 001
47				0.000 016
43				0.000 256
39				0.004 096
35				0.065 536
31				1.048 576
27				16.777 216
23			4	28.435 456
19		1	11	34.967 296
15		19	5	19.476 736
11	12	17	25	11.627 776
7	203	14	43	6.044 416
3	3257	19	29	36.710 656

8. The following chart shows the TOD clock setting for 00:00:00 (0 am), UTC time, for several dates: January 1, 1900, January 1, 1972, and for that instant in time just after each of the 27 leap seconds that will have occurred through January, 2017. Each of these leap seconds is inserted in the UTC time scale beginning at 23:59:60 UTC of the day previous to the one listed and ending at 00:00:00 UTC of the day listed.

Year	Month	Day	Leap Sec.	Clock Setting (Hex)
1900	1	1		0000 0000 0000 0000
1972	1	1		8126 D60E 4600 0000
1972	7	1	1	820B A981 1E24 0000
1973	1	1	2	82F3 00AE E248 0000
1974	1	1	3	84BD E971 146C 0000
1975	1	1	4	8688 D233 4690 0000
1976	1	1	5	8853 BAF5 78B4 0000
1977	1	1	6	8A1F E595 20D8 0000
1978	1	1	7	8BEA CE57 52FC 0000
1979	1	1	8	8DB5 B719 8520 0000
1980	1	1	9	8F80 9FDB B744 0000

Year	Month	Day	Leap Sec.	Clock Setting (Hex)
1981	7	1	10	9230 5C0F CD68 0000
1982	7	1	11	93FB 44D1 FF8C 0000
1983	7	1	12	95C6 2D94 31B0 0000
1985	7	1	13	995D 40F5 17D4 0000
1988	1	1	14	9DDA 69A5 57F8 0000
1990	1	1	15	A171 7D06 3E1C 0000
1991	1	1	16	A33C 65C8 7040 0000
1992	7	1	17	A5EC 21FC 8664 0000
1993	7	1	18	A7B7 0ABE B888 0000
1994	7	1	19	A981 F380 EAAC 0000
1996	1	1	20	AC34 336F ECD0 0000
1997	7	1	21	AEE3 EFA4 02F4 0000
1999	1	1	22	B196 2F93 0518 0000
2006	1	1	23	BE25 1097 973C 0000
2009	1	1	24	C387 0CB9 BB60 0000
2012	7	1	25	C9CC 9A70 4D84 0000
2015	7	1	26	CF2D 54B4 FBA8 0000
2017	1	1	27	D1E0 D681 73CC 0000

9. The following chart shows various time intervals in clock units expressed in hexadecimal notation.

Interval	Clock Units (Hex)
1 microsecond	1000
1 millisecond	3E 8000
1 second	F424 0000
1 minute	39 3870 0000
1 hour	D69 3A40 0000
1 day	1 41DD 7600 0000
365 days	1CA E8C1 3E00 0000
366 days	1CC 2A9E B400 0000
1,461 days*	72C E4E2 6E00 0000

Explanation:

* Number of days in four years, including a leap year. Note that the year 1900 was not a leap year. Thus, the four-year span starting in 1900 has only 1,460 days.

10. The charts in notes 7-9 are useful when examining the value stored by STORE CLOCK. Similar charts for use when examining the value stored by STORE CLOCK EXTENDED are in programming notes at the end of the definition of that instruction.

11. In a multiprocessing configuration, after the TOD clock is set and begins running, the program should delay activity for 2^{20} microseconds (1.048576 seconds) to ensure that the CPU-timer and clock-comparator interruption conditions are recognized by the CPU.

12. Due to the sequencing rules for the results of STORE CLOCK and STORE CLOCK EXTENDED, the execution of STORE CLOCK may be considerably slower than that of STORE CLOCK EXTENDED and STORE CLOCK FAST. Depending on the model, the relative slowness of STORE CLOCK (as compared with STORE CLOCK EXTENDED and STORE CLOCK FAST) is particularly noticeable when multiple STORE CLOCK instructions are executed within a short period of time.
13. Uniqueness of TOD-clock values can be extended to apply to processors in separate configurations by including a configuration identification in the TOD programmable field.
14. Using the standard epoch, programs that issue STORE CLOCK or STORE CLOCK FAST will observe the TOD clock wrap around to zero on September 17, 2042, at 23:53:57.370496 TAI. If the program cannot tolerate such a wrap around, it should be adapted to use STORE CLOCK EXTENDED on a processor supporting the multiple-epoch facility.
15. The results of STORE CLOCK FAST are intended to be approximately equivalent to either (a) the results of STORE CLOCK or (b) bits 8-71 of the results of STORE CLOCK EXTENDED. However, when compared with the results of STORE CLOCK or STORE CLOCK EXTENDED, the values returned by STORE CLOCK FAST do not necessarily indicate the correct sequence of execution of the instruction by one or more CPUs. STORE CLOCK FAST should not be used in programs where a monotonically increasing result is required.

TOD-Clock Synchronization

The following functions are provided if the configuration is part of an ETR network:

- A clock in the stopped state, with the TOD-clock-sync-control bit (bit 34 of control register 0) set to one, is placed in the set state and starts incrementing when an ETR signal occurs.
- The stepping rates for the TOD clock and the ETR are synchronized.
- Bits 32 through the rightmost incremented bit of a clock in the set state are compared with the same bits of the ETR. An unequal condition is

signaled by an external-damage machine-check-interruption condition. The machine-check-interruption condition may not be recognized for up to 1.048576 seconds (2^{20} microseconds) after the unequal condition occurs.

When the server timer protocol (STP) facility is installed, the timing mode, timing state and STP-clock-source state are defined as described below.

Timing Mode

The timing mode specifies the method by which the TOD clock is maintained for purposes of synchronization within a timing network. A TOD clock operates in one of the following timing modes:

Local Timing Mode: When the configuration is in local timing mode, the TOD clock has been initialized to a local time and is being stepped at the rate of the local hardware oscillator. The configuration is not part of a synchronized timing network.

ETR Timing Mode: When the configuration is in ETR-timing mode, the TOD clock has been initialized to the ETR and is being stepped by stepping signals from ETR. To be in ETR-timing mode, the configuration must be part of an ETR network.

If the machine implements hardware-based TOD-clock steering, the ETR timing mode is not available

STP Timing Mode: When the configuration is in STP-timing mode, the TOD clock has been initialized to coordinated server time (CST) and is being stepped at the rate of the local hardware oscillator. In STP timing mode, the TOD clock is steered so as to maintain, or attain, synchronization with CST. To be in STP-timing mode, the configuration must be part of an STP network.

Timing State

The timing state indicates the synchronization state of the TOD clock with respect to the timing network reference time.

Synchronized State: When a configuration is in the synchronized timing state, the TOD clock is in synchronization with the timing-network reference time as defined below:

- If the configuration is in ETR-timing mode, the configuration is synchronized with the ETR.

- If the configuration is in STP timing mode, the configuration is synchronized with coordinated server time (CST).

A configuration that is in the local-timing or uninitialized-timing mode is never in the synchronized state.

Unsyncronized State: When a configuration is in the unsyncronized timing state, the TOD clock is not in synchronization with the timing network reference time as defined below:

- If the configuration is in ETR-timing mode, the configuration has lost synchronization with the ETR.
- If the configuration is in STP timing mode, the configuration has lost or has not been able to attain synchronization with coordinated server time (CST). The configuration is out of synchronization with CST when the TOD clock differs from CST by an amount that exceeds a model dependent STP-sync-check-threshold value.

Stopped State: When a configuration is in the stopped timing state, either the TOD clock is in the stopped state, or TOD-clock recovery is in progress. After TOD-clock recovery completes, the TOD clock enters either the synchronized or unsynchronized state.

STP Clock Source State

The STP-clock-source state indicates whether a usable STP-clock source is available. The STP-clock source is used to determine the coordinated server time (CST) required to be able to synchronize the TOD clock.

Not Usable: The not-usable-STP-clock-source state indicates that a usable STP-clock source is not available to the STP facility. When a usable STP-clock source is not available, CST can not be determined.

Usable: The usable-STP-clock-source state indicates that a usable STP-clock source is available to the STP facility. When a usable STP-clock source is available, CST has been determined and can be used to synchronize the TOD clock to the STP network.

Programming Notes:

1. ETR TOD-clock synchronization provides for synchronizing and checking only bits 32 through the rightmost incremented bit of the TOD clock. Bits 0-31 of the TOD clock may be different from those of the ETR.
2. If the configuration is part of an ETR network, SET CLOCK must place all zeros in bit positions 32 through the rightmost incremented bit position of the TOD clock; otherwise, an external-damage machine-check-interruption condition will be recognized.

TOD-Clock Steering

TOD clock steering provides the means by which the TOD clock can be steered to maintain synchronization to a selected clock source. TOD clock steering is performed using one of the following steering mechanisms:

Offset-Based TOD-Clock Steering: The apparent stepping rate of the TOD clock is changed without changing the physical hardware oscillator which steps the physical clock. This is accomplished by means of a TOD offset register which is added to the physical clock to produce the TOD clock.

Hardware-Based TOD-Clock Steering: The stepping rate of the physical hardware oscillator is directly modifiable and provides the TOD clock frequency. A physical clock is made available via PTFE that is derived from the TOD clock in a manner that provides the appearance of a fixed-frequency physical clock. This is accomplished by means of a TOD-clock offset that is subtracted from the TOD clock to produce the physical clock.

When the STP-hardware-based-TOD-clock-steering facility is not installed, TOD-clock steering is performed using offset-based TOD-clock steering. When the STP-hardware-based-TOD-clock-steering facility is installed, steering is performed using hardware-based TOD-clock steering.

The steering method used is transparent to all programs.

TOD-clock steering includes the semiprivileged instruction PERFORM TIMING FACILITY FUNCTION (PTFF), which is in the "E" format, provides a

7-bit function code in general register 0 and a parameter block address in general register 1.

The presence of the TOD-clock steering facility is indicated by bit 28 of the facility list, as stored by the STORE FACILITY LIST or STORE FACILITY LIST EXTENDED instructions. Facility-indication bit 28, when one indicates that the TOD-clock steering facility is installed. The instruction PERFORM TIMING FACILITY FUNCTION (PTFF) is installed only in the z/Architecture architectural mode. However, when the TOD-clock steering facility is installed, it is not disabled when the configuration switches architectural modes.

The total steering rate is made up of two components, a fine-steering rate and a gross-steering rate.

The fine-steering rate is used to correct that inaccuracy in the local oscillator which is stable over a relatively long period of time. The value will normally be less than the specified tolerance of the local oscillator (typically ± 2.0 ppm), changes will occur infrequently (on the order of once per day to once per week), and changes will be small (typically less than ± 0.2 ppm).

The gross-steering rate is used as a dynamic correction for all other effects, the most predominate being to synchronize time with an external time source and with other clocks in the timing network. The value will normally change frequently (on the order of once per second to once per minute); and the value may range to more than ± 40 ppm.

TOD-clock steering includes the PTFF set-TOD-offset and set-TOD-offset-user control functions which allow a program to apply a 64-bit TOD epoch difference to the TOD clock. The multiple-epoch facility includes the PTFF set-TOD-offset-extended and set-TOD-offset-user-extended functions which allow a program to apply a 72-bit TOD epoch difference to the concatenation of the epoch index and TOD clock.

When the configuration is in STP timing mode, and the timing-control program detects an excessive offset between the system TOD and some reference clock, a new episode may be started with a step change to the TOD offset (see "Episodes" on page 4-57). This is however not visible to programs, as the epoch difference is adjusted in a complementary way. The epoch difference therefore consists of two components: a sync-check offset, and a user-specified epoch difference. A control program may request sync check notification, and subsequently

request that its uncorrected sync check offset be corrected, resulting in a program-visible step in the TOD in a controlled manner.

TOD-clock steering also includes several query functions which may be used by the problem-state program to determine the quality of the TOD clock.

Offset-Based TOD-Clock Steering Overview

When the STP-hardware-based-TOD-clock-steering facility is not installed, offset-based TOD-clock steering is performed by computing a TOD-clock offset that is added to the physical clock to form the system TOD clock. Offset-based TOD-clock steering is accomplished by means of three values that are used to compute the TOD-clock offset: a start time (s), a base offset (b), and a steering rate (r).

The steering rate is a 32-bit signed binary fixed-point value and considered to be scaled by a factor of 2^{44} .

When the multiple-epoch facility is not installed, the start time is a 64-bit unsigned binary integer with a resolution equal to bit 63 of the TOD clock that is set to the physical clock start time for the current steering episode (see "Episodes" on page 4-57). When the multiple-epoch facility is installed, the start time may be extended on the left with up to eight additional bits.

When the multiple-epoch facility is not installed, the base offset is a 64-bit signed binary integer with a resolution equal to bit 63 of the TOD clock. When the multiple-epoch facility is installed, the base offset may be extended on the left with up to eight additional bits.

Hardware-Based TOD-Clock-Steering Overview

When the STP-hardware-based-TOD-clock-steering facility is installed, hardware-based steering of the TOD clock is accomplished by changing the stepping rate of the hardware oscillator. At the start of each steering episode, the hardware steering rate is set to a steering rate that reflects the current total steering rate for the configuration. At an episode start time, the TOD-clock base offset is updated to include the accumulated hardware steering for the previous (old) episode. The TOD-clock base offset is used to compute a current TOD-clock offset that is used to determine the physical clock at any given time. The conceptual steering parameters are the same as for

offset-based TOD-clock steering: a start time (s), a base offset (b), and a steering rate (r) (see “Episodes” on page 4-57).

When hardware-based TOD-clock steering is installed, ETR steering does not apply.

TOD-Offset-Update Events

When the STP-hardware-based-TOD-clock-steering facility is not installed, the TOD offset is updated periodically rather than being computed continuously. This update is referred to as a TOD-offset-update event. A TOD-offset-update event is triggered by the carry out of a bit position of the physical clock. The bit position depends on the model, but is chosen such that for normal steering rates, the difference between the values computed for the TOD offset (d) by consecutive TOD-offset-update events is less than the resolution of the TOD clock.

When the STP-hardware-based-TOD-clock-steering facility is installed, the steering rate can be viewed as being applied continuously. The TOD offset is calculated immediately, whenever it is needed; thus, there is no TOD-offset-update event.

Episodes

The three values, start time (s), base offset (b), and steering rate (r), define a linear steering adjustment which can be applied indefinitely. The duration that these values are applied without being changed is called an episode.

When the STP-hardware-based-TOD-clock-steering facility is not installed, a request by the timing-facility-control program to change the steering rate causes the machine to schedule a new episode to take effect at a future time. To provide a smooth transition, the machine schedules the start time for the new episode to be at the next TOD-offset-update event and computes a new base offset such that there will be no discontinuity in the value of the TOD offset at the instant the new values take effect.

When the STP-hardware-based-TOD-clock-steering facility is installed, a request by timing-facility-control program to change the steering rate causes a new episode to begin immediately. A new base offset is computed such that there is no discontinuity in the value of the TOD offset at the instant the new values take effect.

The machine places the new values into special registers called new-episode start time (new.s), new-episode base offset (new.b), new-episode fine-steering rate (new.f); and new-episode gross-steering rate (new.g); and the previous contents of these four registers are preserved by placing them into registers called old-episode start time (old.s), old-episode base offset (old.b), old-episode fine-steering rate (old.f), and old-episode gross-steering rate (old.g), respectively. The machine continues to use the values for the old episode until the new-episode start time (new.s) and then automatically switches to use the values for the new episode. The registers in use at any particular instant in time are called current start time (s), current base offset (b), and current total steering rate (r). These are collectively referred to as the current-episode registers. Additionally, when the STP-hardware-based-TOD-clock-steering facility is installed, the hardware steering rate (hr) is set to a value that corresponds to the current steering rate in a model-dependent manner.

TOD-Clock-Steering Registers

Figure 4-14 summarizes the TOD-clock-steering registers. The contents of all TOD-clock-steering registers are initialized to zero by power-on reset, except for the user-specified-clock offset, whose initial value may be part of configuration information.

Current Start Time (s): When the machine is operating in the old episode, the current start time is obtained from the old-episode start time (old.s); and when in the new episode, it is obtained from the new-episode start time (new.s). When the multiple-epoch facility is not installed, the current start time (s) is a 64-bit unsigned binary integer that has a resolution equal to bit 63 of the TOD clock. When the multiple-epoch facility is installed, the current start time is a 72-bit unsigned binary integer that has a resolution equal to bit 63 of the TOD clock; however, depending on the model, not all of the leftmost 8 bits may be implemented.

Current Base Offset (b): When the machine is operating in the old episode, the current base offset is obtained from the old-episode base offset (old.b); and when in the new episode, it is obtained from the new-episode base offset (new.b). When the multiple-epoch facility is not installed, the current base offset (b) is a 64-bit signed binary integer that has a resolution equal to bit 63 of the TOD clock. When the multiple-epoch facility is installed, the current base offset

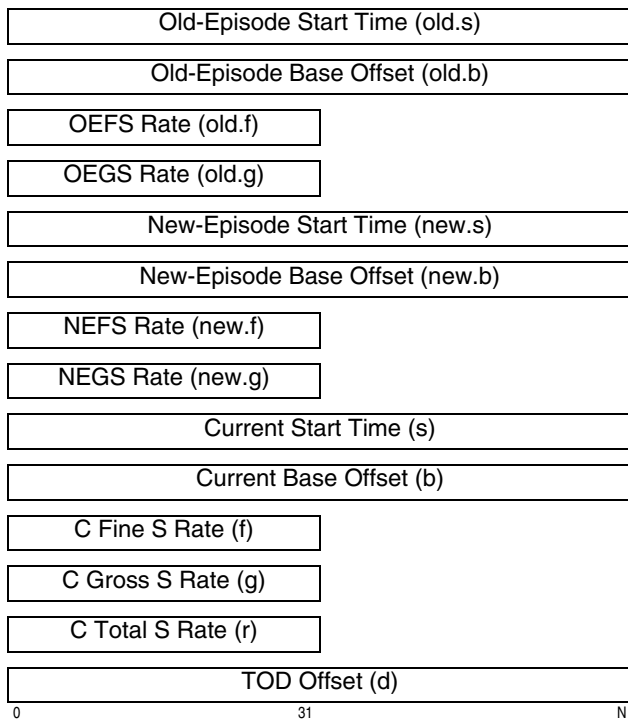

Explanation:

N When the multiple-epoch facility is not installed, N is 63; thus the wider fields shown above are 64 bits. When the multiple-epoch facility is installed, N may be up to 71; thus the wider fields may be up to 72 bits. In either case, the field is right justified, with the rightmost bit having the resolution of a clock unit.

Figure 4-14. TOD-Clock-Steering Registers

is a 72-bit signed binary integer that has a resolution equal to bit 63 of the TOD clock; however, depending on the model, not all of the leftmost 8 bits may be implemented.

Current Steering Rates (f,g,r): When the machine is operating in the old episode, the current fine-steering rate (f) and current gross-steering rate (g) are obtained from the old-episode fine-steering rate (old.f) and gross-steering rate (old.g), respectively; when in the new episode, they are obtained from the new-episode fine-steering rate (new.f) and gross-steering rate (new.g), respectively.

The current total steering rate (r) is obtained from the sum of the current fine-steering rate (f) and the current gross-steering rate (g). A carry, if any, out of bit position 0, is ignored in this addition. The current

total steering rate (r) is a 32-bit signed binary fixed-point value and considered to be scaled by a factor of 2^{-44} .

Programming Note: Bits 0 and 31 of the steering-rate represent steering rates of -2^{-13} and 2^{-44} , respectively. Thus, steering rates of ± 122 parts per million (10.5 seconds per day) may be specified with a precision of 4.9 nanoseconds per day.

TOD Offset (d): When the multiple-epoch facility is not installed, the TOD offset (d) is a 64-bit signed binary integer with a resolution equal to bit 63 of the TOD clock. . When the multiple-epoch facility is installed, the TOD offset is a 72-bit signed binary integer with a resolution equal to bit 63 of the TOD clock.

When the STP-hardware-based-TOD-clock-steering facility is not installed, the contents of the TOD offset are added to the physical clock to obtain the system TOD clock. When the STP-hardware-based-TOD-clock-steering facility is installed, the contents of the TOD offset are subtracted from the system TOD clock to obtain the physical clock.

Depending on the model, rightmost bits of the TOD offset corresponding to bits beyond the resolution of the TOD clock may not be implemented and are treated as zeros.

UTC Information Block (UIB)

The UIB includes information to convert from a TOD clock timestamp to primary reference time (PRT) and then to convert PRT to UTC. The UIB can be inspected by executing PERFORM TIMING FACILITY FUNCTION specifying the PTFQ-FACILITY (Query UTC Information) function. Conversion from TOD to PRT uses the TOD-to-PRT parameters and conversion from PRT to UTC uses the leap-second information.

The information in the UIB is provided by the server-time-protocol (STP) facility that also controls TOD-clock steering. When STP is not installed, all fields in the UIB are zero. STP manages a coordinated timing network (CTN) that provides the illusion of a single global TOD clock – known as coordinated server time (CST) – shared by several machines.

The format of the UIB is shown in Figure 4-15.

Dec	Hex			
0	00	TM	TS	Reserved
4	04	Reserved		
8	08	Leap Second Event Time		
12	0C			
16	10	Old Leap Seconds	New Leap Seconds	
20	14	Reserved		
24	18	PRT Timestamp		
28	1C			
32	20	PRT Dispersion		
36	24			
40	28	PRT Offset		
44	2C			
48	30	PRT Correction Steering Start Time		
52	34			
56	38	PRT Correction Time		
60	3C			
64	40	CST Reference Time		
68	44			
72	48	CST-TOD Dispersion		
76	4C			
80	50	CST Offset		
84	54			
88	58	Maximum Unknown Skew Rate		
92	5C			
:	:	Reserved		
252	FC			
		0	4	8
				16
				31

Figure 4-15. UTC Information Block

Timing Mode (TM): Bits 0-3 of byte 0 of the UIB contain a 4-bit code indicating the timing mode of the system. The codes are defined as follows:

Code	Meaning
0	Local Timing Mode
1	ETR Timing Mode
2	STP Timing Mode
3-15	Reserved

Timing State: Bits 4-7 of byte 0 of the UIB contain a 4-bit code indicating the timing state of the system. The codes are defined as follows:

Code	Meaning
0	Unsynchronized
1	Synchronized
2-15	Reserved

Leap Second Information: Three fields in the UIB provide information for converting from primary reference time to UTC. These are the leap-second-event-time, old-leap-seconds, and new-leap-seconds fields. For a primary reference time less than the leap-second-event time, the old-leap-seconds value applies; for a primary reference time equal to or greater than the leap-second-event time, the new-leap-seconds value applies. The applicable leap-second value is subtracted from the primary reference time (PRT) to form UTC.

Leap Second Event Time: Bytes 8-15 of the UIB, when valid, contain a 64-bit time in TOD-clock timestamp format that specifies the primary reference time at which the new-leap seconds is to take effect.

Old Leap Seconds: Bytes 16-17 of the UIB contain a 16-bit signed binary integer indicating the number of leap seconds in effect prior to the leap-second-event time. Thus, when the leap-second-event time is non-zero, the old-leap-seconds value is in effect for a primary reference time less than the leap-second-event time. When the leap-second-event time is zero, no change has been scheduled, and the old-leap-seconds and new-leap-seconds fields contain the same value. The value is provided in seconds with the low-order bit equaling one second.

New Leap Seconds: Bytes 18-19 of the UIB contain a 16-bit signed binary integer indicating the number of leap seconds in effect for a primary reference time equal to or greater than the leap-second-event time. The value is provided in seconds with the low-order bit equaling one second.

PRT Timestamp: Bytes 24-31 of the UIB, when valid, contain a 64-bit timestamp that specifies the time at which the primary-reference-time (PRT) parameters (PRT dispersion, PRT offset, PRT-correction-steering-start time, and PRT-correction time) were last updated within the CTN. This field has the same format as bits 0-63 of the TOD clock. The PRT-

update-event-time field is valid only when it is non-zero.

PRT Dispersion: Bytes 32-39 of the UIB, when valid, contain a 64-bit unsigned binary integer indicating the total maximum possible dispersion of the PRT offset provided at the most recent PRT-update event. This field has the same format as bits 0-63 of the TOD clock. The PRT-dispersion field is valid only when the PRT-timestamp field is nonzero.

PRT Offset: Bytes 40-47 of the UIB, when valid, contain a 64-bit signed binary integer indicating the PRT offset provided for the most recent PRT information. This field has the same format as bits 0-63 of the TOD clock. The value is the amount to be added to the system TOD to match the estimated time at the primary-reference time source. The margin of error of this value is equal to the PRT dispersion.

PRT Correction Steering Start Time: Bytes 48-55 of the UIB, when valid, contain a 64-bit timestamp having the same format as bits 0-63 of the TOD clock and indicating the time at which PRT-correction steering is to be, or has been, initiated within the CTN. A value of zero indicates that no PRT correction was planned at the time when the UIB was last updated.

PRT Correction Time: Bytes 56-63 of the UIB, when valid, contain a 64-bit unsigned binary integer indicating the estimated amount of time required to correct the PRT offset which is the amount of time PRT-correction will be in effect. This field has the same format as bits 0-63 of the TOD clock. The field is valid when the PRT-correction-steering-start time is nonzero.

CST Reference Time: Bytes 64-71 of the UIB, when valid, contain a 64-bit value in TOD-clock timestamp format indicating the value of the system TOD clock at the most recent time that the CST parameters (CST-TOD dispersion and CST offset) were updated. The field is valid when it is nonzero.

CST-TOD Dispersion: Bytes 72-79 of the UIB, when valid, contain a 64-bit unsigned binary integer indicating the CST-TOD dispersion computed at the most recent CST parameter update. The value has a resolution equal to bit 63 of the TOD clock. The CST-TOD-dispersion field is valid when the CST-reference-time field is nonzero.

CST Offset: Bytes 80-87 of the UIB, when valid, contain a 64-bit signed binary value that indicates the offset of the system TOD clock to the TOD clock at the machine selected as the time source. The CST offset is added to the system-TOD clock to form the Coordinated Server Time (CST) at the machine. For the add operation, a carry out of bit 0 ignored. Bit 63 of the CST offset has a resolution equal to that of bit 63 of the TOD clock. The CST-offset field is valid when the CST-reference-time field is nonzero. For stratum-1 servers, the field is set to zero (by definition, CST is the system TOD at the stratum-1 server).

Maximum Unknown Skew Rate: Bytes 88-91 of the UIB, when valid, contain a 32-bit unsigned binary integer indicating the absolute value of the unknown skew rate of the physical clock. The value has a resolution of one part per 2^{44} . The maximum-skew-rate field is valid when it is nonzero.

Clock Comparator

The clock comparator provides a means of causing an interruption when the TOD-clock value exceeds a value specified by the program.

In a configuration with more than one CPU, each CPU has a separate clock comparator.

The clock comparator has the same format as bits 0-63 of the TOD clock. The clock comparator nominally consists of bits 0-47, which are compared with the corresponding bits of the TOD clock. In some models, higher resolution is obtained by providing more than 48 bits. The bits in positions provided in the clock comparator are compared with the corresponding bits of the clock. When the resolution of the clock is less than that of the clock comparator, the contents of the clock comparator are compared with the clock value as this value would be stored by executing STORE CLOCK or STORE CLOCK FAST.

The clock comparator causes an external interruption with the interruption code 1004 hex; presentation of the interruption is subject to the clock-comparator subclass mask, bit 52 of control register 0. When the TOD-clock-steering facility is not installed, a request for a clock-comparator interruption exists whenever either of the following conditions exists:

1. The TOD clock is running and the value of the clock comparator is less than the value in the compared portion of the clock, both values being

considered unsigned binary integers. Comparison follows the rules of unsigned binary arithmetic.

2. The TOD clock is in the error state or the not-operational state.

When the TOD-clock-steering facility is installed, a request for a clock-comparator interruption exists whenever the physical clock is in the set state and the value of the clock comparator is less than the value in the compared portion of the logical TOD clock.

When the clock-comparator sign control, bit 10 of control register 0, is zero, comparison follows the rules of unsigned binary arithmetic. When the multiple-epoch facility is not installed in the configuration and the clock-comparator sign control is one, it is unpredictable whether the comparison follows the rules of unsigned or signed binary arithmetic. When the multiple-epoch facility is installed in the configuration and the clock-comparator sign control is one, comparison follows the rules of signed binary arithmetic.

A request for a clock-comparator interruption does not remain pending when the value of the clock comparator is made equal to or greater than that of the logical TOD clock or when the value of the logical TOD clock is made less than the clock-comparator value. The latter may occur as a result of the physical clock or logical TOD clock being set; when the multiple-epoch facility is not installed or when the facility is installed but the clock-comparator sign control is zero, the latter may occur as a result of the logical TOD clock wrapping to zero; when the multiple-epoch facility is installed and the clock-comparator sign control is one, the latter may occur as a result of the logical TOD clock, considered as a signed value, transitioning to the maximum negative value.

The clock comparator can be inspected by executing the instruction `STORE CLOCK COMPARATOR` and can be set to a specified value by executing the `SET CLOCK COMPARATOR` instruction.

When the multiple-epoch facility is installed, a change to the clock-comparator sign control may immediately cause the conditions for requesting a clock-comparator interruption to exist or no longer exist (depending on the values of the TOD clock and clock comparator). However, such a change may not immediately cause a request for a clock comparator

to be made or withdrawn. See programming note 3 for additional information.

The contents of the clock comparator and clock-comparator sign control are initialized to zero by initial CPU reset.

Programming Notes:

1. An interruption request for the clock comparator persists as long as the clock-comparator value is less than that of the TOD clock or as long as the TOD clock is in the error state or the not-operational state. Therefore, one of the following actions must be taken after an external interruption for the clock comparator has occurred and before the CPU is again enabled for external interruptions:
 - The value of the clock comparator must be replaced.
 - The TOD clock must be set.
 - The clock-comparator-subclass mask must be set to zero.
 - The TOD clock must wrap to zero (applicable when the multiple-epoch facility is not installed, or when the facility is installed but the clock-comparator sign control is zero).

Otherwise, loops of external interruptions are formed.

2. The instruction `STORE CLOCK`, `STORE CLOCK EXTENDED`, or `STORE CLOCK FAST` may store a value which is greater than that in the clock comparator, even though the CPU is enabled for the clock-comparator interruption. This is because the TOD clock may be incremented one or more times between when instruction execution is begun and when the clock value is accessed. In this situation, the interruption occurs when the execution of `STORE CLOCK`, `STORE CLOCK EXTENDED`, or `STORE CLOCK FAST` is completed.
3. When the multiple-epoch facility is installed in the configuration, the clock-comparator sign control provides the means by which a control program can specify what constitutes a discontinuity in the TOD clock for the purposes of clock-comparator checking: either transitioning from the maximum unsigned TOD-clock value to zero, or transition-

ing from the maximum positive signed TOD-clock value to the maximum negative value.

Assuming that a configuration is re-initialized at least once during a half of an epoch, it is recommended that the clock-comparator sign control be set to the contents of bit position 0 of the TOD clock when the program is initialized. This ensures that clock-comparator checking observes no discontinuity in the TOD clock.

To ensure consistent results when altering the clock-comparator sign control, the program should (a) disable clock-comparator interruptions, (b) set the clock-comparator sign control, (c) issue the SET CLOCK COMPARATOR instruction to set a new comparator value, and then (d) enable for clock-comparator interruptions as appropriate.

Once set, the clock-comparator sign control is intended to remain unchanged until the next initial CPU reset (such as at IPL). Dynamic changing of the clock-comparator sign control without following the recommendations in this note may result in false recognition of a clock-comparator condition that is withdrawn as a result of the changed control or in the delayed recognition of

a clock-comparator condition that becomes pending as a result of the changed control.

4. When the clock-comparator sign control is zero, (a) the program can set the clock comparator to all zeros to ensure that an interruption condition is immediately present, and (b) the program can set the clock comparator to a value of all binary ones to ensure that a clock-comparator interruption is never recognized. When the multiple-epoch facility is installed in the configuration and the clock-comparator sign control is one, (a) the program can set the clock comparator to the maximum negative value (8000000000000000 hex) to ensure that an interruption condition is immediately present, and (b) the program can set the clock comparator value to the maximum positive value (7FFFFFFFFFFFFFFF hex) to ensure that a clock-comparator interruption is never recognized.
5. When the multiple-epoch facility is not installed in the configuration, bit 10 of control register 0 should always be set to zero to ensure consistent unsigned comparison of the clock comparator.
6. Figure 4-16 illustrates the effects of the clock-comparator sign control on the recognition of

clock-comparator interruption conditions, based on various clock-comparator and TOD-clock values.

Register Value	Clock-Comparator Sign Control (CR0.10)																					
	Zero (Unsigned)											One (Signed)										
	CLKC	TOD	CLKC	TOD	CLKC	TOD	CLKC	TOD	CLKC	TOD	CLKC	TOD	CLKC	TOD	CLKC	TOD	CLKC	TOD	CLKC	TOD	CLKC	TOD
00000000 00000000	✓																	✓				
00000000 00000001																						
⋮																						
456789AB CDEF0123			✓																	✓		
456789AB CDEF0124																						
⋮																						
7FFFFFFF FFFFFFFF					✓																	✓
80000000 00000000												✓										
⋮																						
CDEF1234 56789ABC								✓						✓								
CDEF1234 56789ABD																						
⋮																						
FFFFFFFF FFFFFFFF									✓						✓							

Explanation:
 Pairs of columns represent a clock-comparator (CLKC) value, and a range of time-of-day (TOD) clock values for which a clock-comparator interruption condition does or does not exist.
 For each pair of columns, the clock comparator is set to the value shown in the "Register Value" column corresponding to the row in which the check mark (✓) appears. TOD-clock cells that are not shaded indicate that a clock-comparator interruption condition does not exist for the corresponding TOD-clock value in the "Register Value" column. TOD-clock cells that are shaded (if any) indicate that a clock-comparator interruption condition exists for the corresponding values in the "Register Value" column.

Figure 4-16. Effects of the Clock-Comparator Sign Control on the Recognition of Clock-Comparator Interruption Conditions

CPU Timer

The CPU timer provides a means for measuring elapsed CPU time and for causing an interruption when a specified amount of time has elapsed.

In a configuration with more than one CPU, each CPU has a separate CPU timer.

The CPU timer is a binary counter with a format which is the same as that of bits 0-63 of the TOD clock, except that bit 0 is considered a sign. The CPU timer nominally is decremented by subtracting a one in bit position 51 every microsecond. In models having a higher or lower resolution, a different bit position is decremented at such a frequency that the rate of decrementing the CPU timer is the same as if a one were subtracted in bit position 51 every micro-

second. The resolution of the CPU timer is such that the stepping rate is comparable to the instruction-execution rate of the model.

The CPU timer requests an external interruption with the interruption code 1005 hex whenever the CPU-timer value is negative (bit 0 of the CPU timer is one); presentation of the interruption is subject to the CPU-timer subclass mask, bit 53 of control register 0. The request does not remain pending when the CPU-timer value is changed to a nonnegative value.

When the TOD-clock-steering facility is not installed, and both the CPU timer and the TOD clock are running, the stepping rates are synchronized such that both are stepped at the same rate.

When the TOD-clock-steering facility is installed and the STP-hardware-based-TOD-clock-steering facility

is not installed, the CPU timer and TOD clock do not necessarily step at the same rate and may differ by as much as the maximum steering rate. When the TOD-clock-steering facility is installed and the STP-hardware-based-TOD-clock-steering facility is installed, the CPU timer and TOD clock step at the same rate.

Normally, decrementing the CPU timer is not affected by concurrent I/O activity. However, in some models the CPU timer may stop during extreme I/O activity and other similar interference situations. In these cases, the time recorded by the CPU timer provides a more accurate measure of the CPU time used by the program than would have been recorded had the CPU timer continued to step.

The CPU timer is decremented when the CPU is in the operating state or the load state. When the manual rate control is set to instruction step, the CPU timer is decremented only during the time in which the CPU is actually performing a unit of operation. However, depending on the model, the CPU timer may or may not be decremented when the TOD clock is in the error, stopped, or not-operational state.

Depending on the model, the CPU timer may or may not be decremented when the CPU is in the check-stop state.

The CPU timer can be inspected by executing the privileged instruction STORE CPU TIMER and can be set to a specified value by executing the privileged SET CPU TIMER instruction. The general instruction EXTRACT CPU TIME may be used in determining the amount of CPU time consumed by a task.

Depending on the model, the value of the CPU timer stored by an execution of STORE CPU TIMER may be the same as the value stored by a subsequent execution of STORE CPU TIMER on the same CPU when relatively few instructions are executed between the STORE CPU TIMER instructions. Similarly, depending on the model, the value of the CPU TIMER set by an execution of SET CPU TIMER may be the same value as that stored by a subsequent execution of STORE CPU TIMER on the same CPU when relatively few instructions are executed between the setting and storing of the timer.

The CPU timer is set to zero by initial CPU reset.

Programming Notes:

1. The CPU timer in association with a program may be used both to measure CPU-execution time and to signal the end of a time interval on the CPU.
2. The time measured for the execution of a sequence of instructions may depend on the effects of such things as I/O interference, the availability of pages, and instruction retry. Therefore, repeated measurements of the same sequence on the same installation may differ.
3. The fact that a CPU-timer interruption does not remain pending when the CPU timer is set to a positive value eliminates the problem of an undesired interruption. This would occur if, between the time when the old value is stored and a new value is set, the CPU is disabled for CPU-timer interruptions and the CPU timer value goes from positive to negative.
4. The fact that CPU-timer interruptions are requested whenever the CPU timer is negative (rather than just when the CPU timer goes from positive to negative) eliminates the requirement for testing a value to ensure that it is positive before setting the CPU timer to that value.

As an example, assume that a program being timed by the CPU timer is interrupted for a cause other than the CPU timer, external interruptions are disallowed by the new PSW, and the CPU-timer value is then saved by STORE CPU TIMER. This value could be negative if the CPU timer went from positive to negative since the interruption. Subsequently, when the program being timed is to continue, the CPU timer may be set to the saved value by SET CPU TIMER. A CPU-timer interruption occurs immediately after external interruptions are again enabled if the saved value was negative.

The persistence of the CPU-timer-interruption request means, however, that after an external interruption for the CPU timer has occurred, the value of the CPU timer must be replaced, the value in the CPU timer must wrap to a positive value, or the CPU-timer-subclass mask must be set to zero before the CPU is again enabled for external interruptions. Otherwise, loops of external interruptions are formed.

Although an initial CPU reset causes the CPU timer to be set to zero, it also clears the CPU-

timer enablement mask (bit 53 of control register 0). Thus, even if an IPL-new PSW is enabled for external interruptions, a CPU-timer interruption will not immediately occur.

5. The instruction STORE CPU TIMER may store a negative value even though the CPU is enabled for the interruption. This is because the CPU-timer value may be decremented one or more times between when instruction execution is begun and when the CPU timer is accessed. In this situation, the interruption occurs when the execution of STORE CPU TIMER is completed.

Guarded-Storage Facility

The guarded-storage facility provides the means by which the program can designate an area of logical storage comprising from zero to sixty-four guarded-storage sections. The facility includes the following instructions:

- LOAD GUARDED (LGG)
- LOAD LOGICAL AND SHIFT GUARDED (LLGFSG)
- LOAD GUARDED STORAGE CONTROLS (LGSC)
- STORE GUARDED STORAGE CONTROLS (STGSC)

When the second operand of LGG or LLGFSG does not designate a guarded section of the guarded-storage area, the instruction performs its defined load operation. However, when the second operand of the instruction designates a guarded section of the guarded-storage area, control branches to a guarded-storage event handler with indications of the cause of the event.

The guarded-storage facility is intended to be used by various programming languages that implement storage-reclamation techniques often referred to as *garbage collection*. All other instructions that access a range of guarded storage are unaffected by the facility, only the LGG and LLGFSG instructions are capable of generating a guarded-storage event.

Guarded-Storage-Facility Registers

The guarded-storage facility is controlled by a bit in control register 2 and by the following three 64-bit registers:

- Guarded-storage-designation register
- Guarded-storage-section-mask register
- Guarded-storage-event parameter-list-address register

The contents of these three registers may be loaded and inspected by means of the LOAD GUARDED STORAGE CONTROLS and STORE GUARDED STORAGE CONTROLS instructions respectively.

Control Register 2

When the guarded-storage facility is installed, bit 59 of control register 2 is the guarded-storage-facility-enablement (GSFE) control. When bit 59 is zero, attempted execution of the following instructions results in a special-operation exception:

- LOAD GUARDED STORAGE CONTROLS
- STORE GUARDED STORAGE CONTROLS

When the GSFE control is one, the guarded-storage facility is said to be enabled.

Execution of the LOAD GUARDED and LOAD LOGICAL AND SHIFT GUARDED instructions is not subject to the GSFE control. A guarded-storage event is only recognized when the GSFE control is one.

Programming Note: When facility indication 133 is one (indicating that the guarded-storage facility is installed in the configuration), the program can use the LOAD GUARDED and LOAD LOGICAL AND SHIFT GUARDED instructions, regardless of the GSFE control. However, guarded-storage events cannot be recognized without first loading guarded-storage controls, and the control program must set the GSFE control to one in order to successfully execute the LOAD GUARDED STORAGE CONTROLS instruction. Therefore, the program should examine an OS-provided indication of guarded-storage-facility enablement (rather than facility bit 133) to determine if the full capabilities of the facility are available.

Guarded-Storage-Designation (GSD) Register

The guarded-storage designation register is a 64-bit register that defines the attributes of the guarded-storage area as shown in Figure 4-17.

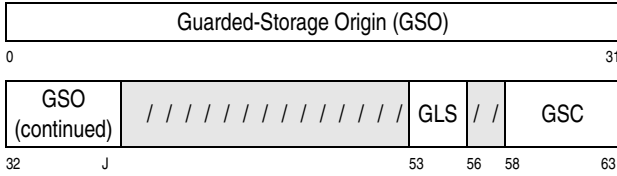

Explanation:

- / Reserved
- GLS Guarded load shift amount
- GSC Guarded-storage characteristic
- J The rightmost significant bit position of the GSO (that is, bit position 63 minus the value of GSC).

Figure 4-17. Guarded-Storage-Designation (GSD) Register

The fields of the GSD register are as follows:

Guarded-Storage Origin (GSO): The location of the guarded-storage area is specified by the leftmost bits of the GSD register. The number of leftmost bits is determined by value of the guarded-storage-characteristic (GSC) in bits 58-63 of the register. Bit positions 0 through (63 – GSC) of the guarded-storage-designation register, padded on the right with binary zeros in bit positions (64 – GSC) through 63, form the 64-bit logical address of the leftmost byte of the guarded-storage area.

Reserved: When the GSC is greater than 25, bit positions (64 – GSC) through 38 are reserved and should contain zeros; otherwise, the results of the guarded-storage-event detection are unpredictable (see “Guarded-Storage-Event Detection” on page 4-70). Bit positions 39-52 and 56-57 of the GSD register are reserved and should contain zeros; otherwise, the program may not operate compatibly in the future.

Guarded-Load Shift (GLS): Bits 53-55 of the guarded-storage-designation register contains a 3-bit unsigned binary integer that is used in the formation of the intermediate result of LOAD LOGICAL AND SHIFT GUARDED. Valid GLS values are 0-4; values 5-7 are reserved and may result in an unpredictable shift amount.

Guarded-Storage Characteristic (GSC): Bit positions 58-63 of the guarded-storage-designation register

contain a 6-bit unsigned binary integer that is treated as a power of two. Valid GSC values are 25-56; values 0-24 and 57-63 are reserved and may result in unpredictable guarded-storage event detection. The GSC designates the following:

- The alignment of the guarded-storage origin. A GSC value of 25 indicates 32 M-byte alignment, a value of 26 indicates 64 M-byte alignment, and so forth.
- The guarded-storage-section size. A GSC value of 25 indicates 512 K-byte sections, a value of 26 indicates a 1 M-byte sections, and so forth.

The relationship between the guarded-storage characteristic, guarded-storage origin, and guarded-storage-section size is shown in Figure 4-18.

GSC	GSO		Section Size	GSC	GSO		Section Size
	Align-ment	GSD Bits			Align-ment	GSD Bits	
25	32 M	0-38	512 K	41	2 T	0-22	32 G
26	64 M	0-37	1 M	42	4 T	0-21	64 G
27	128 M	0-36	2 M	43	8 T	0-20	128 G
28	256 M	0-35	4 M	44	16 T	0-19	256 G
29	512 M	0-34	8 M	45	32 T	0-18	512 G
30	1 G	0-33	16 M	46	64 T	0-17	1 T
31	2 G	0-32	32 M	47	128 T	0-16	2 T
32	4 G	0-31	64 M	48	256 T	0-15	4 T
33	8 G	0-30	128 M	49	512 T	0-14	8 T
34	16 G	0-29	256 M	50	1 P	0-13	16 T
35	32 G	0-28	512 M	51	2 P	0-12	32 T
36	64 G	0-27	1 G	52	4 P	0-11	64 T
37	128 G	0-26	2 G	53	8 P	0-10	128 T
38	256 G	0-25	4 G	54	16 P	0-9	256 T
39	512 G	0-24	8 G	55	32 P	0-8	512 T
40	1 T	0-23	16 G	56	64 P	0-7	1 P

Explanation:		GSO	Guarded-storage origin
G	Gigabytes (2^{30})	M	Megabytes (2^{20})
GSC	Guarded-storage characteristic	P	Petabytes (2^{50})
		T	Terabytes (2^{40})

Figure 4-18. Guarded-Storage-Origin (GSO) Alignment, GSO Bit Range, and Guarded-Storage Section Size based on Guarded-Storage Characteristic (GSC)

Guarded-Storage-Section-Mask (GSSM) Register

The guarded-storage-section mask is a 64-bit register, with each bit corresponding to one of the 64

guarded-storage sections within the guarded-storage area. Bit 0 of the register corresponds to the leftmost section, and bit 63 corresponds to the rightmost section. Each bit, called a *section-guard* bit, controls the access to the respective section of guarded-storage area by the LOAD GUARDED and LOAD LOGICAL AND SHIFT GUARDED instructions, as described below and in the respective instructions' descriptions.

When all 64 bits of the GSSM register are zero, guarded-storage events are not recognized.

Guarded-Storage-Event Parameter-List-Address (GSEPLA) Register

When a guarded-storage-event is recognized, the contents of the GSEPLA register are a 64-bit address that is used to locate the guarded-storage-event parameter list, as described in the section "Guarded-Storage-Event Parameter List (GSEPL)", below. When the CPU is not in the access-register mode, the GSEPLA is a logical address; when the CPU is in the access-register mode, the GSEPLA is a primary virtual address.

Guarded-Storage Control Block (GSCB)

The three guarded-storage registers may be set and inspected by means of the LOAD GUARDED STORAGE CONTROLS and STORE GUARDED STORAGE CONTROLS instructions, respectively. The storage operand for each of these instructions is a 32-byte guarded-storage control block (GSCB), and the contents of the guarded-storage registers occupy the last three eight-byte fields of the block, as shown in Figure 4-19.

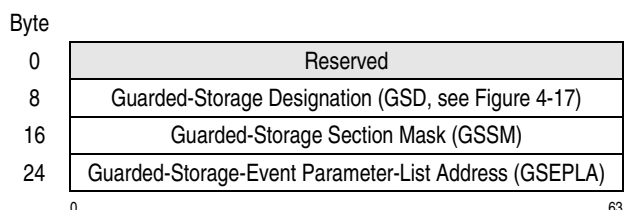

Figure 4-19. Guarded-Storage Control Block (GSCB)

When the GSCB is aligned on a doubleword boundary, CPU access to each of the three defined fields is block concurrent.

For LOAD GUARDED STORAGE CONTROLS, reserved bit positions of the GSCB should contain zeros; otherwise, the program may not operate compatibly in the future.

For STORE GUARDED STORAGE CONTROLS, reserved bit positions that are loaded with nonzero values may or may not be stored as zeros, and reserved values of the GLS and GSC fields of the GSD register may or may not be corrected to model-dependent values.

Guarded-Storage-Event Parameter List (GSEPL)

The guarded-storage-event parameter-list-address (GSEPLA) register contains a 64-bit address of the guarded-storage-event parameter list. When a guarded-storage event is recognized, the GSEPL is accessed using all 64 bits of the GSEPLA, regardless of the current addressing mode of the CPU. The GSEPL is accessed using the current translation mode, except that when the CPU is in the access-register mode, the GSEPL is accessed using the primary address space.

Figure 4-20 illustrates the fields of the guarded-storage-event parameter list.

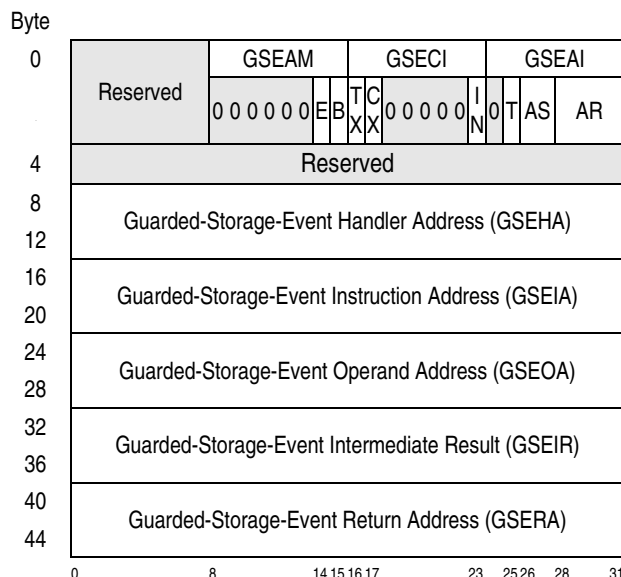

Figure 4-20. Guarded-Storage-Event Parameter List (GSEPL)

The contents of the guarded-storage-event parameter list are as follows:

Reserved: Bytes 0 and 4-7 of the GSEPL are reserved and set to zero when a guarded-storage event is recognized.

Guarded-Storage-Event Addressing Mode (GSEAM): Byte 1 of the GSEPL contains an indication of the addressing mode of the CPU when the guarded-storage-event was recognized, as follows:

Reserved: Bits 0-5 of the GSEAM are reserved and stored as zeros.

Extended-Addressing Mode (E): Bits 6 of the GSEAM contains the extended-addressing-mode bit, bit 31 of the program-status word.

Basic-Addressing Mode (B): Bits 7 of the GSEAM contains the basic-addressing-mode bit, bit 32 of the program-status word.

Guarded-Storage-Event Cause Indications (GSECI): Byte 2 of the GSEPL contains the guarded-storage-event cause indications. The GSECI is encoded as follows:

Transactional-Execution-Mode Indication (TX):

When bit 0 of the GSECI is zero, the CPU was not in the transactional-execution mode when the guarded-storage event was recognized. When bit 0 of the GSECI is one, the CPU was in the transactional-execution mode when the guarded-storage event was recognized.

Constrained-Transactional-Execution-Mode Indication (CX): When bit 1 of the GSECI is zero, the CPU was not in the constrained-transactional-execution mode when the guarded-storage event was recognized. When bit 1 of the GSECI is one, the CPU was in the constrained-transactional-execution mode when the guarded-storage event was recognized. Bit 1 of the GSECI is meaningful only when bit 0 is one.

Reserved: Bits 2-6 of the GSECI are reserved and set to zero when a guarded-storage event is recognized.

Instruction Cause (IN): Bit 7 of the GSECI indicates the instruction that caused the guarded-storage event. When bit 7 is zero, the event was caused by the execution of the LOAD GUARDED instruction. When bit 7 is one, the event was caused by the execution of the LOAD LOGICAL AND SHIFT GUARDED instruction.

Guarded-Storage-Event Access Information (GSEAI): Byte 3 of the GSEPL contains information describing the following CPU attributes:

Reserved: Bit 0 of the GSEAI is reserved and set to zero when a guarded-storage event is recognized.

DAT Mode (T): Bit 1 of the GSEAI indicates the current dynamic-address-translation mode (that is, the T bit is a copy of PSW bit 5).

Address-Space Indication (AS): Bits 2-3 of the GSEAI indicate the current address-space controls (that is, the AS field is a copy of bits 16-17 of the PSW). The AS field is meaningful only when the DAT is enabled (that is, when the T bit is one); otherwise, the AS field is unpredictable.

Access-Register Number (AR): When the CPU is in the access-register mode, bits 4-7 of the GSEAI indicate the access-register number used by the LGG or LLGFSG instruction causing the event (that is, the AR field is a copy of the B₂ field of the LGG or LLGFSG instruction). When the CPU is not in the access-register mode, the AR field is unpredictable.

Guarded-Storage-Event Handler Address (GSEHA): Bytes 8-15 of the GSEPL contain the guarded-storage-event handler address. The GSEHA field is considered to be a branch address and is subject to the action described in “Formation of the Branch Address” on page 5-13. When a guarded-storage event is recognized, the GSEHA field forms the branch address that is used to complete the execution of the LOAD GUARDED or LOAD LOGICAL AND SHIFT GUARDED instruction.

A guarded-storage event is considered to be a PER successful-branching event. If the PER branch-address control is one, the GSEHA is the value compared with control registers 10 and 11.

Guarded-Storage-Event Instruction Address (GSEIA): Bytes 16-23 of the GSEPL contain the guarded-storage-event instruction address. When a guarded-storage event is recognized, the address of the instruction causing the event is stored into the GSEIA field. The address placed in the GSEIA is either that of the LOAD GUARDED or LOAD LOGICAL AND SHIFT GUARDED instruction, or that of the execute-type instruction whose target is a LOAD GUARDED or LOAD LOGICAL AND SHIFT GUARDED instruction.

Storing of the GSEIA field is subject to the current addressing mode when the event is detected. In the 24-bit addressing mode, bits 0-39 of the GSEIA are set to zeros. In the 31-bit addressing mode, bits 0-32 of the GSEIA are set to zeros.

Guarded-Storage-Event Operand Address (GSEOA): Bytes 24-31 of the GSEPL contain the guarded-storage-event operand address. When a guarded-storage event is recognized, the second-operand address of a LOAD GUARDED or LOAD LOGICAL AND SHIFT GUARDED instruction causing the event is stored into the GSEOA field.

The content of the GSEOA field is subject to the current addressing mode when the event is detected. In the 24-bit addressing mode, bits 0-39 of the GSEOA are set to zeros. In the 31-bit addressing mode, bits 0-32 of the GSEOA are set to zeros.

If transactional execution is aborted due to the recognition of a guarded-storage event, the GSEOA field contains the operand address formed during transactional execution. This is true even if the operand address was formed using one or more general registers that were altered during transactional execution, and regardless of whether the register(s) were restored when transactional execution was aborted.

Guarded-Storage-Event Intermediate Result (GSEIR): Bytes 32-39 of the GSEPL contain the guarded-storage-event intermediate result. When a guarded-storage event is recognized, the intermediate result formed by a LOAD GUARDED or LOAD LOGICAL AND SHIFT GUARDED instruction is stored into the GSEIR field.

If the detection of a guarded-storage event causes transactional execution to be aborted, and the model refetches the LGG or LLGFSG second operand to determine if the event persists, the refetching of the second operand and the intermediate-result formation are subject to the addressing mode that was in effect when the event was initially detected.

Guarded-Storage-Event Return Address (GSERA): Bytes 40-47 of the GSEPL contain the guarded-storage-event return address.

When a guarded-storage event is recognized while the CPU is in the transaction-execution mode, the instruction address of the transaction-abort PSW is

placed into the GSERA. In the constrained transactional-execution mode, the instruction address designates the TBEGINC instruction. In the nonconstrained transactional-execution mode, the instruction address designates the instruction following the TBEGIN instruction. The GSERA is subject to the addressing mode in the transaction-abort PSW (that is, the addressing mode prior to entering the transactional-execution mode).

When a guarded-storage event is recognized while the CPU is not in the transactional-execution mode, the contents of the GSERA are identical to the GSEIA.

During the execution of LOAD GUARDED or LOAD LOGICAL AND SHIFT GUARDED, the GSEPL is accessed only if a guarded-storage event is recognized. Multiple accesses may be made to any field of the GSEPL when a guarded-storage event is recognized.

Accesses to the GSEPL during guarded-storage-event processing are considered to be side-effect accesses. Store-type access exceptions are recognized for any byte of the GSEPL including the GSEHA field and reserved fields. If an access exception other than addressing is recognized while accessing the GSEPL, the side-effect-access indication, bit 54 of the translation-exception identification at real location 168-175, is set to one, and the LOAD GUARDED or LOAD LOGICAL AND SHIFT GUARDED instruction causing the guarded-storage event is nullified.

When DAT is on, the GSEPL is accessed using the current address-space control (ASC) mode, except when the CPU is in the access-register mode; in the access-register mode, the GSEPL is accessed in the primary address space.

Programming Notes:

1. The expected usage is that the program does not switch ASC mode between the establishment of GS controls and the recognition of a GS event. If the program switches ASC mode, then the following apply:
 - The GSEPL should be mapped to common addresses in both the space where it was established and in the space where the GS event was recognized.

- If a GS event is recognized in the access-register mode, the GS event handler program may need to examine the GSEAI field to determine the appropriate ALET with which to access the guarded-storage operand.

2. When a nonconstrained transaction is aborted due to a guarded-storage event, the addressing mode from the transaction-abort PSW becomes effective. The addressing mode that was in effect at the time of the guarded-storage event can be determined by inspecting the GSEAM field in the GSE parameter list.

The addressing mode cannot be changed by a constrained transaction; thus, if a constrained transaction is aborted due to a guarded-storage event, the addressing mode is necessarily the same as when the TBEGINC instruction was executed.

Guarded-Storage Facility Operation

Guarded-Storage-Event Detection

Guarded-storage-event detection uses two values formed from the intermediate result of the LOAD GUARDED or LOAD LOGICAL AND SHIFT GUARDED instruction:

- Guarded-storage-operand comparand (GSOC)
- Guarded-storage-mask index (GSMX)

The guarded-storage-operand comparand (GSOC) is formed from the intermediate result of the LOAD GUARDED or LOAD LOGICAL AND SHIFT GUARDED instruction (see “LOAD GUARDED” on page 7-273 for a description of the intermediate result). Specifically, the GSOC comprises bit positions 0 through (63 - GSC) of the intermediate result, inclusive (where GSC is the guarded-storage characteristic in bit positions 58-63 of the guarded-storage-designation register).

The GSOC is compared with the guarded-storage origin (GSO, in the corresponding bit positions of the GSD register). When the GSOC is not equal to the GSO, a guarded-storage event is not recognized, and the execution of the LOAD GUARDED or LOAD LOGICAL AND SHIFT GUARDED is completed by

placing the intermediate result into general register R₁.

When the GSOC is equal to the GSO, the six bits of the intermediate result to the right of the GSOC form an unsigned binary integer called the guarded-storage mask index (GSMX). The section-guard bit of the guarded-storage-section-mask (GSSM) register corresponding to the GSMX is examined. If the section-guard bit is zero, a guarded-storage event is not recognized, and the execution of the LOAD GUARDED or LOAD LOGICAL AND SHIFT GUARDED is completed by placing the intermediate result into general register R₁. However, if the section-guard bit is one, then a guarded-storage event is recognized.

Guarded-storage-event detection is not performed when either (a) the guarded-storage facility is not enabled (by means of bit 59 of control register 2), or (b) all bit positions of the guarded-storage section mask (GSSM) register contain zeros.

Detection of the guarded-storage event is illustrated in Figure 4-21.

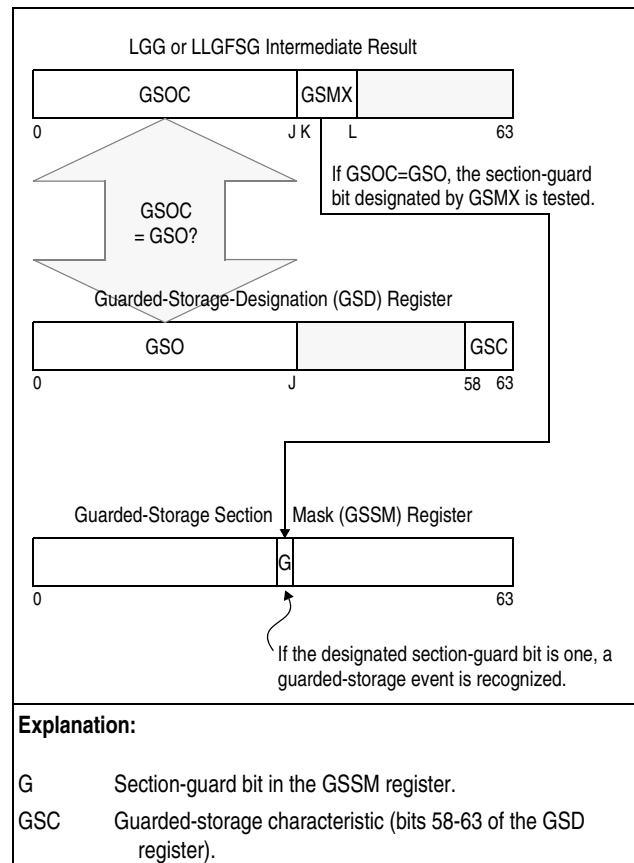

Figure 4-21. Guarded-Storage-Event Detection

GSD	Guarded-storage-designation register.
GSMX	Guarded-storage-mask index (bits K through L of the LGG and LLGFSG intermediate result).
GSO	Guarded-storage origin (bits 0 through J of the GSD)
GSOC	Guarded-storage-operand comparand (bits 0 through J of the LGG and LLGFSG intermediate result).
GSSM	Guarded-storage-section-mask register.
J	The rightmost significant bit position of the GSO (that is, bit position 63 minus the value of GSC).
K	Bit position J + 1
L	Bit position J + 6

Figure 4-21. Guarded-Storage-Event Detection

Guarded-Storage-Event Processing

When a guarded-storage event is recognized while the CPU is in the transactional-execution mode, the following occurs:

1. The transaction is aborted with abort code 19, as described in “Transaction Abort Processing” on page 5-102. If the transaction diagnostic block (TDB) address is not valid, or if the TDB address is valid and accessible, condition code 2 is set in the transaction-abort PSW. If the TDB address is valid, but the TDB is not accessible, condition code 1 is set in the transaction-abort PSW.
2. Depending on the model, the second operand of the LOAD GUARDED or LOAD LOGICAL GUARDED AND SHIFT instruction may be refetched to determine whether the guarded-storage-event condition still exists. If the model refetches the second operand, the access to the second operand and the formation of the intermediate result are both subject to the addressing mode that was in effect at the time the event was initially detected.
 - When the second operand is refetched and the guarded-storage-event condition no longer exists, the following applies:
 - Normal transaction-abort processing concludes by the loading of the transaction-abort PSW.
 - Guarded-storage-event processing does not occur. However, the transaction abort code remains 19.
 - PER basic events associated with an LGG or LLGFSG instruction (or an execute-type instruction whose operand is an LGG or LLGFSG) are not recognized.

- When the second operand is not refetched, or when it is refetched and the guarded-storage-event condition persists, guarded-storage-event processing continues as described below (instead of loading the transaction-abort PSW).

Regardless of whether the CPU was in the transactional-execution mode when a guarded-storage event is recognized, the guarded-storage-event parameter-list-address (GSEPLA) register is used to locate the guarded-storage-event parameter list (GSEPL). The content of the GSEPLA register is a 64-bit address, and 64 bits of the address are used regardless of the current addressing mode. The GSEPL is accessed using the current translation mode, except that when the CPU is in the access-register mode, the GSEPL is accessed using the primary address space.

If an access exception is recognized when accessing the GSEPL, processing is as follows:

- A program interruption occurs.
- If the CPU was not in the transactional-execution mode, then the instruction address in the program-old PSW is set as follows:
 - If the exception condition results in nullification, the instruction address points to the instruction causing the guarded-storage event (that is, the address of the LGG or LLGFSG, or the address of the execute-type instruction whose target is the LGG or LLGFSG).
 - If the exception condition results in suppression or termination, the instruction address points to the next-sequential instruction following the instruction that caused the guarded-storage event.

If the CPU was in the transactional-execution mode, the transaction-abort PSW is placed into the program-old PSW. The transactional-execution-aborted event indication, bit 6 of the program-interruption code, is set to one.

- For all access-exception conditions except addressing, the side-effect-access indication, bit 54 of the translation-exception identification at real locations 168-175, is set to one. (The TEID is not stored for addressing exceptions.)

- The remaining guarded-storage-event processing, described below, does not occur when the GSEPL is not accessible.

If the GSEPL is accessible, the following actions are performed using the fields of the GSEPL:

- Bytes 0 and 4-7 of the GSEPL are set to zeros.
- An indication of the addressing mode is placed into the guarded-storage-event addressing mode (GSEAM, byte 1 of the GSEPL), as follows:
 - Bits 0-5 of the GSEAM are set to zeros.
 - Bits 6 and 7 of the GSEAM are set to bits 31 and 32 of the PSW at the time the guarded-storage event was recognized.
- An indication of the cause of the event is placed into the guarded-storage-event cause-indication field (GSECI, byte 2 of the GSEPL), as follows:
 - If the CPU was in the transactional-execution mode when the guarded-storage event was recognized, bit 0 of the GSECI is set to one; otherwise, bit 0 of byte 2 is set to zero.
 - If the CPU was in the constrained transactional-execution mode when the guarded-storage event was recognized, bit 1 of the GSECI is set to one; otherwise, bit 1 of the GSECI is set to zero.
 - Bits 2-6 of the GSECI are set to zeros.
 - Bit 7 of the GSECI is set to designate the instruction that caused the guarded-storage event. A value of zero means the event was caused by a LGG instruction; a value of one means the event was caused by a LLGFSG instruction.
- An indication of the PSW DAT, addressing-mode, and address-space controls are placed into the guarded-storage-event access-indication field (GSEAI, byte 3 of the GSEPL), as follows:
 - Bit 0 of the GSEAI is reserved and set to zero.
 - The current translation mode, bit 5 of the PSW, is placed into bit 1 of the GSEAI.
 - If DAT is on, bits 16-17 of the PSW are placed into bits 2-3 of the GSEAI. If DAT is off, bits 2-3 of the GSEAI are unpredictable.
- If the CPU is in the access-register mode, the access-register number corresponding to the B_2 field of the LGG or LLGFSG instruction causing the event is placed into bits 4-7 of the GSEAI. If the CPU is not in the AR mode, bits 4-7 of the GSEAI are unpredictable.
- The instruction address in the PSW is replaced by the contents of the guarded-storage-event handler-address field (GSEHA, bytes 8-15 of the GSEPL). The GSEHA field is considered to be a branch address and is subject to the action described in “Formation of the Branch Address” on page 5-13. The current addressing mode is unchanged.
- The address of the instruction causing the guarded-storage event is placed into the guarded-storage-event instruction-address field (GSEIA, bytes 16-23 of the GSEPL). The address placed in the GSEIA is either that of the LGG or LLGFSG instruction, or that of the execute-type instruction whose target is a LGG or LLGFSG. The GSEIA is also placed into the breaking-event address register.
- The second-operand address of the LGG or LLGFSG instruction is placed into the guarded-storage-event operand-address (GSEOA, bytes 24-31 of the GSEPL). If transactional execution was aborted due to the recognition of a guarded-storage event, the GSEOA field contains the operand address formed during transactional execution.
- The intermediate result of the LGG or LLGFSG instruction is placed into the guarded-storage-event intermediate-result field (GSEIR, bytes 32-39 of the GSEPL). If transactional execution is aborted due to the recognition of a guarded-storage event, the GSEIR field is formed using the guarded-storage-operand address (GSEOA) field.
- If the guarded-storage event was recognized during transactional execution, it is model dependent whether the GSEIR is formed from the value that was transactionally fetched or the value that was fetched after the transaction was aborted. In either case, the second operand of the LGG or LLGFSG instruction is fetched, and the intermediate result is formed, using the addressing mode that was in effect when the GSE was ini-

tially detected. (See programming note 3 on page page 4-73.)

- If the CPU was in the transactional-execution mode when guarded-storage event was recognized, the instruction address of the transaction-abort PSW is placed in the guarded-storage-event return address field (GSERA, bytes 40-47 of the GSEPL). If the CPU was in the constrained transactional-execution mode, the GSERA designates the TBEGINC instruction. If the CPU was in the nonconstrained transactional-execution mode, the GSERA designates the instruction following the TBEGIN instruction.

If the CPU was not in the transactional-execution mode when the guarded-storage event was recognized, the content of the GSERA field is identical to that of the GSEIA field.

Finally, the LGG or LLGFSG instruction is considered to have completed without altering general register R₁.

Programming Notes:

1. Programming languages that implement a storage-coalescing technique known as garbage collection may benefit from the guarded-storage facility. In such a programming model, a reference to a program object is performed by first loading a pointer to the object. The LOAD GUARDED and LOAD LOGICAL GUARDED AND SHIFT instructions provide the means by which the program can load a pointer to an object and determine whether the pointer is usable. If no guarded-storage event (GSE) is recognized, the pointer can be used to reference the object. However, if a GSE is recognized, it may indicate that the current pointer designates a storage location that is being reorganized, in which case the object may have been relocated elsewhere. The GSE-handler routine may then modify the pointer to designate the object's new location, and then branch back to location designated by the GSEIA to resume normal program execution.
2. In response to a GSE that is recognized when the CPU is in the transactional-execution mode, the program's GSE handler can attempt to correct the condition that caused the event (that is, update the operand of the LGG or LLGFSG), and then re-execute the transaction by branching to the location designated by the GSERA. If non-constrained transactional execution was aborted, the program should set the condition code to either 2 or 3 prior to branching to the GSERA, depending on whether the condition causing the event was or was not corrected, respectively. If constrained transactional execution was aborted, then the program should not branch to the location designated by the GSERA unless the condition causing the event has been corrected; otherwise, a program loop may result.
3. On models that refetch the second-operand of the LGG or LLGFSG instruction during GSE processing, the following applies:
 - If another CPU or the I/O subsystem modifies the second-operand location in between GSE detection and GSE processing, a GSE may no longer exist, or a GSE may persist but the guarded-storage-event-intermediate-result (GSEIR) field may not contain the value that caused the event.
 - If the second-operand location initially contains a value that will cause a GSE, and during transactional execution, the program changes the location to a different value that would also cause a GSE, then the transaction is aborted due to GSE detection, the contents of the location revert to their initial value (prior to transactional execution), and the GSEIR will contain the initial value prior to transactional execution, not the value at GSE detection.
 - If the second-operand location initially contains a value that will not cause a GSE, and during transactional execution, the location is changed to a value that causes a GSE, then the transaction is aborted due to GSE detection, the contents of the location revert to their initial value (prior to transactional execution), and the GSE condition no longer exists. For a constrained transaction, or for a nonconstrained transaction where the abort handler does not correct this situation, a program loop will likely result.

To ensure reliable contents of the guarded-storage-event-intermediate-result (GSEIR) field, a program executing in the transactional-execution mode should use the NONTRANSACTIONAL STORE instruction if it modifies the second-operand location of a LOAD GUARDED instruction

that is subsequently executed in the same transaction.

4. Similar to other instructions that alter the PSW instruction address, a specification exception is recognized if the PSW instruction address (loaded from the GSEHA field) is odd following a guarded-storage event.
5. During GSE processing, the CPU may recognize an access exception when attempting to update the guarded-storage-event parameter list (GSEPL). Such an access exception may be totally innocuous, for example, due to the GSEPL being temporarily paged out to auxiliary storage by the OS. Assuming the OS remedies the exception, it will load the program-old PSW to resume execution of the interrupted program.

If an access exception is recognized when accessing the GSEPL, and the CPU was not in the transactional-execution mode, the instruction address of the program-old PSW will be set as follows:

- If the exception resulted in nullification, the instruction address will point to the LGG or LLGFSG instruction that caused the GSE (or the execute-type instruction whose operand was the LGG or LLGFSG).
- If the exception resulted in suppression or termination, the instruction address will point to the next-sequential instruction following the instruction that caused the GSE for suppressing or terminating exceptions.

If an access exception is recognized when accessing the GSEPL, and the CPU was in the nonconstrained transactional-execution mode, the program-old PSW will designate the instruction following the outermost TBEGIN; if the CPU was in the constrained transactional-execution mode, the program-old PSW will designate the TBEGINC instruction.

If the CPU was in the nonconstrained transactional-execution mode and a TDB is stored, abort code 19 indicates that transactional execution was aborted due to a GSE. However, a transaction abort-handler routine cannot assume that abort code 19 necessarily indicates that the GSE-handler routine has corrected the cause of the GSE (because of the possible access-exception condition when accessing the GSEPL). In this scenario, an abort-handler routine may need

to re-execute the transaction multiple times to allow for OS resolution of one or more translation exceptions and to allow the GSE handler to correct the cause of the GSE.

Externally Initiated Functions

Resets

Note: Certain externally-initiated functions are described as resetting the CPU into the ESA/390 architectural mode (or simply, ESA/390 mode). When the ESA/390-compatibility-mode facility is installed in the configuration, the same reset operations will reset the CPU into the ESA/390-compatibility mode. In the following discussion of resets and initial-program loading, wherever the phrase *ESA/390* or *ESA/390-compatibility mode* is used, it indicates the respective mode in which the configuration was originally established.

All floating interruptions are defined to be cleared by initiation of manual resets through operator facilities .

Five reset functions are provided:

- CPU reset
- Initial CPU reset
- Subsystem reset
- Clear reset
- Power-on reset

CPU reset provides a means of clearing equipment-check indications and any resultant unpredictability in the CPU state with the least amount of information destroyed. In particular, it is used to clear check conditions when the CPU state is to be preserved for analysis or resumption of the operation. If a CPU reset is caused by the activation of the load-normal or load-with-dump key, (a) if the configuration-*z/Architecture-architectural-mode* (CZAM) facility is not installed, it sets the architectural mode to the ESA/390 or ESA/390 compatibility mode, and (b) if the multithreading facility is installed and enabled, it is disabled. When CPU reset changes the architectural mode to the ESA/390 or ESA/390 compatibility mode from the *z/Architecture* architectural mode, it saves the current PSW so that PSW can be restored by a `SIGNAL PROCESSOR set-architecture` order

that changes the architectural mode back to z/Architecture. When CPU reset changes the architectural mode to the ESA/390-compatibility mode from the z/Architecture architectural mode, it also saves bits 0-31 of the of control registers so that they can be restored by a SIGP set-architecture order that changes the architectural mode back to z/Architecture. See “. CPU Reset” on page 4-78 for details.

Initial CPU reset provides the functions of CPU reset together with initialization of the following:

- Current PSW
- Captured-z/Architecture PSW
- CPU timer
- Clock comparator
- Breaking-event-address register
- Control registers
- Captured z/Architecture control registers (when resetting into the ESA/390-compatibility mode)
- Floating-point-control register
- Prefix register
- TOD programmable register

If initial CPU reset is caused by the activation of the load-normal or load-with-dump key the following applies:

- If the CZAM facility is not installed, initial CPU reset sets the architectural mode to the ESA/390 or ESA/390-compatibility mode
- If multithreading is enabled, the initial-CPU-reset functions are performed for the lowest-numbered CPU of a core, and CPU reset is performed for all other CPUs in the core

Subsystem reset provides a means for clearing floating interruption conditions as well as for invoking I/O-system reset.

Clear reset causes initial CPU reset and subsystem reset to be performed and, additionally, clears or initializes all storage locations and registers in all CPUs in the configuration, with the exception of the TOD clock and epoch index. Such clearing is useful in debugging programs and in ensuring user privacy. Clear reset also releases all locks used by the PERFORM LOCKED OPERATION instruction. If the CZAM facility is not installed, clear reset sets the architectural mode to the ESA/390 or ESA/390-com-

patibility mode. Clearing does not affect external storage, such as direct-access storage devices used by the control program to hold the contents of unaddressable pages.

CPU power-on reset causes initial CPU reset to be performed and clears the contents of general registers, access registers, floating-point registers, and vector registers to zeros with valid checking-block code. Locks used by PERFORM LOCKED OPERATION and associated with the CPU are released unless they are held by a CPU already powered on. The power-on-reset sequences for the TOD clock, epoch index, main storage, and the channel subsystem may be included as part of the CPU power-on sequence, or the power-on sequence for these units may be initiated separately. If CPU power-on reset establishes the configuration, it does the following:

- Sets the architectural mode to one of the following:
 - The ESA/390 mode (when neither the ESA/390-compatibility-mode facility nor the CZAM facility are installed)
 - The ESA/390 compatibility mode (when the ESA/390 compatibility mode is installed)
 - The z/Architecture mode when the CZAM facility is installed
- Initializes the user-specified TOD epoch difference to the low-precision version of the initial value specified for the configuration.

If CPU power-on reset does not establish the configuration, then it sets the architectural mode to that of the CPUs already in the configuration.

CPU reset, initial CPU reset, subsystem reset, and clear reset may be initiated manually by using the operator facilities (see Chapter 12, “Operator Facilities”). Initial CPU reset is part of the initial-program-loading function. Figure 4-22 on page 4-76 summarizes how these four resets are manually initiated. Power-on reset is performed as part of turning power on. The reset actions are tabulated in Figure 4-23 on page 4-76. For information concerning which resets can be performed by the SIGNAL PROCESSOR

instruction, see “Signal-Processor Orders” on page 4-85.

Key Activated	Function Performed on ¹		
	CPU on Which Key Was Activated	Other CPUs in Config.	Remainder of Config.
System-reset-normal key	CPU reset	CPU reset	Subsystem reset
System-reset-clear key	Clear reset ²	Clear reset ²	Clear reset ³
Load-normal or load-with-dump key	Initial CPU reset ⁴ , followed by IPL	CPU reset	Subsystem reset
Load-clear or load-clear-list-directed key	Clear reset ² , followed by IPL	Clear reset ²	Clear reset ³
Explanation:			
¹ Activation of a system-reset or load key may change the configuration, including the connection with I/O, storage units, and other CPUs. ² Only the CPU elements of this reset apply. ³ Only the non-CPU elements of this reset apply. ⁴ When multithreading is enabled, initial CPU reset applies only to the lowest-numbered CPU of a core; CPU reset applies to all other CPUs of the core.			

Figure 4-22. Manual Initiation of Resets

Area Affected	Reset Function				
	Subsystem Reset	CPU Reset	Initial CPU Reset	Clear Reset	Power-On Reset
CPU	U	S	S ¹	S ¹	S
PSW	U	U/V#	C ^{*1}	C ^{*1}	C ^{*1}
Captured-z/Architecture-PSW register	U	U/sv	C	C	C
Prefix register	U	U/V	C	C	C
CPU timer	U	U/V	C	C	C
Clock comparator	U	U/V	C	C	C
TOD programmable register	U	U/V	C	C	C
Control registers	U	U/V ⁶	I	I	I
Captured z/Architecture control registers	U	U/cv	I	I	I
Breaking-event-address register	U	U/V	K	K	K
Floating-point-control register	U	U/V	C	C	C
Access registers	U	U/V	U/V	C	C
General registers	U	U/V	U/V	C	C
Floating-point registers	U	U/V	U/V	C	C
Vector registers	U	U/V	U/V	C	C
Storage keys	U	U	U	C	C ²
Volatile main storage	U	U	U	C	C ²
Nonvolatile main storage	U	U	U	C	U
Expanded storage	U ³	U ³	U ³	U ³	C ²
Epoch index	U	U	U	U	T ²
TOD clock	U ⁴	U ⁴	U ⁴	U ⁴	T ²
TOD clock steering registers	U	U	U	U	C
Floating interruption conditions	C	U	U	C	C ²
I/O system	R	U	U	R	R ⁵
PERFORM LOCKED OPERATION locks	U	U	U	RC	RP
Transaction nesting depth	U	C	C	C	C
Guarded-storage registers	U	U/V	U/V	I	I

Figure 4-23. Summary of Reset Actions (Part 1 of 3)

Area Affected	Reset Function			
	Subsystem Reset	CPU Reset	Initial CPU Reset	Power-On Reset
Explanation:				
#	If the architectural mode is changed from z/Architecture to ESA/390 (that is, neither the ESA/390-compatibility-mode facility nor the configuration-z/Architecture-architectural-mode [CZAM] facility is installed, and the reset is due to activation of the load-normal or load-with-dump key on another CPU), the 16-byte PSW first is placed in the captured-z/Architecture-PSW register, and then does not remain unchanged. Instead, it is changed to an eight-byte PSW, and the bits of the eight-byte PSW are set as follows. Bits 0-11, 13-23, and 25-32 are set equal to the same bits of the 16-byte PSW, bit 12 is set to one, bit 24 is set to zero, and bits 33-63 are set equal to bits 97-127 of the 16-byte PSW. The PSW is invalid in the ESA/390 mode if PSW bit 31 is one. It is unpredictable whether the PSW is invalid in the ESA/390-compatibility mode if PSW bit 31 is one.			
*	Clearing the contents of the PSW to zero causes the PSW to be invalid if the architectural mode is ESA/390.			
1	When the IPL sequence follows the reset function on that CPU, the CPU does not necessarily enter the stopped state, and the PSW is not necessarily cleared to zeros.			
2	When these units are separately powered, the action is performed only when the power for the unit is turned on.			
3	Access to change expanded storage at the time a reset function is performed may cause the contents of the 4 K-byte block in expanded storage to be unpredictable. Access to examine expanded storage does not affect the contents of the expanded storage.			
4	Access to the TOD clock by means of STORE CLOCK at the time the reset function is performed does not cause the value of the TOD clock to be affected.			
5	When the channel subsystem is separately powered or consists of multiple elements which are separately powered, the reset action is applied only to those subchannels, channel paths, and I/O control units and devices on those paths associated with the element which is being powered on.			
6	When CPU reset results in the configuration entering the ESA/390-compatibility mode, bits 0-31 of the control registers are set to zeros.			
C	The condition or contents are cleared. If the area affected is a field, the contents are set to zero with valid checking-block code.			
I	The state or contents are initialized. If the area affected is a field, the contents are set to the initial value with valid checking-block code. For guarded-storage controls, all fields are set to zeros.			
K	The breaking-event-address register is initialized to 0000000000000001 hex with valid checking-block code.			
R	I/O-system reset is performed in the channel subsystem. As part of this reset, system reset is signaled to all I/O control units and devices attached to the channel subsystem.			
RC	All locks in the configuration are released.			
RP	All locks in the configuration are released except for ones held by CPUs already powered on.			
S	The CPU is reset; current operations, if any, are terminated; the ALB and TLB are cleared of entries; interruption conditions in the CPU are cleared; and the CPU is placed in the stopped state. The effect of performing the start function is unpredictable when the stopped state has been entered by means of a reset. If the reset is initiated by the system-reset-clear, load-normal, load-with-dump, load-clear, or load-clear-list-directed key or by a CPU power-on reset that establishes the configuration, the architectural mode is set to one of (a) the ESA/390 mode (when neither the ESA/390-CM facility nor the CZAM facility is installed), (b) the ESA/390-compatibility mode (when the ESA/390 CM facility is installed), or (c) the z/Architecture mode (if the CZAM facility is installed) and the multithreading facility is disabled. Otherwise, the architectural mode and the state of the multithreading facility are unchanged, except that power-on reset sets the architectural mode to that of the CPUs already in the configuration.			
T	The epoch index and TOD clock are initialized to the current time of day and validated; the TOD clock enters the set state.			
U	The state, condition, or contents of the field remain unchanged. However, the result is unpredictable if an operation is in progress that changes the state, condition, or contents of the field at the time of reset.			
U/cv	When the ESA/390-compatibility-mode is installed: if the reset is due to activation of load-normal or load-with-dump key, the captured z/Architecture control registers are set from bits 0-31 of the current control registers (before the control registers are initialized); otherwise, the captured-z/Architecture-control registers are unchanged.			

Figure 4-23. Summary of Reset Actions (Part 2 of 3)

		Reset Function				
		Subsystem Reset	CPU Reset	Initial CPU Reset	Clear Reset	Power-On Reset
U/sv	The captured-z/Architecture-PSW register remains unchanged if the reset is due to activation of the system-reset-normal key or the SIGNAL PROCESSOR CPU-reset order, or it is set with the value of the current 16-byte PSW if the reset is due to activation of the load-normal or load-with-dump key.					
U/V	The contents remain unchanged, provided the field is not being changed at the time the reset function is performed. However, on some models the checking-block code of the contents may be made valid. The result is unpredictable if an operation is in progress that changes the contents of the field at the time of reset.					

Figure 4-23. Summary of Reset Actions (Part 3 of 3)

. CPU Reset

CPU reset causes the following actions:

1. The execution of the current instruction or other processing sequence, such as an interruption, is terminated, and all program-interruption and supervisor-call-interruption conditions are cleared.
2. If the CPU was in the transactional-execution mode, the transaction nesting depth is set to zero, and the CPU leaves the transactional-execution mode.
3. Any pending external-interruption conditions which are local to the CPU are cleared. Floating external-interruption conditions are not cleared.
4. Any pending machine-check-interruption conditions and error indications which are local to the CPU and any check-stop states are cleared. Floating machine-check-interruption conditions are not cleared. Any machine-check condition which is reported to all CPUs in the configuration and which has been made pending to a CPU is said to be local to the CPU.
5. All copies of prefetched instructions or operands are cleared. Additionally, any results to be stored because of the execution of instructions in the current checkpoint interval are cleared.
6. The ART-lookaside buffer and translation-lookaside buffer are cleared of entries.
7. If the reset is caused by activation of the load-normal or load-with-dump key on any CPU in the configuration, the following actions occur:
 - a. If the configuration-z/Architecture-architectural-mode (CZAM) facility is not installed, the current PSW is saved in the captured-z/Architecture-PSW register for subsequent use by a SIGNAL PROCESSOR set-architecture order that restores the z/Architecture mode.
 - b. When the ESA/390-compatibility-mode is installed, the captured z/Architecture control registers are set from bits 0-31 of the current control registers (before the control registers are initialized).
 - c. If the configuration is enabled for multi-threading, the following actions occur:
 - 1) CPU address contraction is performed as described on page 4-85.
 - 2) Multithreading is disabled.
 - d. If the configuration-z/Architecture-architectural-mode (CZAM) facility is not installed, then the following occurs:
 - The architectural mode of the CPU (and of all other CPUs in the configuration because of the initial CPU reset or CPU resets performed by them) is changed from the z/Architecture mode to the ESA/390 or ESA/390-compatibility mode.
 - The current PSW is changed from 16 bytes to eight bytes. The bits of the eight-byte PSW are set as follows: bits 0-11 and 13-32 are set equal to the same bits of the 16-byte PSW, bit 12 is set to one, and bits 33-63 are set equal to bits 97-127 of the 16-byte PSW.

If the resulting architectural mode is the ESA/390-compatibility mode, bits 0-31 of all control registers are set to zeros.

A CPU reset caused by activation of the system-reset-normal key or by the SIGNAL PROCESSOR CPU-reset order, and any CPU reset in the ESA/390 or ESA/390-compatibility mode, (a) do

not change the architectural mode, and (b) do not affect the captured-z/Architecture-PSW register, the captured-z/Architecture control registers (when the ESA/390-compatibility-mode is installed), or the enablement of the multithreading facility.

8. The CPU is placed in the stopped state after actions 1-7 have been completed. When the CCW-type IPL sequence follows the reset function on that CPU, the CPU enters the load state at the completion of the reset function and does not necessarily enter the stopped state during the execution of the reset operation. When the list-directed IPL sequence follows the reset function on that CPU, the CPU enters the operating state and does not necessarily enter the stopped state during the execution of the reset operation.

Registers, storage contents, and the state of conditions external to the CPU remain unchanged by CPU reset. However, the subsequent contents of the register, location, or state are unpredictable if an operation is in progress that changes the contents at the time of the reset. A lock held by the CPU when executing PERFORM LOCKED OPERATION is not released by CPU reset.

When the reset function in the CPU is initiated at the time the CPU is executing an I/O instruction or is performing an I/O interruption, the current operation between the CPU and the channel subsystem may or may not be completed, and the resultant state of the associated channel-subsystem facility may be unpredictable.

Programming Notes:

1. Most operations which would change a state, a condition, or the contents of a field cannot occur when the CPU is in the stopped state. However, some signal-processor functions and some operator functions may change these fields. To eliminate the possibility of losing a field when CPU reset is issued, the CPU should be stopped, and no operator functions should be in progress.
2. If the architectural mode is changed to the ESA/390 or ESA/390-compatibility mode and bit 31 of the current PSW is one, the PSW is invalid.

Initial CPU Reset

Initial CPU reset combines the CPU reset functions with the following clearing and initializing functions:

1. If the reset is caused by activation of the load-normal or load-with-dump key, then the following is performed:
 - a. If the multithreading facility is enabled, CPU address contraction is performed and the multithreading facility is disabled.
 - b. If the configuration-z/Architecture-architectural-mode (CZAM) facility is not installed, the architectural mode of the CPU (and of all other CPUs in the configuration) is set to the ESA/390 or ESA/390-compatibility mode.
2. The contents of the current PSW, captured-z/Architecture-PSW, prefix, CPU timer, clock comparator, and TOD programmable register are set to zero. When the IPL sequence follows the reset function on that CPU, the contents of the PSW are not necessarily set to zero.
3. The contents of the control registers are set to their initial z/Architecture values. All 64 bits of the control registers are set regardless of whether the CPU is in the ESA/390, ESA/390-compatibility, or the z/Architecture architectural mode. When the ESA/390-compatibility-mode facility is installed, the contents of the captured-z/Architecture-control registers are set to bits 0-31 of their respective control registers' initial z/Architecture values.
4. The contents of the floating-point-control register are set to zero.
5. The contents of the breaking-event-address register are initialized to 0000000000000001 hex.

These clearing and initializing functions include validation.

Setting the current PSW to zero when the CPU is in the ESA/390 or ESA/390-compatibility architectural mode at the end of the operation causes the PSW to be invalid, since PSW bit 12 must be one in that mode. Thus, in this case if the CPU is placed in the operating state after a reset without first introducing a new PSW, a specification exception is recognized.

Programming Note: When the multithreading facility is installed and enabled, an initial-CPU reset that is caused by the execution of a SIGP initial-CPU-reset order does not cause multithreading to be disabled.

Subsystem Reset

Subsystem reset operates only on those elements in the configuration which are not CPUs. It performs the following actions:

1. I/O-system reset is performed by the channel subsystem (see “I/O-System Reset” on page 17-13).
2. All floating interruption conditions in the configuration are cleared.
3. The warning-track-interruption facility is unregistered.

As part of I/O-system reset, pending I/O-interruption conditions are cleared, and system reset is signaled to all control units and devices attached to the channel subsystem (see “I/O-System Reset” on page 17-13). The effect of system reset on I/O control units and devices and the resultant control-unit and device state are described in the appropriate System Library publication for the control unit or device. A system reset, in general, resets only those functions in a shared control unit or device that are associated with the particular channel path signaling the reset.

Clear Reset

Clear reset combines the initial-CPU-reset function with an initializing function which causes the following actions:

1. If the multithreading facility is enabled, CPU address contraction is performed and the multithreading facility is disabled.
2. If the configuration-z/Architecture-architectural-mode (CZAM) facility is not installed, the architectural mode of all CPUs in the configuration is set to the ESA/390 or ESA/390-compatibility mode.
3. The access, general, floating-point, and vector registers of all CPUs in the configuration are set to zero. All 64 bits of the general registers and all 128 bits of the vector registers are set to zero regardless of whether the CPU was in the ESA/390, ESA/390-compatibility, or z/Architecture architectural mode when the clear-reset function was initiated.

4. The contents of the main storage in the configuration and the associated storage keys are set to zero with valid checking-block code.
5. The locks used by any CPU in the configuration when executing the PERFORM LOCKED OPERATION instruction are released.
6. A subsystem reset is performed.
7. A new set of wrapping keys and their associated verification patterns are generated.
8. The guarded-storage-facility registers are set to zero.

Validation is included in setting registers and in clearing storage and storage keys.

Programming Notes:

1. The architectural mode is not changed by activation of the system-reset-normal key or by execution of a SIGNAL PROCESSOR CPU-reset or initial-CPU-reset order. All CPUs in the configuration are always in the same architectural mode.
2. For the CPU-reset operation not to affect the contents of fields that are to be left unchanged, the CPU must not be executing instructions and must be disabled for all interruptions at the time of the reset. Except for the operation of the CPU timer and for the possibility of a machine-check interruption occurring, all CPU activity can be stopped by placing the CPU in the wait state and by disabling it for I/O and external interruptions. To avoid the possibility of causing a reset at the time that the CPU timer is being updated or a machine-check interruption occurs, the CPU must be in the stopped state.
3. CPU reset, initial CPU reset, subsystem reset, and clear reset do not affect the value and state of the TOD clock and epoch index.
4. The conditions under which the CPU enters the check-stop state are model-dependent and include malfunctions that preclude the completion of the current operation. Hence, if CPU reset or initial CPU reset is executed while the CPU is in the check-stop state, the contents of the PSW, registers, and storage locations, including the storage keys and the storage location accessed at the time of the error, may have unpredictable values, and, in some cases, the contents may still be in error after the check-stop state is

cleared by these resets. In this situation, a clear reset is required to clear the error.

Power-On Reset

The power-on-reset function for a component of the machine is performed as part of the power-on sequence for that component.

The power-on sequences for the TOD clock, epoch index, main storage, expanded storage, and channel subsystem may be included as part of the CPU power-on sequence, or the power-on sequence for these units may be initiated separately. The following sections describe the power-on resets for the CPU, TOD clock, epoch index, TOD-clock-steering registers, main storage, expanded storage, and channel subsystem. See also “I/O Support Functions” on page 17-1, and the appropriate System Library publication for the channel subsystem, control units, and I/O devices.

CPU Power-On Reset: The power-on reset causes initial CPU reset to be performed and may or may not cause I/O-system reset to be performed in the channel subsystem. The contents of general registers, access registers, floating-point registers, and vector registers are cleared to zeros with valid checking-block code. Locks used by PERFORM LOCKED OPERATION and associated with the CPU are released unless they are held by a CPU already powered on.

If CPU power-on reset establishes the configuration, then it sets the architectural mode to one of the following:

- The ESA/390 mode (when neither the ESA/390-compatibility-mode facility nor the CZAM facility is installed)
- The ESA/390-compatibility mode (when the ESA/390-compatibility-mode facility is installed)
- The z/Architecture architectural mode (when the CZAM facility is installed)

If CPU power-on reset does not establish the configuration, then it sets the architectural mode to that of the CPUs already in the configuration, and the CPU address is expanded if the multithreading facility is already enabled in the configuration.

TOD-Clock and Epoch Index Power-On Reset:

The power-on reset causes the value of the TOD clock and epoch index to be set to the current time of day with valid checking-block code and causes the clock to enter the set state.

When the TOD-clock-steering facility is installed, the TOD clock is never reported to be in the not-set state, as the TOD clock is placed in the set state with meaningful values as part of the initial-machine-loading (IML) process.

TOD-Clock-Steering-Registers Power-On

Reset: The power-on reset causes the value of the TOD-clock-steering registers to be set to zero with valid checking-block code.

Main-Storage Power-On Reset: For volatile main storage (one that does not preserve its contents when power is off) and for storage keys, power-on reset causes zeros with valid checking-block code to be placed in these fields. The contents of nonvolatile main storage, including the checking-block code, remain unchanged.

Expanded-Storage Power-On Reset: The contents of expanded storage are cleared to zeros with valid checking-block code.

Channel-Subsystem Power-On Reset: The channel-subsystem power-on reset causes I/O-system reset to be performed in the channel subsystem. (See “I/O-System Reset” on page 17-13.)

Operation Note: Functions equivalent to a power-on reset are performed when a configuration is activated in a logical partition or virtual machine.

Initial Program Loading

Initial program loading (IPL) provides a manual means for causing a program to be read from a designated device and for initiating execution of that program.

Some models may provide additional controls and indications relating to IPL; this additional information is specified in the System Library publication for the model.

There are two types of IPL: CCW-type IPL and list-directed IPL. CCW-type IPL is provided by all

machine configurations. List-directed IPL may be provided, depending on the model.

CCW-type IPL is described below. List-directed IPL is described in “List-Directed IPL” on page 17-19.

CCW-Type IPL

CCW-type IPL is initiated manually by setting the load-unit-address controls to a four-digit number to designate an input device and by subsequently activating the load-clear or load-normal key. On some models, load-normal and load-clear keys are provided for each primary CPU in the configuration. On other models, a single load-normal and load-clear key are provided for the entire configuration, and apply to the lowest-numbered primary online CPU that is not in the check-stop state. In the description which follows, the term “this CPU” refers to either (a) the CPU in the configuration for which the load-clear load-normal key was activated or (b) the lowest-numbered online primary CPU (as described above). When the multithreading facility is enabled, “this CPU” refers to the CPU which results from CPU address contraction (“CPU-Address Contraction” on page 4-85).

Activating the load-clear key causes a clear reset to be performed on the configuration.

Activating the load-normal key causes an initial CPU reset to be performed on this CPU, a CPU reset to be propagated to all other CPUs in the configuration, and a subsystem reset to be performed on the remainder of the configuration.

When the configuration-z/Architecture-architectural-mode (CZAM) facility is not installed, activating the load-clear key or the load-normal key sets the architectural mode to the ESA/390 or ESA/390-compatibility mode.

In the loading part of the operation, after the resets have been performed, this CPU then enters the load state. This CPU does not necessarily enter the stopped state during the execution of the reset operations. The load indicator is on while the CPU is in the load state.

Subsequently, a channel-program read operation is initiated from the I/O device designated by the load-unit-address controls. The effect of executing the channel program is as if a format-0 CCW beginning at absolute storage location 0 specified a read com-

mand with the modifier bits zeros, a data address of zero, a byte count of 24, the chain-command and SLI flags ones, and all other flags zeros.

The details of the channel-subsystem portion of the IPL operation are defined in “Initial Program Loading” on page 17-16.

When the IPL I/O operation is completed successfully, the subsystem-identification word for the IPL device is stored in absolute storage locations 184-187, zeros are stored in absolute storage locations 188-191, and a new PSW is loaded from absolute storage locations 0-7. If the PSW loading is successful and no machine malfunctions are detected, this CPU leaves the load state, and the load indicator is turned off. If the rate control is set to the process position, the CPU enters the operating state, and the CPU operation proceeds under control of the new PSW. If the rate control is set to the instruction-step position, the CPU enters the stopped state, with the manual indicator on, after the new PSW is loaded.

If the IPL I/O operation or the PSW loading is not completed successfully, the CPU remains in the load state, and the load indicator remains on. The contents of absolute storage locations 0-7 are unpredictable.

Store Status

The store-status operation places an architectural-mode identification and the contents of the CPU registers, except for the TOD clock, in assigned storage locations.

Figure 4-24 lists the fields that are stored when the CPU is in the z/Architecture architectural mode, their length, and their locations in main storage.

Figure 4-25 lists the fields that are stored when the CPU is in the ESA/390-Compatibility mode, their lengths, and their locations in main storage.

In the ESA/390-compatibility mode, when the extended-save-area control, bit 34 of control register 14, is one, and bits 1-19 of the word at absolute locations 212-215 are not all zeros, then other fields are stored in a store-status extended save area. Figure 4-12 lists the fields that are stored, their lengths, and their offsets within the area. Bytes 144-4095 of the extended save area remain unchanged.

Field	Length in Bytes	Absolute Address
Architectural-mode id	1	163
Floating-point registers 0-15	128	4608
General registers 0-15	128	4736
Current PSW	16	4864
Prefix	4	4888
Floating-point control register	4	4892
TOD programmable register	4	4900
CPU timer	8	4904
Zeros	1	4912
Bits 0-55 of clock comparator	7	4913
Access registers 0-15	64	4928
Control registers 0-15	128	4992

Figure 4-24. Assigned Storage Locations for Store Status in the z/Architecture Architectural Mode

Field	Length in Bytes	Absolute Address
Architectural-mode id	1	163
CPU timer	8	216
Clock comparator	8	224
Current PSW	8	256
Prefix	4	264
Access registers 0-15	64	288
Floating-point registers 0, 2, 4, 6	32	352
General registers 0-15 (bits 32-63)	64	384
Control registers 0-15 (bits 32-63)	64	448

Figure 4-25. Assigned Storage Locations for Store Status in the ESA/390-Compatibility Mode

Field	Length in Bytes	Byte Offset
Floating-point registers 0-15	128	0
Floating-point control register	4	128
Reserved (stored as zeros)	12	132
Unchanged	3,952	144

Figure 4-26. Store-Status Extended Save Area

During the execution of the store-status operation, the store-status architectural-mode identification is stored at absolute location 163, as follows:

- Zeros are stored in bit positions 0-6.
- When the CPU is in the ESA/390 architectural mode or ESA/390-compatibility mode, a zero is stored in bit position 7.
- When the CPU is in the z/Architecture architectural mode, a one is stored in bit position 7. When the configuration-z/Architecture-architectural-mode (CZAM) facility is installed, a one is always stored in bit position 7.

When the CPU is in the z/Architecture architectural mode, bits 0-55 of the clock comparator are stored beginning at absolute location 4913, and zeros are stored at absolute location 4912. When the CPU is in the ESA/390-compatibility mode, the entire 64-bit clock comparator is stored beginning at absolute location 224.

The contents of the registers are not changed. If an error is encountered during the operation, the CPU enters the check-stop state.

The store-status operation can be initiated manually by use of the store-status key (see “Store-Status Key” on page 12-5). The store-status operation can also be initiated at the addressed CPU by executing SIGNAL PROCESSOR, specifying the stop-and-store-status order. Execution of SIGNAL PROCESSOR specifying the store-status-at-address order permits the same status information, except for the store-status architectural-mode identification, to be stored at a designated address (see “Signal-Processor Orders” on page 4-85).

Multiprocessing

The multiprocessing facility provides for the interconnection of CPUs, via a common main storage, in order to enhance system availability and to share data and resources. The multiprocessing facility includes the following facilities:

- Shared main storage
- CPU-to-CPU interconnection
- TOD-clock synchronization

Associated with these facilities is an external-interruption condition (malfunction alert), which is described in “Malfunction Alert” on page 6-13; and control-register positions for the TOD-clock-sync-control bit and for the mask for the external-interruption condition, which are listed in “Control Registers” on page 4-8.

The channel subsystem, including all subchannels, in a multiprocessing configuration can be accessed by all CPUs in the configuration. I/O-interruption conditions are floating and can be accepted by any CPU in the configuration.

Shared Main Storage

The shared-main-storage facility permits more than one CPU to have access to common main-storage locations. All CPUs having access to a common main-storage location have access to the entire 4 K-byte block containing that location and to the associated storage key. The channel subsystem and all CPUs in the configuration refer to a shared main-storage location using the same absolute address.

CPU-Address Identification

Each CPU has a number assigned, called its CPU address. A CPU address uniquely identifies one CPU within a configuration. The CPU is designated by specifying this address in the CPU-address field of SIGNAL PROCESSOR. The CPU signaling a malfunction alert, emergency signal, or external call is identified by storing this address in the CPU-address field with the interruption. The CPU address is assigned by the configuration-definition process and, except as indicated below, is not changed as a result of reconfiguration changes. The program can determine the address of the CPU by using STORE CPU ADDRESS.

CPU-Address Expansion

When multithreading is enabled, the CPU address comprises a core identification (core ID), concatenated with an identification of a CPU within the core; the CPU identification within a core is commonly called a thread identification (thread ID, or TID). Within a configuration, all cores provide the same number of CPUs; however, depending on the model and CPU type, some CPUs in a core may not be operational.

Based on the program-specified maximum thread identification specified in bits 59-63 of the parameter register used by the SIGNAL PROCESSOR set-multithreading order, a fixed number of bits are required to represent the thread identification; this number of bits is referred to as the *TID width*.

The core ID is formed from the rightmost bits of the CPU address before multithreading is enabled. The core ID is shifted left by TID-width bits, resulting in the leftmost bits of the CPU address after multithreading is available. The thread ID requires the same TID-width number of bits, and occupies the

rightmost bits of the CPU address after multithreading is enabled. Thread IDs are assigned in a contiguous range of numbers beginning with zero and extending to a maximum of 31; however, a model may implement fewer CPUs per core.

Figure 4-27 illustrates the adjustment of the CPU address when multithreading is enabled.

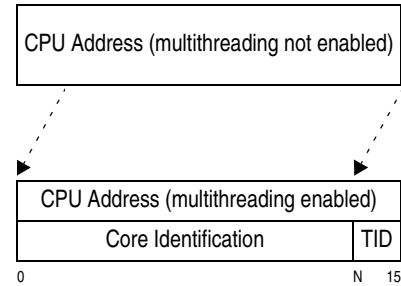

Explanation:

- N Leftmost bit position of the thread ID; also, number of bits in the core ID. $N = 16 - (\text{TID width})$. See Figure 4-28 for details.
- TID Thread identification

Figure 4-27. Adjustment of the CPU Address when Multithreading is Enabled.

Figure 4-28 illustrates the relationship of the program-specified maximum thread identification, the TID width and the CPU-address bits comprising the core identification and thread identification.

Program-Specified Maximum TID ¹	TID Width	CPU Address Bits	
		Core ID	Thread ID
0	0	0-15	–
1	1	0-14	15
2-3	2	0-13	14-15
4-7	3	0-12	13-15
8-15	4	0-11	12-15
16-31	5	0-10	11-15

Explanation:

- ¹ Specified in bits 56-63 of the parameter register for the SIGP set-multithreading order. The number of CPUs per core is one more than the program-specified maximum thread identification.
- Not applicable; multithreading is not enabled.

Figure 4-28. Program-Specified Maximum TID, TID Width, Core ID and Thread ID Fields of the CPU Address

CPU-Address Contraction

When a reset function disables multithreading, (a) the CPU address(es) of the CPU(s) having the thread-ID zero are shifted to the right by the same TID-width number of bits used during enablement, (b) zeros are inserted in the TID-width number of bits on the left of the address, and (c) the CPU address reverts to its original non-multithreading format. All CPUs in a core having nonzero thread IDs when multithreading is enabled are no longer operational when multithreading is disabled.

When multithreading is not enabled, the CPU address remains unchanged from the value assigned by the configuration-definition process. In this case, the thread identification does not exist.

CPU Signaling and Response

The CPU-signaling-and-response facility consists of SIGNAL PROCESSOR and a mechanism to interpret and act on several order codes. The facility provides for communications among CPUs, including transmitting, receiving, and decoding a set of assigned order codes; initiating the specified operation; and responding to the signaling CPU. A CPU can address SIGNAL PROCESSOR to itself. SIGNAL PROCESSOR is described in "SIGNAL PROCESSOR" on page 10-136.

Signal-Processor Orders

Note: Certain SIGP orders are described as resetting the CPU into the ESA/390 architectural mode (or simply, ESA/390 mode). When the ESA/390-compatibility-mode facility is installed in the configuration, the same reset operations will reset the CPU into the ESA/390-compatibility mode. In the following discussion of SIGP orders, wherever the phrase ESA/390 or ESA/390-compatibility mode is used, it indicates the respective mode in which the configuration was originally activated.

The signal-processor orders are specified in bit positions 56-63 of the second-operand address of SIG-

NAL PROCESSOR and are encoded as shown in Figure 4-29.

Code		Order
(Dec)	(Hex)	
0	00	Unassigned
1	01	Sense
2	02	External call
3	03	Emergency signal
4	04	Start
5	05	Stop
6	06	Restart
7	07	Unassigned
8	08	Unassigned
9	09	Stop and store status
10	0A	Unassigned
11	0B	Initial CPU reset
12	0C	CPU reset
13	0D	Set prefix
14	0E	Store status at address
15-16	0F-10	Unassigned
17	11	Store extended status at address (ESA/390-compatibility mode only)
18	12	Set architecture
19	13	Conditional Emergency Signal (z/Architecture only)
20	14	
21	15	Sense Running Status (z/Architecture only)
22	16	Set multithreading (z/Architecture only)
23	17	Store additional status at address (z/Architecture only)
24-255	17-FF	Unassigned

Figure 4-29. Encoding of SIGNAL PROCESSOR Orders

The orders are defined as follows:

Sense

The addressed CPU presents its status to the issuing CPU (see "Status Bits" on page 4-96 for a definition of the bits). No other action is caused at the addressed CPU. The status, if not all zeros, is stored in the general register designated by the R_1 field of the SIGNAL PROCESSOR instruction, and condition code 1 is set; if all status bits are zeros, condition code 0 is set.

External Call

An external-call external-interruption condition is generated at the addressed CPU. The interruption condition becomes pending during the execution of SIGNAL PROCESSOR. The associated interruption occurs when the CPU is enabled for that condition and does not necessarily occur during the execution

of SIGNAL PROCESSOR. The address of the CPU sending the signal is provided with the interruption code when the interruption occurs. Only one external-call condition can be kept pending in a CPU at a time. The order is accepted only when the addressed CPU is in the stopped or the operating state.

Emergency Signal

An emergency-signal external-interruption condition is generated at the addressed CPU. The interruption condition becomes pending during the execution of SIGNAL PROCESSOR. The associated interruption occurs when the CPU is enabled for that condition and does not necessarily occur during the execution of SIGNAL PROCESSOR. The address of the CPU sending the signal is provided with the interruption code when the interruption occurs. At any one time the receiving CPU can keep pending one emergency-signal condition for each CPU in the configuration, including the receiving CPU itself. The order is accepted only when the addressed CPU is in the stopped or the operating state.

Start

The addressed CPU performs the start function (see “CPU States” on page 4-2). The CPU does not necessarily enter the operating state during the execution of SIGNAL PROCESSOR. The order is effective only when the addressed CPU is in the stopped state. The effect of performing the start function is unpredictable when the stopped state has been entered by reset.

Stop

The addressed CPU performs the stop function (see “CPU States” on page 4-2). The CPU does not necessarily enter the stopped state during the execution of SIGNAL PROCESSOR. The order is effective only when the CPU is in the operating state.

Restart

The addressed CPU performs the restart operation (see “Restart Interruption” on page 6-56). The CPU does not necessarily perform the operation during the execution of SIGNAL PROCESSOR. The order is effective only when the addressed CPU is in the stopped or the operating state.

Stop and Store Status

The addressed CPU performs the stop function, followed by the store-status operation (see “Store Status” on page 4-82). The CPU does not necessarily

complete the operation, or even enter the stopped state, during the execution of SIGNAL PROCESSOR. The order is effective only when the addressed CPU is in the stopped or the operating state.

Initial CPU Reset

The addressed CPU performs initial CPU reset (see “Resets” on page 4-74). The execution of an initial-CPU reset initiated by SIGNAL PROCESSOR does not affect the architectural mode or other CPUs, does not disable multithreading, and does not cause I/O to be reset. The reset operation is not necessarily completed during the execution of SIGNAL PROCESSOR.

CPU Reset

The addressed CPU performs CPU reset (see “Resets” on page 4-74). The execution of a CPU reset initiated by SIGNAL PROCESSOR does not affect the architectural mode or other CPUs, does not disable multithreading, and does not cause I/O to be reset. The reset operation is not necessarily completed during the execution of SIGNAL PROCESSOR.

Set Prefix

The contents of bit positions 33-50 of the parameter register of the SIGNAL PROCESSOR instruction are treated as a prefix value, which replaces bits 33-50 of the prefix register of the addressed CPU. Bits 0-32 and 51-63 of the parameter register are ignored. The order is accepted only if the addressed CPU is in the stopped state, the value to be placed in the prefix register designates an 8K block which is available in the configuration, and no other condition precludes accepting the order. Verification of the stopped state of the addressed CPU and of the availability of the designated storage is performed during execution of SIGNAL PROCESSOR. If accepted, the order is not necessarily completed during the execution of SIGNAL PROCESSOR.

The parameter register has the following format:

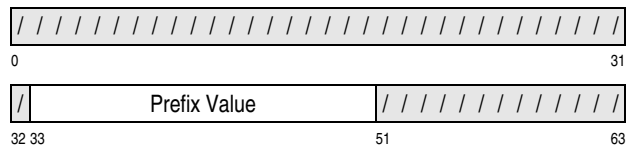

The set-prefix order is completed as follows:

- If the addressed CPU is not in the stopped state, the order is not accepted. Instead, bit 54 (incorrect state) of the general register designated by the R_1 field of the SIGNAL PROCESSOR instruction is set to one, and condition code 1 is set.
- The value to be placed in the prefix register of the addressed CPU is tested for the availability of the designated storage. The absolute address of an 8 K-byte area of storage is formed by appending 13 zeros to the right and 33 zeros to the left of bits 33-50 of the parameter value. This address is treated as a 64-bit absolute address regardless of whether the sending and receiving CPUs are in the 24-bit, 31-bit, or 64-bit addressing mode. The two 4 K-byte blocks of storage within the new prefix area are accessed. The accesses to the blocks are not subject to protection, and the associated reference bits may or may not be set to one. If either block is not available in the configuration, the order is not accepted by the addressed CPU, bit 55 (invalid parameter) of the general register designated by the R_1 field of the SIGNAL PROCESSOR instruction is set to one, and condition code 1 is set.
- The value is placed in the prefix register of the addressed CPU.
- The ALB and TLB of the addressed CPU are cleared of their contents.
- A serializing and checkpoint-synchronizing function is performed on the addressed CPU following insertion of the new prefix value.

Store Status at Address

The contents of bit positions 33-54 of the parameter register of the SIGNAL PROCESSOR instruction are used as the origin of a 512-byte area on a 512-byte boundary in absolute storage into which the status of the addressed CPU is stored. Bits 0-32 and 55-63 of the parameter register are ignored.

The order is accepted only if the addressed CPU is in the stopped state, the status-area origin designates a location which is available in the configuration, and no other condition precludes accepting the order. Verification of the stopped state of the addressed CPU and of the availability of the designated storage is performed during execution of SIGNAL PROCESSOR. If accepted, the order is not necessarily com-

pleted during the execution of SIGNAL PROCESSOR.

The parameter register has the following format:

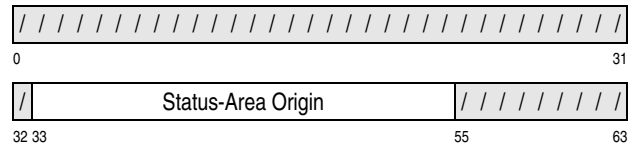

The store-status-at-address order is completed as follows:

- If the addressed CPU is not in the stopped state, the order is not accepted. Instead, bit 54 (incorrect state) of the general register designated by the R_1 field of the SIGNAL PROCESSOR instruction is set to one, and condition code 1 is set.
- The address of the area into which status is to be stored is tested for availability. The absolute address of a 512-byte area of storage is formed by appending 9 zeros to the right and 33 zeros to the left of bits 33-54 of the parameter value. This address is treated as a 64-bit absolute address regardless of whether the sending and receiving CPUs are in the 24-bit, 31-bit, or 64-bit addressing mode. The 512-byte block of storage at this address is accessed. The access is not subject to protection, and the associated reference bit may or may not be set to one. If the block is not available in the configuration, the order is not accepted by the addressed CPU, bit 55 (invalid parameter) of the general register designated by the R_1 field of the SIGNAL PROCESSOR instruction is set to one, and condition code 1 is set.
- The status of the addressed CPU is placed in the designated area. The information stored, and the format of the area receiving the information, are the same as for the stop-and-store-status order, except that each field, rather than being stored at an offset from the beginning of absolute storage, is stored in the designated area at the offsets listed in the figures below, except that an architectural-mode identification and the vector registers are not stored. Figure 4-30 illustrates the status fields in the z/Architecture architectural

mode. Bytes 288-291 and 312-319 of the designated area remain unchanged.

Field	Length in Bytes	Offset in Bytes
Floating-point registers 0-15	128	0
General registers 0-15	128	128
Current PSW	16	256
Prefix	4	280
Floating-point-control register	4	284
TOD programmable register	4	292
CPU timer	8	296
Zeros	1	304
Bits 0-55 of clock comparator	7	305
Access registers 0-15	64	320
Control registers 0-15	128	384

Figure 4-30. Location of Status Fields in Designated Area in the z/Architecture Architectural Mode

Figure 4-30 illustrates the status fields in the ESA/390-compatibility mode.

Field	Length in Bytes	Offset in Bytes
CPU timer	8	216
Clock comparator	8	224
Current PSW	8	256
Prefix	4	264
Access registers 0-15	64	288
Floating-point registers 0, 2, 4, 6	32	352
General registers 0-15 (bits 32-63)	64	384
Control registers 0-15 (bits 32-63)	64	448

Figure 4-31. Location of Status Fields in Designated Area in the ESA/390-compatibility Mode

- A serialization and checkpoint-synchronization function is performed on the addressed CPU following storing of the status.

Programming Note: The architectural mode of the CPU that stored status in a designated area normally is indicated by bit 12 of the PSW stored at offset 256 in the area. The PSW is stored at the same offset, 256, in the ESA/390 mode, ESA/390-compatibility mode, and the z/Architecture mode. Bit 12 is one in an ESA/390 or ESA/390-compatibility mode PSW and zero in a z/Architecture PSW. The store-status-at-address order does not store the architectural-mode identification that is stored at absolute location 163 by the store-status operation and the stop-and-store-status order.

Store Extended Status at Address

The contents of bit positions 33-54 of the parameter register of the SIGNAL PROCESSOR instruction are used as the origin of a 512-byte save area. Bits 0-32 and 55-63 of the parameter register are ignored. The contents of bit positions 1-19 of bytes 212-215 of the save area are used as the origin of a 4,096-byte extended save area. Bits 0 and 20-31 of bytes 212-215 are ignored.

Status of the addressed CPU is stored in the designated save area and extended save area.

The order is accepted only if the CPU is in the ESA/390-compatibility mode, the addressed CPU is in the stopped state, the save-area and extended-save-area origins designate locations that are available in the configuration, the extended-save-area origin is not 0, and no other condition precludes accepting the order. Verification of the ESA/390-compatibility mode, the stopped state of the addressed CPU, and the availability of the designated storage is performed during the execution of SIGNAL PROCESSOR. If accepted, the order is not necessarily completed during the execution of SIGNAL PROCESSOR.

The parameter register has the following format:

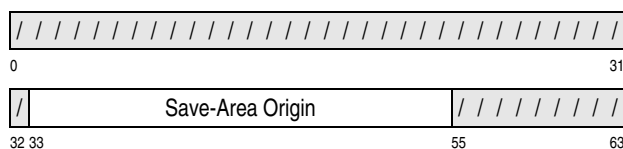

Figure 4-32 lists the fields in the save area, their lengths, and their offsets from the beginning of the area. The field in byte positions 212-215 is provided by the program. The other fields are stored during the execution of the operation specified by the order.

Field	Length in Bytes	Offset in Bytes
Extended-save-area address	4	212
CPU timer	8	216
Clock comparator	8	224
Current PSW	8	256
Prefix	4	264
Access registers 0-15	64	288
Floating-point registers 0, 2, 4, 6	32	352
General registers 0-15 (bits 32-63)	64	384
Control registers 0-15 (bits 32-63)	64	448

Figure 4-32. Save-Area Locations for Store-Extended-Status-at-Address Order

The extended-save-area address in bytes 212-215 of the save area has the following format:

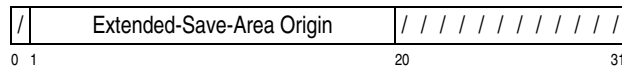

Figure 4-33 lists the fields that are stored in the extended-save area, their lengths, and their offsets from the origin of the area.

Field	Length in Bytes	Byte Offset
Floating-point registers 0-15	128	0
Floating-point control register	4	128
Reserved (stored as zeros)	12	132
Unchanged	3,952	144

Figure 4-33. Extended-Save Area Locations for Store-Extended-Status-at-Address Order.

The store-extended-status-at-address order is completed as follows.

- If the ESA/390-compatibility-mode facility is not installed, the order is not accepted. Instead, bit 62 (invalid order) of the general register designated by the R_1 field of the SIGNAL PROCESSOR instruction is set to one, and condition code 1 is set.
- If the addressed CPU is not in the stopped state, the order is not accepted. Instead, bit 54 (incorrect state) of the general register designated by the R_1 field of the SIGNAL PROCESSOR instruction is set to one, and condition code 1 is set.
- The save area is tested for the availability of the designated storage. The absolute address of the save area is formed by appending 33 zeros to the left and nine zeros to the right of bits 33-54 of the parameter value. This address is treated as a 64-bit absolute address regardless of the addressing modes of the sending and receiving CPUs. The 512-byte block of storage at this address is accessed. The access is not subject to protection, and the associated reference bit may or may not be set to one. If the block is not available in the configuration, the order is not accepted by the addressed CPU, bit 55 (invalid parameter) of the general register designated by the R_1 field of the SIGNAL PROCESSOR instruction is set to one, and condition code 1 is set.

- The extended save area is tested for having a nonzero address and for the availability of the designated storage. The absolute address of the extended save area is formed by appending 33 zeros to the left and 12 zeros to the right of bits 1-19 of bytes 212-215 of the save area. This address is treated as a 64-bit absolute address regardless of the addressing modes of the sending and receiving CPUs. If the address is not zero, the 4,096-byte block of storage at the address is accessed. The access is not subject to protection, and the associated reference bit may or may not be set to one. If the address is zero or the block is not available in the configuration, the order is not accepted by the addressed CPU, bit 55 (invalid parameter) of the general register designated by the R_1 field of the SIGNAL PROCESSOR instruction is set to one, and condition code 1 is set.
- Status of the addressed CPU is stored in the save area, as indicated in Figure 4-32 on page 4-88, and in the extended save area as indicated in Figure 4-33 on page 4-89. Bytes 0-211, 232-255, and 268-287 of the save area and bytes 144-4095 of the extended save area remain unchanged.
- A serialization and checkpoint-synchronization function is performed on the addressed CPU following storing of the status.

Set Architecture

When the configuration-z/Architecture-architectural-mode (CZAM) facility is not installed, the contents of bit positions 56-63 of the parameter register are used as a code specifying an architectural mode to which all CPUs in the configuration are to be set, as follows:

- Code 0 specifies the ESA/390 architectural mode or ESA/390-compatibility mode, with z/Architecture-unique information captured or preserved.
- Code 1 specifies the z/Architecture architectural mode.
- Code 2 specifies the z/Architecture architectural mode, with captured z/Architecture-unique information restored.

Bits 0-55 of the parameter register are ignored. The contents of the CPU-address register of the SIGNAL

PROCESSOR instruction are ignored; all CPUs in the configuration are considered to be addressed.

The order is accepted only if all of the following conditions are true:

- The code is 0, 1, or 2.
- The CZAM facility is not installed.
- The CPU is not already in the mode specified by the code.
- Each of all other CPUs is in either the stopped or the check-stop state.
- No other condition precludes accepting the order.

If accepted, the order is completed by all CPUs during the execution of SIGNAL PROCESSOR. In no case can different CPUs be in different architectural modes.

The set-architecture order is completed as follows:

- If the code in the parameter register is not 0, 1, or 2, if the CZAM facility is installed, or if the CPU is already in the architectural mode specified by the code, the order is not accepted. Instead, bit 55 (invalid parameter) of the general register designated by the R_1 field of the SIGNAL PROCESSOR instruction is set to one, and condition code 1 is set.
- If the code in the parameter register is 0 and multithreading is enabled, return to the ESA/390 architectural mode or ESA/390-compatibility mode is not possible and the order is not accepted. Instead, bit 54 (incorrect state) of the general register designated by the R_1 field of the SIGNAL PROCESSOR instruction is set to one, and condition code 1 is set.
- If it is not true that all other CPUs in the configuration are in the stopped or check-stop state, the order is not accepted. Instead, bit 54 (incorrect state) of the general register designated by the R_1 field of the SIGNAL PROCESSOR instruction is set to one, and condition code 1 is set.
- The architectural mode of all CPUs in the configuration is set as specified by the code, as follows:
 - If the order changes the architectural mode from ESA/390 to z/Architecture and the code

is 1, then, for each CPU in the configuration, the eight-byte current PSW is changed to a 16-byte PSW, and the bits of the 16-byte PSW are set as follows: bits 0-11 and 13-32 are set equal to the same bits of the eight-byte PSW, bit 12 and bits 33-96 are set to zeros, and bits 97-127 are set equal to bits 33-63 of the eight-byte PSW. Also, for each CPU in the configuration, bit 19 of the ESA/390 prefix, which becomes bit 51 of the z/Architecture prefix register, is set to zero.

If the order changes the architectural mode from ESA/390-compatibility mode to z/Architecture and the code is 1, then for each CPU in the configuration, bit 51 of the prefix register is set to zero.

If the order changes the architectural mode from ESA/390 or ESA/390-compatibility mode to z/Architecture and the code is 2, the PSW of the CPU executing SIGNAL PROCESSOR and the prefix values of all CPUs are set as in the code-1 case. For each of all other CPUs in the configuration, the PSW is set with the value of the captured-z/Architecture-PSW register — a PSW saved when the CPU last went from the z/Architecture mode to the ESA/390 or ESA/390-compatibility mode because of a set-architecture order with code 0 or a CPU reset due to activation of the load-normal or load-with-dump key. However, the captured-z/Architecture-PSW register has been set to all zeros if the CPU performed a reset, other than CPU reset, either at the time of the architectural-mode transition or subsequently.

If the order changes the architecture mode from ESA/390-compatibility mode to z/Architecture and the code is 1, bits 0-31 of the control registers for each CPU in the configuration are not modified. If the order changes the architecture mode from ESA/390-compatibility mode to z/Architecture and the code is 2, bits 0-31 of the control registers for the CPU executing SIGNAL PROCESSOR are not modified and bits 0-31 of the control registers for each of all other CPUs in the configuration are set with the values of the captured-z/Architecture-control registers.

If the order changes the architecture mode from ESA/390 to z/Architecture, bits 0-31 of

the control registers for each CPU in the configuration are not modified.

If the order changes the architecture mode to z/Architecture, bits 32-63 of the control registers for each CPU in the configuration are not modified.

- If the order changes the architectural mode from z/Architecture to ESA/390, then, for each CPU in the configuration, (1) the current PSW, which is the updated PSW in the case of the CPU executing SIGNAL PROCESSOR, is saved in the captured-z/Architecture-PSW register, and (2) the 16-byte current PSW is changed to an eight-byte PSW by setting the bits of the eight-byte PSW as follows: bits 0-11 and 13-32 are set equal to the same bits of the 16-byte PSW, bit 12 is set to one, and bits 33-63 are set equal to bits 97-127 of the 16-byte PSW. Bit 51 of the z/Architecture prefix, which becomes bit 19 of the ESA/390 prefix, remains zero.

If the order changes the architectural mode from z/Architecture to the ESA/390-compatibility mode, then, for each CPU in the configuration, (a) bits 0-31 of the control registers are saved in the captured-z/Architecture-control registers, (b) bits 0-31 of all control registers are set to zeros, and (c) bits 32-63 of all control registers are not modified.

If the order changes the architecture mode from z/Architecture to ESA/390, the 32-bit control registers defined in ESA/390 architecture mode for each CPU in the configuration are not modified.

- The ALBs and TLBs of all CPUs in the configuration are cleared of their contents.
- A serialization and checkpoint-synchronization function is performed on all CPUs in the configuration.

If the order changes the architectural mode from z/Architecture to ESA/390 or ESA/390-compatibility and the SIGNAL PROCESSOR instruction causes occurrence of an instruction-fetching PER event, only the rightmost 31 bits of the address of the instruction are stored in the ESA/390 PER-address field.

Programming Notes:

1. If the set-architecture order changes the architectural mode from z/Architecture to ESA/390 and bit 31 of the PSW is one, the PSW is invalid. If the order changes the architectural mode from z/Architecture to the ESA/390-compatibility mode, it is unpredictable whether the PSW is considered to be invalid if bit 31 is one.
2. When a program is intended to operate in the z/Architecture architectural mode but may be loaded in any of the ESA/390, ESA/390-compatibility, or z/Architecture architectural mode, the program can implement a common code path to issue the SIGNAL PROCESSOR set-architecture command to set the architectural mode to z/Architecture. If the program was loaded in a configuration in which the configuration-z/Architecture-architectural-mode facility is installed, then the SIGP instruction will complete with condition code 1, and the status in general register R₁ will indicate invalid parameter (that is, bit 55 of the register will be one). Assuming that the SIGP parameter value is valid (1 or 2), then the program can safely assume that the invalid parameter condition means that the configuration was already in the z/Architecture architectural mode.

Conditional Emergency Signal

An emergency-signal external-interruption condition may be generated at the addressed CPU. The contents of bit positions 48-63 of the parameter register of the SIGNAL PROCESSOR instruction are treated as a check-ASN value which is used as part of the condition checking of the addressed CPU. If signaling is permitted, the interruption condition becomes pending during the execution of SIGNAL PROCESSOR. The associated interruption occurs when the CPU is enabled for that condition and does not necessarily occur during the execution of SIGNAL PROCESSOR. The address of the CPU sending the signal is provided with the interruption code when the interruption occurs. At any one time the receiving CPU can keep pending one emergency-signal condition for each CPU in the configuration, including the receiving CPU itself.

The conditional-emergency-signal order is recognized only when the CPU is in the z/Architecture architectural mode. Otherwise, an unassigned-order condition is recognized.

The order is accepted only when the addressed CPU is in the stopped or the operating state and one of the following conditions of the addressed CPU can be determined:

- The PSW is disabled for external interruptions, I/O interruptions, or both.
- The CPU is in the wait state and the instruction address in the PSW is not zero.
- The CPU is not in the wait state, and the specified check-ASN value equals an ASN of the CPU (primary, secondary, both), regardless of the setting of bit positions 16-17 of the PSW.

When making the above determination of possible conditions is precluded, the conditional nature of the order is not effective, and instead the order is accepted as if an emergency-signal order had been specified.

If the order is accepted, the interruption is made pending, and condition code 0 is set. Otherwise, the interruption is not made pending, bit 54 (incorrect state) of the status register is set to one, and condition code 1 is set.

The parameter register has the following format:

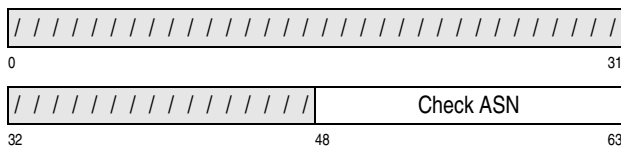

Sense Running Status

When the multithreading facility is not enabled, the following applies:

- If the addressed CPU is running, condition code 0 is set.
- If the addressed CPU is not running, status bit 53 is set to one and all other status bits are set to zero in the general register designated by the R_1 field of the SIGNAL PROCESSOR instruction, and condition code 1 is set.

When the multithreading facility is enabled, the following applies:

- If any CPU of the core in which the addressed CPU is a member is running, condition code 0 is set.

- If all CPUs of the core in which the addressed CPU is a member are not running, status bit 53 is set to one and all other status bits are set to zero in the general register designated by the R_1 field of the SIGNAL PROCESSOR instruction, and condition code 1 is set.

No other action is caused at the addressed CPU.

The sense-running-status order is recognized when the CPU is in the z/Architecture architectural mode. It is unpredictable whether the order is recognized when the CPU is in the ESA/390-compatibility mode; if the order is not recognized, an unassigned-order condition is recognized.

Programming Note: When the multithreading facility is enabled, a sense-running-status order addressed to a stopped CPU will complete with condition code 0 if any other CPU in the same core is running.

Set Multithreading

The set-multithreading order enables the multithreading facility.

Bit positions 59-63 of the parameter register contain the program-specified maximum thread identification to be provided in the configuration. The program-specified maximum thread identification is one less than the number of CPUs to be made addressable in each core. For example, a value of 3 in bit positions 59-63 indicates that four threads are to be provided. Bits 0-58 of the parameter register are reserved and should contain zeros; otherwise, the program may not operate compatibly in the future.

The contents of the CPU-address register of the SIGNAL PROCESSOR instruction are ignored; all CPUs in the configuration are considered to be addressed.

If accepted, the order is completed by all CPUs during the execution of SIGNAL PROCESSOR. The set-multithreading order is completed as follows:

- If the multithreading facility is not installed or the CPU is not in the z/Architecture architectural mode, or an external control prevents the use of multithreading, the order is not accepted. Instead, bit 62 (invalid order) of the general register designated by the R_1 field of the SIGNAL PROCESSOR instruction is set to one, and condition code 1 is set.

- If it is not true that all other CPUs in the configuration are in the stopped or check-stop state, or if the configuration is already enabled for multithreading, the order is not accepted. Instead, bit 54 (incorrect state) of the general register designated by the R_1 field of the SIGNAL PROCESSOR instruction is set to one, and condition code 1 is set.
- If the program-specified maximum thread identification in bit positions 59-63 of the parameter register contains a value not supported by the model, the order is not accepted. Instead, bit 55 (invalid parameter) of the general register designated by the R_1 field of the SIGNAL PROCESSOR instruction is set to one, and condition code 1 is set.
- When the program-specified maximum thread identification is nonzero, the following is performed:
 - The configuration is enabled for multithreading, resulting in CPU-address expansion as described in “CPU-Address Expansion” on page 4-84.
 - The meaning of a CPU-type topology-list entry (TLE) of a SYSIB 15.1.x in the STORE SYSTEM INFORMATION instruction is changed (see “Fields Specific to a CPU-type TLE” on page 10-160).
 - The ALBs and TLBs of all CPUs in the configuration are cleared of their contents.
 - The MT-diagnostic counter set is set to the active state.

When the program-specified maximum thread identification is zero, the configuration is not enabled for multithreading.

- A serialization and checkpoint-synchronization function is performed on all CPUs in the configuration.

Upon successful completion, all CPUs other than the CPU executing the set-multithreading order remain in the stopped or check-stop state. However, if a CPU was in the check-stop state before multithreading is enabled, it is unpredictable whether the CPUs having nonzero thread IDs in the same core are placed in the stopped or check-stopped state.

The architected register context (that is, the contents of the PSW, CPU timer, clock comparator, general registers, floating-point registers and floating-point-control register, vector registers, control registers, access registers, prefix register, and TOD-programmable register) of each CPU before multithreading is enabled becomes the architected register context of the CPU having TID zero of each respective core after multithreading is enabled. Similarly, the architected register context of the CPU having TID zero of each core of an MT-enabled configuration becomes the architected register context of each respective CPU when multithreading is disabled as a result of the activation of the load-normal or load-with-dump key.

The architected register context of all CPUs having a nonzero thread identification are retained when the multithreading facility is disabled as a result of the activation of the load-normal or load-with-dump key. If the multithreading facility is subsequently re-enabled without an intervening clear reset, the architected register context of all CPUs having a nonzero thread identification are restored.

When multithreading is re-enabled after having been disabled by the activation of the load-normal or load-with-dump key, if the value of the program-specified maximum thread identification in bits 59-63 of the parameter register differs from that used in the preceding enablement, then the architected register context of all CPUs having nonzero thread IDs is unpredictable.

Store Additional Status at Address

Additional status information is stored in the status area designated by the parameter register.

When the guarded-storage facility is not installed, the contents of bit positions 0-53 of the parameter register of the SIGNAL PROCESSOR instruction are used as the origin of a 1024-byte area on a 1024-byte boundary in absolute storage into which the additional status of the addressed CPU is stored. Bits 54-63 of the parameter register must be zero.

When the guarded-storage facility is installed, bit positions 60-63 of the parameter register contain a length characteristic (LC) that specifies the size and alignment of the additional-status area as a power of two; an LC value of zero is treated as 10. Bits 0 through 63-LC of the parameter register, with LC zeros appended on the right, are used as the abso-

lute address of a 2^{LC} -byte area, aligned on a 2^{LC} -byte boundary, into which the additional status of the addressed CPU is stored. Bit positions 64-LC through 59 of the parameter register must contain zeros. The valid length-characteristic values are the same as those in the machine-check-extended-save-area designation, as shown in Figure 3-18 on page 3-81; all other LC values are reserved.

The order is accepted only if the addressed CPU is in the stopped state, the status-area origin designates a location which is available in the configuration, and no other condition precludes accepting the order. Verification of the stopped state of the addressed CPU and of the availability of the designated storage is performed during execution of SIGNAL PROCESSOR. If accepted, the order is not necessarily completed during the execution of SIGNAL PROCESSOR.

When the guarded-storage facility is not installed, the parameter register has the following format:

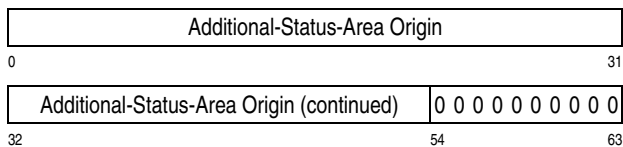

When the guarded-storage facility is installed, the parameter register has the following format:

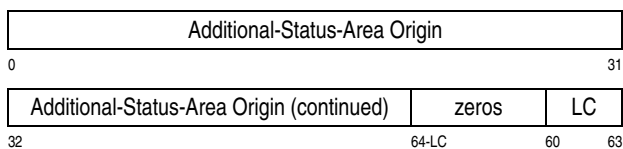

The store-additional-status-at-address order is completed as follows:

- The order is accepted only if at least one of the facilities that produce additional status is installed, including any of the following:
 - Vector facility for z/Architecture
 - Guarded-storage facility
- If neither of these facilities is installed, the order is not accepted. Instead, bit 62 (invalid order) of the general register designated by the R_1 field of the SIGNAL PROCESSOR instruction is set to one, and condition code 1 is set.

- If the addressed CPU is not in the stopped state, the order is not accepted. Instead, bit 54 (incorrect state) of the general register designated by the R_1 field of the SIGNAL PROCESSOR instruction is set to one, and condition code 1 is set.
- If the guarded-storage facility is installed, and a reserved LC value is specified, or if any of the reserved bit positions in the parameter register do not contain zero, the order is not accepted by the addressed CPU, bit 55 (invalid parameter) of the general register designated by the R_1 field of the SIGNAL PROCESSOR instruction is set to one, and condition code 1 is set. When the guarded-storage facility is not installed, bit positions 54-63 of the parameter register are reserved. When the guarded-storage facility is installed, bit positions 64-LC through 59 are reserved.
- The address of the area into which status is to be stored is tested for availability. When the guarded-storage facility is not installed, the absolute address of a 1024-byte area of storage is formed by appending 10 zeros to the right of bits 0-53 of the parameter value. When the guarded-storage facility is installed, the absolute address of a 2^{LC} -byte area of storage is formed by appending LC zeros to the right of bits 0 through 63-LC of the parameter register.

This address is treated as a 64-bit absolute address regardless of whether the sending and receiving CPUs are in the 24-bit, 31-bit, or 64-bit addressing mode. The block of storage at this address is accessed. The access is not subject to protection, and the associated reference bit may or may not be set to one. If the block is not available in the configuration, the order is not accepted by the addressed CPU, bit 55 (invalid parameter) of the general register designated by the R_1 field of the SIGNAL PROCESSOR instruction is set to one, and condition code 1 is set.

- A serialization and checkpoint-synchronization function is performed on the addressed CPU following storing of the status.

The format of the additional-status area is identical to that of the machine-check extended save area as described in “Machine-Check Extended Save Area (MCESA)” on page 11-24. If the minimum length required to store a facility’s registers is not specified

in the length code, then those registers are not stored in the additional-status area.

Programming Note: For a discussion of the relative performance of the SIGNAL PROCESSOR orders, see the programming note following the instruction “SIGNAL PROCESSOR” on page 10-136.

Conditions Determining Response

Conditions Precluding Interpretation of the Order Code

The following situations preclude the initiation of the order. The sequence in which the situations are listed is the order of priority for indicating concurrently existing situations:

1. The access path to the addressed CPU is busy because a concurrently executed SIGNAL PROCESSOR is using the CPU-signaling-and-response facility. The CPU which is concurrently executing the instruction can be any CPU in the configuration other than this CPU, and the CPU address can be any address, including that of this CPU or an invalid address. The order is rejected. Condition code 2 is set.
2. The addressed CPU is not operational; that is, it is not provided in the installation, it is not in the configuration, its use is restricted based on model or CPU type, it is in any of certain customer-engineer test modes, or its power is off. The order is rejected. Condition code 3 is set. This condition cannot arise as a result of a SIGNAL PROCESSOR instruction executed by a CPU addressing itself.
3. One of the following conditions exists at the addressed CPU:
 - a. A previously issued start, stop, restart, stop-and-store-status, set-prefix, store-status-at-address order, or store-additional-status-at-address has been accepted by the addressed CPU, and execution of the function requested by the order has not yet been completed.
 - b. A manual start, stop, restart, or store-status function has been initiated at the addressed CPU, and the function has not yet been completed. This condition cannot arise as a result of a SIGNAL PROCESSOR instruction executed by a CPU addressing itself.

If the currently specified order is sense, external call, emergency signal, start, stop, restart, stop and store status, set prefix, store status at address, set architecture, set multithreading, or store additional status at address, then the order is rejected, and condition code 2 is set. If the currently specified order is one of the reset orders, or an unassigned or not-implemented order, the order code is interpreted as described in “Status Bits” on page 4-96.

4. One of the following conditions exists at the addressed CPU:
 - a. A previously issued initial-CPU-reset or CPU-reset order has been accepted by the addressed CPU, and execution of the function requested by the order has not yet been completed.
 - b. A manual-reset function has been initiated at the addressed CPU, and the function has not yet been completed. This condition cannot arise as a result of a SIGNAL PROCESSOR instruction executed by a CPU addressing itself.

If the currently specified order is sense, external call, emergency signal, start, stop, restart, stop and store status, set prefix, store status at address, set architecture, set multithreading, or store additional status at address, then the order is rejected, and condition code 2 is set. If the currently specified order is one of the reset orders, or an unassigned or not-implemented order, either the order is rejected and condition code 2 is set or the order code is interpreted as described in “Status Bits” on page 4-96.

When any of the conditions described in items 3 and 4 exists, the addressed CPU is referred to as “busy.” Busy is not indicated if the addressed CPU is in the check-stop state or when the operator-intervening condition exists. A CPU-busy condition is normally of short duration; however, the conditions described in item 3 may last indefinitely because of a string of interruptions. In this situation, however, the CPU does not appear busy to any of the reset orders.

When the conditions described in items 1 and 2 above do not apply and operator-intervening and receiver-check status conditions do not exist at the addressed CPU, reset orders may be accepted regardless of whether the addressed CPU has completed a previously accepted order. This may cause

the previous order to be lost when it is only partially completed, making unpredictable whether the results defined for the lost order are obtained.

Status Bits

Various status conditions are defined whereby the issuing and addressed CPUs can indicate their responses to the specified order. The status conditions and their bit positions in the general register designated by the R_1 field of the SIGNAL PROCESSOR instruction are shown in Figure 4-34.

Bit Position	Status Condition
32	Equipment check
33-52	Unassigned; zeros stored
53	Not running
54	Incorrect state
55	Invalid parameter
56	External-call pending
57	Stopped
58	Operator intervening
59	Check stop
60	Unassigned; zero stored
61	Inoperative
62	Invalid order
63	Receiver check

Figure 4-34. Status Conditions

The status condition assigned to bit position 32, and to bit position 55 when the order is set architecture or set multithreading, are generated by the CPU executing SIGNAL PROCESSOR. The remaining status conditions are generated by the addressed CPU.

When the invalid-parameter condition exists for the set-architecture or set multithreading order, bit 55 of the general register designated by the R_1 field of the SIGNAL PROCESSOR instruction is set to one, all other bits in bit positions 32-63 are set to zeros, bits 0-31 of the register remain unchanged, and condition code 1 is set. No other action is taken.

When the equipment-check condition exists, except when the invalid-parameter condition exists for the set-architecture or set multithreading order, bit 32 of the general register designated by the R_1 field of the SIGNAL PROCESSOR instruction is set to one, unassigned bits in bit positions 32-63 of the status register are set to zeros, the other status bits are unpredictable, and bits 0-31 of the register remain unchanged. In this case, condition code 1 is set inde-

pendent of whether the access path to the addressed CPU is busy and independent of whether the addressed CPU is not operational, is busy, or has presented zero status.

When the access path to the addressed CPU is not busy and the addressed CPU is operational and does not indicate busy to the currently specified order, the addressed CPU presents its status to the issuing CPU. These status bits are of two types:

1. Status bits 53, 54, and 55 when the order is neither set architecture nor set-multithreading, 56-59, and 61 indicate the presence of the corresponding conditions in the addressed CPU at the time the order code is received. Except in response to the sense order and the sense-running-status order, each condition is indicated only when the condition precludes the successful execution of the specified order, although invalid parameter is not necessarily indicated when any other precluding condition exists. In the case of sense, all existing status conditions except not-running are indicated; the operator-intervening condition is indicated if it precludes the execution of any installed order.
2. Status bits 62 and 63 indicate that the corresponding conditions were detected by the addressed CPU during reception of the order.

If the presented status is all zeros, the addressed CPU has accepted the order, and condition code 0 is set at the issuing CPU; if the presented status is not all zeros, the order has been rejected, the status is stored at the issuing CPU in the general register designated by the R_1 field of the SIGNAL PROCESSOR instruction, zeros are stored in the unassigned positions in bit positions 32-63 of the register, bits 0-31 of the register remain unchanged, and condition code 1 is set.

When the order is set architecture or set multithreading, "the addressed CPU" refers to each of the other CPUs in the configuration. Those CPUs, in an unpredictable order, are tested for a condition that causes setting of condition code 1, 2, or 3. Conditions are prioritized for a single CPU as if it were the only CPU addressed, but there is no prioritization across CPUs. If a condition is recognized, no further CPUs are tested, the condition code corresponding to the condition is set, and the execution of SIGNAL PROCESSOR is completed.

The status conditions are defined as follows:

Equipment Check: This condition exists when the CPU executing the instruction detects equipment malfunctioning that has affected only the execution of this instruction and the associated order. The order code may or may not have been transmitted and may or may not have been accepted, and the status bits provided by the addressed CPU may be in error. This condition is not detected if the invalid-parameter condition for the set-architecture or set-multithreading order is detected.

Not Running: This condition exists when the addressed CPU is not running. The condition, when present, is indicated only in response to the sense-running-status order. This condition is not reported as a result of a SIGNAL PROCESSOR instruction executed by a CPU addressing itself; condition code 0 is always set in this case. A CPU is running when it is assigned to a physical CPU.

Incorrect State: The condition exists in the following cases:

1. A set-prefix, store-status-at-address, or store-additional-status-at-address order has been rejected because the addressed CPU is not stopped.
2. A set-architecture, or set-multithreading order has been rejected because not all other CPUs are stopped or in the check-stop state.
3. A set-multithreading order or a set-architecture order to set the ESA/390 architectural mode or ESA/390-compatibility mode has been rejected because multithreading is currently enabled.
4. A conditional emergency-signal order has been rejected because the addressed CPU is not in a required state.

When applicable, this status is generated during execution of SIGNAL PROCESSOR and is indicated concurrently with other indications of conditions which preclude execution of the order, except that this status is not generated if an invalid-parameter condition exists for a set-architecture order.

Invalid Parameter: This condition exists in the following cases:

1. The parameter value supplied with a set-prefix, store-status-at-address, or store-additional-sta-

tus-at-address order designates a storage location which is not available in the configuration. When applicable, this status is generated during execution of SIGNAL PROCESSOR, except that it is not necessarily generated when another condition precluding execution of the order also exists.

2. The parameter value supplied with a set-architecture order either is not 0 or 1 or specifies the current architectural mode. When applicable, this status is generated during execution of SIGNAL PROCESSOR, and no other status is generated.
3. The parameter value supplied with a set-multithreading order specifies a value not supported by the model.
4. The parameter value supplied with a store-additional-status-at-address order contains a non-zero value in bit positions 54-63 of the parameter register.
5. The configuration-z/Architecture-architectural-mode (CZAM) facility is installed, and a set-architecture order was specified.

External Call Pending: This condition exists when an external-call interruption condition is pending in the addressed CPU because of a previously issued SIGNAL PROCESSOR order. The condition exists from the time an external-call order is accepted until the resultant external interruption has been completed or a CPU reset occurs. The condition may be due to the issuing CPU or another CPU. The condition, when present, is indicated only in response to sense and to external call.

Stopped: This condition exists when the addressed CPU is in the stopped state. The condition, when present, is indicated only in response to sense. This condition cannot be reported as a result of a SIGNAL PROCESSOR instruction executed by a CPU addressing itself.

Operator Intervening: This condition exists when the addressed CPU is executing certain operations initiated from local or remote operator facilities. The particular manually initiated operations that cause this condition to be present depend on the model and on the order specified. The operator-intervening condition may exist when the addressed CPU uses reloadable control storage to perform an order and the required licensed internal code has not been loaded by the IML function. The operator-intervening

condition, when present, can be indicated in response to all orders. Operator intervening is indicated in response to sense if the condition is present and precludes the acceptance of any of the installed orders. The condition may also be indicated in response to unassigned or uninstalled orders. This condition cannot arise as a result of a SIGNAL PROCESSOR instruction executed by a CPU addressing itself.

Check Stop: This condition exists when the addressed CPU is in the check-stop state. The condition, when present, is indicated only in response to sense, external call, emergency signal, conditional emergency signal, start, stop, restart, set prefix, store status at address, and stop and store status. The condition may also be indicated in response to unassigned or uninstalled orders. This condition cannot be reported as a result of a SIGNAL PROCESSOR instruction executed by a CPU addressing itself.

Inoperative: This condition indicates that the execution of the operation specified by the order code requires the use of a service processor which is inoperative. The failure of the service processor may have been previously reported by a service-processor-damage machine-check condition. The inoperative condition cannot occur for the conditional emergency signal, emergency-signal, external-call, sense, or sense-running-status order codes.

Invalid Order: This condition exists during the communications associated with the execution of SIGNAL PROCESSOR when an unassigned or uninstalled order code is decoded.

Receiver Check: This condition exists when the addressed CPU detects malfunctioning of equipment during the communications associated with the execution of SIGNAL PROCESSOR. When this condition is indicated, the order has not been initiated, and, since the malfunction may have affected the generation of the remaining receiver status bits, these bits are not necessarily valid. A machine-check condition may or may not have been generated at the addressed CPU.

The following chart summarizes which status conditions are presented to the issuing CPU in response to each order code.

Order	Status Condition									
	53 – Not running	54 – Incorrect state	55 – Invalid parameter	56 – External call pending	57 – Stopped	58 – Operator intervening#	59 – Check stop	61 – Inoperative	62 – Invalid order	63 – Receiver check#
Sense	0	0	0	X	X	X	X	0	0	X
External call	0	0	0	X	0	X	X	0	0	X
Emergency signal	0	0	0	0	0	X	X	0	0	X
Start	0	0	0	0	0	X	X	X	0	X
Stop	0	0	0	0	0	X	X	X	0	X
Restart	0	0	0	0	0	X	X	X	0	X
Stop and store status	0	0	0	0	0	X	X	X	0	X
Initial CPU reset	0	0	0	0	0	X	0	X	0	X
CPU reset	0	0	0	0	0	X	0	X	0	X
Set prefix	0	X	X	0	0	X	X	X	0	X
Store status at address	0	X	X	0	0	X	X	X	0	X
Set architecture	0	X	X	0	0	X	0	X	X	X
Conditional emergency signal	0	X	0	0	0	X	X	0	X	X
Sense running status	X	0	0	0	0	0	0	0	X	0
Set multithreading	0	X	X	0	0	X	0	X	X	X
Store additional status at address	0	X	X	0	0	X	X	X	X	X
Unassigned order	0	0	0	0	0	X	E	X	1	0
Explanation										
#	The current state of the operator-intervening condition may depend on the order code that is being interpreted.									
≠	If a one is presented in the receiver-check bit position, the values presented in the other bit positions are not necessarily valid.									
0	A zero is presented in this bit position regardless of the current state of this condition.									
1	A one is presented in this bit position.									
X	A zero or a one is presented in this bit position, reflecting the current state of the corresponding condition.									
E	Either a zero or the current state of the corresponding condition is indicated.									

Figure 4-35. Status Conditions in Response to Order Code

If the presented status bits are all zeros, the order has been accepted, and the issuing CPU sets condition code 0. If one or more ones are presented, the order has been rejected, and the issuing CPU stores the status in the general register designated by the R₁ field of the SIGNAL PROCESSOR instruction and sets condition code 1.

Programming Notes:

1. All SIGNAL PROCESSOR orders except set architecture and set multithreading (for which all CPUs in the configuration are considered to be addressed) can be addressed to this same CPU. The following are examples of functions obtained by a CPU addressing SIGNAL PROCESSOR to itself:
 - a. *Sense* indicates whether an external-call condition is pending.
 - b. *External call* and *emergency signal* cause the corresponding interruption conditions to be generated. *External call* can be rejected because of a previously generated external-call condition.
 - c. *Start* sets condition code 0 and has no other effect.
 - d. *Stop* causes the CPU to set condition code 0, take pending interruptions for which it is enabled, and enter the stopped state.
 - e. *Restart* provides a means to store the current PSW.
 - f. *Stop and store status* causes the machine to stop and store all current status.
2. Two CPUs can simultaneously execute SIGNAL PROCESSOR, with each CPU addressing the other. When this occurs, one CPU, but not both, can find the access path busy because of the transmission of the order code or status bits associated with SIGNAL PROCESSOR that is being executed by the other CPU. Alternatively, both CPUs can find the access path available and transmit the order codes to each other. In particular, two CPUs can simultaneously stop, restart, or reset each other.
3. To obtain status from another CPU which is in the check-stop state by means of the store-status-at-address or store-additional-status-at-address order, a CPU reset operation should first be used to bring the CPU to the stopped state. This reset order does not alter the status, and, depending on the nature of the malfunction, provides the best chance of establishing conditions in the addressed CPU which allow status to be obtained.

Facility Indications

Facilities installed in a configuration are indicated by facility bits stored by the STORE FACILITY LIST (STFL) and STORE FACILITY LIST EXTENDED (STFLE) instructions.

STORE FACILITY LIST stores an indication of up to 32 facilities in the word at real location 200. STFL is described in Chapter 10, "Control Instructions".

STORE FACILITY LIST EXTENDED stores a variable number of doublewords containing facility bits in a program-specified location. STFLE is described in Chapter 7, "General Instructions".

Figure 4-36 shows the meanings of the assigned facility bits.

Bit Meaning When Bit Is One

- | | |
|---|--|
| 0 | The instructions marked "N3" in the instruction-summary figures in Chapters 7 and 10 are installed. |
| 1 | The z/Architecture architectural mode is installed. |
| 2 | The z/Architecture architectural mode is active. When bits 2 and 168 are both zero, the ESA/390 architectural mode is active. When bit 2 is zero and bit 168 is one, the ESA/390-compatibility mode is active. |
| 3 | The DAT-enhancement facility is installed in the z/Architecture architectural mode. The DAT-enhancement facility includes the INVALIDATE DAT TABLE ENTRY (IDTE) and COMPARE AND SWAP AND PURGE (CSPG) instructions. |
| 4 | INVALIDATE DAT TABLE ENTRY (IDTE) performs the invalidation-and-clearing operation by selectively clearing TLB segment-table entries when a segment-table entry or entries are invalidated. IDTE also performs the clearing-by-ASCE operation. Unless bit 4 is one, IDTE simply purges all TLBs. Bit 3 is one if bit 4 is one. |
| 5 | INVALIDATE DAT TABLE ENTRY (IDTE) performs the invalidation-and-clearing operation by selectively clearing TLB region-table entries when a region-table entry or entries are invalidated. Bits 3 and 4 are ones if bit 5 is one. |
| 6 | The ASN-and-LX reuse facility is installed in the z/Architecture architectural mode. |
| 7 | The store-facility-list-extended facility is installed. |
| 8 | The enhanced-DAT facility 1 is installed in the z/Architecture architectural mode. |
| 9 | The sense-running-status facility is installed in the z/Architecture architectural mode. |

Figure 4-36. Assigned Facility Bits (Part 1 of 5)

Bit	Meaning When Bit Is One	Bit	Meaning When Bit Is One
10	The conditional-SSKE facility is installed in the z/Architecture architectural mode.	38	The order-preserving-compression facility is installed in the z/Architecture architectural mode.
11	The configuration-topology facility is installed in the z/Architecture architectural mode.	39	Assigned to IBM internal use.
12	Assigned to IBM internal use.	40	The load-program-parameters facility is installed in the z/Architecture architectural mode.
13	The IPTE-range facility is installed in the z/Architecture architectural mode.	41	The floating-point-support-enhancement facilities (DFP-rounding, FPR-GR-transfer, FPS-sign-handling, and IEEE-exception-simulation) are installed in the z/Architecture architectural mode.
14	The nonquiescing key-setting facility is installed in the z/Architecture architectural mode.	42	The DFP (decimal-floating-point) facility is installed in the z/Architecture architectural mode.
15	Assigned to IBM internal use.	43	The DFP (decimal-floating-point) facility has high performance. Bit 42 is one if bit 43 is one.
16	The extended-translation facility 2 is installed.	44	The PFPO instruction is installed in the z/Architecture architectural mode.
17	The message-security assist is installed.	45	The distinct-operands, fast-BCR-serialization, high-word, and population-count facilities, the interlocked-access facility 1, and the load/store-on-condition facility 1 are installed in the z/Architecture architectural mode.
18	The long-displacement facility is installed in the z/Architecture architectural mode.	46	Assigned to IBM internal use.
19	The long-displacement facility has high performance. Bit 18 is one if bit 19 is one.	47	The CMPSC-enhancement facility is installed in the z/Architecture architectural mode.
20	The HFP-multiply-and-add/subtract facility is installed.	48	The decimal-floating-point zoned-conversion facility is installed in the z/Architecture architectural mode.
21	The extended-immediate facility is installed in the z/Architecture architectural mode.	49	The execution-hint, load-and-trap, and processor-assist facilities, and the miscellaneous-instruction-extensions facility 1 are installed in the z/Architecture architectural mode.
22	The extended-translation facility 3 is installed in the z/Architecture architectural mode.	50	The constrained transactional-execution facility is installed in the z/Architecture architectural mode. This bit is meaningful only when bit 73 is one.
23	The HFP-unnormalized-extension facility is installed in the z/Architecture architectural mode.	51	The local-TLB-clearing facility is installed in the z/Architecture architectural mode.
24	The ETF2-enhancement facility is installed.	52	The interlocked-access facility 2 is installed.
25	The store-clock-fast facility is installed in the z/Architecture architectural mode.	53	The load/store-on-condition facility 2 and load-and-zero-rightmost-byte facility are installed in the z/Architecture architectural mode.
26	The parsing-enhancement facility is installed in the z/Architecture architectural mode.	54	The entropy-encoding compression facility is installed in the z/Architecture architectural mode.
27	The move-with-optional-specifications facility is installed in the z/Architecture architectural mode.	55	Assigned to IBM internal use.
28	The TOD-clock-steering facility is installed in the z/Architecture architectural mode.	57	The message-security-assist extension 5 is installed in the z/Architecture architectural mode.
30	The ETF3-enhancement facility is installed in the z/Architecture architectural mode.	58	The miscellaneous-instruction-extensions facility 2 is installed in the z/Architecture architectural mode.
31	The extract-CPU-time facility is installed in the z/Architecture architectural mode.	59	Assigned to IBM internal use.
32	The compare-and-swap-and-store facility is installed in the z/Architecture architectural mode.	60	Assigned to IBM internal use.
33	The compare-and-swap-and-store facility 2 is installed in the z/Architecture architectural mode.		
34	The general-instructions-extension facility is installed in the z/Architecture architectural mode.		
35	The execute-extensions facility is installed in the z/Architecture architectural mode.		
36	The enhanced-monitor facility is installed in the z/Architecture architectural mode.		
37	The floating-point extension facility is installed in the z/Architecture architectural mode. When bit 37 is one, bit 42 is also one.		

Figure 4-36. Assigned Facility Bits (Part 2 of 5)

Figure 4-36. Assigned Facility Bits (Part 3 of 5)

Bit Meaning When Bit Is One

61	The miscellaneous-instruction-extensions facility 3 is installed in the z/Architecture architectural mode. When bit 61 is one, bit 45 is also one.
62	Assigned to IBM internal use.
63	Assigned to IBM internal use.
64	Assigned to IBM internal use.
65	Assigned to IBM internal use.
66	The reset-reference-bits-multiple facility is installed in the z/Architecture architectural mode.
67	The CPU-measurement counter facility is installed in the z/Architecture architectural mode.
68	The CPU-measurement sampling facility is installed in the z/Architecture architectural mode.
69	Assigned to IBM internal use.
70	Assigned to IBM internal use.
71	Assigned to IBM internal use.
72	Assigned to IBM internal use.
73	The transactional-execution facility is installed in the z/Architecture architectural mode. Bit 49 is one when bit 73 is one.
74	The store-hypervisor-information facility is installed in the z/Architecture architectural mode (see Reference [11.] on page xxx).
75	The access-exception-fetch/store-indication facility is installed in the z/Architecture architectural mode.
76	The message-security-assist extension 3 is installed in the z/Architecture architectural mode.
77	The message-security-assist extension 4 is installed in the z/Architecture architectural mode.
78	The enhanced-DAT facility 2 is installed in the z/Architecture architectural mode.
80	The decimal-floating-point packed-conversion facility is installed in the z/Architecture architectural mode.
81	The PPA-in-order facility is installed in the z/Architecture architectural mode.
82	Assigned to IBM internal use.
128	Assigned to IBM internal use.
129	The vector facility for z/Architecture is installed in the z/Architecture architectural mode.
130	The instruction-execution-protection facility is installed in the z/Architecture architectural mode.
131	The side-effect-access facility is installed in the z/Architecture architectural mode.
133	The guarded-storage facility is installed in the z/Architecture architectural mode.
134	The vector packed decimal facility is installed in the z/Architecture architectural mode. When bit 134 is one, bit 129 is also one.

*Figure 4-36. Assigned Facility Bits (Part 4 of 5)***Bit Meaning When Bit Is One**

135	The vector enhancements facility 1 is installed in the z/Architecture architectural mode. When bit 135 is one, bit 129 is also one.
138	The configuration-z/Architecture-architectural-mode facility is installed.
139	The multiple-epoch facility is installed in the z/Architecture architectural mode. Bits 25 and 28 are one when bit 139 is one.
140	Assigned to IBM internal use.
141	Assigned to IBM internal use.
142	The store-CPU-counter-multiple facility is installed (see Reference [10.] on page xxx).
144	The test-pending-external-interruption facility is installed in the z/Architecture architectural mode.
145	The insert-reference-bits-multiple facility is installed in the z/Architecture architectural mode.
146	The message-security-assist-extension 8 is installed in the z/Architecture architectural mode. Bit 76 is one when bit 146 is one.
147	Reserved for IBM use.
148	The vector-enhancements facility 2 is installed in the z/Architecture architectural mode. When bit 148 is one, bits 129 and 135 are also one.
149	The move-page-and-set-key facility is installed. When bit 149 is one, bit 14 is also one.
151	The DEFLATE-conversion facility is installed in the z/Architecture architectural mode.
152	The vector-packed-decimal-enhancement facility is installed in the z/Architecture architectural mode. When bit 152 is one, bits 129 and 134 are also one.
155	The message-security-assist-extension-9 facility is installed in the z/Architecture architectural mode. Bits 76 and 77 are one when bit 155 is one.
156	Assigned to IBM internal use.
168	The ESA/390-compatibility-mode facility is installed in the configuration.

Figure 4-36. Assigned Facility Bits (Part 5 of 5)

When a facility defined to be installed in a specific architectural mode is installed in the configuration, the corresponding facility bit is set to one, regardless of the architectural mode at the time STORE FACILITY LIST or STORE FACILITY LIST EXTENDED is executed. A facility, which is defined to be installed in a specific architectural mode, is available when the corresponding facility bit is one and the current architectural mode matches the specific architectural mode. However, when instructions defined to be unique to the z/Architecture architectural mode are issued in the ESA/390-compatibility mode (a hybrid architectural mode), it is unpredictable whether an operation exception is recognized, or the instruction

executes according to its z/Architecture definition. For further details, refer to “ESA/390-Compatibility-Mode Facility” on page 5-111.

Unassigned bits are reserved for indication of new facilities; these bits may be stored as ones in the future.

STORE FACILITY LIST and STORE FACILITY LIST EXTENDED may report the absence of a facility, even though the execution of the facility’s instructions may appear to indicate that the facility is installed. The under-reporting of facility indications may occur because one or more systems in the computing environment (to which the application may be relocated) do not have the facility installed.

Programming Note: Prior to the introduction of z/Architecture, determination of the presence of a facility was often accomplished by means of a trial execution of an instruction. If an operation exception

was not recognized during the trial execution, then it could be assumed that the facility was present.

Similarly, certain instructions provide a query function to determine the availability of other functions of the instruction or related instructions. However, a program might attempt to determine the availability of a particular function by trial execution of the function.

With the advent of facility and function indications in z/Architecture, the technique of trial execution should be avoided — particularly if a workload may be relocated to another system in which a facility’s instructions may not be present. In such an environment, STORE FACILITY LIST EXTENDED (STFLE) or an instruction’s query or test function may provide a more accurate indication of facilities and functions that are available on all systems in the computing environment.

Chapter 5. Program Execution

Instructions	5-3	Control Register 5	5-35
Operands	5-3	PC-Number Translation Tables	5-36
Instruction Formats	5-3	Linkage-Table Entries	5-36
Register Operands	5-7	Linkage-First-Table Entries	5-36
Immediate Operands	5-8	Linkage-Second-Table Entries	5-37
Storage Operands	5-9	Entry-Table Entries	5-37
Address Generation	5-10	Table Summary	5-38
Trimodal Addressing	5-10	PC-Number-Translation Process	5-39
Sequential Instruction-Address Generation ..	5-10	Obtaining the Linkage-Table or Linkage-	
Operand-Address Generation	5-11	First-Table Designation	5-42
Formation of the Intermediate Value	5-11	Linkage-Table Lookup	5-42
Formation of the Operand Address	5-12	Linkage-First-Table Lookup	5-42
Branch-Address Generation	5-12	Linkage-Second-Table Lookup	5-43
Formation of the Intermediate Value	5-12	Linkage-Second-Table-Entry-Sequence-	
Formation of the Branch Address	5-13	Number Comparison	5-43
Instruction Execution and Sequencing	5-14	Entry-Table Lookup	5-43
Decision Making	5-14	Recognition of Exceptions during	
Loop Control	5-14	PC-Number Translation	5-44
Subroutine Linkage without the Linkage Stack	5-14	Home Address Space	5-44
Simple Branch Instructions	5-14	Access-Register Introduction	5-45
Other Linkage Instructions	5-17	Summary	5-45
Interruptions	5-22	Access-Register Functions	5-46
Types of Instruction Ending	5-22	Access-Register-Specified Address	
Completion	5-22	Spaces	5-46
Suppression	5-22	Access-Register Instructions	5-52
Nullification	5-23	Access-Register Translation	5-53
Termination	5-23	Access-Register-Translation Control	5-53
Interruptible Instructions	5-24	Control Register 2	5-53
Point of Interruption	5-24	Control Register 5	5-54
Unit of Operation	5-24	Control Register 8	5-54
Execution of Interruptible Instructions	5-24	Access Registers	5-54
Condition-Code Alternative to I		Access-Register-Translation Tables	5-55
nterruptibility	5-25	Dispatchable-Unit Control Table and	
Exceptions to Nullification and Suppression ..	5-26	Access-List Designations	5-55
Modification of DAT-Table Entries	5-27	Access-List Entries	5-56
Trial Execution for Editing Instructions and		ASN-Second-Table Entries	5-57
Translate Instruction	5-27	Access-Register-Translation Process	5-59
Authorization Mechanisms	5-27	Selecting the Access-List-Entry Token	5-62
Mode Requirements	5-28	Obtaining the Primary or Secondary	
Extraction-Authority Control	5-28	Address-Space-Control Element	5-62
PSW-Key Mask	5-28	Checking the First Byte of the ALET	5-62
Secondary-Space Control	5-29	Obtaining the Effective Access-List	
Subsystem-Linkage Control	5-29	Designation	5-62
ASN-Translation Control	5-29	Access-List Lookup	5-62
Authorization Index	5-29	Locating the ASN-Second-Table Entry	5-63
Instructions and Controls Related to		Authorizing the Use of the Access-List	
ASN-and-LX Reuse	5-30	Entry	5-63
PC-Number Translation	5-33	Checking for Access-List-Controlled	
PC-Number Translation Control	5-34	Protection	5-64
Control Register 0	5-35		

Obtaining the Address-Space-Control Element from the ASN-Second-Table Entry	5-64	Transactional-Execution Terminology	5-89
Recognition of Exceptions during Access-Register Translation	5-64	Transactional-Execution Facility Controls	5-92
ART-Lookaside Buffer	5-64	Control Register Bits	5-92
ALB Structure	5-64	Transaction-Diagnostic-Block Address (TDBA).	5-93
Formation of ALB Entries	5-64	Transaction-Abort PSW (TAPSW).	5-93
Use of ALB Entries	5-65	Transaction Nesting Depth (TND)	5-93
Modification of ART Tables	5-66	Transaction Diagnostic Block (TDB)	5-93
Subspace Groups	5-66	Transactional-Execution Facility Instructions	5-97
Subspace-Group Tables	5-66	Restricted Instructions	5-97
Subspace-Group Dispatchable-Unit Control Table	5-66	Transactional-Execution Facility Operation	5-99
Subspace-Group ASN-Second-Table Entries	5-68	Transaction Initiation	5-99
Subspace-Replacement Operations	5-70	Execution in the Transactional-Execution Mode	5-99
Linkage-Stack Introduction	5-70	Normal Transaction Ending	5-99
Summary	5-71	Transaction Abort Conditions	5-100
Linkage-Stack Functions	5-71	Transaction Abort Processing	5-102
Transferring Program Control.	5-71	Program-Interruption Filtering on a Transaction Abort	5-104
Branching Using the Linkage Stack	5-73	Priority of Abort Conditions	5-107
Adding and Retrieving Information.	5-74	Constrained Transaction	5-107
Testing Authorization	5-74	Monitor-Event Counting	5-109
Program-Problem Analysis.	5-75	ESA/390-Compatibility-Mode Facility	5-111
Linkage-Stack Entry-Table Entries	5-75	Sequence of Storage References	5-113
Linkage-Stack Operations	5-76	Conceptual Sequence	5-113
Linkage-Stack-Operations Control.	5-78	Overlapped Operation of Instruction Execution.	5-114
Control Register 0	5-78	Divisible Instruction Execution.	5-115
Control Register 15	5-78	Interlocks for Virtual-Storage References	5-115
Linkage Stack.	5-79	Interlocks between Instructions	5-116
Entry Descriptors	5-79	Interlocks within a Single Instruction	5-116
Header Entries	5-80	Instruction Fetching	5-118
Trailer Entries.	5-81	ART-Table and DAT-Table Fetches	5-119
State Entries.	5-81	Storage-Key Accesses	5-120
Stacking Process	5-84	Storage-Operand References	5-123
Locating Space for a New Entry.	5-84	Storage-Operand Fetch References	5-123
Forming the New Entry.	5-85	Storage-Operand Store References	5-123
Updating the Current Entry.	5-86	Storage-Operand Update References.	5-124
Updating Control Register 15.	5-86	Storage-Operand Consistency	5-125
Recognition of Exceptions during the Stacking Process	5-86	Single-Access References	5-125
Unstacking Process	5-86	Multiple-Access References	5-125
Locating the Current Entry and Processing a Header Entry	5-87	Block-Concurrent References	5-127
Checking for a State Entry	5-88	Relation between Operand Accesses	5-129
Restoring Information.	5-88	Storage Operand References in the Transactional-Execution Mode	5-129
Updating the Preceding Entry	5-89	Other Storage References	5-130
Updating Control Register 15.	5-89	Relation between Storage-Key Accesses	5-130
Recognition of Exceptions during the Unstacking Process	5-89	Serialization.	5-130
Transactional-Execution Facility	5-89	CPU Serialization	5-130
		Specific-Operand Serialization	5-132
		Channel-Program Serialization	5-133
		Quiescing	5-133

Normally, operation of the CPU is controlled by instructions in storage that are executed sequentially, one at a time, left to right in an ascending sequence of storage addresses. A change in the sequential operation may be caused by a breaking event, interruptions, SIGNAL PROCESSOR orders, or manual intervention.

Instructions

Each instruction consists of two major parts:

- An operation code (op code), which specifies the operation to be performed
- The designation of the operands that participate.

Operands

Operands can be grouped in three classes: operands located in registers, immediate operands, and operands in storage. Operands may be either explicitly or implicitly designated.

Register operands can be located in general, floating-point, vector, access, or control registers, with the type of register identified by the op code. The register containing the operand is specified by identifying the register in a four-bit field, called the R field, in the instruction. For some instructions, an operand is located in an implicitly designated register, the register being implied by the op code. For vector registers, the register containing the operand is specified using a four-bit field with the addition of a register extension bit as the most significant bit.

Immediate operands are contained within the instruction, and the 8-bit, 16-bit, or 32-bit field containing the immediate operand is called the I field.

Operands in storage may have an implied length; be specified by a bitmask; be specified by a four-bit or eight-bit length specification, called the L field, in the instruction; or have a length specified by the contents of a general register. The addresses of operands in storage are specified by means of a format that uses the contents of a general register as part of the address. This makes it possible to:

1. Specify a complete address by using an abbreviated notation

2. Perform address manipulation using instructions which employ general registers for operands
3. Modify addresses by program means without alteration of the instruction stream
4. Operate independent of the location of data areas by directly using addresses received from other programs

The address used to refer to storage either is contained in a register designated by the R field in the instruction or is calculated from a base address, index, and displacement, specified by the B, X, and D fields, respectively, in the instruction.

When the CPU is in the access-register mode, a B or R field may designate an access register in addition to being used to specify an address.

To describe the execution of instructions, operands are designated as first and second operands and, in some cases, third, fourth, fifth, and sixth operands.

In general, two operands participate in an instruction execution, and the result replaces the first operand. However, CONVERT TO DECIMAL, TEST BLOCK, VECTOR UNPACK ZONED, and instructions with “store” in the instruction name (other than STORE THEN AND SYSTEM MASK and STORE THEN OR SYSTEM MASK) use the second-operand address to designate a location in which to store. TEST AND SET, COMPARE AND SWAP, COMPARE AND SWAP AND STORE, and COMPARE DOUBLE AND SWAP may perform an update on the second operand. Except when otherwise stated, the contents of all registers and storage locations participating in the addressing or execution part of an operation remain unchanged.

Instruction Formats

An instruction is one, two, or three halfwords in length and must be located in storage on a halfword boundary. Each instruction is in one of the following basic formats: E, I, IE, MII, RI, RIE, RIL, RIS, RR, RRD, RRE, RRF, RRS, RS, RSI, RSL, RSY, RX, RXE, RXF, RXY, S, SI, SIL, SIY, SMI, SS, SSE, SSF, VRI, VRR, VRS, VRV, VRX, and VSI. Figure 5-1 illustrates the various instruction formats and variations. Where a letter appears to the left of a format variant, it represents one of the variations in assembler syn-

tax as illustrated in the description of the instructions in chapters 7-10, 14, and 18-26.

E Format

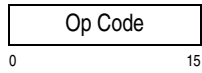

I Format

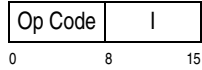

IE Format

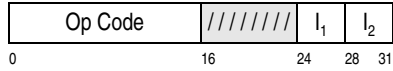

MII Format

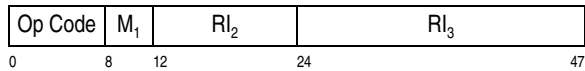

RI Formats

- a.

Op Code	R ₁	OpCd	I ₂
0	8	12	16
- b.

Op Code	R ₁	OpCd	Rl ₂
0	8	12	16
- c.

Op Code	M ₁ ‡	OpCd	Rl ₂
0	8	12	16

RIE Formats

- a.

Op Code	R ₁	////	I ₂	M ₃	////	Op Code
0	8	12	16	32	36	40
- b.

Op Code	R ₁	R ₂	Rl ₄	M ₃	////	Op Code
0	8	12	16	32	36	40
- c.

Op Code	R ₁	M ₃	Rl ₄	I ₂	Op Code
0	8	12	16	32	40
- d.

Op Code	R ₁	R ₃	I ₂	////////	Op Code
0	8	12	16	32	40
- e.

Op Code	R ₁	R ₃	Rl ₂	////////	Op Code
0	8	12	16	32	40
- f.

Op Code	R ₁	R ₂	I ₃	I ₄	I ₅	Op Code
0	8	12	16	24	32	40
- g.

Op Code	R ₁	M ₃	I ₂	////////	Op Code
0	8	12	16	32	40

Figure 5-1. Basic Instruction Formats (Part 1 of 5)

RIL Formats

- a.

Op Code	R ₁	OpCd	I ₂
0	8	12	16
- b.

Op Code	R ₁	OpCd	Rl ₂
0	8	12	16
- c.

Op Code	M ₁	OpCd	Rl ₂
0	8	12	16

RIS Format

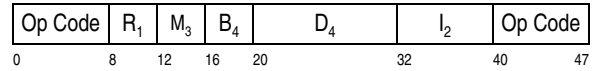

RR Format

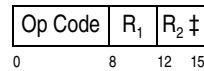

RRD Format

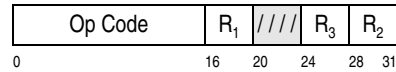

RRE Format

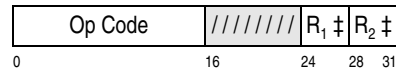

RRF Formats

- a,b

Op Code	R ₃	M ₄ ‡	R ₁	R ₂
0	16	20	24	28
- c-e

Op Code	M ₃ ‡	M ₄ ‡	R ₁	R ₂
0	16	20	24	28

RRS Format

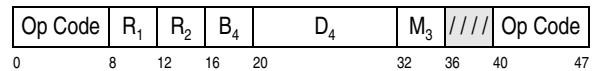

RS Formats

- a.

Op Code	R ₁	R ₃ ‡	B ₂	D ₂
0	8	12	16	20
- b.

Op Code	R ₁	M ₃	B ₂	D ₂
0	8	12	16	20

RSI Format

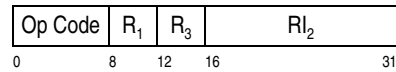

RSL Format

- a.

Op Code	L ₁	////	B ₁	D ₁	////////	Op Code
0	8	12	16	20	32	40
- b.

Op Code	L ₂	B ₂	D ₂	R ₁	M ₃	Op Code
0	8	16	20	32	36	40

Figure 5-1. Basic Instruction Formats (Part 2 of 5)

RSY Formats

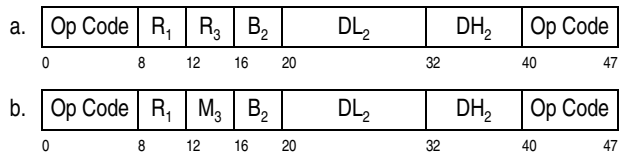

RX Formats

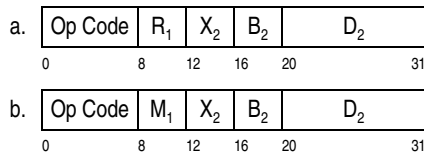

RXE Format

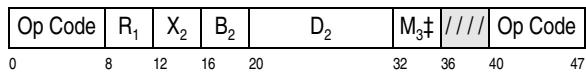

RXF Format

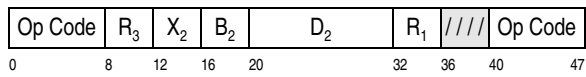

RXY Formats

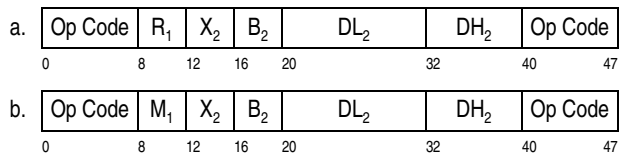

S Format

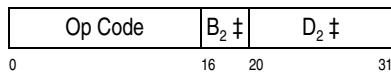

SI Format

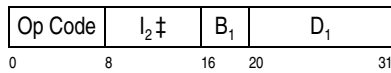

SIL Format

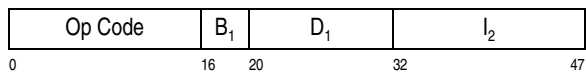

SIY Format

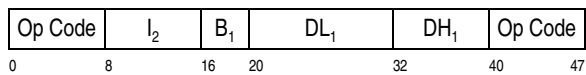

SMI Format

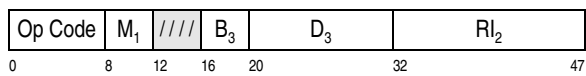
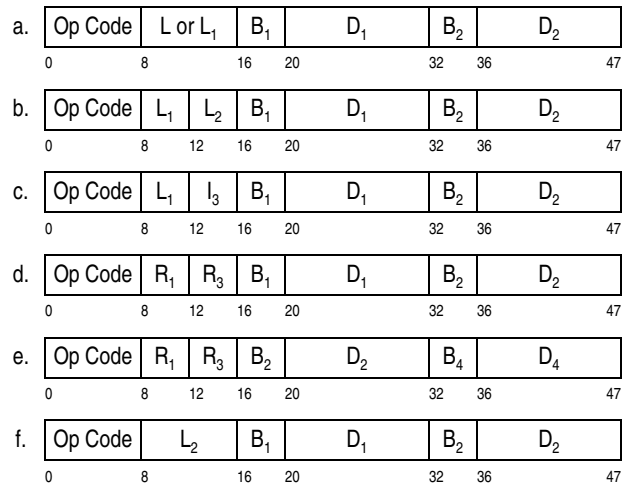
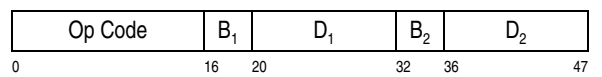

Figure 5-1. Basic Instruction Formats (Part 3 of 5)

SS Formats



SSE Format



SSF Format

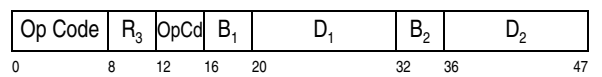

VRI Formats

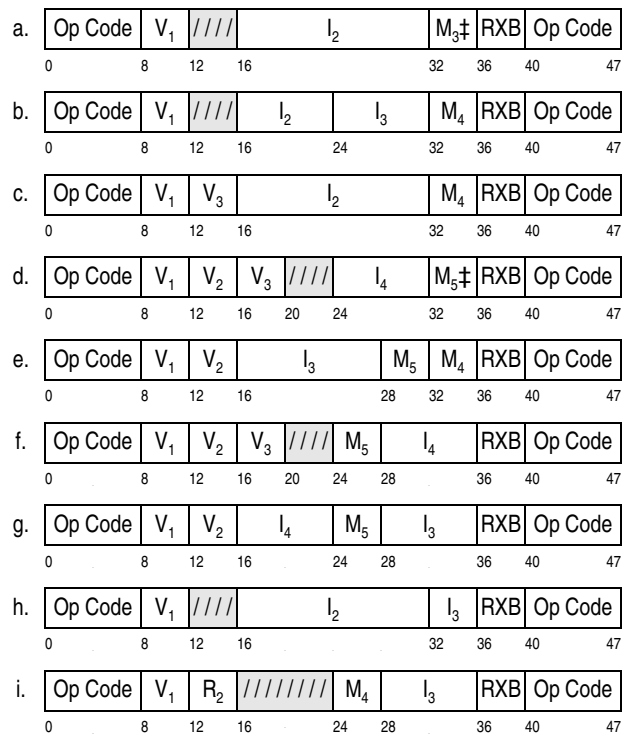
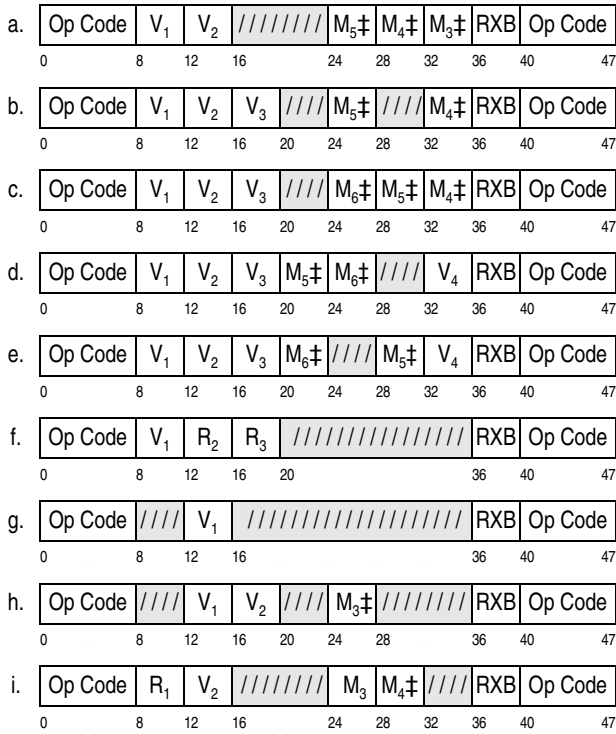
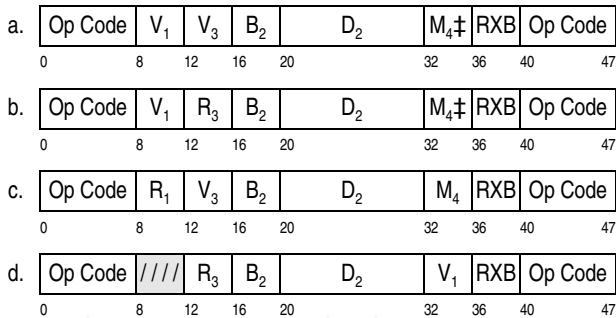

Figure 5-1. Basic Instruction Formats (Part 4 of 5)

VRR Formats



VRS Format



VRV Format

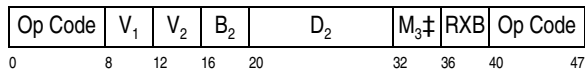

VRX Format

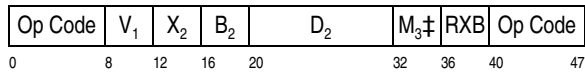

VSI Format

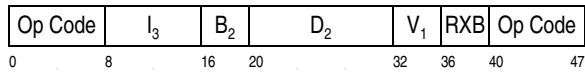

Explanation:

‡ For certain instructions, this operand is not defined.

Figure 5-1. Basic Instruction Formats (Part 5 of 5)

Instruction fields shown in Figure 5-1 on page 5-4 as containing slashes (/) are currently unassigned. These fields in an instruction should contain zeros; otherwise, the program may not operate compatibly in the future.

Some instructions contain fields that vary slightly from the basic format, and in some instructions the operation performed does not follow the general rules stated in this section. All of these exceptions are explicitly identified in the individual instruction descriptions.

The format names indicate, in general terms, the classes of operands which participate in the operation and some details about fields:

- E denotes an operation using implied operands and an extended op-code field.
- I denotes an immediate operation.
- IE denotes an immediate-and-immediate operation.
- MII denotes a masked immediate-and-immediate operation.
- RI denotes a register-and-immediate operation and an extended op-code field.
- RIE denotes a register-and-immediate operation and a longer extended op-code field.
- RIL denotes a register-and-immediate operation, an extended op-code field, and a longer immediate field.
- RIS denotes a register-and-immediate operation and a storage operation.
- RR denotes a register-and-register operation.
- RRD denotes a register-and-register operation, an extended op-code field, and an additional R field.
- RRE denotes a register-and-register operation and an extended op-code field.
- RRF denotes a register-and-register operation, an extended op-code field, and an additional R field, M field, or both.
- RRS denotes a register-and-register operation and a storage operation.
- RS denotes a register-and-storage operation.
- RSI denotes a register-and-immediate operation.
- RSL denotes a storage operation (with an instruction format derived from the ESA/390 RSE format).
- RSY denotes a register-and-storage operation, an extended op-code field, and a long displacement field.
- RX denotes a register-and-indexed-storage operation.

- RXE denotes a register-and-indexed-storage operation and an extended op-code field.
- RXF denotes a register-and-indexed-storage operation, an extended op-code field, and an additional R field.
- RXY denotes a register-and-indexed-storage operation, an extended op-code field, and a long displacement field.
- S denotes an operation using an implied operand and storage.
- SI denotes a storage-and-immediate operation.
- SIL denotes a storage-and-immediate operation, with a 16-bit immediate field.
- SIY denotes a storage-and-immediate operation and a long displacement field.
- SMI denotes a masked storage-and-immediate operation.
- SS denotes a storage-and-storage operation.
- SSE denotes a storage-and-storage operation and an extended op-code field.
- SSF denotes a storage-and-storage operation and an extended op-code field.
- VRI denotes a vector register-and-immediate operation and an extended op-code field.
- VRR denotes a vector register-and-register operation and an extended op-code field.
- VRS denotes a vector register-and-storage operation and an extended op-code field.
- VRV denotes a vector register-and-vector-index-storage operation and an extended op-code field.
- VRX denotes a vector register-and-index-storage operation and an extended op-code field.
- VSI denotes a vector register-and-storage operation and an extended op-code field.

In the I, RR, RS, RSI, RX, SI, and SS formats, the first byte of an instruction contains the op code. In the E, RRE, RRF, S, SIL, and SSE formats, the first two bytes of an instruction contain the op code, except that for some instructions in the S format, the op code is in only the first byte. In the RI, RIL, and SSF formats, the op code is in the first byte and bit positions 12-15 of an instruction. In the RIE, RIS, RRS, RSL, RSY, RXE, RXF, RXY, SIY, VRI, VRR, VRS, VRX, and VSI formats, the op code is in the first byte and the sixth byte of an instruction.

The first two bits of the first or only byte of the op code specify the length and format of the instruction, as follows:

Bit Positions 0-1	Instruction Length (in Halfwords)	Instruction Format
00	One	I / E / RR
01	Two	RX
10	Two	RI / RRD / RRE / RRF / RS / RSI / RX / S / SI
11	Three	MII / RIE / RIL / RIS / RRS / RSL / RSY / RXE / RXF / RXY / SIL / SIY / SMI / SS / SSE / SSF / VRI / VRR / VRS / VRV / VRX / VSI

In the format illustration for each individual instruction description, the op-code field or fields show the op code as hexadecimal digits within single quotes. The hexadecimal representation uses 0-9 for the binary codes 0000-1001 and A-F for the binary codes 1010-1111.

The remaining fields in the format illustration for each instruction are designated by code names, consisting of one or two letters and possibly a subscript number. The subscript number denotes the operand to which the field applies.

Operation code 00 hex will never be assigned to an instruction implemented in the CPU.

Register Operands

In the RR, RRD, RRE, RRF, RX, RXE, RXF, RXY, RS, RSY, RSI, RI, RIE, and RIL formats, the contents of the register designated by the R_1 field are called the first operand. The register containing the first operand is sometimes referred to as the “first-operand location,” and sometimes as “register R_1 .” In the RR, RRD, RRE, and RRF formats, the R_2 field designates the register containing the second operand, and the R_2 field may designate the same register as R_1 . In the RRD, RRF, RXF, RS, RSY, RSI, and RIE formats, the use of the R_3 field depends on the instruction. In the RRF, RS, and RSY formats, the R_3 field may instead be an M_3 field specifying a mask. Certain forms of the RRF format include an M_4 field specifying a mask.

The R field designates a general or access register in the general instructions, a general register in the control instructions, and a floating-point register or a general register in the floating-point instructions.

However, in the instructions EXTRACT STACKED REGISTERS and LOAD ADDRESS EXTENDED, the R field designates both a general register and an access register, and, in the instructions LOAD CONTROL and STORE CONTROL, the R field designates a control register. (This paragraph refers only to register operands, not to the use of access registers in addressing storage operands.)

For access, floating-point, and vector registers, unless otherwise indicated in the individual instruction description, the register operand is one register in length (32 bits for an access register, 64 bits for a floating-point register, and 128 bits for a vector register), and the second operand is the same length as the first. For general and control registers, the register operand is in bit positions 32-63 of the 64-bit register or occupies the entire register, depending on the instruction.

The V field in VRI, VRR, VRS, VRV, VRX, and VSI formats, along with an extra bit designates a vector register operand.

All vector instructions have a field in bits 36-39 of the instruction labeled as RXB. This field contains the most significant bits for all of the vector register designated operands. Bits for register designations not specified by the instruction are reserved and should be set to zero; otherwise, the program may not operate compatibly in the future. The most significant bit is concatenated to the left of the four-bit register designation to create the five-bit vector register designation.

The bits of the RXB field are defined as follows:

0. Most significant bit for the vector register designation in bits 8-11 of the instruction.
1. Most significant bit for the vector register designation in bits 12-15 of the instruction.
2. Most significant bit for the vector register designation in bits 16-19 of the instruction.
3. Most significant bit for the vector register designation in bits 32-35 of the instruction.

Programming Note: Although only two RRF formats are shown in Figure 5-1, five variations are noted. This is because there are five variations in assem-

bler-language syntax for the RRF-format instructions, as shown below.

Variation	Assembler Syntax
a	mnemonic R ₁ ,R ₂ [R ₃ [M ₄]]
b	mnemonic R ₁ ,R ₃ ,R ₂ [M ₄]
c	mnemonic R ₁ ,R ₂ [M ₃]
d	mnemonic R ₁ ,R ₂ ,M ₄
e	mnemonic R ₁ ,M ₃ ,R ₂ [M ₄]

Note on the Definition:

Immediate Operands

In the I format, the contents of the eight-bit immediate-data field, the I field of the instruction, are directly used as the operand.

In the SI format, the contents of the eight-bit immediate-data field, the I₂ field of the instruction, are used directly as the second operand. The B₁ and D₁ fields specify the first operand, which is one byte in length. In the SIY format, the operation is the same except that DH₁ and DL₁ fields are used instead of a D₁ field.

In the RI format for the instructions ADD HALFWORD IMMEDIATE, COMPARE HALFWORD IMMEDIATE, LOAD HALFWORD IMMEDIATE, and MULTIPLY HALFWORD IMMEDIATE, the contents of the 16-bit I₂ field of the instruction are used directly as a signed binary integer, and the R₁ field specifies the first operand, which is 32 or 64 bits in length, depending on the instruction. For the instruction TEST UNDER MASK (TMHH, TMHL, TMLH, TMLL), the contents of the I₂ field are used as a mask, and the R₁ field specifies the first operand, which is 64 bits in length.

For the instructions INSERT IMMEDIATE, AND IMMEDIATE, OR IMMEDIATE, and LOAD LOGICAL IMMEDIATE, the contents of the I₂ field are used as an unsigned binary integer or a logical value, and the R₁ field specifies the first operand, which is 64 bits in length.

For instructions in the RI, RIE, and RSI formats having an RI₂ field, or for instructions in the RIE format having an RI₄ field, the contents of the 16-bit RI₂ or RI₄ field are used as a signed binary integer designating a number of halfwords that are added to the address of the instruction to form the operand address. For instructions in the RIL format, the RI₂ field is 32 bits and is used in the same way.

For instructions in the MII format, the contents of the 12-bit RI_2 field and the 24-bit RI_3 field are used as signed binary integers designating a number of halfwords that are added to the address of the instruction to form the respective operand addresses.

For instructions in the SMI format, the contents of the 16-bit RI_2 field is used as signed binary integer designating a number of halfwords that are added to the address of the instruction to form the operand address.

For the RIE-format instructions COMPARE IMMEDIATE AND BRANCH RELATIVE and COMPARE LOGICAL IMMEDIATE AND BRANCH RELATIVE, the contents of the 8-bit I_2 field are used directly as the second operand. For the RIE-format instructions COMPARE IMMEDIATE AND BRANCH, COMPARE IMMEDIATE AND TRAP, COMPARE LOGICAL IMMEDIATE AND BRANCH, and COMPARE LOGICAL IMMEDIATE AND TRAP, the contents of the 16-bit I_2 field are used directly as the second operand. For the RIE-format instructions COMPARE AND BRANCH RELATIVE, COMPARE IMMEDIATE AND BRANCH RELATIVE, COMPARE LOGICAL AND BRANCH RELATIVE, and COMPARE LOGICAL IMMEDIATE AND BRANCH RELATIVE, the contents of the 16-bit RI_4 field are used as a signed binary integer designating a number of halfwords that are added to the address of the instruction to form the branch address.

For the RIL-format instructions ADD IMMEDIATE, ADD LOGICAL IMMEDIATE, ADD LOGICAL WITH SIGNED IMMEDIATE, COMPARE IMMEDIATE, COMPARE LOGICAL IMMEDIATE, LOAD IMMEDIATE, and MULTIPLY SINGLE IMMEDIATE, the contents of the 32-bit I_2 field are used directly as a the second operand.

For the RIS-format instructions, the contents of the 8-bit I_2 field are used directly as the second operand.

In the SIL format, the contents of the 16-bit I_2 field are used directly as the second operand. The B_1 and D_1 fields specify the first operand, as described below.

In the VRI-a format, the contents of the 16-bit I_2 field are used as a signed binary integer, except for VECTOR GENERATE BYTE MASK where the contents of the I_2 field are used as a bitmask. In the VRI-b format, the contents of the 8-bit I_2 and I_3 fields contain unsigned binary integers. In the VRI-c format, the I_2 field contains a 16-bit unsigned binary integer. In the

VRI-d format, the contents of the 8-bit I_4 field contain an unsigned binary integer. In the VRI-e format the 12-bit I_3 field contains a bitmask.

Storage Operands

The use of B and R fields to designate access registers to refer to storage operands is described in “Access-Register-Specified Address Spaces” on page 5-46.

In the RSL, SI, SIL, SSE, and most SS formats, the contents of the general register designated by the B_1 field are added to the contents of the D_1 field to form the first-operand address. In the RS, RSY, S, SIY, SS, SSE, SSF, VRS, and VSI formats, the contents of the general register designated by the B_2 field are added to the contents of the D_2 field or DH_2 and DL_2 fields to form the second-operand address. In the RX, RXE, RXF, RXY, and VRX formats, the contents of the general registers designated by the X_2 and B_2 fields are added to the contents of the D_2 field or DH_2 and DL_2 fields to form the second-operand address. In the SMI format, the contents of the general register designated by the B_3 field are added to the contents of the D_3 field to form the third-operand address. In the RIS and RRS formats, and in one SS format, the contents of the general register designated by the B_4 field are added to the contents of the D_4 field to form the fourth-operand address.

The VRV format has a vector-element-specified index field.

When a general register contains a 24-bit or 32-bit length of a storage operand, the length is an unsigned binary integer, except that it is signed for COMPARE UNTIL SUBSTRING EQUAL, with a negative value treated as zero. Similarly, the contents of an L, L_1 , or L_2 field of an instruction are an unsigned binary integer. For VRS format instructions which contain a length in a general register the length is an unsigned integer that specifies the number of additional operand bytes to the right of the byte designated by the second operand address.

In the SS format with a single, eight-bit length field, for the instructions AND (NC), EXCLUSIVE OR (XC), MOVE (MVC), MOVE NUMERICS, MOVE ZONES, and OR (OC), L specifies the number of additional operand bytes to the right of the byte designated by the first-operand address. Therefore, the length in bytes of the first operand is 1-256, corresponding to a length code in L of 0-255. Storage results replace the

first operand and are never stored outside the field specified by the address and length. In this format, the second operand has the same length as the first operand. There are variations of the preceding definition that apply to EDIT, EDIT AND MARK, PACK ASCII, PACK UNICODE, TRANSLATE, TRANSLATE AND TEST, UNPACK ASCII, and UNPACK UNICODE.

In the SS format with two length fields, in the RSL format, and in the VSI format, L_1 specifies the number of additional operand bytes to the right of the byte designated by the first-operand address. Therefore, the length in bytes of the first operand is 1-16, corresponding to a length code in L_1 of 0-15. Similarly, L_2 specifies the number of additional operand bytes to the right of the location designated by the second-operand address. Results replace the first operand and are never stored outside the field specified by the address and length. If the first operand is longer than the second, the second operand is extended on the left with zeros up to the length of the first operand. This extension does not modify the second operand in storage.

In the SS format with two R fields, as used by the MOVE TO PRIMARY, MOVE TO SECONDARY, and MOVE WITH KEY instructions, the contents of the general register specified by the R_1 field are a 32-bit unsigned value called the true length. The operands are both of a length called the effective length. The effective length is equal to the true length or 256, whichever is less. The instructions set the condition code to facilitate programming a loop to move the total number of bytes specified by the true length. The SS format with two R fields is also used to specify a range of registers and two storage operands for the LOAD MULTIPLE DISJOINT instruction and to specify one or two registers and one or two storage operands for the PERFORM LOCKED OPERATION instruction.

Address Generation

Trimodal Addressing

Bits 31 and 32 of the current PSW are the addressing-mode bits. Bit 31 is the extended-addressing-mode bit, and bit 32 is the basic-addressing-mode

bit. These bits control the size of the effective address produced by address generation. When bits 31 and 32 of the current PSW both are zeros, the CPU is in the 24-bit addressing mode, and 24-bit instruction and operand effective addresses are generated. When bit 31 of the current PSW is zero and bit 32 is one, the CPU is in the 31-bit addressing mode, and 31-bit instruction and operand effective addresses are generated. When bits 31 and 32 of the current PSW are both one, the CPU is in the 64-bit addressing mode, and 64-bit instruction and operand effective addresses are generated.

Execution of instructions by the CPU involves generation of the addresses of instructions and operands. This section describes address generation as it applies to most instructions. In some instructions, the operation performed does not follow the general rules stated in this section. All of these exceptions are explicitly identified in the individual instruction descriptions.

In the ESA/390-compatibility mode, if the program issues an instruction that is defined to enable the 64-bit addressing mode, it is unpredictable whether an exception is recognized or the CPU enters the 64-bit addressing mode.

Sequential Instruction-Address Generation

When an instruction is fetched from the location designated by the current PSW, the instruction address is increased by the number of bytes in the instruction, and the instruction is executed. The same steps are then repeated by using the new value of the instruction address to fetch the next instruction in the sequence.

In the 24-bit addressing mode, instruction addresses wrap around, with the halfword at instruction address $2^{24} - 2$ being followed by the halfword at instruction address 0. Thus, in the 24-bit addressing mode, any carry out of PSW bit position 104, as a result of updating the instruction address, is lost. In the 31-bit or 64-bit addressing mode, instruction addresses similarly wrap around, with the halfword at instruction address $2^{31} - 2$ or $2^{64} - 2$, respectively, followed by the halfword at instruction address 0. A carry out of PSW bit position 97 or 64, respectively, is lost.

Operand-Address Generation

Formation of the Intermediate Value

An operand address that refers to storage is derived from an intermediate value determined in one of the following ways:

- The intermediate value is calculated from the sum of two or three binary numbers: base address, index (when applicable), and displacement.
- The intermediate value is calculated from the sum of three binary numbers: base address, displacement, and vector element.
- The intermediate value is calculated from the sum of two binary numbers: the address of the instruction and an immediate (RI_2) field in the instruction specifying a number of halfwords.
- The intermediate value is contained in a register designated by an R field in the instruction.

Intermediate Value Designated by Base Address, Index, and Displacement: The base address (B) is a 64-bit number contained in a general register specified by the program in a four-bit field, called the B field, in the instruction. Base addresses can be used as a means of independently addressing each program and data area. In array-type calculations, it can designate the location of an array, and, in record-type processing, it can identify the record. The base address provides for addressing the entire storage. The base address may also be used for indexing.

For instructions having the RX, RXE, RXF, RXY, and VRX-formats, the index (X) is a 64-bit number contained in a general register designated by the program in a four-bit field, called the X field, in the instruction. These instructions permit double indexing; that is, the index can be used to provide the address of an element within an array. For other instruction formats which do not include an X field, the index is not applicable.

The displacement (D) is a 12-bit or 20-bit number contained in a field, called the D field, in the instruction. A 12-bit displacement is unsigned and provides for relative addressing of up to 4,095 bytes beyond the location designated by the base address. A 20-bit displacement is signed and provides for relative addressing of up to 524,287 bytes beyond the base-address location or of up to 524,288 bytes before it.

In array-type calculations, the displacement can be used to specify one of many items associated with an element. In the processing of records, the displacement can be used to identify items within a record.

A 12-bit displacement is in bit positions 20-31 of instructions of certain formats (see Figure 5-1 on page 5-4). In instructions of some formats, a second 12-bit displacement also is in the instruction, in bit positions 36-47.

In the z/Architecture architectural mode, a 20-bit displacement is in instructions of only the RSY, RXY, or SIY format. In these instructions, the D field consists of a DL (low) field in bit positions 20-31 and of a DH (high) field in bit positions 32-39. When the long-displacement facility is installed, the numeric value of the displacement is formed by appending the contents of the DH field on the left of the contents of the DL field. When the long-displacement facility is not installed, the numeric value of the displacement is formed by appending eight zero bits on the left of the contents of the DL field, and the contents of the DH field are ignored.

In the ESA/390-compatibility mode, it is unpredictable whether the long-displacement facility is considered to be installed.

In forming the intermediate sum, the base address and index are treated as 64-bit binary integers. A 12-bit displacement is treated as a 12-bit unsigned binary integer, and 52 zero bits are appended on the left. A 20-bit displacement is treated as a 20-bit signed binary integer, and 44 bits equal to the sign bit are appended on the left. The three are added as 64-bit binary numbers, ignoring overflow. The sum is always 64 bits long and is used as an intermediate value to form the generated address. The bits of the intermediate value are numbered 0-63.

A zero in any of the B_1 , B_2 , X_2 , B_3 , or B_4 fields indicates the absence of the corresponding address component. For the absent component, a zero is used in forming the intermediate sum, regardless of the contents of general register 0. A displacement of zero has no special significance.

Intermediate Value Designated by Base Address, Displacement, and Vector Element: For VRV format instructions, a vector element is used in the formation of the intermediate value. This vector element is an unsigned binary integer value that is added to the base address and 12-bit displacement to form a

64-bit intermediate sum. The vector element is designated by a vector register and an element index. A zero V field accesses the element in vector register zero and does not imply a zero value.

Intermediate Value Designated by an Immediate Field: For the following instructions, the intermediate value is determined using an immediate (RI_2) field in the instruction:

- BRANCH PREDICTION PRELOAD
- BRANCH PREDICTION RELATIVE PRELOAD
- COMPARE HALFWORD RELATIVE LONG
- COMPARE LOGICAL RELATIVE LONG
- COMPARE RELATIVE LONG
- EXECUTE RELATIVE LONG
- LOAD ADDRESS RELATIVE LONG
- LOAD HALFWORD RELATIVE LONG
- LOAD LOGICAL HALFWORD RELATIVE LONG
- LOAD LOGICAL RELATIVE LONG
- LOAD RELATIVE LONG
- PREFETCH DATA RELATIVE LONG
- STORE HALFWORD RELATIVE LONG
- STORE RELATIVE LONG

For BRANCH PREDICTION PRELOAD, the RI_2 field contains a 16-bit signed binary integer; for BRANCH PREDICTION RELATIVE PRELOAD, the RI_2 field contains a 12-bit signed binary integer; and for each of the other instructions listed, the RI_2 field contains a 32-bit signed binary integer. The signed binary integer specifies the number of halfwords that is added to the address of the current instruction (or the address of the execute-type instruction if the instruction having the RI_2 field is the target of an execute-type instruction) to form the intermediate value.

When DAT is on, and the intermediate value is designated by an immediate field, the resulting operand address is in the same address space as that used to fetch instructions.

Intermediate Value in a Register Designated by an R Field: When an instruction description specifies that the contents of a general register designated by an R field are used to address an operand in storage, the register contents are used as the 64-bit intermediate value.

An instruction can designate the same general register both for address computation and as the location of an operand. Address computation is completed before registers, if any, are changed by the operation.

Formation of the Operand Address

Unless otherwise indicated in an individual instruction definition, the generated operand address designates the leftmost byte of an operand in storage.

The generated operand address is always 64 bits long, and the bits are numbered 0-63. The manner in which the generated address is obtained from the intermediate value depends on the current addressing mode. In the 24-bit addressing mode, bits 0-39 of the intermediate value are ignored, bits 0-39 of the generated address are forced to be zeros, and bits 40-63 of the intermediate value become bits 40-63 of the generated address. In the 31-bit addressing mode, bits 0-32 of the intermediate value are ignored, bits 0-32 of the generated address are forced to be zero, and bits 33-63 of the intermediate value become bits 33-63 of the generated address. In the 64-bit addressing mode, bits 0-63 of the intermediate value become bits 0-63 of the generated address.

Programming Note: Since a carry out of the most-significant address bit is ignored, negative values may be used in index and base-address registers. Bits 0-32 of these values are ignored in the 31-bit addressing mode, and bits 0-39 are ignored in the 24-bit addressing mode.

For instructions having the RSY, RXY, or SIY format, a negative value may be used for the displacement.

When the intermediate value is designated by an immediate field in the instruction, the immediate field may contain a negative value.

Branch-Address Generation

Formation of the Intermediate Value

For branch instructions, the address of the next instruction to be executed when the branch is taken is called the branch address. Depending on the branch instruction, the instruction format may be RR, RRE, RX, RXY, RS, RSY, RSI, RI, RIE, or RIL.

Except as noted below, in the RS, RSY, RX, and RXY formats, the branch address is specified by a base address, a displacement, and, in the RX and RXY formats, an index. In the RXY-format instruction BRANCH INDIRECT ON CONDITION, the branch address is formed from the contents of the eight-byte second operand in storage. For the RXY-format

LOAD GUARDED and LOAD LOGICAL AND SHIFT GUARDED instructions, when a guarded-storage event is recognized, the contents of the guarded-storage-event-handler address (in the guarded-storage-event parameter list) forms the branch address. In these formats, the generation of the intermediate value follows the same rules as for the generation of the operand-address intermediate value.

In the RR and RRE formats, the contents of the general register designated by the R_2 field are used as the intermediate value from which the branch address is formed. Unless otherwise specified, general register 0 cannot be designated as containing a branch address, and a value of zero in the R_2 field causes the instruction to be executed without branching.

The relative-branch instructions are in the RSI, RI, RIE, and RIL formats. In the RSI, RI, and RIE formats for the relative-branch instructions, the contents of the RI_2 field are treated as a 16-bit signed binary integer designating a number of halfwords. In the RIL format, the contents of the RI_2 field are treated as a 32-bit signed binary integer designating a number of halfwords. The branch address is the number of halfwords designated by the RI_2 field added to the address of the relative-branch instruction.

The 64-bit intermediate value for a relative branch instruction in the RSI, RI, RIE, or RIL format is the sum of two addends, with overflow from bit position 0 ignored. In the RSI, RI, or RIE format, the first addend is the contents of the RI_2 field with one zero bit appended on the right and 47 bits equal to the sign bit of the contents appended on the left, except that for COMPARE AND BRANCH RELATIVE, COMPARE IMMEDIATE AND BRANCH RELATIVE, COMPARE LOGICAL AND BRANCH RELATIVE and COMPARE LOGICAL IMMEDIATE AND BRANCH RELATIVE, the first addend is the contents of the RI_4 field, with bits appended as described above for the RI_2 field. In the RIL format, the first addend is the contents of the RI_2 field with one zero bit appended on the right and 31 bits equal to the sign bit of the contents appended on the left. In all formats, the second addend is the 64-bit address of the branch instruction. The address of the branch instruction is the instruction address in the PSW before that address is updated to address the next sequential instruction, or it is the address of the target of the execute-type instruction (EXECUTE or EXECUTE RELATIVE LONG) if an execute-type instruction is used. If an execute-type instruction is used in the

24-bit or 31-bit addressing mode, the address of the branch instruction is the target address with 40 or 33 zeros, respectively, appended on the left.

Formation of the Branch Address

The branch address is always 64 bits long, with the bits numbered 0-63. The branch address replaces bits 64-127 of the current PSW.

The manner in which the branch address is obtained from the intermediate value depends on the addressing mode. For those branch instructions which change the addressing mode, the new addressing mode is used. In the 24-bit addressing mode, bits 0-39 of the intermediate value are ignored, bits 0-39 of the branch address are made zeros, and bits 40-63 of the intermediate value become bits 40-63 of the branch address. In the 31-bit addressing mode, bits 0-32 of the intermediate value are ignored, bits 0-32 of the branch address are made zeros, and bits 33-63 of the intermediate value become bits 33-63 of the branch address. In the 64-bit addressing mode, bits 0-63 of the intermediate value become bits 0-63 of the branch address.

For several branch instructions, branching depends on satisfying a specified condition. When the condition is not satisfied, the branch is not taken, normal sequential instruction execution continues, and the branch address is not used. When a branch is taken, bits 0-63 of the branch address replace bits 64-127 of the current PSW. The branch address is not used to access storage as part of the branch operation.

A specification exception due to an odd branch address and access exceptions due to fetching of the instruction at the branch location are not recognized as part of the branch operation but instead are recognized as exceptions associated with the execution of the instruction at the branch location.

A branch instruction, such as BRANCH AND SAVE, can designate the same general register for branch-address computation and as the location of an operand. Branch-address computation is completed before the remainder of the operation is performed.

Some models may maintain information in internal tables about branch instructions and branch addresses for internal branch-prediction logic. Additionally, since the formation of branch addresses is similar to the formation of the target addresses of execute-type instructions, some models may also

maintain information about execute-type instructions and their execute targets in the same or similar internal tables. A model may also provide the BRANCH PREDICTION PRELOAD and BRANCH PREDICTION RELATIVE PRELOAD instructions which allow the program to identify branch instructions and associated branch addresses, and to identify execute-type instructions and associated execute targets, thereby affecting the preloading of such branch-prediction and execute-prediction information into such internal tables.

Instruction Execution and Sequencing

The program-status word (PSW), described in Chapter 4 “Control” contains information required for proper program execution. The PSW is used to control instruction sequencing and to hold and indicate the status of the CPU in relation to the program currently being executed. The active or controlling PSW is called the current PSW.

Branch instructions perform the functions of decision making, loop control, and subroutine linkage. A branch instruction affects instruction sequencing by introducing a new instruction address into the current PSW. The relative-branch instructions with a 16-bit I_2 field allow branching to a location at an offset of up to plus 64K - 2 bytes or minus 64K bytes relative to the location of the branch instruction, without the use of a base register. The relative-branch instructions with a 32-bit I_2 field allow branching to a location at an offset of up to plus 4G - 2 bytes or minus 4G bytes relative to the location of the branch instruction, without the use of a base register.

Decision Making

Facilities for decision making are provided by the BRANCH ON CONDITION, BRANCH RELATIVE ON CONDITION, and BRANCH RELATIVE ON CONDITION LONG instructions. These instructions inspect a condition code that reflects the result of a majority of the arithmetic, logical, and I/O operations. The condition code, which consists of two bits, provides for four possible condition-code settings: 0, 1, 2, and 3.

The specific meaning of any setting depends on the operation that sets the condition code. For example, the condition code reflects such conditions as zero, nonzero, first operand high, equal, overflow, and sub-channel busy. Once set, the condition code remains unchanged until modified by an instruction that causes a different condition code to be set. See Appendix C, “Condition-Code Settings” for a summary of the instructions which set the condition code.

Loop Control

Loop control can be performed by the use of BRANCH ON CONDITION, BRANCH RELATIVE ON CONDITION, and BRANCH RELATIVE ON CONDITION LONG to test the outcome of address arithmetic and counting operations. For some particularly frequent combinations of arithmetic and tests, BRANCH ON COUNT, BRANCH ON INDEX HIGH, and BRANCH ON INDEX LOW OR EQUAL are provided, and relative-branch equivalents of these instructions are also provided. These branches, being specialized, provide increased performance for these tasks.

Subroutine Linkage without the Linkage Stack

This section describes only the methods for subroutine linkage that do not use the linkage stack. For the linkage extensions provided by the linkage stack, see “Linkage-Stack Introduction” on page 5-70. (Those extensions include a different method of operation of the PROGRAM CALL instruction and also the BRANCH AND STACK and PROGRAM RETURN instructions.)

Simple Branch Instructions

Subroutine linkage when a change of the addressing mode is not required is provided by the BRANCH AND LINK and BRANCH AND SAVE instructions. (This discussion of BRANCH AND SAVE applies also to BRANCH RELATIVE AND SAVE and BRANCH RELATIVE AND SAVE LONG.) Both of these instructions permit not only the introduction of a new instruction address but also the preservation of a return address and associated information. The return address is the address of the instruction following the branch instruction in storage, except that it is the address of the instruction following an execute-

type instruction that has the branch instruction as its target.

Both BRANCH AND LINK and BRANCH AND SAVE have an R_1 field. They form a branch address by means of fields that depend on the instruction. The operations of the instructions are summarized as follows:

- In the 24-bit addressing mode, both instructions place the return address in bit positions 40-63 of general register R_1 and leave bits 0-31 of that register unchanged. BRANCH AND LINK places the instruction-length code for the instruction and also the condition code and program mask from the current PSW in bit positions 32-39 of general register R_1 . BRANCH AND SAVE places zeros in those bit positions.
- In the 31-bit addressing mode, both instructions place the return address in bit positions 33-63 and a one in bit position 32 of general register R_1 , and they leave bits 0-31 of the register unchanged.
- In the 64-bit addressing mode, both instructions place the return address in bit positions 0-63 of general register R_1 .
- In any addressing mode, both instructions generate the branch address under the control of the current addressing mode. The instructions place bits 0-63 of the branch address in bit positions 64-127 of the PSW. In the RR format, both instructions do not perform branching if the R_2 field of the instruction is zero.

It can be seen that, in the 24-bit or 31-bit addressing mode, BRANCH AND SAVE places the basic-addressing-mode bit, bit 32 of the PSW, in bit position 32 of general register R_1 . BRANCH AND LINK does so in the 31-bit addressing mode.

The instructions BRANCH AND SAVE AND SET MODE and BRANCH AND SET MODE are for use when a change of the addressing mode is required during linkage. These instructions have R_1 and R_2 fields. The operations of the instructions are summarized as follows:

- BRANCH AND SAVE AND SET MODE sets the contents of general register R_1 the same as BRANCH AND SAVE. In addition, the instruction places the extended-addressing-mode bit, bit 31 of the PSW, in bit position 63 of the register.

- BRANCH AND SET MODE, if R_1 is nonzero, performs as follows. In the 24- or 31-bit mode, it places bit 32 of the PSW in bit position 32 of general register R_1 , and it leaves bits 0-31 and 33-63 of the register unchanged. Note that bit 63 of the register should be zero if the register contains an instruction address. In the 64-bit mode, the instruction places bit 31 of the PSW (a one) in bit position 63 of general register R_1 , and it leaves bits 0-62 of the register unchanged.
- When R_2 is nonzero, both instructions set the addressing mode and perform branching as follows. Bit 63 of general register R_2 is placed in bit position 31 of the PSW. If bit 63 is zero, bit 32 of the register is placed in bit position 32 of the PSW. If bit 63 is one, PSW bit 32 is set to one. Then the branch address is generated from the contents of the register, except with bit 63 of the register treated as a zero, under the control of the new addressing mode. The instructions place bits 0-63 of the branch address in bit positions 64-127 of the PSW. Bit 63 of general register R_2 remains unchanged and, therefore, may be one upon entry to the called program. If R_2 is the same as R_1 , the results in the designated general register are as specified for the R_1 register.

The operations of the simple branch instructions are summarized in Figure 5-2 on page 5-16. For contrast, the figure also shows the BRANCH ON COUNT instruction, which is not for use in linkage, and the LOAD ADDRESS and LOAD ADDRESS EXTENDED instructions.

Programming Notes:

1. A called program that is entered in the 64-bit addressing mode can use bit 63 of the entry-point register to determine the instruction used to perform the call and, thus, the instruction that must be used to perform the return linkage. If bit 63 is zero, BRANCH AND SAVE (BAS or BASR) (or possibly BAL, BALR, BRAS, or BRASL) was used, the addressing mode of the caller is not indicated in the return register, and BRANCH ON CONDITION (BCR) must be used to return without changing the addressing mode during the return. If bit 63 of the entry-point register is one, BASSM or BSM was used, the addressing mode of the caller is indicated in the return register (or at least can be, in the case of BSM), and BSM must be used to return and restore the addressing mode of the caller.

Instruction	Format	In Mode	Address Placed in GR R ₁				Branch or 2nd-Op Address		R ₂ Bit 63	PSW Bit 31 Set to	PSW Bit 32 Set to
			Bits 0-31	Bit 32	Bits 33-62	Bits 63	Bits 0-32	Bits 33-63			
BALR*/BAL	RR/RX	24	U	***	***	IA	SIA	SIA	LSExc	U	U
		31	U	BAM	IA	IA	SIA	SIA	LSExc	U	U
		64	IA	IA	IA	IA	SIA	SIA	LSExc	U	U
BASR*/BAS/ BRAS/BRASL	RR/RX/ RI/RIL	24/31	U	BAM	IA	IA	SIA	SIA	LSExc	U	U
		64	IA	IA	IA	IA	SIA	SIA	LSExc	U	U
BASSM*	RR	24/31	U	BAM	IA	IA	SIA	SIA	0	0	R ₂ 32
		24/31	U	BAM	IA	IA	SIA	SIA	1G0	1	1
		64	IA	IA	IA	1	SIA	SIA	0	0	R ₂ 32
		64	IA	IA	IA	1	SIA	SIA	1G0	1	1
BSM**	RR	24/31	U	BAM	U	U	SIA	SIA	0	0	R ₂ 32
		24/31	U	BAM	U	U	SIA	SIA	1G0	1	1
		64	U	U	U	1	SIA	SIA	0	0	R ₂ 32
		64	U	U	U	1	SIA	SIA	1G0	1	1
BCTR*/BCT/ BCTGR*/BCTG	RR/RX/ RRE/RXY	24/31	NLA	NLA	NLA	NLA	SIA	SIA	LSExc	U	U
		64	NLA	NLA	NLA	NLA	SIA	SIA	LSExc	U	U
LA/LAE	RX/RX	24/31	U	0	Op2Ad	Op2Ad	FZ	SR1	0/1	U	U
		64	Op2Ad	Op2Ad	Op2Ad	Op2Ad	SR1	SR1	0/1	U	U

Explanation:

- The address does not exist, or the bit has no special effect.
- * The action associated with the R₂ field is not performed if the field is zero.
- ** The action associated with the R₁ or R₂ field is not performed if the field is zero.
- *** The instruction-length code, condition code, and program mask are saved in bit positions 32-39 of the link address, and bits 40-63 of the updated instruction address are saved in bit positions 40-63.
- 0/1 Bit 63 can be zero or one.
- 1G0 Bit 63 is one and is left one, but the branch address is generated as if the bit is zero.
- BAM Bit 32 of the link address is set with the basic-addressing-mode bit, bit 32 of the PSW.
- FZ Bits 0-32 of the second-operand address are forced to zeros in the 24-bit or 31-bit addressing mode.
- IA Bits of the link address are set with the updated instruction address as shown.
- LSExc A late specification exception is recognized if the bit is one.
- NLA The instruction does not produce a link address. (The instruction is shown simply as an example of a non-linkage branch instruction.)
- Op2Ad Bits of the address in general register R₁ are set with the corresponding bits of the second-operand address as shown.
- R₂32 The basic-addressing-mode bit, bit 32 of the PSW, is set with bit 32 of general register R₂
- SIA Bits 0-63 of the branch address are used to set the instruction address in the PSW. Bits 0-39 of the branch address are forced to zeros in the 24-bit addressing mode. Bits 0-32 are forced to zeros in the 31-bit addressing mode.
- SR1 Bits of the second-operand address are used to set the corresponding bits of the address in the R₁ general register as shown. Bits 0-39 of the second-operand address are forced to zeros in the 24-bit addressing mode. Bits 0-32 are forced to zeros in the 31-bit addressing mode.
- U Unchanged.

Figure 5-2. Summary of Simple Branch Linkage Instructions and Other Instructions

2. When BSM is executed in the 24-bit or 31-bit addressing mode and used in a forward linkage to set the 64-bit mode, and the R₁ and R₂ of the instruction are the same value, bit 63 of the designated general register does not, upon entry to the called program, correctly indicate the mode of the calling program. (The bit is one, instead of zero, because the program set bit 63 of the R₂ register to one and the instruction does not change bit 63 of the R₁ register in the 24- or 31-bit mode.) BASSM always correctly indicates the addressing mode of the calling program.

- If an entry point can be branched to in the 64-bit addressing mode either by BAS or BASR or by BASSM or BSM, and a USING statement provides addressability to the entry point, bit 63 of the entry-point register must be zeroed to ensure compatible operation regardless of whether the linkage instruction changes the addressing mode. For example, if general register 15 is the entry-point register, the following may be used to set bit 63 to zero.

```
NILL 15,X'FFFE'
```

If the entry point can be branched to in the 64-bit addressing mode only by BASSM or BSM, the entry-point USING statement can accommodate bit 63 being one – without having to zero the bit – as shown below.

```
USING *+1,15
```

Other Linkage Instructions

Note: The discussion in this section of PROGRAM TRANSFER applies equally to PROGRAM TRANSFER WITH INSTANCE, which differs from PROGRAM TRANSFER only as described in “ASN-Second-Table-Entry Instance Number and ASN Reuse” on page 3-25.

PROGRAM TRANSFER WITH INSTANCE is not further referred to in this section.

Linkage between a problem-state program and the supervisor or monitoring program is provided by means of the SUPERVISOR CALL and MONITOR CALL instructions.

The instructions PROGRAM CALL and PROGRAM TRANSFER provide the facility for linkage between programs of different authority and in different address spaces. PROGRAM CALL permits linkage to a number of preassigned programs that may be in either the problem or the supervisor state and may be in either the same address space or an address space different from that of the caller. It permits a change between the 24-bit and 31-bit addressing modes, and it permits an increase of PSW-key-mask authority, which authorizes the execution of the SET PSW KEY FROM ADDRESS instruction and also other functions. In general, PROGRAM CALL is used to transfer control to a program of higher authority. PROGRAM TRANSFER permits a change of the instruction address and address space and a change between the 24-bit and 31-bit addressing modes.

PROGRAM TRANSFER also permits a reduction of PSW-key-mask authority and a change from the supervisor to the problem state. In general, it is used to transfer control from one program to another of equal or lower authority.

When a calling linkage is to increase authority, the calling linkage can be performed by PROGRAM CALL and the return linkage by PROGRAM TRANSFER. Alternatively, when the calling linkage is to decrease authority, the calling linkage can be performed by PROGRAM TRANSFER and the return linkage by PROGRAM CALL.

The operation of PROGRAM CALL is controlled by means of an entry-table entry, which is located as part of a table-lookup process during the execution of the instruction. The entry-table entry specifies either a basic (nonstacking) operation or the stacking operation described in “Linkage-Stack Introduction” on page 5-70. The instruction causes the primary address space to be changed only when the ASN in the entry-table entry is nonzero. When the primary address space is changed, the operation is called PROGRAM CALL with space switching (PC-ss). When the primary address space is not changed, the operation is called PROGRAM CALL to current primary (PC-cp).

PROGRAM TRANSFER specifies the address space which is to become the new primary address space. When the primary address space is changed, the operation is called PROGRAM TRANSFER with space switching (PT-ss). When the primary address space is not changed, the operation is called PROGRAM TRANSFER to current primary (PT-cp).

Basic PROGRAM CALL, and PROGRAM TRANSFER, can be executed successfully in either a basic (24-bit or 31-bit) addressing mode or the extended (64-bit) addressing mode. They do not provide a change between a basic addressing mode and the extended addressing mode.

The BRANCH AND SET AUTHORITY instruction can improve performance by replacing a PT-cp instruction used to perform a calling linkage in which PSW-key-mask authority is reduced, and by replacing a PC-cp instruction used to perform the associated return linkage in which PSW-key-mask authority is restored. BRANCH AND SET AUTHORITY also permits changes between the supervisor and problem states, and it can replace SET PSW KEY FROM ADDRESS by changing the PSW key during the link-

age. The calling-linkage operation is called BRANCH AND SET AUTHORITY in the base-authority state (BSA-ba), and the return-linkage operation is called BRANCH AND SET AUTHORITY in the reduced-authority state (BSA-ra).

The BRANCH IN SUBSPACE GROUP instruction allows linkage within a group of address spaces called a subspace group, where one address space in the group is called the base space and the others are called subspaces. It is intended that each subspace contain a different subset of the storage in the base space, that the base space and each subspace contain a subsystem control program, such as CICS, and application programs, and that each subspace contain the data for a single transaction being processed under the subsystem control program. The placement of the data for each transaction in a different subspace prevents a program that is being executed to process one particular transaction from erroneously damaging the data of other transactions. It is intended that the primary address space be the base space when the control program is being executed, and that it be the subspace for a transaction when an application program is being executed to process that transaction. BRANCH IN SUBSPACE GROUP changes not only the instruction address in the PSW but also the primary address-space-control element in control register 1. BRANCH IN SUBSPACE GROUP does not change the primary ASN in control register 4 or the primary-ASN-second-table-entry origin in control register 5, and, therefore, the base space and the subspaces all are associated with the same ASN, and the programs in those address spaces all are of equal authority.

Although a subspace is intended to be a subset of the base space as described above, BRANCH IN SUBSPACE GROUP does not require this, and the instruction may be useful in ways other than as described above.

BRANCH IN SUBSPACE GROUP uses an access-list-entry token (ALET) in an access register as an identifier of the address space that is to receive control. The instruction saves the updated instruction address to permit a return linkage, but it does not save an identifier of the address space from which control was transferred. However, an ALET equal to 00000000 hex, called ALET 0, can be used to return from a subspace to the base space, and an ALET equal to 00000001 hex, called ALET 1, can be used to return from the base space to the subspace that last had control.

The SET ADDRESSING MODE (SAM24, SAM31, SAM64) instruction can assist in linkage by setting the 24-bit, 31-bit, or 64-bit addressing mode either before or after a linkage operation.

The RESUME PROGRAM instruction is intended for use by a problem-state interruption-handling program to return to the interrupted program. The interruption-handling program can use LOAD ACCESS MULTIPLE and LOAD MULTIPLE instructions to restore the contents of the interrupted program's access and general registers from a save area, except for the contents of one access-and-general register pair. The interruption-handling program then can use RESUME PROGRAM to restore the contents of certain PSW fields, including the instruction address, and also the contents of the remaining access-and-general pair from the save area, with that pair first being used by RESUME PROGRAM to address the save area.

The TRAP instruction (TRAP2, TRAP4) can overlay instructions in an application program and give control to a trap program for performing fix-ups of data used by the application program. The RESUME PROGRAM instruction can be used to return control from the trap program to the application program.

The linkage instructions provided and the functions performed by each are summarized in Figure 5-3 on page 5-19.

Programming Note: This note describes the simple branch-type linkage instructions that were included in 370-XA and carried forward to ESA/370, ESA/390, and z/Architecture. To give the reader a better understanding of the utility and intended usage of these linkage instructions, the following paragraphs in this note describe various program linkages and conventions and the use of the linkage instructions in these situations.

The linkage instructions were originally provided to permit System/370 programs to operate with no modification or only slight modification on 370/XA (and successor) systems and also to provide additional function for those programs which were designed to take advantage of the 31-bit addressing of 370/XA. The instructions provided the capability for both old and new programs to coexist in storage and to communicate with each other. The instructions now have been enhanced to permit usage of the 64-bit addressing of z/Architecture.

Instruction	Format	Instruction Address PSW Bits 64-127		Basic Addr. Mode PSW Bit 32		Extended Addr. Mode PSW Bit 31		Problem State PSW Bit 15		PASN CR4 Bits 48-63		PSW-Key Mask Changed in CR3	Trace
		Save	Set	Save	Set	Save	Set	Save	Set	Save	Set		
BALR	RR	Yes*	R ₂ ¹	BAM31	-	-	-	-	-	-	-	-	R ₂ ¹
BAL	RX	Yes*	Yes*	BAM31	-	-	-	-	-	-	-	-	-
BASR	RR	Yes	R ₂ ¹	BAM	-	-	-	-	-	-	-	-	R ₂ ¹
BAS	RX	Yes	Yes	BAM	-	-	-	-	-	-	-	-	-
BASSM	RR	Yes	R ₂ ¹	BAM	R ₂ ¹	Yes	R ₂ ¹	-	-	-	-	-	-
BRAS	RI	Yes	Yes	BAM	-	-	-	-	-	-	-	-	-
BRASL	RIL	Yes	Yes	BAM	-	-	-	-	-	-	-	-	-
BSA-ba	RRE	Yes	Yes	BAM	BAM	-	-	Yes	Yes ⁴	-	-	“AND” R ₁ ⁵	Yes
BSA-ra	RRE	R ₁ ¹	Yes	R ₁ ¹ BAM	BAM	-	-	-	Yes	-	-	Yes	Yes
BSG	RRE	Yes	Yes	R ₁ ¹ BAM	BAM	-	-	-	-	-	- ³	-	Yes
BSM	RR	-	R ₂ ¹	R ₁ ¹ BAM	R ₂ ¹	R ₁ ¹ EAM64	R ₂ ¹	-	-	-	-	-	-
MC# ²	SI	Yes	Yes	Yes	Yes	Yes	Yes	Yes	Yes	-	-	-	-
PC-cp	S	Yes	Yes	BAM	BAM	-	-	Yes	Yes	-	-	“OR” EKM	Yes
PC-ss	S	Yes	Yes	BAM	BAM	-	-	Yes	Yes	Yes	Yes	“OR” EKM	Yes
PT-cp or PTI-cp	RRE	-	R ₂	-	R ₂ BAM	-	-	-	R ₂ **	-	-	“AND” R ₁	Yes
PT-ss or PTI-ss	RRE	-	R ₂	-	R ₂ BAM	-	-	-	R ₂ **	-	Yes	“AND” R ₁	Yes
RP	S	-	Yes	-	Yes	-	Yes	-	-	-	-	-	Yes
SAM24	E	-	-	-	Yes 0	-	Yes 0	-	-	-	-	-	Yes
SAM31	E	-	-	-	Yes 1	-	Yes 0	-	-	-	-	-	Yes
SAM64	E	-	-	-	Yes 1	-	Yes 1	-	-	-	-	-	Yes
SVC2	RR	Yes	Yes	Yes	Yes	Yes	Yes	Yes	Yes	-	-	-	-
TRAP2	E	Yes	Yes	Yes	Yes	Yes	-	Yes	-	-	-	-	Yes
TRAP4	S	Yes	Yes	Yes	Yes	Yes	-	Yes	-	-	-	-	Yes

Figure 5-3. Summary of Linkage Instructions without the Linkage Stack

Instruction	Format	Instruction Address PSW Bits 64-127		Basic Addr. Mode PSW Bit 32		Extended Addr. Mode PSW Bit 31		Problem State PSW Bit 15		PASN CR4 Bits 48-63		PSW-Key Mask Changed in CR3	Trace
		Save	Set	Save	Set	Save	Set	Save	Set	Save	Set		
Explanation:													
-		No											
*		In the 24-bit addressing mode, the instruction-length code, condition code, and program mask are saved in bit positions 32-39 of the R ₁ general register.											
**		A change from the supervisor to the problem state is allowed; a privileged-operation exception is recognized when a change from the problem to the supervisor state is specified.											
#		Monitor-mask bits provide a means of disallowing linkage, or enabling linkage, for selected classes of events. When the enhanced-monitor facility is installed, the enhanced-monitor-mask bits are also used in controlling linkage (by means of a monitor-event program interruption).											
1		The action takes place only if the associated R field in the instruction is nonzero.											
2		MC and SVC, as part of the interruption, save the entire current PSW and load a new PSW.											
3		The primary address-space-control element is set even though the PASN is not set.											
4		The problem state is set											
5		The PSW key also is set from general register R ₁											
BAM		The basic-addressing-mode bit is saved or set only in the 24-bit or 31-bit addressing mode.											
BAM31		The basic-addressing-mode bit is saved only in the 31-bit addressing mode.											
EAM64		The extended-addressing-mode bit is saved only in the 64-bit addressing mode.											
R ₁		The field or bit is saved in general register R ₁ .											
R ₂		The field or bit is set from general register R ₂ .											

Figure 5-3. Summary of Linkage Instructions without the Linkage Stack

With respect to System/370 programs, it is assumed that old, unmodified programs operate in the 24-bit addressing mode and call, or directly communicate with, other programs operating in the 24-bit addressing mode only. Modified programs normally operate in the 24-bit addressing mode but may have called programs which operate in either the 24-bit or 31-bit addressing mode. They and also modified 370-XA, ESA/370, and ESA/390 programs now may call programs that operate in the 24-bit, 31-bit, or 64-bit addressing mode. New programs may be written to operate in any addressing mode, and, in some cases, a program may be written such that it can be invoked in any addressing mode.

BRANCH AND SAVE AND SET MODE (BASSM) is intended to be the principal calling instruction to sub-routines outside of an assembler/linkage-editor control section (CSECT), for use by all new programs and particularly by programs that must change the addressing mode during the linkage. The calling sequence has normally been:

```

L      15,ACON
BASSM 14,15
...
EXTRN SUB
ACON DC  A(X'80000000'+SUB)

```

where ACON is an A-type address constant, and the X'80000000' should be present to give control in the 31-bit addressing mode or should be omitted to give control in the 24-bit addressing mode.

The return from such a routine normally is:

```
BSM 0,14
```

It is assumed that the A-type address constant will be extended so it may be an eight-byte field containing a 64-bit entry-point address, with bit 63 of the address indicating, when one, that the entry is in the 64-bit addressing mode. This extended constant is shown here as "ACONE". The calling sequence would normally be:

```

LG      15,ACONE
BASSM 14,15
...
EXTRN SUB
ACONE DC  AD(X'1'+SUB)

```

The return from such a routine would normally be:

```
BSM 0,14
```

When a change of the addressing mode is not required, BRANCH AND LINK or BRANCH AND SAVE should be used instead of BASSM.

The BRANCH AND LINK (BAL, BALR) instruction is provided primarily for compatibility with System/370. It is defined to operate in the 31-bit and 64-bit addressing modes to increase the probability that an old, straightforward program can be modified to operate in those addressing modes with minimal or no change. It is recommended, however, that BRANCH AND SAVE (BAS and BASR) be used instead and that BRANCH AND LINK be avoided since it places nonzero information in bit positions 32-39 of the general register in the 24-bit addressing mode, which may lead to problems and may decrease performance.

BRANCH RELATIVE AND SAVE and BRANCH RELATIVE AND SAVE LONG may be used instead of BRANCH AND SAVE.

It is assumed that the normal return from a subroutine called in the 24-bit or 31-bit addressing mode by BRANCH AND LINK (BAL or BALR) will be:

BCR 15,14

However, the standard "return instruction":

BSM 0,14

operates correctly for all cases except for a calling BAL executed in the 24-bit addressing mode. In the 24-bit addressing mode, BAL causes an ILC of 10 to be placed in bit positions 32 and 33 of the link register. Thus, a BSM would return in the 31-bit addressing mode. Note that an EXECUTE of BALR in the 24-bit addressing mode also causes the same ILC effect; an EXECUTE RELATIVE LONG of BALR in the 24-bit addressing mode causes a similar ILC effect (the ILC is 11 binary).

The BRANCH AND SAVE (BAS, BASR) instruction is provided to be used for subroutine linkage to any program either within the same CSECT or known to be in the same addressing mode. BASR with the R_2 field 0 is also useful for obtaining addressability to the instruction stream by getting a 31-bit address, unclut-

tered by leftmost fields, in the 24-bit addressing mode.

The instruction for returning from a routine called in the 24-bit or 31-bit addressing mode by BRANCH AND SAVE (BAS or BASR) may be either:

BCR 15,14

or:

BSM 0,14

The instruction for returning from a routine called in the 64-bit addressing mode by BAS or BASR must be BCR; BSM would set the 24-bit or 31-bit addressing mode, depending on bit 32 of the link register (an address bit), because bit 63 of the link register (the rightmost bit of an instruction address) is zero. BSM can always be used as the return instruction if BASSM is used as the calling instruction.

In some cases, it may be desirable to rewrite a program that is called by an old program which has not been rewritten. In such a case, the old program, which operates in the 24-bit or 31-bit addressing mode, will be given the address of an intermediate program that will set up the correct entry and return modes and then call the rewritten program. Such an intermediate program is sometimes referred to as a *glue module*. The instruction BRANCH AND SET MODE (BSM) with a nonzero R_1 field provides the function necessary to perform this operation efficiently. This is shown in Figure 5-4 on page 5-22 for a linkage from a 24-bit-mode program to a 31-bit-mode program.

Note that the "BSM 14,15" in the glue module causes either an indication of the 64-bit addressing mode to be saved in bit position 63 of general register 14 or an indication of one of the 24-bit and 31-bit addressing modes to be saved in bit position 32 of the register, and that the other bits of the register are unchanged. Thus, when "BSM 0,14" is executed in the new program, control passes directly back to the old program without passing through the glue module again. The glue module could give control to a program in the 64-bit addressing mode and possibly above the 2 G-byte boundary by loading an eight-

byte A-type address constant, with bit 63 set to one, instead of a four-byte A-type address constant.

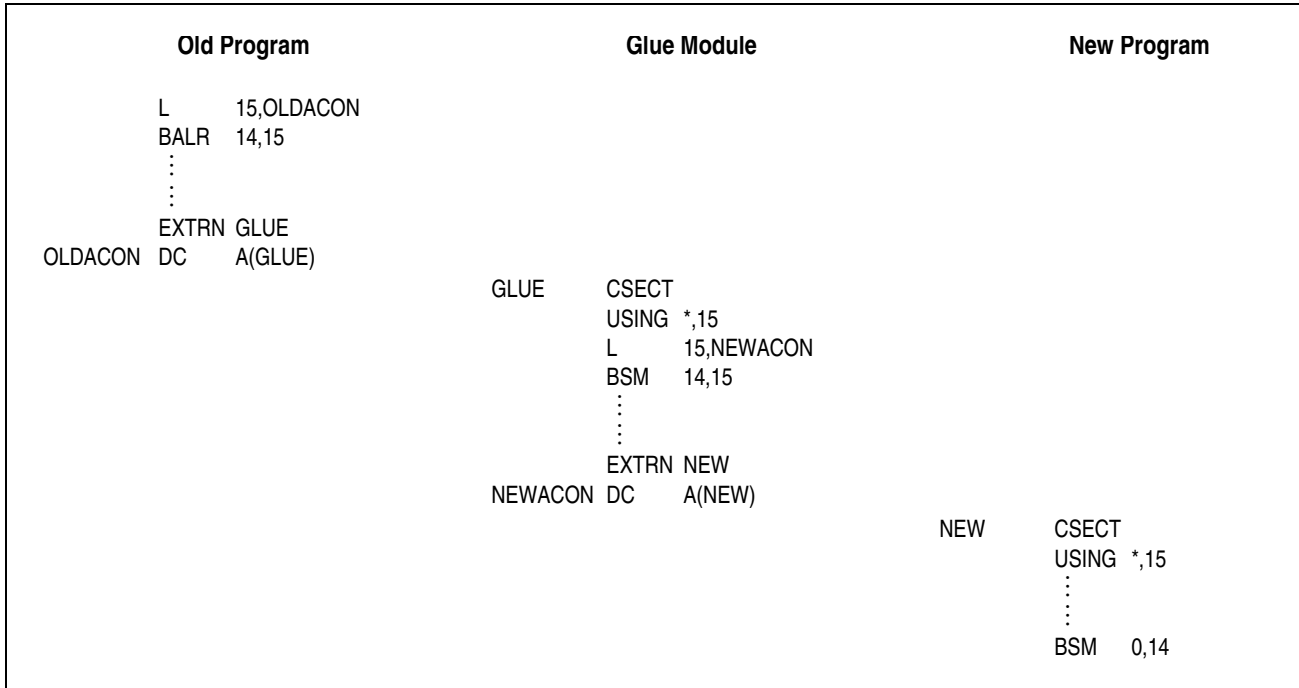

Figure 5-4. Glue Module for Linkage from the 24-Bit Mode to the 31-Bit Mode

Interruptions

Interruptions permit the CPU to change state as a result of conditions external to the system, in sub-channels or input/output (I/O) devices, in other CPUs, or in the CPU itself. Details are to be found in Chapter 6, “interruptions”.

Six classes of interruption conditions are provided: external, I/O, machine check, program, restart, and supervisor call. Each class has two related PSWs, called old and new, in permanently assigned real storage locations. In all classes, an interruption involves storing information identifying the cause of the interruption, storing the current PSW at the old-PSW location, and fetching the PSW at the new-PSW location, which becomes the current PSW.

The old PSW contains CPU-status information necessary for resumption of the interrupted program. At the conclusion of the program invoked by the interruption, the instruction LOAD PSW EXTENDED may be used to restore the current PSW to the value of the old PSW.

Types of Instruction Ending

Instruction execution ends in one of five ways: completion, nullification, suppression, termination, and partial completion.

Partial completion of instruction execution occurs only for interruptible instructions; it is described in “Interruptible Instructions” on page 5-24.

Completion

Completion of instruction execution provides results as called for in the definition of the instruction. When an interruption occurs after the completion of the execution of an instruction, the instruction address in the old PSW designates the next sequential instruction.

Suppression

Except as noted below, suppression of instruction execution causes the instruction to be executed as if it specified “no operation.” The contents of any result fields, including the condition code, are not changed. The instruction address in the old PSW on an interruption after suppression designates the next sequential instruction.

When (a) the AFP-register (additional floating-point register) control bit, bit 45 of control register 0, is one, (b) either an IEEE-invalid-operation condition or an IEEE-division-by-zero condition is recognized, and (c) the respective IEEE mask bit in the floating-point-control (FPC) register is one, then the resulting data-exception program interruption is considered to be suppressing, even though the FPC is altered. See “Data-Exception Code (DXC)” on page 6-17 for details.

When (a) the additional floating-point register (AFP-register) control bit, bit 45 of control register 0, is one, (b) the vector enablement control, bit 46 of control register 0, is one, and (c) a vector-processing exception is recognized, then the resulting vector-processing exception program interruption is considered to be suppressing, even though the FPC is altered. See “Vector-Exception Code” on page 6-20 for details.

In the access-register mode, if an access exception defined to be suppressing is recognized for an operand of `PERFORM LOCKED OPERATION` whose address is in the parameter list, the ALET associated with the address is placed into the access register designated by the R_3 field of the instruction.

Nullification

Except as noted below, nullification of instruction execution has the same effect as suppression, except that when an interruption occurs after the execution of an instruction has been nullified, the instruction address in the old PSW designates the instruction whose execution was nullified (or an execute-type instruction, as appropriate) instead of the next sequential instruction.

In the access-register mode, if an access exception defined to be nullifying is recognized for an operand of `PERFORM LOCKED OPERATION` whose address is in the parameter list, the ALET associated with the address is placed into the access register designated by the R_3 field of the instruction.

Termination

Termination of instruction execution causes the contents of any fields due to be changed by the instruction to be unpredictable. The operation may replace all, part, or none of the contents of the designated result fields and may change the condition code if such change is called for by the instruction. Unless the interruption is caused by a machine-check condition, the validity of the instruction address in the

PSW, the interruption code, and the ILC are not affected, and the state or the operation of the machine is not affected in any other way. The instruction address in the old PSW on an interruption after termination designates the next sequential instruction.

The terms completion, nullification, partial completion, suppression, and termination, and their corresponding effects, apply to the ending of individual instructions. When a transaction aborts, all transactional stores made by instructions while the CPU was in the transactional-execution mode are discarded, nontransactional stores are committed, and general registers designated by the general-register-save mask (GRSM) of the outermost TRANSACTION BEGIN instruction are restored to their contents prior to transactional execution. Any other general registers (not designated by the GRSM), access registers, vector registers, and floating-point registers (including the floating-point control register) that were altered while the CPU was in the transactional-execution mode retain their contents.

When a transaction is aborted, the program-status word is replaced with the transaction-abort PSW, except that the condition code is set to indicate the severity of the abort condition. In the case of a transaction that is aborted due to conditions that result in an interruption, this PSW becomes the old PSW stored as a result of the interruption. See “Transaction-Abort PSW (TAPSW)” on page 5-93 for further details.

If a transaction is aborted due to any cause except a program-interruption condition, the instruction address that is placed into the aborted-transaction-instruction-address field of the transaction diagnostic block is that of the instruction that would have been executed next in the absence of the abort. If a transaction is aborted due to a program-interruption condition, the instruction address that is placed into the aborted-transaction-instruction-address field is that of either the instruction at which the exception condition was detected or the instruction that would have been executed next in the absence of the abort, depending on whether the program-interruption condition was or was not nullifying, respectively. See “Aborted-Transaction Instruction Address (ATIA)” on page 5-95 for additional details.

Programming Note: Although the execution of an instruction is treated as a no-operation when suppression or nullification occurs, stores may be per-

formed as the result of the implicit tracing action associated with some instructions. See “Tracing” on page 4-12.

Interruptible Instructions

Point of Interruption

For most instructions, the entire execution of an instruction is one operation. An interruption is permitted between operations; that is, an interruption can occur after the performance of one operation and before the start of a subsequent operation.

For the following instructions, referred to as interruptible instructions, an interruption is permitted also after partial completion of the instruction:

- COMPARE AND FORM CODEWORD
- COMPARE LOGICAL LONG
- COMPARE UNTIL SUBSTRING EQUAL
- COMPRESSION CALL
- INVALIDATE PAGE TABLE ENTRY (when the IPTE-range facility is installed, and the R_3 field is nonzero)
- MOVE LONG
- PERFORM FRAME MANAGEMENT FUNCTION when the EDAT-1 facility is installed and the frame-size code designates a 1 M-byte frame, or when the EDAT-2 facility is installed and the frame-size code designates a 2 G-byte frame
- SET STORAGE KEY EXTENDED (when the enhanced-DAT facility is installed, and the multiple-block control is one)
- TEST BLOCK
- UPDATE TREE

Unit of Operation

Whenever points of interruption that include those occurring within the execution of an interruptible instruction are discussed, the term “unit of operation” is used. For a noninterruptible instruction, the entire execution consists, in effect, in the execution of one unit of operation.

The execution of an interruptible instruction is considered to consist in the execution of a number of units of operation, and an interruption is permitted between units of operation. The amount of data processed in a unit of operation depends on the particular instruction and may depend on the model and on the particular condition that causes the execution of the instruction to be interrupted.

When an instruction execution consists of a number of units of operation and an interruption occurs after some, but not all, units of operation have been completed, the instruction is said to be partially completed. In this case, the type of ending (completion, nullification, or suppression) is associated with the unit of operation. In the case of termination, the entire instruction is terminated, not just the unit of operation.

An exception may exist that causes the first unit of operation of an interruptible instruction not to be completed. In this case when the ending is nullification or suppression, all operand parameters and result locations remain unchanged, except that the condition code is unpredictable if the instruction is defined to set the condition code.

When a storage-alteration PER event is recognized, fewer than 4K additional bytes are stored to each operand location intersecting with the designated PER storage-area before the event is indicated by an interruption that may occur on completion of a unit of operation. When a zero-address-detection PER event is recognized, the event is indicated by an interruption that may occur on completion of a unit of operation.

Execution of Interruptible Instructions

The execution of an interruptible instruction is completed when all units of operation associated with that instruction are completed. When an interruption occurs after completion, nullification, or suppression of a unit of operation, all preceding units of operation have been completed, and subsequent units of operation and instructions have not been started. The main difference between these types of ending is the handling of the current unit of operation and whether the instruction address stored in the old PSW identifies the current instruction or the next sequential instruction.

At the time of an interruption, changes to storage locations or register contents which are due to be made by instructions following the interrupted instruction have not yet been made.

Completion: On completion of the last unit of operation of an interruptible instruction, the instruction address in the old PSW designates the next sequential instruction. The result location for the current unit of operation has been updated. It depends on the particular instruction how the operand parameters

are adjusted. On completion of a unit of operation other than the last one, the instruction address in the old PSW designates the interrupted instruction or an execute-type instruction, as appropriate. The result location for the current unit of operation has been updated. The operand parameters are adjusted such that the execution of the interrupted instruction is resumed from the point of interruption when the old PSW stored during the interruption is made the current PSW.

Nullification: When a unit of operation is nullified, the instruction address in the old PSW designates the interrupted instruction or an execute-type instruction, as appropriate. The result location for the current unit of operation remains unchanged. The operand parameters are adjusted such that, if the instruction is reexecuted, execution of the interrupted instruction is resumed with the current unit of operation.

Suppression: When a unit of operation is suppressed, the instruction address in the old PSW designates the next sequential instruction. The operand parameters, however, are adjusted so as to indicate the extent to which instruction execution has been completed. If the instruction is reexecuted after the conditions causing the suppression have been removed, the execution is resumed with the current unit of operation.

Termination: When an exception which causes termination occurs as part of a unit of operation of an interruptible instruction, the entire operation is terminated, and the contents, in general, of any fields due to be changed by the instruction are unpredictable. On such an interruption, the instruction address in the old PSW designates the next sequential instruction.

The differences among the four types of ending for a unit of operation are summarized in Figure 5-5 on page 5-25.

If an instruction is defined to set the condition code, the execution of the instruction makes the condition code unpredictable except when the last unit of operation has been completed.

Unit of Operation Is	Instruction Address	Operand Parameters	Current Result Location
Completed			
Last unit of operation	Next instruction	Depends on the instruction	Changed
Any other unit of operation	Current instruction	Next unit of operation	Changed
Nullified	Current Instruction	Current unit of operation	Unchanged
Suppressed	Next Instruction	Current unit of operation	Unchanged
Terminated	Next instruction	Unpredictable	Unpredictable

Figure 5-5. Types of Ending for a Unit of Operation

Condition-Code Alternative to Interruptibility

The following instructions are not interruptible instructions but instead may be completed after performing a CPU-determined subportion of the processing specified by the parameters of the instructions:

- CHECKSUM
- CIPHER MESSAGE
- CIPHER MESSAGE WITH AUTHENTICATION
- CIPHER MESSAGE WITH CIPHER FEEDBACK
- CIPHER MESSAGE WITH CHAINING
- CIPHER MESSAGE WITH COUNTER
- CIPHER MESSAGE WITH OUTPUT FEEDBACK
- COMPARE LOGICAL LONG EXTENDED
- COMPARE LOGICAL LONG UNICODE
- COMPARE LOGICAL STRING
- COMPUTE DIGITAL SIGNATURE AUTHENTICATION
- COMPUTE INTERMEDIATE MESSAGE DIGEST
- COMPUTE LAST MESSAGE DIGEST
- COMPUTE MESSAGE AUTHENTICATION CODE
- CONVERT UTF-16 TO UTF-32
- CONVERT UTF-16 TO UTF-8
- CONVERT UTF-32 TO UTF-16
- CONVERT UTF-32 TO UTF-8
- CONVERT UTF-8 TO UTF-16
- CONVERT UTF-8 TO UTF-32
- DEFLATE CONVERSION CALL
- MOVE LONG EXTENDED

- MOVE LONG UNICODE
- MOVE STRING
- PERFORM CRYPTOGRAPHIC COMPUTATION
- PERFORM RANDOM NUMBER OPERATION
- SEARCH STRING
- SEARCH STRING UNICODE
- TRANSLATE AND TEST EXTENDED
- TRANSLATE AND TEST REVERSE EXTENDED
- TRANSLATE EXTENDED
- TRANSLATE ONE TO ONE
- TRANSLATE ONE TO TWO
- TRANSLATE TWO TO ONE
- TRANSLATE TWO TO TWO

When any of the above instructions is completed after performing only a CPU-determined amount of processing instead of all specified processing, the instruction sets condition code 3. On such completion, the instruction address in the PSW designates the next sequential instruction, and the operand parameters of the instruction have been adjusted so that the processing of the instruction can be resumed simply by branching back to the instruction to execute it again. When the instruction has performed all specified processing, it sets a condition code other than 3.

The points at which any of the above instructions may set condition code 3 are comparable to the points of interruption of an interruptible instruction, and the amount of processing between adjacent points is comparable to a unit of operation of an interruptible instruction. However, since the instruction is not interruptible, each execution is considered the execution of one unit of operation.

Completion with the setting of condition code 3 permits interruptions to occur. Depending on the model and the instruction, condition code 3 may or may not be set when there is not a need for an interruption.

The following applies to instructions which have a condition-code alternative to interruptibility and perform an operation which may be suspended and subsequently resumed:

- When a storage-alteration PER event is recognized, fewer than 4K additional bytes are stored to each operand location intersecting with the designated PER storage-area before the event is indicated by an interruption which may occur on completion of a CPU-determined amount of data (resulting in condition code 3 being set).

- When a zero-address-detection PER event is recognized, the event is indicated by an interruption which may occur on completion of a CPU-determined amount of data (resulting in condition code 3 being set).

The COMPARE UNTIL SUBSTRING EQUAL and COMPRESSION CALL instructions both are interruptible instructions and ones that may set condition code 3 after performing a CPU-determined amount of processing.

Programming Notes:

1. Any interruption, other than supervisor call and some program interruptions, can occur after a partial execution of an interruptible instruction. In particular, interruptions for external, I/O, machine-check, restart, and program interruptions for access exceptions and PER events can occur between units of operation.
2. The amount of data processed in a unit of operation of an interruptible instruction depends on the model and may depend on the type of condition which causes the execution of the instruction to be interrupted or stopped. Thus, when an interruption occurs at the end of the current unit of operation, the length of the unit of operation may be different for different types of interruptions. Also, when the stop function is requested during the execution of an interruptible instruction, the CPU enters the stopped state at the completion of the execution of the current unit of operation. Similarly, in the instruction-step mode, only a single unit of operation is performed, but the unit of operation for the various cases of stopping may be different.

Exceptions to Nullification and Suppression

In certain unusual situations, the result fields of an instruction having a store-type operand are changed in spite of the occurrence of an exception which would normally result in nullification or suppression. These situations are exceptions to the general rule that the operation is treated as a no-operation when an exception requiring nullification or suppression is recognized. Each of these situations may result in the turning on of the change bit associated with the store-type operand, even though the final result in storage may appear unchanged. Depending on the

particular situation, additional effects may be observable. The extent of these effects is described along with each of the situations.

All of these situations are limited to the extent that a store access does not occur and the change bit is not set when the store access is prohibited. For the CPU, a store access is prohibited whenever an access exception exists for that access, or whenever an exception exists which is of higher priority than the priority of an access exception for that access.

When, in these situations, an interruption for an exception requiring suppression occurs, the instruction address in the old PSW designates the next sequential instruction. When an interruption for an exception requiring nullification occurs, the instruction address in the old PSW designates the instruction causing the exception even though partial results may have been stored.

Programming Note: The term *translation-associated access exception* refers to any of the following exceptions: ALE-sequence, ALEN-translation, ALET-specification, ASCE-type, ASTE-sequence (during ART), ASTE-validity (during ART), addressing due to the contents of an ART- or DAT-table entry, extended-authority, page-translation, region-first-translation, region-second-translation, region-third-translation, segment-translation, translation-specification. In some models prior to z/Architecture, if a CPU made a store-type reference where part of the operand was in an accessible page, and the other part of the operand was in a page for which a translation-associated access exception existed, the I/O subsystem could observe the accessible portion of the operand changed to an intermediate value that was then restored to the original value. The visibility of an intermediate operand was limited to the I/O subsystem; other CPUs did not observe an intermediate value.

This behavior is not applicable to any machine that is capable of operating in the z/Architecture architectural mode.

Modification of DAT-Table Entries

When a valid and attached DAT-table entry is changed to a value which would cause an exception, and when, before the TLB is cleared of entries which qualify for substitution for that entry, an attempt is made to refer to storage by using a virtual address requiring that entry for translation, the contents of any fields due to be changed by the instruction are

unpredictable. Results, if any, associated with the virtual address whose DAT-table entry was changed may be placed in those real locations originally associated with the address. Furthermore, it is unpredictable whether or not an interruption occurs for an access exception that was not initially applicable. On some machines, this situation may be reported by means of an instruction-processing-damage machine check with the delayed-access-exception bit also indicated.

Trial Execution for Editing Instructions and Translate Instruction

For the instructions EDIT, EDIT AND MARK, and TRANSLATE, the portions of the operands that are actually used in the operation may be established in a trial execution for operand accessibility that is performed before the execution of the instruction is started. This trial execution consists in an execution of the instruction in which results are not stored. If the first operand of TRANSLATE or either operand of EDIT or EDIT AND MARK is changed by another CPU or by a channel program, after the initial trial execution but before completion of execution, the contents of any fields due to be changed by the instruction are unpredictable.

Authorization Mechanisms

Most of the authorization mechanisms that are described in this section permit the control program to establish the degree of function provided to a particular semiprivileged program. These authorization mechanisms are intended for use by programs considered to be semiprivileged, that is, programs that are executed in the problem state but which may be authorized to use additional capabilities. With these authorization controls, a hierarchy of programs may be established, with programs at a higher level having a greater degree of privilege or authority than programs at a lower level. The range of functions available at each level, and the ability to transfer control from a lower to a higher level, are specified in tables which are managed by the control program. When the linkage stack is used, a nonhierarchical transfer of control also can be specified.

A semiprivileged instruction is one which can be executed in the problem state, but which is subject to the control of one or more of the authorization mechanisms described in this section. There are 25 semi-

privileged instructions and also the privileged LOAD ADDRESS SPACE PARAMETERS instruction that are controlled by the authorization mechanisms. All of these semiprivileged and privileged instructions are described in Chapter 10, “Control Instructions”.

This section also describes, or refers to descriptions of, authorization mechanisms that are available when the ASN-and-LX-reuse facility is installed. These mechanisms do not apply to particular programs or provide for a hierarchy of programs.

The instructions controlled by the authorization mechanisms are listed in Figure 5-6 on page 5-31. The figure also shows additional authorization mechanisms that do not control specifically semiprivileged instructions; they control implicit access-register translation (access-register translation as part of an instruction making a storage reference) and also access-register translation in the LOAD PAGE-TABLE-ENTRY ADDRESS, LOAD REAL ADDRESS, STORE REAL ADDRESS, TEST ACCESS, and TEST PROTECTION instructions and a special form of access-register translation in the BRANCH IN SUBSPACE GROUP instruction. These additional mechanisms (the extended authorization index, ALE sequence number, and ASTE sequence number) index and ALE sequence number) are described in “Access-Register-Specified Address Spaces” on page 5-46, and the ASTE instance number is further described in “ASN-Second-Table-Entry Sequence Number” on page 3-24. The figure also shows the LSTE sequence number, which may be used in PC-number translation in the PROGRAM CALL instruction and is described in “ASN-and-LX-Reuse Control (R).” on page 5-35.

Mode Requirements

Most of the semiprivileged instructions can be executed only with DAT on. Basic PROGRAM CALL, PROGRAM TRANSFER, and PROGRAM TRANSFER WITH INSTANCE, are valid only in the primary-space mode. (Basic PROGRAM CALL is the PROGRAM CALL operation when the linkage stack is not used. When the linkage stack is used, the PROGRAM CALL operation is called stacking PROGRAM CALL). MOVE TO PRIMARY and MOVE TO SECONDARY are valid only in the primary-space and secondary-space modes. BRANCH AND STACK, stacking PROGRAM CALL, and PROGRAM RETURN are valid only in the primary-space and access-register modes. EXTRACT STACKED REG-

ISTERS, EXTRACT STACKED STATE, and MODIFY STACKED STATE are valid only in the primary-space, access-register, and home-space modes. When a semiprivileged instruction is executed in an invalid translation mode, a special-operation exception is recognized.

PROGRAM TRANSFER and PROGRAM TRANSFER WITH INSTANCE specify a new value for the problem-state bit in the PSW. If a program in the problem state attempts to execute PROGRAM TRANSFER or PROGRAM TRANSFER WITH INSTANCE and set the supervisor state, a privileged-operation exception is recognized. A privileged-operation exception is also recognized on an attempt to use RESUME PROGRAM, SET ADDRESS SPACE CONTROL, or SET ADDRESS SPACE CONTROL FAST to set the home-space mode in the problem state.

Extraction-Authority Control

The extraction-authority-control bit is located in bit position 36 of control register 0. In the problem state, bit 36 must be one to allow completion of these instructions:

- EXTRACT PRIMARY ASN
- EXTRACT PRIMARY ASN AND INSTANCE
- EXTRACT SECONDARY ASN
- EXTRACT SECONDARY ASN AND INSTANCE
- INSERT ADDRESS SPACE CONTROL
- INSERT PSW KEY
- INSERT VIRTUAL STORAGE KEY

Otherwise, a privileged-operation exception is recognized. The extraction-authority control is not examined in the supervisor state.

PSW-Key Mask

The PSW-key mask consists of bits 32-47 in control register 3, with the bits corresponding to the values 0-15, respectively, of the PSW key. These bits are used in the problem state to control which keys and entry points are authorized for the program. The PSW-key mask is modified by PROGRAM TRANSFER, and PROGRAM TRANSFER WITH INSTANCE, is modified or loaded by BRANCH AND SET AUTHORITY and PROGRAM CALL, and is loaded by LOAD ADDRESS SPACE PARAMETERS and PROGRAM RETURN. The PSW-key mask is used in the problem state to control the following:

- The PSW-key values that can be set by means of the instruction SET PSW KEY FROM ADDRESS.
- The PSW-key values that are valid for the six move instructions that specify a second access key: MOVE PAGE, MOVE TO PRIMARY, MOVE TO SECONDARY, MOVE WITH DESTINATION KEY, MOVE WITH KEY, and MOVE WITH SOURCE KEY.
- The PSW-key values that are valid for the MOVE WITH OPTIONAL SPECIFICATIONS instruction when a key is explicitly specified for the first, second, or both operands.
- The entry points which can be called by means of PROGRAM CALL. In this case, the PSW-key mask is ANDed with the authorization key mask in the entry-table entry, and, if the result is zero, the program is not authorized.

When an instruction in the problem state attempts to use a key not authorized by the PSW-key mask, a privileged-operation exception is recognized. The same action is taken when an instruction in the problem state attempts to call an entry not authorized by the PSW-key mask. The PSW-key mask is not examined in the supervisor state, all keys and entry points being valid.

Secondary-Space Control

Bit 37 of control register 0 is the secondary-space-control bit. This bit provides a mechanism whereby the control program can indicate whether or not the secondary region-first table, region-second table, region-third table or segment table has been established. Bit 37 may be required to be one to allow completion of SET ADDRESS SPACE CONTROL FAST and MOVE WITH OPTIONAL SPECIFICATIONS, and it must be one to allow completion of these instructions:

- MOVE TO PRIMARY
- MOVE TO SECONDARY
- MOVE WITH OPTIONAL SPECIFICATIONS, when either operand-access control designates the secondary space
- SET ADDRESS SPACE CONTROL

Otherwise, a special-operation exception is recognized. The secondary-space control is examined in both the problem and supervisor states.

Subsystem-Linkage Control

Bit 192 of the primary ASN-second-table entry is the subsystem-linkage-control bit. The subsystem-linkage control must be one to allow completion of these instructions:

- PROGRAM CALL
- PROGRAM TRANSFER
- PROGRAM TRANSFER WITH INSTANCE

Otherwise, a special-operation exception is recognized. The subsystem-linkage control is examined in both the problem and supervisor states and controls both the space-switching and current-primary versions of the instructions.

ASN-Translation Control

Bit 44 of control register 14 is the ASN-translation-control bit. This bit provides a mechanism whereby the control program can indicate whether ASN translation may occur while a particular program is being executed. Bit 44 must be one to allow completion of these instructions:

- LOAD ADDRESS SPACE PARAMETERS
- SET SECONDARY ASN
- SET SECONDARY ASN WITH INSTANCE
- PROGRAM CALL with space switching
- PROGRAM RETURN with space switching and also when the restored secondary ASN is not equal to the restored primary ASN
- PROGRAM TRANSFER with space switching
- PROGRAM TRANSFER WITH INSTANCE with space switching

Otherwise, a special-operation exception is recognized. The ASN-translation control is examined in both the problem and supervisor states. The ASN-translation control is examined by PROGRAM CALL even though PROGRAM CALL obtains the address of the ASN-second-table entry directly from the entry-table entry instead of by performing ASN translation.

Authorization Index

The authorization index is contained in bit positions 32-47 of control register 4. The authorization index is associated with the primary address space and is loaded along with the PASN when PROGRAM CALL with space switching, PROGRAM RETURN with space switching, PROGRAM TRANSFER with space switching, PROGRAM TRANSFER WITH INSTANCE with space switching, or LOAD ADDRESS SPACE

PARAMETERS is executed. The authorization index is used to determine whether a program is authorized to establish a particular address space. A program may be authorized to establish the address space as a secondary-address space, as a primary-address space, or both. The authorization index is examined in both the problem and supervisor states.

Associated with each address space is an authority table. The authorization index is used to select an entry in the authority table. Each entry contains two bits, which indicate whether the program with that authorization index is permitted to establish the address space as a primary address space, as a secondary address space, or both.

The instructions SET SECONDARY ASN with space switching, and SET SECONDARY ASN WITH INSTANCE with space switching, and the instruction PROGRAM RETURN when the restored secondary ASN is not equal to the restored primary ASN, use the authorization index to test the secondary-authority bit in the authority-table entry to determine if the address space can be established as a secondary address space. The tested bit must be one; otherwise, a secondary-authority exception is recognized.

The instructions PROGRAM TRANSFER with space switching and PROGRAM TRANSFER WITH INSTANCE with space switching use the authorization index to test the primary-authority bit in the authority-table entry to determine if the address space can be established as a primary address space. The tested bit must be one; otherwise, a primary-authority exception is recognized.

The instruction PROGRAM CALL with space switching causes a new authorization index to be loaded from the ASN-second-table entry. This permits the program which is called to be given an authorization index which authorizes it to access more or different address spaces than those authorized for the calling program. The instructions PROGRAM RETURN with space switching, PROGRAM TRANSFER with space switching, and PROGRAM TRANSFER WITH INSTANCE with space switching restore the authorization index that is associated with the returned-to address space.

The secondary-authority bit in the authority-table entry may also be used, along with the extended authorization index, to determine if the program is authorized to use an access-list entry in access-reg-

ister translation. This is described in “Access-Register-Specified Address Spaces” on page 5-46.

Instructions and Controls Related to ASN-and-LX Reuse

This section describes instructions and controls that are provided when the ASN-and-LX-reuse facility is installed. The controls apply in both the problem and the supervisor states.

Instructions: The ASN-and-LX-reuse facility provides the following instructions:

- EXTRACT PRIMARY ASN AND INSTANCE
- EXTRACT SECONDARY ASN AND INSTANCE
- PROGRAM TRANSFER WITH INSTANCE
- SET SECONDARY ASN WITH INSTANCE

PROGRAM TRANSFER WITH INSTANCE and SET SECONDARY ASN WITH INSTANCE are similar to PROGRAM TRANSFER and SET SECONDARY ASN, respectively. The space-switching forms of PROGRAM TRANSFER WITH INSTANCE and SET SECONDARY ASN WITH INSTANCE compare an ASTE instance number (ASTEIN) specified by the program in general register 1 to the ASTEIN in the ASN-second-table entry for the address space to which the space switch is to occur. An ASTE-instance exception is recognized if the two ASTEINs are not equal.

ASN-and-LX-Reuse Control: Bit 44 of control register 0 is the ASN-and-LX-reuse control. This bit is used to control both ASN reuse and LX reuse, as described below.

ASN Reuse: When the ASN-and-LX-reuse control is one, PROGRAM RETURN and LOAD ADDRESS SPACE PARAMETERS, when they perform ASN translation of either a primary ASN or a secondary ASN, compare a specified ASTEIN to the ASTEIN in the ASN-second-table entry located by the ASN translation. The two ASTEINs must be equal; otherwise, PROGRAM RETURN recognizes an ASTE-instance exception, and LOAD ADDRESS SPACE PARAMETERS sets condition code 1 or 2. For PROGRAM RETURN, the specified ASTEIN is in the linkage-stack program-call state entry being unstacked. For LOAD ADDRESS SPACE PARAMETERS, the specified ASTEIN is in the first operand of the instruction.

Bit 31 of word 1 of the ASN-second-table entry is the reusable-ASN bit. When the ASN-and-LX-reuse control is one, the space-switching forms of PROGRAM TRANSFER and SET SECONDARY ASN recognize a special-operation exception if the reusable-ASN bit is one in the ASN-second-table entry located by ASN translation. These instructions do not make a comparison to the ASTEIN in the ASN-second-table entry.

Bit 30 of word 1 of the ASN-second-table entry is the controlled-ASN bit. Regardless of the value of the ASN-and-LX-reuse control, PROGRAM TRANSFER WITH INSTANCE and SET SECONDARY ASN WITH INSTANCE recognize a special-operation exception if the controlled-ASN bit is one in the ASN-second-table entry located by ASN translation and the CPU is in the problem state at the beginning of the operation.

A more detailed description of ASN reuse is given in “ASN-Second-Table-Entry Instance Number and ASN Reuse” on page 3-25.

LX Reuse: When the ASN-and-LX-reuse control is one, the linkage table is replaced by a linkage first table and, for each valid linkage-first-table entry, a linkage second table.

The second word of the linkage-second-table entry used contains an LSTE sequence number (LSTESN), and PROGRAM CALL recognizes an LSTE-sequence exception if this LSTESN is nonzero and not equal to an LSTESN specified by the program in general register 15.

A more detailed description of LX reuse is given in “ASN-and-LX-Reuse Control (R):” on page 5-35.

Function or Instruction	Mode Requirement		Authorization Mechanism										Space Switch Event Ctl. (1.57, 13.57)	
	Pr. Op	Trans. Mode	Subs. Link. Ctl. ⁶	Sec.-Space Ctl. (0.37)	ASN-Trans. Ctl. (14.44)	Extr. Auth. Ctl (0.36)	PSW-Key Mask (3.32-3.47)	Auth. Index (4.32-4.47)	Ext.-Auth. Index (8.32-8.47)	ALE Seq. No. ⁷	ASTE Seq. No. ⁸	ASTE Inst. No. ⁹		LSTE Seq. No. ¹⁰
Implicit AR translation		A							EA	ALQ	ASQ			
BAKR		SO-PA					Q							
BSA-ba														
BSA-ra														
BSG		SO-PSAH									ASQ			
EPAR		SO-PSAH				Q								
EPAIR		SO-PSAH				Q								
EREG		SO-PAH												
EREGG		SO-PAH												
ESAR		SO-PSAH				Q								
ESAIR		SO-PSAH				Q								
ESTA		SO-PAH												
IAC		SO-PSAH				Q								
IPK						Q								
IVSK		SO-PSAH				Q								
LASP	P				SO			CC			CC	CC		CC
LPTEA	P								CCA	CCA	CCA			
LRA	P								CCA	CCA	CCA			
LRAG	P								CCA	CCA	CCA			
MSTA		SO-PAH												
MVCDK							Q							
MVCOS		SO-PSAH		SO-MS			Q							
MVCP		SO-PS		SO			Q							
MVCS		SO-PS		SO			Q							

Figure 5-6. Summary of Authorization Mechanisms (Part 1 of 2)

Function or Instruction	Mode Requirement		Authorization Mechanism										Space Switch Event Ctl. (1.57, 13.57)	
	Pr. Op	Trans. Mode	Subs. Link. Ctl. ⁶	Sec.-Space Ctl. (0.37)	ASN-Trans. Ctl. (14.44)	Extr. Auth. Ctl (0.36)	PSW-Key Mask (3.32-3.47)	Auth. Index (4.32-4.47)	Ext.-Auth. Index (8.32-8.47)	ALE Seq. No. ⁷	ASTE Seq. No. ⁸	ASTE Inst. No. ⁹		LSTE Seq. No. ¹⁰
MVCSK							Q							
bPC-cp		SO-P	SO				Q ¹						LSQ	
sPC-cp		SO-PA	SO				Q ¹						LSQ	
bPC-ss		SO-P	SO		SO		Q ¹				ASQ		LSQ	X1
sPC-ss		SO-PA	SO		SO		Q ¹				ASQ		LSQ	X1
PR-cp		SO-PA			SO ⁴			SA ⁵			ASQ	AIN		
PR-ss		SO-PA			SO			PASA ⁹			ASQ	AIN		X1
PT-cp	Q ²	SO-P	SO								ASQ			X1
PT-ss ¹¹	Q ²	SO-P	SO		SO			PA			ASQ			X1
PTI-cp	Q ²	SO-P	SO											
PTI-ss ¹²	Q ²	SO-P	SO		SO			PA			ASQ	AIN		X1
RP	Q ³													X2
SAC	Q ³	SO-PSAH		SO										X2
SACF	Q ³	SO-PSAH		SO ¹³										X2
SPKA							Q							
SSAR-cp		SO-PSAH			SO									
SSAR-ss ¹¹		SO-PSAH			SO			SA			ASQ			
SSAIR-cp		SO-PSAH			SO									
SSAIR-ss ¹²		SO-PSAH			SO			SA			ASQ	AIN		
STRAG	P													
TAR									CC	CC	CC			
TPROT	P								CC	CC	CC			

Figure 5-6. Summary of Authorization Mechanisms (Part 2 of 2)

Explanation for Summary of Authorization Mechanisms:

- 1 The PSW-key mask is ANDed with the authorization key mask in the entry-table entry.
- 2 The exception is recognized on an attempt to set the supervisor state when in the problem state.
- 3 The exception is recognized on an attempt to set the home-space mode when in the problem state.
- 4 ASN translation is performed for the new SASN, and the exception may be recognized, only when the new SASN is not equal to the new PASN.
- 5 Secondary authority is checked for the new SASN, and the exception may be

recognized, only when the new SASN is not equal to the new PASN.

- 6 Subsystem-linkage control is bit 92 of the primary ASN-second-table entry.
- 7 ALE sequence number is bits 8-15 of the access-list entry
- 8 ASTE sequence number is bits 160-191 of the ASN-second-table entry.
- 9 ASTE instance number is bits 352-383 of the ASN-second-table entry
- 10 LSTE sequence number is bits 32-63 of the linkage-second-table entry.
- 11 Special-operation exception is recognized if ASN-and-LX-reuse control, bit 44 of control register 0, is one and reusable-ASN bit, bit 31 of word 1 of the ASN-second-table entry, is one.

12	Special-operation exception is recognized if controlled-ASN bit, bit 30 of word 1 of the ASN-second-table entry, is one and the CPU is in the problem state at the beginning of the operation.	SO-PA	CPU must be in the primary-space or access-register mode; special-operation exception if the CPU is in the secondary-space, home-space, or real mode.
13	Whether the exception is recognized is unpredictable.	SO-PAH	CPU must be in the primary-space, access-register, or home-space mode; special-operation exception if the CPU is in the secondary-space or real mode.
A	Access-register translation occurs only in the access-register mode.	SO-PS	CPU must be in the primary-space or secondary-space mode; special-operation exception if the CPU is in the home-space, access-register, or real mode.
AIN	ASTE-instance exception.	SO-PSAH	CPU must be in the primary-space, secondary-space, access-register, or home-space mode; special-operation exception if the CPU is in the real mode.
ALQ	ALE-sequence exception.	sPC	Stacking PROGRAM CALL.
ASQ	ASTE-sequence exception	X1	When bit 57 of control register 1 is one, a space-switch event is recognized. The operation is completed.
bPC	Basic (nonstacking) PROGRAM CALL.	X2	When bit 57 of control register 1 or 13 is one and the instruction space is changed to or from the home address space, a space-switch event is recognized. The operation is completed.
CC	Test results in setting a condition code.		
CCA	Test results in setting a condition code. The test occurs only in the access-register mode.		
CRx.y	Control register x, bit position y.		
EA	Extended-authority exception.		
LSQ	LSTE-sequence exception.		
P	Privileged-operation exception for privileged instruction.		
PA	Primary-authority exception.		
PASA	Primary-authority exception or secondary-authority exception.		
Q	Privileged-operation exception for semi-privileged instruction. Authority checked only in the problem state.		
SA	Secondary-authority exception.		
SO	Special-operation exception.		
SO-MS	The secondary-space control, bit 37 of control register 0, must be one when either operand of MOVE WITH OPTIONAL SPECIFICATIONS is accessed in the secondary-space mode; otherwise, a special-operation exception is recognized.		
SO-P	CPU must be in the primary-space mode; special-operation exception if the CPU is in the secondary-space, access-register, home-space, or real mode.		

PC-Number Translation

PC-number translation is the process of translating PC number to locate an entry-table entry as part of the execution of the PROGRAM CALL instruction. When the ASN-and-LX-reuse facility is not installed or is not enabled, the PC number is 20 bits in bit positions 44-63 of the effective address used by PROGRAM CALL. When the ASN-and-LX-reuse facility is installed and enabled, the PC number is 20 bits in bit positions 44-63 of the effective address if bit 44 of the address is zero, or it is 32 bits in bit positions 32-63 of the address if bit 44 of the address is one. The facility is enabled if the ASN-and-LX-reuse control, bit 44 of control register 0, is one. The case when the facility is installed and enabled is referred to simply by saying that ASN-and-LX reuse is enabled.

To perform the translation of a PC number to locate an entry-table entry, the PC number is divided into two fields: a linkage index (LX) and an entry index (EX). The entry index is always the rightmost eight

bits of the PC number. When ASN-and-LX reuse is not enabled, the leftmost 12 bits of the 20-bit PC number are the linkage index. In this case, the effective address has the following format:

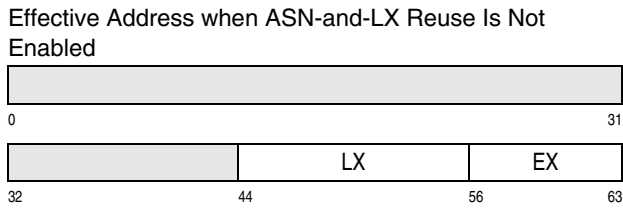

Bit 44 of the effective address has no special meaning and may be zero or one.

When ASN-and-LX reuse is enabled, the linkage index is further divided into a linkage first index (LFX) and a linkage second index (LSX). The linkage second index is always the five bits immediately on the left of the entry index. The size and format of the linkage first index depend on whether the PC number is 20 bits or 32 bits, which in turn depends on whether bit 44 of the effective address is zero or one, respectively. In these cases, the effective address has the following formats:

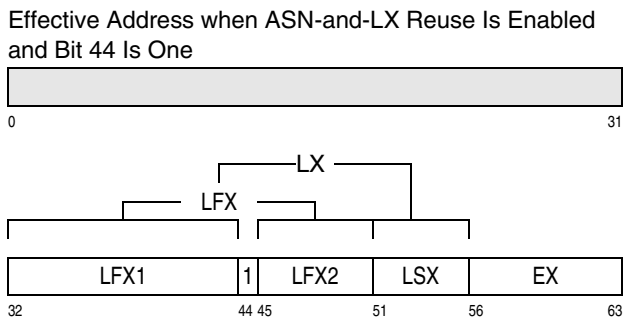
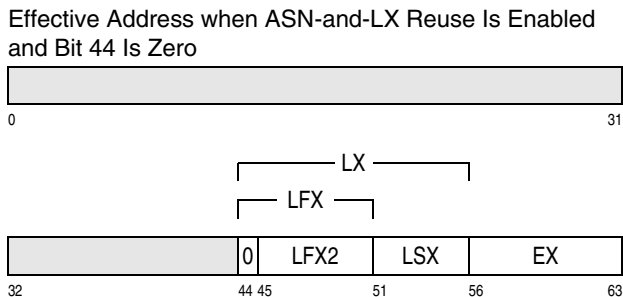

When ASN-and-LX reuse is enabled and bit 44 of the effective address is zero, the linkage first index is bits 44-50, or bits 45-50 (LFX2) with a zero appended on the left. Thus, the linkage first index is seven bits of which the leftmost bit is always zero. When bit 44 is one, the linkage first index is bits 45-50 (LFX2) with bits 32-43 (LFX1) appended on the left, or 18 bits. However, a linkage first table can contain at most 16,384 entries, and, therefore, the leftmost four bits of the linkage first index, bits 32-35 of the effective address, must always be zeros; otherwise, an LFX-translation exception is recognized.

When ASN-and-LX reuse is not enabled, the translation of a PC number is performed by means of two tables: a linkage table and an entry table. When ASN-and-LX reuse is enabled, the translation is performed by means of three tables: a linkage first table, a linkage second table, and an entry table. All of these tables reside in real storage. The linkage-table designation or linkage-first-table designation resides in another area in storage, called the primary ASN-second-table entry (primary ASTE), whose origin is in control register 5. When there are two levels of tables, the entry table is designated by means of a linkage-table entry. When there are three levels of tables, the linkage second table is designated by means of a linkage-first-table entry, and the entry table is designated by means of a linkage-second-table entry.

Programming Notes:

1. Bit 44 of a PROGRAM CALL effective address specifying a 32-bit PC number is not a numeric part of the PC number.
2. The effective address from which a PC number is derived is subject to the addressing mode in the current PSW. Therefore, bits 0-39 of the effective address in the 24-bit addressing mode, and bits 0-32 in the 31-bit addressing mode, are treated as containing zeros.

PC-Number Translation Control

PC-number translation is controlled by means of the ASN-and-LX-reuse control in control register 0 and a linkage-table designation or linkage-first-table designation in the primary ASN-second-table entry designated by the contents of control register 5.

Control Register 0



ASN-and-LX-Reuse Control (R): Bit 44 of control register 0 is the ASN-and-LX-reuse-control bit and is assigned if the ASN-and-LX-reuse facility is installed. When the bit is one, (1) the PC number is 20 bits if bit 44 of the effective address is zero or 32 bits if bit 44 is one, (2) the PC number is divided into a seven-bit (bit 44 is zero) or 18 bit (bit 44 is one) linkage first index, five-bit linkage second index, and eight-bit entry index, (3) the primary ASN-second-table entry contains a linkage-first-table designation instead of a linkage-table designation, and (4) the PC number is translated by means of a linkage first table, linkage second table, and entry table.

Also when the ASN-and-LX-reuse-control bit is one, if the linkage-second-table entry used during PC-number translation performed by PROGRAM CALL contains a nonzero linkage-second-table-entry sequence number (LSTESN), this LSTESN must be equal to an LSTESN specified in bit positions 0-31 of general register 15; otherwise, the PROGRAM CALL instruction cannot be completed, and an LSTESN exception is recognized.

The ASN-and-LX-reuse control in control register 0 is examined in both the problem and the supervisor states. Other uses of this control, related to the ASN-second-table-entry instance number, are summarized in “ASN-Second-Table-Entry Instance Number and ASN Reuse” on page 3-25.

This use of the LSTESN allows a linkage index associated with a particular LSTESN to be made unusable when the linkage index is reassigned to specify a different (different origin) or conceptually different (different contents, or containing ASNs that designate conceptually different address spaces) entry table. The LX-and-LSTESN combination can be made unusable by changing the LSTESN in the linkage-second-table entry.

Control Register 5

Control register 5 specifies the location of the primary ASN-second-table entry. The register has the following format:

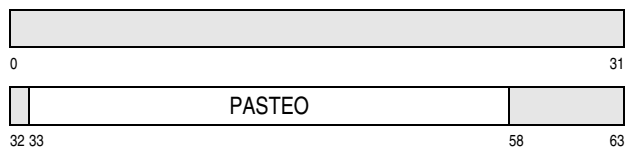

Primary-ASTE Origin (PASTE0): Bits 33-57 of control register 5, with six zeros appended on the right, form a 31-bit real address that designates the beginning of the primary ASTE. Bytes 24-27 of the primary ASTE contain the linkage-table designation if the ASN-and-LX-reuse facility is not installed or is not enabled by a one value of the ASN-and-LX-reuse control in control register 0, or they contain the linkage-first-table designation if the facility is installed and enabled.

The linkage-table designation has the following format:

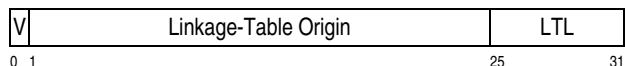

Subsystem-Linkage Control (V): Bit 0 of the linkage-table designation is the subsystem-linkage-control bit. Bit 0 must be one to allow completion of these instructions:

- PROGRAM CALL
- PROGRAM TRANSFER
- PROGRAM TRANSFER WITH INSTANCE

Otherwise, a special-operation exception is recognized. The subsystem-linkage control is examined in both the problem and the supervisor states and controls both the space-switching and current-primary versions of the instructions.

Linkage-Table Origin: Bits 1-24 of the linkage-table designation, with seven zeros appended on the right, form a 31-bit real address that designates the beginning of the linkage table.

Linkage-Table Length (LTL): Bits 25-31 of the linkage-table designation specify the length of the linkage table in units of 128 bytes, thus making the length of the linkage table variable in multiples of 32 four-byte entries. The length of the linkage table, in units of 128 bytes, is one more than the value in bit

positions 25-31. The linkage-table length is compared against the leftmost seven bits of the linkage-index portion of the PC number to determine whether the linkage index designates an entry within the linkage table.

The linkage-first-table designation has the following format:

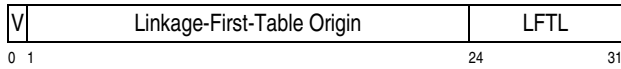

Subsystem-Linkage Control (V): Bit 0 of the linkage-first-table designation has the same definition as bit 0 of the linkage-table designation.

Linkage-First-Table Origin: Bits 1-23 of the linkage-first-table designation, with eight zeros appended on the right, form a 31-bit real address that designates the beginning of the linkage first table.

Linkage-First-Table Length (LFTL): Bits 24-31 of the linkage-first-table designation specify the length of the linkage first table in units of 256 bytes, thus making the length of the linkage first table variable in multiples of 64 four-byte entries. The length of the linkage first table, in units of 256 bytes, is one more than the value in bit positions 24-31. When bit 44 of the effective address specifying the PC number is one, the linkage-first-table length is compared against the leftmost 12 bits of the linkage-first-index portion of the PC number, bits 32-43 of the effective address, to determine whether the linkage first index designates an entry within the linkage first table. When bit 44 of the effective address is zero, the linkage-first-table length is ignored.

PC-Number Translation Tables

If the ASN-and-LX-reuse facility is not installed or is not enabled by a one value of the ASN-and-LX-reuse control in control register 0, the PC-number translation process consists in a two-level lookup using two tables: a linkage table and an entry table. If the facility is installed and enabled, the PC-number translation process consists in a three-level lookup using three tables: a linkage first table, a linkage second table, and an entry table. All of these tables reside in real storage.

Linkage-Table Entries

The entry fetched from the linkage table has the following format:

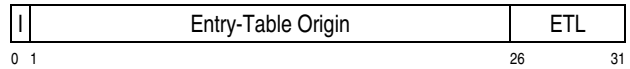

The fields in the linkage-table entry are allocated as follows:

LX-Invalid Bit (I): Bit 0 controls whether the entry table associated with the linkage-table entry is available.

When the bit is zero, PC-number translation proceeds by using the linkage-table entry. When the bit is one, an LX-translation exception is recognized.

Entry-Table Origin: Bits 1-25, with six zeros appended on the right, form a 31-bit real address that designates the beginning of the entry table.

Entry-Table Length (ETL): Bits 26-31 specify the length of the entry table in units of 128 bytes, thus making the table variable in multiples of four 32-byte entries. The length of the entry table, in units of 128 bytes, is one more than the value in bit positions 26-31. The entry-table length is compared against the leftmost six bits of the entry index to determine whether the entry index designates an entry within the entry table.

Linkage-First-Table Entries

The entry fetched from the linkage first table has the following format:

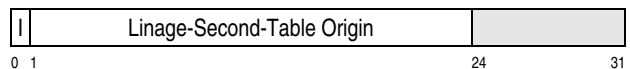

The fields in the linkage-first-table entry are allocated as follows:

LFX-Invalid Bit (I): Bit 0 controls whether the linkage second table associated with the linkage-first-table entry is available.

When the bit is zero, PC-number translation proceeds by using the linkage-first-table entry. When the bit is one, an LFX-translation exception is recognized.

Linkage-Second-Table Origin: Bits 1-23, with eight zeros appended on the right, form a 31-bit real

address that designates the beginning of the linkage second table.

Programming Note: The unused field in the linkage-first-table entry, bits 24-31, should be set to zeros. This field is reserved for future extensions, and programs which place nonzero values in this field may not operate compatibly on future machines.

Linkage-Second-Table Entries

The entry fetched from the linkage second table has the following format:

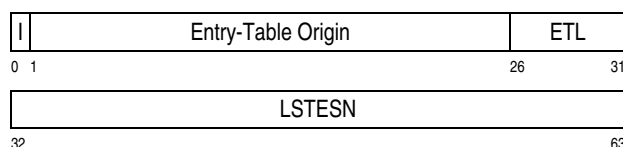

The fields in the linkage-second-table entry are allocated as follows:

LSX-Invalid Bit (I): Bit 0 controls whether the entry table associated with the linkage-second-table entry is available.

When the bit is zero, PC-number translation proceeds by using the linkage-second-table entry. When the bit is one, an LSX-translation exception is recognized.

Entry-Table Origin: Bits 1-25, with six zeros appended on the right, form a 31-bit real address that designates the beginning of the entry table.

Entry-Table Length (ETL): Bits 26-31 specify the length of the entry table in units of 128 bytes, thus making the table variable in multiples of four 32-byte entries. The length of the entry table, in units of 128 bytes, is one more than the value in bit positions 26-31. The entry-table length is compared against the leftmost six bits of the entry index to determine whether the entry index designates an entry within the entry table.

Linkage-Second-Table-Entry Sequence Number (LSTESN): During PC-number translation in PROGRAM CALL when bits 32-63 are not all zeros, bits 32-63 are compared to an LSTESN specified in bit positions 0-31 of general register 15. The comparison must give an equal result; otherwise, an LSTESN-exception is recognized. When bits 32-63 are all zeros, bits 0-31 of general register 15 are ignored.

Programming Note: The format of bits 0-31 of the linkage-second-table entry is the same as the format of the linkage-table entry.

Entry-Table Entries

The format of bits 0-63 of the entry-table entry depends on whether the addressing-mode in effect after the PROGRAM CALL operation is the extended (64-bit) addressing mode or a basic (24-bit or 31-bit) addressing mode. This in turn depends on bits 128 and 129 of the entry-table entry.

Bit 128 of the entry-table entry (T) is the PC-type bit. When bit 128 is zero, PROGRAM CALL is to perform the basic (nonstacking) operation. When bit 128 is one, PROGRAM CALL is to perform the stacking operation.

Bit 129 of the entry-table entry (G) is the entry-extended-addressing-mode bit. In the basic PROGRAM CALL operation, bit 31 of the current PSW, the extended-addressing-mode bit, must equal bit 129; otherwise, a special-operation exception is recognized. In the stacking operation when bit 129 is zero, bit 31 of the current PSW is set to zero, and bit 32 of the PSW, the basic-addressing-mode bit, is set with the value of bit 32 of the entry-table entry (A), the entry-basic-addressing-mode bit. In the stacking operation when bit 129 is one, bits 31 and 32 of the current PSW both are set to one. Thus, the basic PROGRAM CALL operation does not switch between the extended and a basic addressing mode but can switch between the 24-bit and 31-bit modes, and the stacking operation can set any addressing mode.

The 32-byte entry-table entry has the following format:

If Bit 129 is Zero

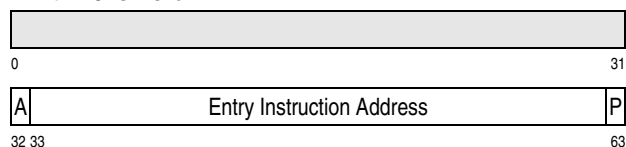

If Bit 129 is One

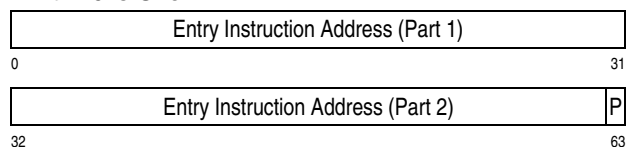

Remaining fields (independent of bit 129)

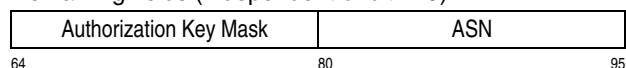

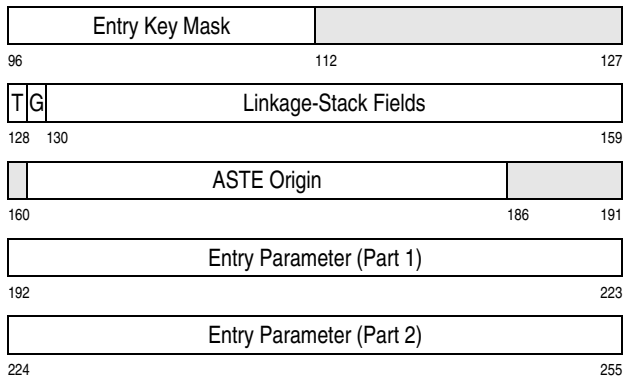

The fields in the entry-table entry are allocated as follows:

Entry Basic Addressing Mode (A): When bit 129 is zero, bit 32 replaces the basic-addressing-mode bit, bit 32 of the current PSW, as part of the PROGRAM CALL operation. In this case if bit 32 is zero, bits 33-39 must also be zeros; otherwise, a PC-translation-specification exception is recognized. When bit 129 is one, bit 32 is a bit of the entry instruction address, and bit 32 of the PSW remains or is set to one.

Entry Instruction Address: When bit 129 is zero, bits 33-62, with 33 zeros appended on the left and a zero appended on the right, form the instruction address which replaces the instruction address in the PSW as part of the PROGRAM CALL operation. When bit 129 is one, bits 0-62, with a zero appended on the right, form the instruction address.

Entry Problem State (P): Bit 63 replaces the problem-state bit, bit 15 of the current PSW, as part of the PROGRAM CALL operation.

Authorization Key Mask: Bits 64-79 are used to verify whether the program issuing the PROGRAM CALL instruction, when in the problem state, is authorized to call this entry point. The authorization key mask and the current PSW-key mask in control register 3 are ANDed, and the result is checked for all zeros. If the result is all zeros, a privileged-operation exception is recognized. The test is not performed in the supervisor state.

ASN: Bits 80-95 specify whether a space-switching (PC-ss) operation or a to-current-primary (PC-cp) operation is to occur. When bits 80-95 are zeros, PC-cp is specified. When bits 80-95 are not all zeros, PC-ss is specified, and the bits are the ASN that replaces the primary ASN.

Entry Key Mask: Bits 96-111 may be ORed into or may replace the PSW-key mask in control register 3 as part of the PROGRAM CALL operation, as determined by a bit in bit positions 130-159.

PC-Type Bit (T): Bit 128 specifies the basic PROGRAM CALL operation when the bit is zero or the stacking PROGRAM CALL operation when the bit is one.

Entry Extended Addressing Mode (G): In the basic PROGRAM CALL operation, bit 129 must match the extended-addressing-mode bit, bit 31 of the current PSW; otherwise, a special-operation exception is recognized. In the stacking operation, bit 129 replaces bit 31 of the PSW.

ASTE Origin: When bits 80-95 are not all zeros, bits 161-185, with six zeros appended on the right, form the 31-bit real ASN-second-table-entry address that should result from applying the ASN-translation process to bits 80-95.

Entry Parameter: When bit 129 is zero, bits 224-255 are placed in bit positions 32-63 of general register 4, and bits 0-31 of the register remain unchanged, as part of the PC operation. When bit 129 is one, bits 192-255 are placed in general register 4 as part of the PC operation.

Bits 130-159 are used in connection with the linkage stack and are described in “Linkage-Stack Entry-Table Entries” on page 5-75.

Bits 112-127, 160, and 186-191 are reserved for possible future extensions and should be zeros.

Programming Note: The entry parameter is intended to provide the called program with an address which can be depended upon and used as the basis of addressability in locating necessary information which may be environment dependent. The parameter may be appropriately changed for each environment by setting up different entry tables. The alternative — obtaining this information from the calling program — may require extensive validity checking or may present an integrity exposure.

Table Summary

Figure 5-7 on page 5-39 presents a summary of information about the tables used in PC-number translation, except for the primary ASN second table.

PC-Number-Translation Process

When the ASN-and-LX-reuse facility is not installed or is not enabled, the translation of the PC number is performed by means of a linkage table and entry table. When the ASN-and-LX-reuse facility is installed and enabled, referred to by saying that ASN-and-LX reuse is enabled, the translation of the PC number is performed by means of a linkage first table, linkage second table and entry table. All of these tables reside in real storage. The translation also requires the use of the primary ASN-second-table entry, which also resides in real storage.

For the purposes of PC-number translation, the PC number is divided into two parts: the leftmost part is called the linkage index (LX), and the rightmost eight bits are called the entry index (EX). When ASN-and-LX reuse is not enabled, the PC number is 20 bits, and the linkage index is 12 bits. When ASN-and-LX reuse is enabled, the linkage index also is divided into two parts: the leftmost part is called the linkage first index (LFX), and the rightmost five bits are called the linkage second index (LSX). When ASN-and LX reuse is enabled and bit 44 of the effective address specifying the PC number is zero, the PC number is 20 bits, and the linkage first index is seven bits, or, when bit 44 is one, the PC number is 32 bits, and the linkage first index is 18 bits.

Table	Boundary (Bytes)	Entry Size (Bytes)	Unit Size		Maximum Number of Units	Maximum Size	
			Bytes	Entries		Bytes	Entries
Linkage Table	12	4	128	32	128	16384	4096
Linkage First Table	256	4	256	64	256 ¹	65536	16384
Linkage Second Table	256	8	256	32	1	256	32
Entry Table	64	32	128	4	64	8192	256

Explanation:

¹ A 20-bit PC number can specify an entry only within the first unit. Bits 0-3 of a 32-bit PC number specify entries beyond the end of the largest possible table.

Figure 5-7. Summary of PC-Number-Translation Tables

When ASN-and-LX reuse is not enabled, the LX is used to select an entry from the linkage table, the starting address and length of which are specified by the linkage-table designation in the primary ASTE. This entry designates the entry table to be used. The EX field of the PC number is used to select an entry from the entry table.

When ASN-and-LX reuse is enabled, the LFX is used to select an entry from the linkage first table, the starting address and length of which are specified by the linkage-first-table designation in the primary ASTE. This entry designates the linkage second table to be used. The LSX is then used to select an entry from the linkage second table, which entry designates the entry table to be used. The EX field of the PC number is then used to select an entry from the entry table.

When ASN-and-LX reuse is enabled, a linkage-second-table-entry sequence number (LSTESN) in general register 15 is compared to the LSTESN in the linkage-second-table entry if the LSTESN in the entry is nonzero.

When, for the purposes of PC-number translation, accesses are made to main storage to fetch entries from the primary ASTE, linkage table, linkage first table, linkage second table, and entry table, key-controlled protection does not apply.

The PC-number-translation process is shown in Figure 5-8 on page 5-40 for when ASN-and-LX-reuse is not enabled and in Figure 5-9 on page 5-41 for when it is enabled.

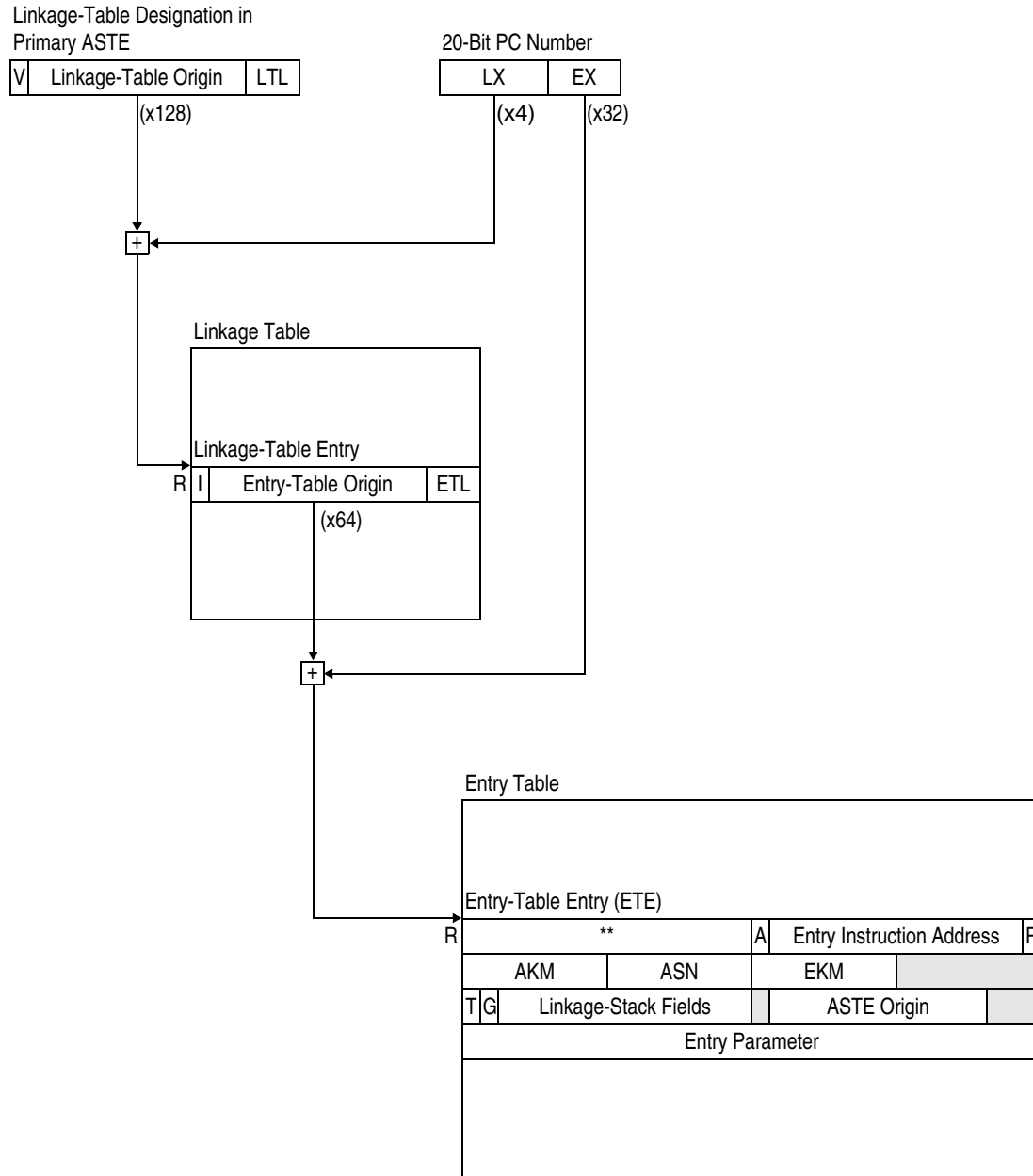

R: Address is real.

** : First word and A of ETE are bits 0-32 of entry-instruction address (EIA) if G is one.

Figure 5-8. PC-Number Translation when ASN-and-LX Reuse Is Not Enabled

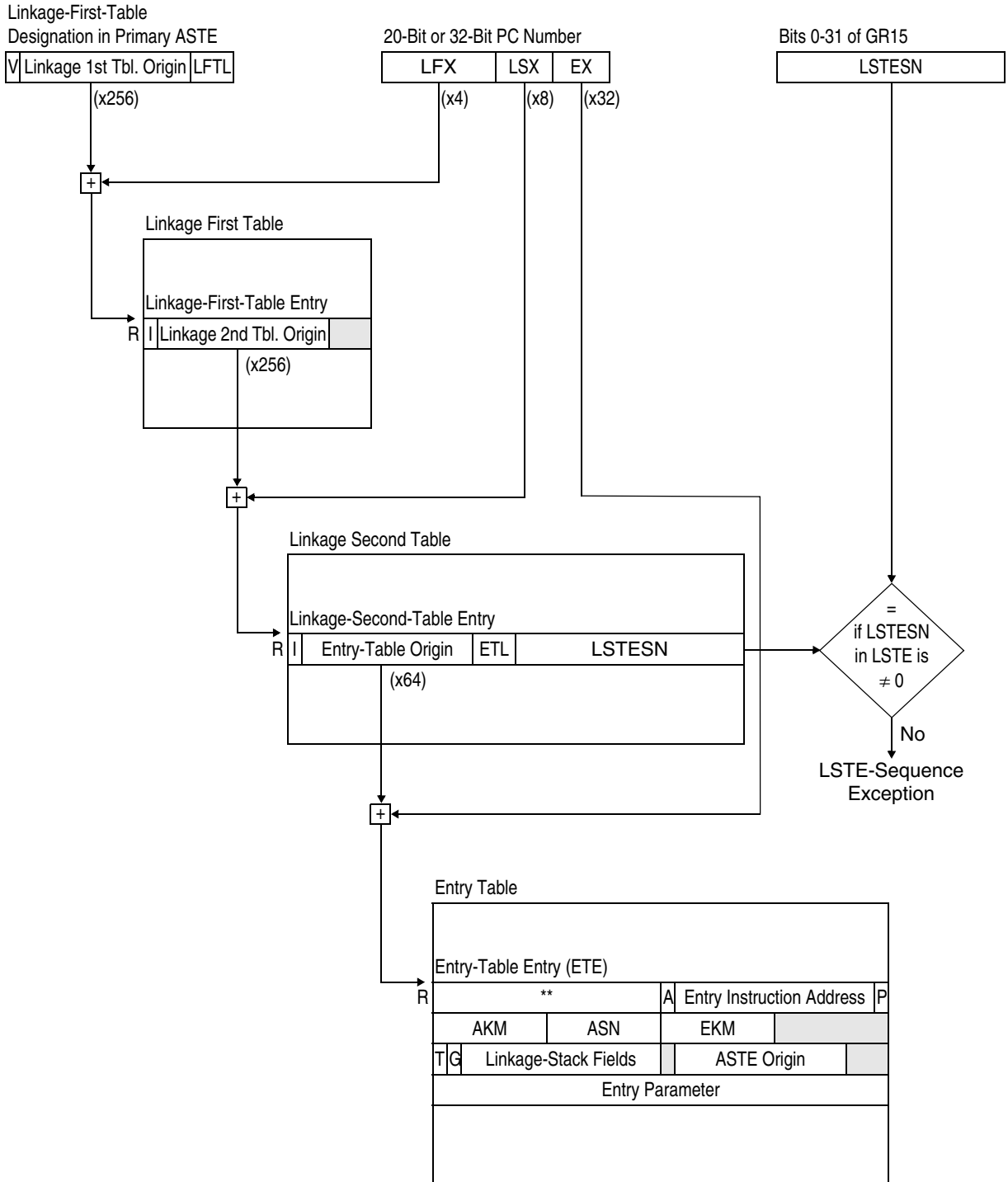

R: Address is real.

*: PC Number is 32 bits if bit 44 of the effective address is one. Bit 44 is not shown in this case.

** : First word and A of ETE are bits 0-32 of entry-instruction address (EIA) if G is one.

Figure 5-9. PC-Number Translation when ASN-and-LX Reuse Is Enabled

Obtaining the Linkage-Table or Linkage-First-Table Designation

The linkage-table or linkage-first-table designation is obtained from bytes 24-27 of the primary ASN-second-table entry, the starting address of which is specified by the contents of control register 5.

The 31-bit real address of the linkage-table or linkage-first-table designation is obtained by appending six zeros on the right to the primary-ASTE origin, bits 33-57 of control register 5, and adding 24. The 31-bit address is formed and used regardless of whether the current PSW specifies the 24-bit, 31-bit, or 64-bit addressing mode.

All four bytes of the linkage-table or linkage-first-table designation appear to be fetched concurrently from the primary ASTE as observed by other CPUs. The fetch access is not subject to protection. When the storage address which is generated for fetching the linkage-table or linkage-first-table designation designates a location which is not available in the configuration, an addressing exception is recognized, and the operation is suppressed. Besides the linkage-table or linkage-first-table designation, no other field in the primary ASTE is examined.

Linkage-Table Lookup

When the ASN-and-LX-reuse facility is not installed or the ASN-and-LX-reuse-control bit, bit 44 of control register 0, is zero, the field fetched from the primary ASTE is a linkage-table designation. The linkage-index (LX) portion of the PC number, in conjunction with the linkage-table origin, is used to select an entry from the linkage table.

The 31-bit real address of the linkage-table entry is obtained by appending seven zeros on the right to the contents of bit positions 1-24 of the linkage-table designation and adding the linkage index, with two rightmost and 17 leftmost zeros appended. When a carry into bit position 0 occurs during the addition, an addressing exception may be recognized, or the carry may be ignored, causing the table to wrap from $2^{31} - 1$ to 0. The 31-bit address is formed and used regardless of whether the current PSW specifies the 24-bit, 31-bit, or 64-bit addressing mode.

As part of the linkage-table-lookup process, the leftmost seven bits of the linkage index are compared against the linkage-table length, bits 25-31 of the linkage-table designation, to establish whether the

addressed entry is within the linkage table. If the value in the linkage-table-length field is less than the value of the seven leftmost bits of the linkage index, an LX-translation exception is recognized.

All four bytes of the linkage-table entry appear to be fetched concurrently as observed by other CPUs. The fetch access is not subject to protection. When the storage address which is generated for fetching the linkage-table entry designates a location which is not available in the configuration, an addressing exception is recognized, and the operation is suppressed.

Bit 0 of the linkage-table entry specifies whether the entry table corresponding to the linkage index is available. This bit is inspected, and, if it is one, an LX-translation exception is recognized.

When no exceptions are recognized in the process of linkage-table lookup, the entry fetched from the linkage table designates the origin and length of the corresponding entry table.

Linkage-First-Table Lookup

When the ASN-and-LX-reuse facility is installed and the ASN-and-LX-reuse-control bit, bit 44 of control register 0, is one, the field fetched from the primary ASTE is a linkage-first-table designation. The linkage-first-index (LFX) portion of the PC number, in conjunction with the linkage-first-table origin, is used to select an entry from the linkage first table.

When bit 44 of the effective address of PROGRAM CALL is zero, the PC number is 20 bits, the linkage first index is bits 44-50 of the effective address, and the 31-bit real address of the linkage-first-table entry is obtained by appending eight zeros on the right to the contents of bit positions 1-23 of the linkage-first-table designation and adding the linkage first index, with two rightmost and 22 leftmost zeros appended.

When bit 44 of the effective address of PROGRAM CALL is one, the PC number is 32 bits, the linkage first index is bits 32-43 of the effective address appended on the left of bits 45-50 of the effective address, and the 31-bit real address of the linkage-first-table entry is obtained by appending eight zeros on the right to the contents of bit positions 1-23 of the linkage-first-table designation and adding the linkage first index, with two rightmost and 11 leftmost zeros appended.

When bit 44 of the effective address is one and a carry into bit position 0 occurs during the addition to form the address of a linkage-first-table entry, an addressing exception may be recognized, or the carry may be ignored, causing the table to wrap from $2^{31} - 1$ to 0.

When bit 44 of the effective address is either zero or one, the 31-bit address of the linkage-first-table entry is formed and used regardless of whether the current PSW specifies the 24-bit, 31-bit, or 64-bit addressing mode.

As part of the linkage-first-table-lookup process when bit 44 of the effective address is one, the leftmost 12 bits of the linkage first index are compared against the linkage-first-table length, bits 24-31 of the linkage-first-table designation, to establish whether the addressed entry is within the linkage first table. For this comparison, the linkage-first-table length is extended with four zero bits on the left. If the value of the extended linkage-first-table length is less than the value of the 12 leftmost bits of the linkage first index, an LFX-translation exception is recognized.

All four bytes of the linkage-first-table entry appear to be fetched concurrently as observed by other CPUs. The fetch access is not subject to protection. When the storage address which is generated for fetching the linkage-first-table entry designates a location which is not available in the configuration, an addressing exception is recognized, and the operation is suppressed.

Bit 0 of the linkage-first-table entry specifies whether the linkage second table corresponding to the linkage first index is available. This bit is inspected, and, if it is one, an LFX-translation exception is recognized.

When no exceptions are recognized in the process of linkage-first-table lookup, the entry fetched from the linkage first table designates the origin of the corresponding linkage second table.

Linkage-Second-Table Lookup

When the ASN-and-LX-reuse facility is installed and the ASN-and-LX-reuse-control bit, bit 44 of control register 0, is one, a linkage-second-table lookup is performed after a linkage-first-table entry has been fetched. The linkage-second-index (LSX) portion of the PC number, in conjunction with the linkage-second-table origin, is used to select an entry from the linkage second table.

The 31-bit real address of the linkage-second-table entry is obtained by appending eight zeros on the right to the linkage-second-table origin, bits 1-23 of the linkage-first-table entry, and adding the linkage second index, with three rightmost and 23 leftmost zeros appended. A carry into bit position 0 cannot occur during this addition. The 31-bit address is formed and used regardless of whether the current PSW specifies the 24-bit, 31-bit, or 64-bit addressing mode.

All eight bytes of the linkage-second-table entry appear to be fetched concurrently as observed by other CPUs. The fetch access is not subject to protection. When the storage address which is generated for fetching the linkage-second-table entry designates a location which is not available in the configuration, an addressing exception is recognized, and the operation is suppressed.

Bit 0 of the linkage-second-table entry specifies whether the entry table corresponding to the linkage second index is available. This bit is inspected, and, if it is one, an LSX-translation exception is recognized.

When no exceptions are recognized in the process of linkage-second-table lookup, the entry fetched from the linkage second table designates the origin of the corresponding entry table. The linkage-second-table entry contains a linkage-second-table-entry sequence number that may be used to test the correctness of the use of the linkage index.

Linkage-Second-Table-Entry-Sequence-Number Comparison

The linkage-second-table entry contains a linkage-second-table-entry sequence number (LSTESN) in bit positions 32-63. If this LSTESN is nonzero, it is compared to an LSTESN in bit positions 0-31 of general register 15, and an LSTE-sequence exception is recognized if the two LSTESNs are not equal.

Entry-Table Lookup

When the ASN-and-LX-reuse facility is not installed or is not enabled, the entry-table entry is located from a linkage-table entry. When the ASN-and-LX-reuse facility is installed and enabled, the entry-table entry is located from a linkage-second-table entry.

The entry-index (EX) portion of the PC number, in conjunction with the entry-table origin contained in the linkage-table or linkage-second-table entry, is used to select an entry from the entry table.

The 31-bit real address of the entry-table entry is obtained by appending six zeros on the right to the entry-table origin bits 1-25 of the linkage-table or linkage-second-table entry, and adding the entry index, with five rightmost and 18 leftmost zeros appended. When a carry into bit position 0 occurs during the addition, an addressing exception may be recognized, or the carry may be ignored, causing the table to wrap from $2^{31} - 1$ to 0. The 31-bit address is formed and used regardless of whether the current PSW specifies the 24-bit, 31-bit, or 64-bit addressing mode.

As part of the entry-table-lookup process, the six leftmost bits of the entry index are compared against the entry-table length, bits 26-31 of the linkage-table or linkage-second-table entry, to establish whether the addressed entry is within the table. If the value in the entry-table length field is less than the value of the six leftmost bits of the entry index, an EX-translation exception is recognized.

The 32-byte entry-table entry is fetched by using the real address. The fetch of the entry appears to be word concurrent, as observed by other CPUs, with the leftmost word fetched first. The order in which the remaining seven words are fetched is unpredictable. The fetch access is not subject to protection. When the storage address which is generated for fetching the entry-table entry designates a location which is not available in the configuration, an addressing exception is recognized, and the operation is suppressed.

The use that is made of the information fetched from the entry-table entry is described in the definition of the PROGRAM CALL instruction.

Recognition of Exceptions during PC-Number Translation

The exceptions which can be encountered during the PC-number-translation process and their priority are described in the definition of the PROGRAM CALL instruction.

Programming Note: The linkage-table or linkage-first-table designation is fetched successfully from the primary ASN-second-table entry regardless of the value of bit 0, the ASX-invalid bit, in the primary ASTE. A one value of this bit may cause an exception to be recognized in other circumstances.

Home Address Space

Facilities are provided which a privileged program, such as the control program, can use to obtain control in and access the home address space of a dispatchable unit (for example, a task).

Each dispatchable unit normally has an address space associated with it in which the control program keeps the principal control blocks that represent the dispatchable unit. This address space is called the home address space of the dispatchable unit. Different dispatchable units may have the same or different home address spaces. When the control program initiates a dispatchable unit, it may set the primary and secondary address spaces equal to the home address space of the dispatchable unit. Thereafter, because of the dispatchable unit's possible use of the PROGRAM CALL, PROGRAM RETURN, PROGRAM TRANSFER, or SET SECONDARY ASN instruction, the control program normally cannot depend on either the primary address space or the secondary address space being the home address space when the home address space must be accessed, for example, during the processing by the control program of an interruption. Therefore, the control program normally must take some special action to ensure that the home address space is addressed when it must be accessed. The home-address-space facilities provide an efficient means to take this action.

The home-address-space facilities include:

- The home address-space-control element (HASCE) in control register 13. The HASCE is used by DAT in the same way as the primary address-space-control element (PASCE) in control register 1 and the secondary address-space-control element (SASCE) in control register 7.
- Home-space mode, which results when DAT is on and the address-space control, PSW bits 16 and 17, has the value 11 binary. When the CPU is in the home-space mode, instruction and logical addresses are home virtual addresses and are translated by DAT by means of the HASCE.
- The ability of the RESUME PROGRAM, SET ADDRESS SPACE CONTROL, and SET ADDRESS SPACE CONTROL FAST instructions to set the home-space mode in the supervisor state, and the ability of the INSERT ADDRESS

SPACE CONTROL instruction to return an indication of the home-space mode.

- The home space-switch-event control, bit 57 of control register 13.
- Recognition of a space-switch event upon completion of a RESUME PROGRAM, SET ADDRESS SPACE CONTROL, or SET ADDRESS SPACE CONTROL FAST instruction if the CPU was in the home-space mode before or after the operation but not both before and after the operation, if any of the following is true: (1) the primary space-switch-event control, bit 57 of control register 1, is one, (2) the home space-switch-event control is one, or (3) a PER event is to be indicated.

The space-switch event can be used to enable or disable PER or tracing when fetching of instructions begins or ends in particular address spaces.

Access-Register Introduction

Many of the functions related to access registers are described in this section and in “Subroutine Linkage without the Linkage Stack” on page 5-14, “Access-Register Translation” on page 5-53, and “Sequence of Storage References” on page 5-113. Additionally, translation modes and access-list-controlled protection are described in Chapter 3, “Storage”; the PER means of restricting storage-alteration events to designated address spaces and the handling of access registers during resets and during the store-status operation are described in Chapter 4, “Control”; interruptions are described in Chapter 6, “Interruptions”; instructions are described in Chapter 7, “General Instructions”, and Chapter 10, “Control Instructions”; the handling of access registers during a machine-check interruption and the programmed validation of the access registers are described in Chapter 11, “Machine-Check Handling”; and the alter-and-display controls for access registers are described in Chapter 12, “Operator Facilities.”

Summary

These major functions are provided:

- A maximum of 16 address spaces, including the instruction space, for immediate and simultaneous use by a semiprivileged program; the

address spaces are specified by 16 registers called access registers.

- Instructions for examining and changing the contents of the access registers.

In addition, control and authority mechanisms are incorporated to control these functions.

Access registers allow a sequence of instructions, or even a single instruction such as MOVE (MVC) or MOVE LONG (MVCL), to operate on storage operands in multiple address spaces, without the requirement of changing either the translation mode or other control information. Thus, a program residing in one address space can use the complete instruction set to operate on data in that address space and in up to 15 other address spaces, and it can move data between any and all pairs of these address spaces. Furthermore, the program can change the contents of the access registers in order to access still other address spaces.

The instructions for examining and changing access-register contents are unprivileged and are described in Chapter 7, “General Instructions.” They are:

- COPY ACCESS
- EXTRACT ACCESS
- LOAD ACCESS MULTIPLE
- LOAD ADDRESS EXTENDED
- SET ACCESS
- STORE ACCESS MULTIPLE

The privileged PURGE ALB instruction and COMPARE AND SWAP AND PURGE instruction are used in connection with access registers and are described in Chapter 10, “Control Instructions.”

Access registers specify address spaces when the CPU is in the access-register mode. The SET ADDRESS SPACE CONTROL and SET ADDRESS SPACE CONTROL FAST instructions allow setting of the access-register mode, and the INSERT ADDRESS SPACE CONTROL instruction provides an indication of the access-register mode. The stacking PROGRAM CALL, PROGRAM RETURN, and RESUME PROGRAM instructions also allow setting of the access-register mode. All of these instructions are described in Chapter 10, “Control Instructions.”

Access registers are used in a special way by the BRANCH IN SUBSPACE GROUP instruction. The use of access registers by that instruction is

described in detail only in the definition of the instruction in Chapter 10, "Control Instructions." However, "Subspace-Group Tables" on page 5-66 describes the use of the dispatchable-unit control table and the extended ASN-second-table entry by BRANCH IN SUBSPACE GROUP.

Access-Register Functions

Access-Register-Specified Address Spaces

The CPU includes sixteen 32-bit access registers numbered 0-15. In the access-register mode, which results when DAT is on and PSW bits 16 and 17 are 01 binary, an instruction B or R field that is used to specify the logical address of a storage operand designates not only a general register but also an access register. The designated general register is used in the ordinary way to form the logical address of the storage operand. The designated access register is used to specify the address space to which the logical address is relative. The access register specifies the address space by specifying an address-space-control element for the address space, and this address-space-control element is used by DAT to translate the logical address. An access register specifies an address-space-control element in an indirect way, not by containing the address-space-control element.

An access register may specify the primary or secondary address-space-control element in control register 1 or 7, respectively, or it may specify an address-space-control element contained in an ASN-second-table entry. In the latter case, the access register designates an entry in a table called an access list, and the designated access-list entry in turn designates the ASN-second-table entry.

The process of using the contents of an access register to obtain an address-space-control element for

use by DAT is called access-register translation (ART). This is depicted in Figure 5-10.

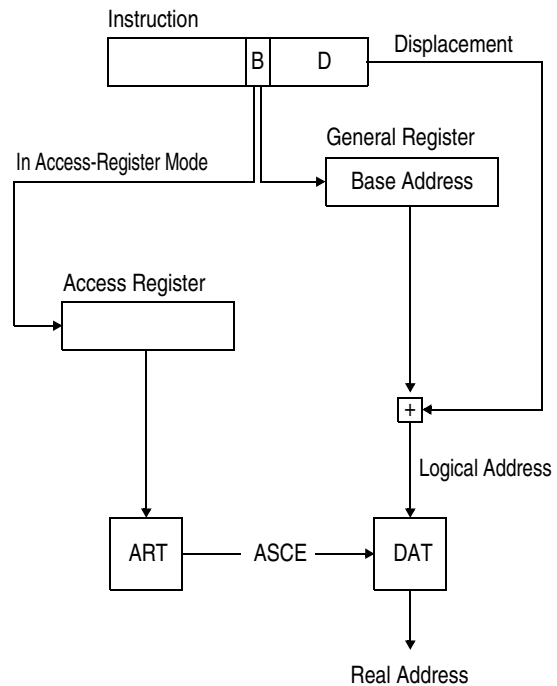

Figure 5-10. Use of Access Registers

An access register is said to specify an AR-specified address space by means of an AR-specified address-space-control element. The virtual addresses in an AR-specified address space are called AR-specified virtual addresses.

In the access-register mode, whereas all storage-operand addresses are AR-specified virtual, instruction addresses are primary virtual.

Designating Access Registers: In the access-register mode, an instruction B or R field designates an access register, for use in access-register translation, under the following conditions:

- The field is a B field which designates a general register containing a base address. The base address is used, along with a displacement (D) and possibly an index (X), to form the logical address of a storage operand.
- The field is an R field which designates a general register containing the logical address of a storage operand.

For example, consider the following instruction:

MVC 0(L,1),0(2)

The second operand, of length L, is to be moved to the first-operand location. The logical address of the second operand is in general register 2, and that of the first-operand location in general register 1. The address space containing the second operand is specified by access register 2, and that containing the first-operand location by access register 1. These two address spaces may be different address spaces, and each may be different from the current instruction address space (the primary address space).

When PSW bits 16 and 17 are 01, the B_2 field of the LOAD REAL ADDRESS and STORE REAL ADDRESS instructions designates an access register, for use in access-register translation, regardless of whether DAT is on or off. When the M_4 field of the LOAD PAGE-TABLE-ENTRY ADDRESS instruction is 0001 binary, or when the M_4 field is 0100 binary and bits 16-17 of the PSW are 01 binary, then the R_2 field designates an access register, for use in access-register translation, regardless of whether DAT is on or off. The B_1 field of TEST ACCESS designates an access register regardless of whether DAT is on or off and regardless of PSW bits 16-17.

The COMPARE AND FORM CODEWORD and UPDATE TREE instructions specify storage operands by means of implicitly designated general registers and access registers.

The MOVE TO PRIMARY and MOVE TO SECONDARY instructions specify storage operands by means of primary virtual and secondary virtual addresses, and access registers do not apply to these instructions. An exception is recognized when either of these instructions is executed in the access-register mode. The MOVE WITH KEY instruction can be used in place of MOVE TO PRIMARY and MOVE TO SECONDARY in the access-register mode. The MOVE WITH SOURCE KEY and MOVE WITH DESTINATION KEY instructions also can be used. The MOVE WITH OPTIONAL SPECIFICATIONS instruction can be used in place of MOVE TO PRIMARY, MOVE TO SECONDARY, MOVE WITH DESTINATION KEY, MOVE WITH KEY, or MOVE WITH SOURCE KEY in the access-register mode.

An instruction R field may designate an access register for other than the purpose of access-register translation.

The fields which may designate access registers, whether or not for access-register translation, are indicated in the summary figure at the beginning of each instruction chapter.

Obtaining the Address-Space-Control Element:

This section and the following ones introduce the access-register-translation process and present the concepts related to access lists.

The address-space-control element specified by an access register is obtained by access-register translation as follows:

- If the access register contains 00000000 hex, the specified address-space-control element is the primary address-space-control element (PASCE), obtained from control register 1.
- If the access register contains 00000001 hex, the specified address-space-control element is the secondary address-space-control element (SASCE), obtained from control register 7.
- If the access register contains any other value, the specified address-space-control element is obtained from an ASN-second-table entry. The contents of the access register designate an access-list entry that contains the real origin of the ASN-second-table entry.

Access register 0 is treated in a special way by access-register translation; it is treated as containing 00000000 hex, and its actual contents are not examined. Thus, a logical address specified by means of a zero B or R field in the access-register mode is always relative to the primary address space, regardless of the contents of access register 0. However, there is one exception to how access register 0 is treated: the TEST ACCESS instruction uses the actual contents of access register 0, instead of treating access register 0 as containing 00000000 hex.

The treatment of an access register containing the value 00000000 hex as designating the current primary address space allows that address space to be addressed, in the access-register mode, without

requiring the use of an access-list entry. This is useful when the primary address space is changed by a space-switching PROGRAM CALL (PC-ss), PROGRAM RETURN (PR-ss), or PROGRAM TRANSFER (PT-ss) instruction. Similarly, the treatment of an access register containing the value 00000001 hex as designating the secondary address space allows that space to be addressed after a space-switching operation, again without requiring the use of an access-list entry.

The contents of the access registers are not changed by the PROGRAM CALL and PROGRAM TRANSFER instructions. Therefore, an access register containing 00000000 or 00000001 hex may specify a different address space after the execution of PROGRAM CALL or PROGRAM TRANSFER than before the execution. For example, if a space-switching PROGRAM CALL instruction is executed, an access register containing 00000000 hex specifies the old primary address space before the execution and the new primary address space after the execution.

Access Lists: The access-list entry that is designated by the contents of an access register can be located in either one of two access lists, the dispatchable-unit access list or the primary-space access list. A bit in the access register specifies which of the two access lists contains the designated entry. Both of the access lists reside in real or absolute storage. The locations of the access lists are specified by means of control registers 2 and 5.

Control register 2 contains the origin of a real-storage area called the dispatchable-unit control table. The dispatchable-unit control table contains the designation — the real or absolute origin, and length — of the dispatchable-unit access list.

Control register 5 contains the origin of a real-storage area called the primary ASN-second-table entry. The primary ASN-second-table entry contains the designation of the primary-space access list.

An access list, either the dispatchable-unit access list or the primary-space access list, contains some multiple of eight 16-byte entries, up to a maximum of 1,024 entries.

Programs and Dispatchable Units: When discussing access lists, it is necessary to distinguish between the terms “program” and “dispatchable unit.” A program is a sequence of instructions and may be referred to as a program module. A program may be

a sequence of calling and called programs. A dispatchable unit, which is sometimes called a process or a task, is a unit of work that is performed through the execution of a program by one CPU at a time. The dispatchable-unit access list is intended to be associated with a dispatchable unit; that is, it is intended that a dispatchable unit have the same dispatchable-unit access list regardless of which program is currently being executed to perform the dispatchable unit. There is no mechanism, except for the LOAD CONTROL instruction, that changes the dispatchable-unit-control-table origin in control register 2.

The primary-space access list is associated with the primary address space that is specified by the primary ASN in control register 4 and the primary address-space-control element in control register 1. The primary-space access list that is available for use by a dispatchable unit changes as the primary address space of the dispatchable unit changes, that is, whenever a program in a different primary address space begins to be executed to perform the dispatchable unit. Whenever a LOAD ADDRESS SPACE PARAMETERS, PROGRAM CALL, PROGRAM RETURN, or PROGRAM TRANSFER instruction replaces the primary ASN in control register 4 and the primary address-space-control element in control register 1, it also replaces the primary-ASN-second-table-entry origin in control register 5.

Thus, for a dispatchable unit, the dispatchable-unit access list is intended to be constant (although its entries may be changed, as will be described), and the primary-space access list is a function of which program is being executed, through being a function of the primary address space of the program. Also, all dispatchable units and programs in the same primary address space have the same primary-space access list.

Access-List-Entry Token: The contents of an access register are called an access-list-entry token (ALET) since, in the general case, they designate an entry in an access list. An ALET has the following format:



The ALET contains a primary-list bit (P) that specifies which access list contains the designated access-list entry: the dispatchable-unit access list if the bit is

zero, or the primary-space access list if the bit is one. The specified access list is called the effective access list.

The ALET also contains an access-list-entry number (ALEN) which, when multiplied by 16, is the number of bytes from the beginning of the effective access list to the designated access-list entry. During access-register translation, an exception is recognized if the ALEN designates an entry that is outside the effective access list or if the leftmost seven bits in the ALET are not all zeros.

The access-list-entry sequence number (ALESN) in the ALET is described in the next section.

The above format of the ALET does not apply when the ALET is 00000000 or 00000001 hex.

An ALET can exist in an access register, in a general register, or in storage, and it has no special protection from manipulation by the problem program. Any program can transfer ALETs back and forth among access registers, general registers, and storage. A called program can save the contents of the access registers in any storage area available to it, load and use the access registers for its own purposes, and then restore the original contents of the access registers before returning to its caller.

Allocating and Invalidating Access-List Entries: It is intended that access lists be provided by the control program and that they be protected from direct manipulation by any problem program. This protection may be obtained by means of key-controlled protection or by placing the access lists in real storage not accessible by any problem program by means of DAT.

As determined by a bit in the entry, an access-list entry is either valid or invalid. A valid access-list entry specifies an address space and can be used by a suitably authorized program to access that space. An invalid access-list entry is available for allocation as a valid entry. It is intended that the control program provide services that allocate valid access-list entries and that invalidate previously allocated entries.

Allocation of an access-list entry may consist in the following steps. A problem program passes some kind of identification of an address space to the control program, and it passes a specification of either the dispatchable-unit access list or the primary-space access list. The control program checks, by

some means, the authority of the problem program to access the address space. If the problem program is authorized, the control program selects an invalid entry in the specified access list, changes it to a valid entry specifying the subject address space, and returns to the problem program an access-list-entry token (ALET) that designates the allocated entry. The problem program can subsequently place the ALET in an access register in order to access the address space. Later, through the use of the invalidation service of the control program, the access-list entry that was allocated may be made invalid. An exception is recognized during access-register translation if an ALET is used that designates an invalid access-list entry.

It may be that a particular access-list entry is allocated, then invalidated, and then allocated again, this time specifying a different address space than the first time. To guard against erroneous use of an ALET that designates a conceptually wrong address space, an access-list-entry sequence number (ALESN) is provided in both the ALET and the access-list entry. When the control program allocates an access-list entry, it should place the same ALESN in the entry and in the designating ALET that it returns to the problem program. When the control program reallocates an access-list entry, it should change the value of the ALESN. An exception is recognized during access-register translation if the ALESN in the ALET used is not equal to the ALESN in the designated access-list entry.

The ALESN check is a reliability mechanism, not an authority mechanism, because the ALET is not protected from the problem program, and the problem program can change the ALESN in the ALET to any value. Also, this is not a fail-proof reliability mechanism because the ALESN is one byte and its value wraps around after 256 reallocations, assuming that the value is incremented by one for each reallocation.

Authorizing the Use of Access-List Entries: Although an access list is intended to be associated with either a dispatchable unit or a primary address space, the valid entries in the list are intended to be associated with the different programs that are executed, in some order, to perform the work of the dispatchable unit. It is intended that each program be able to have a particular authority that permits the use of only those access-list entries that are associated with the program. The authority being referred to here is represented by a 16-bit extended authorization index (EAX) in control register 8.

Other elements used in the related authorization mechanism are: (1) a private bit in the access-list entry, (2) an access-list-entry authorization index (ALEAX) in the access-list entry, and (3) the authority table.

A program is authorized to use an access-list entry, in access-register translation, if any of the following conditions is met:

1. The private bit in the access-list entry is zero. This condition provides a high-performance means to authorize any and all programs that are executed to perform the dispatchable unit.
2. The ALEAX in the access-list entry is equal to the EAX in control register 8. This condition provides a high-performance means to authorize only particular programs.
3. The EAX selects a secondary bit that is one in the authority table associated with the address space that is specified by the access-list entry. The authority table is locatable in that the

access-list entry contains the real origin of the ASN-second-table entry (ASTE) for the address space, and the ASTE contains the real origin of the authority table. This condition provides another means, less well-performing than condition 2, for authorizing only particular programs. However, providing for condition 3 to be met instead of condition 2 can be advantageous because it permits several programs, each executed with a different EAX, all to use a single access-list entry to access a particular address space.

Access-register translation tests for the three conditions in the order indicated by their numbers, and a higher-numbered condition is not tested for if a lower-numbered condition is met. An exception is recognized if none of the conditions is met.

Figure 5-11 shows an example of how the authorization mechanism can be used. In the figure, “PB=0” means that the private bit is zero, and “PB=1” means that the private bit is one.

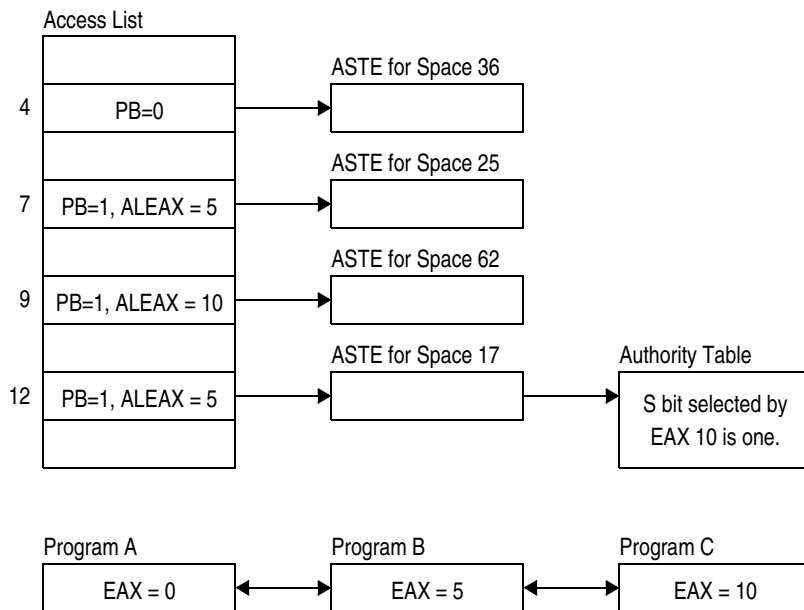

Figure 5-11. Example of Authorizing the Use of Access-List Entries

The figure shows an access list — assume it is a dispatchable-unit access list — in which the entries of interest are entries 4, 7, 9, and 12. Each access-list entry contains a private bit, an ALEAX, and the real origin of the ASTE for an address space. The private bit in entry 4 is zero, and, therefore, the value of the

ALEAX in entry 4 is immaterial and is not shown. The private bits in entries 7, 9, and 12 are ones, and the ALEAX values in these entries are as shown. The numbers used to identify the address spaces (36, 25, 62, and 17) are arbitrary. They may be the ASNs of the address spaces; however, ASNs are in no way

used in access-register translation. Only the authority table for address space 17 is shown. In it, the secondary bit selected by EAX 10 is one. Assume that no secondary bits are ones in the authority tables for the other spaces.

The figure also shows a sequence of three programs, named A, B, and C, that is executed to perform the work of the dispatchable unit associated with the access list. These programs may be in the same or different address spaces. The EAX in control register 8 when each of these programs is executed is 0, 5, and 10, respectively.

Each of programs A, B, and C can use access-list entry (ALE) 4 to access address space 36 since the private bit in ALE 4 is zero. Program B can use ALE 7 to access space 25 because the ALEAX in the ALE equals the EAX for the program, and no other program can use this ALE. Similarly, only program C can use ALE 9. Program B can use ALE 12 because the ALEAX and EAX are equal, and program C can use it because A's EAX selects a secondary bit that is one in the authority table for space 17.

The example would be the same if programs A, B, and C were all in the same address space and the access list were the primary-space access list for that space.

An ALE in which the private bit is zero may be called public because the ALE can be used by any program, regardless of the value of the current EAX. An ALE in which the private bit is one may be called private because the ability of a program to use the ALE depends on the current EAX.

Notes on the Authorization Mechanism: An access list is a kind of capability list, in the sense in which the word "capability" is used in computer science. It is up to the control program to formulate the policies that are used to allocate entries in an access list, and the programmed authorization checking required during allocation may be very complex and lengthy. After a valid entry has been made in an access list, the access-register-translation process enforces the control-program policies in a well-performing way by means of the authorization mechanism described above.

Using access lists has an advantage over using only ASNs and authority tables. For example, assume that an access register could contain an ASN and that access-register translation would do ASN translation

of the ASN and then use the EAX to test the authority table. This would make the EAX relevant to all existing address spaces, and, therefore, it would make the management of EAXs and their assignment to programs more difficult. With the actual definitions of the ALET and access-register translation, an EAX is relevant to only the address spaces that are represented in the current dispatchable-unit and primary-space access lists. Also, since ASN translation is not done as a part of access-register translation, the number of concurrently existing address spaces, as represented by ASN-second-table entries, can be greater than the number of available ASNs (64K).

The entry-table entry and linkage stack can be used to assign EAXs to programs and to change the EAX in control register 8 during program linkages. These components are introduced in "Linkage-Stack Introduction" on page 5-70. The privileged EXTRACT AND SET EXTENDED AUTHORITY instruction also is available for saving and changing the EAX in control register 8.

The SET SECONDARY ASN instruction and the authorization index (AX), bits 32-47 of control register 4, can play a role in the use of access registers. The space-switching form of SET SECONDARY ASN (SSAR-ss) establishes a new secondary address space if the secondary bit selected by the AX is one in the authority table associated with the new secondary space. The secondary space can be addressed by means of an ALET having the value 00000001 hex.

Revoking Accessing Capability: Another mechanism, which is a combined authority and integrity mechanism, is part of access-register translation, and it is described in this section.

An access-list entry (ALE) contains an ASN-second-table-entry sequence number (ASTESN), and so does the ASTE designated by the ALE. During access-register translation, the ASTESN in the ALE must equal the ASTESN in the designated ASTE; otherwise, an exception is recognized.

When the control program allocates an ALE, it should copy the ASTESN from the designated ASTE into the ALE. Subsequently, the control program can, in effect, revoke the addressing capability represented by the ALE by changing the ASTESN in the ASTE. Changing the ASTESN in the ASTE makes all previously usable ALEs that designate the ASTE unusable.

Making an ALE unusable may be required in either of two cases:

1. Some element of the control-program policy for determining the authority of a program to have access to the address space specified by the ASTE has changed. This may mean that some or all of the programs that were authorized to the address space, and for which ALEs have been allocated, are no longer authorized. Changing the ASTESN in the ASTE ends the usability of all ALEs that designate the ASTE. If this revocation of capability is to be selective, then, when an exception is recognized because of unequal ASTESNs, the control program can reapply its programmed procedures for determining authorization, and an ALE which should have remained usable can be made usable again by copying the new ASTESN into it. When the usability of an ALE is restored, the control program normally should cause reexecution of the instruction that encountered the exception.
2. The ASTE has been reassigned to specify a conceptually different address space, and ALEs which specified the old address space must not be allowed to specify the new one. (Bit 0 of the ASTE, the ASX-invalid bit, can be set to one to delete the assignment of the ASTE to an address space, and this prevents the use of the ASTE in access-register translation. But after reassignment, bit 0 normally is set back to zero.)

The ASTESN mechanism may be regarded as an authority mechanism in the first case above and as an integrity mechanism in the second.

The ASTESN mechanism is especially valuable because it avoids the need of the control program to keep track of the access lists that contain the ALEs that designate each ASTE. Furthermore, it avoids the need of searching through these access lists in order to find the ALEs and set them invalid, to prevent the use of the ALEs in access-register translation. The latter activity could be particularly time-consuming, or could present a particularly difficult management problem, because the access lists could be in auxiliary storage, such as a direct-access storage device, when the need arises to invalidate the ALEs.

The ASTESN is a four-byte field. Assuming a reasonable frequency of authorization-policy changes or address-space reassignments, the approximately four billion possible values of the ASTESN provide a

fail-proof authority or integrity mechanism over the lifetime of the system.

Programming Note: Refer to “Modification of ART Tables” on page 5-66 for a discussion of ALB maintenance required when modifying any of the tables used in access-register translation.

Preventing Store References: The access-list entry contains a fetch-only bit which, when one, specifies that the access-list entry cannot be used to perform storage-operand store references. The principal description of the effect of the fetch-only bit is in “Access-List-Controlled Protection” on page 3-13.

Improving Translation Performance: Access-register translation (ART) conceptually occurs each time a logical address is used to reference a storage operand in the access-register mode. To improve performance, ART normally is implemented such that some or all of the information contained in the ART tables (access-list-designation sources, access lists, ASN second tables, and authority tables) is maintained in a special buffer referred to as the ART-lookaside buffer (ALB). The CPU necessarily refers to an ART-table entry in real storage only for the initial access to that entry. The information in the entry may be placed in the ALB, and subsequent translations may be performed using the information in the ALB.

The PURGE ALB instruction and the COMPARE AND SWAP AND PURGE instruction can be used to clear all information from the ALB after a change has been made to an ART-table entry in real storage.

Access-Register Instructions

The following instructions are provided for examining and changing the contents of access registers:

- COPY ACCESS
- EXTRACT ACCESS
- LOAD ACCESS MULTIPLE
- LOAD ADDRESS EXTENDED
- SET ACCESS
- STORE ACCESS MULTIPLE

The SET ACCESS instruction replaces the contents of a specified access register with the contents of bit positions 32-63 of the specified general register. Conversely, the EXTRACT ACCESS instruction moves the contents of an access register to bit positions 32-63 of a general register. The COPY

ACCESS instruction moves the contents of one access register to another.

The LOAD ACCESS MULTIPLE instruction loads a specified set of consecutively numbered access registers from a specified storage location whose length in words equals the number of access registers loaded. Conversely, the STORE ACCESS MULTIPLE instruction function stores the contents of a set of access registers at a storage location.

The LOAD ADDRESS EXTENDED instruction is similar to the LOAD ADDRESS instruction in that it loads a specified general register with an effective address specified by means of the B, X, and D fields of the instruction. In addition, LOAD ADDRESS EXTENDED operates on the access register having the same number as the general register loaded. When the address-space control, PSW bits 16 and 17, is 00, 10, or 11 binary, LOAD ADDRESS EXTENDED loads the access register with 00000000, 00000001, or 00000002 hex, respectively. When the address space control is 01 binary, LOAD ADDRESS EXTENDED loads the target access register with a value that depends on the B field of the instruction. If the B field is zero, LOAD ADDRESS EXTENDED loads the target access register with 00000000 hex. If the B field is nonzero, LOAD ADDRESS EXTENDED loads the target access register with the contents of the access register designated by the B field. However, in the last case when bits 0-6 of the access register designated by the B field are not all zeros, the results in the target general register and access register are unpredictable.

The address-space-control values 00, 01, 10, and 11 binary specify primary-space, access-register, secondary-space, and home-space mode, respectively, when DAT is on. LOAD ADDRESS EXTENDED functions the same regardless of whether DAT is on or off.

When used in access-register translation, the access-register values 00000000 and 00000001 hex specify the primary and secondary address spaces, respectively, and the value 00000002 hex designates entry 2 in the dispatchable-unit access list. Loading the target access register with 00000002 hex when the address-space control is 11 binary is intended to support assignment, by the control program, of entry 2 in the dispatchable-unit access list as specifying the home address space.

Access-Register Translation

Access-register translation is introduced in “Access-Register-Specified Address Spaces” on page 5-46.

Access-Register-Translation Control

Access-register translation is controlled by an address-space control and by controls in control registers 2, 5, and 8. The address-space control, PSW bits 16 and 17, is described in “Translation Modes” on page 3-40. The other controls are described below.

Additional controls are located in the access-register-translation tables.

Control Register 2

The location of the dispatchable-unit control table is specified in control register 2. The register has the following format:

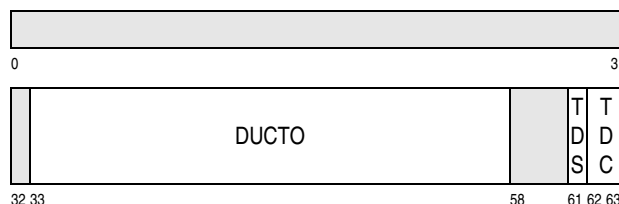

Dispatchable-Unit-Control-Table Origin (DUCTO): Bits 33-57 of control register 2, with six zeros appended on the right, form a 31-bit real address that designates the beginning of the dispatchable-unit control table. Access-register translation may obtain the dispatchable-unit access-list designation from the dispatchable-unit control table.

Transaction Diagnostic Scope (TDS): Bit 61 is described in “Transaction Diagnostic Scope (TDS)” on page 5-92.

Transaction Diagnostic Control (TDC): Bits 62-63 are described in “Transaction Diagnostic Control (TDC)” on page 5-92.

Control Register 5

The location of the primary ASN-second-table entry is specified in control register 5. The register has the following format:

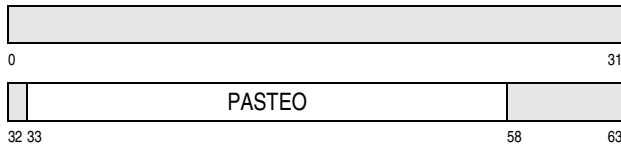

Primary-ASTE Origin (PASTE0): Bits 33-57 of control register 5, with six zeros appended on the right, form a 31-bit real address that designates the beginning of the primary ASN-second-table entry. Access-register translation may obtain the primary-space access-list designation from the primary ASTE. The primary-ASTE origin is implicitly set by LOAD ADDRESS SPACE PARAMETERS when it performs PASN translation and by the space-switching forms of PROGRAM CALL, PROGRAM RETURN, and PROGRAM TRANSFER. When any of these instructions places the primary-ASTE origin in control register 5, it also places zeros in bit positions 32 and 58-63 of the register and leaves bits 0-31 of the register unchanged. Bits 0-32 and 58-63 of control register 5 are subject to possible future assignment, and they should not be depended upon to be zeros.

Control Register 8

The extended authorization index is in control register 8. The register has the following format:

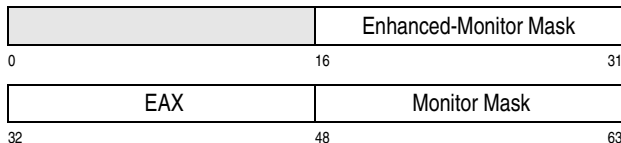

Extended Authorization Index (EAX): Bits 32-47 of control register 8 are the extended authorization index. During access-register translation, the EAX may be compared against the access-list-entry authorization index (ALEAX) in an access-list entry, and it may be used as an index to locate a secondary bit in an authority table. The EAX may be set by a stacking PROGRAM CALL operation, and it is restored by PROGRAM RETURN. The EAX can also be saved and set by the privileged instruction EXTRACT AND SET EXTENDED AUTHORITY.

Access Registers

There are sixteen 32-bit access registers numbered 0-15. The contents of an access register are called an access-list-entry token (ALET). An ALET has the following format:

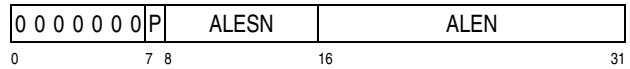

The fields in the ALET are allocated as follows:

Primary-List Bit (P): When the ALET is not 00000000 or 00000001 hex, bit 7 specifies the access list to be used by access-register translation. When bit 7 is zero, the dispatchable-unit access list is used; this is specified by the dispatchable-unit access-list designation in the dispatchable-unit control table designated by the contents of control register 2. When bit 7 is one, the primary-space access list is used; this is specified by the primary-space access-list designation in the primary ASTE designated by the contents of control register 5.

Access-List-Entry Sequence Number (ALESN): Bits 8-15 may be used as a check on whether the access-list entry designated by the ALET has been invalidated and reallocated since the ALET was obtained. During access-register translation when the ALET is not 00000000 or 00000001 hex, bits 8-15 of the ALET are compared against the access-list-entry sequence number (ALESN) in the designated access-list entry.

Access-List-Entry Number (ALEN): When the ALET is not 00000000 or 00000001 hex, bits 16-31 of the ALET designate an entry in either the dispatchable-unit access list or the primary-space access list, as determined by bit 7. The access-list designation that is used is called the effective access-list designation; it consists of the effective access-list origin and the effective access-list length.

During access-register translation, the ALEN, with four zeros appended on the right, is added to the 31-bit real or absolute address specified by the effective access-list origin, and the result is the real or absolute address of the designated access-list entry. The ALEN is compared against the effective access-list length to determine whether the designated access-list entry is within the list, and an ALEN-translation exception is recognized if the entry is outside the list. Although the largest possible value of the

ALET is 65,535, an access list can contain at most 1,024 entries.

Bits 0-6 must be zeros during access-register translation; otherwise, an ALET-specification exception is recognized.

When the ALET is 00000000 or 00000001 hex, it specifies the primary or secondary address space, respectively, and the above format does not apply.

Access register 0 usually is treated in access-register translation as containing 00000000 hex, and its actual contents are not examined; the access-register translation done as part of TEST ACCESS is the only exception. Access register 0 is also treated as containing 00000000 hex when it is designated by the B field of LOAD ADDRESS EXTENDED when PSW bits 16 and 17 are 01 binary. When access register 0 is specified for TEST ACCESS or as a source for COPY ACCESS, EXTRACT ACCESS, or STORE ACCESS MULTIPLE, the actual contents of the access register are used. Access register 0, like any other access register, can be loaded by COPY ACCESS, LOAD ACCESS MULTIPLE, LOAD ADDRESS EXTENDED, and SET ACCESS.

Another definition of ALETs 00000000 and 00000001 hex is given in "BRANCH IN SUBSPACE GROUP" on page 10-13.

Access-Register-Translation Tables

When the ALET being translated is not 00000000 or 00000001 hex, access-register translation performs a two-level lookup to locate first the effective access-list designation and then an entry in the effective access list. The effective access-list designation resides in real storage. The effective access list resides in real or absolute storage.

Access-register translation uses an origin in the access-list entry to locate an ASN-second-table entry, and it may perform a one-level lookup to locate an entry in an authority table. The ASN-second-table entry resides in real storage. The authority table resides in real or absolute storage.

Authority-table entries are described in "Authority-Table Entries" on page 3-36. Access-list designa-

tions, access-list entries, and ASN-second-table entries are described in the following sections.

Dispatchable-Unit Control Table and Access-List Designations

When the ALET being translated is not 00000000 or 00000001 hex, access-register translation obtains the dispatchable-unit access-list designation if bit 7 of the ALET is zero, or it obtains the primary-space access-list designation if bit 7 is one. The obtained access-list designation is called the effective access-list designation.

The dispatchable-unit access-list designation (DUALD) is located in bytes 16-19 of a 64-byte area called the dispatchable-unit control table (DUCT). The DUCT resides in real storage, and its location is specified by the DUCT origin in control register 2.

The dispatchable-unit control table has the following format:

Hex	Dec	
0	0	BASTE0
4	4	SA SSASTE0
8	8	
C	12	SSASTESN
10	16	DUALD (see below)
14	20	PSW-Key Mask PSW Key RA P
18	24	
1C	28	////////////////////////////////////
In the 24-Bit or 31-Bit Addressing Mode		
20	32	
24	36	BA Bits 33-63 of Return Address
In the 64-Bit Addressing Mode		
20	32	Bits 0-31 of Return Address
24	36	Bits 32-63 of Return Address
28	40	
2C	44	Trap-Control-Block Address E
30	48	
34	52	
38	56	
3C	60	

Bytes 0-7 (BASTE0, SA, and SSASTE0) and 12-15 (SSASTESN) of the DUCT are described in "Sub-

space-Group Dispatchable-Unit Control Table” on page 5-66. Bytes 20-23 (PSW key mask, PSW key, RA, and P) and 32-39 (BA and return address) are described in “BRANCH AND SET AUTHORITY” on page 10-7. Bytes 44-47 (trap-control-block address and E) are described in “TRAP” on page 10-177. Bytes 8-11, 24-27, 40-43, and 48-63 are reserved for possible future extensions and should contain all zeros. Bytes 28-31 are available for use by programming.

The primary-space access-list designation (PSALD) is located in bytes 16-19 of a 64-byte area called the primary ASN-second-table entry. The primary ASTE resides in real storage, and its location is specified by the primary-ASTE origin in control register 5. The format of the primary ASTE is described in “ASN-Second-Table Entries” on page 5-57.

The dispatchable-unit and primary-space access-list designations both have the same format, which is as follows:

Access-List Designation

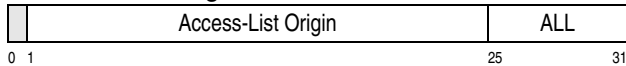

The fields in the access-list designation are allocated as follows:

Access-List Origin: Bits 1-24 of the access-list designation, with seven zeros appended on the right, form a 31-bit address that designates the beginning of the access list. This address is treated unpredictably as either a real address or an absolute address.

Access-List Length (ALL): Bits 25-31 of the access-list designation specify the length of the access list in units of 128 bytes, thus making the length of the access list variable in multiples of eight 16-byte entries. The length of the access list, in units of 128 bytes, is one more than the value in bit positions 25-31. The access-list length, with six zeros appended on the left, is compared against bits 0-12 of an access-list-entry number (bits 16-28 of an access-list-entry token) to determine whether the access-list-entry number designates an entry in the access list.

Bit 0 is reserved for a possible future extension and should be zero.

Programming Note: The maximum number of access-list entries allowed by an access-list designation is 1,024. There are two access lists available for use at any time. Therefore, a maximum of 2,048 sixteen-exabyte (16E) address spaces can be addressable without control-program intervention, which is a total of 2⁷⁵ bytes.

Access-List Entries

The effective access list is the dispatchable-unit access list if bit 7 of the ALET being translated is zero, or it is the primary-space access list if bit 7 is one. The entry fetched from the effective access list is 16 bytes in length and has the following format:

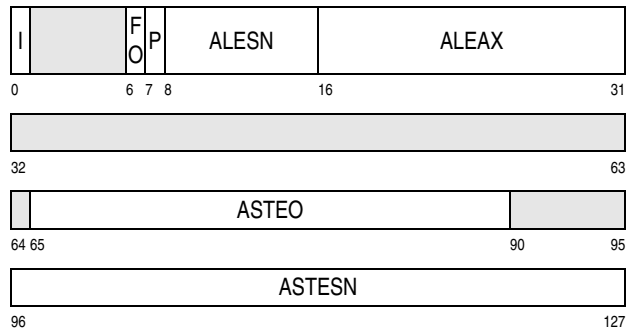

The fields in the access-list entry are allocated as follows:

ALEN-Invalid Bit (I): Bit 0, when zero, indicates that the access-list entry specifies an address space. When bit 0 is one during access-register translation, an ALEN-translation exception is recognized.

Fetch-Only Bit (FO): Bit 6 controls which types of operand references are permitted to the address space specified by the access-list entry. When bit 6 is zero, both fetch-type and store-type references are permitted. When bit 6 is one, only fetch-type references are permitted, and an attempt to store causes a protection exception for access-list-controlled protection to be recognized and the operation to be suppressed.

Private Bit (P): Bit 7, when zero, specifies that any program is authorized to use the access-list entry in access-register translation. When bit 7 is one, authorization is determined as described for bits 16-31.

Access-List-Entry Sequence Number (ALESN): Bits 8-15 are compared against the ALESN in the ALET during access-register translation. Inequality causes an ALE-sequence exception to be recog-

nized. It is intended that the control program change bits 8-15 each time it reallocates the access-list entry.

Access-List-Entry Authorization Index (ALEAX): Bits 16-31 may be used to determine whether the program for which access-register translation is being performed is authorized to use the access-list entry. The program is authorized if any of the following conditions is met:

1. Bit 7 is zero.
2. Bits 16-31 are equal to the extended authorization index (EAX) in control register 8.
3. The EAX selects a secondary bit that is one in the authority table for the specified address space.

ASN-Second-Table-Entry Origin (ASTE0): Bits 65-89, with six zeros appended on the right, form the 31-bit real address of the ASTE for the specified address space. Access-register translation obtains the address-space-control element for the address space from the ASTE.

ASTE Sequence Number (ASTESN): Bits 96-127 may be used to revoke the addressing capability represented by the access-list entry. Bits 96-127 are compared against an ASTE sequence number (ASTESN) in the designated ASTE during access-register translation.

Bits 1-5, 32-64, and 90-95 are reserved for possible future extensions and should be zeros.

In both the dispatchable-unit access list and the primary-space access list, access-list entries 0 and 1 are not used in access-register translation. Bits 1-127 of access-list entry 0 and bits 1-63 of access-list entry 1 are reserved for possible future extensions and should be zeros. Bit 0 of access-list entries 0 and 1, and bits 64-127 of access-list entry 1, are available for use by programming. The control program should set bit 0 of access-list entries 0 and 1 to one in order to prevent the use of these entries by means of ALETs in which the ALEN is 0 or 1.

ASN-Second-Table Entries

The first 48 bytes of the 64-byte ASN-second-table entry have the following format:

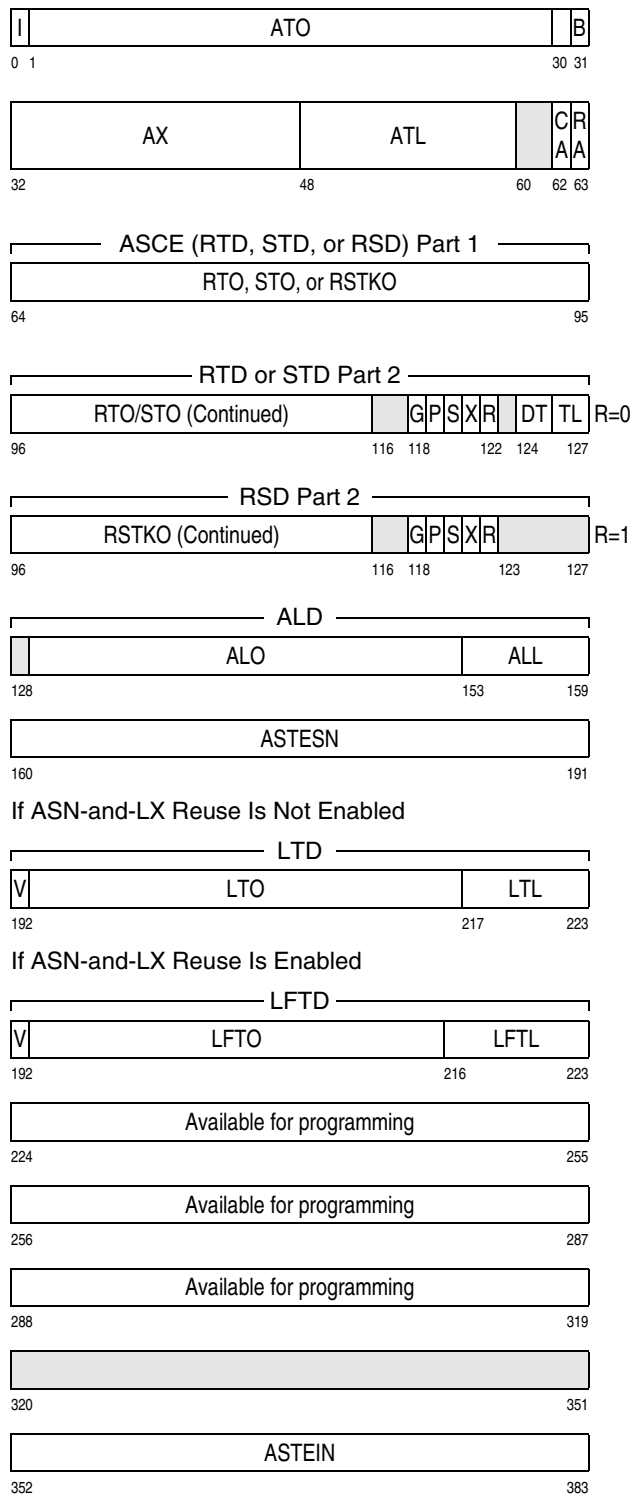

The fields in bytes 0-47 of the ASN-second-table entry (ASTE) are defined with respect to certain

mechanisms and instructions in “ASN-Second-Table Entries” on page 3-31. The fields in the ASTE are defined with respect to the BRANCH IN SUBSPACE GROUP instruction in “Subspace-Group ASN-Second-Table Entries” on page 5-68. With respect to access-register translation only, and only for an instruction other than BRANCH IN SUBSPACE GROUP, the fields in the ASTE are allocated as follows:

ASX-Invalid Bit (I): Bit 0 controls whether the address space associated with the ASTE is available. When bit 0 is zero, access-register translation proceeds. When the bit is one, an ASTE-validity exception is recognized. When the primary-space ALD is fetched, the ASX-invalid bit in the primary ASTE is ignored.

Authority-Table Origin (ATO): Bits 1-29, with two zeros appended on the right, form a 31-bit address that designates the beginning of the authority table. This address is treated unpredictably as either a real address or an absolute address, although it is treated as a real address for ASN authorization. The authority table is accessed in access-register translation only if the private bit in the access-list entry is one and the access-list-entry authorization index (ALEAX) in the access-list entry is not equal to the extended authorization index (EAX) in control register 8.

Base-Space Bit (B): Bit 31 is ignored during access-register translation. Bit 31 is further described in “Subspace-Group ASN-Second-Table Entries” on page 5-68.

Authorization Index (AX): Bits 32-47 are not used in access-register translation.

Authority-Table Length (ATL): Bits 48-59 specify the length of the authority table in units of four bytes, thus making the authority table variable in multiples of 16 entries. The length of the authority table, in units of four bytes, is one more than the ATL value. The contents of the ATL field are used to establish whether the entry designated by a particular EAX is within the authority table. An extended-authority exception is recognized if the entry is not within the table.

Controlled-ASN Bit (CA): Bit 62 is not used in access-register translation.

Reusable-ASN Bit (RA): Bit 63 is not used in access-register translation.

Address-Space-Control Element (ASCE): Bits 64-127 are an eight-byte address-space-control element (ASCE) that may be a segment-table designation (STD), a region-table designation (RTD), or a real-space designation (RSD). (The term region-table designation is used to mean a region-first-table designation, region-second-table designation, or region-third-table designation.) The ASCE field is obtained as the result of access-register translation and is used by DAT to translate the logical address for the storage-operand reference being made. Bit 121, the space-switch-event control, is not used in or as a result of access-register translation. The other fields in the ASCE (RTO, STO, RSTKO, G, P, S, R, DT, and TL) are described in “Control Register 1” on page 3-42.

Access-List Designation (ALD): When this ASTE is designated by the primary-ASTE origin in control register 5, bits 128-159 are the primary-space access-list designation (PSALD). See the description of the access-list designation in “Dispatchable-Unit Control Table and Access-List Designations” on page 5-55. During access-register translation when the primary-list bit, bit 7, in the ALET being translated is one, the PSALD is the effective access-list designation.

ASN-Second-Table-Entry Sequence Number (ASTESN): Bits 160-191 are used to control revocation of the accessing capability represented by access-list entries that designate the ASTE. During access-register translation, bits 160-191 are compared against the ASTESN in the access-list entry, and inequality causes an ASTE-sequence exception to be recognized. It is intended that the control program change the value of bits 160-191 when the authorization policies for the address space specified by the ASTE change or when the ASTE is reasigned to specify another address space.

Linkage-Table Designation (LTD) or Linkage-First-Table Designation (LFTD): Bits 192-223 are not used in access-register translation.

ASN-Second-Table-Entry Instance Number (ASTEIN): Bits 352-383 are not used in access-register translation.

Bits 224-319 in the ASTE are available for use by programming.

Programming Note: All unused fields in the ASTE, including the unused fields in bytes 0-31, bytes 40-43, and bytes 48-63, should be set to zeros. These fields are reserved for future extensions, and programs which place nonzero values in these fields may not operate compatibly on future machines.

Access-Register-Translation Process

This section describes the access-register-translation process as it is performed during a storage-operand reference in the access-register mode. The following instructions perform access-register translation as described in this section, but with the exceptions noted below.

- LOAD PAGE-TABLE-ENTRY ADDRESS when the M_4 field is 0001 binary, or when the M_4 field is 0100 binary and bits 16-17 of the PSW are 01 binary
- LOAD REAL ADDRESS and STORE REAL ADDRESS when PSW bits 16 and 17 are 01 binary
- TEST ACCESS in any translation mode
- TEST PROTECTION in the access-register mode

For LOAD PAGE-TABLE-ENTRY ADDRESS, LOAD REAL ADDRESS, TEST ACCESS, and TEST PROTECTION, the following exceptions cause a setting of the condition code instead of being treated as program-interruption conditions:

- ALET specification
- ALEN translation
- ALE sequence
- ASTE validity
- ASTE sequence
- Extended authority

BRANCH IN SUBSPACE GROUP performs access-register translation as described in “BRANCH IN SUBSPACE GROUP” on page 10-13.

Access-register translation operates on the access register designated in a storage-operand reference in order to obtain an address-space-control element for use by DAT. When one of access-registers 1-15 is designated, the access-list-entry token (ALET) that is in the access register is used to obtain the address-space-control element. When access register 0 is

designated, an ALET having the value 00000000 hex is used, except that TEST ACCESS uses the actual contents of access register 0.

When the ALET is 00000000 or 00000001 hex, the primary or secondary address-space-control element, respectively, is obtained.

When the ALET is other than 00000000 or 00000001 hex, the leftmost seven bits of the ALET are checked for zeros, the primary-list bit in the ALET and the contents of control register 2 or 5 are used to obtain the effective access-list designation, and the access-list entry number (ALEN) in the ALET is used to select an entry in the effective access list.

The access-list entry is checked for validity and for containing the correct access-list-entry sequence number (ALESN).

The ASN-second-table entry (ASTE) addressed by the access-list entry is checked for validity and for containing the correct ASN-second-table-entry sequence number (ASTESN).

Whether the program is authorized to use the access-list entry is determined through the use of one or more of: (1) the private bit and access-list-entry authorization index (ALEAX) in the access-list entry, (2) the extended authorization index (EAX) in control register 8, and (3) an entry in the authority table addressed by the ASN-second-table entry.

If a store-type reference is to be performed, the fetch-only bit in the access-list entry is checked for being zero.

When no exceptions are recognized, the address-space-control element in the ASN-second-table entry is obtained.

In order to avoid the delay associated with references to real or absolute storage, the information fetched from real or absolute storage normally may also be placed in a special buffer, the ART-lookaside buffer (ALB), and subsequent translations involving the same information may be performed by using the contents of the ALB. The operation of the ALB is described in “ART-Lookaside Buffer” on page 5-64.

Whenever access to real or absolute storage is made during access-register translation for the purpose of fetching an entry from an access-list-designation source (DUCT or PASTE), access list, ASN second

table, or authority table, key-controlled protection does not apply.

The principal features of access-register translation, including the effect of the ALB, are shown in Figure 5-12 on page 5-61.

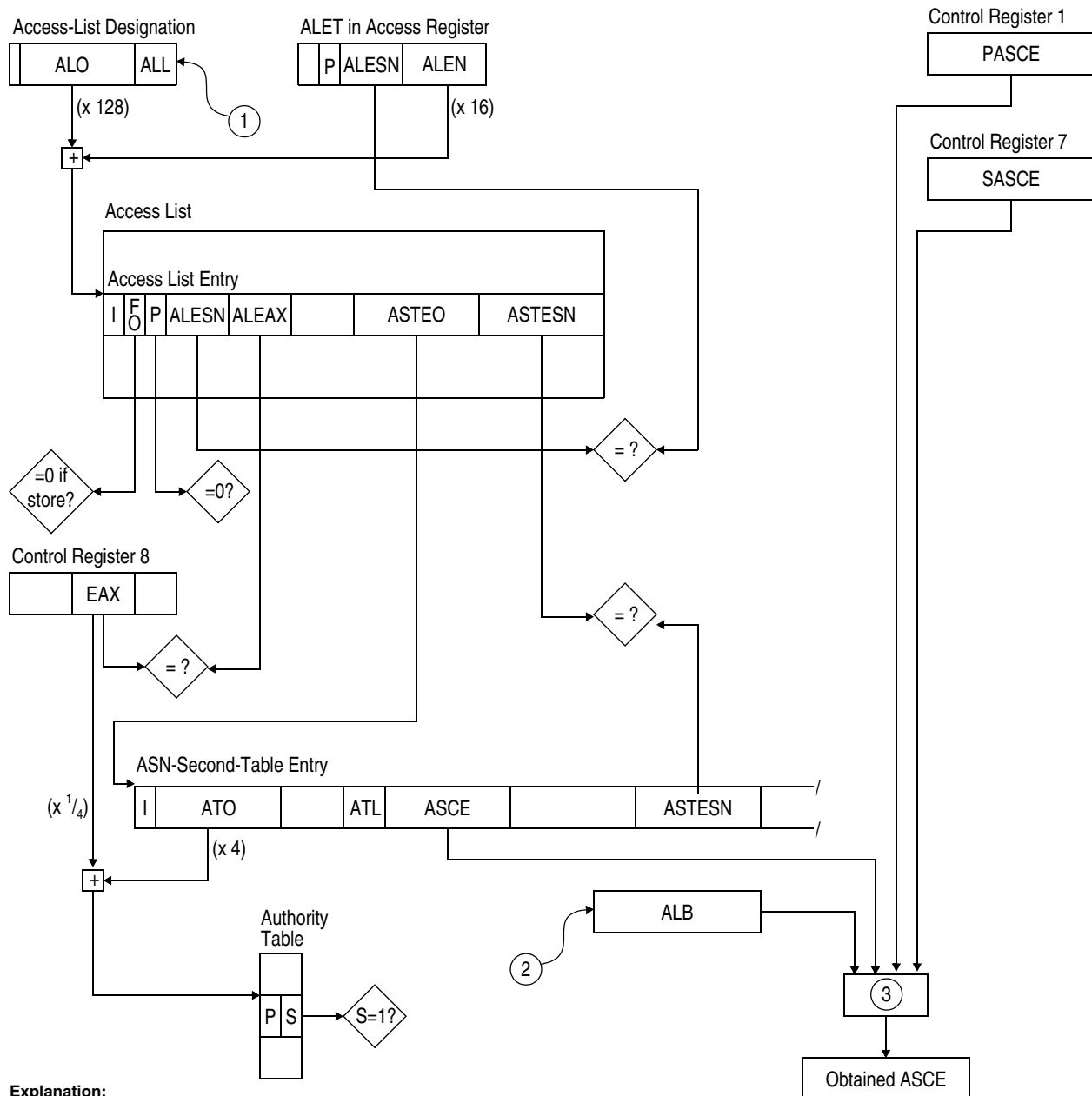

Explanation:

- 1 The appropriate ALD is obtained:
When P in the ALET is zero (and the ALET is not zero or one), the DUALD in the DUCT is obtained.
When P in the ALET is one, the PSALD in the primary ASTE is obtained.
- 2 Information, which may include the ALD-source origin, ALET, ALO, and EAX, is used to search the ALB. This information, along with information from the ALE, ASTE, and ATE, may be placed in the ALB.
- 3 The appropriate ASCE is obtained:
When the AR number is zero (except for TAR) or when the ALET is zero, the PASCE in CR 1 is obtained.
When the ALET is one, the SASCE in CR 7 is obtained.
When the ALET is larger than one:
- If a match exists, the ASCE from the ALB is used.
- If no match exists, tables from real or absolute storage are fetched. The resulting ASCE from the ASTE is obtained, and entries may be formed in the ALB.

Figure 5-12. Access-Register Translation

Selecting the Access-List-Entry Token

When one of access registers 1-15 is designated, or for the access register designated by the R_1 . field of TEST ACCESS, access-register translation uses the access-list-entry token (ALET) that is in the access register. When access register 0 is designated, except for TEST ACCESS, an ALET having the value 00000000 hex is used, and the contents of access register 0 are not examined.

Obtaining the Primary or Secondary Address-Space-Control Element

When the ALET being translated is 00000000 hex, the primary address-space-control element in control register 1 is obtained. When the ALET is 00000001 hex, the secondary address-space-control element in control register 7 is obtained. In each of these two cases, access-register translation is completed.

Checking the First Byte of the ALET

When the ALET being translated is other than 00000000 or 00000001 hex, bits 0-6 of the ALET are checked for being all zeros. If bits 0-6 are not all zeros, an ALET-specification exception is recognized, and the operation is suppressed.

Obtaining the Effective Access-List Designation

The primary-list bit, bit 7, in the ALET is used to perform a lookup to obtain the effective access-list designation. When bit 7 is zero, the effective ALD is the dispatchable-unit ALD located in bytes 16-19 of the dispatchable-unit control table (DUCT). When bit 7 is one, the effective ALD is the primary-space ALD located in bytes 16-19 of the primary ASN-second-table entry (primary ASTE).

When bit 7 is zero, the 31-bit real address of the dispatchable-unit ALD is obtained by appending six zeros on the right to the DUCT origin, bits 33-57 of control register 2, and adding 16. The addition cannot cause a carry into bit position 0.

When bit 7 is one, the 31-bit real address of the primary-space ALD is obtained by appending six zeros on the right to the primary-ASTE origin, bits 33-57 of control register 5, and adding 16. The addition cannot cause a carry into bit position 0.

The obtained 31-bit real address is used to fetch the effective ALD — either the dispatchable-unit ALD or the primary-space ALD, depending on bit 7 of the

ALET. The fetch of the effective ALD appears to be word concurrent, as observed by other CPUs, and is not subject to protection. When the storage address that is generated for fetching the effective ALD refers to a location which is not available in the configuration, an addressing exception is recognized, and the operation is suppressed. When the primary-space ALD is fetched, bit 0, the ASX-invalid bit, in the primary ASTE is ignored.

Access-List Lookup

A lookup in the effective access list is performed. The effective access list is the dispatchable-unit access list if bit 7 of the ALET is zero, or it is the primary-space access list if bit 7 is one. The effective access list is treated unpredictably as being in either real or absolute storage.

The access-list-entry-number (ALEN) portion of the ALET is used to select an entry in the effective access list. The 31-bit real or absolute address of the access-list entry is obtained by appending seven zeros on the right to bits 1-24 of the effective ALD and adding the ALEN, with four rightmost and 11 leftmost zeros appended. When a carry into bit position 0 occurs during the addition, an addressing exception may be recognized, or the carry may be ignored, causing the access list to wrap from $2^{31} - 1$ to 0. The 31-bit address is formed and used regardless of whether the current PSW specifies the 24-bit, 31-bit, or 64-bit addressing mode.

As part of the access-list-lookup process, the leftmost 13 bits of the ALEN are compared against the effective access-list length, bits 25-31 of the effective ALD, to establish whether the addressed entry is within the access list. For this comparison, the access-list length is extended with six leftmost zeros. If the value formed from the access-list length is less than the value in the 13 leftmost bits of the ALEN, an ALEN-translation exception is recognized, and the operation is nullified.

The 16-byte access-list entry is fetched by using the real or absolute address. The fetch of the entry appears to be word concurrent as observed by other CPUs, with the leftmost word fetched first. The order in which the remaining three words are fetched is unpredictable. The fetch access is not subject to protection. When the storage address that is generated for fetching the access-list entry refers to a location which is not available in the configuration, an

addressing exception is recognized, and the operation is suppressed.

Bit 0 of the access-list entry indicates whether the access-list entry specifies an address space by designating an ASN-second-table entry. This bit is inspected, and, if it is one, an ALEN-translation exception is recognized, and the operation is nullified.

When bit 0 is zero, the access-list-entry sequence number (ALESN) in bit positions 8-15 of the access-list entry is compared against the ALESN in the ALET to determine whether the ALET designates the conceptually correct access-list entry. Inequality causes an ALE-sequence exception to be recognized and the operation to be nullified.

Locating the ASN-Second-Table Entry

The ASN-second-table-entry (ASTE) origin in the access-list entry is used to locate the ASTE. Bits 65-89 of the access-list entry, with six zeros appended on the right, form the 31-bit real address of the ASTE.

The 64-byte ASTE is fetched by using the real address. The fetch of the entry appears to be word concurrent as observed by other CPUs, with the left-most word fetched first, except that the fetch of the address-space-control element in the entry appears to be doubleword concurrent as observed by other CPUs. After the first word is fetched, the order in which the ASCE and the remaining words are fetched is unpredictable. The fetch access is not subject to protection. When the storage address that is generated for fetching the ASTE refers to a location which is not available in the configuration, an addressing exception is recognized, and the operation is suppressed.

Bit 0 of the ASTE indicates whether the ASTE specifies an address space. This bit is inspected, and, if it is one, an ASTE-validity exception is recognized, and the operation is nullified.

When bit 0 is zero, the ASTE sequence number (ASTESN) in bit positions 160-191 of the ASTE is compared against the ASTESN in bit positions 96-127 of the access-list entry to determine whether the addressing capability represented by the access-list entry has been revoked. Inequality causes an ASTE-sequence exception to be recognized and the operation to be nullified.

Authorizing the Use of the Access-List Entry

The private bit, bit 7, in the access-list entry is used to determine whether the program is authorized to use the access-list entry. The access-list-entry authorization index (ALEAX) in bit positions 16-31 of the access-list entry, the extended authorization index (EAX) in bit positions 32-47 of control register 8, and the authority table designated by the ASTE may also be used.

When the private bit is zero, the program is authorized, and the authorization step of access-register translation is completed.

When the private bit is one but the ALEAX is equal to the EAX, the program is authorized, and the authorization step of access-register translation is completed.

When the private bit is one and the ALEAX is not equal to the EAX, a process called the extended-authorization process is performed. Extended authorization uses the EAX to select an entry in the authority table designated by the ASTE, and it tests the secondary-authority bit in the selected entry for being one. The program is authorized if the tested bit is one.

Extended authorization is the same as the secondary-ASN-authorization process described in "ASN Authorization" on page 3-35, except as follows:

- The authority-table origin is treated as a real or absolute address instead of as a real address.
- The EAX in control register 8 is used instead of the authorization index (AX) in control register 4.
- When the value in bit positions 0-11 of the EAX is greater than the authority-table length (ATL) in the ASTE, an extended-authority exception is recognized instead of a secondary-authority exception. The operation is nullified if the extended-authority exception is recognized.

When the private bit is one, the ALEAX is not equal to the EAX, and the secondary bit in the authority-table entry selected by the EAX is not one, an extended-authority exception is recognized, and the operation is nullified.

Checking for Access-List-Controlled Protection

If a store-type reference is to be performed and the fetch-only bit, bit 6, in the access-list entry is one, a protection exception is recognized, and the operation is suppressed.

Obtaining the Address-Space-Control Element from the ASN-Second-Table Entry

When the ALET being translated is other than 00000000 or 00000001 hex and no exception is recognized in the steps described above, access-register translation obtains the address-space-control element from bit positions 64-127 of the ASTE.

Recognition of Exceptions during Access-Register Translation

The exceptions which can be encountered during the access-register-translation process and their priority are shown in the section “Access Exceptions” in Chapter 6, “Interruptions.”

Programming Note: When updating an access-list entry or ASN-second-table entry, the program should change the entry from invalid to valid (set bit 0 of the entry to zero) as the last step of the updating. This ensures, because the leftmost word is fetched first, that words of a partially updated entry will not be fetched.

ART-Lookaside Buffer

To enhance performance, the access-register-translation (ART) mechanism normally is implemented such that access-list designations and information specified in access lists, ASN second tables, and authority tables are maintained in a special buffer, referred to as the ART-lookaside buffer (ALB). Access-list designations, access-list entries, ASN-second-table entries, and authority-table entries are collectively referred to as ART-table entries. The CPU necessarily refers to an ART-table entry in real or absolute storage only for the initial access to that entry. The information in the entry may be placed in the ALB, and subsequent ART operations may be performed using the information in the ALB. The presence of the ALB affects the ART process to the extent that (1) a modification of an ART-table entry in real or absolute storage does not necessarily have

an immediate effect, if any, on the translation, (2) the comparison against the access-list length in an access-list designation that is in storage and used in a translation may be omitted if an ALB access-list entry is used, and (3) the comparison against the authority-table length in an ASN-second-table entry that is in storage and used in a translation may be omitted if an ALB authority-table entry is used. In a multiple-CPU configuration, each CPU has its own ALB.

Entries within the ALB are not explicitly addressable by the program.

Information is not necessarily retained in the ALB under all conditions for which such retention is possible. Furthermore, information in the ALB may be cleared under conditions additional to those for which clearing is mandatory.

ALB Structure

The description of the logical structure of the ALB covers the implementation by all systems operating as defined by z/Architecture. The ALB entries are considered as being of four types: ALB access-list designations (ALB ALDs), ALB access-list entries (ALB ALEs), ALB ASN-second-table entries (ALB ASTEs), and ALB authority-table entries (ALB ATEs). An ALB entry is considered as containing within it both the information obtained from the ART-table entry in real or absolute storage and the attributes used to fetch the ART-table entry from real or absolute storage.

There is not an indication in an ALB ALD of whether the ALD-source origin used to select the ALD in real storage was the dispatchable-unit-control-table origin or the primary-ASTE origin.

Note: The following sections describe the conditions under which information may be placed in the ALB, the conditions under which information from the ALB may be used for access-register translation, and how changes to the tables affect the ART process.

Formation of ALB Entries

The formation of ALB entries and the effect of any manipulation of the contents of an ART-table entry in real or absolute storage by the program depend on whether the entry is attached to a particular CPU and on whether the entry is valid.

The *attached* state of an ART-table entry denotes that the CPU to which the entry is attached can attempt to use the entry for access-register translation. The ART-table entry may be attached to more than one CPU at a time.

An access-list entry or ASN-second-table entry is *valid* when the invalid bit associated with the entry is zero. Access-list designations and authority-table entries have no invalid bit and are always valid. The primary-space access-list designation is valid regardless of the value of the invalid bit in the primary ASTE.

An ART-table entry may be placed in the ALB whenever the entry is attached and valid.

An access-list designation is attached to a CPU when the designation is within the dispatchable-unit-control table designated by the dispatchable-unit-control-table origin in control register 2 or is within the primary ASTE designated by the primary-ASTE origin in control register 5.

An access-list entry is attached to a CPU when the entry is within the access list specified by either an attached access-list designation (ALD) or a usable ALB ALD. A usable ALB ALD is explained in the next section.

An ASN-second-table entry is attached to a CPU when it is designated by the ASTE origin in either an attached and valid access-list entry (ALE) or a usable ALB ALE. A usable ALB ALE is explained in the next section.

An authority-table entry is attached to a CPU when it is within the authority table designated by either an attached and valid ASN-second-table entry (ASTE) or a usable ALB ASTE. A usable ALB ASTE is explained in the next section.

Subject to the attached and valid constraints defined above, the CPU may form ALB entries in anticipation of future storage references or as a result of the speculative execution of instructions. Such ALB entries may be formed independent of the content of the access registers. See "Overlapped Operation of Instruction Execution" on page 5-114 for additional details.

Use of ALB Entries

The *usable* state of an ALB entry denotes that the CPU can attempt to use the ALB entry for access-register translation. A usable ALB entry attaches the next-lower-level table, if any, and may be usable for a particular instance of access-register translation.

An ALB ALD is in the usable state when the ALDSO field in the ALB ALD matches the current dispatchable-unit-control-table origin or the current primary-ASTE origin.

An ALB ALD may be used for a particular instance of access-register translation when either of the following conditions is met:

1. The primary-list bit in the ALET to be translated is zero, and the ALDSO field in the ALB ALD matches the current dispatchable-unit-control-table origin.
2. The primary-list bit in the ALET to be translated is one, and the ALDSO field in the ALB ALD matches the current primary-ASTE origin.

An ALB ALE is in the usable state when the ALO field in the ALB ALE matches the ALO field in an attached ALD or a usable ALB ALD.

An ALB ALE may be used for a particular instance of access-register translation when all of the following conditions are met:

1. The ALET to be translated has a value larger than 1. (If the ALET is 0 or 1, the contents of CR 1 or CR 7 are used.)
2. The ALO field in the ALB ALE matches the ALO field in the ALD or ALB ALD being used in the translation.
3. The ALEN field in the ALB ALE matches the ALEN field in the ALET to be translated.

An ALB ASTE is in the usable state when the ASTEO field in the ALB ASTE matches the ASTEO field in an attached and valid ALE or a usable ALB ALE.

An ALB ASTE may be used for a particular instance of access-register translation when the ASTEO field in the ALB ASTE matches the ASTEO field in the ALE or ALB ALE being used in the translation.

An ALB ATE may be used for a particular instance of access-register translation when both of the following conditions are met:

1. The ATO field in the ALB ATE matches the ATO field in the ASTE or ALB ASTE being used in the translation.
2. The EAX field in the ALB ATE matches the current EAX.

Modification of ART Tables

When an attached but invalid ART-table entry is made valid, or when an unattached but valid ART-table entry is made attached, and no entry formed from the ART-table entry is already in the ALB, the change takes effect no later than the end of the current instruction.

When an attached and valid ART-table entry is changed, and when, before the ALB is cleared of copies of that entry, an attempt is made to perform ART requiring that entry, unpredictable results may occur, to the following extent. The use of the new value may begin between instructions or during the execution of an instruction, including the instruction that caused the change. Moreover, until the ALB is cleared of copies of the entry, the ALB may contain both the old and the new values, and it is unpredictable whether the old or new value is selected for a particular ART operation. If the old and new values are used as representations of effective space designations, failure to recognize that the effective space designations are the same may occur, with the result that operand overlap may not be recognized. Effective space designations and operand overlap are discussed in “Interlocks within a Single Instruction” on page 5-116.

When LOAD ACCESS MULTIPLE or LOAD CONTROL changes the parameters associated with ART, the values of these parameters at the start of the operation are in effect for the duration of the operation.

All entries are cleared from the ALB by the execution of PURGE ALB, a COMPARE AND SWAP AND PURGE instruction that purges the ALB, and SET PREFIX, and by CPU reset.

Subspace Groups

The subspace-group facility includes the BRANCH IN SUBSPACE GROUP instruction, allocations of fields in the address-space-control element, dispatchable-unit control table, and ASN-second-table entry, and subspace-replacement operations of the PROGRAM CALL, PROGRAM RETURN, PROGRAM TRANSFER, PROGRAM TRANSFER WITH INSTANCE, SET SECONDARY ASN, SET SECONDARY ASN WITH INSTANCE, and LOAD ADDRESS SPACE PARAMETERS instructions. BRANCH IN SUBSPACE GROUP is introduced in “Subroutine Linkage without the Linkage Stack” on page 5-14 and described in detail in “BRANCH IN SUBSPACE GROUP” on page 10-13.

Subspace-Group Tables

This section describes the use of the dispatchable-unit control table and ASN-second-table entry by the subspace-group facility.

Subspace-Group Dispatchable-Unit Control Table

The dispatchable-unit control table has the following format:

Hex	Dec	
0	0	BASTE0
4	4	SSASTE0
8	8	
C	12	SSASTESN
10	16	DUALD
14	20	PSW-Key Mask
18	24	PSW-Key R A P
1C	28	//////////
In the 24-Bit or 31-Bit Addressing Mode		
20	32	
24	36	Bits 33-63 of Return Address
In the 64-Bit Addressing Mode		
20	32	Bits 0-31 of Return Address
24	36	Bits 32-63 of Return Address

28	40		
2C	44	Trap-Control-Block Address	E
30	48		
34	52		
38	56		
3C	60		

The fields in the dispatchable-unit control table that are used by the subspace-group facility are allocated as follows:

Base-ASTE Origin (BASTE0): Bits 1-25 of bytes 0-3, with six zeros appended on the right, form a 31-bit real address that designates the beginning of the ASN-second-table entry that specifies the base space of a subspace group associated with the dispatchable unit. A comparison of bits 1-25 of bytes 0-3 to the primary-ASTE origin (PASTE0) in bit positions 33-57 of control register 5 is made by BRANCH IN SUBSPACE GROUP to determine whether the current primary address space is in the subspace group for the current dispatchable unit. For this comparison, either bits 1-25 may be compared to the PASTE0 or the entire contents of bytes 0-3 may be compared to the contents of bit positions 33-63 of control register 5. A comparison of bits 1-25 of bytes 0-3 to the destination-ASTE origin (DASTE0) obtained from an access-list entry by access-register translation of an ALET other than ALETs 0 and 1 is made by BRANCH IN SUBSPACE GROUP to determine if the destination ASTE is the base-space ASTE. For this comparison, either bits 1-25 may be compared to the DASTE0 or the entire contents of bytes 0-3 may be compared to the DASTE0 with one leftmost and six rightmost zeros appended. A comparison of bits 1-25 of bytes 0-3 to an ASTE origin (ASTE0) obtained by ASN translation may be made by PROGRAM CALL, PROGRAM RETURN, PROGRAM TRANSFER, PROGRAM TRANSFER WITH INSTANCE, SET SECONDARY ASN, SET SECONDARY ASN WITH INSTANCE, and LOAD ADDRESS SPACE PARAMETERS. For this comparison, either bits 1-25 may be compared to the ASTE0 or the entire contents of bytes 0-3 may be compared to the ASTE0 with one leftmost and six rightmost zeros appended. When BRANCH IN SUBSPACE GROUP uses ALET 0, bits 1-25 of bytes 0-3, with six zeros appended on the right, designate the destination ASTE.

Subspace-Active Bit (SA): Bit 0 of bytes 4-7 indicates, when one, that the last BRANCH IN SUBSPACE GROUP instruction executed for the

dispatchable unit transferred control to a subspace of the subspace group associated with the dispatchable unit. Bit 0 being zero indicates any one of the following: the last BRANCH IN SUBSPACE GROUP instruction executed for the dispatchable unit transferred control to the base space of the subspace group, BRANCH IN SUBSPACE GROUP has not yet been executed for the dispatchable unit, or the dispatchable unit is not associated with a subspace group. BRANCH IN SUBSPACE GROUP sets bit 0 of bytes 4-7 to one when it transfers control to a subspace of the subspace group associated with the dispatchable unit, and it sets bit 0 to zero when it transfers control to the base space of the subspace group.

Subspace-ASTE Origin (SSASTE0): Bits 1-25 of bytes 4-7, with six zeros appended on the right, form a 31-bit real address that designates the beginning of the ASN-second-table entry that specifies the subspace last given control by a BRANCH IN SUBSPACE GROUP instruction executed for the dispatchable unit. When BRANCH IN SUBSPACE GROUP transfers control to a subspace by means of an ALET other than ALET 1, it places the ASTE0 for the subspace (the destination ASTE0) in bit positions 1-25 of bytes 4-7, places zeros in bit positions 26-31 of bytes 4-7, and sets the subspace-active bit, bit 0 of bytes 4-7, to one. When BRANCH IN SUBSPACE GROUP uses ALET 1 to transfer control to a subspace, bits 1-25 of bytes 4-7, with six zeros appended on the right, designate the destination ASTE, and BRANCH IN SUBSPACE GROUP sets the subspace-active bit to one and either sets bits 26-31 of bytes 4-7 to zeros or leaves those bits unchanged. However, if bits 1-25 are all zeros, a special-operation exception is recognized. When BRANCH IN SUBSPACE GROUP transfers control to the base space of the subspace group, it sets the subspace-active bit to zero, and bits 1-31 of bytes 4-7 remain unchanged. Bits 1-25 of bytes 4-7 may be used by PROGRAM CALL, PROGRAM RETURN, PROGRAM TRANSFER, PROGRAM TRANSFER WITH INSTANCE, SET SECONDARY ASN, SET SECONDARY ASN WITH INSTANCE, and LOAD ADDRESS SPACE PARAMETERS to set bits 0-55 and 57-63 of the primary ASCE in control register 1 or the secondary ASCE in control register 7 from the same bits of the ASCE in the subspace ASTE.

Subspace-ASTE Sequence Number (SS-ASTESN): Bytes 12-15 may be used to revoke the linkage capability represented by the SSASTE0, bits 1-25 of bytes 4-7, in the DUCT. When BRANCH

IN SUBSPACE GROUP transfers control to a subspace by means of an ALET other than ALET 1, it obtains the ASTESN in the subspace ASTE and places it in bytes 12-15. When BRANCH IN SUBSPACE GROUP uses ALET 1 to transfer control to a subspace, it compares bytes 12-15 to the ASTESN in the subspace ASTE, and it recognizes an ASTE-sequence exception if they are unequal. When the SSASTE0 is used by PROGRAM CALL, PROGRAM RETURN, PROGRAM TRANSFER, PROGRAM TRANSFER WITH INSTANCE, SET SECONDARY ASN, SET SECONDARY ASN WITH INSTANCE, and LOAD ADDRESS SPACE PARAMETERS to set bits 0-55 and 57-63 of the primary ASCE in control register 1 or the secondary ASCE in control register 7 from the same bits of the ASCE in the subspace ASTE, those instructions first compare bytes 12-15 to the ASTESN in the subspace ASTE, and they recognize an ASTE-sequence exception if the two fields are unequal.

Bytes 16-19 are described in “Dispatchable-Unit Control Table and Access-List Designations” on page 5-55. Bytes 20-23 are described in “BRANCH AND SET AUTHORITY” on page 10-7. Bytes 32-39 and 44-47 are described in “TRAP” on page 10-177. Bytes 24-27, 40-43, and 48-63 are reserved for possible future extensions and should contain all zeros. Bytes 28-31 are available for use by programming.

Subspace-Group ASN-Second-Table Entries

The first 48 bytes of the 64-byte ASN-second-table entry have the following format:

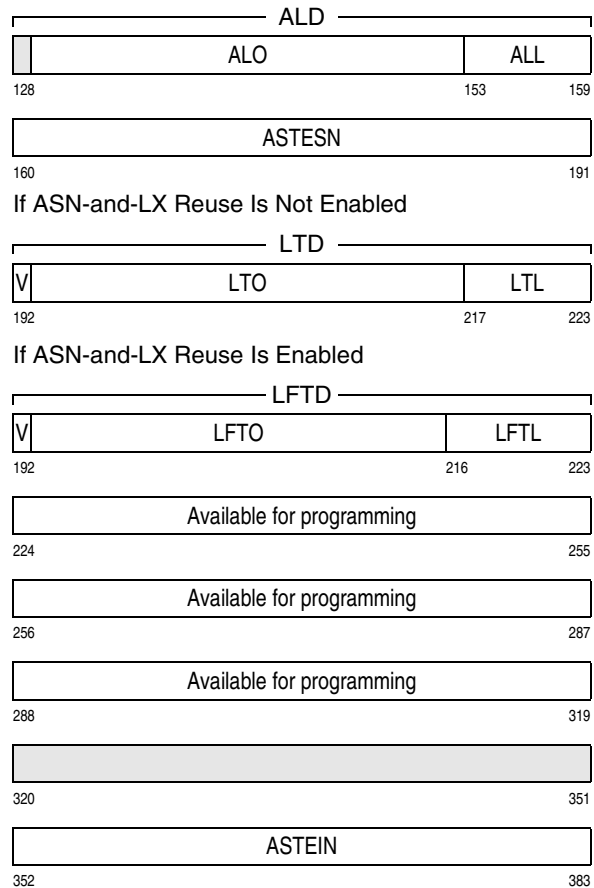
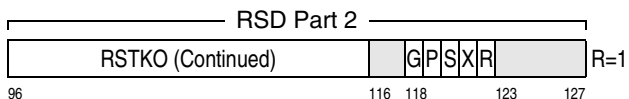
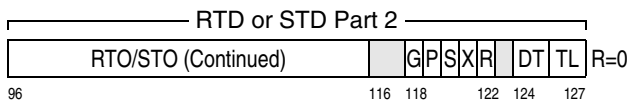
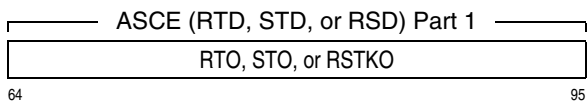
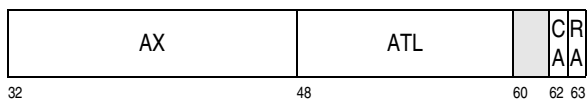
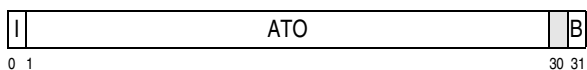

For BRANCH IN SUBSPACE GROUP, the fields in bytes 0-47 of the ASTE are allocated as follows:

ASX-Invalid Bit (I): Bit 0 controls whether the address space associated with the ASTE is available. When bit 0 is zero during access-register translation of ALET 1 or an ALET other than 0 and 1 for BRANCH IN SUBSPACE GROUP, the translation proceeds. When the bit is one, an ASTE-validity exception is recognized. The bit is ignored during access-register translation of ALET 0. When the ASTE is designated by a subspace-ASTE origin (SSASTE0) in a dispatchable-unit control table, bit 0 is also used as described in the definition of bits 160-191 (ASTESN).

Authority-Table Origin (ATO): Bits 1-29 are not used by BRANCH IN SUBSPACE GROUP.

Base-Space Bit (B): Bit 31 specifies, when one, that the address space associated with the ASTE is the base space of a subspace group. When BRANCH IN SUBSPACE GROUP uses an ALET

other than ALETs 0 and 1 to locate a destination ASTE, it recognizes a special-operation exception if the destination-ASTE origin does not equal the base-ASTE origin in the dispatchable-unit control table and bit 31 is one in the destination ASTE.

Authorization Index (AX): Bits 32-47 are not used by BRANCH IN SUBSPACE GROUP.

Authority-Table Length (ATL): Bits 48-59 are not used by BRANCH IN SUBSPACE GROUP.

Controlled-ASN Bit (CA): Bit 62 is not used by BRANCH IN SUBSPACE GROUP.

Reusable-ASN Bit (RA): Bit 63 is not used by BRANCH IN SUBSPACE GROUP.

Address-Space-Control Element (ASCE): Bits 64-127 are an eight-byte address-space-control element (ASCE) that may be a segment-table designation (STD), a region-table designation (RTD), or a real-space designation (RSD). (The term “region-table designation” is used to mean a region-first-table designation, region-second-table designation, or region-third-table designation.) The ASCE field is obtained as the result of access-register translation done for BRANCH IN SUBSPACE GROUP. When BRANCH IN SUBSPACE GROUP uses an ALET other than ALETs 0 and 1 to locate a destination ASTE, it recognizes a special-operation exception if the destination-ASTE origin does not equal the base-ASTE origin in the dispatchable-unit control table and the subspace-group-control bit, bit 118 (G), in the destination ASTE is zero. When BRANCH IN SUBSPACE GROUP transfers control to the base space of a subspace group associated with the current dispatchable unit, it places bits 64-127 in control register 1; otherwise, when BRANCH IN SUBSPACE GROUP transfers control to a subspace of the subspace group, it places bits 64-119 and 121-127 in bit positions 0-55 and 57-63, respectively, of control register 1. Bits 64-127 are used after ASN translation by PROGRAM CALL, PROGRAM RETURN, PROGRAM TRANSFER, SET SECONDARY ASN, and LOAD ADDRESS SPACE PARAMETERS as described in “ASN-Second-Table Entries” on page 3-31.

Access-List Designation (ALD): When this ASTE is designated by the primary-ASTE origin in control register 5, bits 128-159 are the primary-space access-list designation (PSALD). During access-register translation when the primary-list bit, bit 7, in the

ALET being translated is one, the PSALD is the effective access-list designation.

ASN-Second-Table-Entry Sequence Number (ASTESN): Bits 160-191 are used to control revocation of the accessing capability represented by access-list entries that designate the ASTE. During access-register translation, bits 160-191 are compared against the ASTESN in the access-list entry, and inequality causes an ASTE-sequence exception to be recognized.

Linkage-Table Designation (LTD) or Linkage-First-Table Designation (LFTD): Bits 192-223 are not used by BRANCH IN SUBSPACE GROUP.

ASN-Second-Table-Entry Instance Number (ASTEIN): Bits 352-383 are not used by BRANCH IN SUBSPACE GROUP.

Bits 224-319 in the ASTE are available for use by programming.

When the ASTE is designated by a subspace-ASTE origin (SSASTE0) in a dispatchable-unit control table, bits 160-191 are also used to control revocation of the linkage capability represented by that SSASTE0. When BRANCH IN SUBSPACE GROUP uses ALET 1 to transfer control to the subspace specified by the SSASTE0, or when PROGRAM CALL, PROGRAM RETURN, PROGRAM TRANSFER, SET SECONDARY ASN, or LOAD ADDRESS SPACE PARAMETERS uses the SSASTE0 to set bits 0-55 and 57-63 of the primary ASCE in control register 1 or the secondary ASCE in control register 7 from the same bits of the ASCE in the subspace ASTE, those instructions first test bit 0 of the subspace ASTE for being zero and recognize an ASTE-validity exception if it is not, and they then compare bits 160-191 to the subspace-ASTE sequence number (SSASTESN) in the dispatchable-unit control table and recognize an ASTE-sequence exception if there is an inequality. However, when either of the two named exception conditions exists for LOAD ADDRESS SPACE PARAMETERS, the instruction sets condition code 1 or 2 instead of recognizing the exception.

Programming Note: All unused fields in the ASTE, including the unused fields in bytes 0-31 and all of bytes 32-63, should be set to zeros. These fields are reserved for future extensions, and programs which place nonzero values in these fields may not operate compatibly on future machines.

Subspace-Replacement Operations

The subspace-group facility includes subspace-replacement operations of PROGRAM CALL, PROGRAM TRANSFER, PROGRAM RETURN, SET SECONDARY ASN, and LOAD ADDRESS SPACE PARAMETERS. The operations apply when the dispatchable unit for which any of the five named instructions is executed is in a state called subspace active. A dispatchable unit is subspace active if it has used BRANCH IN SUBSPACE GROUP to transfer control to a subspace of its subspace group and has not subsequently used BRANCH IN SUBSPACE GROUP to return control to the base space of the group.

The definitions of the subspace-replacement operations are included in the definitions of the five named instructions in Chapter 10, "Control Instructions." The operations are described in a general way as follows. Whenever (1) an address space is established as the primary or secondary address space as a result of ASN translation or (2) PROGRAM CALL obtains the origin of the ASN-second-table entry specifying a new primary address space from the entry-table entry used, then, if that address space is in a subspace group, as indicated by the subspace-group-control bit, bit 54 (G), being one in the address-space-control element (ASCE) for the address space (the new PASCE in control register 1 or SASCE in control register 7), and if the dispatchable unit is subspace-active, as indicated by the subspace-active bit, bit 0 (SA) of word 1, in the dispatchable-unit control table (DUCT) being one, the ASN-second-table-entry (ASTE) origin (ASTE0) for the address space, which was obtained by ASN translation or from the entry-table entry, is compared to the base-ASTE origin (BASTE0), bits 1-25 of word 0, in the DUCT. If that ASTE0 and the BASTE0 are equal, the following occurs. An ASTE-validity exception is recognized if bit 0 in the ASTE for the last subspace entered by the dispatchable unit, which ASTE is designated by the subspace-ASTE origin (SSASTE0) in the DUCT, is one. An ASTE-sequence exception is recognized if the ASTE-sequence number (ASTESN) in word 5 of the subspace ASTE does not equal the subspace ASTESN (SSASTESN) in word 3 of the DUCT. However, LOAD ADDRESS SPACE PARAMETERS sets a nonzero condition code instead of recognizing the ASTE-validity or ASTE-sequence exception. If no exception exists, bits 0-55 and 57-63 of the ASCE for the address space (the PASCE in control register 1

or SASCE in control register 7) are replaced by the same bits of the ASCE in word 2 of the subspace ASTE.

If an addressing exception is recognized when attempting to access the DUCT or subspace ASTE, the instruction execution is suppressed. If an ASTE-validity or ASTE-sequence exception is recognized, the instruction execution is nullified. Such nullification or suppression causes all control register contents to remain unchanged from what they were at the beginning of the instruction execution.

Key-controlled protection does not apply to any accesses to the DUCT or subspace ASTE.

For comparing the ASTE0 obtained by ASN translation to the BASTE0, either the ASTE0 may be compared to the BASTE0 or the ASTE0, with one leftmost and six rightmost zeros appended, may be compared to the entire contents of word 0 of the DUCT.

When the SSASTE0 in the DUCT is used to access the subspace ASTE, no check is made for whether the SSASTE0 is all zeros.

The references to the DUCT and subspace ASTE are single-access references and appear to be word concurrent as observed by other CPUs. The words of the DUCT are accessed in no particular order. The words of the subspace ASTE are accessed in no particular order except that word 0 is accessed first.

The exceptions that can be recognized during a subspace-replacement operation are referred to collectively as the subspace-replacement exceptions and are listed in priority order in "Subspace-Replacement Exceptions" on page 6-56.

Linkage-Stack Introduction

Many of the functions related to the linkage stack are described in this section and in "Linkage-Stack Operations" on page 5-76. Additionally, tracing of the stacking PROGRAM CALL instruction and of the PROGRAM RETURN instruction is described in Chapter 5, "Program Execution"; interruptions in Chapter 6, "Interruptions"; and the instructions are described in Chapter 10, "Control Instructions."

Summary

These major functions are provided:

1. A table-based subroutine-linkage mechanism that provides PSW and control-register status changing and which saves and restores this status and the contents of general registers and access registers through the use of an entry in a linkage stack.
2. A branch-type linkage mechanism that uses the linkage stack.
3. Instructions for placing an additional two words of status in the current linkage-stack entry and for retrieving all of the status and the general-register and access-register contents that are in the entry.
4. An instruction for determining whether a program is authorized to use a particular access-list-entry token.
5. Aids for program-problem analysis.

In addition, control and authority mechanisms are incorporated to control these functions.

It is intended that a separate linkage stack be associated with and used by each dispatchable unit. The linkage stack for a dispatchable unit resides in the home address space of the dispatchable unit.

It is intended that a dispatchable unit's linkage stack be protected from the dispatchable unit by means of key-controlled protection. Key-controlled protection does not apply to the linkage-stack instructions that place information in or retrieve information from the linkage stack.

The linkage-stack functions are for use by programs considered to be semi privileged, that is, programs which are executed in the problem state but which are authorized to use additional functions. With these authorization controls, a nonhierarchical organization of programs may be established, with each program in a sequence of calling and called programs having a degree of authority that is arbitrarily different from those of programs before or after it in the sequence. The range of functions available to each program, and the ability to transfer control from one program to another, are prescribed in tables that are managed by the control program.

The linkage-stack instructions, which are semiprivileged, are described in Chapter 10, "Control Instructions." They are:

- BRANCH AND STACK
- EXTRACT STACKED REGISTERS
- EXTRACT STACKED STATE
- MODIFY STACKED STATE
- PROGRAM RETURN
- TEST ACCESS

In addition, the PROGRAM CALL instruction optionally forms an entry in the linkage stack. A PROGRAM CALL instruction that operates on the linkage stack is called stacking PROGRAM CALL. Recognition of PROGRAM CALL as stacking PROGRAM CALL is under the control of a bit in the entry-table entry.

Linkage-Stack Functions

Transferring Program Control

The use of the linkage stack permits programs operating at arbitrarily different levels of authority to be linked directly without the intervention of the control program. The degree of authority of each program in a sequence of calling and called programs may be arbitrarily different, thus allowing a nonhierarchical organization of programs to be established. Modular authorization control can be obtained principally by associating an extended authorization index with each program module. This allows program modules with different authorities to coexist in the same address space. On the other hand, the extended authorization index in effect during the execution of a called program module can be the one that is associated with the calling program module, thus allowing the called module to be executed with different authorities on behalf of different dispatchable units. Options concerning the PSW-key mask and the secondary ASN are other means of associating different authorities with different programs or with the same called program. The authority of each program is prescribed in tables that are managed by the control program. By setting up the tables so that the same program can be called by means of different PC numbers, the program can be assigned different authorities depending on which PC number is used to call it. The tables also allow control over which PC numbers can be used by a program to call other programs.

The stacking PROGRAM CALL and PROGRAM RETURN linkage operations can link programs residing in different address spaces and having different

levels of authority. The execution state and the contents of the general registers and access registers are saved during the execution of stacking PROGRAM CALL and are partially restored during the execution of PROGRAM RETURN. A linkage stack provides an efficient means of saving and restoring both the execution state and the contents of registers during linkage operations.

During the execution of a PROGRAM CALL instruction, the PC-number-translation process is performed to locate a 32-byte entry-table entry. When the PC-type bit in the entry-table entry is one, the stacking PROGRAM CALL operation is specified; otherwise, the basic PROGRAM CALL operation is specified.

In addition to the information applying to both basic PROGRAM CALL and stacking PROGRAM CALL (described in "PC-Number Translation" on page 5-33 and consisting of an authorization key mask and specifications of the new ASN, addressing mode, instruction address, problem state, PSW-key mask, primary-ASTE address, and entry parameter), the entry-table entry contains information that specifies options concerning the address-space control and PSW key in the PSW, and the PSW-key mask, extended authorization index, and secondary ASN in the control registers.

During the stacking PROGRAM CALL operation and by means of the additional information in the entry-table entry, the address-space control in the PSW can be set to specify either the primary-space mode or the access-register mode. The PSW key can be either left unchanged or replaced from the entry-table entry. The PSW-key mask in control register 3 can be either ORed to or replaced from the entry-table entry. The extended authorization index in control register 8 can be either left unchanged or replaced from the entry-table entry. The secondary ASN in control register 3 can be set equal to the primary ASN of either the calling program or the called program; thus, the ability of the called program to have access to the primary address space of the calling program can be controlled.

The stacking PROGRAM CALL operation always forms an entry, called a state entry, in the linkage stack to save the execution state and the contents of general registers 0-15 and access registers 0-15. The saved execution state includes a called-space identification, the numeric part of the PC number used, the updated PSW before any changes are

made due to the entry-table entry, the extended authorization index, PSW-key mask, primary ASN, and secondary ASN existing before the operation, and the extended-addressing-mode bit existing after the operation. However, the value of the PER mask in the saved updated PSW is unpredictable. The linkage-stack state entry also contains an entry-type code that identifies the entry as one that was formed by PROGRAM CALL. If the ASN-and-LX-reuse facility is installed and enabled, the state entry also contains the primary ASN-second-table-entry instance number (primary ASTEIN) and secondary ASTEIN existing before the operation.

A space-switching operation occurs when the address-space number (ASN) specified in the entry-table entry is nonzero. When space switching occurs, the operation is called PROGRAM CALL with space switching (PC-ss), and the ASN in the entry-table entry is placed in control register 4 as a new primary ASN. When no space switching occurs, the operation is called PROGRAM CALL to current primary (PC-cp), and there is no change to the primary ASN in control register 4.

PROGRAM CALL with space switching obtains the new ASN from the entry-table entry and places it in control register 4 as the primary ASN. It obtains a new primary-ASTE origin from the entry-table entry and new primary address-space-control element from the new primary ASTE, and it places them in control registers 5 and 1, respectively. It sets the secondary address-space-control element in control register 7 equal to either the old primary address-space-control element, or the new one, depending on whether it sets the secondary ASN in control register 3 equal to the old primary ASN or the new one, respectively. PROGRAM CALL to current primary sets the secondary ASN equal to the primary ASN and the secondary address-space-control element equal to the primary address-space-control element.

If the ASN-and-LX-reuse facility is installed and enabled, PROGRAM CALL with space switching obtains the ASN-second-table-entry instance number (ASTEIN) from the new primary ASTE and places it in control register 4 as the new primary ASTEIN. It sets the secondary ASTEIN in control register 3 equal to either the old primary ASTEIN or the new one, depending on whether it set the secondary ASN equal to the old primary ASN or the new one, respectively. PROGRAM CALL to current primary sets the secondary ASTEIN equal to the primary ASTEIN.

The instruction PROGRAM RETURN restores most of the information saved in the linkage stack by the stacking PROGRAM CALL operation. It restores the PSW, extended authorization index, PSW-key mask, primary ASN, secondary ASN, and the contents of general registers 2-14 and access-registers 2-14. However, the PER mask in the current PSW remains unchanged. If the ASN-and-LX-reuse facility is installed and enabled, PROGRAM RETURN restores the primary ASTEIN and secondary ASTEIN. The operation of PROGRAM RETURN is referred to by saying that PROGRAM RETURN unstacks a state entry.

For PROGRAM RETURN, a space-switching operation occurs when the restored primary ASN is not equal to the primary ASN existing before the operation. When space switching occurs, the operation is called PROGRAM RETURN with space switching (PR-ss). When no space switching occurs, the operation is called PROGRAM RETURN to current primary (PR-cp).

PROGRAM RETURN with space switching performs ASN translation of the restored primary ASN to obtain a new primary-ASTE origin and a new primary address-space-control element, which it places in control registers 5 and 1, respectively. For PROGRAM RETURN with space switching or to current primary, (1) if the restored secondary ASN is the same as the restored primary ASN, the secondary address-space-control element in control register 7 is set equal to the new primary address-space-control element in control register 1, or (2) if the restored secondary ASN is not the same as the restored primary ASN, ASN translation and ASN authorization of the restored secondary ASN are performed to obtain a new secondary address-space-control element, which is placed in control register 7.

If the ASN-and-LX-reuse facility is installed and enabled, PROGRAM RETURN with space switching requires that the ASN-second-table-entry instance number (ASTEIN) in the new primary ASTE be equal to the primary ASTEIN saved in the state entry being unstacked. PROGRAM RETURN with space switching or to current primary, if the restored secondary ASN is not the same as the restored primary ASN, requires that the ASTEIN in the new secondary ASTE be equal to the saved ASTEIN. An exception is recognized if either of these requirements is not met.

The stacking PROGRAM CALL operation and the PROGRAM RETURN operation each can be per-

formed successfully only in the primary-space mode or access-register mode. An exception is recognized when the CPU is in the real mode, secondary-space mode, or home-space mode.

A bit, named the unstack-suppression bit, can be set to one in a linkage-stack state entry to cause an exception if an attempt is made by PROGRAM RETURN to unstack the entry. When the bit is one, the entry still can be operated on by the instructions that add information to or retrieve information from the entry. The unstack-suppression bit is intended to allow the control program to gain control when an attempt is made to unstack a state entry in which the bit is one.

Branching Using the Linkage Stack

The execution state and the contents of the general registers and access registers can also be saved in the linkage stack by means of the instruction BRANCH AND STACK. BRANCH AND STACK uses a branch address as do the other branching instructions, instead of using a PC number. BRANCH AND STACK, along with PROGRAM RETURN, can link programs residing in the same address space and having the same level of authority; that is, BRANCH AND STACK does not change the execution state except for the instruction address.

BRANCH AND STACK forms a linkage-stack state entry that is almost the same as one formed by PROGRAM CALL. When it is necessary to distinguish between these two types of state entry, an entry formed by PROGRAM CALL is called a program-call state entry, and one formed by BRANCH AND STACK is called a branch state entry. A branch state entry differs from a program-call state entry in two ways: (1) it contains a different entry-type code, which identifies it as a branch state entry, and (2) it contains the basic-addressing-mode bit and instruction address existing after the operation instead of a called-space identification and the numeric part of the PC number used. These new values of PSW bits 32 and 64-127 are in addition to the complete PSW that is saved in the state entry.

For BRANCH AND STACK, the basic- and extended addressing mode bits and the instruction address that are part of the complete PSW saved in the state entry can be the current (at the beginning of the operation) addressing-mode bits and the updated instruction address (the address of the next sequential instruction), or they can be specified in a register.

This register can be one that had link information placed in it by a BRANCH AND LINK (BALR only), BRANCH AND SAVE, BRANCH AND SAVE AND SET MODE, or BRANCH AND SET MODE instruction. Thus, BRANCH AND STACK can be used either in a calling program or at (or near) the entry point of a called program, and, in either case, a PROGRAM RETURN instruction located at the end of the called program will return correctly to the calling program. The ability to use BRANCH AND STACK at an entry point allows the linkage stack to be used without changing old calling programs.

When the R_2 field of BRANCH AND STACK is zero, the instruction is executed without causing branching.

When PROGRAM RETURN unstacks a branch state entry, it ignores the extended authorization index, PSW-key mask, primary ASN, secondary ASN, primary ASTEIN, and secondary ASTEIN in the entry. The PROGRAM RETURN instruction restores the PSW and the contents of general registers 2-14 and access registers 2-14 that were saved in the entry. However, the PER mask in the current PSW remains unchanged.

BRANCH AND STACK can be executed successfully only in the primary-space mode or access-register mode. An exception is recognized when the CPU is in the real mode, secondary-space mode, or home-space mode. The unstack-suppression bit has the same effect in a branch state entry as it does in a program-call state entry.

Adding and Retrieving Information

The instruction MODIFY STACKED STATE can be used by a program to place two words of information, contained in a designated general-register pair, in an area, called the modifiable area, of the current linkage-stack state entry (a branch state entry or a program-call state entry). This is intended to allow a called program to establish a recovery routine that will be given control by the control program, if necessary.

The instructions EXTRACT STACKED REGISTERS and EXTRACT STACKED STATE can be used by a program to obtain any of the information saved in the current state entry by BRANCH AND STACK or PROGRAM CALL or placed there by MODIFY STACKED STATE. EXTRACT STACKED REGISTERS (EREGG) places the contents of a specified

range of general registers and access registers back in the registers from which the contents were saved. EXTRACT STACKED REGISTERS (EREG) does the same except that it restores only bits 32-63 of the general registers and leaves bits 0-31 unchanged. EXTRACT STACKED STATE obtains pairs of words of the nonregister information saved or placed in a state entry and places them in bit positions 32-63 of a designated general-register pair. Alternatively, EXTRACT STACKED STATE obtains two double-words containing a PSW saved in the state entry and places them in bit positions 0-63 of a designated general-register pair. If the ASN-and-LX-reuse facility is installed, EXTRACT STACKED STATE can place the contents of two words of the state entry in bit positions 0-31 of a designated general-register pair. These contents are the saved secondary ASTEIN and primary ASTEIN if the ASN-and-LX-reuse facility is enabled. EXTRACT STACKED STATE sets the condition code to indicate whether the current state entry is a branch state entry or a program-call state entry.

Testing Authorization

The instruction TEST ACCESS has as operands an access-list-entry token (ALET) in a designated access register and an extended authorization index (EAX) in a designated general register. TEST ACCESS applies the access-register-translation process, which uses the specified EAX instead of the current EAX in control register 8, to the ALET, and it sets the condition code to indicate the result. The condition code may indicate: (1) the ALET is 00000000 hex, (2) the ALET designates an entry in the dispatchable-unit access list and can be translated without exceptions in access-register translation, (3) the ALET designates an entry in the primary-space access list and can be translated without exceptions in access-register translation, or (4) the ALET is 00000001 hex or causes exceptions in access-register translation.

The principal purpose of TEST ACCESS is to allow a called program to determine whether an ALET passed to it by the calling program is authorized for use by the calling program by means of the calling program's EAX. This is in support of a possible programming convention in which a called program will not operate on an AR-specified address space by means of its own EAX unless the calling program is authorized to operate on that space by means of the calling program's EAX. The called program can obtain the calling program's EAX, for use by TEST

ACCESS, from the current linkage-stack state entry by means of the EXTRACT STACKED STATE instruction.

Another purpose of TEST ACCESS is to indicate the special cases in which the ALET is 00000000 hex, designating the primary address space, or 00000001 hex, designating the secondary address space. Because PROGRAM CALL may change the primary and secondary address spaces, ALETs 00000000 hex and 00000001 hex may designate different address spaces when used by the called program than when used by the calling program.

Still another purpose of TEST ACCESS is to indicate whether the ALET designates an entry in the primary-space access list since such a designation after the primary address space was changed by a space-switching program-linkage operation may be an error.

Program-Problem Analysis

To aid program-problem analysis, the option is provided of having a trace entry made implicitly for three additional linkage operations when the linkage stack is used. When branch tracing is on, a trace entry is made each time a BRANCH AND STACK instruction is executed and causes branching. When ASN tracing is on, a trace entry is made each time the stacking PROGRAM CALL operation is performed and each time PROGRAM RETURN unstacks a linkage-stack state entry formed by PROGRAM CALL. When mode tracing is on, a trace entry is made each time the stacking PROGRAM CALL operation or PROGRAM RETURN operation is performed and changes PSW bit 31, except that, for PROGRAM RETURN, a trace entry for mode tracing is not made if one due to ASN tracing is made. A detailed definition of tracing is contained in "Tracing" on page 4-12.

As a further analysis aid, BRANCH AND STACK when it causes branching, stacking PROGRAM CALL, and PROGRAM RETURN are also recognized as PER successful-branching events. For PROGRAM RETURN, the unstacked state entry may have been formed by BRANCH AND STACK or PROGRAM CALL.

The execution of a space-switching stacking PROGRAM CALL or PROGRAM RETURN instruction causes a space-switch event if the primary space-switch-event control is one before or after the operation or if a PER event is to be indicated.

Linkage-Stack Entry-Table Entries

All of the fields in the entry-table entry except bits 130-159 are described in "Entry-Table Entries" on page 5-37. This section describes only bits 130-159.

The entry-table entry has the following format:

If Bit 129 is Zero

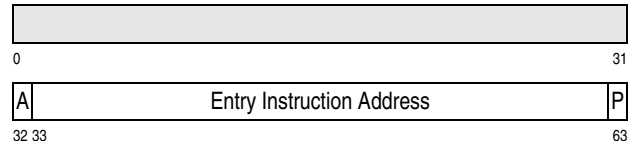

If Bit 129 is One

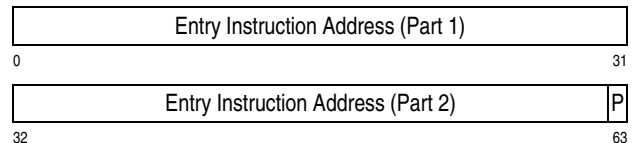

Remaining fields (independent of bit 129)

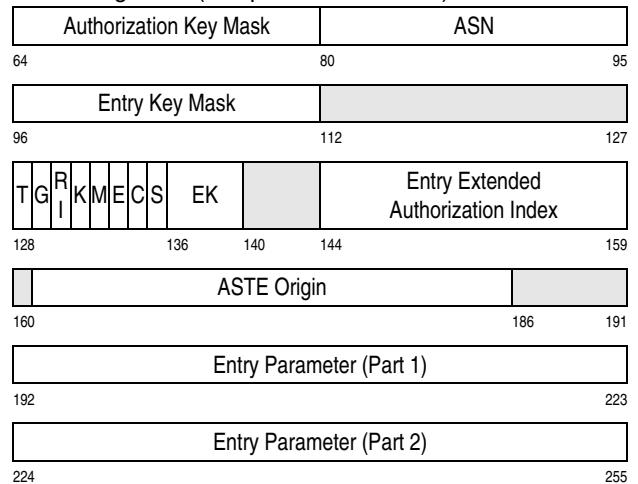

The fields in bit positions 130-159 are allocated as follows:

Reserved (RI): Bit 130 is reserved for IBM use.

PSW-Key Control (K): Bit 131, when one, specifies that bits 136-139 are to replace the PSW key in the PSW as part of the stacking PROGRAM CALL operation. When this bit is zero, the PSW key remains unchanged. Bit 131 is ignored during the basic PROGRAM CALL operation.

PSW-Key-Mask Control (M): Bit 132, when one, specifies that bits 96-111 are to replace the PSW-key

mask in control register 3 as part of the stacking PROGRAM CALL operation. When this bit is zero, bits 96-111 are ORed into the PSW-key mask in control register 3 as part of the stacking PROGRAM CALL operation. Bit 132 is ignored during the basic PROGRAM CALL operation.

Extended-Authorization-Index Control (E): Bit 133, when one, specifies that bits 144-159 are to replace the current extended authorization index in control register 8 as part of the stacking PROGRAM CALL operation. When this bit is zero, the current extended authorization index remains unchanged. Bit 133 is ignored during the basic PROGRAM CALL operation.

Address-Space-Control Control (C): Bit 134, when one, specifies that bit 17 of the current PSW is to be set to one as part of the stacking PROGRAM CALL operation. When this bit is zero, bit 17 is set to zero. Because the CPU must be in either the primary-space mode or the access-register mode when a stacking PROGRAM CALL instruction is issued, the result is that the CPU is placed in the access-register mode if bit 134 is one or the primary-space mode if bit 134 is zero. Bit 134 is ignored during the basic PROGRAM CALL operation.

Secondary-ASN Control (S): Bit 135, when one, specifies that bits 80-95 are to become the new secondary ASN, and the new SASCE is to be set equal to the new PASCE, as part of the stacking PROGRAM CALL with-space-switching (PC-ss) operation. When this bit is zero, the new SASN and SASCE are set equal to the PASN and PASCE, respectively, of the calling program. When the ASN-and-LX-reuse facility is installed and enabled, bit 135 similarly specifies, when one, that the new SASTEIN is to be set equal to the new PASTEIN or, when zero, that the new SASTEIN is to be set equal to the PASTEIN of the calling program. Bit 135 is ignored during the basic PROGRAM CALL operation and the stacking PROGRAM CALL to-current-primary (PC-cp) operation.

Entry Key (EK): Bits 136-139 replace the PSW key in the PSW as part of the stacking PROGRAM CALL operation if the PSW-key control, bit 131, is one. Bits 136-139 are ignored, and the current PSW key remains unchanged, if bit 131 is zero. Bits 136-139 are ignored during the basic PROGRAM CALL operation.

Entry Extended Authorization Index: Bits 144-159 replace the current extended authorization index, bits 32-47 of control register 8, as part of the stacking PROGRAM CALL operation if the extended-authorization-index control, bit 133, is one. Bits 144-159 are ignored, and the current extended authorization index remains unchanged, if bit 133 is zero. Bits 144-159 are ignored during the basic PROGRAM CALL operation.

Bits 130 and 140-143 are reserved for possible future extensions and should be zeros.

Linkage-Stack Operations

A linkage stack may be formed by the control program for each dispatchable unit. The linkage stack is used to save the execution state and the contents of the general registers and access registers during the BRANCH AND STACK and stacking PROGRAM CALL operations. The linkage stack is also used to restore a portion of the execution state and general-register and access-register contents during the PROGRAM RETURN operation.

A linkage stack resides in virtual storage. The linkage stack for a dispatchable unit is in the home address space for that dispatchable unit. The home address space is designated by the home address-space-control element in control register 13.

The linkage stack is intended to be protected from problem-state programs so that these programs cannot examine or modify the information saved in the linkage stack, except by means of the EXTRACT STACKED REGISTERS, EXTRACT STACKED STATE, and MODIFY STACKED STATE instructions. This protection can be obtained by means of key-controlled protection.

A linkage stack may consist of a number of linkage-stack sections chained together. A linkage-stack section is variable in length. The maximum length of each linkage-stack section is 65,560 bytes.

There are three types of entry in the linkage stack: header entry, trailer entry, and state entry. A header entry and a trailer entry are at the beginning and end, respectively, of a linkage-stack section, and they are used to chain linkage-stack sections together. Header entries and trailer entries are formed by the control program. A state entry is used to contain the

execution state and register contents that are saved during the BRANCH AND STACK or stacking PROGRAM CALL operation, and it is formed during the operation. A state entry is further distinguished as being a branch state entry if it was formed by BRANCH AND STACK or as being a program-call state entry if it was formed by PROGRAM CALL.

The actions of forming a state entry and saving information in it during the BRANCH AND STACK and stacking PROGRAM CALL operations are called the stacking process. The actions of restoring information from a state entry and logically deleting the entry during the PROGRAM RETURN operation are called the unstacking process. The part of the unstacking process that locates a state entry is also performed during the EXTRACT STACKED REGISTERS, EXTRACT STACKED STATE, and MODIFY STACKED STATE operations.

Each type of linkage-stack entry has a length that is a multiple of eight bytes. A header entry and trailer entry each has a length of 16 bytes. A state entry has a length of 296 bytes.

Each of the header entry, trailer entry, and state entry has a common eight-byte area at its end, called the entry descriptor. The linkage-stack-entry address in control register 15 designates the leftmost byte of the entry descriptor of the last linkage-stack entry, other than the trailer entry, in a linkage-stack section. This entry is called the current linkage-stack entry, and the section is called the current linkage-stack section.

Each entry descriptor in a linkage-stack section, except the one in the trailer entry of the section, includes a field that specifies the amount of space existing between the end of the entry descriptor and the beginning of the trailer entry. This field is named the remaining-free-space field. The remaining-free-space field in a trailer entry is unused.

When a new state entry is to be formed in the linkage stack during the stacking process, the new entry is placed immediately after the entry descriptor of the current linkage-stack entry, provided that there is enough remaining free space in the current linkage-stack section to contain the new entry. If there is not enough remaining free space in the current section, and if the trailer entry in the current section indicates that another section follows the current section, the new entry is placed immediately after the entry descriptor of the header entry of that following section, provided that there is enough remaining free

space in that section. If the trailer entry indicates that there is not a following section, an exception is recognized, and a program interruption occurs. It is then the responsibility of the control program to allocate another section, chain it to the current section, and cause the BRANCH AND STACK or stacking PROGRAM CALL instruction to be reexecuted. If there is a following section but there is not enough remaining free space in it, an exception is recognized.

If the remaining-free-space value that is used to locate a trailer entry is not a multiple of 8, an exception is recognized. The remaining-free-space value in the header entry of a linkage-stack section must be set to a multiple of 8 to ensure that the remaining-free-space value that may be used to locate the trailer entry of the section will be a multiple of 8.

When the stacking process is successful in forming a new state entry, it updates the linkage-stack-entry address in control register 15 so that the address designates the leftmost byte of the entry descriptor of the new entry, which thus becomes the new current linkage-stack entry.

When, during the unstacking process in PROGRAM RETURN, the current linkage-stack entry is a state entry, the process operates on that entry and then updates the linkage-stack-entry address so that it designates the entry descriptor of the preceding entry in the same linkage-stack section. The preceding entry thus becomes the current entry. The new current entry may be another state entry, or it may be a header entry.

The header entry of a linkage-stack section indicates whether there is a preceding section. If there is a preceding section, the header entry contains the address of the last linkage-stack entry, other than the trailer entry, in the preceding section. That last entry should be a state entry (not another header entry), unless there is an error in the linkage stack.

If the unstacking process is performed when the current linkage-stack entry is a header entry, and if the header entry indicates that a preceding linkage-stack section exists, the unstacking process proceeds by treating the entry designated in the preceding section as if it were the current entry, provided that this entry is a state entry. If the header entry does not indicate a preceding section, or if the entry designated in the preceding section is not a state entry, an exception is recognized.

When the unstacking process is performed in EXTRACT STACKED REGISTERS, EXTRACT STACKED STATE, or MODIFY STACKED STATE, the process locates a state entry but does not change the linkage-stack-entry address in control register 15.

Each entry descriptor in a linkage-stack section includes a field that specifies the length of the next linkage-stack entry, other than the trailer entry, in the section. When a state entry is created during the stacking process, zeros are placed in this field in the created entry, and the length of the state entry is placed in this field in the preceding entry. When a state entry is logically deleted during the unstacking process in PROGRAM RETURN, zeros are placed in this field in the preceding entry. This field is named the next-entry-size field.

When the stacking or unstacking process operates on the linkage stack, key-controlled protection does not apply, but low-address and DAT protection do apply.

Linkage-Stack-Operations Control

The use of the linkage stack is controlled by the ASN-and-LX-reuse control in control register 0, the home address-space-control element in control register 13 and the linkage-stack-entry address in control register 15. The home address-space-control element is described in “Dynamic Address Translation” on page 3-38.

The ASN-and-LX-reuse control and the linkage-stack-entry address are

Control Register 0

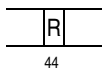

ASN-and-LX-Reuse Control (R): Bit 44 of control register 0 is the ASN-and-LX-reuse-control bit (R) and is assigned if the ASN-and-LX-reuse facility is installed. The effects of a one value of the bit specifically on the linkage stack are as follows:

- BRANCH AND STACK and stacking PROGRAM CALL save the secondary ASN-second-table-entry instance number (ASTEIN), bits 0-31 of control register 3, and the primary ASTEIN, bits 0-31 of control register 4,

in bytes 176-179 and 180-183, respectively, of the linkage-stack state entry that either of the instructions forms.

- PROGRAM RETURN with space switching, after it has used the PASN in bytes 134 and 135 of the state entry to locate an ASN-second-table entry, compares the primary ASTEIN in bytes 180-183 of the state entry to the ASTEIN in the ASN-second-table entry. PROGRAM RETURN to current primary or with space switching, if it uses the SASN in bytes 130 and 131 of the state entry to locate an ASN-second-table entry (because the new SASN is not equal to the new PASN), compares the secondary ASTEIN in bytes 176-179 of the state entry to the ASTEIN in the ASN-second-table entry. The one or two comparisons of ASTEINs must each give equal results; otherwise, an ASTE-instance exception is recognized. The comparisons occur regardless of the reusable-ASN bits in the ASN-second-table entries. PROGRAM RETURN to current primary or with space switching restores the secondary and primary ASTEINs saved in the state entry to bit positions 0-31 of control registers 3 and 4, respectively (if no exception is recognized). When unstacking a state entry formed by BRANCH AND STACK, PROGRAM RETURN does not compare or restore ASTEINs.

The effect of the ASN-and-LX-reuse control on PC-number translation is described in “ASN-and-LX-Reuse Control (R):” on page 5-35. Other effects of the control are described in “ASN-Second-Table-Entry Instance Number and ASN Reuse” on page 3-25.

Control Register 15

The location of the entry descriptor of the current linkage-stack entry is specified in control register 15. The register has the following format:

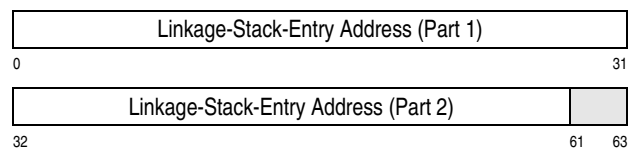

Linkage-Stack-Entry Address: Bits 0-60 of control register 15, with three zeros appended on the right, form the 64-bit home virtual address of the

entry descriptor of the current linkage-stack entry in the current linkage-stack section. Bits 0-60 are changed during the stacking process in BRANCH AND STACK and stacking PROGRAM CALL and during the unstacking process in PROGRAM RETURN. Bits 61-63 of control register 15 are set to zeros when bits 0-60 are changed.

Linkage Stack

The linkage stack consists of one or more linkage-stack sections containing linkage-stack entries. There are three principal types of linkage-stack entry: header entry, trailer entry, and state entry. A state entry is further distinguished as being either a branch state entry or a program-call state entry.

Each type of linkage-stack entry has an entry descriptor at its end. The leftmost byte of the entry descriptor of the current linkage-stack entry in the current linkage-stack section is designated by the linkage-stack-entry address in control register 15.

The linkage stack resides in the home address space, designated by the home address-space-control element in control register 13.

Entry Descriptors

An entry descriptor is at the end of each linkage-stack entry. The entry descriptor is eight bytes in length and has the following format:

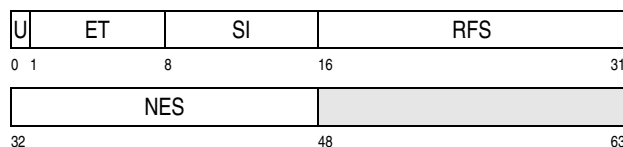

The fields in the entry descriptor are allocated as follows:

Unstack-Suppression Bit (U): When bit 0 is one in the entry descriptor of a header entry or state entry encountered during the unstacking process in PROGRAM RETURN, a stack-operation exception is recognized. Bit 0 is ignored in a trailer entry and during the unstacking process in EXTRACT STACKED REGISTERS, EXTRACT STACKED STATE, and MODIFY STACKED STATE. The control program can temporarily set bit 0 to one in the current linkage-stack entry (a header entry or state entry) to prevent PROGRAM RETURN from being executed successfully while still allowing EXTRACT STACKED REGIS-

TERS, EXTRACT STACKED STATE, and MODIFY STACKED STATE to be executed successfully. Bit 0 is set to zero in the entry descriptor of a state entry when the entry is formed during the stacking process.

Entry Type (ET): Bits 1-7 are a code that specifies the type of the linkage-stack entry containing the entry descriptor. The assigned codes are:

Code (in Binary)	Entry Type
0001001	Header entry
0001010	Trailer entry
0001100	Branch State entry
0001101	Program-call state entry

Codes 0000000-0001000, 0001011, and 0001110 through 0111111 binary are reserved for possible future assignments. Codes 1000000 through 1111111 binary are available for use by programming.

Bits 1-7 are set to 0001100 or 0001101 binary in the entry descriptor of a state entry when the entry is formed during the stacking process.

A stack-type exception is recognized during the unstacking process in EXTRACT STACKED REGISTERS, EXTRACT STACKED STATE, MODIFY STACKED STATE, or PROGRAM RETURN if bits 1-7 in the current linkage-stack entry do not indicate that the entry is a state entry or a header entry; or, when the current entry is a header entry, if bits 1-7 in the entry designated by the backward stack-entry address in the header entry do not indicate that the designated entry is a state entry. However, a stack-specification exception is recognized, instead of a stack-type exception, if both the current entry and the designated entry are header entries.

Section Identification (SI): Bits 8-15 are an identification, provided by the control program, of the linkage-stack section containing the entry descriptor. In the state entry formed by a stacking process, the process sets bits 8-15 equal to the contents of the section-identification field in the preceding linkage-stack entry.

Remaining Free Space (RFS): Bits 16-31 specify the number of bytes between the end of this entry descriptor and the beginning of the trailer entry in the same linkage-stack section, except that this field in a trailer entry has no meaning. Thus, in the last state

entry in a section, or in the header entry if there is no state entry, bits 16-31 specify the number of bytes available in the section for performance of the stacking process. In the state entry formed by a stacking process, the process sets bits 16-31 equal to the contents of the remaining-free-space field in the preceding linkage-stack entry minus the size, in bytes, of the new entry. Bits 16-31 must be a multiple of 8 (bits 29-31 must be zeros) in the entry descriptor of the header entry in a linkage-stack section; otherwise, a value that is not a multiple of 8 will be propagated to bits 16-31 in the entry descriptor of each state entry in the section, and a stack-specification exception will be recognized if the stacking process attempts to locate the trailer entry in the section in order to proceed to the next section.

Next-Entry Size (NES): Bits 32-47 specify the size in bytes of the next linkage-stack entry, other than a trailer entry, in the same linkage-stack section. This field in the current linkage-stack entry contains all zeros. This field in a trailer entry has no meaning. When the stacking process forms a state entry, it places zeros in the next-entry-size field of the new entry, and it places the size of the new entry in the next-entry-size field of the preceding entry. When the unstacking process logically deletes a state entry, it places zeros in the next-entry-size field of the preceding entry, which entry becomes the current entry.

Bits 48-63 are set to zeros in a state entry when the entry is formed during the stacking process. In a header entry, trailer entry, or state entry, bits 48-63 are reserved for possible future extensions and should always be zeros.

Programming Note: No entry-type code will be assigned in which the leftmost bit of the code is one. The control program can temporarily set the leftmost bit to one in the entry-type code of the current linkage-stack entry (a header entry or a state entry) to prevent the successful execution of EXTRACT STACKED REGISTERS, EXTRACT STACKED STATE, MODIFY STACKED STATE, or PROGRAM RETURN.

Header Entries

A header entry is at the beginning of each linkage-stack section. The header entry is 16 bytes in length and has the following format:

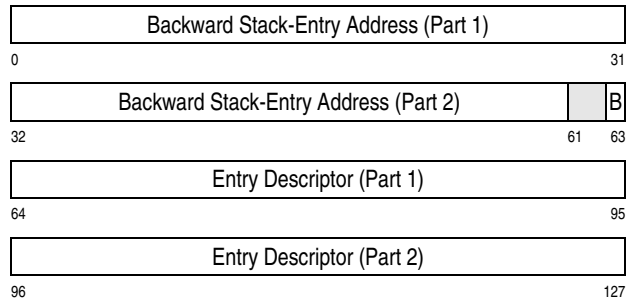

The fields in the first eight bytes of the header entry are allocated as follows:

Backward Stack-Entry Validity Bit (B): Bit 63 when one, specifies that the preceding linkage-stack section is available and that the backward stack-entry address, bits 0-60 is valid. Bit 63 is set to one during the stacking process when the process proceeds to this section from the preceding one because there is not enough space available in the preceding section to perform the process. During the unstacking process when this header entry is the current linkage-stack entry, a stack-empty exception is recognized if bit 63 is zero.

Backward Stack-Entry Address (BSEA): When bit 63 is one, bits 0-60 with three zeros appended on the right, form the 64-bit home virtual address of the entry descriptor of the last linkage-stack entry, other than the trailer entry, in the preceding linkage-stack section. However, if the current linkage-stack entry is in the preceding or an earlier linkage-stack section, bits 0-60 may have no meaning because the entry they designate, and earlier entries, may have been logically deleted. Bits 0-60 are set during the stacking process when the process proceeds to this section from the preceding one because there is not enough space available in the preceding section to perform the process. During the unstacking process when this header entry is the current linkage-stack entry and bit 63 is one, the entry designated by bits 0-60 is treated as the current entry.

Bits 61 and 62 are set to zeros when bits 0-60 are set during the stacking process. Bits 61 and 62 are reserved for possible future extensions.

Trailer Entries

A trailer entry is at the end of each linkage-stack section. The trailer entry begins immediately after the area specified by the remaining-free-space field in the entry descriptors of the header entry and each state entry in the same linkage-stack section. The trailer entry is 16 bytes in length and has the following format:

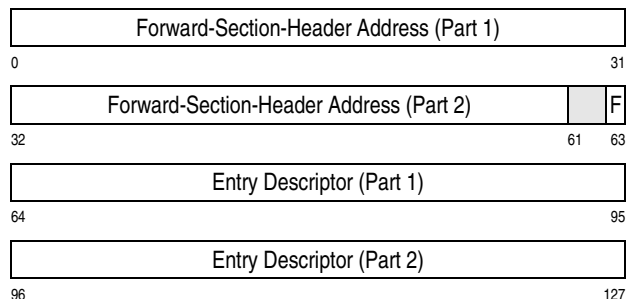

The fields in the first eight bytes of the trailer entry are allocated as follows:

Forward-Section Validity Bit (F): Bit 63 when one, specifies that the next linkage-stack section is available and that the forward-section-header address, bits is valid. During the stacking process when there is not enough space available in the current linkage-stack section to perform the process, a stack-full exception is recognized if bit 63 in the trailer entry of the current section is zero.

Forward-Section-Header Address (FSHA):

When bit 63 is one, bits 0-60, with three zeros appended on the right, form the 64-bit home virtual address of the entry descriptor of the header entry in the next linkage-stack section. During the stacking process when there is not enough space available in the current section to perform the process and bit 63 is one, the header entry designated by bits 0-60 becomes the current linkage-stack entry.

Bits 61 and 62 are reserved for possible future extensions.

Programming Note: All of the fields in the trailer entry are set only by the control program.

State Entries

Zero, one, or more state entries may follow the header entry in each linkage-stack section. A state entry may be a branch state entry, formed by a

BRANCH AND STACK instruction, or a program-call state entry, formed by a stacking PROGRAM CALL instruction. The state entry is 296 bytes in length and has the following format:

Hex	Dec	Contents	Bytes
0 8 ⋮ 70 78	0 8 ⋮ 112 120	Contents of General Registers 0 - 15	128
80 88 ⋮ D0 D8	128 136 ⋮ 208 216	Other Status Information	96
E0 E8 ⋮ 110 118	224 232 ⋮ 272 280	Contents of Access Registers 0 - 15	64
120	288	Entry Descriptor	8

Bytes 0-127 of the state entry contain the contents of general registers 0-15 in the ascending order of the register numbers. Bytes 224-287 contain the contents of access registers 0-15 in the ascending order of the register numbers. The contents of these fields are moved from the registers to the state entry during the BRANCH AND STACK and stacking PROGRAM CALL operations. The contents of general registers 2-14 and access registers 2-14 are restored from the state entry to the registers during the PROGRAM RETURN operation. The contents of a specified range of general registers and access registers can be restored from the state entry to the registers by EXTRACT STACKED REGISTERS.

Bytes 128-223 of the state entry contain the other status information that is placed in the entry by BRANCH AND STACK, stacking PROGRAM CALL,

and MODIFY STACKED STATE. A portion of this status information is restored to the PSW and control registers by PROGRAM RETURN, and all of the information can be examined by means of EXTRACT STACKED STATE. Bytes 288-295 contain the entry descriptor. EXTRACT STACKED STATE sets the condition code to indicate whether the entry-type code in the entry descriptor specifies a branch state entry or a program-call state entry.

Bytes 128-223 of the state entry have the following detailed format:

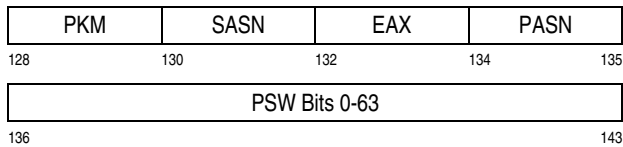

In a Branch State Entry Made in 24-Bit or 31-Bit Mode

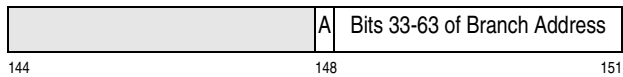

In a Branch State Entry Made in 64-Bit Mode

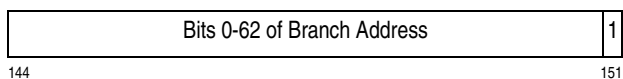

In a Program-Call State Entry Made When Resulting Mode Is 24 Bit or 31 Bit

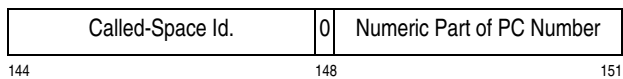

In a Program-Call State Entry Made When Resulting Mode Is 64 Bit

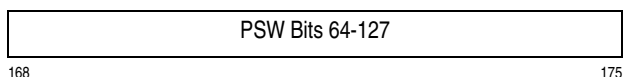
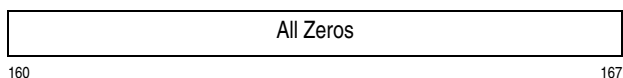
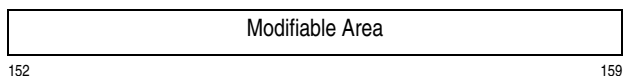
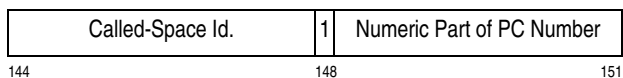

If ASN-and-LX Reuse Is Enabled; otherwise Unpredictable

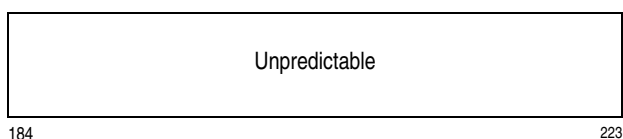
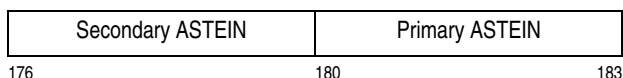

The fields in bytes 128-183 are allocated as follows. In the following, "of the calling program" means the value existing at the beginning of the execution of the BRANCH AND STACK or stacking PROGRAM CALL instruction that formed the state entry.

PSW-Key Mask (PKM): Bytes 128-129 contain the PSW-key mask, bits 32-47 of control register 3, of the calling program. The PSW-key mask is saved in the state entry by BRANCH AND STACK or stacking PROGRAM CALL, and it is restored to the control register by a PROGRAM RETURN instruction that unstacks an entry formed by stacking PROGRAM CALL.

Secondary ASN (SASN): Bytes 130-131 contain the secondary ASN, bits 48-63 of control register 3, of the calling program. The SASN is saved in the state entry by BRANCH AND STACK or stacking PROGRAM CALL, and it is restored to the control register by a PROGRAM RETURN instruction that unstacks an entry formed by stacking PROGRAM CALL.

Extended Authorization Index (EAX): Bytes 132-133 contain the extended authorization index, bits 32-47 of control register 8, of the calling program. The EAX is saved in the state entry by BRANCH AND STACK or stacking PROGRAM CALL, and it is restored to the control register by a PROGRAM RETURN instruction that unstacks an entry formed by stacking PROGRAM CALL.

Primary ASN (PASN): Bytes 134-135 contain the primary ASN, bits 48-63 of control register 4, of the calling program. The PASN is saved in the state entry by BRANCH AND STACK or stacking PROGRAM CALL, and it is restored to the control register by a PROGRAM RETURN instruction that unstacks an entry formed by stacking PROGRAM CALL.

Program-Status Word (PSW): In a branch state entry formed by a BRANCH AND STACK instruction in which the R_1 field is zero, and in a program-call state entry, bytes 136-143 and 168-175 contain the updated PSW of the calling program. Bytes 136-143 contain bits 0-63 of the PSW, and bytes 168-175 contain bits 64-127 of the PSW. Thus, the basic and extended addressing-mode bits in this PSW specify the addressing mode of the calling program, and the instruction address designates the next sequential instruction following the BRANCH AND STACK or stacking PROGRAM CALL instruction that formed the state entry, or following an execute-type instruction that had the BRANCH AND STACK or stacking PROGRAM CALL instruction as its target instruction. In a branch state entry formed by a BRANCH AND STACK instruction in which the R_1 field is nonzero, bytes 136-143 and 168-175 contain the PSW of the calling program, except that the extended-address-

ing-mode bit in bit position 31 of bytes 136-139, the basic-addressing-mode bit in bit position 0 of byte 140, and the instruction address in bytes 168-175 are as specified by the contents of the general register designated by the R_1 field. See the definition of BRANCH AND STACK in Chapter 10, "Control Instructions" for how the basic- and extended-addressing-mode bits and instruction address are specified. The value of the PER mask in bytes 136-143 is always unpredictable. The PSW is saved in the state entry by BRANCH AND STACK or stacking PROGRAM CALL and is restored as the current PSW by PROGRAM RETURN, except that the PER mask is not restored. PROGRAM RETURN does not change the PER mask in the current PSW.

Basic Addressing Mode (A): In a branch state entry made in the 24-bit or 31-bit addressing mode, bit position 0 of bytes 148-151 contains the basic-addressing-mode bit, bit 32 of the PSW, at the end of the execution of the BRANCH AND STACK instruction that formed the state entry. The basic-addressing-mode bit is saved in bit position 0 of bytes 148-151 by BRANCH AND STACK. BRANCH AND STACK does not change the basic-addressing-mode bit in the PSW.

Branch Address: In a branch state entry made in the 24-bit or 31-bit addressing mode, bit positions 1-31 of bytes 148-151 contain bits 33-63 of the instruction address in the PSW at the end of the execution of the BRANCH AND STACK instruction that formed the state entry, and the contents of bytes 144-147 are unpredictable. In a branch state entry made in the 64-bit addressing mode, bytes 144-151 contain bits 0-62 of that instruction address with a one appended on the right. The instruction address is saved in bytes 148-151 or 144-151 (depending on the addressing mode) by BRANCH AND STACK. When the R_2 field of BRANCH AND STACK is non-zero, the instruction causes branching, and the instruction address in bytes 148-151 or 144-151 is the branch address. When the R_2 field of BRANCH AND STACK is zero, the instruction is executed without branching, and the instruction address in bytes 148-151 or 144-151 is the address of the next sequential instruction following the BRANCH AND STACK instruction, or following an execute-type instruction that had the BRANCH AND STACK instruction as its target instruction.

Called-Space Identification: In a program-call state entry, bytes 144-147 contain the called-space

identification (CSI). The CSI is saved in the state entry by stacking PROGRAM CALL.

If the PROGRAM CALL operation was space switching, bytes 0 and 1 of the CSI (bytes 144 and 145 of the state entry) contain the new primary ASN that was placed in control register 4 by the PROGRAM CALL instruction. When the ASN-and-LX-reuse facility is not enabled, bytes 2 and 3 of the CSI (bytes 146 and 147 of the state entry) contain the rightmost two bytes of the ASTE sequence number (ASTESN) in the new primary ASTE whose address was placed in control register 5 by the PROGRAM CALL instruction. When the ASN-and-LX-reuse facility is installed and enabled, bytes 2 and 3 of the CSI (bytes 146 and 147 of the state entry) contain the rightmost two bytes of the ASTE instance number (ASTEIN) in the new primary ASTE whose address was placed in control register 5 by the PROGRAM CALL instruction.

If the PROGRAM CALL operation was the to-current-primary operation, the CSI is all zeros.

Numeric Part of PC Number: In a program-call state entry, bit positions 1-31 of bytes 148-151 contain the numeric part of the PC number used by the stacking PROGRAM CALL instruction that formed the entry. When ASN-and-LX reuse is not enabled, or when it is and bit 44 of the effective address used by stacking PROGRAM CALL is zero, stacking PROGRAM CALL places bits 44-63 of the effective address, with 11 zeros appended on the left, in bit positions 1-31 of bytes 148-151. When ASN-and-LX reuse is enabled and bit 44 of the effective address is one, stacking PROGRAM CALL places bits 45-63 of the effective address, with bits 32-43 of the effective address appended on the left, in bit positions 1-31 of bytes 148-151. In any case, stacking PROGRAM CALL places a zero in bit position 0 of the bytes if the resulting addressing mode is the 24-bit or 31-bit mode or a one in bit position 0 if the resulting addressing mode is the 64-bit mode.

Modifiable Area: Bytes 152-159 are the field that is set by MODIFY STACKED STATE. BRANCH AND STACK and stacking PROGRAM CALL place all zeros in bytes 152-159.

Secondary ASTEIN (SASTEIN): If the ASN-and-LX-reuse facility is installed and is enabled by a one value of the ASN-and-LX-reuse control in control register 0, bytes 176-179 contain the secondary ASTEIN, bits 0-31 of control register 3, of the calling

program. The SASTEIN is saved in the state entry by BRANCH AND STACK or stacking PROGRAM CALL. When PROGRAM RETURN unstacks a program-call state entry, it compares the SASTEIN in the state entry to the ASTEIN in the ASN-second-table entry if SASN translation occurs, and it always restores the SASTEIN to control register 3.

Primary ASTEIN (PASTEIN): If the ASN-and-LX-reuse facility is installed and is enabled by the ASN-and-LX-reuse control in control register 0, bytes 180-183 contain the primary ASTEIN, bits 0-31 of control register 4, of the calling program. The PASTEIN is saved in the state entry by BRANCH AND STACK or stacking PROGRAM CALL. When PROGRAM RETURN unstacks a program-call state entry, it compares the PASTEIN in the state entry to the ASTEIN in the ASN-second-table entry if PASN translation occurs, and it always restores the PASTEIN to control register 4.

All zeros are placed in bytes 160-167 by BRANCH AND STACK and stacking PROGRAM CALL.

The contents of bytes 184-223 are unpredictable.

Stacking Process

The stacking process is performed as part of a BRANCH AND STACK or stacking PROGRAM CALL operation. The process locates space for a new linkage-stack state entry, forms the entry, updates the next-entry-size field in the preceding entry, and updates the linkage-stack-entry address in control register 15 so that the new entry becomes the current linkage-stack entry.

For the stacking process to be performed successfully, DAT must be on and the CPU must be in the primary-space mode or access-register mode; otherwise, a special-operation exception is recognized, and the operation is suppressed.

Except as just mentioned, the stacking process is performed independent of the current addressing mode and translation mode, as specified by bits 31, 32, 16, and 17 of the current PSW. All addresses used during the stacking process are always 64-bit home virtual addresses.

During the stacking process when any address is formed through the addition or subtraction of a value to or from another address, a carry out of, or a bor-

row into, bit position 0 of the address, if any, is ignored.

When the stacking process fetches or stores by using an address that designates, after translation, a location that is not available in the configuration, an addressing exception is recognized, and the operation is suppressed.

Key-controlled protection does not apply to the accesses made during the stacking process, but DAT protection and low-address protection do apply. A protection exception causes the operation to be suppressed.

Locating Space for a New Entry

The linkage-stack-entry address in control register 15 is used to locate the current linkage-stack entry. Bits 0-60 of control register 15, with three zeros appended on the right, form the 64-bit home virtual address of the leftmost byte of the entry descriptor of the current linkage-stack entry.

The first word of the entry descriptor of the current linkage-stack entry is fetched by using the 64-bit home virtual address. This fetch is for the purpose of obtaining the section-identification and remaining-free-space fields in the word; the unstack-suppression bit and entry-type field in the word are not examined.

The 16-bit unsigned binary value in the remaining-free-space field, bits 16-31 of the entry descriptor, is compared against the size in bytes of the linkage-stack entry to be formed. The size of a state entry is 296 bytes. If the value in the field is equal to or greater than the size of the entry to be formed, processing continues as described in "Forming the New Entry" on page 5-85; otherwise, processing continues as described below.

When the remaining-free-space field in the current linkage-stack entry indicates that there is not enough space available in the current linkage-stack section to form the new entry, the first doubleword of the trailer entry of the current section is fetched. The address for fetching this doubleword is determined as follows: to the address formed from the contents of control register 15, add 8 to address the first byte after the entry descriptor of the current entry, and then add the contents of the remaining-free-space field of the current entry to address the first byte of the trailer entry. The remaining-free-space value used in the addition

must be a multiple of 8; otherwise, a stack-specification exception is recognized, and the operation is nullified.

If the forward-section-validity bit, bit 63 of the trailer entry is zero, a stack-full exception is recognized, and the operation is nullified; otherwise, the forward-section-header address in the trailer entry is used to locate the header entry in the next linkage-stack section. Bits 0-60 of the trailer entry, with three zeros appended on the right, form the 64-bit home virtual address of the leftmost byte of the entry descriptor of the header entry in the next section.

The first word of the entry descriptor of the header entry in the next linkage-stack section is fetched. This fetch is for the purpose of obtaining the section-identification and remaining-free-space fields in the word; the unstack-suppression bit and entry-type field in the word are not examined.

The value in the remaining-free-space field of the header entry in the next linkage-stack section is compared against the size in bytes of the entry to be formed. If the value in the field is equal to or greater than the size of the entry to be formed, the following occurs:

- The linkage-stack-entry address, bits 0-60 of control register 15, is placed, as the backward stack-entry address, in bit positions 0-60 of the header entry in the next linkage-stack section, and zeros are placed in bit positions 61 and 62.
- The backward stack-entry validity bit, bit 63, in the header entry in the next section is set to one.
- Bits 0-60 of the 64-bit home virtual address of the entry descriptor of the header entry in the next section are placed in bit positions 0-60 of control register 15, and zeros are placed in bit positions 61-63 of control register 15. Thus, the header entry in the next section becomes the current linkage-stack entry, and the next section becomes the current linkage-stack section.
- Processing continues as described in “Forming the New Entry”.

If the value in the remaining-free-space field of the header entry in the next section (before the next section becomes the current section) is less than the

size of the linkage-stack entry to be formed, a stack-specification exception is recognized, and the operation is nullified.

Forming the New Entry

When the remaining-free-space field in the current linkage-stack entry indicates that there is enough space available in the current linkage-stack section to form the new entry, the new entry is formed beginning immediately after the entry descriptor of the current entry.

The new entry is a state entry. The contents of general registers 0-15 are stored in bytes 0-127 of the new entry, in the ascending order of the register numbers. The contents of access registers 0-15 are stored in bytes 224-287 of the new entry, in the ascending order of the register numbers. The PSW-key mask, bits 32-47 of control register 3; secondary ASN, bits 48-63 of control register 3; extended authorization index, bits 32-47 of control register 8; and primary ASN, bits 48-63 of control register 4, are stored in bytes 128-129, 130-131, 132-133, and 134-135, respectively, of the new entry. The current PSW, in which the instruction address has been updated, is stored in bytes 136-143 and 168-175 of the new entry. Bytes 136-143 contain bits 0-63 of the PSW, and bytes 168-175 contain bits 64-127 of the PSW. However, the value of the PER mask, bit 1 in the PSW stored, is unpredictable. Also, if the instruction being executed is a BRANCH AND STACK instruction in which the R_1 field is nonzero, the extended- and basic-addressing-mode bits stored in bytes 139 and 140, respectively, of the new entry, and the instruction address stored in bytes 168-175 of the new entry, are as specified by the contents of the general register designated by the R_1 field.

If the ASN-and-LX-reuse facility is installed and is enabled by a one value of the ASN-and-LX-reuse control, bit 44 of control register 0, the secondary ASTEIN, bits 0-31 of control register 3, and the primary ASTEIN, bits 0-31 of control register 4, are stored in bytes 176-179 and 180-183, respectively, of the new entry.

When the instruction is PROGRAM CALL, the called-space identification is stored in bytes 144-147 of the new entry. When the instruction is performing the space-switching PROGRAM CALL operation and the ASN-and-LX-reuse facility is not enabled, the called-space identification is the two-byte ASN, bytes 10 and 11 in the entry-table entry used by the instruc-

tion, followed by bytes 2 and 3 of the ASTE sequence number, bytes 2 and 3 being bits 176-191, in the ASN-second-table entry specified by the ASN. When the instruction is performing the space-switching PROGRAM CALL operation and the ASN-and-LX-reuse facility is installed and enabled, the called-space identification is the two-byte ASN, bytes 10 and 11 in the entry-table entry used by the instruction, followed by bytes 2 and 3 of the ASTE instance number, bytes 2 and 3 being bits 368-383, in the ASN-second-table entry specified by the ASN. When the instruction is performing the to-current-primary PROGRAM CALL operation, the called-space identification is all zeros.

When the instruction is BRANCH AND STACK in the 24-bit or 31-bit addressing mode, the basic-addressing-mode bit from the current PSW is stored in bit position 0 of byte 148 in the state entry, bits 33-63 of the branch address, or of the updated instruction address if the operation is performed without branching, are stored in bit positions 1-31 of bytes 148-151, and the contents of bytes 144-147 are unpredictable. In the 64-bit addressing mode, bits 0-62 of the branch address or updated instruction address, with a one appended on the right, are stored in bytes 144-151 of the state entry.

When the instruction is PROGRAM CALL, the numeric part of the PC number used, with 11 zeros appended on the left if the number is 20 bits, is stored in bit positions 1-31 of bytes 148-151. If the resulting addressing mode after the execution of PROGRAM CALL is the 24-bit or 31-bit addressing mode, a zero is stored in bit position 0 of byte 148. If the resulting addressing mode is the 64-bit addressing mode, a one instead of a zero is stored in bit position 0 of byte 148.

Zeros are stored in bytes 152-167 of the new entry. The contents of bytes 176-223 are unpredictable, or the contents of bytes 184-223 are unpredictable if the secondary ASTEIN and primary ASTEIN were stored.

Bytes 288-295 of the new entry are its entry descriptor. The unstack-suppression bit, bit 0, of this entry descriptor is set to zero. The code 0001100 binary is stored in the entry-type field, bits 1-7, of this entry descriptor if the instruction being executed is BRANCH AND STACK. The code 0001101 binary is stored if the instruction is PROGRAM CALL. The value in the section-identification field of the current linkage-stack entry is stored in the section-identifica-

tion field, bits 8-15, of this entry descriptor. The value in the remaining-free-space field of the current entry, minus the size in bytes of the new entry, is stored in the remaining-free-space field of this entry descriptor. Zeros are stored in the next-entry-size field, bits 32-47, and in bit positions 48-63 of this entry descriptor.

The stores into the new entry appear to be word concurrent as observed by other CPUs. The order in which the stores occur is unpredictable.

Updating the Current Entry

The size in bytes of the new linkage-stack entry is stored in the next-entry-size field of the current entry. The remainder of the current entry remains unchanged.

The order of the stores into the current entry and the new entry is unpredictable.

Updating Control Register 15

Bits 0-60 of the 64-bit home virtual address of the entry descriptor of the new linkage-stack entry are placed in bit positions 0-60 of control register 15, the linkage-stack-entry address. Zeros are placed in bit positions 61-63 of control register 15. Thus, the new entry becomes the current linkage-stack-entry.

Recognition of Exceptions during the Stacking Process

The exceptions which can be encountered during the stacking process and their priority are described in the definitions of the BRANCH AND STACK and PROGRAM CALL instructions.

Programming Note: Any exception recognized during the execution of BRANCH AND STACK and PROGRAM CALL causes either nullification or suppression. Therefore, if an exception is recognized, the stacking process does not store into any linkage-stack entry or change the contents of control register 15.

Unstacking Process

The unstacking process is performed as part of the PROGRAM RETURN operation. The process locates the last state entry in the linkage stack, restores a portion of the information in the entry to the CPU registers, updates the next-entry-size field in the preceding entry, and updates the linkage-stack-entry

address in control register 15 so that the preceding entry becomes the current linkage-stack entry. The part of the unstacking process that locates the last state entry is also performed as part of the EXTRACT STACKED REGISTERS, EXTRACT STACKED STATE, and MODIFY STACKED STATE operations.

For the unstacking process to be performed successfully, DAT must be on and the CPU must be in the primary-space mode or access-register mode; otherwise, a special-operation exception is recognized, and the operation is suppressed. However, when the unstacking process is performed as part of EXTRACT STACKED REGISTERS, EXTRACT STACKED STATE, or MODIFY STACKED STATE, the CPU may be in the primary-space, access-register, or home-space mode.

Except as just mentioned, the unstacking process is performed independent of the current addressing mode and translation mode, as specified by bits 31, 32, 16, and 17 of the current PSW. All addresses used during the unstacking process are always 64-bit home virtual addresses.

During the unstacking process when any address is formed through the addition or subtraction of a value to or from another address, a carry out of, or a borrow into, bit position 0 of the address, if any, is ignored.

When the unstacking process fetches or stores by using an address that designates, after translation, a location that is not available in the configuration, an addressing exception is recognized, and the operation is suppressed.

Key-controlled protection does not apply to the accesses made during the unstacking process, but DAT protection and low-address protection do apply. A protection exception causes the operation to be suppressed.

Locating the Current Entry and Processing a Header Entry

The linkage-stack-entry address in control register 15 is used to locate the current linkage-stack entry. Bits 0-60 of control register 15, with three zeros appended on the right, form the 64-bit home virtual address of the leftmost byte of the entry descriptor of the current linkage-stack entry.

The first word of the entry descriptor of the current linkage-stack entry is fetched by using the 64-bit home virtual address. If the entry-type code in bits 1-7 of the entry descriptor is not 0001001 binary, indicating that the entry is not a header entry, processing continues as described in “Checking for a State Entry”; otherwise, processing continues as described below.

When the entry-type code in the current linkage-stack entry is 0001001 binary, indicating a header entry, the next processing depends on which instruction is being executed. When the unstacking process is performed as part of the PROGRAM RETURN operation and the unstack-suppression bit, bit 0, in the entry descriptor of the current entry is one, a stack-operation exception is recognized, and the operation is nullified. When the unstacking process is performed as part of EXTRACT STACKED REGISTERS, EXTRACT STACKED STATE, or MODIFY STACKED STATE, the unstack-suppression bit is ignored.

When there is not an exception due to the unstack-suppression bit, the first doubleword of the current linkage-stack entry (a header entry) is fetched. The address of this doubleword is determined by subtracting 8 from the address of the entry descriptor of the current entry.

If the backward stack-entry validity bit, bit 63, of the current entry is zero, a stack-empty exception is recognized, and the operation is nullified; otherwise, the backward stack-entry address in the current entry is used to locate a linkage-stack entry referred to here as the designated entry. Bits 0-60 of the current entry, with three zeros appended on the right, form the 64-bit home virtual address of the leftmost byte of the entry descriptor of the designated entry.

It is assumed in this definition of the unstacking process that the designated linkage-stack entry is the last entry, other than the trailer entry, in the preceding linkage-stack section. This assumption does not imply any processing that is not explicitly described.

The first word of the entry descriptor of the designated entry is fetched. If the entry-type code in this entry descriptor is not 0001001 binary, indicating that the entry is not a header entry, the following occurs:

- When the unstacking process is performed as part of the PROGRAM RETURN operation, bits 0-60 of the 64-bit home virtual address of the

entry descriptor of the designated entry are placed in bit positions 0-60 of control register 15, and zeros are placed in bit positions 61-63 of control register 15. Thus, the designated entry becomes the current linkage-stack entry, and the preceding section (based on the assumption) becomes the current linkage-stack section. When the unstacking process is performed as part of EXTRACT STACKED REGISTERS, EXTRACT STACKED STATE, or MODIFY STACKED STATE, the contents of control register 15 remain unchanged, but the designated entry is temporarily, during the remainder of the definition of the instruction, referred to as the current linkage-stack entry.

- Processing continues as described in “Checking for a State Entry”.

If the entry-type code in the designated entry is 0001001 binary, indicating a header entry, a stack-specification exception is recognized, and the operation is nullified.

Checking for a State Entry

When the entry-type code in the current linkage-stack entry indicates that the entry is not a header entry, the code is checked for being 0001100 or 0001101 binary, which are the codes assigned to a state entry.

If the current linkage-stack entry is a state entry, the next processing depends on which instruction is being executed. When the unstacking process is performed as part of the PROGRAM RETURN operation, processing continues as described in “Restoring Information” on page 5-88. When the process is performed as part of EXTRACT STACKED REGISTERS, EXTRACT STACKED STATE, or MODIFY STACKED STATE, the process is completed; that is, no additional processing occurs as a part of the unstacking process.

If the current linkage-stack entry is not a state entry (and necessarily not a header entry either), a stack-type exception is recognized, and the operation is nullified.

Restoring Information

The remaining parts of the unstacking process occur only in the PROGRAM RETURN operation.

The current linkage-stack entry is a state entry. If the unstack-suppression bit in the entry is one, a stack-operation exception is recognized, and the operation is nullified.

When there is not an exception due to the unstack-suppression bit, a portion of the contents of the current linkage-stack entry are restored to the CPU registers. The contents of general registers 2-14 and access registers 2-14 are restored to those registers from where they were saved in the current entry by the stacking process. When the entry-type code in the current entry is 0001101 binary, indicating a program-call state entry, the PSW-key mask and secondary ASN in control register 3, extended authorization index in control register 8, and primary ASN in control register 4 are similarly restored. During this restoration, the authorization index in control register 4 and the monitor masks and enhanced-monitor masks in control register 8 remain unchanged. (The authorization index may be changed by the part of the PROGRAM RETURN execution that occurs after the unstacking process.)

When the state entry is a program-call state entry, and if the ASN-and-LX-reuse facility is installed and is enabled by a one value of the ASN-and-LX-reuse control in control register 0, the secondary ASTEIN in control register 3 and the primary ASTEIN in control register 4 are restored from where they were saved in the state entry. However, the primary ASTEIN and secondary ASTEIN may be subject to certain tests, as described in the PROGRAM RETURN definition.

When the entry-type code is 0001100 binary, indicating a branch state entry, the PSW-key mask, secondary ASN, extended authorization index, primary ASN, secondary ASTEIN, and primary ASTEIN in the current entry are ignored, and all contents of the control registers remain unchanged.

When the current entry is either a branch state entry or a program-call state entry, bits 0-63 and 64-127 of the current PSW are restored from bytes 136-143 and bytes 168-175, respectively, of the entry, except that the PER mask is not restored. The PER mask in the current PSW remains unchanged. Bytes 144-159 and bytes 160-167 of the current entry are ignored.

The fetches from the current entry appear to be word concurrent as observed by other CPUs. The order in which the fetches occur is unpredictable.

Updating the Preceding Entry

Zeros are stored in the next-entry-size field, bits 32-47, of the entry descriptor of the preceding linkage-stack entry. The remainder of the preceding entry remains unchanged. The address of the entry descriptor of the preceding entry is determined by subtracting the size in bytes of the current entry from the address of the entry descriptor of the current entry.

The order of the store into the preceding entry and the fetches from the current entry is unpredictable.

Updating Control Register 15

Bits 0-60 of the 64-bit home virtual address of the entry descriptor of the preceding linkage-stack entry are placed in bit positions 0-60 of control register 15, the linkage-stack-entry address. Zeros are placed in bit positions 61-63 of control register 15. Thus, the preceding entry becomes the current linkage-stack entry.

Recognition of Exceptions during the Unstacking Process

The exceptions which can be encountered during the unstacking process and their priority are described in the definition of the PROGRAM RETURN instruction. The exceptions which apply to EXTRACT STACKED REGISTERS, EXTRACT STACKED STATE, and MODIFY STACKED STATE are described in the definitions of those instructions.

Programming Notes:

1. Any exceptions recognized during the execution of EXTRACT STACKED REGISTERS, EXTRACT STACKED STATE, MODIFY STACKED STATE, or PROGRAM RETURN cause either nullification or suppression. Therefore, if an exception is recognized, the unstacking process does not change the contents of any CPU register (except for updating the instruction address in the PSW in the case of suppression) or store into any linkage-stack entry.
2. The unstacking process in PROGRAM RETURN does not restore the PER mask in the PSW so that an act of turning PER on or off after the execution of the related BRANCH AND STACK or PROGRAM CALL instruction but before the execution of the PROGRAM RETURN instruction will not be counteracted. When PROGRAM CALL or PROGRAM RETURN is space switch-

ing, the space-switch event can be used as a signal to turn PER on or off, if desired.

Transactional-Execution Facility

This section describes the registers, instructions, controls, and operation of the transactional-execution facility. The transactional-execution facility provides the means by which a program can issue multiple instructions, the storage-operand accesses of which appear to occur as a single concurrent operation as observed by other CPUs and by the channel subsystem.

Three special-purpose controls (the transaction-abort PSW, the transaction diagnostic-block address, and the transaction nesting depth), five control register bits, and six general instructions are used to control the transactional-execution facility. When the facility is installed, it is installed in all CPUs in the configuration. Facility indication 73, when one, indicates that the transactional-execution facility is installed.

When the transactional-execution facility is installed, the configuration may also provide the constrained transactional-execution facility. See "Constrained Transaction" (below) for details on constrained transactions. When facility indications 50 and 73 are both one, the constrained transactional-execution facility is installed.

Note: In the following discussion of the transactional-execution facility, the instruction name TRANSACTION BEGIN refers to the instructions having the mnemonics TBEGIN and TBEGINC. Discussions pertaining to a specific instruction are indicated by the instruction name followed by the mnemonic in parentheses or brackets, or simply by the mnemonic.

Transactional-Execution Terminology

The following terms are used pervasively in the description of the transactional-execution facility.

Note: Of necessity, some of these terms are cross-referential. They appear in alphabetical order only for convenience.

Abort: A transaction is said to abort when it is ended prior to a TRANSACTION END instruction

that results in a transaction nesting depth of zero. When a transaction aborts, the following occurs:

- Transactional store accesses made by any and all levels of the transaction are discarded (that is, not committed).
- Nontransactional store accesses made by any and all levels of the transaction are committed.
- Registers designated by the general-register-save mask of the outermost TRANSACTION BEGIN instruction are restored to their contents prior to transactional execution (that is, to their contents at execution of the outermost TRANSACTION BEGIN instruction). General registers not designated by the general-register-save mask of the outermost TRANSACTION BEGIN instruction are not restored.
- Access registers, vector registers, floating-point registers, and the floating-point control register are not restored. Any changes made to these registers during transactional execution are retained when the transaction aborts.

A transaction may be aborted due to a variety of reasons, including attempted execution of a restricted instruction, attempted modification of a restricted resource, transactional conflict, exceeding various CPU resources, any interruption, a TRANSACTION ABORT instruction, and other reasons. “Transaction Abort Code (TAC)” on page 5-95 provides specific reasons why a transaction may be aborted.

Commit: At the completion of the outermost TRANSACTION END instruction, the CPU is said to commit the store accesses made by the transaction such that they are visible to other CPUs and the channel subsystem. As observed by other CPUs and by the channel subsystem, all fetch and store accesses made by all nested levels of the transaction appear to occur as a single concurrent operation when the commit occurs.

The contents of the general registers, access registers, vector registers, floating-point registers, and the floating-point control register are not modified by the commit process. Any changes made to these registers during transactional execution are retained when the transaction’s stores are committed.

Conflict: A transactional access made by one CPU is said to conflict with either (a) a transactional access or nontransactional access made by another

CPU, or (b) a nontransactional access made by the channel subsystem, if both accesses are to any location within the same cache line, and one or both of the accesses is a store.

A conflict may be detected by a CPU’s speculative execution of instructions, even though the conflict may not be detected in the conceptual sequence.

Programming Note: Because of speculative execution by the CPU, a conflict may be detected at a storage location that would not necessarily be accessed by the conceptual execution sequence.

Constrained Transaction: A constrained transaction is a transaction that executes in the constrained transactional-execution mode (see below) and is subject to the following limitations:

- A subset of the general instructions is available.
- A limited number of instructions may be executed.
- A limited number of storage-operand locations may be accessed.
- The transaction is limited to a single nesting level.

In the absence of repeated interruptions, guarded-storage-event detection, or conflicts with other CPUs or the channel subsystem, a constrained transaction will eventually complete, thus an abort-handler routine is not required. Constrained transactions are described in detail in “Constrained Transaction” on page 5-107.

Programming Note: When the TBEGIN instruction is executed while the CPU is already in the nonconstrained transactional-execution mode, execution continues as a nested nonconstrained transaction.

Constrained Transactional-Execution Mode: When the transaction nesting depth is zero, and a transaction is initiated by the TRANSACTION BEGIN (TBEGIN) instruction, the CPU enters the constrained transactional-execution mode. While the CPU is in the constrained transactional-execution mode, the transaction nesting depth is always one.

Nested Transaction: When the TRANSACTION BEGIN instruction is issued while the CPU is in the nonconstrained transactional-execution mode, the

transaction is said to be nested. See “Transaction Nesting Depth (TND)” on page 5-93 below.

The transactional-execution facility uses a model called *flattened nesting*. In the flattened-nesting model, stores made by an inner transaction are not observable by other CPUs and by the channel subsystem until the outermost transaction commits its stores. Similarly, if a transaction aborts, all nested transactions abort, and all transactional stores of all nested transactions are discarded.

Nonconstrained Transaction: A nonconstrained transaction is a transaction that executes in the nonconstrained transactional-execution mode (see below). Although a nonconstrained transaction is not limited in the manner described in “Constrained Transaction” on page 5-107, it may still be aborted due to a variety of causes as described in “Abort” on page 5-89.

Nonconstrained Transactional-Execution Mode: When a transaction is initiated by the TRANSACTION BEGIN (TBEGIN) instruction, the CPU enters the nonconstrained transactional-execution mode. While the CPU is in the nonconstrained transactional-execution mode, the transaction nesting depth may vary from one to the maximum transaction nesting depth.

Nontransactional Access: Nontransactional accesses are storage operand accesses made by the CPU when it is not in the transactional-execution mode (that is, classic storage accesses outside of a transaction). Additionally, the NONTRANSACTIONAL STORE instruction may be used to cause a nontransactional store access while the CPU is in the nonconstrained transactional-execution mode.

Accesses made by the channel subsystem are nontransactional accesses.

Outer / Outermost Transaction: A transaction with a lower-numbered transaction nesting depth is said to be an outer transaction. A transaction with a transaction-nesting-depth value of one is said to be the outermost transaction.

An outermost TRANSACTION BEGIN instruction is one that is executed when the transaction nesting depth is initially zero. An outermost TRANSACTION END instruction is one that causes the transaction

nesting depth to transition from one to zero. A constrained transaction is always the outermost transaction.

Program-Interruption Filtering: When a transaction is aborted due to certain program-interruption conditions, the program can optionally prevent the interruption from occurring. This technique is called program-interruption filtering. Program-interruption filtering is subject to the transactional class of the interruption, the effective program-interruption-filtering control from the TRANSACTION BEGIN instruction, and the transactional-execution program-interruption-filtering override in control register 0.

Transaction: A transaction comprises the storage-operand accesses made, and selected general registers altered, while the CPU is in the transactional-execution mode. For a nonconstrained transaction, storage-operand accesses may include both transactional accesses and nontransactional accesses. For a constrained transaction, storage-operand accesses are limited to transactional accesses. As observed by other CPUs and by the channel subsystem, all storage-operand accesses made by the CPU while in the transactional-execution mode appear to occur as a single concurrent operation. If a transaction is aborted, transactional store accesses are discarded, and any registers designated by the general-register-save mask of the outermost TRANSACTION BEGIN instruction are restored to their contents prior to transactional execution.

Transactional Accesses: Transactional accesses are storage operand accesses made while the CPU is in the transactional-execution mode, with the exception of accesses made by the NONTRANSACTIONAL STORE instruction.

Transactional-Execution Mode: The term transactional-execution mode describes the common operation of both the nonconstrained and the constrained transactional-execution modes. Thus, when the transaction nesting depth is nonzero, the CPU is in the transactional-execution mode. Where specific operation is described, the terms nonconstrained and constrained are used to qualify the transactional-execution mode.

When the transaction nesting depth is zero, the CPU is not in the transactional-execution mode (also called the nontransactional-execution mode).

Transactional-Execution Facility Controls

The following section describes the controls that affect the operation of the transactional-execution facility.

Control Register Bits

The transactional-execution facility is controlled by two bits in control register zero and three bits in control register two.

Control Register 0 Bits: The bit assignments are as follows:

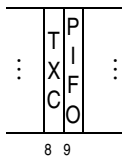

Transactional-Execution Control (TXC): Bit 8 of control register zero is the transactional-execution control. This bit provides a mechanism whereby the control program can indicate whether or not the transactional-execution facility is usable by the program. Bit 8 must be one to successfully enter the transactional-execution mode.

When bit 8 of control register 0 is zero, attempted execution of the EXTRACT TRANSACTION NESTING DEPTH, TRANSACTION BEGIN, and TRANSACTION END instructions results in a special-operation exception.

Transactional-Execution Program-Interruption-Filtering Override (PIFO): Bit 9 of control register zero is the transactional-execution program-interruption-filtering override. This bit provides a mechanism by which the control program can ensure that any program-exception condition that occurs while the CPU is in the transactional-execution mode results in an interruption, regardless of the effective program-interruption-filtering control specified or implied by the TRANSACTION BEGIN instruction(s). See “Program-Interruption Filtering on a Transaction Abort” on page 5-104 for details.

Programming Note: Even though facility indication 73 may be one (indicating that the transactional-execution facility is installed in the configuration), the

program should determine whether the facility is enabled by examining an OS-provided indication of whether the OS supports the facility.

Control Register 2 Bits: The bit assignments are as follows:

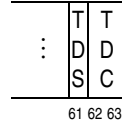

Transaction Diagnostic Scope (TDS): Bit 61 of control register 2 controls the applicability of the transaction diagnostic control (TDC) in bits 62-63 of the register, as follows.

TDS Value Meaning

- 0 The TDC applies regardless of whether the CPU is in the problem or supervisor state.
- 1 The TDC applies only when the CPU is in the problem state. When the CPU is in the supervisor state, processing is as if the TDC contained zero.

Transaction Diagnostic Control (TDC): Bits 62-63 of control register 2 are a 2-bit unsigned integer that may be used to cause transactions to be randomly aborted for diagnostic purposes. The encoding of the TDC is as follows:

TDC Value Meaning

- 0 Normal operation; transactions are not aborted as a result of the TDC.
- 1 Abort every transaction at a random instruction, but before execution of the outermost TRANSACTION END instruction.
- 2 Abort random transactions at a random instruction.
- 3 Reserved.

When a transaction is aborted due to a nonzero TDC, then either of the following may occur:

- The abort code is set to any of codes 7-11, 13-16, or 255, with the value of the code randomly chosen by the CPU; the condition code is set corresponding to the abort code, as indicated in Figure 5-14 on page 5-102.

- For a nonconstrained transaction, the condition code is set to one. In this case, the abort code is not applicable.

It is model dependent whether TDC value 1 is implemented. If not implemented, a value of 1 acts as if 2 was specified.

For a constrained transaction, a TDC value of 1 is treated as if a TDC value of 2 was specified.

If a TDC value of 3 is specified, the results are unpredictable.

Transaction-Diagnostic-Block Address (TDBA)

When the B_1 field of an outermost TRANSACTION BEGIN (TBEGIN) instruction is nonzero, a valid transaction-diagnostic-block address (TDBA) is set from the first-operand address of the instruction. When the CPU is in the primary-space or access-register mode, the TDBA designates a location in the primary address space. When the CPU is in the secondary-space, or home-space mode, the TDBA designates a location in the secondary or home address space, respectively. When DAT is off, the TDBA designates a location in real storage.

The TDBA is used by the CPU to locate the transaction diagnostic block – called the *TBEGIN-specified TDB* – if the transaction is subsequently aborted. The rightmost three bits of the TDBA are always zero, meaning that the TBEGIN-specified TDB is on a doubleword boundary. The transaction diagnostic block is described in “Transaction Diagnostic Block (TDB)” on page 5-93.

When the B_1 field of an outermost TRANSACTION BEGIN (TBEGIN) instruction is zero, the transaction-diagnostic-block address is invalid, and no TBEGIN-specified TDB is stored if the transaction is subsequently aborted.

Programming Note: Abort processing may be significantly slower when the TDBA is valid.

Transaction-Abort PSW (TAPSW)

During the execution of the TRANSACTION BEGIN (TBEGIN) instruction when the nesting depth is initially zero, the transaction-abort PSW is set to the contents of the current PSW; the instruction address of the transaction-abort PSW designates the next sequential instruction (that is, the instruction follow-

ing the outermost TBEGIN). During the execution of the TRANSACTION BEGIN (TBEGIN) instruction when the nesting depth is initially zero, the transaction-abort PSW is set to the contents of the current PSW, except that the instruction address of the transaction-abort PSW designates the TBEGIN instruction (rather than the next sequential instruction following the TBEGIN).

When a transaction is aborted, the condition code in the transaction-abort PSW is replaced with a code indicating the severity of the abort condition. Subsequently, if the transaction was aborted due to causes that do not result in an interruption, the PSW is loaded from the transaction-abort PSW; if the transaction was aborted due to causes that result in an interruption, the transaction-abort PSW is stored as the interruption old PSW.

The transaction-abort PSW is not altered during the execution of any inner TRANSACTION BEGIN instruction.

Transaction Nesting Depth (TND)

The transaction nesting depth is a 16-bit unsigned value that is incremented each time a TRANSACTION BEGIN instruction is completed with condition code 0 and decremented each time a TRANSACTION END instruction is completed with condition code 0. The transaction nesting depth is reset to zero when a transaction is aborted or by CPU reset.

All models implement a maximum TND of 15.

Programming Notes:

1. When the CPU is in the constrained transactional-execution mode, the transaction nesting depth is always one.
2. Although the maximum TND can be represented as a 4-bit value, the TND is defined to be a 16-bit value to facilitate its inspection in the transaction-diagnostic block.

Transaction Diagnostic Block (TDB)

When a transaction is aborted, various status information is saved in a transaction diagnostic block (TDB). The CPU places status into one or two TDBs, as follows:

TBEGIN-Specified TDB: The 256-byte location specified by a valid transaction-diagnostic-block address. When the transaction-diagnostic-block address is valid, the TBEGIN-specified TDB is always stored on a transaction abort. When the transaction-diagnostic-block address is not valid, a TBEGIN-specified TDB is not stored.

Access exceptions for the TBEGIN-specified TDB are recognized during the execution of the outermost TRANSACTION BEGIN (TBEGIN) instruction. If an access exception is recognized for the TBEGIN-specified TDB, the CPU does not enter the transactional-execution mode.

The recognition of PER storage-alteration events and zero-address-detection events for the TBEGIN-specified

TDB is described in the section “PER Operation” on page 4-29.

Program-Interruption TDB: Real locations 6,144-6,399 (1800-18FF hex). The program-interruption TDB is stored when a transaction is aborted due to program interruption. When a transaction is aborted due to other causes, the contents of the program-interruption TDB are unpredictable.

The program-interruption TDB is not subject to any protection mechanism. PER storage-alteration events are not detected for the program-interruption TDB when it is stored during a program interruption.

The transaction diagnostic block has the following format:

Dec	Hex						
0	00	Format	Flags	Reserved	TND		
8	08	Transaction Abort Code					
16	10	Conflict Token					
24	18	Aborted-Transaction Instruction Address					
32	20	EAID ¹	DXC/VXC ¹	Reserved	Program Interruption Identification ¹		
40	28	Translation-Exception Identification ¹					
48	30	Breaking-Event Address ¹					
56	38	Reserved					
:	:						
128	80	General Registers					
:	:						
248	F8						
		0	8	16	32	48	63

Explanation:

¹ Field is stored only in the TBEGIN-specified TDB; otherwise, the field is reserved. The program interruption identification is only stored for filtered program-interruption conditions. The translation-exception identification are stored only for filtered access-list-controlled, DAT, or instruction-execution protection, ASCE-type, page translation, region-first translation, region-second translation, region-third translation, and segment translation program-interruption conditions. The DXC is stored only for filtered data program-exception conditions. The VXC is stored only for filtered vector-processing program-exception conditions.

Figure 5-13. Transaction Diagnostic Block (TDB)

The fields of the transaction diagnostic block are as follows:

Format: Byte 0 contains a validity and format indication, as follows:

Value	Meaning
0	The remaining fields of the TDB are unpredictable.

Value	Meaning
1	A format-1 TDB, the remaining fields of which are described below.
2-255	Reserved

Programming Note: A TDB in which the format field is zero is referred to as a *null TDB*.

Flags: Byte 1 contains various indications, as follows:

Conflict-Token Validity (CTV): When a transaction is aborted due to a fetch or store conflict (that is, abort codes 9 or 10, respectively), bit 0 of byte 1 is the conflict-token-validity indication. When the CTV indication is one, the conflict token in bytes 16-23 of the TDB contain the logical address at which the conflict was detected. When the CTV indication is zero, bytes 16-23 of the TDB are unpredictable.

When a transaction is aborted due to any reason other than a fetch or store conflict, bit 0 of byte 1 is stored as zero.

Constrained-Transaction Indication (CTI): When the CPU was in the constrained transactional-execution mode, bit 1 of byte 1 is set to one. When the CPU was in the nonconstrained transactional-execution mode, bit 1 of byte 1 is set to zero.

Reserved: Bits 2-7 of byte 1 are reserved, and stored as zeros.

Transaction Nesting Depth (TND): Bytes 6-7 contain the transaction nesting depth when the transaction was aborted.

Transaction Abort Code (TAC): Bytes 8-15 contain a 64-bit unsigned transaction abort code. Each code point indicates a reason for a transaction being aborted, as summarized in Figure 5-14 on page 5-102.

It is model dependent whether the transaction abort code is stored in the program-interruption TDB when a transaction is aborted due to conditions other than a program interruption.

Conflict Token: For transactions that are aborted due to fetch or store conflict (that is, abort codes 9 and 10, respectively), bytes 16-23 contain the logical address of the storage location at which the conflict

was detected. The conflict token is meaningful only when the CTV bit, bit 0 of byte 1, is one.

When the CTV bit is zero, bytes 16-23 are unpredictable.

Programming Note: Because of speculative execution by the CPU, the conflict token may designate a storage location that would not necessarily be accessed by the transaction's conceptual execution sequence.

Aborted-Transaction Instruction Address (ATIA): Bytes 24-31 contain an instruction address that identifies the instruction that was executing when an abort was detected. When a transaction is aborted due to abort codes 2, 5, 6, 11, 13, 19, or 256 or higher, or when a transaction is aborted due to abort codes 4 or 12 and the program-exception condition is nullifying, the ATIA points directly to the instruction that was being executed. When a transaction is aborted due to abort codes 4 or 12, and the program-exception condition is not nullifying, the ATIA points past the instruction that was being executed (see the programming note, below).

When a transaction is aborted due to abort codes 7-10, 14-16, or 255, the ATIA does not necessarily indicate the exact instruction causing the abort, but may point to an earlier or later instruction within the transaction.

If a transaction is aborted due to an instruction that is the target of an execute-type instruction, the ATIA identifies the execute-type instruction, either pointing to the instruction or past it, depending on the abort code as described above. The ATIA does not indicate the target of the execute-type instruction.

The ATIA is subject to the addressing mode when the transaction is aborted. In the 24-bit addressing mode, bits 0-39 of the field contain zeros. In the 31-bit addressing mode, bits 0-32 of the field contain zeros.

It is model dependent whether the aborted-transaction instruction address is stored in the program-interruption TDB when a transaction is aborted due to conditions other than a program interruption.

Programming Note: When a transaction is aborted due to abort code 4 or 12, and the program-exception condition is not nullifying, the ATIA does not point to the instruction causing the abort. By subtracting

the number of halfwords indicated by the interruption-length code (ILC) from the ATIA, the instruction causing the abort can be identified in conditions that are suppressing or terminating, or for non-PER events that are completing. When a transaction is aborted due to a PER event, and no other program-exception condition is present, the ATIA is unpredictable.

When the transaction-diagnostic-block address is valid, the ILC may be examined in program-interruption identification (PIID) in bytes 36-39 of the TBEGIN-specified TDB. When filtering does not apply, the ILC may be examined in the PIID at location 140-143 in real storage.

Exception Access Identification (EAID): For transactions that are aborted due to certain filtered program-exception conditions, byte 32 of the TBEGIN-specified TDB contains the exception access identification. The format of the EAID, and the cases for which it is stored, are identical to those described in real location 160 when the exception condition results in an interruption. See “Exception Access Identification” on page 3-74 for details.

For transactions that are aborted for other reasons, including any exception conditions that result in a program interruption, byte 32 is unpredictable. Byte 32 is always unpredictable in the program-interruption TDB .

Data-Exception Code (DXC) / Vector-Exception Code (VXC): For transactions that are aborted due to filtered data-exception program-exception conditions, byte 33 of the TBEGIN-specified TDB contains the data-exception code. The format of the DXC, and the cases for which it is stored, are identical to those described in real location 147 when the exception condition results in an interruption. See “Data-Exception Code” on page 3-74 and page 6-17 for details.

For transactions that are aborted due to filtered vector-processing exception program-exception conditions, byte 33 of the TBEGIN-specified TDB contains the vector-exception code. The format of the VXC, and the cases for which it are stored, are identical to those described in real location 147 when the exception condition results in an interruption. See “Vector-Exception Code” on page 3-74 and page 6-20 for details.

For transactions that are aborted for other reasons, including any exception conditions that result in a program interruption, byte 33 is unpredictable. Byte

33 is always unpredictable in the program-interruption TDB .

Program Interruption Identification (PIID): For transactions that are aborted due to filtered program-exception conditions, bytes 36-39 of the TBEGIN-specified TDB contain the program interruption identification. The format of the PIID is identical to that described in real locations 140-143 when the condition results in an interruption, except that (a) the instruction-length code in bits 13-14 of the PIID is respective to the instruction at which the exception condition was detected, and (b) bit 22 of the PIID is unpredictable. See “Program-Interruption Identification” on page 3-74 for details.

For transactions that are aborted for other reasons, including exception conditions that result in a program interruption, bytes 36-39 are unpredictable. Bytes 36-39 are always unpredictable in the program-interruption TDB .

Translation-Exception Identification (TEID): For transactions that are aborted due to any of the following filtered program-exception conditions, bytes 40-47 of the TBEGIN-specified TDB contain the translation-exception identification.

- Access-list-controlled, DAT, or instruction-execution protection
- ASCE-type
- Page translation
- Region-first translation
- Region-second translation
- Region-third translation
- Segment translation exception

The format of the TEID is identical to that described in real locations 168-175 when the condition results in an interruption. See “Translation-Exception Identification” on page 3-76 for details.

For transactions that are aborted for other reasons, including exception conditions that result in a program interruption, bytes 40-47 are unpredictable. Bytes 40-47 are always unpredictable in the program-interruption TDB .

Breaking-Event Address: For transactions that are aborted due to filtered program-exception conditions, bytes 48-55 of the TBEGIN-specified TDB contain the breaking-event address. The format of the breaking-event address is identical to that described in real locations 272-279 when the condition results

in an interruption. See “Breaking-Event Address” on page 3-80 and page 4-46 for details.

For transactions that are aborted for other reasons, including exception conditions that result in a program interruption, bytes 48-55 are unpredictable. Bytes 48-55 are always unpredictable in the program-interruption TDB.

General Registers: Bytes 128-255 contain the contents of general registers 0-15 at the time the transaction was aborted. The registers are stored in ascending order, beginning with general register 0 in bytes 128-135, general register 1 in bytes 136-143, and so forth.

Reserved: All other fields are reserved. Unless indicated otherwise, the contents of reserved fields are unpredictable.

As observed by other CPUs and the channel subsystem, accesses to the TDB(s) during a transaction abort are multiple-access update references occurring after any nontransactional stores, and the fields of the TDB(s) are not necessarily accessed in any order.

Programming Notes:

1. A transaction may be aborted due to causes that are outside the scope of the immediate configuration in which it executes. For example, transient events recognized by a hypervisor (such as LPAR or z/VM) may cause a transaction to be aborted.
2. The information provided in the transaction-diagnostic block is intended for diagnostic purposes and is substantially correct. However, because an abort may have been caused by an event outside the scope of the immediate configuration, information such as the abort code or program interruption identification may not accurately reflect conditions within the configuration, and thus should not be used in determining program action.
3. An example of the scenario described in the above notes may occur if a configuration’s first execution of an additional-floating-point (AFP) instruction occurs within a transaction. The control program can eliminate this scenario by executing the first AFP instruction outside of a transaction.

In addition to the diagnostic information saved in the TDB, when a transaction is aborted due to any data-exception program-exception condition and both the AFP-register control, bit 45 of control register 0, and the effective allow-floating-point-operation control (F) are one, the data-exception code (DXC) is placed into byte 2 of the floating-point control register (FPCR), regardless of whether filtering applies to the program-interruption condition. When a transaction is aborted, and either or both the AFP-register control or effective allow-floating-point-operation control are zero, the DXC is not placed into the FPCR.

Transactional-Execution Facility Instructions

When the transactional-execution facility is installed, the following general instructions are provided.

- EXTRACT TRANSACTION NESTING DEPTH
- NONTRANSACTIONAL STORE
- TRANSACTION ABORT
- TRANSACTION BEGIN
- TRANSACTION END

Restricted Instructions

When the CPU is in the transactional-execution mode, attempted execution of certain instructions is restricted and causes the transaction to be aborted.

When issued in the constrained transactional-execution mode, attempted execution of restricted instructions may also result in a transaction-constraint program interruption, or may result in execution proceeding as if the transaction was not constrained. See “Constrained Transaction” on page 5-107 for further details.

Restricted instructions include all instructions that are not defined in Chapters 7-9 and 18-26 of this document and the following nonprivileged instructions.

- COMPARE AND SWAP AND STORE
- LOAD GUARDED STORAGE CONTROLS
- PERFORM LOCKED OPERATION
- PERFORM PROCESSOR ASSIST
- STORE FACILITY LIST EXTENDED
- STORE GUARDED STORAGE CONTROLS
- SUPERVISOR CALL

Under the conditions listed below, the following instructions are restricted:

- BRANCH AND LINK (BALR), BRANCH AND SAVE (BASR), and BRANCH AND SAVE AND SET MODE, when the R_2 field of the instruction is nonzero and branch tracing is enabled
- BRANCH AND SAVE AND SET MODE and BRANCH AND SET MODE, when the R_2 field is nonzero and mode tracing is enabled; SET ADDRESSING MODE, when mode tracing is enabled
- MONITOR CALL, when a monitor-event condition is recognized

When the CPU is in the transactional-execution mode, it is model dependent whether the following instructions are restricted:

- CIPHER MESSAGE
- CIPHER MESSAGE WITH AUTHENTICATION
- CIPHER MESSAGE WITH CIPHER FEEDBACK
- CIPHER MESSAGE WITH CHAINING
- CIPHER MESSAGE WITH COUNTER
- CIPHER MESSAGE WITH OUTPUT FEEDBACK
- COMPRESSION CALL
- COMPUTE DIGITAL SIGNATURE AUTHENTICATION
- COMPUTE INTERMEDIATE MESSAGE DIGEST
- COMPUTE LAST MESSAGE DIGEST
- COMPUTE MESSAGE AUTHENTICATION CODE
- CONVERT UNICODE-16 TO UNICODE-32
- CONVERT UNICODE-16 TO UNICODE-8
- CONVERT UNICODE-32 TO UNICODE-16
- CONVERT UNICODE-32 TO UNICODE-8
- CONVERT UNICODE-8 TO UNICODE-16
- CONVERT UNICODE-8 TO UNICODE-32
- DEFLATE CONVERSION CALL
- PERFORM CRYPTOGRAPHIC COMPUTATION
- PERFORM RANDOM NUMBER OPERATION
-

When the effective allow-AR-modification (A) control is zero, the following instructions are restricted:

- COPY ACCESS
- LOAD ACCESS MULTIPLE
- LOAD ADDRESS EXTENDED
- SET ACCESS

When the effective allow-floating-point-operation (F) control is zero, all floating-point and vector instructions are restricted (that is, all instructions described in Chapters 9 and 18-25).

Under certain circumstances, the following instructions may be restricted:

- EXTRACT CPU TIME
- EXTRACT PSW
- STORE CLOCK
- STORE CLOCK EXTENDED
- STORE CLOCK FAST

It is model dependent whether the following instructions are restricted:

- PREFETCH DATA (RELATIVE LONG), when the code in the M_1 field is either 6 or 7.
- STORE CHARACTERS UNDER MASK (STCMH), when the M_3 field is zero and the code in the R_1 field is either 6 or 7.

If a model does not restrict the above two instructions for the cited conditions, then it is unpredictable whether attempted execution results in transactional execution being aborted with abort code 16.

When a nonconstrained transaction is aborted because of the attempted execution of a restricted instruction, the transaction abort code in the transaction diagnostic block is set to 11 (restricted instruction), and the condition code is set to 3, except as follows. When a nonconstrained transaction is aborted due to the attempted execution of an instruction that would otherwise result in a privileged-operation exception, it is unpredictable whether the abort code is set to 11 (restricted instruction) or 4 (unfiltered program interruption resulting from the recognition of the privileged-operation program interruption). When a nonconstrained transaction is aborted due to the attempted execution of MONITOR CALL, and both a monitor-event condition and a specification-exception condition are present, it is unpredictable whether the abort code is set to 11 or 4, or, if the program interruption is filtered, 12.

Additional instructions may be restricted in a constrained transaction, as described in “Constrained Transaction” on page 5-107. Although these instructions are not currently defined to be restricted in a nonconstrained transaction, they may be restricted under certain circumstances in a nonconstrained transaction on future processors. See “Constrained

Transaction” on page 5-107 for details on the additional restrictions and alternate results if a restricted instruction is attempted.

Programming Notes:

1. Certain restricted instructions may be allowed in the transactional-execution mode on future processors. Therefore, the program should not rely on the transaction being aborted due to the attempted execution of a restricted instruction. The TRANSACTION ABORT instruction should be used to reliably cause a transaction to be aborted.
2. In a nonconstrained transaction, the program should provide an alternative nontransactional code path to accommodate a transaction that aborts due the attempted execution of an instruction that is restricted under certain conditions.
3. The effective allow-AR-modification and effective allow-floating-point-operation controls (A and F bits, respectively) are described in “TRANSACTION BEGIN (TBEGIN)” on page 7-401.

Transactional-Execution Facility Operation

The transactional-execution facility is under the control of bits 8-9 of control register 0, bits 61-63 of control register 2, the transaction nesting depth, the transaction-diagnostic-block address, and the transaction-abort PSW. See “Transactional-Execution Facility Controls” on page 5-92 for details on these controls.

Following an initial CPU reset, the contents of bit positions 8-9 of control register 0, bit positions 62-63 of control register 2, and the transaction nesting depth are set to zero. When the transactional-execution control, bit 8 of control register 0, is zero, the CPU cannot be placed into the transactional-execution mode.

Transaction Initiation

When the transaction nesting depth is zero, execution of the TRANSACTION BEGIN (TBEGIN) instruction resulting in condition code zero causes the CPU to enter the nonconstrained transactional-execution mode. When the transaction nesting depth is zero, execution of the TRANSACTION BEGIN (TBEGINC)

instruction resulting in condition code zero causes the CPU to enter the constrained transactional-execution mode.

When the CPU is in the nonconstrained transactional-execution mode, execution of the TRANSACTION BEGIN instruction resulting in condition code zero causes the CPU to remain in the nonconstrained transactional-execution mode. Details of the instructions may be found in “TRANSACTION BEGIN (TBEGIN)” on page 7-401 and “TRANSACTION BEGIN (TBEGINC)” on page 7-406.

Execution in the Transactional-Execution Mode

Except where explicitly noted otherwise, all rules that apply for nontransactional execution also apply to transactional execution. This section describes additional characteristics of processing while the CPU is in the transactional-execution mode.

As observed by the CPU, fetches and stores made in the transactional-execution mode are no different than those made while not in the transactional-execution mode. See “Storage-Operand Consistency” on page 5-125 and “Relation between Operand Accesses” on page 5-129 for a description of the rules of storage ordering.

As observed by other CPUs and by the channel subsystem, all storage-operand accesses made while a CPU is in the transactional-execution mode appear to be a single block-concurrent access. Storage accesses for instruction and DAT- and ART-table fetches follow the non-transactional rules.

Normal Transaction Ending

The CPU leaves the transactional-execution mode normally by means of a TRANSACTION END instruction that causes the transaction nesting depth to transition to zero; in this case the transaction is said to complete. See “TRANSACTION END” on page 7-408 for the details.

When the CPU leaves the transactional-execution mode by means of the completion of a TRANSACTION END instruction, all stores made while in the transactional-execution mode are committed, that is, the stores appear to occur as a single block-concurrent operation as observed by other CPUs and by the channel subsystem.

Transaction Abort Conditions

A transaction may be implicitly aborted for a variety of causes, or it may be explicitly aborted by the TRANSACTION ABORT instruction. The following text enumerates each possible cause of a transaction abort, the corresponding abort code, and the condition code that is placed into the transaction-abort PSW.

External Interruption: The transaction-abort code is set to 2, and the condition code in the transaction-abort PSW is set to 2. The transaction-abort PSW is stored as the external-old PSW as a part of external-interruption processing.

Program Interruption (Unfiltered): A program-exception condition that results in an interruption (that is, an unfiltered condition) causes the transaction to be aborted with code 4. The condition code in the transaction-abort PSW is set specific to the program interruption code, as described in “Transaction Abort Processing” on page 5-102 and Figure 5-15 on page 5-104. The transaction-abort PSW is stored as the program-old PSW as a part of program-interruption processing.

An instruction that would otherwise result in a transaction being aborted due to an operation exception may yield alternate results: For a nonconstrained transaction, the transaction may instead be aborted with abort code 11 (restricted instruction); for a constrained transaction, a transaction-constraint program interruption may be recognized instead of the operation exception.

When a PER event is recognized in conjunction with any other unfiltered program-exception condition, the condition code is set to 3.

Machine-Check Interruption: The transaction-abort code is set to 5, and the condition code in the transaction-abort PSW is set to 2. The transaction-abort PSW is stored as the machine-check-old PSW as a part of machine-check interruption processing.

I/O Interruption: The transaction-abort code is set to 6, and the condition code in the transaction-abort PSW is set to 2. The transaction-abort PSW is stored as the I/O-old PSW as a part of I/O interruption processing.

Fetch Overflow: A fetch-overflow condition is detected when the transaction attempts to fetch from more locations than the CPU supports. The transac-

tion-abort code is set to 7, and the condition code is set to either 2 or 3.

Store Overflow: A store-overflow condition is detected when the transaction attempts to store to more locations than the CPU supports. The transaction-abort code is set to 8, and the condition code is set to either 2 or 3.

Fetch Conflict: A fetch-conflict condition is detected when another CPU or the channel subsystem attempts to store into a location that has been transactionally fetched by this CPU. The transaction-abort code is set to 9, and the condition code is set to 2.

Store Conflict: A store-conflict condition is detected when another CPU or the channel subsystem attempts to access a location that has been stored during transactional execution by this CPU. The transaction-abort code is set to 10, and the condition code is set to 2.

Restricted Instruction: When the CPU is in the transactional-execution mode, attempted execution of a restricted instruction causes the transaction to be aborted. The transaction-abort code is set to 11, and the condition code is set to 3.

Restricted instructions, and the conditions under which they are restricted is described in “Restricted Instructions” on page 5-97.

Program-Interruption Condition (Filtered): A program-interruption condition that does not result in an interruption (that is, a filtered condition) causes the transaction to be aborted with a transaction-abort code of 12. The condition code is set to 3. See “Program-Interruption Filtering on a Transaction Abort” on page 5-104 for details on program-interruption filtering.

Nesting Depth Exceeded: The nesting-depth-exceeded condition is detected when the transaction nesting depth is at the maximum allowable value for the configuration, and a TRANSACTION BEGIN instruction is executed. The transaction is aborted with a transaction-abort code of 13, and the condition code is set to 3.

Cache Fetch-Related Condition: A condition related to storage locations fetched by the transaction is detected by the CPU's cache circuitry. The

transaction is aborted with a transaction-abort code of 14, and the condition code is set to either 2 or 3.

Cache Store-Related Condition: A condition related to storage locations stored by the transaction is detected by the CPU's cache circuitry. The transaction is aborted with a transaction-abort code of 15, and the condition code is set to either 2 or 3.

Cache Other Condition: A cache other condition is detected by the CPU's cache circuitry. The transaction is aborted with a transaction-abort code of 16, and the condition code is set to 2 or 3.

On some models, attempting to execute a nontransactional store and a transactional store in a transaction when both designate any locations within the same cache line, results in the transaction being aborted with abort code 16 and condition code 3 set. This occurs even if the nontransactional store does not overlap the transactional store.

During transactional execution, if the CPU accesses instructions or storage operands using different logical addresses that are mapped to the same absolute address, it is model dependent whether the transaction is aborted. If the transaction is aborted due to accesses using different logical addresses mapped to the same absolute address, abort code 14, 15, or 16 is set, depending on the condition.

Guarded-Storage Event: Execution of a LOAD GUARDED or LOAD LOGICAL AND SHIFT GUARDED instruction resulted in the recognition of a guarded-storage event. The transaction is aborted with a transaction-abort code of 19, and the condition code is set to two.

If a guarded-storage event is recognized while the CPU is in the transactional-execution mode, the guarded-storage event is processed as described in "Guarded-Storage-Event Processing" on page 4-71. If the guarded-storage event is recognized while the CPU is in the constrained transactional-memory mode, no transaction diagnostic block is stored.

Miscellaneous Condition: A miscellaneous condition is any other condition recognized by the CPU that causes the transaction to abort. The transaction-abort code is set to 255, and the condition code is set to either 2 or 3.

When multiple configurations are executing in the same machine (for example, logical partitions or vir-

tual machines), a transaction may be aborted due to an external, machine-check, or I/O interruption that occurred in a different configuration.

Programming Notes:

1. The miscellaneous condition may result from any of the following:
 - COMPARE AND REPLACE DAT TABLE ENTRY, COMPARE AND SWAP AND PURGE, INVALIDATE DAT TABLE ENTRY, INVALIDATE PAGE TABLE ENTRY, PERFORM FRAME MANAGEMENT FUNCTION in which the NQ control is zero and SK control is one, SET STORAGE KEY EXTENDED in which the NQ control is zero, performed by another CPU in the configuration; the condition code is set to 2.
 - An operator function (such as reset, restart, or stop) or the equivalent SIGNAL PROCESSOR order is performed on the CPU. The condition code is set to 2.
 - Any other condition not enumerated above; the condition code is set to 2 or 3.
2. The location at which fetch and store conflicts are detected may be anywhere within the same cache line.
3. Under certain conditions, the CPU may not be able to distinguish between similar abort conditions. For example, a fetch or store overflow may be indistinguishable from a respective fetch or store conflict.
4. Speculative execution of multiple instruction paths by the CPU may result in a transaction being aborted due to conflict or overflow conditions, even if such conditions do not occur in the conceptual sequence. While in the constrained transactional-execution mode, the CPU may temporarily inhibit speculative execution, allowing the transaction to attempt to complete without detecting such conflicts or overflows speculatively.

When multiple abort conditions apply, it is unpredictable which abort code is reported by the CPU.

TABORT Instruction: Execution of the TRANSACTION ABORT instruction causes the transaction to abort. The transaction-abort code is set from the second-operand address. The condition code is set to

either 2 or 3, depending on whether bit 63 of the second-operand address is zero or one, respectively.

Figure 5-14 summarizes the abort codes stored in the transaction diagnostic block, and the corresponding condition code.

Code	Reason for Abort	CC Set
2	External interruption	2
4	Program interruption (unfiltered)	2 or 3 †
5	Machine-check interruption	2
6	I/O interruption	2
7	Fetch overflow	2 or 3
8	Store overflow	2 or 3
9	Fetch conflict	2
10	Store conflict	2
11	Restricted instruction	3
12	Program-interruption condition (filtered)	3
13	Nesting depth exceeded	3
14	Cache fetch-related	2 or 3
15	Cache store-related	2 or 3
16	Cache other	2 or 3
19	Guarded-storage event recognized	2
255	Miscellaneous condition	2 or 3
≥ 256	TABORT instruction	2 or 3
‡	Cannot be determined; no TDB stored	1
Explanation:		
†	See Figure 5-16 on page 5-104 to determine which condition code is set based on the interruption code.	
‡	This situation occurs when a transaction aborts, but the TDB has become inaccessible subsequent to the successful execution of the outermost TRANSACTION BEGIN (TBEGIN) instruction. No TBEGIN-specified TDB is stored, and the condition code is set to 1.	

Figure 5-14. Transaction Abort Codes

Programming Notes:

1. Abort codes 0-255 are reserved for use by the CPU. If the program specifies any of these codes in the TRANSACTION ABORT instruction, a specification exception is recognized, and the transaction is aborted with the resulting abort code indicating a program interruption (code 4) or program-interruption condition (code 12).
2. Abort codes 17-18 and 20-254 are reserved for potential enhancements. Such enhancements may result in the setting of either condition code 2 or 3.

3. Depending on the model, the CPU may not be able to distinguish between certain abort reasons. For example, a fetch/store overflow and a fetch/store conflict may not be distinguishable by the CPU in all circumstances.

Therefore, the program should be able to accommodate unanticipated abort reasons.

4. Abort code 0 is reserved and will never be assigned to a meaningful abort indication.

Transaction Abort Processing

Abort processing consists of the following steps:

1. All nontransactional store accesses made while the CPU was in the transactional-execution mode are committed.

All other (transactional) stores made while the CPU was in the transactional-execution mode are discarded.

2. The CPU leaves the transactional-execution mode. Subsequent stores occur nontransactionally.

3. When the transaction is aborted due to a guarded-storage event, the PSW instruction address and the guarded-storage-event parameter list (if accessible) are updated as described in “Guarded-Storage-Event Processing” on page 4-71.

In all other cases, the current PSW is replaced with the contents of the transaction-abort PSW, except that the condition code is set according to Figure 5-14 on page 5-102 and Figure 5-16 on page 5-104.

4. When the transaction-diagnostic-block address is valid, diagnostic information identifying the reason for the abort and the contents of the general registers are stored into the TBEGIN-specified transaction diagnostic block (TDB). The TDB fields stored and conditions under which they are stored are described in “Transaction Diagnostic Block (TDB)” on page 5-93.

If the transaction-diagnostic-block address is valid, but the block has become inaccessible subsequent to the execution of the outermost TRANSACTION BEGIN (TBEGIN) instruction, the block is not accessed, and condition code 1 applies. If the transaction-diagnostic-block address is not valid, no TBEGIN-specified TDB is

stored, and condition code 2 or 3 applies, depending on the reason for aborting.

For transactions that are aborted due to program-exception conditions that result in an interruption, the program-interruption TDB is stored. See “Transaction Diagnostic Block (TDB)” on page 5-93 for a description of the contents of the TDB.

5. The transaction nesting depth is set to zero.
6. Any general register pairs designated to be saved by the outermost TRANSACTION BEGIN instruction are restored. General register pairs that were not designated to be saved by the outermost TRANSACTION BEGIN instruction are not restored when a transaction is aborted.
7. A serialization function is performed.
8. If the transaction is aborted due to an exception condition that results in an interruption, any and all other interruption codes or parameters associated with the interruption are stored at the assigned-storage locations corresponding to the type of interruption. The current PSW, as set in step 3, is stored into the interruption-old PSW.

Programming Notes:

1. Attempted execution of a SUPERVISOR CALL instruction while in the transactional-execution mode results in the transaction being aborted due to a restricted instruction. An SVC interruption cannot occur in this case.
2. Access registers, vector registers, floating-point registers, the floating-point-control register, and any general registers not specified by the outermost TRANSACTION BEGIN instruction’s general-register-save mask are not restored when a transaction aborts.
3. When the CPU was in the nonconstrained transactional-execution mode, the instruction address of the transaction-abort PSW designates the storage location following the outermost TRANSACTION BEGIN (TBEGIN) instruction. The sequence of instructions at this location should be able to accommodate all four condition codes, even though a failing transaction only causes

codes 1, 2, and 3 to be set. A summary of the condition code meanings is as follows:

CC	Meaning
0	The transaction was successfully initiated.
1	The transaction was aborted due to an indeterminate condition. The transaction diagnostic block could not be stored. Reexecution of the transaction is unlikely to be productive.
2	The transaction was aborted due to a transient condition. Reexecution of the transaction may be productive.
3	The transaction was aborted due to a persistent condition. Reexecution of the transaction under current conditions is unlikely to be productive. If conditions change, for example, data that is manipulated transactionally is rearranged, then reexecution may be more productive.

When the CPU was in the constrained transactional-execution mode, the instruction address of the transaction-abort PSW designated the TRANSACTION BEGIN (TBEGINC) instruction. By definition, a constrained transaction does not normally provide an abort-handler routine; however, when a transaction is aborted due to the recognition of a guarded-storage event, the guarded-storage-event handler may be used to remove the cause of the guarded-storage event.

4. When using nested transactions, an inner transaction may cause abort conditions to occur that may not otherwise occur in the outermost transaction. Examples of such conditions include the following:
 - The inner transaction may issue the TRANSACTION ABORT instruction, specifying an unanticipated abort code.
 - The inner transaction may result in an unanticipated program-interruption condition.
 - The inner transaction may filter program-interruption conditions that are not filtered by the outermost transaction, thus resulting in a different abort code.

Any transaction abort-handler routine must be able to accommodate unanticipated abort and exception conditions that occur within inner

transactions, even if they never occur in the outermost transaction.

Program-Interruption Filtering on a Transaction Abort

A program-exception condition that is recognized while in the transactional-execution mode always results in the transaction being aborted. For a non-constrained transaction, the program can optionally specify that certain program-exception conditions not result in an interruption. This action is called program-interruption filtering. Program-interruption filtering is subject to the following controls:

- The transactional-execution program-interruption-filtering override, bit 9 of control register 0
- The effective program-interruption-filtering control (PIFC)
- The program-interruption code corresponding to the exception condition recognized.

When the transactional-execution program-interruption filtering override is zero, the program specifies which classes of exception conditions are to be filtered by means of the program-interruption-filtering control (PIFC), bits 14-15 of the I_2 field of the TRANSACTION BEGIN (TBEGIN) instruction. The effective PIFC is the highest value of the PIFC in the TBEGIN instruction for the current nesting level and for all outer levels.

For most program-exception conditions, there is a corresponding transactional-execution class. The effective PIFC and the transactional-execution classes interact as follows:

Effective PIFC	Results based on Transactional-Execution Class
0	No program-interruption filtering occurs. Exception conditions having classes 1, 2, or 3 always result in an interruption.
1	Limited program-interruption filtering occurs. Exception conditions having classes 1 or 2 result in an interruption; conditions having class 3 do not result in an interruption.
2	Moderate program-interruption filtering occurs. Only exception conditions having class 1 result in an interruption; conditions having classes 2 or 3 do not result in an interruption.

The TRANSACTION BEGIN (TBEGIN) instruction provides no explicit program-interruption-filtering control; an implied PIFC of zero is assumed for TBEGIN. Thus, when the CPU enters the constrained transactional-execution mode as a result of TBEGIN, the effective PIFC is zero; when the CPU remains in the nonconstrained transactional-execution mode as a result of TBEGIN, the effective PIFC is unchanged.

Figure 5-15 summarizes the relationship of the effective PIFC, the type of program-interruption filtering, the transactional-execution class, and whether the exception condition results in an interruption.

Effective PIFC	Program-Interruption Filtering	Result Based on Transactional-Execution (TX) Class		
		1	2	3
0	None	Interrupt	Interrupt	Interrupt
1	Limited	Interrupt	Interrupt	Filtered
2	Moderate	Interrupt	Filtered	Filtered

Explanation:

PIFC Program-Interruption-Filtering Control (bits 14-15 of the I_2 field of the TBEGIN instruction; zeros for TBEGIN); the effective PIFC is the highest value specified (or implied) for the current and all outer-level TRANSACTION BEGIN instructions.

Figure 5-15. Effective PIFC and Transactional-Execution Program-Interruption Classes

Figure 5-16 lists the program-interruption conditions, the corresponding transactional-execution class, and the condition code that is set when the transaction is aborted due to a program-interruption condition.

Code (Hex)	Exception Condition	TX Class	CC Set
0001	Operation	1	3
0002	Privileged operation	1	3
0003	Execute	1	3
0004	Protection	1 or 2 †	2 or 3 ‡
0005	Addressing	1 or 2 †	2 or 3 ‡
0006	Specification	3	2 or 3 ‡
0007	Data (DXC 01, 02, 03, and FE)	1	2
0007	Data (all other DXCs)	3	2 or 3 ‡
0008	Fixed-point overflow	3	2 or 3 ‡
0009	Fixed-point divide	3	2 or 3 ‡
000A	Decimal overflow	3	2 or 3 ‡
000B	Decimal divide	3	2 or 3 ‡
000C	HFP exponent overflow	3	2 or 3 ‡
000D	HFP exponent underflow	3	2 or 3 ‡

Figure 5-16. Transactional-Execution Classes for Various Program-Interruption Conditions (Part 1 of 3)

Code (Hex)	Exception Condition	TX Class	CC Set
000E	HFP significance	3	2 or 3 ‡
000F	HFP divide	3	2 or 3 ‡
0010	Segment translation	1 or 2 †	2 or 3 ‡
0011	Page translation	1 or 2 †	2 or 3 ‡
0012	Translation specification	1	3
0013	Special operation	1	3
0015	Operand	—	—
0016	Trace table	—	—
0018	Transaction constraint	1	3
001B	Vector processing	3	2 or 3 ‡
001C	Space-switch event	—	—
001D	HFP square root	3	2 or 3 ‡
001F	PC-translation specification	—	—
0020	AFX translation	—	—
0021	ASX translation	—	—
0022	LX translation	—	—
0023	EX translation	—	—
0024	Primary authority	—	—
0025	Secondary authority	—	—
0026	LFX translation	—	—
0027	LSX translation	—	—
0028	ALET specification	2	2 or 3 ‡
0029	ALEN translation	2	2 or 3 ‡
002A	ALE sequence	2	2 or 3 ‡
002B	ASTE validity	2	2 or 3 ‡
002C	ASTE sequence	2	2 or 3 ‡
002D	Extended authority	2	2 or 3 ‡
002E	LSTE sequence	—	—
002F	ASTE instance	—	—
0030	Stack full	—	—
0031	Stack empty	—	—
0032	Stack specification	—	—
0033	Stack type	—	—
0034	Stack operation	—	—
0038	ASCE type	1 or 2 †	2 or 3 ‡
0039	Region-first translation	1 or 2 †	2 or 3 ‡
003A	Region-second translation	1 or 2 †	2 or 3 ‡
003B	Region-third translation	1 or 2 †	2 or 3 ‡
0040	Monitor event	—	—
0080	PER event	1	3 *
Explanation:			
—	Not applicable; the exception cannot occur in the transactional-execution mode because the instruction that causes the exception is a restricted instruction.		
†	Access exceptions recognized during the fetching of an instruction in the transactional-execution mode are TX class 1 (that is, they cannot be filtered). Access exceptions when accessing a storage operand in the transactional-execution mode are TX class 2.		

Figure 5-16. Transactional-Execution Classes for Various Program-Interruption Conditions (Part 2 of 3)

Code (Hex)	Exception Condition	TX Class	CC Set
‡	When the exception condition is not filtered, the condition code is 2; when the condition is filtered, the condition code is 3.		
*	The CPU sets condition code 3. A control program or hypervisor may change the condition code in the program-old PSW to 2.		

Figure 5-16. Transactional-Execution Classes for Various Program-Interruption Conditions (Part 3 of 3)

When a program-interruption condition does not result in an interruption (that is, the condition is filtered), the program-new PSW is not loaded, and none of the assigned storage locations associated with a program interruption is stored; these locations include the program-interruption identification, the breaking-event address, the program-old PSW, and, when applicable, the data-exception code, PER code, PER address, exception access identification, PER access identification, operand access identification, and translation-exception identification. When a program-interruption condition results in an interruption (that is, the condition is unfiltered), most assigned storage locations associated with a program interruption are stored as is normal; however, the instruction-length code in bits 13-14 of the program-interruption identification is respective to the instruction at which the exception condition was detected, and the transaction-abort PSW is stored as the program-old PSW.

When a PER event is recognized in conjunction with any other filtered program-exception condition, the following applies:

- The transaction class and condition code for the PER event apply. In this case, the PER exception condition cannot be filtered, and the condition code is set to 3.
- The program-interruption code in the prefix area does not include the non-PER exception condition, nor are any other non-PER program-interruption parameters stored in the prefix area.

When the transactional-execution program-interruption filtering override (bit 9 of control register 0) is one, program-interruption conditions are not subject to program-interruption filtering. In this case, execution proceeds as if the effective PIFC was zero.

Access-exception conditions recognized during the fetching of an instruction are never subject to pro-

gram-interruption filtering. In these cases, the exception condition results both in the transaction being aborted and in a program interruption.

In addition to the program-interruption code representing the cause of the interruption, bit 6 of the program-interruption code at real locations 142-143 is set to one, indicating that the program interruption occurred during transactional execution. The fields of the program-old PSW are set as described in step 3 of “Transaction Abort Processing” on page 5-102.

Programming Notes:

1. A MONITOR CALL instruction that would otherwise cause a monitor-event is a restricted instruction. Therefore, a monitor-event program interruption can never occur while the CPU is in the transactional-execution mode, thus the monitor code at real locations 176-183 is not stored when the transaction is aborted.

Similarly, any other program-interruption condition listed in Figure 5-16 having a not-applicable transaction class (–) and condition code cannot occur as the instructions that cause these exceptions are restricted. Thus, neither the program-interruption identification nor any of the other ancillary program-interruption information are stored in real locations in the prefix area.

2. The following example illustrates the instructions necessary to initiate and end a nonconstrained transaction. Note that if the transaction is aborted, it is retried several times before finally branching to the non-transactional fallback path at label NO_RETRY.

```

LOOP      LHI    15,0      Zero counter
          TBEGIN TDB,X'F000' Restore GRs 0-7 if aborted.
          JNZ   ABORT     CC≠0: Aborted or can't init.
          ⋮
          ⋮              Transactional-execution code
          ⋮
          TEND                End of transaction.
          ⋮
ABORT     JC    5,NO_RETRY CC 1/3: Not worth retrying.
          AHI   15,1      Increment counter.
          CIJNL 15,6,NO_RETRY Give up after 6 attempts
          PPA   15,0,1    Request assistance.
          J     LOOP     And try it again.
          ⋮
NO_RETRY DS    0H        Perform fall-back path

```

3. As shown in programming note 2, the first conditional branch instruction following a TBEGIN should be one of the following:

- A branch to the abort handler for all possible aborting conditions; that is, a conditional branch instruction having a mask of 0111 binary (as shown in programming note 2). In this case, separate conditional branches in an out-of-line abort handler may be used to accommodate the three possible aborting conditions. This is the preferred sequence.
- A branch to the next instruction to be executed in the transactional-execution mode; that is, a conditional branch instruction having a mask of 1000 binary. In this case, separate conditional branches to accommodate the aborting conditions may immediately follow the first conditional branch. This is not the preferred sequence and may result in significant performance degradation.

Other branching combinations – such as having a first, second, and third conditional branch following the TBEGIN to handle the respective condition code 1, 2, and 3 cases – may result in unnecessary or repetitive aborting of the transaction.

4. Programming note 2 shows the use of the PERFORM PROCESSOR ASSIST (PPA) instruction. The program can improve the likelihood of success when rediving the transaction by invoking the PPA instruction before branching back to the label LOOP following an abort. PPA is described on page 7-351.

5. As shown in programming note 2, the loop counter in general register 15 is not subject to the general-register save mask (GRSM) in the TRANSACTION BEGIN instruction; thus, the register is not restored if the transaction aborts. Therefore, the program should not alter the contents of general register 15 within the transaction.

However, if the loop counter was changed to use a register that is subject to the GRSM, for example general register 7, then the transaction could safely alter that register within the transaction, *and* the program could use the same register for the loop counter. If the transaction completes successfully, any results in general register 7 are available following the TRANSACTION END instruction. However, if the transaction aborts,

the original value of general register 7 (that is, the value before the TBEGIN) is restored, thus the register can also be used for the loop counter in the abort handler.

6. Program-interruption filtering may be useful in programs that, for various reasons, defer the validation of data – sometimes called *speculative execution*. Instead of establishing a potentially complicated recovery environment, the program simply executes nonconstrained transaction(s) in which the effective program-interruption filtering control (PIFC) is nonzero. This allows the program's abort-handler routine to receive control for certain types of program-interruption conditions directly – without operating-system intervention.

An effective PIFC of 1 indicates that limited filtering is to be performed by the CPU; this may be useful in the recognition of unexpected data or arithmetic exceptions. An effective PIFC of 2 indicates that moderate filtering is to be performed; this may be useful in the recognition of inaccessible storage locations.

However, it should be noted that if a program is aborted due to various types of filtered access exceptions, it does not necessarily indicate that the location would be inaccessible if the program attempted nontransactional execution. For example, the program might specify a PIFC of 2, and subsequently be aborted due to a page-translation exception. This exception may indicate that the storage location is not part of the virtual address space, or it may simply indicate that the block of storage has been paged out.

Priority of Abort Conditions

During transactional execution, multiple abort conditions may be present simultaneously. Abort conditions having corresponding interruptions are honored in the order defined in “Priority of Program-Interruption Conditions” on page 6-52. Except for the restricted-instruction abort condition, abort conditions that do not correspond to interruptions may occur in any order. The priority of the restricted-instruction abort condition is equivalent to a program-interruption priority of 7.D (see “Priority of Program-

Interruption Conditions” on page 6-52). Figure 5-17 illustrates the priority of each of the abort conditions.

Priority	Abort Condition
A.	Fetch-overflow (abort code 7)
B.	Store overflow (abort code 8)
C.	Fetch conflict (abort code 9)
D.	Store Conflict (abort code 10)
E.	Nesting depth exceeded (abort code 13)
F.	Cache fetch-related condition (abort code 14)
G.	Cache store-related condition (abort code 15)
H.	Cache other condition (abort code 16)
I.	Miscellaneous condition (abort code 255)
J. 1.	Exigent machine check (abort code 5)
2.	a. Program interruption (unfiltered; abort code 4)
	b. Restricted instruction (abort code 11)
	c. Program interruption (filtered; abort code 12)
3.	a. TABORT instruction (abort code > 255)
4.	Repressible machine check (abort code 5)
5.	External interruption (abort code 2)
6.	Input/output interruption (abort code 6)
Explanation:	
The meaning of the priority indications is similar to that described in Figure 6-8 on page 6-52.	

Figure 5-17. Priority of Abort Conditions

Constrained Transaction

In the absence of constraint violations, repeated occurrences of interruptions, guarded-storage events, or conflicts with other CPUs or the channel subsystem, a constrained transaction will eventually complete, thus an abort-handler routine is not required. A constrained transaction is initiated by the TRANSACTION BEGIN (TBEGIN) instruction when the transaction nesting depth is initially zero. A constrained transaction is subject to the following constraints:

1. The transaction executes no more than 32 instructions, not including the TRANSACTION BEGIN (TBEGIN) and TRANSACTION END instructions.
2. All instructions in the transaction must be within 256 contiguous bytes of storage, including the TRANSACTION BEGIN (TBEGIN) and any TRANSACTION END instructions.
3. In addition to all instructions listed in the section “Restricted Instructions” on page 5-97, the fol-

lowing restrictions apply to a constrained transaction.

- a. Instructions are limited to those defined in Chapter 7, “General Instructions.”
- b. Branching instructions are limited to the following:
 - BRANCH RELATIVE ON CONDITION in which the M_1 field is nonzero and the RI_2 field contains a positive value
 - BRANCH RELATIVE ON CONDITION LONG in which the M_1 field is nonzero, and the RI_2 field contains a positive value that does not cause address wrap-around.
 - COMPARE AND BRANCH RELATIVE, COMPARE IMMEDIATE AND BRANCH RELATIVE, COMPARE LOGICAL AND BRANCH RELATIVE, and COMPARE LOGICAL IMMEDIATE AND BRANCH RELATIVE in which the M_3 field is nonzero and the RI_4 field contains a positive value

(that is, only forward branches with nonzero branch masks)

- c. Except for TRANSACTION END and instructions which cause a specific-operand serialization, instructions which cause a serialization function are restricted. The instructions which are restricted for this reason and are not restricted for other reasons are as follows:
 - COMPARE AND SWAP
 - COMPARE DOUBLE AND SWAP
 - STORE CLOCK
 - STORE CLOCK EXTENDED
 - TEST AND SET
 - TRANSACTION ABORT
 - TRANSACTION BEGIN (TBEGIN and TBEGINC)
- d. All SS-format, SSE-format, and SSF-format instructions are restricted.
- e. All of the following general instructions are restricted.
 - BRANCH INDIRECT ON CONDITION
 - BRANCH PREDICTION PRELOAD

- BRANCH PREDICTION RELATIVE PRELOAD
- CHECKSUM
- CIPHER MESSAGE
- CIPHER MESSAGE WITH AUTHENTICATION
- CIPHER MESSAGE WITH CIPHER FEEDBACK
- CIPHER MESSAGE WITH CHAINING
- CIPHER MESSAGE WITH COUNTER
- CIPHER MESSAGE WITH OUTPUT FEEDBACK
- COMPARE AND FORM CODEWORD
- COMPARE LOGICAL LONG, COMPARE LOGICAL LONG EXTENDED, and COMPARE LOGICAL LONG UNICODE
- COMPARE LOGICAL STRING
- COMPARE UNTIL SUBSTRING EQUAL
- COMPRESSION CALL
- COMPUTE INTERMEDIATE MESSAGE DIGEST
- COMPUTE LAST MESSAGE DIGEST
- COMPUTE MESSAGE AUTHENTICATION CODE
- CONVERT TO BINARY
- CONVERT TO DECIMAL
- CONVERT UNICODE-16 TO UNICODE-32, CONVERT UNICODE-16 TO UNICODE-8, CONVERT UNICODE-32 TO UNICODE-16, CONVERT UNICODE-32 TO UNICODE-8, CONVERT UNICODE-8 TO UNICODE-16, and CONVERT UNICODE-8 TO UNICODE-32
- DIVIDE, DIVIDE LOGICAL, and DIVIDE SINGLE
- EXECUTE and EXECUTE RELATIVE LONG
- EXTRACT CPU ATTRIBUTE
- EXTRACT CPU TIME
- EXTRACT PSW
- EXTRACT TRANSACTION NESTING DEPTH
- LOAD AND ADD, LOAD AND ADD LOGICAL, LOAD AND AND, LOAD AND EXCLUSIVE OR, and LOAD AND OR
- LOAD PAIR FROM QUADWORD
- MONITOR CALL
- MOVE LONG, MOVE LONG EXTENDED, and MOVE LONG UNICODE
- MOVE STRING
- NONTRANSACTIONAL STORE

- PERFORM CRYPTOGRAPHIC COMPUTATION
 - PERFORM RANDOM NUMBER OPERATION
 - PREFETCH DATA (RELATIVE LONG)
 - SEARCH STRING and SEARCH STRING UNICODE
 - SET ADDRESSING MODE
 - STORE CHARACTERS UNDER MASK (STCMH), when the M_3 field is zero
 - STORE CLOCK FAST
 - STORE FACILITY LIST EXTENDED
 - STORE PAIR TO QUADWORD
 - TEST ADDRESSING MODE
 - TRANSLATE AND TEST EXTENDED and TRANSLATE AND TEST REVERSE EXTENDED
 - TRANSLATE EXTENDED
 - TRANSLATE ONE TO ONE, TRANSLATE ONE TO TWO, TRANSLATE TWO TO ONE, and TRANSLATE TWO TO TWO
 - UPDATE TREE
4. The transaction's storage operands access no more than four octowords. Note: LOAD ON CONDITION and STORE ON CONDITION are considered to reference storage regardless of the condition code.
 5. The transaction executing on this CPU, or stores by other CPUs or the channel subsystem, do not access storage operands in any 4 K-byte blocks that contain the 256 bytes of storage beginning with the TRANSACTION BEGIN (TBEGIN) instruction.
 6. The transaction does not access instructions or storage operands using different logical addresses that are mapped to the same absolute address.
 7. Operand references made by each instruction in the transaction must be within a single doubleword, except that for LOAD ACCESS MULTIPLE, LOAD MULTIPLE, LOAD MULTIPLE HIGH, STORE ACCESS MULTIPLE, STORE MULTIPLE, and STORE MULTIPLE HIGH, operand references must be within a single octoword.

If a constrained transaction violates any of constraints 1-7, listed above, then it is unpredictable whether a transaction-constraint program interruption is recognized. However, if a transaction-constraint program interruption is not recognized for one trans-

action-constraint violation, it may still be recognized for a subsequent violation within the same constrained transaction.

If the execution of a LOAD GUARDED or LOAD LOGICAL AND SHIFT GUARDED instruction results in the recognition of a guarded-storage event while the CPU is in the constrained transactional-execution mode, the transaction is aborted and the PSW instruction address and guarded-storage-event parameters are updated as described in "Guarded-Storage-Event Processing" on page 4-71.

Programming Notes:

1. The chance of successfully completing a constrained transaction improves if the transaction meets the following criteria:
 - a. The instructions issued are fewer than the maximum of 32.
 - b. The storage-operand references are fewer than the maximum of 4 octowords.
 - c. The storage-operand references are on the same cache line.
 - d. Storage-operand references to the same locations occur in the same order by all transactions.
2. A constrained transaction is not necessarily assured of successfully completing on its first execution. However, if a constrained transaction that does not violate any of the listed constraints is aborted, the CPU employs special circuitry to ensure that a repeated execution of the transaction is subsequently successful.
3. Within a constrained transaction, TRANSACTION BEGIN is a restricted instruction, thus a constrained transaction cannot be nested.
4. Violation of any of constraints 1-7 by a constrained transaction may result in a program loop.

Monitor-Event Counting

When the execution of a MONITOR CALL instruction causes a monitor event to occur, the enhanced-monitor facility is installed, and the enhanced-monitor-

mask bit corresponding to the monitor class is one, a monitor-event counting operation is performed. See “MONITOR CALL” on page 7-287 for further details on the execution of the MONITOR CALL instruction.

The enhanced-monitor counter-array size contained in the word at real location 264, extended on the left with 32 binary zeros, is logically compared with the monitor code formed by the first-operand address. If the monitor code is greater than or equal to the enhanced-monitor counter-array size, then one is logically added to the enhanced-monitor exception count contained in the word at real location 268, and the instruction completes. Any carry as a result of this addition is ignored.

If the monitor code is less than the enhanced-monitor counter-array size (extended on the left with 32 zeros), then one is added to the enhanced-monitor counter corresponding to the monitor code. An enhanced-monitor counter comprises two discontinuous storage locations: an unsigned halfword which is incremented first, and an unsigned word which is incremented whenever a carry out of bit position 0 of the halfword addition occurs.

The enhanced-monitor counter-array origin in bits 0-60 of the doubleword at real location 256, appended on the right with three binary zeros, forms the 64-bit virtual address of the enhanced-monitor counter array in the home address space.

Although the enhanced-monitor counter array is located in the home address space (as designated by control register 13), the updating of a counter occurs regardless of whether DAT is on. The access to the counters may be performed with the use of the translation-lookaside buffer (TLB), and TLB entries may be formed, regardless of whether DAT is on.

The enhanced-monitor-counter-array-size field at real location 264 specifies the number of halfword and word entries in the array; the halfword entries in the array appear first, followed immediately by the word entries.

The monitor code multiplied by two is added to the enhanced-monitor counter-array origin to form the 64-bit virtual address of a halfword to which one is logically added. If this addition results in a carry out of bit position 0 of the halfword, then one is logically added to the corresponding word. The enhanced-monitor-counter-array-size value multiplied by two is added to the monitor code multiplied by four; this

value is added to the enhanced-monitor counter-array origin to form the 64-bit virtual address of the word. Any carry in the word addition is ignored.

Key-controlled protection does not apply to any accesses made in the process of incrementing the counters. Except for addressing exceptions, any other access exception recognized in the process of incrementing the counters results in (a) one being logically added to the enhanced-monitor exception count contained in the word at real location 268, and (b) the instruction completing; any carry as a result of this addition is ignored. It is unpredictable whether an addressing-exception condition occurring in the process of incrementing an enhanced-monitor counter results in the incrementing of the enhanced-monitor exception counter or the recognition of the addressing exception.

The word portion of a counter is accessed only if the addition of the corresponding halfword portion of the counter results in an overflow. If the addition of the halfword results in an overflow, the storing of the updated halfword is performed only if both the halfword and word portions of the counter are accessible.

Locations within the enhanced-monitor counter array that are accessed by an enhanced-monitor counting operation are subject to PER storage-alteration events; however, PER storage-alteration events do not apply to updates made to the exception counter. During an enhanced-monitor counting operation, a PER storage-alteration event is recognized only if all counter-array locations updated by the event are accessible.

Figure 5-18 illustrates the structures used in the monitor-event-counting operation.

Programming Notes:

1. It is recommended that the enhanced-monitor counter array be allocated on a cache-line boundary of the CPU's first-level data cache. The cache line size may be determined by the EXTRACT CPU ATTRIBUTES (ECAG) instruction.
2. The enhanced-monitor counters may be incremented using a non-interlocked update. Therefore, each enhanced-monitor counter array should be processor unique.

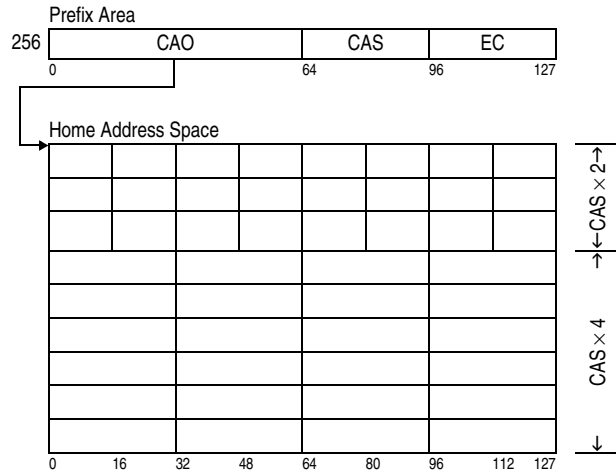

Explanation:

- CAO Enhanced-monitor counter-array origin
- CAS Enhanced-monitor counter-array size
- EC Enhanced-monitor exception count

Figure 5-18. Monitor-Event-Counting Structures

3. It is recommended that the enhanced-monitor-counter-array be allocated in fixed storage such that dynamic-address-translation (DAT) exceptions do not occur when accessing the array.
4. In the ESA/390-compatibility mode, all 16 bits of the enhanced-monitor mask (bits 16-31 of control register 8) are always zeros. Thus, an enhanced-monitor-counting event is never recognized in this mode.

ESA/390-Compatibility-Mode Facility

The ESA/390-compatibility-mode (390-CM) facility provides an environment supporting ESA/390 applications in a hybrid architectural mode having the following attributes:

- Except as described below, operation is similar to that of the ESA/390 architectural mode described in Reference [1.] on page xxix and the ESA/extended-configuration (ESA/XC) architecture described in Reference [12.] on page xxx.
- PSWs in assigned storage locations, in the second operand of LOAD PSW, and in the second operand of RESUME PROGRAM when the P bit in the parameter list is zero, all have the short-PSW format shown in Figure 4-3 on page 4-8,

except that when loading the PSW, (a) bit 5 must be zero, and (b) it is unpredictable whether bit 31 must be zero.

- The prefix area is a 4 K-byte block, aligned on a 4 K-byte boundary. The prefix register accommodates absolute addresses on a 4 K-byte boundary.

PSWs, interruption parameters, and the results of operator- or SIGP-initiated store-status operations in the prefix area are at the locations defined in the ESA/390 architecture.

- Low address protection applies only to effective addresses designating locations 0-511.
- Dynamic address translation is not supported. Attempted execution of any instruction that enables DAT results in the recognition of a specification exception.

Attempted execution of an instruction that implicitly performs DAT, including LOAD PAGE TABLE ENTRY ADDRESS, LOAD REAL ADDRESS, and STORE REAL ADDRESS, results in an operation exception being recognized, except that attempted execution of LOAD REAL ADDRESS may result in a privileged-operation exception in the problem state.

- The expanded-storage facility is not installed. Attempted execution of the PAGE IN and PAGE OUT instructions results in an operation exception being recognized.
- Instructions that may perform address-space-number (ASN) translation are not supported. Attempted execution of an instruction that may perform ASN translation results in a special-operation exception being recognized, except that it is unpredictable whether attempted execution of LOAD ADDRESS SPACE PARAMETERS results in an operation exception, privileged-operation exception (when the CPU is in the problem state), special-operation exception, or specification exception (if the first operand is not doubleword aligned). Consequently, ASN tracing is not supported.
- The branch-and-set-authority facility is not supported. Attempted execution of the BRANCH AND SET AUTHORITY instruction results in either an operation exception or special-operation exception being recognized.

- Except as noted below, access-register translation is not supported within the scope of the configuration (since, in most cases ART requires that DAT is enabled).

ART may be performed by the TEST ACCESS instruction. It is unpredictable whether a special-operation exception is recognized by TEST ACCESS when bit position 47 of control register 0 contains zero.

For configurations that are operating in the ESA/XC mode, ART may be performed for the configuration using tables provided by the host program. See Reference [12.] on page xxx for details of ART performed in this context.

- Bits 0-31 of the general, control, and prefix registers as defined in the ESA/390 architecture occupy bits 32-63 of the respective registers as defined in the z/Architecture architecture.
- Bits 0-31 of the (z/Architecture) control registers contain zeros and cannot be modified. Attempted execution of the LOAD CONTROL (LCTLG) instruction results in an operation exception being recognized. Because of this restriction, z/unique functions corresponding to the following controls are unavailable:
 - Transactional-execution control (CR0, bit 8)
 - Transactional-execution program-interruption-filtering override (CR0, bit 9)
 - Clock-comparator sign control (CR0, bit 10)
 - Measurement-counter-extraction-authorization control (CR0, bit 15)
 - Warning-track-interruption control (CR0, bit 30)
 - Enhanced-monitor masks (CR8, bits 16-31)
 - Branch and mode tracing controls (CR12, bits 0 and 1, respectively)
- It is unpredictable whether any of bits 32-63 of a control register that are unique to z/Architecture features have any effect, specifically:
 - It is unpredictable whether bit 32 of control registers 10 and 11 are used in forming the PER address range.
 - For explicit tracing, it is unpredictable whether bit 32 of control register 12 is used in forming the trace-entry address.
- If the program issues any other instruction that is defined as being unique to the z/Architecture architectural mode, it is unpredictable whether an

operation exception is recognized or the instruction executes according to its z/Architecture definition.

- If the program issues an instruction that is defined to enable the 64-bit addressing mode, the results are as follows:
 - For BRANCH AND SAVE AND SET MODE and BRANCH AND SET MODE, when the R_2 field is nonzero and bit 63 of general register R_2 is one, it is unpredictable whether (a) the CPU enters the 64-bit addressing mode, (b) bit 31 of the PSW is set to one, resulting in an early specification exception being recognized, or (c) the branch address in general register R_2 is considered to be odd, resulting in a late specification exception being recognized.
 - For LOAD PSW and RESUME PROGRAM, it is unpredictable whether (a) the CPU enters the 64-bit addressing mode, or (b) bit 31 of the PSW is set to one, resulting in an early specification exception being recognized. Similarly, if LOAD PSW EXTENDED does not result in an operation exception, the results are as described for LOAD PSW, above.
 - For SET ADDRESSING MODE (SAM64), it is unpredictable whether (a) the CPU enters the 64-bit addressing mode, or (b) an operation exception is recognized.
- If the program issues an instruction that is valid in both the ESA/390 and z/Architecture architectural modes, but the instruction specifies an attribute that is unique to the z/Architecture architectural mode, it is unpredictable whether an exception condition is recognized, the attribute is ignored, or the instruction executes according to its z/Architecture definition. This behavior applies as follows:
 - It is unpredictable whether the long displacement facility is installed. If installed, the long-displacement facility may apply to the following instructions:
 - ADD LOGICAL WITH CARRY (ALC)
 - COMPARE LOGICAL LONG UNICODE
 - DIVIDE LOGICAL (DL)
 - LOAD REVERSED (LRV, LRVH)
 - MOVE LONG UNICODE
 - MULTIPLY LOGICAL (ML)

- STORE REVERSED (STRV, STRVH)
 - SUBTRACT LOGICAL WITH BORROW (SLB)
- It is unpredictable whether the ETF3-enhancement facility is considered to be installed by the following instructions:
- CONVERT UTF-16 TO UTF8
 - CONVERT UTF8 TO UTF-16

If the ETF3-enhancement facility is not installed, then there is no M_3 field in bits 16-19 of the instruction, and enhanced well-formedness checking does not occur.

- It is unpredictable whether any of the CMPSC-enhancement facility, the entropy-encoding compression facility, and the order-preserving compression facility are considered to be installed by the COMPRESSION CALL instruction. When the facilities are not installed, their respective enablement controls are ignored.
- It is unpredictable whether any new function code added in the message-security-assist extension 3 or higher is supported by the following instructions:
- CIPHER MESSAGE
 - CIPHER MESSAGE WITH CHAINING
 - COMPUTE INTERMEDIATE MESSAGE DIGEST
 - COMPUTE LAST MESSAGE DIGEST
 - COMPUTE MESSAGE AUTHENTICATION CODE

If the function code is not supported, then a specification exception is recognized if the function is attempted. The query function will only indicate the availability of functions that are valid in the ESA/390 architectural mode.

- It is unpredictable whether functions of the PERFORM LOCKED OPERATION that are unique to z/Architecture operate as defined or result in a specification exception being recognized. The test operation will only indicate the availability of functions that are valid in the ESA/390 architectural mode.
- It is unpredictable whether z/Architecture-unique functions that have been added to floating-point instructions are available. Similarly, it is unpredictable whether z/Architecture unique controls and indications in the

floating-point-control register are available. See “Impacts on ESA/390 and ESA/390-Compatibility Mode” on page 9-52.

- It is unpredictable whether either or both the IPTE-range facility or the local-TLB-clearing facility is considered to be installed, as used by the INVALIDATE PAGE TABLE ENTRY instruction. When the facilities are not installed, their respective enablement controls are ignored. See “INVALIDATE PAGE TABLE ENTRY” on page 10-37 for details.
- It is unpredictable whether PER instruction-fetching nullification, zero-address-detection, and storage-key-alteration events are recognized.
 - SIGP order codes that are unique to the z/Architecture architectural mode result in an invalid-order status condition being recognized.

The ESA/390-compatibility mode is available only to a virtual machine under the control of a hypervisor program such as z/VM.

Programming-System Notes:

Sequence of Storage References

The following sections describe the effects which can be observed in storage due to overlapped operations and piecemeal execution of a CPU program. Most of the effects described in these sections are observable only when two or more CPUs or channel programs are in simultaneous execution and access common storage locations. Thus, most of the effects need be taken into account by a program only if the program interacts with another CPU or a channel program.

Some of the effects described in the following sections are independent of interaction with another CPU or a channel program. These effects, which are therefore more readily observable, relate to prefetched instructions and overlapping operands of a single instruction. These effects are described in “Conceptual Sequence” and in “Interlocks for Virtual-Storage References” on page 5-115.

Conceptual Sequence

The CPU conceptually processes instructions one at a time, with the execution of one instruction preced-

ing the execution of the following instruction. The execution of the instruction designated by a successful branch follows the execution of the branch. Similarly, an interruption takes place between instructions or, for interruptible instructions, between units of operation of such instructions.

The sequence of events implied by the processing just described is sometimes called the conceptual sequence.

Each operation of instruction execution appears to the program itself to be performed sequentially, with the current instruction being fetched after the preceding operation is completed and before the execution of the current operation is begun. This appearance is maintained even though the storage-implementation characteristics and overlap of instruction execution with storage accessing may cause actual processing to be different. The results generated are those that would have been obtained had the operations been performed in the conceptual sequence. Thus, it is possible for an instruction to modify the next succeeding instruction in storage.

A case in which the copies of prefetched instructions are not necessarily discarded occurs when the fetch and the store are done by means of different effective addresses that map to the same real address. This case is described in more detail in “Interlocks for Virtual-Storage References” on page 5-115.

When the transactional-execution facility is installed, the CPU may appear to deviate from the conceptual sequence to the extent that when a transaction is aborted, the following may be visible by the program:

- Although transactional stores are discarded, stores made by the NONTRANSACTIONAL STORE instruction are observable by all CPUs and by the channel subsystem.
- General registers that were altered by the transaction, but not designated to be saved by the TRANSACTION BEGIN instruction, contain modified values
- Access registers, vector registers, and floating-point registers (including the floating-point-control register) that were altered by the transaction contain modified values.
- The breaking-event-address register may contain the address of a breaking-event instruction within the aborted transaction.

- While in the nonconstrained transactional-execution mode, if a CPU makes transactional and non-transactional stores to the same storage location, and the transaction then aborts, the contents of the storage location are unpredictable.

Overlapped Operation of Instruction Execution

In simple models in which operations are not overlapped, the conceptual and actual sequences are essentially the same. However, in more complex machines, overlapped operation, buffering of operands and results, and execution times which are comparable to the propagation delays between units can cause the actual sequence to differ considerably from the conceptual sequence. Except as noted below, these machines employ special circuitry to detect dependencies between operations and ensure that the results obtained, as observed by the CPU which generates them, are those that would have been obtained if the operations had been performed in the conceptual sequence. However, other CPUs and channel programs may, unless otherwise constrained, observe a sequence that differs from the conceptual sequence.

Exceptions to the conceptual-sequence ordering of instruction execution are as follows:

- The modification of ART and DAT table entries may not have immediate effect on the conceptual sequence. See “Modification of Translation Tables” on page 3-67, “Modification of DAT-Table Entries” on page 5-27, and “Modification of ART Tables” on page 5-66 for further details.
- To improve performance, a machine may speculatively execute multiple instructions – including multiple instruction paths – in parallel, discarding results from the speculatively-executed instructions that do not represent the conceptual sequence. Speculative execution may result in the formation of ALB and TLB entries, even though such entries might not be created in the conceptual sequence. However, TLB and ALB entries are not formed as a result of, or subsequent to, the execution of following instructions unless such execution occurs in the conceptual sequence:
 - BRANCH IN SUBSPACE GROUP
 - LOAD CONTROL that alters control registers 0, 1, 2, 5, 7, 8, or 13

- LOAD PSW
- LOAD PSW EXTENDED
- LOAD PAGE TABLE ENTRY ADDRESS
- LOAD REAL ADDRESS
- MONITOR CALL that results in a monitor-counting operation
- MOVE WITH OPTIONAL SPECIFICATIONS
- PROGRAM CALL
- PROGRAM RETURN
- PROGRAM TRANSFER (WITH INSTANCE)
- SET ADDRESS SPACE CONTROL
- SET ADDRESS SPACE CONTROL FAST
- SET SECONDARY ASN (WITH INSTANCE)
- SET SYSTEM MASK
- STORE REAL ADDRESS
- STORE THEN AND SYSTEM MASK
- STORE THEN OR SYSTEM MASK
- TEST ACCESS

Divisible Instruction Execution

It can normally be assumed that the execution of each instruction occurs as an indivisible event. However, in actual operation, the execution of an instruction consists in a series of discrete steps. Depending on the instruction, operands may be fetched and stored in a piecemeal fashion, and some delay may occur between fetching operands and storing results. As a consequence, intermediate or partially completed results may be observable by other CPUs and by channel programs.

When a program interacts with the operation on another CPU, or with a channel program, the program may have to take into consideration that a single operation may consist in a series of storage references, that a storage reference may in turn consist in a series of accesses, and that the conceptual and observed sequences of these accesses may differ.

Storage references associated with instruction execution are of the following types: instruction fetches, ART-table and DAT-table fetches, and storage-operand references. For the purpose of describing the sequence of storage references, accesses to storage in order to perform ASN translation, PC-number translation, tracing, and the linkage-stack stacking and unstacking processes are considered to be storage-operand references.

Programming Note: The sequence of execution of a CPU may differ from the simple conceptual definition in the following ways:

- As observed by the CPU itself, instructions may appear to be prefetched when different effective addresses are used. (See “Interlocks for Virtual-Storage References”.)
- As observed by other CPUs and by channel programs, the execution of an instruction may appear to be performed as a sequence of piecemeal steps. This is described for each type of storage reference in the following sections.
- As observed by other CPUs and by channel programs, the storage-operand accesses associated with one instruction are not necessarily performed in the conceptual sequence. (See “Relation between Operand Accesses” on page 5-129.)
- As observed by channel programs, in certain unusual situations, the contents of storage may appear to change and then be restored to the original value.

Interlocks for Virtual-Storage References

As described in the immediately preceding sections, CPU operation appears, with certain exceptions, to be performed sequentially as observed by the CPU itself; the stores performed by one instruction generally appear to be completed before the next instruction and its operands are fetched. This appearance is maintained in overlapped machines by means of interlock circuitry that detects accesses to a common storage location.

For those instructions which alter the contents of storage and have more than one operand, the instruction definition normally describes the results that are obtained when the operands overlap in storage, this definition being in terms of a sequence of stores and fetches. The interlock circuitry is used in determining whether operand overlap exists.

The purpose of this section is to define those cases in which the machine must appear to operate sequentially, and in which operands of a single instruction must or must not be treated as overlapping.

Proper operation is provided in part by comparing effective addresses. For the purpose of this definition, the term “effective address” means an address

before translation, if any, regardless of whether the address is virtual, real, or absolute. If two effective addresses have the same value, the effective addresses are said to be the same even though one may be real or in a different address space.

The values of two virtual effective addresses do not necessarily indicate whether or not the addresses designate the same storage location. The address-translation tables may be set up so that different effective addresses map to the same real address, or so that the same effective address in different address spaces maps to different real addresses.

The interlocks for virtual-storage references are considered in two situations: storage references of one instruction as they affect storage references of another instruction, and multiple storage references of a single instruction.

Interlocks between Instructions

Except as described below, as observed by the CPU itself, the storage accesses for operands for each instruction appear to occur in the conceptual sequence independent of the effective address used. That is, the operand stores for one instruction appear to be completed before the operand fetches for the next instruction occur. For instruction fetches, the operand stores for one instruction necessarily appear to be completed before the next instruction is fetched only when the same effective address is used for the operand store and the instruction fetch.

When an instruction changes the contents of a main-storage location in which a conceptually subsequent instruction is to be executed, either directly or by means of an execute-type instruction, and when different effective addresses are used to designate that location for storing the result and fetching the instruction, the instruction may appear to be fetched before the store occurs. If an intervening operation causes the prefetched instructions to be discarded, then the updated value is recognized. A definition of when prefetched instructions must be discarded is included in “Instruction Fetching” on page 5-118.

Any change to the storage key appears to be completed before the conceptually following reference to the associated storage block is made, regardless of whether the reference to the storage location is made by means of a virtual, real, or absolute address. Analogously, any conceptually prior references to the

storage block appear to be completed when the key for that block is changed or inspected.

When the CPU is in the transactional-execution mode, and an instruction changes the contents of a main-storage location from which a conceptually subsequent instruction may be fetched, the transaction may be aborted with any of abort codes 14, 15, 16, or 255 and condition code 3.

Programming Note: Depending on the model, detection of a changed storage location may include any location within the same or adjacent cache lines as that of the store, regardless of whether the changed location is actually an instruction. Because of the characteristics described above and in the preceding paragraph, self-modifying code within a transaction is strongly discouraged.

Interlocks within a Single Instruction

For those instructions which alter the contents of storage and have more than one operand, the instruction definition normally describes the results which are obtained when the operands overlap in storage. This result is normally defined in terms of the sequence of the storage accesses; that is, a portion of the results of a store-type operand must appear to be placed in storage before some portion of the other operand is fetched. This definition applies provided that the store and fetch accesses are specified by means of the same effective addresses and the same effective space designations.

When multiple address spaces are involved in the access-register mode, the term “effective space designation” is used to denote the value used by the machine to determine whether two spaces are the same. In the access-register mode, the 32-bit access-list-entry-token (ALET) value associated with each storage-operand address is called the effective space designation. When a B field of zero is specified, a value of all zeros is used for the effective space designation. If the effective space designations are different, the spaces are considered to be different even if both ALETs map to the same address-space-control-element value.

When the store and the fetch accesses are specified by means of different effective space designations or by means of different effective addresses, the operand fetch may appear to precede the operand store.

Figure 5-19 on page 5-117 summarizes the cases of overlap and the specified results, including when

MOVE LONG (MVCL) sets condition code 3, for each case.

Effective Space Designations Equal?	Effective Addresses Overlap Destructively?	Operand Overlap Destructively in Real Storage?	Is Overlap Recognized?	
			MVCL Sets CC 3	Operand Results
Yes	No	No	No	No
		Yes	No	Unpredictable
	Yes	No	–	–
		Yes	Yes	Yes
No	No	No	No	No
		Yes	No	Unpredictable
	Yes	No	No	No
		Yes	No	Unpredictable
Explanation:				
– This case cannot occur.				

Figure 5-19. Virtual-Storage Interlocks within a Single Instruction

Effective space designations may be represented by ALB entries, and the test for whether two effective space designations are the same may be performed by comparing ALB entries. If the program changes an attached and valid ART-table entry without subsequently causing the execution of PURGE ALB or a COMPARE AND SWAP AND PURGE instruction that purges the ALB, two effective space designations that are the same may have different representations in the ALB, and failure to recognize operand overlap may result. The use of the ALB never causes overlap to be recognized when the effective space designations are different.

Programming Note: A single main-storage location can be accessed by means of more than one address in several ways:

1. The DAT tables may be set up such that multiple addresses in a single address space, or addresses in different address spaces, including the real address specified by a real-space designation, map to a single real address.
2. The translation of logical, instruction, and virtual addresses may be changed by loading the DAT parameters in the control registers, by changing the address-space-control bits in the PSW, or, for logical and instruction addresses, by turning DAT on or off.
3. In the access-register mode, different address spaces may be selected by means of each

access register. In addition, the primary address space is selected for instruction fetching and the target of an execute-type instruction.

4. STORE USING REAL ADDRESS performs a store by means of a real address.
5. Certain other instructions also use real addresses (even when a logical address is not translated by means of a real-space designation, which is a situation covered in case 1), the instructions MOVE TO PRIMARY and MOVE TO SECONDARY access two address spaces, and the instruction MOVE WITH OPTIONAL SPECIFICATIONS may access one or two address spaces.
6. Accesses to storage for the purpose of storing and fetching information for interruptions is performed by means of real addresses, and, for the store-status function, by means of absolute addresses, whereas accesses by the program may be by means of virtual addresses.
7. The real-to-absolute mapping may be changed by means of the SET PREFIX instruction or a reset.
8. A main-storage location may be accessed by channel programs by means of an absolute address and by the CPU by means of an absolute, a real, or a virtual address.

9. A main-storage location may be accessed by another CPU by means of one type of address and by this CPU by means of a different type of address.

The primary purpose of this section on interlocks is to describe the effects caused in cases 1, 3, and 4, above.

For case 2, no effect is observable because prefetched instructions are discarded when the translation parameters are changed, and the delay of stores by a CPU is not observable by the CPU itself.

For case 5, for those instructions which fetch by using real addresses (for example, LOAD REAL ADDRESS, which fetches a segment-table entry and a page-table entry, and may fetch a region-table entry), no effect is observable because only operand accesses between instructions are involved. All instructions that store by using a real address, except STORE USING REAL ADDRESS, or that store across address spaces, except in the access-register mode, cause prefetched instructions to be discarded, and no effect is observable.

Cases 6 and 7 are situations which are defined to cause serialization, with the result that prefetched instructions are discarded. In these cases, no effect is observable.

The handling of cases 8 and 9 involves accesses as observed by other CPUs and by channel programs and is covered in the following sections in this chapter.

Instruction Fetching

Instruction fetching consists in fetching the one, two, or three halfwords designated by the instruction address in the current PSW. The immediate field of an instruction is accessed as part of an instruction fetch. If, however, an instruction designates a storage operand at the location occupied by the instruction itself, the location is accessed both as an instruction and as a storage operand. The fetch of the target instruction of an execute-type instruction is considered to be an instruction fetch.

The bytes of an instruction may be fetched piecemeal and are not necessarily accessed in a left-to-right direction. The instruction may be fetched multiple times for a single execution; for example, it may be

fetched for testing the addressability of operands or for inspection of PER events, and it may be refetched for actual execution.

Instructions are not necessarily fetched in the sequence in which they are conceptually executed and are not necessarily fetched each time they are executed. In particular, the fetching of an instruction may precede the storage-operand references for an instruction that is conceptually earlier. The instruction fetch occurs prior to all storage-operand references for all instructions that are conceptually later.

An instruction may be prefetched by using a virtual address only when the associated DAT table entries are attached and valid or when entries which qualify for substitution for the table entries exist in the TLB. An instruction that has been prefetched may be interpreted for execution only for the same virtual address for which the instruction was prefetched.

No limit is established on the number of instructions which may be prefetched, and multiple copies of the contents of a single storage location may be fetched. As a result, the instruction executed is not necessarily the most recently fetched copy. Storing caused by other CPUs and by channel programs does not necessarily change the copy of prefetched instructions. However, if a store that is conceptually earlier is made by the same CPU using the same effective address as that by which the instruction is subsequently fetched, the updated information is obtained, except as noted below. If the effective addresses are different, the updated information is not necessarily obtained. However, the updated information is obtained if either execution is in the real mode since prefetched instructions are discarded if DAT is turned on or off.

All copies of prefetched instructions are discarded when:

- A serializing function is performed. However, for PROGRAM TRANSFER, PROGRAM TRANSFER WITH INSTANCE, SET SECONDARY ASN, SET SECONDARY ASN WITH INSTANCE, and TRACE, it is unpredictable whether or not a store into a trace-table entry from which a subsequent instruction is fetched will be observed by the CPU that performed the store; for PROGRAM CALL and PROGRAM RETURN it is unpredictable whether or not a store into a trace-table entry or linkage-stack entry from which a subsequent instruction is fetched will be observed by

the CPU that performed the store. Additionally, when the store-clock-fast facility is installed and the TRACE TOD-clock control in bit 32 of control register 0 is one, it is unpredictable whether explicit tracing causes serialization to be performed.

- The CPU enters the operating state.
- DAT is turned on or off.
- A change is made to a translation parameter in control register 1 when in the primary-space, secondary-space, or access-register mode, or in control register 13 when in the home-space mode.

The SET ADDRESS SPACE CONTROL instruction can change the translation mode between any of the primary-space, secondary-space, access-register, and home-space modes, and it performs serialization. The SET ADDRESS SPACE CONTROL FAST instruction can perform the same mode changes, but it does not serialize.

Programming Notes:

1. As observed by a CPU itself, its own instruction prefetching may be apparent when different effective addresses map to a single real address. This is described in “Conceptual Sequence” on page 5-113 and “Interlocks for Virtual-Storage References” on page 5-115.
2. Any means of changing PSW bits 16 and 17, except the SET ADDRESS SPACE CONTROL FAST instruction, causes serialization to be performed and prefetched instructions to be discarded. Turning DAT on or off causes prefetched instructions to be discarded. Therefore, any change of the translation mode, except a change made by SET ADDRESS SPACE CONTROL FAST, always causes prefetched instructions to be discarded.
3. The following are some effects of instruction prefetching on one CPU as observed by other CPUs and by channel programs.

It is possible for one CPU to prefetch the contents of a storage location, after which another CPU or a channel program can change the contents of that storage location and then set a flag to indicate that the change has been made. Subsequently, the first CPU can test and find the flag

set, branch to the modified location, and execute the original prefetched contents.

It is possible, if another CPU or a channel program concurrently modifies the instruction, for one CPU to recognize the changes to some but not all bit positions of an instruction.

It is possible for one CPU to prefetch an instruction and subsequently, before the instruction is executed, for another CPU to change the storage key. As a result, the first CPU may appear to execute instructions from a protected storage location. However, the copy of the instructions executed is the copy prefetched before the location was protected.

4. Previous versions of both the *ESA/390 Principles of Operation* and the *z/Architecture Principles of Operation* have allowed a CPU to not recognize a store into the instruction stream when the CPU was operating in the home-space or access-register modes. To ensure that stores into the instruction stream were recognized in these modes, the program was required to insert a serializing operation following the store.

No IBM processor has ever implemented this characteristic; stores into the instruction stream using the same effective address as that by which a subsequent instruction is fetched have always been recognized, regardless of the address-space-control mode. This characteristic is now removed from the architecture. Any serializing operations that were inserted to ensure recognition of stores into the instruction stream while in the AR or home-space modes may be safely removed from programs that execute on IBM processors.

ART-Table and DAT-Table Fetches

The access-register-translation (ART) table entries are access-list designations, access-list entries, ASN-second-table entries, and authority-table entries. The dynamic-address-translation (DAT) table entries are region-table entries, segment-table entries, and page-table entries. The fetching of these entries may occur as follows:

1. An ART-table entry may be prefetched into the ART-lookaside buffer (ALB) and used from the ALB without refetching from storage, until the entry is cleared by a COMPARE AND SWAP

AND PURGE, PURGE ALB, or SET PREFIX instruction, by CPU reset, or by a set prefix or set-architecture SIGNAL PROCESSOR order. A DAT-table entry may be prefetched into the translation-lookaside buffer (TLB) and used from the TLB without refetching from storage, until the entry is cleared by a COMPARE AND REPLACE DAT TABLE ENTRY, COMPARE AND SWAP AND PURGE, INVALIDATE DAT TABLE ENTRY, INVALIDATE PAGE TABLE ENTRY, PURGE TLB, or SET PREFIX instruction, by CPU reset, or by a set prefix or set-architecture SIGNAL PROCESSOR order. ART-table and DAT-table entries are not necessarily fetched in the sequence conceptually called for; they may be fetched at any time they are attached and valid, including during the execution of conceptually previous instructions.

2. The fetching of access-list designations, access-list entries, ASN-second-table entries, and DAT-table entries appears to be word concurrent as observed by other CPUs, except that the fetching of an address-space-control element from an ASN-second-table entry appears to be double-word concurrent as observed by other CPUs. The reference to an entry may appear to access a single byte at a time as observed by channel programs.
3. The order in which the words of an access-list entry or ASN-second-table entry are fetched is unpredictable, except that the leftmost word of an entry is fetched first. However, the leftmost word of an ASN-second-table entry is not fetched when access-list-entry token 00000000 hex is translated for BRANCH IN SUBSPACE GROUP.
4. An ART-table or DAT-table entry may be fetched even after some operand references for the instruction have already occurred. The fetch may occur as late as just prior to the actual byte access requiring the ART-table or DAT-table entry.
5. An ART-table or DAT-table entry may be fetched for each use of the address, including any trial execution, and for each reference to each byte of each operand.
6. The DAT page-table-entry fetch precedes the reference to the page. When no copy of the page-table entry is in the TLB, the fetch of the associated segment-table entry precedes the fetch of the page-table entry. When no copy of the seg-

ment-table entry is in the TLB, the fetch of the region-third-table entry, if one is required, precedes the fetch of the segment-table entry. Similarly, the fetch of a required region-second-table entry precedes the fetch of the region-first-table entry, and the fetch of a required region-first-table entry precedes the fetch of the region-second-table entry.

7. When no copy of a region-table entry or segment-table entry designated by means of an ART-obtained address-space-control element is in the TLB, the ART fetch of the ASN-second-table entry precedes the DAT region-table-entry or segment-table-entry fetch. When no copy of a required authority-table entry is in the ALB, the ART fetch of the associated ASN-second-table entry precedes the fetch of the authority-table entry. When no copy of a required ASN-second-table entry is in the ALB, the fetch of the associated access-list entry precedes the fetch of the ASN-second-table entry. When no copy of a required access-list entry is in the ALB, the fetch of the associated access-list designation precedes the fetch of the access-list entry.

Storage-Key Accesses

In the following sections, the term *key-setting instruction* refers either to the SET STORAGE KEY EXTENDED instruction, to the PERFORM FRAME MANAGEMENT FUNCTION instruction when the set-key control is one, or to the MOVE PAGE instruction when setting the storage key. When the nonquiescing key-setting facility is installed, a *nonquiescing key-setting instruction* refers to a SET STORAGE KEY EXTENDED instruction in which the nonquiescing control is set to one, to a PERFORM FRAME MANAGEMENT FUNCTION instruction in which the set-key control is set to one, and to a MOVE PAGE instruction when setting the storage key. (For PFMF, it is unpredictable whether a quiescing operation is performed when the nonquiescing key-setting facility is installed; thus in the following discussion, PFMF may be considered to be either quiescing or nonquiescing.)

References to the storage key are handled as follows:

1. Whenever a reference to storage is made and key-controlled protection applies to the reference, the four access-control bits and the fetch-

protection bit associated with the storage location are inspected concurrently. The inspection of the access-control and fetch-protection bits occurs concurrently with the reference to the storage location, except that when a nonquiescing key-setting operation is performed for a storage location by one CPU, the following applies:

- The inspection of the access-control and fetch-protection bits for the storage location by any CPU may precede a store reference to the location. In the case where the inspection of the access-control and fetch-protection bits precedes the store, the inspection occurs no earlier than after the last serialization operation on the CPU, and no earlier than the last quiescing key-setting operation for the same storage location on any CPU.
- When a unit of operation or instruction execution on any other CPU causes multiple accesses to the same 4 K-byte block as that of the key-setting operation, the other CPU necessarily inspects the access-control and fetch-protection bits only for the first reference to the block. The other CPU does not necessarily inspect the access-control and fetch-protection bits for the subsequent accesses within the block by the same unit of operation.

When (a) EDAT-1 does not apply,¹ (b) EDAT-1 applies but the storage is accessed by means of a segment-table entry in which the STE-format control is zero, (c) EDAT-1 applies, the storage is accessed by means of a segment-table entry in which the STE-format control is one, but the ACCF-validity control is zero, or (d) EDAT-2 applies, the storage is accessed by means of a region-third-table entry in which the RTTE-format control is one, but the ACCF-validity control is zero, the access-control bits and the fetch-protection bit are in bits 0-4 of the storage key for the 4 K-byte block.

When EDAT-1 applies and the storage is accessed by means of a segment-table entry in which both the STE-format control and ACCF-validity control are one, it is unpredictable whether bits 0-4 of the storage key or bits 48-52 of the segment-table entry provide the access-control bits and fetch-protection bit. Furthermore, when the segment-table entry provides the access-control bits and fetch-protection bit, a

buffered copy from the translation-lookaside buffer may be used.

When EDAT-2 applies and the storage is accessed by means of a region-third-table entry in which both the RTTE-format control and ACCF-validity control are one, it is unpredictable whether bits 0-4 of the storage key or bits 48-52 of the region-third-table entry provide the access-control bits and fetch-protection bit. Furthermore, when the region-third-table entry provides the access-control bits and fetch-protection bit, a buffered copy from the translation-lookaside buffer may be used.

For accesses made by the channel subsystem, the access-control bits and fetch-protection bits are in bits 0-4 of the storage key for the 4 K-byte block.

2. When storing is performed by a CPU, the change bit is set to one in the associated storage key concurrently with the completion of the store access, as observed by the CPU itself. When storing is performed by a CPU or a channel program, the change bit is set to one in the associated storage key either before or after the completion of the store access, as observed by other (if the store was performed by a CPU) or all (if the store was performed by a channel program) CPUs. As observed by other or all CPUs, the change bit is set no earlier than (1) after the last serialization function performed previously by the CPU or channel program performing the store, and (2) after the execution, by any CPU in the configuration, of a quiescing key-setting instruction that last set the associated storage key before the completion of the store. As observed by other or all CPUs, a change-bit setting necessarily occurs only when any of the following occurs subsequent to the storing operation:

- The CPU or channel program that performed the store performs a serialization function.
- The store was performed by a CPU or a channel program, and any CPU in the configuration sets the subject change bit by executing a key-setting instruction after the store access is completed. The change-bit setting due to the store access occurs before the setting by the key-setting instruction, except that when the nonquiescing key-setting facil-

1. See "Enhanced-DAT Terminology:" on page 3-41 for an explanation of EDAT applicability.

ity is installed, the change bit may appear to be set following a nonquiescing key-setting instruction.

- The store was performed by a CPU and is or will be completed, and any CPU in the configuration executes a COMPARE AND REPLACE DAT TABLE ENTRY, COMPARE AND SWAP AND PURGE, INVALIDATE DAT TABLE ENTRY, or INVALIDATE PAGE TABLE ENTRY instruction that clears from the ALB or TLB of the storing CPU any entry used to complete the store. Completion of the clearing instruction is delayed until the subject store and change-bit setting have been completed.
 - The store was performed by a CPU, and that CPU examines the subject change bit by means of an INSERT STORAGE KEY EXTENDED or RESET REFERENCE BIT EXTENDED instruction. See “Relation between Operand Accesses” on page 5-129.
3. The following discussion assumes that other CPUs are not simultaneously executing nonquiescing key-setting operations for the same storage key. See the programming note below.
- a. When the conditional-SSKE facility is not installed, the SET STORAGE KEY EXTENDED instruction causes all seven bits to be set concurrently in the storage key. When the conditional-SSKE facility is installed, SET STORAGE KEY EXTENDED may be used to set all or portions of the storage key based on program-specified criteria. The access to the storage key for SET STORAGE KEY EXTENDED follows the sequence rules for storage-operand store references and is a single-access reference. When the enhanced-DAT facility is installed, SET STORAGE KEY EXTENDED or PERFORM FRAME MANAGEMENT FUNCTION may be used to set all or portions of one or more storage keys based on program-specified criteria. When the move-page-and-set-key facility is installed, MOVE PAGE may be used to set the key based on program-specified criteria.
 - b. The INSERT STORAGE KEY EXTENDED instruction provides a consistent image of bits 0-6 of the storage key for a 4 K-byte block. Similarly, the instructions INSERT

VIRTUAL STORAGE KEY and TEST PROTECTION provide a consistent image of the access-control bits and the fetch-protection bit. The access to the storage key for all of these instructions follows the sequence rules for storage-operand fetch references and is a single-access reference.

- c. The instruction RESET REFERENCE BIT EXTENDED modifies only the reference bit. All other bits of the storage key remain unchanged. The reference bit and change bit are inspected concurrently to set the condition code. The fetch and store accesses to the storage key for RESET REFERENCE BIT EXTENDED follow the sequence rules for storage-operand fetch and store references, respectively, and are single-access references.
- d. For each of the 64 storage keys accessed, the instruction RESET REFERENCE BITS MULTIPLE modifies only the reference bit. All other bits of the storage key remain unchanged. The fetch and store accesses to each of the individual storage keys for RESET REFERENCE BITS MULTIPLE follow the sequence rules for storage-operand fetch and store references, respectively, and are single-access references.

The record of references provided by the reference bit is not necessarily accurate. However, in the majority of situations, reference recording approximately coincides with the related storage reference.

The change bit may be set in cases when no storing has occurred. See “Exceptions to Nullification and Suppression” on page 5-26.

Programming Note: When a nonquiescing key-setting instruction is executed on one CPU to set the storage key of a block, the program should ensure that no other CPU or I/O subsystem is simultaneously referencing the storage block in which the key is being set; similarly, the program should ensure that no other CPU is attempting to set the storage key of the block. In a virtual storage environment, the program can ensure that other CPUs do not access the block using a virtual address by simply not mapping the block to any virtual address.

Failure to comply with this restriction may result in either of the following:

- An unpredictable storage key for the block may be used in the enforcement of key-controlled protection.
- An unpredictable storage key for the block may be inspected by key-inspecting instructions such as IRBM, ISKE, IVSK, RRBE, and RRBm.

Storage-Operand References

A storage-operand reference is the fetching or storing of the explicit operand or operands in the storage locations designated by the instruction.

During the execution of an instruction, all or some of the storage operands for that instruction may be fetched, intermediate results may be maintained for subsequent modification, and final results may be temporarily held prior to placing them in storage. Stores caused by other CPUs and by channel programs do not necessarily affect these intermediate results.

Storage-operand references are of three types: fetches, stores, and updates.

Storage-Operand Fetch References

When the bytes of a storage operand participate in the instruction execution only as a source, the operand is called a fetch-type operand, and the reference to the location is called a storage-operand fetch reference. A fetch-type operand is identified in individual instruction definitions by indicating that the access exception is for fetch.

All bits within a single byte of a fetch-type operand are accessed concurrently. When an operand consists of more than one byte, the bytes may be fetched from storage piecemeal, one byte at a time. Unless otherwise specified, the bytes are not necessarily fetched in any particular sequence.

The storage-operand fetch references of one instruction occur after those of all preceding instructions and before those of subsequent instructions, as observed by other CPUs and by channel programs. The operands of any one instruction are fetched in the sequence specified for that instruction. The CPU may fetch the operands of instructions before the instructions are executed. There is no defined limit on the length of time between when an operand is fetched and when it is used. Still, as observed by the

CPU itself, its storage-operand references are performed in the conceptual sequence.

For certain special instructions, the fetch references for multiple operands may appear to be interlocked against certain accesses by other CPUs and by channel programs. Such a fetch reference is called an interlocked-fetch reference. The fetch accesses associated with an interlocked-fetch reference do not necessarily occur one immediately after the other, but store accesses by other CPUs may not occur at the same locations as the interlocked-fetch reference between the fetch accesses of the interlocked-fetch reference.

The storage-operand fetch reference for the LOAD PAIR DISJOINT instruction may be an interlocked-fetch reference. Whether or not LOAD PAIR DISJOINT is able to fetch both operands by means of an interlocked fetch is indicated by the condition code.

Storage-Operand Store References

When the bytes of a storage operand participate in the instruction execution only as a destination, to the extent of being replaced by the result, the operand is called a store-type operand, and the reference to the location is called a storage-operand store reference.

A store-type operand is identified in individual instruction definitions by indicating that the access exception is for store.

All bits within a single byte of a store-type operand are accessed concurrently. When an operand consists of more than one byte, the bytes may be placed in storage piecemeal, one byte at a time. Unless otherwise specified, the bytes are not necessarily stored in any particular sequence.

The CPU may delay placing results in storage. There is no defined limit on the length of time that results may remain pending before they are stored. This delay does not affect the sequence in which results are placed in storage.

With the exceptions noted below, the results of one instruction are placed in storage after the results of all preceding instructions have been placed in storage and before any results of the succeeding instructions are stored, as observed by other CPUs and by the channel subsystem. However, the following exception cases exist:

- When a transaction aborts, only the results of non transactional stores are committed to storage; transactional stores are discarded.

The results of any one instruction are stored in the sequence specified for that instruction.

The CPU does not fetch operands, ART-table entries, or DAT-table entries from a storage location until all information destined for that location by the CPU has been stored. Prefetched instructions may appear to be updated before the information appears in storage.

The stores are necessarily completed only as a result of a serializing operation and before the CPU enters the stopped state.

Storage-Operand Update References

In some instructions, the storage-operand location participates both as a source and as a destination. In these cases, the reference to the location consists first in a fetch and subsequently in a store. The operand is called an update-type operand, and the combination of the two accesses is referred to as an update reference. Instructions such as MOVE ZONES, TRANSLATE, OR (OC, OI), and ADD DECIMAL cause an update to the first-operand location. An update-type operand is identified in the individual instruction definition by indicating that the access exception is for both fetch and store.

Noninterlocked-Update References: For most instructions which have update-type operands, the fetch and store accesses associated with an update reference do not necessarily occur one immediately after the other, and it is possible for other CPUs and channel programs to make fetch and store accesses to the same location during this time. Such an update reference is sometimes called a noninterlocked-update storage reference.

Interlocked-Update References: For certain special instructions, the update reference is interlocked against certain accesses by other CPUs and channel programs. Such an update reference is called an interlocked-update reference. The fetch and store accesses associated with an interlocked-update reference do not necessarily occur one immediately after the other, but all store accesses by other CPUs and channel programs and the fetch and store accesses associated with interlocked-update references by other CPUs are prevented from occurring at

the same location between the fetch and the store accesses of an interlocked-update reference.

The storage-operand update reference for the following instructions appears to be an interlocked-update reference as observed by other CPUs and channel programs.

- ADD IMMEDIATE (ASI and AGSI), when the interlocked-access facility 1 is installed and the first operand is aligned on an integral boundary corresponding to its size
- ADD LOGICAL WITH SIGNED IMMEDIATE, when the interlocked-access facility 1 is installed and the first operand is aligned on an integral boundary corresponding to its size
- AND (NI and NIY), when the interlocked-access facility 2 is installed
- COMPARE AND REPLACE DAT TABLE ENTRY
- COMPARE AND SWAP
- COMPARE AND SWAP AND PURGE
- COMPARE AND SWAP AND STORE
- COMPARE DOUBLE AND SWAP
- EXCLUSIVE OR (XI and XIY), when the interlocked-access facility 2 is installed
- LOAD AND ADD
- LOAD AND ADD LOGICAL
- LOAD AND AND
- LOAD AND EXCLUSIVE OR
- LOAD AND OR
- OR (OI and OIY), when the interlocked-access facility 2 is installed
- STORE CHARACTERS UNDER MASK, on models in which the instruction with a mask of zero fetches and stores the byte designated by the second-operand address
- TEST AND SET

Within the limitations of the above requirements, the fetch and store accesses associated with an update reference follow the same rules as the fetches and stores described in the previous sections.

Programming Notes:

1. When two CPUs attempt to update information at a common main-storage location by means of a noninterlocked-update reference, it is possible for both CPUs to fetch the information and subsequently make the store access. The change made by the first CPU to store the result in such a case is lost. Similarly, if one CPU updates the contents of a field by means of a noninterlocked-update reference, but another CPU makes a

store access to that field between the fetch and store parts of the update reference, the effect of the store is lost. If, instead of a store access, a CPU makes an interlocked-update reference to the common storage field between the fetch and store portions of a noninterlocked-update reference due to another CPU, any change in the contents produced by the interlocked-update reference is lost.

2. Except for STORE CHARACTERS UNDER MASK, the instructions listed in this section (“Interlocked-Update References”) facilitate updating of a common storage field by two or more CPUs. To ensure that no changes are lost, all CPUs must use an instruction providing an interlocked-update reference.
3. Only those bytes which are included in the result field of both operations are considered to be part of the common main-storage location. However, all bits within a common byte are considered to be common even if the bits modified by the two operations do not overlap. As an example, if (1) one CPU executes the instruction OR (OC) with a length of 1 and the value 80 hex in the second-operand location, (2) the other CPU executes AND (NC) with a length of 1 and the value FE hex in the second-operand location, and (3) the first operand of both instructions is the same byte, then the result of one of the updates can be lost. This is because the updates to the byte by both NC and OC are not interlocked-update references.
4. When the store access is part of an update reference by the CPU, the execution of the storing is not necessarily contingent on whether the information to be stored is different from the original contents of the location. In particular, the contents of all designated byte locations are replaced, and, for each byte in the field, the entire contents of the byte are replaced.

Depending on the model, an access to store information may be performed, for example, in the following cases:

- a. Execution of the OR instruction (OI, OIY, or OC) with a second operand of all zeros.
- b. Execution of OR (OC) with the first-and second-operand fields coinciding.
- c. For those locations of the first operand of TRANSLATE where the argument and function values are the same.

Storage-Operand Consistency

Single-Access References

A fetch reference is said to be a single-access reference if the value is fetched in a single access to each byte of the data field. In the case of overlapping operands, the location may be accessed once for each operand. A store-type reference is said to be a single-access reference if a single store access occurs to each byte location within the data field. An update reference is said to be single access if both the fetch and store accesses are each single access.

Except for the accesses associated with multiple-access references and the stores associated with storage change and restoration for DAT-associated access exceptions, all storage-operand references are single-access references.

Multiple-Access References

In some cases, multiple accesses may be made to all or some of the bytes of a storage operand. The following cases may involve multiple-access references:

1. The storage operands of the following instructions:
 - CHECKSUM
 - CIPHER MESSAGE
 - CIPHER MESSAGE WITH AUTHENTICATION
 - CIPHER MESSAGE WITH CIPHER FEEDBACK
 - CIPHER MESSAGE WITH CHAINING
 - CIPHER MESSAGE WITH COUNTER
 - CIPHER MESSAGE WITH OUTPUT FEEDBACK
 - COMPARE AND FORM CODEWORD
 - COMPARE UNTIL SUBSTRING EQUAL
 - COMPUTE INTERMEDIATE MESSAGE DIGEST
 - COMPUTE LAST MESSAGE DIGEST
 - COMPUTE MESSAGE AUTHENTICATION CODE
 - CONVERT FROM PACKED
 - CONVERT FROM ZONED
 - CONVERT TO BINARY
 - CONVERT TO DECIMAL

- CONVERT TO PACKED
 - CONVERT TO ZONED
 - CONVERT UTF-16 TO UTF-32
 - CONVERT UTF-16 TO UTF-8
 - CONVERT UTF-32 TO UTF-16
 - CONVERT UTF-32 TO UTF-8
 - CONVERT UTF-8 TO UTF-16
 - CONVERT UTF-8 TO UTF-32
 - LOAD ADDRESS SPACE PARAMETERS
 - MOVE INVERSE
 - MOVE LONG UNICODE
 - MOVE PAGE
 - MOVE RIGHT TO LEFT
 - MOVE WITH OFFSET
 - PACK
 - PACK ASCII
 - PACK UNICODE
 - PERFORM CRYPTOGRAPHIC COMPUTATION
 - PERFORM CRYPTOGRAPHIC KEY MANAGEMENT OPERATION
 - PERFORM FRAME MANAGEMENT FUNCTION, when the clear-frame control is one
 - PERFORM RANDOM NUMBER OPERATION
 - RESUME PROGRAM
 - STORE SYSTEM INFORMATION
 - TEST BLOCK
 - TRANSLATE
 - TRANSLATE AND TEST
 - TRANSLATE AND TEST EXTENDED
 - TRANSLATE AND TEST REVERSE
 - TRANSLATE AND TEST REVERSE EXTENDED
 - TRANSLATE EXTENDED
 - TRANSLATE ONE TO ONE
 - TRANSLATE ONE TO TWO
 - TRANSLATE TWO TO ONE
 - TRANSLATE TWO TO TWO
 - UNPACK
 - UNPACK ASCII
 - UNPACK UNICODE
 - UPDATE TREE
2. The storage operands of MOVE LONG and MOVE LONG EXTENDED, when the padding character is not B1 hex.
 3. The stores into that portion of the first operand of MOVE LONG, MOVE LONG EXTENDED, or MOVE LONG UNICODE which is filled with padding bytes.
 4. The storage operands of the decimal instructions.

5. The main-storage operands of PAGE IN and PAGE OUT.
6. The storage operands of the I/O instructions.
7. The stores into a trace entry.
8. The stores associated with the stop-and-store-status and store-status-at-address SIGNAL PROCESSOR orders.
9. The trap control block and trap save area used by TRAP.
10. The operands, dictionaries, and symbol-translation table of COMPRESSION CALL.
11. The operands and parameter block of DEFLATE CONVERSION CALL.
12. The storage operand and parameter block of COMPUTE DIGITAL SIGNATURE AUTHENTICATION.

When a storage-operand store reference to a location is not a single-access reference, the value placed at a byte location is not necessarily the same for each store access; thus, intermediate results in a single-byte location may be observed by other CPUs and by channel programs.

Programming Notes:

1. When multiple fetch, store, or update accesses are made to a single byte that is being changed by another CPU or by a channel program, the result is not necessarily limited to that which could be obtained by fetching or storing the bits individually. For example, the execution of MULTIPLY DECIMAL may consist in repetitive additions and subtractions, each of which causes the second operand to be fetched from storage and the first operand to be updated in storage.
2. When CPU instructions which make multiple-access references are used to modify storage locations being simultaneously accessed by another CPU or by a channel program, multiple store accesses to a single byte by the CPU may result in intermediate values being observed by the other CPU or by the channel program. To avoid these intermediate values (for example, when modifying a CCW chain), only instructions making single-access references should be used.

3. An instruction fetch, including the fetch of the target of an execute-type instruction, is a multiple-access reference.

Block-Concurrent References

For some references, the accesses to all bytes within a halfword, word, doubleword, or quadword are specified to appear to be block concurrent as observed by other CPUs and channel programs. The halfword, word, doubleword, or quadword is referred to in this section as a block. When a fetch-type reference is specified to appear to be concurrent within a block, no store access to the block by another CPU or channel program is permitted during the time that bytes contained in the block are being fetched. When a store-type reference is specified to appear to be concurrent within a block, no access to the block, either fetch or store, is permitted by another CPU or channel program during the time that the bytes within the block are being stored.

For all instructions in the RX, RXE, RXY, S, SIL, SIY, VRV, and VRX formats, with the exception of CONVERT TO DECIMAL, CONVERT TO BINARY, LOAD PSW EXTENDED, RESUME PROGRAM, STORE CLOCK EXTENDED, STORE SYSTEM INFORMATION, TRAP, VECTOR LOAD, VECTOR LOAD TO BLOCK BOUNDARY, VECTOR STORE, and the I/O instructions, when the operand is addressed on a boundary which is integral to the size of the operand, the storage-operand references appear to be block concurrent as observed by other CPUs. For LOAD PSW EXTENDED, the accesses to each of the two doublewords of the storage operand appear to be doubleword concurrent as observed by other CPUs.

For the instructions VECTOR LOAD, VECTOR LOAD MULTIPLE, VECTOR LOAD TO BLOCK BOUNDARY, VECTOR STORE, and VECTOR STORE MULTIPLE, when the operand is addressed on an integral block boundary up to eight bytes, the storage-operand references appear to be block concurrent with respect to that integral block boundary. Note that integral boundaries greater than eight bytes are by definition on an integral 8 byte boundary.

For VECTOR LOAD WITH LENGTH, VECTOR LOAD RIGHTMOST WITH LENGTH, VECTOR STORE WITH LENGTH, and VECTOR STORE RIGHTMOST WITH LENGTH, when the operand is addressed on an integral boundary up to eight bytes and the number of bytes accessed is a multiple of the integral boundary, the storage-operand references

appear to be block concurrent with respect to that integral block boundary. If the number of bytes accessed is less than the integral boundary, the storage-operand references appear to be block concurrent with an integral boundary that is the greatest common power of two divisor between the storage-operand address and the number of bytes accessed. For example, if the storage-operand address is on a doubleword boundary and the number of storage-operand bytes is a multiple of two, the storage-operand references will appear halfword concurrent as observed by other CPUs.

For the instructions COMPARE AND SWAP, COMPARE AND SWAP AND PURGE, COMPARE DOUBLE AND SWAP, COMPARE HALFWORD RELATIVE LONG, COMPARE LOGICAL RELATIVE LONG, COMPARE RELATIVE LONG, LOAD AND ADD, LOAD AND ADD LOGICAL, LOAD AND AND, LOAD AND EXCLUSIVE OR, LOAD AND OR, LOAD HALFWORD RELATIVE LONG, LOAD LOGICAL HALFWORD RELATIVE LONG, LOAD LOGICAL RELATIVE LONG, LOAD PAIR DISJOINT, LOAD RELATIVE LONG, STORE HALFWORD RELATIVE LONG, and STORE RELATIVE LONG, all accesses to the storage operand appear to be block concurrent as observed by other CPUs. For COMPARE AND SWAP AND STORE, all accesses to the first operand and the store of the second operand appear to be block concurrent as observed by other CPUs.

For the instruction PERFORM LOCKED OPERATION, the accesses to the even-numbered storage operands appear to be word concurrent, as observed by other CPUs, for function codes that are a multiple of 4 and appear to be doubleword concurrent, as observed by other CPUs, for function codes that are one, 2, or 3 more than a multiple of 4. The accesses to the doublewords in the parameter list appear to be doubleword concurrent, as observed by other CPUs, regardless of the function code.

The instructions LOAD MULTIPLE (LM), LOAD MULTIPLE DISJOINT, LOAD MULTIPLE HIGH, STORE MULTIPLE (STM), and STORE MULTIPLE HIGH, when the operand or operands start on a word boundary; the instructions LOAD MULTIPLE (LMG) and STORE MULTIPLE (STMG), when the operand starts on a doubleword boundary; and the instructions COMPARE LOGICAL (CLC), COMPARE LOGICAL CHARACTERS UNDER MASK, INSERT CHARACTERS UNDER MASK, LOAD CONTROL (LCTLG), STORE CHARACTERS UNDER MASK, and STORE CONTROL (STCTG) access their stor-

age operands in a left-to-right direction, and all bytes accessed within each doubleword appear to be accessed concurrently as observed by other CPUs.

The instructions VECTOR LOAD MULTIPLE and VECTOR STORE MULTIPLE, when the operands start on a quadword boundary accesses to their storage operands appear to be doubleword concurrent, as observed by other CPUs. The doublewords may be accessed in any order.

When any operand of EXTRACT CPU TIME starts on a doubleword boundary, all eight bytes within the operand appear to be accessed concurrently as observed by other CPUs.

The instructions LOAD ACCESS MULTIPLE, LOAD CONTROL (LCTL), STORE ACCESS MULTIPLE, and STORE CONTROL (STCTL) access the storage operand in a left-to-right direction, and all bytes accessed within each word appear to be accessed concurrently as observed by other CPUs.

When destructive overlap does not exist, the operands of MOVE (MVC), MOVE WITH KEY, MOVE TO PRIMARY, and MOVE TO SECONDARY are accessed as follows:

1. The first operand is accessed in a left-to-right direction, and all bytes accessed within a doubleword appear to be accessed concurrently as observed by other CPUs.
2. The second operand is accessed in a left-to-right direction, and all bytes within a doubleword in the second operand that are moved into a single doubleword in the first operand appear to be fetched concurrently as observed by other CPUs. Thus, if the first and second operands begin on the same byte offset within a doubleword, the fetch of the second operand appears to be doubleword concurrent as observed by other CPUs. If the offsets within a doubleword differ by 4, the fetch of the second operand appears to be word concurrent as observed by other CPUs.

Destructive overlap is said to exist when the result location is used as a source after the result has been stored, assuming processing to be performed one byte at a time.

The operands of MOVE WITH SOURCE KEY, MOVE WITH DESTINATION KEY, and MOVE STRING are accessed the same as those of MOVE (MVC), except that destructive overlap is assumed not to exist.

The operands of MOVE RIGHT TO LEFT are accessed the same as those of MOVE (MVC), except that neither operand is accessed in a defined direction, as observed by other CPUs. Furthermore, if destructive overlap exists, results are unpredictable. Refer to page 7-301 for the definition of destructive overlap for MOVE RIGHT TO LEFT.

Except as noted in the individual instruction descriptions, accesses to operands of MOVE LONG, MOVE LONG EXTENDED, and MOVE LONG UNICODE do not necessarily appear to occur in a left-to-right direction as observed by other CPUs and by channel programs. The operands of these instructions do appear to be accessed doubleword concurrent, as observed by other CPUs, when all of the following are true:

- Both operands start on doubleword boundaries and are an integral number of doublewords in length.
- The operands do not overlap.
- The nonpadding part of the operation is being executed.

The operands of COMPARE LOGICAL LONG, COMPARE LOGICAL LONG EXTENDED, and COMPARE LOGICAL LONG UNICODE appear to be accessed doubleword concurrent, as observed by other CPUs, when both operands start on doubleword boundaries and are an integral number of doublewords in length.

The operands of COMPARE LOGICAL STRING appear to be accessed doubleword concurrent, as observed by other CPUs, when both operands start on doubleword boundaries. The operands of SEARCH STRING and SEARCH STRING UNICODE appear to be accessed doubleword concurrent, as observed by other CPUs, when it starts on a doubleword boundary.

For EXCLUSIVE OR (XC), the operands are processed in a left-to-right direction, and, when the first and second operands coincide, all bytes accessed within a doubleword appear to be accessed concurrently as observed by other CPUs.

Programming Notes:

1. In the case of EXCLUSIVE OR (XC) designating operands which coincide exactly, the bytes within the field may appear to be accessed as many as three times, by two fetches and one store: once as the fetch portion of the first operand update, once as the second-operand fetch, and then once as the store portion of the first-operand update. Each of the three accesses appears to be doubleword concurrent as observed by other CPUs, but the three accesses do not necessarily appear to occur one immediately after the other. One or both fetch accesses may be omitted since the instruction can be completed without fetching the operands.
2. All z/Architecture-capable machines have implemented LOAD REVERSED and STORE REVERSED as block concurrent if they are aligned on an integral boundary of their operand size. LOAD REVERSED and STORE REVERSED have never been implemented as multiple-access references.

Relation between Operand Accesses

As observed by other CPUs and by channel programs, storage-operand fetches associated with one instruction execution appear to precede all storage-operand references for conceptually subsequent instructions. A storage-operand store specified by one instruction appears to precede all storage-operand stores specified by conceptually subsequent instructions, but it does not necessarily precede storage-operand fetches specified by conceptually subsequent instructions. However, a storage-operand store appears to precede a conceptually subsequent storage-operand fetch from the same main-storage location.

When an instruction has two storage operands both of which cause fetch references, it is unpredictable which operand is fetched first, or how much of one operand is fetched before the other operand is fetched. When the two operands overlap, the common locations may be fetched independently for each operand.

When an instruction has two storage operands the first of which causes a store and the second a fetch reference, it is unpredictable how much of the second

operand is fetched before the results are stored. In the case of destructively overlapping operands, the portion of the second operand which is common to the first is not necessarily fetched from storage.

When an instruction has two storage operands the first of which causes an update reference and the second a fetch reference, it is unpredictable which operand is fetched first, or how much of one operand is fetched before the other operand is fetched. Similarly, it is unpredictable how much of the result is processed before it is returned to storage. In the case of destructively overlapping operands, the portion of the second operand which is common to the first is not necessarily fetched from storage.

The independent fetching of a single location for each of two operands may affect the program execution in the following situation. When the same storage location is designated by two operand addresses of an instruction, and another CPU or a channel program causes the contents of the location to change during execution of the instruction, the old and new values of the location may be used simultaneously. For example, comparison of a field to itself may yield a result other than equal, or EXCLUSIVE-ORing of a field with itself may yield a result other than zero.

Storage Operand References in the Transactional-Execution Mode

While the CPU is in the transactional-execution mode, the normal rules for instruction, ART and DAT table, and operand fetching apply, except where explicitly noted otherwise. This section describes additional rules for operand storage accesses. Instruction and ART and DAT table fetching are not impacted by transactional execution.

As observed by other CPUs and by the channel subsystem, when the CPU is in the transactional-execution mode, transactional and nontransactional stores are committed when the transaction ends. When a transaction is aborted all transactional stores are discarded; only nontransactional stores made by the transaction are committed when a transaction is aborted.

As observed by other CPUs and by the channel subsystem, all storage-operand fetches and stores made while a CPU is in the transactional-execution mode appear to be a single block-concurrent access. Stor-

age accesses by other CPUs or by the channel subsystem may prevent a transaction from maintaining block-concurrent access, in which case the transaction aborts with either store or fetch conflict.

Programming Note: Storage accesses made while the CPU is in the transactional-execution mode are said to be block concurrent, even though the references may not represent a contiguous block of storage on an integral boundary.

Other Storage References

The restart, program, supervisor-call, external, input/output, and machine-check PSWs appear to be accessed doubleword concurrent as observed by other CPUs. These references appear to occur after the conceptually previous unit of operation and before the conceptually subsequent unit of operation. The relationship between the new-PSW fetch, the old-PSW store, and the interruption-code store is unpredictable.

Store accesses for interruption codes are not necessarily single-access stores. The store accesses for the external and supervisor-call-interruption codes appear to occur between the conceptually previous and conceptually subsequent operations. The store accesses for the program-interruption codes may precede the storage-operand references associated with the instruction which results in the program interruption.

Relation between Storage-Key Accesses

As observed by other CPUs, storage-key fetches and stores due to instructions that explicitly manipulate a storage key (INSERT REFERENCE BITS MULTIPLE, INSERT STORAGE KEY EXTENDED, INSERT VIRTUAL STORAGE KEY, PERFORM FRAME MANAGEMENT FUNCTION [when SK is one], MOVE PAGE [when setting the key], RESET REFERENCE BIT EXTENDED, and SET STORAGE KEY EXTENDED) are ordered among themselves and among storage-operand references as if the storage-key accesses were themselves storage-operand fetches and stores, respectively.

Accesses of the access-control and fetch-protection bits due to storage-operand references are concurrent with the references. When EDAT-1 applies and a

storage-operand reference is made using a segment-table entry in which the STE-format and ACCF-validity controls are both one, the source of the access-control and fetch-protection bits may be any of the following: (a) the storage key for the corresponding 4 K-byte block, (b) the access-control bits and the fetch-protection bit in the segment-table entry, or (c) a buffered copy of these bits in the TLB; it is unpredictable which source is used. Similarly, when EDAT-2 applies and a storage-operand reference is made using a region-third-table entry in which the RTTE-format and ACCF-validity controls are both one, the source of the access-control and fetch-protection bits may be any of the following: (a) the storage key for the corresponding 4 K-byte block, (b) the access-control bits and the fetch-protection bit in the region-third-table entry, or (c) a buffered copy of these bits in the TLB; it is unpredictable which source is used.

Accesses of the reference and change bits due to storage-operand references are in no particular order within the interval in which they are defined to occur. (See the description of when the change bit is set in "Storage-Key Accesses" on page 5-120.) However, whether due to an instruction that explicitly manipulates a storage key or due to a storage-operand reference, a storage-key store appears to precede a conceptually subsequent storage-key fetch from the same storage key.

Serialization

The sequence of functions performed by a CPU is normally independent of the functions performed by other CPUs and by channel programs. Similarly, the sequence of functions performed by a channel program is normally independent of the functions performed by other channel programs and by CPUs. However, at certain points in its execution, serialization of the CPU occurs. Serialization also occurs at certain points for channel programs.

CPU Serialization

All interruptions, entering or leaving the transactional-execution mode, and the execution of certain instructions cause a serialization of CPU operations. A serialization operation consists in completing all conceptually previous main storage accesses and related reference-bit and change-bit settings by the

CPU, as observed by other CPUs and by the channel subsystem, before the conceptually subsequent main storage accesses and related reference-bit and change-bit settings occur. Serialization affects the sequence of all CPU accesses to main storage and to the storage keys, except for those associated with ART-table-entry and DAT-table-entry fetching.

As observed by all CPUs and by the channel subsystem, a serializing operation performed while a CPU is in the transactional-execution mode occurs when the CPU leaves the transactional-execution mode, as a result of any of the following: a TRANSACTION END instruction that decrements the transaction nesting depth to zero (normal ending), or a transaction-abort condition.

Serialization is performed by CPU reset, all interruptions, the entering or leaving of the transactional-execution mode, and the execution of the following instructions:

- The general instruction BRANCH ON CONDITION (BCR) with the M_1 and R_2 field containing 1111 binary and 0000 binary, respectively.
- When the fast-BCR-serialization facility is installed, the general instruction BRANCH ON CONDITION (BCR) with the M_1 and R_2 fields containing 1110 binary and 0000 binary, respectively.
- The general instructions COMPARE AND SWAP, COMPARE AND SWAP AND STORE, COMPARE DOUBLE AND SWAP, STORE CLOCK, STORE CLOCK EXTENDED, SUPERVISOR CALL, and TEST AND SET.
- COMPARE AND SWAP AND PURGE, which can also cause the ALB and the TLB to be cleared of all entries on all CPUs.
- COMPARE AND REPLACE DAT TABLE ENTRY, INVALIDATE DAT TABLE ENTRY, and INVALIDATE PAGE TABLE ENTRY.
- All I/O instructions .
- LOAD PSW, LOAD PSW EXTENDED, PERFORM FRAME MANAGEMENT FUNCTION, SET STORAGE KEY EXTENDED, and MOVE PAGE when the KFC field is 4 or 5.
- MOVE TO PRIMARY, MOVE TO SECONDARY, and SET ADDRESS SPACE CONTROL.

- PAGE IN and PAGE OUT.
- PERFORM LOCKED OPERATION. A serialization function is performed immediately after the lock is obtained and again immediately before it is released. However, values fetched from the parameter list before the lock is obtained are not necessarily refetched.
- PROGRAM CALL, and, when the state entry to be unstacked is a program-call state entry, PROGRAM RETURN. However, it is unpredictable whether or not a store into a trace-table entry or linkage-stack entry from which a subsequent instruction is fetched will be observed by the CPU that performed the store.
- PROGRAM TRANSFER, PROGRAM TRANSFER WITH INSTANCE, SET SECONDARY ASN, and SET SECONDARY ASN WITH INSTANCE, and TRACE. However, it is unpredictable whether or not a store into a trace-table entry from which a subsequent instruction is fetched will be observed by the CPU that performed the store. Additionally, when the store-clock-fast facility is installed and the TRACE TOD-clock control in bit 32 of control register 0 is one, it is unpredictable whether explicit tracing causes a serialization function to be performed.
- PURGE ALB, PURGE TLB, and SET PREFIX. PURGE ALB and SET PREFIX also cause the ALB to be cleared of all entries. PURGE TLB and SET PREFIX also cause the TLB to be cleared of all entries.
- SIGNAL PROCESSOR. The set-architecture SIGNAL PROCESSOR order causes serialization on all CPUs in the configuration.
- TEST BLOCK.
- TRANSACTION BEGIN and TRANSACTION END

The four trace functions — branch tracing, ASN tracing, mode tracing, and explicit tracing — cause a serialization function to be performed before the trace action and after completion of the trace action. However, it is unpredictable whether or not a store into a trace-table entry from which a subsequent instruction is fetched will be observed by the CPU that performed the store. Additionally, when the store-clock-fast facility is installed and the TRACE TOD-clock control in bit 32 of control register 0 is one, it is

unpredictable whether explicit tracing causes a serialization function to be performed.

In the following discussion, the term *serializing instruction* refers to an instruction which causes one or more serialization functions to be performed. The term *serializing operation* refers to a unit of operation within an instruction or to a machine operation such as an interruption which causes a serialization function to be performed.

The sequence of events associated with a serializing operation is as follows:

1. All conceptually previous storage accesses by the CPU are completed as observed by other CPUs and by channel programs. This includes all conceptually previous stores and changes to the storage keys.
2. The normal function associated with the serializing operation is performed. In the case of instruction execution, operands are fetched, and the storing of results is completed. The exceptions are LOAD PSW, LOAD PSW EXTENDED, and SET PREFIX, in which the operand may be fetched before previous stores have been completed, and interruptions, in which the interruption code and associated fields may be stored prior to the serialization. The fetching of the serializing instruction occurs before the execution of the instruction and may precede the execution of previous instructions, but may not precede the completion of any previous serializing operation. In the case of an interruption, the old PSW, the interruption code, and other information, if any, are stored, and the new PSW is fetched, but not necessarily in that sequence.
3. Finally, instruction fetch and operand accesses for conceptually subsequent operations may begin.

A serializing function affects the sequence of storage accesses that are under the control of the CPU in which the serializing function takes place. It does not affect the sequence of storage accesses under the control of other CPUs and of channel programs.

Programming Notes:

1. The following are some effects of a serializing operation:
 - a. When the execution of an instruction changes the contents of a storage location that is used as a source of a following instruction and when different addresses are used to designate the same absolute location for storing the result and fetching the instruction, a serializing operation following the change ensures that the modified instruction is executed.
 - b. When a serializing operation takes place, other CPUs and channel programs observe instruction and operand fetching and result storing to take place in the sequence established by the serializing operation.
2. Storing into a location from which a serializing instruction is fetched does not necessarily affect the execution of the serializing instruction unless a serializing function has been performed after the storing and before the execution of the serializing instruction.
3. Following is an example showing the effects of serialization. Location A initially contains FF hex.

CPU 1	CPU 2
MVI A,X'00'	G CLI A,X'00'
BCR 15,0	BNE G

The BCR 15,0 instruction executed by CPU 1 is a serializing instruction that ensures that the store by CPU 1 at location A is completed. However, CPU 2 may loop indefinitely, or until the next interruption on CPU 2, because CPU 2 may already have fetched from location A for every execution of the CLI instruction. A serializing instruction must be in the CPU-2 loop to ensure that CPU 2 will again fetch from location A.

Specific-Operand Serialization

Certain instructions cause specific-operand serialization to be performed for an operand of the instruction. As observed by other CPUs and by the channel subsystem, a specific-operand-serialization operation consists in completing all conceptually previous storage accesses to the specified operand by the CPU before a conceptually subsequent accesses to the specific storage operand of the instruction may occur.

At the completion of an instruction causing specific-operand serialization, the instruction's store is completed as observed by other CPUs and channel programs.

Specific-operand serialization is performed by the execution of the following instructions:

- ADD IMMEDIATE (ASI, AGSI) and ADD LOGICAL WITH SIGNED IMMEDIATE, for the first operand, when the interlocked-access facility 1 is installed and the first operand is aligned on a boundary which is integral to the size of the operand.
- AND (NI, NIY), when the interlocked-access facility 2 is installed
- EXCLUSIVE OR (XI, XIY), when the interlocked-access facility 2 is installed
- LOAD AND ADD, LOAD AND ADD LOGICAL, LOAD AND AND, LOAD AND EXCLUSIVE OR, LOAD AND OR, for the second operand.
- OR (OI, OIY), when the interlocked-access facility 2 is installed

Channel-Program Serialization

Serialization of a channel program occurs as follows:

1. All storage accesses and storage-key accesses by the channel program follow initiation of the execution of START SUBCHANNEL, or, if suspended, RESUME SUBCHANNEL, as observed by CPUs and by other channel programs. This includes all accesses for the CCWs, IDAWs, MIDAWs, and data.
2. All storage accesses and storage-key accesses by the channel program are completed, as observed by CPUs and by other channel programs, before the subchannel status indicating status-pending with primary status is made available to any CPU.
3. If a CCW contains a PCI flag or a suspend flag which is one, all storage accesses and storage-key accesses due to CCWs preceding it in the CCW chain are completed, as observed by CPUs and by other channel programs, before the subchannel status indicating status-pending with

intermediate status (PCI or suspended) is made available to any CPU.

The serialization of a channel program does not affect the sequence of storage accesses or storage-key accesses performed by other channel programs or by a CPU.

Quiescing

Quiescing is an additional means of serialization that may be performed to ensure that updates to a configuration-wide resource are immediately visible to all CPUs. A quiescing operation initiated by one CPU causes the following to occur on all other CPUs in the configuration:

- Any instruction or unit of operation executing on the CPU is completed.
- Any transaction executing on the CPU is aborted with abort code 255; the condition code is set to 2.
- All locally-cached copies of the configuration-wide resource being updated are discarded.
- Resumption of instruction execution is delayed until the update to the configuration-wide resource is visible to all CPUs.

Quiescing may occur as a result of the execution of the following key-setting instructions:

- PERFORM FRAME MANAGEMENT FUNCTION (when the set-key control is one)
- SET STORAGE KEY EXTENDED.

When the nonquiescing key-setting facility is not installed, a quiescing operation is performed by either of the above instructions. Similarly, when the nonquiescing key-setting facility is installed, but the nonquiescing (NQ) control of the SSKE instruction is zero, a quiescing operation is performed. When the nonquiescing key-setting facility is installed and the NQ control of the SSKE instruction is one, a quiescing operation is not necessarily performed. When the nonquiescing key-setting facility is installed and the set-key control of a PFMF instruction is one, a quiescing operation is not necessarily performed. When the KFC value is 4 or 5 for a MVRPG instruction, a quiescing operation is not necessarily performed.

instructions and channel operations) is limited to CPU serialization and channel-program serialization.

Programming Note: Although quiescing is defined as a additional serialization mechanism, the term *serialization function* (used in the description of CPU

Chapter 6. Interruptions

Interruption Action	6-2	Fixed-Point-Divide Exception	6-27
Interruption Code	6-5	Fixed-Point-Overflow Exception	6-27
Enabling and Disabling	6-6	HFP-Divide Exception	6-28
Handling of Floating Interruption Conditions	6-6	HFP-Exponent-Overflow Exception	6-28
Instruction-Length Code	6-7	HFP-Exponent-Underflow Exception	6-28
Zero ILC	6-7	HFP-Significance Exception	6-28
ILC on Instruction-Fetching Exceptions	6-8	HFP-Square-Root Exception	6-29
Exceptions Associated with the PSW	6-9	LFX-Translation Exception	6-29
Early Exception Recognition	6-9	LSTE-Sequence Exception	6-29
Late Exception Recognition	6-10	LSX-Translation Exception	6-29
External Interruption	6-11	LX-Translation Exception	6-30
Clock Comparator	6-12	Monitor Event	6-30
CPU Timer	6-12	Operand Exception	6-31
Emergency Signal	6-13	Operation Exception	6-31
External Call	6-13	Page-Translation Exception	6-32
Interrupt Key	6-13	PC-Translation-Specification Exception	6-32
Malfunction Alert	6-13	PER Event	6-32
Measurement Alert	6-14	Primary-Authority Exception	6-33
Service Signal	6-14	Privileged-Operation Exception	6-33
Timing Alert	6-14	Protection Exception	6-34
ETR-Timing-Alert Condition	6-14	Region-First-Translation Exception	6-35
STP-Timing-Alert Condition	6-14	Region-Second-Translation Exception	6-36
Warning Track	6-15	Region-Third-Translation Exception	6-36
I/O Interruption	6-15	Secondary-Authority Exception	6-37
Machine-Check Interruption	6-16	Segment-Translation Exception	6-37
Program Interruption	6-16	Space-Switch Event	6-37
Data-Exception Code (DXC)	6-17	Special-Operation Exception	6-38
Priority of Program Interruptions for Data		Specification Exception	6-40
Exceptions	6-17	Stack-Empty Exception	6-44
Vector-Exception Code	6-20	Stack-Full Exception	6-45
Program-Interruption Conditions	6-20	Stack-Operation Exception	6-45
Addressing Exception	6-20	Stack-Specification Exception	6-45
AFX-Translation Exception	6-22	Stack-Type Exception	6-45
ALEN-Translation Exception	6-22	Trace-Table Exception	6-45
ALE-Sequence Exception	6-22	Transaction-Constraint Exception	6-46
ALET-Specification Exception	6-22	Transactional-Execution-Aborted Event	6-46
ASCE-Type Exception	6-22	Translation-Specification Exception	6-46
ASTE-Instance Exception	6-23	Vector Processing Exception	6-47
ASTE-Sequence Exception	6-23	Collective Program-Interruption Names	6-47
ASTE-Validity Exception	6-24	Recognition of Access Exceptions	6-47
ASX-Translation Exception	6-24	Multiple Program-Interruption Conditions	6-51
Crypto-Operation Exception	6-24	Access Exceptions	6-53
Data Exception	6-25	ASN-Translation Exceptions	6-55
Decimal-Divide Exception	6-26	Subspace-Replacement Exceptions	6-56
Decimal-Overflow Exception	6-26	Trace Exceptions	6-56
Execute Exception	6-26	Restart Interruption	6-56
EX-Translation Exception	6-26	Supervisor-Call Interruption	6-57
Extended-Authority Exception	6-27	Priority of Interruptions	6-57

The interruption mechanism permits the CPU to change its state as a result of conditions external to the configuration, within the configuration, or within the CPU itself. To permit fast response to conditions of high priority and immediate recognition of the type of condition, interruption conditions are grouped into six classes: external, input/output, machine check, program, restart, and supervisor call.

Interruption Action

An interruption consists in storing the current PSW as an old PSW, storing information identifying the cause of the interruption, and fetching a new PSW. Processing resumes as specified by the new PSW.

The old PSW stored on an interruption normally contains the address of the instruction that would have been executed next had the interruption not

occurred, thus permitting resumption of the interrupted program. For program and supervisor-call interruptions, the information stored also contains a code that identifies the length of the last-executed instruction, thus permitting the program to respond to the cause of the interruption. In the case of some program conditions for which the normal response is reexecution of the instruction causing the interruption, the instruction address directly identifies the instruction last executed.

Except for restart, an interruption can occur only when the CPU is in the operating state. The restart interruption can occur with the CPU in either the stopped or operating state.

The details of source identification, location determination, and instruction execution are explained in later sections and are summarized in Figure 6-1 on page 6-2.

Source Identification	Interruption Code		PSW-Mask Bits	Mask Bits in Control Registers		ILC Set	Execution of Instruction Identified by Old PSW							
				Reg	Bit									
MACHINE CHECK Old PSW: 352-367 (z/Arch), 48-55 (390-CM) New PSW: 480-495 (z/Arch), 112-119 (390-CM) Exigent condition Repressible condition	Locations 232-239 ¹		13	14	35-39	u	terminated or nullified ² unaffected ²							
								13						
SUPERVISOR CALL Old PSW: 320-335 (z/Arch), 32-39 (390-CM) New PSW: 448-463 (z/Arch), 96-103 (390-CM) Instruction bits	Locations 138-139 00000000 ssssssss					1, 2, 3	completed							
PROGRAM Old PSW: 336-351 (z/Arch), 40-47 (390-CM) New PSW: 464-479 (z/Arch), 104-111 (390-CM) Operation Privileged operation Execute Protection Addressing Specification Data Fixed-point overflow Fixed-point divide Decimal overflow Decimal divide	Locations 142-143													

Figure 6-1. Interruption Action (Part 1 of 4)

Source Identification	Interruption Code		PSW-Mask Bits	Mask Bits in Control Registers		ILC Set	Execution of Instruction Identified by Old PSW
				Reg	Bit		
HFP exp. overflow	000000t0	p0001100	000C			1, 2, 3	completed
HFP exp. underflow	000000t0	p0001101	000D	22		1, 2, 3	completed
HFP significance	000000t0	p0001110	000E	23		1, 2, 3	completed
HFP divide	000000t0	p0001111	000F			1, 2, 3	suppressed
Segment translation	000000t0	p0010000	0010			1, 2, 3	nullified
Page translation	000000t0	p0010001	0011			1, 2, 3	nullified
Translation spec	000000t0	p0010010	0012			1, 2, 3	suppressed
Special operation	000000t0	p0010011	0013	0	33	1, 2, 3	suppressed
Operand	00000000	p0010101	0015			2, 3	suppressed
Trace table	00000000	p0010110	0016			1, 2, 3	nullified
Transaction constraint	000000t0	00011000	0018			1, 2, 3	suppressed
Vector-processing	000000t0	p0011011	001B			2, 3	suppressed
Space-switch event	00000000	p0011100	001C	1	57	0, 1, 2, 3	completed
HFP square root	000000t0	p0011101	001D			2, 3	suppressed
PC-transl spec	00000000	p0011111	001F			2, 3	suppressed
AFX translation	00000000	p0100000	0020			1, 2, 3	nullified
ASX translation	00000000	p0100001	0021			1, 2, 3	nullified
LX translation	00000000	p0100010	0022			2, 3	nullified
EX translation	00000000	p0100011	0023			2, 3	nullified
Primary authority	00000000	p0100100	0024			2, 3	nullified
Secondary authority	00000000	p0100101	0025			1, 2, 3	nullified
LFX translation	00000000	p0100110	0026			2, 3	nullified
LSX translation	00000000	p0100111	0027			2, 3	nullified
ALET specification	000000t0	p0101000	0028			1, 2, 3	suppressed
ALEN translation	000000t0	p0101001	0029			1, 2, 3	nullified
ALE sequence	000000t0	p0101010	002A			1, 2, 3	nullified
ASTE validity	000000t0	p0101011	002B			1, 2, 3	nullified
ASTE sequence	000000t0	p0101100	002C			1, 2, 3	nullified
Extended authority	000000t0	p0101101	002D			1, 2, 3	nullified
LSTE sequence	00000000	p0101110	002E			2, 3	nullified
ASTE instance	00000000	p0101111	002F			1, 2, 3	nullified
Stack full	00000000	p0110000	0030			2, 3	nullified
Stack empty	00000000	p0110001	0031			1, 2, 3	nullified
Stack specification	00000000	p0110010	0032			1, 2, 3	nullified
Stack type	00000000	p0110011	0033			1, 2, 3	nullified
Stack operation	00000000	p0110100	0034			1, 2, 3	nullified
ASCE type	000000t0	p0111000	0038			1, 2, 3	nullified
Region first trans	000000t0	p0111001	0039			1, 2, 3	nullified
Region second trans	000000t0	p0111010	003A			1, 2, 3	nullified
Region third trans	000000t0	p0111011	003B			1, 2, 3	nullified
Monitor event	000000t0	p1000000	0040	8	32-47	2, 3	completed

Figure 6-1. Interruption Action (Part 2 of 4)

Source Identification	Interruption Code		PSW-Mask Bits	Mask Bits in Control Registers		ILC Set	Execution of Instruction Identified by Old PSW	
				Reg	Bit			
PER basic event	000000tn	1nnnnnn ⁵	0080	1	9	32-36	0, 1, 2, 3	completed ⁶
PER nullification event	000000t0	10000000	0080	1	9	33,39	0	nullified ⁷
Crypto operation	000000t1	p0011001	0119				2, 3	nullified
Transactional-execution aborted event	0000001n	nnnnnnnn	0200		0	8-9	1, 2, 3	completed ⁸
EXTERNAL	Location 134-135							
Old PSW: 304-319 (z/Arch), 24-31 (390-CM) New PSW: 432-447 (z/Arch), 88-95 (390-CM)	Binary	Hex ³						
Interrupt key	00000000	01000000	0040	7	0	57	u	unaffected
Clock comparator	00010000	00000100	1004	7	0	52	u	unaffected
CPU timer	00010000	00000101	1005	7	0	53	u	unaffected
Warning track	00010000	00000111	1007	7	0	30	u	unaffected
Malfunction alert	00010010	00000000	1200	7	0	48	u	unaffected
Emergency Signal	00010010	00000001	1201	7	0	49	u	unaffected
External call	00010010	00000010	1202	7	0	50	u	unaffected
Timing alert	00010100	00000110	1406	7	0	59	u	unaffected
Measurement alert	00010100	00000111	1407	7	0	58	u	unaffected
Service signal	00100100	00000001	2401	7	0	54	u	unaffected
INPUT/OUTPUT	Locations	184-191						
Old PSW: 368-383 (z/Arch), 56-63 (390-CM) New PSW: 496-511 (z/Arch), 120-127 (390-CM)								
I/O-interruption subclass				6	6	32-39 ⁴	u	unaffected
RESTART	None							
Old PSW: 288-303 (z/Arch), 8-15 (390-CM) New PSW: 416-431 (z/Arch), 0-7 (390-CM)								
Restart key							u	unaffected
Explanation:								
Locations for the old PSWs, new PSWs, and interruption codes are real locations.								
z/Arch Interruption PSW locations when the CPU is in the z/Architecture architectural mode.								
390-CM Interruption PSW locations when the CPU is in the ESA/390-compatibility mode.								
¹ A model-independent machine-check interruption code of 64 bits is stored at real locations 232-239.								
² The effect of the machine-check condition is indicated by bits in the machine-check-interruption code. The setting of these bits indicates the extent of the damage and whether the unit of operation is nullified, terminated, or unaffected.								
³ The interruption code in the column labeled "Hex" is the hex code for the basic interruption; this code does not show the effects of concurrent interruption conditions represented by n or p in the column labeled "Binary."								
⁴ Bits 32-39 of control register 6 provide detailed masking of I/O-interruption subclasses 0-7 respectively.								
⁵ When the interruption code indicates a PER basic event, an ILC of 0 may be stored only when bits 8-15 of the interruption code are 10000110 (PER, specification).								
⁶ The unit of operation is completed, unless a program exception concurrently indicated causes the unit of operation to be nullified, suppressed, or terminated.								
⁷ The unit of operation is nullified and no other program interruption is indicated when a nullifying PER event is recognized.								

Figure 6-1. Interruption Action (Part 3 of 4)

Source Identification	Interruption Code	PSW-Mask Bits	Mask Bits in Control Registers		ILC Set	Execution of Instruction Identified by Old PSW
			Reg	Bit		
s	A transactional-execution aborted event indication always accompanies another program-interruption indication. The completed indication refers only to the TBEGIN or TBEGINC instruction, as identified by the old PSW. The instruction identified by the aborted-transaction instruction address in the TDB is either nullified, suppressed, or completed.					
n	A possible nonzero code indicating another concurrent program-interruption condition					
p	If one, the bit indicates a concurrent PER-event interruption condition.					
s	Bits of the I field of SUPERVISOR CALL.					
t	Transactional-execution-aborted event					
u	Not stored.					

Figure 6-1. Interruption Action (Part 4 of 4)

Programming Note: In the ESA/390-compatibility mode, an old PSW stored during interruption processing has the short format, as illustrated in Figure 4-3 on page 4-8. If the model does not recognize a specification exception when PSW bit 31 is one in the ESA/390-compatibility mode (thus allowing the CPU to operate in the 64-bit addressing mode), any nonzero bits in bit positions 0-32 of the PSW instruction address will be lost when storing the interruption-old PSW.

Similarly in the ESA/390-compatibility mode, if the model allows the execution of either (a) LOAD PSW EXTENDED or (b) RESUME PROGRAM with the P bit, bit 13 of the parameter list, set to one, then a 16-byte PSW may be loaded. If such a PSW has a format error in which bit 31 is zero, but any of bits 64-96 (bits 0-32 of the instruction address) are nonzero, then an early specification exception is recognized. However, the program-old PSW that is stored when such a PSW becomes active has the short PSW format in which the invalid instruction-address bits are not stored.

Interruption Code

The six classes of interruptions (external, I/O, machine check, program, restart, and supervisor call) are distinguished by the storage locations at which the old PSW is stored and from which the new PSW is fetched. For most classes, the causes are further identified by an interruption code and, for some classes, by additional information placed in permanently assigned real storage locations during the interruption. (See “Assigned Storage Locations” on page 3-73.) For external, program, and supervi-

sor-call interruptions, the interruption code consists of 16 bits.

For external interruptions, the interruption code is stored at real locations 134-135. A parameter may be stored at real locations 128-131, or a CPU address may be stored at real locations 132-133.

For I/O interruptions, the I/O-interruption code is stored at real locations 184-195. The I/O-interruption code consists of a 32-bit subsystem-identification word, a 32-bit interruption parameter, and a 32-bit I/O-interruption identification word.

For machine-check interruptions, the interruption code consists of 64 bits and is stored at real locations 232-239. Additional information for identifying the cause of the interruption and for recovering the state of the machine may be provided by the contents of the machine-check failing-storage address and the contents of the fixed-logout and machine-check-save areas. (See Chapter 11, “Machine-Check Handling.”)

For supervisor-call interruptions, the interruption code comprises eight binary zeros concatenated with the 8-bit immediate operand of the SUPERVISOR CALL instruction (as modified by an execute-type instruction, if applicable). The interruption code is stored at real locations 138-139, and the instruction-length code is stored in bit positions 5 and 6 of real location 137.

For program interruptions, the interruption code is stored at real locations 142-143, and the instruction-length code is stored in bit positions 5 and 6 of real location 141. In the z/Architecture architectural mode, further information may be provided in the

form of the data-exception code (DXC) or vector-exception code (VXC), monitor-class number, PER code, addressing-and-translation-mode identification, PER address, exception access identification, PER access identification, operand-access identification, translation-exception identification, and monitor code, which are stored at real locations 144-162 and 168-183. In the ESA/390-compatibility mode, the DXC, translation-exception identification, monitor-class number, PER code, addressing-and-translation-mode identification, PER address, monitor code, exception access identification, and PER access identification, may be stored at real locations 144-161.

Enabling and Disabling

By means of mask bits in the current PSW, floating-point-control (FPC) register, and control registers, the CPU may be enabled or disabled for all external, I/O, and machine-check interruptions and for some program interruptions. When a mask bit is one, the CPU is enabled for the corresponding class of interruptions, and those interruptions can occur.

When a mask bit is zero, the CPU is disabled for the corresponding interruptions. The conditions that cause I/O interruptions remain pending. External-interruption conditions either remain pending or persist until the cause is removed. Machine-check-interruption conditions, depending on the type, are ignored, remain pending, or cause the CPU to enter the check-stop state. The disallowed program-interruption conditions are ignored, except that some causes are indicated also by the setting of the condition code, and IEEE exceptions set flags in the FPC register. The setting of the HFP-significance and HFP-exponent-underflow program-mask bits affects the manner in which HFP operations are completed when the corresponding condition occurs. Similarly, the setting of the IEEE mask bits in the FPC register affects the manner in which IEEE computational operations are completed when the corresponding condition occurs.

Programming Notes:

1. Mask bits in the PSW provide a means of disallowing most maskable interruptions; thus, subsequent interruptions can be disallowed by the new PSW introduced by an interruption. Furthermore, the mask bits can be used to establish a hierarchy of interruption priorities, where a condition in

one class can interrupt the program handling a condition in another class but not vice versa. To prevent an interruption-handling routine from being interrupted before the necessary house-keeping steps are performed, the new PSW must disable the CPU for further interruptions within the same class or within a class of lower priority.

2. Because the mask bits in control registers are not changed as part of the interruption procedure, these masks cannot be used to prevent an interruption immediately after a previous interruption in the same class. The mask bits in control registers provide a means for selectively enabling the CPU for some sources and disabling it for others within the same class.
3. Controlling bits exist for several program interruptions, but with no mask bit in the PSW. Such bits include the IEEE mask bits in the FPC register, the monitor masks in bit positions 48-63 of control register 8, the primary space-switch-event-control bit in bit position 57 of control register 1, and the home space-switch-event-control bit in bit position 57 of control register 13. A bit of this nature is somewhat arbitrarily considered to be a "mask" bit only if the polarity is such that interruption is enabled when the bit is one.

Thus, for example, the SSM-suppression-control bit, bit 33 of control register 0, is considered to be a mask bit, while the AFP-register-control bit, bit 45 of control register 0, is not. Regardless of the polarity of such control bits, to avoid another program interruption, an interruption-handling routine must avoid issuing instructions subject to these bits until they have been set appropriately.

In the z/Architecture architectural mode, the enhanced-monitor masks in bit positions 16-31 of control register 8 are an exception to the above definition of a mask in that they work in conjunction with the monitor masks in bit positions 48-63 of control register 8. When both a monitor mask bit and its corresponding enhanced-monitor mask bit are one, a monitor-event counting operation occurs rather than an interruption.

Handling of Floating Interruption Conditions

An interruption condition which can be presented to any CPU in the configuration is called a floating inter-

ruption condition. The condition is presented to the first CPU in the configuration which is enabled for the corresponding interruption and which can perform the interruption, and then the condition is cleared and not presented to any other CPU in the configuration. A CPU cannot perform the interruption when it is in the check-stop state, has an invalid prefix, is in a string of program interruptions due to a specification exception of the type which is recognized early or is in the stopped state. However, a CPU with the rate control set to instruction step can perform the interruption when the start key is activated.

Service signal, I/O, and certain machine-check conditions are floating interruption conditions. Additionally, when the STP-floating-interrupt facility is installed and STP timing-alert floating interruptions are enabled, STP timing-alert external-interruption conditions are floating interruption conditions.

Instruction-Length Code

The instruction-length code (ILC) occupies two bit positions and provides the length of the last instruction executed. It permits identifying the instruction causing the interruption when the instruction address in the old PSW designates the next sequential instruction. The ILC is provided also by the BRANCH AND LINK instructions in the 24-bit addressing mode.

The ILC for program and supervisor-call interruptions is stored in bit positions 5 and 6 of the bytes at real locations 141 and 137, respectively. For external, I/O, machine-check, and restart interruptions, the ILC is not stored since it cannot be related to the length of the last-executed instruction.

For supervisor-call and program interruptions, a nonzero ILC identifies in halfwords the length of the instruction that was last executed. That instruction may be one for which a specification exception was recognized due to an odd instruction address or for which an access exception (addressing, ASCE-type, page-translation, protection, region-translation, segment-translation, or translation-specification) was recognized during the fetching of the instruction. Whenever an instruction is executed by means of EXECUTE, instruction-length code 2 is set to indicate the length of EXECUTE and not that of the target instruction. Similarly, when an instruction is executed by means of EXECUTE RELATIVE LONG, instruction length code 3 is set.

The value of a nonzero instruction-length code is related to the leftmost two bits of the instruction. The value does not depend on whether the operation code is assigned or on whether the instruction is installed. The following table summarizes the meaning of the instruction-length code:

ILC		Instruction Bits 0-1	Instruction Length
Decimal	Binary		
0	00		Not available
1	01	00	One halfword
2	10	01	Two halfwords
2	10	10	Two halfwords
3	11	11	Three halfwords

Except as noted below, when a transaction is aborted due to a program interruption, the ILC stored in bit positions 5-6 of real location 141 is respective to the instruction identified by the aborted-transaction instruction address (ATIA) in the program-interruption TDB. Similarly, when a nonconstrained transaction is aborted due to a program interruption, and the transaction-diagnostic-block address is valid, the ILC stored in bit positions 5-6 of byte 37 in the TBEGIN-specified-TDB is respective to the instruction identified by the ATIA in the TDB. However, when a transaction is aborted due to a program interruption and a null TDB is stored, the ILC is unpredictable.

Programming Note: When a transaction is aborted due to a program interruption, the ILC is not meaningful with respect to the instruction address in the program-old PSW. If a constrained transaction is aborted due to a program interruption, the instruction address in the program-old PSW points directly to the TBEGINC instruction that initiated constrained transactional execution. If a nonconstrained transaction is aborted due to an unfiltered program interruption, the instruction address in the program-old PSW points six bytes past the outermost TBEGIN instruction that initiated nonconstrained transactional execution. The program can determine whether a constrained or nonconstrained transaction was aborted by examining the constrained-transaction indication in the program-interruption TDB (bit 1 of the flags byte, stored at real location 6,145).

Zero ILC

Instruction-length code 0, after a program interruption (other than for an instruction-fetching nullification event), indicates that the instruction address stored in the old PSW does not identify the instruction caus-

ing the interruption. In the case of a program interruption due to an instruction-fetching nullification event, the ILC is set to zero. The remainder of this section discusses zero ILC due to cases other than for instruction-fetching nullification events.

An ILC of 0 occurs when a specification exception due to a PSW-format error is recognized as part of early exception recognition and the PSW has been introduced by LOAD PSW, LOAD PSW EXTENDED, PROGRAM RETURN, or an interruption. (See “Exceptions Associated with the PSW” on page 6-9.) In the case of LOAD PSW, LOAD PSW EXTENDED, or PROGRAM RETURN, the instruction address of the instruction or of an execute-type instruction (EXECUTE or EXECUTE RELATIVE LONG) has been replaced by the instruction address in the new PSW. When the invalid PSW is introduced by an interruption, the PSW-format error cannot be attributed to an instruction.

In the case of LOAD PSW, LOAD PSW EXTENDED, PROGRAM RETURN, and the supervisor-call interruption, a PER event may be indicated concurrently with a specification exception for which the ILC is 0.

In the case of a PROGRAM RETURN instruction that causes both a space-switch event and a PSW-format error, the space-switch event is recognized, but it is unpredictable whether the ILC is 0 or 1, or 0 or 2 if EXECUTE was used, or 0 or 3 if EXECUTE RELATIVE LONG was used.

ILC on Instruction-Fetching Exceptions

When a program interruption occurs because of an exception that prohibits access to the instruction, the instruction is considered to have been executed without being fetched, and the instruction-length code cannot be set on the basis of the first two bits of the instruction. As far as the significance of the ILC for this case is concerned, the following two situations are distinguished:

1. When an odd instruction address causes a specification exception to be recognized or when an addressing, protection, or translation-specification exception is encountered on fetching an instruction, the ILC is set to 1, 2, or 3, indicating the multiple of 2 by which the instruction address has been incremented. It is unpredictable whether the instruction address is incremented by 2, 4, or 6. By reducing the instruction address in the old PSW by the number of halfword locations indicated in the ILC, the instruction address

originally appearing in the PSW may be obtained.

2. When an ASCE-type, region-translation, segment-translation, or page-translation exception is recognized while fetching an instruction, the ILC is arbitrarily set to 1, 2, or 3. In this case, the operation is nullified, and the instruction address is not incremented.

The ILC is not necessarily related to the first two bits of the instruction when the first halfword of an instruction can be fetched but an access exception is recognized on fetching the second or third halfword. The ILC may be arbitrarily set to 1, 2, or 3 in these cases. The instruction address is or is not updated, as described in situations 1 and 2 above.

When any exceptions or any PER events other than an instruction-fetching-nullification event are encountered on fetching the target instruction of EXECUTE, the ILC is 2. When any exceptions or any PER events other than an instruction-fetching-nullification event are encountered on fetching the target instruction of EXECUTE RELATIVE LONG, the ILC is 3. When a PER instruction-fetching-nullification event is encountered on fetching the target of an execute-type instruction, and no other exception is recognized, the ILC is 0.

Programming Notes:

1. A nonzero instruction-length code for a program interruption indicates the number of halfword locations by which the instruction address in the program old PSW must be reduced to obtain the instruction address of the last instruction executed, unless one of the following situations exists:
 - a. The interruption is caused by an exception resulting in nullification.
 - b. An interruption for a PER event occurs before the execution of an interruptible instruction is completed, and no other program-interruption condition is indicated concurrently.
 - c. The interruption is caused by a PER event or space-switch event due to LOAD PSW, LOAD PSW EXTENDED, or a branch or linkage instruction, including SUPERVISOR CALL (but not including MONITOR CALL).

d. The interruption is caused by an addressing exception or protection exception for the storage operand of a LOAD CONTROL instruction that loads the control register (1 or 13) containing the address-space-control element that specifies the address space from which instructions are fetched.

For situations a and b above, the instruction address in the PSW is not incremented, and the instruction designated by the instruction address is the same as the last one executed. These situations are the only ones in which the instruction address in the old PSW identifies the instruction causing the exception. Situation b can be distinguished from a PER event indicated after completion of an interruptible or noninterruptible instruction in that, for situation b, the instruction address in the PSW is the same as the PER address at real location 152.

For situation c, the instruction address has been replaced as part of the operation, and the address of the last instruction executed cannot be calculated using the one appearing in the program old PSW.

For situation d, the effective address of the last instruction executed can be calculated, but, since the address-space-control element for the instruction address space is unpredictable, the corresponding real address is unknown.

2. The instruction-length code (ILC) is redundant when a PER event is indicated since the PER address in the doubleword at real location 152 identifies the instruction causing the interruption (or the execute-type instruction, as appropriate). Similarly, the ILC is may be unpredictable when the operation is nullified; in this case the instruction address in the PSW is not incremented. If the ILC value is required in this case, it can be derived from the operation code of the instruction identified by the old PSW.
3. The address of the last instruction executed before a program interruption is insufficient to locate the program problem if one of the following situations exists:
 - a. The interruption is caused by an access exception encountered in fetching an instruction, and the instruction address was introduced into the PSW by a means other than sequential operation (by a branch or linkage instruction, LOAD PSW, LOAD PSW

EXTENDED, an interruption, or conclusion of an IPL sequence).

- b. The interruption is caused by a specification exception due to an odd instruction address, which necessarily also results from introduction of an instruction address into the PSW.
- c. The interruption is caused by an early specification exception due to a STORE THEN OR SYSTEM MASK or SET SYSTEM MASK instruction that switches to or from the real mode while introducing invalid values in bit positions 0-7 of the PSW.

For situations a and b, the instruction address was replaced by the operation preceding the last instruction execution, and the address of the program location related to that preceding operation is unavailable.

For situation c, the address of the last instruction executed is available, but the corresponding real address is unknown.

4. The address of the last instruction executed is not available when an interruption is caused by an early specification exception due to a LOAD PSW, LOAD PSW EXTENDED, or PROGRAM RETURN instruction or an interruption.

Exceptions Associated with the PSW

Exceptions associated with erroneous information in the current PSW may be recognized as follows:

- When the information is introduced into the PSW (called early exception recognition)
- As part of the execution of the next instruction (called late exception recognition)

Errors in the PSW which are specification-exception conditions are called PSW-format errors.

Early Exception Recognition

For the following error conditions, a program interruption for a specification exception occurs immediately after the PSW becomes active:

- Any of the unassigned bits (0, 2-4, 25-30, or 33-63) is a one.
- Bit 12 is a one.

- Bit 24 is one (recognition of this condition is optional)
- Bits 31 and 32 are zero and one, respectively, and bits 64-96 are not all zeros.
- Bits 31 and 32 are both zero, and bits 64-103 are not all zeros.
- Bits 31 and 32 are one and zero, respectively.
- A specification exception is recognized due to an odd instruction address in the PSW (PSW bit 127 is one).
- An access exception (addressing, ASCE-type, page-translation, protection, region-translation, segment-translation, or translation-specification) is associated with the location designated by the instruction address or with the location of the second or third halfword of the instruction starting at the designated instruction address.

Programming Note: Bit 12 of an 8-byte short-format PSW in storage is inverted when the 16-byte current PSW is loaded from the following locations:

- An assigned storage location in the ESA/390-compatibility mode.
- The second operand of LOAD PSW (in the z/Architecture architecture mode and in the ESA/390-compatibility mode).
- The second operand of RESUME PROGRAM when the P bit in the parameter list is zero (in the z/Architecture architecture mode and in the ESA/390-compatibility mode).

The interruption occurs regardless of whether the wait state is specified. If the invalid PSW causes the CPU to become enabled for a pending I/O, external, or machine-check interruption, the program interruption occurs instead, and the pending interruption is subject to the mask bits of the new PSW introduced by the program interruption.

When an interruption or the execution of LOAD PSW, LOAD PSW EXTENDED, or PROGRAM RETURN introduces a PSW with one of the above error conditions, the instruction-length code is set to 0, and the newly introduced PSW is stored unmodified as the old PSW. Except as noted below, when one of the above error conditions is introduced by execution of SET SYSTEM MASK or STORE THEN OR SYSTEM MASK, the instruction-length code is set to 2, and the instruction address is incremented by 4. When one of the above error conditions is introduced by execution of SET SYSTEM MASK or STORE THEN OR SYSTEM MASK that is the target of EXECUTE RELATIVE LONG, the instruction-length code is set to 3, and the instruction address is incremented by 6. The PSW containing the invalid value introduced into the system-mask field is stored as the old PSW.

Late Exception Recognition

For the following conditions, the exception is recognized as part of the execution of the next instruction:

The instruction-length code and instruction address stored in the program old PSW under these conditions are discussed in “ILC on Instruction-Fetching Exceptions” on page 6-8, and an example is given in Figure 4-11 on page 4-44.

If an I/O, external, or machine-check-interruption condition is pending and the PSW causes the CPU to be enabled for that condition, the corresponding interruption occurs, and the PSW is not inspected for exceptions which are recognized late. Similarly, a PSW specifying the wait state is not inspected for exceptions which are recognized late.

Programming Notes:

1. The execution of BRANCH AND SET AUTHORITY, LOAD ADDRESS SPACE PARAMETERS, LOAD PSW, LOAD PSW EXTENDED, PROGRAM CALL, PROGRAM RETURN, PROGRAM TRANSFER, PROGRAM TRANSFER WITH INSTANCE, RESUME PROGRAM, SET PREFIX, SET SECONDARY ASN, SET SECONDARY ASN WITH INSTANCE, SET SYSTEM MASK, STORE THEN AND SYSTEM MASK, and STORE THEN OR SYSTEM MASK is suppressed on an addressing or protection exception, and hence the program old PSW provides information concerning the program causing the exception.
2. When the first halfword of an instruction can be fetched but an access exception is recognized on fetching the second or third halfword, the ILC is not necessarily related to the operation code.
3. If the new PSW introduced by an interruption contains a PSW-format error, a string of interruptions may occur. (See “Priority of Interruptions” on page 6-57.)

External Interruption

The external interruption provides a means by which the CPU responds to various signals originating from either inside or outside the configuration.

In the z/Architecture architectural mode, an external interruption causes the old PSW to be stored at real locations 304-319 and a new PSW to be fetched from real locations 432-447. In the ESA/390-compatibility mode, an external interruption causes the short-format old PSW to be stored at real locations 24-31 and a short-format new PSW to be fetched from real locations 88-95.

The source of the interruption is identified in the interruption code which is stored at real locations 134-135. The instruction-length code is not stored.

Additionally, for the malfunction-alert, emergency-signal, and external-call conditions, a 16-bit CPU address is associated with the source of the interruption and is stored at real locations 132-133. When the CPU address is stored, bit 6 of the interruption code is set to one. For all other conditions, no CPU address is stored, bit 6 of the interruption code is set to zero, and zeros are stored at real locations 132-133.

For the timing-alert, measurement-alert, and service-signal interruptions, a 32-bit parameter is associated with the interruption and is stored at real locations 128-131. Bit 5 of the external-interruption code indicates that a parameter has been stored. When bit 5 is zero, the contents of real locations 128-131 remain unchanged.

External-interruption conditions are presented as one of three types of interruption requests: pendable, direct-condition, and floating as described below:

- A pendable interruption request is preserved and remains pending in each CPU until it is honored at the CPU. The pendable interruption condition is cleared when the interruption occurs.
- A direct-condition interruption request is pending only during the time that the condition exists. If the condition is removed before the request is honored, then no interruption occurs. If the condition persists, then more than one interruption

may result from a single occurrence of the condition.

- A floating interruption request is held pending external to the CPU. The interruption can be accepted by any CPU in the configuration. The information associated with the interruption is not transferred to a particular CPU until the interruption occurs. The floating interruption condition is cleared when the interruption is accepted at any CPU in the configuration.

The clock comparator and CPU timer external-interruption conditions result in direct-condition interruption requests. The interrupt-key, malfunction-alert, warning-track, emergency-signal, and external-call external-interruption conditions result in pendable interruption requests. The service-signal external-interruption condition results in a floating interruption request. The timing-alert external-interruption condition results in either a floating interruption request or a pendable interruption request. See the individual description of each of the external-interruption conditions for additional details.

When several interruption requests for a single source are generated before the interruption occurs, and the interruption condition is a pendable or floating interruption request, only one request for that source is preserved and remains pending.

An external interruption for a particular source can occur only when the CPU is enabled for interruption by that source. The external interruption occurs at the completion of a unit of operation. The external mask, PSW bit 7, and external subclass-mask bits in control register 0 control whether the CPU is enabled for a particular source. Each source for an external interruption has a subclass-mask bit assigned to it, and the source can cause an interruption only when the external-mask bit is one and the corresponding subclass-mask bit is one.

When the CPU becomes enabled for a pendable or floating external-interruption condition, the interruption occurs at the completion of the instruction execution or interruption that causes the enabling.

More than one source may present a request for an external interruption at the same time. When the CPU becomes enabled for more than one concurrently pending request, the interruption occurs for the pending condition or conditions having the highest priority.

The priorities for external-interruption requests in descending order are as follows:

- Interrupt key
- Malfunction alert
- Emergency signal
- External call
- Clock comparator
- CPU timer
- Timing alert
- Warning track
- Service signal or measurement alert

All requests are honored one at a time. When more than one emergency-signal request exists at a time or when more than one malfunction-alert request exists at a time, the request associated with the smallest CPU address is honored first.

Clock Comparator

When the TOD-clock-steering facility is not installed, an interruption request for the clock comparator exists whenever either of the following conditions is met:

1. The TOD clock is in the set or not-set state, and the value of the clock comparator is less than the value in the compared portion of the TOD clock, both compare values being considered unsigned binary integers.
2. The TOD clock is in the error or not-operational state.

When the TOD-clock-steering facility is installed, an interruption request for the clock comparator exists whenever the physical clock is in the set state and the value of the clock comparator is less than the value in the compared portion of the logical TOD clock, both compare values being considered unsigned binary integers.

When the TOD-clock-steering facility is installed and a CPU remains in the wait state for a long period of time, clock-comparator interruptions may be proportionally late by the maximum steering rate.

If the condition responsible for the request is removed before the request is honored, the request does not remain pending, and no interruption occurs. Conversely, the request is not cleared by the interruption, and, if the condition persists, more than one

interruption may result from a single occurrence of the condition.

When the TOD-clock-steering facility is not installed, and the TOD clock is set or changes state, interruption conditions, if any, that are due to the clock comparator may or may not be recognized for up to 1.048576 seconds after the change.

When the TOD-clock-steering facility is installed and the physical clock is set or changes state, or the logical TOD clock is changed by PTFE-ATO or PTFE-STO, the CPUs in the configuration do not necessarily recognize this change for purposes of clock comparator interruptions until one of the following instructions is issued: SET CLOCK COMPARATOR (SCKC), STORE CLOCK (STCK), or STORE CLOCK EXTENDED (STCKE). If a CPU is in the wait state when this change occurs, it may not recognize the change until it leaves the wait state and one of the aforementioned instructions is executed.

The subclass-mask bit is in bit position 52 of control register 0. This bit is initialized to zero.

The clock-comparator condition is indicated by an external-interruption code of 1004 hex.

CPU Timer

An interruption request for the CPU timer exists whenever the CPU-timer value is negative (bit 0 of the CPU timer is one). If the value is made positive before the request is honored, the request does not remain pending, and no interruption occurs. Conversely, the request is not cleared by the interruption, and, if the condition persists, more than one interruption may occur from a single occurrence of the condition.

When the TOD-clock-steering facility is not installed, and the TOD clock is set or changes state, interruption conditions, if any, that are due to the CPU timer may or may not be recognized for up to 1.048576 seconds after the change.

When the TOD-clock-steering facility is installed, CPU timer interruptions may or may not be recognized while the physical clock is in the stopped state. After the physical clock enters the set state, interruption conditions for the CPU timer are not necessarily recognized until SET CPU TIMER (SPT) is issued.

CPU timer interruptions are not affected by changes to the logical TOD clock.

The subclass-mask bit is in bit position 53 of control register 0. This bit is initialized to zero.

The CPU-timer condition is indicated by an external-interruption code of 1005 hex.

Emergency Signal

An interruption request for an emergency signal is generated when the CPU accepts the emergency-signal order specified by a SIGNAL PROCESSOR instruction addressing this CPU. The instruction may have been executed by this CPU or by another CPU in the configuration. The request is preserved and remains pending in the receiving CPU until it is cleared. The pending request is cleared when it causes an interruption and by CPU reset.

Facilities are provided for holding a separate emergency-signal request pending in the receiving CPU for each CPU in the configuration, including the receiving CPU itself.

The subclass-mask bit is in bit position 49 of control register 0. This bit is initialized to zero.

The emergency-signal condition is indicated by an external-interruption code of 1201 hex. The address of the CPU that executed the SIGNAL PROCESSOR instruction is stored at real locations 132-133.

External Call

An interruption request for an external call is generated when the CPU accepts the external-call order specified by a SIGNAL PROCESSOR instruction addressing this CPU. The instruction may have been executed by this CPU or by another CPU in the configuration. The request is preserved and remains pending in the receiving CPU until it is cleared. The pending request is cleared when it causes an interruption and by CPU reset.

Only one external-call request, along with the processor address, may be held pending in a CPU at a time.

The subclass-mask bit is in bit position 50 of control register 0. This bit is initialized to zero.

The external-call condition is indicated by an external-interruption code of 1202 hex. The address of the CPU that executed the SIGNAL PROCESSOR instruction is stored at real locations 132-133.

Interrupt Key

An interruption request for the interrupt key is generated when the operator activates that key. The request is preserved and remains pending in the CPU until it is cleared. The pending request is cleared when it causes an interruption and by CPU reset.

When the interrupt key is activated while the CPU is in the load state, it depends on the model whether an interruption request is generated or the condition is lost.

The subclass-mask bit is in bit position 57 of control register 0. This bit is initialized to one.

The interrupt-key condition is indicated by an external-interruption code of 0040 hex.

Malfunction Alert

An interruption request for a malfunction alert is generated when another CPU in the configuration enters the check-stop state or loses power. The request is preserved and remains pending in the receiving CPU until it is cleared. The pending request is cleared when it causes an interruption and by CPU reset.

Facilities are provided for holding a separate malfunction-alert request pending in the receiving CPU for each of the other CPUs in the configuration. Removal of a CPU from the configuration does not generate a malfunction-alert condition.

The subclass-mask bit is in bit position 48 of control register 0. This bit is initialized to zero.

The malfunction-alert condition is indicated by an external-interruption code of 1200 hex. The address of the CPU that generated the condition is stored at real locations 132-133.

Measurement Alert

The measurement-alert external interruption is described in the publication *The Load-Program-Parameter and CPU-Measurement Facilities* (SA23-2260).

The measurement-alert subclass-mask bit is in bit position 58 of control register 0. This bit is initialized to one, which enables the interruption.

The measurement-alert condition is indicated by an external interruption code of 1407 hex. The interruption parameter stored at real locations 128-131 indicate the cause or causes for the interruption.

Service Signal

An interruption request for a service signal is generated upon the completion of certain configuration-control and maintenance functions, such as those initiated by means of the model-dependent DIAGNOSE instruction. A 32-bit parameter is provided with the interruption to assist the program in determining the operation for which the interruption is reported.

Service signal is a floating interruption condition and is presented to the first CPU in the configuration which can perform the interruption. The interruption condition is cleared when it causes an interruption in any one of the CPUs and also by subsystem reset.

The subclass-mask bit is in bit position 54 of control register 0. This bit is initialized to zero.

The service-signal condition is indicated by an external-interruption code of 2401 hex. A 32-bit parameter is stored at real locations 128-131.

Timing Alert

An interruption request for a timing alert is generated when an ETR-timing-alert or STP-timing-alert condition is detected.

If the same timing-alert condition occurs more than once before the interruption occurs, the request is generated only once.

When the STP-floating-interrupt facility is not installed or is not enabled for STP timing-alert floating interruptions, the timing-alert condition causes a

pendable interruption request to be generated for each CPU in the configuration and to remain pending at each CPU until it is cleared. The pending request is cleared when it causes an interruption at the CPU and by CPU reset.

When the STP-floating-interrupt facility is installed and is enabled for STP timing-alert floating interruptions, an STP timing-alert condition causes a floating interruption request to be generated.

The subclass-mask bit is in bit position 59 of control register 0. This bit is initialized to zero.

The timing-alert condition is indicated by an external interruption code of 1406 hex. The interruption parameter stored at real locations 128-131 indicate the reason or reasons for the signal.

ETR-Timing-Alert Condition

An ETR-timing-alert condition is detected when a port-availability change occurs at any port in the current CPC-port group or when an ETR alert occurs. The terms specific to the ETR are not defined in this publication.

STP-Timing-Alert Condition

An STP-timing-alert condition is detected when any of the following occur:

Timing Status Change: A timing-status-change condition is detected when a timing-status change has occurred for the configuration. Timing status for a configuration includes the timing mode, timing state, the STP-clock-source state, and certain external time source conditions.

A timing-state change from the synchronized state to the unsynchronized or stopped state is reported as an ETR- or STP-sync-check machine-check condition rather than a timing-alert external interruption condition.

An STP-clock-source-state change from the usable state to the not-usable is reported as a clock-source-error machine-check condition rather than a timing-alert external interruption condition.

Link Availability Change: A link-availability-change condition is detected when the availability of an STP link has changed. The condition is detected whenever an STP link state that was unavailable becomes available for STP communication, or when

a link that was available becomes unavailable for STP communication.

A timing-alert condition is not generated by a link-availability-change condition if a CTN configuration-change machine check condition is detected concurrently with the link-availability change.

Time Control Parameter Change: The time control-parameter-change condition is detected when any of the time-control parameters change for the configuration, including when a time-control-parameter change is scheduled. Time-control parameters for a configuration include the following:

- Total-time offset (the combination of time-zone offset and DST offset)
- Leap seconds offset
- Time-zone offset
- Daylight-savings-time (DST) offset
- Scheduled changes to any of the above

A 32-bit parameter is associated with the interruption and is stored at real locations 128-131. The field is defined as shown below:

Bit	Meaning
0-13	Reserved
14	Timing-status change
15	Link-availability change
16	Time-control-parameter change
17-31	Reserved

Multiple alert conditions may be indicated concurrently in the external-interruption parameter field.

Warning Track

An interruption request for a warning-track event may be generated to inform the control program it is nearing the end of the current execution interval on a shared CPU. The interruption request is a pending-condition type which may be generated when the configuration is registered and is enabled for warning-track interruptions.

When the configuration is enabled for multithreading, a warning-track interruption may be made pending for each CPU of a core.

The subclass-mask bit is in bit position 30 of control register 0. This bit is initialized to zero.

The warning-track condition is indicated by an external-interruption code of 1007 hex.

I/O Interruption

The input/output (I/O) interruption provides a means by which the CPU responds to conditions originating in I/O devices and the channel subsystem.

A request for an I/O interruption may occur at any time, and more than one request may occur at the same time. The requests are preserved and remain pending until accepted by a CPU, or until cleared by some other means, such as subsystem reset.

The I/O interruption occurs at the completion of a unit of operation. Priority is established among requests so that in each CPU only one interruption request is processed at a time. Priority among requests for interruptions of differing I/O-interruption subclasses is according to the numerical value of the I/O-interruption subclass (with zero having the highest priority), in conjunction with the I/O-interruption subclass-mask settings in control register 6. For more details, see "I/O Interruptions" on page 16-1.

When a CPU becomes enabled for I/O interruptions and the channel subsystem has established priority for a pending I/O-interruption condition, the interruption occurs at the completion of the instruction execution or interruption that causes the enabling.

In the z/Architecture architectural mode, an I/O interruption causes the old PSW to be stored at real locations 368-383 and a new PSW to be fetched from real locations 496-511. In the ESA/390-compatibility mode, an I/O interruption causes the short-format old PSW to be stored at real locations 56-63 and a short-format new PSW to be fetched from real locations 120-127.

Additional information, in the form of a twelve-byte I/O-interruption code, is stored at real locations 184-195. The I/O-interruption code consists of a 32-bit subsystem-identification word, a 32-bit interruption parameter, and a 32-bit I/O-interruption identification word.

An I/O interruption can occur only while a CPU is enabled for the interruption subclass presenting the request. The I/O-mask bit, bit 6 of the PSW, and the I/O-interruption subclass mask in control register 6 determine whether the CPU is enabled for a particular I/O interruption.

I/O interruptions are grouped into eight I/O-interruption subclasses, numbered from 0-7. Each I/O-interruption subclass has an associated I/O-interruption subclass-mask bit in bit positions 32-39 of control register 6. Each subchannel has an I/O-interruption subclass value associated with it. The CPU is enabled for I/O interruptions of a particular I/O-interruption subclass only when PSW bit 6 is one and the associated I/O-interruption subclass-mask bit in control register 6 is also one. If the corresponding I/O-interruption subclass-mask bit is zero, then the CPU is disabled for I/O interruptions with that subclass value. I/O interruptions for all subclasses are disallowed when PSW bit 6 is zero.

Machine-Check Interruption

The machine-check interruption is a means for reporting to the program the occurrence of equipment malfunctions. Information is provided to assist the program in determining the source of the fault and extent of the damage.

In the z/Architecture architectural mode, a machine-check interruption causes the old PSW to be stored at real locations 352-367 and a new PSW to be fetched from real locations 480-495. In the ESA/390-compatibility mode, a machine-check interruption causes the short-format old PSW to be stored at real locations 48-55 and a short-format new PSW to be fetched from real locations 112-119.

The cause and severity of the malfunction are identified by a 64-bit machine-check-interruption code stored at real locations 232-239 and an indication of the architectural mode to be stored at real location 163. In the z/Architecture architectural mode, further information identifying the cause of the interruption and the location of the fault may be stored at real locations 244-255 and 4608-5119. In the ESA/390-compatibility mode, further information identifying the cause of the interruption and the location of the fault may be stored at real locations 216-231, 244-251, 288-511, and in the machine-check extended save area pointed to by real locations 212-215.

The interruption action and the storing of the associated information are under the control of PSW bit 13 and bits in control register 14. See Chapter 11, "Machine-Check Handling" for more detailed information.

Program Interruption

Program interruptions are used to report exceptions and events which occur during execution of the program.

In the z/Architecture architectural mode, a program interruption causes the old PSW to be stored at real locations 336-351 and a new PSW to be fetched from real locations 464-479. In the ESA/390-compatibility mode, a program interruption causes the short-format old PSW to be stored at real locations 40-47 and a short-format new PSW to be fetched from real locations 104-111.

The cause of the interruption is identified by the interruption code. The interruption code is placed at real locations 142-143, the instruction-length code is placed in bit positions 5 and 6 of the byte at real location 141 with the rest of the bits set to zeros, and zeros are stored at real location 140. When a transaction is aborted due to a program interruption, the instruction-length code is respective to the instruction at which the exception condition was detected. For some causes, additional information identifying the reason for the interruption is stored at real locations 144-183.

If the PER-3 facility is installed, then, as part of the program interruption action, the contents of the breaking-event-address register are placed in real storage locations 272-279.

Except for PER events and the crypto-operation exception, the condition causing the interruption is indicated by a coded value placed in the rightmost seven bit positions of the interruption code. Only one condition at a time can be indicated.

PER events are indicated by setting bit 8 of the interruption code to one. When this is the only condition, bits 0-7 and 9-15 are also set to zeros. When a PER event is indicated concurrently with another program-interruption condition, bit 8 is one, and bits 0-7 and 9-15 are set as for the other condition.

The crypto-operation exception is indicated by an interruption code of 0119 hex, (or 0199, 0319, or 0399 hex, if a concurrent PER event, a concurrent transactional-execution-aborted event, or both are indicated, respectively).

When a program interruption is recognized during transactional execution, bit 6 of the interruption code is set to one. Bits 0-5 of the interruption code are set to zero.

When there is a corresponding mask bit, a program interruption can occur only when that mask bit is one. The program mask in the PSW controls four of the exceptions, the IEEE masks in the FPC register control the IEEE exceptions, bit 33 in control register 0 controls whether SET SYSTEM MASK causes a special-operation exception, bits 48-63 in control register 8 control interruptions due to monitor events, and a hierarchy of masks control interruptions due to PER events. When any controlling mask bit is zero, the condition is ignored; the condition does not remain pending.

Programming Notes:

1. When the new PSW for a program interruption has a PSW-format error or causes an exception to be recognized in the process of instruction fetching, a string of program interruptions may occur. See “Priority of Interruptions” on page 6-57 for a description of how such strings are terminated.
2. Some of the conditions indicated as program exceptions may be recognized also by the channel subsystem, in which case the exception is indicated in the subchannel-status word or extended-status word.

Data-Exception Code (DXC)

When a data exception causes a program interruption, a data-exception code (DXC) is stored at location 147, and zeros are stored at locations 144-146. The DXC distinguishes between the various types of data-exception conditions. When the AFP-register (additional floating-point register) control bit, bit 45 of control register 0, is one, the DXC is also placed in the DXC field of the floating-point-control (FPC) register. The DXC field in the FPC register remains unchanged when any other program exception is reported. The DXC is an 8-bit code indicating the

specific cause of a data exception. The data exceptions and data-exception codes are shown in Figure 6-2 and Figure 6-3 on page 6-18.

Priority of Program Interruptions for Data Exceptions

DXC 2 and 3 are mutually exclusive and are of higher priority than any other DXC. Thus, for example, DXC 2 (BFP instruction) takes precedence over any IEEE exception; and DXC 3 (DFP instruction) takes precedence over any IEEE exception or simulated IEEE exception. As another example, if the conditions for both DXC 3 (DFP instruction) and DXC 1 (AFP register) exist, DXC 3 is reported.

When both a specification exception and an AFP-register data exception or a vector-instruction data exception apply, it is unpredictable which one is reported.

DXC (Hex)	Data Exception
00	General operand
01	AFP register
02	BFP instruction
03	DFP instruction
04	Quantum Exception
07	Simulated Quantum Exception
08	IEEE inexact and truncated
0B	Simulated IEEE inexact
0C	IEEE inexact and incremented
10	IEEE underflow, exact
13	Simulated IEEE underflow, exact
18	IEEE underflow, inexact and truncated
1B	Simulated IEEE underflow, inexact
1C	IEEE underflow, inexact and incremented
20	IEEE overflow, exact
23	Simulated IEEE overflow, exact
28	IEEE overflow, inexact and truncated
2B	Simulated IEEE overflow, inexact
2C	IEEE overflow, inexact and incremented
40	IEEE division by zero
43	Simulated IEEE division by zero
80	IEEE invalid operation
83	Simulated IEEE invalid operation

Figure 6-2. Data-exception codes (DXC)

DXC (Hex)	Data Exception
FE	Vector instruction
FF	Compare-and-trap instruction

Figure 6-2. Data-exception codes (DXC) (Continued)

Exception	Applicable Instruction Types	CR0.45	FPC Mask	FPC Flag	DXC (Binary)	Instruction Action	DXC Placed in Real Loc. 147	DXC Placed in FPC Byte 2
General operand	Various ¹	0	none	none	0000 0000	Suppress or Terminate	Yes	No
		1					Yes	Yes
AFP register	FPS & HFP	0*	none	none	0000 0001	Suppress	Yes	No
BFP instruction	BFP	0*	none	none	0000 0010	Suppress	Yes	No
DFP instruction	DFP	0*	none	none	0000 0011	Suppress	Yes	No
IEEE invalid operation	ICMP	1*	0.0	1.0	1000 0000	Suppress ²	Yes	Yes
IEEE division by zero	ICMP	1*	0.1	1.1	0100 0000	Suppress ²	Yes	Yes
IEEE overflow	ICMP	1*	0.2	1.2	0010 xy00	Complete	Yes	Yes
IEEE underflow	ICMP	1*	0.3	1.3	0001 xy00	Complete	Yes	Yes
IEEE inexact	ICMP	1*	0.4	1.4	0000 1y00	Complete	Yes	Yes
Quantum Exception	ICMP	1*	0.5	1.5	0000 0100	Complete	Yes	Yes
Simulated IEEE invalid operation	IXS	1*	0.0	1.0	1000 0011	Complete	Yes	Yes
Simulated IEEE division by zero	IXS	1*	0.1	1.1	0100 0011	Complete	Yes	Yes
Simulated IEEE overflow	IXS	1*	0.2	1.2	0010 w011	Complete	Yes	Yes
Simulated IEEE underflow	IXS	1*	0.3	1.3	0001 w011	Complete	Yes	Yes
Simulated IEEE inexact	IXS	1*	0.4	1.4	0000 1011	Complete	Yes	Yes
Simulated Quantum Exception	IXS	1*	0.5	1.5	0000 0111	Complete	Yes	Yes
Vector instruction	VEC	0 [†]	none	none	1111 1110	Suppress	Yes	Unp
		1 [‡]					Yes	Yes

Figure 6-3. Data Exceptions

Exception	Applicable Instruction Types	CR0.45	FPC Mask	FPC Flag	DXC (Binary)	Instruction Action	DXC Placed in Real Loc. 147	DXC Placed in FPC Byte 2
Compare-and-trap instruction	CT & LT	0	none	none	1111 1111	Complete	Yes	No
		1					Yes	Yes
Explanation:								
¹	General-operand data exception applies to the decimal instructions (Chapter 8), the general instructions COMPRESSION CALL, CONVERT TO BINARY, and PERFORM RANDOM NUMBER OPERATION (Chapter 7), and the DFP instructions CONVERT FROM PACKED, CONVERT FROM SIGNED PACKED, CONVERT FROM UNSIGNED PACKED, and CONVERT FROM ZONED (Chapter 20).							
²	When the FPC mask bit corresponding to the exception condition is one, the DXC is stored in the FPC register, even though the resulting data-exception program interruption is considered to be suppressing.							
0*	This exception is recognized only when CR0.45 is zero.							
1*	This exception is recognized only when CR0.45 is one.							
0†	This exception may be recognized if CR0.46 is zero or one							
1‡	This exception is recognized only when CR0.46 is zero.							
w	For simulated IEEE overflow and simulated IEEE underflow, bit 4 of the DXC is set to bit 4 of the signaling flags in the FPC register.							
xy	For IEEE overflow and IEEE underflow, bits 4 and 5 of the DXC are set to 00, 10, or 11 binary, indicating that the result is exact, inexact and truncated, or inexact and incremented, respectively.							
y	For IEEE inexact, bit 5 of the DXC is set to zero or one, indicating that the result is inexact and truncated or inexact and incremented, respectively.							
BFP	Binary-floating-point instructions (Chapter 19).							
CT	COMPARE AND TRAP, COMPARE IMMEDIATE AND TRAP, COMPARE LOGICAL AND TRAP, or COMPARE LOGICAL IMMEDIATE AND TRAP instructions.							
DFP	Decimal-floating-point instructions (Chapter 20).							
FPS	Floating-point-support instructions (Chapter 9).							
HFP	Hexadecimal-floating-point instructions (Chapter 18).							
ICMP	IEEE computational instructions.							
IXS	IEEE-exception-simulation instructions (LOAD FPC AND SIGNAL and SET FPC AND SIGNAL).							
LT	Load-and-trap facility instructions.							
UNP	Unpredictable if FPC byte 2 is updated if CR0.46 is one. Otherwise, FPC Byte 2 is not updated.							
VEC	Vector instructions (Chapters 21, 22, 23, 24, and 25).							

Figure 6-3. Data Exceptions (Continued)

Programming Note: The data-exception code (DXC) in bits 16-23 of the floating-point control register (FPCR) is primarily intended for use by floating-point applications that rely on the enablement of the AFP-register control, bit 45 of control register 0. When a data-exception program interruption occurs as a result of the execution of a compare-and-trap or a load-and-trap facility instruction (DXC 255), the DXC in the FPCR may contain an unpredictable value under the following conditions.

- For a control program, an instruction examining the FPCR (for example, EXTRACT FPC) is the first instruction that is subject to the AFP control to be executed since the last initial-CPU reset.
- For a task running under a control program such as z/OS, an instruction examining the FPCR is

the first instruction that is subject to the AFP control to be executed by the task.

This unpredictability is the result of the control program or task being dispatched with the AFP control initially set to zero, and only applies to DXC 255 in the FPCR. Subsequent inspections of the DXC in the FPCR will yield predictable values.

If the program always needs to observe a predictable compare-and-trap DXC value in the FPCR, it should first issue any instruction that is subject to the AFP control (for example EXTRACT FPC) before issuing an instruction that causes the data-exception program interruption for the compare-and-trap condition. Alternatively, the program can inspect the DXC stored in real location 147, as copied into a control-program-supplied diagnostic work area; the DXC stored at location 147 is predictable in all cases.

Vector-Exception Code

When a vector-processing exception causes a program interruption, a vector-exception code (VXC) is stored at location 147, and zeros are stored at locations 144-146. The VXC is also placed in the DXC field of the floating-point-control (FPC) register if bit 45 of control register 0 is one. When bit 45 of control register 0 is zero and bit 46 of control register 0 is one, the DXC field of the FPC register and the contents of storage at location 147 are unpredictable. The VXC distinguishes between various types of vector floating point exceptions and which element caused the exception.

The VXC has the following format:

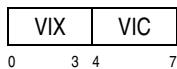

Bits 0-3 of the VXC are the vector index (VIX). The index in the VXC is always the index of the source element that caused the trapping exception, except for one special case in VECTOR LOAD LENGTHENED (see the programming note on page 24-27). If trapping vector-processing exception conditions exist for multiple elements, the exception of the lowest-indexed source element is recognized.

Bits 4-7 of the VXC are the vector interrupt code (VIC). This field can have the following values:

- 0001 - IEEE invalid operation
- 0010 - IEEE division by zero
- 0011 - IEEE overflow
- 0100 - IEEE underflow
- 0101 - IEEE inexact

Program-Interruption Conditions

The following is a detailed description of each program-interruption condition.

Addressing Exception

An addressing exception is recognized when the CPU attempts to reference a main-storage location that is not available in the configuration. A main-storage location is not available in the configuration when the location is not installed, when the storage unit is not in the configuration, or when power is off in the storage unit. An address designating a storage loca-

tion that is not available in the configuration is referred to as invalid.

The operation is suppressed when the address of the instruction is invalid. Similarly, the operation is suppressed when the address of the target instruction of an execute-type instruction (EXECUTE or EXECUTE RELATIVE LONG) is invalid. Also, the unit of operation is suppressed when an addressing exception is encountered in accessing a table or table entry. The tables and table entries to which the rule applies are the dispatchable-unit-control table, the primary ASN-second-table entry, and entries in the access list, region first table, region second table, region third table, segment table, page table, linkage table, linkage-first table, linkage-second table, entry table, ASN first table, ASN second table, authority table, linkage stack, and trace table. Addressing exceptions result in suppression when they are encountered for references to the region first table, region second table, region third table, segment table, and page table, in both implicit references for dynamic address translation and references associated with the execution of LOAD PAGE-TABLE-ENTRY ADDRESS, LOAD REAL ADDRESS, STORE REAL ADDRESS, and TEST PROTECTION. Similarly, addressing exceptions for accesses to the dispatchable-unit-control table, primary ASN-second-table entry, access list, ASN second table, or authority table result in suppression when they are encountered in access-register translation done either implicitly or as part of LOAD PAGE-TABLE-ENTRY ADDRESS, LOAD REAL ADDRESS, STORE REAL ADDRESS, TEST ACCESS, or TEST PROTECTION.

Except for some specific instructions whose execution is suppressed, the operation is terminated for an operand address that can be translated but designates an unavailable location. See Figure 6-4 on page 6-21.

For termination, changes may occur only to result fields. In this context, the term "result field" includes the condition code, registers, and any storage locations that are provided and that are designated to be changed by the instruction. Therefore, if an instruction is due to change only the contents of a field in storage, and every byte of the field is in a location that is not available in the configuration, the operation is suppressed. When part of an operand location is available in the configuration and part is not, storing may be performed in the part that is available in the configuration.

When an addressing exception occurs during the fetching of an instruction or during the fetching of a DAT table entry associated with an instruction fetch, it is unpredictable whether the ILC is 1, 2, or 3. When the exception is associated with fetching the target of EXECUTE, the ILC is 2. When the exception is associated with fetching the target of EXECUTE RELATIVE LONG, the ILC is 3.

In all cases of addressing exceptions not associated with instruction fetching, the ILC is 1, 2, or 3, indicating the length of the instruction that caused the reference.

An addressing exception is indicated by a program-interruption code of 0005 hex (or 0085, 0205, or 0285 hex, if a concurrent PER event, a concurrent transactional-execution-aborted event, or both are indicated, respectively).

Exception	Action on			
	Table-Entry Fetch ¹	Table-Entry Store ²	Instruction Fetch	Operand Reference
Addressing exception	Suppress	Suppress	Suppress	Suppress for IPTE, LASP, LPSW, LPSWE, MSCH, PLO ⁶ , RP, SCKC, SPT, SPX, SSCH, SSM, STCRW, STNSM, STOSM, TPI, and TPROT. Terminate for all others. ⁴
Protection exception for key-controlled protection	—	—	Suppress	Suppress for IPTE, LASP, LPSW, LPSWE, MSCH, PLO ⁶ , RP, SCKC, SPT, SPX, SSCH, SSM, STCRW, STNSM, STOSM, and TPI ⁵ . Terminate for all others. ⁴
Protection exception for access-list-controlled protection	—	—	—	Suppress
Protection exception for instruction-execution protection	—	—	Suppress	—
Protection exception for DAT protection	—	Suppress ³	—	Suppress ⁵
Protection exception for low-address protection	—	Suppress	—	Suppress for IPTE, PLO ⁶ , STCRW, STNSM, STOSM, and TPI ⁵ . Terminate for all others. ⁴

Explanation:

— Not applicable

¹ Table entries include region table, segment table, page table, linkage table, linkage-first table, linkage-second table, entry table, ASN first table, ASN second table, authority table, dispatchable-unit-control table, primary ASN-second-table entry, access list, and linkage stack.

² Table entries include linkage stack and trace table.

³ DAT protection applies to the linkage stack but not the trace table.

⁴ For termination, changes may occur only to result fields. In this context, “result field” includes condition code, registers, and storage locations, if any, which are designated to be changed by the instruction. However, no change is made to a storage location or a storage key when the reference causes an access exception. Therefore, if an instruction is due to change only the contents of a field in main storage, and every byte of that field would cause an access exception, the result is the same as if the operation had been suppressed. The action may be, for key-controlled protection and low-address protection, suppression instead of termination; see “Suppression on Protection” on page 3-15.

⁵ When the effective address of TPI is zero, the store access is to implicit real locations 184-191, and key-controlled protection, DAT protection, and low-address protection do not apply.

⁶ Suppression occurs only for the compare-and-load and compare-and-swap operations.

Figure 6-4. Summary of Action for Addressing and Protection Exceptions

AFX-Translation Exception

An AFX-translation exception is recognized when, during ASN translation in the space-switching form of PROGRAM RETURN, PROGRAM TRANSFER, PROGRAM TRANSFER WITH INSTANCE, SET SECONDARY ASN, or SET SECONDARY ASN WITH INSTANCE, or during ASN translation in PROGRAM RETURN when the restored SASN does not equal the restored PASN, bit 0 of the ASN-first-table entry used is not zero.

The ASN being translated is stored at real locations 174 and 175, and real locations 172 and 173 are set with zeros.

The operation is nullified.

The instruction-length code is 1 or 2, except that when the exception occurs during the fetching of the target of EXECUTE RELATIVE LONG, the ILC is 3.

The AFX-translation exception is indicated by a program-interruption code of 0020 hex (or 00A0 hex if a concurrent PER event is indicated).

ALEN-Translation Exception

An ALEN-translation exception is recognized during access-register translation when either:

1. The access register used contains an access-list-entry number that designates an access-list entry which is beyond the end of the access list designated by the effective access-list designation.
2. Bit 0 of the access-list entry is not zero.

The number of the access register is stored in bit positions 4-7 of real location 160, and bits 0-3 of the location are set to zeros.

The operation is nullified.

The instruction-length code is 1, 2, or 3.

The ALEN-translation exception is indicated by a program-interruption code of 0029 hex (or 00A9, 0229, or 02A9 hex, if a concurrent PER event, a concurrent transactional-execution-aborted event, or both are indicated, respectively).

ALE-Sequence Exception

An ALE-sequence exception is recognized during access-register translation when the access register

used contains an access-list-entry sequence number (ALESN) which is not equal to the ALESN in the access-list entry that is designated by the access register.

The number of the access register is stored in bit positions 4-7 at real location 160, and bits 0-3 are set to zeros.

The operation is nullified.

The instruction-length code is 1, 2, or 3.

The ALE-sequence exception is indicated by a program-interruption code of 002A hex (or 00AA, 022A, or 02AA hex, if a concurrent PER event, a concurrent transactional-execution-aborted event, or both are indicated, respectively).

ALET-Specification Exception

An ALET-specification exception is recognized during access-register translation when bit positions 0-6 of the access-list-entry token in the access register used do not contain all zeros. However, when access-register 0 is used, except in TEST ACCESS, it is treated as containing all zeros, and this exception is not recognized. TEST ACCESS uses the actual contents of access register 0.

The operation is suppressed.

The instruction-length code is 1, 2, or 3.

The ALET-specification exception is indicated by a program-interruption code of 0028 hex (or 00A8, 0228, or 02A8 hex, if a concurrent PER event, a concurrent transactional-execution-aborted event, or both are indicated, respectively).

ASCE-Type Exception

An ASCE-type exception is recognized when any of the following is true during dynamic address translation:

1. The address-space-control element being used is a region-second-table designation, and bits 0-10 of the virtual address being translated are not all zeros.
2. The address-space-control element being used is a region-third-table designation, and bits 0-21 of the virtual address being translated are not all zeros.

3. The address-space-control element being used is a segment-table designation, and bits 0-32 of the virtual address being translated are not all zeros.

The exception is recognized as part of the execution of an instruction that needs the address-space-control element in the translation of an instruction, operand, or side-effect address, except for the operand address in LOAD PAGE-TABLE-ENTRY ADDRESS, LOAD REAL ADDRESS, and TEST PROTECTION, in which case the condition is indicated by the setting of the condition code.

When an interruption occurs, information about the virtual address causing the exception is stored at real locations 168-175 and conditionally at real location 160. See “Assigned Storage Locations” on page 3-73 for a detailed description of this information.

The unit of operation is nullified.

When the exception occurs during fetching of an instruction, it is unpredictable whether the ILC is 1, 2, or 3. When the exception occurs during a reference to the target of EXECUTE, the ILC is 2. When the exception occurs during a reference to the target of EXECUTE RELATIVE LONG, the ILC is 3.

When the exception occurs during a reference to an operand location, the instruction-length code (ILC) is 1, 2, or 3 and indicates the length of the instruction causing the exception.

The ASCE-type exception is indicated by a program-interruption code of 0038 hex (or 00B8, 0238, or 02B8 hex, if a concurrent PER event, a concurrent transactional-execution-aborted event, or both are indicated, respectively).

ASTE-Instance Exception

An ASTE-instance exception is recognized when the ASN-and-LX-reuse facility is installed, and any of the following is true:

1. During ASN translation in PROGRAM TRANSFER WITH INSTANCE with space switching, the ASTEIN in bit positions 0-31 of general register R₁ is not equal to the ASTEIN in the located ASTE.
2. During PASN translation in PROGRAM RETURN with space switching, the ASN-and-LX-reuse control in control register 0 is one and the

PASTEIN in the linkage-stack state entry is not equal to the ASTEIN in the located ASTE.

3. During ASN translation in SET SECONDARY ASN WITH INSTANCE with space switching, the ASTEIN in bit positions 0-31 of general register R₁ is not equal to the ASTEIN in the located ASTE.
4. During SASN translation in PROGRAM RETURN to current primary or with space switching, the ASN-and-LX-reuse control in control register 0 is one, and the SASTEIN in the linkage-stack state entry is not equal to the ASTEIN in the located ASTE.

Information is stored as follows:

- In cases 1 and 2, bit 2 of real location 160 is set to one, and bits 0, 1, and 3-7 are set to zeros.
- In cases 3 and 4, bit 3 of real location 160 is set to one, and bits 0-2 and 4-7 are set to zeros.

The operation is nullified.

The instruction-length code is 1, 2, or 3.

The ASTE-instance exception is indicated by a program-interruption code of 002F hex (or 00AF hex if a concurrent PER event is indicated).

ASTE-Sequence Exception

An ASTE-sequence exception is recognized when any of the following is true:

1. During access-register translation, except as in 2, the access-list entry used contains an ASN-second-table-entry sequence number (ASTESN) which is not equal to the ASTESN in the ASN-second-table entry that is designated by the access-list entry. The access-list entry is the one designated by the access register used.
2. During access-register translation of ALET 1 by BRANCH IN SUBSPACE GROUP, the subspace ASTESN (SSASTESN) in the dispatchable-unit control table (DUCT) is not equal to the ASTESN in the subspace ASTE designated by the subspace-ASTE origin (SSASTEO) in the DUCT.
3. During a subspace-replacement operation, the subspace ASTESN (SSASTESN) in the dispatchable-unit control table (DUCT) is not equal to the ASTESN in the subspace ASTE design-

nated by the subspace-ASTE origin (SSASTE0) in the DUCT.

In the first and second cases, the number of the access register is stored in bit positions 4-7 at real location 160, and bits 0-3 are set to zeros. In the third case, all zeros are stored at real location 160.

The operation is nullified.

The instruction-length code is 1, 2, or 3.

The ASTE-sequence exception is indicated by a program-interruption code of 002C hex (or 00AC, 022C, or 02AC hex, if a concurrent PER event, a concurrent transactional-execution-aborted event, or both are indicated, respectively).

Programming Note: The storing of zeros at real location 160 in the case of an ASTE-sequence exception recognized during a subspace-replacement operation is a unique indication since the use of access register 0 in access-register translation cannot result in the exception.

ASTE-Validity Exception

An ASTE-validity exception is recognized when any of the following is true:

1. During access-register translation, except as in 2, the access-list entry used designates an ASN-second-table entry in which bit 0 is not zero. The access-list entry is the one designated by the access register used.
2. During access-register translation of ALET 1 by BRANCH IN SUBSPACE GROUP, the subspace-ASTE origin (SSASTE0) in the dispatchable-unit control table designates an ASN-second-table entry in which bit 0 is not zero.
3. During a subspace-replacement operation, the subspace-ASTE origin (SSASTE0) in the dispatchable-unit control table designates an ASN-second-table entry in which bit 0 is not zero.

In the first and second cases, the number of the access register is stored in bit positions 4-7 at real location 160, and bits 0-3 are set to zeros. In the third case, all zeros are stored at real location 160.

The operation is nullified.

The instruction-length code is 1, 2, or 3.

The ASTE-validity exception is indicated by a program-interruption code of 002B hex (or 00AB, 022B, or 02AB hex, if a concurrent PER event, a concurrent transactional-execution-aborted event, or both are indicated, respectively).

Programming Note: The storing of zeros at real location 160 in the case of an ASTE-validity exception recognized during a subspace-replacement operation is a unique indication since the use of access register 0 in access-register translation cannot result in the exception.

ASX-Translation Exception

An ASX-translation exception is recognized when, during execution of the space-switching form of PROGRAM CALL, during ASN translation in the space-switching form of PROGRAM RETURN, PROGRAM TRANSFER, PROGRAM TRANSFER WITH INSTANCE, SET SECONDARY ASN, or SET SECONDARY ASN WITH INSTANCE, or during ASN translation in PROGRAM RETURN when the restored SASN does not equal the restored PASN, bit 0 of the ASN-second-table entry used is not zero.

The ASN being translated is stored at real locations 174 and 175, and real locations 172 and 173 are set with zeros.

The operation is nullified.

The instruction-length code is 1 or 2, except that when the exception occurs during the fetching of the target of EXECUTE RELATIVE LONG, the ILC is 3.

The ASX-translation exception is indicated by a program-interruption code of 0021 hex (or 00A1 hex if a concurrent PER event is indicated).

Crypto-Operation Exception

A crypto-operation exception is recognized when a crypto-facility instruction is executed while bit 61 of control register 0 is zero on a CPU which has the crypto facility installed and available. The crypto-operation exception is also recognized when a crypto-facility instruction is executed and the crypto facility is not installed or available on this CPU, but the facility can be made available to the program either on this CPU or another CPU in the configuration.

When a crypto-facility instruction is executed and the crypto facility is not installed on any CPU which is or

can be placed in the configuration, it depends on the model whether a crypto-operation exception or an operation exception is recognized.

The operation is nullified when the crypto-operation exception is recognized.

The instruction-length code is 2, except that when the exception occurs during the fetching of the target of EXECUTE RELATIVE LONG, the ILC is 3.

The crypto-operation exception is indicated by a program-interruption code of 0119 hex (or 0199, 0319, or 0399 hex, if a concurrent PER event, a concurrent transactional-execution-aborted event, or both are indicated, respectively).

Data Exception

The data exceptions are shown in Figure 6-3 on page 6-18. A mask bit may or may not control whether an interruption occurs, as noted for each exception.

When a non-maskable data exception is recognized, a program interruption for a data exception always occurs.

Each of the IEEE exceptions is controlled by a mask bit in the floating-point-control (FPC) register. The handling of these exceptions is described in the section “IEEE Exceptions” on page 9-18.

A data exception is recognized for the following cases:

- **General-operand** data exception is recognized for the following cases:
 - An instruction which operates on decimal operands encounters invalid decimal digit or sign codes or has its operands specified improperly. The operation is suppressed, except that, for EDIT and EDIT AND MARK, it is model dependent whether the operation is suppressed or terminated. See the section “General-Operand Data Exception” on page 8-5 for details.
 - COMPRESSION CALL encounters errors in its dictionaries, in which case it is model dependent whether the operation is suppressed or terminated.

- PERFORM RANDOM NUMBER OPERATION when the reseed counter is zero for the generate operation, in which case the operation is suppressed.

The general-operand data exception is reported with DXC 0.

Note: In earlier versions of the architecture, the general-operand data exception was known as the decimal-operand data exception.

- **AFP-register** data exception is recognized when bit 45 of control register 0 is zero, and a floating-point-support (FPS) instruction or a hexadecimal-floating-point (HFP) instruction specifies a floating-point register other than 0, 2, 4, or 6. AFP-register data exception is also recognized when bit 45 of control register 0 is zero and a PFPO instruction is executed. The operation is suppressed and is reported with DXC 1.
- **BFP-instruction** data exception is recognized when bit 45 of control register 0 is zero and a BFP instruction is executed. The operation is suppressed and is reported with DXC 2.
- **Compare-and-trap-instruction** data exception is recognized when the operands compared by COMPARE AND TRAP, COMPARE IMMEDIATE AND TRAP, COMPARE LOGICAL AND TRAP, or COMPARE LOGICAL IMMEDIATE AND TRAP match the conditions specified by the M_3 field of the instruction. The operation is completed and is reported with DXC FF hex.

When the load-and-trap facility is installed, compare-and-trap-instruction data exception is recognized when all zeros are loaded into the first operand of LOAD AND TRAP, LOAD HIGH AND TRAP, LOAD LOGICAL AND TRAP, and LOAD LOGICAL THIRTY ONE BITS AND TRAP. The operation is completed and is reported with DXC FF hex.

- **DFP-instruction** data exception is recognized when bit 45 of control register 0 is zero and a DFP instruction is executed. The operation is suppressed and is reported with DXC 3.
- **IEEE-exception** data exceptions are recognized when an IEEE computational instruction encounters an enabled exceptional condition. The operation is suppressed or completed, depending on

the type of exception. See the section “IEEE Exceptions” on page 19-7 for details.

- **Simulated IEEE-exception** data exceptions are recognized when an IEEE-exception-simulation instruction (LOAD FPC AND SIGNAL or SET FPC AND SIGNAL) encounters an enabled signaling flag. The operation is completed. See the section “IEEE Exceptions” on page 19-7 for details.
- **Vector-instruction** data exceptions are recognized when bit 46 of control register 0 is zero and a vector instruction is executed (a vector instruction any instruction defined in chapters 21, 22, 23, 24, or 25). It is unpredictable if a data exception is recognized if bit 45 of control register 0 is zero, bit 46 of control register 0 is one, and a vector instruction is executed. The operation is suppressed and is reported with DXC FE hex.

The instruction-length code is 1, 2, or 3.

The data exception is indicated by a program-interruption code of 0007 hex (or 0087, 0207, or 0287 hex, if a concurrent PER event, a concurrent transactional-execution-aborted event, or both are indicated, respectively).

Decimal-Divide Exception

A decimal-divide exception is recognized when either of the following is true:

- For DIVIDE DECIMAL when the divisor is zero or the quotient exceeds the specified data-field size. the sign codes of both the divisor and dividend are valid, and the digit or digits used in establishing the exception are valid.
- For VECTOR DIVIDE DECIMAL, VECTOR REMAINDER DECIMAL, and VECTOR SHIFT AND DIVIDE DECIMAL, when the divisor is zero and the divisor sign code used is valid. The divisor sign code used is the third operand sign code when the force operand 3 positive (P3) bit is zero, and is a positive sign code when the force operand 3 positive (P3) bit is one.

The operation is suppressed.

The instruction-length code is 2 or 3.

The decimal-divide exception is indicated by a program-interruption code of 000B hex (or 008B, 020B, or 028B hex, if a concurrent PER event, a concurrent

transactional-execution-aborted event, or both are indicated, respectively).

Decimal-Overflow Exception

A decimal-overflow exception is recognized when the designated destination of a decimal operation is too short to contain all nonzero digits of the result.

The interruption may be disallowed by the decimal-overflow mask (PSW bit 21).

The operation is completed. When the destination is a storage operand, the overflow digits are ignored, and condition code 3 is set. When the destination is a vector register, the overflow digits are replaced with zeros, and if the condition code set (CS) flag is one, condition code 3 is set.

The instruction-length code is 2 or 3.

The decimal-overflow exception is indicated by a program-interruption code of 000A hex (or 008A, 020A, or 028A hex, if a concurrent PER event, a concurrent transactional-execution-aborted event, or both are indicated, respectively).

Execute Exception

The execute exception is recognized when the target instruction of an execute-type instruction (EXECUTE or EXECUTE RELATIVE LONG) is one of the following instructions:

- Another execute-type instruction
- TRANSACTION ABORT
- TRANSACTION BEGIN
- TRANSACTION END

The operation is suppressed.

The instruction-length code is 2 or 3 and indicates the length of the execute-type instruction that attempted to execute the target instruction.

The execute exception is indicated by a program-interruption code of 0003 hex (or 0083, 0203, or 0283 hex, if a concurrent PER event, a concurrent transactional-execution-aborted event, or both are indicated, respectively).

EX-Translation Exception

An EX-translation exception is recognized during PC-number translation in PROGRAM CALL when the

entry-table entry designated by the entry-index part of the PC number is beyond the end of the entry table as designated by the linkage-table or linkage-second-table entry used.

When ASN-and-LX reuse is not installed or is not enabled by a one value of the ASN-and-LX-reuse control in control register 0, or if it is installed and enabled and bit 44 of the second-operand address used by PROGRAM CALL is zero, bits 44-63 of the address (a 20-bit PC number), with 12 zeros appended on the left, are stored in the word at real location 172. When ASN-and-LX reuse is installed and enabled and bit 44 of the second-operand address is one, bits 32-63 of the address (a 32-bit PC number) are stored in the word at real location 172.

The operation is nullified.

The instruction-length code is 2, except that when the exception occurs during the fetching of the target of EXECUTE RELATIVE LONG, the ILC is 3.

The EX-translation exception is indicated by a program-interruption code of 0023 hex (or 00A3 hex if a concurrent PER event is indicated).

Extended-Authority Exception

An extended-authority exception is recognized during access-register translation when all of the following are true:

1. The private bit in the access-list entry used is one.
2. The access-list-entry authorization index (ALEAX) in the access-list entry is not equal to the extended authorization index (EAX) in control register 8.
3. Either of the following is true:
 - a. The authority-table entry designated by the EAX is beyond the length of the authority table used. The authority table is the one designated by the ASN-second-table entry that is designated by the access-list entry used.
 - b. The secondary-authority bit designated by the EAX is zero.

The access-list entry is the one designated by the access register used.

The number of the access register is stored in bit positions 4-7 at real location 160, and bits 0-3 are set to zeros.

The operation is nullified.

The instruction-length code is 1, 2, or 3.

The extended-authority exception is indicated by a program-interruption code of 002D hex (or 00AD, 022D, or 02AD hex, if a concurrent PER event, a concurrent transactional-execution-aborted event, or both are indicated, respectively).

Fixed-Point-Divide Exception

A fixed-point-divide exception is recognized when any of the following is true:

1. In signed or unsigned binary division when the result is defined to be 32 bits, the divisor is zero, or the quotient cannot be expressed as a 32-bit signed or unsigned, respectively, binary integer.
2. In signed or unsigned binary division when the result is defined to be 64 bits, the divisor is zero, or the quotient cannot be expressed as a 64-bit signed or unsigned, respectively, binary integer.
3. The result of CONVERT TO BINARY cannot be expressed as a 32-bit signed binary integer for a 32-bit result or as a 64-bit signed binary integer for a 64-bit result.

In the case of division, the operation is suppressed. The execution of CONVERT TO BINARY (CVB, CVBY) is completed by ignoring the leftmost bits that cannot be placed in the register. The execution of CONVERT TO BINARY (CVBG) is suppressed.

The instruction-length code is 1, 2, or 3.

The fixed-point-divide exception is indicated by a program-interruption code of 0009 hex (or 0089, 0209, or 0289 hex, if a concurrent PER event, a concurrent transactional-execution-aborted event, or both are indicated, respectively).

Fixed-Point-Overflow Exception

A fixed-point-overflow exception is recognized when an overflow occurs during signed binary arithmetic, signed left-shift operations, or some decimal to binary conversions,

The interruption may be disallowed by the fixed-point-overflow mask (PSW bit 20).

The operation is completed. The result is obtained by ignoring the overflow information, and condition code 3 is set, except for VECTOR CONVERT TO BINARY instructions where condition code 3 is set only when the condition code set (CS) flag is one.

The instruction-length code is 1, 2, or 3.

The fixed-point-overflow exception is indicated by a program-interruption code of 0008 hex (or 0088, 0208, or 0288 hex, if a concurrent PER event, a concurrent transactional-execution-aborted event, or both are indicated, respectively).

HFP-Divide Exception

An HFP-divide exception is recognized when in HFP division the divisor has a zero fraction.

The operation is suppressed.

The instruction-length code is 1 or 2, except that when the exception occurs during the fetching of the target of EXECUTE RELATIVE LONG, the ILC is 3.

The HFP-divide exception is indicated by a program-interruption code of 000F hex (or 008F, 020F, or 028F hex, if a concurrent PER event, a concurrent transactional-execution-aborted event, or both are indicated, respectively).

HFP-Exponent-Overflow Exception

An HFP-exponent-overflow exception is recognized when the result characteristic of an HFP operation exceeds 127 and the result fraction is not zero.

The operation is completed. The fraction is normalized, and the sign and fraction of the result remain correct. The result characteristic is made 128 smaller than the correct characteristic.

The instruction-length code is 1, 2, or 3.

The HFP-exponent-overflow exception is indicated by a program-interruption code of 000C hex (or 008C, 020C, or 028C hex, if a concurrent PER event, a concurrent transactional-execution-aborted event, or both are indicated, respectively).

HFP-Exponent-Underflow Exception

An HFP-exponent-underflow exception is recognized when the result characteristic of an HFP operation is less than zero and the result fraction is not zero. For an extended-format HFP result, HFP-exponent underflow is indicated only when the high-order characteristic underflows.

The interruption may be disallowed by the HFP-exponent-underflow mask (PSW bit 22).

The operation is completed. The HFP-exponent-underflow mask also affects the result of the operation. When the mask bit is zero, the sign, characteristic, and fraction are set to zero, making the result a true zero. When the mask bit is one, the fraction is normalized, the characteristic is made 128 larger than the correct characteristic, and the sign and fraction remain correct.

The instruction-length code is 1, 2, or 3.

The HFP-exponent-underflow exception is indicated by a program-interruption code of 000D hex (or 008D, 020D, or 028D hex, if a concurrent PER event, a concurrent transactional-execution-aborted event, or both are indicated, respectively).

HFP-Significance Exception

An HFP-significance exception is recognized when the result fraction in HFP addition or subtraction is zero.

The interruption may be disallowed by the HFP-significance mask (PSW bit 23).

The operation is completed. The HFP-significance mask also affects the result of the operation. When the mask bit is zero, the operation is completed by replacing the result with a true zero. When the mask bit is one, the operation is completed without further change to the characteristic of the result.

The instruction-length code is 1 or 2, except that when the exception occurs during the fetching of the target of EXECUTE RELATIVE LONG, the ILC is 3.

The HFP-significance exception is indicated by a program-interruption code of 000E hex (or 008E, 020E, or 028E hex, if a concurrent PER event, a concurrent transactional-execution-aborted event, or both are indicated, respectively).

HFP-Square-Root Exception

An HFP-square-root exception is recognized when the second operand of an HFP SQUARE ROOT instruction is less than zero.

The operation is suppressed.

The instruction-length code is 2 or 3.

The HFP-square-root exception is indicated by a program-interruption code of 001D hex (or 009D, 021D, or 029D hex, if a concurrent PER event, a concurrent transactional-execution-aborted event, or both are indicated, respectively).

LFX-Translation Exception

An LFX-translation exception may be recognized only when the ASN-and-LX-reuse facility is installed and the ASN-and-LX-reuse control in control register 0 is one.

An LFX-translation exception is recognized during PC-number translation in PROGRAM CALL when either:

1. The linkage-first-table entry specified by the linkage-first-index part of the PC number is beyond the end of the linkage first table as designated by the linkage-first-table designation used.
2. Bit 0 of the linkage-first-table entry is not zero.

When bit 44 of the second-operand address used by PROGRAM CALL is zero, bits 44-63 of the address (a 20-bit PC number), with 12 zeros appended on the left, are stored in the word at real location 172. When bit 44 of the second-operand address is one, bits 32-63 of the address (a 32-bit PC number) are stored in the word at real location 172.

The operation is nullified.

The instruction-length code is 2, except that when the exception occurs during the fetching of the target of EXECUTE RELATIVE LONG, the ILC is 3.

The LFX-translation exception is indicated by a program-interruption code of 0026 hex (or 00A6 hex if a concurrent PER event is indicated).

LSTE-Sequence Exception

An LSTE-sequence exception may be recognized only when the ASN-and-LX-reuse facility is installed

and the ASN-and-LX-reuse control in control register 0 is one.

An LSTE-sequence exception is recognized during PC-number translation in PROGRAM CALL when the linkage-second-table-entry sequence number (LSTESN) in the linkage-second-table entry used is nonzero and not equal to the LSTESN in bit positions 0-31 of general register 15.

When bit 44 of the second-operand address used by PROGRAM CALL is zero, bits 44-63 of the address (a 20-bit PC number), with 12 zeros appended on the left, are stored in the word at real location 172. When bit 44 of the second-operand address is one, bits 32-63 of the address (a 32-bit PC number) are stored in the word at real location 172.

The operation is nullified.

The instruction-length code is 2, except that when the exception occurs during the fetching of the target of EXECUTE RELATIVE LONG, the ILC is 3.

The LSTE-sequence exception is indicated by a program-interruption code of 002E hex (or 00AE hex if a concurrent PER event is indicated).

LSX-Translation Exception

An LSX-translation exception may be recognized only when the ASN-and-LX-reuse facility is installed and the ASN-and-LX-reuse control in control register 0 is one.

An LSX-translation exception is recognized during PC-number translation in PROGRAM CALL when bit 0 of the linkage-second-table entry specified by the linkage-second-index part of the PC number is not zero.

When bit 44 of the second-operand address used by PROGRAM CALL is zero, bits 44-63 of the address (a 20-bit PC number), with 12 zeros appended on the left, are stored in the word at real location 172. When bit 44 of the second-operand address is one, bits 32-63 of the address (a 32-bit PC number) are stored in the word at real location 172.

The operation is nullified.

The instruction-length code is 2, except that when the exception occurs during the fetching of the target of EXECUTE RELATIVE LONG, the ILC is 3.

The LSX-translation exception is indicated by a program-interruption code of 0027 hex (or 00A7 hex if a concurrent PER event is indicated).

LX-Translation Exception

An LX-translation exception may be recognized only when the ASN-and-LX-reuse facility is not installed or the ASN-and-LX-reuse control in control register 0 is zero.

An LX-translation exception is recognized during PC-number translation in PROGRAM CALL when either:

1. The linkage-table entry designated by the linkage-index part of the PC number is beyond the end of the linkage table as designated by the linkage-table designation used.
2. Bit 0 of the linkage-table entry is not zero.

Bits 44-63 of the second-operand address used by PROGRAM CALL (a 20-bit PC number), with 12 zeros appended on the left, are stored in the word at real location 172.

The operation is nullified.

The instruction-length code is 2, except that when the exception occurs during the fetching of the target of EXECUTE RELATIVE LONG, the ILC is 3.

The LX-translation exception is indicated by a program-interruption code of 0022 hex (or 00A2 hex if a concurrent PER event is indicated).

Monitor Event

A monitor event is recognized when MONITOR CALL is executed and the monitor-mask bit in control register 8 corresponding to the monitor class specified by instruction bits 12-15 is one. The information in control register 8 has the following format:

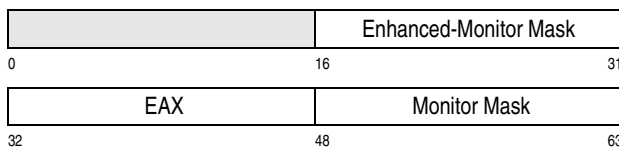

The monitor-mask bits, bits 48-63 of control register 8, correspond to monitor classes 0-15, respectively. Any number of monitor-mask bits may be on at a time; together they specify the classes of monitor

events that are monitored at that time. The mask bits are initialized to zeros.

When the enhanced-monitor facility is installed, the enhanced-monitor-mask bits, bits 16-31 of control register 8, correspond to the monitor classes 0-15, respectively. Any number of enhanced-monitor-mask bits may be on at a time; together they specify the classes of monitor events that result in monitor-call program interruptions versus monitor-event counting operations.

When a monitor event occurs and either (a) the enhanced-monitor facility is not installed, or (b) the facility is installed but the enhanced-monitor-mask bit corresponding to the monitor class specified in bits 12-15 of the MONITOR CALL instruction is zero, then a monitor-event program interruption occurs. When a monitor event occurs, the enhanced-monitor facility is installed, and the enhanced-monitor-mask bit corresponding to the monitor class is one, a monitor-event-counting operation is performed, as described in "Monitor-Event Counting" on page 5-109. Note, in the ESA/390-compatibility mode, the enhanced-monitor masks are always zero; thus, a monitor-event counting operation never occurs.

When a monitor-event program interruption occurs, additional information is stored at real locations in the prefix area, as follows:

The contents of bit positions 8-15 of the MONITOR CALL instruction are stored at real location 149 and constitute the monitor-class number. Zeros are stored at real location 148. The contents of real locations 148-149 are as follows:

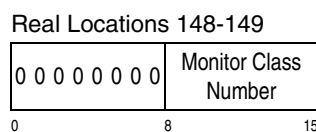

The effective address specified by the B₁ and D₁ fields of the instruction forms the monitor code. In the z/Architecture architectural mode, the monitor code is stored in the doubleword at real location 176, as shown in Figure 6-5. In the ESA/390-compatibility mode, bits 32-63 of the monitor code are stored in the word at real location 156, as shown in Figure 6-6. The value of the address is under control of the addressing mode, bits 31 and 32 of the current PSW. In the 24-bit addressing mode, bits 0-39 of the

address are zeros, while in the 31-bit addressing mode, bits 0-32 are zeros.

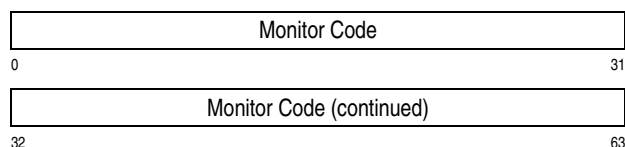

Figure 6-5. Monitor Code in Real Locations 176-183 in the z/Architecture Architectural Mode

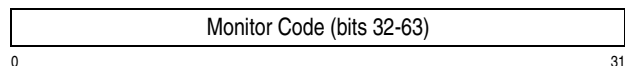

Figure 6-6. Monitor Code in Real Locations 156-159 in the ESA/390-compatibility Mode

The operation is completed.

The instruction-length code is 2, except that when the exception occurs during the execution of a MONITOR CALL instruction that is the target of EXECUTE RELATIVE LONG, the ILC is 3.

The monitor event is indicated by a program-interruption code of 0040 hex (or 00C0 hex if a concurrent PER event is indicated).

Operand Exception

An operand exception is recognized when any of the following is true:

1. Execution of CLEAR SUBCHANNEL, HALT SUBCHANNEL, MODIFY SUBCHANNEL, RESUME SUBCHANNEL, START SUBCHANNEL, STORE SUBCHANNEL, or TEST SUBCHANNEL is attempted and bit positions 32-47 of general register 1 do not contain 0001 hex. However, an exception due to ones in bit positions 32-39 of the register may or may not be recognized.
2. Execution of MODIFY SUBCHANNEL is attempted, and bits 1 and 6 of word 1 of the SCHIB operand are not zeros or bits 9-10 and 25-30 of word 6 of the SCHIB operand are not all zeros.
3. Execution of MODIFY SUBCHANNEL is attempted, and bits 9 and 10 of word 1 of the SCHIB operand are both one.
4. Execution of MOVE PAGE with KFC values of 4 or 5 and the two operands have identical real

addresses. It is model dependent whether or not this exception is recognized.

5. Execution of RESET CHANNEL PATH is attempted, and bits 40-55 of general register 1 are not all zeros.
6. Execution of SET ADDRESS LIMIT is attempted, and bits 32 and 48-63 of general register 1 are not all zeros.
7. Execution of SET CHANNEL MONITOR is attempted, bit 62 of general register 1 is one, and bits 59-63 of general register 2 are not all zeros.
8. Execution of SET CHANNEL MONITOR is attempted, and bits 36-61 of general register 1 are not all zeros.
9. Execution of START SUBCHANNEL is attempted, and bits 5, 13, and 25-28 of word 1 of the ORB operand are not all zeros.
10. Execution of START SUBCHANNEL is attempted, and bit 11 of word 1 of the ORB operand is not zero. This exception may or may not be recognized.

The operation is suppressed.

The instruction-length code is 2, except that when the exception occurs during the fetching of the target of EXECUTE RELATIVE LONG, the ILC is 3.

The operand exception is indicated by a program-interruption code of 0015 hex (or 0095 hex if a concurrent PER event is indicated).

Operation Exception

An operation exception is recognized when the CPU attempts to execute an instruction with an invalid operation code. The operation code may be unassigned, or the instruction with that operation code may not be installed on the CPU.

The operation is suppressed.

The instruction-length code is 1, 2, or 3.

The operation exception is indicated by a program-interruption code of 0001 hex (or 0081, 0201, or 0281 hex, if a concurrent PER event, a concurrent transactional-execution-aborted event, or both are indicated, respectively).

An operation exception detected while the CPU is in the nonconstrained transactional-execution mode may result in the transaction being aborted due to a restricted instruction (abort code 11). An operation exception detected while the CPU is in the constrained transactional-execution mode may be indicated as a transaction-constraint exception (program-interruption code 0018 hex).

Programming Notes:

1. Some models may offer instructions not described in this publication, such as those provided for assists or as part of special or custom features. Consequently, operation codes not described in this publication do not necessarily cause an operation exception to be recognized. Furthermore, these instructions may cause modes of operation to be set up or may otherwise alter the machine so as to affect the execution of subsequent instructions. To avoid causing such an operation, an instruction with an operation code not described in this publication should be executed only when the specific function associated with the operation code is desired.
2. Operation code 00 hex will never be assigned to an instruction implemented in the CPU.

Page-Translation Exception

A page-translation exception is recognized when the page-invalid bit is one.

The exception is recognized as part of the execution of an instruction that needs the page-table entry in the translation of an instruction, operand, or side-effect address, except for the operand address in LOAD REAL ADDRESS and TEST PROTECTION, in which case the condition is indicated by the setting of the condition code, and except for an operand address in MOVE PAGE, in which case the condition is indicated by the setting of the condition code if the condition-code-option bit, bit 55 of general register 0, is one.

When an interruption occurs, information about the virtual address causing the exception is stored at real locations 168-175 and conditionally at real locations 160 and 162. See “Assigned Storage Locations” on page 3-73 for a detailed description of this information.

The unit of operation is nullified.

When the exception occurs during fetching of an instruction, it is unpredictable whether the ILC is 1, 2, or 3. When the exception occurs during a reference to the target of EXECUTE, the ILC is 2. When the exception occurs during a reference to the target of EXECUTE RELATIVE LONG, the ILC is 3.

When the exception occurs during a reference to an operand location, the instruction-length code (ILC) is 1, 2, or 3 and indicates the length of the instruction causing the exception.

The page-translation exception is indicated by a program-interruption code of 0011 hex (or 0091, 0211, or 0291 hex, if a concurrent PER event, a concurrent transactional-execution-aborted event, or both are indicated, respectively).

PC-Translation-Specification Exception

A PC-translation-specification exception is recognized during PC-number translation in PROGRAM CALL when either of the following is true for the entry-table entry (ETE) used:

1. The PROGRAM CALL operation is the basic operation (bit 128 of the ETE is zero) in the 24-bit or 31-bit addressing mode (bit 31 of the PSW is zero), bit 32 of the ETE is zero (specifying the 24-bit mode), and bits 33-39 of the ETE are not all zeros.
2. The PROGRAM CALL operation is the stacking operation (bit 128 of the ETE is one), bits 32 and 129 of the ETE are zeros (specifying the 24-bit mode), and bits 33-39 of the ETE are not all zeros.

The operation is suppressed.

The instruction-length code is 2, except that when the exception occurs during the fetching of the target of EXECUTE RELATIVE LONG, the ILC is 3.

The PC-translation-specification exception is indicated by a program-interruption code of 001F hex (or 009F hex if a concurrent PER event is indicated).

PER Event

A PER event is recognized when the CPU is enabled for PER and one or more of these events occur.

The PER mask, bit 1 of the PSW, controls whether the CPU is enabled for PER. When the PER mask is zero, PER events are not recognized. When the bit is

one, PER events are recognized, subject to the PER-event-mask bits in control register 9.

For a PER instruction-fetching nullification event, the unit of operation is nullified. For other PER events, the unit of operation is completed, unless another condition has caused the unit of operation to be nullified, suppressed, or terminated.

In the z/Architecture architectural mode, information identifying the event is stored at real locations 150-159 and conditionally at real location 161. In the ESA/390-compatibility mode, information identifying the event is stored at real locations 150-155 and conditionally at real location 161.

The instruction-length code is 0, 1, 2, or 3. Code 0 is set for the PER instruction-fetching basic event only if a specification exception is indicated concurrently. Code 0 is always set when the PER instruction-fetching nullification event is indicated.

The PER event is indicated by setting bit 8 of the program-interruption code to one.

See “Program-Event Recording” on page 4-26 for a detailed description of the PER event and the associated interruption information.

Primary-Authority Exception

A primary-authority exception is recognized during ASN authorization in PROGRAM TRANSFER with space switching (PT-ss) or PROGRAM TRANSFER WITH INSTANCE with space switching (PTI-ss) when either:

1. The authority-table entry indicated by the authorization index in control register 4 is beyond the end of the authority table used. The authority table is the one designated by the ASN-second-table entry for the ASN used.
2. The primary-authority bit indicated by the authorization index is zero.

The ASN used is stored at real locations 174-175, and real locations 172-173 are set to zeros.

The operation is nullified.

The instruction-length code is 2, except that when the exception occurs during the fetching of the target of EXECUTE RELATIVE LONG, the ILC is 3.

The primary-authority exception is indicated by a program-interruption code of 0024 hex (or 00A4 hex if a concurrent PER event is indicated).

Privileged-Operation Exception

A privileged-operation exception is recognized when any of the following is true:

1. Execution of a privileged instruction is attempted in the problem state.
2. The value of the rightmost bit of the general register designated by the R_2 field of the PROGRAM TRANSFER or PROGRAM TRANSFER WITH INSTANCE instruction is zero and would cause the PSW problem-state bit to change from the problem state (one) to the supervisor state (zero).
3. In the problem state, the key value specified by the second operand of the SET PSW KEY FROM ADDRESS instruction corresponds to a zero PSW-key-mask bit in control register 3.
4. In the problem state, the key value specified by the rightmost byte of the register designated by the R_3 field for the instruction MOVE TO PRIMARY, MOVE TO SECONDARY, or MOVE WITH KEY corresponds to a zero PSW-key-mask bit in control register 3.
5. In the problem state, any of the following instructions is encountered, and the extraction-authority control, bit 4 of control register 0, is zero.
 - EXTRACT PRIMARY ASN
 - EXTRACT SECONDARY ASN
 - INSERT ADDRESS SPACE CONTROL
 - INSERT PSW KEY
 - INSERT VIRTUAL STORAGE KEY
6. In the problem state, the result of ANDing the authorization key mask (AKM) with the PSW-key mask in control register 3 during PROGRAM CALL produces a result of zero.
7. In the problem state, bits 20-23 of the second-operand address of the SET ADDRESS SPACE CONTROL or SET ADDRESS SPACE CONTROL FAST instruction have the value 0011 binary.
8. In the problem state, the key value specified by the rightmost byte of general register 1 for the instruction MOVE WITH SOURCE KEY or MOVE

WITH DESTINATION KEY corresponds to a zero PSW-key-mask bit in control register 3.

9. In the problem state, the key value specified by the rightmost byte of the register designated by the R_1 field for the instruction BRANCH AND SET AUTHORITY corresponds to a zero PSW-key-mask bit in control register 3.
10. In the problem state, bits 16 and 17 of the PSW field in the second operand of RESUME PROGRAM have the value 11 binary.
11. Execution of MOVE PAGE is attempted in the problem state, and any of the following is true:
 - The KFC value is 1 or 2 and the access key specified in general register 0 bits 56-59 designates a PSW-key-mask (PKM) bit position in control register 3 that contains zero.
 - The move-page-and-set-key facility is installed and the KFC value is 4 or 5.
12. Execution of MOVE WITH OPTIONAL SPECIFICATIONS is attempted in the problem state, and any of the following is true:
 - The specified-access-key control for the first operand, bit 46 of general register 0, is one; and the corresponding specified-access key, bits 32-35 of the register, designates a PSW-key-mask (PKM) bit position in control register 3 that contains zero.
 - The specified-access-key control for the second operand, bit 62 of general register 0, is one; and the corresponding specified-access key, bits 48-51 of the register, designates a PKM bit position that contains zero.
 - Either or both bits 46 and 62 of general register 0 are zero, and the PSW key, bits 8-11 of the PSW, designates a PKM bit position that contains zero.

The operation is suppressed.

The instruction-length code is 1, 2, or 3.

The privileged-operation exception is indicated by a program-interruption code of 0002 hex (or 0082, 0202, or 0282 hex, if a concurrent PER event, a con-

current transactional-execution-aborted event, or both are indicated, respectively).

Protection Exception

A protection exception is recognized when any of the following is true:

Access-List-Controlled Protection: The CPU attempts to store, in the access-register mode, by means of an access-list entry which has the fetch-only bit set to one.

DAT Protection: The CPU attempts to store, with DAT on, into any of the following:

- A page which has the DAT-protection bit set to one in the page-table entry used in the translation
- A segment which has the DAT-protection bit set to one in the segment-table entry used in the translation
- When EDAT-1 applies,¹ a region which has the DAT-protection bit set to one in any region-table entry used in the translation.

Instruction-Execution Protection: The instruction-execution-protection facility is installed and enabled, and the CPU attempts to fetch an instruction, with DAT on, from any of the following:

- A page which has the instruction-execution-protection control set to one in the page-table entry used in the translation.
- When EDAT-1 applies, a segment which has the instruction-execution-protection control set to one in the format-1 segment-table entry used in the translation.
- When EDAT-2 applies, a region which has the instruction-execution-protection control set to one in the format-1 region-third-table entry used in the translation.

Key-Controlled Protection: The CPU attempts to access a storage location that is protected against the type of reference, and the access key does not match the storage key.

Low-Address Protection: The CPU attempts a store that is subject to low-address protection, the effective

1. See "Enhanced-DAT Terminology:" on page 3-41 for an explanation of the term "enhanced-DAT applies."

address is in the range 0-511 or 4096-4607, and the low-address protection control, bit 35 of control register 0, is one.

The operation is suppressed when the location of the instruction is protected against fetching. Similarly, the operation is suppressed when the location of the target instruction of an execute-type instruction is protected against fetching.

For access-list-controlled protection, DAT-protection, and instruction-execution protection, the operation is suppressed. For key-controlled protection and low-address protection, the operation may be either suppressed or terminated, depending on the type of suppression-on-protection facility that is installed. See “Suppression on Protection” on page 3-15 and Figure 6-4 on page 6-21 for details.

For termination, changes may occur only to result fields. In this context, the term “result field” includes condition code, registers, and storage locations, if any, which are due to be changed by the instruction. However, no change is made to a storage location when a reference to that location causes a protection exception. Therefore, if an instruction is due to change only the contents of a field in storage, and every byte of that field would cause a protection exception, the operation is suppressed. When termination occurs on fetching, the protected information is not loaded into an addressable register nor moved to another storage location.

In the z/Architecture architectural mode, information about the address causing the exception is stored at real locations 168-175 and conditionally at real location 160. In the ESA/390-compatibility mode, information about the address causing the exception may be stored at real locations 144-147 and 160. See “Suppression on Protection” on page 3-15.

When the exception occurs during fetching of an instruction, it is unpredictable whether the ILC is 1, 2, or 3. When the exception occurs during the fetching of the target of EXECUTE, the ILC is 2. When the exception occurs during the fetching of the target of EXECUTE RELATIVE LONG, the ILC is 3.

For a protected operand location, the instruction-length code (ILC) is 1, 2, or 3, indicating the length of the instruction that caused the reference, except that when the protected operand location is accessed by an instruction that is the target of an EXECUTE or

EXECUTE RELATIVE LONG instruction, the ILC is 2 or 3, respectively.

The protection exception is indicated by a program-interruption code of 0004 hex (or 0084, 0204, or 0284 hex, if a concurrent PER event, a concurrent transactional-execution-aborted event, or both are indicated, respectively).

Region-First-Translation Exception

A region-first-translation exception is recognized when a region first table is in the translation path for translation of a virtual address and either:

1. The region-first-table entry indicated by the region-first-index portion of the virtual address is outside the region first table.
2. The region-invalid bit is one.

The exception is sometimes called simply a region-translation exception, which term applies also to a region-second-translation exception and a region-third-translation exception.

The exception is recognized as part of the execution of an instruction that needs the region-first-table entry in the translation of an instruction, operand, or side-effect address, except for the operand address in LOAD PAGE-TABLE-ENTRY ADDRESS, LOAD REAL ADDRESS and TEST PROTECTION, in which case the condition is indicated by the setting of the condition code.

When an interruption occurs, information about the virtual address causing the exception is stored at real locations 168-175 and conditionally at real locations 160 and 162. See “Assigned Storage Locations” on page 3-73 for a detailed description of this information.

The unit of operation is nullified.

When the exception occurs during fetching of an instruction, it is unpredictable whether the ILC is 1, 2, or 3. When the exception occurs during the fetching of the target of EXECUTE, the ILC is 2. When the exception occurs during the fetching of the target of EXECUTE RELATIVE LONG, the ILC is 3.

When the exception occurs during a reference to an operand location, the instruction-length code (ILC) is 1, 2, or 3 and indicates the length of the instruction causing the exception.

The region-first-translation exception is indicated by a program-interruption code of 0039 hex (or 00B9, 0239, or 02B9 hex, if a concurrent PER event, a concurrent transactional-execution-aborted event, or both are indicated, respectively).

Region-Second-Translation Exception

A region-second-translation exception is recognized when a region second table is in the translation path for translation of a virtual address and either:

1. The region-second-table entry indicated by the region-second-index portion of the virtual address is outside the region second table.
2. The region-invalid bit is one.

The exception is sometimes called simply a region-translation exception, which term applies also to a region-first-translation exception and a region-third-translation exception.

The exception is recognized as part of the execution of an instruction that needs the region-second-table entry in the translation of an instruction, operand, or side-effect address, except for the operand address in LOAD PAGE-TABLE-ENTRY ADDRESS, LOAD REAL ADDRESS and TEST PROTECTION, in which case the condition is indicated by the setting of the condition code.

When an interruption occurs, information about the virtual address causing the exception is stored at real locations 168-175 and conditionally at real locations 160 and 162. See “Assigned Storage Locations” on page 3-73 for a detailed description of this information.

The unit of operation is nullified.

When the exception occurs during fetching of an instruction, it is unpredictable whether the ILC is 1, 2, or 3. When the exception occurs during the fetching of the target of EXECUTE, the ILC is 2. When the exception occurs during the fetching of the target of EXECUTE RELATIVE LONG, the ILC is 3.

When the exception occurs during a reference to an operand location, the instruction-length code (ILC) is 1, 2, or 3 and indicates the length of the instruction causing the exception.

The region-second-translation exception is indicated by a program-interruption code of 003A hex (or

00BA, 023A, or 02BA hex, if a concurrent PER event, a concurrent transactional-execution-aborted event, or both are indicated, respectively).

Region-Third-Translation Exception

A region-third-translation exception is recognized when a region third table is in the translation path for translation of a virtual address and either:

1. The region-third-table entry indicated by the region-third-index portion of the virtual address is outside the region third table.
2. The region-invalid bit is one.

The exception is sometimes called simply a region-translation exception, which term applies also to a region-first-translation exception and a region-second-translation exception.

The exception is recognized as part of the execution of an instruction that needs the region-third-table entry in the translation of an instruction, operand, or side-effect address, except for the operand address in LOAD PAGE-TABLE-ENTRY ADDRESS, LOAD REAL ADDRESS and TEST PROTECTION, in which case the condition is indicated by the setting of the condition code.

When an interruption occurs, information about the virtual address causing the exception is stored at real locations 168-175 and conditionally at real locations 160 and 162. See “Assigned Storage Locations” on page 3-73 for a detailed description of this information.

The unit of operation is nullified.

When the exception occurs during fetching of an instruction, it is unpredictable whether the ILC is 1, 2, or 3. When the exception occurs during the fetching of the target of EXECUTE, the ILC is 2. When the exception occurs during the fetching of the target of EXECUTE RELATIVE LONG, the ILC is 3.

When the exception occurs during a reference to an operand location, the instruction-length code (ILC) is 1, 2, or 3 and indicates the length of the instruction causing the exception.

The region-third-translation exception is indicated by a program-interruption code of 003B hex (or 00BB, 023B, or 02BB hex, if a concurrent PER event, a con-

current transactional-execution-aborted event, or both are indicated, respectively).

Secondary-Authority Exception

A secondary-authority exception is recognized during ASN authorization in SET SECONDARY ASN with space switching, SET SECONDARY ASN WITH INSTANCE with space switching, or during ASN authorization in PROGRAM RETURN when the restored SASN does not equal the restored PASN, when either:

1. The authority-table entry indicated by the authorization index in control register 4 is beyond the end of the authority table used. The authority table is the one designated by the ASN-second-table entry for the ASN used. For PROGRAM RETURN, the ASN is the SASN being restored from the linkage-stack state entry used.
2. The secondary-authority bit indicated by the authorization index is zero.

The ASN used is stored at real locations 174-175, and real locations 172-173 are set to zeros.

The operation is nullified.

The instruction-length code is 1 or 2, except that when the exception occurs during the fetching of the target of EXECUTE RELATIVE LONG, the ILC is 3.

The secondary-authority exception is indicated by a program-interruption code of 0025 hex (or 00A5 hex if a concurrent PER event is indicated).

Segment-Translation Exception

A segment-translation exception is recognized when either:

1. The segment-table entry indicated by the segment-index portion of a virtual address is outside the segment table.
2. The segment-invalid bit is one.

The exception is recognized as part of the execution of an instruction that needs the segment-table entry in the translation of an instruction, operand, or side-effect address, except for the operand address in LOAD PAGE-TABLE-ENTRY ADDRESS, LOAD REAL ADDRESS and TEST PROTECTION, in which case the condition is indicated by the setting of the condition code.

When an interruption occurs, information about the virtual address causing the exception is stored at real locations 168-175 and conditionally at real locations 160 and 162. See “Assigned Storage Locations” on page 3-73 for a detailed description of this information.

The unit of operation is nullified.

When the exception occurs during fetching of an instruction, it is unpredictable whether the ILC is 1, 2, or 3. When the exception occurs during the fetching of the target of EXECUTE, the ILC is 2. When the exception occurs during the fetching of the target of EXECUTE RELATIVE LONG, the ILC is 3.

When the exception occurs during a reference to an operand location, the instruction-length code (ILC) is 1, 2, or 3 and indicates the length of the instruction causing the exception.

The segment-translation exception is indicated by a program-interruption code of 0010 hex (or 0090, 0210, or 0290 hex, if a concurrent PER event, a concurrent transactional-execution-aborted event, or both are indicated, respectively).

Space-Switch Event

A space-switch event is recognized at the completion of the operation in each of the following cases:

1. The space-switching form of PROGRAM CALL, PROGRAM RETURN, PROGRAM TRANSFER, or PROGRAM TRANSFER WITH INSTANCE is executed and any of the following is true:
 - a. The primary space-switch-event-control bit, bit 57 of control register 1, is one before the operation.
 - b. The primary space-switch-event-control bit is one after the operation.
 - c. A PER event is indicated.
2. RESUME PROGRAM, SET ADDRESS SPACE CONTROL, or SET ADDRESS SPACE CONTROL FAST is executed, the CPU is in the home-space mode either before or after the operation, but not both before and after the operation, and any of the following is true:
 - a. The primary space-switch-event-control bit, bit 57 of control register 1, is one.

- b. The home space-switch-event-control bit, bit 57 of control register 13, is one.
- c. A PER event is indicated.

For PROGRAM CALL, PROGRAM RETURN, PROGRAM TRANSFER, and PROGRAM TRANSFER WITH INSTANCE, and for a RESUME PROGRAM, SET ADDRESS SPACE CONTROL, or SET ADDRESS SPACE CONTROL FAST instruction that changes the translation mode to the home-space mode, the old PASN, which is in bit positions 48-63 of control register 4 before the operation, is stored at real locations 174-175, and the old primary space-switch-event-control bit is placed in bit position 0 and zeros are placed in bit positions 1-15 at real locations 172-173.

For a RESUME PROGRAM, SET ADDRESS SPACE CONTROL, or SET ADDRESS SPACE CONTROL FAST instruction that changes the translation mode away from the home-space mode, zeros are stored at real locations 174-175, and the home space-switch-event-control bit is placed in bit position 0 and zeros are placed in bit positions 1-15 at real locations 172-173.

For a PROGRAM RETURN instruction that introduces a PSW-format error, it is unpredictable whether the instruction-length code is 0 or 1, or 0 or 2 if EXECUTE was used, or 0 or 3 if EXECUTE RELATIVE LONG was used.

The operation is completed.

The instruction-length code is 0, 1, or 2, except that when the exception occurs during the fetching of the target of EXECUTE RELATIVE LONG, the ILC is 0 or 3.

The space-switch event is indicated by a program-interruption code of 001C hex (or 009C hex if a concurrent PER event is indicated).

Programming Notes:

1. The space-switch event permits the control program to gain control whenever a program enters or leaves a particular address space. The primary space-switch-event-control bit is loaded into control register 1, along with the remaining bits of the primary address-space-control element, whenever control register 1 is loaded.

2. The space-switch event may be useful in obtaining programmed authorization checking, in causing additional trace information to be recorded, or in enabling or disabling the CPU for PER or tracing.
3. Bit 121 of the ASN-second-table entry (ASTE) is loaded into bit position 57 of control register 1 as part of the PC-ss, PR-ss, PT-ss, and PTI-ss operations. If bit 121 of the ASTE for a particular address space is set to one, then a space-switch event is recognized when a program enters or leaves the address space by means of any of PC-ss, PR-ss, PT-ss, or PTI-ss.
4. The occurrence of a space-switch event at the completion of a PC-ss, PR-ss, PT-ss, or PTI-ss operation when any PER event is indicated, or at the completion of execution of a RESUME PROGRAM, SET ADDRESS SPACE CONTROL, or SET ADDRESS SPACE CONTROL FAST instruction that changes to or from the home-space mode when any PER event is indicated, permits the control program to determine the address space from which the instruction causing the PER event was fetched.

Special-Operation Exception

A special-operation exception is recognized when any of the following is true:

1. Execution of any of the following instructions is attempted with DAT off:
 - EXTRACT PRIMARY ASN
 - EXTRACT SECONDARY ASN
 - INSERT ADDRESS SPACE CONTROL
 - INSERT VIRTUAL STORAGE KEY
 - MOVE WITH OPTIONAL SPECIFICATIONS
 - SET ADDRESS SPACE CONTROL
 - SET SECONDARY ASN
2. Execution of BRANCH AND SET AUTHORITY is attempted, and the R₂ field is zero in the base-authority state or nonzero in the reduced-authority state.
3. Execution of BRANCH AND STACK, stacking PROGRAM CALL, PROGRAM RETURN, or TRAP is attempted, and the CPU is not in the primary-space or access-register mode.
4. Execution of BRANCH IN SUBSPACE GROUP is attempted, and any of the following is true:

- The current primary address space is not in a subspace group associated with the current dispatchable unit, that is, the primary-ASTE origin (PASTE0) in control register 5 does not equal the base-ASTE origin (BASE0) in the dispatchable-unit control table (DUCT).
 - The access-list-entry token (ALET) in access register R₂ is ALET 1, but a subspace has not previously been entered by the dispatchable unit by means of BRANCH IN SUBSPACE GROUP, that is, the subspace-ASTE origin (SSASTE0) in the DUCT is all zeros.
 - The ALET used is other than ALET 0 and ALET 1, and the destination ASTE (DASTE) does not specify the base space or a subspace of the subspace group, that is, the DASTE origin (DASTE0) obtained from an access-list entry does not equal the BASE0 in the DUCT, and either the subspace-group bit (G) in the address-space-control element in the DASTE is zero or the base-space bit (B) in the DASTE is one.
5. Execution of EXTRACT STACKED REGISTERS, EXTRACT STACKED STATE or MODIFY STACKED STATE is attempted, and the CPU is not in the primary-space, access-register, or home-space mode.
 6. Execution of EXTRACT TRANSACTION NESTING DEPTH, TRANSACTION BEGIN, or TRANSACTION END is attempted, and the transactional-execution control, bit 8 of control register 0, is zero.
 7. Execution of LOAD ADDRESS SPACE PARAMETERS, PROGRAM CALL with space switching (PC-ss), PROGRAM TRANSFER with space switching (PT-ss), PROGRAM TRANSFER WITH INSTANCE with space switching (PT-ss), SET SECONDARY ASN, or SET SECONDARY ASN WITH INSTANCE is attempted, or execution of a PROGRAM RETURN instruction requiring PASN or SASN translation is attempted, and the ASN-translation control, bit 44 of control register 14, is zero.
 8. Execution of LOAD GUARDED STORAGE CONTROLS or STORE GUARDED STORAGE CONTROLS is attempted, and the guarded-storage-facility-enablement (GSFE) control, bit 59 of control register 2, is zero.
 9. Execution of LOAD PAGE-TABLE-ENTRY ADDRESS is attempted and the effective address-space-control element specified by the M₄ field of the instruction designates the real space.
 10. Execution of LOAD REAL ADDRESS (LRA) is attempted in the 24-bit or 31-bit addressing mode, and bits 0-32 of the resulting real or absolute address are not all zeros.
 11. Execution of MOVE TO PRIMARY or MOVE TO SECONDARY is attempted, and the CPU is not in the primary-space or secondary-space mode.
 12. Execution of MOVE TO PRIMARY, MOVE TO SECONDARY, or SET ADDRESS SPACE CONTROL is attempted, and the secondary-space control, bit 37 of control register 0, is zero. The exception may be recognized for this reason when execution of SET ADDRESS SPACE CONTROL FAST is attempted.
 13. Execution of MOVE WITH OPTIONAL SPECIFICATIONS is attempted, and either of the following conditions are true:
 - Bit 47 of general register 0 is one, bits 40-41 of the register contain 11 binary, and the problem-state bit, bit 15 of the current PSW, is one.
 - The secondary-space control, bit 37 of control register 0 is zero, and any of the following conditions are true:
 - Bit 47 of general register 0 is zero, and bits 16-17 of the current PSW are 10 binary.
 - Bit 47 of general register 0 is one, and bits 40-41 of the register are 10 binary.
 - Bit 63 of general register 0 is zero, and bits 16-17 of the current PSW are 10 binary.
 - Bit 63 of general register 0 is one, and bits 56-57 of the register are 10 binary.
 14. Execution of basic PROGRAM CALL, PROGRAM TRANSFER, or PROGRAM TRANSFER WITH INSTANCE is attempted, and the CPU is not in the primary-space mode.

15. Execution of basic PROGRAM CALL is attempted, and the extended-addressing-mode bit, bit 31 of the current PSW, does not equal the entry-extended-addressing-mode bit, bit 129, in the entry-table entry.
16. Execution of PROGRAM CALL, PROGRAM TRANSFER, or PROGRAM TRANSFER WITH INSTANCE is attempted, and the subsystem-linkage control, bit 192 of the primary ASN-second-table entry, is zero.
17. Execution of the space-switching form of PROGRAM TRANSFER or SET SECONDARY ASN is attempted, the ASN-and-LX-reuse control in control register 0 is one, and the reusable-ASN bit in the located ASTE is one.
18. Execution of the space-switching form of PROGRAM TRANSFER WITH INSTANCE or SET SECONDARY ASN WITH INSTANCE is attempted, the controlled-ASN bit is one in the ASN-second-table entry used, and the CPU is in the problem state at the beginning of the operation.
19. Execution of SET SYSTEM MASK is attempted in the supervisor state, and the SSM-suppression control, bit 33 of control register 0, is one.
20. Execution of TRANSACTION ABORT is attempted, and the CPU is not in the transactional-execution mode at the beginning of the instruction.
21. Execution of TRAP is attempted, and either of the following is true:
 - The TRAP-enabled bit, bit 31 in bytes 44-47 of the dispatchable-unit control table, is zero.
 - The PSW control, bit 13 of bytes 0-3 of the trap control table, is zero and bit 31 of the current PSW, the extended-addressing-mode bit, is one.

The operation is suppressed.

The instruction-length code is 1, 2, or 3.

The special-operation exception is indicated by a program-interruption code of 0013 hex (or 0093, 0213, or 0293 hex, if a concurrent PER event, a concurrent transactional-execution-aborted event, or both are indicated, respectively).

Specification Exception

A specification exception is recognized when any of the following is true:

1. A one is introduced into an unassigned bit position of the PSW (that is, any of bit positions 0, 2-4, 25-30, or 33-63). This is handled as an early PSW specification exception.
2. A one is introduced into bit position 12 of the PSW. This is handled as an early PSW specification exception.
3. The PSW is invalid in any of the following ways:
 - a. Bit 31 of the PSW is one and bit 32 is zero.
 - b. Bits 31 and 32 of the PSW are zero, indicating the 24-bit addressing mode, and bits 64-103 of the PSW are not all zeros.
 - c. Bit 31 of the PSW is zero and bit 32 is one, indicating the 31-bit addressing mode, and bits 64-96 of the PSW are not all zeros.
 - d. In the ESA/390-compatibility mode, bit 5 of the PSW is one.
 - e. In the ESA/390-compatibility mode, bit 31 of the PSW is one. It is unpredictable whether this condition is recognized.

This is handled as an early PSW specification exception. Note, items b and c, above, do not apply to SAM24 and SAM31, respectively. See items 48 and 49 in this list for further explanation.

4. The PSW contains an odd instruction address.
5. An operand address does not designate an integral boundary in an instruction requiring such integral-boundary designation.
6. An odd-numbered general register is designated by an R field of an instruction that requires an even-numbered register designation.
7. A floating-point register other than 0, 1, 4, 5, 8, 9, 12, or 13 is designated for an extended operand.
8. The multiplier or divisor in decimal arithmetic exceeds 15 digits and sign.
9. The length of the first-operand field is less than or equal to the length of the second-operand field in decimal multiplication or division.
10. Execution of CIPHER MESSAGE, CIPHER MESSAGE WITH AUTHENTICATION, CIPHER

MESSAGE WITH CIPHER FEEDBACK, CIPHER MESSAGE WITH CHAINING, CIPHER MESSAGE WITH COUNTER, CIPHER MESSAGE WITH OUTPUT FEEDBACK, COMPUTE DIGITAL SIGNATURE AUTHENTICATION, COMPUTE INTERMEDIATE MESSAGE DIGEST, COMPUTE LAST MESSAGE DIGEST, COMPUTE MESSAGE AUTHENTICATION CODE, PERFORM CRYPTOGRAPHIC KEY MANAGEMENT OPERATION, PERFORM CRYPTOGRAPHIC COMPUTATION, or PERFORM RANDOM NUMBER OPERATION is attempted, and the function code in bits 57-63 of general register 0 contain an unassigned or uninstalled function code.

11. Execution of CIPHER MESSAGE, CIPHER MESSAGE WITH CIPHER FEEDBACK, CIPHER MESSAGE WITH CHAINING, CIPHER MESSAGE WITH OUTPUT FEEDBACK, or PERFORM RANDOM NUMBER OPERATION is attempted, and the R_1 or R_2 field designates an odd-numbered register or general register 0.
12. Execution of CIPHER MESSAGE, CIPHER MESSAGE WITH CHAINING, CIPHER MESSAGE WITH COUNTER, CIPHER MESSAGE WITH OUTPUT FEEDBACK, COMPUTE INTERMEDIATE MESSAGE DIGEST or COMPUTE MESSAGE AUTHENTICATION CODE is attempted, and the second operand length is not a multiple of the data block size of the designated function. This specification-exception condition does not apply to the query functions.
13. Execution of CIPHER MESSAGE WITH AUTHENTICATION or CIPHER MESSAGE WITH COUNTER is attempted, and the R_1 , R_2 , or R_3 field designates an odd-numbered register or general register 0.
14. Execution of CIPHER MESSAGE WITH AUTHENTICATION is attempted, the function code is nonzero, the LPC flag is one (indicating that the last blocks of plaintext or ciphertext are being processed), but the LAAD flag is zero.
15. Execution of CIPHER MESSAGE WITH CIPHER FEEDBACK is attempted, and any of the following applies:
 - The second operand length is not a multiple of the length of cipher feedback. This specification-exception condition does not apply to the query functions.
 - For DEA or TDEA functions, bits 32-39 of general register 0 specify a value that is zero or greater than 8.
 - For AES functions, bits 32-39 of general register 0 specify a value that is zero or greater than 16.
16. Execution of COMPARE AND FORM CODEWORD is attempted, and general registers 1, 2, and 3 do not initially contain even values.
17. Execution of COMPARE AND REPLACE DATABLE ENTRY is attempted and either of the following conditions exist:
 - The DTT field, bit positions 59-61 of general register R_2 , contain 001, 010, or 011 binary.
 - Bit positions 52-63 of general register $R_2 + 1$ contain nonzero values.
18. Execution of COMPARE AND SWAP AND STORE is attempted and any of the following conditions exist:
 - The function code specifies an unassigned value.
 - The store characteristic specifies an unassigned value.
 - The function code is 0, and the first operand is not designated on a word boundary.
 - The function code is 1, and the first operand is not designated on a doubleword boundary.
 - The function code is 2, and any of the following is true:
 - The compare-and-swap-and-store facility 2 is not installed.
 - The first operand is not designated on a quadword boundary.
 - The R_3 field does not designate the even-numbered register of an even-odd register pair.
 - The second operand is not designated on an integral boundary corresponding to the size of the store value.

19. Execution of COMPARE LOGICAL LONG UNICODE or MOVE LONG UNICODE is attempted, and the contents of either general register $R_1 + 1$ or $R_3 + 1$ do not specify an even number of bytes.
20. Execution of COMPARE LOGICAL STRING, MOVE STRING or SEARCH STRING is attempted, and bits 32-55 of general register 0 are not all zeros.
21. Execution of COMPRESSION CALL is attempted, and bits 48-51 of general register 0 have any of the values 0000 and 0110-1111 binary when bit 44 is 0.
22. Execution of COMPUTE INTERMEDIATE MESSAGE DIGEST, COMPUTE LAST MESSAGE DIGEST, or COMPUTE MESSAGE AUTHENTICATION CODE is attempted, and bit 56 of general register 0 is not zero.
23. Execution of COMPUTE DIGITAL SIGNATURE AUTHENTICATION, COMPUTE INTERMEDIATE MESSAGE DIGEST, COMPUTE LAST MESSAGE DIGEST, or COMPUTE MESSAGE AUTHENTICATION CODE is attempted, and the R_2 field designates an odd-numbered register or general register 0.
24. Execution of the COMPUTE LAST MESSAGE DIGEST functions KLMD-SHAKE-128 or KLMD-SHAKE-256 is attempted, and the R_1 field designates an odd-numbered register or general register 0.
25. Execution of CONVERT HFP TO BFP, CONVERT TO FIXED (BFP or HFP), or LOAD FP INTEGER (BFP) is attempted, and the M_3 field does not designate a valid modifier.
26. Execution of DEFLATE CONVERSION CALL is attempted, and any of the following applies:
 - The function code in bits 57-63 of general register 0 designate an unassigned or uninstalled function code.
 - The parameter block is not designated on a doubleword boundary.
 - The R_1 or R_2 field designates an odd-numbered register or general register 0.
 - The R_3 field designates general register 0 or 1.
 - The DFLTCC-CMPR or DFLTCC-XPND function is specified and the specified history-buffer type is circular and the third operand is not designated on a 4 K-byte boundary.
- The DFLTCC-GDHT function is specified and the second-operand length equals zero.
- The DFLTCC-CMPR or DFLTCC-XPND function is specified, the continuation flag (CF) field of the parameter block is initially zero, and the second-operand length equals zero.
27. Execution of DIVIDE TO INTEGER is attempted, and the M_4 field does not designate a valid modifier.
28. Execution of EXTRACT STACKED STATE is attempted, and the code in bit positions 56-63 of general register R_2 is greater than 4 when the ASN-and-LX-reuse facility is not installed or is greater than 5 when the facility is installed.
29. Execution of INVALIDATE DAT TABLE ENTRY is attempted, and bits 44-51 of general register R_2 are not all zeros.
30. Execution of INVALIDATE PAGE TABLE ENTRY is attempted, the IPTE-range facility is installed, the R_3 field is nonzero, and the page index in general register R_2 plus the additional-entry count in general register R_3 is greater than 255.
31. Execution of LOAD COUNT TO BLOCK BOUNDARY is attempted, and the M_3 field specifies a reserved value.
32. Execution of LOAD FPC or LOAD FPC AND SIGNAL is attempted, and one or more bits of the second operand corresponding to unsupported bits in the FPC register are one.
33. Execution of LOAD PAGE-TABLE-ENTRY ADDRESS is attempted and the M_4 field of the instruction contains any value other than 0000-0100 binary.
34. Execution of LOAD PSW is attempted and bit 12 of the doubleword at the second-operand address is zero. It is model dependent whether or not this exception is recognized.
35. Execution of MONITOR CALL is attempted, and bit positions 8-11 of the instruction do not contain zeros.
36. Execution of MOVE PAGE is attempted, and bit positions 48-51 of general register 0 do not con-

- tain zeros or bits 52 and 53 of the register are both one.
37. Execution of PACK ASCII is attempted, and the L_2 field is greater than 31.
 38. Execution of PACK UNICODE is attempted, and the L_2 field is greater than 63 or is even.
 39. Execution of PERFORM FLOATING POINT OPERATION is attempted, bit 32 of general register 0 is zero, and one or more fields in bits 33-63 are invalid or designate an uninstalled function.
 40. Execution of PERFORM FRAME MANAGEMENT FUNCTION is attempted, and either or both of the following are true:
 - Bits 32-45, 52, 55, or 63 of general register R_1 are not zero.
 - The frame-size code in general register R_1 specifies a reserved value.
 41. Execution of PERFORM LOCKED OPERATION is attempted, and any of the following is true:
 - The T bit, bit 55 of general register 0 is zero, and the function code in bits 56-63 of the register is invalid.
 - Bits 32-54 of general register 0 are not all zeros.
 - In the access-register mode, for function codes that cause use of a parameter list containing an ALET, the R_3 field is zero.
 42. Execution of PERFORM RANDOM NUMBER OPERATION is attempted, bit 56 of general register 0 is one, and the length in general register $R_2 + 1$ is greater than 512.
 43. Execution of PERFORM TIMING FACILITY FUNCTION is attempted, and either of the following is true:
 - Bit 56 of general register 0 is not zero.
 - Bits 57-63 of general register 0 specify an unassigned or uninstalled function code.
 44. Execution of PROGRAM TRANSFER or PROGRAM TRANSFER WITH INSTANCE is attempted, and all of the following are true:
 - The extended-addressing-mode bit in the PSW is zero.
 - The basic-addressing-mode bit, bit 32, in the general register designated by the R_2 field of the instruction is zero.
 - Bits 33-39 of the instruction address in the same register are not all zeros.
 45. Execution of RESUME PROGRAM is attempted, and any of the following is true:
 - Bits 31, 32, and 64-127 of the PSW field in the second operand are not valid for placement in the current PSW. The exception is recognized if any of the following is true:
 - Bits 31 and 32 are both zero and bits 64-103 are not all zeros.
 - Bits 31 and 32 are zero and one, respectively, and bits 64-96 are not all zeros.
 - Bits 31 and 32 are one and zero, respectively.
 - Bit 127 is one.
 - Bits 0-12 of the parameter list are not all zeros.
 46. Execution of SEARCH STRING UNICODE is attempted, and bits 32-47 of general register 0 are not all zeros.
 47. Execution of SET ADDRESS SPACE CONTROL or SET ADDRESS SPACE CONTROL FAST is attempted, and bits 52 and 53 of the second-operand address are not both zeros.
 48. Execution of SET ADDRESSING MODE (SAM24) is attempted, and bits 0-39 of the unupdated instruction address in the PSW, bits 64-103 of the PSW, are not all zeros.
 49. Execution of SET ADDRESSING MODE (SAM31) is attempted, and bits 0-32 of the unupdated instruction address in the PSW, bits 64-96 of the PSW, are not all zeros.
 50. Execution of SET CLOCK PROGRAMMABLE FIELD is attempted, and bits 32-47 of general register 0 are not all zeros.
 51. Execution of SET BFP ROUNDING MODE (SRNMB) is attempted, and either bits 56-60 of the second-operand address are not all zeros, or bits 61-63 of the second-operand address do not designate a valid rounding mode.

52. Execution of SET FPC or SET FPC AND SIGNAL is attempted, and one or more bits of the first operand corresponding to unsupported bits in the FPC register are one.
53. Execution of STORE SYSTEM INFORMATION is attempted, the function code in general register 0 is valid, and bits 36-55 of general register 0 and bits 32-47 of general register 1 are not all zeros.
54. Execution of TRANSACTION ABORT is attempted, and the second-operand address is between 0 and 255
55. Execution of TRANSACTION BEGIN (TBEGIN) is attempted, and the program-interruption-filtering control, bits 14-15 of I_2 field of the instruction, contains the value 3.
56. Execution of TRANSACTION BEGIN (TBEGINC) is attempted, and the B_1 field is not zero.
57. Execution of TRANSLATE AND TEST EXTENDED or TRANSLATE AND TEST REVERSE EXTENDED is attempted, the A bit, bit 0 of the M_3 field, is one, and the argument-character length in general register $R_1 + 1$ is not an even number.
58. Execution of TRANSLATE TWO TO ONE or TRANSLATE TWO TO TWO is attempted, and the length in general register $R_1 + 1$ does not specify an even number of bytes.
59. Execution of UNPACK ASCII is attempted, and the L_1 field is greater than 31.
60. Execution of UNPACK UNICODE is attempted, and the L_1 field is greater than 63 or is even.
61. Execution of UPDATE TREE is attempted, and the initial contents of general registers 4 and 5 are not a multiple of 8 in the 24-bit or 31-bit addressing mode or are not a multiple of 16 in the 64-bit addressing mode.
62. Execution of a vector instruction is attempted, and an instruction-specified reason was recognized. See instruction descriptions in Chapters 21-25 for detailed reasons for specification exceptions.

The execution of the instruction identified by the old PSW is suppressed. However, for early PSW specifi-

cation exceptions (causes 1-3) the operation that introduces the new PSW is completed, but an interruption occurs immediately thereafter.

Except as noted below, the instruction-length code (ILC) is 1, 2, or 3, indicating the length of the instruction causing the exception.

When the instruction address is odd (cause 4 on page 6-40), it is unpredictable whether the ILC is 1, 2, or 3.

When the exception is recognized because of an early PSW specification exception (causes 1-3) and the exception has been introduced by LOAD PSW, LOAD PSW EXTENDED, PROGRAM RETURN, or an interruption, the ILC is 0. When the exception is introduced by SET ADDRESSING MODE (SAM24, SAM31), the ILC is 1, or it is 2 if SET ADDRESSING MODE was the target of EXECUTE, or 3 if the SET ADDRESSING MODE was the target of EXECUTE RELATIVE LONG. When the exception is introduced by SET SYSTEM MASK or by STORE THEN OR SYSTEM MASK, the ILC is 2, except that when the SSM or STOSM instruction is the target of EXECUTE RELATIVE LONG, the ILC is 3.

The specification exception is indicated by a program-interruption code of 0006 hex (or 0086, 0206, or 0286 hex, if a concurrent PER event, a concurrent transactional-execution-aborted event, or both are indicated, respectively).

Programming Note: See “Exceptions Associated with the PSW” on page 6-9 for a definition of when the exceptions associated with the PSW are recognized.

Stack-Empty Exception

A stack-empty exception is recognized during the unstacking process in EXTRACT STACKED REGISTERS, EXTRACT STACKED STATE, MODIFY STACKED STATE, or PROGRAM RETURN when the current linkage-stack entry is a header entry and the backward stack-entry validity bit in the header entry is zero.

The operation is nullified.

The instruction-length code is 1 or 2, except that when the exception occurs during the fetching of the target of EXECUTE RELATIVE LONG, the ILC is 3.

The stack-empty exception is indicated by a program-interruption code of 0031 hex (or 00B1 hex if a concurrent PER event is indicated).

Stack-Full Exception

A stack-full exception is recognized during the stacking process in BRANCH AND STACK or stacking PROGRAM CALL when there is not enough remaining free space in the current linkage-stack section and the forward-section validity bit in the trailer entry of the section is zero.

The operation is nullified.

The instruction-length code is 2, except that when the exception occurs during the fetching of the target of EXECUTE RELATIVE LONG, the ILC is 3.

The stack-full exception is indicated by a program-interruption code of 0030 hex (or 00B0 hex if a concurrent PER event is indicated).

Stack-Operation Exception

A stack-operation exception is recognized during the unstacking process in PROGRAM RETURN when the unstack-suppression bit is one in any linkage-stack state entry or header entry encountered during the process.

The operation is nullified.

The instruction-length code is 1 or 2, except that when the exception occurs during the fetching of the target of EXECUTE RELATIVE LONG, the ILC is 3.

The stack-operation exception is indicated by a program-interruption code of 0034 hex (or 00B4 hex if a concurrent PER event is indicated).

Stack-Specification Exception

A stack-specification exception is recognized in each of the following cases:

1. During the stacking process in BRANCH AND STACK or stacking PROGRAM CALL when there is not enough remaining free space in the current linkage-stack section and either of the following is true:
 - a. The remaining-free-space value used to locate the trailer entry of the current section is not a multiple of 8.
 - b. There is not enough remaining free space in the next section.

2. During the unstacking process in EXTRACT STACKED REGISTERS, EXTRACT STACKED STATE, MODIFY STACKED STATE, or PROGRAM RETURN when the current linkage-stack entry is a header entry in which the backward stack-entry address designates another header entry.

The operation is nullified.

The instruction-length code is 1 or 2, except that when the exception occurs during the fetching of the target of EXECUTE RELATIVE LONG, the ILC is 3.

The stack-specification exception is indicated by a program-interruption code of 0032 hex (or 00B2 hex if a concurrent PER event is indicated).

Stack-Type Exception

A stack-type exception is recognized during the unstacking process in EXTRACT STACKED REGISTERS, EXTRACT STACKED STATE, MODIFY STACKED STATE, or PROGRAM RETURN in each of the following cases:

1. The current linkage-stack entry is not a header entry or a state entry.
2. When the current linkage-stack entry is a header entry, the preceding entry, designated by the backward stack-entry address in the header entry, is not a header entry or a state entry. (A stack-specification exception is recognized if the preceding entry is a header entry.)

The operation is nullified.

The instruction-length code is 1 or 2, except that when the exception occurs during the fetching of the target of EXECUTE RELATIVE LONG, the ILC is 3.

The stack-type exception is indicated by a program-interruption code of 0033 hex (or 00B3 hex if a concurrent PER event is indicated).

Trace-Table Exception

A trace-table exception is recognized when the CPU attempts to store a trace-table entry which would reach or cross the next 4 K-byte block boundary. For the purpose of recognizing this exception in the TRACE instruction, the explicit trace entry is treated

as being 76 bytes long for TRACE (TRACE) and as 144 bytes long for TRACE (TRACG). For a PROGRAM CALL instruction that would cause storing of both a PROGRAM CALL trace entry and a mode-switch trace entry, the exception is recognized for the first entry when either the first or the second entry would reach or cross the boundary.

The operation is nullified.

The instruction-length code is 1, 2, or 3, indicating the length of the instruction causing the exception.

The trace-table exception is indicated by a program-interruption code of 0016 hex (or 0096 hex if a concurrent PER event is indicated).

Transaction-Constraint Exception

A transaction-constraint exception is recognized when a constrained transaction violates one or more of its constraints. See “Constrained Transaction” on page 5-107 for details on the constraints.

The unit of operation is suppressed.

When the exception occurs as a result of the fetching of an instruction, it is unpredictable whether the ILC is 1, 2, or 3. Otherwise, the instruction-length code (ILC) is 1, 2, or 3 and indicates the length of the instruction at which the exception was detected.

The transaction-constraint exception is indicated by a program-interruption code of 0218 hex (or 0298 hex if a concurrent PER event is indicated).

Programming Note: The instruction designated by the aborted-transaction instruction address is not necessarily the instruction that caused the transaction-constraint exception.

Transactional-Execution-Aborted Event

A transactional-execution-aborted event is recognized when a transaction is aborted due to a program-interruption condition that results in an interruption.

The instruction-length code stored in bits 5-6 of real location 141, and, when a TBEGIN-specified transaction diagnostic block (TDB) is stored, the instruction-length code stored in bits 5-6 of byte 37 of the TDB, is 1, 2, or 3, reflecting the length of the instruction that caused the abort, except that when the excep-

tion occurs during fetching of an instruction, it is unpredictable whether the ILC is 1, 2, or 3.

The transactional-execution-aborted event is indicated by setting bit 6 of the program-interruption code at real locations 142-143 to one. The remainder of the program-interruption code at real locations 142-143 identifies the program-interruption condition that caused the abort. When a TBEGIN-specified transaction diagnostic block is stored, bit 6 is not set in the program-interruption code in bytes 38-39 of the TDB.

See “Transaction Abort Processing” on page 5-102 for a detailed description of transaction abort processing due to program interruptions.

Translation-Specification Exception

A translation-specification exception is recognized when translation of a virtual address is attempted and any of the following is true:

1. In the lookup in the table designated by the address-space-control element used for the translation, the table-type bits in the selected table entry do not equal the designation-type bits in the address-space-control element.
2. In a lookup in a table designated by an entry in a region first table, region second table, or region third table, the value of the table-type bits in the selected table entry is not one less than the value of the same bits in the designating table entry.
3. The private-space control, bit 55 in the address-space-control element used for the translation, is one, and either of the following is true:
 - The segment-table entry used for the translation is valid, and the common-segment bit, bit 59, in the segment-table entry is one.
 - EDAT-2 applies, the region-third-table entry used for the translation is valid, and the common-region bit, bit 59, in the region-third-table entry is one.
4. The page-table entry used for the translation is valid, and bit position 52 does not contain zero.
5. The page-table entry used for the translation is valid, EDAT-1 does not apply, the instruction-execution-protection facility is not installed, and bit position 55 does not contain zero. It is model dependent whether this condition is recognized.

Any of the reasons 1-5 listed above is referred to by saying that the DAT-table entry has a format error.

The exception is recognized only as part of the execution of an instruction using address translation, that is, when DAT is on and a logical address, instruction address, or virtual address must be translated, or when LOAD PAGE-TABLE-ENTRY ADDRESS, LOAD REAL ADDRESS or STORE REAL ADDRESS is executed.

The unit of operation is suppressed.

When the exception occurs during fetching of an instruction, it is unpredictable whether the ILC is 1, 2, or 3. When the exception occurs during the fetching of the target of EXECUTE, the ILC is 2. When the exception occurs during the fetching of the target of EXECUTE RELATIVE LONG, the ILC is 3.

When the exception occurs during a reference to an operand location, the instruction-length code (ILC) is 1, 2, or 3 and indicates the length of the instruction causing the exception.

The translation-specification exception is indicated by a program-interruption code of 0012 hex (or 0092, 0212, or 0292 hex, if a concurrent PER event, a concurrent transactional-execution-aborted event, or both are indicated, respectively).

Programming Note: When a translation-specification exception is recognized in the process of translating an instruction address, the operation is suppressed. In this case, the instruction-length code (ILC) is needed to derive the address of the instruction, as the instruction address in the old PSW has been incremented by the amount indicated by the ILC. In the case of region-first-translation, region-second-translation, region-third-translation, segment-translation, and page-translation exceptions, the operation is nullified, the instruction address in the old PSW identifies the instruction, and the ILC may be arbitrarily set to 1, 2, or 3.

Vector Processing Exception

A vector-processing exception is recognized when there is an exception while executing a vector floating point instruction. See the section “IEEE Exceptions” on page 19-7 for details.

The operation is suppressed.

The instruction-length code is 3, except that when the instruction is target of EXECUTE, the ILC is 2.

Each of the IEEE exceptions is controlled by a mask bit in the floating-point-control (FPC) register. The handling of these exceptions is described in the section “IEEE Exceptions” on page 9-18.

The vector-processing exception is indicated by a program-interruption code of 001B hex (or 009B, 021B, or 029B hex, if a concurrent PER event, a concurrent transactional-execution-aborted event, or both are indicated, respectively).

Collective Program-Interruption Names

For the sake of convenience, certain program exceptions are grouped together under a single collective name. These collective names are used when it is necessary to refer to the complete set of exceptions, such as in instruction definitions. Four collective names are used:

- Access exceptions
- ASN-translation exceptions
- Subspace-replacement exceptions
- Trace exceptions

The individual exceptions and their priorities are listed in “Multiple Program-Interruption Conditions” on page 6-51.

Recognition of Access Exceptions

Figure 6-7 on page 6-48 summarizes the conditions that can cause access exceptions and the action taken when they are encountered.

Any access exception is recognized as part of the execution of the instruction with which the exception is associated. An access exception is not recognized when the CPU attempts to prefetch from an unavailable location or detects some other access-exception condition, but a branch instruction or an interruption changes the instruction sequence such that the instruction is not executed.

Every instruction can cause an access exception to be recognized because of instruction fetch. Additionally, access exceptions associated with instruction

Condition ²	Translation for Virtual Address of LPTEA		Translation for Virtual Address of LOAD REAL ADDRESS		Translation for TAR and TPROT, and Access for Logical Address of TPROT ¹		Translation and Access for Any Other Address	
	Indication	Action	Indication	Action	Indication	Action	Indication	Action
Access register³ Bits 0-6 not all zeros	cc3	Complete	cc3	Complete	cc3	Complete	AS	Suppress
Effective access-list designation Invalid address of designation	A	Suppress	A	Suppress	A	Suppress	A	Suppress
Access-list entry³ Access-list-length violation	cc3	Complete	cc3	Complete	cc3	Complete	AT	Nullify
Invalid address of entry	A	Suppress	A	Suppress	A	Suppress	A	Suppress
I bit on	cc3	Complete	cc3	Complete	cc3	Complete	AT	Nullify
Sequence number in access register not equal to sequence number in entry	cc3	Complete	cc3	Complete	cc3	Complete	ALQ	Nullify
ASN-second-table entry³ Invalid address of entry	A	Suppress	A	Suppress	A	Suppress	A	Suppress
I bit on	cc3	Complete	cc3	Complete	cc3	Complete	AV	Nullify
Sequence number in access-list entry not equal to sequence number in entry	cc3	Complete	cc3	Complete	cc3	Complete	ASQ	Nullify
Authority-table entry^{3,4} Authority-table-length violation	cc3	Complete	cc3	Complete	cc3	Complete	EA	Nullify
Invalid address of entry	A	Suppress	A	Suppress	A	Suppress	A	Suppress
Second-authority bit not one	cc3	Complete	cc3	Complete	cc3	Complete	EA	Nullify
Address-space-control element Bits 0-10, 0-21, or 0-32 of instruction or operand address not all zeros when address-space-control element is a region-second-table designation, region-third-table designation, or segment-table designation, respectively	cc3	Complete	cc3	Complete	cc3	Complete	ATY	Nullify
Region-table-entry designation by address-space-control element or region-table-entry Entry outside of table	cc3	Complete	cc3	Complete	cc3	Complete	RT	Nullify
Invalid address of entry	A	Suppress	A	Suppress	A	Suppress	A	Suppress
I bit on	cc2	Complete	cc3	Complete	cc3	Complete	RT	Nullify
TT in entry not equal DT in address-space-control element or not one less than TT in next-higher-level entry	TS	Suppress	TS	Suppress	TS	Suppress	TS	Suppress

Figure 6-7. Handling of Access Exceptions (Part 1 of 3)

Condition ²	Translation for Virtual Address of LPTEA		Translation for Virtual Address of LOAD REAL ADDRESS		Translation for TAR and TPROT, and Access for Logical Address of TPROT ¹		Translation and Access for Any Other Address	
	Indication	Action	Indication	Action	Indication	Action	Indication	Action
Segment-table entry designation by address-space-control element or region-table-entry								
Entry outside of table	cc3	Complete	cc3	Complete	cc3	Complete	ST	Nullify
Invalid address of entry	A	Suppress	A	Suppress	A	Suppress	A	Suppress
I bit on (except as follows)	cc2	Complete	cc1	Complete	cc3	Complete	ST	Nullify
I bit on (LRA in 24-bit or 31-bit mode when bits 0-32 of entry address not all zeros)	-	-	cc3	Complete	-	-	-	-
One in a bit position which is checked for zero ⁵	TS	Suppress	TS	Suppress	TS	Suppress	TS	Suppress
TT in entry not equal DT in address-space-control element or not one less than TT in next-higher-level entry (TT not zero)	TS	Suppress	TS	Suppress	TS	Suppress	TS	Suppress
Page-table entry								
Invalid address of entry	-	-	A	Suppress	A	Suppress	A	Suppress
I bit on (except as follow)	-	-	cc2	Complete	cc3	Complete	PT	Nullify
I bit on (LRA in 24-bit or 31-bit mode when bits 0-32 of entry address not all zeros)	-	-	cc3	Complete	cc3	Complete	PT	Nullify
One in a bit position which is checked for zeros ⁵	-	-	TS	Suppress	TS	Suppress	TS	Suppress
Access for instruction fetch								
Location protected (key-controlled or instruction-execution protection)	-	-	-	-	-	-	P	Suppress
Invalid address	-	-	-	-	-	-	A	Suppress
Access for operand								
Location protected (low-address, DAT, or key-controlled protection)	-	-	-	-	cc set ⁶	Complete	P	Term.*
Invalid address	-	-	-	-	A	Suppress	A	Term.*
Explanation								
-	The condition does not apply.							
*	Action is to terminate except where otherwise specified in this publication. For access-list-controlled protection, DAT protection, and instruction-execution protection, the action is always to suppress.							
¹	TAR does not have a logical address. The rows "Address-space-control element" through "Access for operands" apply only to TPROT, not to TAR.							
²	Protection applies only to accesses for instruction fetch and for operands. It does not apply to the fetching of the effective access-list designation or any of the listed entries.							
³	Exceptions related to an access register, effective access-list designation, access-list entry, ASN-second-table entry, or authority-table entry are recognized only in the access-register mode except that, for LOAD REAL ADDRESS and STORE REAL ADDRESS, they are recognized when PSW bits 16 and 17 are 01 binary, and, for TEST ACCESS, they are recognized regardless of the translation mode.							

Figure 6-7. Handling of Access Exceptions (Part 2 of 3)

Condition ²	Translation for Virtual Address of LPTEA		Translation for Virtual Address of LOAD REAL ADDRESS		Translation for TAR and TPROT, and Access for Logical Address of TPROT ¹		Translation and Access for Any Other Address	
	Indi-cation	Action	Indi-cation	Action	Indi-cation	Action	Indi-cation	Action
⁴	Authority table is not accessed and secondary-authority bit is not checked if the private bit in the access-list entry is zero or the access-list- entry authorization index in the access-list entry is equal to the extended authorization index in control register 8.							
⁵	A translation-specification exception for a format error in a table entry is recognized only when the execution of an instruction requires the entry for translation of an address.							
⁶	The condition code is set as follows: 0 Operand location not protected. 1 Fetches permitted, but stores not permitted. 2 Neither fetches nor stores permitted.							
A	Addressing exception.							
ALQ	ALE-sequence exception.							
AS	ALET-specification exception.							
ASQ	ASTE-sequence exception.							
AT	ALEN-translation exception.							
ATY	ASCE-type exception.							
AV	ASTE-validity exception.							
cc1	Condition code 1 set.							
cc2	Condition code 2 set.							
cc3	Condition code 3 set.							
EA	Extended-authority exception.							
P	Protection exception.							
PT	Page-translation exception.							
RT	Region-first-translation, region-second-translation, or region-third translation exception, depending on the level of the table.							
ST	Segment-translation exception.							
TS	Translation-specification exception.							

Figure 6-7. Handling of Access Exceptions (Part 3 of 3)

execution may occur because of an access to an operand in storage.

An access exception due to fetching an instruction is indicated when the first instruction halfword cannot be fetched without encountering the exception. When the first halfword of the instruction has no access exceptions, access exceptions may be indicated for additional halfwords according to the instruction length specified by the first two bits of the instruction; however, when the operation can be performed without accessing the second or third halfwords of the instruction, it is unpredictable whether the access exception is indicated for the unused part. Since the indication of access exceptions for instruction fetch is

common to all instructions, it is not covered in the individual instruction definitions.

Except where otherwise indicated in the individual instruction description, the following rules apply for exceptions associated with an access to an operand location. For a fetch-type operand, access exceptions are necessarily indicated only for that portion of the operand which is required for completing the operation. It is unpredictable whether access exceptions are indicated for those portions of a fetch-type operand and which are not required for completing the operation. For a store-type operand, access exceptions are recognized for the entire operand even if the operation could be completed without the use of the inaccessible part of the operand. In situations where the

value of a store-type operand is defined to be unpredictable, it is unpredictable whether an access exception is indicated.

Whenever an access to an operand location can cause an access exception to be recognized, the word “access” is included in the list of program exceptions in the description of the instruction. This entry also indicates which operand can cause the exception to be recognized and whether the exception is recognized on a fetch or store access to that operand location. Access exceptions are recognized only for the portion of the operand as defined for each particular instruction.

Multiple Program-Interruption Conditions

Except for PER basic events, only one program-interruption condition is indicated with a program interruption. The existence of one condition, however, does not preclude the existence of other conditions. When more than one program-interruption condition exists, only the condition having the highest priority is identified in the interruption code.

When multiple conditions of the same priority apply, it is unpredictable which is indicated.

When multiple parts of the same storage operand are subject to separate access controls, the priority of access exceptions associated with the parts is unpredictable and is not necessarily related to the sequence specified for the access of bytes within the operand. For example, when (a) the first operand of a MOVE (MVC) instruction crosses a segment boundary, (b) the invalid bit is one in the segment-table entry used to translate the leftmost part of the operand, and (c) the DAT-protection bit is one in a valid page-table entry used to translate the rightmost part of the operand, then it is unpredictable whether a segment-translation exception or protection exception is recognized.

When an instruction has two storage operands and access-exception conditions exist for both operands, it is unpredictable which condition is recognized. A subsequent execution of the same instruction (with the same exception conditions) may result in the exception condition being recognized for the same operand as the first execution, or for the other operand.

The type of ending which occurs (nullification, suppression, or termination) is that which is defined for the type of exception that is indicated in the interruption code. However, if a condition is indicated which permits termination, and another condition also exists which would cause either nullification or suppression, then the unit of operation is suppressed.

Figure 6-8 on page 6-52 lists the priorities of all program-interruption conditions other than PER basic events and exceptions associated with some of the more complex control instructions. All exceptions associated with references to storage for a particular instruction halfword or a particular operand byte are grouped as a single entry called “access.” Figure 6-9 on page 6-54 lists the priority of access exceptions for a single access. Thus, the second figure specifies which of several exceptions, encountered either in the access of a particular portion of an instruction or in any particular access associated with an operand, has highest priority, and the first figure specifies the priority of this condition in relation to other conditions detected in the operation. Similarly, the priorities for exceptions occurring as part of ASN translation and tracing are covered in Figure 6-10 on page 6-56 and Figure 6-12 on page 6-56, respectively.

For some instructions, the priority is shown in the individual instruction description.

The relative priorities of any two conditions listed in the figure can be found by comparing the priority numbers, as found in the figure, from left to right until a mismatch is found. If the first inequality is between numeric characters, either the two conditions are mutually exclusive or, if both can occur, the condition with the smaller number is indicated. If the first inequality is between alphabetic characters, then the two conditions are not exclusive, and it is unpredictable which is indicated when both occur.

To understand the use of the table, consider an example involving the instruction ADD DECIMAL, which is a six-byte instruction. Assume that the first four bytes of the instruction can be accessed but that the instruction crosses a boundary so that an addressing exception exists for the last two bytes. Additionally, assume that the first operand addressed by the instruction contains invalid decimal digits and is in a location that can be fetched from, but not stored into, because of key-controlled protection. The

three exceptions which could result from attempted execution of the ADD DECIMAL are:

Priority Number	Exception
6.2.B	Access exceptions for third instruction halfword
8.B	Access exceptions (operand 1).
8.D	Data exception

Since the first inequality (6≠8) is between numeric characters, the addressing exception would be indicated. If, however, the entire ADD DECIMAL instruction can be fetched, and only the second two exceptions listed above exist, then the inequality (B ≠D) is between alphabetic characters, and it is unpredictable whether the protection exception or the data exception would be indicated.

Any	Transaction constraint exception, except for one caused by a restricted instruction ⁸
1.	Specification exception due to any PSW error of the type that causes an immediate interruption. ¹
2.	Specification exception due to an odd instruction address in the PSW.
3.	Access exceptions for first halfword of an execute-type instruction. ²
4.A	Access exceptions for second halfword of an execute-type instruction. ²
4.B	Access exceptions for third halfword of EXECUTE RELATIVE LONG. ²
5.1	PER event due to instruction-fetching nullification on an execute-type instruction. (With PER-3)
5.2	Specification exception due to target instruction of EXECUTE not being specified on halfword boundary. ²
6.1	Access exceptions for first instruction halfword.
6.2.A	Access exceptions for second instruction halfword. ³ (With PER-3)
6.2.B	Access exceptions for third instruction halfword. ³ (With PER-3)
6.3	PER event due to instruction-fetching nullification. (PER-3)
7.A	Access exceptions for second instruction halfword. ³ (Without PER-3)
7.B	Access exceptions for third instruction halfword. ³ (Without PER-3)
7.C.1	Operation exception.
7.C.2	Privileged-operation exception for privileged instructions.
7.C.3	Execute exception.
7.C.4	Special-operation exception. ⁴
7.D	Transaction-constraint exception due to any restricted instruction.
8.A	Specification exception due to conditions other than those included in 1, 2, and 5.2 above.
8.B ⁵	Access exceptions for an access to an operand in storage. ⁶
8.C ⁵	Access exceptions for any other access to an operand in storage. ⁶
8.D.1	Data exception. ⁷
8.D.2	Vector-processing exception.
8.E	Decimal-divide exception. ⁷
8.F	Trace exceptions.

Figure 6-8. Priority of Program-Interruption Conditions

9.	<p>Events other than PER events, exceptions which result in completion, and the following exceptions:</p> <ul style="list-style-type: none"> • Fixed-point divide, • HFP divide, • Operand, • Special-operation recognized by any of the following: <ul style="list-style-type: none"> – LOAD PAGE-TABLE-ENTRY ADDRESS due to a real-space designation – LOAD REAL ADDRESS <p>See the definition of the TRAP instruction for other priorities of the special-operation exception.</p> <ul style="list-style-type: none"> • Square root. <p>Either these exceptions and events are mutually exclusive or their priority is specified in the corresponding definitions.</p>
Explanation:	
Numbers indicate priority, with “1” being the highest priority; letters indicate no priority.	
1	PSW errors which cause an immediate interruption may be introduced by a new PSW loaded as a result of an interruption or by the instructions BRANCH AND SET AUTHORITY, LOAD PSW, LOAD PSW EXTENDED, PROGRAM RETURN, SET SYSTEM MASK, and STORE THEN OR SYSTEM MASK. The priority shown in the chart is for a PSW error introduced by an interruption and may also be considered as the priority for a PSW error introduced by the previous instruction. The error is introduced only if the instruction introducing the error encounters no other exceptions. The resulting interruption has a higher priority than any interruption caused by the instruction which would have been executed next; it has lower priority, however, than any interruption caused by the instruction which introduced the erroneous PSW.
2	Priorities 3, 4.A, and 5.1 are for both EXECUTE and EXECUTE RELATIVE LONG, priority 4.B is for EXECUTE RELATIVE LONG, priority 5.2 is for EXECUTE; priorities starting with 6 are for the target instruction. When no execute-type instruction is encountered, priorities 3-5 do not apply.
3	Separate accesses may occur for each halfword of an instruction. The second instruction halfword is accessed only if bits 0-1 of the instruction are not both zeros. The third instruction halfword is accessed only if bits 0-1 of the instruction are both ones. Access exceptions for one of these halfwords are not necessarily recognized if the instruction can be completed without use of the contents of the halfword or if an exception of lower priority can be determined without the use of the halfword.
4	Except for the special-operation-exception conditions listed in priority 9.
5	As in instruction fetching, separate accesses may occur for each portion of an operand. Each of these accesses, and also accesses for different operands, are of equal priority, and the two entries 8.B and 8.C are listed to represent the relative priorities of exceptions associated with any two of these accesses. Access exceptions for INSERT STORAGE KEY EXTENDED, INSERT VIRTUAL STORAGE KEY, INVALIDATE PAGE TABLE ENTRY, LOAD PAGE-TABLE-ENTRY ADDRESS, LOAD REAL ADDRESS, PERFORM FRAME MANAGEMENT FUNCTION, RESET REFERENCE BIT EXTENDED, SET STORAGE KEY EXTENDED, STORE REAL ADDRESS, and TEST PROTECTION are also included in 8.B.
6	For MOVE LONG, MOVE LONG EXTENDED, COMPARE LOGICAL LONG, and COMPARE LOGICAL LONG EXTENDED, an access exception for a particular operand can be indicated only if the R field for that operand designates an even-numbered register.
7	The exception can be indicated only if any operand data fetched that is responsible for the exception were fetched without encountering an access exception.
8	Except as noted, the transaction-constraint exception may occur at any priority.

Figure 6-8. Priority of Program-Interruption Conditions (Continued)

Access Exceptions

The access exceptions consist of those exceptions which can be encountered while using an absolute, instruction, logical, real, or virtual address to access storage. Thus, in the access-register mode, the exceptions are:

1. ALET specification
2. ALFN translation
3. ALE sequence
4. ASTE validity
5. ASTE sequence
6. Extended authority

7. Addressing (the ART tables)
8. ASCE type
9. Region first translation
10. Region second translation
11. Region third translation
12. Segment translation
13. Page translation
14. Translation specification
15. Addressing (the DAT tables)
16. Addressing (the operand or instruction)
17. Protection (access-list-controlled, DAT, instruction-execution, key-controlled, and low-address)

With DAT on but in other than the access-register mode, exceptions 8-17 in the above list, except for access-list-controlled protection, can be encountered.

With DAT off, the exceptions are:

18. Addressing (the operand or instruction)
19. Protection (key-controlled and low-address)

Additionally, even with DAT off, the instruction STORE REAL ADDRESS can encounter exceptions 1-17, the instructions LOAD PAGE-TABLE-ENTRY ADDRESS and LOAD REAL ADDRESS can encounter exceptions 7, 14, and 15, and the instructions COMPARE AND REPLACE DAT TABLE ENTRY, INVALIDATE DAT TABLE ENTRY, and INVALIDATE PAGE TABLE ENTRY can encounter exception 15.

The access exceptions are listed in more detail in Figure 6-9 on page 6-54.

Programming Note: The priorities in Figure 6-9 on page 6-54 could be renumbered, but they are kept as they are to allow easier comparison to the corresponding ESA/390 priorities. Specifically, B.1.A.1-B.1.A.9 could be changed to B.1-B.9, but ESA/390 contains “B.1.B Translation-specification exception due to invalid encoding of bits 8-12 of control register 0.”

A.	Protection exception (low-address protection) due to a store-type operand reference with an effective address in the range 0-511 or 4096-4607. Not recognized if DAT is on and the address-space-control element to be used in the translation cannot be obtained because of another exception.
B.1.A.1	ALET-specification exception due to bits 0-6 of access register not being all zeros. ¹
B.1.A.2	Addressing exception for access to effective access-list designation. ²
B.1.A.3	ALEN-translation exception due to access-list entry being outside the list. ¹
B.1.A.4	Addressing exception for access to access-list entry. ²
B.1.A.5	ALEN-translation exception due to I bit in access-list entry having the value one. ¹
B.1.A.6	ALE-sequence exception due to access-list-entry sequence number (ALESN) in access register not being equal to ALESN in access-list entry. ¹
B.1.A.7	Addressing exception for access to ASN-second-table entry. ²
B.1.A.8	ASTE-validity exception due to I bit in ASN-second-table entry having the value one. ¹
B.1.A.9	ASTE-sequence exception due to ASN-second-table-entry sequence number (ASTESN) in access-list entry not being equal to ASTESN in ASN-second-table entry. ¹
	Note: Exceptions B.1.A.10 through B.1.A.12 are recognized only when the private bit in the access-list entry is one and the ALEAX in the entry is not equal to the EAX in control register 8.
B.1.A.10	Extended-authority exception due to authority-table entry being outside table. ¹
B.1.A.11	Addressing exception for access to authority-table entry. ²
B.1.A.12	Extended-authority exception due to (1) private bit in access-list entry not being zero, (2) access-list-entry authorization index in access-list entry not being equal to extended authorization index in control register 8, and (3) secondary-authority bit selected by extended authorization index not being one. ¹
B.2.A	Protection exception (access-list-controlled protection) due to store-type operand reference to a virtual address which is protected against stores. ¹
B.2.B.1	ASCE-type exception due to bits 0-10, 0-21, or 0-32 of instruction or operand address not being zeros when address-space-control element is a region-second-table designation, region-third-table designation, or segment-table designation, respectively. ³
B.2.B.2	Region-first-, region-second-, region-third-, or segment-translation exception due to required entry in table designated by address-space-control element being outside of table. ³
	Note: Exceptions B.2.B.3 through B.2.B.6 are recognized for a region-first-table, region-second-table, region-third-table, and segment-table entry in the order in which the entries are used.

Figure 6-9. Priority of Access Exceptions (Part 1 of 2)

B.2.B.3	Addressing exception for access to table entry. ⁴
B.2.B.4	Region-first-, region-second-, region-third-, or segment-translation exception due to I bit in table entry having the value one. ³
B.2.B.5	Translation-specification exception due to (1) TT in table entry not equal to DT in designating address-space-control element or not one less than TT in designating next-higher-level table entry, (2) invalid one in segment-table entry if this entry is a segment-table entry (common-segment bit if private- space bit in address-space-control element is one), or (3) invalid one in region-third-table entry if EDAT-2 applies and this entry is a region-third-table entry (common-region bit if private-space bit in address-space-control element is one).
B.2.B.6	Region-second-, region-third-, or segment-translation exception due to required entry in next-lower-level table entry, if any, being outside of table. ³
B.2.B.7	Addressing exception for access to page-table entry. ⁵
B.2.B.8	Page-translation exception due to I bit in page-table entry having the value one. ^{3,7}
B.2.B.9	Translation-specification exception due to invalid ones in page-table entry in which I bit is zero. ⁸ A one in bit position 52 of a valid PTE always causes the exception. When EDAT-1 does not apply and the instruction-execution-protection facility is not installed, it is model dependent whether a one in bit position 55 of a valid PTE causes the exception.
B.3.A	Protection exception (instruction-execution protection) due to an instruction fetch from a virtual address which is protected from instruction execution. ⁶
B.3.B	Protection exception (DAT protection) due to a store-type or update-type reference to a virtual address which is protected against stores. ⁶
B.3.C	Addressing exception for access to instruction or operand.
B.4	Protection exception (key-controlled protection) due to attempt to access a protected instruction or operand location.
Explanation:	
1	Not applicable when not in the access-register mode; not applicable for execution of TEST ACCESS and for translation of operand address of LOAD PAGE-TABLE-ENTRY ADDRESS, LOAD REAL ADDRESS, and TEST PROTECTION.
2	Not applicable when not in the access-register mode, except applicable for execution of TEST ACCESS and, when PSW bits 16 and 17 are 01 binary, for translation of operand address of LOAD REAL ADDRESS and second-operand address of STORE REAL ADDRESS; also applicable for LOAD PAGE-TABLE-ENTRY ADDRESS when the M ₄ field is 0001 binary or when the M ₄ field is 0100 binary and PSW bits 16-17 are 01 binary.
3	Not applicable when DAT is off except for translation of second-operand address of STORE REAL ADDRESS; not applicable to operand addresses of LOAD PAGE-TABLE-ENTRY ADDRESS, LOAD REAL ADDRESS and TEST PROTECTION.
4	Not applicable when DAT is off except for translation of operand address of LOAD PAGE-TABLE-ENTRY ADDRESS, LOAD REAL ADDRESS and second-operand address of STORE REAL ADDRESS.
5	Not applicable when DAT is off, except for execution of INVALIDATE PAGE TABLE ENTRY and for translation of operand address of LOAD PAGE-TABLE-ENTRY ADDRESS and LOAD REAL ADDRESS and second-operand address of STORE REAL ADDRESS.
6	Not applicable when DAT is off.
7	For MOVE PAGE, if the condition is true for both operands, the exception is recognized for the second operand. Also, if the condition-code-option bit is one, the exception is not recognized. Instead, condition code 1 is set if the condition is true for only the first operand, or condition code 2 is set if the condition is true for the second operand or both operands.
8	Not applicable when DAT is off except for translation of operand address of LOAD REAL ADDRESS and second-operand address of STORE REAL ADDRESS.

Figure 6-9. Priority of Access Exceptions (Part 2 of 2)

ASN-Translation Exceptions

The ASN-translation exceptions are those exceptions which are common to the process of translating an

ASN in the instructions PROGRAM RETURN, PROGRAM TRANSFER, PROGRAM TRANSFER WITH INSTANCE, SET SECONDARY ASN, and SET SEC-

ONDARY ASN WITH INSTANCE. The exceptions and the priority in which they are detected are shown in Figure 6-10.

- | |
|---|
| <ol style="list-style-type: none"> 1. Addressing exception for access to ASN- first-table entry. 2. AFX-translation exception due to I bit (bit 0) in ASN-first-table entry being one. 3. Addressing exception for access to ASN-second-table entry. 4. ASX-translation exception due to I bit (bit 0) in ASN-second-table entry being one. |
|---|

Figure 6-10. Priority of ASN-Translation Exceptions

Subspace-Replacement Exceptions

The subspace-replacement exceptions are those exceptions which can be recognized during a subspace-replacement operation in PROGRAM CALL, PROGRAM RETURN, PROGRAM TRANSFER, PROGRAM TRANSFER WITH INSTANCE, SET SECONDARY ASN, or SET SECONDARY ASN WITH INSTANCE. The exceptions and their priority are shown in Figure 6-11 on page 6-56.

- | |
|---|
| <ol style="list-style-type: none"> 1. Addressing exception for access to dispatchable-unit control table. 2. Addressing exception for access to subspace ASN-second-table entry. 3. ASTE-validity exception due to bit 0 being one in subspace ASN-second-table entry. 4. ASTE-sequence exception due to subspace ASN-second-table-entry sequence number in dispatchable-unit control table not being equal to ASN-second-table-entry sequence number in subspace ASN-second-table entry. |
|---|

Figure 6-11. Priority of Subspace-Replacement Exceptions

Trace Exceptions

The trace exceptions are those exceptions which can be encountered while forming a trace-table entry. The exceptions and their priority are shown in Figure 6-12 on page 6-56.

- | |
|---|
| <ol style="list-style-type: none"> A. Protection exception (low-address protection) due to entry address being in the range 0-511 or 4096-4607. B.1 Trace-table exception due to new entry reaching or crossing next 4 K-byte boundary. |
|---|

Figure 6-12. Priority of Trace Exceptions

- | |
|---|
| <ol style="list-style-type: none"> B.2 Addressing exception for access to trace-table entry. |
|---|

Figure 6-12. Priority of Trace Exceptions

Restart Interruption

The restart interruption provides a means for the operator or another CPU to invoke the execution of a specified program. The CPU cannot be disabled for this interruption.

In the z/Architecture architectural mode, a restart interruption causes the old PSW to be stored at real locations 288-303 and a new PSW, designating the start of the program to be executed, to be fetched from real locations 416-431. In the ESA/390-compatibility mode, a restart interruption causes the short-format old PSW to be stored at real locations 8-15 and a short-format new PSW to be fetched from real locations 0-7. The instruction-length code and interruption code are not stored.

If the CPU is in the operating state, the exchange of the PSWs occurs at the completion of the current unit of operation and after all other pending interruption conditions for which the CPU is enabled have been honored. If the CPU is in the stopped state, the CPU enters the operating state and exchanges the PSWs without first honoring any other pending interruptions.

The restart interruption is initiated by activating the restart key. The operation can also be initiated at the addressed CPU by executing a SIGNAL PROCESSOR instruction which specifies the restart order.

When the rate control is set to the instruction-step position, it is unpredictable whether restart causes a unit of operation or additional interruptions to be performed after the PSWs have been exchanged.

Programming Note: To perform a restart when the CPU is in the check-stop state, the CPU has to be reset. Resetting with loss of the least amount of information can be accomplished by means of the system-reset-normal key, which does not clear the contents of program-addressable registers, including the control registers, but causes the channel subsystem to be reset. The CPU-reset SIGNAL PROCESSOR order can be used to clear the CPU without affecting the channel subsystem.

Supervisor-Call Interruption

The supervisor-call interruption occurs when the instruction SUPERVISOR CALL is executed. The CPU cannot be disabled for the interruption, and the interruption occurs immediately upon the execution of the instruction.

In the z/Architecture architectural mode, the supervisor-call interruption causes the old PSW to be stored at real locations 320-335 and a new PSW to be fetched from real locations 448-463. In the ESA/390-compatibility mode, the supervisor-call interruption causes the short-format old PSW to be stored at real locations 32-39 and a short-format new PSW to be fetched from real locations 96-103.

The contents of bit positions 8-15 of the SUPERVISOR CALL instruction are placed in the rightmost byte of the interruption code. The leftmost byte of the interruption code is set to zero. The instruction-length code is 1, unless the instruction was executed by means of an execute-type instruction. When the SUPERVISOR CALL instruction was executed by means of EXECUTE, the instruction-length code is 2; when it is executed by means of EXECUTE RELATIVE LONG, the instruction-length code is 3.

The interruption code is placed at real locations 138-139; the instruction-length code is placed in bit positions 5 and 6 of the byte at real location 137, with the other bits set to zeros; and zeros are stored at real location 136.

Priority of Interruptions

During the execution of an instruction, several interruption-causing events may occur simultaneously. The instruction may give rise to a program interruption, a request for an external interruption may be received, equipment malfunctioning may be detected, an I/O-interruption request may be made, and the restart key may be activated. Instead of the program interruption, a supervisor-call interruption might occur; or both can occur if PER is active. Simultaneous interruption requests are honored in a predetermined order.

An exigent machine-check condition has the highest priority. When it occurs, the current operation is ter-

minated or nullified. Program and supervisor-call interruptions that would have occurred as a result of the current operation may be eliminated. Any pending repressible machine-check conditions may be indicated with the exigent machine-check interruption. Every reasonable attempt is made to limit the side effects of an exigent machine-check condition, and requests for external, I/O, and restart interruptions normally remain unaffected.

In the absence of an exigent machine-check condition, interruption requests existing concurrently at the end of a unit of operation are honored, in descending order of priority, as follows:

- Supervisor call
- Program
- Repressible machine check
- External
- Input/output
- Restart

The processing of multiple simultaneous interruption requests consists in storing the old PSW and fetching the new PSW belonging to the interruption first honored. This new PSW is subsequently stored without the execution of any instructions, and the new PSW associated with the next interruption is fetched. Storing and fetching of PSWs continues until no more interruptions are to be serviced. The priority is reevaluated after each new PSW is loaded. Each evaluation takes into consideration any additional interruptions which may have become pending. Additionally, external and I/O interruptions, as well as machine-check interruptions due to repressible conditions, occur only if the current PSW at the instant of evaluation indicates that the CPU is interruptible for the cause.

Instruction execution is resumed using the last-fetched PSW. The order of executing interruption subroutines is, therefore, the reverse of the order in which the PSWs are fetched.

If the new PSW for a program interruption does not specify the wait state and has an odd instruction address, or causes an access exception to be recognized, another program interruption occurs. Since this second interruption introduces the same unacceptable PSW, a string of interruptions is established. These program exceptions are recognized as part of the execution of the following instruction, and the string may be broken by an external, I/O, machine-check, or restart interruption or by the stop function.

If the new PSW for a program interruption contains a one in bit position 12 or in an unassigned bit position, if the leftmost 40 bits of the instruction address are not zeros when bit 31 and 32 indicate 24-bit addressing, or the leftmost 33 bits are not zeros when bits 31 and 32 indicate 31-bit addressing, or if bit 32 is zero when bit 31 is one, another program interruption occurs. This condition is of higher priority than restart, I/O, external, or repressible machine-check conditions, or the stop function, and CPU reset has to be used to break the string of interruptions.

A string of interruptions for other interruption classes can also exist if the new PSW allows the interruption which has just occurred. These include machine-check interruptions, external interruptions, and I/O interruptions due to program-controlled-interruption (PCI) conditions generated because of CCWs which form a loop. Furthermore, a string of interruptions involving more than one interruption class can exist. For example, assume that the CPU timer is negative and the CPU-timer subclass mask is one. If the external new PSW has a one in an unassigned bit position, and the program new PSW is enabled for

external interruptions, then a string of interruptions occurs, alternating between external and program. Even more complex strings of interruptions are possible. As long as more interruptions must be serviced, the string of interruptions cannot be broken by employing the stop function; CPU reset is required.

Similarly, CPU reset has to be invoked to terminate the condition that exists when an interruption is attempted with a prefix value designating a storage location that is not available to the CPU.

Interruptions for all requests for which the CPU is enabled occur before the CPU is placed in the stopped state. When the CPU is in the stopped state, restart has the highest priority.

Programming Note: The order in which concurrent interruption requests are honored can be changed to some extent by masking.

Chapter 7. General Instructions

Data Format	7-4	CIPHER MESSAGE WITH AUTHENTICATION	7-78
Binary-Integer Representation	7-4	CIPHER MESSAGE WITH CIPHER FEEDBACK	7-92
Binary Arithmetic	7-5	CIPHER MESSAGE WITH COUNTER	7-107
Signed Binary Arithmetic	7-5	CIPHER MESSAGE WITH OUTPUT FEEDBACK	7-120
Addition and Subtraction	7-5	COMPARE	7-134
Fixed-Point Overflow	7-6	COMPARE IMMEDIATE	7-134
Unsigned Binary Arithmetic	7-6	COMPARE RELATIVE LONG	7-135
Signed and Logical Comparison	7-7	COMPARE AND BRANCH	7-135
Instructions	7-7	COMPARE AND BRANCH RELATIVE	7-135
ADD	7-25	COMPARE IMMEDIATE AND BRANCH	7-136
ADD IMMEDIATE	7-26	RELATIVE	7-136
ADD HALFWORD	7-28	COMPARE AND FORM CODEWORD	7-137
ADD HALFWORD IMMEDIATE	7-28	COMPARE AND SWAP	7-144
ADD HIGH	7-28	COMPARE DOUBLE AND SWAP	7-144
ADD IMMEDIATE HIGH	7-29	COMPARE AND SWAP AND STORE	7-146
ADD LOGICAL	7-29	COMPARE AND TRAP	7-149
ADD LOGICAL IMMEDIATE	7-29	COMPARE IMMEDIATE AND TRAP	7-149
ADD LOGICAL HIGH	7-30	COMPARE HALFWORD	7-150
ADD LOGICAL WITH CARRY	7-30	COMPARE HALFWORD IMMEDIATE	7-150
ADD LOGICAL WITH SIGNED IMMEDIATE	7-31	COMPARE HALFWORD RELATIVE LONG	7-150
ADD LOGICAL WITH SIGNED IMMEDIATE HIGH	7-32	COMPARE HIGH	7-151
AND	7-32	COMPARE IMMEDIATE HIGH	7-151
AND IMMEDIATE	7-34	COMPARE LOGICAL	7-152
AND WITH COMPLEMENT	7-34	COMPARE LOGICAL IMMEDIATE	7-152
BRANCH AND LINK	7-35	COMPARE LOGICAL RELATIVE LONG	7-153
BRANCH AND SAVE	7-36	COMPARE LOGICAL AND BRANCH	7-154
BRANCH AND SAVE AND SET MODE	7-36	COMPARE LOGICAL AND BRANCH RELATIVE	7-154
BRANCH AND SET MODE	7-38	COMPARE LOGICAL IMMEDIATE AND BRANCH	7-154
BRANCH INDIRECT ON CONDITION	7-39	COMPARE LOGICAL IMMEDIATE AND BRANCH RELATIVE	7-154
BRANCH ON CONDITION	7-40	COMPARE LOGICAL AND TRAP	7-155
BRANCH ON COUNT	7-41	COMPARE LOGICAL IMMEDIATE AND TRAP	7-156
BRANCH ON INDEX HIGH	7-41	COMPARE LOGICAL CHARACTERS UNDER MASK	7-157
BRANCH ON INDEX LOW OR EQUAL	7-41	COMPARE LOGICAL HIGH	7-157
BRANCH PREDICTION PRELOAD	7-42	COMPARE LOGICAL IMMEDIATE HIGH	7-158
BRANCH PREDICTION RELATIVE PRELOAD	7-42	COMPARE LOGICAL LONG	7-158
BRANCH RELATIVE AND SAVE	7-45	COMPARE LOGICAL LONG EXTENDED	7-160
BRANCH RELATIVE AND SAVE LONG	7-45	COMPARE LOGICAL LONG UNICODE	7-163
BRANCH RELATIVE ON CONDITION	7-46	COMPARE LOGICAL STRING	7-166
BRANCH RELATIVE ON CONDITION LONG	7-46	COMPARE UNTIL SUBSTRING EQUAL	7-167
BRANCH RELATIVE ON COUNT	7-47	COMPRESSION CALL	7-170
BRANCH RELATIVE ON COUNT HIGH	7-47		
BRANCH RELATIVE ON INDEX HIGH	7-48		
BRANCH RELATIVE ON INDEX LOW OR EQUAL	7-48		
CHECKSUM	7-49		
CIPHER MESSAGE	7-53		
CIPHER MESSAGE WITH CHAINING	7-53		

COMPUTE INTERMEDIATE MESSAGE	
DIGEST	7-188
COMPUTE LAST MESSAGE DIGEST	7-201
COMPUTE MESSAGE AUTHENTICATION	
CODE	7-219
CONVERT TO BINARY	7-230
CONVERT TO DECIMAL	7-231
CONVERT UTF-16 TO UTF-32	7-231
CONVERT UTF-16 TO UTF-8	7-234
CONVERT UNICODE TO UTF-8	7-234
CONVERT UTF-32 TO UTF-16	7-238
CONVERT UTF-32 TO UTF-8	7-241
CONVERT UTF-8 TO UTF-16	7-244
CONVERT UTF-8 TO UNICODE	7-244
CONVERT UTF-8 TO UTF-32	7-248
COPY ACCESS	7-252
DIVIDE	7-252
DIVIDE LOGICAL	7-253
DIVIDE SINGLE	7-254
EXCLUSIVE OR	7-254
EXCLUSIVE OR IMMEDIATE	7-256
EXECUTE	7-256
EXECUTE RELATIVE LONG	7-256
EXTRACT ACCESS	7-257
EXTRACT CPU ATTRIBUTE	7-257
EXTRACT CPU TIME	7-260
EXTRACT PSW	7-261
EXTRACT TRANSACTION NESTING	
DEPTH	7-261
FIND LEFTMOST ONE	7-262
INSERT CHARACTER	7-262
INSERT CHARACTERS UNDER MASK	7-262
INSERT IMMEDIATE	7-263
INSERT PROGRAM MASK	7-264
LOAD	7-264
LOAD IMMEDIATE	7-264
LOAD RELATIVE LONG	7-264
LOAD ACCESS MULTIPLE	7-265
LOAD ADDRESS	7-266
LOAD ADDRESS EXTENDED	7-266
LOAD ADDRESS RELATIVE LONG	7-267
LOAD AND ADD	7-268
LOAD AND ADD LOGICAL	7-268
LOAD AND AND	7-269
LOAD AND EXCLUSIVE OR	7-269
LOAD AND OR	7-270
LOAD AND TEST	7-270
LOAD AND TRAP	7-271
LOAD AND ZERO RIGHTMOST BYTE	7-271
LOAD BYTE	7-272
LOAD BYTE HIGH	7-272
LOAD COMPLEMENT	7-272
LOAD COUNT TO BLOCK BOUNDARY	7-273
LOAD GUARDED	7-274

LOAD LOGICAL AND SHIFT GUARDED	7-274
LOAD GUARDED STORAGE CONTROLS	7-275
LOAD HALFWORD	7-276
LOAD HALFWORD IMMEDIATE	7-276
LOAD HALFWORD RELATIVE LONG	7-276
LOAD HALFWORD HIGH	7-277
LOAD HALFWORD IMMEDIATE ON	
CONDITION	7-277
LOAD HALFWORD HIGH IMMEDIATE ON	
CONDITION	7-277
LOAD HIGH	7-278
LOAD HIGH AND TRAP	7-278
LOAD LOGICAL	7-278
LOAD LOGICAL RELATIVE LONG	7-278
LOAD LOGICAL AND TRAP	7-279
LOAD LOGICAL AND ZERO RIGHTMOST	
BYTE	7-279
LOAD LOGICAL CHARACTER	7-279
LOAD LOGICAL CHARACTER HIGH	7-280
LOAD LOGICAL HALFWORD	7-280
LOAD LOGICAL HALFWORD RELATIVE	
LONG	7-280
LOAD LOGICAL HALFWORD HIGH	7-281
LOAD LOGICAL IMMEDIATE	7-281
LOAD LOGICAL THIRTY ONE BITS	7-281
LOAD LOGICAL THIRTY ONE BITS AND	
TRAP	7-282
LOAD MULTIPLE	7-282
LOAD MULTIPLE DISJOINT	7-283
LOAD MULTIPLE HIGH	7-283
LOAD NEGATIVE	7-283
LOAD ON CONDITION	7-284
LOAD HIGH ON CONDITION	7-284
LOAD PAIR DISJOINT	7-285
LOAD PAIR FROM QUADWORD	7-286
LOAD POSITIVE	7-287
LOAD REVERSED	7-287
MONITOR CALL	7-288
MOVE	7-289
MOVE INVERSE	7-290
MOVE LONG	7-290
MOVE LONG EXTENDED	7-294
MOVE LONG UNICODE	7-297
MOVE NUMERICS	7-301
MOVE RIGHT TO LEFT	7-301
MOVE STRING	7-302
MOVE WITH OFFSET	7-303
MOVE ZONES	7-304
MULTIPLY	7-305
MULTIPLY HALFWORD	7-306
MULTIPLY HALFWORD IMMEDIATE	7-306
MULTIPLY LOGICAL	7-307
MULTIPLY SINGLE	7-308
MULTIPLY SINGLE IMMEDIATE	7-308

NAND	7-309	STORE CLOCK	7-387
NEXT INSTRUCTION ACCESS INTENT . .	7-310	STORE CLOCK FAST	7-387
NONTRANSACTIONAL STORE	7-311	STORE CLOCK EXTENDED	7-388
NOR	7-312	STORE FACILITY LIST EXTENDED	7-390
NOT EXCLUSIVE OR	7-312	STORE GUARDED STORAGE CONTROLS	7-391
OR	7-313	STORE HALFWORD	7-391
OR IMMEDIATE	7-314	STORE HALFWORD RELATIVE LONG . . .	7-392
OR WITH COMPLEMENT	7-315	STORE HALFWORD HIGH	7-392
PACK	7-315	STORE HIGH	7-392
PACK ASCII	7-316	STORE MULTIPLE	7-393
PACK UNICODE	7-317	STORE MULTIPLE HIGH	7-393
PERFORM CRYPTOGRAPHIC COMPUTATION	7-317	STORE ON CONDITION	7-393
PERFORM LOCKED OPERATION	7-338	STORE HIGH ON CONDITION	7-394
PERFORM PROCESSOR ASSIST	7-352	STORE PAIR TO QUADWORD	7-394
PERFORM RANDOM NUMBER OPERATION	7-353	STORE REVERSED	7-395
POPULATION COUNT	7-366	SUBTRACT	7-395
PREFETCH DATA	7-366	SUBTRACT HALFWORD	7-396
PREFETCH DATA RELATIVE LONG	7-367	SUBTRACT HIGH	7-397
ROTATE LEFT SINGLE LOGICAL	7-368	SUBTRACT LOGICAL	7-397
ROTATE THEN AND SELECTED BITS . . .	7-369	SUBTRACT LOGICAL IMMEDIATE	7-398
ROTATE THEN EXCLUSIVE OR SELECTED BITS	7-369	SUBTRACT LOGICAL HIGH	7-398
ROTATE THEN OR SELECTED BITS	7-369	SUBTRACT LOGICAL WITH BORROW . . .	7-399
ROTATE THEN INSERT SELECTED BITS	7-370	SUPERVISOR CALL	7-399
ROTATE THEN INSERT SELECTED BITS HIGH	7-372	TEST ADDRESSING MODE	7-400
ROTATE THEN INSERT SELECTED BITS LOW	7-372	TEST AND SET	7-400
SEARCH STRING	7-373	TEST UNDER MASK (TEST UNDER MASK HIGH, TEST UNDER MASK LOW)	7-401
SEARCH STRING UNICODE	7-375	TRANSACTION ABORT	7-402
SELECT	7-377	TRANSACTION BEGIN (TBEGIN)	7-402
SELECT HIGH	7-377	TRANSACTION BEGIN (TBEGINC)	7-407
SET ACCESS	7-378	TRANSACTION END	7-409
SET ADDRESSING MODE	7-378	TRANSLATE	7-409
SET PROGRAM MASK	7-379	TRANSLATE AND TEST	7-410
SHIFT LEFT DOUBLE	7-379	TRANSLATE AND TEST EXTENDED	7-411
SHIFT LEFT DOUBLE LOGICAL	7-380	TRANSLATE AND TEST REVERSE EXTENDED	7-411
SHIFT LEFT SINGLE	7-380	TRANSLATE AND TEST REVERSE	7-416
SHIFT LEFT SINGLE LOGICAL	7-381	TRANSLATE EXTENDED	7-416
SHIFT RIGHT DOUBLE	7-382	TRANSLATE ONE TO ONE	7-419
SHIFT RIGHT DOUBLE LOGICAL	7-382	TRANSLATE ONE TO TWO	7-419
SHIFT RIGHT SINGLE	7-383	TRANSLATE TWO TO ONE	7-419
SHIFT RIGHT SINGLE LOGICAL	7-384	TRANSLATE TWO TO TWO	7-419
STORE	7-384	UNPACK	7-424
STORE RELATIVE LONG	7-385	UNPACK ASCII	7-424
STORE ACCESS MULTIPLE	7-385	UNPACK UNICODE	7-425
STORE CHARACTER	7-386	UPDATE TREE	7-426
STORE CHARACTER HIGH	7-386	Protection of Cryptographic Keys	7-432
STORE CHARACTERS UNDER MASK . . .	7-386	Protection of DES Keys	7-433
		Protection of AES Keys	7-435
		Protection of ECC Keys	7-437

This chapter includes most of the unprivileged instructions described in this publication. Other unprivileged instructions are described in chapters 8-9 and 18-26.

Data Format

The general instructions treat data as being of four types: signed binary integers, unsigned binary integers, unstructured logical data, and decimal data. Data is treated as decimal by the conversion, packing, and unpacking instructions. Decimal data is described in Chapter 8, "Decimal Instructions."

The general instructions manipulate data which resides in general registers or in storage or is introduced from the instruction stream. Some general instructions operate on data which resides in the PSW or the TOD clock.

In a storage-and-storage operation the operand fields may be defined in such a way that they overlap. The effect of this overlap depends upon the operation. When the operands remain unchanged, as in COMPARE or TRANSLATE AND TEST, overlapping does not affect the execution of the operation. For instructions such as MOVE and TRANSLATE, one operand is replaced by new data, and the execution of the operation may be affected by the amount of overlap and the manner in which data is fetched or stored. For purposes of evaluating the effect of overlapped operands, data is considered to be handled one eight-bit byte at a time. Special rules apply to the operands of MOVE LONG and MOVE INVERSE. See "Interlocks within a Single Instruction" on page 5-116 for how overlap is detected in the access-register mode.

Binary-Integer Representation

Binary integers are treated as signed or unsigned.

In an unsigned binary integer, all bits are used to express the absolute value of the number. When two unsigned binary integers of different lengths are added, the shorter number is considered to be extended on the left with zeros.

In some operations, the result is achieved by the use of the one's complement of the number. The one's

complement of a number is obtained by inverting each bit of the number, including the sign.

For signed binary integers, the leftmost bit represents the sign, which is followed by the numeric field. Positive numbers are represented in true binary notation with the sign bit set to zero. When the value is zero, all bits are zeros, including the sign bit. Negative numbers are represented in two's-complement binary notation with a one in the sign-bit position.

Specifically, a negative number is represented by the two's complement of the positive number of the same absolute value. The two's complement of a number is obtained by forming the one's complement of the number, adding a value of one in the rightmost bit position, allowing a carry into the sign position, and ignoring any carry out of the sign position.

This number representation can be considered the rightmost portion of an infinitely long representation of the number. When the number is positive, all bits to the left of the most significant bit of the number are zeros. When the number is negative, these bits are ones. Therefore, when a signed operand must be extended with bits on the left, the extension is achieved by setting these bits equal to the sign bit of the operand.

The notation for signed binary integers does not include a negative zero. It has a number range in which, for a given length, the set of negative nonzero numbers is one larger than the set of positive nonzero numbers. The maximum positive number consists of a sign bit of zero followed by all ones, whereas the maximum negative number (the negative number with the greatest absolute value) consists of a sign bit of one followed by all zeros.

A signed binary integer of either sign, except for zero and the maximum negative number, can be changed to a number of the same magnitude but opposite sign by forming its two's complement. Forming the two's complement of a number is equivalent to subtracting the number from zero. The two's complement of zero is zero.

The two's complement of the maximum negative number cannot be represented in the same number of bits. When an operation, such as LOAD COMPLEMENT, attempts to produce the two's complement of the maximum negative number, the result is the maximum negative number, and a fixed-point-overflow exception is recognized. An overflow does not result,

however, when the maximum negative number is complemented as an intermediate result but the final result is within the representable range. An example of this case is a subtraction of the maximum negative number from -1. The product of two maximum negative numbers of a given length is representable as a positive number of double that length.

In discussions of signed binary integers in this publication, a signed binary integer includes the sign bit. Thus, the expression “32-bit signed binary integer” denotes an integer with 31 numeric bits and a sign bit, and the expression “64-bit signed binary integer” denotes an integer with 63 numeric bits and a sign bit.

In an arithmetic operation, a carry out of the numeric field of a signed binary integer is carried into the sign bit. However, in algebraic left-shifting, the sign bit does not change even if significant numeric bits are shifted out.

Programming Notes:

1. An alternate way of forming the two’s complement of a signed binary integer is to invert all bits to the left of the rightmost one bit, leaving the rightmost one bit and all zero bits to the right of it unchanged.
2. The numeric bits of a signed binary integer may be considered to represent a positive value, with the sign representing a value of either zero or the maximum negative number.

Binary Arithmetic

Many of the instructions that perform a register-and-storage or register-and-register binary-arithmetic operation are provided in sets of three instructions corresponding to three different combinations of operand lengths. These three instructions have the same name but different operation codes and mnemonics. For example, ADD (A) operates on 32-bit operands and produces a 32-bit result, ADD (AG) operates on 64-bit operands and produces a 64-bit result, and ADD (AGF) operates on a 64-bit operand and a 32-bit operand and produces a 64-bit result. The letter “G” alone in the mnemonic indicates a completely 64-bit operation, and the letters “GF” indicate a 32-to-64-bit operation.

In a 32-to-64-bit operation, the intermediate result is 64 bits. LOAD COMPLEMENT (LCGFR) forms the two’s complement of the maximum negative 32-bit number without recognizing overflow.

Except for the instructions of the high-word facility, a 32-bit operand in a general register is in bit positions 32-63 of the register. In an operation on the operand, such as by ADD (A), bits 0-31 of the register are unused and remain unchanged. A 64-bit operand in a general register is in bit positions 0-63 of the register, and all of the bits participate in an operation on the operand, such as by ADD (AG). However, some instructions, which do not have “G” in their mnemonics, use a 64-bit operand of which the leftmost 32 bits are in bit positions 32-63 of the even register of an even-odd general-register pair, and the rightmost 32 bits are in bit positions 32-63 of the odd register of the pair.

The bits of a 32-bit operand in storage are numbered 0-31. When the operand is in bit positions 32-63 of a general register, the bits are numbered 32-63.

Signed Binary Arithmetic

Addition and Subtraction

Addition of signed binary integers is performed by adding all bits of each operand, including the sign bits. When one of the operands is shorter, the shorter operand is considered to be extended on the left to the length of the longer operand by propagating the sign-bit value.

For a 32-bit signed binary integer in a general register, the sign bit is bit 32 of the register. For a 64-bit signed binary integer in a general register, the sign bit is bit 0 of the register.

Subtraction is performed by adding the one’s complement of the second operand and a value of one to the first operand.

Fixed-Point Overflow

A fixed-point-overflow condition exists for signed binary addition or subtraction when the carry out of the sign-bit position and the carry out of the leftmost numeric bit position disagree. Detection of an overflow does not affect the result produced by the addition. In mathematical terms, signed addition and subtraction produce a fixed-point overflow when the result is outside the range of representation for

signed binary integers. Specifically, for ADD, LOAD AND ADD, LOAD COMPLEMENT, and LOAD POSITIVE instructions which operate on 32-bit signed binary integers, there is an overflow when the proper result would be greater than or equal to $+2^{31}$ or less than -2^{31} . The actual result placed in the general register after an overflow differs from the proper result by 2^{32} . Similarly, for ADD, LOAD AND ADD, LOAD COMPLEMENT, and LOAD POSITIVE instructions which operate on 64-bit signed binary integers, there is an overflow when the proper result would be greater than or equal to $+2^{63}$ or less than -2^{63} , and the actual result placed in the general register after an overflow differs from the proper result by 2^{64} . ADD (AGF) and SUBTRACT (SGF) have the same 64-bit result and overflow rules as ADD (AG) and SUBTRACT (SG).

The instructions SHIFT LEFT SINGLE and SHIFT LEFT DOUBLE produce an overflow when the result is outside the range of representation for signed binary integers. The actual result differs from that for addition and subtraction in that the sign of the result remains the same as the original sign.

For MULTIPLY SINGLE (MSC and MSRKC), there is an overflow result when the proper result would be greater than or equal to $+2^{31}$ or less than -2^{31} . Similarly, for MULTIPLY SINGLE (MSGC and MSGRKC), there is an overflow result when the proper result would be greater than or equal to $+2^{63}$ or less than -2^{63} . The actual result placed in the general register after an overflow is the rightmost 32 bits (MSC, MSRKC) or 64 bits (MSGC, MSGRKC) of the product.

When an overflow result occurs, condition code 3 is set. When the fixed-point overflow mask (bit 20 of the PSW) is one, a fixed-point-overflow program-exception condition is recognized.

Unsigned Binary Arithmetic

Addition of unsigned binary integers is performed by adding all bits of each operand. Subtraction is performed by adding the one's complement of the second operand (the subtrahend) and a value of one to the first operand (the minuend). In any case, when one of the operands is shorter, the shorter operand is considered to be extended on the left with zeros. During subtraction, this extension applies before an operand is complemented, and it applies to the value of one.

Unsigned binary arithmetic is used in address arithmetic for adding the X, B, and D fields. (See "Address Generation" on page 5-10.) It is also used to obtain the addresses of the function bytes in TRANSLATE and TRANSLATE AND TEST. Furthermore, unsigned binary arithmetic is used on 32-bit or 64-bit unsigned binary integers by ADD LOGICAL, ADD LOGICAL WITH CARRY, DIVIDE LOGICAL, MULTIPLY LOGICAL, SUBTRACT LOGICAL, and SUBTRACT LOGICAL WITH BORROW.

Given the same length operands, ADD (A, AG, AGF) and ADD LOGICAL (AL, ALG, ALGF) produce the same 32-bit or 64-bit result. The instructions differ only in the interpretation of this result. ADD interprets the result as a signed binary integer and inspects it for sign, magnitude, and overflow to set the condition code accordingly. ADD LOGICAL interprets the result as an unsigned binary integer and sets the condition code according to whether the result is zero and whether there was a carry out of bit position 32, for a 32-bit integer, or out of bit position 0 for a 64-bit integer. Such a carry is not considered an overflow, and no program interruption for overflow can occur for ADD LOGICAL.

SUBTRACT LOGICAL differs from ADD LOGICAL in that the one's complement of the second operand and a value of one are added to the first operand.

For ADD LOGICAL WITH CARRY, a carry from a previous operation is represented by a one value of bit 18 of the current PSW. Bit 18 is the leftmost bit of the two-bit condition code in the PSW. For SUBTRACT LOGICAL WITH BORROW, a borrow from a previous operation is represented by a zero value of bit 18. A borrow is equivalent to the absence of a carry.

For VECTOR ADD WITH CARRY, a carry from a previous operation is represented by a one in the rightmost bit of each element of a vector register. For VECTOR SUBTRACT WITH BORROW INDICATION, an indication of borrow from a previous operation is represented by a one in the rightmost bit of each element of a vector register. The indication of borrow is equivalent to a carry. The vector integer instructions may be found in Chapter 22.

Programming Notes:

1. Logical addition and subtraction may be used to perform arithmetic on multiple-precision binary-integer operands. Thus, for multiple-precision

addition, ADD LOGICAL can be used to add the lowest-order corresponding parts of the operands, and ADD LOGICAL WITH CARRY can be used to add the other corresponding parts of the operands, moving from right to left in the operands.

2. Another use for ADD LOGICAL is to increment values representing binary counters, which are allowed to wrap around from all ones to all zeros without indicating overflow.

Signed and Logical Comparison

Comparison operations determine whether two operands are equal or not and, for most operations, which of two unequal operands is the greater (high). Signed-binary-comparison operations are provided which treat the operands as signed binary integers, and logical-comparison operations are provided which treat the operands as unsigned binary integers or as unstructured data.

COMPARE (C, CG, CGF) and COMPARE HALFWORD are signed-binary-comparison operations. These instructions are equivalent to SUBTRACT (S, SG, SGF) and SUBTRACT HALFWORD without replacing either operand, the resulting difference being used only to set the condition code. The operations permit comparison of numbers of opposite sign which differ by 2^{63} or more. Thus, unlike SUBTRACT, COMPARE cannot cause overflow.

Logical comparison of two operands is performed byte by byte, in a left-to-right sequence. The operands are equal when all their bytes are equal. When the operands are unequal, the comparison result is determined by a left-to-right comparison of corresponding bit positions in the first unequal pair of bytes: the zero bit in the first unequal pair of bits indicates the low operand, and the one bit the high operand. Since the remaining bit and byte positions do not change the comparison, it is not necessary to continue comparing unequal operands beyond the first unequal bit pair.

Instructions

The general instructions and their mnemonics, formats, and operation codes are listed in Figure 7-1 on

page 7-13. The figure also indicates which instructions are new in z/Architecture as compared to ESA/390, when the condition code is set, the instruction fields that designate access registers, and the exceptional conditions in operand designations, data, or results that cause a program interruption.

The instructions that are new in z/Architecture are indicated in Figure 7-1 by “N.” A few of the instructions that are new in z/Architecture have also been added to ESA/390, and these are indicated by “N3.”

When the operands of an instruction are 32-bit operands, the mnemonic for the instruction normally does not include a letter indicating the operand length; however some mnemonics for instructions with 32-bit operands contain the letter “F”. If there is an instruction with the same name but with 64-bit operands, its mnemonic includes the letter “G.” If there is an instruction with the same name but with a 64-bit first operand and a 32-bit second operand, its mnemonic includes the letters “GF.” Certain instruction mnemonics indicate the length of the first and second operands with combinations of G (64-bit), F (32-bit), or H (16-bit), although the F is usually omitted for the first operand.

In Figure 7-1, when there is an instruction with 32-bit operands and other instructions with the same name but with “G” or “GF” added in their mnemonics, the first instruction has “(32)” after its name, and the other instructions have “(64)” or “(64←32),” respectively, after their names. Some 32-bit operand-length instructions do not have 64-bit operand-length counterparts, and they do not have “(32)” after their names. However, all instructions for multiplication or division are marked to show, or approximately show, operand lengths.

A detailed definition of instruction formats, operand designation and length, and address generation is contained in “Instructions” on page 5-3. Exceptions to the general rules stated in that section are explicitly identified in the individual instruction descriptions.

Note: In the detailed descriptions of the individual instructions, the mnemonic and the symbolic operand designations for the assembler language are shown with each instruction. For LOAD AND TEST with 32-bit operands, for example, LTR is the mnemonic and R_1, R_2 the operand designation.

Certain fields of various instructions are considered to be optional, as indicated by the field being con-

tained within brackets [] in the assembler syntax. When an optional field is not specified, the assembler places zeros in that field of the instruction.

Programming Notes:

1. Trimodal addressing affects the general instructions only in the manner in which logical storage addresses are handled, except as follows.

The instructions BRANCH AND LINK (BAL, BALR), BRANCH AND SAVE (BAS, BASR), BRANCH AND SAVE AND SET MODE, BRANCH AND SET MODE, BRANCH RELATIVE AND SAVE, and BRANCH RELATIVE AND SAVE LONG place information in bit positions 32-39 of general register R_1 as in ESA/390 in the 24-bit or 31-bit addressing mode or place address bits in those bit positions in the 64-bit addressing mode.

The instruction BRANCH AND SAVE AND SET MODE places a zero in bit position 63 of general register R_1 in the 24-bit or 31-bit addressing mode or places a one in that bit position in the 64-bit addressing mode.

The instruction BRANCH AND SET MODE leaves the contents of bit position 63 of general register R_1 unchanged in the 24-bit or 31-bit addressing mode or places a one in that bit position in the 64-bit addressing mode.

The following instructions leave bits 0-31 of a general register unchanged in the 24-bit or 31-bit addressing mode but place or update address or length information in them in the 64-bit addressing mode. Also, the leftmost byte of the results in registers may be handled differently depending on whether the addressing mode is the 24-bit or the 31-bit mode.

- BRANCH AND LINK (BAL, BALR)
- BRANCH AND SAVE (BAS, BASR)
- BRANCH AND SAVE AND SET MODE
- BRANCH RELATIVE AND SAVE
- BRANCH RELATIVE AND SAVE LONG
- CHECKSUM
- COMPARE AND FORM CODEWORD
- COMPARE LOGICAL LONG
- COMPARE LOGICAL LONG EXTENDED
- COMPARE LOGICAL LONG UNICODE
- COMPARE LOGICAL STRING
- COMPARE UNTIL SUBSTRING EQUAL
- COMPRESSION CALL

- CONVERT UTF-16 TO UTF-32
- CONVERT UTF-16 TO UTF-8
- CONVERT UTF-32 TO UTF-16
- CONVERT UTF-32 TO UTF-8
- CONVERT UTF-8 TO UTF-16
- CONVERT UTF-8 TO UTF-32
- LOAD ADDRESS
- LOAD ADDRESS EXTENDED
- LOAD ADDRESS RELATIVE LONG
- MOVE LONG
- MOVE LONG EXTENDED
- MOVE LONG UNICODE
- MOVE STRING
- SEARCH STRING
- TRANSLATE EXTENDED
- TRANSLATE AND TEST
- TRANSLATE AND TEST EXTENDED
- TRANSLATE AND TEST REVERSE
- TRANSLATE AND TEST REVERSE EXTENDED
- TRANSLATE ONE TO ONE
- TRANSLATE ONE TO TWO
- TRANSLATE TWO TO ONE
- TRANSLATE TWO TO TWO
- UPDATE TREE

The instructions in the preceding list are sometimes called modal instructions.

2. Bits 0-31 of general registers are changed by two types of instructions. The first type is a modal instruction, as listed in the preceding note, when the instruction is executed in the 64-bit addressing mode. The second type is an instruction having, independent of the addressing mode, either a 64-bit result operand in a single general register or a 128-bit result operand in an even-odd general-register pair.

Most of the instructions of the second type are indicated by a "G," either alone or in "GF," in their mnemonics. The other instructions that change or may change bits 0-31 of a general register regardless of the current addressing mode are:

- AND IMMEDIATE (NIHF, NIHH, NIHL only)
- EXCLUSIVE OR IMMEDIATE (XIHF only)
- INSERT CHARACTERS UNDER MASK (ICMH only)
- INSERT IMMEDIATE (IIHF, IIHH, IIHL only)
- LOAD LOGICAL IMMEDIATE (LLIHF, LLIHH, LLIHL only)
- LOAD MULTIPLE DISJOINT
- LOAD MULTIPLE HIGH
- LOAD PAIR FROM QUADWORD

- OR IMMEDIATE (OIHF, OIHH, OIHL only)

All of the instructions of the second type are sometimes referred to as “G-type” instructions.

If a program is not executed in the 64-bit addressing mode and does not contain a G-type instruction, it cannot change bits 0-31 of any general register.

3. It is not intended or expected that old programs not containing G-type instructions will be able to be executed successfully in the 64-bit addressing mode. However, this may be possible, particularly if, by programming convention, bits 0-31 of the general registers are always all zeros when an old program is given control.

4. The following additional general instructions are available when the extended-translation facility 2 is installed:

- COMPARE LOGICAL LONG UNICODE
- MOVE LONG UNICODE
- PACK ASCII
- PACK UNICODE
- TRANSLATE ONE TO ONE
- TRANSLATE ONE TO TWO
- TRANSLATE TWO TO ONE
- TRANSLATE TWO TO TWO
- UNPACK ASCII
- UNPACK UNICODE

5. The long-displacement facility uses new instruction formats, named RSY, RXY, and SIY, to provide 20-bit signed displacements. In connection with the long-displacement facility, all previously existing general instructions of the RSE or RXE format are changed to be of format RSY or RXY, respectively, where the new formats differ from the old by using a previously unused byte, now named DH, in the instructions. When the long-displacement facility is installed, the displacement for an instruction operand address is formed by appending DH on the left of the previous displacement field, now named DL, of the instruction. When the long-displacement facility is not installed, eight zero bits are appended on the left of DL, and DH is ignored.

The following additional general instruction is available when the long-displacement facility is installed.

- LOAD BYTE

The following additional RSY-format versions of general instructions are available when the long-displacement facility is installed.

- COMPARE AND SWAP
- COMPARE DOUBLE AND SWAP
- COMPARE LOGICAL CHARACTERS UNDER MASK
- LOAD ACCESS MULTIPLE
- LOAD MULTIPLE
- STORE ACCESS MULTIPLE
- STORE CHARACTERS UNDER MASK
- STORE MULTIPLE

The following additional RXY-format versions of general instructions are available when the long-displacement facility is installed.

- ADD
- ADD HALFWORD
- ADD LOGICAL
- AND
- COMPARE
- COMPARE HALFWORD
- COMPARE LOGICAL
- CONVERT TO BINARY
- CONVERT TO DECIMAL
- EXCLUSIVE OR
- INSERT CHARACTER
- INSERT CHARACTER UNDER MASK
- LOAD
- LOAD ADDRESS
- LOAD HALFWORD
- MULTIPLY SINGLE
- OR
- STORE
- STORE CHARACTER
- STORE HALFWORD
- SUBTRACT
- SUBTRACT HALFWORD
- SUBTRACT LOGICAL

The following additional SIY-format versions of general instructions are available when the long-displacement facility is installed.

- AND
- COMPARE LOGICAL
- EXCLUSIVE OR
- MOVE
- OR
- TEST UNDER MASK

6. The following additional general instructions are available when the message-security assist is installed:

- CIPHER MESSAGE
- CIPHER MESSAGE WITH CHAINING
- COMPUTE INTERMEDIATE MESSAGE DIGEST
- COMPUTE LAST MESSAGE DIGEST
- COMPUTE MESSAGE AUTHENTICATION CODE

7. The following additional general instructions are available when the extended-translation facility 3 is installed:

- CONVERT UTF-16 TO UTF-32
- CONVERT UTF-32 TO UTF-16
- CONVERT UTF-32 TO UTF-8
- CONVERT UTF-8 TO UTF-32
- SEARCH STRING UNICODE
- TRANSLATE AND TEST REVERSE

Additionally, CONVERT UNICODE TO UTF-8 (CUUTF) and CONVERT UTF-8 TO UNICODE (CUTFU) are renamed to CONVERT UTF-16 TO UTF-8 (CU21) and CONVERT UTF-8 TO UTF-16 (CU12), respectively, in order to conform to the names used by this facility. The old names continue to be recognized.

8. The following additional general instructions are available when the extended-immediate facility is installed:

- ADD IMMEDIATE (AFI, AGFI)
- ADD LOGICAL IMMEDIATE (ALFI, ALGFI)
- AND IMMEDIATE (NIHF, NILF)
- COMPARE IMMEDIATE (CFI, CGFI)
- COMPARE LOGICAL IMMEDIATE (CLFI, CLGFI)
- EXCLUSIVE OR IMMEDIATE (XIHF, XILF)
- FIND LEFTMOST ONE (FLOGR)
- INSERT IMMEDIATE (IIHF, IILF)
- LOAD AND TEST (LT, LTG)
- LOAD BYTE (LBR, LGBR)
- LOAD HALFWORD (LHR, LGHR)
- LOAD IMMEDIATE (LGFI)
- LOAD LOGICAL CHARACTER (LLC, LLCR, LLGCR)
- LOAD LOGICAL HALFWORD (LLGHR, LLH, LLHR)
- LOAD LOGICAL IMMEDIATE (LLIHF, LLILF)
- OR IMMEDIATE (OIHF, OILF)
- SUBTRACT LOGICAL IMMEDIATE (SLFI, SLGFI)

The instructions that are part of the extended-immediate facility are indicated in Figure 7-1 by “EI.”

9. The STORE CLOCK FAST general instruction is available when the store-clock-fast facility is installed.

10. The STORE FACILITY LIST EXTENDED general instruction is available when the store-facility-list-extended facility is installed.

11. When the ETF2-enhancement facility is installed, new functions are provided for the TRANSLATE ONE TO ONE, TRANSLATE ONE TO TWO, TRANSLATE TWO TO ONE, and TRANSLATE TWO TO TWO instructions.

12. When the ETF3-enhancement facility is installed, improved well-formedness checking is provided for the CONVERT UTF-16 TO UTF-32, CONVERT UTF-16 TO UTF-8, CONVERT UTF-8 TO UTF-16, and CONVERT UTF-8 TO UTF-32 instructions.

13. The COMPARE AND SWAP AND STORE general instruction is available if the compare-and-swap-and-store facility is installed.

14. The EXTRACT CPU TIME general instruction is available if the extract-CPU-time facility is installed.

15. The following additional general instructions are available when the parsing-enhancement facility is installed:

- TRANSLATE AND TEST EXTENDED
- TRANSLATE AND TEST REVERSE EXTENDED

16. The EXECUTE RELATIVE LONG general instruction is available when the execute-extension facility is installed.

17. The following additional general instructions are available when the general-instructions-extension facility is installed:

- ADD IMMEDIATE (AGSI, ASI)
- ADD LOGICAL WITH SIGNED IMMEDIATE (ALGSI, ALSI)
- COMPARE AND BRANCH (CGRB, CRB)
- COMPARE AND BRANCH RELATIVE (CGRJ, CRJ)
- COMPARE AND TRAP (CGRT, CRT)
- COMPARE HALFWORD (CGH)
- COMPARE HALFWORD IMMEDIATE (CGHSI, CHHSI, CHSI)

- COMPARE HALFWORD RELATIVE LONG (CGHRL, CHRL)
 - COMPARE IMMEDIATE AND BRANCH (CGIB, CIB)
 - COMPARE IMMEDIATE AND BRANCH RELATIVE (CGIJ, CIJ)
 - COMPARE IMMEDIATE AND TRAP (CIT, CGIT)
 - COMPARE LOGICAL AND BRANCH (CLGRB, CLRB)
 - COMPARE LOGICAL AND BRANCH RELATIVE (CLGRJ, CLRJ)
 - COMPARE LOGICAL AND TRAP (CLGRT, CLRT)
 - COMPARE LOGICAL IMMEDIATE (CLFHSI, CLGHSI, CLHHSI)
 - COMPARE LOGICAL IMMEDIATE AND BRANCH (CLIB, CLGIB)
 - COMPARE LOGICAL IMMEDIATE AND BRANCH RELATIVE (CLGIJ, CLIJ)
 - COMPARE LOGICAL IMMEDIATE AND TRAP (CLFIT, CLGIT)
 - COMPARE LOGICAL RELATIVE LONG (CLGFRL, CLGHRL, CLGRL, CLHRL, CLRL)
 - COMPARE RELATIVE LONG (CGFRL, CGRL, CRL)
 - EXTRACT CPU ATTRIBUTE (ECAG)
 - LOAD ADDRESS EXTENDED (LAEY)
 - LOAD AND TEST (LTGF)
 - LOAD HALFWORD RELATIVE LONG (LGHRL, LHRL)
 - LOAD LOGICAL HALFWORD RELATIVE LONG (LLGHRL, LLHRL)
 - LOAD LOGICAL RELATIVE LONG (LLGFRL)
 - LOAD RELATIVE LONG (LGFRL, LGRL, LRL)
 - MOVE (MVHI, MVGHI, MVHHI)
 - MULTIPLY (MFY)
 - MULTIPLY HALFWORD (MHY)
 - MULTIPLY SINGLE IMMEDIATE (MSFI, MSGFI)
 - PREFETCH DATA (PFD)
 - PREFETCH DATA RELATIVE LONG (PFDRL)
 - ROTATE THEN AND SELECTED BITS (RNSBG)
 - ROTATE THEN EXCLUSIVE OR SELECTED BITS (RXSBG)
 - ROTATE THEN INSERT SELECTED BITS (RISBG)
 - ROTATE THEN OR SELECTED BITS (ROSBG)
 - STORE HALFWORD RELATIVE LONG (STHRL)
 - STORE RELATIVE LONG (STGRL, STRL)
18. The following additional general instructions are available when the high-word facility is installed:
- ADD HIGH (AHHHR, AHHLR)
 - ADD IMMEDIATE HIGH (AIH)
 - ADD LOGICAL HIGH (ALHHR, ALHLR)
 - ADD LOGICAL WITH SIGNED IMMEDIATE HIGH (ALSIH, ALSIHN)
 - BRANCH RELATIVE ON COUNT HIGH (BRCTH)
 - COMPARE HIGH (CHHR, CHLR, CHF)
 - COMPARE IMMEDIATE HIGH (CIH)
 - COMPARE LOGICAL HIGH (CLHHR, CLHLR, CLHF)
 - COMPARE LOGICAL IMMEDIATE HIGH (CLIH)
 - LOAD BYTE HIGH (LBH)
 - LOAD HALFWORD HIGH (LHH)
 - LOAD HIGH (LFH)
 - LOAD LOGICAL CHARACTER HIGH (LLCH)
 - LOAD LOGICAL HALFWORD HIGH (LLHH)
 - ROTATE THEN INSERT SELECTED BITS HIGH (RISBHG)
 - ROTATE THEN INSERT SELECTED BITS LOW (RISBLG)
 - STORE CHARACTER HIGH (STCH)
 - STORE HALFWORD HIGH (STHH)
 - STORE HIGH (STFH)
 - SUBTRACT HIGH (SHHHR, SHHLR)
 - SUBTRACT LOGICAL HIGH (SLHHR, SLHLR)
19. The following additional general instructions are available when the interlocked-access facility 1 is installed:
- LOAD AND ADD (LAA, LAAG)
 - LOAD AND ADD LOGICAL (LAAL, LAALG)
 - LOAD AND AND (LAN, LANG)
 - LOAD AND EXCLUSIVE OR (LAX, LAXG)
 - LOAD AND OR (LAO, LAOG)
 - LOAD PAIR DISJOINT (LPD, LPDG)
20. The following additional general instructions are available when the load/store-on-condition facility 1 is installed:
- LOAD ON CONDITION (LOC, LOCG, LOCGR, LOCR)
 - STORE ON CONDITION (STOC, STOCG)

21. The following additional general instructions are available when the distinct-operands facility is installed:
- ADD (ARK, AGRK)
 - ADD IMMEDIATE (AHIK, AGHIK)
 - ADD LOGICAL (ALRK, ALGRK)
 - ADD LOGICAL WITH SIGNED IMMEDIATE (ALHSIK, ALGHSIK)
 - AND (NRK, NGRK)
 - EXCLUSIVE OR (XRK, XGRK)
 - OR (ORK, OGRK)
 - SHIFT LEFT SINGLE (SLAK)
 - SHIFT LEFT SINGLE LOGICAL (SLLK)
 - SHIFT RIGHT SINGLE (SRAK)
 - SHIFT RIGHT SINGLE LOGICAL (SRLK)
 - SUBTRACT (SRK, SGRK)
 - SUBTRACT LOGICAL (SLRK, SLGRK)
22. The POPULATION COUNT general instruction is available when the population-count facility is installed.
23. The following additional general instructions are available when the message-security-assist extension 4 is installed:
- CIPHER MESSAGE WITH CIPHER FEED-BACK
 - CIPHER MESSAGE WITH COUNTER
 - CIPHER MESSAGE WITH OUTPUT FEED-BACK
 - PERFORM CRYPTOGRAPHIC COMPUTATION
24. The following additional general instructions are available when the execution-hint facility is installed:
- BRANCH PREDICTION PRELOAD (BPP)
 - BRANCH PREDICTION RELATIVE PRELOAD (BPRP)
 - NEXT INSTRUCTION ACCESS INTENT (NIAI)
25. The following additional general instructions are available when the load-and-trap facility is installed:
- LOAD AND TRAP (LAT and LGAT)
 - LOAD HIGH AND TRAP (LFHAT)
 - LOAD LOGICAL AND TRAP (LLGFAT)
 - LOAD LOGICAL THIRTY ONE BITS AND TRAP (LLGTAT)
26. The following additional general instructions are available when the miscellaneous-instruction-extensions facility 1 is installed:
- COMPARE LOGICAL AND TRAP (CLT, CLGT)
 - ROTATE THEN INSERT SELECTED BITS (RISBGN)
27. The following additional general instructions are available when the load-and-zero-rightmost-byte facility is installed:
- LOAD AND ZERO RIGHTMOST BYTE (LZRF, LZRG)
 - LOAD LOGICAL AND ZERO RIGHTMOST BYTE (LLZRGF)
28. The following additional general instructions are available when the load/store-on-condition facility 2 is installed:
- LOAD HALFWORD HIGH IMMEDIATE ON CONDITION (LOCHHI)
 - LOAD HALFWORD IMMEDIATE ON CONDITION (LOCHI, LOCGHI)
 - LOAD HIGH ON CONDITION (LOCFH, LOCFHR)
 - STORE HIGH ON CONDITION (STOCFH)
29. The PERFORM RANDOM NUMBER OPERATION general instruction is available when the message-security-assist extension 5 is installed:
30. The LOAD COUNT TO BLOCK BOUNDARY general instruction is available when the vector facility for z/Architecture is installed. Other instructions of the vector facility for z/Architecture are described in Chapters 21-24.
31. The following additional general instructions are available when the miscellaneous-instruction-extensions facility 2 is installed:
- ADD HALFWORD (AGH)
 - BRANCH INDIRECT ON CONDITION
 - MULTIPLY (MG, MGRK)
 - MULTIPLY HALFWORD (MGH)
 - MULTIPLY SINGLE (MSC, MSGC, MSGRKC, MSRKC)
 - SUBTRACT HALFWORD (SGH)

32. The following additional general instructions are available when the guarded-storage facility is installed:

- LOAD GUARDED (LGG)
- LOAD GUARDED STORAGE CONTROLS (LGSC)
- LOAD LOGICAL AND SHIFT GUARDED (LLGFSG)
- STORE GUARDED STORAGE CONTROLS (STGSC)

33. The CIPHER MESSAGE WITH AUTHENTICATION general instruction is available when the message-security-assist extension 8 is installed.

34. The following additional general instructions are available when the miscellaneous-instruction-extensions facility 3 is installed:

- AND WITH COMPLEMENT (NCRK, NCGRK)
- MOVE RIGHT TO LEFT

- NAND (NNRK, NNGRK)
- NOT EXCLUSIVE OR (NXRK, NXGRK)
- NOR (NORK, NOGRK)
- OR WITH COMPLEMENT (OCRK, OCGRK)
- SELECT (SELR, SELGR)
- SELECT HIGH (SELFHR)

In addition, POPULATION COUNT includes a control in an M_3 field for counting the number of one bits in each byte or the entire 64-bit register.

Figure 7-1 lists the instructions, mnemonics, characteristics, and operation codes of the general instructions. In the Characteristics columns of this figure, a facility code associated with the instruction may be indicated in the third column (immediately to the left of the first vertical ruling in the Characteristics columns). If the facility code is blank, E2, MS, or N3, then the instruction is supported in the ESA/390-compatibility mode, although not all operands or functions of the instruction may be valid.

Name	Mnemonic	Characteristics					Op-code	Page
ADD (32)	A	RX-a	C	A	IF	B ₂	5A	7-26
ADD (32)	AR	RR	C		IF		1A	7-25
ADD (32)	ARK	RRF-a	C DO		IF		B9F8	7-25
ADD (32)	AY	RXY-a	C LD	A	IF	B ₂	E35A	7-26
ADD (64)	AG	RXY-a	C N	A	IF	B ₂	E308	7-26
ADD (64)	AGR	RRE	C N		IF		B908	7-25
ADD (64)	AGRK	RRF-a	C DO		IF		B9E8	7-25
ADD (64←32)	AGF	RXY-a	C N	A	IF	B ₂	E318	7-26
ADD (64←32)	AGFR	RRE	C N		IF		B918	7-25
ADD HALFWORD (32←16)	AH	RX-a	C	A	IF	B ₂	4A	7-27
ADD HALFWORD (32←16)	AHY	RXY-a	C LD	A	IF	B ₂	E37A	7-27
ADD HALFWORD (64←16)	AGH	RXY-a	C MI2	A	IF	B ₂	E338	7-28
ADD HALFWORD IMMEDIATE (32←16)	AHI	RI-a	C		IF		A7A	7-28
ADD HALFWORD IMMEDIATE (64←16)	AGHI	RI-a	C N		IF		A7B	7-28
ADD HIGH (32)	AHHHR	RRF-a	C HW		IF		B9C8	7-28
ADD HIGH (32)	AHHLR	RRF-a	C HW		IF		B9D8	7-28
ADD IMMEDIATE (32)	AFI	RIL-a	C EI		IF		C29	7-26
ADD IMMEDIATE (32←16)	AHIK	RIE-d	C DO		IF		ECD8	7-26
ADD IMMEDIATE (32←8)	ASI	SIY	C GE	A	IF £ ¹	ST B ₁	EB6A	7-26
ADD IMMEDIATE (64←16)	AGHIK	RIE-d	C DO		IF		ECD9	7-26
ADD IMMEDIATE (64←32)	AGFI	RIL-a	C EI		IF		C28	7-26
ADD IMMEDIATE (64←8)	AGSI	SIY	C GE	A	IF £ ¹	ST B ₁	EB7A	7-26
ADD IMMEDIATE HIGH (32)	AIH	RIL-a	C HW		IF		CC8	7-29
ADD LOGICAL (32)	AL	RX-a	C	A		B ₂	5E	7-29
ADD LOGICAL (32)	ALR	RR	C				1E	7-29
ADD LOGICAL (32)	ALRK	RRF-a	C DO				B9FA	7-29
ADD LOGICAL (32)	ALY	RXY-a	C LD	A		B ₂	E35E	7-29
ADD LOGICAL (64)	ALG	RXY-a	C N	A		B ₂	E30A	7-29
ADD LOGICAL (64)	ALGR	RRE	C N				B90A	7-29
ADD LOGICAL (64)	ALGRK	RRF-a	C DO				B9EA	7-29
ADD LOGICAL (64←32)	ALGF	RXY-a	C N	A		B ₂	E31A	7-29
ADD LOGICAL (64←32)	ALGFR	RRE	C N				B91A	7-29
ADD LOGICAL HIGH (32)	ALHHHR	RRF-a	C HW				B9CA	7-30
ADD LOGICAL HIGH (32)	ALHHLR	RRF-a	C HW				B9DA	7-30

Figure 7-1. Summary of General Instructions (Part 1 of 13)

Name	Mnemonic	Characteristics						Op-code	Page	
ADD LOGICAL IMMEDIATE (32)	ALFI	RIL-a	C	EI				C2B	7-29	
ADD LOGICAL IMMEDIATE (64←32)	ALGFI	RIL-a	C	EI				C2A	7-29	
ADD LOGICAL WITH CARRY (32)	ALC	RXY-a	C	N3	A		B ₂	E398	7-30	
ADD LOGICAL WITH CARRY (32)	ALCR	RRE	C	N3				B998	7-30	
ADD LOGICAL WITH CARRY (64)	ALCG	RXY-a	C	N	A		B ₂	E388	7-30	
ADD LOGICAL WITH CARRY (64)	ALCGR	RRE	C	N				B988	7-30	
ADD LOGICAL WITH SIGNED IMMEDIATE (32←16)	ALHSIK	RIE-d	C	DO				ECDA	7-31	
ADD LOGICAL WITH SIGNED IMMEDIATE (32←8)	ALSI	SIY	C	GE	A	£ ¹	ST B ₁	EB6E	7-31	
ADD LOGICAL WITH SIGNED IMMEDIATE (64←16)	ALGHSIK	RIE-d	C	DO				ECDB	7-31	
ADD LOGICAL WITH SIGNED IMMEDIATE (64←8)	ALGSI	SIY	C	GE	A	£ ¹	ST B ₁	EB7E	7-31	
ADD LOGICAL WITH SIGNED IMMEDIATE HIGH (32)	ALSIH	RIL-a	C	HW				CCA	7-32	
ADD LOGICAL WITH SIGNED IMMEDIATE HIGH (32)	ALSIHN	RIL-a		HW				CCB	7-32	
AND (32)	N	RX-a	C		A		B ₂	54	7-32	
AND (32)	NR	RR	C					14	7-32	
AND (32)	NRK	RRF-a	C	DO				B9F4	7-32	
AND (32)	NY	RXY-a	C	LD	A		B ₂	E354	7-33	
AND (64)	NG	RXY-a	C	N	A		B ₂	E380	7-33	
AND (64)	NGR	RRE	C	N				B980	7-32	
AND (64)	NGRK	RRF-a	C	DO				B9E4	7-32	
AND (character)	NC	SS-a	C		a ⁹ A		ST B ₁ B ₂	D4	7-33	
AND (immediate)	NI	SI	C		A	£ ²	ST B ₁	94	7-33	
AND (immediate)	NIY	SIY	C	LD	A	£ ²	ST B ₁	EB54	7-33	
AND IMMEDIATE (high high)	NIHH	RI-a	C	N				A54	7-34	
AND IMMEDIATE (high low)	NIHL	RI-a	C	N				A55	7-34	
AND IMMEDIATE (high)	NIHF	RIL-a	C	EI				C0A	7-34	
AND IMMEDIATE (low high)	NILH	RI-a	C	N				A56	7-34	
AND IMMEDIATE (low low)	NILL	RI-a	C	N				A57	7-34	
AND IMMEDIATE (low)	NILF	RIL-a	C	EI				C0B	7-34	
AND WITH COMPLEMENT (32)	NCRK	RRF-a	C	MI3				B9F5	7-34	
AND WITH COMPLEMENT (64)	NCGRK	RRF-a	C	MI3				B9E5	7-34	
BRANCH AND LINK	BAL	RX-a			a ⁹		B	45	7-35	
BRANCH AND LINK	BALR	RR			a ^{2,9}	T	B	05	7-35	
BRANCH AND SAVE	BAS	RX-a			a ⁹		B	4D	7-36	
BRANCH AND SAVE	BASR	RR			a ^{2,9}	T	B	0D	7-36	
BRANCH AND SAVE AND SET MODE	BASSM	RR			a ^{2,3,9}	T	B	0C	7-36	
BRANCH AND SET MODE	BSM	RR			a ^{3,9}	T	B	0B	7-37	
BRANCH INDIRECT ON CONDITION	BIC	RXY-b		MI2	a ⁹ A		B	B ₂	E347	7-38
BRANCH ON CONDITION	BC	RX-b			a ⁹		B	47	7-39	
BRANCH ON CONDITION	BCR	RR			a ⁹	£ ¹	B	07	7-39	
BRANCH ON COUNT (32)	BCT	RX-a			a ⁹		B	46	7-40	
BRANCH ON COUNT (32)	BCTR	RR			a ⁹		B	06	7-40	
BRANCH ON COUNT (64)	BCTG	RXY-a		N	a ⁹		B	E346	7-40	
BRANCH ON COUNT (64)	BCTGR	RRE		N	a ⁹		B	B946	7-40	
BRANCH ON INDEX HIGH (32)	BXH	RS-a			a ⁹		B	86	7-41	
BRANCH ON INDEX HIGH (64)	BXHG	RSY-a		N	a ⁹		B	EB44	7-41	
BRANCH ON INDEX LOW OR EQUAL (32)	BXLE	RS-a			a ⁹		B	87	7-41	
BRANCH ON INDEX LOW OR EQUAL (64)	BXLEG	RSY-a		N	a ⁹		B	EB45	7-41	
BRANCH PREDICTION PRELOAD	BPP	SMI		EH	a ⁹			C7	7-42	
BRANCH PREDICTION RELATIVE PRELOAD	BPRP	MII		EH	a ⁹			C5	7-42	
BRANCH RELATIVE AND SAVE	BRAS	RI-b			a ⁹		B	A75	7-45	
BRANCH RELATIVE AND SAVE LONG	BRASL	RIL-b		N3	a ⁹		B	C05	7-45	
BRANCH RELATIVE ON CONDITION	BRC	RI-c			a ¹⁰		B	A74	7-46	
BRANCH RELATIVE ON CONDITION LONG	BRCL	RIL-c		N3	a ¹⁰		B	C04	7-46	
BRANCH RELATIVE ON COUNT (32)	BRCT	RI-b			a ⁹		B	A76	7-47	
BRANCH RELATIVE ON COUNT (64)	BRCTG	RI-b		N	a ⁹		B	A77	7-47	
BRANCH RELATIVE ON COUNT HIGH (32)	BRCTH	RIL-b		HW	a ⁹		B	CC6	7-47	
BRANCH RELATIVE ON INDEX HIGH (32)	BRXH	RSI			a ⁹		B	84	7-47	
BRANCH RELATIVE ON INDEX HIGH (64)	BRXHG	RIE-e		N	a ⁹		B	EC44	7-47	
BRANCH RELATIVE ON INDEX LOW OR EQ. (32)	BRXLE	RSI			a ⁹		B	85	7-47	

Figure 7-1. Summary of General Instructions (Part 2 of 13)

Name	Mnemonic	Characteristics										Op-code	Page		
BRANCH RELATIVE ON INDEX LOW OR EQ. (64)	BRXLG	RIE-e	N	α^9								B		EC45	7-48
CHECKSUM	CKSM	RRE	C	α^9	A	SP	IC						R_2	B241	7-49
CIPHER MESSAGE	KM	RRE	C	MS	$\alpha^{5,9}$	A	SP	IC	GM	I1		ST	R_1, R_2	B92E	7-52
CIPHER MESSAGE WITH AUTHENTICATION	KMA	RRF-b	C	M8	$\alpha^{5,9}$	A	SP	IC	GM	I1		ST	R_1, R_2, R_3	B929	7-77
CIPHER MESSAGE WITH CHAINING	KMC	RRE	C	MS	$\alpha^{5,9}$	A	SP	IC	GM	I1		ST	R_1, R_2	B92F	7-52
CIPHER MESSAGE WITH CIPHER FEEDBACK	KMF	RRE	C	M4	$\alpha^{5,9}$	A	SP	IC	GM	I1		ST	R_1, R_2	B92A	7-91
CIPHER MESSAGE WITH COUNTER	KMCTR	RRF-b	C	M4	$\alpha^{5,9}$	A	SP	IC	GM	I1		ST	R_1, R_2, R_3	B92D	7-106
CIPHER MESSAGE WITH OUTPUT FEEDBACK	KMO	RRE	C	M4	$\alpha^{5,9}$	A	SP	IC	GM	I1		ST	R_1, R_2	B92B	7-119
COMPARE (32)	C	RX-a	C			A							B_2	59	7-133
COMPARE (32)	CR	RR	C											19	7-133
COMPARE (32)	CY	RXY-a	C	LD		A							B_2	E359	7-133
COMPARE (64)	CG	RXY-a	C	N		A							B_2	E320	7-133
COMPARE (64)	CGR	RRE	C	N										B920	7-133
COMPARE (64←32)	CGF	RXY-a	C	N		A							B_2	E330	7-133
COMPARE (64←32)	CGFR	RRE	C	N										B930	7-133
COMPARE AND BRANCH (32)	CRB	RRS	GE	α^9								B		ECF6	7-134
COMPARE AND BRANCH (64)	CGRB	RRS	GE	α^9								B		ECE4	7-134
COMPARE AND BRANCH RELATIVE (32)	CRJ	RIE-b	GE	α^{10}								B		EC76	7-134
COMPARE AND BRANCH RELATIVE (64)	CGRJ	RIE-b	GE	α^{10}								B		EC64	7-135
COMPARE AND FORM CODEWORD	CFC	S	C		α^9	A	SP	II		GM	I1			B21A	7-136
COMPARE AND SWAP (32)	CS	RS-a	C		α^9	A	SP		\$			ST	B_2	BA	7-143
COMPARE AND SWAP (32)	CSY	RSY-a	C	LD	α^9	A	SP		\$			ST	B_2	EB14	7-143
COMPARE AND SWAP (64)	CSG	RSY-a	C	N	α^9	A	SP		\$			ST	B_2	EB30	7-143
COMPARE AND SWAP AND STORE	CSST	SSF	C	CS	α^1	A	SP		\$	GM		ST	B_1, B_2	C82	7-145
COMPARE AND TRAP (32)	CRT	RRF-c	GE						Dc					B972	7-148
COMPARE AND TRAP (64)	CGRT	RRF-c	GE						Dc					B960	7-148
COMPARE DOUBLE AND SWAP (32)	CDS	RS-a	C		α^9	A	SP		\$			ST	B_2	BB	7-143
COMPARE DOUBLE AND SWAP (32)	CDSY	RSY-a	C	LD	α^9	A	SP		\$			ST	B_2	EB31	7-143
COMPARE DOUBLE AND SWAP (64)	CDSG	RSY-a	C	N	α^9	A	SP		\$			ST	B_2	EB3E	7-143
COMPARE HALFWORD (32←16)	CH	RX-a	C			A							B_2	49	7-149
COMPARE HALFWORD (32←16)	CHY	RXY-a	C	LD		A							B_2	E379	7-149
COMPARE HALFWORD (64←16)	CGH	RXY-a	C	GE		A							B_2	E334	7-149
COMPARE HALFWORD IMMEDIATE (16←16)	CHHSI	SIL	C	GE		A							B_1	E554	7-149
COMPARE HALFWORD IMMEDIATE (32←16)	CHI	RI-a	C											A7E	7-149
COMPARE HALFWORD IMMEDIATE (32←16)	CHSI	SIL	C	GE		A							B_1	E55C	7-149
COMPARE HALFWORD IMMEDIATE (64←16)	CGHI	RI-a	C	N										A7F	7-149
COMPARE HALFWORD IMMEDIATE (64←16)	CGHSI	SIL	C	GE		A							B_1	E558	7-149
COMPARE HALFWORD RELATIVE LONG (32←16)	CHRL	RIL-b	C	GE		A*								C65	7-149
COMPARE HALFWORD RELATIVE LONG (64←16)	CGHRL	RIL-b	C	GE		A*								C64	7-149
COMPARE HIGH (32)	CHF	RXY-a	C	HW		A							B_2	E3CD	7-150
COMPARE HIGH (32)	CHHR	RRE	C	HW										B9CD	7-150
COMPARE HIGH (32)	CHLR	RRE	C	HW										B9DD	7-150
COMPARE IMMEDIATE (32)	CFI	RIL-a	C	EI										C2D	7-133
COMPARE IMMEDIATE (64←32)	CGFI	RIL-a	C	EI										C2C	7-134
COMPARE IMMEDIATE AND BRANCH (32←8)	CIB	RIS	GE	α^9								B		ECFE	7-135
COMPARE IMMEDIATE AND BRANCH (64←8)	CGIB	RIS	GE	α^9								B		ECFC	7-135
COMPARE IMMEDIATE AND BRANCH RELATIVE (32←8)	CIJ	RIE-c	GE	α^{10}								B		EC7E	7-135
COMPARE IMMEDIATE AND BRANCH RELATIVE (64←8)	CGIJ	RIE-c	GE	α^{10}								B		EC7C	7-135
COMPARE IMMEDIATE AND TRAP (32←16)	CIT	RIE-a	GE						Dc					EC72	7-148
COMPARE IMMEDIATE AND TRAP (64←16)	CGIT	RIE-a	GE						Dc					EC70	7-148
COMPARE IMMEDIATE HIGH (32)	CIH	RIL-a	C	HW										CCD	7-150
COMPARE LOGICAL (32)	CL	RX-a	C			A							B_2	55	7-151
COMPARE LOGICAL (32)	CLR	RR	C											15	7-151
COMPARE LOGICAL (32)	CLY	RXY-a	C	LD		A							B_2	E355	7-151
COMPARE LOGICAL (64)	CLG	RXY-a	C	N		A							B_2	E321	7-151
COMPARE LOGICAL (64)	CLGR	RRE	C	N										B921	7-151
COMPARE LOGICAL (64←32)	CLGF	RXY-a	C	N		A							B_2	E331	7-151
COMPARE LOGICAL (64←32)	CLGFR	RRE	C	N										B931	7-151
COMPARE LOGICAL (character)	CLC	SS-a	C		α^9	A							B_1, B_2	D5	7-151

Figure 7-1. Summary of General Instructions (Part 3 of 13)

Name	Mnemonic	Characteristics										Op-code	Page		
COMPARE LOGICAL (immediate)	CLI	SI	C		A							B ₁	95	7-151	
COMPARE LOGICAL (immediate)	CLII	SIY	C	LD	A							B ₁	EB55	7-151	
COMPARE LOGICAL AND BRANCH (32)	CLRB	RRS		GE	a ⁹						B		ECF7	7-153	
COMPARE LOGICAL AND BRANCH (64)	CLGRB	RRS		GE	a ⁹						B		ECE5	7-153	
COMPARE LOGICAL AND BRANCH RELATIVE (32)	CLRJ	RIE-b		GE	a ¹⁰						B		EC77	7-153	
COMPARE LOGICAL AND BRANCH RELATIVE (64)	CLGRJ	RIE-b		GE	a ¹⁰						B		EC65	7-153	
COMPARE LOGICAL AND TRAP (32)	CLRT	RRF-c		GE						Dc			B973	7-154	
COMPARE LOGICAL AND TRAP (32)	CLT	RSY-b	MI1		A					Dc		B ₂	EB23	7-154	
COMPARE LOGICAL AND TRAP (64)	CLGRT	RRF-c		GE						Dc			B961	7-154	
COMPARE LOGICAL AND TRAP (64)	CLGT	RSY-b	MI1		A					Dc		B ₂	EB2B	7-154	
COMPARE LOGICAL CHAR. UNDER MASK (high)	CLMH	RSY-b	C	N	A							B ₂	EB20	7-156	
COMPARE LOGICAL CHAR. UNDER MASK (low)	CLM	RS-b	C		A							B ₂	BD	7-156	
COMPARE LOGICAL CHAR. UNDER MASK (low)	CLMY	RSY-b	C	LD	A							B ₂	EB21	7-156	
COMPARE LOGICAL HIGH (32)	CLHF	RXY-a	C	HW	A							B ₂	E3CF	7-156	
COMPARE LOGICAL HIGH (32)	CLHHR	RRE	C	HW									B9CF	7-156	
COMPARE LOGICAL HIGH (32)	CLHLR	RRE	C	HW									B9DF	7-156	
COMPARE LOGICAL IMMEDIATE (16←16)	CLHHSI	SIL	C	GE	A						B ₁		E555	7-151	
COMPARE LOGICAL IMMEDIATE (32)	CLFI	RIL-a	C	EI									C2F	7-151	
COMPARE LOGICAL IMMEDIATE (32←16)	CLFHSI	SIL	C	GE	A						B ₁		E55D	7-151	
COMPARE LOGICAL IMMEDIATE (64←16)	CLGHSI	SIL	C	GE	A						B ₁		E559	7-151	
COMPARE LOGICAL IMMEDIATE (64←32)	CLGFI	RIL-a	C	EI									C2E	7-151	
COMPARE LOGICAL IMMEDIATE AND BRANCH (32←8)	CLIB	RIS		GE	a ⁹						B		ECFF	7-153	
COMPARE LOGICAL IMMEDIATE AND BRANCH (64←8)	CLGIB	RIS		GE	a ⁹						B		ECFD	7-153	
COMPARE LOGICAL IMMEDIATE AND BRANCH RELATIVE (32←8)	CLIJ	RIE-c		GE	a ¹⁰						B		EC7F	7-153	
COMPARE LOGICAL IMMEDIATE AND BRANCH RELATIVE (64←8)	CLGIJ	RIE-c		GE	a ¹⁰						B		EC7D	7-153	
COMPARE LOGICAL IMMEDIATE AND TRAP (32←16)	CLFIT	RIE-a		GE						Dc			EC73	7-155	
COMPARE LOGICAL IMMEDIATE AND TRAP (64←16)	CLGIT	RIE-a		GE						Dc			EC71	7-155	
COMPARE LOGICAL IMMEDIATE HIGH (32)	CLIH	RIL-a	C	HW									CCF	7-157	
COMPARE LOGICAL LONG	CLCL	RR	C		a ⁹	A	SP	II				R ₁ R ₂	0F	7-157	
COMPARE LOGICAL LONG EXTENDED	CLCLE	RS-a	C		a ⁹	A	SP	IC				R ₁ R ₃	A9	7-159	
COMPARE LOGICAL LONG UNICODE	CLCLU	RSY-a	C	E2	a ⁹	A	SP	IC				R ₁ R ₂	EB8F	7-162	
COMPARE LOGICAL RELATIVE LONG (32)	CLRL	RIL-b	C	GE		A*	SP						C6F	7-152	
COMPARE LOGICAL RELATIVE LONG (32←16)	CLHRL	RIL-b	C	GE		A*							C67	7-152	
COMPARE LOGICAL RELATIVE LONG (64)	CLGRL	RIL-b	C	GE		A*	SP						C6A	7-152	
COMPARE LOGICAL RELATIVE LONG (64←16)	CLGHRL	RIL-b	C	GE		A*							C66	7-152	
COMPARE LOGICAL RELATIVE LONG (64←32)	CLGFRL	RIL-b	C	GE		A*	SP						C6E	7-152	
COMPARE LOGICAL STRING	CLST	RRE	C		a ⁹	A	SP	IC	G0			R ₁ R ₂	B25D	7-165	
COMPARE RELATIVE LONG (32)	CRL	RIL-b	C	GE		A*	SP						C6D	7-134	
COMPARE RELATIVE LONG (64)	CGRL	RIL-b	C	GE		A*	SP						C68	7-134	
COMPARE RELATIVE LONG (64←32)	CGFRL	RIL-b	C	GE		A*	SP						C6C	7-134	
COMPARE UNTIL SUBSTRING EQUAL	CUSE	RRE	C		a ⁹	A	SP	II	GM			R ₁ R ₂	B257	7-166	
COMPRESSION CALL	CMPSC	RRE	C		a ^{5,9}	A	SP	II	Dg	GM		ST	R ₁ R ₂	B263	7-169
COMPUTE INTERMEDIATE MESSAGE DIGEST	KIMD	RRE	C	MS	a ^{5,9}	A	SP	IC	GM	I1		ST	R ₁ R ₂	B93E	7-187
COMPUTE LAST MESSAGE DIGEST	KLMD	RRE	C	MS	a ^{5,9}	A	SP	IC	GM	I1		ST	R ₂	B93F	7-200
COMPUTE MESSAGE AUTHENTICATION CODE	KMAC	RRE	C	MS	a ^{5,9}	A	SP	IC	GM	I1		ST	R ₂	B91E	7-218
CONVERT TO BINARY (32)	CVB	RX-a			a ⁹	A			Dg	IK			B ₂	4F	7-229
CONVERT TO BINARY (32)	CVBY	RXY-a		LD	a ⁹	A			Dg	IK			B ₂	E306	7-229
CONVERT TO BINARY (64)	CVBG	RXY-a		N	a ⁹	A			Dg	IK			B ₂	E30E	7-229
CONVERT TO DECIMAL (32)	CVD	RX-a			a ⁹	A						ST	B ₂	4E	7-230
CONVERT TO DECIMAL (32)	CVDY	RXY-a		LD	a ⁹	A						ST	B ₂	E326	7-230
CONVERT TO DECIMAL (64)	CVDG	RXY-a		N	a ⁹	A						ST	B ₂	E32E	7-230
CONVERT UNICODE TO UTF-8	CUUTF	RRF-c	C		a ^{5,9}	A	SP	IC				ST	R ₁ R ₂	B2A6	7-233
CONVERT UTF-16 TO UTF-32	CU24	RRF-c	C	E3	a ^{5,9}	A	SP	IC				ST	R ₁ R ₂	B9B1	7-230
CONVERT UTF-16 TO UTF-8	CU21	RRF-c	C		a ^{5,9}	A	SP	IC				ST	R ₁ R ₂	B2A6	7-233
CONVERT UTF-32 TO UTF-16	CU42	RRE	C	E3	a ^{5,9}	A	SP	IC				ST	R ₁ R ₂	B9B3	7-237

Figure 7-1. Summary of General Instructions (Part 4 of 13)

Name	Mnemonic	Characteristics										Op-code	Page	
CONVERT UTF-32 TO UTF-8	CU41	RRE	C	E3	$\alpha^{3,9}$	A	SP	IC		ST	R ₁	R ₂	B9B2	7-240
CONVERT UTF-8 TO UNICODE	CUTFU	RRF-c	C		$\alpha^{5,9}$	A	SP	IC		ST	R ₁	R ₂	B2A7	7-243
CONVERT UTF-8 TO UTF-16	CU12	RRF-c	C		$\alpha^{5,9}$	A	SP	IC		ST	R ₁	R ₂	B2A7	7-243
CONVERT UTF-8 TO UTF-32	CU14	RRF-c	C	E3	$\alpha^{3,9}$	A	SP	IC		ST	R ₁	R ₂	B9B0	7-247
COPY ACCESS	CPYA	RRE			α^6						U ₁	U ₂	B24D	7-251
DIVIDE (32←64)	D	RX-a			α^9	A	SP	IK				B ₂	5D	7-251
DIVIDE (32←64)	DR	RR			α^9		SP	IK					1D	7-251
DIVIDE LOGICAL (32←64)	DL	RXY-a		N3	α^9	A	SP	IK				B ₂	E397	7-252
DIVIDE LOGICAL (32←64)	DLR	RRE		N3	α^9		SP	IK					B997	7-252
DIVIDE LOGICAL (64←128)	DLG	RXY-a		N	α^9	A	SP	IK				B ₂	E387	7-252
DIVIDE LOGICAL (64←128)	DLGR	RRE		N	α^9		SP	IK					B987	7-252
DIVIDE SINGLE (64)	DSG	RXY-a		N	α^9	A	SP	IK				B ₂	E30D	7-253
DIVIDE SINGLE (64)	DSGR	RRE		N	α^9		SP	IK					B90D	7-253
DIVIDE SINGLE (64←32)	DSGF	RXY-a		N	α^9	A	SP	IK				B ₂	E31D	7-253
DIVIDE SINGLE (64←32)	DSGFR	RRE		N	α^9		SP	IK					B91D	7-253
EXCLUSIVE OR (32)	X	RX-a	C			A						B ₂	57	7-253
EXCLUSIVE OR (32)	XR	RR	C										17	7-253
EXCLUSIVE OR (32)	XRK	RRF-a	C	DO									B9F7	7-253
EXCLUSIVE OR (32)	XY	RXY-a	C	LD		A						B ₂	E357	7-253
EXCLUSIVE OR (64)	XG	RXY-a	C	N		A						B ₂	E382	7-253
EXCLUSIVE OR (64)	XGR	RRE	C	N									B982	7-253
EXCLUSIVE OR (64)	XGRK	RRF-a	C	DO									B9E7	7-253
EXCLUSIVE OR (character)	XC	SS-a	C		α^9	A				ST	B ₁	B ₂	D7	7-254
EXCLUSIVE OR (immediate)	XI	SI	C			A		ϵ^2		ST	B ₁		97	7-254
EXCLUSIVE OR (immediate)	XIY	SIY	C	LD		A		ϵ^2		ST	B ₁		EB57	7-254
EXCLUSIVE OR IMMEDIATE (high)	XIHF	RIL-a	C	EI									C06	7-255
EXCLUSIVE OR IMMEDIATE (low)	XILF	RIL-a	C	EI									C07	7-255
EXECUTE	EX	RX-a			α^9	AI	SP	EX					44	7-255
EXECUTE RELATIVE LONG	EXRL	RIL-b		XX	α^9	AI*		EX					C60	7-255
EXTRACT ACCESS	EAR	RRE										U ₂	B24F	7-256
EXTRACT CPU ATTRIBUTE	ECAG	RSY-a		GE	α^9								EB4C	7-256
EXTRACT CPU TIME	ECTG	SSF		ET	$\alpha^{8,9}$	A		GM		R ₃	B ₁	B ₂	C81	7-259
EXTRACT PSW	EPSW	RRE		N3	$\alpha^{8,9}$								B98D	7-260
EXTRACT TRANSACTION NESTING DEPTH	ETND	RRE		TX	α^9			SO					B2EC	7-260
FIND LEFTMOST ONE	FLOGR	RRE	C	EI			SP						B983	7-261
INSERT CHARACTER	IC	RX-a				A						B ₂	43	7-261
INSERT CHARACTER	ICY	RXY-a		LD		A						B ₂	E373	7-261
INSERT CHARACTERS UNDER MASK (high)	ICMH	RSY-b	C	N		A						B ₂	EB80	7-261
INSERT CHARACTERS UNDER MASK (low)	ICM	RS-b	C			A						B ₂	BF	7-261
INSERT CHARACTERS UNDER MASK (low)	ICMY	RSY-b	C	LD		A						B ₂	EB81	7-261
INSERT IMMEDIATE (high high)	IIHH	RI-a		N									A50	7-262
INSERT IMMEDIATE (high low)	IIHL	RI-a		N									A51	7-262
INSERT IMMEDIATE (high)	IIHF	RIL-a		EI									C08	7-262
INSERT IMMEDIATE (low high)	II LH	RI-a		N									A52	7-262
INSERT IMMEDIATE (low low)	II LL	RI-a		N									A53	7-262
INSERT IMMEDIATE (low)	II LF	RIL-a		EI									C09	7-262
INSERT PROGRAM MASK	IPM	RRE											B222	7-263
LOAD (32)	L	RX-a				A						B ₂	58	7-263
LOAD (32)	LR	RR											18	7-263
LOAD (32)	LY	RXY-a		LD		A						B ₂	E358	7-263
LOAD (64)	LG	RXY-a		N		A						B ₂	E304	7-263
LOAD (64)	LGR	RRE		N									B904	7-263
LOAD (64←32)	LGF	RXY-a		N		A						B ₂	E314	7-263
LOAD (64←32)	LGFR	RRE		N									B914	7-263
LOAD ACCESS MULTIPLE	LAM	RS-a			α^6	A	SP					UB	9A	7-264
LOAD ACCESS MULTIPLE	LAMY	RSY-a		LD	α^6	A	SP					UB	EB9A	7-264
LOAD ADDRESS	LA	RX-a											41	7-265
LOAD ADDRESS	LAY	RXY-a		LD									E371	7-265
LOAD ADDRESS EXTENDED	LAE	RX-a			α^6						U ₁	BP	51	7-265
LOAD ADDRESS EXTENDED	LAEY	RXY-a		GE	α^6					U ₁	BP		E375	7-265
LOAD ADDRESS RELATIVE LONG	LARL	RIL-b		N3									C00	7-266

Figure 7-1. Summary of General Instructions (Part 5 of 13)

Name	Mnemonic	Characteristics										Op-code	Page		
LOAD AND ADD (32)	LAA	RSY-a	C	IA	α^9	A	SP	IF	£		ST	B_2	EBF8	7-267	
LOAD AND ADD (64)	LAAG	RSY-a	C	IA	α^9	A	SP	IF	£		ST	B_2	EBE8	7-267	
LOAD AND ADD LOGICAL (32)	LAAL	RSY-a	C	IA	α^9	A	SP	£			ST	B_2	EBFA	7-267	
LOAD AND ADD LOGICAL (64)	LAALG	RSY-a	C	IA	α^9	A	SP	£			ST	B_2	EBEA	7-267	
LOAD AND AND (32)	LAN	RSY-a	C	IA	α^9	A	SP	£			ST	B_2	EBF4	7-268	
LOAD AND AND (64)	LANG	RSY-a	C	IA	α^9	A	SP	£			ST	B_2	EBE4	7-268	
LOAD AND EXCLUSIVE OR (32)	LAX	RSY-a	C	IA	α^9	A	SP	£			ST	B_2	EBF7	7-268	
LOAD AND EXCLUSIVE OR (64)	LAXG	RSY-a	C	IA	α^9	A	SP	£			ST	B_2	EBE7	7-268	
LOAD AND OR (32)	LAO	RSY-a	C	IA	α^9	A	SP	£			ST	B_2	EBF6	7-269	
LOAD AND OR (64)	LAOG	RSY-a	C	IA	α^9	A	SP	£			ST	B_2	EBE6	7-269	
LOAD AND TEST (32)	LT	RXY-a	C	EI		A						B_2	E312	7-270	
LOAD AND TEST (32)	LTR	RR		C									12	7-269	
LOAD AND TEST (64)	LTG	RXY-a	C	EI		A						B_2	E302	7-270	
LOAD AND TEST (64)	LTGR	RRE		C	N								B902	7-269	
LOAD AND TEST (64←32)	LTGF	RXY-a	C	GE		A						B_2	E332	7-270	
LOAD AND TEST (64←32)	LTGFR	RRE		C	N								B912	7-269	
LOAD AND TRAP (32)	LAT	RXY-a		LT		A		Dc				B_2	E39F	7-270	
LOAD AND TRAP (64)	LGAT	RXY-a		LT		A		Dc				B_2	E385	7-270	
LOAD AND ZERO RIGHTMOST BYTE (32)	LZRF	RXY-a		LZ		A						B_2	E33B	7-270	
LOAD AND ZERO RIGHTMOST BYTE (64)	LZRG	RXY-a		LZ		A						B_2	E32A	7-270	
LOAD BYTE (32←8)	LB	RXY-a		LD		A							E376	7-271	
LOAD BYTE (32←8)	LBR	RRE		EI									B926	7-271	
LOAD BYTE (64←8)	LGB	RXY-a		LD		A							E377	7-271	
LOAD BYTE (64←8)	LGBR	RRE		EI									B906	7-271	
LOAD BYTE HIGH (32←8)	LBH	RXY-a		HW		A						B_2	E3C0	7-271	
LOAD COMPLEMENT (32)	LCR	RR		C				IF					13	7-271	
LOAD COMPLEMENT (64)	LCGR	RRE		C	N			IF					B903	7-272	
LOAD COMPLEMENT (64←32)	LCGFR	RRE		C	N								B913	7-272	
LOAD COUNT TO BLOCK BOUNDARY	LCBB	RXE		C	VF		SP						E727	7-272	
LOAD GUARDED (64)	LGG	RXY-a		GF	α^{12}	A	SP				B	ST	B_2	E34C	7-273
LOAD GUARDED STORAGE CONTROLS	LGSC	RXY-a		GF	α^1	A		SO				B_2	E34D	7-274	
LOAD HALFWORD (32←16)	LH	RX-a				A						B_2	48	7-275	
LOAD HALFWORD (32←16)	LHR	RRE		EI									B927	7-275	
LOAD HALFWORD (32←16)	LHY	RXY-a		LD		A						B_2	E378	7-275	
LOAD HALFWORD (64←16)	LGH	RXY-a		N		A						B_2	E315	7-275	
LOAD HALFWORD (64←16)	LGHR	RRE		EI									B907	7-275	
LOAD HALFWORD HIGH (32←16)	LHH	RXY-a		HW		A						B_2	E3C4	7-276	
LOAD HALFWORD HIGH IMMEDIATE ON CONDITION (32←16)	LOCHHI	RIE-g		L2									EC4E	7-276	
LOAD HALFWORD IMMEDIATE (32←16)	LHI	RI-a											A78	7-275	
LOAD HALFWORD IMMEDIATE (64←16)	LGHI	RI-a		N									A79	7-275	
LOAD HALFWORD IMMEDIATE ON CONDITION (32←16)	LOCHI	RIE-g		L2									EC42	7-276	
LOAD HALFWORD IMMEDIATE ON CONDITION (64←16)	LOGHI	RIE-g		L2									EC46	7-276	
LOAD HALFWORD RELATIVE LONG (32←16)	LHRL	RIL-b		GE		A*							C45	7-275	
LOAD HALFWORD RELATIVE LONG (64←16)	LGHRL	RIL-b		GE		A*							C44	7-275	
LOAD HIGH (32)	LFH	RXY-a		HW		A						B_2	E3CA	7-277	
LOAD HIGH AND TRAP (32)	LFHAT	RXY-a		LT		A		Dc				B_2	E3C8	7-277	
LOAD HIGH ON CONDITION (32)	LOCFH	RSY-b		L2								B_2	EBE0	7-283	
LOAD HIGH ON CONDITION (32)	LOCFHR	RRF-c		L2									B9E0	7-283	
LOAD IMMEDIATE (64←32)	LGFI	RIL-a		EI									C01	7-263	
LOAD LOGICAL (64←32)	LLGF	RXY-a		N		A						B_2	E316	7-277	
LOAD LOGICAL (64←32)	LLGFR	RRE		N									B916	7-277	
LOAD LOGICAL AND TRAP (64←32)	LLGFAT	RXY-a		LT		A		Dc				B_2	E39D	7-278	
LOAD LOGICAL AND ZERO RIGHTMOST BYTE (64←32)	LLZRGF	RXY-a		LZ		A						B_2	E33A	7-278	
LOAD LOGICAL AND SHIFT GUARDED (64←32)	LLGFSG	RXY-a		GF	α^{12}	A	SP				B	ST	B_2	E348	7-273
LOAD LOGICAL CHARACTER (32←8)	LLC	RXY-a		EI		A						B_2	E394	7-278	
LOAD LOGICAL CHARACTER (32←8)	LLCR	RRE		EI									B994	7-278	
LOAD LOGICAL CHARACTER (64←8)	LLGC	RXY-a		N		A						B_2	E390	7-278	

Figure 7-1. Summary of General Instructions (Part 6 of 13)

Name	Mnemonic	Characteristics						Op-code	Page	
LOAD LOGICAL CHARACTER (64←8)	LLGCR	RRE	EI				B ₂	B984	7-278	
LOAD LOGICAL CHARACTER HIGH (32←8)	LLCH	RXY-a	HW	A			B ₂	E3C2	7-279	
LOAD LOGICAL HALFWORD (32←16)	LLH	RXY-a	EI	A			B ₂	E395	7-279	
LOAD LOGICAL HALFWORD (32←16)	LLHR	RRE	EI					B995	7-279	
LOAD LOGICAL HALFWORD (64←16)	LLGH	RXY-a	N	A			B ₂	E391	7-279	
LOAD LOGICAL HALFWORD (64←16)	LLGHR	RRE	EI					B985	7-279	
LOAD LOGICAL HALFWORD HIGH (32←16)	LLHH	RXY-a	HW	A			B ₂	E3C6	7-280	
LOAD LOGICAL HALFWORD RELATIVE LONG (32←16)	LLHRL	RIL-b	GE	A*				C42	7-279	
LOAD LOGICAL HALFWORD RELATIVE LONG (64←16)	LLGHRL	RIL-b	GE	A*				C46	7-279	
LOAD LOGICAL IMMEDIATE (high high)	LLIHH	RI-a	N					A5C	7-280	
LOAD LOGICAL IMMEDIATE (high low)	LLIHL	RI-a	N					A5D	7-280	
LOAD LOGICAL IMMEDIATE (high)	LLIHF	RIL-a	EI					C0E	7-280	
LOAD LOGICAL IMMEDIATE (low high)	LLILH	RI-a	N					A5E	7-280	
LOAD LOGICAL IMMEDIATE (low low)	LLILL	RI-a	N					A5F	7-280	
LOAD LOGICAL IMMEDIATE (low)	LLILF	RIL-a	EI					C0F	7-280	
LOAD LOGICAL RELATIVE LONG (64←32)	LLGFRL	RIL-b	GE	A* SP				C4E	7-277	
LOAD LOGICAL THIRTY ONE BITS (64←31)	LLGT	RXY-a	N	A			B ₂	E317	7-281	
LOAD LOGICAL THIRTY ONE BITS (64←31)	LLGTR	RRE	N					B917	7-280	
LOAD LOGICAL THIRTY ONE BITS AND TRAP (64←31)	LLGTAT	RXY-a	LT	A	Dc		B ₂	E39C	7-281	
LOAD MULTIPLE (32)	LM	RS-a		A			B ₂	98	7-281	
LOAD MULTIPLE (32)	LMY	RSY-a	LD	A			B ₂	EB98	7-281	
LOAD MULTIPLE (64)	LMG	RSY-a	N	A			B ₂	EB04	7-281	
LOAD MULTIPLE DISJOINT (64←32&32)	LMD	SS-e	N	A ⁹			B ₂	B ₄	EF	7-282
LOAD MULTIPLE HIGH (32)	LMH	RSY-a	N	A			B ₂	B ₄	EB96	7-282
LOAD NEGATIVE (32)	LNR	RR	C					11	7-282	
LOAD NEGATIVE (64)	LNGR	RRE	C N					B901	7-282	
LOAD NEGATIVE (64←32)	LNGFR	RRE	C N					B911	7-283	
LOAD ON CONDITION (32)	LOC	RSY-b	L1	A			B ₂	EBF2	7-283	
LOAD ON CONDITION (32)	LOCR	RRF-c	L1					B9F2	7-283	
LOAD ON CONDITION (64)	LOCG	RSY-b	L1	A			B ₂	EBE2	7-283	
LOAD ON CONDITION (64)	LOCGR	RRF-c	L1					B9E2	7-283	
LOAD PAIR DISJOINT (32)	LPD	SSF	C IA	A ⁹	A SP		B ₁	B ₂	C84	7-284
LOAD PAIR DISJOINT (64)	LPDG	SSF	C IA	A ⁹	A SP		B ₁	B ₂	C85	7-284
LOAD PAIR FROM QUADWORD (64&64←128)	LPQ	RXY-a	N	A ⁹	A SP			B ₂	E38F	7-285
LOAD POSITIVE (32)	LPR	RR	C			IF		10	7-286	
LOAD POSITIVE (64)	LPGR	RRE	C N			IF			B900	7-286
LOAD POSITIVE (64←32)	LPGFR	RRE	C N						B910	7-286
LOAD RELATIVE LONG (32)	LRL	RIL-b	GE	A SP					C4D	7-263
LOAD RELATIVE LONG (64)	LGRL	RIL-b	GE	A* SP					C48	7-263
LOAD RELATIVE LONG (64←32)	LGFRL	RIL-b	GE	A* SP					C4C	7-263
LOAD REVERSED (16)	LRVH	RXY-a	N3	A			B ₂	E31F	7-286	
LOAD REVERSED (32)	LRV	RXY-a	N3	A			B ₂	E31E	7-286	
LOAD REVERSED (32)	LRVR	RRE	N3						B91F	7-286
LOAD REVERSED (64)	LRVG	RXY-a	N	A			B ₂	E30F	7-286	
LOAD REVERSED (64)	LRVGR	RRE	N						B90F	7-286
MONITOR CALL	MC	SI		A ^{4,8,9}	SP	ME	ST		AF	7-287
MOVE (16←16)	MVHHI	SIL	GE	A			ST	B ₁	E544	7-288
MOVE (32←16)	MVHI	SIL	GE	A			ST	B ₁	E54C	7-288
MOVE (64←16)	MVGHI	SIL	GE	A			ST	B ₁	E548	7-288
MOVE (character)	MVC	SS-a		A ⁹			ST	B ₁ B ₂	D2	7-288
MOVE (immediate)	MVI	SI		A			ST	B ₁	92	7-288
MOVE (immediate)	MVIY	SIY	LD	A			ST	B ₁	EB52	7-288
MOVE INVERSE	MVCIN	SS-a		A ⁹			ST	B ₁ B ₂	E8	7-289
MOVE LONG	MVCL	RR	C	A ⁹	A SP	II	ST	R ₁ R ₂	0E	7-289
MOVE LONG EXTENDED	MVCLE	RS-a	C	A ⁹	A SP	IC	ST	R ₁ R ₃	A8	7-293
MOVE LONG UNICODE	MVCLU	RSY-a	C E2	A ⁹	A SP	IC	ST	R ₁ R ₃	EB8E	7-296
MOVE NUMERICS	MVN	SS-a		A ⁹			ST	B ₁ B ₂	D1	7-300
MOVE RIGHT TO LEFT	MVCRL	SSE	MI3	A ⁹		G0	ST	B ₁ B ₂	E50A	7-300

Figure 7-1. Summary of General Instructions (Part 7 of 13)

Name	Mnemonic	Characteristics										Op-code	Page	
MOVE STRING	MVST	RRE	C		α^9	A	SP	IC	G0	ST	R ₁	R ₂	B255	7-301
MOVE WITH OFFSET	MVO	SS-b			α^9	A				ST	B ₁	B ₂	F1	7-302
MOVE ZONES	MVZ	SS-a			α^8	A				ST	B ₁	B ₂	D3	7-303
MULTIPLY (128←64)	MG	RXY-a	MI2			A	SP					B ₂	E384	7-304
MULTIPLY (128←64)	MGRK	RRF-a	MI2				SP						B9EC	7-304
MULTIPLY (64←32)	M	RX-a				A	SP					B ₂	5C	7-304
MULTIPLY (64←32)	MFY	RXY-a	GE			A	SP					B ₂	E35C	7-304
MULTIPLY (64←32)	MR	RR					SP						1C	7-304
MULTIPLY HALFWORD (32←16)	MH	RX-a				A						B ₂	4C	7-305
MULTIPLY HALFWORD (32←16)	MHY	RXY-a	GE			A						B ₂	E37C	7-305
MULTIPLY HALFWORD (64←16)	MGH	RXY-a	MI2			A						B ₂	E33C	7-305
MULTIPLY HALFWORD IMMEDIATE (32←16)	MHI	RI-a											A7C	7-305
MULTIPLY HALFWORD IMMEDIATE (64←16)	MGHI	RI-a	N										A7D	7-305
MULTIPLY LOGICAL (128←64)	MLG	RXY-a	N			A	SP					B ₂	E386	7-306
MULTIPLY LOGICAL (128←64)	MLGR	RRE	N				SP						B986	7-306
MULTIPLY LOGICAL (64←32)	ML	RXY-a	N3			A	SP					B ₂	E396	7-306
MULTIPLY LOGICAL (64←32)	MLR	RRE	N3				SP						B996	7-305
MULTIPLY SINGLE (32)	MS	RX-a				A						B ₂	71	7-307
MULTIPLY SINGLE (32)	MSC	RXY-a	C	MI2		A		IF				B ₂	E353	7-307
MULTIPLY SINGLE (32)	MSR	RRE											B252	7-307
MULTIPLY SINGLE (32)	MSRKC	RRF-a	C	MI2				IF					B9FD	7-307
MULTIPLY SINGLE (32)	MSY	RXY-a	LD			A						B ₂	E351	7-307
MULTIPLY SINGLE (64)	MSG	RXY-a	N			A						B ₂	E30C	7-307
MULTIPLY SINGLE (64)	MSGC	RXY-a	C	MI2		A		IF				B ₂	E383	7-307
MULTIPLY SINGLE (64)	MSGR	RRE	N										B90C	7-307
MULTIPLY SINGLE (64)	MSGRKC	RRF-a	C	MI2				IF					B9ED	7-307
MULTIPLY SINGLE (64←32)	MSGF	RXY-a	N			A						B ₂	E31C	7-307
MULTIPLY SINGLE (64←32)	MSGFR	RRE	N										B91C	7-307
MULTIPLY SINGLE IMMEDIATE (32)	MSFI	RI-a	GE										C21	7-307
MULTIPLY SINGLE IMMEDIATE (64←32)	MSGFI	RI-a	GE										C20	7-307
NAND (32)	NNRK	RRF-a	C	MI3									B974	7-308
NAND (64)	NNGRK	RRF-a	C	MI3									B964	7-308
NEXT INSTRUCTION ACCESS INTENT	NIAI	IE	EH										B2FA	7-309
NONTRANSACTIONAL STORE (64)	NTSTG	RXY-a	TX	α^9	A	SP				ST		B ₂	E325	7-310
NOR (32)	NORK	RRF-a	C	MI3									B976	7-311
NOR (64)	NOGRK	RRF-a	C	MI3									B966	7-311
NOT EXCLUSIVE OR (32)	NXRK	RRF-a	C	MI3									B977	7-311
NOT EXCLUSIVE OR (64)	NXGRK	RRF-a	C	MI3									B967	7-311
OR (32)	O	RX-a	C			A						B ₂	56	7-312
OR (32)	OR	RR	C										16	7-312
OR (32)	ORK	RRF-a	C	DO									B9F6	7-312
OR (32)	OY	RXY-a	C	LD		A						B ₂	E356	7-312
OR (64)	OG	RXY-a	C	N		A						B ₂	E381	7-312
OR (64)	OGR	RRE	C	N									B981	7-312
OR (64)	OGRK	RRF-a	C	DO									B9E6	7-312
OR (character)	OC	SS-a	C		α^9	A				ST	B ₁	B ₂	D6	7-312
OR (immediate)	OI	SI	C			A		\mathbb{F}^2		ST	B ₁		96	7-312
OR (immediate)	OIY	SIY	C	LD		A		\mathbb{F}^2		ST	B ₁		EB56	7-312
OR IMMEDIATE (high high)	OIHH	RI-a	C	N									A58	7-313
OR IMMEDIATE (high low)	OIHL	RI-a	C	N									A59	7-313
OR IMMEDIATE (high)	OIHF	RI-a	C	EI									C0C	7-313
OR IMMEDIATE (low high)	OILH	RI-a	C	N									A5A	7-313
OR IMMEDIATE (low low)	OILL	RI-a	C	N									A5B	7-313
OR IMMEDIATE (low)	OILF	RI-a	C	EI									C0D	7-313
OR WITH COMPLEMENT (32)	OCRK	RRF-a	C	MI3									B975	7-314
OR WITH COMPLEMENT (64)	OCGRK	RRF-a	C	MI3									B965	7-314
PACK	PACK	SS-b			α^9	A				ST	B ₁	B ₂	F2	7-314
PACK ASCII	PKA	SS-f	E2	α^9	A	SP				ST	B ₁	B ₂	E9	7-315
PACK UNICODE	PKU	SS-f	E2	α^9	A	SP				ST	B ₁	B ₂	E1	7-316
PERFORM CRYPTOGRAPHIC COMPUTATION	PCC	RRE	C	M4	$\alpha^{5,9}$	A	SP	IC	GM 11	ST			B92C	7-316
PERFORM PROCESSOR ASSIST	PPA	RRF-c	PA	α^1									B2E8	7-351

Figure 7-1. Summary of General Instructions (Part 8 of 13)

Name	Mnemonic	Characteristics										Op-code	Page			
PERFORM LOCKED OPERATION	PLO	SS-e	C		α^1	A	SP		\$	GM		ST		FC	EE	7-337
PERFORM RANDOM NUMBER OPERATION	PRNO	RRE	C	M5	$\alpha^{5,9}$	A	SP	IC	Dg	GM	11	ST	R ₁	R ₂	B93C	7-352
POPULATION COUNT	POPCNT	RRF-c	C	PK										B ₂	B9E1	7-365
PREFETCH DATA	PF	RXY-b		GE	$\alpha^{9,11}$										E336	7-365
PREFETCH DATA RELATIVE LONG	PFDR	RIL-c		GE	$\alpha^{9,11}$										C62	7-366
ROTATE LEFT SINGLE LOGICAL (32)	RLL	RSY-a		N3											EB1D	7-367
ROTATE LEFT SINGLE LOGICAL (64)	RLLG	RSY-a		N											EB1C	7-367
ROTATE THEN AND SELECTED BITS (64)	RNSBG	RIE-f	C	GE											EC54	7-368
ROTATE THEN EXCLUSIVE OR SEL. BITS (64)	RXSBG	RIE-f	C	GE											EC57	7-368
ROTATE THEN INSERT SELECTED BITS (64)	RISBG	RIE-f	C	GE											EC55	7-369
ROTATE THEN INSERT SELECTED BITS (64)	RISBGN	RIE-f		MI1											EC59	7-369
ROTATE THEN INSERT SELECTED BITS HIGH (32)	RISBHG	RIE-f		HW											EC5D	7-371
ROTATE THEN INSERT SELECTED BITS LOW (32)	RISBLG	RIE-f		HW											EC51	7-371
ROTATE THEN OR SELECTED BITS (64)	ROSBG	RIE-f	C	GE											EC56	7-368
SEARCH STRING	SRST	RRE	C		α^9	A	SP	IC		G0				R ₂	B25E	7-372
SEARCH STRING UNICODE	SRSTU	RRE	C	E3	α^9	A	SP	IC		G0			R ₁	R ₂	B9BE	7-374
SELECT (32)	SELR	RRF-a		MI3											B9F0	7-376
SELECT (64)	SELGR	RRF-a		MI3											B9E3	7-376
SELECT HIGH (32)	SELFHR	RRF-a		MI3											B9C0	7-376
SET ACCESS	SAR	RRE			α^6								U ₁		B24E	7-377
SET ADDRESSING MODE (24)	SAM24	E		N3	$\alpha^{3,9}$		SP		T						010C	7-377
SET ADDRESSING MODE (31)	SAM31	E		N3	$\alpha^{3,9}$		SP		T						010D	7-377
SET ADDRESSING MODE (64)	SAM64	E		N	$\alpha^{3,9}$				T						010E	7-377
SET PROGRAM MASK	SPM	RR	L												04	7-378
SHIFT LEFT DOUBLE (64)	SLDA	RS-a	C				SP		IF						8F	7-378
SHIFT LEFT DOUBLE LOGICAL (64)	SLDL	RS-a					SP								8D	7-379
SHIFT LEFT SINGLE (32)	SLA	RS-a	C						IF						8B	7-379
SHIFT LEFT SINGLE (32)	SLAK	RSY-a	C	DO					IF						EBDD	7-379
SHIFT LEFT SINGLE (64)	SLAG	RSY-a	C	N					IF						EB0B	7-379
SHIFT LEFT SINGLE LOGICAL (32)	SLL	RS-a													89	7-380
SHIFT LEFT SINGLE LOGICAL (32)	SLLK	RSY-a		DO											EBDF	7-380
SHIFT LEFT SINGLE LOGICAL (64)	SLLG	RSY-a		N											EB0D	7-380
SHIFT RIGHT DOUBLE (64)	SRDA	RS-a	C				SP								8E	7-381
SHIFT RIGHT DOUBLE LOGICAL (64)	SRDL	RS-a					SP								8C	7-381
SHIFT RIGHT SINGLE (32)	SRA	RS-a	C												8A	7-382
SHIFT RIGHT SINGLE (32)	SRAK	RSY-a	C	DO											EBDC	7-382
SHIFT RIGHT SINGLE (64)	SRAG	RSY-a	C	N											EB0A	7-382
SHIFT RIGHT SINGLE LOGICAL (32)	SRL	RS-a													88	7-383
SHIFT RIGHT SINGLE LOGICAL (32)	SRLK	RSY-a		DO											EBDE	7-383
SHIFT RIGHT SINGLE LOGICAL (64)	SRLG	RSY-a		N											EB0C	7-383
STORE (32)	ST	RX-a				A						ST		B ₂	50	7-383
STORE (32)	STY	RXY-a	LD			A						ST		B ₂	E350	7-384
STORE (64)	STG	RXY-a	N			A						ST		B ₂	E324	7-384
STORE ACCESS MULTIPLE	STAM	RS-a				A	SP					ST		UB	9B	7-384
STORE ACCESS MULTIPLE	STAMY	RSY-a	LD			A	SP					ST		UB	EB9B	7-384
STORE CHARACTER	STC	RX-a				A						ST		B ₂	42	7-385
STORE CHARACTER	STCY	RXY-a	LD			A						ST		B ₂	E372	7-385
STORE CHARACTER HIGH (8)	STCH	RXY-a	HW			A						ST		B ₂	E3C3	7-385
STORE CHARACTERS UNDER MASK (high)	STCMH	RSY-b	N		$\alpha^{9,11}$	A						ST		B ₂	EB2C	7-385
STORE CHARACTERS UNDER MASK (low)	STCM	RS-b				A						ST		B ₂	BE	7-385
STORE CHARACTERS UNDER MASK (low)	STCMY	RSY-b	LD			A						ST		B ₂	EB2D	7-385
STORE CLOCK	STCK	S	C		$\alpha^{8,9}$	A			\$			ST		B ₂	B205	7-386
STORE CLOCK EXTENDED	STCKE	S	C		$\alpha^{8,9}$	A			\$			ST		B ₂	B278	7-387
STORE CLOCK FAST	STCKF	S	C	SC	$\alpha^{8,9}$	A						ST		B ₂	B27C	7-386
STORE FACILITY LIST EXTENDED	STFLE	S	C	FL	α^1	A	SP			G0		ST		B ₂	B2B0	7-389
STORE GUARDED STORAGE CONTROLS	STGSC	RXY-a	GF		α^1	A		SO				ST	B ₂		E349	7-390
STORE HALFWORD (16)	STH	RX-a				A						ST		B ₂	40	7-390
STORE HALFWORD (16)	STHY	RXY-a	LD			A						ST		B ₂	E370	7-391
STORE HALFWORD HIGH (16)	STHH	RXY-a	HW			A						ST		B ₂	E3C7	7-391
STORE HALFWORD RELATIVE LONG (16)	STHRL	RIL-b	GE			A*						ST			C47	7-391
STORE HIGH (32)	STFH	RXY-a	HW			A						ST		B ₂	E3CB	7-391

Figure 7-1. Summary of General Instructions (Part 9 of 13)

Name	Mnemonic	Characteristics						Op-code	Page	
STORE HIGH ON CONDITION	STOCFH	RSY-b	L2	A			ST	B ₂	EBE1	7-393
STORE MULTIPLE (32)	STM	RS-a		A			ST	B ₂	90	7-392
STORE MULTIPLE (32)	STMY	RSY-a	LD	A			ST	B ₂	EB90	7-392
STORE MULTIPLE (64)	STMG	RSY-a	N	A			ST	B ₂	EB24	7-392
STORE MULTIPLE HIGH (32)	STMH	RSY-a	N	A			ST	B ₂	EB26	7-392
STORE ON CONDITION (32)	STOC	RSY-b	L1	A			ST	B ₂	EBF3	7-392
STORE ON CONDITION (64)	STOCG	RSY-b	L1	A			ST	B ₂	EBE3	7-392
STORE PAIR TO QUADWORD (64&64→128)	STPQ	RXY-a	N	a ⁹	A	SP	ST	B ₂	E38E	7-393
STORE RELATIVE LONG (32)	STRL	RIL-b	GE	A*	SP		ST		C4F	7-384
STORE RELATIVE LONG (64)	STGRL	RIL-b	GE	A*	SP		ST		C4B	7-384
STORE REVERSED (16)	STRVH	RXY-a	N3	A			ST	B ₂	E33F	7-394
STORE REVERSED (32)	STRV	RXY-a	N3	A			ST	B ₂	E33E	7-394
STORE REVERSED (64)	STRVG	RXY-a	N	A			ST	B ₂	E32F	7-394
SUBTRACT (32)	S	RX-a	C	A		IF		B ₂	5B	7-395
SUBTRACT (32)	SR	RR	C			IF			1B	7-394
SUBTRACT (32)	SRK	RRF-a	C DO			IF			B9F9	7-394
SUBTRACT (32)	SY	RXY-a	C LD	A		IF		B ₂	E35B	7-395
SUBTRACT (64)	SG	RXY-a	C N	A		IF		B ₂	E309	7-395
SUBTRACT (64)	SGR	RRE	C N			IF			B909	7-394
SUBTRACT (64)	SGRK	RRF-a	C DO			IF			B9E9	7-394
SUBTRACT (64←32)	SGF	RXY-a	C N	A		IF		B ₂	E319	7-395
SUBTRACT (64←32)	SGFR	RRE	C N			IF			B919	7-394
SUBTRACT HALFWORD (32←16)	SH	RX-a	C	A		IF		B ₂	4B	7-395
SUBTRACT HALFWORD (32←16)	SHY	RXY-a	C LD	A		IF		B ₂	E37B	7-395
SUBTRACT HALFWORD (64←16)	SGH	RXY-a	C MI2	A		IF		B ₂	E339	7-395
SUBTRACT HIGH (32)	SHHHR	RRF-a	C HW			IF			B9C9	7-396
SUBTRACT HIGH (32)	SHHLR	RRF-a	C HW			IF			B9D9	7-396
SUBTRACT LOGICAL (32)	SL	RX-a	C	A				B ₂	5F	7-396
SUBTRACT LOGICAL (32)	SLR	RR	C						1F	7-396
SUBTRACT LOGICAL (32)	SLRK	RRF-a	C DO						B9FB	7-396
SUBTRACT LOGICAL (32)	SLY	RXY-a	C LD	A				B ₂	E35F	7-396
SUBTRACT LOGICAL (64)	SLG	RXY-a	C N	A				B ₂	E30B	7-397
SUBTRACT LOGICAL (64)	SLGR	RRE	C N						B90B	7-396
SUBTRACT LOGICAL (64)	SLGRK	RRF-a	C DO						B9EB	7-396
SUBTRACT LOGICAL (64←32)	SLGF	RXY-a	C N	A				B ₂	E31B	7-397
SUBTRACT LOGICAL (64←32)	SLGFR	RRE	C N						B91B	7-396
SUBTRACT LOGICAL HIGH (32)	SLHHR	RRF-a	C HW						B9CB	7-397
SUBTRACT LOGICAL HIGH (32)	SLHLR	RRF-a	C HW						B9DB	7-397
SUBTRACT LOGICAL IMMEDIATE (32)	SLFI	RIL-a	C EI						C25	7-397
SUBTRACT LOGICAL IMMEDIATE (64←32)	SLGFI	RIL-a	C EI						C24	7-397
SUBTRACT LOGICAL WITH BORROW (32)	SLB	RXY-a	C N3	A				B ₂	E399	7-398
SUBTRACT LOGICAL WITH BORROW (32)	SLBR	RRE	C N3						B999	7-398
SUBTRACT LOGICAL WITH BORROW (64)	SLBG	RXY-a	C N	A				B ₂	E389	7-398
SUBTRACT LOGICAL WITH BORROW (64)	SLBGR	RRE	C N						B989	7-398
SUPERVISOR CALL	SVC	I		a ¹		¢			0A	7-398
TEST ADDRESSING MODE	TAM	E	C N3	a ⁹					010B	7-399
TEST AND SET	TS	SI	C	a ⁹	A	\$	ST	B ₂	93	7-399
TEST UNDER MASK	TM	SI	C		A			B ₁	91	7-400
TEST UNDER MASK	TMY	SIY	C LD		A			B ₁	EB51	7-400
TEST UNDER MASK (high high)	TMHH	RI-a	C N						A72	7-400
TEST UNDER MASK (high low)	TMHL	RI-a	C N						A73	7-400
TEST UNDER MASK (low high)	TMLH	RI-a	C N						A70	7-400
TEST UNDER MASK (low low)	TMLL	RI-a	C N						A71	7-400
TEST UNDER MASK HIGH	TMH	RI-a	C						A70	7-400
TEST UNDER MASK LOW	TML	RI-a	C						A71	7-400
TRANSACTION ABORT	TABORT	S	TX	a ⁹	SP	SO \$ EX			B2FC	7-401
TRANSACTION BEGIN (nonconstrained)	TBEGIN	SIL	C TX	a ⁹	A SP	SO \$ EX	ST		E560	7-401
TRANSACTION BEGIN (constrained)	TBEGINC	SIL	C CX	a ⁹	SP	SO \$ EX			E561	7-406
TRANSACTION END	TEND	S	C TX			SO \$ EX			B2F8	7-408
TRANSLATE	TR	SS-a		a ⁹	A		ST	B ₁	DC	7-408
TRANSLATE AND TEST	TRT	SS-a	C	a ⁹	A	GM		B ₁ B ₂	DD	7-409

Figure 7-1. Summary of General Instructions (Part 10 of 13)

Name	Mnemonic	Characteristics										Op-code	Page
TRANSLATE AND TEST EXTENDED	TRTE	RRF-c	C	PE	α^9	A	SP	IC	G1		RM	B9BF	7-410
TRANSLATE AND TEST REVERSE	TRTR	SS-a	C	E3	α^9	A			GM		B ₁ B ₂	D0	7-415
TRANSLATE AND TEST REVERSE EXTENDED	TRTRE	RRF-c	C	PE	α^9	A	SP	IC	G1		RM	B9BD	7-410
TRANSLATE EXTENDED	TRE	RRE	C		α^9	A	SP	IC	G0		ST R ₁ R ₂	B2A5	7-415
TRANSLATE ONE TO ONE	TROO	RRF-c	C	E2	α^9	A	SP	IC	GM		ST RM R ₂	B993	7-418
TRANSLATE ONE TO TWO	TROT	RRF-c	C	E2	α^9	A	SP	IC	GM		ST RM R ₂	B992	7-418
TRANSLATE TWO TO ONE	TRTO	RRF-c	C	E2	α^9	A	SP	IC	GM		ST RM R ₂	B991	7-418
TRANSLATE TWO TO TWO	TRTT	RRF-c	C	E2	α^9	A	SP	IC	GM		ST RM R ₂	B990	7-418
UNPACK	UNPK	SS-b			α^9	A					ST B ₁ B ₂	F3	7-423
UNPACK ASCII	UNPKA	SS-a	C	E2	α^9	A	SP				ST B ₁ B ₂	EA	7-423
UNPACK UNICODE	UNPKU	SS-a	C	E2	α^9	A	SP				ST B ₁ B ₂	E2	7-424
UPDATE TREE	UPT	E	C		α^9	A	SP	II	GM I4		ST	0102	7-425

Explanation:

⌄	Causes serialization and checkpoint synchronization.
⌄ ¹	Causes serialization and checkpoint synchronization when the M ₁ and R ₂ fields contain 1111 binary and 0000 binary, respectively. Causes only serialization when the fast-BCR-serialization facility is installed, and the M ₁ and R ₂ fields contain 1110 binary and 0000 binary, respectively.
\$	Causes serialization.
£	Causes specific-operand serialization.
£ ¹	Causes specific-operand serialization when the interlocked-access facility 1 is installed and the storage operand is aligned on an integral boundary corresponding to its size.
£ ²	Causes specific-operand serialization when the interlocked-access facility 2 is installed.
α^1	Restricted from transactional execution.
α^2	Restricted from transactional execution when R ₂ nonzero and branch tracing is enabled.
α^3	Restricted from transactional execution when mode tracing is enabled.
α^4	Restricted from transactional execution when a monitor-event condition occurs.
α^5	Model dependent whether the instruction is restricted from transactional execution.
α^6	Restricted from transactional execution when the effective allow-AR-modification control is zero.
α^7	Restricted from transactional execution when the effective allow-floating-point-operation control is zero.
α^8	May be restricted from transactional execution depending on machine conditions.
α^9	Restricted in the constrained transactional-execution mode; a transaction-constraint program exception may be recognized. For STCMH, the instruction is restricted only when the M ₃ field is zero.
α^{10}	Restricted to forward branches in the constrained transactional-execution mode.
α^{11}	For PFD and PFDRL, it is model dependent whether the instruction is restricted from transactional execution when the code in the M ₁ field is 6 or 7; for STCMH, it is model dependent whether the instruction is restricted when the M ₃ field is zero, and the code in the R ₁ field is 6 or 7.
α^{12}	Restricted from transactional execution when a guarded-storage event is recognized. When in the transactional-execution mode, the transaction is aborted, and the guarded-storage event is processed.
*	PER zero-address-detection not recognized.
32H	32 high-order bits of a register.
32L	32 low-order bits of a register.
A	Access exceptions for logical addresses.
AI	Access exceptions for instruction address.
B	PER branch event. (For LGG and LLGFSG, the PER branch event is only recognized coincident with a guarded-storage event.)
B ₁	B ₁ field designates an access register in the access-register mode.
B ₂	B ₂ field designates an access register in the access-register mode.
B ₄	B ₄ field designates an access register in the access-register mode.
BP	B ₂ field designates an access register when PSW bits 16 and 17 have the value 01 binary.
C	Condition code is set.
CS	Compare-and-swap-and-store facility.
CX	Constrained transactional-execution facility
Dc	Compare-and-trap data exception
Dg	General-operand data exception.
DO	Distinct-operands facility
E	E instruction format.

Figure 7-1. Summary of General Instructions (Part 11 of 13)

	Name	Mnemonic	Characteristics	Op-code	Page
EH	Execution-hint facility				
EI	Extended-immediate facility.				
ET	Extract-CPU-time facility.				
EX	Execute exception.				
E2	Extended-translation facility 2.				
E3	Extended-translation facility 3.				
FC	Designation of access registers depends on the function code of the instruction.				
FL	Store-facility-list-extended facility.				
G0	Instruction execution includes the implied use of general register 0.				
G1	Instruction execution includes the implied use of general register 1.				
GE	General-instructions-extension facility.				
GF	Guarded-storage facility.				
GM	Instruction execution includes the implied use of multiple general registers: <ul style="list-style-type: none"> • General registers 1, 2, and 3 for COMPARE AND FORM CODEWORD. • General registers 0 and 1 for CIPHER MESSAGE, CIPHER MESSAGE WITH AUTHENTICATION, CIPHER MESSAGE WITH CHAINING, CIPHER MESSAGE WITH CIPHER FEEDBACK, CIPHER MESSAGE WITH COUNTER, CIPHER MESSAGE WITH OUTPUT FEEDBACK, COMPARE AND SWAP AND STORE, COMPARE UNTIL SUBSTRING EQUAL, COMPRESSION CALL, COMPUTE INTERMEDIATE MESSAGE DIGEST, COMPUTE LAST MESSAGE DIGEST, COMPUTE MESSAGE AUTHENTICATION CODE, EXTRACT CPU TIME, PERFORM CRYPTOGRAPHIC COMPUTATION, PERFORM LOCKED OPERATION, PERFORM RANDOM NUMBER OPERATION, TRANSLATE ONE TO ONE, TRANSLATE ONE TO TWO, TRANSLATE TWO TO ONE, and TRANSLATE TWO TO TWO • General registers 1 and 2 for TRANSLATE AND TEST and TRANSLATE AND TEST REVERSE. • General registers 0-5 for UPDATE TREE. • 				
HW	High-word facility				
I	I instruction format.				
I1	Access register 1 is implicitly designated in the access-register mode.				
I4	Access register 4 is implicitly designated in the access-register mode.				
IA	Interlocked-access facility 1				
IC	Condition code alternative to interruptible instruction				
IE	IE instruction format.				
IF	Fixed-point-overflow exception.				
II	Interruptible instruction.				
IK	Fixed-point-divide exception.				
L	New condition code is loaded.				
L1	Load/store-on-condition facility 1.				
L2	Load/store-on-condition facility 2.				
LD	Long-displacement facility.				
LT	Load-and-trap facility				
LZ	Load-and-zero-rightmost-byte facility.				
ME	Monitor event.				
MI1	Miscellaneous-instruction-extensions facility 1				
MI2	Miscellaneous-instruction-extensions facility 2				
MI3	Miscellaneous-instruction-extensions facility 3				
MII	MII instruction format.				
MS	Message-security assist.				
M4	Message-security-assist extension 4.				
M5	Message-security-assist extension 5.				
M8	Message-security-assist extension 8.				
N	Instruction is new in z/Architecture as compared to ESA/390.				
N3	Instruction is new in z/Architecture and has been added to ESA/390. Any RSY or RXY instructions still use the RSE or RXE format and 12-bit displacements in ESA/390. RSY- and RXY-format instructions having the N3 facility code may use long displacements in the ESA/390-compatibility mode.				
PA	Processor-assist facility.				

Figure 7-1. Summary of General Instructions (Part 12 of 13)

Name	Mnemonic	Characteristics	Op-code	Page
PE		Parsing-enhancement facility.		
PK		Population-count facility		
R ₁		R ₁ field designates an access register in the access-register mode.		
R ₂		R ₂ field designates an access register in the access-register mode.		
R ₃		R ₃ field designates an access register in the access-register mode.		
RI		RI instruction format.		
RIE		RIE instruction format.		
RIL		RIL instruction format.		
RIS		RIS instruction format.		
RM		R ₁ field designates an access register in the access-register mode, and access-register 1 also is used in the access-register mode.		
RR		RR instruction format.		
RRE		RRE instruction format.		
RRF		RRF instruction format.		
RRS		RRS instruction format.		
RS		RS instruction format.		
RSI		RSI instruction format.		
RSY		RSY instruction format.		
RX		RX instruction format.		
RXY		RXY instruction format.		
S		S instruction format.		
SC		Store-clock-fast facility.		
SI		SI instruction format.		
SIL		SIL instruction format.		
SIY		SIY instruction format.		
SMI		SMI instruction format.		
SO		Special-operation exception.		
SP		Specification exception.		
SS		SS instruction format.		
SSF		SSF instruction format.		
ST		PER storage-alteration event. (For LGG and LLGFSG, the PER storage-alteration event is only recognized coincident with a guarded-storage event.)		
T		Trace exceptions (includes trace table, addressing, and low-address protection).		
TX		Transactional-execution facility		
U ₁		R ₁ field designates an access register unconditionally.		
U ₂		R ₂ field designates an access register unconditionally.		
UB		R ₁ and R ₃ fields designate access registers unconditionally, and B ₂ field designates an access register in the access-register mode.		
VF		Vector facility for z/Architecture		
XX		Execute-extension facility.		

Figure 7-1. Summary of General Instructions (Part 13 of 13)

ADD

Register-and-register formats:

AR R₁,R₂ [RR]

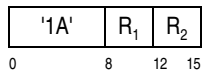

AGR R₁,R₂ [RRE]

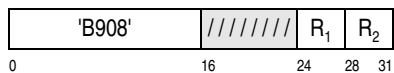

AGFR R₁,R₂ [RRE]

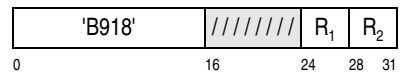

ARK R₁,R₂,R₃ [RRF-a]

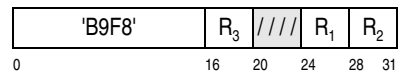

AGRK R_1, R_2, R_3 [RRF-a]

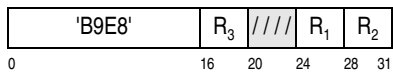

Register-and-storage formats:

A $R_1, D_2(X_2, B_2)$ [RX-a]

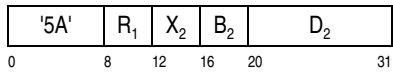

AY $R_1, D_2(X_2, B_2)$ [RXY-a]

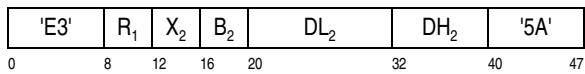

AG $R_1, D_2(X_2, B_2)$ [RXY-a]

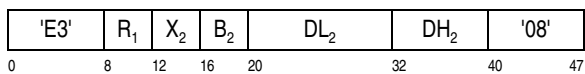

AGF $R_1, D_2(X_2, B_2)$ [RXY-a]

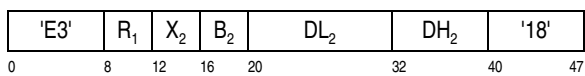

ADD IMMEDIATE

Register-and-immediate formats:

AFI R_1, I_2 [RIL-a]

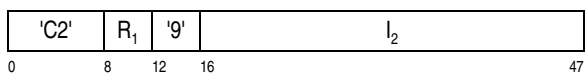

AGFI R_1, I_2 [RIL-a]

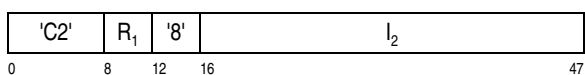

AHIK R_1, R_3, I_2 [RIE-d]

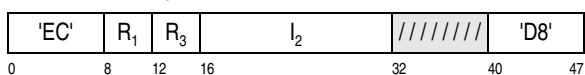

AGHIK R_1, R_3, I_2 [RIE-d]

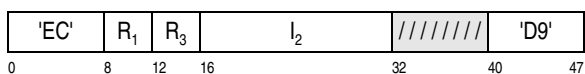

Storage-and-immediate formats:

ASI $D_1(B_1), I_2$ [SIY]

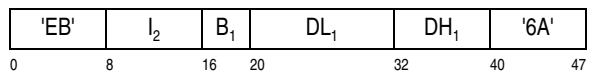

AGSI $D_1(B_1), I_2$ [SIY]

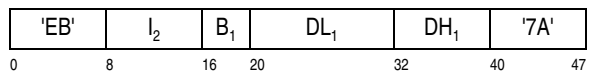

For ADD (A, AG, AGF, AGFR, AGR, AR, and AY) and for ADD IMMEDIATE (AFI, AGFI, AGSI, and ASI), the second operand is added to the first operand, and the sum is placed at the first-operand location. For ADD (AGRK and ARK) and for ADD IMMEDIATE (AGHIK and AHIK), the second operand is added to the third operand, and the sum is placed at the first-operand location.

For ADD (A, AR, ARK, and AY) and for ADD IMMEDIATE (AFI), the operands and the sum are treated as 32-bit signed binary integers. For ADD (AG, AGR, and AGRK), they are treated as 64-bit signed binary integers. For ADD (AGFR, AGF) and for ADD IMMEDIATE (AGFI), the second operand is treated as a 32-bit signed binary integer, and the first operand and the sum are treated as 64-bit signed binary integers. For ADD IMMEDIATE (ASI), the second operand is treated as an 8-bit signed binary integer, and the first operand and the sum are treated as 32-bit signed binary integers. For ADD IMMEDIATE (AGSI), the second operand is treated as an 8-bit signed binary integer, and the first operand and the sum are treated as 64-bit signed binary integers. For ADD IMMEDIATE (AHIK), the first and third operands are treated as 32-bit signed binary integers, and the second operand is treated as a 16-bit signed binary integer. For ADD IMMEDIATE (AGHIK), the first and third operands are treated as 64-bit signed binary integers, and the second operand is treated as a 16-bit signed binary integer.

When there is an overflow, the result is obtained by allowing any carry into the sign-bit position and ignoring any carry out of the sign-bit position, and condition code 3 is set. If the fixed-point-overflow mask is one, a program interruption for fixed-point overflow occurs.

When the interlocked-access facility 1 is installed and the first operand of ADD IMMEDIATE (ASI, AGSI) is aligned on an integral boundary corresponding to its

size, then the fetch and store of the first operand are performed as an interlocked update as observed by other CPUs, and a specific-operand-serialization operation is performed. When the interlocked-access facility 1 is not installed, or when the first operand of ADD IMMEDIATE (ASI, AGSI) is not aligned on an integral boundary corresponding to its size, then the fetch and store of the operand are not performed as an interlocked update.

The displacement for A is treated as a 12-bit unsigned binary integer. The displacement for AY, AG, AGF, AGSI and ASI, is treated as a 20-bit signed binary integer.

Resulting Condition Code:

- 0 Result zero; no overflow
- 1 Result less than zero; no overflow
- 2 Result greater than zero; no overflow
- 3 Overflow

Program Exceptions:

- Access (fetch and store, operand 1 of AGSI and ASI only; fetch, operand 2 of A, AY, AG, and AGF only)
- Fixed-point overflow
- Operation (AY, if the long-displacement facility is not installed; AFI and AGFI, if the extended-immediate facility is not installed; AGSI and ASI, if the general-instructions-extension facility is not installed; ARK, AGRK, AHIK, and AGHIK, if the distinct-operands facility is not installed)

Programming Notes:

1. Accesses to the first operand of ADD IMMEDIATE (AGSI and ASI) consist in fetching a first-operand from storage and subsequently storing the updated value.
2. When the interlocked-access facility 1 is not installed, or when the first operand is not aligned on an integral boundary corresponding to its size, the fetch and store accesses to the first operand do not necessarily occur one immediately after the other. Under such conditions, ADD IMMEDIATE (AGSI and ASI) cannot be safely used to update a location in storage if the possibility exists that another CPU or a channel program may also be updating the location. An example of this effect is shown in “Multiprogramming and Multiprocessing Examples” in Appen-

dix A, “Number Representation and Instruction-Use Examples.”

When the interlocked-access facility 1 is installed and the first operand is aligned on an integral boundary corresponding to its size, the operand is accessed using a block-concurrent interlocked update.

3. For certain programming languages which ignore overflow conditions on arithmetic operations, the setting of condition code 3 obscures the sign of the result. However, for ADD IMMEDIATE, the sign of the I_2 field (which is known at the time of code generation) may be used in setting a branch mask which will accurately determine the resulting sign, as shown below.

I_2 Value	Result to be Tested		
	Positive	Negative	Zero
Positive	0010	0101 ^a	1000
Negative	0011 ^b	0100	1000 ^c
Zero	0010	0100	1000

Explanation:

^a If the first operand was positive, then a mask of 0001 covers that case (overflow). If the first operand was negative, then a mask of 0100 is appropriate. Combining the two gives a mask of 0101.

^b Similarly, a mask of 0010 (first operand was positive) and mask of 0001 (first operand was negative) yields a mask of 0011 which covers both cases.

^c A separate test for zero may be required when the I_2 field contains 80000000 hex.

Figure 7-2. Branch Masks to Determine Resulting Sign for ADD IMMEDIATE

The technique described above is also applicable to ADD HALFWORD IMMEDIATE.

ADD HALFWORD

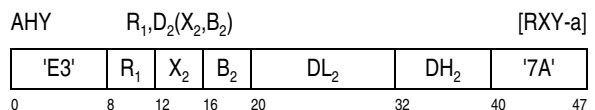
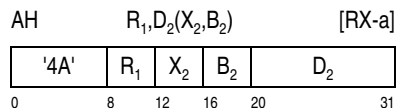

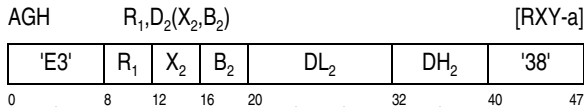

ADD HALFWORD IMMEDIATE

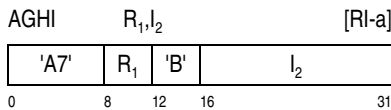
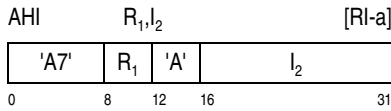

The second operand is added to the first operand, and the sum is placed at the first-operand location. The second operand is two bytes in length and is treated as a 16-bit signed binary integer. For ADD HALFWORD (AH, AHY) and ADD HALFWORD IMMEDIATE (AHI), the first operand and the sum are treated as 32-bit signed binary integers. For ADD HALFWORD (AGH) and ADD HALFWORD IMMEDIATE (AGHI), they are treated as 64-bit signed binary integers.

When there is an overflow, the result is obtained by allowing any carry into the sign-bit position and ignoring any carry out of the sign-bit position, and condition code 3 is set. If the fixed-point-overflow mask is one, a program interruption for fixed-point overflow occurs.

The displacement for AH is treated as a 12-bit unsigned binary integer. The displacement for AGH and AHY is treated as a 20-bit signed binary integer.

Resulting Condition Code:

- 0 Result zero; no overflow
- 1 Result less than zero; no overflow
- 2 Result greater than zero; no overflow
- 3 Overflow

Program Exceptions:

- Access (fetch, operand 2 of AH, AGH, AHY)
- Fixed-point overflow
- Operation (AHY, if the long-displacement facility is not installed; AGH, if the miscellaneous-instruction-extensions facility 2 is not installed)

Programming Notes:

1. An example of the use of the ADD HALFWORD instruction is given in Appendix A, "Number Representation and Instruction-Use Examples."
2. See programming note 3 on page 7-27 for ADD IMMEDIATE regarding the implications of ignoring overflow.

ADD HIGH

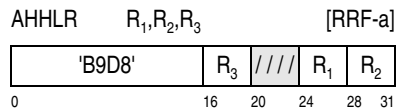
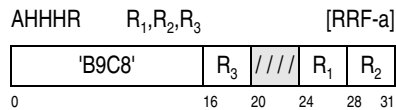

The second operand is added to the third operand, and the sum is placed at the first-operand location. The operands and the sum are treated as 32-bit signed binary integers. The first and second operands are in bits 0-31 of general registers R_1 and R_2 , respectively; bits 32-63 of general register R_1 are unchanged, and bits 32-63 of general register R_2 are ignored. For AHHHR, the third operand is in bits 0-31 of general register R_3 ; bits 32-63 of the register are ignored. For AHHLR, the third operand is in bits 32-63 of general register R_3 ; bits 0-31 of the register are ignored.

When there is an overflow, the result is obtained by allowing any carry into the sign-bit position and ignoring any carry out of the sign-bit position, and condition code 3 is set. If the fixed-point-overflow mask is one, a program interruption for fixed-point overflow occurs.

Resulting Condition Code:

- 0 Result zero; no overflow
- 1 Result less than zero; no overflow
- 2 Result greater than zero; no overflow
- 3 Overflow

Program Exceptions:

- Fixed-point overflow
- Operation (if the high-word facility is not installed)

ADD IMMEDIATE HIGH

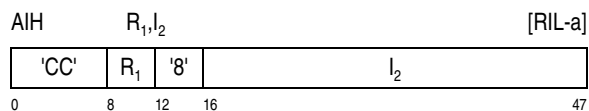

The second operand is added to the first operand, and the sum is placed at the first-operand location. The operands and the sum are treated as 32-bit signed binary integers. The first operand is in bits 0-31 of general register R₁; bits 32-63 of the register are unchanged.

When there is an overflow, the result is obtained by allowing any carry into the sign-bit position and ignoring any carry out of the sign-bit position, and condition code 3 is set. If the fixed-point-overflow mask is one, a program interruption for fixed-point overflow occurs.

Resulting Condition Code:

- 0 Result zero; no overflow
- 1 Result less than zero; no overflow
- 2 Result greater than zero; no overflow
- 3 Overflow

Program Exceptions:

- Fixed-point overflow
- Operation (if the high-word facility is not installed)

ADD LOGICAL

Register-and-register formats:

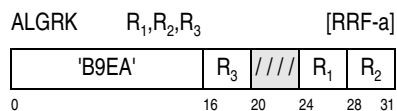
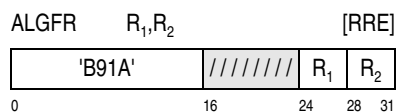
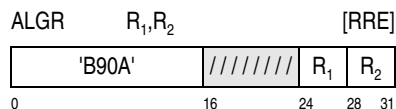
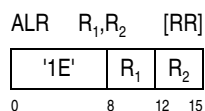

Register-and-storage formats:

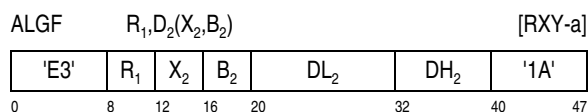
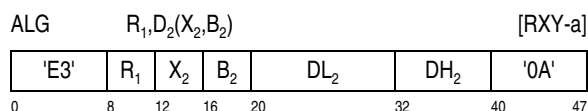
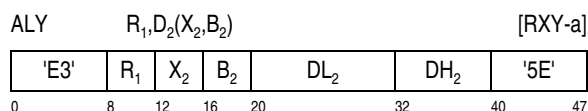
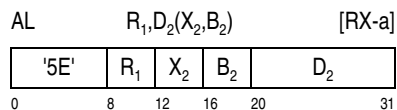

ADD LOGICAL IMMEDIATE

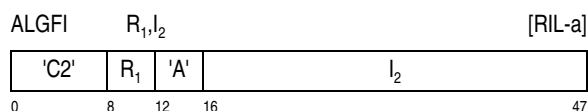
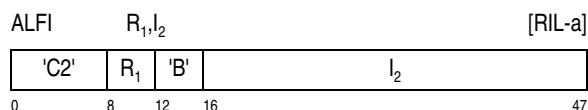

For ADD LOGICAL (AL, ALG, ALGF, ALGFR, ALGR, ALR, and ALY) and for ADD LOGICAL IMMEDIATE (ALGFI and ALFI), the second operand is added to the first operand, and the sum is placed at the first-operand location. For ADD LOGICAL (ALGRK and ALRK), the second operand is added to the third operand, and the sum is placed at the first-operand location.

For ADD LOGICAL (AL, ALR, ALRK, and ALY) and for ADD LOGICAL IMMEDIATE (ALFI), the operands

and the sum are treated as 32-bit unsigned binary integers. For ADD LOGICAL (ALG, ALGR, and ALGRK), they are treated as 64-bit unsigned binary integers. For ADD LOGICAL (ALGFR, ALGF) and for ADD LOGICAL IMMEDIATE (ALGFI), the second operand is treated as a 32-bit unsigned binary integer, and the first operand and the sum are treated as 64-bit unsigned binary integers.

The displacement for AL is treated as a 12-bit unsigned binary integer. The displacement for ALY, ALG, and ALGF is treated as a 20-bit signed binary integer.

Resulting Condition Code:

- 0 Result zero; no carry
- 1 Result not zero; no carry
- 2 Result zero; carry
- 3 Result not zero; carry

Program Exceptions:

- Access (fetch, operand 2 of AL, ALY, ALG, and ALGF only)
- Operation (ALY, if the long-displacement facility is not installed; ALFI and ALGFI, if the extended-immediate facility is not installed; ALRK and ALGRK, if the distinct-operands facility is not installed)

ADD LOGICAL HIGH

ALHHHR R_1, R_2, R_3 [RRF-a]

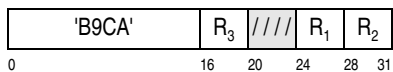

ALHHLR R_1, R_2, R_3 [RRF-a]

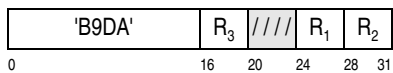

The second operand is added to the third operand, and the sum is placed at the first-operand location. The operands and the sum are treated as 32-bit unsigned binary integers. The first and second operands are in bits 0-31 of general registers R₁ and R₂, respectively; bits 32-63 of general register R₁ are unchanged, and bits 32-63 of general register R₂ are ignored. For ALHHHR, the third operand is in bits 0-31 of general register R₃; bits 32-63 of the register are ignored. For ALHHLR, the third operand is in bits

32-63 of general register R₃; bits 0-31 of the register are ignored.

Resulting Condition Code:

- 0 Result zero; no carry
- 1 Result not zero; no carry
- 2 Result zero; carry
- 3 Result not zero; carry

Program Exceptions:

- Operation (if the high-word facility is not installed)

ADD LOGICAL WITH CARRY

Register-and-register formats:

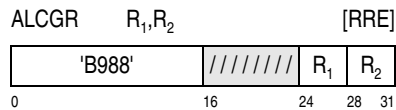
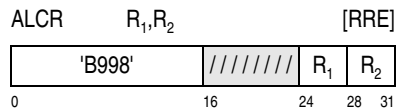

Register-and-storage formats:

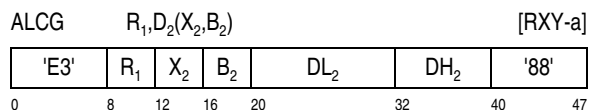

The second operand and the carry are added to the first operand, and the sum is placed at the first-operand location. For ADD LOGICAL WITH CARRY (ALCR, ALC), the operands, the carry, and the sum are treated as 32-bit unsigned binary integers. For ADD LOGICAL WITH CARRY (ALCGR, ALCG), they are treated as 64-bit unsigned binary integers.

Resulting Condition Code:

- 0 Result zero; no carry
- 1 Result not zero; no carry
- 2 Result zero; carry
- 3 Result not zero; carry

Program Exceptions:

- Access (fetch, operand 2 of ALC and ALCG only)

Programming Notes:

1. A carry is represented by a one value of bit 18 of the current PSW. Bit 18 is the leftmost bit of the two-bit condition code in the PSW. Bit 18 is set to one by an execution of an ADD LOGICAL or ADD LOGICAL WITH CARRY instruction that produces a carry out of bit position 0 of the result.
2. ADD and ADD LOGICAL may provide better performance than ADD LOGICAL WITH CARRY, depending on the model.

ADD LOGICAL WITH SIGNED IMMEDIATE

Storage-and-immediate formats:

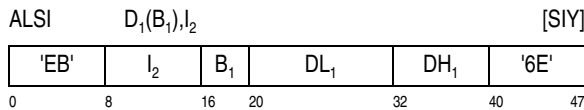

Register-and-immediate formats:

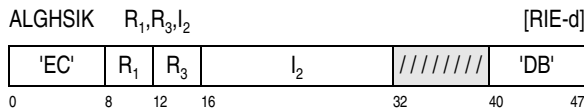
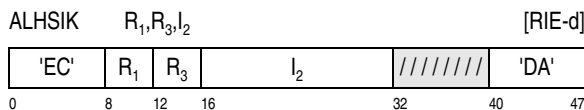

For ALGSI and ALSI, the second operand is added to the first operand, and the sum is placed at the first-operand location. For ALGHSIK and ALHSIK, the second operand is added to the third operand, and the sum is placed at the first-operand location.

For ALSI, the first operand and the sum are treated as 32-bit unsigned binary integers. For ALGSI, the

first operand and the sum are treated as 64-bit unsigned binary integers. For both ALSI and ALGSI, the second operand is treated as an 8-bit signed binary integer.

For ALHSIK, the first and third operands are treated as 32-bit unsigned binary integers. For ALGHSIK, the first and third operands are treated as 64-bit unsigned binary integers. For both ALGHSIK and ALHSIK, the second operand is treated as a 16-bit signed binary integer.

When the interlocked-access facility 1 is installed and the first operand of ALGSI or ALSI is aligned on an integral boundary corresponding to its size, then the fetch and store of the first operand is performed as an interlocked update as observed by other CPUs, and a specific-operand-serialization operation is performed. When the interlocked-access facility 1 is not installed, or when the first operand of ADD LOGICAL WITH SIGNED IMMEDIATE (ALSI, ALGSI) is not aligned on an integral boundary corresponding to its size, then the fetch and store of the operand are not performed as an interlocked update.

When the second operand contains a negative value, the condition code is set as though a SUBTRACT LOGICAL operation was performed. Condition code 0 is never set when the second operand is negative.

The displacement is treated as a 20-bit signed binary integer.

Resulting Condition Code:

- 0 Result zero; no carry
- 1 Result not zero; no carry
- 2 Result zero; carry
- 3 Result not zero; carry

Program Exceptions:

- Access (fetch and store, operand 1)
- Operation (ALGSI and ALSI, if the general-instructions-extension facility is not installed; ALGHSIK, and ALHSIK, if the distinct-operands facility is not installed)

Programming Notes:

1. When the second operand contains a negative value, the condition-code setting can also be

interpreted as indicating the presence or absence of a borrow, as follows:

- 1 Result not zero; borrow
- 2 Result zero; no borrow
- 3 Result not zero; no borrow

- 2. Accesses to the first operand of consist in fetching a first-operand from storage and subsequently storing the updated value.

When the interlocked-access facility 1 is not installed, or when the first operand is not aligned on an integral boundary corresponding to its size, the fetch and store accesses to the first operand do not necessarily occur one immediately after the other. Under such conditions, ADD LOGICAL WITH SIGNED IMMEDIATE cannot be safely used to update a location in storage if the possibility exists that another CPU or a channel program may also be updating the location. An example of this effect is shown in "Multiprogramming and Multiprocessing Examples" in Appendix A, "Number Representation and Instruction-Use Examples."

When the interlocked-access facility 1 is installed and the first operand is aligned on an integral boundary corresponding to its size, the operand is accessed using a block-concurrent interlocked update.

- 3. When the second operand is negative, the instruction effectively performs a subtraction operation.

ADD LOGICAL WITH SIGNED IMMEDIATE HIGH

ALSIH R_1, I_2 [RIL-a]

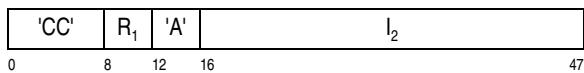

ALSIHN R_1, I_2 [RIL-a]

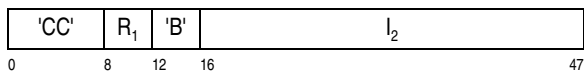

The second operand is added to the first operand, and the sum is placed at the first-operand location. The first operand and the sum are treated as 32-bit

unsigned binary integers. The second operand is treated as a 32-bit signed binary integer. The first operand is in bits 0-31 of general register R₁; bits 32-63 of the register are unchanged.

Resulting Condition Code:

For ALSIH, the code is set as follows:

- 0 Result zero; no carry
- 1 Result not zero; no carry
- 2 Result zero; carry
- 3 Result not zero; carry

For ALSIHN, the code remains unchanged.

Program Exceptions:

- Operation (if the high-word facility is not installed)

Programming Note: See programming notes 1 and 3 for ADD LOGICAL WITH SIGNED IMMEDIATE.

AND

Register-and-register formats:

NR R_1, R_2 [RR]

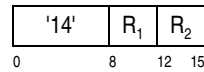

NGR R_1, R_2 [RRE]

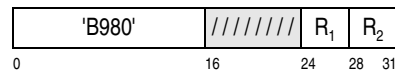

NRK R_1, R_2, R_3 [RRF-a]

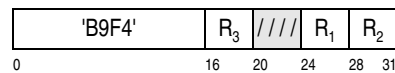

NGRK R_1, R_2, R_3 [RRF-a]

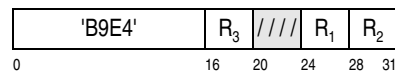

Register-and-storage formats:

N $R_1, D_2(X_2, B_2)$ [RX-a]

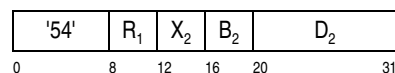



Storage-and-immediate formats:

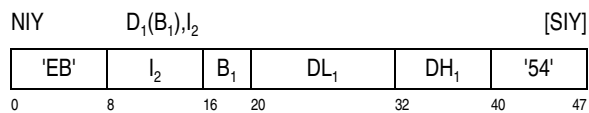
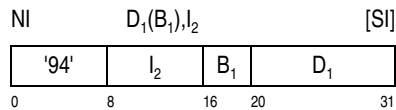

Storage-and-storage format:

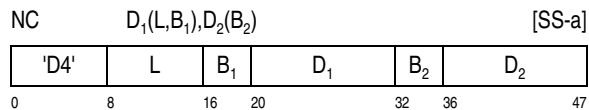

For N, NC, NG, NGR, NI, NIY, NR, and NY, the AND of the first and second operands is placed at the first-operand location. For NGRK and NRK, the AND of the second and third operands is placed at the first-operand location.

The connective AND is applied to the operands bit by bit. The contents of a bit position in the result are set to one if the corresponding bit positions in both operands contain ones; otherwise, the result bit is set to zero.

For AND (NC), each operand is processed left to right. When the operands overlap, the result is obtained as if the operands were processed one byte at a time and each result byte were stored immediately after fetching the necessary operand bytes.

For AND (NI, NIY), the first operand is one byte in length, and only one byte is stored. When the interlocked-access facility 2 is installed, the update of the first operand appears to be an interlocked-update reference as observed by other CPUs and channel programs, and a specific-operand-serialization operation is performed.

For AND (N, NR, NRK, and NY), the operands are 32 bits, and for AND (NG, NGR, and NGRK), they are 64 bits.

The displacements for N, NI, and both operands of NC are treated as 12-bit unsigned binary integers. The displacement for NY, NIY, and NG is treated as a 20-bit signed binary integer.

Resulting Condition Code:

- | | |
|---|-----------------|
| 0 | Result zero |
| 1 | Result not zero |
| 2 | -- |
| 3 | -- |

Program Exceptions:

- Access (fetch, operand 2, N, NY, NG, and NC; fetch and store, operand 1, NI, NIY, and NC)
- Operation (NY and NIY, if the long-displacement facility is not installed; NGRK and NRK, if the distinct-operands facility is not installed)
- Transaction constraint (NC)

Programming Notes:

1. An example of the use of the AND instruction is given in Appendix A, "Number Representation and Instruction-Use Examples."
2. The AND instruction may be used to set a bit to zero.
3. Accesses to the first operand of AND (NC) – and, when the interlocked-access facility 2 is not installed, accesses to the first operand of AND (NI, NIY) – consist in fetching a first-operand byte from storage and subsequently storing the updated value. These fetch and store accesses to a particular byte do not necessarily occur one immediately after the other. Thus, these instructions cannot be safely used to update a location in storage if the possibility exists that another CPU or a channel program may also be updating the location. An example of this effect is shown for OR (OI) in "Multiprogramming and Multiprocessing Examples" on page A-45.

When the interlocked-access facility 2 is installed, AND (NI, NIY) can be safely used to update a location in storage, even if the possibility exists that another CPU or a channel program may also be updating the location.

AND IMMEDIATE

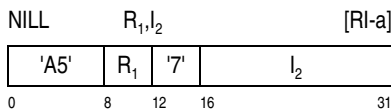
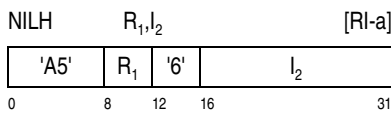
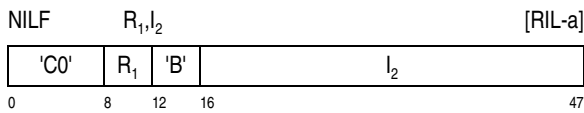
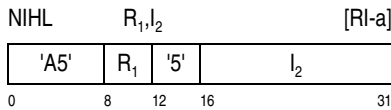
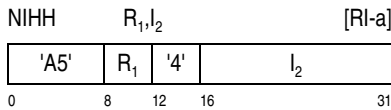
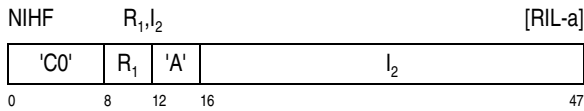

The second operand is ANDed with bits of the first operand, and the result replaces those bits of the first operand. The remainder of the first operand remains unchanged.

For each instruction, the bits of the first operand that are ANDed with the second operand and then replaced are as follows:

Instruction	Bits ANDed and Replaced
NIHF	0-31
NIHH	0-15
NIHL	16-31
NILF	32-63
NILH	32-47
NILL	48-63

The connective AND is applied to the operands bit by bit. The contents of a bit position in the result are set to one if the corresponding bit positions in both oper-

ands contain ones; otherwise, the result bit is set to zero.

Resulting Condition Code:

- 0 Result is zero
- 1 Result is not zero
- 2 --
- 3 --

Program Exceptions:

- Operation (NIHF, NILF, if the extended-immediate facility is not installed)

Programming Note: The setting of the condition code is based only on the bits that are ANDed and replaced.

AND WITH COMPLEMENT

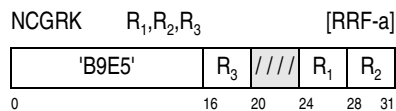
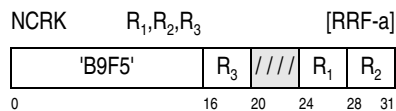

The second operand is ANDed with the bit-wise complement of the third operand and the result is placed in the first-operand location.

The connective AND is applied to the second operand and bit-wise complemented third operand, bit by bit. The contents of a bit position in the result are set to one if the corresponding bit positions in the second and third operands contain one and zero, respectively; otherwise, the result bit is set to zero.

For NCRK, the operands are 32 bits, and for NCGRK, they are 64 bits.

Resulting Condition Code:

- 0 Result zero
- 1 Result not zero
- 2 --
- 3 --

Program Exceptions:

- Operation (if the miscellaneous-instruction-extensions facility 3 is not installed)

Programming Note: This instruction is useful for zeroing selected bits based on a mask.

BRANCH AND LINK

Register-and-register format:

BALR R₁,R₂ [RR]

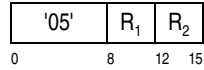

Register-and-storage format:

BAL R₁,D₂(X₂,B₂) [RX-a]

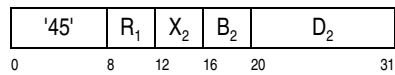

Information from the current PSW, including the updated instruction address, is saved as link information at the first-operand location. Subsequently, the instruction address in the PSW is replaced by the branch address.

The link information in the 24-bit addressing mode consists of the instruction-length code (ILC), the condition code (CC), the program-mask bits, and the rightmost 24 bits of the updated instruction address, arranged in bit positions 32-63 of the first-operand location in the following format:

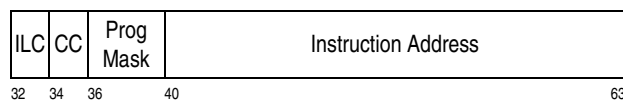

When BRANCH AND LINK is not the target of an execute-type instruction, the ILC is set to 1 for BALR or 2 for BAL. When BRANCH AND LINK is the target of an EXECUTE instruction, the ILC is set to 2. When BRANCH AND LINK is the target of an EXECUTE RELATIVE LONG instruction, the ILC is set to 3.

The link information in the 31-bit addressing mode consists of bit 32 of the PSW, the basic-addressing-mode bit (always a one) and the rightmost 31 bits of the updated instruction address, arranged in bit posi-

tions 32-63 of the first-operand location in the following format:

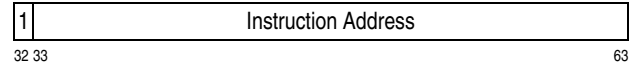

In the 24-bit or 31-bit addressing mode, bits 0-31 of the first-operand location remain unchanged.

The link information in the 64-bit addressing mode consists of the updated instruction address, placed in bit positions 0-63 of the first-operand location.

In the RX format, the second-operand address is used as the branch address. In the RR format, the contents of general register R₂ are used to generate the branch address; however, when the R₂ field is zero, the operation is performed without branching. The branch address is computed before general register R₁ is changed.

Condition Code: The code remains unchanged.

Program Exceptions:

- Trace (R₂ field nonzero, BALR only)
- Transaction constraint

Programming Notes:

1. An example of the use of the BRANCH AND LINK instruction is given in Appendix A, "Number Representation and Instruction-Use Examples."
2. When the R₂ field in the RR format is zero, the link information is loaded without branching.
3. The BRANCH AND LINK instruction (BAL and BALR) is provided for compatibility purposes. It is recommended that, where possible, the BRANCH AND SAVE instruction (BAS and BASR), BRANCH RELATIVE AND SAVE, or BRANCH RELATIVE AND SAVE LONG be used and BRANCH AND LINK avoided, since the latter places nonzero information in bit positions 32-39 of the link register in the 24-bit addressing mode, which may lead to problems. Additionally, in the 24-bit addressing mode, BRANCH AND LINK may be slower than the other instructions because BRANCH AND LINK must construct the ILC, condition code, and program mask to be placed in bit positions 32-39 of the link register.

4. The condition-code and program-mask information, which is provided in the leftmost byte of the link information only in the 24-bit addressing mode, can be obtained in any addressing mode by means of the INSERT PROGRAM MASK instruction.

BRANCH AND SAVE

BASR R_1, R_2 [RR]

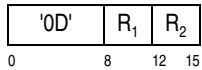

BAS $R_1, D_2(X_2, B_2)$ [RX-a]

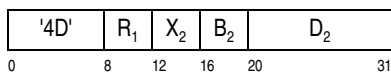

Information from the current PSW, including the updated instruction address, is saved as link information at the first-operand location. Subsequently, the instruction address in the PSW is replaced by the branch address.

In the 24-bit or 31-bit addressing mode, the link information is bits 32 and 97-127 of the PSW, consisting of the basic-addressing-mode bit and the rightmost 31 bits of the updated instruction address. The link information is placed in bit positions 32 and 33-63, respectively, of the first-operand location, and bits 0-31 of the location remain unchanged.

In the 64-bit addressing mode, the link information consists of the updated instruction address, placed in bit positions 0-63 of the first-operand location.

In the RX format, the second-operand address is used as the branch address. In the RR format, the contents of general register R_2 are used to generate the branch address; however, when the R_2 field is zero, the operation is performed without branching. The branch address is computed before general register R_1 is changed.

Condition Code: The code remains unchanged.

Program Exceptions:

- Trace (R_2 field nonzero, BASR only)
- Transaction constraint

Programming Notes:

1. An example of the use of the BRANCH AND SAVE instruction is given in Appendix A, "Number Representation and Instruction-Use Examples."
2. The BRANCH AND SAVE instruction (BAS and BASR) is intended to be used for linkage to programs known to be in the same addressing mode as the caller. This instruction should be used in place of the BRANCH AND LINK instruction (BAL and BALR). See the programming notes on pages 5-15 and 5-18 in the section "Subroutine Linkage without the Linkage Stack" for a detailed discussion of this and other linkage instructions. See also the programming note under BRANCH AND LINK for a discussion of the advantages of the BRANCH AND SAVE instruction.

BRANCH AND SAVE AND SET MODE

BASSM R_1, R_2 [RR]

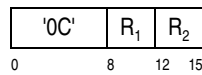

Information from the current PSW, including the updated instruction address, is saved as link information at the first-operand location. Subsequently, if the R_2 field is nonzero, the addressing-mode bits and instruction address in the PSW are replaced as specified by the second operand.

In the 24-bit or 31-bit addressing mode, the link information is bits 32 and 97-127 of the PSW, consisting of the basic-addressing-mode bit and the rightmost 31 bits of the updated instruction address. The link information is placed in bit positions 32 and 33-63, respectively, of the first-operand location, and bits 0-31 of the location remain unchanged. In the 64-bit addressing mode, the link information is the updated instruction address in bits 64-126 of the PSW with a one appended on the right, placed in bit positions 0-63 of the first-operand location.

The contents of general register R_2 specify the new addressing mode and designate the branch address; however, when the R_2 field is zero, the operation is performed without branching and without setting either addressing-mode bit.

When the contents of general register R_2 are used and bit 63 of the register is zero, bit 31 of the current PSW, the extended-addressing-mode bit, is set to zero, bit 32 of the register specifies the new basic addressing mode and replaces bit 32 of the PSW, and the branch address is generated from the contents of the register under the control of the new addressing mode. The branch address replaces the instruction address in the PSW.

In the z/Architecture architectural mode, when the contents of general register R_2 are used and bit 63 of the register is one, the following occurs. Bits 31 and 32 of the current PSW are set to one, the branch address is generated from the contents of the register, except with bit 63 of the register treated as a zero, under the control of the new extended addressing mode, and the branch address replaces the instruction address in the PSW. Bit 63 of the register remains one. However, if R_2 is the same as R_1 , the results in the designated general register are as specified for the R_1 register.

The new value for the PSW is computed before general register R_1 is changed.

In the ESA/390-compatibility mode, when the R_2 field is nonzero and bit 63 of general register R_2 is one, it is unpredictable which of the following occurs:

- The CPU enters the 64-bit addressing mode as described above for the z/Architecture architectural mode.
- Bit 31 of the PSW is set to zero, bit 32 of the register specifies the new basic addressing mode and replaces bit 32 of the PSW, and the branch address is generated from the contents of the register, including bit 63, under the control of the new addressing mode. The branch address replaces the instruction address in the PSW. Subsequently, a late specification exception is recognized due to an odd instruction address.

Condition Code: The code remains unchanged.

Program Exceptions:

- Trace (R_2 field nonzero)
- Transaction constraint

Programming Notes:

1. An example of the use of the BRANCH AND SAVE AND SET MODE instruction is given in Appendix A, “Number Representation and Instruction-Use Examples.”
2. BRANCH AND SAVE AND SET MODE is intended to be the principal calling instruction to subroutines which may operate in a different addressing mode from that of the caller. See the programming notes on pages 5-15 and 5-18 in the section “Subroutine Linkage without the Linkage Stack” for a detailed discussion of this and other linkage instructions.
3. An old 24-bit or 31-bit program can use BRANCH AND SAVE AND SET MODE to call a new 64-bit program without any change, provided that bits 0-31 of general register R_2 are all zeros. The old program can load into bit positions 32-63 of general register R_2 a four-byte address constant, which is provided from outside the program, in which bit 63 in the register (bit 31 of the constant in storage) either is or is not one. If the addressing mode is not changed to the 64-bit mode by the execution of the BRANCH AND SAVE AND SET MODE instruction, or even if it is, the called program can set the 64-bit mode by issuing a SET ADDRESSING MODE (SAM64) instruction.
4. See the programming notes on page 5-15 (under “Simple Branch Instructions”).

BRANCH AND SET MODE

BSM R_1, R_2 [RR]

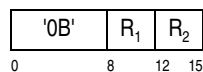

In the 24-bit or 31-bit addressing mode, bit 32 of the current PSW, the basic-addressing-mode bit, is inserted into bit position 32 of the first operand, and bits 0-31 and 33-63 of the operand remain unchanged. In the 64-bit addressing mode, a one is inserted into bit position 63 of the first operand, and bits 0-62 of the operand remain unchanged. Subsequently, the addressing-mode bits and instruction address in the PSW are replaced as specified by the second operand. The action associated with an operand is not performed if the associated R field is zero.

The contents of general register R_2 specify the new addressing mode and designate the branch address; however, when the R_2 field is zero, the operation is performed without branching and without setting either addressing-mode bit.

When the contents of general register R_2 are used and bit 63 of the register is zero, bit 31 of the current PSW, the extended-addressing-mode bit, is set to zero, bit 32 of the register specifies the new basic addressing mode and replaces bit 32 of the PSW, and the branch address is generated from the contents of the register under the control of the new addressing mode. The branch address replaces the instruction address in the PSW.

In the z/Architecture architectural mode, when the contents of general register R_2 are used and bit 63 of the register is one, the following occurs. Bits 31 and 32 of the current PSW are set to one, the branch address is generated from the contents of the register, except with bit 63 of the register treated as a zero, under the control of the new extended addressing mode, and the branch address replaces the instruction address in the PSW. Bit 63 of the register remains one. However, if R_2 is the same as R_1 , the results in the designated general register are as specified for the R_1 register.

The new value for the PSW is computed before general register R_1 is changed.

In the ESA/390-compatibility mode, when the R_2 field is nonzero and bit 63 of general register R_2 is one, it is unpredictable which of the following occurs:

- The CPU enters the 64-bit addressing mode as described above for the z/Architecture architectural mode.
- Bit 31 of the PSW is set to zero, bit 32 of the register specifies the new basic addressing mode and replaces bit 32 of the PSW, and the branch address is generated from the contents of the register, including bit 63, under the control of the new addressing mode. The branch address replaces the instruction address in the PSW. Subsequently, a late specification exception is recognized due to an odd instruction address.

Condition Code: The code remains unchanged.

Program Exceptions:

- Trace
- Transaction constraint

Programming Notes:

1. An example of the use of the BRANCH AND SET MODE instruction is given in Appendix A, “Number Representation and Instruction-Use Examples.”
2. BRANCH AND SET MODE with an R_1 field of zero is intended to be the standard return instruction in a program entered by means of BRANCH AND SAVE AND SET MODE. It can also be the return instruction in a program entered in the 24-bit or 31-bit addressing mode by means of BRANCH AND SAVE, BRANCH RELATIVE AND SAVE, or BRANCH RELATIVE AND SAVE LONG. BRANCH AND SET MODE with a nonzero R_1 field is intended to be used in a “glue module” to connect either old 24-bit programs and newer programs that are executed in the 31-bit addressing mode or old 24-bit or 31-bit programs and new programs that are executed in the 64-bit addressing mode. See the programming notes on pages 5-15 and 5-18 in the section “Subroutine Linkage without the Linkage Stack” for a detailed discussion of this and other linkage instructions.

BRANCH INDIRECT ON CONDITION



The instruction-address in the current PSW is replaced by the branch address if the condition code in the current PSW designates a bit position in the M_1 field containing a one; otherwise, normal instruction sequencing proceeds with the updated instruction address.

The eight-byte second operand in storage is used as the branch address. The branch address is subject to the current addressing mode. All eight bytes of the second operand are accessed, regardless of the addressing mode.

The M_1 field is used as a four-bit mask. The four condition codes (0, 1, 2, and 3) correspond, left to right, with the four bits of the mask, as follows:

Condition Code	0	1	2	3
Instruction Bit Number of Mask	8	9	10	11
Mask Position Value	8	4	2	1

The current condition code is used to select the corresponding mask bit. If the mask bit selected by the condition code is one, the branch is successful. If the mask bit selected is zero, normal instruction sequencing proceeds with the next sequential instruction.

The displacement is treated as a 20-bit signed binary integer.

It is model dependent whether an access exception or PER zero-address-detection event is recognized for the second operand when the condition code in the current PSW designates a bit position in the M_1 field containing a zero.

Condition Code: The code remains unchanged.

Program Exceptions:

- Access (fetch, operand 2)
- Operation (if the miscellaneous-instruction-extensions facility 2 is not installed)
- Transaction constraint

Programming Notes:

1. Unlike other branch-type instructions such as BRANCH ON CONDITION, where PER zero-address detection is not performed on the branch address, a PER zero-address-detection event may be recognized for the second operand of BRANCH INDIRECT ON CONDITION.
2. BRANCH INDIRECT ON CONDITION may be useful in returning to a calling program based on a return address in memory (such as in a program stack or save area).
3. The second operand is fetched using the current DAT and address-space controls in the PSW. However, the branch address that is fetched from the second-operand location is treated as an instruction address and is treated as a real

address in the real mode, as a primary virtual address in the primary-space mode, secondary-space mode, or access-register mode, and as a home virtual address in the home-space mode.

4. The High-Level Assembler provides extended-mnemonic suffixes for BRANCH INDIRECT ON CONDITION as follows:

M_1 Field			Extended Mnemonics	
Decimal	Hex	Binary		
1	1	0001	BIO	—
2	2	0010	BIP	BIH
4	4	0100	BIM	BIL
7	7	0111	BINZ	BINE
8	8	1000	BIZ	BIE
11	B	1011	BINM	BINL
13	D	1101	BINP	BINH
14	E	1110	BINO	—
15	F	1111	BI	—

When an extended mnemonic is coded, the M_1 field must be omitted.

5. BRANCH INDIRECT ON CONDITION may be useful in a table-based branch mechanism.

BRANCH ON CONDITION

BCR M_1, R_2 [RR]

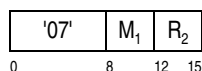

BC $M_1, D_2(X_2, B_2)$ [RX-b]

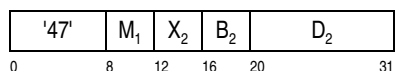

The instruction address in the current PSW is replaced by the branch address if the condition code has one of the values specified by M_1 ; otherwise, normal instruction sequencing proceeds with the updated instruction address.

In the RX format, the second-operand address is used as the branch address. In the RR format, the contents of general register R_2 are used to generate the branch address; however, when the R_2 field is zero, the operation is performed without branching.

The M_1 field is used as a four-bit mask. The four condition codes (0, 1, 2, and 3) correspond, left to right, with the four bits of the mask, as follows:

Condition Code	0	1	2	3
Instruction Bit Number of Mask	8	9	10	11
Mask Position Value	8	4	2	1

The current condition code is used to select the corresponding mask bit. If the mask bit selected by the condition code is one, the branch is successful. If the mask bit selected is zero, normal instruction sequencing proceeds with the next sequential instruction.

When the M_1 and R_2 fields of BRANCH ON CONDITION (BCR) are 1111 binary and 0000 binary, respectively, a serialization and checkpoint-synchronization function is performed. When the fast-BCR-serialization facility is installed and the M_1 and R_2 fields of BRANCH ON CONDITION (BCR) are 1110 binary and 0000 binary, respectively, a serialization function is performed.

Condition Code: The code remains unchanged.

Program Exceptions:

- Transaction constraint

Programming Notes:

1. An example of the use of the BRANCH ON CONDITION instruction is given in Appendix A, "Number Representation and Instruction-Use Examples."
2. When a branch is to depend on more than one condition, the pertinent condition codes are specified in the mask as the sum of their mask position values. A mask of 12, for example, specifies that a branch is to be made when the condition code is 0 or 1.
3. When all four mask bits are zeros or when the R_2 field in the RR format contains zero, the branch instruction is equivalent to a no-operation. When all four mask bits are ones, that is, the mask value is 15, the branch is unconditional unless the R_2 field in the RR format is zero.
4. Execution of BCR 15,0 (that is, an instruction with a value of 07F0 hex) may result in significant performance degradation. To ensure optimum

performance, the program should avoid use of BCR 15,0 except in cases when the serialization or checkpoint-synchronization function is actually required.

When the fast-BCR-serialization facility is installed, and the program only needs the serialization function (without the checkpoint synchronization function), then BCR 14,0 should be used. Depending on the model, this may be faster than BCR 15,0.

5. Note that the relation between the RR and RX formats in branch-address specification is not the same as in operand-address specification. For branch instructions in the RX format, the branch address is the address specified by X_2 , B_2 , and D_2 ; in the RR format, the branch address is contained in the register designated by R_2 . For operands, the address specified by X_2 , B_2 , and D_2 is the operand address, but the register designated by R_2 contains the operand, not the operand address.

BRANCH ON COUNT

Register-and-register formats:

BCTR R_1, R_2 [RR]

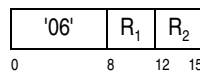

BCTGR R_1, R_2 [RRE]

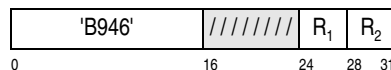

Register-and-storage formats:

BCT $R_1, D_2(X_2, B_2)$ [RX-a]

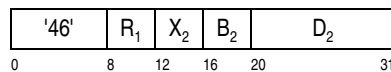

BCTG $R_1, D_2(X_2, B_2)$ [RXY-a]

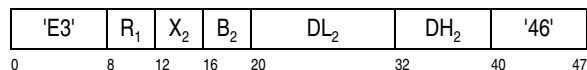

A one is subtracted from the first operand, and the result is placed at the first-operand location. For BRANCH ON COUNT (BCT, BCTR), the first operand and result are treated as 32-bit binary integers, with overflow ignored. For BRANCH ON COUNT

(BCTG, BCTGR), the first operand and result are treated as 64-bit binary integers, with overflow ignored. When the result is zero, normal instruction sequencing proceeds with the updated instruction address. When the result is not zero, the instruction address in the current PSW is replaced by the branch address.

In the RX or RXY format, the second-operand address is used as the branch address. In the RR or RRE format, the contents of general register R_2 are used to generate the branch address; however, when the R_2 field is zero, the operation is performed without branching. The branch address is generated before general register R_1 is changed.

Condition Code: The code remains unchanged.

Program Exceptions:

- Transaction constraint

Programming Notes:

1. An example of the use of the BRANCH ON COUNT instruction is given in Appendix A, "Number Representation and Instruction-Use Examples."
2. The first operand and result can be considered as either signed or unsigned binary integers since the result of a binary subtraction is the same in both cases.
3. An initial count of one results in zero, and no branching takes place; an initial count of zero results in -1 and causes branching to be performed; an initial count of -1 results in -2 and causes branching to be performed; and so on. In a loop, branching takes place each time the instruction is executed until the result is again zero. Note that for BCT or BCTR, because of the number range, an initial count of -2^{31} results in a positive value of $2^{31} - 1$, or, for BCTG or BCTGR, an initial count of -2^{63} results in a positive value of $2^{63} - 1$.
4. Counting is performed without branching when the R_2 field in the RR or RRE format contains zero.

BRANCH ON INDEX HIGH

BXH $R_1, R_3, D_2(B_2)$ [RS-a]

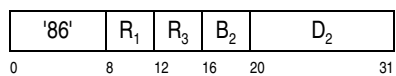

BXHG $R_1, R_3, D_2(B_2)$ [RSY-a]

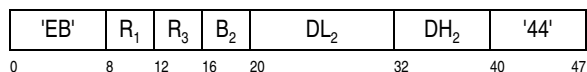

BRANCH ON INDEX LOW OR EQUAL

BXLE $R_1, R_3, D_2(B_2)$ [RS-a]

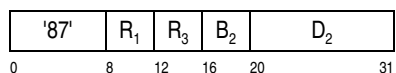

BXLEG $R_1, R_3, D_2(B_2)$ [RSY-a]

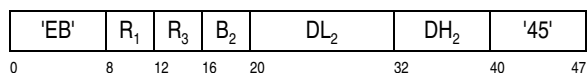

An increment is added to the first operand, and the sum is compared with a compare value. The result of the comparison determines whether branching occurs. Subsequently, the sum is placed at the first-operand location. The second-operand address is used as a branch address. The R_3 field designates registers containing the increment and the compare value.

For BRANCH ON INDEX HIGH, when the sum is high, the instruction address in the current PSW is replaced by the branch address. When the sum is low or equal, normal instruction sequencing proceeds with the updated instruction address.

For BRANCH ON INDEX LOW OR EQUAL, when the sum is low or equal, the instruction address in the current PSW is replaced by the branch address. When the sum is high, normal instruction sequencing proceeds with the updated instruction address.

When the R_3 field is even, it designates a pair of registers; the contents of the even and odd registers of the pair are used as the increment and the compare value, respectively. When the R_3 field is odd, it designates a single register, the contents of which are used as both the increment and the compare value.

For purposes of the addition and comparison, all operands and results are treated as 32-bit signed binary integers for BXH and BXLE or as 64-bit signed binary integers for BXHG and BXLEG. Overflow caused by the addition is ignored.

The original contents of the compare-value register are used as the compare value even when that register is also specified to be the first-operand location. The branch address is generated before general register R_1 is changed.

The sum is placed at the first-operand location, regardless of whether the branch is taken.

Condition Code: The code remains unchanged.

Program Exceptions:

- Transaction constraint

Programming Notes:

1. Several examples of the use of the BRANCH ON INDEX HIGH and BRANCH ON INDEX LOW OR EQUAL instructions are given in Appendix A, “Number Representation and Instruction-Use Examples.”
2. The word “index” in the names of these instructions indicates that one of the major purposes is the incrementing and testing of an index value. The increment, being a signed binary integer, may be used to increase or decrease the value in general register R_1 by an arbitrary amount, subject to the limit of the integer size.
3. Care must be taken in the 31-bit addressing mode when a data area in storage is at the right-most end of a 31-bit address space and a BRANCH ON INDEX HIGH (BXH) or BRANCH ON INDEX LOW OR EQUAL (BXLE) instruction is used to step upward through the data. Since the addition and comparison operations performed during the execution of these instructions treat the operands as 32-bit signed binary integers, the value following $2^{31} - 1$ is not 2^{31} , which cannot be represented in that format, but -2^{31} . The instruction does not provide an indication of such overflow. Consequently, some common looping techniques based on the use of these instructions do not work when a data area ends

at address $2^{31} - 1$. This problem is illustrated in a BRANCH ON INDEX LOW OR EQUAL example in Appendix A, “Number Representation and Instruction-Use Examples.” A similar caution applies in the 64-bit addressing mode when data is at the end of a 64-bit address space and BRANCH ON INDEX HIGH (BXHG) or BRANCH ON INDEX LOW OR EQUAL (BXLEG) is used.

BRANCH PREDICTION PRELOAD

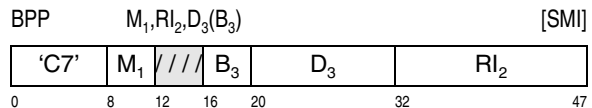

BRANCH PREDICTION RELATIVE PRELOAD

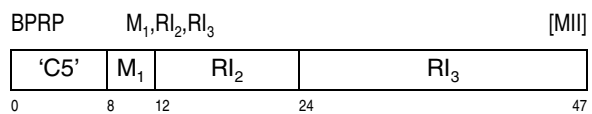

Subject to the controls in the M_1 field, the CPU is provided with information about a branch or execute-type instruction designated by the second operand. The predicted target address of the designated instruction is specified by the third operand.

The contents of the RI_2 field are a signed binary integer specifying the number of halfwords that is added to the address of the current instruction to generate the address of a branch, or execute-type instruction. For BRANCH PREDICTION PRELOAD, the RI_2 field contains a signed 16-bit integer. For BRANCH PREDICTION RELATIVE PRELOAD, the RI_2 field contains a signed 12-bit integer.

When adding the number of halfwords specified in the RI_2 field to the address of the current instruction, the result is subject to the current addressing mode. That is, the result is treated as a 24-bit address in the 24-bit addressing mode, a 31-bit address in the 31-bit addressing mode, or a 64-bit address in the 64-bit addressing mode.

The M_1 field contains a 4-bit unsigned binary integer that is used as a code to signal the CPU attributes of

the instruction designated by the second operand. The codes are as follows:

Code	Meaning
0	The instruction is a branch instruction that is 4 bytes in length. The branch instruction is not used for calling linkage or a returning linkage and there may be multiple potential targets of this branch instruction.
1-4	Reserved.
5	The instruction is a branch instruction that is 2 bytes in length. The branch instruction is used for calling linkage and there is only one target of this branch instruction.
6	The instruction is a branch instruction that is 2 bytes in length. The branch instruction is used for returning linkage.
7	The instruction is a branch instruction that is 2 bytes in length. The branch instruction is used for calling linkage and there may be multiple potential targets of this branch instruction.
8	The instruction is a branch instruction that is 4 bytes in length. The branch instruction is not used for calling linkage or returning linkage and there is only one target of this branch instruction.
9	The instruction is a branch instruction that is 4 bytes in length. The branch instruction is used for calling linkage and there is only one target of the branch instruction.
10	The instruction is a branch instruction that is 4 bytes in length. The branch instruction is used for returning linkage.
11	The instruction is a branch instruction that is 4 bytes in length. The branch instruction is used for calling linkage and there may be multiple potential targets of this branch instruction.
12	The instruction is a branch instruction that is 6 bytes in length. The branch instruction is not used for calling linkage or returning linkage and there is only one target of this branch instruction.
13	The instruction is a branch instruction that is 6 bytes in length. The branch instruction is used for calling linkage and there is only one target of this branch instruction.
14	The instruction is an EXECUTE instruction.
15	The instruction is an EXECUTE RELATIVE LONG instruction.

For BRANCH PREDICTION PRELOAD when the M_1 field specifies a branch instruction, the third operand address is the predicted branch-target address of the

instruction designated by the second operand. For BRANCH PREDICTION PRELOAD when the M_1 field specifies an execute-type instruction, the third operand address is the execute-target address of the instruction designated by the second operand.

For BRANCH PREDICTION RELATIVE PRELOAD, when the M_1 field specifies a branch instruction, the contents of the RI_3 field are a 24-bit signed binary integer specifying the number of halfwords that is added to the address of the BRANCH PREDICTION RELATIVE PRELOAD instruction to generate the branch-target address of the instruction designated by the second operand. For BRANCH PREDICTION RELATIVE PRELOAD, when the M_1 field specifies an execute-type instruction, the contents of the RI_3 field are a 24-bit signed binary integer specifying the number of halfwords that is added to the address of the BRANCH PREDICTION RELATIVE PRELOAD instruction to generate the execute-target address of the instruction designated by the second operand. When adding the number of halfwords specified by the RI_3 field to the address of the BRANCH PREDICTION RELATIVE PRELOAD instruction, the result is subject to the current addressing mode. That is, the result is treated as a 24-bit address in the 24-bit addressing mode, a 31-bit address in the 31-bit addressing mode, or a 64-bit address in the 64-bit addressing mode.

When the boundary of the third operand of BRANCH PREDICTION PRELOAD is not on a halfword boundary, it is model dependent whether the instruction acts as a no-operation.

Depending on the model, the CPU may not implement all of the branch-attribute codes. For codes that are not recognized by the CPU, and for reserved codes, the instruction acts as a no-operation.

The second and third operand addresses are instruction or effective addresses, not logical addresses. No access exceptions are recognized for the second or third operands. For BRANCH PREDICTION PRELOAD, there is no specification exception when the third operand specifies an odd address.

Condition Code: The code remains unchanged.

Program Exceptions:

- Operation (if the execution-hint facility is not installed)

Programming Notes:

1. In the absence of any branch-history information observed during program execution or provided by BPP or BPRP, current processor models that implement branch-prediction logic assume that the following operations represent conditional branches that are taken (that is, branches that update the PSW instruction address):

- BAL, BAS, BCT, BCTG, BRAS, BRASL, BRCT, BRCTG, BRCTH, BRXLE, BRXLG, BXLE, and BXLEG
- BALR, BASR, BCTGR, and BCTR, when the R₂ field is nonzero
- BC, BIC, BRC, and BRCL, when the mask field is 1111 binary
- BCR, when both the mask field is 1111 binary and the R₂ field is nonzero

Similarly, for the purposes of branch prediction, the following operations are assumed to represent conditional branches that are not taken:

- BC, BIC, BRC, and BRCL, when the mask field is between 0001 and 1110 binary, inclusive
- BCR, when both the mask field is between 0001 and 1110 binary, inclusive, and the R₂ field is nonzero
- BRXH, BRXHG, BXH, and BXHG
- CGIB, CGIJ, CGRB, CGRJ, CIB, CIJ, CLGIB, CLGIJ, CLGRB, CLGRJ, CLIB, CLIJ, CLRB, CLRJ, CRB, and CRJ, when bits 0-2 of the mask field are between 001 and 110 binary

Additionally, for the purposes of branch-prediction, the following operations are not considered to be branches.

- BALR, BASR, BCTGR, and BCTR, when the R₂ field is zero
- BC, BIC, BRC, and BRCL, when the mask field is 0000 binary
- BCR, when either the mask field is 0000 binary or the R₂ field is zero

The predictive behavior of conditional-branching operations not listed above is model dependent.

The BPP and BPRP instructions provide a means by which the program can influence the branch-history logic, informing the CPU that the branching instruction designated by the second operand is expected to be a taken branch,

regardless of the assumed behavior described above.

2. BRANCH PREDICTION PRELOAD and BRANCH PREDICTION RELATIVE PRELOAD inform the CPU of a branch instruction and its predicted target, but this does not guarantee that the CPU will necessarily retain or use this branch-prediction information.
3. If a CPU retains the specified branch-prediction information, it is model dependent how long the information is retained.
4. Figure 7-3 shows the branch-prediction codes and their most-common usage. Refer to the definition of the codes on page 7-43 for a complete explanation of the codes and their respective meanings.

M ₁ Code Value	IL	Corresponding Branch Instruction(s) by Mnemonic	Usage Type
0	4	BC ² , BIC ²	Branch table
1		(none - code is reserved)	
2		(none - code is reserved)	
3		(none - code is reserved)	
4		(none - code is reserved)	
5	2	BALR ¹ , BASR ¹ , BCR ^{1,2}	Static calling linkage
6	2	BCR ^{1,2}	Returning linkage
7	2	BALR ¹ , BASR ¹ , BCR ^{1,2}	Dynamic calling linkage
8	4	BC ² , BIC ² , BCT, BRXH, BRXLE, BXH, BXLE, BRC ² , BRCT, BRCTG, BCTGR ¹	Conditional or unconditional branches
9	4	BAL, BAS, BRAS	Static calling linkage
10	4	BC ³ , BIC ²	unconditional returning linkage
11	4	BAL, BAS,	Dynamic calling linkage
12	6	BRCTH, BRCL ² , BCTG, BXHG, BXLEG, BRXHG, BRXLG, CGRJ ² , CLGRJ ² , CRJ ² , CLRJ ² , CGIJ ² , CLGIJ ² , CIJ ² , CLIJ ² , CGRB ² , CLGRB ² , CRB ² , CLRB ² , CGIB ² , CLGIB ² , CIB ² , CLIB ²	Conditional or unconditional branches
13	6	BRASL	Static calling linkage
14	4	EX	
15	6	EXRL	

Figure 7-3. Branch-Prediction Codes and Most-Common Usage (Part 1 of 2)

M ₁ Code Value	IL	Corresponding Branch Instruction(s) by Mnemonic	Usage Type
Explanation:			
IL		Instruction length	
¹		When the R ₂ field is not zero.	
²		When the mask field is not zero.	
³		When the mask field is 1111 binary.	
Notes:			
1.		A usage type of <i>branch table</i> indicates an instruction that is used to branch to a table of other instructions. An example is the "B BR_TBL(15)" instruction shown in programming note 3 for "TRANSLATE AND TEST EXTENDED" on page 7-410.	
2.		A usage type of <i>linkage</i> designates an instruction that calls or returns from a subroutine, as described in "Subroutine Linkage without the Linkage Stack" on page 5-14. Static calling linkage indicates a branch whose target location is a single location that is not changed by the program during execution. Dynamic calling linkage indicates a branch whose target location may be one of many locations that is determined by the program during execution.	

Figure 7-3. Branch-Prediction Codes and Most-Common Usage (Part 2 of 2)

- Performance degradation may occur for any of the following:
 - The RI₂ field is zero or the second operand designates an instruction that is not a branch instruction or execute-type instruction.
 - The RI₂ and M₁ fields designate a branch instruction and the branch is not taken.
 - The M₁ field designates a code specifying an incorrect length, instruction or usage type for the instruction designated by the second operand as shown by programming note 4.
 - The M₁ field designates a code specifying that the instruction designated by the second operand is a calling-linkage instruction, however there is no direct returning-linkage instruction. That is, the returning-linkage instruction is executed from a nested use of calling and returning subroutine linkage.
 - For BRANCH PREDICTION PRELOAD, the third operand specifies an odd address or designates an incorrect branch-target for the instruction designated by the second operand. For BRANCH PREDICTION RELATIVE PRELOAD, the RI₃ field designates an incorrect branch-target for the instruction designated by the RI₂ field.

- BRANCH PREDICTION PRELOAD or BRANCH PREDICTION RELATIVE PRELOAD are the target of an execute-type instruction.

- Other than the performance implications described in the preceding note, the use of BPP or BPRP in a program does not change the execution sequence from that of a program that does not use BPP or BPRP.

BRANCH RELATIVE AND SAVE

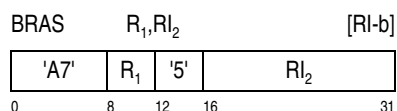

BRANCH RELATIVE AND SAVE LONG

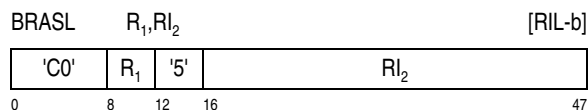

Information from the current PSW, including the updated instruction address, is saved as link information at the first-operand location. Subsequently, the instruction address in the PSW is replaced by the branch address.

In the 24-bit or 31-bit addressing mode, the link information is bits 32 and 97-127 of the PSW, consisting of the basic-addressing-mode bit and the rightmost 31 bits of the updated instruction address. The link information is placed in bit positions 32 and 33-63, respectively, of the first-operand location, and bits 0-31 of the location remain unchanged.

In the 64-bit addressing mode, the link information consists of the updated instruction address, placed in bit positions 0-63 of the first-operand location.

The contents of the RI₂ field are a signed binary integer specifying the number of halfwords that is added to the address of the instruction to generate the branch address.

Condition Code: The code remains unchanged.

Program Exceptions:

- Transaction constraint

Programming Notes:

1. The operation is the same as that of the BRANCH AND SAVE (BAS) instruction except for the means of specifying the branch address. An example of the use of BRANCH AND SAVE is given in Appendix A, “Number Representation and Instruction-Use Examples.”
2. The BRANCH RELATIVE AND SAVE and BRANCH RELATIVE AND SAVE LONG instructions, like the BRANCH AND SAVE instruction, are intended to be used for linkage to programs known to be in the same addressing mode as the caller. These instructions should be used in place of the BRANCH AND LINK instruction (BAL and BALR). See the programming notes on pages 5-15 and 5-18 in the section “Subroutine Linkage without the Linkage Stack” for a detailed discussion of these and other linkage instructions. See also the programming note under BRANCH AND LINK for a discussion of the advantages of the BRANCH RELATIVE AND SAVE, BRANCH RELATIVE AND SAVE LONG, and BRANCH AND SAVE instructions.
3. When the instruction is the target of an execute-type instruction, the branch is relative to the target address; see “Branch-Address Generation” on page 5-12.

BRANCH RELATIVE ON CONDITION

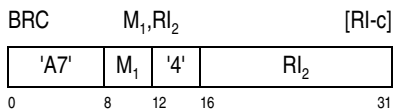

BRANCH RELATIVE ON CONDITION LONG

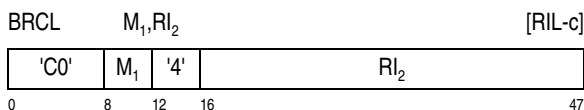

The instruction address in the current PSW is replaced by the branch address if the condition code has one of the values specified by M_1 ; otherwise, nor-

mal instruction sequencing proceeds with the updated instruction address.

The contents of the RI_2 field are a signed binary integer specifying the number of halfwords that is added to the address of the instruction to generate the branch address.

The M_1 field is used as a four-bit mask. The four condition codes (0, 1, 2, and 3) correspond, left to right, with the four bits of the mask, as follows:

Condition Code	0	1	2	3
Instruction Bit Number of Mask	8	9	10	11
Mask Position Value	8	4	2	1

The current condition code is used to select the corresponding mask bit. If the mask bit selected by the condition code is one, the branch is successful. If the mask bit selected is zero, normal instruction sequencing proceeds with the next sequential instruction.

Condition Code: The code remains unchanged.

Program Exceptions:

- Transaction constraint

Programming Notes:

1. The operation is the same as that of the BRANCH ON CONDITION instruction except for the means of specifying the branch address. An example of the use of BRANCH ON CONDITION is given in Appendix A, “Number Representation and Instruction-Use Examples.”
2. When a branch is to depend on more than one condition, the pertinent condition codes are specified in the mask as the sum of their mask position values. A mask of 12, for example, specifies that a branch is to be made when the condition code is 0 or 1.
3. When all four mask bits are zeros, the branch instruction is equivalent to a no-operation. When all four mask bits are ones, that is, the mask value is 15, the branch is unconditional.
4. When the instruction is the target of an execute-type instruction, the branch is relative to the target address; see “Branch-Address Generation” on page 5-12.

BRANCH RELATIVE ON COUNT

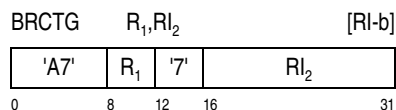
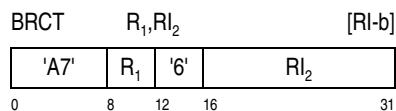

BRANCH RELATIVE ON COUNT HIGH

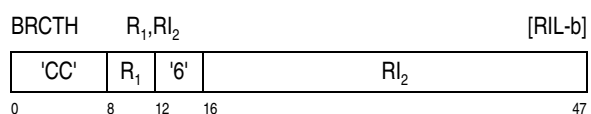

A one is subtracted from the first operand, and the result is placed at the first-operand location. For BRANCH RELATIVE ON COUNT (BRCT), the first operand and result are treated as 32-bit binary integers in bits 32-63 of general register R_1 , with overflow ignored; bits 0-31 of the register are unchanged. For BRANCH RELATIVE ON COUNT HIGH (BRCTH), the first operand and result are treated as 32-bit binary integers in bits 0-31 of general register R_1 , with overflow ignored; bits 32-63 of the register are unchanged. For BRANCH RELATIVE ON COUNT (BRCTG), the first operand and result are treated as 64-bit binary integers, with overflow ignored. When the result is zero, normal instruction sequencing proceeds with the updated instruction address. When the result is not zero, the instruction address in the current PSW is replaced by the branch address.

The contents of the RI_2 field are a signed binary integer specifying the number of halfwords that is added to the address of the instruction to generate the branch address.

Condition Code: The code remains unchanged.

Program Exceptions:

- Operation (BRCTH, if the high-word facility is not installed)
- Transaction constraint

Programming Notes:

1. The operation is the same as that of the BRANCH ON COUNT instruction except for the means of specifying the branch address. An example of the use of BRANCH ON COUNT is given in Appendix A, "Number Representation and Instruction-Use Examples."
2. The first operand and result can be considered as either signed or unsigned binary integers since the result of a binary subtraction is the same in both cases.
3. An initial count of one results in zero, and no branching takes place; an initial count of zero results in -1 and causes branching to be executed; an initial count of -1 results in -2 and causes branching to be executed; and so on. In a loop, branching takes place each time the instruction is executed until the result is again zero. Note that for BRCT, because of the number range, an initial count of -2^{31} results in a positive value of $2^{31} - 1$, or, for BRCTG, an initial count of -2^{63} results in a positive value of $2^{63} - 1$.
4. When the instruction is the target of an execute-type instruction, the branch is relative to the target address; see "Branch-Address Generation" on page 5-12.

BRANCH RELATIVE ON INDEX HIGH

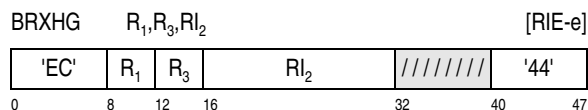
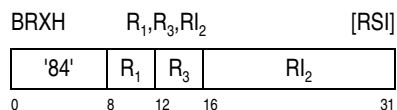

BRANCH RELATIVE ON INDEX LOW OR EQUAL

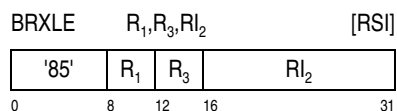

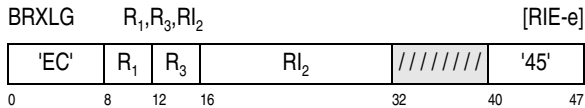

An increment is added to the first operand, and the sum is compared with a compare value. The result of the comparison determines whether branching occurs. Subsequently, the sum is placed at the first-operand location. The R_3 field designates registers containing the increment and the compare value.

The contents of the RI_2 field are a signed binary integer specifying the number of halfwords that is added to the address of the instruction to generate the branch address.

For BRANCH RELATIVE ON INDEX HIGH, when the sum is high, the instruction address in the current PSW is replaced by the branch address. When the sum is low or equal, normal instruction sequencing proceeds with the updated instruction address.

For BRANCH RELATIVE ON INDEX LOW OR EQUAL, when the sum is low or equal, the instruction address in the current PSW is replaced by the branch address. When the sum is high, normal instruction sequencing proceeds with the updated instruction address.

When the R_3 field is even, it designates a pair of registers; the contents of the even and odd registers of the pair are used as the increment and the compare value, respectively. When the R_3 field is odd, it designates a single register, the contents of which are used as both the increment and the compare value.

For purposes of the addition and comparison, all operands and results are treated as 32-bit signed binary integers for BRXH and BRXLE or as 64-bit signed binary integers for BRXHG and BRXLG. Overflow caused by the addition is ignored.

The original contents of the compare-value register are used as the compare value even when that register is also specified to be the first-operand location.

The sum is placed at the first-operand location, regardless of whether the branch is taken.

Condition Code: The code remains unchanged.

Program Exceptions:

- Transaction constraint

Programming Notes:

1. The operations are the same as those of the BRANCH ON INDEX HIGH and BRANCH ON INDEX LOW OR EQUAL instructions except for the means of specifying the branch address. Several examples of the use of BRANCH ON INDEX HIGH and BRANCH ON INDEX LOW OR EQUAL are given in Appendix A, "Number Representation and Instruction-Use Examples."
2. The word "index" in the names of these instructions indicates that one of the major purposes is the incrementing and testing of an index value. The increment, being a signed binary integer, may be used to increase or decrease the value in general register R_1 by an arbitrary amount.
3. Care must be taken in the 31-bit addressing mode when a data area in storage is at the right-most end of an address space and a BRANCH RELATIVE ON INDEX HIGH (BRXH) or BRANCH RELATIVE ON INDEX LOW OR EQUAL (BRXLE) instruction is used to step upward through the data. Since the addition and comparison operations performed during the execution of these instructions treat the operands as 32-bit signed binary integers, the value following $2^{31} - 1$ is not 2^{31} , which cannot be represented in that format, but -2^{31} . The instruction does not provide an indication of such overflow. Consequently, some common looping techniques based on the use of these instructions do not work when a data area ends at address $2^{31} - 1$. This problem is illustrated in a BRANCH ON INDEX LOW OR EQUAL example in Appendix A, "Number Representation and Instruction-Use Examples." A similar caution applies in the 64-bit addressing mode when data is at the end of a 64-bit address space and BRANCH RELATIVE ON INDEX HIGH (BRXHG) or BRANCH RELATIVE ON INDEX LOW OR EQUAL (BRXLG) is used.
4. When the instruction is the target of an execute-type instruction, the branch is relative to the target address; see "Branch-Address Generation" on page 5-12.

CHECKSUM

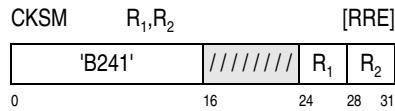

Successive four-byte elements of the second operand are added to the first operand in bit positions 32-63 of general register R_1 to form a 32-bit checksum in those bit positions. The first operand and the four-byte elements are treated as 32-bit unsigned binary integers. After each addition of an element, a carry out of bit position 32 of the first operand is added to bit position 63 of the first operand. Bits 0-31 of general register R_1 always remain unchanged. If the second operand is not a multiple of four bytes, its last one, two, or three bytes are treated as appended on the right with the number of all-zeros bytes needed to form a four-byte element. The four-byte elements are added to the first operand until either the entire second operand or a CPU-determined amount of the second operand has been processed. The result is indicated in the condition code.

The R_2 field designates an even-odd pair of general registers and must designate an even-numbered register; otherwise, a specification exception is recognized.

The location of the leftmost byte of the second operand is specified by the contents of the R_2 general register. The number of bytes in the second-operand location is specified by the 32-bit or 64-bit unsigned binary integer in the $R_2 + 1$ general register.

The handling of the address in general register R_2 and the length in general register $R_2 + 1$ is dependent on the addressing mode. In the 24-bit addressing mode, the contents of bit positions 40-63 of general register R_2 constitute the address, and the contents of bit positions 0-39 are ignored. In the 31-bit addressing mode, the contents of bit positions 33-63 of the register constitute the address, and the contents of bit positions 0-32 are ignored. In the 64-bit addressing mode, the contents of bit positions 0-63 of the register constitute the address. In the 24-bit or 31-bit addressing mode, the length is a 32-bit unsigned binary integer in bit positions 32-63 of general register $R_2 + 1$, and the contents of bit positions 0-31 are ignored. In the 64-bit addressing mode, the length is a 64-bit unsigned binary integer in the register.

The addition of second-operand four-byte elements to the first operand proceeds left to right, four-byte element by four-byte element, and ends as soon as (1) the entire second operand has been processed or (2) a lesser CPU-determined amount of the second operand has been processed. In either case, the result in bit positions 32-63 of general register R_1 is a 32-bit checksum for the part of the second operand that has been processed. When the second operand is not a multiple of four bytes, the final second-operand bytes in excess of a multiple of four are conceptually appended on the right with an appropriate number of all-zeros bytes to form the final four-byte element.

If the operation ends because the entire second operand has been processed, the condition code is set to 0. If the operation ends because a lesser CPU-determined amount of the second operand has been processed, the condition code is set to 3. When the operation is to end with a setting of condition code 3, any carry out of bit position 32 of the first operand is added to bit position 63 of the first operand before the operation ends.

At the completion of the operation, the 32-bit or 64-bit operand-length field in the $R_2 + 1$ register is decremented by the number of actual second-operand bytes added to the first operand (not including any conceptually appended all-zeros bytes), and the address in the R_2 register is incremented by the same number. Thus, the 32-bit or 64-bit operand-length field contains a zero value if the condition code is set to 0, or it contains a nonzero value if the condition code is set to 3. In the 24-bit or 31-bit addressing mode, bits 0-31 of the $R_2 + 1$ register always remain unchanged.

When condition code 3 is set, the general registers used by the instruction have been set so that the remainder of the second operand can be processed by simply branching back to reexecute the instruction.

The amount of processing that results in the setting of condition code 3 is determined by the CPU on the basis of improving system performance, and it may be a different amount each time the instruction is executed. The minimum amount is four bytes or the number of bytes specified in the $R_2 + 1$ general register, whichever is smaller.

At the completion of the operation in the 24-bit or 31-bit addressing mode, the leftmost bits which are

not part of the address in bit positions 32-63 of general register R_2 may be set to zeros or may remain unchanged, even when the initial length in register $R_2 + 1$ is zero. Bits 0-31 of general register R_2 remain unchanged.

When the R_1 register is the same register as the R_2 or $R_2 + 1$ register, the results are unpredictable.

Access exceptions for the portion of the second operand to the right of the last byte processed may or may not be recognized. For a second operand longer than 4K bytes, access exceptions are not recognized for locations more than 4K bytes beyond the last byte processed.

Access exceptions are not recognized if the R_2 field is odd. When the length of the second operand is zero, no access exceptions are recognized.

Resulting Condition Code:

- 0 Entire second operand processed
- 1 --
- 2 --
- 3 CPU-determined amount of the second operand processed

Program Exceptions:

- Access (fetch, operand 2)
- Specification
- Transaction constraint

Programming Notes:

1. The initial contents of bit positions 32-63 of the R_1 general register contribute to the 32-bit checksum. The program normally should set those contents to all zeros before issuing the CHECKSUM instruction.
2. A 16-bit checksum is used in, for example, the TCP/IP application. The following program can be executed after the CHECKSUM instruction to produce in bit positions 32-63 of general register R_2 a 16-bit checksum from the 32-bit checksum in bit positions 32-63 of general register R_1 . The program is annotated to show the contents of bit positions 32-63 of the R_2 and $R_2 + 1$ registers after the execution of each instruction. The con-

tents of bit positions 32-63 of the R_1 register are represented as A,B, meaning the value A in bit positions 32-47 and the value B in bit positions 48-63. The value C is a carry from $A + B$. Note that bit positions 32-63 of register $R_2 + 1$ are known to contain all zeros when CHECKSUM has set condition code 0.

Program		R_2 Bits 32-63	$R_2 + 1$ Bits 32-63
LR	R_2, R_1	A,B	0,0
SRDL	$R_2, 16$	0,A	B,0
ALR	$R_2, R_2 + 1$	B,A	B,0
ALR	R_2, R_1	$A+B+C, A+B$	B,0
SRL	$R_2, 16$	0,A+B+C	B,0

3. The CHECKSUM instruction may be used in computing hash values as illustrated in the following programming example. The variable KEY contains a string to be mapped into a slot in a hash table. The variable SIZE is a prime number designating the size of the hash table. The value of SIZE is determined by (a) the number of strings to be hashed into the table divided by the acceptable number of hash collisions, and (b) a value that is not too close to a power of two. Following the DIVIDE (D) instruction, the remainder in register 0 represents the resulting hash value.

SR	1,1	Zero accumulator
LA	2,KEY	Point to string
LA	3,L'KEY	Load string length
LOOP	CKSM 1,2	Compute checksum
	BNZ LOOP	Repeat if not done
SR	0,0	Zero for divide
D	0,SIZE	Compute hash value
	...	
KEY	DS CL64	String to be hashed
SIZE	DS F	Size of hash table

4. In the access-register mode, access register 0 designates the primary address space regardless of the contents of access register 0.
5. The storage-operand references of CHECKSUM may be multiple-access references. (See "Storage-Operand Consistency" on page 5-125.)
6. Figure 7-4 on page 7-51 contains a summary of the operation.

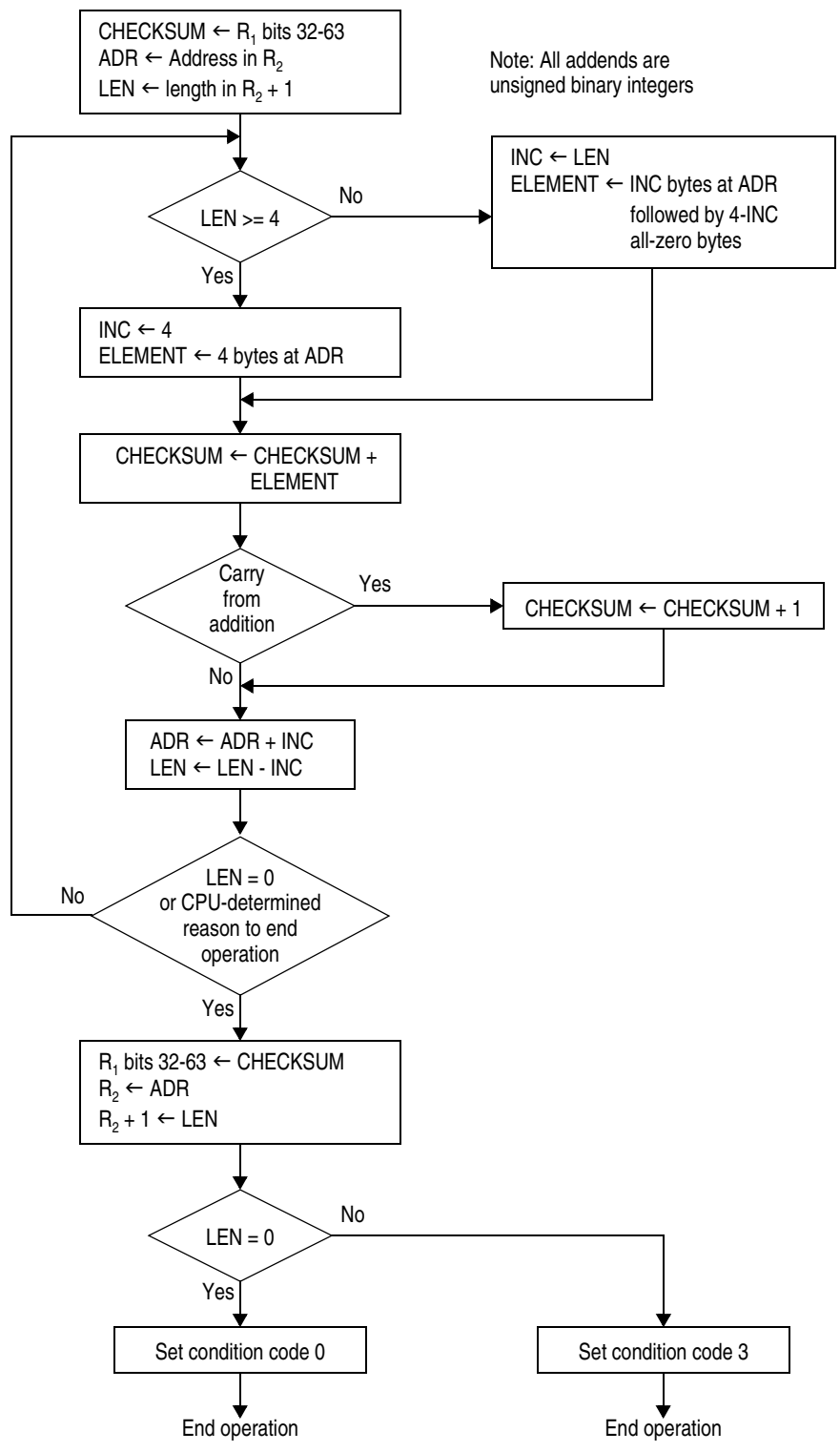
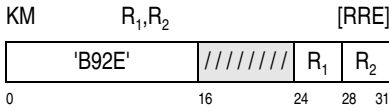
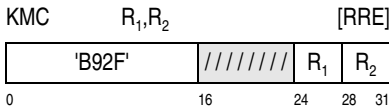

Figure 7-4. Execution of CHECKSUM

CIPHER MESSAGE



CIPHER MESSAGE WITH CHAINING



A function specified by the function code in general register 0 is performed.

Bits 16-23 of the instruction are ignored.

Bit positions 57-63 of general register 0 contain the function code. Figure 7-5 and 7-6 show the assigned function codes for CIPHER MESSAGE and CIPHER MESSAGE WITH CHAINING, respectively. All other function codes are unassigned. For cipher functions, bit 56 is the modifier bit which specifies whether an encryption or a decryption operation is to be performed. The modifier bit is ignored for all other functions. All other bits of general register 0 are ignored.

General register 1 contains the logical address of the leftmost byte of the parameter block in storage. In the 24-bit addressing mode, the contents of bit positions 40-63 of general register 1 constitute the address, and the contents of bit positions 0-39 are ignored. In the 31-bit addressing mode, the contents of bit positions 33-63 of general register 1 constitute the address, and the contents of bit positions 0-32 are ignored. In the 64-bit addressing mode, the contents of bit positions 0-63 of general register 1 constitute the address.

The function codes for CIPHER MESSAGE are as follows.

Code	Function	Parm. Block Size (bytes)	Data Block Size (bytes)
0	KM-Query *	16	—
1	KM-DEA *	8	8
2	KM-TDEA-128 *	16	8
3	KM-TDEA-192 *	24	8
9	KM-Encrypted-DEA	32	8
10	KM-Encrypted-TDEA-128	40	8
11	KM-Encrypted-TDEA-192	48	8
18	KM-AES-128 *	16	16
19	KM-AES-192 *	24	16
20	KM-AES-256 *	32	16
26	KM-Encrypted-AES-128	48	16
27	KM-Encrypted-AES-192	56	16
28	KM-Encrypted-AES-256	64	16
50	KM-XTS-AES-128	32	16
52	KM-XTS-AES-256	48	16
58	KM-XTS-Encrypted-AES-128	64	16
60	KM-XTS-Encrypted-AES-256	80	16

Explanation:

- Not applicable
- * Function is also defined in the ESA/390 architectural mode and the ESA/390-compatibility mode. It is unpredictable whether other function codes are available in the ESA/390-compatibility mode.

Figure 7-5. Function Codes for CIPHER MESSAGE

The function codes for CIPHER MESSAGE WITH CHAINING are as follows.

Code	Function	Parm. Block Size (bytes)	Data Block Size (bytes)
0	KMC-Query *	16	—
1	KMC-DEA *	16	8
2	KMC-TDEA-128 *	24	8
3	KMC-TDEA-192 *	32	8
9	KMC-Encrypted-DEA	40	8

Figure 7-6. Function Codes for CIPHER MESSAGE WITH CHAINING

Code	Function	Parm. Block Size (bytes)	Data Block Size (bytes)
10	KMC-Encrypted-TDEA-128	48	8
11	KMC-Encrypted-TDEA-192	56	8
18	KMC-AES-128 *	32	16
19	KMC-AES-192 *	40	16
20	KMC-AES-256 *	48	16
26	KMC-Encrypted-AES-128	64	16
27	KMC-Encrypted-AES-192	72	16
28	KMC-Encrypted-AES-256	80	16
67	KMC-PRNG	32	8
Explanation:			
—	Not applicable		
*	Function is also defined in the ESA/390 architectural mode and the ESA/390-compatibility mode. It is unpredictable whether other function codes are available in the ESA/390-compatibility mode.		

Figure 7-6. Function Codes for CIPHER MESSAGE WITH CHAINING (Continued)

All other function codes are unassigned.

The query function provides the means of indicating the availability of the other functions. The contents of general registers R_1 , R_2 , and $R_2 + 1$ are ignored for the query function.

For all other functions, the second operand is ciphered as specified by the function code using a cryptographic key in the parameter block, and the result is placed in the first-operand location. For CIPHER MESSAGE WITH CHAINING, ciphering also uses an initial chaining value in the parameter block, and the chaining value is updated as part of the operation. For XTS functions, ciphering also uses an XTS parameter in the parameter block, and the XTS parameter is updated as part of the operation.

The R_1 field designates a general register and must designate an even-numbered register other than general register 0; otherwise, a specification exception is recognized. The R_2 field designates an even-odd pair of general registers and must designate an even-numbered register other than general register 0; otherwise, a specification exception is recognized.

The location of the leftmost byte of the first and second operands is specified by the contents of the R_1 and R_2 general registers, respectively. The number of bytes in the second-operand location is specified in general register $R_2 + 1$. The first operand is the same length as the second operand.

As part of the operation, the addresses in general registers R_1 and R_2 are incremented by the number of bytes processed, and the length in general register $R_2 + 1$ is decremented by the same number. The formation and updating of the addresses and length is dependent on the addressing mode.

In the 24-bit addressing mode, the contents of bit positions 40-63 of general registers R_1 and R_2 constitute the addresses of the first and second operands, respectively, and the contents of bit positions 0-39 are ignored; bits 40-63 of the updated addresses replace the corresponding bits in general registers R_1 and R_2 , carries out of bit position 40 of the updated address are ignored, and the contents of bit positions 32-39 of general registers R_1 and R_2 are set to zeros. In the 31-bit addressing mode, the contents of bit positions 33-63 of general registers R_1 and R_2 constitute the addresses of the first and second operands, respectively, and the contents of bit positions 0-32 are ignored; bits 33-63 of the updated addresses replace the corresponding bits in general registers R_1 and R_2 , carries out of bit position 33 of the updated address are ignored, and the content of bit position 32 of general registers R_1 and R_2 is set to zero. In the 64-bit addressing mode, the contents of bit positions 0-63 of general registers R_1 and R_2 constitute the addresses of the first and second operands, respectively; bits 0-63 of the updated addresses replace the contents of general registers R_1 and R_2 , and carries out of bit position 0 are ignored.

In both the 24-bit and the 31-bit addressing modes, the contents of bit positions 32-63 of general register $R_2 + 1$ form a 32-bit unsigned binary integer which specifies the number of bytes in the first and second operands, and the contents of bit positions 0-31 are ignored; bits 32-63 of the updated value replace the corresponding bits in general register $R_2 + 1$. In the 64-bit addressing mode, the contents of bit positions 0-63 of general register $R_2 + 1$ form a 64-bit unsigned binary integer which specifies the number of bytes in the first and second operands; and the updated value replaces the contents of general register $R_2 + 1$.

In the 24-bit or 31-bit addressing mode, the contents of bit positions 0-31 of general registers R_1 , R_2 , and $R_2 + 1$, always remain unchanged.

Figure 7-7 on page 7-54 shows the contents of the general registers just described.

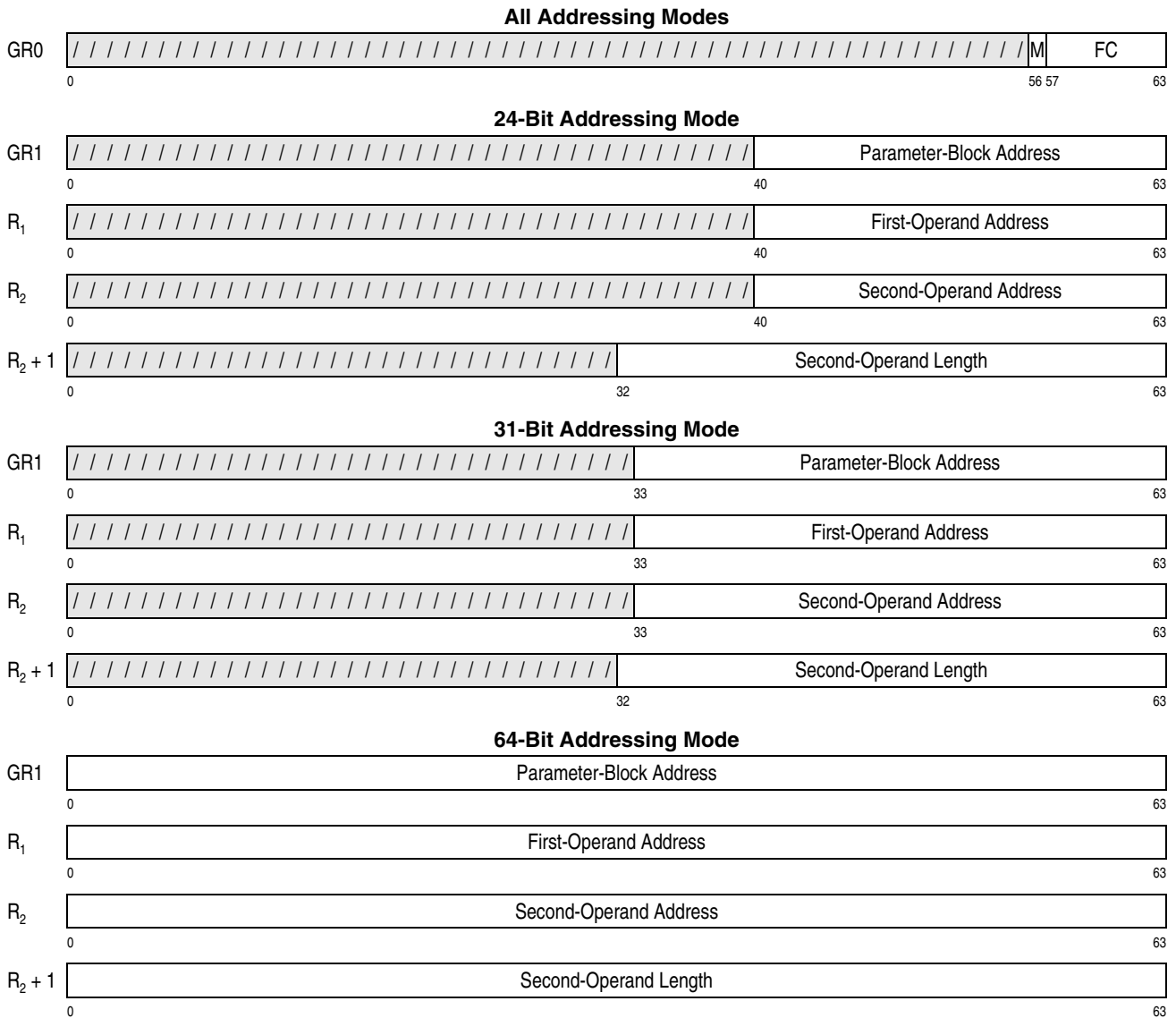

Figure 7-7. General Register Assignment for KM and KMC

In the access-register mode, access registers 1, R_1 , and R_2 specify the address spaces containing the parameter block, first, and second operands, respectively.

The result is obtained as if processing starts at the left end of both the first and second operands and proceeds to the right, block by block. The operation is ended when the number of bytes in the second operand as specified in general register $R_2 + 1$ have been processed and placed at the first-operand location

(called normal completion) or when a CPU-determined number of blocks that is less than the length of the second operand have been processed (called partial completion). The CPU-determined number of blocks depends on the model, and may be a different number each time the instruction is executed. The CPU-determined number of blocks is usually non-zero. In certain unusual situations, this number may be zero, and condition code 3 may be set with no progress. However, the CPU protects against endless recurrence of this no-progress case.

The results in the first-operand location, the chaining-value field, or the XTS parameter field are unpredictable if any of the following situations occur:

1. The cryptographic-key field or the encrypted cryptographic-key field overlaps any portion of the first operand.
2. The XTS parameter field overlaps any portion of the first operand.
3. The chaining-value field overlaps any portion of the first operand or the second operand.
4. The first and second operands overlap destructively. Operands are said to overlap destructively when the first-operand location would be used as a source after data would have been moved into it, assuming processing to be performed from left to right and one byte at a time.

When the operation ends due to normal completion, condition code 0 is set and the resulting value in $R_2 + 1$ is zero. When the operation ends due to partial completion, condition code 3 is set and the resulting value in $R_2 + 1$ is nonzero.

A PER storage-alteration event may be recognized both for the first-operand location and for the portion of the parameter block that is stored. A PER zero-address-detection event may be recognized for the first- and second-operand locations and for the parameter block. When PER events are detected for one or more of these locations, it is unpredictable which location is identified in the PER access identification (PAID) and PER ASCE ID (AI).

When a storage-alteration PER event is recognized, fewer than 4K additional bytes are stored into the first-operand locations before the event is reported.

When the second-operand length is initially zero, the parameter block, first, and second operands are not accessed, general registers R_1 , R_2 , and $R_2 + 1$ are not changed, and condition code 0 is set.

When the contents of the R_1 and R_2 fields are the same, the contents of the designated registers are incremented only by the number of bytes processed, not by twice the number of bytes processed.

As observed by this CPU, other CPUs, and channel programs, references to the parameter block and storage operands may be multiple-access references, accesses to these storage locations are not necessarily block-concurrent, and the sequence of these accesses or references is undefined.

In certain unusual situations, instruction execution may complete by setting condition code 3 without updating the registers, the chaining value, and the XTS parameter to reflect the last unit of the first and second operands processed. The size of the unit processed in this case depends on the situation and the model, but is limited such that the portion of the first and second operands which have been processed and not reported do not overlap in storage. In all cases, change bits are set and PER storage-alteration events are reported, when applicable, for all first-operand locations processed.

For functions that perform a comparison of the wrapping-key verification pattern field in the parameter block with the wrapping-key verification-pattern register, it is unpredictable whether access exceptions and PER zero-address-detection events are recognized for the first and second operands when the comparison results in a mismatch.

Access exceptions may be reported for a larger portion of an operand than is processed in a single execution of the instruction; however, access exceptions are not recognized for locations beyond the length of an operand nor for locations more than 4K bytes beyond the current location being processed.

Symbols Used in Function Descriptions

The following symbols are used in the subsequent description of the CIPHER MESSAGE and CIPHER MESSAGE WITH CHAINING functions. For data-encryption-algorithm (DEA) functions, the DEA-key-parity bit in each byte of the DEA key is ignored, and the operation proceeds normally, regardless of the DEA-key parity of the key.

Further description of the data-encryption algorithm may be found in Reference [13.] on page xxx. Further description of the AES standard may be found in Reference [14.] on page xxx. The XTS multiplication operation is the same as the GCM (Galois/counter mode) multiplication operation. Further description of

the GCM multiplication over $GF(2^{128})$ may be found in Reference [17.] on page xxx.

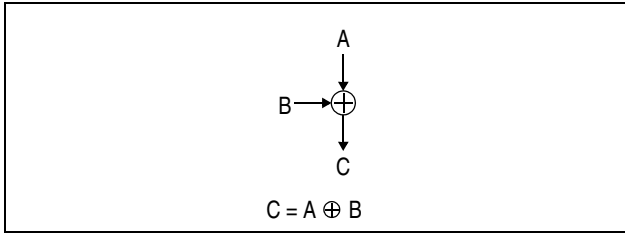
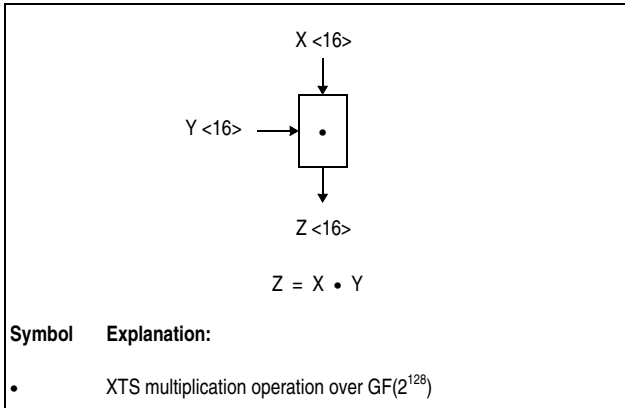
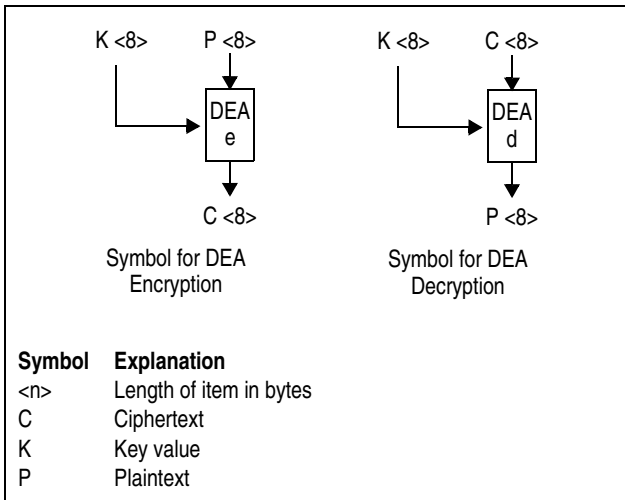

Figure 7-8. Symbol For Bit-Wise Exclusive OR



Symbol	Explanation:
•	XTS multiplication operation over $GF(2^{128})$

Figure 7-9. Symbol For XTS Multiplication Operation Over $GF(2^{128})$



Symbol	Explanation
<n>	Length of item in bytes
C	Ciphertext
K	Key value
P	Plaintext

Figure 7-10. Symbols for DEA Encryption and Decryption

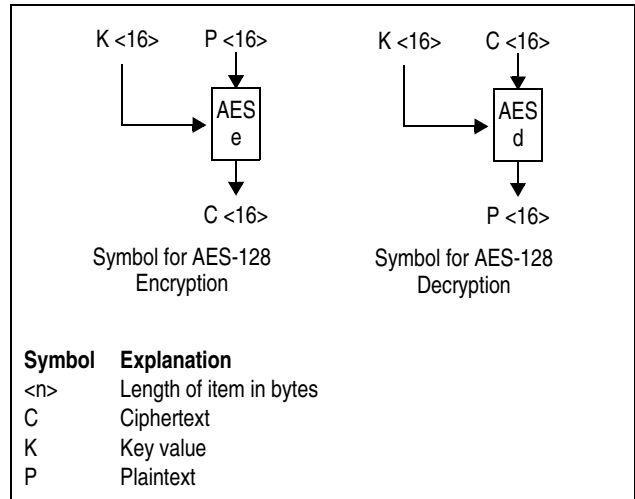

Symbol	Explanation
<n>	Length of item in bytes
C	Ciphertext
K	Key value
P	Plaintext

Figure 7-11. Symbols for AES-128 Encryption and Decryption

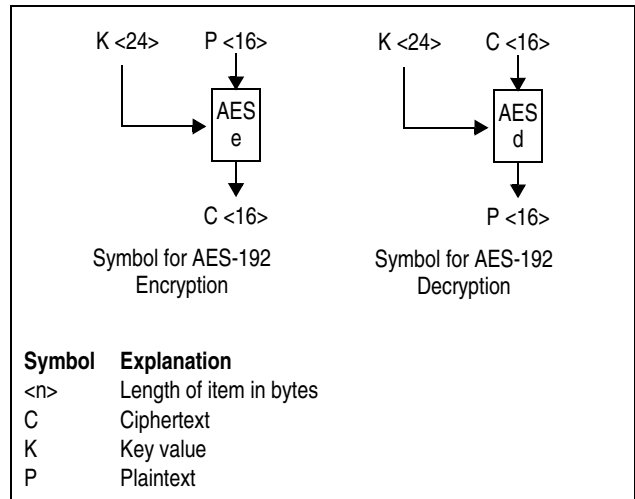

Symbol	Explanation
<n>	Length of item in bytes
C	Ciphertext
K	Key value
P	Plaintext

Figure 7-12. Symbols for AES-192 Encryption and Decryption

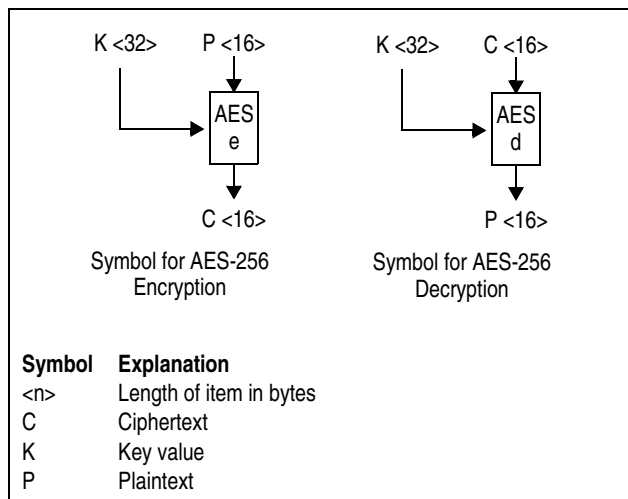

Figure 7-13. Symbols for AES-256 Encryption and Decryption

KM-Query (KM Function Code 0)

The locations of the operands and addresses used by the instruction are as shown in Figure 7-7 on page 7-54.

The parameter block used for the function has the following format:

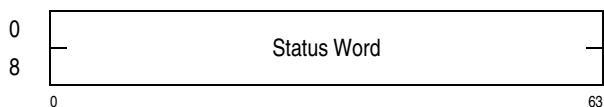

Figure 7-14. Parameter Block for KM-Query

A 128-bit status word is stored in the parameter block. Bits 0-127 of this field correspond to function codes 0-127, respectively, of the CIPHER MESSAGE instruction. When a bit is one, the corresponding function is installed; otherwise, the function is not installed.

Condition code 0 is set when execution of the KM-Query function completes; condition codes 1 and 3 are not applicable to this function.

KM-DEA (KM Function Code 1)

KM-Encrypted-DEA (KM Function Code 9)

The locations of the operands and addresses used by the instruction are as shown in Figure 7-7 on page 7-54.

The parameter block used for the KM-DEA function has the following format:

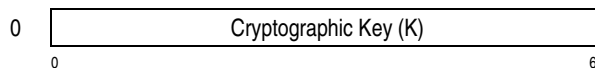

Figure 7-15. Parameter Block for KM-DEA

For the KM-DEA function, the cryptographic key is in byte offsets 0-7 of the parameter block.

The parameter block used for the KM-Encrypted-DEA function has the following format:

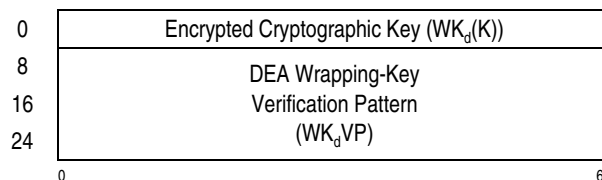

Figure 7-16. Parameter Block for KM-Encrypted-DEA

For the KM-Encrypted-DEA function, the contents of byte offsets 8-31 of the parameter block are compared with the contents of the DEA wrapping-key verification-pattern register. If they mismatch, the first-operand and parameter-block locations remain unchanged, and the operation is completed by setting condition code 1. If they match, the contents of byte offsets 0-7 of the parameter block are deciphered using the DEA wrapping key to obtain the 64-bit cryptographic key. (See the section, “Protection of Cryptographic Keys” on page 7-431, for details.)

The following description applies to both functions.

When the modifier bit in general register 0 is zero, an encipher operation is performed. The 8-byte plaintext blocks (P1, P2, ..., Pn) in operand 2 are enciphered using the DEA algorithm with the 64-bit cryptographic key. Each plaintext block is independently enciphered; that is, the encipher operation is performed without chaining. The ciphertext blocks (C1, C2, ...,

Cn) are stored in operand 1. The operation is shown in Figure 7-17.

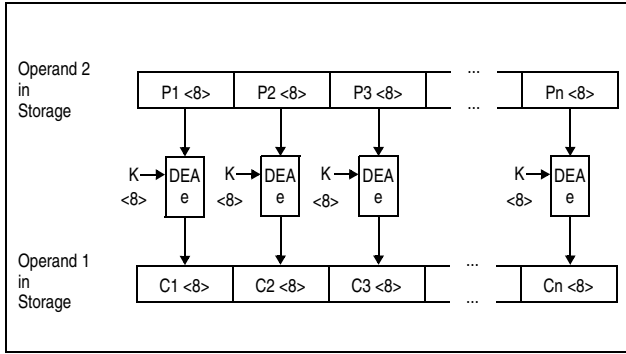

Figure 7-17. KM-DEA Encipher Operation Using 64-Bit Key

When the modifier bit in general register 0 is one, a decipher operation is performed. The 8-byte ciphertext blocks (C1, C2, ..., Cn) in operand 2 are deciphered using the DEA algorithm with the 64-bit cryptographic key. Each ciphertext block is independently deciphered; that is, the decipher operation is performed without chaining. The plaintext blocks (P1, P2, ..., Pn) are stored in operand 1. The operation is shown in Figure 7-18.

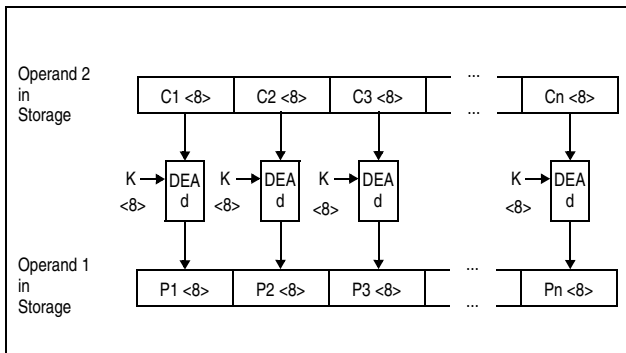

Figure 7-18. KM-DEA Decipher Operation Using 64-Bit Key

KM-TDEA-128 (KM Function Code 2)

KM-Encrypted-TDEA-128 (KM Function Code 10)

The locations of the operands and addresses used by the instruction are as shown in Figure 7-7 on page 7-54.

The parameter block used for the KM-TDEA-128 function has the following format:

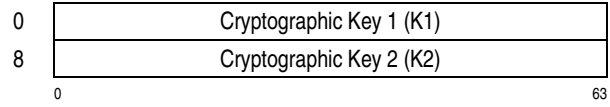

Figure 7-19. Parameter Block for KM-TDEA-128

For the KM-TDEA-128 function, the cryptographic key is in byte offsets 0-15 of the parameter block.

The parameter block used for the KM-Encrypted-TDEA-128 function has the following format:

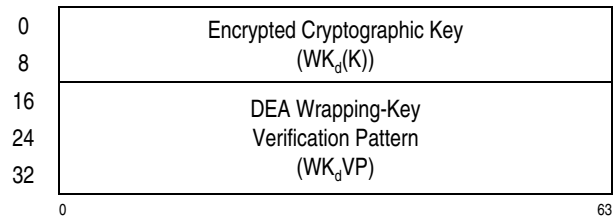

Figure 7-20. Parameter Block for KM-Encrypted-TDEA-128

For the KM-Encrypted-TDEA-128 function, the contents of byte offsets 16-39 of the parameter block are compared with the contents of the DEA wrapping-key verification-pattern register. If they mismatch, the first-operand and parameter-block locations remain unchanged, and the operation is completed by setting condition code 1. If they match, the contents of byte offsets 0-15 of the parameter block are deciphered using the DEA wrapping key to obtain the 128-bit cryptographic key, $K = K1 \parallel K2$, where K1 is the leftmost 64 bits of K and K2 is the rightmost 64 bits of K. (See the section, "Protection of Cryptographic Keys" on page 7-431, for details.)

The following description applies to both functions.

When the modifier bit in general register 0 is zero, an encipher operation is performed. The 8-byte plaintext blocks (P1, P2, ..., Pn) in operand 2 are enciphered using the TDEA (triple DEA) algorithm with the two 64-bit cryptographic keys. Each plaintext block is independently enciphered; that is, the encipher operation is performed without chaining. The ciphertext

blocks (C1, C2, ..., Cn) are stored in operand 1. The operation is shown in Figure 7-21.

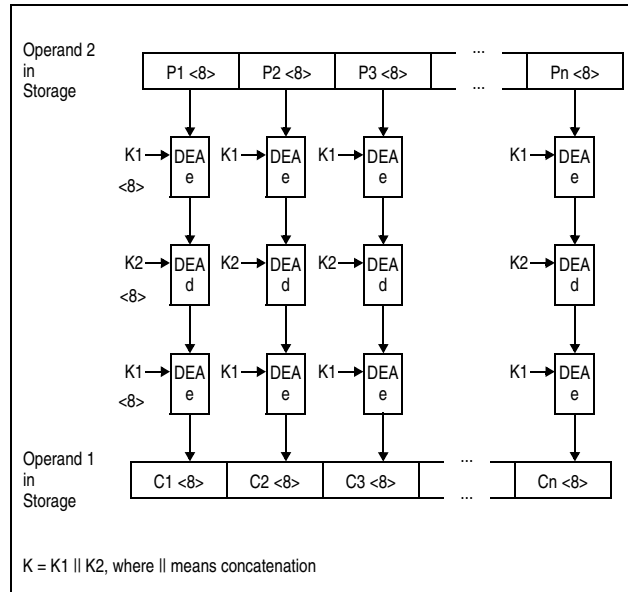

Figure 7-21. KM-TDEA Encipher Operation Using 128-Bit Key

When the modifier bit in general register 0 is one, a decipher operation is performed. The 8-byte ciphertext blocks (C1, C2, ..., Cn) in operand 2 are deciphered using the TDEA algorithm with the two 64-bit cryptographic keys. Each ciphertext block is independently deciphered; that is, the decipher operation is performed without chaining. The plaintext blocks

(P1, P2, ..., Pn) are stored in operand 1. The operation is shown in Figure 7-22.

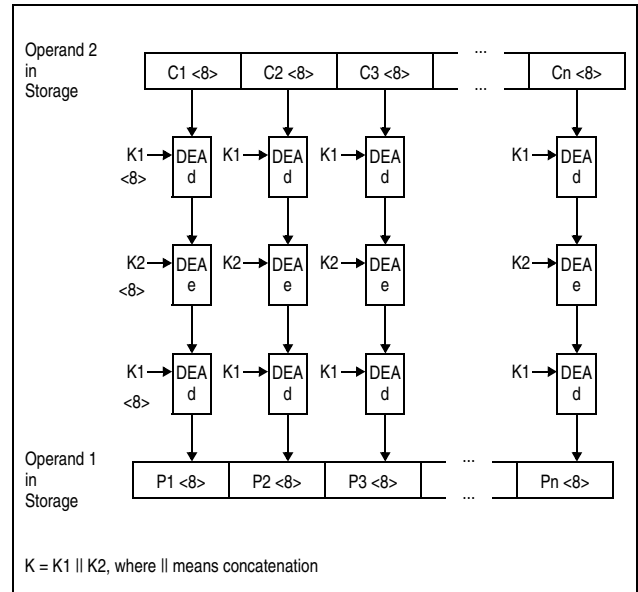

Figure 7-22. KM TDEA Decipher Operation Using 128-Bit Key

KM-TDEA-192 (KM Function Code 3)

KM-Encrypted-TDEA-192 (KM Function Code 11)

The locations of the operands and addresses used by the instruction are as shown in Figure 7-7 on page 7-54.

The parameter block used for the KM-TDEA-192 function has the following format:

0	Cryptographic Key 1 (K1)
8	Cryptographic Key 2 (K2)
16	Cryptographic Key 3 (K3)
0	63

Figure 7-23. Parameter Block for KM-TDEA-192

For the KM-TDEA-192 function, the cryptographic key is in byte offsets 0-23 of the parameter block.

The parameter block used for the KM-Encrypted-TDEA-192 function has the following format:

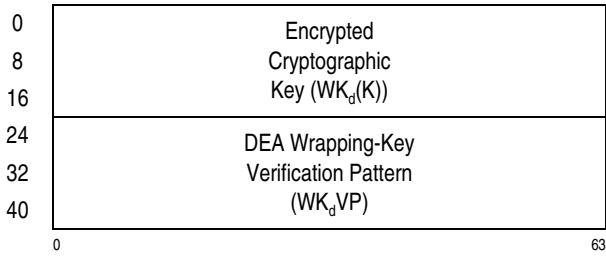

Figure 7-24. Parameter Block for KM-Encrypted-TDEA-192

For the KM-Encrypted-TDEA-192 function, the contents of byte offsets 24-47 of the parameter block are compared with the contents of the DEA wrapping-key verification-pattern register. If they mismatch, the first-operand and parameter-block locations remain unchanged, and the operation is completed by setting condition code 1. If they match, the contents of byte offsets 0-23 of the parameter block are deciphered using the DEA wrapping key to obtain the 192-bit cryptographic key, $K = K1 \parallel K2 \parallel K3$, where $K1$ is the leftmost 64 bits of K , $K2$ is the middle 64 bits of K , and $K3$ is the rightmost 64 bits of K . (See the section, "Protection of Cryptographic Keys" on page 7-431, for details.)

The following description applies to both functions.

When the modifier bit in general register 0 is zero, an encipher operation is performed. The 8-byte plaintext blocks ($P1, P2, \dots, Pn$) in operand 2 are enciphered using the TDEA algorithm with the three 64-bit cryp-

tographic keys. Each plaintext block is independently enciphered; that is, the encipher operation is performed without chaining. The ciphertext blocks ($C1, C2, \dots, Cn$) are stored in operand 1. The operation is shown in Figure 7-25.

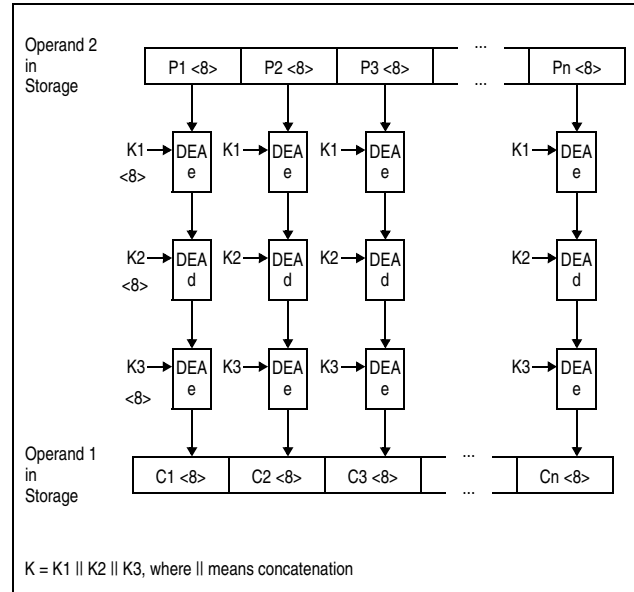

Figure 7-25. KM TDEA Encipher Operation Using 192-Bit Key

When the modifier bit in general register 0 is one, a decipher operation is performed. The 8-byte ciphertext blocks ($C1, C2, \dots, Cn$) in operand 2 are deciphered using the TDEA algorithm with the three 64-bit cryptographic keys. Each ciphertext block is independently deciphered; that is, the decipher operation is performed without chaining. The plaintext

blocks (P1, P2, ..., Pn) are stored in operand 1. The operation is shown in Figure 7-26.

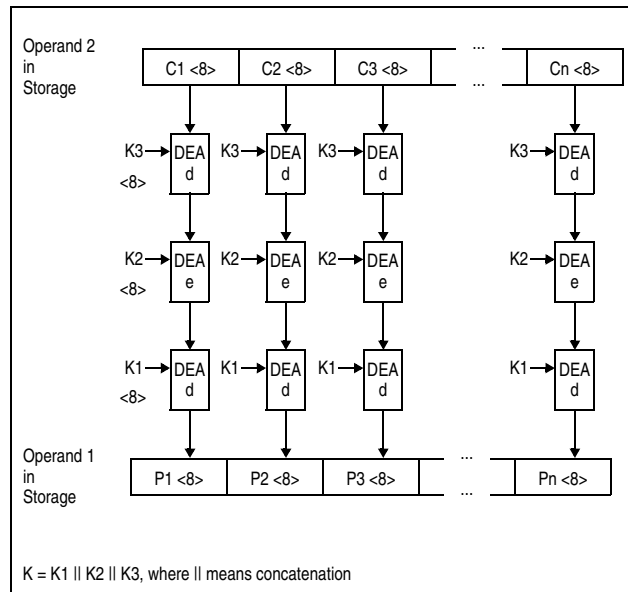

Figure 7-26. KM TDEA Decipher Operation Using 192-Bit Key

KM-AES-128 (KM Function Code 18)

KM-Encrypted-AES-128 (KM Function Code 26)

The locations of the operands and addresses used by the instruction are as shown in Figure 7-7 on page 7-54.

The parameter block used for the KM-AES-128 function has the following format:

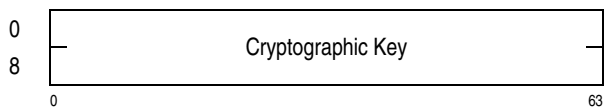

Figure 7-27. Parameter Block for KM-AES-128

For the KM-AES-128 function, the cryptographic key is in byte offsets 0-15 of the parameter block.

The parameter block used for the KM-encrypted-AES-128 function has the following format:

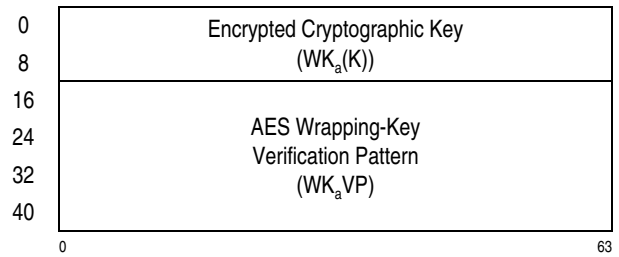

Figure 7-28. Parameter Block for KM-Encrypted-AES-128

For the KM-Encrypted-AES-128 function, the contents of byte offsets 16-47 of the parameter block are compared with the contents of the AES wrapping-key verification-pattern register. If they mismatch, the first-operand and parameter-block locations remain unchanged, and the operation is completed by setting condition code 1. If they match, the contents of byte offsets 0-15 of the parameter block are deciphered using the AES wrapping key to obtain the 128-bit cryptographic key, K. (See the section, “Protection of Cryptographic Keys” on page 7-431, for details.)

The following description applies to both functions.

When the modifier bit in general register 0 is zero, an encipher operation is performed. The 16-byte plaintext blocks (P1, P2, ..., Pn) in operand 2 are enciphered using the AES algorithm with the 128-bit cryptographic key. Each plaintext block is independently enciphered; that is, the encipher operation is performed without chaining. The ciphertext blocks (C1, C2, ..., Cn) are stored in operand 1. The operation is shown in Figure 7-29.

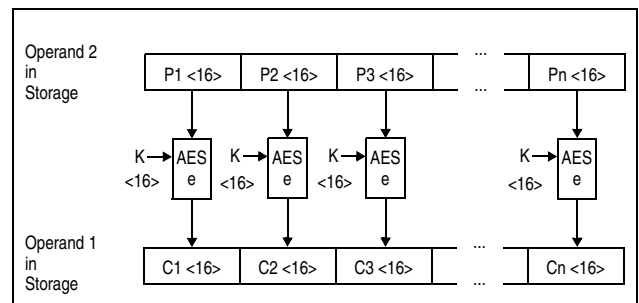

Figure 7-29. KM-AES Encipher Operation Using 128-Bit Key

When the modifier bit in general register 0 is one, a decipher operation is performed. The 16-byte ciphertext blocks (C1, C2, ..., Cn) in operand 2 are deciphered using the AES algorithm with the 128-bit cryptographic key. Each ciphertext block is independently deciphered; that is, the decipher operation is performed without chaining. The plaintext blocks (P1, P2, ..., Pn) are stored in operand 1. The operation is shown in Figure 7-26.

phered using the AES algorithm with the 128-bit cryptographic key. Each ciphertext block is independently deciphered; that is, the decipher operation is performed without chaining. The plaintext blocks (P1, P2, ..., Pn) are stored in operand 1. The operation is shown in Figure 7-30.

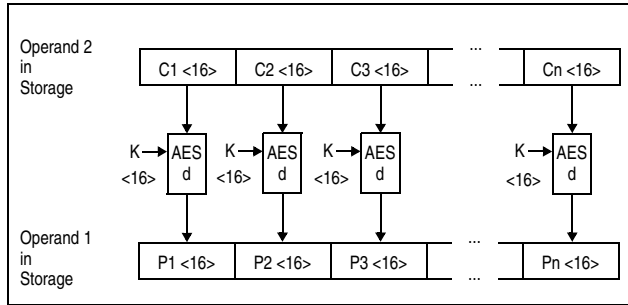

Figure 7-30. KM-AES Decipher Operation Using 128-Bit Key

KM-AES-192 (KM Function Code 19)

KM-Encrypted-AES-192 (KM Function Code 27)

The locations of the operands and addresses used by the instruction are as shown in Figure 7-7 on page 7-54.

The parameter block used for the KM-AES-192 function has the following format:

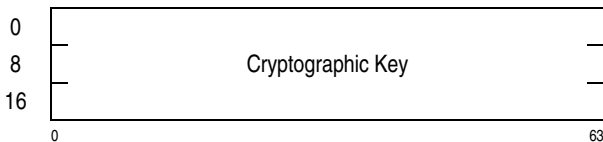

Figure 7-31. Parameter Block for KM-AES-192

For the KM-AES-192 function, the cryptographic key is in byte offsets 0-23 of the parameter block.

The parameter block used for the KM-Encrypted-AES-192 function has the following format:

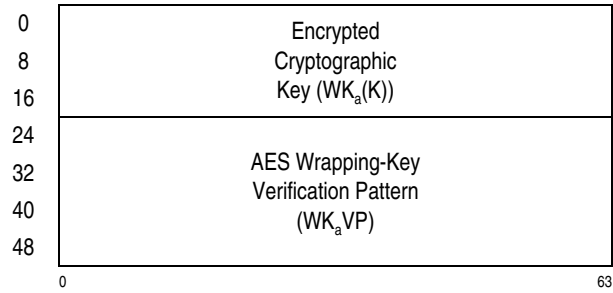

Figure 7-32. Parameter Block for KM-Encrypted-AES-192

For the KM-Encrypted-AES-192 function, the contents of byte offsets 24-55 of the parameter block are compared with the contents of the AES wrapping-key verification-pattern register. If they mismatch, the first-operand and parameter-block locations remain unchanged, and the operation is completed by setting condition code 1. If they match, the contents of byte offsets 0-23 of the parameter block are deciphered using the AES wrapping key to obtain the 192-bit cryptographic key, K. (See the section, “Protection of Cryptographic Keys” on page 7-431, for details.)

The following description applies to both functions.

When the modifier bit in general register 0 is zero, an encipher operation is performed. The 16-byte plaintext blocks (P1, P2, ..., Pn) in operand 2 are enciphered using the AES algorithm with the 192-bit cryptographic key. Each plaintext block is independently enciphered; that is, the encipher operation is performed without chaining. The ciphertext blocks (C1, C2, ..., Cn) are stored in operand 1. The operation is shown in Figure 7-33.

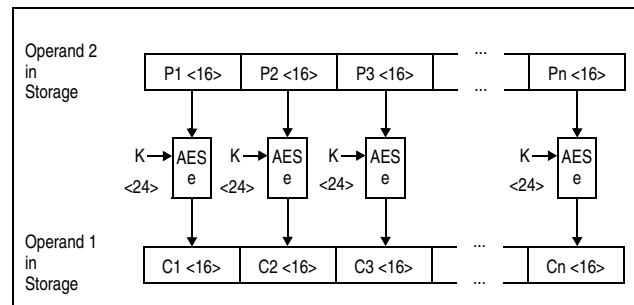

Figure 7-33. KM AES Encipher Operation Using 192-Bit Key

When the modifier bit in general register 0 is one, a decipher operation is performed. The 16-byte ciphertext blocks (C1, C2, ..., Cn) in operand 2 are deciphered using the AES algorithm with the 192-bit cryptographic key. Each ciphertext block is independently deciphered; that is, the decipher operation is performed without chaining. The plaintext blocks (P1, P2, ..., Pn) are stored in operand 1. The operation is shown Figure 7-34.

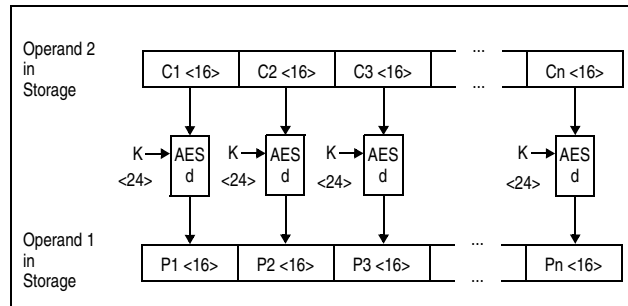

Figure 7-34. KM AES Decipher Operation Using 192-Bit Key

KM-AES-256 (KM Function Code 20)

KM-Encrypted-AES-256 (KM Function Code 28)

The locations of the operands and addresses used by the instruction are as shown in Figure 7-7 on page 7-54.

The parameter block used for the KM-AES-256 function has the following format:

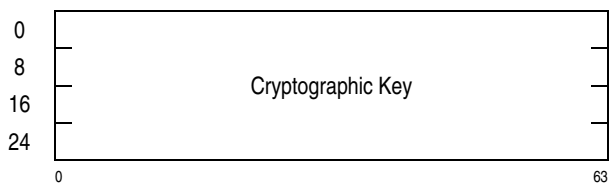

Figure 7-35. Parameter Block for KM-AES-256

For the KM-AES-256 function, the cryptographic key is in byte offsets 0-31 of the parameter block.

The parameter block used for the KM-Encrypted-AES-256 function has the following format:

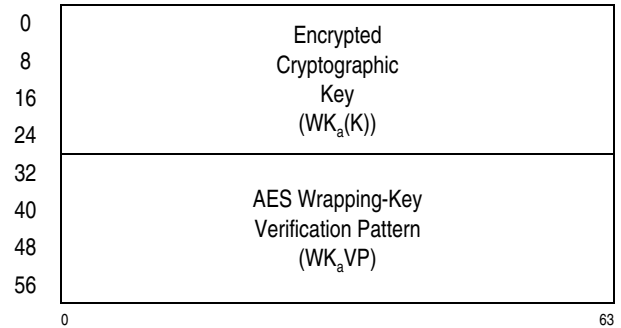

Figure 7-36. Parameter Block for KM-Encrypted-AES-256

For the KM-Encrypted-AES-256 function, the contents of byte offsets 32-63 of the parameter block are compared with the contents of the AES wrapping-key verification-pattern register. If they mismatch, the first-operand and parameter-block locations remain unchanged, and the operation is completed by setting condition code 1. If they match, the contents of byte offsets 0-31 of the parameter block are deciphered using the AES wrapping key to obtain the 256-bit cryptographic key, K. (See the section, “Protection of Cryptographic Keys” on page 7-431, for details.)

The following description applies to both functions.

When the modifier bit in general register 0 is zero, an encipher operation is performed. The 16-byte plaintext blocks (P1, P2, ..., Pn) in operand 2 are enciphered using the AES algorithm with the 256-bit cryptographic key. Each plaintext block is independently enciphered; that is, the encipher operation is performed without chaining. The ciphertext blocks (C1, C2, ..., Cn) are stored in operand 1. The operation is shown in Figure 7-37.

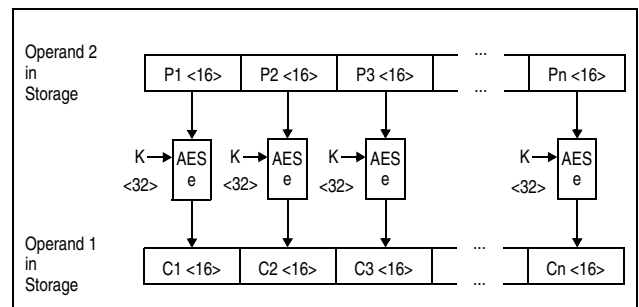

Figure 7-37. KM AES Encipher Operation Using 256-Bit Key

When the modifier bit in general register 0 is one, a decipher operation is performed. The 16-byte ciphertext blocks (C1, C2, ..., Cn) in operand 2 are deciphered using the AES algorithm with the 256-bit cryptographic key. Each ciphertext block is independently deciphered; that is, the decipher operation is performed without chaining. The plaintext blocks (P1, P2, ..., Pn) are stored in operand 1. The operation is shown in Figure 7-38.

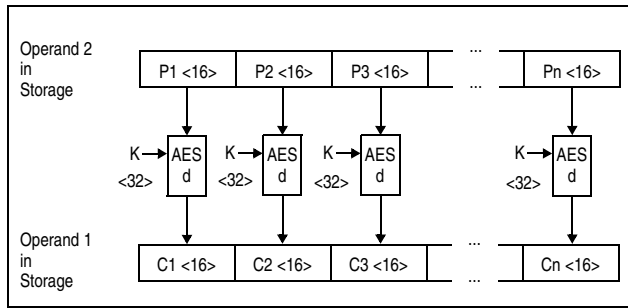

Figure 7-38. KM AES Decipher Operation Using 256-Bit Key

KM-XTS-AES-128 (KM Function Code 50)

KM-XTS-Encrypted-AES-128 (KM Function Code 58)

The locations of the operands and addresses used by the instruction are as shown in Figure 7-7 on page 7-54.

The parameter block used for the KM-XTS-AES-128 function has the following format:

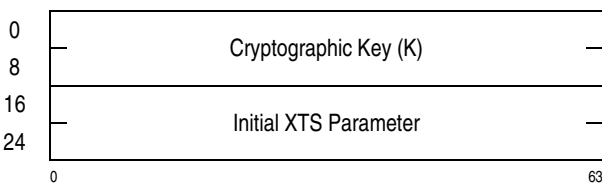

Figure 7-39. Parameter Block for KM-XTS-AES-128

For the KM-XTS-AES-128 function, the cryptographic key is in byte offsets 0-15 of the parameter block, and the initial XTS parameter is in bytes offsets 16-31 of the parameter block.

The parameter block used for the KM-XTS-encrypted-AES-128 function has the following format:

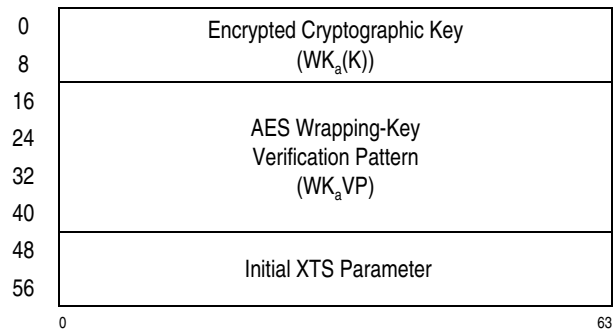

Figure 7-40. Parameter Block for KM-XTS-Encrypted-AES-128

For the KM-XTS-Encrypted-AES-128 function, the contents of byte offsets 16-47 of the parameter block are compared with the contents of the AES wrapping-key verification-pattern register. If they mismatch, the first-operand and parameter-block locations remain unchanged, and the operation is completed by setting condition code 1. If they match, byte offsets 48-63 of the parameter block contain the initial XTS parameter, and the contents of byte offsets 0-15 of the parameter block are deciphered using the AES wrapping key to obtain the 128-bit cryptographic key. (See the section “Protection of Cryptographic Keys” on page 7-431 for details.)

The following description applies to both functions.

When the modifier bit in general register 0 is zero, an encipher operation is performed. The 16-byte plaintext blocks (P1, P2, ..., Pn) in operand 2 are enciphered using the AES-encryption algorithm with the 128-bit cryptographic key and the 128-bit initial XTS parameter.

Except for the first block, the XTS parameter used is the XTS parameter for the previous block multiplied by the value of 2 in $GF(2^{128})$. To encrypt the first block of plaintext, the initial XTS parameter is used.

The XTS parameter for each block is exclusive-ORed with the corresponding plaintext block. The result of the exclusive-OR operation is then encrypted using the AES-encryption algorithm with the 128-bit cryptographic key. The result of the encryption is then exclusive-ORed with the XTS parameter to produce the ciphertext block. The XTS parameter for this block is multiplied by the value of 2 in $GF(2^{128})$ to

obtain the XTS parameter for the next block. The operation is shown in Figure 7-41.

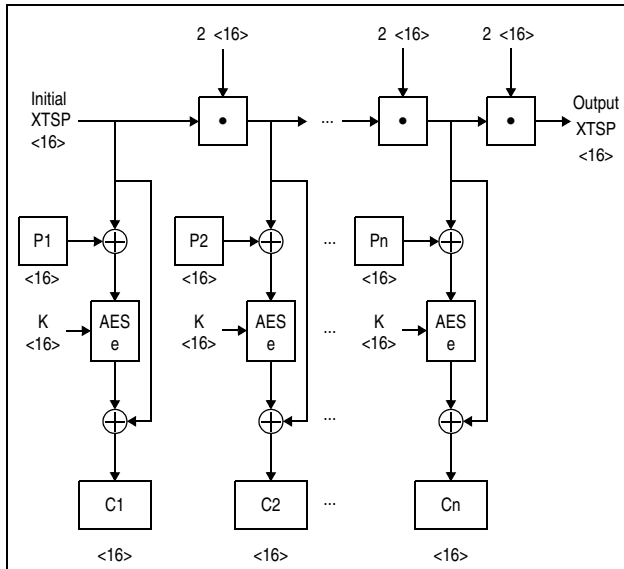

Figure 7-41. KM-XTS-AES-128 Encipher Operation

The ciphertext blocks (C1, C2, ..., Cn) are stored in operand 1. The result of the final GCM multiplication, called the output XTS parameter (output XTSP), is stored into the initial XTS parameter field of the parameter block.

When the modifier bit in general register 0 is one, a decipher operation is performed. The 16-byte ciphertext blocks (C1, C2, ..., Cn) in operand 2 are deciphered using the AES-decryption algorithm with the 128-bit cryptographic key and the 128-bit initial XTS parameter.

Except for the first block, the XTS parameter used is the XTS parameter for the previous block multiplied by the value of 2 in $GF(2^{128})$. To decrypt the first block of ciphertext, the initial XTS parameter is used.

The XTS parameter for each block is exclusive-ORed with the corresponding ciphertext block. The result of the exclusive-OR operation is then decrypted using the AES-decryption algorithm with the 128-bit cryptographic key. The result of the encryption is then exclusive-ORed with the XTS parameter to produce the plaintext block. The XTS parameter for this block is multiplied by the value of 2 in $GF(2^{128})$ to obtain the

XTS parameter for the next block. The operation is shown in Figure 7-42.

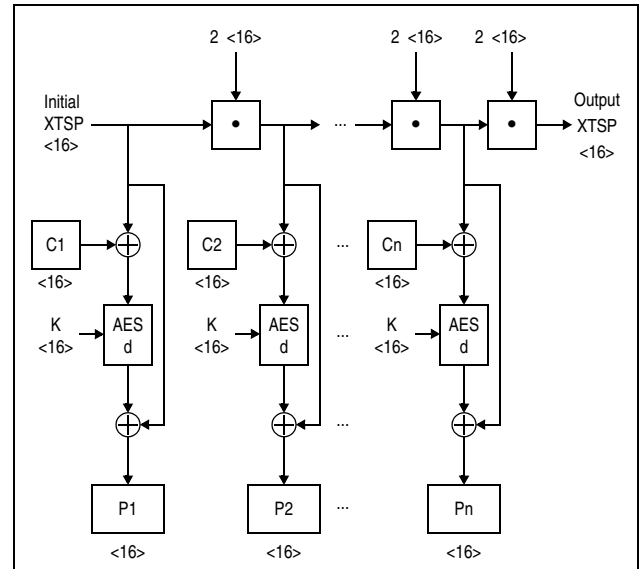

Figure 7-42. KM-XTS-AES-128 Decipher Operation

The plaintext blocks (P1, P2, ..., Pn) are stored in operand 1. The result of the final GCM multiplication, called the output XTS parameter (output XTSP), is stored into the initial XTS parameter field of the parameter block.

KM-XTS-AES-256 (KM Function Code 52)

KM-XTS-Encrypted-AES-256 (KM Function Code 60)

The locations of the operands and addresses used by the instruction are as shown in Figure 7-7 on page 7-54.

The parameter block used for the KM-XTS-AES-256 function has the following format:

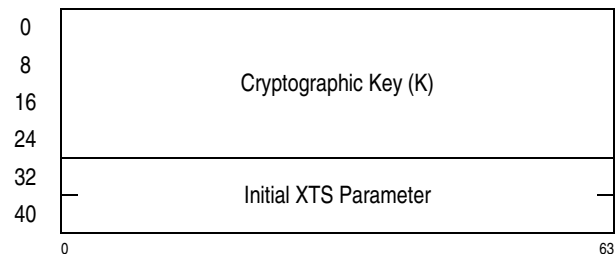

Figure 7-43. Parameter Block for KM-XTS-AES-256

For the KM-XTS-AES-256 function, the cryptographic key is in byte offsets 0-31 of the parameter block, and

the initial XTS parameter is in bytes offsets 32-47 of the parameter block.

The parameter block used for the KM-XTS-encrypted-AES-256 function has the following format:

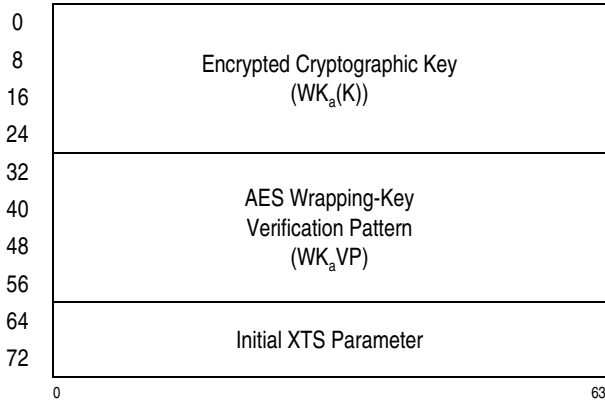

Figure 7-44. Parameter Block for KM-XTS-Encrypted-AES-256

For the KM-XTS-Encrypted-AES-256 function, the contents of byte offsets 32-63 of the parameter block are compared with the contents of the AES wrapping-key verification-pattern register. If they mismatch, the first-operand and parameter-block locations remain unchanged, and the operation is completed by setting condition code 1. If they match, byte offsets 64-79 of the parameter block contain the initial XTS parameter, and the contents of byte offsets 0-31 of the parameter block are deciphered using the AES wrapping key to obtain the 256-bit cryptographic key. (See the section “Protection of Cryptographic Keys” on page 7-431 for details.)

The following description applies to both functions.

When the modifier bit in general register 0 is zero, an encipher operation is performed. The 16-byte plaintext blocks (P1, P2, ..., Pn) in operand 2 are enciphered using the AES-encryption algorithm with the 256-bit cryptographic key and the 128-bit initial XTS parameter.

Except for the first block, the XTS parameter used is the XTS parameter for the previous block multiplied by the value of 2 in GF(2¹²⁸). To encrypt the first block of plaintext, the initial XTS parameter is used.

The XTS parameter for each block is exclusive-ORed with the corresponding plaintext block. The result of the exclusive-OR operation is then encrypted using

the AES-encryption algorithm with the 256-bit cryptographic key. The result of the encryption is then exclusive-ORed with the XTS parameter to produce the ciphertext block. The XTS parameter for this block is multiplied by the value of 2 in GF(2¹²⁸) to obtain the XTS parameter for the next block. The operation is shown in Figure 7-45.

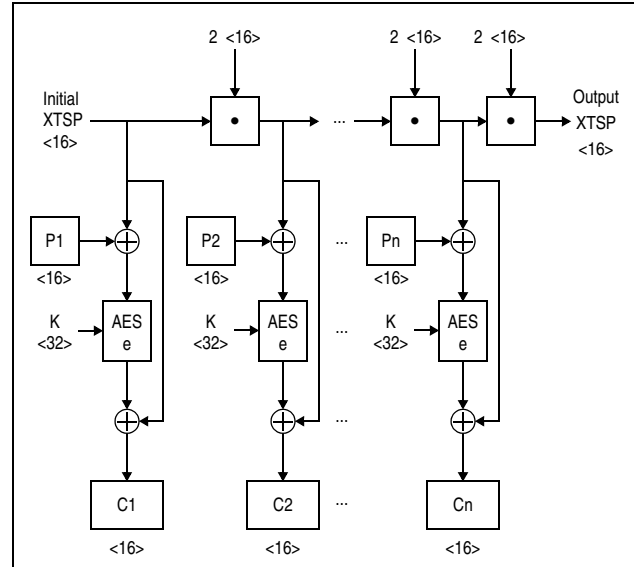

Figure 7-45. KM-XTS-AES-256 Encipher Operation

The ciphertext blocks (C1, C2, ..., Cn) are stored in operand 1. The result of the final GCM multiplication, called the output XTS parameter (output XTSP), is stored into the initial XTS parameter field of the parameter block.

When the modifier bit in general register 0 is one, a decipher operation is performed. The 16-byte ciphertext blocks (C1, C2, ..., Cn) in operand 2 are deciphered using the AES-decryption algorithm with the 256-bit cryptographic key and the 128-bit initial XTS parameter.

Except for the first block, the XTS parameter used is the XTS parameter for the previous block multiplied by the value of 2 in GF(2¹²⁸). To decrypt the first block of ciphertext, the initial XTS parameter is used.

The XTS parameter for each block is exclusive-ORed with the corresponding ciphertext block. The result of the exclusive-OR operation is then decrypted using the AES-decryption algorithm with the 256-bit cryptographic key. The result of the encryption is then exclusive-ORed with the XTS parameter to produce the plaintext block. The XTS parameter for this block is multiplied by the value of 2 in GF(2¹²⁸) to obtain the

XTS parameter for the next block. The operation is shown in Figure 7-46.

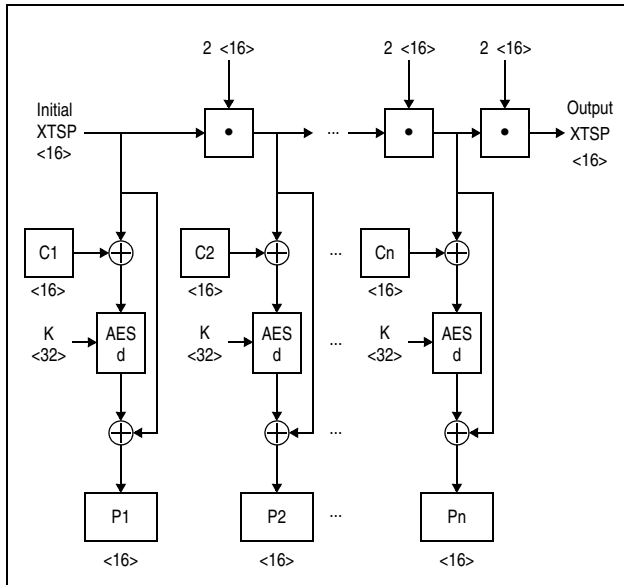

Figure 7-46. XTS-AES-256 Decipher Operation

The plaintext blocks (P1, P2, ..., Pn) are stored in operand 1. The result of the final GCM multiplication, called the output XTS parameter (output XTSP), is stored into the initial XTS parameter field of the parameter block.

KMC-Query (KMC Function Code 0)

The locations of the operands and addresses used by the instruction are as shown in Figure 7-7 on page 7-54.

The parameter block used for the function has the following format:

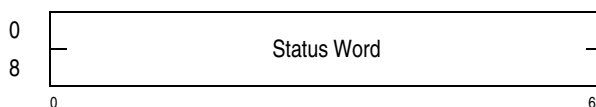

Figure 7-47. Parameter Block for KMC-Query

A 128-bit status word is stored in the parameter block. Bits 0-127 of this field correspond to function codes 0-127, respectively, of the CIPHER MESSAGE WITH CHAINING instruction. When a bit is one, the corresponding function is installed; otherwise, the function is not installed.

Condition code 0 is set when execution of the KMC-Query function completes; condition codes 1 and 3 are not applicable to this function.

KMC-DEA (KMC Function Code 1)

KMC-Encrypted-DEA (KMC Function Code 9)

The locations of the operands and addresses used by the instruction are as shown in Figure 7-7 on page 7-54.

The parameter block used for the KMC-DEA function has the following format:

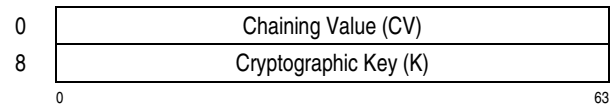

Figure 7-48. Parameter Block for KMC-DEA

For the KMC-DEA function, the chaining value is in byte offsets 0-7 of the parameter block and the cryptographic key is in byte offsets 8-15 of the parameter block.

The parameter block used for the KMC-Encrypted-DEA function has the following format:

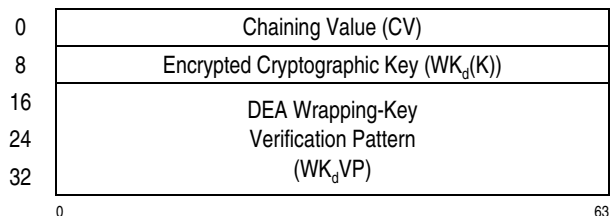

Figure 7-49. Parameter Block for KMC-Encrypted-DEA

For the KMC-Encrypted-DEA function, the contents of byte offsets 16-39 of the parameter block are compared with the contents of the DEA wrapping-key verification-pattern register. If they mismatch, the first-operand and parameter-block locations remain unchanged, and the operation is completed by setting condition code 1. If they match, the contents of byte offsets 8-15 of the parameter block are deciphered using the DEA wrapping key to obtain the 64-bit cryptographic key. (See the section, “Protection of Cryptographic Keys” on page 7-431, for details.) The chaining value is in byte offsets 0-7 of the parameter block.

The following description applies to both functions.

When the modifier bit in general register 0 is zero, an encipher operation is performed. The 8-byte plaintext blocks (P1, P2, ..., Pn) in operand 2 are enciphered

using the DEA algorithm with the 64-bit cryptographic key and the 64-bit chaining value.

The chaining value, called the initial chaining value (ICV), for deriving the first ciphertext block is the chaining value in the parameter block; the chaining value for deriving each subsequent ciphertext block is the corresponding previous ciphertext block. The ciphertext blocks (C1, C2, ..., Cn) are stored in operand 1. The last ciphertext block is the output chaining value (OCV) and is stored into the chaining-value field of the parameter block. The operation is shown in Figure 7-50.

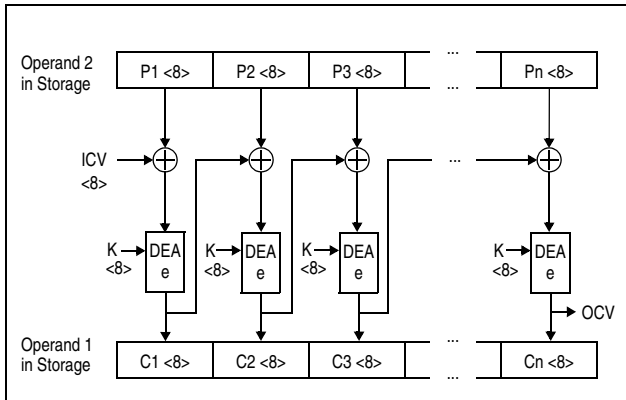

Figure 7-50. KMC DEA Encipher Operation Using 64-Bit Key

When the modifier bit in general register 0 is one, a decipher operation is performed. The 8-byte ciphertext blocks (C1, C2, ..., Cn) in operand 2 are deciphered using the DEA algorithm with the 64-bit cryptographic key and the 64-bit chaining value.

The chaining value, called the initial chaining value (ICV), for deriving the first plaintext block is in the parameter block; the chaining value for deriving each subsequent plaintext block is the corresponding previous ciphertext block. The plaintext blocks (P1, P2, ..., Pn) are stored in operand 1. The last ciphertext block is the output chaining value (OCV) and is

stored into the chaining-value field in the parameter block. The operation is shown in Figure 7-51.

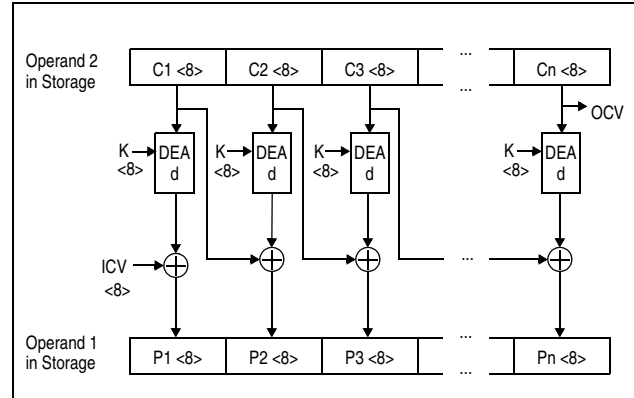

Figure 7-51. KMC DEA Decipher Operation Using 64-Bit Key

KMC-TDEA-128 (KMC Function Code 2)

KMC-Encrypted-TDEA-128 (KMC Function Code 10)

The locations of the operands and addresses used by the instruction are as shown in Figure 7-7 on page 7-54.

The parameter block used for the KMC-TDEA-128 function has the following format:

0	Chaining Value (CV)
8	Cryptographic Key 1 (K1)
16	Cryptographic Key 2 (K2)
0	63

Figure 7-52. Parameter Block for KMC-TDEA-128

For the KMC-TDEA-128 function, the chaining value is in byte offsets 0-7 of the parameter block and the cryptographic key is in byte offsets 8-23 of the parameter block.

The parameter block used for the KMC-Encrypted-TDEA-128 function has the following format:

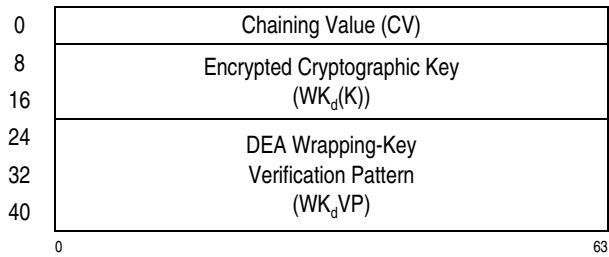

Figure 7-53. Parameter Block for KMC-Encrypted-TDEA-128

For the KMC-Encrypted-TDEA-128 function, the contents of byte offsets 24-47 of the parameter block are compared with the contents of the DEA wrapping-key verification-pattern register. If they mismatch, the first-operand and parameter-block locations remain unchanged, and the operation is completed by setting condition code 1. If they match, the contents of byte offsets 8-23 of the parameter block are deciphered using the DEA wrapping key to obtain the 128-bit cryptographic key. (See the section, “Protection of Cryptographic Keys” on page 7-431, for details.) The chaining value is in byte offsets 0-7 of the parameter block.

The following description applies to both functions.

When the modifier bit in general register 0 is zero, an encipher operation is performed. The 8-byte plaintext blocks (P_1, P_2, \dots, P_n) in operand 2 are enciphered using the TDEA algorithm with the two 64-bit cryptographic keys and the 64-bit chaining value.

The chaining value, called the initial chaining value (ICV), for deriving the first ciphertext block is the chaining value in the parameter block; the chaining value for deriving each subsequent ciphertext block is the corresponding previous ciphertext block. The ciphertext blocks (C_1, C_2, \dots, C_n) are stored in operand 1. The last ciphertext block is the output chaining

value (OCV) and is stored into the chaining-value field of the parameter block. The operation is shown in Figure 7-54.

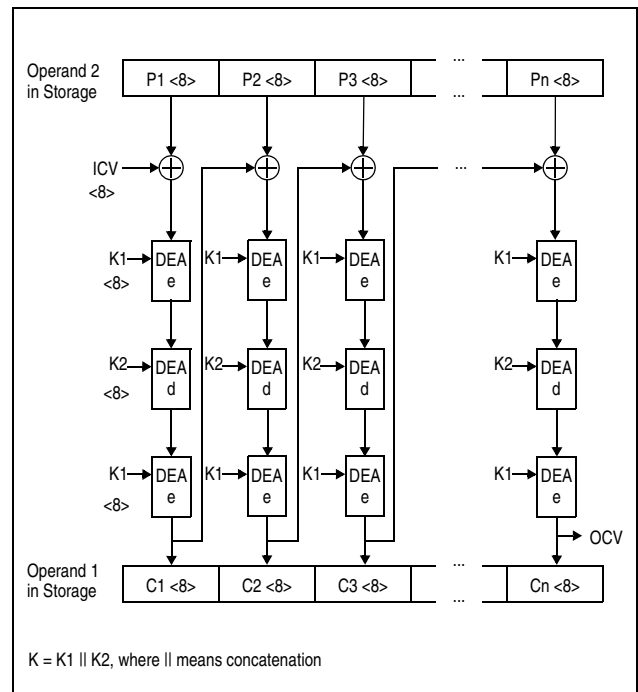

Figure 7-54. KMC TDEA Encipher Operation Using 128-Bit Key

When the modifier bit in general register 0 is one, a decipher operation is performed. The 8-byte ciphertext blocks (C_1, C_2, \dots, C_n) in operand 2 are deciphered using the TDEA algorithm with the two 64-bit cryptographic keys and the 64-bit chaining value.

The chaining value, called the initial chaining value (ICV), for deriving the first plaintext block is in the parameter block; the chaining value for deriving each subsequent plaintext block is the corresponding previous ciphertext block. The plaintext blocks (P_1, P_2, \dots, P_n) are stored in operand 1. The last ciphertext block is the output chaining value (OCV) and is

stored into the chaining-value field in the parameter block. The operation is shown in Figure 7-55.

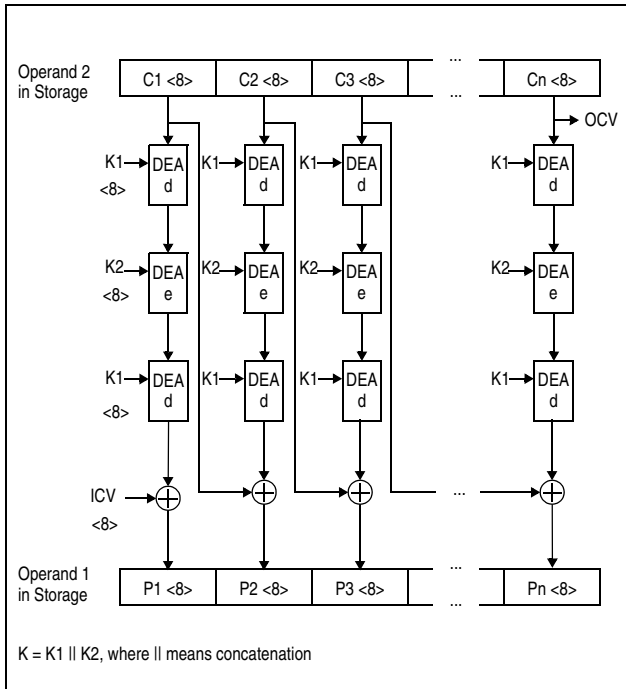

Figure 7-55. KMC TDEA Decipher Operation Using 128-Bit Key

KMC-TDEA-192 (KMC Function Code 3)

KMC-Encrypted-TDEA-192 (KMC Function Code 11)

The locations of the operands and addresses used by the instruction are as shown in Figure 7-7 on page 7-54.

The parameter block used for the KMC-TDEA-192 function has the following format:

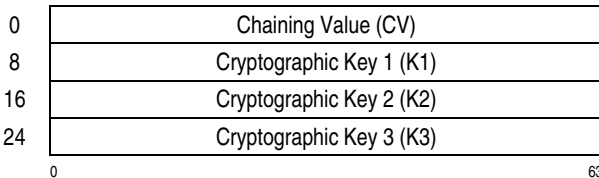

Figure 7-56. Parameter Block for KMC-TDEA-192

For the KMC-TDEA-192 function, the chaining value is in byte offsets 0-7 of the parameter block and the

cryptographic key is in byte offsets 8-31 of the parameter block.

The parameter block used for the KMC-Encrypted-TDEA-192 function has the following format:

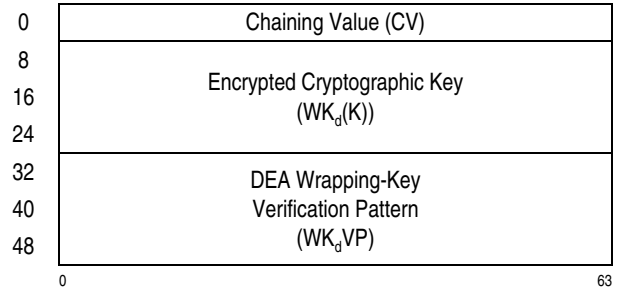

Figure 7-57. Parameter Block for KMC-Encrypted-TDEA-192

For the KMC-Encrypted-TDEA-192 function, the contents of byte offsets 32-55 of the parameter block are compared with the contents of the DEA wrapping-key verification-pattern register. If they mismatch, the first-operand and parameter-block locations remain unchanged, and the operation is completed by setting condition code 1. If they match, the contents of byte offsets 8-31 of the parameter block are deciphered using the DEA wrapping key to obtain the 192-bit cryptographic key. (See the section, "Protection of Cryptographic Keys" on page 7-431, for details.) The chaining value is in byte offsets 0-7 of the parameter block.

The following description applies to both functions.

When the modifier bit in general register 0 is zero, an encipher operation is performed. The 8-byte plaintext blocks (P1, P2, ..., Pn) in operand 2 are enciphered using the TDEA algorithm with the three 64-bit cryptographic keys and the 64-bit chaining value.

The chaining value, called the initial chaining value (ICV), for deriving the first ciphertext block is the chaining value in the parameter block; the chaining value for deriving each subsequent ciphertext block is the corresponding previous ciphertext block. The ciphertext blocks (C1, C2, ..., Cn) are stored in operand 1. The last ciphertext block is the output chaining value (OCV) and is stored into the chaining-value

field of the parameter block. The operation is shown in Figure 7-58.

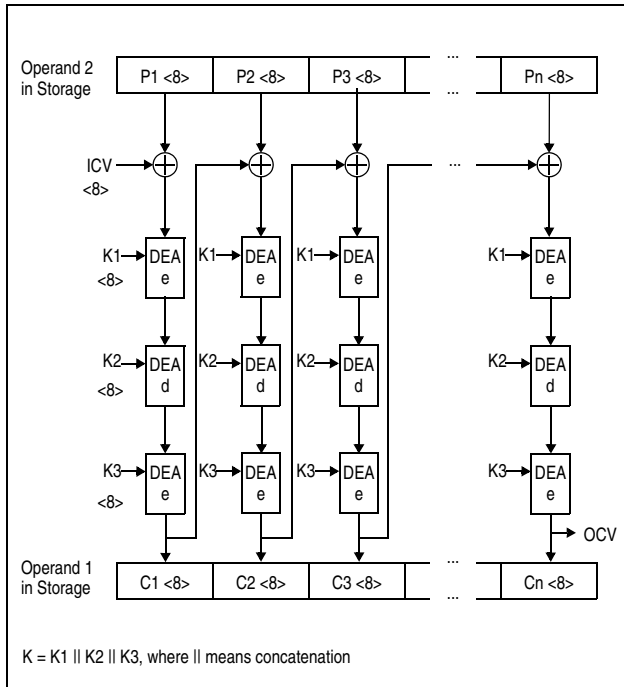

Figure 7-58. KMC TDEA Encipher Operation Using 192-Bit Key

When the modifier bit in general register 0 is one, a decipher operation is performed. The 8-byte ciphertext blocks (C1, C2, ..., Cn) in operand 2 are deciphered using the TDEA algorithm with the three 64-bit cryptographic keys and the 64-bit chaining value.

The chaining value, called the initial chaining value (ICV), for deriving the first plaintext block is in the parameter block; the chaining value for deriving each subsequent plaintext block is the corresponding previous ciphertext block. The plaintext blocks (P1, P2, ..., Pn) are stored in operand 1. The last ciphertext block is the output chaining value (OCV) and is

stored into the chaining-value field in the parameter block. The operation is shown in Figure 7-59.

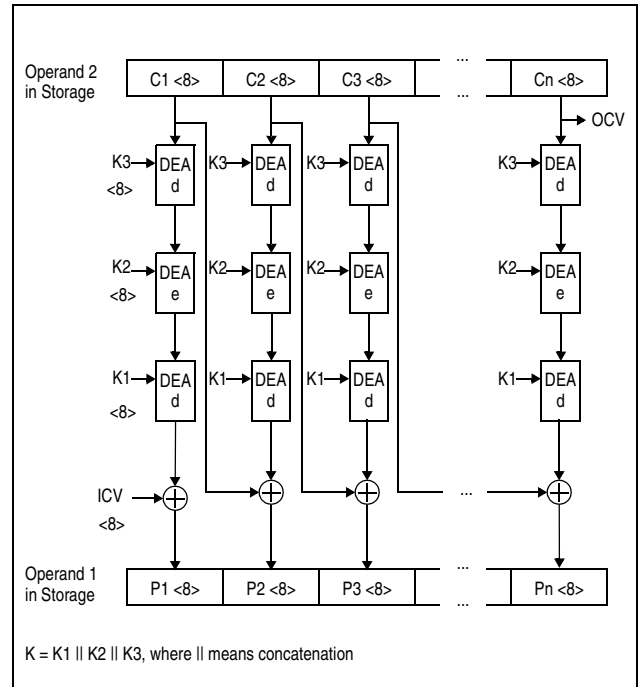

Figure 7-59. KMC TDEA Decipher Operation Using 192-Bit Key

KMC-AES-128 (KMC Function Code 18)

KMC-Encrypted-AES-128 (KMC Function Code 26)

The locations of the operands and addresses used by the instruction are as shown in Figure 7-7 on page 7-54.

The parameter block used for the KMC-AES-128 function has the following format:

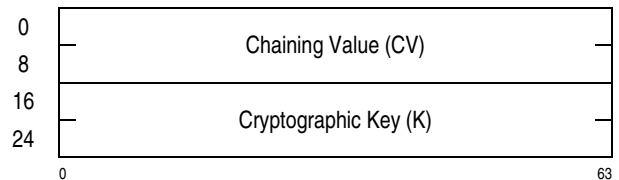

Figure 7-60. Parameter Block for KMC-AES-128

For the KMC-AES-128 function, the chaining value is in byte offsets 0-15 of the parameter block and the cryptographic key is in byte offsets 16-31 of the parameter block.

The parameter block used for the KMC-Encrypted-AES-128 function has the following format:

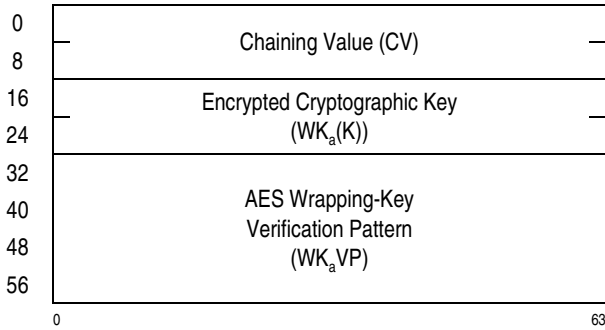

Figure 7-61. Parameter Block for KMC-Encrypted-AES-128

For the KMC-Encrypted-AES-128 function, the contents of byte offsets 32-63 of the parameter block are compared with the contents of the AES wrapping-key verification-pattern register. If they mismatch, the first-operand and parameter-block locations remain unchanged, and the operation is completed by setting condition code 1. If they match, the contents of byte offsets 16-31 of the parameter block are deciphered using the AES wrapping key to obtain the 128-bit cryptographic key, K. (See the section, “Protection of Cryptographic Keys” on page 7-431, for details.) The chaining value is in byte offsets 0-15 of the parameter block.

The following description applies to both functions.

When the modifier bit in general register 0 is zero, an encipher operation is performed. The 16-byte plaintext blocks (P1, P2, ..., Pn) in operand 2 are enciphered using the AES algorithm with the 128-bit cryptographic key and the 128-bit chaining value.

The chaining value, called the initial chaining value (ICV), for deriving the first ciphertext block is the chaining value in the parameter block; the chaining value for deriving each subsequent ciphertext block is the corresponding previous ciphertext block. The ciphertext blocks (C1, C2, ..., Cn) are stored in operand 1. The last ciphertext block is the output chaining value (OCV) and is stored into the chaining-value field in the parameter block.

The operation is shown in Figure 7-62.

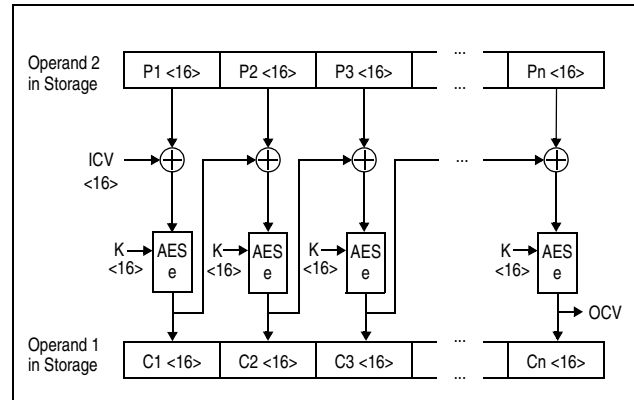

Figure 7-62. KMC AES Encipher Operation Using 128-Bit Key

When the modifier bit in general register 0 is one, a decipher operation is performed. The 16-byte ciphertext blocks (C1, C2, ..., Cn) in operand 2 are deciphered using the AES algorithm with the 128-bit cryptographic key and the 128-bit chaining value.

The chaining value, called the initial chaining value (ICV), for deriving the first plaintext block is in the parameter block; the chaining value for deriving each subsequent plaintext block is the corresponding previous ciphertext block. The plaintext blocks (P1, P2, ..., Pn) are stored in operand 1. The last ciphertext block is the output chaining value (OCV) and is stored into the chaining-value field in the parameter block. The operation is shown in Figure 7-63.

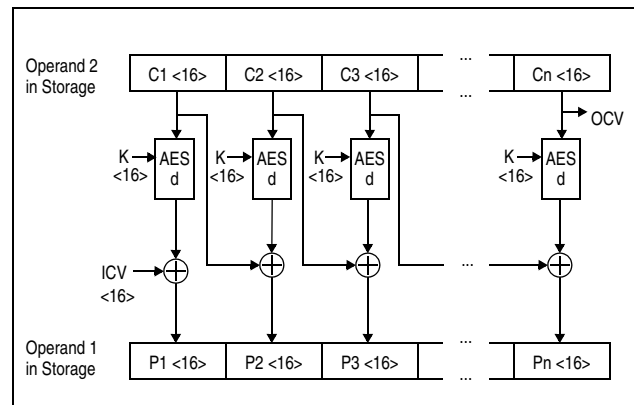

Figure 7-63. KMC AES Decipher Operation Using 128-Bit Key

KMC-AES-192 (KMC Function Code 19)

KMC-Encrypted-AES-192 (KMC Function Code 27)

The locations of the operands and addresses used by the instruction are as shown in Figure 7-7 on page 7-54.

The parameter block used for the KMC-AES-192 function has the following format:

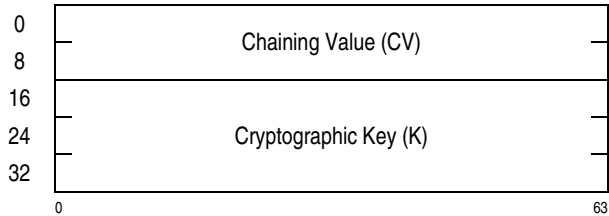

Figure 7-64. Parameter Block for KMC-AES-192

For the KMC-AES-192 function, the chaining value is in byte offsets 0-15 of the parameter block and the cryptographic key is in byte offsets 16-39 of the parameter block.

The parameter block used for the KMC-Encrypted-AES-192 function has the following format:

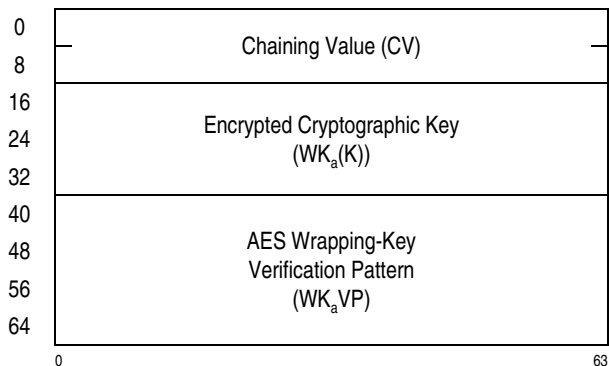

Figure 7-65. Parameter Block for KMC-Encrypted-AES-192

For the KMC-Encrypted-AES-192 function, the contents of byte offsets 40-71 of the parameter block are compared with the contents of the AES wrapping-key verification-pattern register. If they mismatch, the first-operand and parameter-block locations remain unchanged, and the operation is completed by setting condition code 1. If they match, the contents of byte offsets 16-39 of the parameter block are deciphered using the AES wrapping key to obtain the 192-bit cryptographic key, K. (See the section, “Pro-

tection of Cryptographic Keys” on page 7-431, for details.) The chaining value is in byte offsets 0-15 of the parameter block.

The following description applies to both functions.

When the modifier bit in general register 0 is zero, an encipher operation is performed. The 16-byte plaintext blocks (P1, P2, ..., Pn) in operand 2 are enciphered using the AES algorithm with the 192-bit cryptographic key and the 128-bit chaining value.

The chaining value, called the initial chaining value (ICV), for deriving the first ciphertext block is the chaining value in the parameter block; the chaining value for deriving each subsequent ciphertext block is the corresponding previous ciphertext block. The ciphertext blocks (C1, C2, ..., Cn) are stored in operand 1. The last ciphertext block is the output chaining value (OCV) and is stored into the chaining-value field of the parameter block. The operation is shown in Figure 7-66.

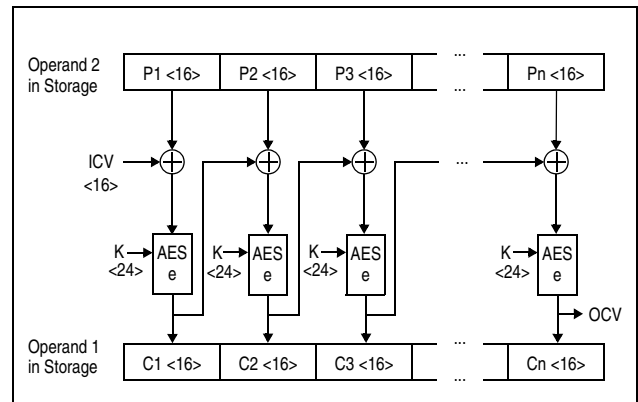

Figure 7-66. KMC AES Encipher Operation Using 192-Bit Key

When the modifier bit in general register 0 is one, a decipher operation is performed. The 16-byte ciphertext blocks (C1, C2, ..., Cn) in operand 2 are deciphered using the AES algorithm with the 192-bit cryptographic key and the 128-bit chaining value.

The chaining value, called the initial chaining value (ICV), for deriving the first plaintext block is in the parameter block; the chaining value for deriving each subsequent plaintext block is the corresponding previous ciphertext block. The plaintext blocks (P1, P2, ..., Pn) are stored in operand 1. The last ciphertext block is the output chaining value (OCV) and is

stored into the chaining-value field in the parameter block. The operation is shown in Figure 7-67.

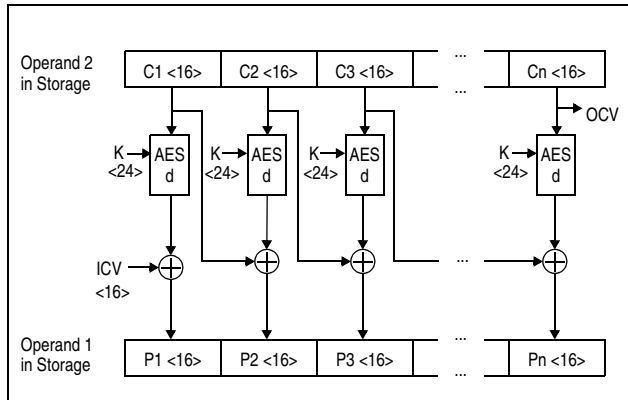

Figure 7-67. KMC AES Decipher Operation Using 192-Bit Key

KMC-AES-256 (KMC Function Code 20)

KMC-Encrypted-AES-256 (KMC Function Code 28)

The locations of the operands and addresses used by the instruction are as shown in Figure 7-7 on page 7-54.

The parameter block used for the KMC-AES-256 function has the following format:

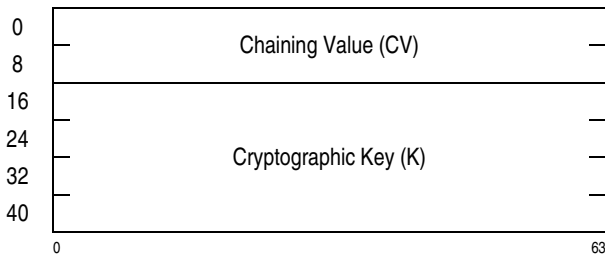

Figure 7-68. Parameter Block for KMC-AES-256

For the KMC-AES-256 function, the chaining value is in byte offsets 0-15 of the parameter block and the cryptographic key is in byte offsets 16-63 of the parameter block.

The parameter block used for the KMC-Encrypted-AES-256 function has the following format:

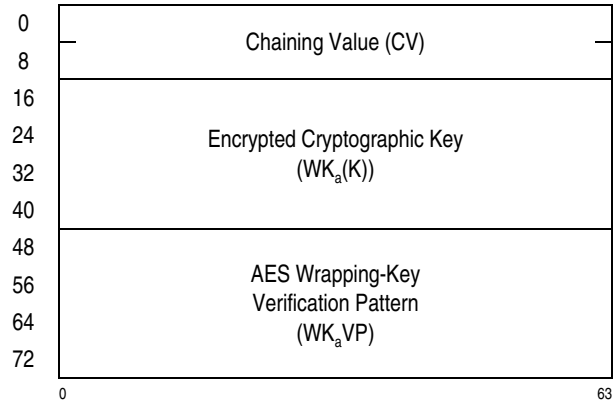

Figure 7-69. Parameter Block for KMC-Encrypted-AES-256

For the KMC-Encrypted-AES-256 function, the contents of byte offsets 48-79 of the parameter block are compared with the contents of the AES wrapping-key verification-pattern register. If they mismatch, the first-operand and parameter-block locations remain unchanged, and the operation is completed by setting condition code 1. If they match, the contents of byte offsets 16-47 of the parameter block are deciphered using the AES wrapping key to obtain the 256-bit cryptographic key, K. (See the section, “Protection of Cryptographic Keys” on page 7-431, for details.) The chaining value is in byte offsets 0-15 of the parameter block.

The following description applies to both functions.

When the modifier bit in general register 0 is zero, an encipher operation is performed. The 16-byte plaintext blocks (P1, P2, ..., Pn) in operand 2 are enciphered using the AES algorithm with the 256-bit cryptographic key and the 128-bit chaining value.

The chaining value, called the initial chaining value (ICV), for deriving the first ciphertext block is the chaining value in the parameter block; the chaining value for deriving each subsequent ciphertext block is the corresponding previous ciphertext block. The ciphertext blocks (C1, C2, ..., Cn) are stored in operand 1. The last ciphertext block is the output chaining value (OCV) and is stored into the chaining-value

field of the parameter block. The operation is shown in Figure 7-70.

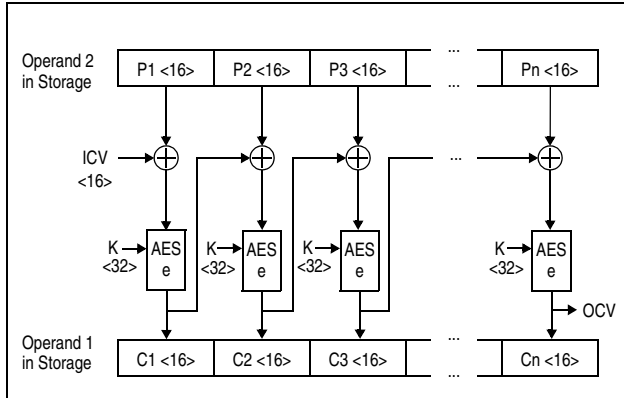

Figure 7-70. KMC AES Encipher Operation Using 256-Bit Key

When the modifier bit in general register 0 is one, a decipher operation is performed. The 16-byte ciphertext blocks (C1, C2, ..., Cn) in operand 2 are deciphered using the AES algorithm with the 256-bit cryptographic key and the 128-bit chaining value.

The chaining value, called the initial chaining value (ICV), for deriving the first plaintext block is in the parameter block; the chaining value for deriving each subsequent plaintext block is the corresponding previous ciphertext block. The plaintext blocks (P1, P2, ..., Pn) are stored in operand 1. The last ciphertext block is the output chaining value (OCV) and is

stored into the chaining-value field in the parameter block. The operation is shown in Figure 7-71.

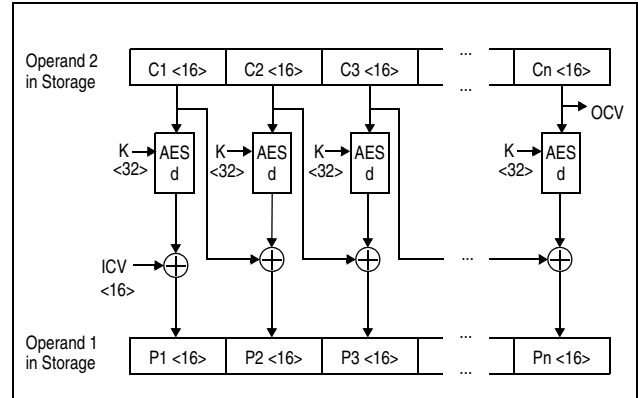

Figure 7-71. KMC AES Decipher Operation Using 256-Bit Key

KMC-PRNG (KMC Function Code 67)

The locations of the operands and addresses used by the instruction are as shown in Figure 7-7 on page 7-54.

The parameter block used for the function has the following format:

0	Chaining Value (CV)
8	Cryptographic Key 1 (K1)
16	Cryptographic Key 2 (K2)
24	Cryptographic Key 3 (K3)
0	63

Figure 7-72. Parameter Block for KMC-PRNG

Regardless of the value of the modifier bit in general register 0, the 8-byte plaintext blocks in operand 2 are used to generate the 8-byte ciphertext blocks in operand 1 based on a pseudo-random-number-generation algorithm. The algorithm is based on TDEA using three 64-bit cryptographic keys and a 64-bit chaining value. The output chaining value (OCV) is

stored in the chaining-value field of the parameter block. The operation is shown in Figure 7-73.

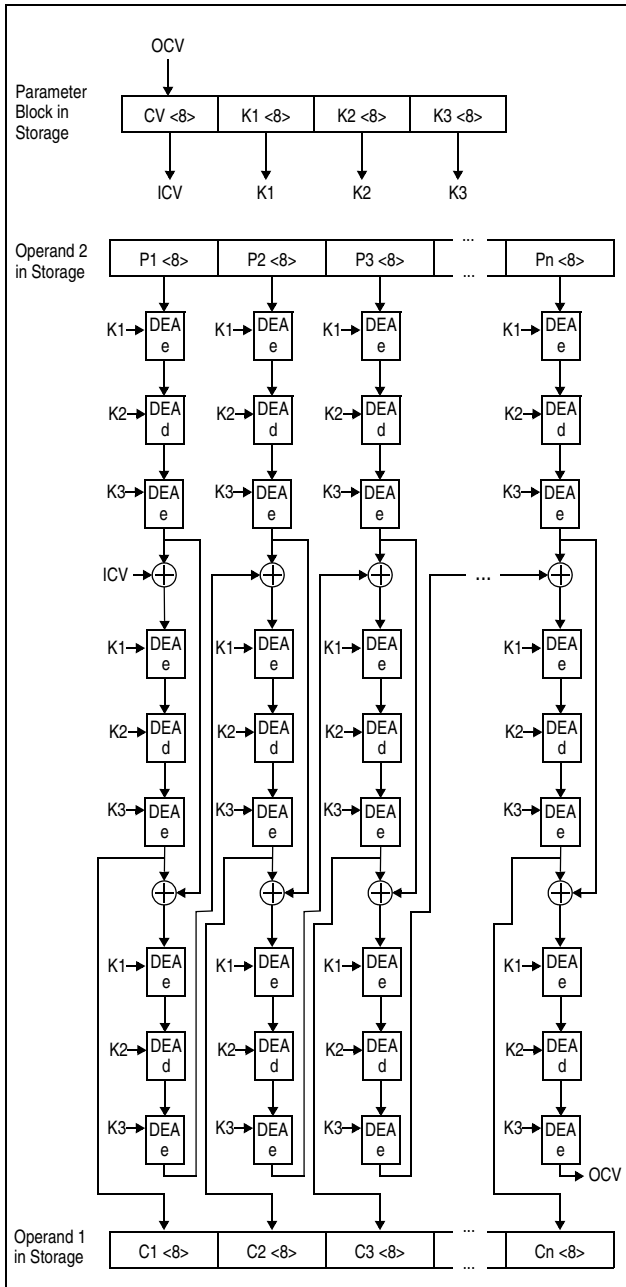

Figure 7-73. KMC-PRNG Operation

Special Conditions for KM and KMC

A specification exception is recognized and no other action is taken if any of the following occurs:

1. Bits 57-63 of general register 0 specify an unsigned or uninstalled function code.

2. The R_1 or R_2 field designates an odd-numbered register or general register 0.
3. The second operand length is not a multiple of the data block size of the designated function (see Figure 7-5 on page 7-52 to determine the data block sizes for CIPHER MESSAGE functions; see Figure 7-6 on page 7-52 to determine the data block sizes for CIPHER MESSAGE WITH CHAINING functions). This specification-exception condition does not apply to the query functions.

Resulting Condition Code:

- 0 Normal completion
- 1 Verification-pattern mismatch
- 2 --
- 3 Partial completion

Program Exceptions:

- Access (fetch, operand 2, cryptographic key, and wrapping-key verification pattern; store, operand 1; fetch and store, chaining value, XTS parameter)
- Operation (if the message-security assist is not installed)
- Specification
- Transaction constraint

1.-6.	Exceptions with the same priority as the priority of program-interruption conditions for the general case.
7.A	Access exceptions for second instruction halfword.
7.B	Operation exception.
7.C	Transaction constraint
8.	Specification exception due to invalid function code or invalid register number.
9.	Specification exception due to invalid operand length.
10.	Condition code 0 due to second-operand length originally zero.
11.A.1	Access exceptions for an access to the parameter block.
11.A.2.	Condition code 1 due to verification-pattern mismatch.

Figure 7-74. Priority of Execution: KM and KMC

11.B	Access exceptions for an access to the first, or second operand.
12.	Condition code 0 due to normal completion (second-operand length originally nonzero, but stepped to zero).
13.	Condition code 3 due to partial completion (second-operand length still nonzero).

Figure 7-74. Priority of Execution: KM and KMC

Programming Notes:

1. The performance of the query function (code 0) may be significantly slower than that of simply examining a location in storage. If the program needs to frequently test for the availability of a function, it should perform the query function once during initialization; subsequently it should examine the stored results of the query function in memory with an instruction such as TEST UNDER MASK.
2. When condition code 3 is set, the general registers containing the operand addresses and length, and the chaining value or the XTS parameter in the parameter block, are usually updated such that the program can simply branch back to the instruction to continue the operation.

For unusual situations, the CPU protects against endless reoccurrence of the no-progress case and also protects against setting condition code 3 when the portion of the first and second operands to be reprocessed overlap in storage. Thus, the program can safely branch back to the instruction whenever condition code 3 is set with no exposure to an endless loop and no exposure to incorrectly retrying the instruction.

3. If the length of the second operand is nonzero initially and condition code 0 is set, the registers are updated in the same manner as for condition code 3. For CIPHER MESSAGE WITH CHAINING, the chaining value in this case is such that additional operands can be processed as if they were part of the same chain.
4. To save storage, the first and second operands may overlap exactly or the starting point of the first operand may be to the left of the starting point of the second operand. In either case, the overlap is not destructive.
5. For XTS functions, the program must compute the initial XTS parameter by using the appropri-

ate Compute-XTS-Parameter PCC functions before processing the first part of a message.

6. The initial XTS parameter used in the KM-XTS-AES-128 (or the KM-XTS-Encrypted-AES-128) function is computed by using the AES encryption algorithm with a 128-bit cryptographic key, which shall be different from the 128-bit cryptographic key used in the KM-XTS-AES-128 (or the KM-XTS-Encrypted-AES-128) function.

Similarly, the initial XTS parameter used in the KM-XTS-AES-256 (or the KM-XTS-Encrypted-AES-256) function is computed by using the AES-encryption algorithm with a 256-bit cryptographic key, which shall be different from the 256-bit cryptographic key used in the KM-XTS-AES-256 (or the KM-XTS-Encrypted-AES-256) function.

7. As observed by this CPU, other CPUs, and the I/O subsystem, inconsistent results may be briefly stored in the first-operand location. See the section “Effects of CPU Retry” on page 11-3 for further details.

CIPHER MESSAGE WITH AUTHENTICATION

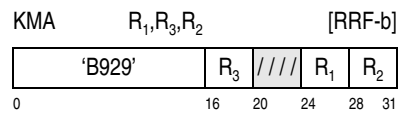

A function specified by the function code in general register 0 is performed.

General register 0 contains various controls affecting the operation of the instruction, as follows:

Flags (F): Bit positions 48-55 of general register 0 contain an 8-bit flags field controlling the operation of the function. The flags field is meaningful only when the function code in bits 57-63 of general register 0 designates a ciphering function (that is, when the function code is nonzero). The format of the flags field is as follows:

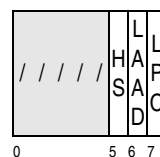

The individual flag fields are as follows:

Reserved: Bits 0-4 of the flags field are reserved and should contain zeros; otherwise, the program may not operate compatibly in the future.

Hash-subkey-Supplied (HS) Flag: Bit 5 of the flags field indicates whether the hash-subkey (H) field in the parameter block contains a valid hash subkey. The HS flag is meaningful only when the function code is nonzero, and the function does not use an encrypted cryptographic key; the HS flag is ignored for functions that use an encrypted cryptographic key.

Last-AAD (LAAD) Flag: Bit 6 of the flags field qualifies the contents of the third operand. When the LAAD flag is one, it indicates that the third operand designates the last series of additional-authenticated-data (AAD) blocks. When the LAAD flag is zero, it indicates that the third operand does not designate the last series of AAD blocks.

Last-Plaintext / Ciphertext (LPC) Flag: Bit 7 of the flags field qualifies the contents of the second operand. When the LPC flag is one, it indicates that the second operand designates the last series of plaintext or ciphertext blocks. When the LPC flag is zero, it indicates that the second operand does not designate the last series of plaintext or ciphertext blocks.

A specification exception is recognized, and the operation is suppressed when the LPC flag is one, and the LAAD flag is zero.

Modifier (M): When the function code in bits 57-63 of general register 0 is nonzero, bit position 56 of general register 0 contains a modifier bit indicating encryption or decryption is to be performed by the function. When the M bit is zero, the function performs encryption of the second operand; when the M bit is one, the function performs decryption of the second operand. The M bit is ignored when the function code is zero.

Function Code (FC): Bit positions 57-63 of general register 0 contain the function code. Figure 7-75 shows the assigned function codes for CIPHER

MESSAGE WITH AUTHENTICATION. All other function codes are unassigned.

Code	Function	Param. Block Size (bytes)	Data Block Size (bytes)
0	KMA-Query	16	—
18	KMA-GCM-AES-128	96	16
19	KMA-GCM-AES-192	104	16
20	KMA-GCM-AES-256	112	16
26	KMA-GCM-Encrypted-AES-128	128	16
27	KMA-GCM-Encrypted-AES-192	136	16
28	KMA-GCM-Encrypted-AES-256	144	16
Explanation:			
— Not applicable			

Figure 7-75. Function Codes for CIPHER MESSAGE WITH AUTHENTICATION

Bits 0-31 of general register 0 are ignored. Bits 32-47 of general register 0 are reserved and should contain zeros; otherwise, the program may not operate compatibly in the future.

The query function provides the means of indicating the availability of the other functions. The contents of general registers R_1 , R_2 , $R_2 + 1$, R_3 , and $R_3 + 1$ are ignored for the query function.

For functions other than the query function (that is, for functions having a nonzero function code), a message-authentication tag is formed from the contents of the third operand and from the contents of either the resulting first operand or the second operand, depending on whether the M bit is 0 or 1, respectively. Based on the M bit, the second operand is either encrypted or decrypted using a cryptographic key and counter values from the parameter block, and the result is placed in the first-operand location.

General register 1 contains the logical address of the leftmost byte of the parameter block in storage. In the 24-bit addressing mode, the contents of bit positions 40-63 of general register 1 constitute the address, and the contents of bit positions 0-39 are ignored. In the 31-bit addressing mode, the contents of bit positions 33-63 of general register 1 constitute the address, and the contents of bit positions 0-32 are ignored. In the 64-bit addressing mode, the contents of bit positions 0-63 of general register 1 constitute the address.

The R_1 field designates a general register and must designate an even-numbered register other than general register 0; otherwise, a specification exception is recognized. The R_2 and R_3 fields each designate an even-odd pair of general registers and must designate even-numbered registers other than general register 0; otherwise, a specification exception is recognized. A specification exception is also recognized if the R_3 field designates the same register as either the R_1 or R_2 fields.

The location of the leftmost byte of the first, second, and third operands is specified by the contents of general registers R_1 , R_2 , and R_3 , respectively. The number of bytes in the second-operand location is specified in general register $R_2 + 1$. The first operand is the same length as the second operand. The number of bytes in the third-operand location is specified in general register $R_3 + 1$.

As part of the operation, the address in general register R_3 is incremented by the number of third-operand bytes processed, and the length in general register $R_3 + 1$ is decremented by the same number; additionally, the addresses in general registers R_1 and R_2 are each incremented by the number of second-operand bytes processed, and the length in general register $R_2 + 1$ is decremented by the same number. The formation and updating of the addresses and length is dependent on the addressing mode.

In the 24-bit addressing mode, the contents of bit positions 40-63 of general registers R_1 , R_2 , and R_3 constitute the addresses of the first, second, and third operands, respectively, and the contents of bit positions 0-39 are ignored; bits 40-63 of the updated addresses replace the corresponding bits in general registers R_1 , R_2 , and R_3 , carries out of bit position 40 of the updated address are ignored, and the contents of bit positions 32-39 of general registers R_1 , R_2 , and R_3 are set to zeros. In the 31-bit addressing mode, the contents of bit positions 33-63 of general registers R_1 , R_2 , and R_3 constitute the addresses of the first, second, and third operands, respectively, and the contents of bit positions 0-32 are ignored; bits

33-63 of the updated addresses replace the corresponding bits in general registers R_1 , R_2 , and R_3 , carries out of bit position 33 of the updated address are ignored, and the content of bit position 32 of general registers R_1 , R_2 , and R_3 is set to zero. In the 64-bit addressing mode, the contents of bit positions 0-63 of general registers R_1 , R_2 , and R_3 constitute the addresses of the first, second, and third operands, respectively; bits 0-63 of the updated addresses replace the contents of general registers R_1 , R_2 , and R_3 , and carries out of bit position 0 are ignored.

In both the 24-bit and the 31-bit addressing modes, the contents of bit positions 32-63 of general register $R_2 + 1$ form a 32-bit unsigned binary integer which specifies the number of bytes in the first and second operands, and the contents of bit positions 0-31 are ignored; bits 32-63 of the updated value replace the corresponding bits in general register $R_2 + 1$. In the 64-bit addressing mode, the contents of bit positions 0-63 of general register $R_2 + 1$ form a 64-bit unsigned binary integer which specifies the number of bytes in the first and second operands; the updated value replaces the contents of general register $R_2 + 1$.

In both the 24-bit and the 31-bit addressing modes, the contents of bit positions 32-63 of general register $R_3 + 1$ form a 32-bit unsigned binary integer which specifies the number of bytes in the third operand, and the contents of bit positions 0-31 are ignored; bits 32-63 of the updated value replace the corresponding bits in general register $R_3 + 1$. In the 64-bit addressing mode, the contents of bit positions 0-63 of general register $R_3 + 1$ form a 64-bit unsigned binary integer which specifies the number of bytes in the third operand; the updated value replaces the contents of general register $R_3 + 1$.

In the 24-bit or 31-bit addressing mode, the contents of bit positions 0-31 of general registers R_1 , R_2 , $R_2 + 1$, R_3 , and $R_3 + 1$ always remain unchanged.

Figure 7-76 on page 7-79 shows the contents of the general registers just described.

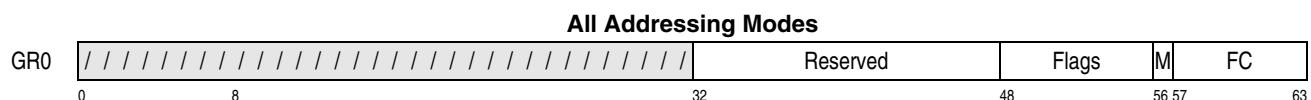

Figure 7-76. General Register Assignment for CIPHER MESSAGE WITH AUTHENTICATION (Part 1 of 2)

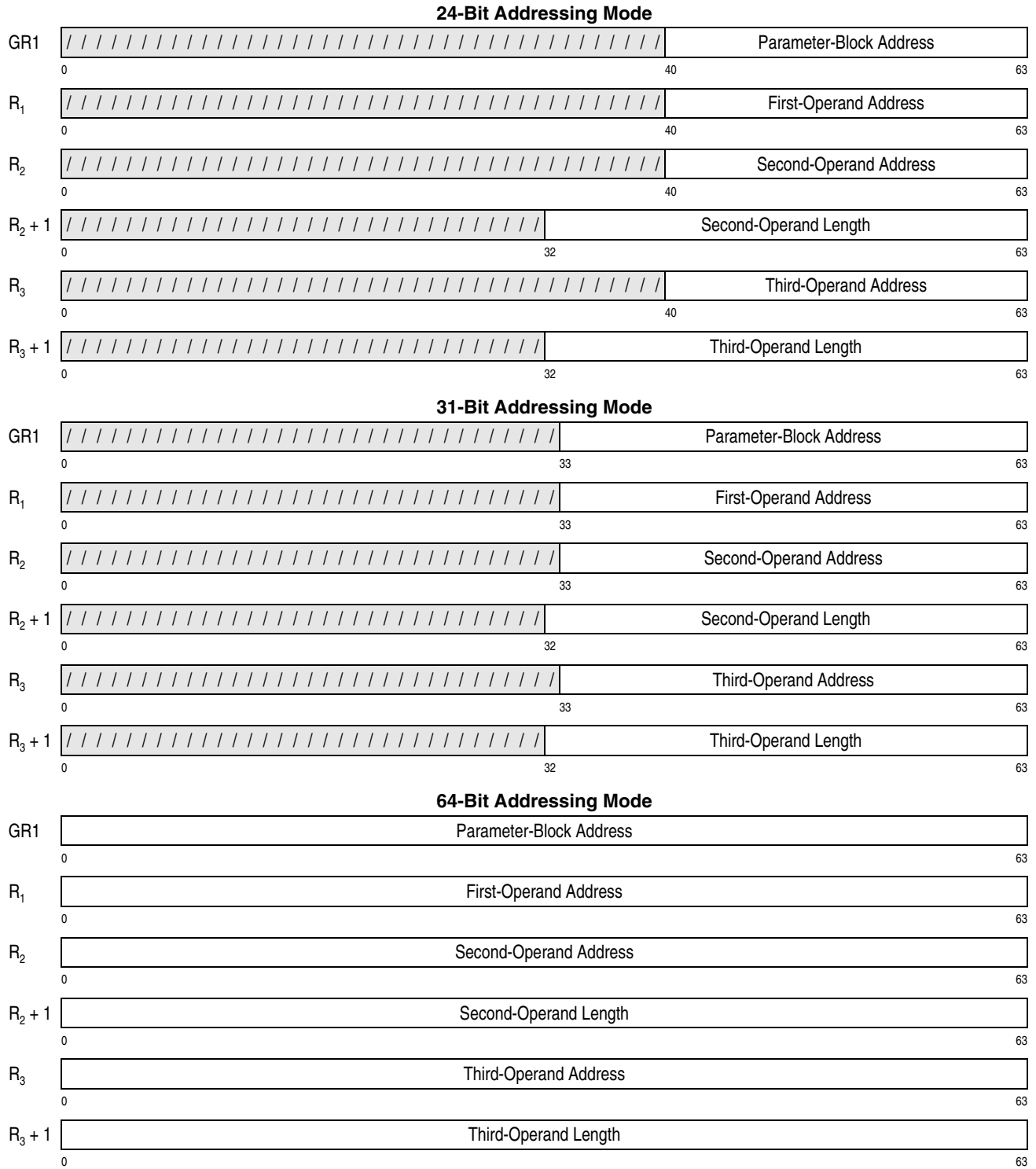

Figure 7-76. General Register Assignment for CIPHER MESSAGE WITH AUTHENTICATION (Part 2 of 2)

In the access-register mode, access registers 1, R₁, R₂, and R₃ specify the address spaces containing the parameter block, first, second, and third operands, respectively.

KMA-Query (Function Code 0)

The locations of the operands and addresses used by the instruction are as shown in Figure 7-76 on page 7-79.

The parameter block used for the function has the following format:

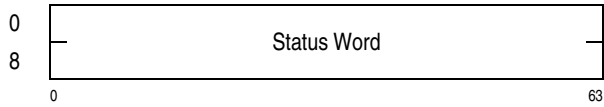

Figure 7-77. Parameter Block for KMA-Query

A 128-bit status word is stored in the parameter block. Bits 0-127 of this field correspond to function codes 0-127, respectively, of the CIPHER MESSAGE WITH AUTHENTICATION instruction. When a bit is one, the corresponding function is installed; otherwise, the function is not installed.

Condition code 0 is set when execution of the KMA-Query function completes; condition codes 1, 2, and 3 are not applicable to this function.

KMA-GCM-AES Functions

Note: The description of the KMA-GCM-AES instruction assumes that the reader is familiar with the Galois counter mode (GCM) described in Reference [17.] on page xxx. In particular, see [17] for a description of the GCM functions GHASH and GCTR.

This section illustrates the operation for six KMA-GCM-AES functions:

- KMA-GCM-AES-128 (function code 18)
- KMA-GCM-AES-192 (function code 19)
- KMA-GCM-AES-256 (function code 20)
- KMA-GCM-Encrypted AES-128 (function code 26)
- KMA-GCM-Encrypted AES-192 (function code 27)
- KMA-GCM-Encrypted AES-256 (function code 28)

The locations of the operands and addresses used by each of these functions are as shown in Figure 7-76 on page 7-79.

The parameter block used for all KMA-GCM-AES functions has a common format as shown in Figure 7-78, below.

Offset		
Dec	Hex	
00	00	Reserved
08	08	
16	10	Counter Value (CV)
24	18	
32	20	Tag (T)
40	28	
48	30	Hash Subkey (H)
56	38	
64	40	Total AAD Length (TAADL)
72	48	
80	50	Total Plaintext or Ciphertext Length (TPCL)
:	:	
X	X	Initial Counter Value (J_0)
Y	Y	
:	:	Cryptographic Key (K) (for functions 18-20)
X	X	
Y	Y	Encrypted Cryptographic Key ($WK_a(K)$) (for functions 26-28)
Z	Z	
		AES Wrapping-Key Verification Pattern (WK_aVP) (only present for functions 26-28)

Explanation:

- X 72 (48 hex) plus the length of K (in bytes)
- Y 80 (50 hex) plus the length of K (in bytes)
- Z Y plus 24 (18 hex; the first byte of the last 8 bytes).

Figure 7-78. Parameter Block for KMA-GCM-AES Functions

The fields of the parameter block for all KMA-GCM-AES functions are as follows:

Reserved: Bytes 0-11 of the parameter block are reserved. The reserved field may contain model dependent values at the completion of the instruction.

Counter Value (CV): Bytes 12-15 of the parameter block contain a 32-bit binary integer. The leftmost 12 bytes of the initial-counter value (J_0 , in bytes 64-79 of the parameter block) are concatenated with the contents of the CV field on the right to form the initial-counter block (ICB) that is used by the GCTR function (described in Reference [17.] on page xxx).

For each execution of the instruction, the CPU increments the CV field in the parameter block by the number of second-operand blocks processed. A carry out of bit position 0 of the CV field is ignored.

Tag (T): Bytes 16-31 of the parameter block contain the message-authentication tag field.

For each block of the third operand, and for each block of the resulting first operand (when M is 0) or each block of the second operand (when M is 1), the CPU uses the tag field as both input and output to the GHASH function. When all AAD and ciphertext has been hashed, the concatenation of the TAADL and TPCL fields are hashed using GHASH, and the results of the hash are encrypted using the GCTR function to produce a last tag (T) field in the parameter block.

Hash Subkey (H): For the KMA-GCM-AES functions, bytes 32-47 of the parameter block contain a 128-bit hash subkey that is used by the GHASH functions of the instruction. When the hash-subkey-supplied flag (HS, bit 53 of general register 0) is zero, the CPU computes the hash subkey by encrypting 128 bits of binary zeros using the cryptographic key (K), stores the hash subkey in the H field, and sets the HS flag to one. When the HS flag is one, the CPU uses the program-supplied hash subkey in the H field; the H field and HS flag are not altered in this case.

For the KMA-GCM-encrypted-AES functions, bytes 32-47 of the parameter block are reserved and should contain zeros; otherwise, the program may not operate compatibly in the future. In this case, the CPU always computes the hash subkey by encrypting 128 bits of binary zeros using the deciphered cryptographic key (K); the H field and HS flag are not altered in this case.

Total AAD Length (TAADL): Bytes 48-55 of the parameter block contain a 64-bit unsigned binary integer designating the total length in bits of the entire additional-authenticated-data (AAD) for the message being processed.

Total Plaintext or Ciphertext Length (TPCL): Bytes 56-63 of the parameter block contain a 64-bit unsigned binary integer designating the total length in bits of the entire plaintext or ciphertext for the message being processed.

Initial Counter Value (J₀): Bytes 64-79 of the parameter block contain a 128-bit initial counter value that is used (a) to provide the leftmost 96 bits of the initial-counter block used by the GCTR function, and (b) to encrypt the last authentication tag (T) field.

Cryptographic Key (K): The cryptographic key used in the encipher and decipher operations begins at byte 80 of the parameter block. The size of the key field and its offset in the parameter block are dependent on the function code, as shown in Figure 7-79.

Function Code	Function	Key Length (bytes)	Key Offset (bytes)
18	KMA-GCM-AES-128	16	80-95
19	KMA-GCM-AES-192	24	80-103
20	KMA-GCM-AES-256	32	80-111
26	KMA-GCM-Encrypted-AES-128	16	80-95
27	KMA-GCM-Encrypted-AES-192	24	80-103
28	KMA-GCM-Encrypted-AES-256	32	80-111

Figure 7-79. Key Lengths and Offsets for KMA-GCM Functions

AES Wrapping-Key Verification Pattern (WK_aVP): For the KMA-GCM-encrypted-AES functions (codes 26-28), the 32 bytes immediately following the key in the parameter block contain the AES wrapping-key verification pattern (WK_aVP).

For the KM-AES functions (codes 18-20), the WK_aVP field is not present in the parameter block.

Symbols Used in KMA-GCM-AES Function Descriptions

The following symbols are used in the subsequent description of the KMA-GCM-AES functions.

Further description of the AES standard may be found in Reference [14.] on page xxx. Further description of the Galois-counter mode of encryption and decryption may be found in Reference [17.] on page xxx.

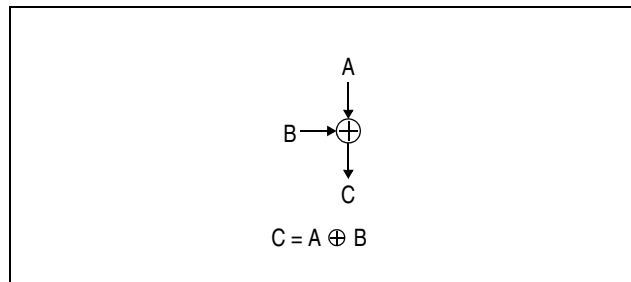

Figure 7-80. Symbol For Bit-Wise Exclusive OR

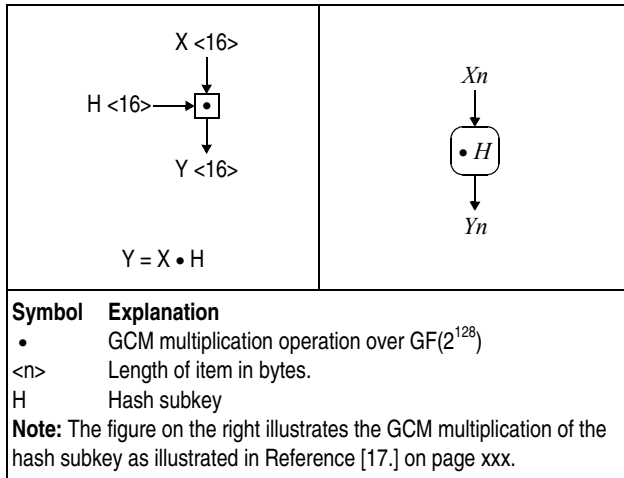

Figure 7-81. Symbols For GCM Multiplication Operation Over $GF(2^{128})$

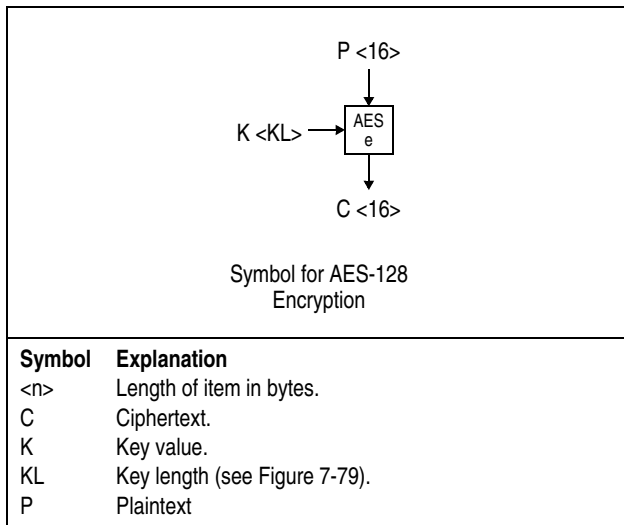

Figure 7-82. Symbols for AES Encryption

The following description applies to all KMA-GCM-AES functions. A sequence of operations is performed, depending on the flags and function code in general register 0, as follows:

Wrapping-Key Verification: For the KMA-GCM-encrypted-AES functions (function codes 26-28), the contents of the 32-byte WK_aVP field are compared with the contents of the AES wrapping-key verification-pattern register. If they mismatch, the first-oper- and parameter-block locations remain unchanged, and the operation is completed by setting condition code 1. If they match, the contents of the key field of the parameter block are deciphered using the AES wrapping key to obtain the cryptographic key, K. (See the section “Protection of Cryptographic Keys” on page 7-431 for details.)

For the KMA-GCM-AES functions that do not use encrypted keys (codes 18-20), wrapping-key verification is not performed.

Computing the Hash Subkey: A hash subkey is used in the GHASH processing to produce the resulting message-authentication tag. GHASH processing is described in Reference [17.] on page xxx.

For KMA-GCM-AES functions (function codes 18-20), the following applies:

- When the hash-subkey-supplied flag (HS, bit 53 of general register 0) is zero, a block of 128 binary zeros is encrypted using the AES algorithm described in Reference [14.] on page xxx. The AES algorithm uses the key (K) field from the parameter block, as shown in Figure 7-83, below.

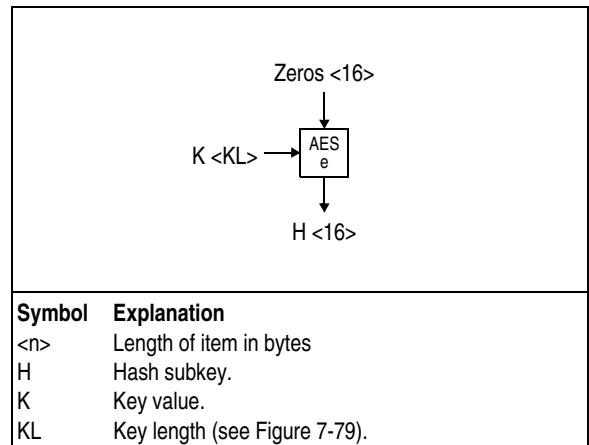

Figure 7-83. Encrypting the Hash Subkey

The resulting 128-bit hash subkey is placed into the H field of the parameter block, and the HS flag is set to one in general register 0.

- When the HS flag is one, the H field in the parameter block is used as the hash subkey. In this case, the H field and HS flag are not altered.

For KMA-GCM-encrypted-AES functions (function codes 26-28), the HS flag is ignored. A block of 128 binary zeros is always encrypted using the AES algorithm as shown in Figure 7-83, using the decrypted key (K). In this case, the H field of the parameter block and the HS flag are not altered.

Additional-Authenticated-Data (AAD) Hashing: AAD hashing is not performed when either of the following conditions apply. In either of these conditions,

general registers R_3 and R_3+1 are not modified, and it is model dependent whether the T field in the parameter block is fetched and stored back unmodified.

- The third-operand length in general register $R_3 + 1$ is initially less than 16, and the last-AAD flag (LAAD, bit 54 of general register 0) is zero. In this case, the instruction completes by setting condition code 2.
- The third-operand length is initially zero, and the LAAD flag is one. In this case, processing continues as described in “Ciphering and Hashing” on page 7-85.

When the third-operand length in general register $R_3 + 1$ is nonzero, additional-authenticated-data hashing is performed. In this case, general register R_3 contains the address of a storage location containing data from which a message-authentication tag is computed using the GHASH algorithm described in Reference [17.] on page xxx. In addition to the blocks of the third operand, the GHASH function uses the hash subkey (described above) and the tag field in the parameter block as input values.

The result is obtained as if processing starts at the left end of the third operand and proceeds to the right, block by block. When one or more full 16-byte blocks of AAD remain, the processing is illustrated in Figure 7-84.

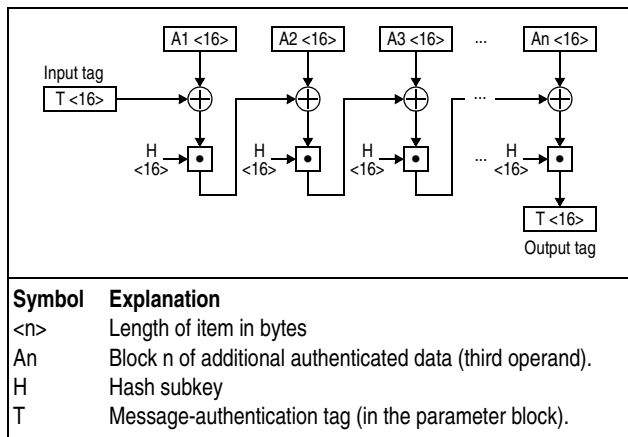

Figure 7-84. GHASH Processing of Full Blocks.

The AAD-hashing process ends when any of the following is true:

- A CPU-determined number of blocks that is less than the length of the third operand has been processed. In this case, the message-authenti-

cation tag computed thus far is placed into the T field of the parameter block, general register R_3 is incremented by the number of third-operand bytes processed, general register $R_3 + 1$ is decremented by the same amount, and the instruction completes by setting condition code 3.

- The last-AAD flag (LAAD, bit 54 of general register 0) is zero, and number of bytes remaining in the third operand is less than 16. In this case, the message-authentication tag computed thus far is placed into the T field of the parameter block, general register R_3 is incremented by the number of third-operand bytes processed (if any), general register $R_3 + 1$ is decremented by the same amount, and the instruction completes by setting condition code 2.
- The LAAD flag is one, and the number of bytes remaining in the third operand is between 1 and 15. In this case, the following is performed:
 - A copy of the remaining short block is padded on the right with sufficient binary zeros to form a full block that is hashed using GHASH.
 - General register R_3 is incremented by the number of third-operand bytes processed, and the third-operand length in general register $R_3 + 1$ is set to zero.

Processing of the last block of the third operand is illustrated in Figure 7-85.

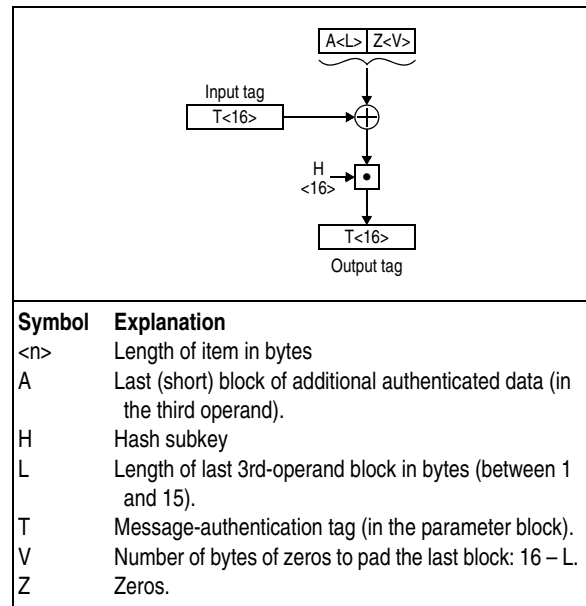

Figure 7-85. GHASH Processing of Last (Short) Block

- The LAAD flag is one and the number of bytes remaining in the third operand is zero.

For either of the above two cases (when the LAAD flag is one), it is model dependent whether the instruction completes with condition code 3, or processing continues with the ciphering and hashing of the second operand, as described below.

Ciphering and Hashing: The ciphering-and-hashing process is not performed when either of the following conditions apply. In either of these conditions, general registers R_1 , R_2 , and R_2+1 are not modified, and it is model dependent whether the CV and T fields in the parameter block are fetched and stored back unmodified.

- The second-operand length in general register $R_2 + 1$ is initially less than 16, and the last-plaintext/ciphertext flag (LPC, bit 55 of general register 0) is zero. In this case, the instruction completes by setting condition code 2.
- The second-operand length is initially zero, and the LPC flag is one. In this case, processing continues as described in “Last Message-Authentication-Tag Hashing and Encryption” on page 7-87.

Depending on the M bit (bit 56 of general register 0), each block of the second operand is either encrypted or decrypted using the GCTR function described in Reference [17.] on page xxx. The respective encrypted or decrypted result is placed at the first-operand location, and the encrypted operand is hashed using the GHASH function. The combination of the GCTR and GHASH processing is described as the GCM function in Reference [17.] on page xxx.

Conceptually, the result is obtained as if processing starts at the left end of the first and second operands and proceeds to the right, block by block, as illustrated in Figure 7-86 and Figure 7-87. However, depending on the model, a unit of operation may process multiple blocks of the first and second operands in parallel; thus, the blocks may not necessarily be accessed in left-to-right order. Furthermore, multiple accesses may be made to a block, and in the case of the encryption operation, a first-operand block may be re-fetched after it is stored.

The GCTR function uses a 16-byte initial-counter block (ICB) formed from the concatenation of the leftmost 12 bytes of the initial-counter-value (J_0) on the

left with the four-byte counter value (CV) on the right. GCTR also uses the key field (either directly from the parameter block for the KMA-GCM-AES functions, or the decrypted key for the KMA-GCM-encrypted-AES functions). For each block that is ciphered by GCTR, the counter value (CV) is incremented by one; a carry out of bit position 0 of the counter value is ignored. The GCTR function then uses a 16-byte counter block (CB) formed from the leftmost 12 bytes of J_0 concatenated with the incremented counter value.

The GHASH function uses the encrypted data (that is, the encrypted first-operand result when M is 0 or the second operand when M is one), the tag (T) field from either the parameter block or from the preceding step, and the hash subkey.

When the M bit is zero (that is, when the second operand is being encrypted), GCM processing of full blocks is illustrated in Figure 7-86.

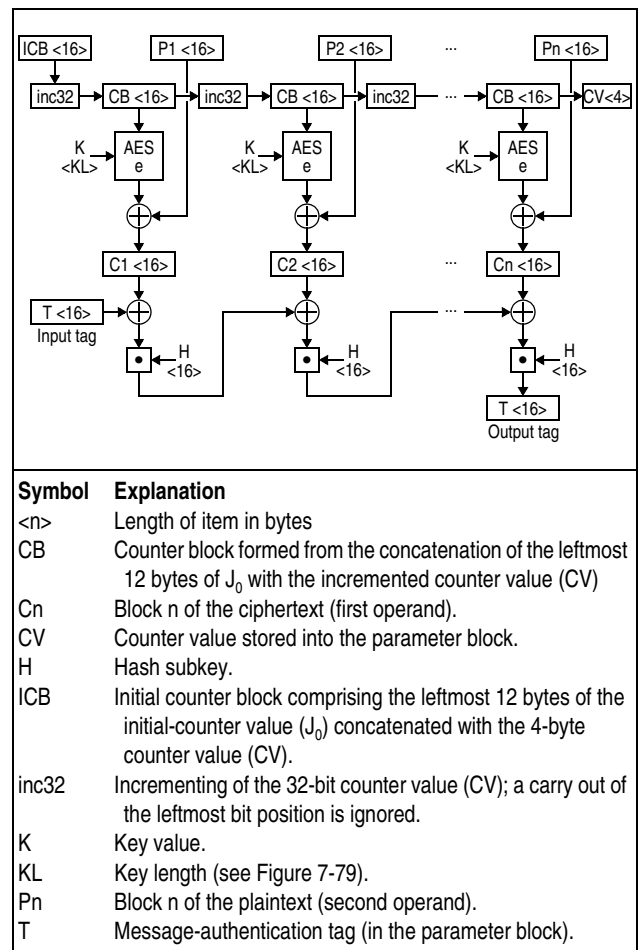

Figure 7-86. Combined Ciphering and Hashing of Full Blocks for Encryption

When the M bit is one (that is, when the second operand is being decrypted), GCM processing of full blocks is illustrated in Figure 7-87.

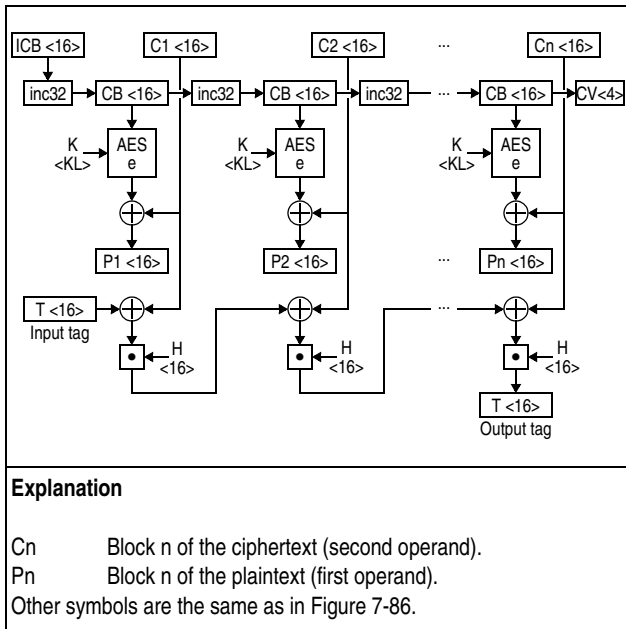

Figure 7-87. Combined Ciphering and Hashing of Full Blocks for Decryption

The ciphering-and-hashing process for either encryption or decryption continues until any of the following is true:

- A CPU-determined number of blocks that is less than the length of the second operand has been processed. In this case, the current counter value is placed into the CV field of the parameter block, the message-authentication tag computed thus far is placed into the T field of the parameter block, general registers R_1 and R_2 are incremented by the number of second-operand bytes processed, general register $R_2 + 1$ is decremented by the same amount, and the instruction completes by setting condition code 3.
- The last-plaintext/ciphertext flag (LPC, bit 55 of general register 0) is zero, and number of bytes

remaining in the second operand is less than 16. In this case, the current counter value is placed into the CV field of the parameter block, the message-authentication tag computed thus far (if any) is placed into the T field of the parameter block, general registers R_1 and R_2 are incremented by the number of second-operand bytes processed (if any), general register $R_2 + 1$ is decremented by the same amount, and the instruction completes by setting condition code 2.

- The LPC flag is one, and the number of bytes remaining in the second operand is between 1 and 15. In this case, the following is performed:
 - A copy of the remaining bytes of the second operand is padded on the right with sufficient binary zeros to form a full block that is ciphered using the GCTR algorithm, and the leftmost bytes of the resulting encrypted or decrypted block are placed at the first-operand location. The number of bytes placed at the first-operand location is the same as the number of bytes remaining in the second operand (that is, less than 16).
 - The GHASH algorithm is then applied to the ciphertext. When M is zero, the input to the GHASH algorithm consists of a copy of the short block stored into the first-operand location, padded on the right with sufficient binary zeros to form a full block. When M is one, the input to the GHASH algorithm is the same as the input to the GCTR algorithm (that is, a copy of the remaining bytes of the second operand, padded on the right with sufficient binary zeros to form a full block).
 - The current counter value is placed into the CV field of the parameter block, the resulting tag value is placed in the parameter block, general registers R_1 and R_2 are incremented by the number of second-operand bytes processed, and general register $R_2 + 1$ is set to zero.

GCM processing of the last block of the second operand is illustrated in Figure 7-88.

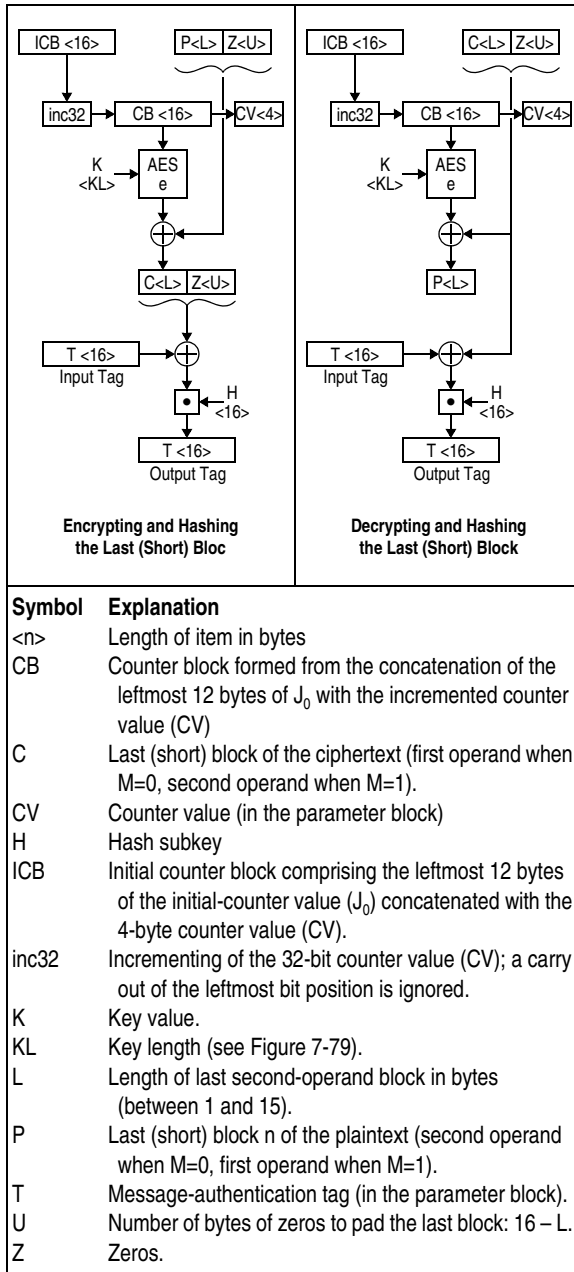

Figure 7-88. Ciphering and Hashing of the Last (Short) Block.

- The LPC flag is one, and the number of bytes remaining in the second operand is zero.

For either of the above two cases (when the LPC flag is one), it is model dependent whether the instruction completes with condition code 3 or continues processing with the last message-authentication-tag hashing and encryption, as described below.

Last Message-Authentication-Tag Hashing and Encryption: A 128-bit value comprising the concatenation of the 64-bit total-AAD-length (TAADL) and total-plaintext-or-ciphertext-length (TPCL) fields from the parameter block is hashed using the GHASH function. The GHASH function uses the concatenated lengths field, the tag (T) field as computed in the ciphering-and-hashing operation, and the hash subkey.

The resulting 128-bit output of GHASH is then processed by the GCTR algorithm. Note, unlike the ciphering-and-hashing operation, the input counter to GCTR is the initial-counter-block (J_0) field from the parameter block. The resulting 128-bit value replaces the tag (T) field in the parameter block, and the instruction completes with condition code 0. Figure 7-89 illustrates the hashing and encryption of the last tag value.

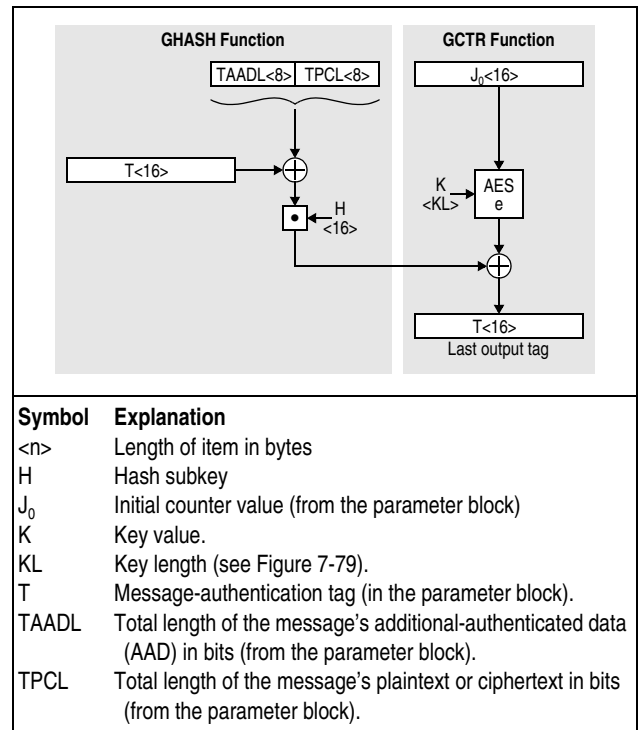

Figure 7-89. Hashing and Encrypting the Last Tag

Common Operation: The detection of conditions resulting in condition code 3 depends on the model, and may be a different number each time the instruction is executed. The CPU-determined number of blocks is usually nonzero. In certain unusual situations, this number may be zero, and condition code 3 may be set with no progress. However, the CPU protects against endless reoccurrence of this no-progress case.

The results are unpredictable if either of the following is true:

- The third operand overlaps destructively with any portion of the parameter block that may be updated during AAD processing.
- The LAAD flag is one, and any of the following is true:
 - The second operand overlaps destructively with any portion of the parameter block that may be updated during ciphering and hashing.
 - The first operand overlaps destructively with any portion of the parameter block that may be accessed during ciphering and hashing.
 - The first operand overlaps destructively with the second operand, but the operands do not designate the same location.

Operands are said to overlap destructively when a location would be used as a source after data would have been moved into it, assuming processing to be performed from left to right.

Figure 7-90 illustrates the various condition codes set by the instruction, and the resulting second- and third-operand lengths based on the LAAD and LPC flags.

Condition Code	LAAD	LPC	3rd-operand length	2nd-operand length
0	1	1	0	0
1	—	—	Unchanged†	Unchanged†
2	0	—	< 16	Unchanged
	1	0	0	< 16
3	0	—	>= 16	Unchanged
	1	0	0	>= 16
	1 ‡	1 ‡	0 ‡	0 ‡

Explanation:

— Not applicable

† Also, first-, second-, and third-operand addresses in general registers R₁, R₂, and R₃ are unchanged

‡ It is model dependent whether CC3 is set for these conditions (which are identical to the CC0 conditions).

LAAD Last-additional-authenticated-data flag, bit 54 of general register 0

LPC Last-plaintext/ciphertext flag, bit 55 of general register 0

Figure 7-90. Condition Codes and Resulting Operand Lengths, based on LAAD and LPC

Store-type access exceptions may be recognized for any location in the parameter block, even though only the CV, T, and H fields are actually stored by the instruction.

A PER storage-alteration event may be recognized both for the first-operand location and for the portion of the parameter block that is stored. A PER zero-address-detection event may be recognized for the first-, second-, and third-operand locations and for the parameter block (including the reserved field of the parameter block). When PER events are detected for one or more of these locations, it is unpredictable which location is identified in the PER access identification (PAID) and PER ASCE ID (AI).

It is unpredictable how many bytes of the first-, second-, or third-operand locations has been processed when a PER storage-alteration event is recognized for the parameter block. When a storage-alteration PER event is recognized for the first-operand location, fewer than 4K additional bytes are stored into the first-operand locations before the event is reported.

When the third-operand length is initially zero, the third operand is not accessed, and the third-operand address and third-operand length in general registers R₃ and R₃ + 1, respectively, are not changed. When the second-operand length is initially zero, the second operand is not accessed, and the second-operand address and second-operand length in general registers R₂ and R₂ + 1, respectively, are not changed. However, the parameter block may be accessed even when the second- and third-operand lengths are both zero.

When the contents of the R₁ and R₂ fields are the same, the contents of the designated registers are incremented only by the number of bytes processed, not by a multiple of the number of bytes processed.

As observed by this CPU, other CPUs, and channel programs, references to the parameter block and storage operands may be multiple-access references, accesses to these storage locations are not necessarily block-concurrent, and the sequence of these accesses or references is undefined.

In certain unusual situations, instruction execution may complete by setting condition code 3 without updating the registers to reflect the last unit of the first, second, and third operands processed. The size of the unit processed in this case depends on the sit-

uation and the model, but is limited such that the portion of the first and second operands which have been processed and not reported do not overlap in storage; and the portion of the first and third operands which have been processed and not reported do not overlap in storage. In all cases, change bits are set and PER storage-alteration events are reported, when applicable, for all first-operand locations processed.

For functions that perform a comparison of the wrapping-key verification pattern field in the parameter block with the wrapping-key verification-pattern register, it is unpredictable whether access exceptions and PER zero-address-detection events are recognized for the first, second, and third operands when the comparison results in a mismatch and respective operand's length is nonzero.

Access exceptions may be reported for a larger portion of an operand than is processed in a single execution of the instruction; however, access exceptions are not recognized for locations beyond the length of an operand nor for locations more than 4K bytes beyond the current location being processed.

Special Conditions for KMA

A specification exception is recognized and no other action is taken if any of the following occurs:

1. Bits 57-63 of general register 0 specify an unassigned or uninstalled function code.
2. The R₁, R₂, or R₃ field designates an odd-numbered register or general register 0.
3. The R₃ field designates the same register as either the R₁ or R₂ fields.
4. The function code is nonzero, and the LPC flag is one (indicating that the last blocks of plaintext or ciphertext are being processed), but the LAAD flag is zero (indicating that not all AAD has been processed).

Resulting Condition Code:

- 0 Normal completion
- 1 Verification-pattern mismatch
- 2 Incomplete processing (remaining third-operand length is less than 16 when the LAAD flag is

- zero, or remaining second-operand length is less than 16 when the LPC flag is zero)
- 3 Partial completion (model-dependent limit exceeded)

Program Exceptions:

- Access (fetch, operand 2, operand 3, parameter block fields; store, operand 1, counter value, hash subkey, tag)
- Operation (if the message-security-assist extension 8 is not installed)
- Specification
- Transaction constraint

1.-7.	Exceptions with the same priority as the priority of program-interruption conditions for the general case.
8.	Specification exception due to invalid function code or invalid register number.
9.	Specification exception due to LPC flag being one when the LAAD flag is zero (applicable only when the function code is nonzero).
10.A.1	Access exceptions for an access to the parameter block.
10.A.2.	Condition code 1 due to verification-pattern mismatch.
10.B	Access exceptions for an access to the first, second, or third operand.
11.	Condition code 3 due to partial processing of the third operand.
12.	Condition code 2 due to the remaining third-operand length being less than 16 when the LAAD flag is zero.
13.	Condition code 3 due to partial processing of the second operand.
14.	Condition code 2 due to remaining second-operand length being less than 16 when the LPC flag is zero.
15.	Condition code 0 due to normal completion.

Figure 7-91. Priority of Execution: KMA

Programming Notes:

1. The performance of the query function (code 0) may be significantly slower than that of simply examining a location in storage. If the program needs to frequently test for the availability of a

function, it should perform the query function once during initialization; subsequently it should examine the stored results of the query function in memory with an instruction such as TEST UNDER MASK.

2. As observed by this CPU, other CPUs, and the I/O subsystem, inconsistent results may be briefly stored in the first-operand location. See the section “Effects of CPU Retry” on page 11-3 for further details.
3. When processing an individual message, the program should initially set the following fields in the parameter block and not alter these fields until the instruction completes with condition code 0; otherwise, the results will not conform to the GCM standard, as described in Reference [17.] on page xxx.
 - a. *Counter Value (CV)*: The CV field should be initialized with the rightmost 4 bytes of the initial-counter-value (J_0) field.
 - b. *Tag (T)*: The tag field should be initialized to zeros.
 - c. *The Hash Subkey (H)*: For KMA-GCM-AES functions (codes 18-20), the following applies:
 - When the HS flag is one, the program supplies a pre-computed hash subkey in the H field. The subkey comprises 16 bytes of zeros, encrypted using the AES algorithm.
 - When the HS flag is zero, the CPU encrypts 16 bytes of zeros using the AES algorithm and key field in the parameter block, stores the results in the H field, and sets the HS flag to one.

For KM-GCM-encrypted-AES functions (codes 26-28), the CPU always calculates the hash subkey, and the H field and HS flags are not altered.

- d. *Initial-Counter Value (J_0)*: The initial-counter value is derived from an initialization vector (IV) provided by the program. If the program uses a 96-bit IV (as recommended in Reference [17.] on page xxx), then it should store the IV into the leftmost 12 bytes of the J_0 field, and store 00000001 hex in the rightmost bytes of the J_0 field. If the program uses an IV having a different length, then it must

supply a 16-byte hashed value of the IV in the J_0 field using the GHASH algorithm (as described in Reference [17]).

- e. *Key Value (K) and Wrapping-Key Verification Pattern (WK_aVP)*: For proper ciphering of an individual message, the key must be the same for all executions of the instruction. For KM-encrypted-AES functions, the wrapping-key-verification-pattern field must also remain unchanged.
4. When processing the last plaintext or ciphertext block(s) (that is, when the LPC flag is one), the total-AAD-length (TAADL) and total-plaintext/ciphertext-length (TPCL) fields in the parameter block should contain the total length in bits of the respective AAD and plaintext or ciphertext for the entire message.
5. The program is responsible for comparing the hashed tag of a decrypted message with that of the message when it was encrypted to ensure authenticity of the message.
6. The LAAD and LPC flags provide the means by which a message can be ciphered and hashed when not all components of the message are available for a single execution of the instruction. For example, if the plaintext or ciphertext portion of a message spans multiple disk or tape records, and not all blocks of the message have been read into storage, the program can process the earlier blocks of the message by issuing the instruction with the LPC flag set to zero. When the final plaintext or ciphertext blocks of the message are available, the program can then complete the message ciphering by issuing the instruction with the LPC flag set to one.

When condition code 2 is set due to either or both the LAAD or LPC flag being zero, the general registers containing the operand addresses and lengths, and the parameter block are updated to indicate the progress thus far. However, unlike condition code 3 (where the program can simply branch back to the instruction to continue the operation), the program is responsible for updating the operand addresses and lengths, and the LAAD and LPC flags, as necessary, before branching back to the instruction. If the program simply branches back to the instruction in response to condition code 2, a nonproductive program loop will result.

7. When condition code 3 is set, the general registers containing the operand addresses and lengths, and the parameter block, are usually updated such that the program can simply branch back to the instruction to continue the operation.

CIPHER MESSAGE WITH CIPHER FEEDBACK

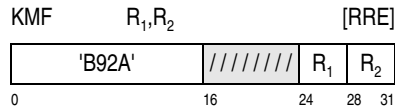

A function specified by the function code in general register 0 is performed.

Bits 16-23 of the instruction are ignored.

Bit positions 32-39 of general register 0 contain the length of cipher feedback in bytes (LCFB, also known as “s”), and bit positions 57-63 of general register 0 contain the function code. Figure 7-92 shows the assigned function codes for CIPHER MESSAGE WITH CIPHER FEEDBACK. All other function codes are unassigned. For cipher functions, bit 56 is the modifier bit which specifies whether an encryption or a decryption operation is to be performed. The modifier bit is ignored for all other functions. Bits 0-31 and 40-55 of general register 0 are ignored.

General register 1 contains the logical address of the leftmost byte of the parameter block in storage. In the 24-bit addressing mode, the contents of bit positions 40-63 of general register 1 constitute the address, and the contents of bit positions 0-39 are ignored. In the 31-bit addressing mode, the contents of bit positions 33-63 of general register 1 constitute the address, and the contents of bit positions 0-32 are ignored. In the 64-bit addressing mode, the contents of bit positions 0-63 of general register 1 constitute the address.

The function codes for CIPHER MESSAGE WITH CIPHER FEEDBACK are as follows.

Code	Function	Parm. Block Size (bytes)	Data Block Size ¹ (bytes)
0	KMF-Query	16	—
1	KMF-DEA	16	8
2	KMF-TDEA-128	24	8
3	KMF-TDEA-192	32	8
9	KMF-Encrypted-DEA	40	8
10	KMF-Encrypted-TDEA-128	48	8
11	KMF-Encrypted-TDEA-192	56	8
18	KMF-AES-128	32	16
19	KMF-AES-192	40	16
20	KMF-AES-256	48	16
26	KMF-Encrypted-AES-128	64	16
27	KMF-Encrypted-AES-192	72	16
28	KMF-Encrypted-AES-256	80	16

Explanation:

¹ The size of ciphertext and plaintext segments (s) range from 1 to the data-block size, depending on the value of the LCFB in bits 32-39 of general register 0.

— Not applicable

Figure 7-92. Function Codes for CIPHER MESSAGE WITH CIPHER FEEDBACK

All other function codes are unassigned.

The query function provides the means of indicating the availability of the other functions. The contents of general registers R₁, R₂, and R₂ + 1 are ignored for the query function.

For all other functions, the second operand is ciphered as specified by the function code using a cryptographic key and an initial chaining value in the parameter block, and the result is placed in the first-operand location. The chaining value is updated as part of the operation.

The R₁ field designates a general register and must designate an even-numbered register other than general register 0; otherwise, a specification exception is recognized. The R₂ field designates an even-odd pair of general registers and must designate an

even-numbered register other than general register 0; otherwise, a specification exception is recognized.

The location of the leftmost byte of the first and second operands is specified by the contents of the R_1 and R_2 general registers, respectively. The number of bytes in the second-operand location is specified in general register $R_2 + 1$ and must be a multiple of the cipher-feedback length in bits 32-39 of general register 0; otherwise, a specification exception is recognized. The first operand is the same length as the second operand.

As part of the operation, the addresses in general registers R_1 and R_2 are incremented by the number of bytes processed, and the length in general register $R_2 + 1$ is decremented by the same number. The formation and updating of the addresses and length is dependent on the addressing mode.

In the 24-bit addressing mode, the contents of bit positions 40-63 of general registers R_1 and R_2 constitute the addresses of the first and second operands, respectively, and the contents of bit positions 0-39 are ignored; bits 40-63 of the updated addresses replace the corresponding bits in general registers R_1 and R_2 , carries out of bit position 40 of the updated address are ignored, and the contents of bit positions 32-39 of general registers R_1 and R_2 are set to zeros. In the 31-bit addressing mode, the contents of bit positions 33-63 of general registers R_1 and R_2 constitute the addresses of the first and second operands,

respectively, and the contents of bit positions 0-32 are ignored; bits 33-63 of the updated addresses replace the corresponding bits in general registers R_1 and R_2 , carries out of bit position 33 of the updated address are ignored, and the content of bit position 32 of general registers R_1 and R_2 is set to zero. In the 64-bit addressing mode, the contents of bit positions 0-63 of general registers R_1 and R_2 constitute the addresses of the first and second operands, respectively; bits 0-63 of the updated addresses replace the contents of general registers R_1 and R_2 , and carries out of bit position 0 are ignored.

In both the 24-bit and the 31-bit addressing modes, the contents of bit positions 32-63 of general register $R_2 + 1$ form a 32-bit unsigned binary integer which specifies the number of bytes in the first and second operands, and the contents of bit positions 0-31 are ignored; bits 32-63 of the updated value replace the corresponding bits in general register $R_2 + 1$. In the 64-bit addressing mode, the contents of bit positions 0-63 of general register $R_2 + 1$ form a 64-bit unsigned binary integer which specifies the number of bytes in the first and second operands; and the updated value replaces the contents of general register $R_2 + 1$.

In the 24-bit or 31-bit addressing mode, the contents of bit positions 0-31 of general registers R_1 , R_2 , and $R_2 + 1$, always remain unchanged.

Figure 7-93 on page 7-92 shows the contents of the general registers just described.

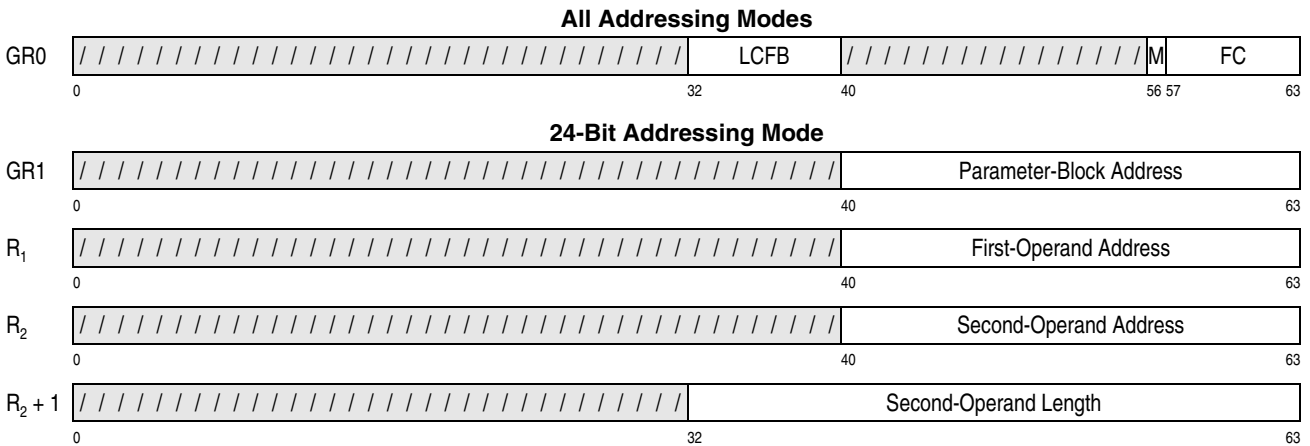

Figure 7-93. General Register Assignment for KMF (Part 1 of 2)

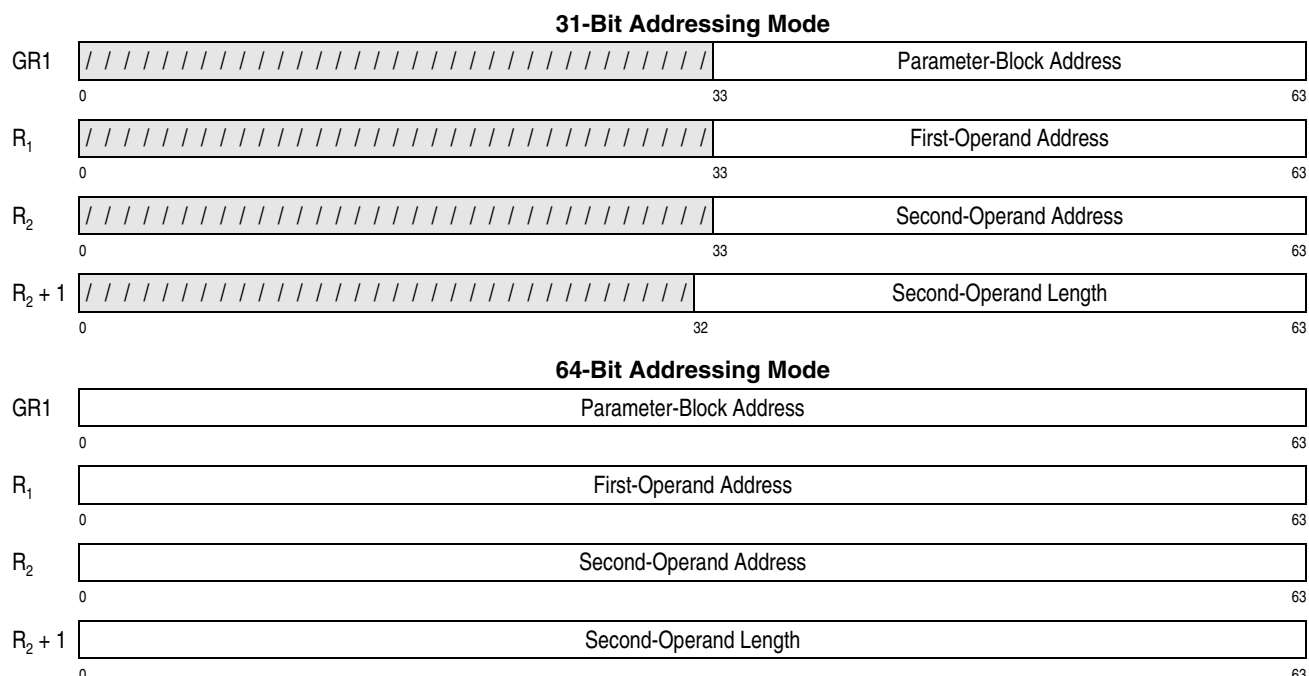

Figure 7-93. General Register Assignment for KMF (Part 2 of 2)

In the access-register mode, access registers 1, R₁, and R₂ specify the address spaces containing the parameter block, first, and second operands, respectively.

The result is obtained as if processing starts at the left end of both the first and second operands and proceeds to the right, block by block. The operation is ended when the number of bytes in the second operand as specified in general register R₂ + 1 have been processed and placed at the first-operand location (called normal completion) or when a CPU-determined number of blocks that is less than the length of the second operand have been processed (called partial completion). The CPU-determined number of blocks depends on the model, and may be a different number each time the instruction is executed. The CPU-determined number of blocks is usually non-zero. In certain unusual situations, this number may be zero, and condition code 3 may be set with no progress. However, the CPU protects against endless recurrence of this no-progress case.

The results in the first-operand location and the chaining-value field are unpredictable if any of the following situations occur:

1. The cryptographic-key field or the encrypted cryptographic-key field overlaps any portion of the first operand.

2. The chaining-value field overlaps any portion of the first operand or the second operand.
3. The first and second operands overlap destructively. Operands are said to overlap destructively when the first-operand location would be used as a source after data would have been moved into it, assuming processing to be performed from left to right and one byte at a time.

When the operation ends due to normal completion, condition code 0 is set and the resulting value in R₂ + 1 is zero. When the operation ends due to partial completion, condition code 3 is set and the resulting value in R₂ + 1 is nonzero.

A PER storage-alteration event may be recognized both for the first-operand location and for the portion of the parameter block that is stored. A PER zero-address-detection event may be recognized for the first- and second-operand locations and for the parameter block. When PER events are detected for one or more of these locations, it is unpredictable which location is identified in the PER access identification (PAID) and PER ASCE ID (AI).

When a storage-alteration PER event is recognized, fewer than 4K additional bytes are stored into the first-operand locations before the event is reported.

When the second-operand length is initially zero, the parameter block, first, and second operands are not accessed, general registers R_1 , R_2 , and $R_2 + 1$ are not changed, and condition code 0 is set.

When the contents of the R_1 and R_2 fields are the same, the contents of the designated registers are incremented only by the number of bytes processed, not by twice the number of bytes processed.

As observed by this CPU, other CPUs, and channel programs, references to the parameter block and storage operands may be multiple-access references, accesses to these storage locations are not necessarily block-concurrent, and the sequence of these accesses or references is undefined.

In certain unusual situations, instruction execution may complete by setting condition code 3 without updating the registers and chaining value to reflect the last unit of the first and second operands processed. The size of the unit processed in this case depends on the situation and the model, but is limited such that the portion of the first and second operands which have been processed and not reported do not overlap in storage. In all cases, change bits are set and PER storage-alteration events are reported, when applicable, for all first-operand locations processed.

For functions that perform a comparison of the wrapping-key verification pattern field in the parameter block with the wrapping-key verification-pattern register, it is unpredictable whether access exceptions and PER zero-address-detection events are recognized for the first and second operands when the comparison results in a mismatch.

Access exceptions may be reported for a larger portion of an operand than is processed in a single execution of the instruction; however, access exceptions are not recognized for locations beyond the length of an operand nor for locations more than 4K bytes beyond the current location being processed.

Symbols Used in Function Descriptions

The following symbols are used in the subsequent description of the CIPHER MESSAGE WITH CIPHER FEEDBACK functions. For data-encryption-algorithm (DEA) functions, the DEA-key-parity bit in each byte of the DEA key is ignored, and the operation proceeds normally, regardless of the DEA-key parity of the key.

Further description of the data-encryption algorithm may be found in Reference [13.] on page xxx. Further description of the AES standard may be found in Reference [14.] on page xxx. Further description of the cipher-feedback mode of encryption and decryption may be found in Reference [16.] on page xxx.

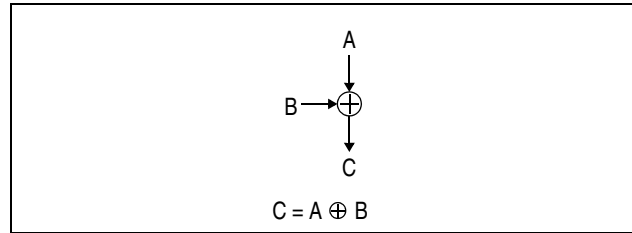

Figure 7-94. Symbol For Bit-Wise Exclusive OR

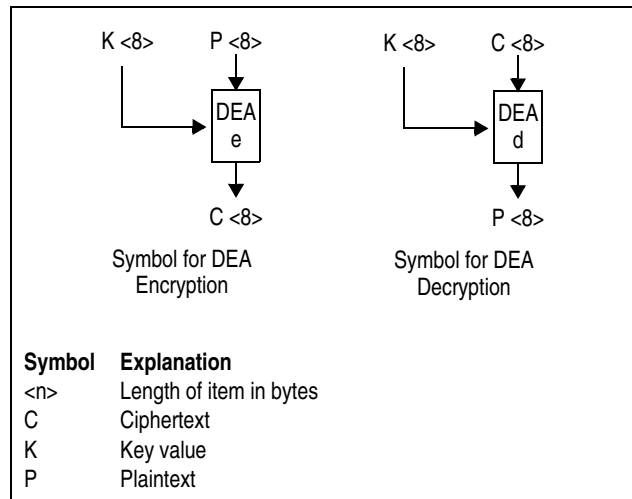

Figure 7-95. Symbols for DEA Encryption and Decryption

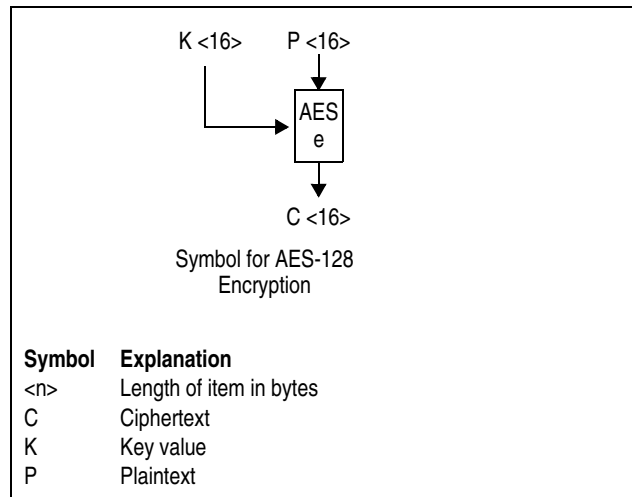

Figure 7-96. Symbols for AES-128 Encryption

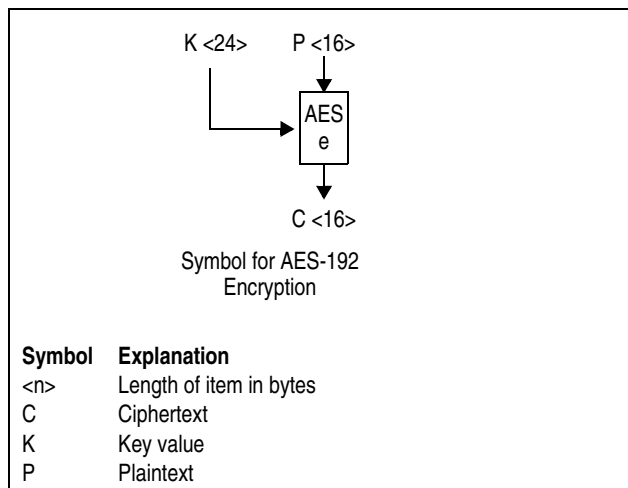

Figure 7-97. Symbols for AES-192 Encryption

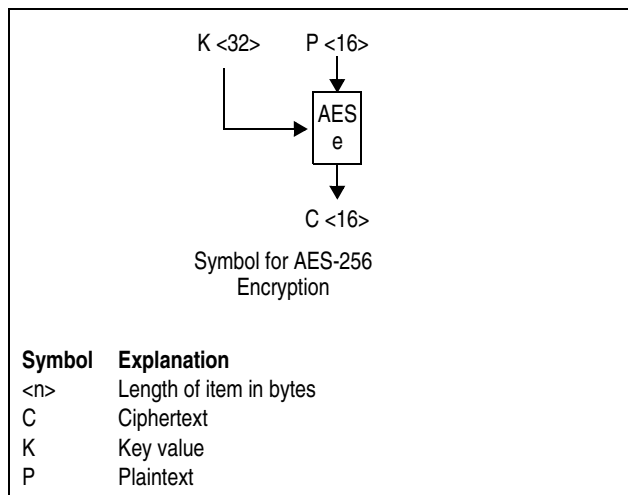

Figure 7-98. Symbols for AES-256 Encryption

KMF-Query (Function Code 0)

The locations of the operands and addresses used by the instruction are as shown in Figure 7-93 on page 7-92.

The parameter block used for the function has the following format:

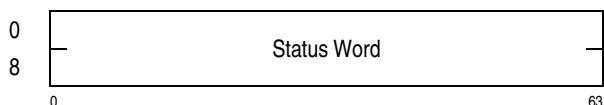

Figure 7-99. Parameter Block for KMF-Query

A 128-bit status word is stored in the parameter block. Bits 0-127 of this field correspond to function codes 0-127, respectively, of the CIPHER MESSAGE WITH CIPHER FEEDBACK instruction. When a bit is

one, the corresponding function is installed; otherwise, the function is not installed.

Condition code 0 is set when execution of the KMF-Query function completes; condition codes 1 and 3 are not applicable to this function.

In the following function descriptions, the term *input block* refers to the 8- or 16-byte input to the DEA or AES algorithms, respectively. Similarly, the term *output block* refers to the 8- or 16-byte results from the respective algorithms. The term *segment* refers to the s-byte portions of the first and second operands.

KMF-DEA (Function Code 1)

KMF-Encrypted-DEA (Function Code 9)

The locations of the operands and addresses used by the instruction are as shown in Figure 7-93 on page 7-92.

The parameter block used for the KMF-DEA function has the following format:

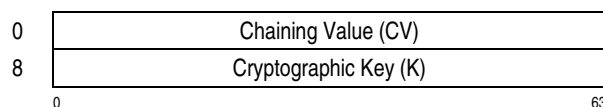

Figure 7-100. Parameter Block for KMF-DEA

For the KMF-DEA function, the chaining value is in byte offset 0-7 of the parameter block and the cryptographic key is in byte offsets 8-15 of the parameter block.

The parameter block used for the KMF-Encrypted-DEA function has the following format:

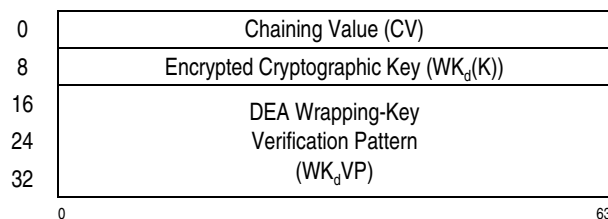

Figure 7-101. Parameter Block for KMF-Encrypted-DEA

For the KMF-Encrypted-DEA function, the contents of byte offsets 16-39 of the parameter block are compared with the contents of the DEA wrapping-key verification-pattern register. If they mismatch, the first-operand and parameter-block locations remain unchanged, and the operation is completed by set-

ting condition code 1. If they match, byte offsets 0-7 of the parameter block contain the chaining value, and the contents of byte offsets 8-15 of the parameter block are deciphered using the DEA wrapping key to obtain the 64-bit cryptographic key. (See the section, "Protection of Cryptographic Keys" on page 7-431 for details.)

The following description applies to both functions.

When the modifier bit in general register 0 is zero, an encipher operation is performed. The *s*-byte plaintext segments (P1, P2, ..., Pn) in operand 2 are enciphered using the DEA-encryption algorithm with the 64-bit cryptographic key and the 64-bit chaining value, where *s* is the length of cipher feedback in bytes (LCFB).

The first input block to the DEA-encryption algorithm is the initial chaining value (ICV) in the parameter block. Each input block is enciphered to produce an output block. The *s* leftmost bytes of each output block are exclusive-ORed with the corresponding *s*-byte plaintext segment to form a *s*-byte ciphertext segment. The remaining (8 - *s*) bytes of each output block are ignored. Each ciphertext segment is concatenated to the right of the (8 - *s*) rightmost bytes of the previous input block to form the next input block.

The process is repeated with the successive input blocks until a ciphertext segment is produced for every plaintext segment, or until a CPU-determined number of ciphertext segments have been produced.

The ciphertext segments (C1, C2, ..., Cn) are stored in operand 1. The final next-input block is stored into

the chaining-value field of the parameter block. The operation is shown in Figure 7-102.

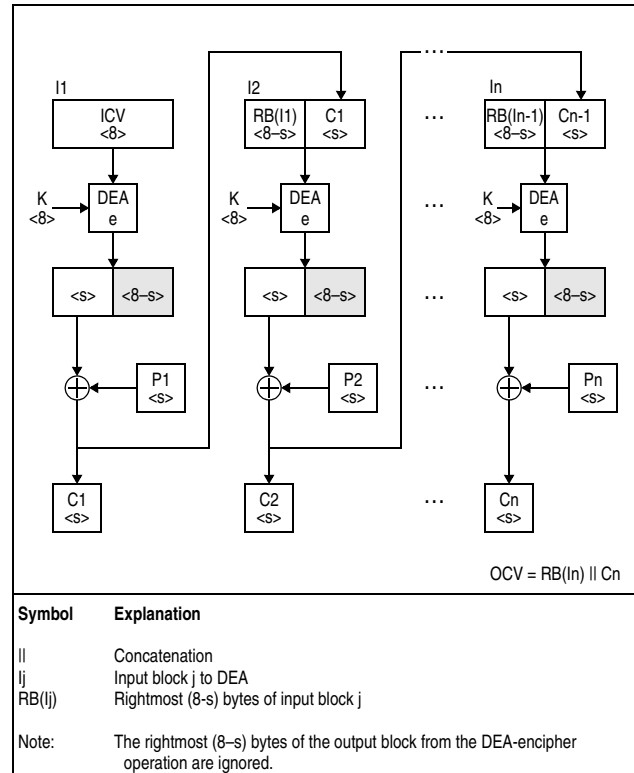

Figure 7-102. KMF-DEA Encipher Operation

When the modifier bit in general register 0 is one, a decipher operation is performed. The *s*-byte ciphertext segments (C1, C2, ..., Cn) in operand 2 are deciphered using the DEA-encryption algorithm with the 64-bit cryptographic key and the 64-bit chaining value, where *s* is the length of cipher feedback in bytes.

The first input block to the DEA-encryption algorithm is the initial chaining value (ICV) in the parameter block. Each input block is enciphered to produce an output block. The *s* leftmost bytes of each output block are exclusive-ORed with the corresponding *s*-byte ciphertext segment to form a *s*-byte plaintext segment. The remaining (8 - *s*) bytes of each output block are ignored. Each ciphertext segment is concatenated to the right of the (8 - *s*) rightmost bytes of the previous input block to form the next input block.

The process is repeated with the successive input blocks until a plaintext segment is produced for every ciphertext segment, or until a CPU-determined number of plaintext segments have been produced.

The plaintext segments (P1, P2, ..., Pn) are stored in operand 1. The final next-input block (OCV) is stored into the chaining-value field of the parameter block. The operation is shown in Figure 7-103.

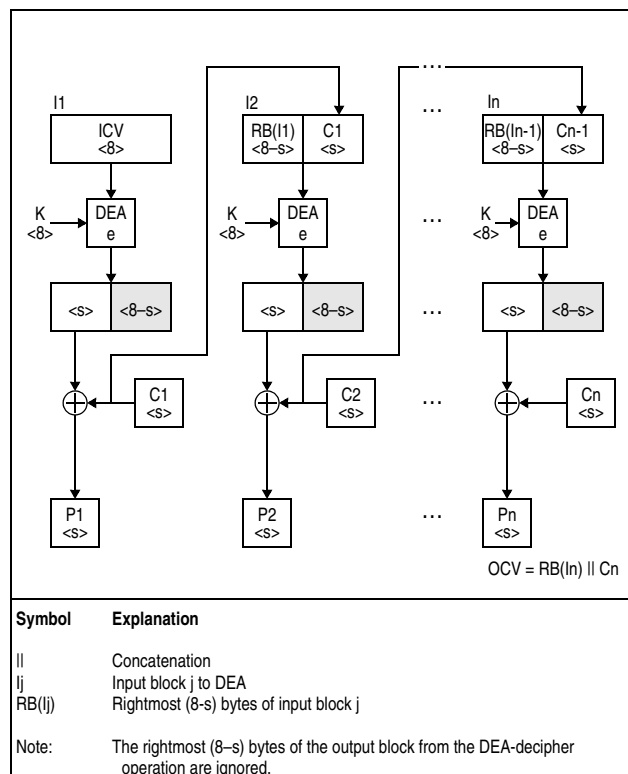

Figure 7-103. KMF-DEA Decipher Operation

KMF-TDEA-128 (Function Code 2)

KMF-Encrypted-TDEA-128 (Function Code 10)

The locations of the operands and addresses used by the instruction are as shown in Figure 7-93 on page 7-92.

The parameter block used for the KMF-TDEA-128 function has the following format:

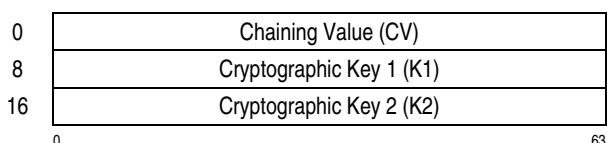

Figure 7-104. Parameter Block for KMF-TDEA-128

For the KMF-TDEA-128 function, the chaining value is in byte offset 0-7 of the parameter block and the cryptographic key is in byte offsets 8-23 of the parameter block.

The parameter block used for the KMF-Encrypted-TDEA-128 function has the following format:

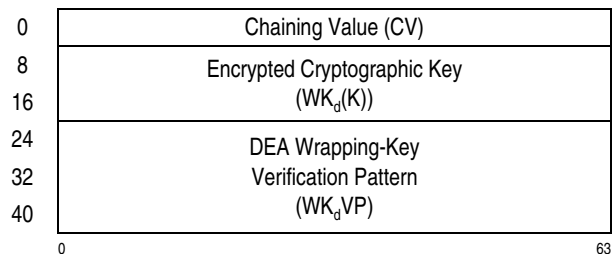

Figure 7-105. Parameter Block for KMF-Encrypted-TDEA-128

For the KMF-Encrypted-TDEA-128 function, the contents of byte offsets 24-47 of the parameter block are compared with the contents of the DEA wrapping-key verification-pattern register. If they mismatch, the first-operand and parameter-block locations remain unchanged, and the operation is completed by setting condition code 1. If they match, byte offsets 0-7 of the parameter block contain the chaining value, and the contents of byte offsets 8-23 of the parameter block are deciphered using the DEA wrapping key to obtain the 128-bit cryptographic key. (See the section, "Protection of Cryptographic Keys" on page 7-431 for details.)

The following description applies to both functions.

When the modifier bit in general register 0 is zero, an encipher operation is performed. The s-byte plaintext segments (P1, P2, ..., Pn) in operand 2 are enciphered using the TDEA-encryption algorithm with the 128-bit cryptographic key and the 64-bit chaining value, where s is the length of cipher feedback in bytes.

The first input block to the TDEA-encryption algorithm is the initial chaining value (ICV) in the parameter block. Each input block is enciphered to produce an output block. The s leftmost bytes of each output block are exclusive-ORed with the corresponding s-byte plaintext segment to form a s-byte ciphertext segment. The remaining (8 - s) bytes of each output block are ignored. Each ciphertext segment is concatenated to the right of the (8 - s) rightmost bytes of the previous input block to form the next input block.

The process is repeated with the successive input blocks until a ciphertext segment is produced for every plaintext segment, or until a CPU-determined number of ciphertext segments have been produced.

The ciphertext segments (C1, C2, ..., Cn) are stored in operand 1. The final next-input block is stored into the chaining-value field of the parameter block. The operation is shown in Figure 7-106.

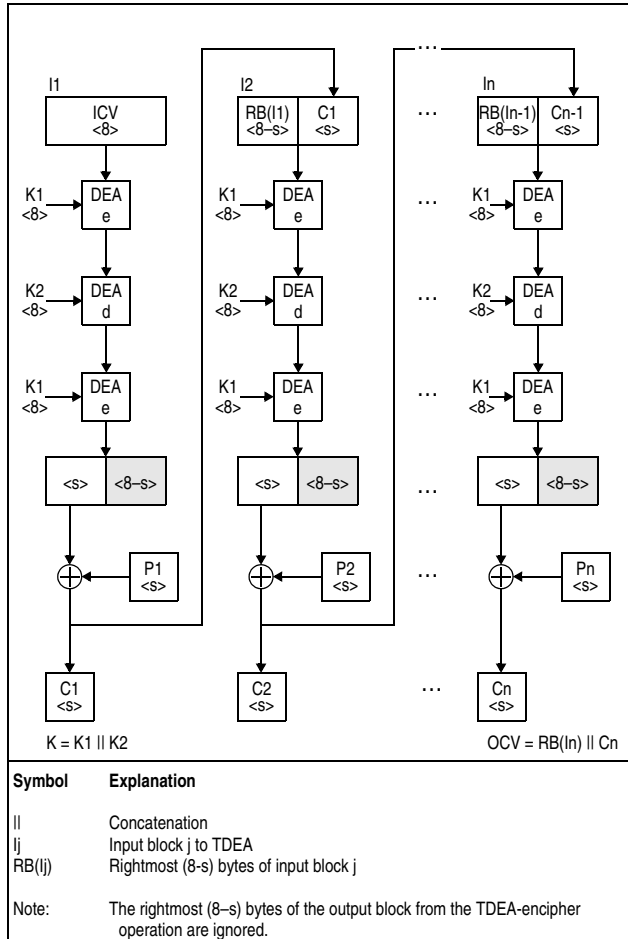

Figure 7-106. KMF-TDEA-128 Encipher Operation

When the modifier bit in general register 0 is one, a decipher operation is performed. The s-byte ciphertext segments (C1, C2, ..., Cn) in operand 2 are deciphered using the TDEA-encryption algorithm with the 128-bit cryptographic key and the 64-bit chaining value, where s is the length of cipher feedback in bytes.

The first input block to the TDEA-encryption algorithm is the initial chaining value (ICV) in the parameter block. Each input block is enciphered to produce an output block. The s leftmost bytes of each output block are exclusive-ORed with the corresponding s-byte ciphertext segment to form a s-byte plaintext segment. The remaining (8 - s) bytes of each output block are ignored. Each ciphertext segment is con-

catenated to the right of the (8 - s) rightmost bytes of the previous input block to form the next input block.

The process is repeated with the successive input blocks until a plaintext segment is produced for every ciphertext segment, or until a CPU-determined number of plaintext segments have been produced.

The plaintext segments (P1, P2, ..., Pn) are stored in operand 1. The final next-input block (OCV) is stored into the chaining-value field of the parameter block. The operation is shown in Figure 7-107.

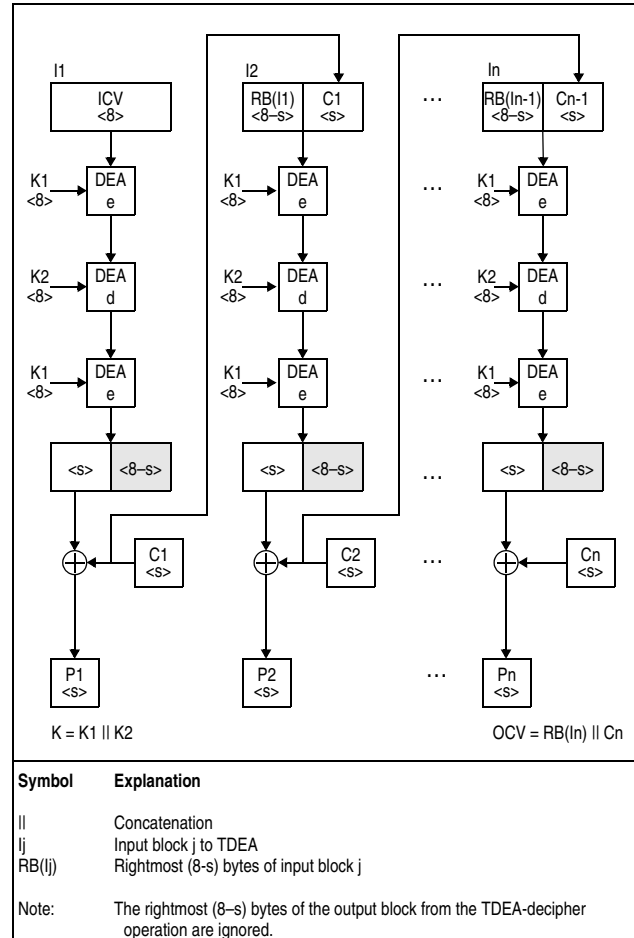

Figure 7-107. KMF-TDEA-128 Decipher Operation

KMF-TDEA-192 (Function Code 3)

KMF-Encrypted-TDEA-192 (Function Code 11)

The locations of the operands and addresses used by the instruction are as shown in Figure 7-93 on page 7-92.

The parameter block used for the KMF-TDEA-192 function has the following format:

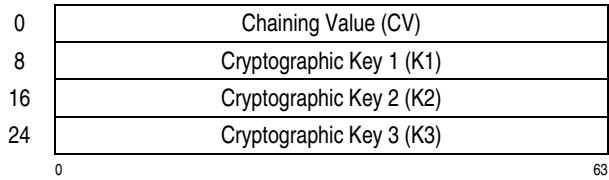

Figure 7-108. Parameter Block for KMF-TDEA-192

For the KMF-TDEA-192 function, the chaining value is in byte offset 0-7 of the parameter block and the cryptographic key is in byte offsets 8-31 of the parameter block.

The parameter block used for the KMF-Encrypted-TDEA-192 function has the following format:

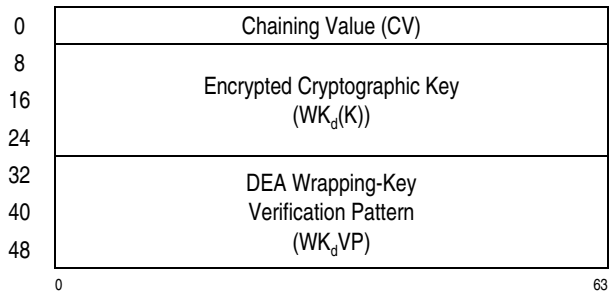

Figure 7-109. Parameter Block for KMF-Encrypted-TDEA-192

For the KMF-Encrypted-TDEA-192 function, the contents of byte offsets 32-55 of the parameter block are compared with the contents of the DEA wrapping-key verification-pattern register. If they mismatch, the first-operand and parameter-block locations remain unchanged, and the operation is completed by setting condition code 1. If they match, byte offsets 0-7 of the parameter block contain the chaining value, and the contents of byte offsets 8-31 of the parameter block are deciphered using the DEA wrapping key to obtain the 192-bit cryptographic key. (See the section, “Protection of Cryptographic Keys” on page 7-431 for details.)

The following description applies to both functions.

When the modifier bit in general register 0 is zero, an encipher operation is performed. The s -byte plaintext segments (P_1, P_2, \dots, P_n) in operand 2 are enciphered using the TDEA-encryption algorithm with the 192-bit cryptographic key and the 64-bit chaining

value, where s is the length of cipher feedback in bytes.

The first input block to the TDEA-encryption algorithm is the initial chaining value (ICV) in the parameter block. Each input block is enciphered to produce an output block. The s leftmost bytes of each output block are exclusive-ORed with the corresponding s -byte plaintext segment to form a s -byte ciphertext segment. The remaining $(8 - s)$ bytes of each output block are ignored. Each ciphertext segment is concatenated to the right of the $(8 - s)$ rightmost bytes of the previous input block to form the next input block.

The process is repeated with the successive input blocks until a ciphertext segment is produced for every plaintext segment, or until a CPU-determined number of ciphertext segments have been produced.

The ciphertext segments (C_1, C_2, \dots, C_n) are stored in operand 1. The final next-input block (OCV) is stored into the chaining-value field of the parameter block. The operation is shown in Figure 7-110.

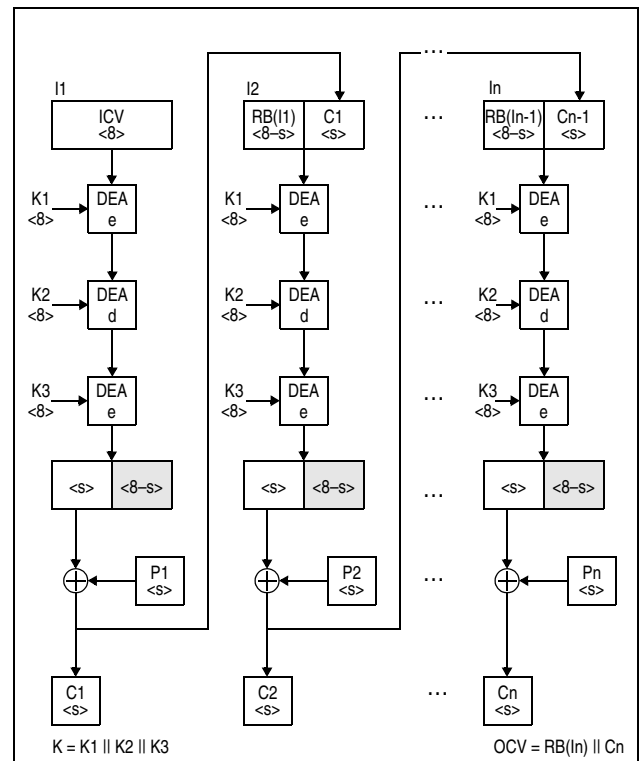

Figure 7-110. KMF-TDEA-192 Encipher Operation

Symbol	Explanation
	Concatenation
I _j	Input block j to TDEA
RB(I _j)	Rightmost (8-s) bytes of input block j
Note:	The rightmost (8-s) bytes of the output block from the TDEA-encipher operation are ignored.

Figure 7-110. KMF-TDEA-192 Encipher Operation

When the modifier bit in general register 0 is one, a decipher operation is performed. The s-byte ciphertext segments (C1, C2, ..., Cn) in operand 2 are deciphered using the TDEA-encryption algorithm with the 192-bit cryptographic key and the 64-bit chaining value, where s is the length of cipher feedback in bytes.

The first input block to the TDEA-encryption algorithm is the initial chaining value (ICV) in the parameter block. Each input block is enciphered to produce an output block. The s leftmost bytes of each output block are exclusive-ORed with the corresponding s-byte ciphertext segment to form a s-byte plaintext segment. The remaining (8 - s) bytes of each output block are ignored. Each ciphertext segment is concatenated to the right of the (8 - s) rightmost bytes of the previous input block to form the next input block.

The process is repeated with the successive input blocks until a plaintext segment is produced for every ciphertext segment, or until a CPU-determined number of plaintext segments have been produced.

The plaintext segments (P1, P2, ..., Pn) are stored in operand 1. The final next-input block is stored into

the chaining-value field of the parameter block. The operation is shown in Figure 7-111.

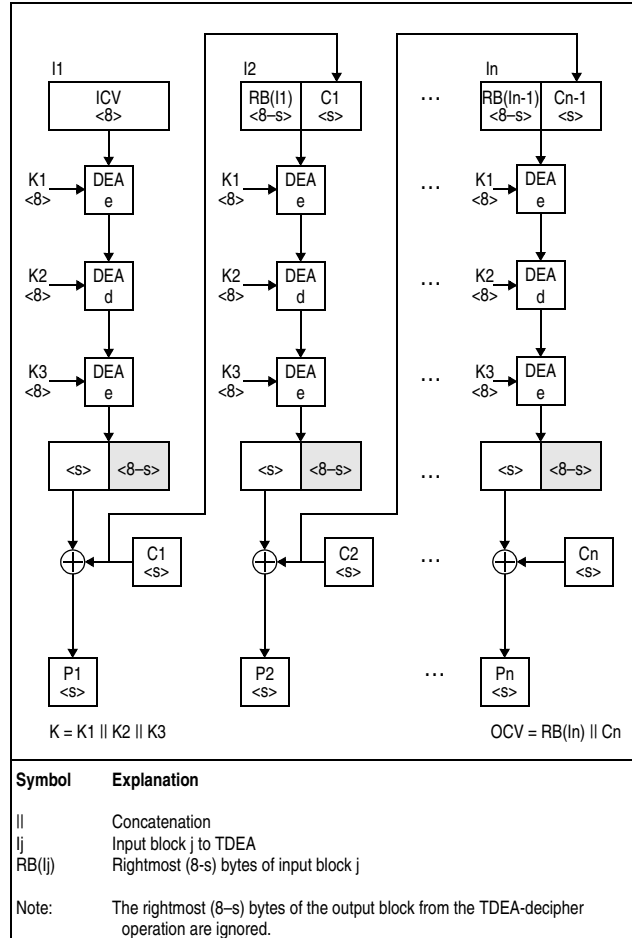

Figure 7-111. KMF-TDEA-192 Decipher Operation

KMF-AES-128 (Function Code 18)

KMF-Encrypted-AES-128 (Function Code 26)

The locations of the operands and addresses used by the instruction are as shown in Figure 7-93 on page 7-92.

The parameter block used for the KMF-AES-128 function has the following format:

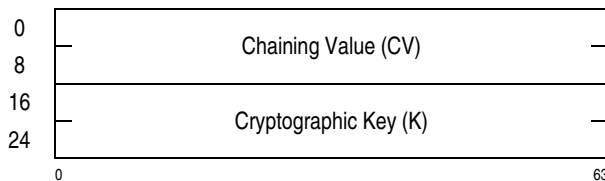

Figure 7-112. Parameter Block for KMF-AES-128

For the KMF-AES-128 function, the chaining value is in byte offset 0-15 of the parameter block and the cryptographic key is in byte offsets 16-31 of the parameter block.

The parameter block used for the KMF-Encrypted-AES-128 function has the following format:

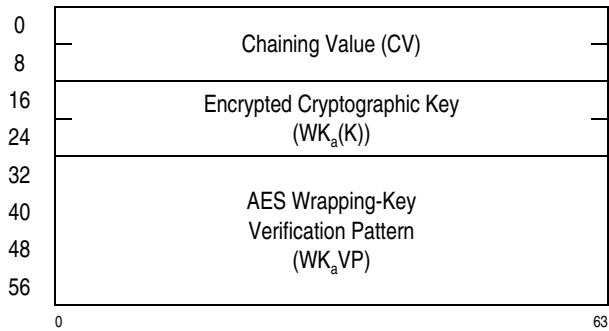

Figure 7-113. Parameter Block for KMF-Encrypted-AES-128

For the KMF-Encrypted-AES-128 function, the contents of byte offsets 32-63 of the parameter block are compared with the contents of the AES wrapping-key verification-pattern register. If they mismatch, the first-operand and parameter-block locations remain unchanged, and the operation is completed by setting condition code 1. If they match, byte offsets 0-15 of the parameter block contain the chaining value, and the contents of byte offsets 16-31 of the parameter block are deciphered using the AES wrapping key to obtain the 128-bit cryptographic key. (See the section “Protection of Cryptographic Keys” on page 7-431 for details.)

The following description applies to both functions.

When the modifier bit in general register 0 is zero, an encipher operation is performed. The *s*-byte plaintext segments (P1, P2, ..., Pn) in operand 2 are enciphered using the AES-encryption algorithm with the 128-bit cryptographic key and the 128-bit chaining value, where *s* is the length of cipher feedback in bytes.

The first input block to the AES-encryption algorithm is the initial chaining value (ICV) in the parameter block. Each input block is enciphered to produce an output block. The *s* leftmost bytes of each output block are exclusive-ORed with the corresponding *s*-byte plaintext segment to form a *s*-byte ciphertext segment. The remaining (16 - *s*) bytes of each output block are ignored. Each ciphertext segment is con-

catenated to the right of the (16 - *s*) rightmost bytes of the previous input block to form the next input block.

The process is repeated with the successive input blocks until a ciphertext segment is produced for every plaintext segment, or until a CPU-determined number of ciphertext segments have been produced.

The ciphertext segments (C1, C2, ..., Cn) are stored in operand 1. The final next-input block is stored into the chaining-value field of the parameter block. The operation is shown in Figure 7-114.

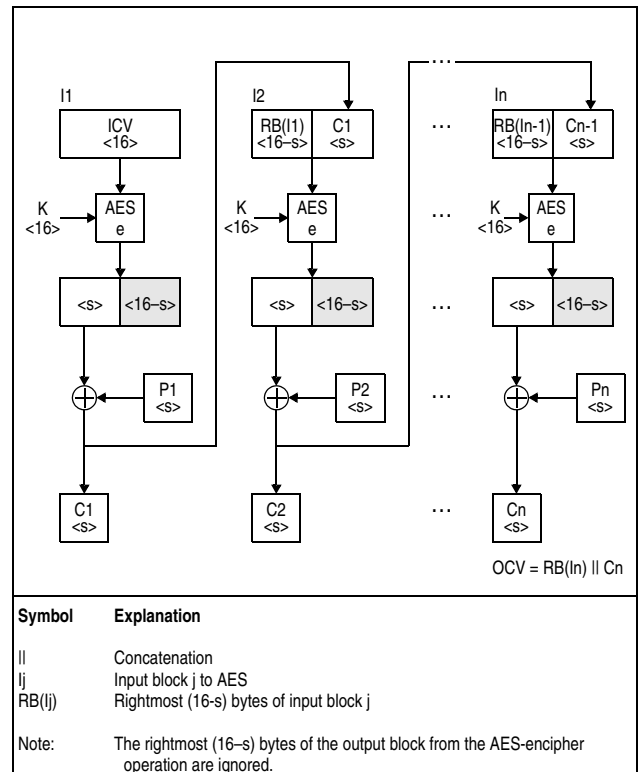

Figure 7-114. KMF-AES-128 Encipher Operation

When the modifier bit in general register 0 is one, a decipher operation is performed. The *s*-byte ciphertext segments (C1, C2, ..., Cn) in operand 2 are deciphered using the AES-encryption algorithm with the 128-bit cryptographic key and the 128-bit chaining value, where *s* is the length of cipher feedback in bytes.

The first input block to the AES-encryption algorithm is the initial chaining value (ICV) in the parameter block. Each input block is enciphered to produce an output block. The *s* leftmost bytes of each output block are exclusive-ORed with the corresponding *s*-

byte ciphertext segment to form a s-byte plaintext segment. The remaining (16 - s) bytes of each output block are ignored. Each ciphertext segment is concatenated to the right of the (16 - s) rightmost bytes

of the previous input block to form the next input block.

The process is repeated with the successive input blocks until a plaintext segment is produced for every ciphertext segment, or until a CPU-determined number of plaintext segments have been produced.

The plaintext segments (P1, P2, ..., Pn) are stored in operand 1. The final next-input block (OCV) is stored into the chaining-value field of the parameter block. The operation is shown in Figure 7-115.

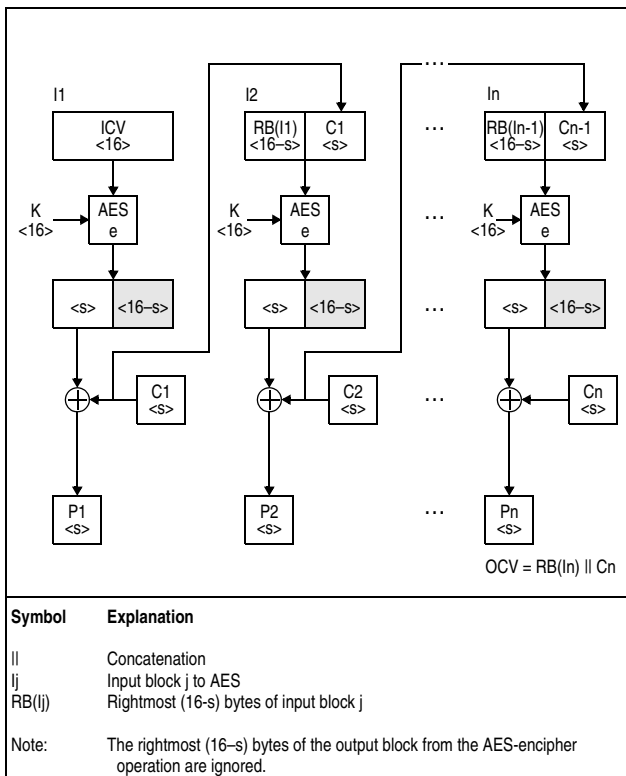

Figure 7-115. KMF-AES-128 Decipher Operation

KMF-AES-192 (Function Code 19)

KMF-Encrypted-AES-192 (Function Code 27)

The locations of the operands and addresses used by the instruction are as shown in Figure 7-93 on page 7-92.

The parameter block used for the KMF-AES-192 function has the following format:

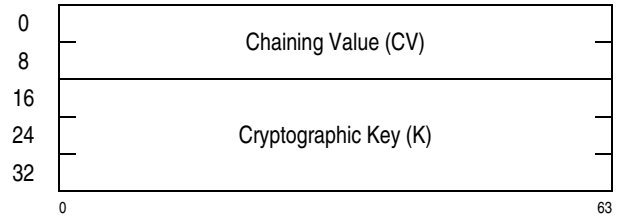

Figure 7-116. Parameter Block for KMF-AES-192

For the KMF-AES-192 function, the chaining value is in byte offset 0-15 of the parameter block and the cryptographic key is in byte offsets 16-39 of the parameter block.

The parameter block used for the KMF-Encrypted-AES-192 function has the following format:

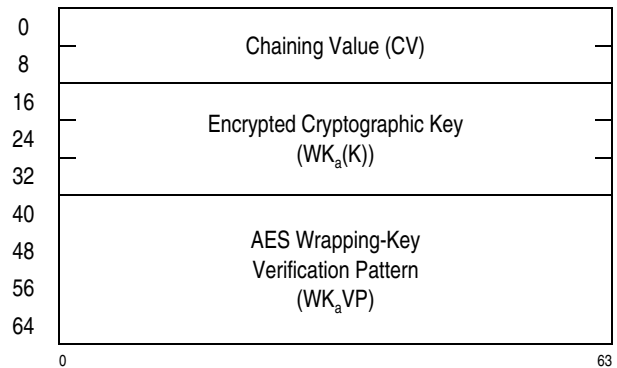

Figure 7-117. Parameter Block for KMF-Encrypted-AES-192

For the KMF-Encrypted-AES-192 function, the contents of byte offsets 40-71 of the parameter block are compared with the contents of the AES wrapping-key verification-pattern register. If they mismatch, the first-operand and parameter-block locations remain unchanged, and the operation is completed by setting condition code 1. If they match, byte offsets 0-15 of the parameter block contain the chaining value, and the contents of byte offsets 16-39 of the parameter block are deciphered using the AES wrapping key to obtain the 192-bit cryptographic key. (See the section “Protection of Cryptographic Keys” on page 7-431 for details.)

The following description applies to both functions.

When the modifier bit in general register 0 is zero, an encipher operation is performed. The s-byte plaintext

segments (P1, P2, ..., Pn) in operand 2 are enciphered using the AES-encryption algorithm with the 192-bit cryptographic key and the 128-bit chaining value, where s is the length of cipher feedback in bytes.

The first input block to the AES-encryption algorithm is the initial chaining value (ICV) in the parameter block. Each input block is enciphered to produce an output block. The s leftmost bytes of each output block are exclusive-ORed with the corresponding s-byte plaintext segment to form a s-byte ciphertext segment. The remaining (16 - s) bytes of each output block are ignored. Each ciphertext segment is concatenated to the right of the (16 - s) rightmost bytes of the previous input block to form the next input block.

The process is repeated with the successive input blocks until a ciphertext segment is produced for every plaintext segment, or until a CPU-determined number of ciphertext segments have been produced.

The ciphertext segments (C1, C2, ..., Cn) are stored in operand 1. The final next-input block (OCV) is stored into the chaining-value field of the parameter block. The operation is shown in Figure 7-118.

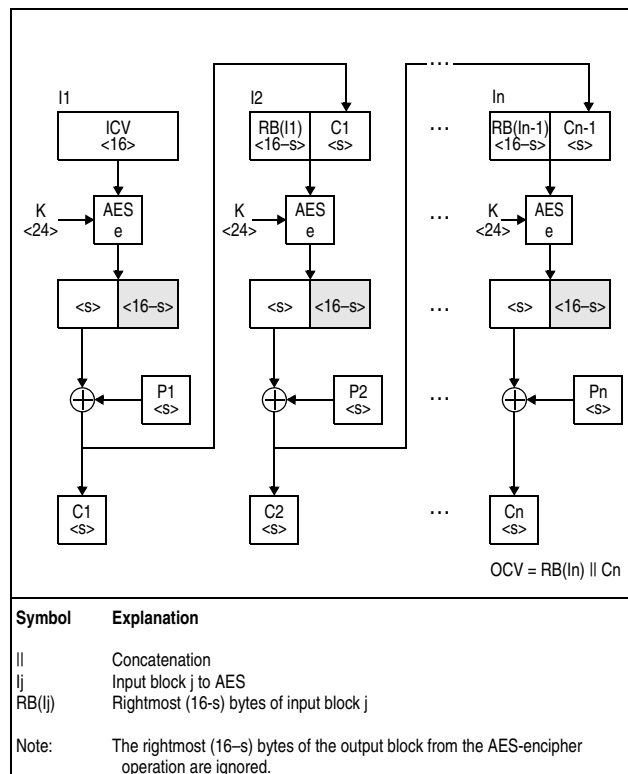

Figure 7-118. KMF-AES-192 Encipher Operation

When the modifier bit in general register 0 is one, a decipher operation is performed. The s-byte ciphertext segments (C1, C2, ..., Cn) in operand 2 are deciphered using the AES-encryption algorithm with the 192-bit cryptographic key and the 128-bit chaining value, where s is the length of cipher feedback in bytes.

The first input block to the AES-encryption algorithm is the initial chaining value (ICV) in the parameter block. Each input block is enciphered to produce an output block. The s leftmost bytes of each output block are exclusive-ORed with the corresponding s-byte ciphertext segment to form a s-byte plaintext segment. The remaining (16 - s) bytes of each output block are ignored. Each ciphertext segment is concatenated to the right of the (16 - s) rightmost bytes of the previous input block to form the next input block.

The process is repeated with the successive input blocks until a plaintext segment is produced for every ciphertext segment, or until a CPU-determined number of plaintext segments have been produced.

The plaintext segments (P1, P2, ..., Pn) are stored in operand 1. The final next-input block (OCV) is stored into the chaining-value field of the parameter block. The operation is shown in Figure 7-119.

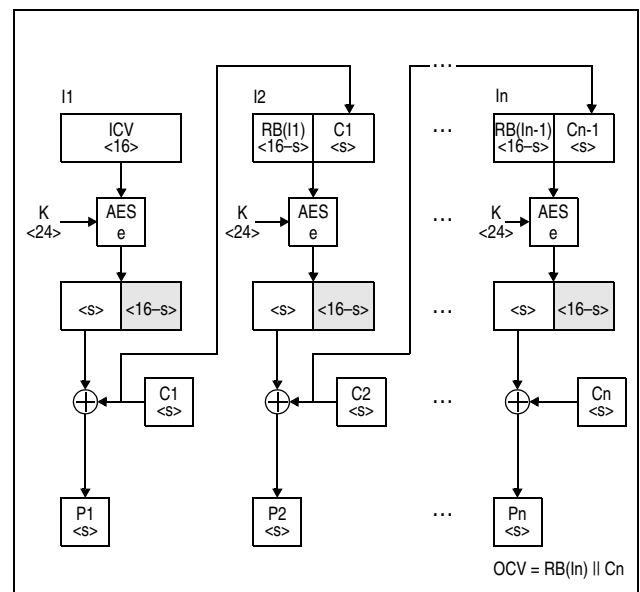

Figure 7-119. KMF-AES-192 Decipher Operation

Symbol	Explanation
	Concatenation
I _j	Input block j to AES
RB(I _j)	Rightmost (16-s) bytes of input block j
Note:	The rightmost (16-s) bytes of the output block from the AES-decipher operation are ignored.

Figure 7-119. KMF-AES-192 Decipher Operation

KMF-AES-256 (Function Code 20)

KMF-Encrypted-AES-256 (Function Code 28)

The locations of the operands and addresses used by the instruction are as shown in Figure 7-93 on page 7-92.

The parameter block used for the KMF-AES-256 function has the following format:

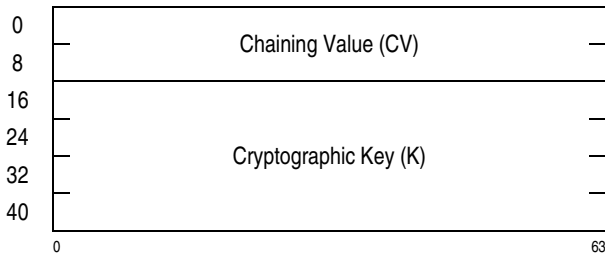

Figure 7-120. Parameter Block for KMF-AES-256

For the KMF-AES-256 function, the chaining value is in byte offset 0-15 of the parameter block and the cryptographic key is in byte offsets 16-47 of the parameter block.

The parameter block used for the KMF-Encrypted-AES-256 function has the following format:

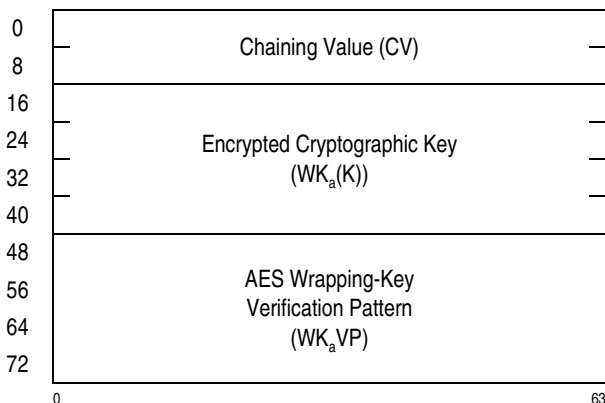

Figure 7-121. Parameter Block for KMF-Encrypted-AES-256

For the KMF-Encrypted-AES-256 function, the contents of byte offsets 48-79 of the parameter block are compared with the contents of the AES wrapping-key verification-pattern register. If they mismatch, the first-operand and parameter-block locations remain unchanged, and the operation is completed by setting condition code 1. If they match, byte offsets 0-15 of the parameter block contain the chaining value, and the contents of byte offsets 16-47 of the parameter block are deciphered using the AES wrapping key to obtain the 256-bit cryptographic key. (See the section “Protection of Cryptographic Keys” on page 7-431 for details.)

The following description applies to both functions.

When the modifier bit in general register 0 is zero, an encipher operation is performed. The s-byte plaintext segments (P1, P2, ..., Pn) in operand 2 are enciphered using the AES-encryption algorithm with the 256-bit cryptographic key and the 128-bit chaining value, where s is the length of cipher feedback in bytes.

The first input block to the AES-encryption algorithm is the initial chaining value (ICV) in the parameter block. Each input block is enciphered to produce an output block. The s leftmost bytes of each output block are exclusive-ORed with the corresponding s-byte plaintext segment to form a s-byte ciphertext segment. The remaining (16 - s) bytes of each output block are ignored. Each ciphertext segment is concatenated to the right of the (16 - s) rightmost bytes of the previous input block to form the next input block.

The process is repeated with the successive input blocks until a ciphertext segment is produced for every plaintext segment, or until a CPU-determined number of ciphertext segments have been produced.

The ciphertext segments (C1, C2, ..., Cn) are stored in operand 1. The final next-input block (OCV) is

stored into the chaining-value field of the parameter block. The operation is shown in Figure 7-122.

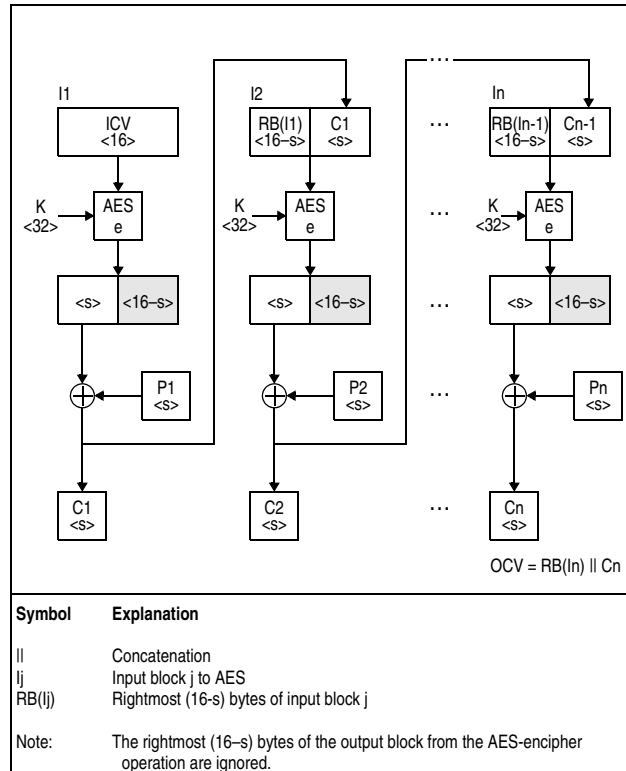

Figure 7-122. KMF-AES-256 Encipher Operation

When the modifier bit in general register 0 is one, a decipher operation is performed. The s-byte ciphertext segments (C1, C2, ..., Cn) in operand 2 are deciphered using the AES-encryption algorithm with the 256-bit cryptographic key and the 128-bit chaining value, where s is the length of cipher feedback in bytes.

The first input block to the AES-encryption algorithm is the initial chaining value (ICV) in the parameter block. Each input block is enciphered to produce an output block. The s leftmost bytes of each output block are exclusive-ORed with the corresponding s-byte ciphertext segment to form a s-byte plaintext segment. The remaining (16 - s) bytes of each output block are ignored. Each ciphertext segment is concatenated to the right of the (16 - s) rightmost bytes of the previous input block to form the next input block.

The process is repeated with the successive input blocks until a plaintext segment is produced for every ciphertext segment, or until a CPU-determined number of plaintext segments have been produced.

The plaintext segments (P1, P2, ..., Pn) are stored in operand 1. The final next-input block is stored into the chaining-value field of the parameter block. The operation is shown in Figure 7-123.

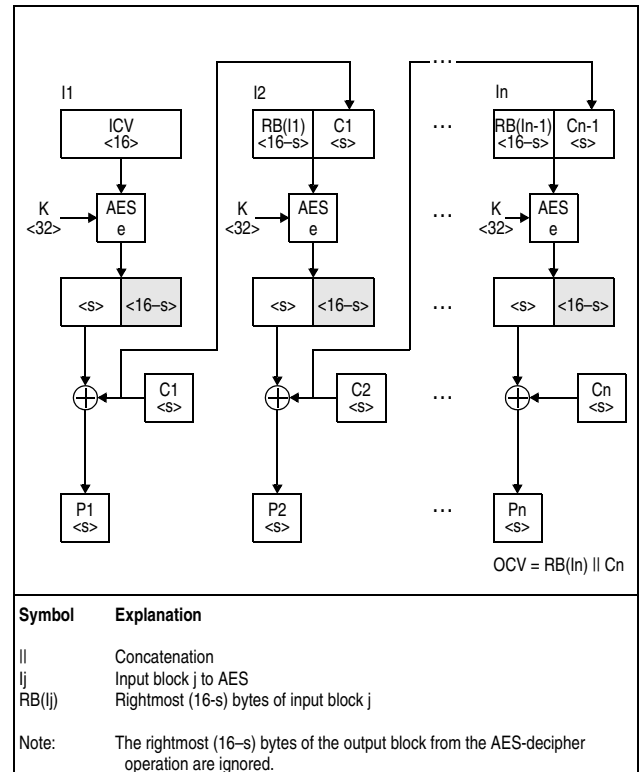

Figure 7-123. KMF-AES-256 Decipher Operation

Special Conditions

A specification exception is recognized and no other action is taken if any of the following occurs:

1. For DEA or TDEA functions, bits 32-39 of general register 0 specify a value that is zero or greater than 8.
2. For AES functions, bits 32-39 of general register 0 specify a value that is zero or greater than 16.
3. Bits 57-63 of general register 0 specify an unsigned or uninstalled function code.
4. The R₁ or R₂ field designates an odd-numbered register or general register 0.
5. The second operand length is not a multiple of the length of cipher feedback. This specification-exception condition does not apply to the query functions.

Resulting Condition Code:

- 0 Normal completion
- 1 Verification-pattern mismatch
- 2 --
- 3 Partial completion

Program Exceptions:

- Access (fetch, operand 2, cryptographic key, and wrapping-key verification pattern; store, operand 1; fetch and store, chaining value)
- Operation (if the message-security-assist extension 4 is not installed)
- Specification
- Transaction constraint

1.-6.	Exceptions with the same priority as the priority of program-interruption conditions for the general case.
7.A	Access exceptions for second instruction halfword.
7.B	Operation exception.
7.C	Transaction constraint
8.	Specification exception due to invalid function code or invalid register number.
9.	Specification exception due to invalid operand length.
10.	Condition code 0 due to second-operand length originally zero.
11.A.1	Access exceptions for an access to the parameter block.
11.A.2.	Condition code 1 due to verification-pattern mismatch.
11.B	Access exceptions for an access to the first, or second operand.
12.	Condition code 0 due to normal completion (second-operand length originally nonzero, but stepped to zero).
13.	Condition code 3 due to partial completion (second-operand length still nonzero).

Figure 7-124. Priority of Execution: KMF

Programming Notes:

1. The performance of the query function (code 0) may be significantly slower than that of simply

examining a location in storage. If the program needs to frequently test for the availability of a function, it should perform the query function once during initialization; subsequently it should examine the stored results of the query function in memory with an instruction such as TEST UNDER MASK.

2. See the programming notes for CIPHER MESSAGE WITH CHAINING.
3. In earlier versions of the architecture, CIPHER MESSAGE WITH CIPHER FEEDBACK was known as CIPHER MESSAGE WITH CFB.
4. As observed by this CPU, other CPUs, and the I/O subsystem, inconsistent results may be briefly stored in the first-operand location. See the section "Effects of CPU Retry" on page 11-3 for further details.

CIPHER MESSAGE WITH COUNTER

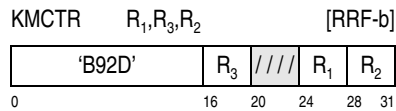

A function specified by the function code in general register 0 is performed.

Bits 20-23 of the instruction are ignored.

Bit positions 57-63 of general register 0 contain the function code. Figure 7-125 shows the assigned function codes for CIPHER MESSAGE WITH COUNTER. All other function codes are unassigned. For cipher functions, bit 56 is the modifier bit which specifies whether an encryption or a decryption operation is to be performed. The modifier bit is ignored for all other functions. All other bits of general register 0 are ignored.

General register 1 contains the logical address of the leftmost byte of the parameter block in storage. In the 24-bit addressing mode, the contents of bit positions 40-63 of general register 1 constitute the address, and the contents of bit positions 0-39 are ignored. In the 31-bit addressing mode, the contents of bit positions 33-63 of general register 1 constitute the address, and the contents of bit positions 0-32 are ignored. In the 64-bit addressing mode, the contents

of bit positions 0-63 of general register 1 constitute the address.

The function codes for CIPHER MESSAGE WITH COUNTER are as follows.

Code	Function	Parm. Block Size (bytes)	Data Block Size (bytes)
0	KMCTR-Query	16	—
1	KMCTR-DEA	8	8
2	KMCTR-TDEA-128	16	8
3	KMCTR-TDEA-192	24	8
9	KMCTR-Encrypted-DEA	32	8
10	KMCTR-Encrypted-TDEA-128	40	8
11	KMCTR-Encrypted-TDEA-192	48	8
18	KMCTR-AES-128	16	16
19	KMCTR-AES-192	24	16
20	KMCTR-AES-256	32	16
26	KMCTR-Encrypted-AES-128	48	16
27	KMCTR-Encrypted-AES-192	56	16
28	KMCTR-Encrypted-AES-256	64	16
Explanation:			
— Not applicable			

Figure 7-125. Function Codes for CIPHER MESSAGE WITH COUNTER

All other function codes are unassigned.

The query function provides the means of indicating the availability of the other functions. The contents of general registers R_1 , R_2 , $R_2 + 1$, and R_3 are ignored for the query function.

For all other functions, the second operand is ciphered as specified by the function code using a cryptographic key and counter values, and the result is placed in the first-operand location.

The R_1 and R_3 fields each designate a general register and must designate an even-numbered register other than general register 0; otherwise, a specification exception is recognized. The R_2 field designates an even-odd pair of general registers and must designate an even-numbered register other than general register 0; otherwise, a specification exception is recognized.

The location of the leftmost byte of the first, second, and third operands is specified by the contents of the R_1 , R_2 , and R_3 general registers, respectively. The number of bytes in the second-operand location is specified in general register $R_2 + 1$. The first operand and the third operand are the same length as the second operand.

As part of the operation, the addresses in general registers R_1 , R_2 , and R_3 are incremented by the number of bytes processed, and the length in general register $R_2 + 1$ is decremented by the same number. The formation and updating of the addresses and length is dependent on the addressing mode.

In the 24-bit addressing mode, the contents of bit positions 40-63 of general registers R_1 , R_2 , and R_3 constitute the addresses of the first, second, and third operands, respectively, and the contents of bit positions 0-39 are ignored; bits 40-63 of the updated addresses replace the corresponding bits in general registers R_1 , R_2 , and R_3 , carries out of bit position 40 of the updated address are ignored, and the contents of bit positions 32-39 of general registers R_1 , R_2 , and R_3 are set to zeros. In the 31-bit addressing mode, the contents of bit positions 33-63 of general registers R_1 , R_2 , and R_3 constitute the addresses of the first, second, and third operands, respectively, and the contents of bit positions 0-32 are ignored; bits 33-63 of the updated addresses replace the corresponding bits in general registers R_1 , R_2 , and R_3 , carries out of bit position 33 of the updated address are ignored, and the content of bit position 32 of general registers R_1 , R_2 , and R_3 is set to zero. In the 64-bit addressing mode, the contents of bit positions 0-63 of general registers R_1 , R_2 , and R_3 constitute the addresses of the first, second, and third operands, respectively; bits 0-63 of the updated addresses replace the contents of general registers R_1 , R_2 , and R_3 , and carries out of bit position 0 are ignored.

In both the 24-bit and the 31-bit addressing modes, the contents of bit positions 32-63 of general register $R_2 + 1$ form a 32-bit unsigned binary integer which specifies the number of bytes in the first, second, and third operands, and the contents of bit positions 0-31 are ignored; bits 32-63 of the updated value replace the corresponding bits in general register $R_2 + 1$. In the 64-bit addressing mode, the contents of bit positions 0-63 of general register $R_2 + 1$ form a 64-bit unsigned binary integer which specifies the number of bytes in the first, second, and third operands; the updated value replaces the contents of general register $R_2 + 1$.

In the 24-bit or 31-bit addressing mode, the contents of bit positions 0-31 of general registers R_1 , R_2 , $R_2 + 1$, and R_3 always remain unchanged.

Figure 7-126 on page 7-108 shows the contents of the general registers just described.

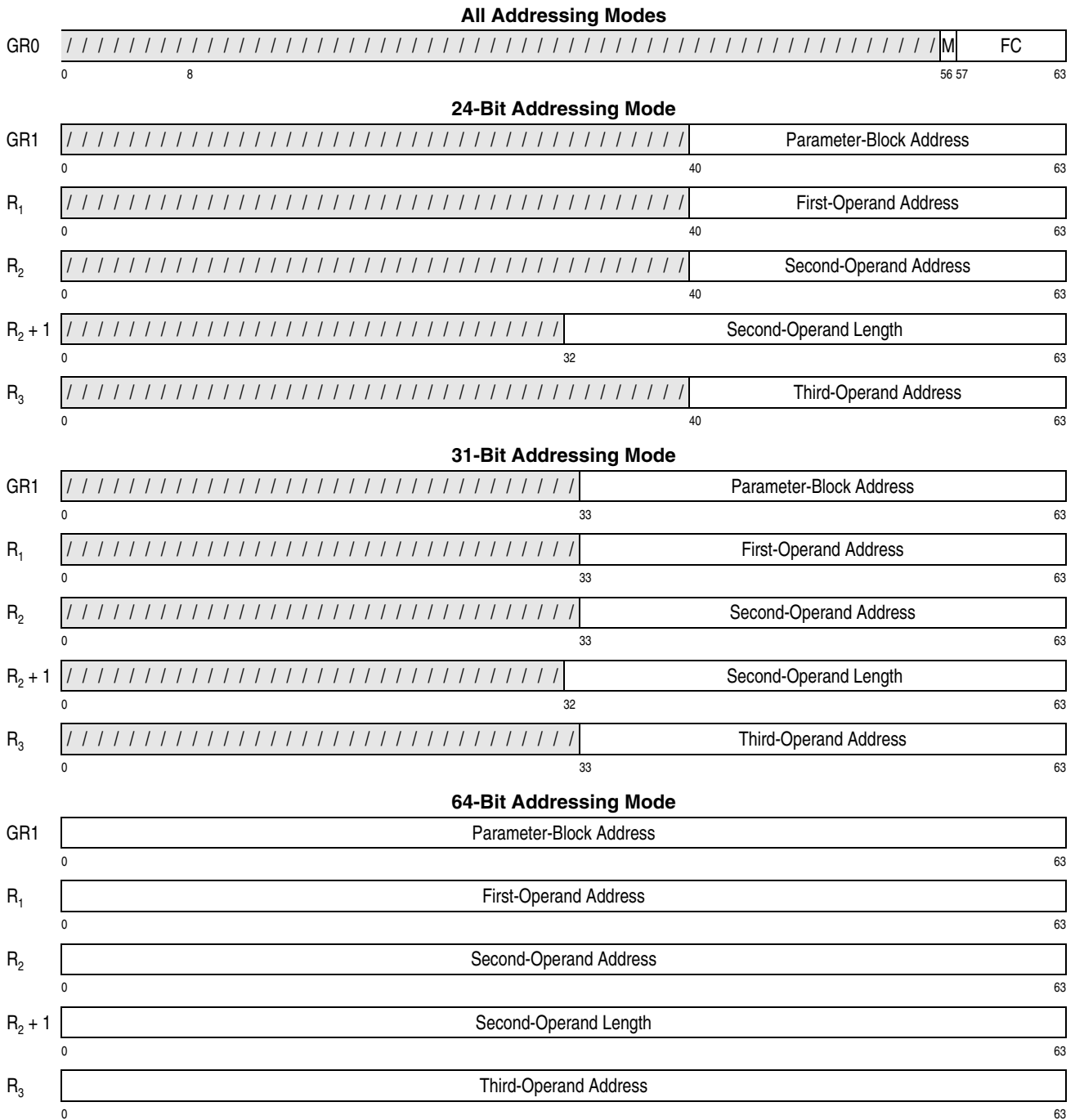

Figure 7-126. General Register Assignment for KMCTR

In the access-register mode, access registers 1, R_1 , R_2 , and R_3 specify the address spaces containing the parameter block, first, second, and third operands, respectively.

The result is obtained as if processing starts at the left end of the first, second, and third operands and proceeds to the right, block by block. The operation is ended when the number of bytes in the second oper-

and as specified in general register $R_2 + 1$ have been processed and placed at the first-operand location (called normal completion) or when a CPU-determined number of blocks that is less than the length of the second operand have been processed (called partial completion). The CPU-determined number of blocks depends on the model, and may be a different number each time the instruction is executed. The CPU-determined number of blocks is usually non-zero. In certain unusual situations, this number may be zero, and condition code 3 may be set with no progress. However, the CPU protects against endless recurrence of this no-progress case.

The results in the first-operand location are unpredictable if any of the following situations occurs:

1. The cryptographic-key field or the encrypted cryptographic-key field overlaps any portion of the first operand.
2. The first and second operands overlap destructively.
3. The first and third operands overlap destructively.

Operands are said to overlap destructively when the first-operand location would be used as a source after data would have been moved into it, assuming processing to be performed from left to right and one byte at a time.

When the operation ends due to normal completion, condition code 0 is set and the resulting value in $R_2 + 1$ is zero. When the operation ends due to partial completion, condition code 3 is set and the resulting value in $R_2 + 1$ is nonzero.

A PER storage-alteration event may be recognized both for the first-operand location and for the portion of the parameter block that is stored. A PER zero-address-detection event may be recognized for the first-, second-, and third-operand locations and for the parameter block. When PER events are detected for one or more of these locations, it is unpredictable which location is identified in the PER access identification (PAID) and PER ASCE ID (AI).

When a storage-alteration PER event is recognized, fewer than 4K additional bytes are stored into the first-operand locations before the event is reported.

When the second-operand length is initially zero, the parameter block, first, second, and third operands

are not accessed, general registers R_1 , R_2 , $R_2 + 1$, and R_3 are not changed, and condition code 0 is set.

When the contents of any two or all three of the R_1 , R_2 , and R_3 fields are the same, the contents of the designated registers are incremented only by the number of bytes processed, not by a multiple of the number of bytes processed.

As observed by this CPU, other CPUs, and channel programs, references to the parameter block and storage operands may be multiple-access references, accesses to these storage locations are not necessarily block-concurrent, and the sequence of these accesses or references is undefined.

In certain unusual situations, instruction execution may complete by setting condition code 3 without updating the registers to reflect the last unit of the first, second, and third operands processed. The size of the unit processed in this case depends on the situation and the model, but is limited such that the portion of the first and second operands which have been processed and not reported do not overlap in storage; and the portion of the first and third operands which have been processed and not reported do not overlap in storage. In all cases, change bits are set and PER storage-alteration events are reported, when applicable, for all first-operand locations processed.

For functions that perform a comparison of the wrapping-key verification pattern field in the parameter block with the wrapping-key verification-pattern register, it is unpredictable whether access exceptions and PER zero-address-detection events are recognized for the first, second, and third operands when the comparison results in a mismatch.

Access exceptions may be reported for a larger portion of an operand than is processed in a single execution of the instruction; however, access exceptions are not recognized for locations beyond the length of an operand nor for locations more than 4K bytes beyond the current location being processed.

Symbols Used in Function Descriptions

The following symbols are used in the subsequent description of the CIPHER MESSAGE WITH COUNTER functions. For data-encryption-algorithm (DEA) functions, the DEA-key-parity bit in each byte of the DEA key is ignored, and the operation pro-

ceeds normally, regardless of the DEA-key parity of the key.

Further description of the data-encryption algorithm may be found in Reference [13.] on page xxx. Further description of the AES standard may be found in Reference [14.] on page xxx. Further description of the counter mode of encryption and decryption may be found in Reference [16.] on page xxx.

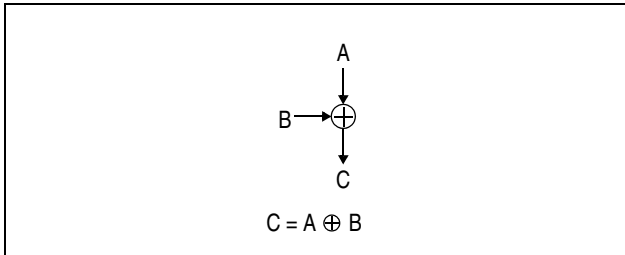

Figure 7-127. Symbol For Bit-Wise Exclusive OR

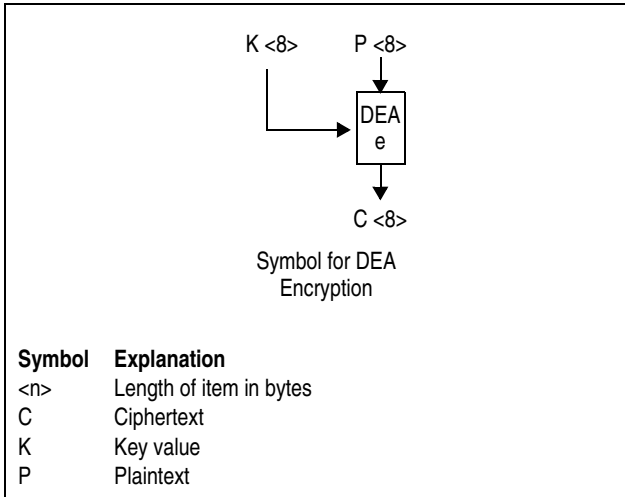

Figure 7-128. Symbols for DEA Encryption

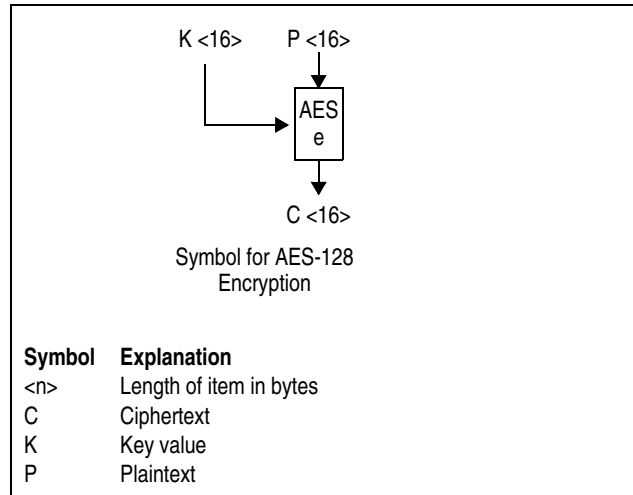

Figure 7-129. Symbols for AES-128 Encryption

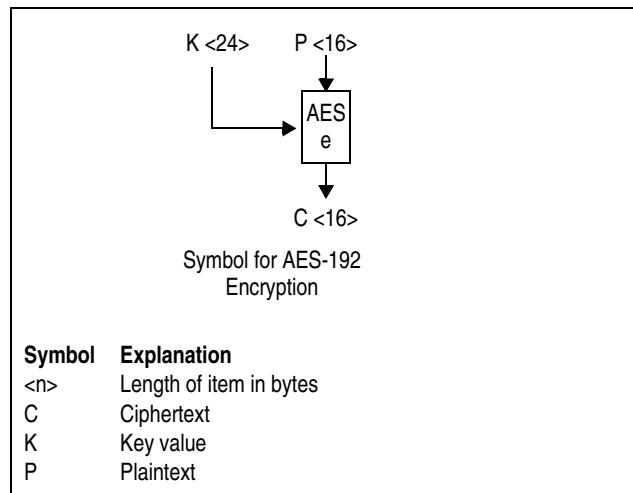

Figure 7-130. Symbols for AES-192 Encryption

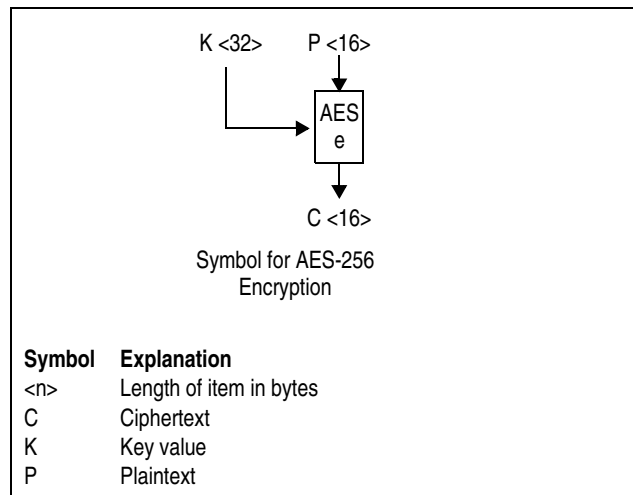

Figure 7-131. Symbols for AES-256 Encryption

KMCTR-Query (Function Code 0)

The locations of the operands and addresses used by the instruction are as shown in Figure 7-126 on page 7-108.

The parameter block used for the function has the following format:

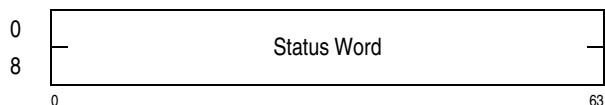

Figure 7-132. Parameter Block for KMCTR-Query

A 128-bit status word is stored in the parameter block. Bits 0-127 of this field correspond to function codes 0-127, respectively, of the CIPHER MESSAGE WITH COUNTER instruction. When a bit is one, the corresponding function is installed; otherwise, the function is not installed.

Condition code 0 is set when execution of the KMCTR-Query function completes; condition codes 1 and 3 are not applicable to this function.

KMCTR-DEA (Function Code 1)

KMCTR-Encrypted-DEA (Function Code 9)

The locations of the operands and addresses used by the instruction are as shown in Figure 7-126 on page 7-108.

The parameter block used for the KMCTR-DEA function has the following format:

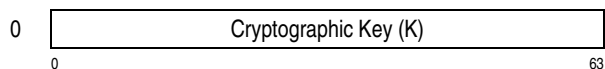

Figure 7-133. Parameter Block for KMCTR-DEA

For the KMCTR-DEA function, the cryptographic key is in byte offsets 0-7 of the parameter block.

The parameter block used for the KMCTR-Encrypted-DEA function has the following format:

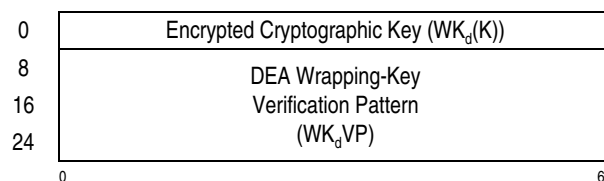

Figure 7-134. Parameter Block for KMCTR-Encrypted-DEA

For the KMCTR-Encrypted-DEA function, the contents of byte offsets 8-31 of the parameter block are compared with the contents of the DEA wrapping-key verification-pattern register. If they mismatch, the first-operand and parameter-block locations remain unchanged, and the operation is completed by setting condition code 1. If they match, the contents of byte offsets 0-7 of the parameter block are deciphered using the DEA wrapping key to obtain the 64-bit cryptographic key. (See the section “Protection of Cryptographic Keys” on page 7-431 for details.)

The following description applies to both functions.

When the modifier bit in general register 0 is zero, an encipher operation is performed. The 8-byte plaintext blocks (P1, P2, ..., Pn) in operand 2 are enciphered using the DEA algorithm with the 64-bit cryptographic key and using 8-byte counter-value blocks (R1, R2, ..., Rn) in operand 3. Each plaintext block is independently enciphered; that is, the encipher operation is performed without chaining. The ciphertext blocks (C1, C2, ..., Cn) are stored in operand 1. The operation is shown in Figure 7-135.

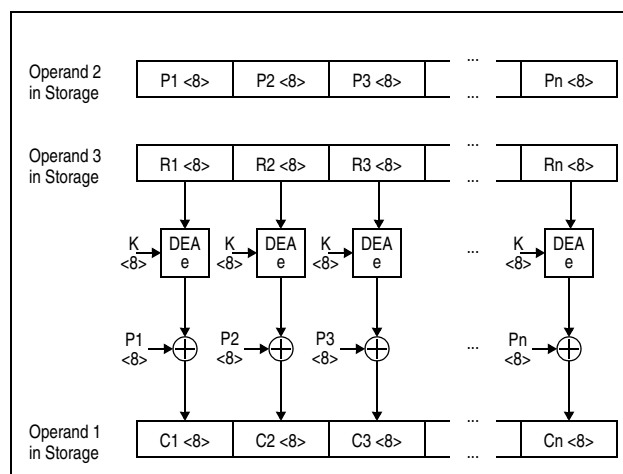

Figure 7-135. KMCTR DEA Encipher Operation Using 64-Bit Key

When the modifier bit in general register 0 is one, a decipher operation is performed. The 8-byte ciphertext blocks (C1, C2, ..., Cn) in operand 2 are deciphered using the DEA algorithm with the 64-bit cryptographic key and using 8-byte counter-value blocks (R1, R2, ..., Rn) in operand 3. Each ciphertext block is independently deciphered; that is, the decipher operation is performed without chaining. The plaintext blocks (P1, P2, ..., Pn) are stored in operand 1. The operation is shown in Figure 7-136.

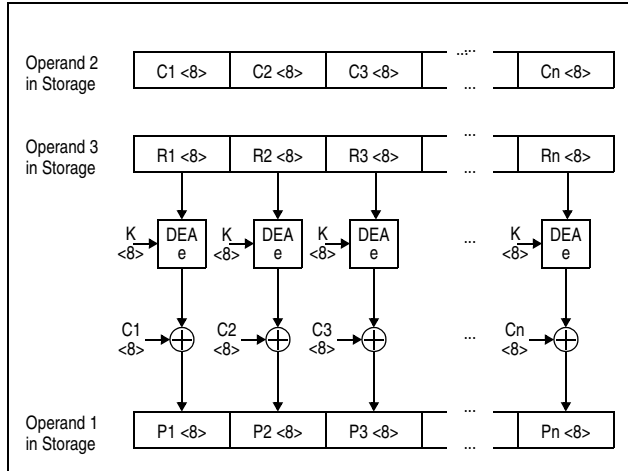

Figure 7-136. KMCTR DEA Decipher Operation Using 64-Bit Key

KMCTR-TDEA-128 (Function Code 2)

KMCTR-Encrypted-TDEA-128 (Function Code 10)

The locations of the operands and addresses used by the instruction are as shown in Figure 7-126 on page 7-108.

The parameter block used for the KMCTR-TDEA-128 function has the following format:

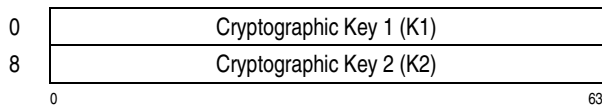

Figure 7-137. Parameter Block for KMCTR-TDEA-128

For the KMCTR-TDEA-128 function, the cryptographic key is in byte offsets 0-15 of the parameter block.

The parameter block used for the KMCTR-Encrypted-TDEA-128 function has the following format:

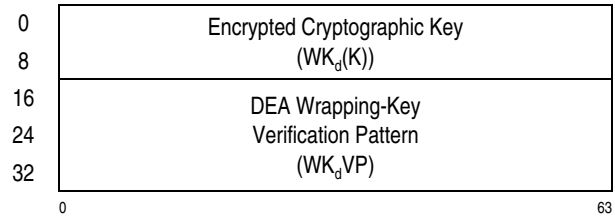

Figure 7-138. Parameter Block for KMCTR Encrypted-TDEA-128

For the KMCTR-Encrypted-TDEA-128 function, the contents of byte offsets 16-39 of the parameter block are compared with the contents of the DEA wrapping-key verification-pattern register. If they mismatch, the first-operand and parameter-block locations remain unchanged, and the operation is completed by setting condition code 1. If they match, the contents of byte offsets 0-15 of the parameter block are deciphered using the DEA wrapping key to obtain the 128-bit cryptographic key, $K = K1 \parallel K2$, where K1 is the leftmost 64 bits of K and K2 is the rightmost 64 bits of K. (See the section “Protection of Cryptographic Keys” on page 7-431 for details.)

The following description applies to both functions.

When the modifier bit in general register 0 is zero, an encipher operation is performed. The 8-byte plaintext blocks (P1, P2, ..., Pn) in operand 2 are enciphered using the TDEA (triple DEA) algorithm with the two 64-bit cryptographic keys and using 8-byte counter-value blocks (R1, R2, ..., Rn) in operand 3. Each plaintext block is independently enciphered; that is, the encipher operation is performed without chaining.

The ciphertext blocks (C1, C2, ..., Cn) are stored in operand 1. The operation is shown in Figure 7-139.

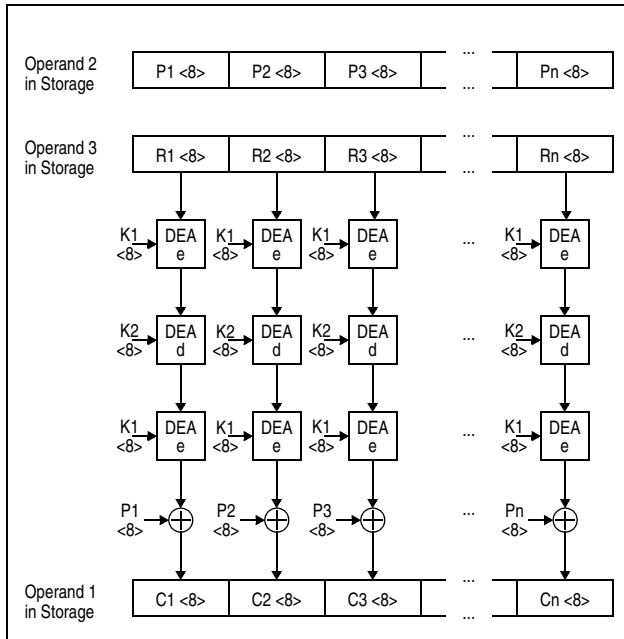

Figure 7-139. KMCTR TDEA Encipher Operation Using 128-Bit Key

When the modifier bit in general register 0 is one, a decipher operation is performed. The 8-byte ciphertext blocks (C1, C2, ..., Cn) in operand 2 are deciphered using the TDEA algorithm with the two 64-bit cryptographic keys and using 8-byte counter-value blocks (R1, R2, ..., Rn) in operand 3. Each ciphertext block is independently deciphered; that is, the decipher operation is performed without chaining. The

plaintext blocks (P1, P2, ..., Pn) are stored in operand 1. The operation is shown in Figure 7-140.

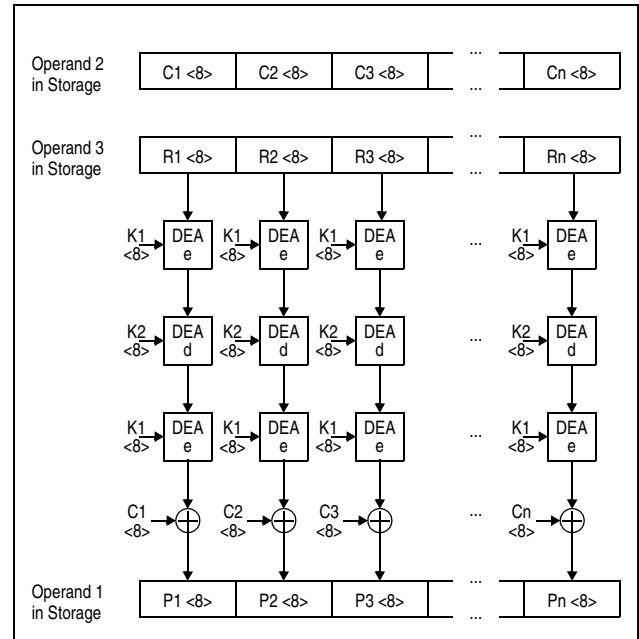

Figure 7-140. KMCTR TDEA Decipher Operation Using 128-Bit Key

KMCTR-TDEA-192 (Function Code 3)

KMCTR-Encrypted-TDEA-192 (Function Code 11)

The locations of the operands and addresses used by the instruction are as shown in Figure 7-126 on page 7-108.

The parameter block used for the KMCTR-TDEA-192 function has the following format:

0	Cryptographic Key 1 (K1)
8	Cryptographic Key 2 (K2)
16	Cryptographic Key 3 (K3)
0	63

Figure 7-141. Parameter Block for KMCTR-TDEA-192

For the KMCTR-TDEA-192 function, the cryptographic key is in byte offsets 0-23 of the parameter block.

The parameter block used for the KMCTR-Encrypted-TDEA-192 function has the following format:

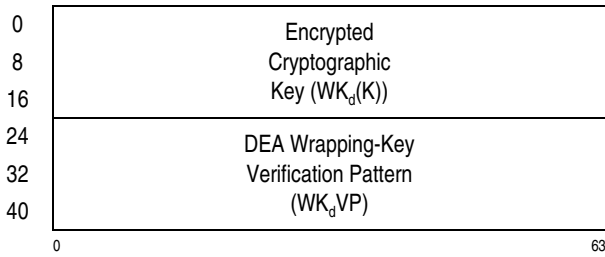

Figure 7-142. Parameter Block for KMCTR-Encrypted-TDEA-192

For the KMCTR-Encrypted-TDEA-192 function, the contents of byte offsets 24-47 of the parameter block are compared with the contents of the DEA wrapping-key verification-pattern register. If they mismatch, the first-operand and parameter-block locations remain unchanged, and the operation is completed by setting condition code 1. If they match, the contents of byte offsets 0-23 of the parameter block are deciphered using the DEA wrapping key to obtain the 192-bit cryptographic key, $K = K1 \parallel K2 \parallel K3$, where $K1$ is the leftmost 64 bits of K , $K2$ is the middle 64 bits of K , and $K3$ is the rightmost 64 bits of K . (See the section “Protection of Cryptographic Keys” on page 7-431 for details.)

The following description applies to both functions.

When the modifier bit in general register 0 is zero, an encipher operation is performed. The 8-byte plaintext blocks ($P1, P2, \dots, Pn$) in operand 2 are enciphered using the TDEA algorithm with the three 64-bit cryptographic keys and using 8-byte counter-value blocks

($R1, R2, \dots, Rn$) in operand 3. Each plaintext block is independently enciphered; that is, the encipher operation is performed without chaining. The ciphertext blocks ($C1, C2, \dots, Cn$) are stored in operand 1. The operation is shown in Figure 7-143.

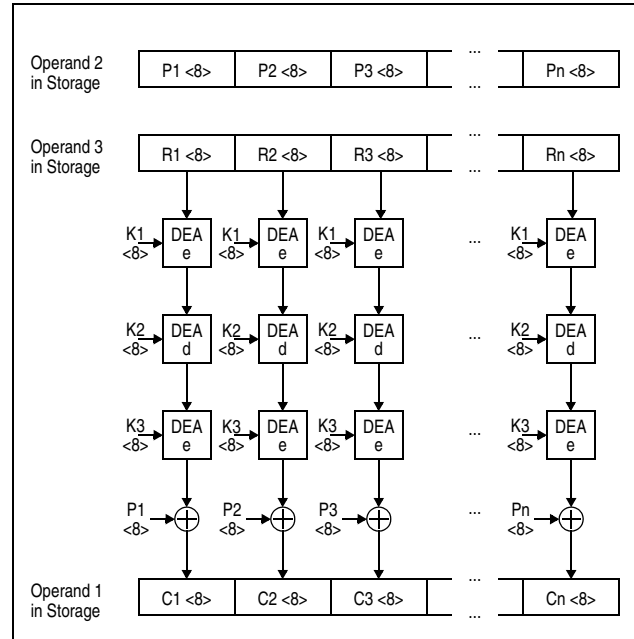

Figure 7-143. KMCTR TDEA Encipher Operation Using 192-Bit Key

When the modifier bit in general register 0 is one, a decipher operation is performed. The 8-byte ciphertext blocks ($C1, C2, \dots, Cn$) in operand 2 are deciphered using the TDEA algorithm with the three 64-bit cryptographic keys and using 8-byte counter-value blocks ($R1, R2, \dots, Rn$) in operand 3. Each ciphertext block is independently deciphered; that is, the decipher operation is performed without chaining.

The plaintext blocks (P1, P2, ..., Pn) are stored in operand 1. The operation is shown in Figure 7-144.

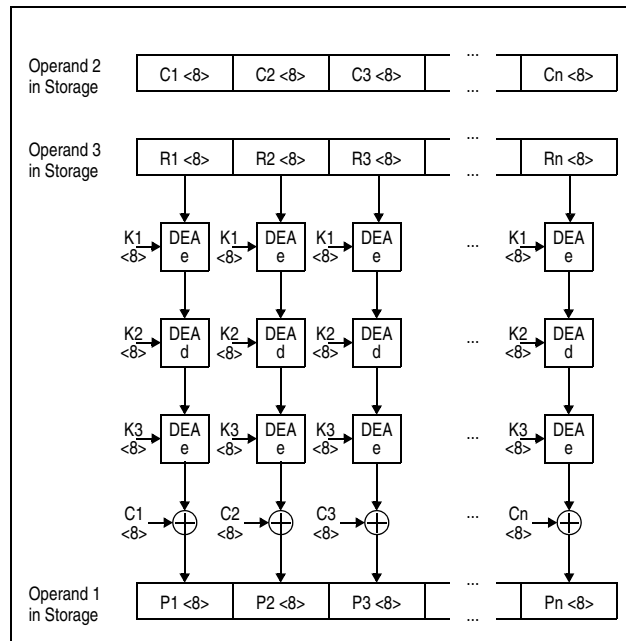

Figure 7-144. KMCTR TDEA Decipher Operation Using 192-Bit Key

KMCTR-AES-128 (Function Code 18)

KMCTR-Encrypted-AES-128 (Function Code 26)

The locations of the operands and addresses used by the instruction are as shown in Figure 7-126 on page 7-108.

The parameter block used for the KMCTR-AES-128 function has the following format:

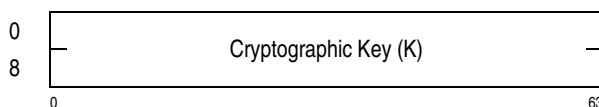

Figure 7-145. Parameter Block for KMCTR-AES-128

For the KMCTR-AES-128 function, the cryptographic key is in byte offsets 0-15 of the parameter block.

The parameter block used for the KMCTR-encrypted-AES-128 function has the following format:

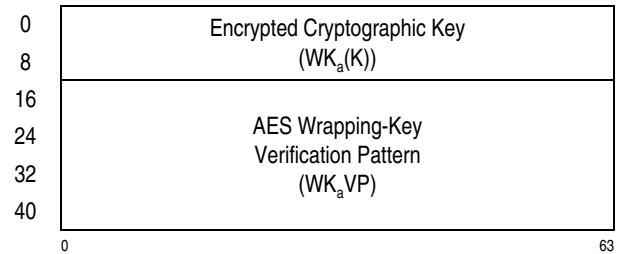

Figure 7-146. Parameter Block for KMCTR-Encrypted-AES-128

For the KMCTR-Encrypted-AES-128 function, the contents of byte offsets 16-47 of the parameter block are compared with the contents of the AES wrapping-key verification-pattern register. If they mismatch, the first-operand and parameter-block locations remain unchanged, and the operation is completed by setting condition code 1. If they match, the contents of byte offsets 0-15 of the parameter block are deciphered using the AES wrapping key to obtain the 128-bit cryptographic key, K. (See the section “Protection of Cryptographic Keys” on page 7-431 for details.)

The following description applies to both functions.

When the modifier bit in general register 0 is zero, an encipher operation is performed. The 16-byte plaintext blocks (P1, P2, ..., Pn) in operand 2 are enciphered using the AES algorithm with the 128-bit cryptographic key and using 16-byte counter-value blocks (R1, R2, ..., Rn) in operand 3. Each plaintext block is independently enciphered; that is, the encipher operation is performed without chaining. The

ciphertext blocks (C1, C2, ..., Cn) are stored in operand 2. The operation is shown in Figure 7-147.

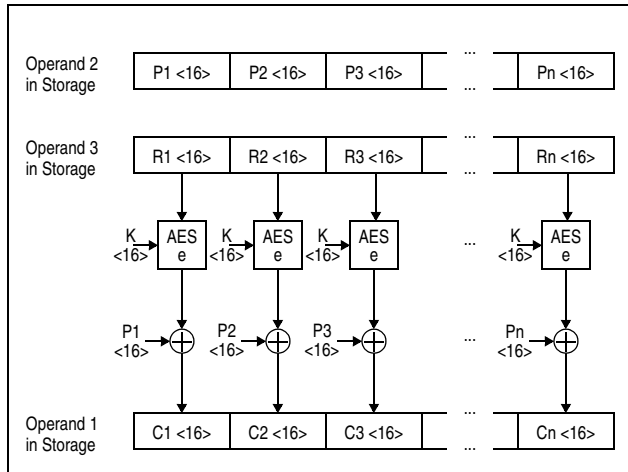

Figure 7-147. KMCTR AES Encipher Operation Using 128-Bit Key

When the modifier bit in general register 0 is one, a decipher operation is performed. The 16-byte ciphertext blocks (C1, C2, ..., Cn) in operand 2 are deciphered using the AES algorithm with the 128-bit cryptographic key and using 16-byte counter-value blocks (R1, R2, ..., Rn) in operand 3. Each ciphertext block is independently deciphered; that is, the decipher operation is performed without chaining. The plaintext blocks (P1, P2, ..., Pn) are stored in operand 1. The operation is shown in Figure 7-148.

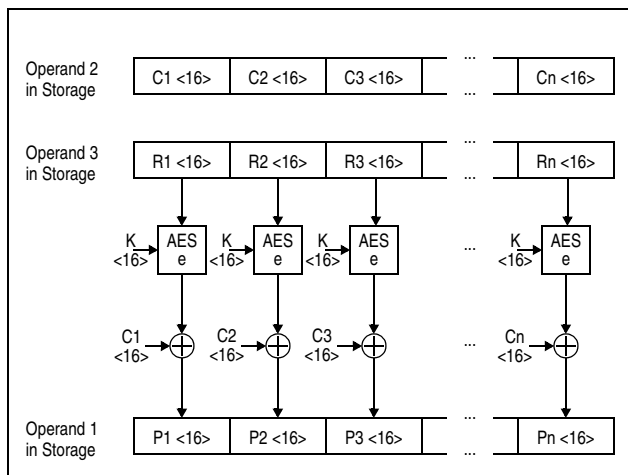

Figure 7-148. KMCTR AES Decipher Operation Using 128-Bit Key

KMCTR-AES-192 (Function Code 19)

KMCTR-Encrypted-AES-192 (Function Code 27)

The locations of the operands and addresses used by the instruction are as shown in Figure 7-126 on page 7-108.

The parameter block used for the KMCTR-AES-192 function has the following format:

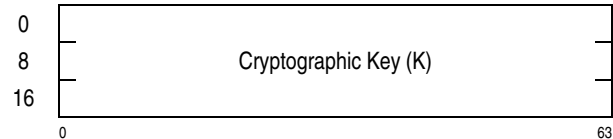

Figure 7-149. Parameter Block for KMCTR-AES-192

For the KMCTR-AES-192 function, the cryptographic key is in byte offsets 0-23 of the parameter block.

The parameter block used for the KMCTR-Encrypted-AES-192 function has the following format:

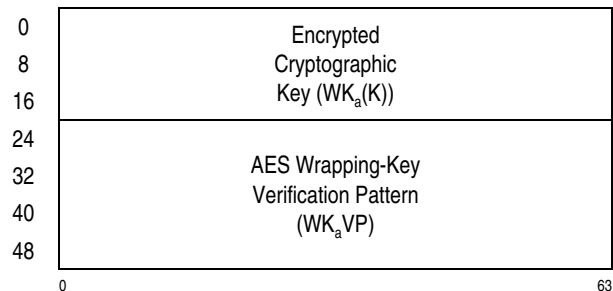

Figure 7-150. Parameter Block for KMCTR-Encrypted-AES-192

For the KMCTR-Encrypted-AES-192 function, the contents of byte offsets 24-55 of the parameter block are compared with the contents of the AES wrapping-key verification-pattern register. If they mismatch, the first-operand and parameter-block locations remain unchanged, and the operation is completed by setting condition code 1. If they match, the contents of byte offsets 0-23 of the parameter block are deciphered using the AES wrapping key to obtain the 192-bit cryptographic key, K. (See the section “Protection of Cryptographic Keys” on page 7-431 for details.)

The following description applies to both functions.

When the modifier bit in general register 0 is zero, an encipher operation is performed. The 16-byte plaintext blocks (P1, P2, ..., Pn) in operand 2 are enciphered using the AES algorithm with the 192-bit cryptographic key and using 16-byte counter-value blocks (R1, R2, ..., Rn) in operand 3. Each plaintext block is independently enciphered; that is, the encipher operation is performed without chaining. The ciphertext blocks (C1, C2, ..., Cn) are stored in operand 1. The operation is shown in Figure 7-151.

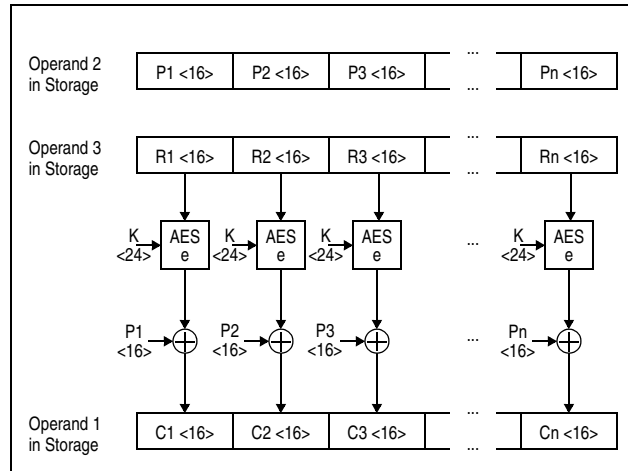

Figure 7-151. KMCTR AES Encipher Operation Using 192-Bit Key

When the modifier bit in general register 0 is one, a decipher operation is performed. The 16-byte ciphertext blocks (C1, C2, ..., Cn) in operand 2 are deciphered using the AES algorithm with the 192-bit cryptographic key and using 16-byte counter-value blocks (R1, R2, ..., Rn) in operand 3. Each ciphertext block is independently deciphered; that is, the decipher operation is performed without chaining. The plaintext blocks (P1, P2, ..., Pn) are stored in operand 1. The operation is shown in Figure 7-152.

plaintext blocks (P1, P2, ..., Pn) are stored in operand 1. The operation is shown in Figure 7-152.

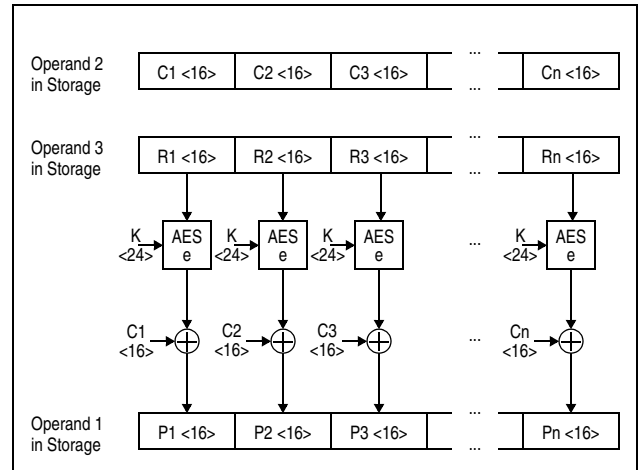

Figure 7-152. KMCTR AES Decipher Operation Using 192-Bit Key

KMCTR-AES-256 (Function Code 20)

KMCTR-Encrypted-AES-256 (Function Code 28)

The locations of the operands and addresses used by the instruction are as shown in Figure 7-126 on page 7-108.

The parameter block used for the KMCTR-AES-256 function has the following format:

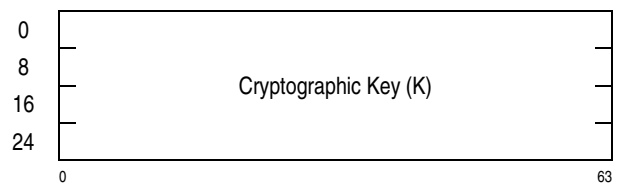

Figure 7-153. Parameter Block for KMCTR-AES-256

For the KMCTR-AES-256 function, the cryptographic key is in byte offsets 0-31 of the parameter block.

The parameter block used for the KMCTR-Encrypted-AES-256 function has the following format:

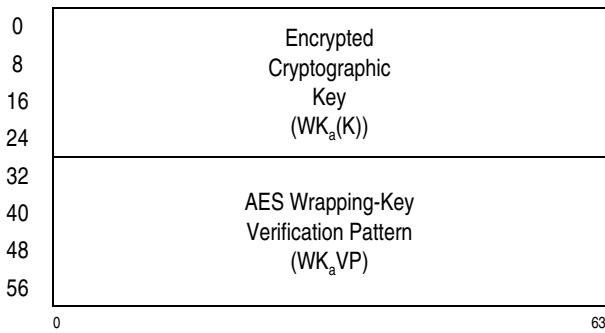

Figure 7-154. Parameter Block for KMCTR-Encrypted-AES-256

For the KMCTR-Encrypted-AES-256 function, the contents of byte offsets 32-63 of the parameter block are compared with the contents of the AES wrapping-key verification-pattern register. If they mismatch, the first-operand and parameter-block locations remain unchanged, and the operation is completed by setting condition code 1. If they match, the contents of byte offsets 0-31 of the parameter block are deciphered using the AES wrapping key to obtain the 256-bit cryptographic key, K. (See the section “Protection of Cryptographic Keys” on page 7-431 for details.)

The following description applies to both functions.

When the modifier bit in general register 0 is zero, an encipher operation is performed. The 16-byte plaintext blocks (P1, P2, ..., Pn) in operand 2 are enciphered using the AES algorithm with the 256-bit cryptographic key and using 16-byte counter-value blocks (R1, R2, ..., Rn) in operand 3. Each plaintext block is independently enciphered; that is, the encipher operation is performed without chaining. The

ciphertext blocks (C1, C2, ..., Cn) are stored in operand 1. The operation is shown in Figure 7-155.

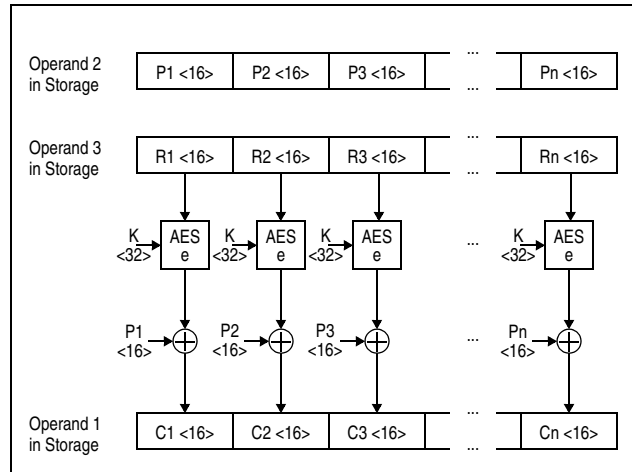

Figure 7-155. KMCTR AES Encipher Operation Using 256-Bit Key

When the modifier bit in general register 0 is one, a decipher operation is performed. The 16-byte ciphertext blocks (C1, C2, ..., Cn) in operand 2 are deciphered using the AES algorithm with the 256-bit cryptographic key and using 16-byte counter-value blocks (R1, R2, ..., Rn) in operand 3. Each ciphertext block is independently deciphered; that is, the decipher operation is performed without chaining. The plaintext blocks (P1, P2, ..., Pn) are stored in operand 1. The operation is shown in Figure 7-156.

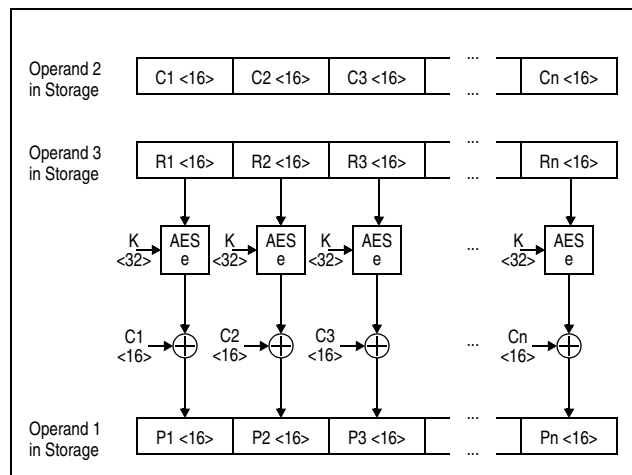

Figure 7-156. KMCTR AES Decipher Operation Using 256-Bit Key

Special Conditions for KMCTR

A specification exception is recognized and no other action is taken if any of the following occurs:

1. Bits 57-63 of general register 0 specify an unassigned or uninstalled function code.
2. The R₁, R₂, or R₃ field designates an odd-numbered register or general register 0.
3. The second operand length is not a multiple of the data block size of the designated function (see Figure 7-125 on page 7-107 to determine the data block sizes for CIPHER MESSAGE WITH COUNTER functions). This specification-exception condition does not apply to the query functions.

Resulting Condition Code:

- 0 Normal completion
- 1 Verification-pattern mismatch
- 2 --
- 3 Partial completion

Program Exceptions:

- Access (fetch, operand 2, operand 3, cryptographic key, and wrapping-key verification pattern; store, operand 1)
- Operation (if the message-security-assist extension 4 is not installed)
- Specification
- Transaction constraint

1.-6.	Exceptions with the same priority as the priority of program-interruption conditions for the general case.
7.A	Access exceptions for second instruction halfword.
7.B	Operation exception.
7.C	Transaction constraint
8.	Specification exception due to invalid function code or invalid register number.
9.	Specification exception due to invalid operand length.
10.	Condition code 0 due to second-operand length originally zero.
11.A.1	Access exceptions for an access to the parameter block.

Figure 7-157. Priority of Execution: KMCTR

11.A.2.	Condition code 1 due to verification-pattern mismatch.
11.B	Access exceptions for an access to the first, second, or third operand.
12.	Condition code 0 due to normal completion (second-operand length originally nonzero, but stepped to zero).
13.	Condition code 3 due to partial completion (second-operand length still nonzero).

Figure 7-157. Priority of Execution: KMCTR (Continued)

Programming Notes:

1. The performance of the query function (code 0) may be significantly slower than that of simply examining a location in storage. If the program needs to frequently test for the availability of a function, it should perform the query function once during initialization; subsequently it should examine the stored results of the query function in memory with an instruction such as TEST UNDER MASK.
2. As observed by this CPU, other CPUs, and the I/O subsystem, inconsistent results may be briefly stored in the first-operand location. See the section "Effects of CPU Retry" on page 11-3 for further details.

CIPHER MESSAGE WITH OUTPUT FEEDBACK

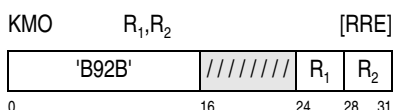

A function specified by the function code in general register 0 is performed.

Bits 16-23 of the instruction are ignored.

Bit positions 57-63 of general register 0 contain the function code. Figure 7-158 shows the assigned function codes for CIPHER MESSAGE WITH OUTPUT FEEDBACK. All other function codes are unassigned. For cipher functions, bit 56 is the modifier bit which specifies whether an encryption or a decryption operation is to be performed. The modifier bit is ignored for all other functions. All other bits of general register 0 are ignored.

General register 1 contains the logical address of the leftmost byte of the parameter block in storage. In the 24-bit addressing mode, the contents of bit positions 40-63 of general register 1 constitute the address, and the contents of bit positions 0-39 are ignored. In the 31-bit addressing mode, the contents of bit positions 33-63 of general register 1 constitute the address, and the contents of bit positions 0-32 are ignored. In the 64-bit addressing mode, the contents of bit positions 0-63 of general register 1 constitute the address.

The function codes for CIPHER MESSAGE WITH OUTPUT FEEDBACK are as follows.

Code	Function	Parm. Block Size (bytes)	Data Block Size (bytes)
0	KMO-Query	16	—
1	KMO-DEA	16	8
2	KMO-TDEA-128	24	8
3	KMO-TDEA-192	32	8
9	KMO-Encrypted-DEA	40	8
10	KMO-Encrypted-TDEA-128	48	8
11	KMO-Encrypted-TDEA-192	56	8
18	KMO-AES-128	32	16
19	KMO-AES-192	40	16
20	KMO-AES-256	48	16
26	KMO-Encrypted-AES-128	64	16
27	KMO-Encrypted-AES-192	72	16
28	KMO-Encrypted-AES-256	80	16
Explanation:			
— Not applicable			

Figure 7-158. Function Codes for CIPHER MESSAGE WITH OUTPUT FEEDBACK

All other function codes are unassigned.

The query function provides the means of indicating the availability of the other functions. The contents of general registers R_1 , R_2 , and $R_2 + 1$ are ignored for the query function.

For all other functions, the second operand is ciphered as specified by the function code using a cryptographic key and an initial chaining value in the parameter block, and the result is placed in the first-

operand location. The chaining value is updated as part of the operation.

The R_1 field designates a general register and must designate an even-numbered register other than general register 0; otherwise, a specification exception is recognized. The R_2 field designates an even-odd pair of general registers and must designate an even-numbered register other than general register 0; otherwise, a specification exception is recognized.

The location of the leftmost byte of the first and second operands is specified by the contents of the R_1 and R_2 general registers, respectively. The number of bytes in the second-operand location is specified in general register $R_2 + 1$. The first operand is the same length as the second operand.

As part of the operation, the addresses in general registers R_1 and R_2 are incremented by the number of bytes processed, and the length in general register $R_2 + 1$ is decremented by the same number. The formation and updating of the addresses and length is dependent on the addressing mode.

In the 24-bit addressing mode, the contents of bit positions 40-63 of general registers R_1 and R_2 constitute the addresses of the first and second operands, respectively, and the contents of bit positions 0-39 are ignored; bits 40-63 of the updated addresses replace the corresponding bits in general registers R_1 and R_2 , carries out of bit position 40 of the updated address are ignored, and the contents of bit positions 32-39 of general registers R_1 and R_2 are set to zeros. In the 31-bit addressing mode, the contents of bit positions 33-63 of general registers R_1 and R_2 constitute the addresses of the first and second operands, respectively, and the contents of bit positions 0-32 are ignored; bits 33-63 of the updated addresses replace the corresponding bits in general registers R_1 and R_2 , carries out of bit position 33 of the updated address are ignored, and the content of bit position 32 of general registers R_1 and R_2 is set to zero. In the 64-bit addressing mode, the contents of bit positions 0-63 of general registers R_1 and R_2 constitute the addresses of the first and second operands, respectively; bits 0-63 of the updated addresses replace the contents of general registers R_1 and R_2 , and carries out of bit position 0 are ignored.

In both the 24-bit and the 31-bit addressing modes, the contents of bit positions 32-63 of general register $R_2 + 1$ form a 32-bit unsigned binary integer which specifies the number of bytes in the first and second

operands, and the contents of bit positions 0-31 are ignored; bits 32-63 of the updated value replace the corresponding bits in general register $R_2 + 1$. In the 64-bit addressing mode, the contents of bit positions 0-63 of general register $R_2 + 1$ form a 64-bit unsigned binary integer which specifies the number of bytes in the first and second operands; and the updated value replaces the contents of general register $R_2 + 1$.

In the 24-bit or 31-bit addressing mode, the contents of bit positions 0-31 of general registers R_1 , R_2 , and $R_2 + 1$, always remain unchanged.

Figure 7-159 on page 7-121 shows the contents of the general registers just described.

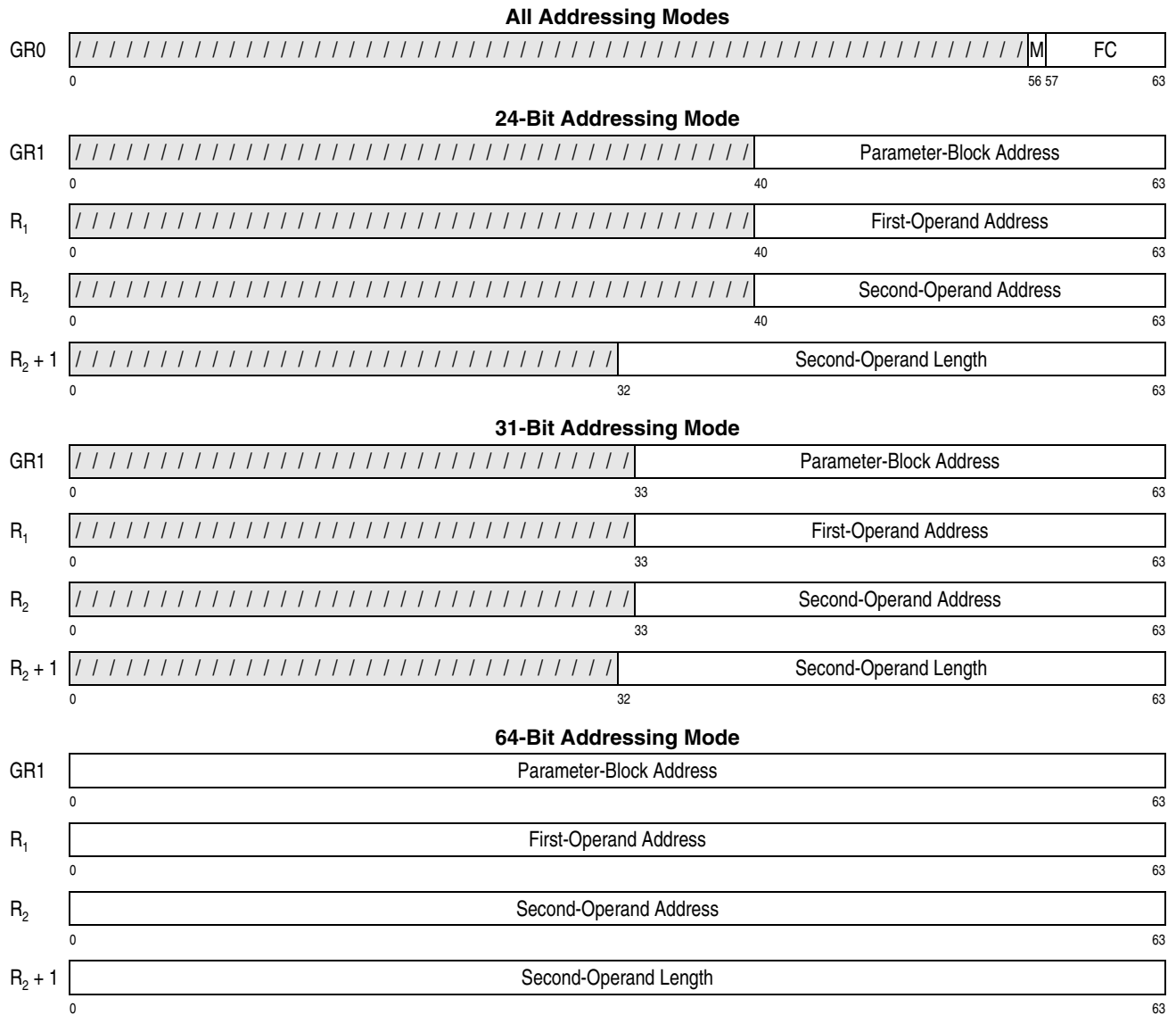

Figure 7-159. General Register Assignment for KMO

In the access-register mode, access registers 1, R_1 , and R_2 specify the address spaces containing the parameter block, first, and second operands, respectively.

The result is obtained as if processing starts at the left end of both the first and second operands and proceeds to the right, block by block. The operation is ended when the number of bytes in the second operand as specified in general register $R_2 + 1$ have been processed and placed at the first-operand location

(called normal completion) or when a CPU-determined number of blocks that is less than the length of the second operand have been processed (called partial completion). The CPU-determined number of blocks depends on the model, and may be a different number each time the instruction is executed. The CPU-determined number of blocks is usually non-zero. In certain unusual situations, this number may be zero, and condition code 3 may be set with no progress. However, the CPU protects against end-less reoccurrence of this no-progress case.

The results in the first-operand location and the chaining-value field are unpredictable if any of the following situations occur:

1. The cryptographic-key field or the encrypted cryptographic-key field overlaps any portion of the first operand.
2. The chaining-value field overlaps any portion of the first operand or the second operand.
3. The first and second operands overlap destructively. Operands are said to overlap destructively when the first-operand location would be used as a source after data would have been moved into it, assuming processing to be performed from left to right and one byte at a time.

When the operation ends due to normal completion, condition code 0 is set and the resulting value in $R_2 + 1$ is zero. When the operation ends due to partial completion, condition code 3 is set and the resulting value in $R_2 + 1$ is nonzero.

A PER storage-alteration event may be recognized both for the first-operand location and for the portion of the parameter block that is stored. A PER zero-address-detection event may be recognized for the first- and second-operand locations and for the parameter block. When PER events are detected for one or more of these locations, it is unpredictable which location is identified in the PER access identification (PAID) and PER ASCE ID (AI).

When a storage-alteration PER event is recognized, fewer than 4K additional bytes are stored into the first-operand locations before the event is reported.

When the second-operand length is initially zero, the parameter block, first, and second operands are not accessed, general registers R_1 , R_2 , and $R_2 + 1$ are not changed, and condition code 0 is set.

When the contents of the R_1 and R_2 fields are the same, the contents of the designated registers are incremented only by the number of bytes processed, not by twice the number of bytes processed.

As observed by this CPU, other CPUs, and channel programs, references to the parameter block and storage operands may be multiple-access references, accesses to these storage locations are not necessarily block-concurrent, and the sequence of these accesses or references is undefined.

In certain unusual situations, instruction execution may complete by setting condition code 3 without updating the registers and chaining value to reflect the last unit of the first and second operands processed. The size of the unit processed in this case depends on the situation and the model, but is limited such that the portion of the first and second operands which have been processed and not reported do not overlap in storage. In all cases, change bits are set and PER storage-alteration events are reported, when applicable, for all first-operand locations processed.

For functions that perform a comparison of the wrapping-key verification pattern field in the parameter block with the wrapping-key verification-pattern register, it is unpredictable whether access exceptions and PER zero-address-detection events are recognized for the first and second operands when the comparison results in a mismatch.

Access exceptions may be reported for a larger portion of an operand than is processed in a single execution of the instruction; however, access exceptions are not recognized for locations beyond the length of an operand nor for locations more than 4K bytes beyond the current location being processed.

Symbols Used in Function Descriptions

The following symbols are used in the subsequent description of the CIPHER MESSAGE WITH OUTPUT FEEDBACK functions. For data-encryption-algorithm (DEA) functions, the DEA-key-parity bit in each byte of the DEA key is ignored, and the operation proceeds normally, regardless of the DEA-key parity of the key.

Further description of the data-encryption algorithm may be found in Reference [13.] on page xxx. Further description of the AES standard may be found in Reference [14.] on page xxx. Further description of the

output-feedback mode of encryption and decryption may be found in Reference [16.] on page xxx.

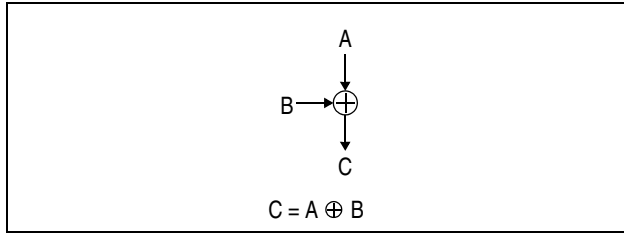

Figure 7-160. Symbol For Bit-Wise Exclusive OR

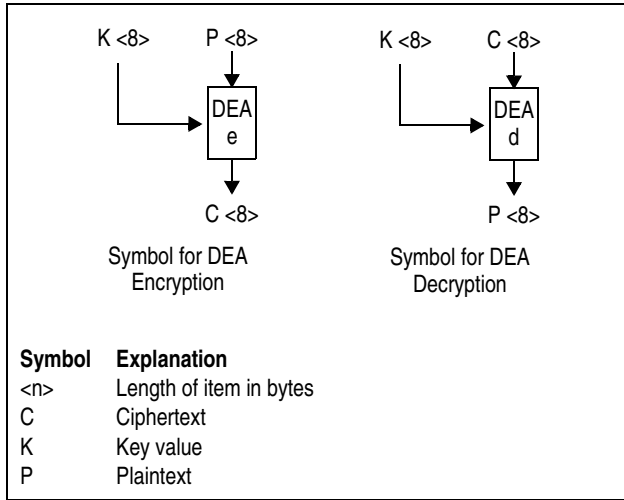

Figure 7-161. Symbols for DEA Encryption and Decryption

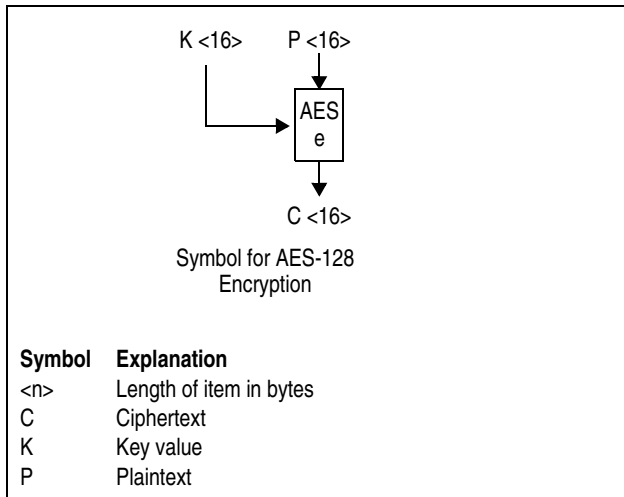

Figure 7-162. Symbols for AES-128 Encryption

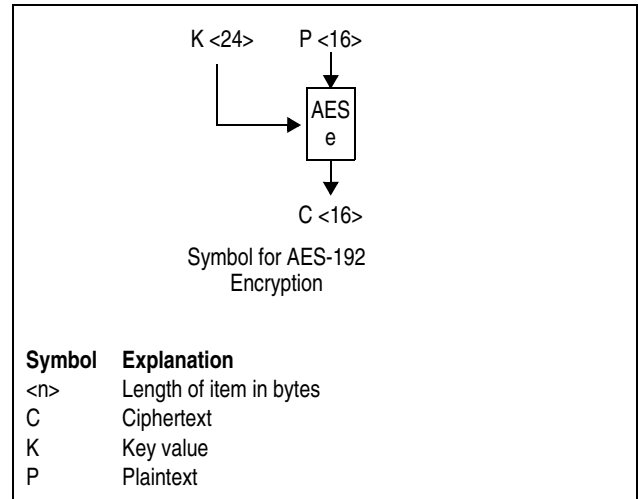

Figure 7-163. Symbols for AES-192 Encryption

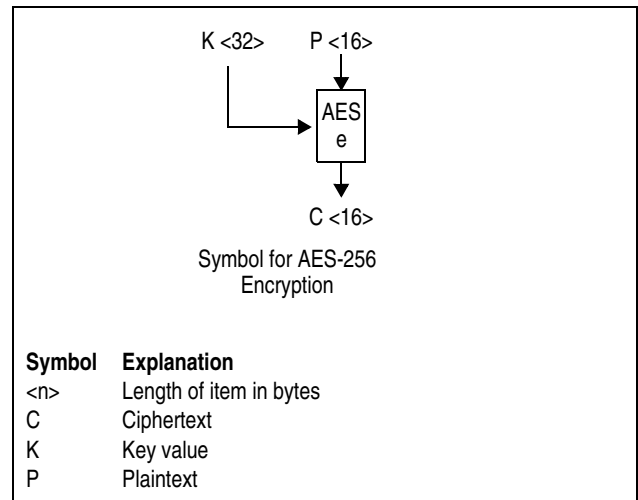

Figure 7-164. Symbols for AES-256 Encryption

KMO-Query (Function Code 0)

The locations of the operands and addresses used by the instruction are as shown in Figure 7-159 on page 7-121.

The parameter block used for the function has the following format:

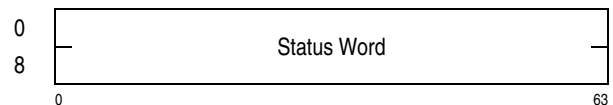

Figure 7-165. Parameter Block for KMO-Query

A 128-bit status word is stored in the parameter block. Bits 0-127 of this field correspond to function codes 0-127, respectively, of the CIPHER MESSAGE WITH OUTPUT FEEDBACK instruction. When a bit

is one, the corresponding function is installed; otherwise, the function is not installed.

Condition code 0 is set when execution of the KMO-Query function completes; condition codes 1 and 3 are not applicable to this function.

KMO-DEA (Function Code 1)

KMO-Encrypted-DEA (Function Code 9)

The locations of the operands and addresses used by the instruction are as shown in Figure 7-159 on page 7-121.

The parameter block used for the KMO-DEA function has the following format:

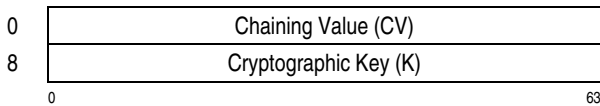

Figure 7-166. Parameter Block for KMO-DEA

For the KMO-DEA function, the chaining value is in byte offset 0-7 of the parameter block and the cryptographic key is in byte offsets 8-15 of the parameter block.

The parameter block used for the KMO-Encrypted -DEA function has the following format:

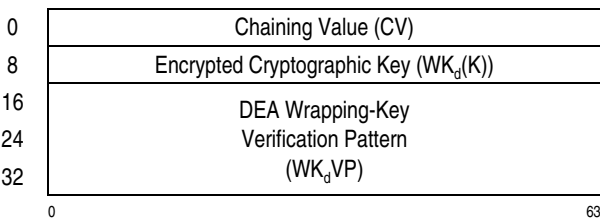

Figure 7-167. Parameter Block for KMO-Encrypted-DEA

For the KMO-Encrypted-DEA function, the contents of byte offsets 16-39 of the parameter block are compared with the contents of the DEA wrapping-key verification-pattern register. If they mismatch, the first-operand and parameter-block locations remain unchanged, and the operation is completed by setting condition code 1. If they match, byte offsets 0-7 of the parameter block contain the chaining value, and the contents of byte offsets 8-15 of the parameter block are deciphered using the DEA wrapping key to obtain the 64-bit cryptographic key. (See the section “Protection of Cryptographic Keys” on page 7-431 for details.)

The following description applies to both functions.

When the modifier bit in general register 0 is zero, an encipher operation is performed. The 8-byte plaintext blocks (P_1, P_2, \dots, P_n) in operand 2 are enciphered using the DEA-encryption algorithm with the 64-bit cryptographic key and the 64-bit chaining value.

The first input block to the DEA-encryption algorithm is the initial chaining value (ICV) in the parameter block. Each input block is enciphered to produce an output block. Each output block is exclusive-ORed with the corresponding plaintext block to form a ciphertext block. Each output block is also used as the next input block.

The process is repeated with the successive input blocks until a ciphertext block is produced for every plaintext block, or until a CPU-determined number of ciphertext blocks have been produced.

The ciphertext blocks (C_1, C_2, \dots, C_n) are stored in operand 1. The next input block, called the output chaining value (OCV), is stored into the chaining-value field of the parameter block. The operation is shown in Figure 7-168.

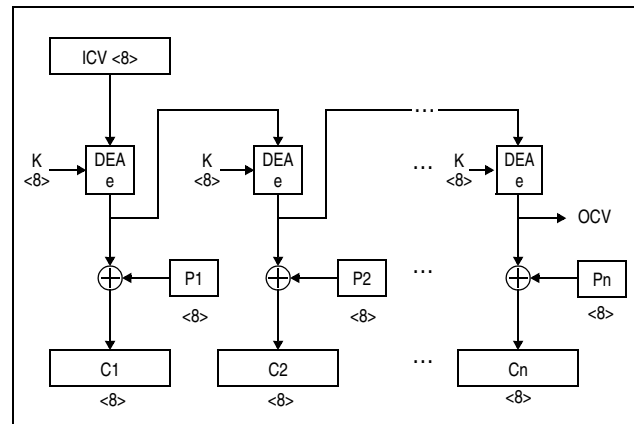

Figure 7-168. KMO-DEA Encipher Operation

When the modifier bit in general register 0 is one, a decipher operation is performed. The 8-byte ciphertext blocks (C_1, C_2, \dots, C_n) in operand 2 are deciphered using the DEA-encryption algorithm with the 64-bit cryptographic key and the 64-bit chaining value.

The first input block to the DEA-encryption algorithm is the initial chaining value (ICV) in the parameter block. Each input block is enciphered to produce an output block. Each output block is exclusive-ORed

with the corresponding ciphertext block to form a plaintext block. Each output block is also used as the next input block.

The process is repeated with the successive input blocks until a plaintext block is produced for every ciphertext block, or until a CPU-determined number of plaintext blocks have been produced.

The plaintext blocks (P1, P2, ..., Pn) are stored in operand 1. The next input block, called the output chaining value (OCV), is stored into the chaining-value field of the parameter block. The operation is shown in Figure 7-169.

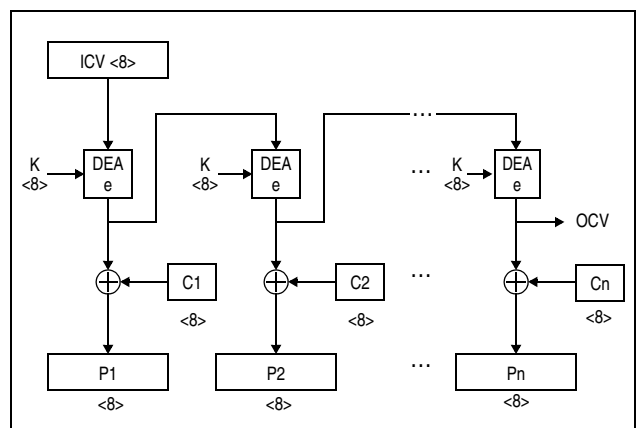

Figure 7-169. KMO-DEA Decipher Operation

KMO-TDEA-128 (Function Code 2)

KMO-Encrypted-TDEA-128 (Function Code 10)

The locations of the operands and addresses used by the instruction are as shown in Figure 7-159 on page 7-121.

The parameter block used for the KMO-TDEA-128 function has the following format:

0	Chaining Value (CV)
8	Cryptographic Key 1 (K1)
16	Cryptographic Key 2 (K2)
0	63

Figure 7-170. Parameter Block for KMO-TDEA-128

For the KMO-TDEA-128 function, the chaining value is in byte offset 0-7 of the parameter block and the cryptographic key is in byte offsets 8-23 of the parameter block.

The parameter block used for the KMO-Encrypted-TDEA-128 function has the following format:

0	Chaining Value (CV)
8	Encrypted Cryptographic Key (WK ₀ (K))
16	DEA Wrapping-Key Verification Pattern (WK ₀ VP)
24	
32	
40	
0	63

Figure 7-171. Parameter Block for KMO-Encrypted-TDEA-128

For the KMO-Encrypted-TDEA-128 function, the contents of byte offsets 24-47 of the parameter block are compared with the contents of the DEA wrapping-key verification-pattern register. If they mismatch, the first-operand and parameter-block locations remain unchanged, and the operation is completed by setting condition code 1. If they match, byte offsets 0-7 of the parameter block contain the chaining value, and the contents of byte offsets 8-23 of the parameter block are deciphered using the DEA wrapping key to obtain the 128-bit cryptographic key. (See the section “Protection of Cryptographic Keys” on page 7-431 for details.)

The following description applies to both functions.

When the modifier bit in general register 0 is zero, an encipher operation is performed. The 8-byte plaintext blocks (P1, P2, ..., Pn) in operand 2 are enciphered using the TDEA-encryption algorithm with the 128-bit cryptographic key and the 64-bit chaining value.

The first input block to the TDEA-encryption algorithm is the initial chaining value (ICV) in the parameter block. Each input block is enciphered to produce an output block. Each output block is exclusive-ORed with the corresponding plaintext block to form a ciphertext block. Each output block is also used as the next input block.

The process is repeated with the successive input blocks until a ciphertext block is produced for every plaintext block, or until a CPU-determined number of ciphertext blocks have been produced.

The ciphertext blocks (C1, C2, ..., Cn) are stored in operand 1. The next input block, called the output chaining value (OCV), is stored into the chaining-

value field of the parameter block. The operation is shown in Figure 7-172.

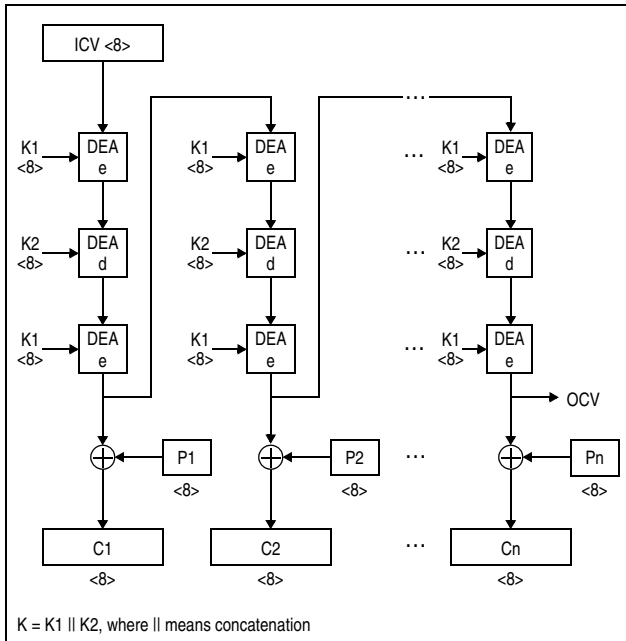

Figure 7-172. KMO-TDEA-128 Encipher Operation

When the modifier bit in general register 0 is one, a decipher operation is performed. The 8-byte ciphertext blocks (C1, C2, ..., Cn) in operand 2 are deciphered using the TDEA-encryption algorithm with the 128-bit cryptographic key and the 64-bit chaining value.

The first input block to the TDEA-encryption algorithm is the initial chaining value (ICV) in the parameter block. Each input block is enciphered to produce an output block. Each output block is exclusive-ORed with the corresponding ciphertext block to form a plaintext block. Each output block is also used as the next input block.

The process is repeated with the successive input blocks until a plaintext block is produced for every ciphertext block, or until a CPU-determined number of plaintext blocks have been produced.

The plaintext blocks (P1, P2, ..., Pn) are stored in operand 1. The next input block, called the output chaining value (OCV), is stored into the chaining-

value field of the parameter block. The operation is shown in Figure 7-173.

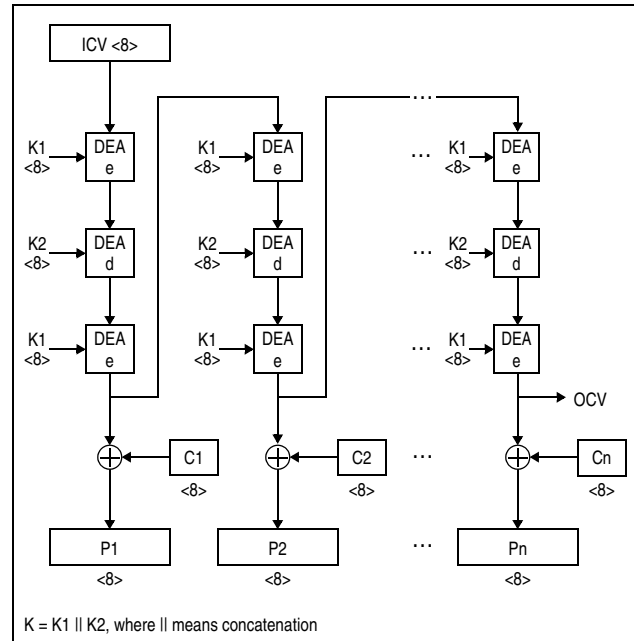

Figure 7-173. KMO-TDEA-128 Decipher Operation

KMO-TDEA-192 (Function Code 3)

KMO-Encrypted-TDEA-192 (Function Code 11)

The locations of the operands and addresses used by the instruction are as shown in Figure 7-159 on page 7-121.

The parameter block used for the KMO-TDEA-192 function has the following format:

0	Chaining Value (CV)
8	Cryptographic Key 1 (K1)
16	Cryptographic Key 2 (K2)
24	Cryptographic Key 3 (K3)
0	63

Figure 7-174. Parameter Block for KMO-TDEA-192

For the KMO-TDEA-192 function, the chaining value is in byte offset 0-7 of the parameter block and the cryptographic key is in byte offsets 8-31 of the parameter block.

The parameter block used for the KMO-Encrypted-TDEA-192 function has the following format:

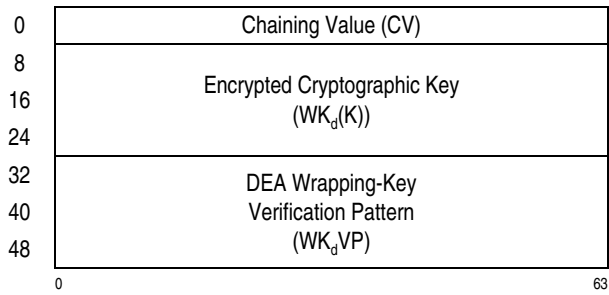

Figure 7-175. Parameter Block for KMO-Encrypted-TDEA-192

For the KMO-Encrypted-TDEA-192 function, the contents of byte offsets 32-55 of the parameter block are compared with the contents of the DEA wrapping-key verification-pattern register. If they mismatch, the first-operand and parameter-block locations remain unchanged, and the operation is completed by setting condition code 1. If they match, byte offsets 0-7 of the parameter block contain the chaining value, and the contents of byte offsets 8-31 of the parameter block are deciphered using the DEA wrapping key to obtain the 192-bit cryptographic key. (See the section “Protection of Cryptographic Keys” on page 7-431 for details.)

The following description applies to both functions.

When the modifier bit in general register 0 is zero, an encipher operation is performed. The 8-byte plaintext blocks (P1, P2, ..., Pn) in operand 2 are enciphered using the TDEA-encryption algorithm with the 192-bit cryptographic key and the 64-bit chaining value.

The first input block to the TDEA-encryption algorithm is the initial chaining value (ICV) in the parameter block. Each input block is enciphered to produce an output block. Each output block is exclusive-ORed with the corresponding plaintext block to form a ciphertext block. Each output block is also used as the next input block.

The process is repeated with the successive input blocks until a ciphertext block is produced for every plaintext block, or until a CPU-determined number of ciphertext blocks have been produced.

The ciphertext blocks (C1, C2, ..., Cn) are stored in operand 1. The next input block, called the output chaining value (OCV), is stored into the chaining-value field of the parameter block. The operation is shown in Figure 7-176.

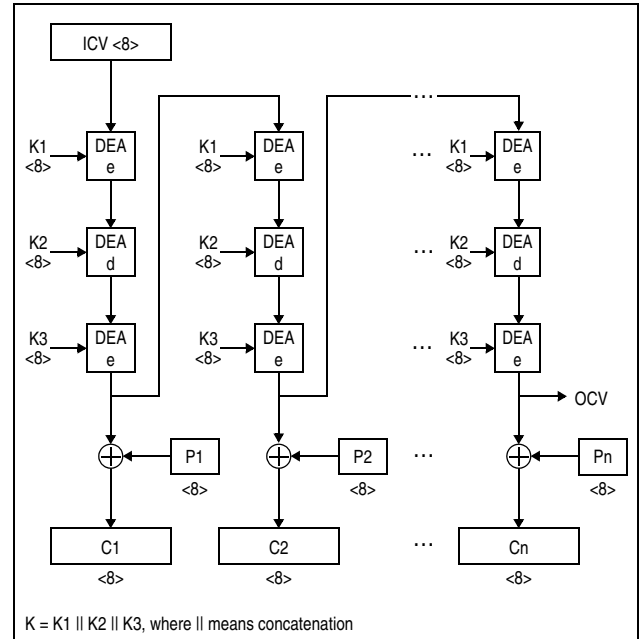

Figure 7-176. KMO-TDEA-192 Encipher Operation

When the modifier bit in general register 0 is one, a decipher operation is performed. The 8-byte ciphertext blocks (C1, C2, ..., Cn) in operand 2 are deciphered using the TDEA-encryption algorithm with the 192-bit cryptographic key and the 64-bit chaining value.

The first input block to the TDEA-encryption algorithm is the initial chaining value (ICV) in the parameter block. Each input block is enciphered to produce an output block. Each output block is exclusive-ORed with the corresponding ciphertext block to form a plaintext block. Each output block is also used as the next input block.

The process is repeated with the successive input blocks until a plaintext block is produced for every ciphertext block, or until a CPU-determined number of plaintext blocks have been produced.

The plaintext blocks (P1, P2, ..., Pn) are stored in operand 1. The next input block, called the output chaining value (OCV), is stored into the chaining-

value field of the parameter block. The operation is shown in Figure 7-177.

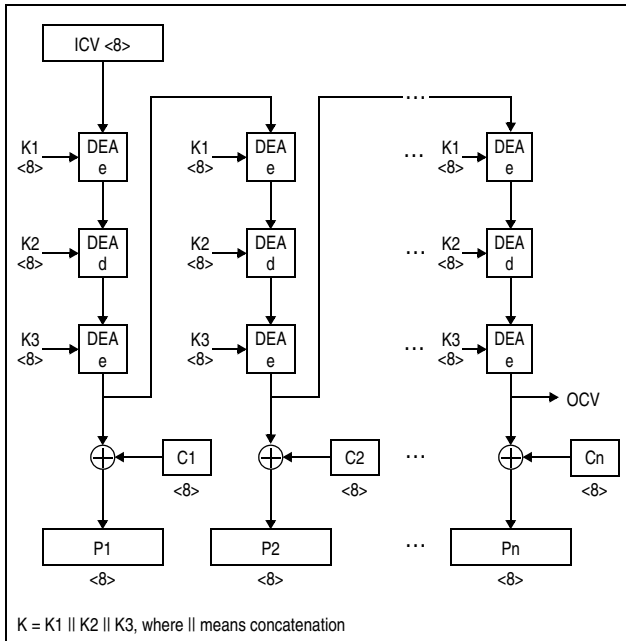

Figure 7-177. KMO-TDEA-192 Decipher Operation

KMO-AES-128 (Function Code 18)

KMO-Encrypted-AES-128 (Function Code 26)

The locations of the operands and addresses used by the instruction are as shown in Figure 7-159 on page 7-121.

The parameter block used for the KMO-AES-128 function has the following format:

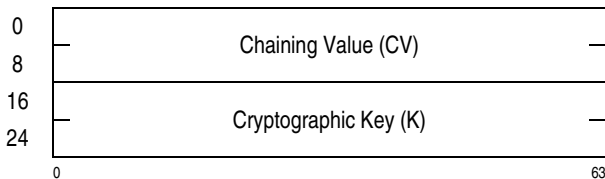

Figure 7-178. Parameter Block for KMO-AES-128

For the KMO-AES-128 function, the chaining value is in byte offset 0-15 of the parameter block and the cryptographic key is in byte offsets 16-31 of the parameter block.

The parameter block used for the KMO-Encrypted-AES-128 function has the following format:

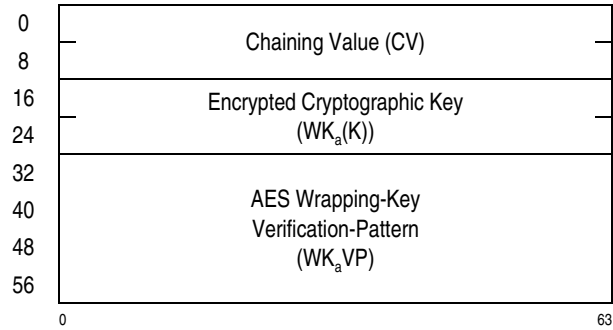

Figure 7-179. Parameter Block for KMO-Encrypted-AES-128

For the KMO-Encrypted-AES-128 function, the contents of byte offsets 32-63 of the parameter block are compared with the contents of the AES wrapping-key verification-pattern register. If they mismatch, the first-operand and parameter-block locations remain unchanged, and the operation is completed by setting condition code 1. If they match, byte offsets 0-15 of the parameter block contain the chaining value, and the contents of byte offsets 16-31 of the parameter block are deciphered using the AES wrapping key to obtain the 128-bit cryptographic key. (See the section “Protection of Cryptographic Keys” on page 7-431 for details.)

The following description applies to both functions.

When the modifier bit in general register 0 is zero, an encipher operation is performed. The 16-byte plaintext blocks (P1, P2, ..., Pn) in operand 2 are enciphered using the AES-encryption algorithm with the 128-bit cryptographic key and the 128-bit chaining value.

The first input block to the AES-encryption algorithm is the initial chaining value (ICV) in the parameter block. Each input block is enciphered to produce an output block. Each output block is exclusive-ORed with the corresponding plaintext block to form a ciphertext block. Each output block is also used as the next input block.

The process is repeated with the successive input blocks until a ciphertext block is produced for every plaintext block, or until a CPU-determined number of ciphertext blocks have been produced.

The ciphertext blocks (C1, C2, ..., Cn) are stored in operand 1. The next input block, called the output chaining value (OCV), is stored into the chaining-value field of the parameter block. The operation is shown in Figure 7-180.

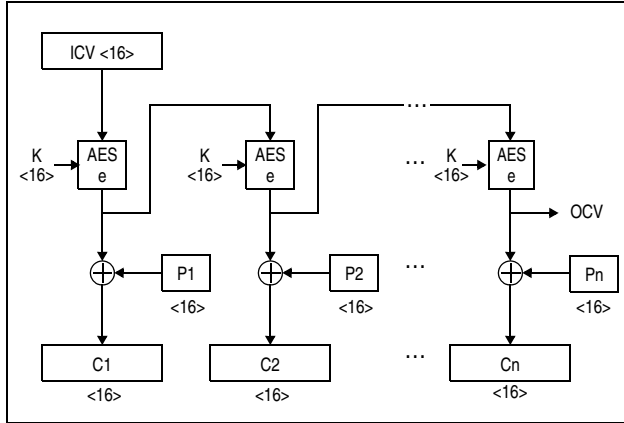

Figure 7-180. KMO-AES-128 Encipher Operation

When the modifier bit in general register 0 is one, a decipher operation is performed. The 16-byte ciphertext blocks (C1, C2, ..., Cn) in operand 2 are deciphered using the AES-encryption algorithm with the 128-bit cryptographic key and the 128-bit chaining value.

The first input block to the AES-encryption algorithm is the initial chaining value (ICV) in the parameter block. Each input block is enciphered to produce an output block. Each output block is exclusive-ORed with the corresponding ciphertext block to form a plaintext block. Each output block is also used as the next input block.

The process is repeated with the successive input blocks until a plaintext block is produced for every ciphertext block, or until a CPU-determined number of plaintext blocks have been produced.

The plaintext blocks (P1, P2, ..., Pn) are stored in operand 1. The next input block, called the output chaining value (OCV), is stored into the chaining-

value field of the parameter block. The operation is shown in Figure 7-181.

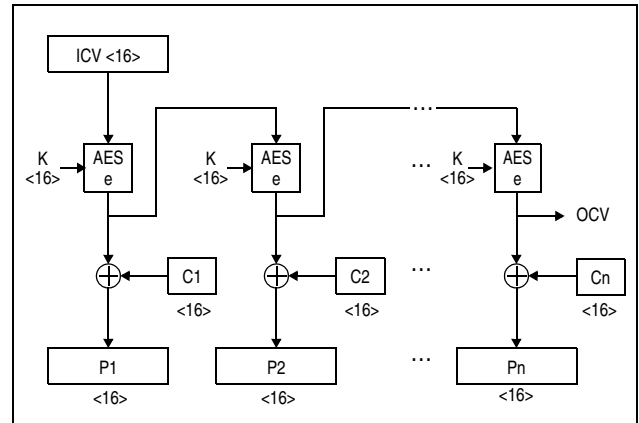

Figure 7-181. KMO-AES-128 Decipher Operation

KMO-AES-192 (Function Code 19)

KMO-Encrypted-AES-192 (Function Code 27)

The locations of the operands and addresses used by the instruction are as shown in Figure 7-159 on page 7-121.

The parameter block used for the KMO-AES-192 function has the following format:

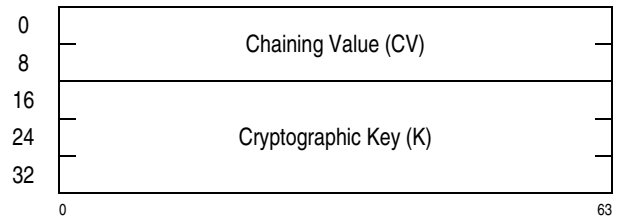

Figure 7-182. Parameter Block for KMO-AES-192

For the KMO-AES-192 function, the chaining value is in byte offset 0-15 of the parameter block and the cryptographic key is in byte offsets 16-39 of the parameter block.

The parameter block used for the KMO-Encrypted-AES-192 function has the following format:

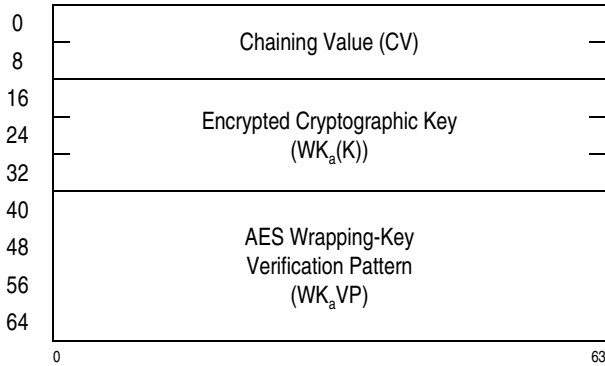

Figure 7-183. Parameter Block for KMO-Encrypted-AES-192

For the KMO-Encrypted-AES-192 function, the contents of byte offsets 40-71 of the parameter block are compared with the contents of the AES wrapping-key verification-pattern register. If they mismatch, the first-operand and parameter-block locations remain unchanged, and the operation is completed by setting condition code 1. If they match, byte offsets 0-15 of the parameter block contain the chaining value, and the contents of byte offsets 16-39 of the parameter block are deciphered using the AES wrapping key to obtain the 192-bit cryptographic key. (See the section “Protection of Cryptographic Keys” on page 7-431 for details.)

The following description applies to both functions.

When the modifier bit in general register 0 is zero, an encipher operation is performed. The 16-byte plaintext blocks (P1, P2, ..., Pn) in operand 2 are enciphered using the AES-encryption algorithm with the 192-bit cryptographic key and the 128-bit chaining value.

The first input block to the AES-encryption algorithm is the initial chaining value (ICV) in the parameter block. Each input block is enciphered to produce an output block. Each output block is exclusive-ORed with the corresponding plaintext block to form a ciphertext block. Each output block is also used as the next input block.

The process is repeated with the successive input blocks until a ciphertext block is produced for every plaintext block, or until a CPU-determined number of ciphertext blocks have been produced.

The ciphertext blocks (C1, C2, ..., Cn) are stored in operand 1. The next input block, called the output chaining value (OCV), is stored into the chaining-value field of the parameter block. The operation is shown in Figure 7-184.

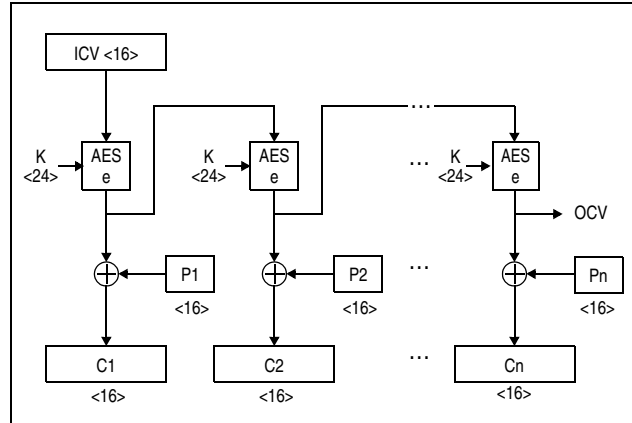

Figure 7-184. KMO-AES-192 Encipher Operation

When the modifier bit in general register 0 is one, a decipher operation is performed. The 16-byte ciphertext blocks (C1, C2, ..., Cn) in operand 2 are deciphered using the AES-encryption algorithm with the 192-bit cryptographic key and the 128-bit chaining value.

The first input block to the AES-encryption algorithm is the initial chaining value (ICV) in the parameter block. Each input block is enciphered to produce an output block. Each output block is exclusive-ORed with the corresponding ciphertext block to form a plaintext block. Each output block is also used as the next input block.

The process is repeated with the successive input blocks until a plaintext block is produced for every ciphertext block, or until a CPU-determined number of plaintext blocks have been produced.

The plaintext blocks (P1, P2, ..., Pn) are stored in operand 1. The next input block, called the output chaining value (OCV), is stored into the chaining-

value field of the parameter block. The operation is shown in Figure 7-185.

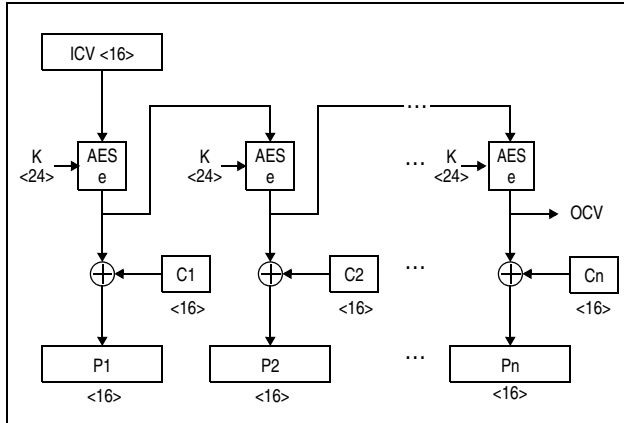

Figure 7-185. KMO-AES-192 Decipher Operation

KMO-AES-256 (Function Code 20)

KMO-Encrypted-AES-256 (Function Code 28)

The locations of the operands and addresses used by the instruction are as shown in Figure 7-159 on page 7-121.

The parameter block used for the KMO-AES-256 function has the following format:

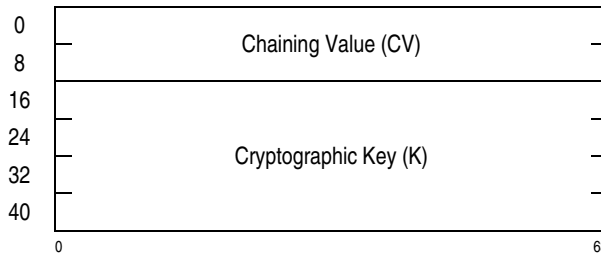

Figure 7-186. Parameter Block for KMO-AES-256

For the KMO-AES-256 function, the chaining value is in byte offset 0-15 of the parameter block and the cryptographic key is in byte offsets 16-47 of the parameter block.

The parameter block used for the KMO-Encrypted-AES-256 function has the following format:

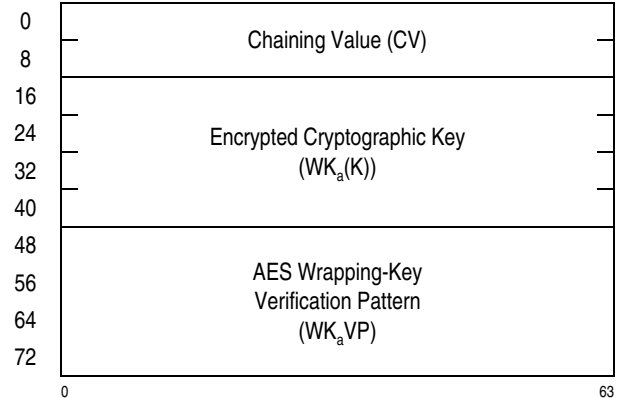

Figure 7-187. Parameter Block for KMO-AES-256

For the KMO-Encrypted-AES-256 function, the contents of byte offsets 48-79 of the parameter block are compared with the contents of the AES wrapping-key verification-pattern register. If they mismatch, the first-operand and parameter-block locations remain unchanged, and the operation is completed by setting condition code 1. If they match, byte offsets 0-15 of the parameter block contain the chaining value, and the contents of byte offsets 16-47 of the parameter block are deciphered using the AES wrapping key to obtain the 256-bit cryptographic key. (See the section “Protection of Cryptographic Keys” on page 7-431 for details.)

The following description applies to both functions.

When the modifier bit in general register 0 is zero, an encipher operation is performed. The 16-byte plaintext blocks (P1, P2, ..., Pn) in operand 2 are enciphered using the AES-encryption algorithm with the 256-bit cryptographic key and the 128-bit chaining value.

The first input block to the AES-encryption algorithm is the initial chaining value (ICV) in the parameter block. Each input block is enciphered to produce an output block. Each output block is exclusive-ORed with the corresponding plaintext block to form a ciphertext block. Each output block is also used as the next input block.

The process is repeated with the successive input blocks until a ciphertext block is produced for every plaintext block, or until a CPU-determined number of ciphertext blocks have been produced.

The ciphertext blocks (C1, C2, ..., Cn) are stored in operand 1. The next input block, called the output chaining value (OCV), is stored into the chaining-value field of the parameter block. The operation is shown in Figure 7-188.

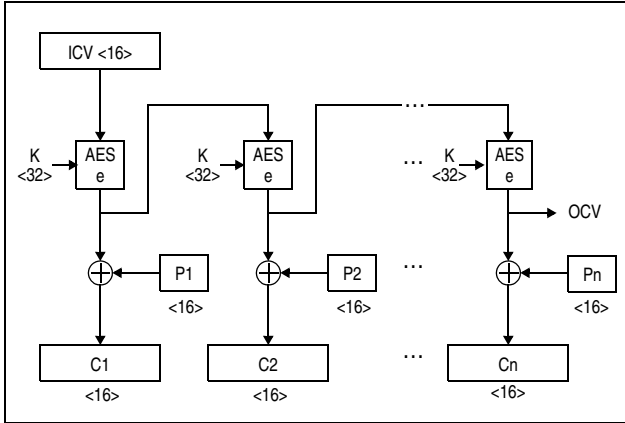

Figure 7-188. KMO-AES-256 Encipher Operation

When the modifier bit in general register 0 is one, a decipher operation is performed. The 16-byte ciphertext blocks (C1, C2, ..., Cn) in operand 2 are deciphered using the AES-encryption algorithm with the 256-bit cryptographic key and the 128-bit chaining value.

The first input block to the AES-encryption algorithm is the initial chaining value (ICV) in the parameter block. Each input block is enciphered to produce an output block. Each output block is exclusive-ORed with the corresponding ciphertext block to form a plaintext block. Each output block is also used as the next input block.

The process is repeated with the successive input blocks until a plaintext block is produced for every ciphertext block, or until a CPU-determined number of plaintext blocks have been produced.

The plaintext blocks (P1, P2, ..., Pn) are stored in operand 1. The next input block, called the output chaining value (OCV), is stored into the chaining-

value field of the parameter block. The operation is shown in Figure 7-189.

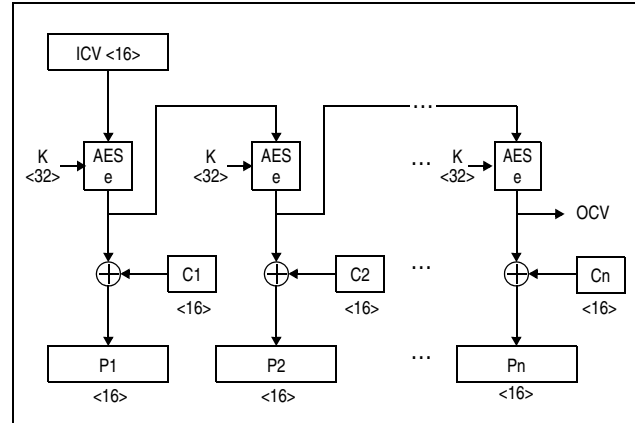

Figure 7-189. KMO-AES-256 Decipher Operation

Special Conditions

A specification exception is recognized and no other action is taken if any of the following occurs:

1. Bits 57-63 of general register 0 specify an unassigned or uninstalled function code.
2. The R₁ or R₂ field designates an odd-numbered register or general register 0.
3. The second operand length is not a multiple of the data block size of the designated function (see Figure 7-158 on page 7-120 to determine the data block sizes for CIPHER MESSAGE WITH OUTPUT FEEDBACK functions). This specification-exception condition does not apply to the query functions.

Resulting Condition Code:

- 0 Normal completion
- 1 Verification-pattern mismatch
- 2 --
- 3 Partial completion

Program Exceptions:

- Access (fetch, operand 2, cryptographic key, and wrapping-key verification pattern; store, operand 1; fetch and store, chaining value)
- Operation (if the message-security-assist extension 4 is not installed)
- Specification

- Transaction constraint

1.-6.	Exceptions with the same priority as the priority of program-interruption conditions for the general case.
7.A	Access exceptions for second instruction halfword.
7.B	Operation exception.
7.C	Transaction constraint
8.	Specification exception due to invalid function code or invalid register number.
9.	Specification exception due to invalid operand length.
10.	Condition code 0 due to second-operand length originally zero.
11.A.1	Access exceptions for an access to the parameter block.
11.A.2.	Condition code 1 due to verification-pattern mismatch.
11.B	Access exceptions for an access to the first or second operand.
12.	Condition code 0 due to normal completion (second-operand length originally nonzero, but stepped to zero).
13.	Condition code 3 due to partial completion (second-operand length still nonzero).

Figure 7-190. Priority of Execution: KMO

Programming Notes:

1. The performance of the query function (code 0) may be significantly slower than that of simply examining a location in storage. If the program needs to frequently test for the availability of a function, it should perform the query function once during initialization; subsequently it should examine the stored results of the query function in memory with an instruction such as TEST UNDER MASK.
2. See the programming notes for CIPHER MESSAGE WITH CHAINING.
3. In earlier versions of the architecture, CIPHER MESSAGE WITH OUTPUT FEEDBACK was known as CIPHER MESSAGE WITH OFB.

4. As observed by this CPU, other CPUs, and the I/O subsystem, inconsistent results may be briefly stored in the first-operand location. See the section “Effects of CPU Retry” on page 11-3 for further details.

COMPARE

Register-and-register formats:

CR R₁,R₂ [RR]

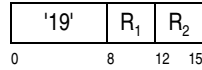

CGR R₁,R₂ [RRE]

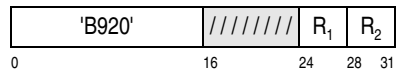

CGFR R₁,R₂ [RRE]

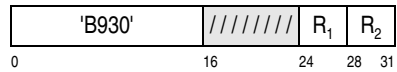

Register-and-storage formats:

C R₁,D₂(X₂,B₂) [RX-a]

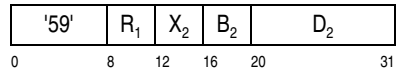

CY R₁,D₂(X₂,B₂) [RXY-a]

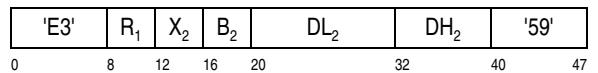

CG R₁,D₂(X₂,B₂) [RXY-a]

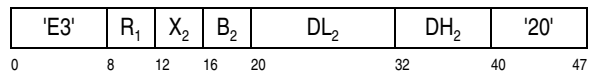

CGF R₁,D₂(X₂,B₂) [RXY-a]

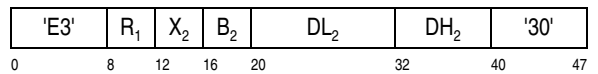

COMPARE IMMEDIATE

CFI R₁,I₂ [RIL-a]

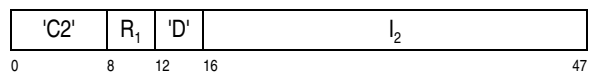

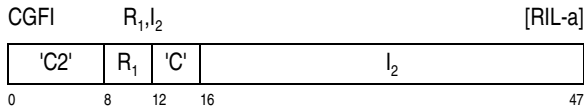

COMPARE RELATIVE LONG

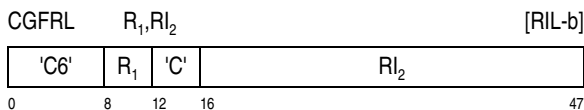
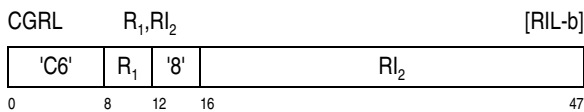
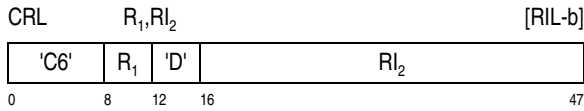

The first operand is compared with the second operand, and the result is indicated in the condition code.

For COMPARE (CR, C, CY), COMPARE IMMEDIATE (CFI), and COMPARE RELATIVE LONG (CRL), the operands are treated as 32-bit signed binary integers. For COMPARE (CGR, CG) and COMPARE RELATIVE LONG (CGRL), they are treated as 64-bit signed binary integers. For COMPARE (CGFR, CGF), COMPARE IMMEDIATE (CGFI), and COMPARE RELATIVE LONG (CGFRL), the second operand is treated as a 32-bit signed binary integer, and the first operand is treated as a 64-bit signed binary integer.

The displacement for COMPARE (C) is treated as a 12-bit unsigned binary integer. The displacement for COMPARE (CY, CG, and CGF) is treated as a 20-bit signed binary integer.

For COMPARE RELATIVE LONG, the contents of the R₂ field are a signed binary integer specifying the number of halfwords that is added to the address of the instruction to generate the address of the second operand in storage. When DAT is on, the second operand is accessed using the same addressing-space mode as that used to access the instruction. When DAT is off, the second operand is accessed using a real address.

For COMPARE RELATIVE LONG (CRL, CGFRL), the second operand must be aligned on a word

boundary, and for COMPARE RELATIVE LONG (CGRL), the second operand must be aligned on a doubleword boundary; otherwise, a specification exception is recognized.

Resulting Condition Code:

- 0 Operands equal
- 1 First operand low
- 2 First operand high
- 3 --

Program Exceptions:

- Access (operand 2 of C, CY, CG, CGF, CRL, CGRL, and CGFRL only)
- Operation (CY, if the long-displacement facility is not installed; CFI and CGFI, if the extended-immediate facility is not installed; CGFRL, CGRL, and CRL, if the general-instructions-extension facility is not installed)
- Specification (CGFRL, CGRL, and CRL only)

Programming Notes:

1. For COMPARE RELATIVE LONG, the second operand must be aligned on an integral boundary corresponding to the operand's size.
2. When COMPARE RELATIVE LONG is the target of an execute-type instruction, the second-operand address is relative to the target address.

COMPARE AND BRANCH

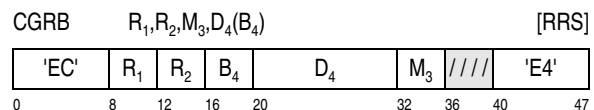
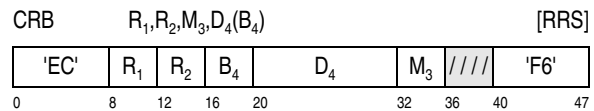

COMPARE AND BRANCH RELATIVE

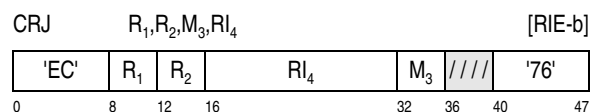

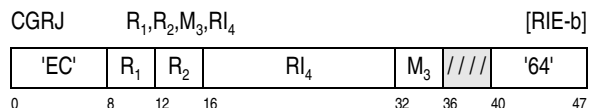

COMPARE IMMEDIATE AND BRANCH

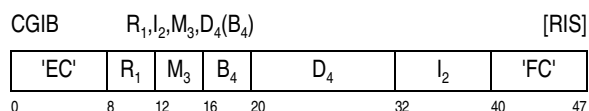
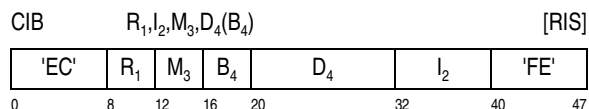

COMPARE IMMEDIATE AND BRANCH RELATIVE

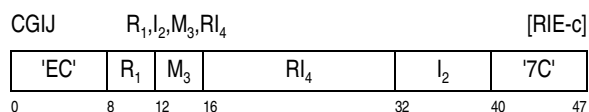
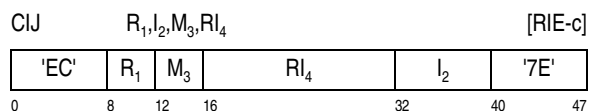

The first operand is compared with the second operand. If the mask bit in the M_3 field corresponding to the comparison result is one, the instruction address in the current PSW is replaced by the branch address specified by the fourth operand; otherwise, normal instruction sequencing proceeds with the updated instruction address.

For COMPARE AND BRANCH (CRB), COMPARE AND BRANCH RELATIVE (CRJ), COMPARE IMMEDIATE AND BRANCH (CIB) and COMPARE IMMEDIATE AND BRANCH RELATIVE (CIJ), the first operand is treated as a 32-bit signed binary integer. For COMPARE AND BRANCH (CGRB), COMPARE AND BRANCH RELATIVE (CGRJ), COMPARE IMMEDIATE AND BRANCH (CGIB) and COMPARE IMMEDIATE AND BRANCH RELATIVE (CGIJ), the first operand is treated as a 64-bit signed binary integer.

For COMPARE AND BRANCH (CRB) and COMPARE AND BRANCH RELATIVE (CRJ), the second operand is treated as a 32-bit signed binary integer. For COMPARE AND BRANCH (CGRB) and COMPARE AND BRANCH RELATIVE (CGRJ), the second operand is treated as a 64-bit signed binary integer. For COMPARE IMMEDIATE AND BRANCH and COMPARE IMMEDIATE AND BRANCH RELATIVE, the second operand is treated as an 8-bit signed binary integer.

The comparison results and corresponding M_3 bits are as follows:

Comparison Result	M_3 Bit
Equal	0
First operand low	1
First operand high	2

Bit 3 of the M_3 field is reserved and should be zero; otherwise, the program may not operate compatibly in the future.

For COMPARE AND BRANCH and COMPARE IMMEDIATE AND BRANCH, the fourth-operand address is used as the branch address. For COMPARE AND BRANCH RELATIVE and COMPARE IMMEDIATE AND BRANCH RELATIVE, the contents of the RI_4 field are a signed binary integer specifying the number of halfwords that is added to the address of the instruction to generate the branch address.

Condition Code: The code remains unchanged.

Program Exceptions:

- Operation (if the general-instructions-extension facility is not installed).
- Transaction constraint

Programming Notes:

1. When bit positions 0-2 of the M_3 field contain zeros, the instruction acts as a NOP, however this is not the preferred instruction with which to create a NOP. When bit positions 0-2 of the M_3 field contain 111 binary, a branch always occurs.
2. When COMPARE AND BRANCH RELATIVE or COMPARE IMMEDIATE AND BRANCH RELATIVE are the target of an execute-type instruction, the branch is relative to the target address. See "Branch-Address Generation" on page 5-12.

3. The high-level assembler (HLASM) provides extended-mnemonic formats for all of the multiple-operation instructions which perform a compare (arithmetic or logical) followed by a branch or trap. In the extended-mnemonic format, the mask field is not explicitly coded; rather the branch mask is implicitly indicated by the extended mnemonic.

The extended-mnemonic names are formed by concatenating the base mnemonic, followed by one of the suffix characters, as shown below.

Suffix Chars	Meaning	Mask Field
E	Equal	8
H	First operand high	2
L	First operand low	4
NE	Not equal	6
NH	First operand not high	12
NL	First operand not low	10

Consider the following example of a COMPARE IMMEDIATE AND BRANCH RELATIVE (CGIJ) instruction that is coded using an extended mnemonic:

```
CGIJNE 10,-123,SKIP
:
SKIP DS 0H (128 bytes past CGIJNE)
```

The implied mask field corresponding to the mnemonic suffix (NE) is 6, thus the generated code is ECA60040857C hex.

COMPARE AND FORM CODEWORD

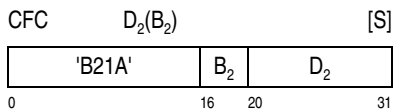

General register 2 contains an index, which is used along with contents of general registers 1 and 3 to designate the starting addresses of two fields in storage, called the first and third operands. The first and third operands are logically compared, and a codeword is formed in general register 2 for use in sort/merge algorithms.

The second-operand address is not used to address data. Bits 49-62 of the second-operand address, with

one rightmost and one leftmost zero appended, are used as a 16-bit index limit. Bit 63 of the second-operand address is the operand-control bit; the operand-control bit is applicable when the first and third operands are unequal. When bit 63 is zero, the codeword is formed from the one's complement of the high operand; when bit 63 is one, the codeword is formed from the low operand. The remainder of the second-operand address is ignored.

General registers 1 and 3 contain the base addresses of the first and third operands. Bits 48-63 of general register 2 are used as an index for addressing both the first and third operands. General registers 1, 2, and 3 must all initially contain even values; otherwise, a specification exception is recognized.

In the access-register mode, access register 1 specifies the address space containing the first and third operands.

The size of the units by which the first and third operands are compared, the size of the resulting codeword, and the participation of bits 0-31 of general registers 1, 2, and 3 in the operation depend on the addressing mode. In the 24-bit or 31-bit addressing mode, the comparison unit is two bytes, the codeword is four bytes, and bits 0-31 of the registers are ignored and remain unchanged. In the 64-bit addressing mode, the comparison unit is six bytes, the codeword is eight bytes, and bits 0-31 of the registers are used in and may be changed by the operation.

Operation in the 24-Bit or 31-Bit Addressing Mode

The operation consists in comparing the first and third operands halfword by halfword and incrementing the index until an unequal pair of halfwords is found or the index exceeds the index limit. This proceeds in units of operation, between which interruptions may occur.

At the start of a unit of operation, the index, bits 48-63 of general register 2, is logically compared with the index limit. If the index is larger, the instruction is completed by placing bits 32-63 of general register 3, with bit 32 set to one, in bit positions 32-63 of general register 2, and by setting condition code 0.

If the index is less than or equal to the index limit, the index is applied to the first-operand and third-operand

and base addresses to locate the current pair of halfwords to be compared. The index, with 48 leftmost zeros appended, and bits 32-63 of general register 1, with 32 leftmost zeros appended, are added to form a 64-bit intermediate value. A carry out of bit position 32, if any, is ignored. The address of the current first-operand halfword is generated from the intermediate value by following the normal rules for operand address generation. The address of the current third-operand halfword is formed in the same manner by adding bits 32-63 of general register 3 and the index.

The current first-operand and third-operand halfwords are logically compared. If they are equal, the contents of general register 2 are incremented by 2, and a unit of operation ends.

If the compare values are unequal, the contents of general register 2 are incremented by 2 and then shifted left logically by 16 bit positions. The shifting occurs only within bit positions 32-63. If the operand-control bit is zero, (1) the one's complement of the higher halfword is placed in bit positions 48-63 of general register 2, and (2) if operand 1 was higher, bits 32-63 of general registers 1 and 3 are interchanged. If the operand-control bit is one, (1) the lower halfword is placed in bit positions 48-63 of general register 2, and (2) if operand 1 was lower, bits 32-63 of general registers 1 and 3 are interchanged. Condition code 2 is set if general registers 1 and 3 are interchanged; otherwise, condition code 1 is set.

For the purpose of recognizing access exceptions, operand 1 and operand 3 are both considered to have a length equal to 2 more than the value of the index limit minus the index.

Operation in the 64-bit Addressing Mode

The operation consists in comparing the first and third operands in units of six bytes at a time and incrementing the index until an unequal pair of six-byte units is found or the index exceeds the index limit. This proceeds in units of operation, between which interruptions may occur.

At the start of a unit of operation, the index, bits 48-63 of general register 2, is logically compared with the index limit. If the index is larger, the instruction is completed by placing bits 0-63 of general register 3, with bit 0 set to one, in bit positions 0-63 of general register 2, and by setting condition code 0.

If the index is less than or equal to the index limit, the index is applied to the first-operand and third-operand base addresses to locate the current pair of six-byte units to be compared. The index, with 48 leftmost zeros appended, and bits 0-63 of general register 1 are added to form the 64-bit address of the current first-operand six-byte unit. A carry out of bit position 0, if any, is ignored. The address of the current third-operand six-byte unit is formed in the same manner by adding bits 0-63 of general register 3 and the index.

The current first-operand and third-operand six-byte units are logically compared. If they are equal, the contents of general register 2 are incremented by 6, and a unit of operation ends.

If the compare values are unequal, the contents of general register 2 are incremented by 6 and then shifted left logically by 48 bit positions. If the operand-control bit is zero, (1) the one's complement of the higher six-byte unit is placed in bit positions 16-63 of general register 2, and (2) if operand 1 was higher, bits 0-63 of general registers 1 and 3 are interchanged. If the operand-control bit is one, (1) the lower six-byte unit is placed in bit positions 16-63 of general register 2, and (2) if operand 1 was lower, bits 0-63 of general registers 1 and 3 are interchanged. Condition code 2 is set if general registers 1 and 3 are interchanged; otherwise, condition code 1 is set.

For the purpose of recognizing access exceptions, operand 1 and operand 3 are both considered to have a length equal to 6 more than the value of the index limit minus the index. However, depending on the model, access exceptions may or may not be recognized for the portion of a storage operand to the right of the first unequal byte when the operand is not needed to form the codeword in general register 2.

Specifications Independent of Addressing Mode

The condition code is unpredictable if the instruction is interrupted.

When the index is initially larger than the index limit, access exceptions are not recognized for the storage operands. For operands longer than 4K bytes, access exceptions are not recognized more than 4K bytes beyond the byte being processed. Access exceptions are not recognized when a specification-exception condition exists.

If the B_2 field designates general register 2, it is unpredictable whether or not the index limit is recomputed; thus, in this case the operand length is unpredictable. However, in no case can the operands exceed 2^{15} bytes in length.

Resulting Condition Code:

- 0 Operands equal
- 1 Operand-control bit zero and operand 1 low, or operand-control bit one and operand 3 low
- 2 Operand-control bit zero and operand 1 high, or operand-control bit one and operand 3 high
- 3 --

Program Exceptions:

- Access (fetch, operands 1 and 3)
- Specification
- Transaction constraint

Programming Notes:

1. An example of the use of COMPARE AND FORM CODEWORD is given in “Sorting Instructions” in Appendix A, “Number Representation and Instruction-Use Examples.”
2. The offset of the halfword or six-byte unit (depending on the addressing mode) of the first and third operands at which comparison is to begin should be placed in bit positions 48-63 of general register 2 before executing COMPARE AND FORM CODEWORD. The index limit derived from the second-operand address should be the offset of the last halfword or six-byte unit of the first and third operands for which comparison can be made. When the operands do not compare equal, the leftmost 16 bits of the codeword formed in general register 2 (bits 32-47 of the register in the 24-bit or 31-bit addressing mode, or bits 0-15 in the 64-bit addressing mode) by the execution of COMPARE AND FORM CODEWORD gives the offset of the first halfword or six-byte unit not compared. If the codewords compare equal in an UPDATE TREE operation, bit positions 32-47 of general register 2 in the 24-bit or 31-bit addressing mode, or bit positions 0-15 in the 64-bit addressing mode, will contain

the offset at which another COMPARE AND FORM CODEWORD should resume comparison for breaking codeword ties. Operand-control-bit values of zero or one are used for sorting operands in ascending or descending order, respectively. Refer to “Sorting Instructions” on page A-53 for a discussion of the use of codewords in sorting.

3. The condition code indicates the results of comparing operands up to 32,768 bytes long. Equal operands result in a negative codeword in bit positions 32-63 of general register 2 in the 24-bit or 31-bit addressing mode, or in bit positions 0-63 in the 64-bit addressing mode. A negative codeword also results in the 24-bit or 31-bit mode when the index limit is 32,766 and the operands that are compared differ in only their last two bytes, or in the 64-bit mode when the limit is 32,762 and the operands differ in only their last six bytes. If this latter codeword is used by UPDATE TREE, an incorrect result may be indicated in general registers 0 and 1. Therefore, the index limit should not exceed 32,764 in the 24-bit or 31-bit mode, or 32,760 in the 64-bit mode, when the resulting codeword is to be used by UPDATE TREE.
4. Special precautions should be taken if COMPARE AND FORM CODEWORD is made the target of an execute-type instruction. See the programming note concerning interruptible instructions under EXECUTE.
5. Further programming notes concerning interruptible instructions are included in “Interruptible Instructions” in Chapter 5, “Program Execution.”
6. The storage-operand references of COMPARE AND FORM CODEWORD may be multiple-access references. (See “Storage-Operand Consistency”.)
7. Figure 7-191 on page 7-139 and Figure 7-192 on page 7-140 contain summaries of the operation in the 24-bit or 31-bit addressing mode, and Figure 7-193 on page 7-141 and Figure 7-194 on page 7-142 contain summaries of the operation in the 64-bit addressing mode.

Operand-Control Bit	Relation	Resulting Condition Code	Result in GR2 (Bits 32-63)	Result in GR1 (Bits 32-63)	Result in GR3 (Bits 32-63)
0	op1 = op3	0	OGR3b1	–	–
0	op1 < op3	1	X, nop3	–	–
0	op1 > op3	2	X, nop1	OGR3	OGR1
1	op1 = op3	0	OGR3b1	–	–
1	op1 < op3	2	X, top1	OGR3	OGR1
1	op1 > op3	1	X, top3	–	–

Explanation:

– The bits remain unchanged.

OGR1 The original value of GR1 bits 32-63.

OGR3 The original value of GR3 bits 32-63.

OBR3b1 The original value of GR3 bits 32-63 with bit 32 set to one.

X Bits 32-47 of GR2 are 2 more than the index of the first unequal halfword.

nop1 Bits 48-63 of GR2 are the one's complement of the first unequal halfword in operand 1.

nop3 Bits 48-63 of GR2 are the one's complement of the first unequal halfword in operand 3.

top1 Bits 48-63 of GR2 are the first unequal halfword in operand 1.

top3 Bits 48-63 of GR2 are the first unequal halfword in operand 3.

Figure 7-191. Operation of COMPARE AND FORM CODEWORD in the 24-Bit or 31-bit Addressing Mode

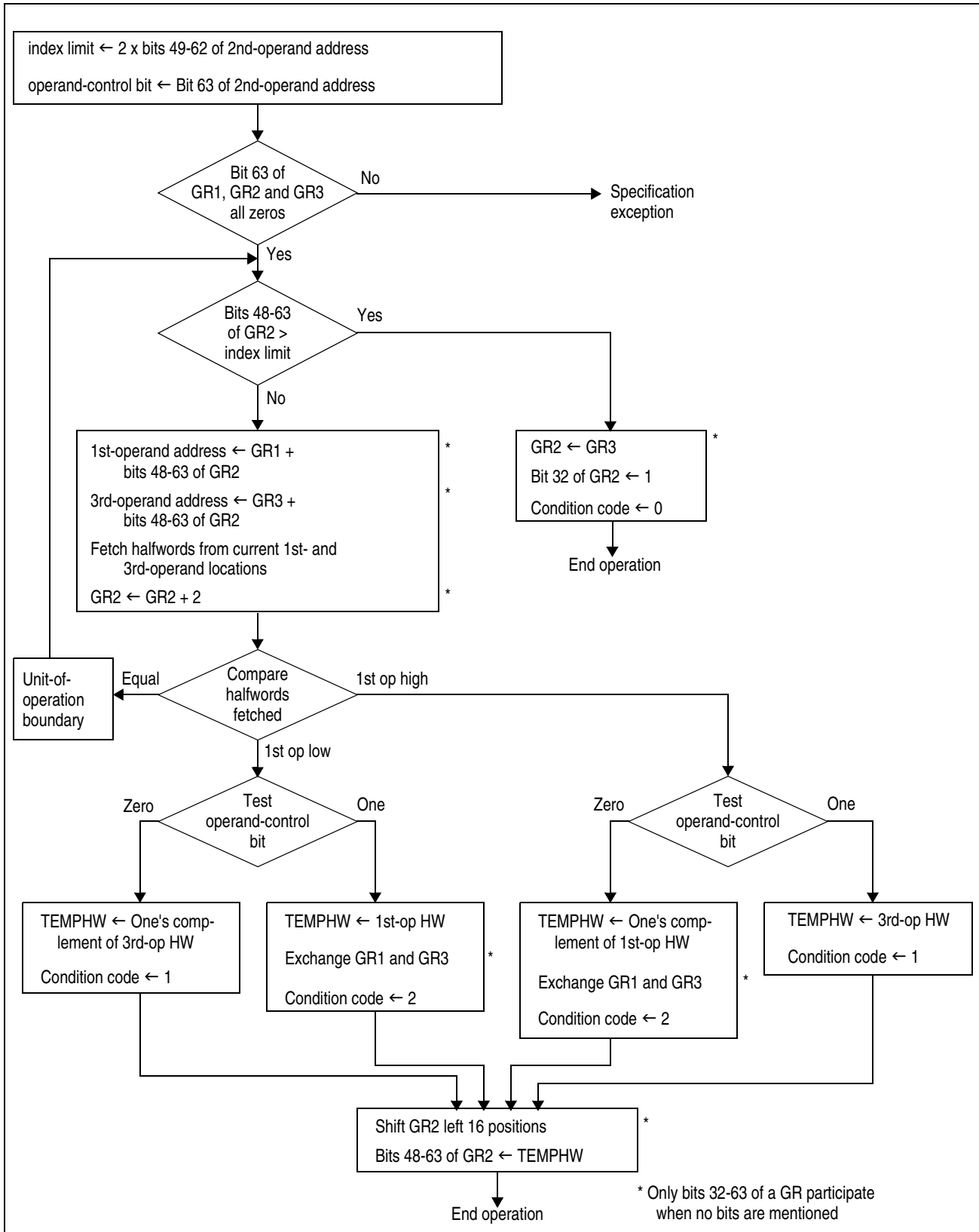

Figure 7-192. Execution of COMPARE AND FORM CODEWORD in the 24-bit or 31-bit Addressing Mode

Operand-Control Bit	Relation	Resulting Condition Code	Result in GR2 (Bits 0-63)	Result in GR1 (Bits 0-63)	Result in GR3 (Bits 0-63)
0	op1 = op3	0	OGR3b1	–	–
0	op1 < op3	1	X, nop3	–	–
0	op1 > op3	2	X, nop1	OGR3	OGR1
1	op1 = op3	0	OGR3b1	–	–
1	op1 < op3	2	X, top1	OGR3	OGR1
1	op1 > op3	1	X, top3	–	–

Explanation:

– The bits remain unchanged.
OGR1 The original value of GR1 bits 0-63.
OGR3 The original value of GR3 bits 0-63.
OBR3b1 The original value of GR3 bits 0-63 with bit 0 set to one.
X Bits 0-15 of GR2 are 6 more than the index of the first unequal six-byte unit.
nop1 Bits 16-63 of GR2 are the one's complement of the first unequal six-byte unit in operand 1.
nop3 Bits 16-63 of GR2 are the one's complement of the first unequal six-byte unit in operand 3.
top1 Bits 16-63 of GR2 are the first unequal six-byte unit in operand 1.
top3 Bits 16-63 of GR2 are the first unequal six-byte unit in operand 3.

Figure 7-193. Operation of COMPARE AND FORM CODEWORD in the 64-bit Addressing Mode

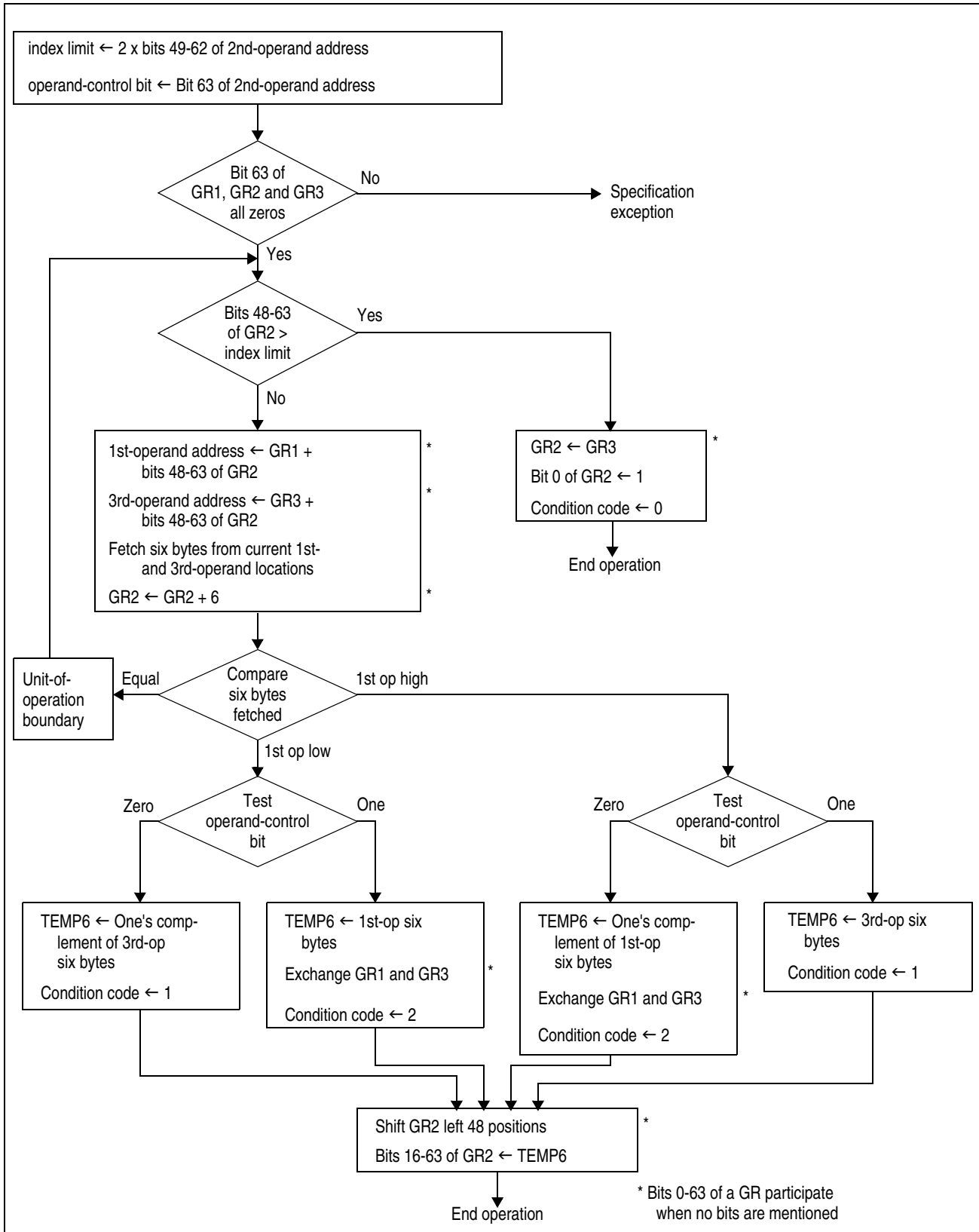
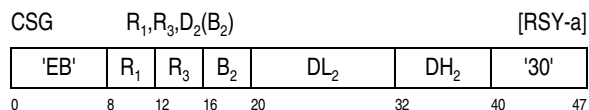
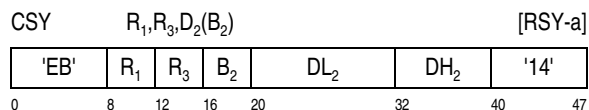
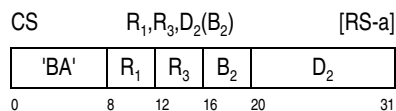
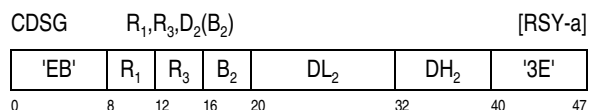
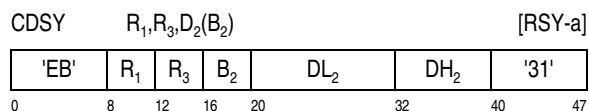
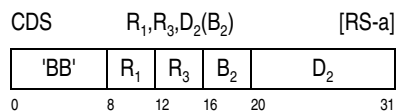

Figure 7-194. Execution of COMPARE AND FORM CODEWORD in the 64-bit Addressing Mode

COMPARE AND SWAP



COMPARE DOUBLE AND SWAP



The first and second operands are compared. If they are equal, the third operand is stored at the second-operand location. If they are unequal, the second operand is loaded into the first-operand location. The result of the comparison is indicated in the condition code.

For COMPARE AND SWAP (CS, CSY), the first and third operands are 32 bits in length, with each operand occupying bit positions 32-63 of a general register. The second operand is a word in storage.

For COMPARE AND SWAP (CSG), the first and third operands are 64 bits in length, with each operand occupying bit positions 0-63 of a general register. The second operand is a doubleword in storage.

For COMPARE DOUBLE AND SWAP (CDS, CDSY), the first and third operands are 64 bits in length. The first 32 bits of an operand occupy bit positions 32-63 of the even-numbered register of an even-odd pair of general registers, and the second 32 bits occupy bit positions 32-63 of the odd-numbered register of the pair. The second operand is a doubleword in storage.

For COMPARE DOUBLE AND SWAP (CDSG), the first and third operands are 128 bits in length. The first 64 bits of an operand occupy bit positions 0-63 of the even-numbered register of an even-odd pair of general registers, and the second 64 bits occupy bit positions 0-63 of the odd-numbered register of the pair. The second operand is a quadword in storage.

When an equal comparison occurs, the third operand is stored at the second-operand location. The fetch of the second operand for purposes of comparison and the store into the second-operand location appear to be a block-concurrent interlocked-update reference as observed by other CPUs.

When the result of the comparison is unequal, the second operand is loaded at the first-operand location, and the second-operand location remains unchanged. However, on some models, the contents may be fetched and subsequently stored back unchanged at the second-operand location. This update appears to be a block-concurrent interlocked-update reference as observed by other CPUs.

A serialization function is performed before the operand is fetched and again after the operation is completed.

The displacement for CS and CDS is treated as a 12-bit unsigned binary integer. The displacement for CSY, CSG, CDSY, and CDSG is treated as a 20-bit signed binary integer.

The second operand of COMPARE AND SWAP (CS, CSY) must be designated on a word boundary. The second operand of COMPARE AND SWAP (CSG) and COMPARE DOUBLE AND SWAP (CDS, CDSY) must be designated on a doubleword boundary. The second operand of COMPARE DOUBLE AND SWAP (CDSG) must be designated on a quadword boundary. The R_1 and R_3 fields for COMPARE DOUBLE AND SWAP must each designate an even-numbered register. Otherwise, a specification exception is recognized.

Resulting Condition Code:

- 0 First and second operands equal, second operand replaced by third operand
- 1 First and second operands unequal, first operand replaced by second operand
- 2 --
- 3 --

Program Exceptions:

- Access (fetch and store, operand 2)
- Operation (CSY and CDSY, if the long-displacement facility is not installed)
- Specification
- Transaction constraint

Programming Notes:

1. Several examples of the use of the COMPARE AND SWAP and COMPARE DOUBLE AND SWAP instructions are given in Appendix A, "Number Representation and Instruction-Use Examples."
2. Some of the following notes are worded, with respect to operand size, for CS, CSY, CDS, and CDSY. Similar notes, worded for a larger operand size, would apply to CSG and CDSG.
3. COMPARE AND SWAP can be used by CPU programs sharing common storage areas in either a multiprogramming or multiprocessing environment. Two examples are:
 - a. By performing the following procedure, a CPU program can modify the contents of a storage location even though the possibility exists that the CPU program may be interrupted by another CPU program that will update the location or that another CPU program may simultaneously update the location. First, the entire word containing the byte or bytes to be updated is loaded into a general register. Next, the updated value is computed and placed in another general register. Then COMPARE AND SWAP is executed with the R_1 field designating the register that contains the original value and the R_3 field designating the register that contains the updated value. If the update has been successful, condition code 0 is set. If the storage location no longer contains the original value, the update has not been successful, the general register designated by the R_1

field of the COMPARE AND SWAP instruction contains the new current value of the storage location, and condition code 1 is set. When condition code 1 is set, the CPU program can repeat the procedure using the new current value.

- b. COMPARE AND SWAP can be used for controlled sharing of a common storage area, including the capability of leaving a message (in a chained list of messages) when the common area is in use. To accomplish this, a word in storage can be used as a control word, with a zero value in the word indicating that the common area is not in use and that no messages exist, a negative value indicating that the area is in use and that no messages exist, and a nonzero positive value indicating that the common area is in use and that the value is the address of the most recent message added to the list. Thus, any number of CPU programs desiring to seize the area can use COMPARE AND SWAP to update the control word to indicate that the area is in use or to add messages to the list. The single CPU program which has seized the area can also safely use COMPARE AND SWAP to remove messages from the list.

4. COMPARE DOUBLE AND SWAP can be used in a manner similar to that described for COMPARE AND SWAP. In addition, it has another use. Consider a chained list, with a control word used to address the first message in the list, as described in programming note 3.b above. If multiple CPU programs are to be permitted to delete messages by using COMPARE AND SWAP (and not just the single CPU program which has seized the common area), there is a possibility the list will be incorrectly updated. This would occur if, for example, after one CPU program has fetched the address of the most recent message in order to remove the message, another CPU program removes the first two messages and then adds the first message back into the chain. The first CPU program, on continuing, cannot easily detect that the list is changed. By increasing the size of the control word to a doubleword containing both the first message address and a word with a change number that is incremented for each modification of the list, and by using COMPARE DOUBLE AND SWAP to update both fields together, the possibility of the list being

incorrectly updated is reduced to a negligible level. That is, an incorrect update can occur only if the first CPU program is delayed while changes exactly equal in number to a multiple of 2^{32} take place *and* only if the last change places the original message address in the control word.

5. To ensure successful updating of a common storage field by two or more CPUs, all updates must be done by means of an interlocked-update reference (the section "Interlocked-Update References" on page 5-124 lists the instructions that perform an interlocked-update reference). For example, in a configuration where the interlocked-access facility 2 is not installed, if one CPU executes OR IMMEDIATE and another CPU executes COMPARE AND SWAP to update the same byte, the fetch by OR IMMEDIATE may occur either before the fetch by COMPARE AND SWAP or between the fetch and the store by COMPARE AND SWAP, and then the store by OR IMMEDIATE may occur after the store by COMPARE AND SWAP, in which case the change made by COMPARE AND SWAP is lost.
6. For the case of a condition-code setting of 1, COMPARE AND SWAP and COMPARE DOUBLE AND SWAP may or may not, depending on the model, cause any of the following to occur for the second-operand location: a PER storage-alteration event may be recognized; a protection exception for storing may be recognized; and, provided no access exception exists, the change bit may be set to one. Because the contents of storage remain unchanged, the change bit may or may not be one when a PER storage-alteration event is recognized.
7. The performance of CDSG on some models may be significantly slower than that of CSG. When quadword consistency is not required by the program, alternate code sequences should be used.

COMPARE AND SWAP AND STORE

CSST $D_1(B_1), D_2(B_2), R_3$ [SSF]

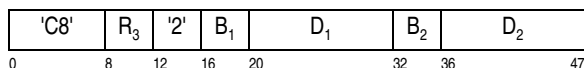

The first operand is compared with the third operand. If they are equal, the replacement value is stored into the first-operand location, and subsequently, the

store value is placed into the second-operand location. If they are not equal, then the first operand is loaded into the third-operand location, and the second operand is not changed. The result is indicated by the condition code.

The size of the first and third operands, the size of the replacement value, and the alignment of the first operand are determined by the contents of a function code (FC) in bits 56-63 of general register 0. The assigned function codes are as follows:

- When the function code is 0, the operands are 32 bits in length. The first operand is a word in storage, and the third operand is in bits 32-63 of general register R₃. The replacement value is in bytes 0-3 of the parameter list.
- When the function code is 1, the operands are 64 bits in length. The first operand is a doubleword in storage, and the third operand is in bits 0-63 of general register R₃. The replacement value is bytes 0-7 of the parameter list.
- When the function code is 2 and the compare-and-swap-and-store facility 2 is installed, the operands are 128 bits in length. The first operand is a quadword in storage, and the third operand is in bits 0-63 of general registers R₃ and R₃ + 1. The replacement value is in bytes 0-15 of the parameter list.

The size of the store value and the alignment of the second operand are determined by a store characteristic (SC) in bits 48-55 of general register 0. The store characteristic is expressed as a power of two; the assigned store characteristics are 0, 1, 2, and 3. An SC of 0 means that one byte is stored on a byte boundary; an SC of 1 means that two bytes are stored on a halfword boundary, an SC of 2 means that four bytes are stored on a word boundary, and an SC of 3 means that eight bytes are stored on a doubleword boundary. When the CSST facility 2 is installed, an SC of 4 is also assigned; an SC of 4 means that sixteen bytes are stored on a quadword boundary. The store value begins at byte 16 of the parameter list.

Bits 0-31 of general register 0 are ignored. Bits 32-47 of general register 0 and bits 60-63 of general register 1 are reserved and should contain zeros; otherwise, the program may not operate compatibly in the future.

General register 1 contains the logical address of a parameter list that contains the replacement value and the store value. The parameter list is on a quad-word boundary. In the access-register mode, access register 1 specifies the address space containing the parameter list.

The handling of the parameter-list address is dependent on the addressing mode. In the 24-bit addressing mode, the contents of bit positions 40-59 of general register 1, with four zeros appended to the

right, constitute the address, and bit positions 0-39 are ignored. In the 31-bit addressing mode, the contents of bit positions 33-59 of the register, with four zeros appended to the right, constitute the address, and bit positions 0-32 are ignored. In the 64-bit addressing mode, the contents of bit positions 0-59 of the register, with four zeros appended to the right, constitute the address.

Figure 7-195 illustrates contents of the registers and parameter list just described.

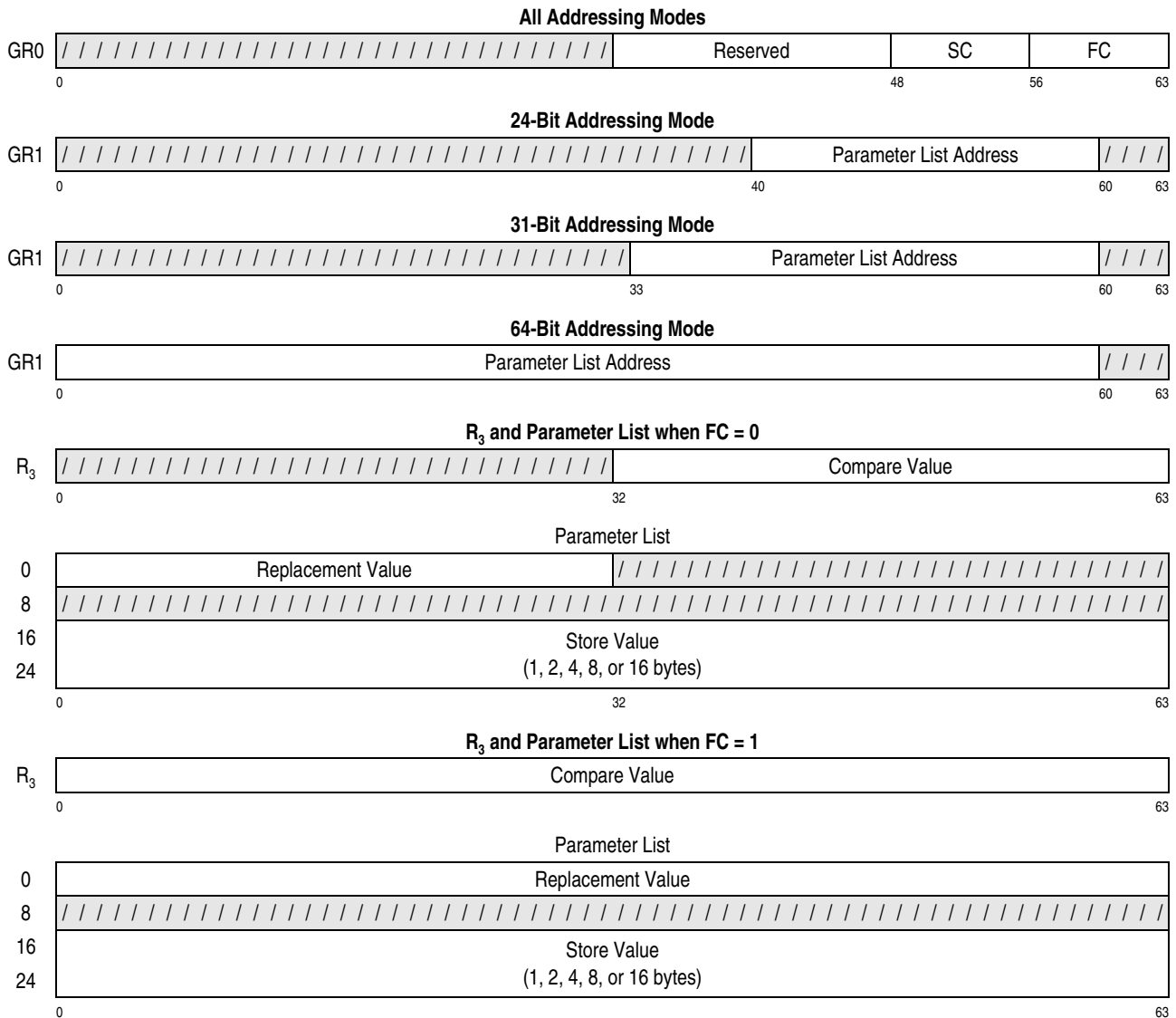

Figure 7-195. Register Contents for COMPARE AND SWAP AND STORE

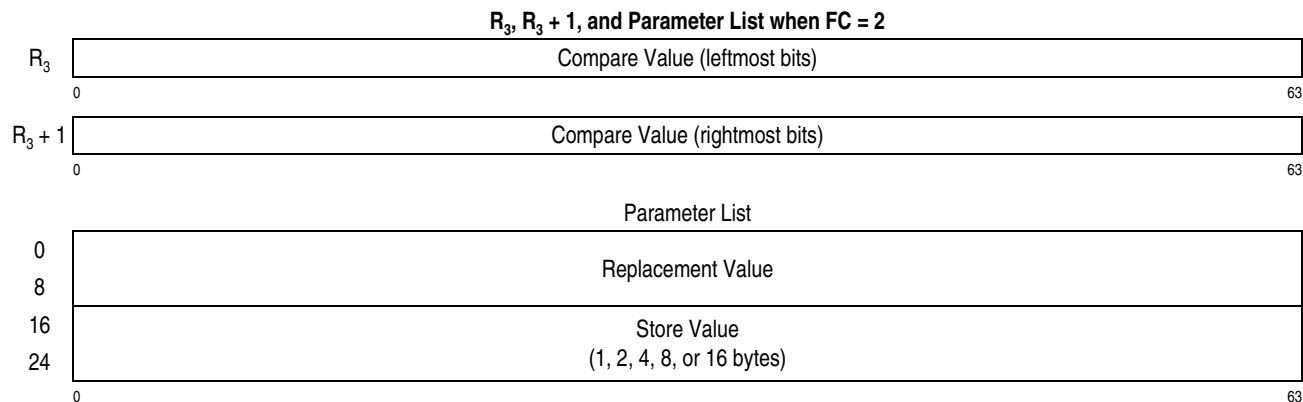

Figure 7-195. Register Contents for COMPARE AND SWAP AND STORE

When an equal comparison occurs, the replacement value is stored at the first-operand location, and the store value is stored at the second-operand location. The fetch of the first operand for purposes of comparison, and the store of the replacement value into the first-operand location, both appear to be a block-concurrent interlocked-update reference as observed by other CPUs. The store of the store value appears to be block-concurrent as observed by other CPUs.

When the result of the comparison is unequal, the first operand is loaded into the third-operand location, and the first operand remains unchanged. However, on some models, the contents of the first operand may be fetched and subsequently stored back unchanged at the first-operand location. This update appears to be a block-concurrent interlocked-update reference as observed by other CPUs.

As observed by this CPU and by other CPUs, all fetches appear to occur before all stores, and the store into the first operand appears to occur before the store into the second operand. Access-exception conditions are recognized for the entire 32-byte parameter list and for the second operand, regardless of whether the first and third operands are or are not equal. For the second operand, PER storage-alteration and zero-address-detection events are recognized, and a change bit is set, only if a store occurs.

A serialization function is performed before the operation begins and again after the operation is completed.

Special Conditions

A specification exception is recognized for any of the following conditions:

- The function code specifies an unassigned value.
- The store characteristic specifies an unassigned value.
- The function code is 0, and the first operand is not designated on a word boundary.
- The function code is 1, and the first operand is not designated on a doubleword boundary.
- The function code is 2, and any of the following is true:
 - The compare-and-swap-and-store facility 2 is not installed.
 - The first operand is not designated on a quadword boundary.
 - The R_3 field does not designate the even-numbered register of an even-odd register pair.
- The second operand is not designated on an integral boundary corresponding to the size of the store value.

For all of the above conditions, and for all addressing and protection exceptions, the operation is suppressed.

Resulting Condition Code:

- 0 First and third operands equal; first operand replaced by replacement value, and second operand replaced by store value
- 1 First and third operands unequal; third operand replaced by first operand
- 2 --
- 3 --

Program Exceptions:

- Access (fetch, parameter list; fetch and store, operand 1; store, operand 2)
- Operation (if the compare-and-swap-and-store facility is not installed)
- Specification
- Transaction constraint

Programming Notes:

1. COMPARE AND SWAP AND STORE may be used in conjunction with other COMPARE AND SWAP or COMPARE DOUBLE AND SWAP instructions to manipulate locks, queue pointers, or other fields that require interlocked updates.
2. COMPARE AND SWAP AND STORE should not be used to manipulate fields that are also manipulated by PERFORM LOCKED OPERATION.
3. The store value is intended to provide a separate “footprint” of the interlocked-update operation in a location apart from the first operand in a single unit of operation.
4. The performance of COMPARE AND SWAP AND STORE may be significantly slower than the that of separate COMPARE AND SWAP, BRANCH ON CONDITION, and STORE instructions.
5. COMPARE AND SWAP AND STORE should only be used when an interruption between the compare-and-swap operation and the store operation cannot be tolerated, and other means of disabling for interruptions are not practical.

COMPARE AND TRAP

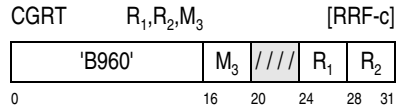
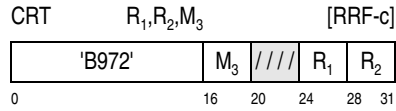

COMPARE IMMEDIATE AND TRAP

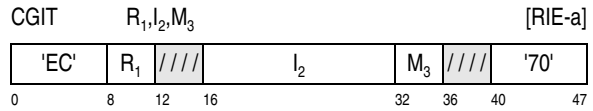
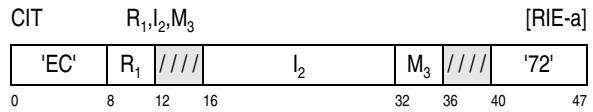

The first operand is compared with the second operand. If the mask bit in the M_3 field corresponding to the comparison result is one, a compare-and-trap-instruction data exception is recognized, and the operation is completed; otherwise, normal instruction sequencing proceeds with the updated instruction address.

The comparison results and corresponding M_3 bits are as follows:

Comparison Result	M_3 Bit
Equal	0
First operand low	1
First operand high	2

Bit 3 of the M_3 field is reserved and should be zero; otherwise, the program may not operate compatibly in the future.

For COMPARE AND TRAP (CRT) and COMPARE IMMEDIATE AND TRAP (CIT), the first operand is treated as a 32-bit signed binary integer. For COMPARE AND TRAP (CGRT) and COMPARE IMMEDIATE AND TRAP (CGIT), the first operand is treated as a 64-bit signed binary integer.

For COMPARE IMMEDIATE AND TRAP, the second operand is treated as a 16-bit signed binary integer.

For COMPARE AND TRAP (CRT), the second operand is treated as a 32-bit signed binary integer. For COMPARE AND TRAP (CGRT), the second operand is treated as a 64-bit signed binary integer.

Condition Code: The code remains unchanged.

Program Exceptions:

- Data
- Operation (if the general-instructions-extension facility is not installed)

Programming Notes:

1. Possible uses of COMPARE AND TRAP and COMPARE IMMEDIATE AND TRAP include checking for pointers containing zero (null pointer), or array range checking.
2. On most models, when a data exception is not recognized, the performance of COMPARE AND TRAP and COMPARE IMMEDIATE AND TRAP is typically similar to other COMPARE instructions. When a data exception is recognized, the instruction may be significantly slower than an equivalent COMPARE instruction followed by a BRANCH ON CONDITION instruction.
3. When bit positions 0-2 of the M_3 field contain zeros, the instruction acts as a NOP, however this is not the preferred instruction with which to create a NOP. When bit positions 0-2 of the M_3 field contain 111 binary, a data exception is always recognized.
4. When a data exception is recognized, the compare-and-trap data-exception code (DXC FF hex) is stored, as described in “Data Exception” on page 6-25.
5. The discussion of extended mnemonics in programming note 3 for COMPARE AND BRANCH on page 7-136 also applies to the compare-and-trap instructions.

COMPARE HALFWORD

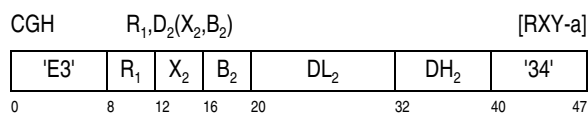
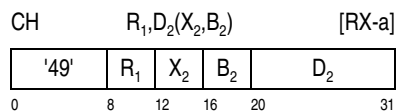

COMPARE HALFWORD IMMEDIATE

Register-and-immediate formats:

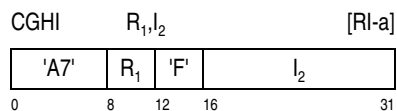
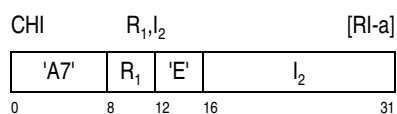

Storage-and-immediate formats:

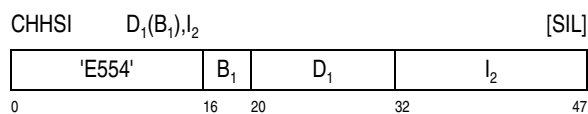

COMPARE HALFWORD RELATIVE LONG

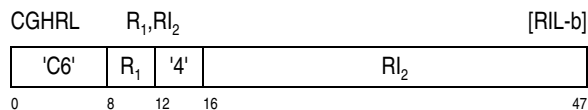
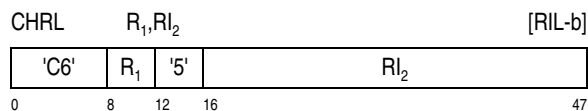

The first operand is compared with the second operand, and the result is indicated in the condition code. The second operand is two bytes in length and is treated as a 16-bit signed binary integer.

For COMPARE HALFWORD IMMEDIATE (CHHSI), the first operand is treated as a 16-bit signed binary integer. For COMPARE HALFWORD (CH, CHY), COMPARE HALFWORD IMMEDIATE (CHI and CHSI), and COMPARE HALFWORD RELATIVE LONG (CHRL), the first operand is treated as a 32-bit signed binary integer. For COMPARE HALFWORD (CGH), COMPARE HALFWORD IMMEDIATE (CGHI and CGHSI), and COMPARE HALFWORD RELATIVE LONG (CGHRL), the first operand is treated as a 64-bit signed binary integer.

The displacement for COMPARE HALFWORD (CH) and for COMPARE HALFWORD IMMEDIATE (CGHSI, CHHSI, CHSI) is treated as a 12-bit unsigned binary integer. The displacement for COMPARE HALFWORD (CHY, CGH) is treated as a 20-bit signed binary integer.

For COMPARE HALFWORD RELATIVE LONG, the contents of the RI_2 field are a signed binary integer specifying the number of halfwords that is added to the address of the instruction to generate the address of the second operand in storage. When DAT is on, the second operand is accessed using the same addressing-space mode as that used to access the instruction. When DAT is off, the second operand is accessed using a real address.

Resulting Condition Code:

- 0 Operands equal
- 1 First operand low
- 2 First operand high
- 3 --

Program Exceptions:

- Access (fetch, operand 1 of CGHSI, CHHSI, and CHSI only; fetch, operand 2 of CGH, CGHRL, CH, CHRL, CHY only)
- Operation (CHY, if the long-displacement facility is not installed; CGH, CHRL, CGHRL, CGHSI, CHHSI, and CHSI, if the general-instructions-extension facility is not installed)

Programming Notes:

1. An example of the use of the COMPARE HALFWORD instruction is given in Appendix A, "Number Representation and Instruction-Use Examples."
2. For COMPARE HALFWORD RELATIVE LONG, the second operand is necessarily aligned on an integral boundary corresponding to the operand's size.
3. When COMPARE HALFWORD RELATIVE LONG is the target of an execute-type instruction, the second-operand address is relative to the target address.

COMPARE HIGH

Register-and-register formats:

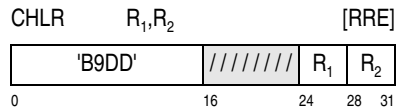
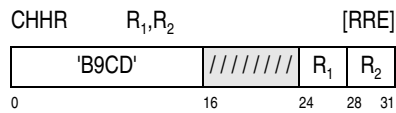

Register-and-storage format:

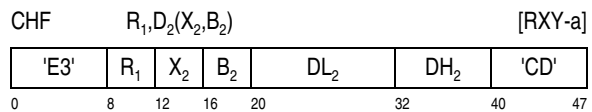

COMPARE IMMEDIATE HIGH

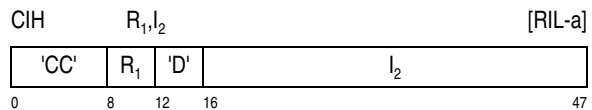

The first operand is compared with the second operand, and the result is indicated in the condition code.

The operands are treated as 32-bit signed binary integers. The first operand is in bit positions 0-31 of general register R_1 ; bit positions 32-63 of the register are ignored. For COMPARE HIGH (CHHR), the second operand is in bit positions 0-31 of general register R_2 ; bit positions 32-63 of the register are ignored.

For COMPARE HIGH (CHLR), the second operand is in bit positions 32-63 of general register R₂; bit positions 0-31 of the register are ignored.

The displacement for CHF is treated as a 20-bit signed binary integer.

Resulting Condition Code:

- 0 Operands equal
- 1 First operand low
- 2 First operand high
- 3 --

Program Exceptions:

- Access (operand 2 of CHF only)
- Operation (if the high-word facility is not installed)

COMPARE LOGICAL

Register-and-register formats:

CLR R₁,R₂ [RR]

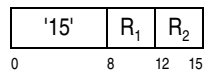

CLGR R₁,R₂ [RRE]

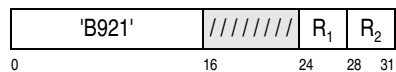

CLGFR R₁,R₂ [RRE]

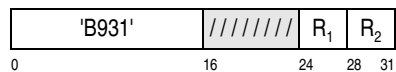

Register-and-storage formats:

CL R₁,D₂(X₂,B₂) [RX-a]

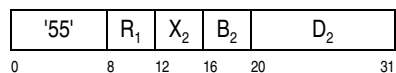

CLY R₁,D₂(X₂,B₂) [RXY-a]

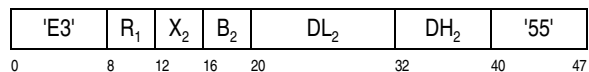

CLG R₁,D₂(X₂,B₂) [RXY-a]

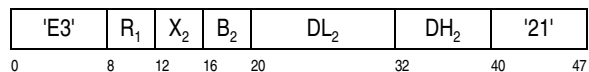

CLGF R₁,D₂(X₂,B₂) [RXY-a]

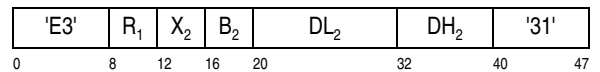

Storage-and-storage format:

CLC D₁(L,B₁),D₂(B₂) [SS-a]

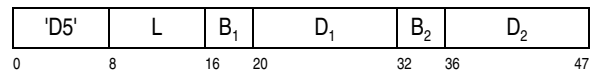

COMPARE LOGICAL IMMEDIATE

Register-and-immediate formats:

CLFI R₁,I₂ [RIL-a]

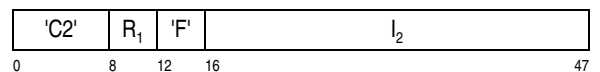

CLGFI R₁,I₂ [RIL-a]

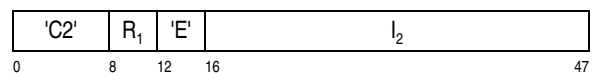

Storage-and-immediate formats:

CLI D₁(B₁),I₂ [SI]

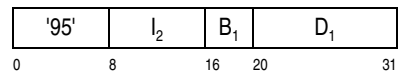

CLIIY D₁(B₁),I₂ [SIY]

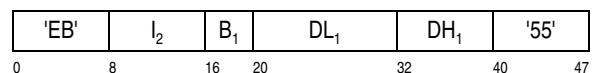

CLFHSI D₁(B₁),I₂ [SIL]

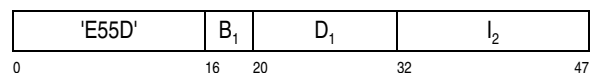

CLGHSI D₁(B₁),I₂ [SIL]

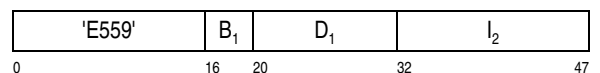

CLHHSI D₁(B₁),I₂ [SIL]

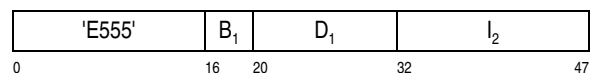

COMPARE LOGICAL RELATIVE LONG

CLRL R_1, R_2 [RIL-b]

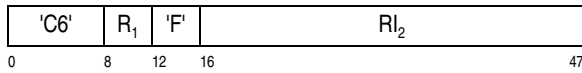

CLGRL R_1, R_2 [RIL-b]

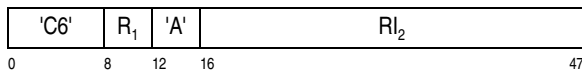

CLGFRL R_1, R_2 [RIL-b]

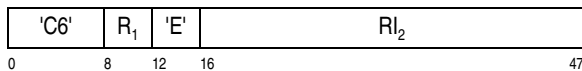

CLHRL R_1, R_2 [RIL-b]

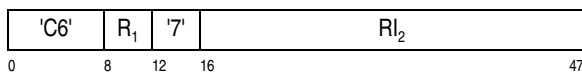

CLGHRL R_1, R_2 [RIL-b]

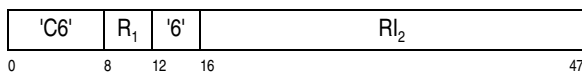

The first operand is compared with the second operand, and the result is indicated in the condition code.

The lengths of the operands are as follows:

- For COMPARE LOGICAL (CLR, CL, CLY), COMPARE LOGICAL IMMEDIATE (CLFI), and COMPARE LOGICAL RELATIVE LONG (CLRL), the operands are treated as 32 bits.
- For COMPARE LOGICAL (CLGR, CLG) and COMPARE LOGICAL RELATIVE LONG (CLGRL), the operands are treated as 64 bits.
- For COMPARE LOGICAL (CLGFR, CLGF), COMPARE LOGICAL IMMEDIATE (CLGFI), and COMPARE LOGICAL RELATIVE LONG (CLGFRL), the first operand is treated as 64 bits, and the second operand is treated as 32 bits with 32 zeros appended on the left.
- For COMPARE LOGICAL IMMEDIATE (CLHHSI), the operands are treated as 16 bits.
- For COMPARE LOGICAL IMMEDIATE (CLFHHSI) and COMPARE LOGICAL RELATIVE LONG (CLHRL), the first operand is treated as 32 bits,

and the second operand is treated as 16 bits with 16 zeros appended on the left.

- For COMPARE LOGICAL IMMEDIATE (CLGHSI) and COMPARE LOGICAL RELATIVE LONG (CLGHRL), the first operand is treated as 64 bits, and the second operand is treated as 16 bits with 48 zeros appended on the left.
- For COMPARE LOGICAL IMMEDIATE (CLI, CLIY), the operands are treated as 8 bits.
- For COMPARE LOGICAL (CLC), the first and second operands have the same length, in the range of one to 256 bytes.

The comparison proceeds left to right, byte by byte, and ends as soon as an inequality is found or the end of the fields is reached. For COMPARE LOGICAL (CL, CLY, CLG, CLGF, CLC), COMPARE LOGICAL IMMEDIATE (CLFHHSI, CLGHSI, CLHHSI) and COMPARE LOGICAL RELATIVE LONG, access exceptions may or may not be recognized for the portion of a storage operand to the right of the first unequal byte.

The displacements for CL, CLI, CLFHHSI, CLGHSI, CLHHSI, and both operands of CLC are treated as 12-bit unsigned binary integers. The displacement for CLY, CLG, CLGF, and CLIY is treated as a 20-bit signed binary integer.

For COMPARE LOGICAL RELATIVE LONG, the contents of the R_2 field are a signed binary integer specifying the number of halfwords that is added to the address of the instruction to generate the address of the second operand in storage. When DAT is on, the second operand is accessed using the same addressing-space mode as that used to access the instruction. When DAT is off, the second operand is accessed using a real address.

For COMPARE LOGICAL RELATIVE LONG (CLRL, CLGFRL), the second operand must be aligned on a word boundary, and for COMPARE LOGICAL RELATIVE LONG (CLGRL), the second operand must be aligned on a doubleword boundary; otherwise, a specification exception is recognized.

Resulting Condition Code:

- | | |
|---|--------------------|
| 0 | Operands equal |
| 1 | First operand low |
| 2 | First operand high |
| 3 | -- |

Program Exceptions:

- Access (fetch, operand 2, CL, CLC, CLG, CLGF, CLGFRL, CLGHRL, CLGRL, CLHRL, CLRL, and CLY; fetch, operand 1, CLC, CLFHSI, CLGHSI, CLHHSI, CLI, and CLIY)
- Operation (CLY and CLIY, if the long-displacement facility is not installed; CLFI and CLGFI, if the extended-immediate facility is not installed; CLFHSI, CLGFRL, CLGHSI, CLGHRL, CLGRL, CLHHSI, CLHRL, and CLRL, if the general-instructions-extension facility is not installed)
- Specification (CLRL, CLGFRL, CLGRL)
- Transaction constraint (CLC)

Programming Notes:

1. Examples of the use of the COMPARE LOGICAL instruction are given in Appendix A, “Number Representation and Instruction-Use Examples.”
2. COMPARE LOGICAL treats all bits of each operand alike as part of a field of unstructured logical data. For COMPARE LOGICAL (CLC), the comparison may extend to field lengths of 256 bytes.
3. For COMPARE LOGICAL RELATIVE LONG, the second operand must be aligned on an integral boundary corresponding to the operand’s size.
4. When COMPARE LOGICAL RELATIVE LONG is the target of an execute-type instruction, the second-operand address is relative to the target address.

COMPARE LOGICAL AND BRANCH

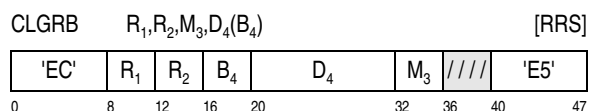
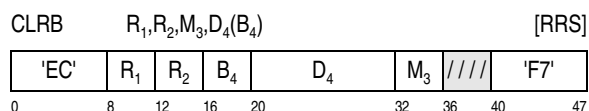

COMPARE LOGICAL AND BRANCH RELATIVE

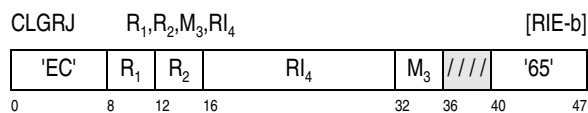
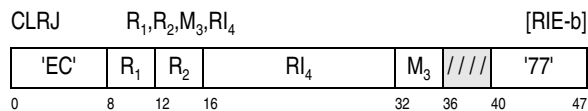

COMPARE LOGICAL IMMEDIATE AND BRANCH

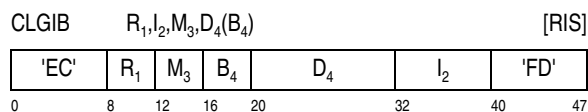
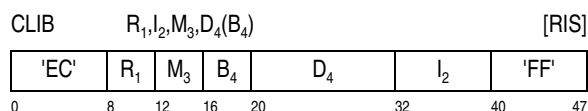

COMPARE LOGICAL IMMEDIATE AND BRANCH RELATIVE

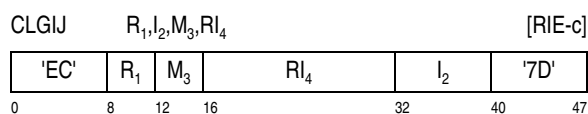
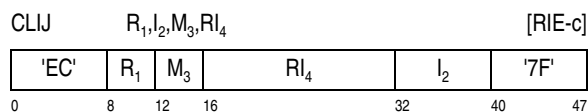

The first operand is compared with the second operand. If the mask bit in the M₃ field corresponding to the comparison result is one, the instruction address in the current PSW is replaced by the branch address specified by the fourth operand; otherwise, normal instruction sequencing proceeds with the updated instruction address.

For COMPARE LOGICAL AND BRANCH (CLRB), COMPARE LOGICAL AND BRANCH RELATIVE (CLRJ), COMPARE LOGICAL IMMEDIATE AND BRANCH (CLIB), and COMPARE LOGICAL IMMEDIATE AND BRANCH RELATIVE (CLIJ), the first

operand is treated as a 32-bit unsigned binary integer. For COMPARE LOGICAL AND BRANCH (CLGRB), COMPARE LOGICAL AND BRANCH RELATIVE (CLGRJ), COMPARE LOGICAL IMMEDIATE AND BRANCH (CLGIB), and COMPARE LOGICAL IMMEDIATE AND BRANCH RELATIVE (CLGIJ), the first operand is treated as a 64-bit unsigned binary integer.

For COMPARE LOGICAL AND BRANCH (CLRB) and COMPARE LOGICAL AND BRANCH RELATIVE (CLRJ), the second operand is treated as a 32-bit unsigned binary integer. For COMPARE LOGICAL AND BRANCH (CLGRB) and COMPARE LOGICAL AND BRANCH RELATIVE (CLGRJ), the second operand is treated as a 64-bit unsigned binary integer. For COMPARE LOGICAL IMMEDIATE AND BRANCH and COMPARE LOGICAL IMMEDIATE AND BRANCH RELATIVE, the second operand is treated as an 8-bit unsigned binary integer. When the size of the second operand is smaller than the size of the first operand, the second operand is extended on the left with zeros to match the size of the first operand.

The comparison results and corresponding M_3 bits are as follows:

Comparison Result	M_3 Bit
Equal	0
First operand low	1
First operand high	2

Bit 3 of the M_3 field is reserved and should be zero; otherwise, the program may not operate compatibly in the future.

For COMPARE LOGICAL AND BRANCH and COMPARE LOGICAL IMMEDIATE AND BRANCH, the fourth operand is used as the branch address. For COMPARE LOGICAL AND BRANCH RELATIVE and COMPARE LOGICAL IMMEDIATE AND BRANCH RELATIVE, the contents of the R_4 field are a signed binary integer specifying the number of halfwords that is added to the address of the instruction to generate the branch address.

Condition Code: The code remains unchanged.

Program Exceptions:

- Operation (if the general-instructions-extension facility is not installed).
- Transaction constraint

Programming Notes:

1. When bit positions 0-2 of the M_3 field contain zeros, the instruction acts as a NOP, however this is not the preferred instruction with which to create a NOP. When bit positions 0-2 of the M_3 field contain 111 binary, a branch always occurs.
2. When COMPARE LOGICAL AND BRANCH RELATIVE or COMPARE LOGICAL IMMEDIATE AND BRANCH RELATIVE are the target of an execute-type instruction, the branch is relative to the target address. See “Branch-Address Generation” on page 5-12.
3. The discussion of extended mnemonics in programming note 3 for COMPARE AND BRANCH on page 7-136 also applies to the compare-logical-and-branch instructions.

COMPARE LOGICAL AND TRAP

Register-and-register formats:

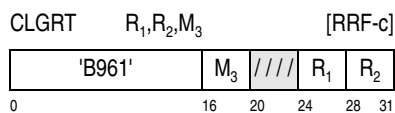
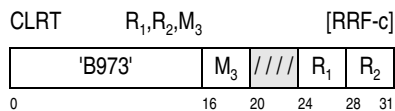

Register-and-storage formats:

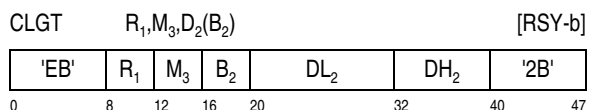

COMPARE LOGICAL IMMEDIATE AND TRAP

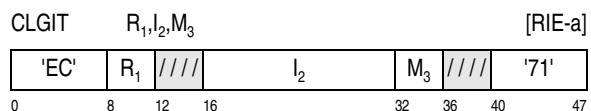
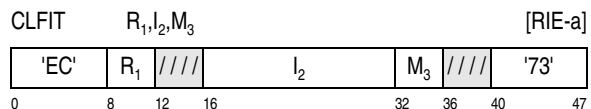

The first operand is compared with the second operand. If the mask bit in the M_3 field corresponding to the comparison result is one, a compare-and-trap-instruction data exception is recognized, and the operation is completed; otherwise, normal instruction sequencing proceeds with the updated instruction address.

The comparison results and corresponding M_3 bits are as follows:

Comparison Result	M_3 Bit
Equal	0
First operand low	1
First operand high	2

Bit 3 of the M_3 field is reserved and should be zero; otherwise, the program may not operate compatibly in the future.

For COMPARE LOGICAL AND TRAP (CLRT, CLT) and COMPARE LOGICAL IMMEDIATE AND TRAP (CLFIT), the first operand is treated as a 32-bit unsigned binary integer. For COMPARE LOGICAL AND TRAP (CLGRT, CLGT) and COMPARE LOGICAL IMMEDIATE AND TRAP (CLGIT), the first operand is treated as a 64-bit unsigned binary integer.

For COMPARE LOGICAL IMMEDIATE AND TRAP, the second operand is treated as a 16-bit unsigned binary integer. For COMPARE LOGICAL AND TRAP (CLRT, CLT), the second operand is treated as a 32-bit unsigned binary integer. For COMPARE LOGICAL AND TRAP (CLGRT, CLGT), the second operand is treated as a 64-bit unsigned binary integer. When the size of the second operand is smaller than the size of the first operand, the second operand is extended on the left with zeros to match the size of the first operand.

For COMPARE LOGICAL AND TRAP (CLT, CLGT), when bit positions 0-2 of the M_3 field contain either 000 or 111 binary, it is model dependent whether an access exception is recognized for the second operand and location; if accessible, it is model dependent whether a PER zero-address-detection event is recognized for the location.

Condition Code: The code remains unchanged.

Program Exceptions:

- Access (fetch, operand 2, CLT, CLGT)
- Data
- Operation (CLRT, CLGRT, CLFIT, CLGIT, if the general-instructions-extension facility is not installed; CLT, CLGT if the miscellaneous-instruction-extensions facility 1 is not installed)

Programming Notes:

1. Possible uses of COMPARE LOGICAL AND TRAP and COMPARE LOGICAL IMMEDIATE AND TRAP include checking for pointers containing zero (null pointer), or array range checking.
2. On most models, when a data exception is not recognized, the performance of COMPARE LOGICAL AND TRAP and COMPARE LOGICAL IMMEDIATE AND TRAP is typically similar to other COMPARE LOGICAL instructions. When a data exception is recognized, the instruction may be significantly slower than an equivalent COMPARE LOGICAL instruction followed by a BRANCH ON CONDITION instruction.
3. For CLFIT, CLGIT, CLGRT, and CLRT, when bit positions 0-2 of the M_3 field contain zeros, the instruction acts as a NOP, however this is not the preferred instruction with which to create a NOP. This NOP characteristic may not apply to CLGT and CLT.

When bit positions 0-2 of the M_3 field contain 111 binary, a data exception is always recognized.

4. When a data exception is recognized, the compare-and-trap data-exception code (DXC FF hex) is stored, as described in "Data Exception" on page 6-25.
5. The discussion of extended mnemonics in programming note 3 for COMPARE AND BRANCH

on page 7-136 also applies to the compare-logical-and-trap instructions.

COMPARE LOGICAL CHARACTERS UNDER MASK

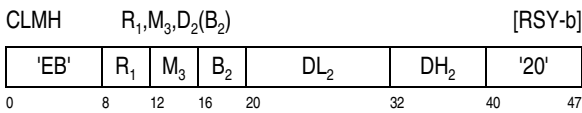
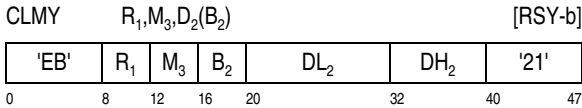
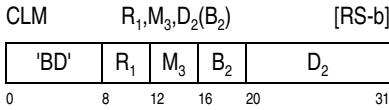

The first operand is compared with the second operand under control of a mask, and the result is indicated in the condition code.

The contents of the M_3 field are used as a mask. These four bits, left to right, correspond one for one with four bytes, left to right, of general register R_1 . For COMPARE LOGICAL CHARACTERS UNDER MASK (CLM, CLMY), the four bytes to which the mask bits correspond are in bit positions 32-63 of general register R_1 . For COMPARE LOGICAL CHARACTERS UNDER MASK (CLMH), the four bytes are in the high-order half, bit positions 0-31, of the register. The byte positions corresponding to ones in the mask are considered as a contiguous field and are compared with the second operand. The second operand is a contiguous field in storage, starting at the second-operand address and equal in length to the number of ones in the mask. The bytes in the general register corresponding to zeros in the mask do not participate in the operation.

The comparison proceeds left to right, byte by byte, and ends as soon as an inequality is found or the end of the fields is reached.

When the mask is not zero, exceptions associated with storage-operand access are recognized for no

more than the number of bytes specified by the mask. Access exceptions may or may not be recognized for the portion of a storage operand to the right of the first unequal byte. When the mask is zero, access exceptions are recognized for one byte at the second-operand address.

The displacement for CLM is treated as a 12-bit unsigned binary integer. The displacement for CLMY and CLMH is treated as a 20-bit signed binary integer.

Resulting Condition Code:

- 0 Operands equal, or mask bits all zeros
- 1 First operand low
- 2 First operand high
- 3 --

Program Exceptions:

- Access (fetch, operand 2)
- Operation (CLMY, if the long-displacement facility is not installed)

Programming Note: An example of the use of the COMPARE LOGICAL CHARACTERS UNDER MASK instruction is given in Appendix A, "Number Representation and Instruction-Use Examples."

COMPARE LOGICAL HIGH

Register-and-register formats:

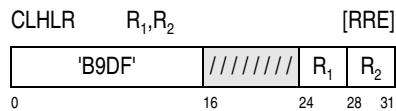
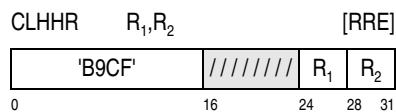

Register-and-storage format:



COMPARE LOGICAL IMMEDIATE HIGH

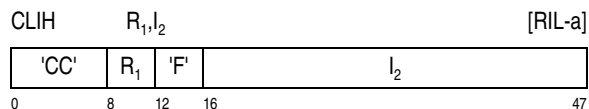

The first operand is compared with the second operand, and the result is indicated in the condition code.

The operands are treated as 32-bit unsigned binary integers. The first operand is in bit positions 0-31 of general register R_1 ; bit positions 32-63 of the register are ignored. For COMPARE LOGICAL HIGH (CLHHR), the second operand is in bit positions 0-31 of general register R_2 ; bit positions 32-63 of the register are ignored. For COMPARE LOGICAL HIGH (CLHLR), the second operand is in bit positions 32-63 of general register R_2 ; bit positions 0-31 of the register are ignored.

The displacement for CLHF is treated as a 20-bit signed binary integer.

Resulting Condition Code:

- 0 Operands equal
- 1 First operand low
- 2 First operand high
- 3 --

Program Exceptions:

- Access (operand 2 of CLHF only)
- Operation (if the high-word facility is not installed)

COMPARE LOGICAL LONG

CLCL R_1, R_2 [RR]

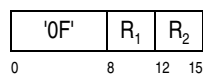

The first operand is compared with the second operand, and the result is indicated in the condition code. The shorter operand is considered to be extended on the right with padding bytes.

The R_1 and R_2 fields each designate an even-odd pair of general registers and must designate an even-numbered register; otherwise, a specification exception is recognized.

The location of the leftmost byte of the first operand and second operand is designated by the contents of general registers R_1 and R_2 , respectively. The number of bytes in the first-operand and second-operand locations is specified by unsigned binary integers in bit positions 40-63 of general registers $R_1 + 1$ and $R_2 + 1$, respectively. Bit positions 32-39 of general register $R_2 + 1$ contain the padding byte. The contents of bit positions 0-39 of general register $R_1 + 1$ and of bit positions 0-31 of general register $R_2 + 1$ are ignored.

The handling of the addresses in general registers R_1 and R_2 is dependent on the addressing mode.

In the 24-bit addressing mode, the contents of bit positions 40-63 of general registers R_1 and R_2 constitute the address, and the contents of bit positions 0-39 are ignored. In the 31-bit addressing mode, the contents of bit positions 33-63 of the registers constitute the address, and the contents of bit positions 0-32 are ignored. In the 64-bit addressing mode, the contents of bit positions 0-63 constitute the address.

The contents of the registers just described are shown in Figure 7-196.

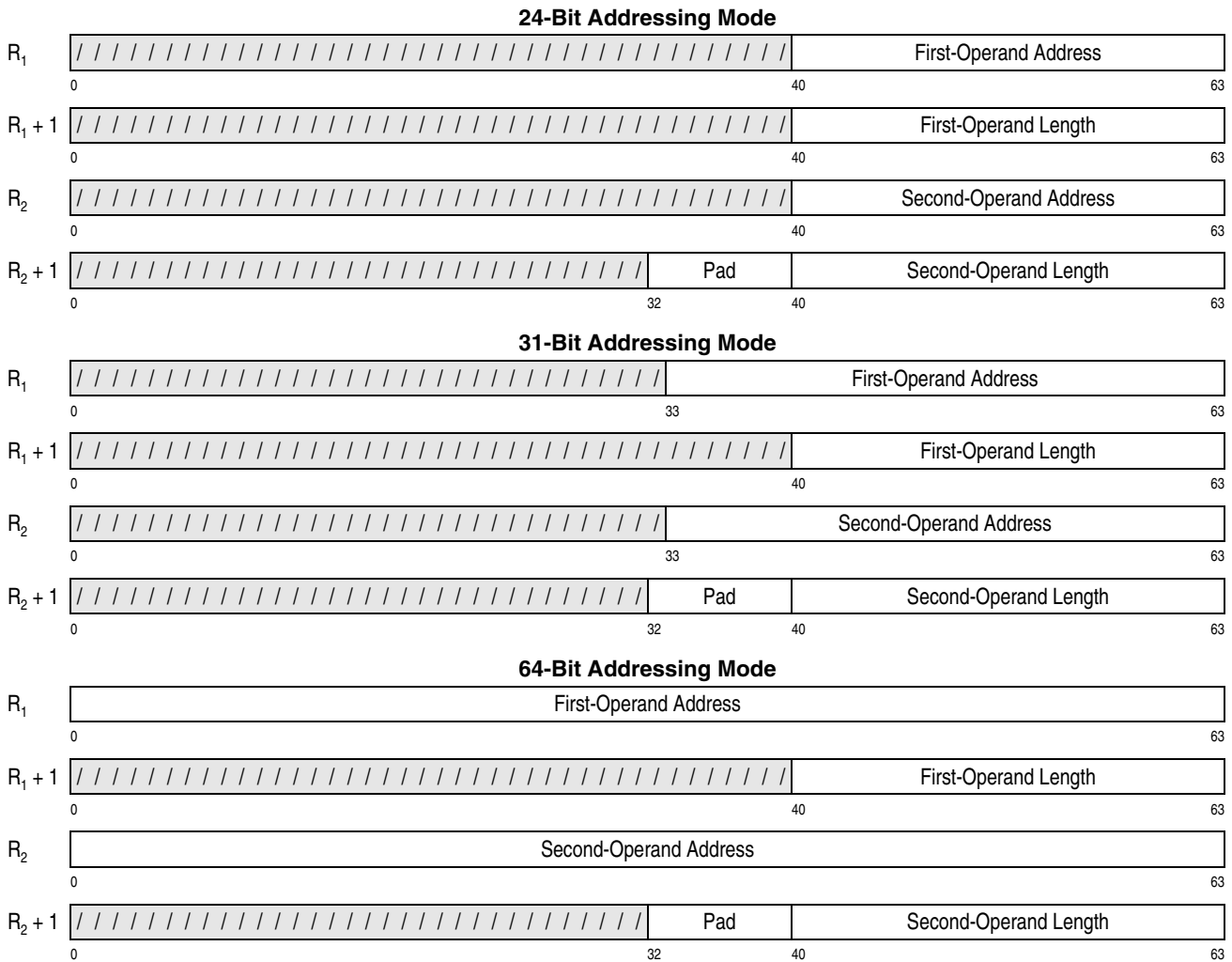

Figure 7-196. Register Contents for COMPARE LOGICAL LONG

The comparison proceeds left to right, byte by byte, and ends as soon as an inequality is found or the end of the longer operand is reached. If the operands are not of the same length, the shorter operand is considered to be extended on the right with the appropriate number of padding bytes.

If both operands are of zero length, the operands are considered to be equal.

The execution of the instruction is interruptible. When an interruption occurs, other than one that follows termination, the lengths in general registers $R_1 + 1$ and $R_2 + 1$ are decremented by the number of bytes compared, and the addresses in general registers R_1 and R_2 are incremented by the same number, so that the

instruction, when reexecuted, resumes at the point of interruption. In the 24-bit or 31-bit addressing mode, the leftmost bits which are not part of the address in bit positions 32-63 of general registers R_1 and R_2 are set to zeros, and the contents of bit positions 0-31 remain unchanged. In any addressing mode, the contents of bit positions 0-39 of general registers $R_1 + 1$ and $R_2 + 1$ remain unchanged, and the condition code is unpredictable. If the operation is interrupted after the shorter operand has been exhausted, the length field pertaining to the shorter operand is zero, and its address is updated accordingly.

If the operation ends because of an inequality, the address fields in general registers R_1 and R_2 at com-

pletion identify the first unequal byte in each operand. The lengths in bit positions 40-63 of general registers $R_1 + 1$ and $R_2 + 1$ are decremented by the number of bytes that were equal, unless the inequality occurred with the padding byte, in which case the length field for the shorter operand is set to zero. The addresses in general registers R_1 and R_2 are incremented by the amounts by which the corresponding length fields were reduced.

If the two operands, including the padding byte, if necessary, are equal, both length fields are made zero at completion, and the addresses are incremented by the corresponding operand-length values.

At the completion of the operation, in the 24-bit or 31-bit addressing mode, the leftmost bits which are not part of the address in bit positions 32-63 of general registers R_1 and R_2 are set to zeros, even when one or both of the initial length values are zero. In any addressing mode, the contents of bit positions 0-39 of general registers $R_1 + 1$ and $R_2 + 1$ remain unchanged.

Access exceptions for the portion of a storage operand to the right of the first unequal byte may or may not be recognized. For operands longer than 2K bytes, access exceptions are not recognized more than 2K bytes beyond the byte being processed. Access exceptions are not indicated for locations more than 2K bytes beyond the first unequal byte.

When the length of an operand is zero, no access exceptions are recognized for that operand. Access exceptions are not recognized for an operand if the R field associated with that operand is odd.

Resulting Condition Code:

- 0 Operands equal, or both zero length
- 1 First operand low
- 2 First operand high
- 3 --

Program Exceptions:

- Access (fetch, operands 1 and 2)
- Specification
- Transaction constraint

Programming Notes:

1. An example of the use of the COMPARE LOGICAL LONG instruction is given in Appendix A,

“Number Representation and Instruction-Use Examples.”

2. When the R_1 and R_2 fields are the same, the operation proceeds in the same way as when two distinct pairs of registers having the same contents are specified, except that the contents of the designated registers are incremented or decremented only by the number of bytes compared, not by twice the number of bytes compared. In the absence of dynamic modification of the operand area by another CPU or by a channel program, condition code 0 is set. However, it is unpredictable whether access exceptions are recognized for the operand since the operation can be completed without storage being accessed.
3. Special precautions should be taken when COMPARE LOGICAL LONG is made the target of an execute-type instruction. See the programming note concerning interruptible instructions under EXECUTE.
4. Other programming notes concerning interruptible instructions are included in “Interruptible Instructions” in Chapter 5, “Program Execution.”
5. In the access-register mode, access register 0 designates the primary address space regardless of the contents of access register 0.

COMPARE LOGICAL LONG EXTENDED

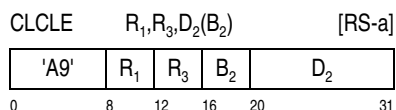

The first operand is compared with the third operand until unequal bytes are compared, the end of the longer operand is reached, or a CPU-determined number of bytes have been compared, whichever occurs first. The shorter operand is considered to be extended on the right with padding bytes. The result is indicated in the condition code.

The R_1 and R_3 fields each designate an even-odd pair of general registers and must designate an even-numbered register; otherwise, a specification exception is recognized.

The location of the leftmost byte of the first operand and third operand is designated by the contents of general registers R_1 and R_3 , respectively. In the 24-bit or 31-bit addressing mode, the number of bytes in the first-operand and third-operand locations is specified by the contents of bit positions 32-63 of general registers $R_1 + 1$ and $R_3 + 1$, respectively, and those contents are treated as 32-bit unsigned binary integers. In the 64-bit addressing mode, the number of bytes in the first-operand and third-operand locations is specified by the entire contents of general registers $R_1 + 1$ and $R_3 + 1$, respectively, and those contents are treated as 64-bit unsigned binary integers.

In the 24-bit addressing mode, the contents of bit positions 40-63 of general registers R_1 and R_3 constitute the address, and the contents of bit positions 0-39 are ignored. In the 31-bit addressing mode, the contents of bit positions 33-63 of the registers constitute the address, and the contents of bit positions 0-32 are ignored. In the 64-bit addressing mode, the contents of bit positions 0-63 constitute the address.

The second-operand address is not used to address data; instead, the rightmost eight bits of the second-operand address, bits 56-63, are the padding byte. Bits 0-55 of the second-operand address are ignored.

The handling of the addresses in general registers R_1 and R_3 is dependent on the addressing mode.

The contents of the registers and address just described are shown in Figure 7-197.

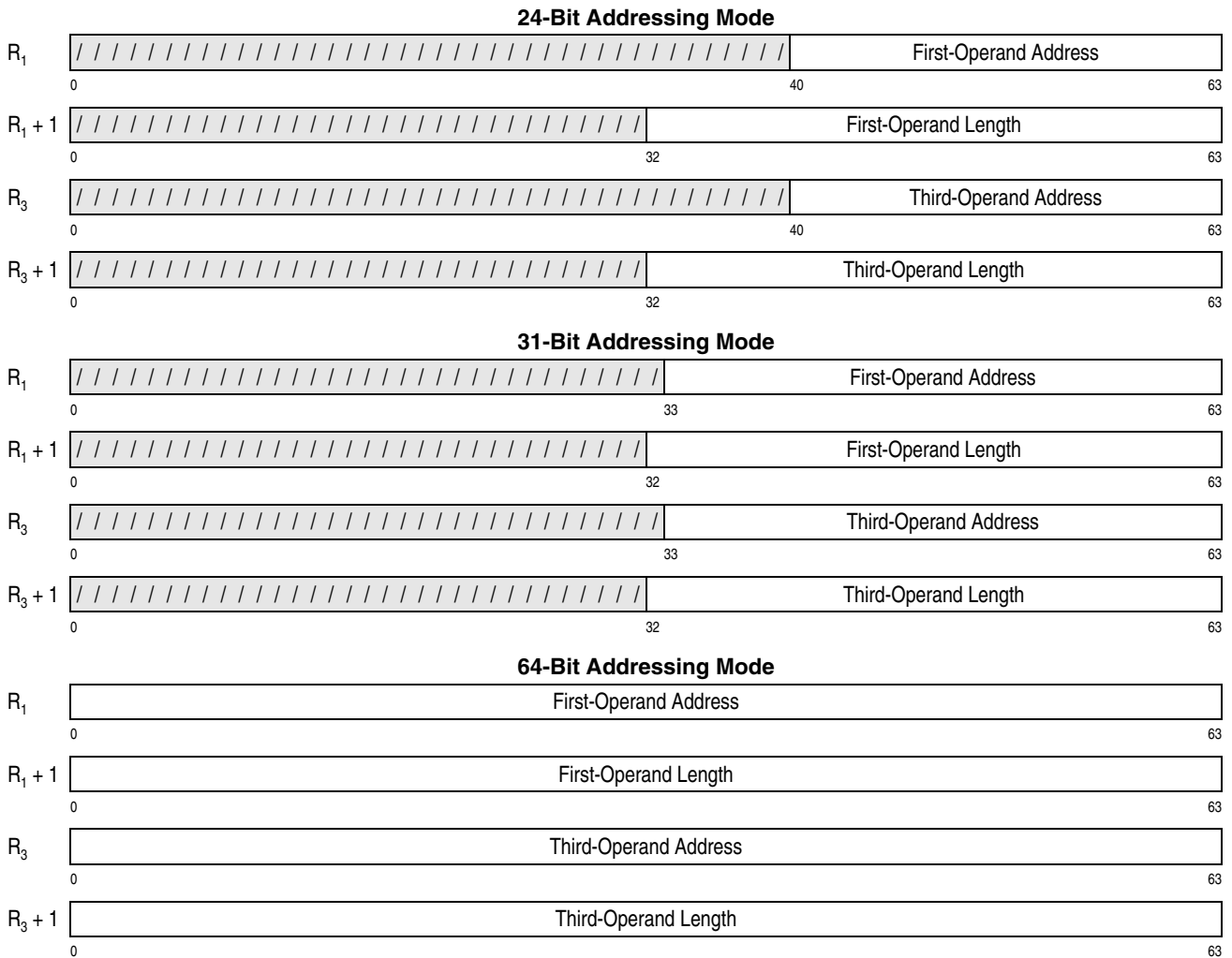

Figure 7-197. Register Contents and Second-Operand Address for COMPARE LOGICAL LONG EXTENDED (Part 1 of 2)

All Addressing Modes

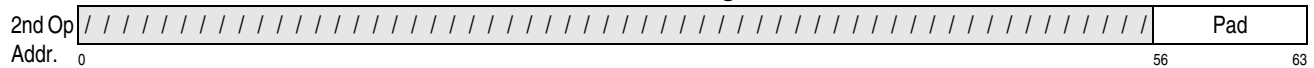

Figure 7-197. Register Contents and Second-Operand Address for COMPARE LOGICAL LONG EXTENDED (Part 2 of 2)

The comparison proceeds left to right, byte by byte, and ends as soon as an inequality is found, the end of the longer operand is reached, or a CPU-determined number of bytes have been compared, whichever occurs first. If the operands are not of the same length, the shorter operand is considered to be extended on the right with the appropriate number of padding bytes.

If both operands are of zero length, the operands are considered to be equal.

If the operation ends because of an inequality, the address fields in general registers R_1 and R_3 at completion identify the first unequal byte in each operand. The lengths in bit positions 32-63, in the 24-bit or 31-bit addressing mode, or in bit positions 0-63, in the 64-bit addressing mode, of general registers $R_1 + 1$ and $R_3 + 1$ are decremented by the number of bytes that were equal, unless the inequality occurred with the padding byte, in which case the length field for the shorter operand is set to zero. The addresses in general registers R_1 and R_3 are incremented by the amounts by which the corresponding length fields were decremented. Condition code 1 is set if the first operand is low, or condition code 2 is set if the first operand is high.

If the two operands, including the padding byte, if necessary, are equal, both length fields are made zero at completion, and the addresses are incremented by the corresponding operand-length values. Condition code 0 is set.

If the operation is completed because a CPU-determined number of bytes have been compared without finding an inequality or reaching the end of the longer operand, the lengths in general registers $R_1 + 1$ and $R_3 + 1$ are decremented by the number of bytes compared, and the addresses in general registers R_1 and R_3 are incremented by the same number, so that the instruction, when reexecuted, resumes at the next bytes to be compared. If the operation is completed after the shorter operand has been exhausted, the length field pertaining to the shorter operand is zero, and the operand address is updated accordingly. Condition code 3 is set.

In the 24-bit or 31-bit addressing mode, the contents of bit positions 0-31 of general registers R_1 , $R_1 + 1$, R_3 , and $R_3 + 1$, always remain unchanged.

The padding byte may be formed from $D_2(B_2)$ multiple times during the execution of the instruction, and the registers designated by R_1 and R_3 may be updated multiple times. Therefore, if B_2 equals R_1 , $R_1 + 1$, R_3 , or $R_3 + 1$ and is subject to change during the execution of the instruction, the results are unpredictable.

The amount of processing that results in the setting of condition code 3 is determined by the CPU on the basis of improving system performance, and it may be a different amount each time the instruction is executed. The maximum amount is approximately 4K bytes of either operand.

At the completion of the operation in the 24-bit or 31-bit addressing mode, the leftmost bits which are not part of the address in bit positions 32-63 of general registers R_1 and R_3 may be set to zeros or may remain unchanged from their original values, even when one or both of the initial length values are zero.

Access exceptions for the portion of a storage operand to the right of the first unequal byte may or may not be recognized. For operands longer than 4K bytes, access exceptions are not recognized more than 4K bytes beyond the byte being processed. Access exceptions are not indicated for locations more than 4K bytes beyond the first unequal byte.

When the length of an operand is zero, no access exceptions are recognized for that operand. Access exceptions are not recognized for an operand if the R field associated with that operand is odd.

Resulting Condition Code:

- 0 All bytes compared; operands equal, or both zero length
- 1 All bytes compared, first operand low
- 2 All bytes compared, first operand high
- 3 CPU-determined number of bytes compared without finding an inequality

Program Exceptions:

- Access (fetch, operands 1 and 3)
- Specification
- Transaction constraint

Programming Notes:

1. COMPARE LOGICAL LONG EXTENDED is intended for use in place of COMPARE LOGICAL LONG when the operand lengths are specified as 32-bit or 64-bit binary integers. COMPARE LOGICAL LONG EXTENDED sets condition code 3 in cases in which COMPARE LOGICAL LONG would be interrupted.
2. When condition code 3 is set, the program can simply branch back to the instruction to continue the comparison. The program need not determine the number of bytes that were compared.
3. The function of not processing more than approximately 4K bytes of either operand is intended to permit software polling of a flag that may be set by a program on another CPU during long operations.
4. When the R_1 and R_3 fields are the same, the operation proceeds in the same way as when two distinct pairs of registers having the same contents are specified, except that the contents of the designated registers are incremented or decremented only by the number of bytes compared, not by twice the number of bytes compared. In the absence of dynamic modification of the operand area by another CPU or by a channel program, the condition code is finally set to 0 after possible settings to 3. However, it is unpredictable whether access exceptions are recognized for the operand since the operation can be completed without storage being accessed. If storage is not accessed, condition code 3 may or may not be set regardless of the operand length.
5. In the access-register mode, access register 0 designates the primary address space regardless of the contents of access register 0.

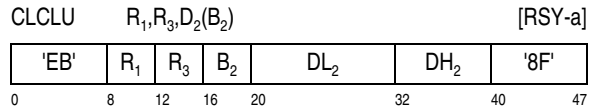
COMPARE LOGICAL LONG UNICODE

The first operand is compared with the third operand until unequal two-byte Unicode characters are compared, the end of the longer operand is reached, or a CPU-determined number of characters have been compared, whichever occurs first. The shorter operand is considered to be extended on the right with two-byte padding characters. The result is indicated in the condition code.

The R_1 and R_3 fields each designate an even-odd pair of general registers and must designate an even-numbered register; otherwise, a specification exception is recognized.

The location of the leftmost character of the first operand and third operand is designated by the contents of general registers R_1 and R_3 , respectively. In the 24-bit or 31-bit addressing mode, the number of bytes in the first-operand and third-operand locations is specified by the contents of bit positions 32-63 of general registers $R_1 + 1$ and $R_3 + 1$, respectively, and those contents are treated as 32-bit unsigned binary integers. In the 64-bit addressing mode, the number of bytes in the first-operand and third-operand locations is specified by the contents of bit positions 0-63 of general registers $R_1 + 1$ and $R_3 + 1$, respectively, and those contents are treated as 64-bit unsigned binary integers.

The contents of general registers $R_1 + 1$ and $R_3 + 1$ must specify an even number of bytes; otherwise, a specification exception is recognized.

The handling of the addresses in general registers R_1 and R_3 is dependent on the addressing mode.

In the 24-bit addressing mode, the contents of bit positions 40-63 of general registers R_1 and R_3 constitute the address, and the contents of bit positions 0-39 are ignored. In the 31-bit addressing mode, the contents of bit positions 33-63 of the registers constitute the address, and the contents of bit positions 0-32 are ignored. In the 64-bit addressing mode, the contents of bit positions 0-63 of the registers constitute the address.

The second-operand address is not used to address data; instead, the rightmost 16 bits of the second-operand address, bits 48-63, are the two-byte padding character. Bits 0-47 of the second-operand address are ignored.

The contents of the registers and address just described are shown in Figure 7-198.

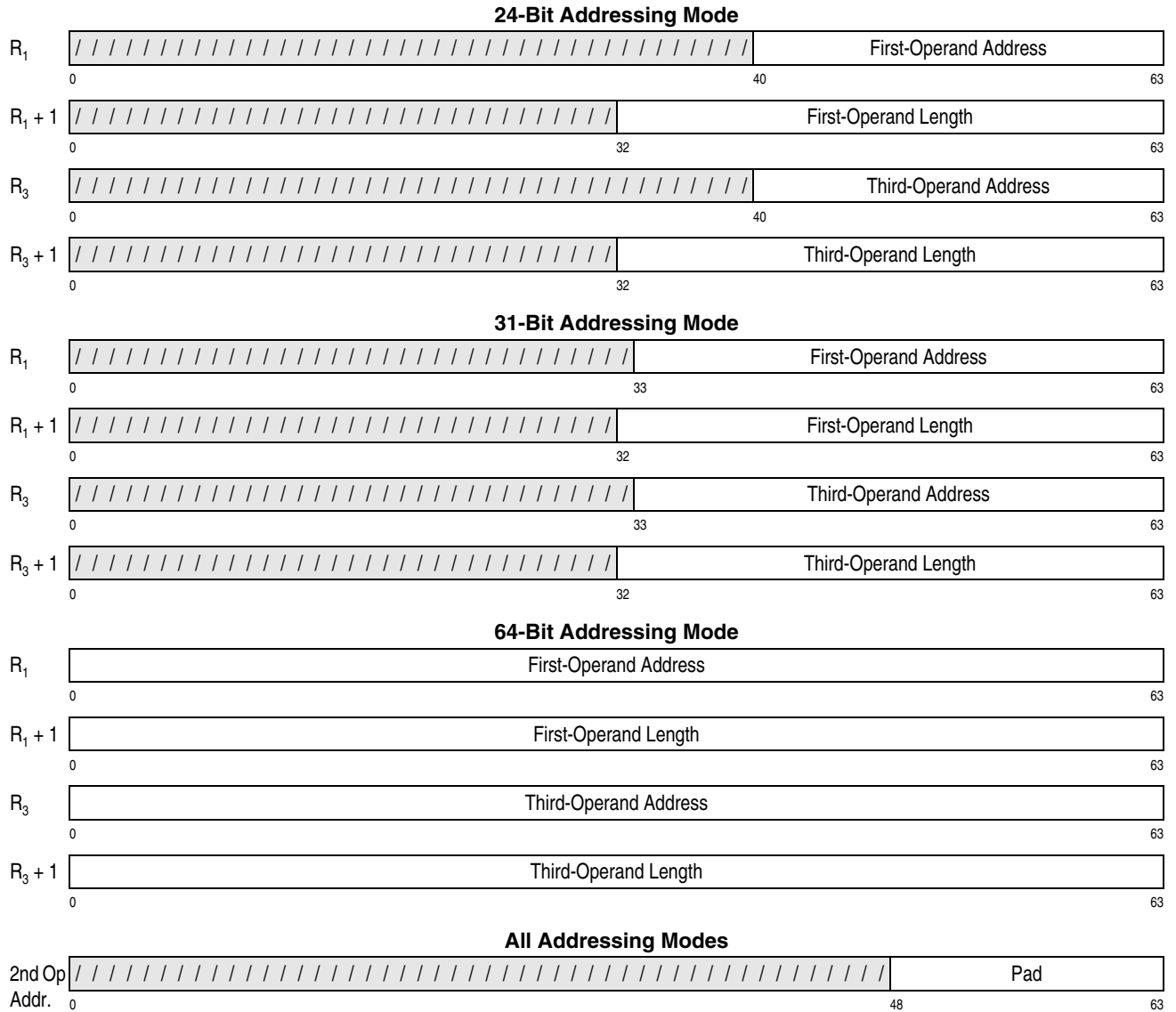

Figure 7-198. Register Contents and Second-Operand Address for COMPARE LOGICAL LONG UNICODE

The comparison proceeds left to right, character by character, and ends as soon as an inequality is found, the end of the longer operand is reached, or a CPU-determined number of characters have been compared, whichever occurs first. If the operands are not of the same length, the shorter operand is considered to be extended on the right with the appropriate number of two-byte padding characters.

If both operands are of zero length, the operands are considered to be equal.

If the operation ends because of an inequality, the address fields in general registers R_1 and R_3 at completion identify the first unequal two-byte character in each operand. The lengths in bit positions 32-63, in the 24-bit or 31-bit addressing mode, or in bit positions 0-63, in the 64-bit addressing mode, of general

registers $R_1 + 1$ and $R_3 + 1$ are decremented by 2 times the number of characters that were equal, unless the inequality occurred with the two-byte padding character, in which case the length field for the shorter operand is set to zero. The addresses in general registers R_1 and R_3 are incremented by the amounts by which the corresponding length fields were decremented. Condition code 1 is set if the first operand is low, or condition code 2 is set if the first operand is high.

If the two operands, including the two-byte padding character, if necessary, are equal, both length fields are made zero at completion, and the addresses are incremented by the corresponding operand-length values. Condition code 0 is set.

If the operation is completed because a CPU-determined number of characters have been compared without finding an inequality or reaching the end of the longer operand, the lengths in general registers $R_1 + 1$ and $R_3 + 1$ are decremented by 2 times the number of characters compared, and the addresses in general registers R_1 and R_3 are incremented by the same number, so that the instruction, when reexecuted, resumes at the next characters to be compared. If the operation is completed after the shorter operand has been exhausted, the length field pertaining to the shorter operand is zero, and the operand address is updated accordingly. Condition code 3 is set.

In the 24-bit or 31-bit addressing mode, the contents of bit positions 0-31 of general registers R_1 , $R_1 + 1$, R_3 , and $R_3 + 1$, always remain unchanged.

The two-byte padding character may be formed from $D_2(B_2)$ multiple times during the execution of the instruction, and the registers designated by R_1 and R_3 may be updated multiple times. Therefore, if B_2 equals R_1 , $R_1 + 1$, R_3 , or $R_3 + 1$ and is subject to change during the execution of the instruction, the results are unpredictable.

The amount of processing that results in the setting of condition code 3 is determined by the CPU on the basis of improving system performance, and it may be a different amount each time the instruction is executed.

At the completion of the operation in the 24-bit or 31-bit addressing mode, the leftmost bits which are not part of the address in bit positions 32-63 of gen-

eral registers R_1 and R_3 may be set to zeros or may remain unchanged from their original values, including the case when one or both of the initial length values are zero.

Access exceptions for the portion of a storage operand to the right of the first unequal character may or may not be recognized. For operands longer than 4K bytes, access exceptions are not recognized more than 4K bytes beyond the character being processed. Access exceptions are not indicated for locations more than 4K bytes beyond the first unequal character.

When the length of an operand is zero, no access exceptions are recognized for that operand. Access exceptions are not recognized for an operand if the R field or length associated with that operand is odd.

Resulting Condition Code:

- 0 All characters compared; operands equal, or both zero length
- 1 First operand low
- 2 First operand high
- 3 CPU-determined number of characters compared without finding an inequality

Program Exceptions:

- Access (fetch, operands 1 and 3)
- Operation (if the extended-translation facility 2 is not installed)
- Specification
- Transaction constraint

Programming Notes:

1. COMPARE LOGICAL LONG UNICODE is intended for use in place of COMPARE LOGICAL LONG or COMPARE LOGICAL LONG EXTENDED when two-byte characters are to be compared. The characters may be Unicode characters or any other double-byte characters. COMPARE LOGICAL LONG UNICODE sets condition code 3 in cases in which COMPARE LOGICAL LONG would be interrupted.
2. When condition code 3 is set, the program can simply branch back to the instruction to continue the comparison. The program need not determine the number of characters that were compared.

- When the R_1 and R_3 fields are the same, the operation proceeds in the same way as when two distinct pairs of registers having the same contents are specified, except that the contents of the designated registers are incremented or decremented only by 2 times the number of characters compared, not by 4 times the number of characters compared. In the absence of dynamic modification of the operand area by another CPU or by a channel program, the condition code is finally set to 0 after possible settings to 3. However, it is unpredictable whether access exceptions are recognized for the operand since the operation can be completed without storage being accessed. If storage is not accessed, condition code 3 may or may not be set regardless of the operand length.
- In the access-register mode, access register 0 designates the primary address space regardless of the contents of access register 0.
- The padding character may be represented in the displacement field of the instruction. The following example illustrates padding with a Unicode space character.

```
CLCLU 6,8,X'020'
```

When the B_2 field of the instruction designates general register 0, and the long-displacement facility is not installed, the padding character is limited to a character whose representation is less than or equal to FFF hex.

COMPARE LOGICAL STRING

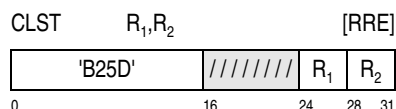

The first operand is compared with the second operand until unequal bytes are compared, the end of either operand is reached, or a CPU-determined number of bytes have been compared, whichever occurs first. The CPU-determined number is at least 256. The result is indicated in the condition code.

The location of the leftmost byte of the first operand and second operand is designated by the contents of general registers R_1 and R_2 , respectively.

The handling of the addresses in general registers R_1 and R_2 is dependent on the addressing mode. In the 24-bit addressing mode, the contents of bit positions 40-63 of general registers R_1 and R_2 constitute the address, and the contents of bit positions 0-39 are ignored. In the 31-bit addressing mode, the contents of bit positions 33-63 of the registers constitute the address, and the contents of bit positions 0-32 are ignored. In the 64-bit addressing mode, the contents of bit positions 0-63 constitute the address.

The first and second operands may be of the same or different lengths. The end of an operand is indicated by an ending character in the last byte position of the operand. The ending character to be used to determine the end of an operand is specified in bit positions 56-63 of general register 0. Bit positions 32-55 of general register 0 are reserved for possible future extensions and must contain all zeros; otherwise, a specification exception is recognized.

The operation proceeds left to right, byte by byte, and ends as soon as the ending character is encountered in either or both operands, unequal bytes which do not include an ending character are compared, or a CPU-determined number of bytes have been compared, whichever occurs first. The CPU-determined number is at least 256. When the ending character is encountered simultaneously in both operands, including when it is in the first byte position of the operands, the operands are of the same length and are considered to be equal, and condition code 0 is set. When the ending character is encountered in only one operand, that operand, which is the shorter operand, is considered to be low, and condition code 1 or 2 is set. Condition code 1 is set if the first operand is low, or condition code 2 is set if the second operand is low. Similarly, when unequal bytes which do not include an ending character are compared, condition code 1 is set if the lower byte is in the first operand, or condition code 2 is set if the lower byte is in the second operand. When a CPU-determined number of bytes have been compared, condition code 3 is set.

When condition code 1 or 2 is set, the address of the last byte processed in the first and second operands is placed in general registers R_1 and R_2 , respectively. That is, when condition code 1 is set, the address of the ending character or first unequal byte in the first operand, whichever was encountered, is placed in general register R_1 , and the address of the second-operand byte corresponding in position to the first-operand byte is placed in general register R_2 . When

condition code 2 is set, the address of the ending character or first unequal byte in the second operand, whichever was encountered, is placed in general register R_2 , and the address of the first-operand byte corresponding in position to the second-operand byte is placed in general register R_1 . When condition code 3 is set, the address of the next byte to be processed in the first and second operands is placed in general registers R_1 and R_2 , respectively. Whenever an address is placed in a general register, bits 32-39 of the register, in the 24-bit addressing mode, or bit 32 in the 31-bit addressing mode, are set to zeros. Bits 0-31 of the R_1 and R_2 registers always remain unchanged in the 24-bit or 31-bit mode.

When condition code 0 is set, the contents of general registers R_1 and R_2 remain unchanged.

The amount of processing that results in the setting of condition code 3 is determined by the CPU on the basis of improving system performance, and it may be a different amount each time the instruction is executed.

Access exceptions for the first and second operands are recognized only for that portion of the operand which is necessarily examined in the operation.

Resulting Condition Code:

- 0 Entire operands equal; general registers R_1 and R_2 unchanged
- 1 First operand low; general registers R_1 and R_2 updated with addresses of last bytes processed
- 2 First operand high; general registers R_1 and R_2 updated with addresses of last bytes processed
- 3 CPU-determined number of bytes equal; general registers R_1 and R_2 updated with addresses of next bytes

Program Exceptions:

- Access (fetch, operands 1 and 2)
- Specification
- Transaction constraint

Programming Notes:

1. Several examples of the use of the COMPARE LOGICAL STRING instruction are given in Appendix A, "Number Representation and Instruction-Use Examples."

2. When condition code 0 is set, no indication is given of the position of either ending character.
3. When condition code 3 is set, the program can simply branch back to the instruction to continue the comparison. The program need not determine the number of bytes that were compared.
4. R_1 or R_2 may be zero, in which case general register 0 is treated as containing an address and also the ending character.
5. In the access-register mode, access register 0 designates the primary address space regardless of the contents of access register 0.

COMPARE UNTIL SUBSTRING EQUAL

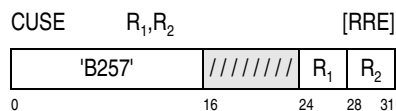

The first operand is compared with the second operand until equal substrings (sequences of bytes) of a specified length are found, the end of the longer operand is reached, or a CPU-determined number of unequal bytes have been compared, whichever occurs first. The shorter operand is considered to be extended on the right with padding bytes. The CPU-determined number is at least 256. The result is indicated in the condition code.

The R_1 and R_2 fields each designate an even-odd pair of general registers and must designate an even-numbered register; otherwise, a specification exception is recognized.

The location of the leftmost byte of the first operand and second operand is specified by the contents of the R_1 and R_2 general registers, respectively. In the 24-bit or 31-bit addressing mode, the number of bytes in the first-operand and second-operand locations is specified by the 32-bit signed binary integer in bit positions 32-63 of general registers $R_1 + 1$ and $R_2 + 1$, respectively. In the 64-bit addressing mode, the number of bytes is specified by the 64-bit signed binary integer in bit positions 0-63 of those registers. When an operand length is negative, it is treated as zero, and it remains unchanged upon completion of the instruction.

Bits 56-63 of general register 0 specify the unsigned substring length, a value of 0-255, in bytes. Bits 56-63 of general register 1 are the padding byte. Bits 0-55 of general registers 0 and 1 are ignored.

The handling of the addresses in general registers R_1 and R_2 is dependent on the addressing mode. In the 24-bit addressing mode, the contents of bit positions 40-63 of general registers R_1 and R_2 constitute the

address, and the contents of bit positions 0-39 are ignored. In the 31-bit addressing mode, the contents of bit positions 33-63 of the registers constitute the address, and the contents of bit positions 0-32 are ignored. In the 64-bit addressing mode, the contents of bit positions 0-63 constitute the address.

The contents of the registers just described are shown in Figure 7-199.

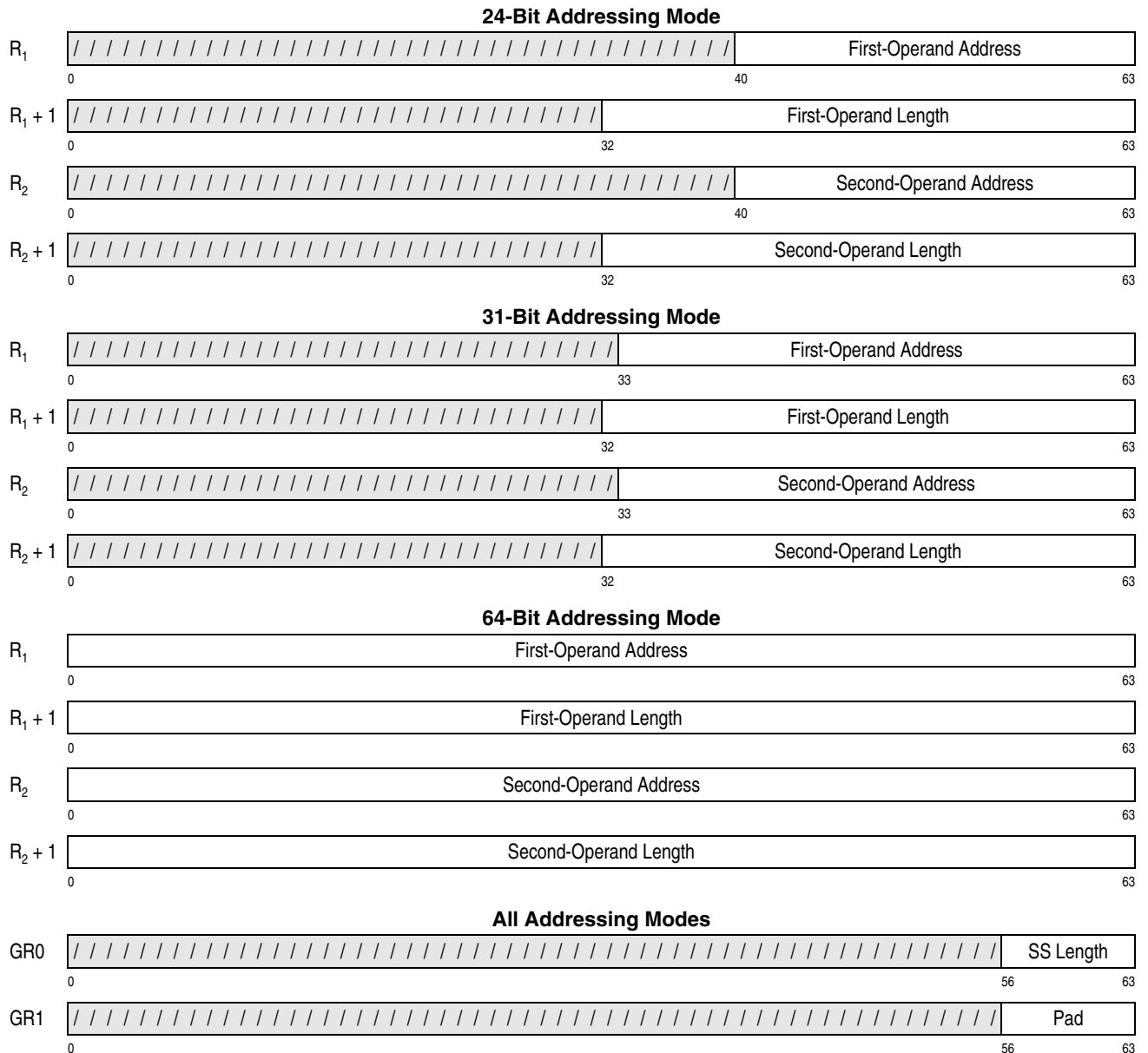

Figure 7-199. Register Contents for COMPARE UNTIL SUBSTRING EQUAL

The result is obtained as if the operands were processed from left to right. However, multiple accesses

may be made to all or some of the bytes of each operand.

The comparison proceeds left to right, byte by byte, and ends as soon as (1) equal substrings of the specified length are found, (2) the end of the longer operand is reached without finding equal substrings of the specified length, or (3) the last bytes compared are unequal, and a CPU-determined number of bytes have been compared. The CPU-determined number is at least 256. If the operands are not of the same length, the shorter operand is considered to be extended on the right with the appropriate number of padding bytes.

If the operation ends because equal substrings of the specified length were found, the condition code is set to 0. If the operation ends because the end of the longer operand was reached without finding equal substrings of the specified length, the condition code is set to 1 if equal bytes were the last bytes compared, or it is set to 2 if unequal bytes were the last bytes compared. If the operation ends because unequal bytes were compared when a CPU-determined number of bytes had been compared, the condition code is set to 3.

If the specified substring length is zero, it is considered that equal substrings of the specified length were found, and condition code 0 is set.

If both operands are of zero length but the specified substring length is not zero, it is considered that the end of the longer operand was reached when unequal bytes were the last bytes compared, and condition code 2 is set.

If equal bytes have been compared but then unequal bytes are compared, it is considered that all bytes so far compared are unequal.

At the completion of the operation, the operand-length fields in the $R_1 + 1$ and $R_2 + 1$ registers are decremented by the number of unequal bytes compared (including equal bytes before unequal bytes compared), and the addresses in the R_1 and R_2 registers are incremented by the same number. However, in the case when a byte of the longer operand is compared against the padding byte, the length field for the shorter operand is not decremented below zero, and the corresponding address is not incremented above the address of the first byte after the shorter operand. In the 24-bit or 31-bit addressing mode, the leftmost bits which are not part of the addresses in bit positions 32-63 of registers R_1 and R_2 are set to zeros, even if the substring length is zero or both operand lengths are initially zero.

Thus, when condition code 0 or 1 is set, the resulting addresses in the R_1 and R_2 registers designate the first bytes of equal substrings in the two operands, and the lengths in the $R_1 + 1$ and $R_2 + 1$ registers have been decremented by the number of bytes preceding the equal substrings, except when the equal substring in the shorter operand begins with the padding byte, in which case the length field for the shorter operand is zero, and the corresponding address field has been incremented by the operand length. When condition code 2 is set, each address field designates the first byte after the corresponding operand, and both length fields are zero. When condition code 3 is set, each address field designates the first byte after the last compared byte of the corresponding operand, and both length fields have been decremented by the number of bytes compared, except that a length field is not decremented below zero.

When the contents of the R_1 and R_2 fields are the same, the first and second operands may be compared, or the condition code may be set to 0 or 1 without comparing the operands.

In the 24-bit or 31-bit addressing mode, the contents of bit positions 0-31 of general registers R_1 , $R_1 + 1$, R_2 , and $R_2 + 1$, always remain unchanged.

The substring length and padding byte may be fetched from general registers 0 and 1 multiple times during the execution of the instruction, and the registers designated by R_1 and R_2 may be updated multiple times. Therefore, if R_1 or R_2 is zero, the results are unpredictable.

When condition code 3 is set, the general registers used by the instruction have been set so that the remainder of the operands can be processed by simply branching back and reexecuting the instruction.

The amount of processing that results in the setting of condition code 3 is determined by the CPU on the basis of improving system performance, and it may be a different amount each time the instruction is executed.

The execution of the instruction is interruptible when the last bytes compared are unequal; it is not interruptible when the last bytes compared are equal. When an interruption occurs, other than one that follows termination, the contents of the registers designated by the R_1 and R_2 fields are updated the same as upon normal completion of the instruction, so that

the instruction, when reexecuted, resumes at the point of interruption. The condition code is unpredictable.

Access exceptions for the portion of a storage operand to the right of the last byte processed may or may not be recognized. For operands longer than 4K bytes, access exceptions are not recognized for locations more than 4K bytes beyond the last byte processed.

When the length of an operand is zero, no access exceptions are recognized for that operand. Access exceptions are not recognized for an operand if the R field associated with that operand is odd. Although the operand address and length fields remain unchanged when a zero substring length is specified, the recognition of access exceptions is not necessarily prevented.

Resulting Condition Code:

- 0 Equal substrings of specified length found
- 1 End of longer operand reached when last bytes compared are equal
- 2 End of longer operand reached when last bytes compared are unequal
- 3 Last bytes compared are unequal, and CPU-determined number of bytes compared

Program Exceptions:

- Access (fetch, operands 1 and 2)
- Specification
- Transaction constraint

Programming Notes:

1. When the R₁ and R₂ fields are the same, the operation proceeds in the same way as when two distinct pairs of registers having the same contents are specified, and, in the absence of dynamic modification of the operand area by another CPU or by a channel program, condition code 0, 1, or 2 is set (as explained in the next note). However, it is unpredictable whether access exceptions are recognized for the operand since the operation can be completed without storage being accessed.
2. If the contents of the R₁ and R₂ fields are the same and the operand length is nonzero, and provided that another CPU or a channel program is not changing an operand, condition code 0 is

set if the operand length is equal to or greater than the specified substring length, or condition code 1 is set if the operand length is less than the specified substring length. Whether or not R₁ equals R₂, if both operand lengths are zero, condition code 0 is set if the specified substring length is zero, or condition code 2 is set if the specified substring length is nonzero. In all of these cases, the addresses in the R₁ and R₂ registers and the lengths in the R₁ + 1 and R₂ + 1 registers remain unchanged.

3. Special precautions should be taken when COMPARE UNTIL SUBSTRING EQUAL is made the target of an execute-type instruction. See the programming note concerning interruptible instructions under EXECUTE.
4. Other programming notes concerning interruptible instructions are included in "Interruptible Instructions" on page 5-24.
5. In the access-register mode, access register 0 designates the primary address space regardless of the contents of access register 0.
6. The storage-operand references of COMPARE UNTIL SUBSTRING EQUAL may be multiple-access references. (See "Storage-Operand Consistency" on page 5-125.)

COMPRESSION CALL

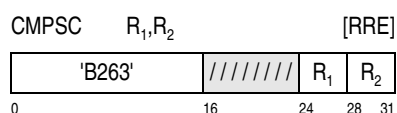

This definition assumes knowledge of the introductory information and information about dictionary formats in Appendix D.

The second operand is compressed or expanded, depending on a specification in general register 0, and the results are placed at the first-operand location. The compressed-data operand consists of either index symbols corresponding to entries in a dictionary designated by an address in general register 1, or codewords which are converted to index symbols depending on the specification of entropy encoding. This dictionary is a compression dictionary during a compression operation or an expansion dictionary during an expansion operation.

During compression when format-1 sibling descriptors are specified in general register 0, an expansion dictionary immediately follows the compression dictionary. During compression when the symbol-translation option is specified in general register 0, the index symbols resulting from compression are translated to interchange symbols by means of a symbol-translation table designated by the address and an offset in general register 1, and it is the interchange symbols that are placed at the first-operand location. During compression when the order preservation option is specified in general register 0, a modified form of symbol translation occurs. During compression when the entropy-encoding option is specified in general register 0, the index symbols are translated into codewords via a modified version of symbol translation whose parameters are specified by the address and offset in general register 1. The number of bits in an index or interchange symbol in the compressed-data operand or in an index symbol used in entropy encoding is specified in general register 0. The operation proceeds until the end of either operand is reached or a CPU-determined amount of data has been processed, whichever occurs first. The results are indicated in the condition code.

The R_1 and R_2 fields each designate an even-odd pair of general registers and must designate an even-numbered register; otherwise, a specification exception is recognized.

The location of the leftmost byte containing any bit of the first operand and second operand is designated by an address in general registers R_1 and R_2 , respectively. The number of bytes containing any bits of the first operand and second operand is specified by bits 32-63 of general registers $R_1 + 1$ and $R_2 + 1$, respectively, in the 24-bit or 31-bit addressing mode or by bits 0-63 of the registers in the 64-bit addressing mode. The contents of general registers $R_1 + 1$ and $R_2 + 1$ are treated as 32-bit unsigned binary integers in the 24-bit or 31-bit addressing mode or as 64-bit unsigned binary integers in the 64-bit addressing mode.

The location of the leftmost byte of the compression dictionary during compression, or of the expansion dictionary during expansion, is designated on a 4 K-byte boundary by an address in general register 1. Optionally, general register 1 also contains an offset to the first byte of an entropy descriptor or symbol translation table.

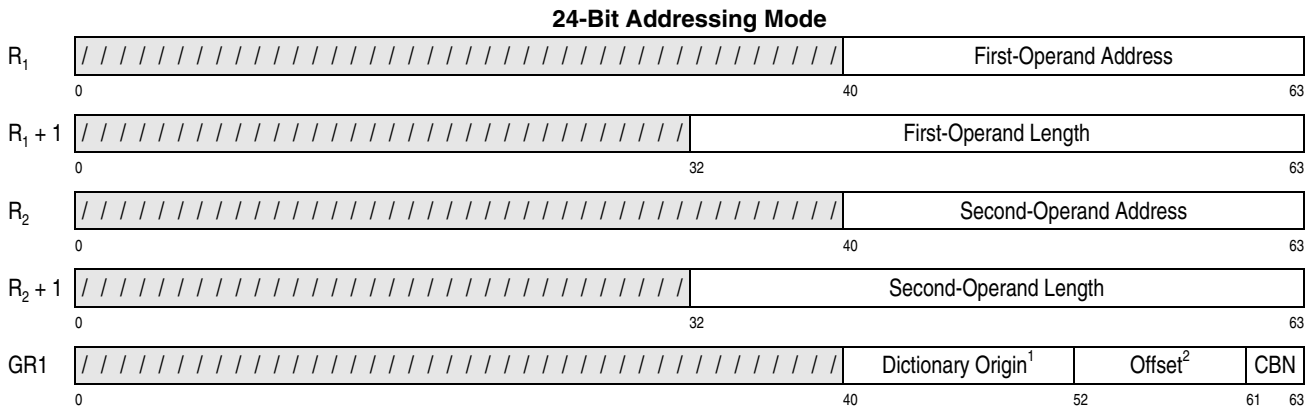
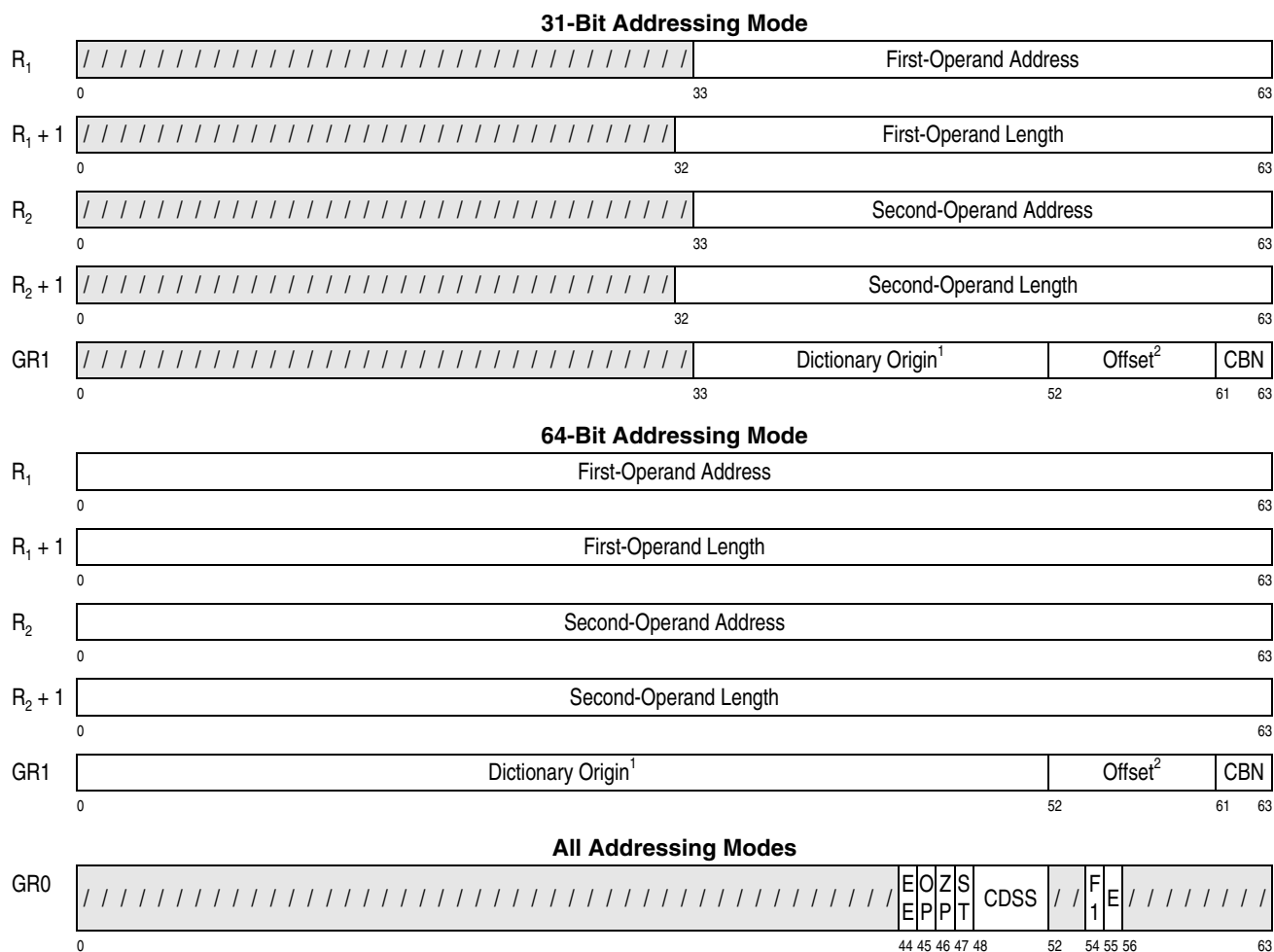

Figure 7-200. Register Contents for COMPRESSION CALL (Part 1 of 2)



Explanation:

- ¹ Compression dictionary during compression, or expansion dictionary during expansion
- ² The Offset field is only meaningful during compression when any of the ST, EE, and OP bits are one. When the ST, EE, and OP bits are zero during compression, or the EE bit is zero during expansion, the Offset field is ignored.

CBN Compressed-data bit number

CDSS Compressed-data symbol size

CDSS (binary)	Symbol Size	Dictionary Size
0000	Causes a specification exception to be recognized	
0001	9 bits	512 entries, 4K bytes
0010	10 bits	1K entries, 8K bytes
0011	11 bits	2K entries, 16K bytes
0100	12 bits	4K entries, 32K bytes
0101	13 bits	8K entries, 64K bytes
0110-1111	Causes a specification exception to be recognized	

E Expansion operation

EE Entropy-encoding option (when the entropy-encoding compression facility is installed).

F1 Format-1 sibling descriptors (ignored during expansion)

Offset Offset to symbol translation table or entropy descriptor

OP Order-preservation option (ignored during expansion, or when the order-preserving-compression facility is not installed)

ST Symbol-translation option (ignored during expansion, implied one for entropy encoding)

ZP Zero padding control (when the CMPSC-enhancement facility is installed).

Figure 7-200. Register Contents for COMPRESSION CALL (Part 2 of 2)

The handling of the addresses in general registers R_1 , R_2 , and 1 is dependent on the addressing mode. In the 24-bit addressing mode, the contents of bit positions 40-63 of registers R_1 and R_2 constitute the address, and the contents of bit positions 0-39 are ignored. In the 31-bit addressing mode, the contents of bit positions 33-63 of registers R_1 and R_2 constitute the address, and the contents of bit positions 0-32 are ignored. In the 64-bit addressing mode, the contents of bit positions 0-63 of registers R_1 and R_2 constitute the address. In the 24-bit addressing mode, the contents of bit positions 40-51 of register 1, with 12 rightmost zeros appended, constitute the address, and the contents of bit positions 0-39 and 52-63 are ignored. In the 31-bit addressing mode, the contents of bit positions 33-51 of register 1, with 12 rightmost zeros appended, constitute the address, and the contents of bit positions 0-32 and 52-63 are ignored. In the 64-bit addressing mode, the contents of bit positions 0-51 of register 1, with 12 rightmost zeros appended, constitute the address, and the contents of bit positions 52-63 are ignored.

Although the contents of bit positions 52-63 of general register 1 are ignored in the formation of a dictionary address, those contents are used as follows. The contents of bit positions 61-63 of the register are the compressed-data bit number (CBN). At the beginning of the operation, the CBN designates the leftmost bit within the leftmost byte of the compressed-data operand. The compressed-data operand is the first operand during compression, or it is the second operand during expansion. When the symbol-translation or order-preservation option is specified during compression and the entropy-encoding option is not specified, the contents of bit positions 52-60 of the register, with seven rightmost zeros appended, are the byte offset from the beginning of the compression dictionary to the leftmost byte of the symbol-translation table. When the entropy-encoding option is specified the contents of bit positions 52-60 of the register, with seven rightmost zeros appended, are the byte offset from the beginning of the compression dictionary to the leftmost byte of the entropy descriptor. When the entropy encoding option is specified during compression, the leftmost byte of the entropy encoding symbol translation table is located at the byte offset plus 32. Symbol translation and order-preservation cannot be specified during expansion, and the contents of bit positions 52-60 are ignored during expansion.

The contents of the registers just described and also of general register 0 are shown in Figure 7-200 on page 7-170.

Bit 55 (E) of general register 0 specifies the compression operation if zero or the expansion operation if one.

When the CMPSC-enhancement facility is installed, bit 46 of general register 0 is the zero-padding (ZP) control. When the ZP control is zero, zero padding of the first operand is not performed. When the ZP control is one, zero padding of the first operand may be performed, as described below. When the CMPSC-enhancement facility is not installed, bit 46 of general register 0 is ignored.

Bit 44 (EE) of general register 0 is the entropy-encoding-option bit; this bit is only meaningful when the entropy-encoding-compression facility is installed. Bit 45 (OP) of general register 0 is the order-preservation-option bit; this bit is only meaningful when the order-preserving-compression facility is installed. Bit 47 (ST) of general register 0 is the symbol-translation-option bit. When bit 44 (EE) is one, bit 45 (OP) must be zero; otherwise results are unpredictable.

During compression when bits 45 and 47 are both zero, the operation produces indexes, called index symbols, to compression-dictionary entries that represent character strings, and the operation then places the index symbols in the compressed-data operand. During compression when bit 45 is zero and bit 47 is one, the operation still produces index symbols but then translates the index symbols to other symbols, called interchange symbols, that it then places in the compressed-data operand. This symbol translation is done by using the symbol-translation table specified by the address and offset in general register 1. During compression when bit 45 is one, bit 47 is ignored, and a modified form of symbol translation is done by using the symbol-translation table. Bits 45 and 47 and the offset in general register 1 are ignored during expansion. During expansion, the compressed-data operand always contains index symbols that designate entries in the expansion dictionary.

When bit 44 of general register 0 is one during compression the operation produces indexes called index symbols which are translated to codewords which are then placed in the compressed-data operand. The translation is done by using the symbol-translation table specified by the address and offset + 32

bytes. During expansion the compressed-data operand always contains codewords that are converted to index symbols by the process shown in Figure 7-205, “Entropy Encoded Expansion” on page 7-186 which are then used to designate entries in the expansion dictionary.

When bit 44 of general register 0 is zero, bits 48-51 (CDSS) of the register specify the number of bits in the index symbols or interchange symbols in the compressed-data operand, as shown in the figure. Bits 48-51 must not have any of the values 0000 or 0110-1111 binary; otherwise, a specification exception is recognized. When bit 44 (EE) of general register 0 is one, bits 48-51 (CDSS) are ignored. When order preservation, entropy encoding, and symbol-translation are not specified, bits 48-51 also specify, as shown in the figure, the number of eight-byte entries in each of the compression and expansion dictionaries, and, thus, they specify the size in bytes of each of the dictionaries. When order preservation, entropy encoding or symbol translation is specified, the compression dictionary is considered to extend to the beginning of the symbol-translation table, that is, the size in bytes of the compression dictionary is the offset in bit positions 52-60 of general register 1, with seven rightmost zeros appended. The size in bytes of the symbol-translation table is considered to be one fourth that of the compression dictionary. However, the offset in general register 1 must be at least as large as the size of the compression dictionary would be if symbol translation were not specified and the CDSS were one less than it actually is, and, when the CDSS is 0001 binary, the offset must be at least 2K bytes; otherwise, the results are unpredictable. For example, if the CDSS is 0101, the offset must be at least 32 K-bytes. When entropy encoding is specified, the compression dictionary must be at least 2K bytes and at most 64 K-bytes; otherwise, the results are unpredictable.

Bit 54 (F1) of general register 0 specifies that the compression dictionary contains format-0 sibling descriptors if the bit is zero or format-1 sibling descriptors if the bit is one. Sibling descriptors are used during the compression operation. A format-0 sibling descriptor is eight bytes at an index position in the compression dictionary. A format-1 sibling descriptor is 16 bytes, with the first eight bytes at an index position in the compression dictionary and the second eight bytes at the same index position in the expansion dictionary. During compression when bit 54 is one, an expansion dictionary is considered to immediately follow the compression dictionary speci-

fied by the address in general register 1. Bit 54 is ignored during expansion. During compression when bit 54 is one, bits 44, 45 and 47 of general register 0 must be zeros; otherwise, the results are unpredictable.

Bits 47 and 54 of general register 0 must not both be ones; otherwise, the results are unpredictable.

The unused bit positions in general register 0 are reserved for possible future extensions and should contain zeros; otherwise, the program may not operate compatibly in the future.

In the access-register mode, the contents of access register R_1 are used for accessing the first operand, and the contents of access register R_2 are used for accessing the second operand, the dictionaries, the entropy descriptor, and the symbol-translation table.

When the entropy-encoding option is not specified and the first or second operand lengths are initially zero, the dictionary, first, and second operands are not accessed and condition code 0 or 1 is set.

The operation starts at the left end of both operands and proceeds to the right. The operation is ended when the end of either operand is reached or when a CPU-determined amount of data has been processed, whichever occurs first.

During a compression operation, the end of the first operand is considered to be reached when the number of unused bit positions remaining in the first-operand location is not sufficient to contain additional compressed data. When the entropy-encoding option is specified and the first operand length is non-zero, this check can only be performed after compression is attempted and the codeword size is determined.

During an expansion operation, the end of the first-operand location is considered to be reached when any of the following conditions are met:

1. The number of unused byte positions remaining in the first-operand location is not sufficient to contain all the characters that would result from expansion of the next index symbol or codeword.
2. Immediately when the number of unused byte positions is zero, that is, immediately when the expansion of an index symbol or codeword completely fills the first-operand location.

During an expansion operation, the end of the second-operand location is considered to be reached when the next index symbol or codeword does not reside entirely within the second-operand location or if the entropy-encoding option is specified and a codeword of all zeros is encountered. The second-operand location ends at the beginning of the byte designated by the sum of the address in general register R_2 and the length in general register $R_2 + 1$, regardless of the compressed-data bit number in bit positions 61-63 of general register 1.

If the operation is ended because the end of the second operand is reached, condition code 0 is set. If the operation is ended because the end of the first operand is reached, condition code 1 is set, except that condition code 0 is set provided that the end of the second operand is also reached. If the operation is ended because a CPU-determined amount of data has been processed, condition code 3 is set.

At the completion of the operation, the length in general register $R_1 + 1$ is decremented by the number of complete bytes stored at the first-operand location, and the address in general register R_1 is incremented by the same amount. During compression, a complete byte is considered to be stored only if all of its bit positions contain bits of compressed data. During compression when the first bit of compressed data stored is not in bit position 0 of a byte, the bits in the byte to the left of the first bit of compressed data remain unchanged. During compression if the last byte stored does not completely contain compressed data, the bits in the byte to the right of the rightmost bit of compressed data in the byte either are unchanged or are set to zeros.

The length in general register $R_2 + 1$ is decremented by the number of complete bytes processed at the second-operand location, and the address in general register R_2 is incremented by the same amount. During expansion, a complete byte is considered to be processed only if all of its bits have been used to produce expanded data.

The leftmost bits which are not part of the address in general registers R_1 and R_2 may be set to zeros or may remain unchanged. However, in the 24-bit or 31-bit addressing mode, bits 0-31 of these registers and also of general registers $R_1 + 1$ and $R_2 + 1$ always remain unchanged.

When all of the following conditions are met, zero padding may be performed, as described below.

- The CMPSC-enhancement facility is installed.
- The zero-padding (ZP) control, bit 46 of general register 0, is one.
- Any of the following is true:
 - The end of the first operand is reached (CC1).
 - The end of the second operand is reached (CC0).
 - A CPU-determined amount of data has been processed (CC3).
 - A codeword consisting of all zero bits is found in the middle of the compressed operand (CC0).
- The last byte of compressed or expanded data does not coincide with the rightmost byte of a model-dependent integral storage boundary.
- The remaining length in general register $R_1 + 1$ is sufficient to store up to the model-dependent integral storage boundary.

It is model dependent whether zero padding is performed. When none of the conditions listed above are met, zero padding is not performed.

Zero padding consists of storing zeros to the right of the last compressed or expanded byte, up to a model-dependent integral storage boundary. The address in general register R_1 and the length in general register $R_1 + 1$ are not updated to account for the zero padding. PER storage-alteration events are recognized for stores that occur as a result of zero padding. The model-dependent integral storage boundary is no larger than 4,096.

When the R_1 and R_2 fields do not designate general register 0, the handling of general register 1 is as follows. The bit number of the bit following the last bit of compressed data processed is placed in bit positions 61-63 of general register 1, and bits 52-60 of the register and the leftmost bits which are not part of the address in the register may be set to zeros or may remain unchanged, except that when one or both of the original length values are so small that no compressed data can be processed, all bits in the register may remain unchanged. However, when bits 44, 45 or 47 of general register 0 are one, bits 52-60 of general register 1 always remain unchanged. Also, in

the 24-bit or 31-bit addressing mode, bits 0-31 of the register always remain unchanged.

If (a) the operands overlap one another, (b) the first operand overlaps the dictionaries, entropy descriptor, or the symbol-translation table in storage in any way, or (c) either the R_1 or the R_2 field designates general register 0, the results are unpredictable.

The compression dictionary is a tree of entries in which a parent entry may have child entries. Each entry represents one or more characters called extension characters, and it also represents a character symbol consisting of the extension characters represented by the entry preceded by the extension characters represented by all of the entry's ancestors.

When order preservation is not specified, the compression process uses an unordered comparison algorithm: the children of a parent are not considered to be in any particular order, and the next characters from the string being compressed are compared against the extension characters represented by the children in the left-to-right order of the children until either a match is found or all of the children have been processed. (However, see Appendix D, "Restriction on Identical Child and Sibling Characters" for a restriction on identical first extension characters of children of the same parent.) The result of the compression process is the index symbol that designates the last matched entry, which is the parent entry if no match was found on any child or there are no children.

The order-preservation option causes the compression process to use an ordered comparison algorithm: the children of a parent are considered to be ordered such that the string of one or more extension characters represented by any child is always earlier in the collating sequence than the string of one or more extension characters represented by the next child of the same parent, that is, the children are considered to be in collating-sequence order. The next characters from the string being compressed are compared against the extension characters represented by the children in the left-to-right order of the children until any of the following is true: (1) a match is found on an entry without children, or a match is found on an entry with children but there is not another character in the string; (2) the next characters from the string have a collating-sequence value less than that of the extension characters represented by a child of the last matched parent; or (3)

the next characters from the string have a collating-sequence value greater than that of the extension characters represented by the last child of the last matched parent. The result of the compression process in each of the three cases is as follows:

Case Resulting Index Symbol

- 1 If the process ends because of a match on an entry without children or because of a match on an entry when there is not another character in the string, the result is the index symbol that designates the entry.
- 2 If the process ends because the next characters of the string have a value less than that of the characters represented by a child, the result is the index symbol that designates the child.
- 3 If the process ends because the next characters of the string have a value greater than that of the characters represented by the last child, the result is the index symbol that designates the last child.

Note that Case 2 includes the case when the next character of the string match the leftmost extension characters represented by a child but there are not as many next characters remaining in the string as there are additional extension characters represented in the child.

When symbol translation is specified, the symbol-translation table consists of two-byte entries, and an entry contains an interchange symbol in the rightmost bit positions of the entry. The length of the interchange symbol is specified by bits 48-51 of general register 0. The left-hand bits that are not part of the interchange symbol in a symbol-translation-table entry must be zeros; otherwise, the results are unpredictable.

To translate an index symbol to an interchange symbol, the index symbol is multiplied by 2 and then added to the address of the beginning of the symbol-translation table to locate an entry in the table, and then the interchange symbol is obtained from the entry.

When order preservation is specified, the index symbol produced by the compression process is used to locate a symbol-translation-table entry containing an interchange symbol just as when the symbol-translation option is specified. The resulting interchange symbol that is placed in the compressed-data operand depends on which of the above three cases the

index symbol was produced. The resulting interchange symbol is as follows:

Case Resulting Interchange Symbol

- | | |
|---|---|
| 1 | The interchange symbol in the entry. |
| 2 | The interchange symbol in the entry, minus one; that is, one is subtracted from the value of the interchange symbol that is in the entry to form the interchange symbol that is stored. |
| 3 | The interchange symbol in the entry, plus one; that is, one is added to the value of the interchange symbol that is in the entry to form the interchange symbol that is stored. |

In the above, the result of subtracting one from an interchange symbol consisting of all zero bits is an interchange symbol consisting of all one bits, and the result of adding one to an interchange symbol consisting of all one bits is an interchange symbol consisting of all zero bits.

When entropy encoding is specified, the index symbol produced by the compression process is used to locate a two-byte symbol-translation-table entry containing a codeword. The size of the codeword is determined and that number of leftmost bits of the symbol-translation-table entry are placed in the compressed data operand. The size of the codeword can be determined by the process shown in Figure 7-206, "Entropy Encoded Compression" on page 7-187.

The execution of the instruction is interruptible. When an interruption occurs, other than one that follows termination, the contents of the registers designated by the R_1 and R_2 fields and of general register 1 are updated the same as upon normal completion of the instruction, so that the instruction, when reexecuted, resumes at the point of interruption. The condition code is unpredictable.

For operands longer than 4K bytes, access exceptions are not recognized for locations more than 4K bytes beyond the current location being processed. Access exceptions may be recognized for all locations in the dictionaries and symbol-translation table if those areas are specified to be used and even if the locations would not be used during the operation. Access exceptions are not recognized for an operand, the dictionaries, or the symbol-translation table if the R field associated with that operand is odd.

Also, when the R_1 field is odd, PER storage-alteration events are not recognized, and no change bits are set.

If an access exception is due to be recognized for either of the operands or for a dictionary, entropy descriptor, or the symbol-translation table, the result is that either the exception is recognized or condition code 3 is set. If condition code 3 is set, the exception will be recognized when the instruction is executed again to continue processing the same operands, assuming that the exception condition still exists.

During compression, regardless of whether the exception is recognized or condition code 3 is set, a nullifying access-exception condition or a suppressing DAT-protection exception condition is handled so that an index symbol is generated only if it is the one that would result if there were no access-exception condition.

During compression or expansion, regardless of whether the exception is recognized or condition code 3 is set, a nullifying or suppressing access-exception condition may result in data having been stored at the first-operand location at or to the right of the location designated by the final address in general register R_1 , which result is not true nullification or suppression. The amount of data stored depends on the reason for the access-exception condition. If the condition is due to a reference to a dictionary or the symbol-translation table, up to 4K bytes of data may have been stored at or to the right of the location designated by the final address. If the condition is due to a reference to the first or second operand, part of one index or interchange symbol, during compression, or part of one character symbol, during expansion, may have been stored at or to the right of the location designated by the final address. In all cases, the storing will be repeated when the instruction is executed again to continue processing the same operands.

If the end of the first operand is reached and an access exception is due to be recognized for the second operand, it is unpredictable whether condition code 1 is set or the access exception is recognized.

During expansion when the expansion dictionary is not logically correct, unusual storing may occur as described in Appendix D, "Expansion Process". The results of an access exception in this case may not be true nullification or suppression.

Special Conditions

A specification exception is recognized for any of the following conditions:

1. Either the R_1 or R_2 fields contain an odd-numbered register.
2. Bits 48-51 of general register 0 contain any value not in the range of 0001-0101 binary and bit 44 of general register 0 is zero.

During compression of each character symbol, either the characters in the symbol or the dictionary character entries (not sibling descriptors) representing characters of the symbol are counted, and a general-operand data exception is recognized if this count becomes too large. The count can reach at least 260 without the exception being recognized.

During compression, the number of child characters or sibling characters processed during the processing of each parent entry are counted, and a general-operand data exception is recognized if this count becomes too large. The count can reach at least 260 without the exception being recognized. That is, a parent must not have more than 260 children; otherwise, a general-operand data exception may be recognized. Extension characters are not counted toward the maximum number of child and sibling characters until a child becomes a parent. When the examine child bit is zero, and a match is encountered, further matches are stopped and the child does not become a parent.

During expansion of each character symbol, either the characters in the symbol or the dictionary entries representing characters of the symbol are counted, and a general-operand data exception is recognized if this count becomes too large. If the characters in the symbol are counted, the count can reach at least 260 without the exception being recognized. If the dictionary entries representing characters of the symbol are counted, the count can reach at least 127 without the exception being recognized.

Certain error conditions in the dictionaries cause a general-operand data exception to be recognized and the operation to be either suppressed or terminated. Some of these error conditions are described in the sections “Expansion Process”, “Results of Dictionary Errors”, “Compression Dictionary”, and “Expansion Dictionary” in Appendix D.

When entropy encoding is specified, the entropy descriptor must satisfy the following properties otherwise a general-operand data exception is recognized.

1. The sum of the sixteen entries must add up to the number of dictionary entries plus one.
2. There is no arithmetic underflow or overflow when performing bounds calculations see Figure 7-204, “Entropy Descriptor Validation” on page 7-186.

During compression, when entropy encoding is specified, a symbol-translation-table entry with a zero value or an entry not padded on the right with zeros will cause a general-operand data exception to be recognized.

Resulting Condition Code:

- | | |
|---|--|
| 0 | End of second operand reached |
| 1 | End of first operand reached and end of second operand not reached |
| 2 | -- |
| 3 | CPU-determined amount of data processed |

Program Exceptions:

- Access (fetch, operand 2, dictionaries, and symbol-translation table; store, operand 1)
- Data with DXC 0, general operand
- Specification
- Transaction constraint

Programming Notes:

1. When condition code 3 is set, the program can simply branch back to the instruction to continue the operation. The program need not determine the amount of data processed.
2. During compression when a nullifying access exception is due to be recognized, an index symbol is generated only if it is the one that would result if there were no access-exception condition. The result of this is that compression of the same expanded data by means of one or more executions of the instruction and by using the same dictionary always results in the same compressed data. That is, (1) the best possible matches in the dictionary are always found for the characters in the second operand, or else the execution is ended by either setting CC3 or rec-

ognizing the exception, and (2) the results of compression are repeatable (although possibly by means of a different number of executions of the instruction) and predictable.

For example, if the next characters of the string being compressed are ABC, and dictionary entry A has a child B, which has a child C, the normal operation is to compress ABC as a single index symbol, but if the C of the string is in the first byte of an invalid page (a page-translation exception is due to be recognized), no index symbol is generated. More specifically, an index symbol corresponding to the character symbol AB is not generated because this is not the index symbol that would be generated if the access-exception condition did not exist.

In the above, “best possible match” refers only to the characters in the second operand. In the example above, if the next two characters of the second operand (the string) are AB, and these are the last two characters of the second operand, the best possible match is on AB, even though there could be a match on ABC if the second operand included one more byte containing C.

Expansion is normally always repeatable. An index symbol is always expanded to exactly the character symbol it represents unless an exception that causes termination is recognized.

3. During expansion, if at least one unused byte position remains in the first operand location, COMPRESSION CALL may completely process the next index symbol in the second operand before it determines that the first-operand location does not have sufficient unused byte positions to contain the expanded data that would result from the next index symbol. If that next index symbol causes encountering of bad dictionary entries, the result can be either a data exception or condition code 1.

COMPRESSION CALL immediately sets condition code 1 when processing of an index symbol exactly fills the first-operand location, except that it sets condition code 0 if the end of the second-operand location also has been reached. Immediately setting condition code 1 has the advantage that data can be compressed using one dictionary and then followed immediately, possibly on a bit boundary, by a different type of data compressed using another dictionary. The com-

pressed data can be successfully expanded if, during the expansion of the data compressed using the first dictionary, the length of the first-operand location is specified to be exactly the length of the expanded data that will be produced. Condition code 1 will then be set when the first-operand location is full, at which time the specification of the dictionary can be changed in order to expand the remainder of the compressed data using the second dictionary. If the definition allowed condition code 1 not to be set, it might be attempted to expand the next index symbol, which resulted from use of the second dictionary, by means of the first dictionary, and this might cause recognition of a general-operand data exception. For example, the next index symbol, which properly designates a character entry in the second dictionary, might designate the second half of a format-1 sibling descriptor in the first dictionary, and that second half might begin with a character, such as 0 (F0 hex), that would appear to be an invalid partial symbol length in a character entry.

4. A nullifying access-exception condition due to a reference to a dictionary or the symbol-translation table may result in the storing of data at or to the right of the location designated by the final address in general register R₁. This storing and the processing needed to produce the data stored will be repeated when COMPRESSION CALL is executed again to continue processing the same operands. The repeated processing will reduce the performance of the instruction execution, and it should be avoided by ensuring that the environment in which the program is executed is one in which page-translation-exception conditions for the dictionaries and symbol-translation table are infrequent.
5. Following is an example of how the compressed-data bit number (CBN) is used and set. In this example:
 - The operation is an expansion operation.
 - The CDSS in general register 0 is 0010 binary. Therefore, there are 1K entries in the expansion dictionary, and the length of an index symbol is 10 bits.
 - The second operand (compressed-data operand) begins at location 6000 hex and has a length of five bytes. The initial CBN is

7. Therefore, there are three index symbols to be expanded, and the final CBN will be 5.

- The compressed data beginning at location 6000 hex is 0081FF9FF8 hex. Therefore, the three index symbols are 103, 3FC, and 3FF hex.
- The first operand (expanded-data operand) begins at location 5000 hex and has a length of 64 bytes. The three index symbols are expanded to a total of 14 bytes of expanded data.

The following figure shows the initial and final contents of general registers R_1 , $R_1 + 1$, R_2 , and $R_2 + 1$, the contents of locations 6000-6004 hex in binary, and the way a cursor corresponding to the CBN is advanced during the expansion operation.

Register	Initial Contents in Hex	Final Contents in Hex
R_1	5000	500E
R_1+1	40	32
R_2	6000	6004
R_2+1	5	1

Contents of Locations 6000-6004 Hex in Binary

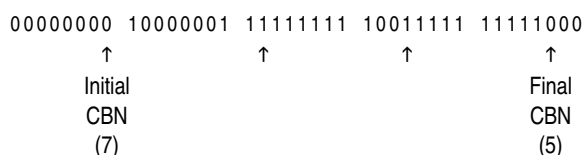

6. The reason for allowing a parent to have no more than 260 children is as follows. The parent can contain five identical child characters. Then, 255 different sibling characters are possible — all of these must be different from the child characters and each other, or else they may be wasted (never matched against), depending on the implementation. Thus, every possible child is permitted.
7. Symbol translation is for use by VTAM. VTAM will begin by doing compression by means of software and an adaptive dictionary. When the adaptive dictionary has matured such that the degree of compression becomes sufficiently good (crosses some threshold), VTAM will “freeze” (stop adapting) its dictionary, inform the other end of the session to freeze also, transform its adaptive dictionary to the dictionary form used by

COMPRESSION CALL, and then use COMPRESSION CALL to continue on with the compression. The other end of the session can continue to use its frozen adaptive dictionary.

Following is clarification about the STT offset. Assume VTAM uses a 4K-entry adaptive dictionary, which is the largest size VTAM uses. All of the entries in this dictionary correspond to character symbols because there are no sibling descriptors in the VTAM dictionary. The VTAM dictionary cannot map one-to-one to a COMPRESSION CALL dictionary because the latter requires that some of the entries be sibling descriptors. Therefore, VTAM must have an 8K-entry dictionary for use in the basic compression operation. Only the first hundred or so entries in the second 4K of the 8K need to be used, and these entries compensate for (take the place of) the entries in the first 4K that must be sibling descriptors. The STT can and should, to save space, begin immediately after those hundred or so entries in the second 4K. In this example, the index symbols will be 13 bits but will be transformed to 12-bit interchange symbols.

8. A program may place the dictionaries in pages that are managed by means of chaining fields at their beginnings. In this case, either the parts of a dictionary have to be moved to be compacted into contiguous locations or there have to be holes in the dictionaries. The definition of COMPRESSION CALL contains nothing explicitly to support holes. However, assuming there is at least one character that never appears in the expanded data, that character can be used as a child character in a parent entry or as a sibling character in a sibling descriptor to specify a child or children that will never be referenced, thus creating a hole.
9. The references to the operands, dictionaries, and symbol-translation table for COMPRESSION CALL may be multiple-access references. (See “Storage-Operand Consistency” on page 5-125.)
10. Setting the ZP control to one may provide improved performance on models in which the CMPSC-enhancement facility is installed.
11. Zero padding is not necessarily performed in every case where it is permissible.
12. Figure 7-201 on page 7-181 and Figure 7-203 on page 7-185 show possible forms (not the only possible forms) of the compression process

(without order preservation), the order preservation compression process and expansion processes. The figures do not show testing for or the results of dictionary errors.

13. As observed by this CPU, other CPUs, and the I/O subsystem, inconsistent results may be briefly stored in the first-operand location. See

the section “Effects of CPU Retry” on page 11-3 for further details.

14. When the entropy-encoding option is specified the minimum dictionary size is 128-bytes or 16 entries. The dictionary must also be a multiple of 16 entries.

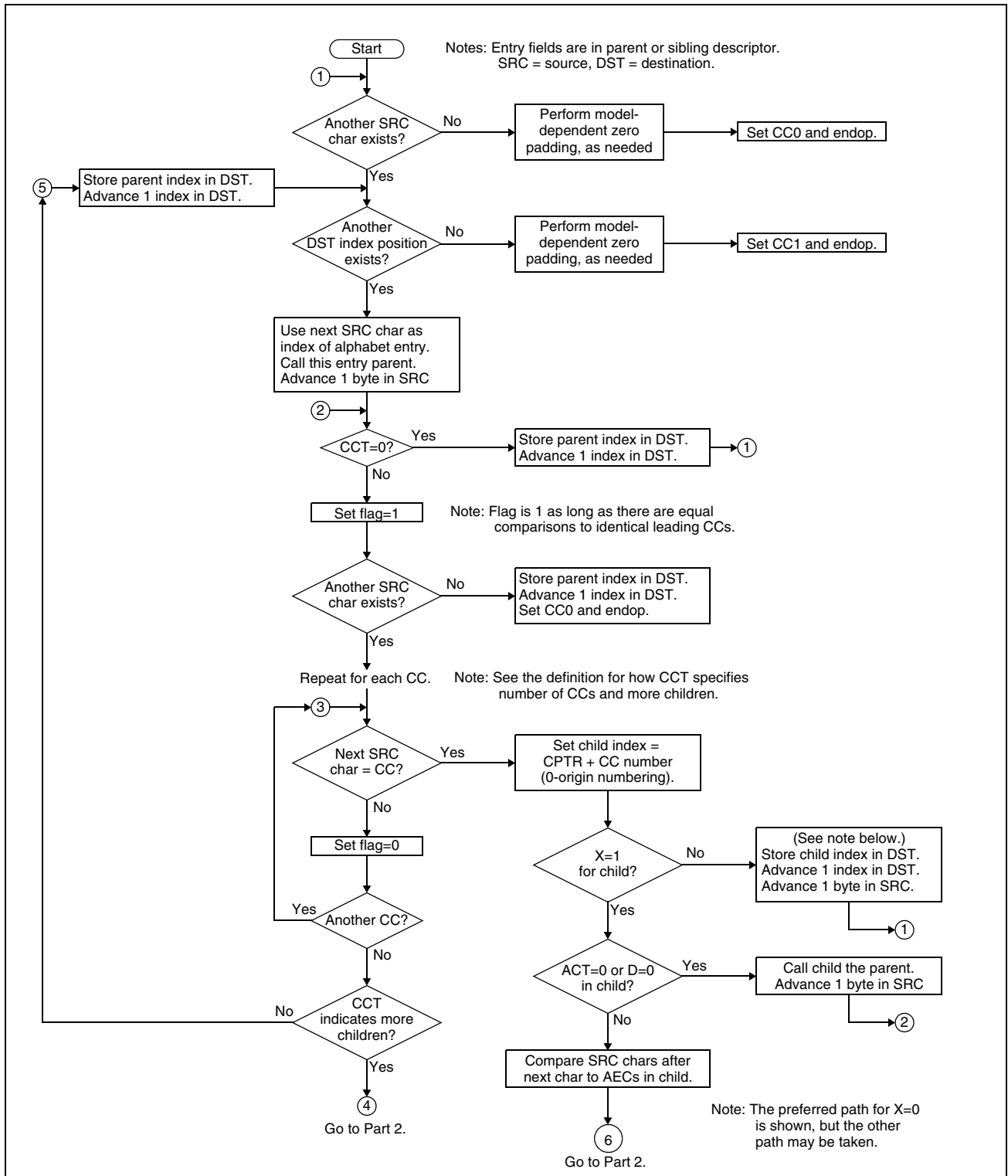

Figure 7-201. Compression Process (Part 1 of 2)

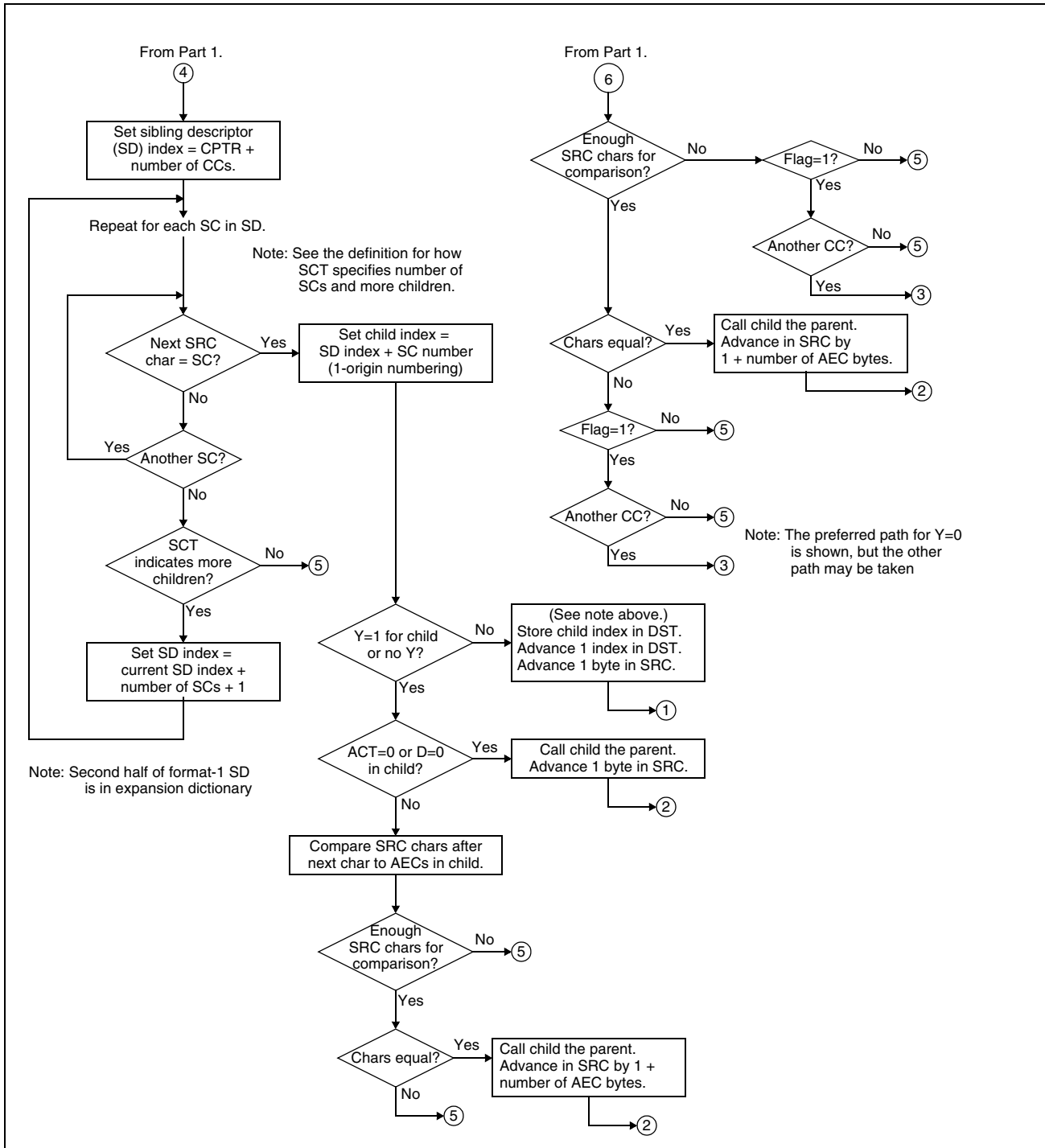

Figure 7-201. Compression Process (Part 2 of 2)

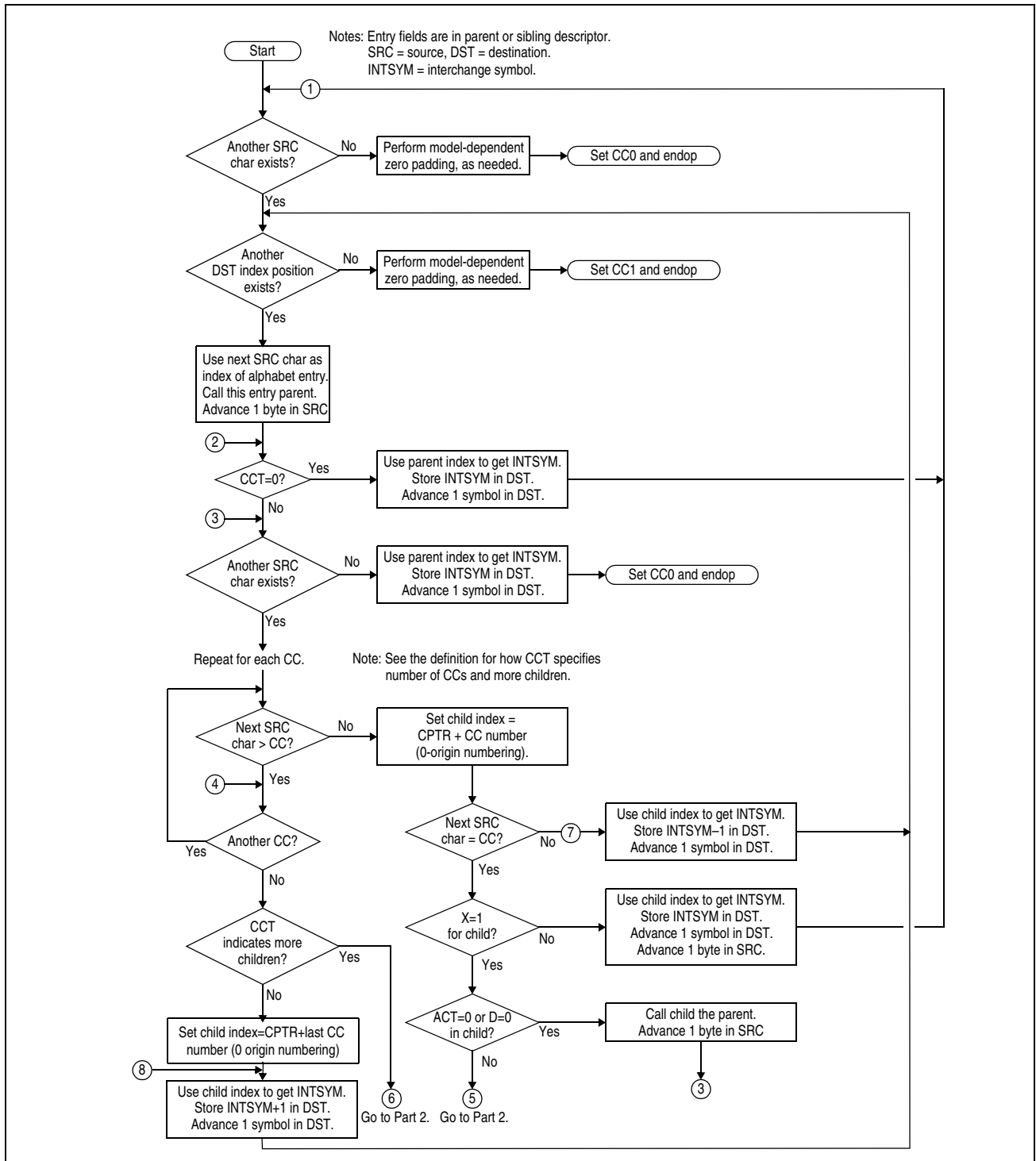

Figure 7-202. Order-Preservation Compression Process (Part 1 of 2)

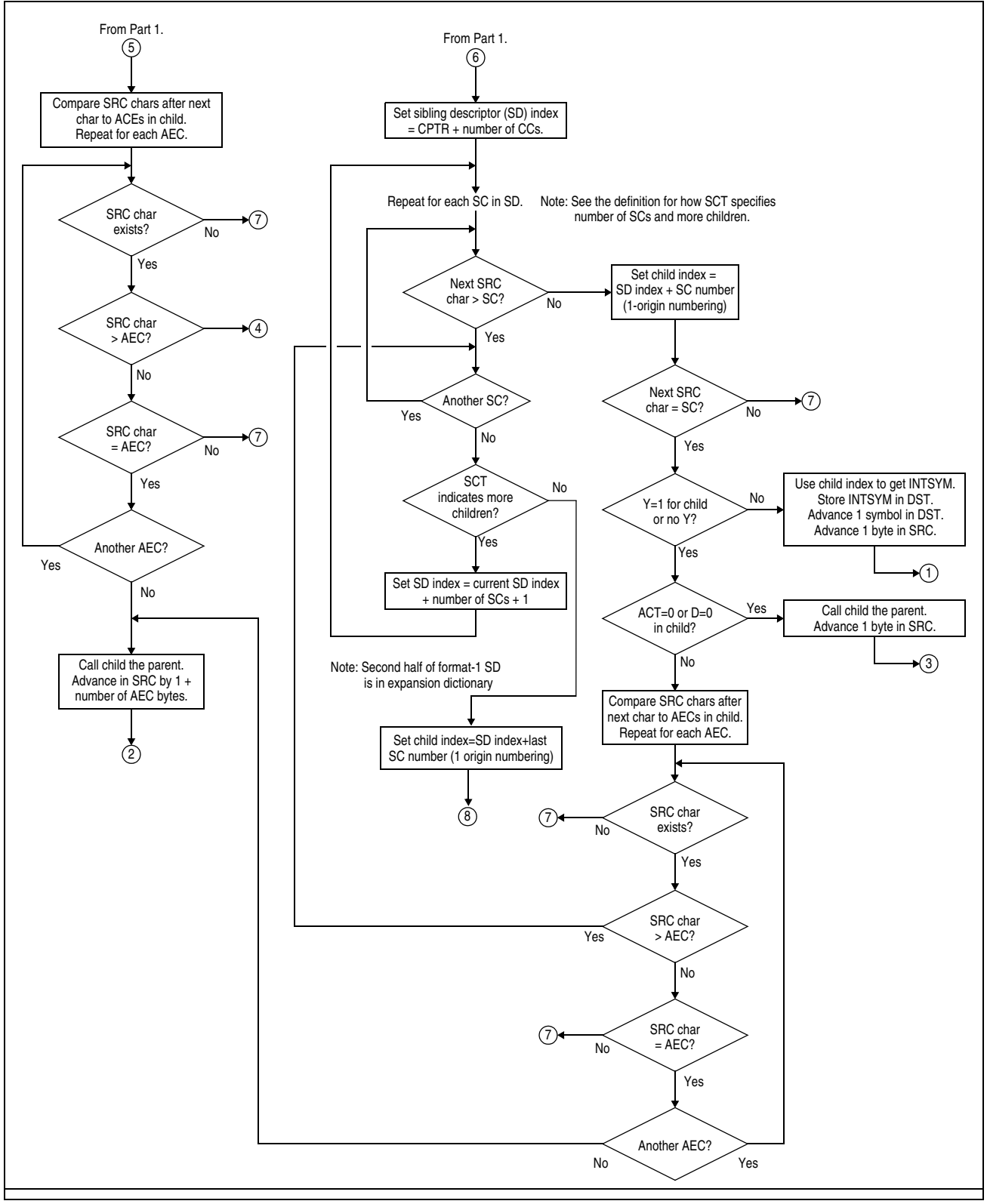

Figure 7-202. Order-Preservation Compression Process (Part 2 of 2)

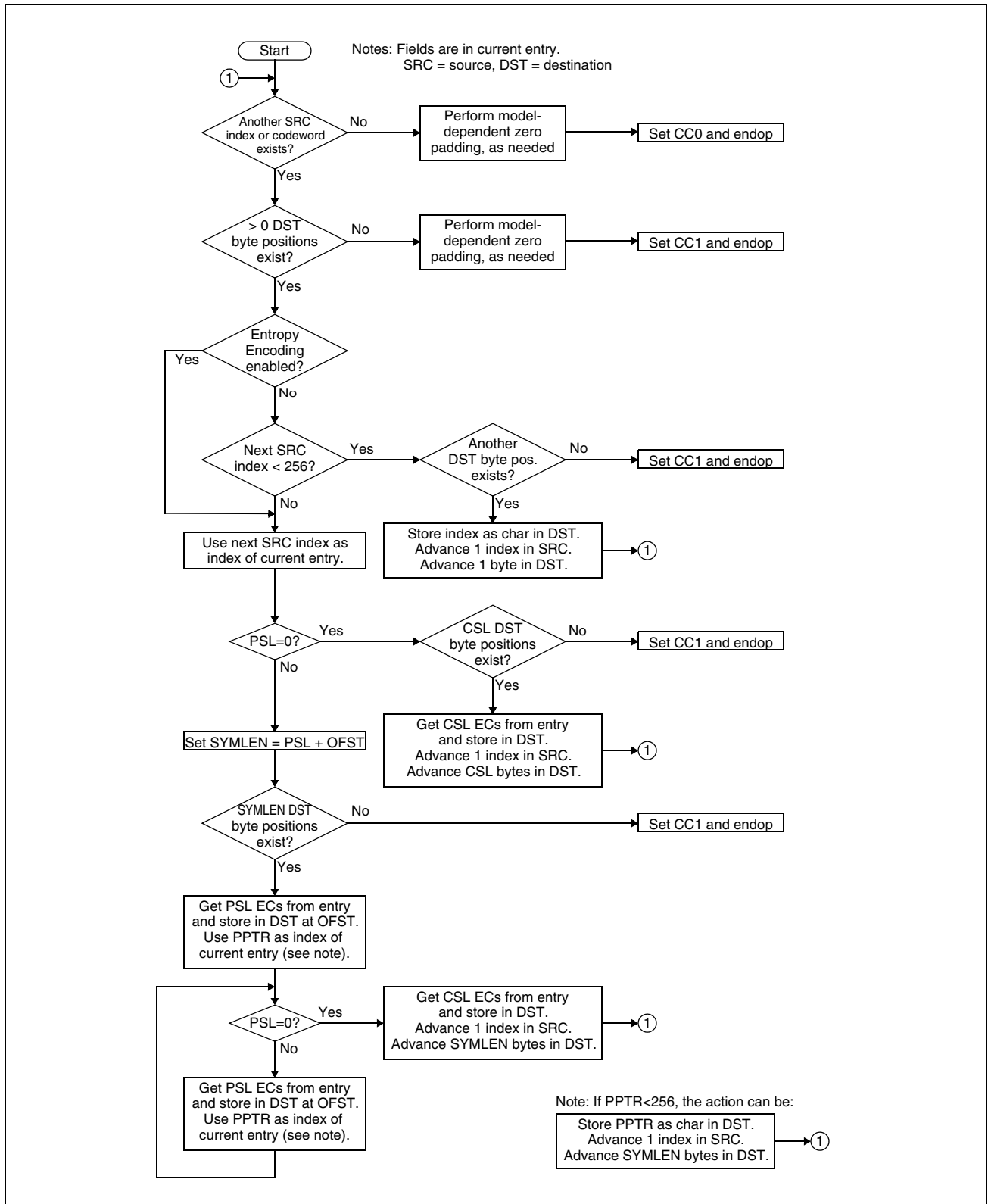

Figure 7-203. Expansion Process

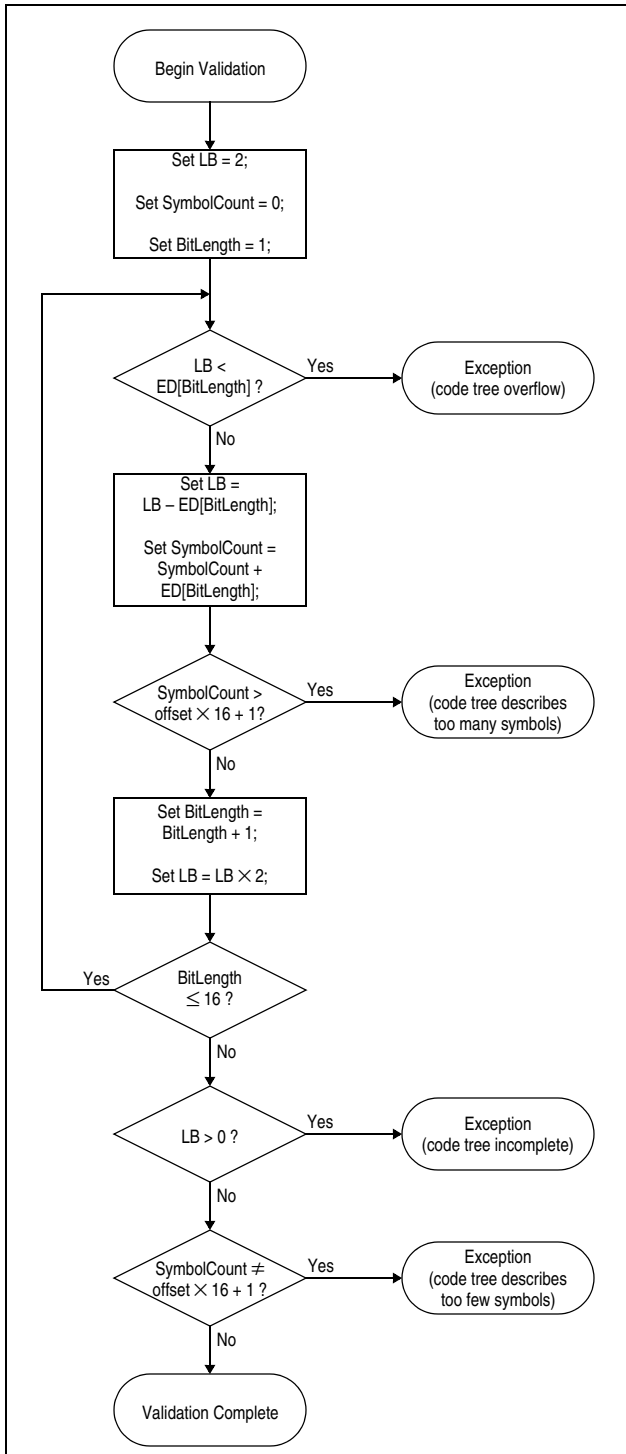

Figure 7-204. Entropy Descriptor Validation

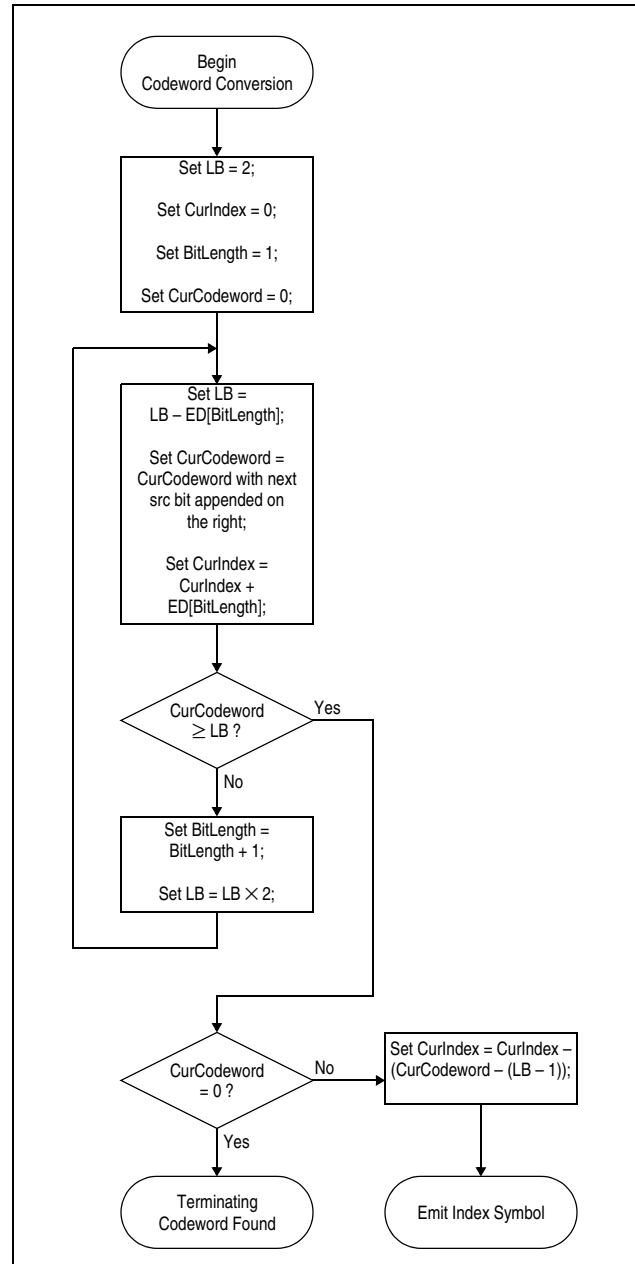

Figure 7-205. Entropy Encoded Expansion

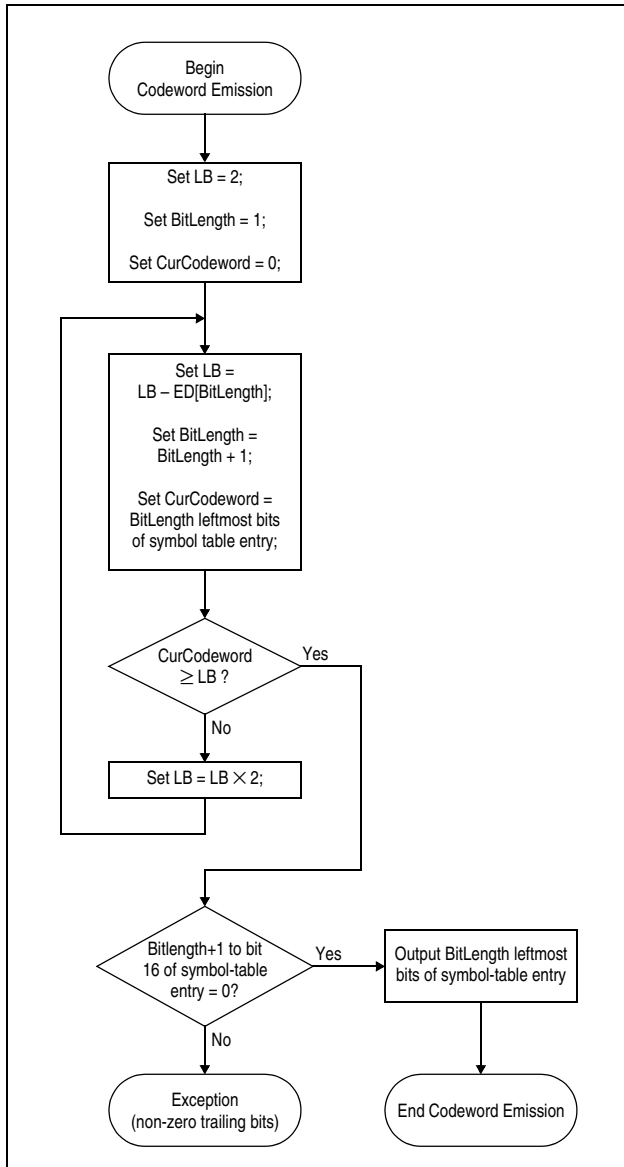
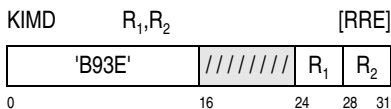

Figure 7-206. Entropy Encoded Compression

COMPUTE INTERMEDIATE MESSAGE DIGEST



A function specified by the function code in general register 0 is performed.

Bits 16-23 of the instruction and the R₁ field are reserved and should contain zeros; otherwise, the program may not operate compatibly in the future.

Bit positions 57-63 of general register 0 contain the function code. Figure 7-207 shows the assigned function codes for COMPUTE INTERMEDIATE MESSAGE DIGEST. All other function codes are unassigned. Bit 56 of general register 0 must be zero; otherwise, a specification exception is recognized. All other bits of general register 0 are ignored.

The assigned function codes are enumerated in Figure 7-207. All other function codes are unassigned.

Code	Function	Parm. Block Size (bytes)	Data Block Size (bytes)
0	KIMD-Query *	16	—
1	KIMD-SHA-1 *	20	64
2	KIMD-SHA-256 *	32	64
3	KIMD-SHA-512 *	64	128
32	KIMD-SHA3-224	200	144
33	KIMD-SHA3-256	200	136
34	KIMD-SHA3-384	200	104
35	KIMD-SHA3-512	200	72
36	KIMD-SHAKE-128	200	168
37	KIMD-SHAKE-256	200	136
65	KIMD-GHASH	32	16

Explanation:

- Not applicable
- * Function is also defined in the ESA/390 architectural mode and the ESA/390-compatibility mode. It is unpredictable whether other function codes are available in the ESA/390-compatibility mode.

Figure 7-207. Function Codes for COMPUTE INTERMEDIATE MESSAGE DIGEST

General register 1 contains the logical address of the leftmost byte of the parameter block in storage. In the 24-bit addressing mode, the contents of bit positions 40-63 of general register 1 constitute the address, and the contents of bit positions 0-39 are ignored. In the 31-bit addressing mode, the contents of bit positions 33-63 of general register 1 constitute the address, and the contents of bit positions 0-32 are ignored. In the 64-bit addressing mode, the contents of bit positions 0-63 of general register 1 constitute the address.

The query function provides the means of indicating the availability of the other functions. The contents of general registers R_2 and $R_2 + 1$ are ignored for the query function.

For all other functions, the second operand is processed as specified by the function code using an initial chaining value in the parameter block, and the result replaces the chaining value. For COMPUTE LAST MESSAGE DIGEST, the operation also uses a message bit length in the parameter block. The operation proceeds until the end of the second-operand location is reached or a CPU-determined number of bytes have been processed, whichever occurs first. The result is indicated in the condition code.

The R_2 field designates an even-odd pair of general registers and must designate an even-numbered register other than general register 0; otherwise, a specification exception is recognized.

The location of the leftmost byte of the second operand is specified by the contents of the R_2 general register. The number of bytes in the second-operand location is specified in general register $R_2 + 1$. For all functions except KIMD-query, the number of bytes in general register $R_2 + 1$ must be a multiple of the data block size for the function; otherwise, a specification exception is recognized.

As part of the operation, the address in general register R_2 is incremented by the number of bytes processed from the second operand, and the length in general register $R_2 + 1$ is decremented by the same number. The formation and updating of the address and length is dependent on the addressing mode.

In the 24-bit addressing mode, the contents of bit positions 40-63 of general register R_2 constitute the

address of the second operand, and the contents of bit positions 0-39 are ignored; bits 40-63 of the updated address replace the corresponding bits in general register R_2 , carries out of bit position 40 of the updated address are ignored, and the contents of bit positions 32-39 of general register R_2 are set to zeros. In the 31-bit addressing mode, the contents of bit positions 33-63 of general register R_2 constitute the address of the second operand, and the contents of bit positions 0-32 are ignored; bits 33-63 of the updated address replace the corresponding bits in general register R_2 , carries out of bit position 33 of the updated address are ignored, and the content of bit position 32 of general register R_2 is set to zero. In the 64-bit addressing mode, the contents of bit positions 0-63 of general register R_2 constitute the address of the second operand; bits 0-63 of the updated address replace the contents of general register R_2 and carries out of bit position 0 are ignored.

In both the 24-bit and the 31-bit addressing modes, the contents of bit positions 32-63 of general register $R_2 + 1$ form a 32-bit unsigned binary integer which specifies the number of bytes in the second operand; and the updated value replaces the contents of bit positions 32-63 of general register $R_2 + 1$. In the 64-bit addressing mode, the contents of bit positions 0-63 of general register $R_2 + 1$ form a 64-bit unsigned binary integer which specifies the number of bytes in the second operand; and the updated value replaces the contents of general register $R_2 + 1$.

In the 24-bit or 31-bit addressing mode, the contents of bit positions 0-31 of general registers R_2 and $R_2 + 1$, always remain unchanged.

Figure 7-208 shows the contents of the general registers just described.

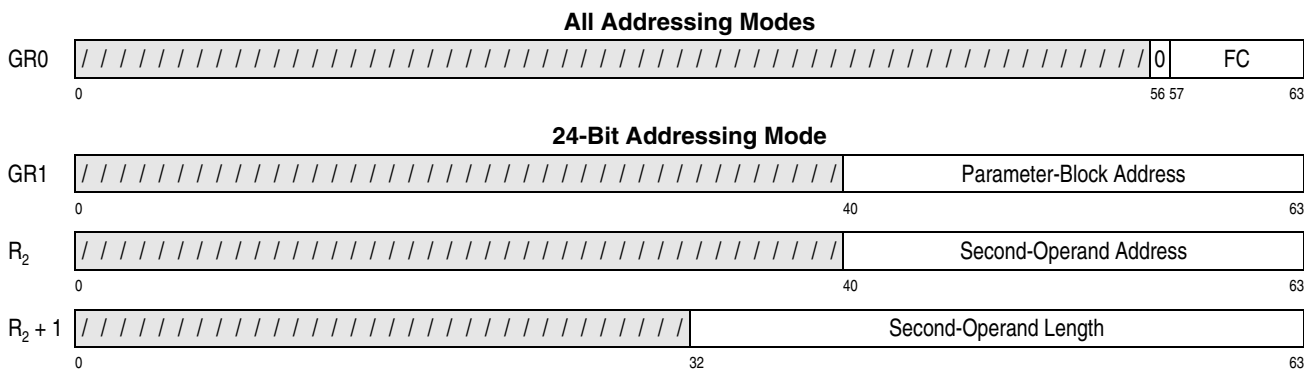

Figure 7-208. General Register Assignment for KIMD and KLMD (Part 1 of 2)

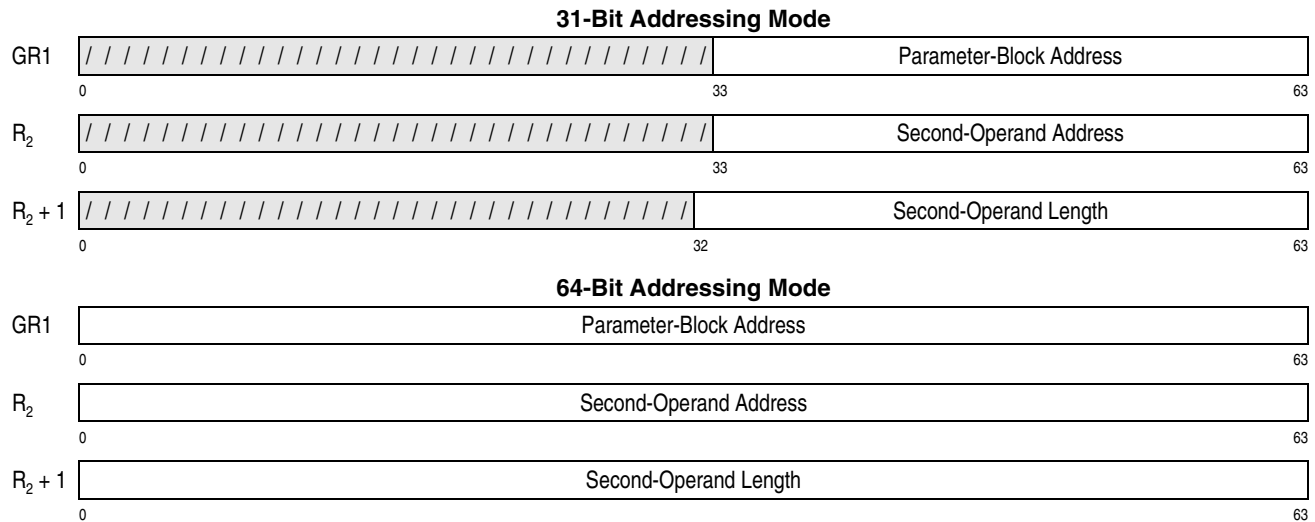

Figure 7-208. General Register Assignment for KIMD and KLMD (Part 2 of 2)

In the access-register mode, access registers 1 and R_2 specify the address spaces containing the parameter block and second operand, respectively.

The result is obtained as if processing starts at the left end of the second operand and proceeds to the right, block by block. The operation is ended when all source bytes in the second operand have been processed (called normal completion), or when a CPU-determined number of blocks that is less than the length of the second operand have been processed (called partial completion). The CPU-determined number of blocks depends on the model, and may be a different number each time the instruction is executed. The CPU-determined number of blocks is usually nonzero. In certain unusual situations, this number may be zero, and condition code 3 may be set with no progress. However, the CPU protects against endless reoccurrence of this no-progress case.

When the chaining-value field overlaps any portion of the second operand, the result in the chaining-value field is unpredictable.

Normal completion occurs when the number of bytes in the second operand as specified in general register $R_2 + 1$ have been processed.

When the operation ends due to normal completion, condition code 0 is set, the second-operand address in general register R_2 is updated, and the second-operand length in $R_2 + 1$ is zero. When the operation

ends due to partial completion, condition code 3 is set and the resulting value in $R_2 + 1$ is nonzero.

When the second-operand length is initially zero, the second operand is not accessed, the second-operand address and second-operand length in general registers R_2 and $R_2 + 1$, respectively, are not changed, and condition code 0 is set. The parameter block is not accessed.

A PER storage-alteration event is recognized, when applicable, for the portion of the parameter block that is stored. A PER zero-address-detection event is recognized, when applicable, for the second-operand location and for the parameter block. When PER events are detected for more than one location, it is unpredictable which location is identified in the PER access identification (PAID) and PER ASCE ID (AI).

As observed by this CPU, other CPUs, and channel programs, references to the parameter block and storage operands may be multiple-access references, accesses to these storage locations are not necessarily block-concurrent, and the sequence of these accesses or references is undefined.

Access exceptions may be reported for a larger portion of the second operand than is processed in a single execution of the instruction; however, access exceptions are not recognized for locations beyond the length of the second operand nor for locations more than 4K bytes beyond the current location being processed.

Symbols Used in Function Descriptions

The following symbols are used in the subsequent description of the COMPUTE INTERMEDIATE MESSAGE DIGEST and COMPUTE LAST MESSAGE DIGEST functions. Further description of the secure hash algorithm may be found in Reference [15.] on page xxx. Further description of the GCM (Galois/counter mode) multiplication over $GF(2^{128})$ may be found in Reference [17.] on page xxx. Further description of the SHA-3 and SHAKE hash algorithms and the KECCAK family of sponge functions may be found in Reference [21.] on page xxx.

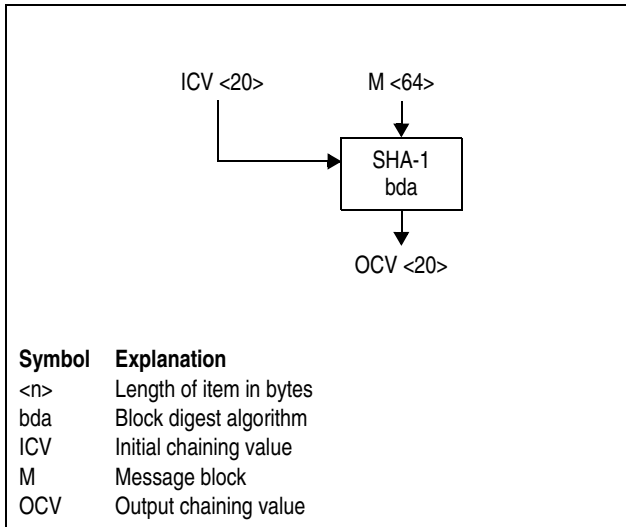

Figure 7-209. Symbol for SHA-1 Block Digest Algorithm

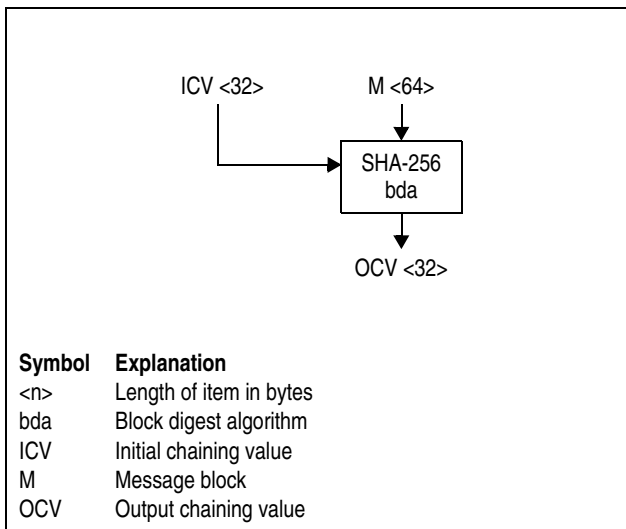

Figure 7-210. Symbol for SHA-256 Block Digest Algorithm

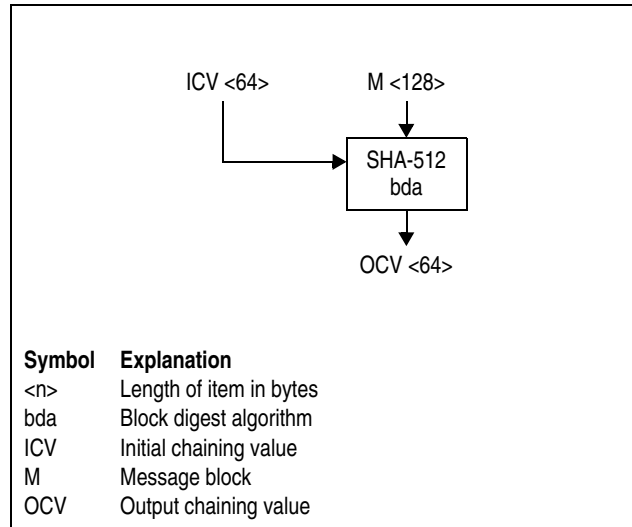

Figure 7-211. Symbol for SHA-512 Block Digest Algorithm

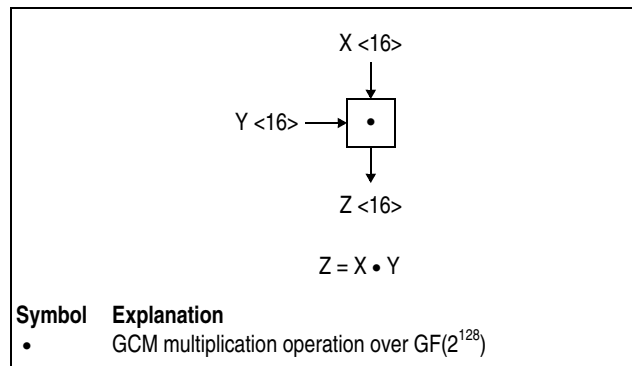

Figure 7-212. Symbol For GCM Multiplication Operation Over $GF(2^{128})$

KIMD-Query (KIMD Function Code 0)

The locations of the operands and addresses used by the instruction are as shown in Figure 7-208 on page 7-188.

The parameter block used for the function has the following format:

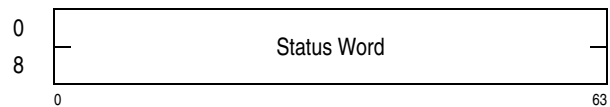

Figure 7-213. Parameter Block for KIMD-Query

A 128-bit status word is stored in the parameter block. Bits 0-127 of this field correspond to function codes 0-127, respectively, of the COMPUTE INTERMEDIATE MESSAGE DIGEST instruction. When a bit is one, the corresponding function is installed; otherwise, the function is not installed.

Condition code 0 is set when execution of the KIMD-Query function completes; condition code 3 is not applicable to this function.

KIMD-SHA-1 (KIMD Function Code 1)

The locations of the operands and addresses used by the instruction are as shown in Figure 7-208 on page 7-188.

The parameter block used for the function has the following format:

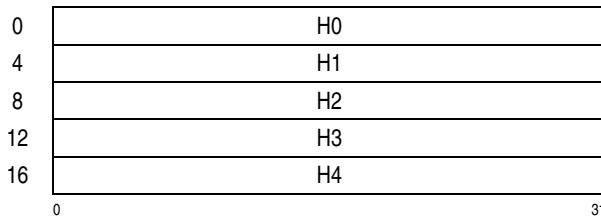

Figure 7-214. Parameter Block for KIMD-SHA-1

A 20-byte intermediate message digest is generated for the 64-byte message blocks in operand 2 using the SHA-1 block digest algorithm with the 20-byte chaining value (called H fields) in the parameter block. The generated intermediate message digest, also called the output chaining value (OCV), is stored in the chaining-value field of the parameter block. The operation is shown in Figure 7-215.

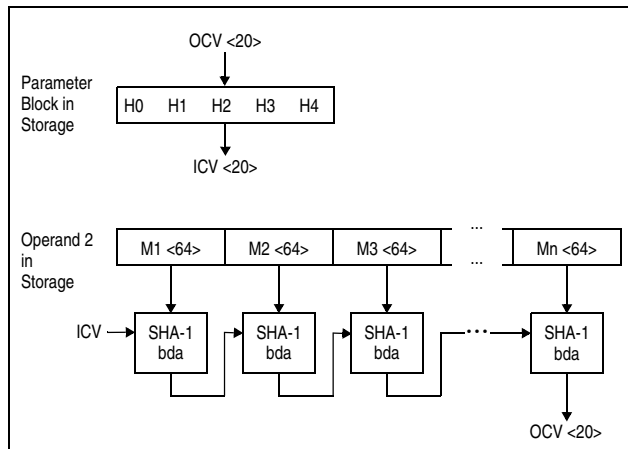

Figure 7-215. KIMD-SHA-1

KIMD-SHA-256 (KIMD Function Code 2)

The locations of the operands and addresses used by the instruction are as shown in Figure 7-208 on page 7-188.

The parameter block used for the function has the following format:

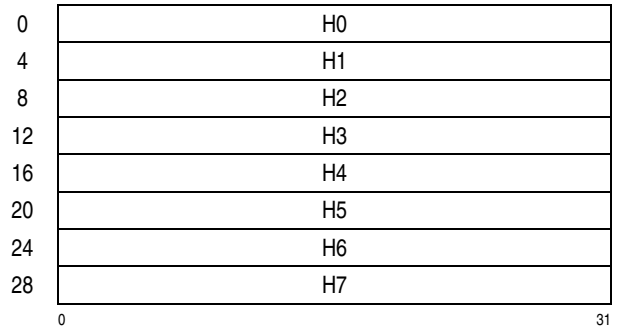

Figure 7-216. Parameter Block for KIMD-SHA-256

A 32-byte intermediate message digest is generated for the 64-byte message blocks in operand 2 using the SHA-256 block digest algorithm with the 32-byte chaining value (called H fields) in the parameter block. The generated intermediate message digest, also called the output chaining value (OCV), is stored in the chaining-value field of the parameter block. The operation is shown in Figure 7-217.

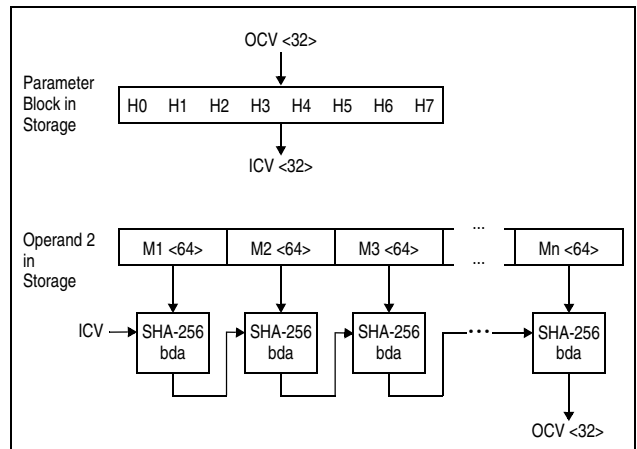

Figure 7-217. KIMD-SHA-256

KIMD-SHA-512 (KIMD Function Code 3)

The locations of the operands and addresses used by the instruction are as shown in Figure 7-208 on page 7-188.

The parameter block used for the function has the following format:

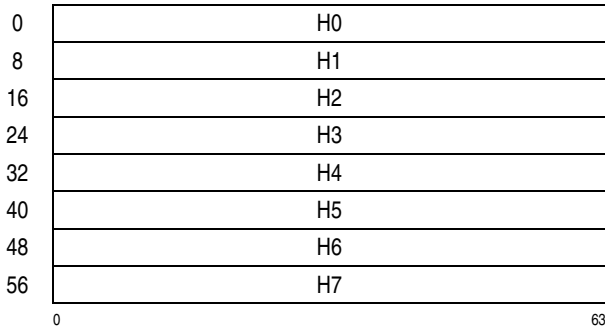

Figure 7-218. Parameter Block for KIMD-SHA-512

A 64-byte intermediate message digest is generated for the 128-byte message blocks in operand 2 using the SHA-512 block digest algorithm with the 64-byte chaining value (called H fields) in the parameter block. The generated intermediate message digest, also called the output chaining value (OCV), is stored in the chaining-value field of the parameter block. The operation is shown in Figure 7-219.

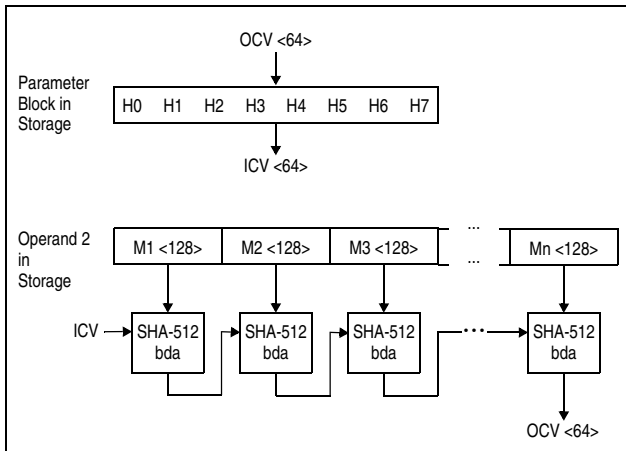

Figure 7-219. KIMD-SHA-512

KIMD-SHA3-224 (KIMD Function Code 32)

The locations of the operands and addresses used by the instruction are as shown in Figure 7-208 on page 7-188.

The parameter block used for the function has the following format:

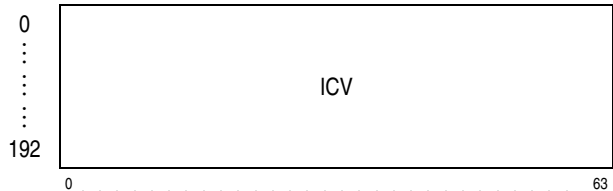

Figure 7-220. Parameter Block for KIMD-SHA3-224

The initial chaining value (ICV) represents the 1600-bit state array used by the KECCAK[c] functions which implement the SHA-3 algorithms described in Reference [21.] on page xxx.

A 200-byte intermediate message digest is generated for the 144-byte message blocks in operand 2 using the KECCAK[c] algorithm with the 200-byte initial chaining value in the parameter block. The generated intermediate message digest, also called the output chaining value (OCV), is stored in the chaining-value field of the parameter block. See programming note 10 on page 7-199 regarding the numbering of the bits in the parameter block and second operand as compared with the numbering of the bits in the state array.

The operation is shown in Figure 7-221.

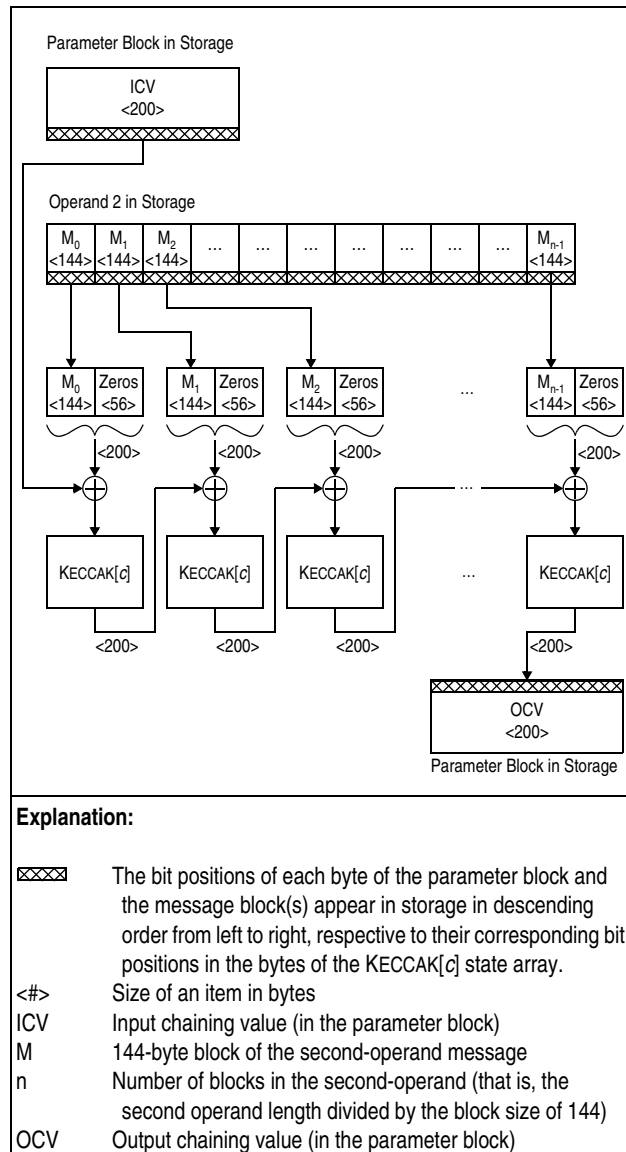

Figure 7-221. KIMD-SHA3-224 Processing

KIMD-SHA3-256 (KIMD Function Code 33)

The locations of the operands and addresses used by the instruction are as shown in Figure 7-208 on page 7-188.

The parameter block used for the function has the following format:

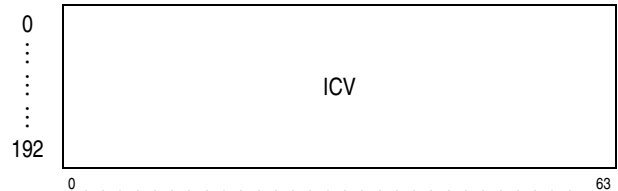
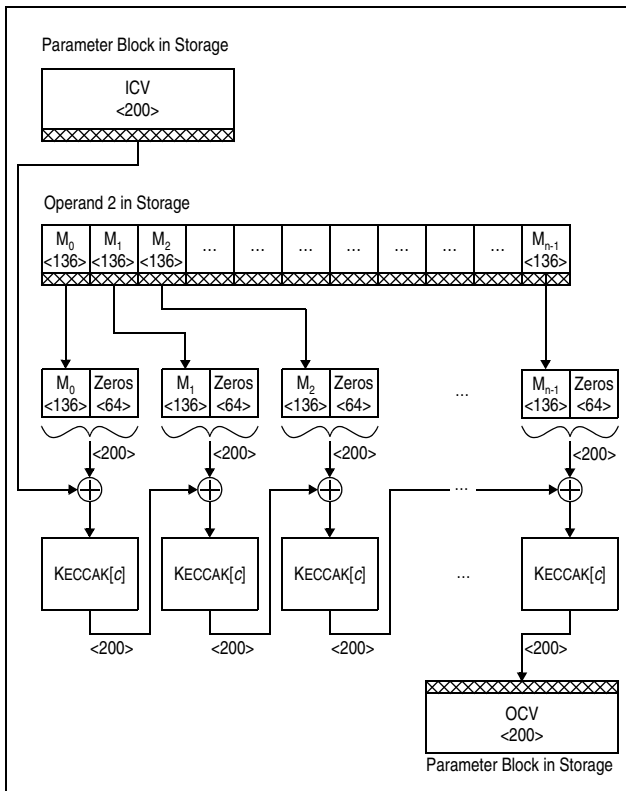

Figure 7-222. Parameter Block for KIMD-SHA3-256

The initial chaining value (ICV) represents the 1600-bit state array used by the KECCAK[c] functions which implement the SHA-3 algorithms described in Reference [21.] on page xxx.

A 200-byte intermediate message digest is generated for the 136-byte message blocks in operand 2 using the KECCAK[c] algorithm with the 200-byte initial chaining value in the parameter block. The generated intermediate message digest, also called the output chaining value (OCV), is stored in the chaining-value field of the parameter block. See programming note 10 on page 7-199 regarding the numbering of the bits in the parameter block and second operand as compared with the numbering of the bits in the state array.

The operation is shown in Figure 7-223.



Explanation:

- ⊗ The bit positions of each byte of the parameter block and the message block(s) appear in storage in descending order from left to right, respective to their corresponding bit positions in the bytes of the KECCAK[c] state array.
- ⊕ Bitwise exclusive-OR operation
- <#> Size of an item in bytes
- ICV Input chaining value (in the parameter block)
- M 136-byte block of the second-operand message
- n Number of blocks in the second-operand (that is, the second operand length divided by the block size of 136)
- OCV Output chaining value (in the parameter block)

Figure 7-223. KIMD-SHA3-256 Processing

KIMD-SHA3-384 (KIMD Function Code 34)

The locations of the operands and addresses used by the instruction are as shown in Figure 7-208 on page 7-188.

The parameter block used for the function has the following format:

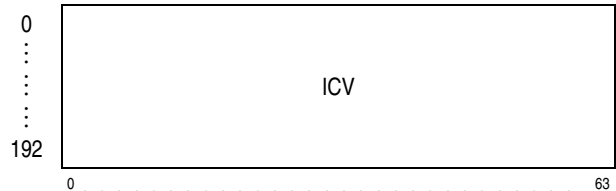

Figure 7-224. Parameter Block for KIMD-SHA3-384

The initial chaining value (ICV) represents the 1600-bit state array used by the KECCAK[c] functions which implement the SHA-3 algorithms described in Reference [21.] on page xxx.

A 200-byte intermediate message digest is generated for the 104-byte message blocks in operand 2 using the KECCAK[c] algorithm with the 200-byte initial chaining value in the parameter block. The generated intermediate message digest, also called the output chaining value (OCV), is stored in the chaining-value field of the parameter block. See programming note 10 on page 7-199 regarding the numbering of the bits in the parameter block and second operand as compared with the numbering of the bits in the state array.

The operation is shown in Figure 7-225.

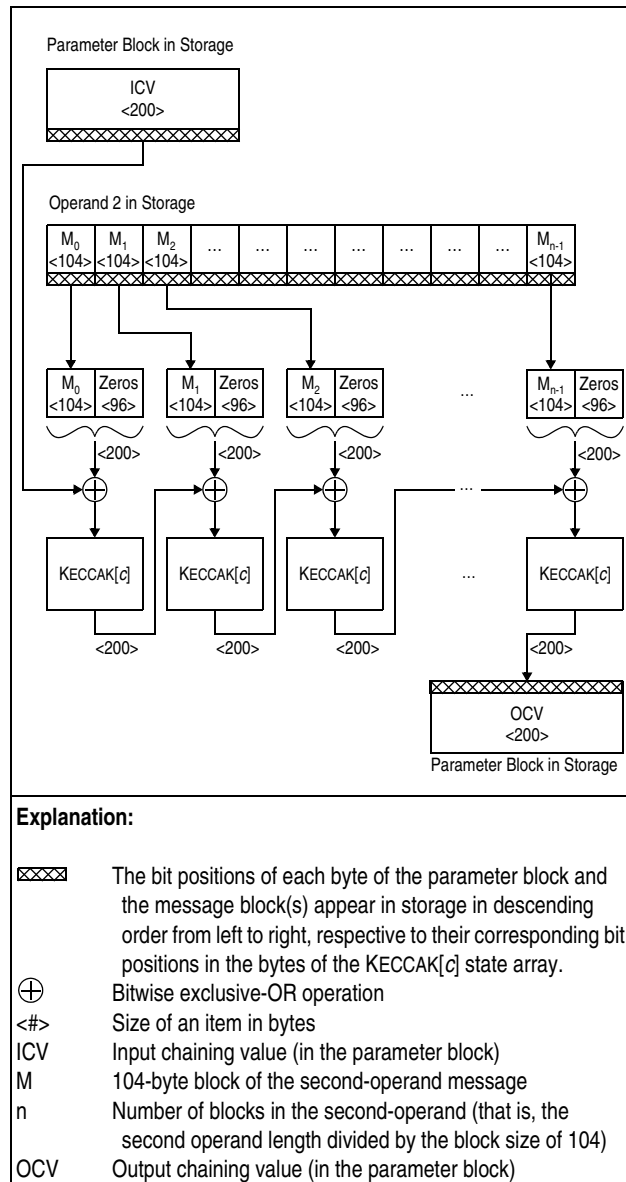

Figure 7-225. KIMD-SHA3-384 Processing

KIMD-SHA3-512 (KIMD Function Code 35)

The locations of the operands and addresses used by the instruction are as shown in Figure 7-208 on page 7-188.

The parameter block used for the function has the following format:

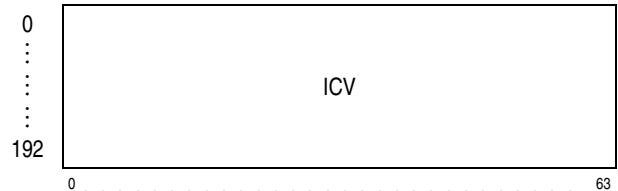
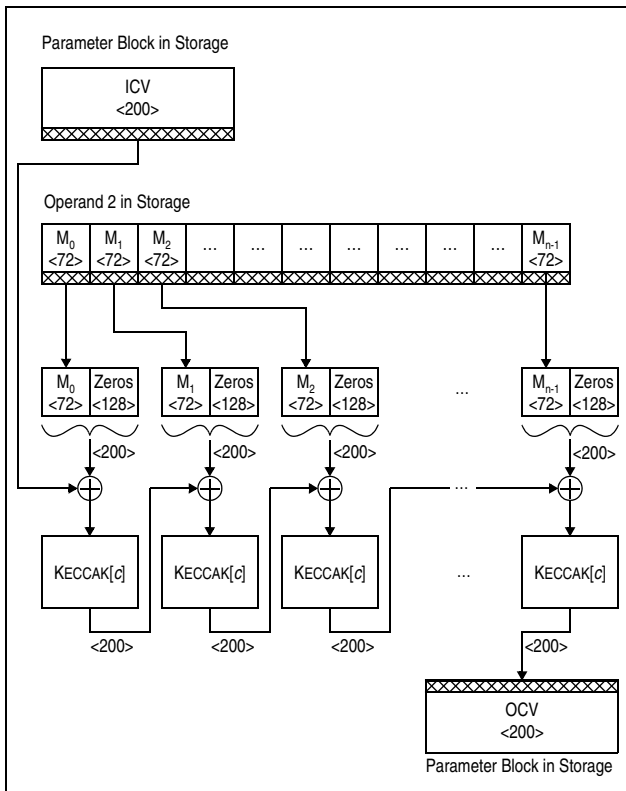

Figure 7-226. Parameter Block for KIMD-SHA3-512

The initial chaining value (ICV) represents the 1600-bit state array used by the KECCAK[c] functions which implement the SHA-3 algorithms described in Reference [21.] on page xxx.

A 200-byte intermediate message digest is generated for the 72-byte message blocks in operand 2 using the KECCAK[c] algorithm with the 200-byte initial chaining value in the parameter block. The generated intermediate message digest, also called the output chaining value (OCV), is stored in the chaining-value field of the parameter block. See programming note 10 on page 7-199 regarding the numbering of the bits in the parameter block and second operand as compared with the numbering of the bits in the state array.

The operation is shown in Figure 7-227.



Explanation:

- ⊗ The bit positions of each byte of the parameter block and the message block(s) appear in storage in descending order from left to right, respective to their corresponding bit positions in the bytes of the KECCAK[c] state array.
- ⊕ Bitwise exclusive-OR operation
- <#> Size of an item in bytes
- ICV Input chaining value (in the parameter block)
- M 72-byte block of the second-operand message
- n Number of blocks in the second-operand (that is, the second operand length divided by the block size of 72)
- OCV Output chaining value (in the parameter block)

Figure 7-227. KIMD-SHA3-512 Processing

KIMD-SHAKE-128 (KIMD Function Code 36)

The locations of the operands and addresses used by the instruction are as shown in Figure 7-208 on page 7-188.

The parameter block used for the function has the following format:

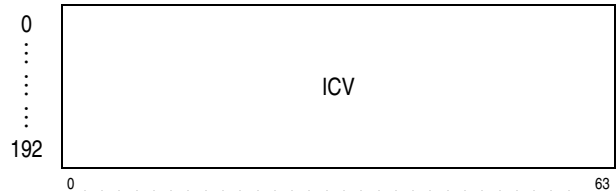

Figure 7-228. Parameter Block for KIMD-SHAKE-128

The initial chaining value (ICV) represents the 1600-bit state array used by the KECCAK[c] functions which implement the SHAKE algorithms described in Reference [21.] on page xxx.

A 200-byte intermediate message digest is generated for the 168-byte message blocks in operand 2 using the KECCAK[c] algorithm with the 200-byte initial chaining value in the parameter block. The generated intermediate message digest, also called the output chaining value (OCV), is stored in the chaining-value field of the parameter block. See programming note 10 on page 7-199 regarding the numbering of the bits in the parameter block and second operand as compared with the numbering of the bits in the state array.

The operation is shown in Figure 7-229.

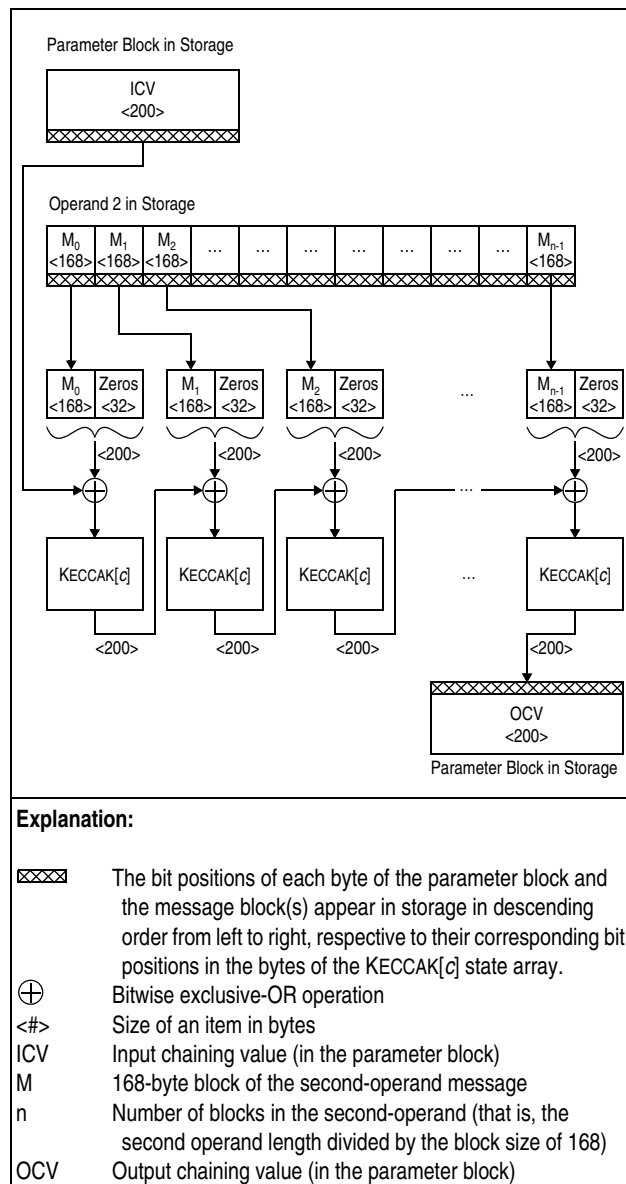

Figure 7-229. KIMD-SHAKE-128 Processing

KIMD-SHAKE-256 (KIMD Function Code 37)

The operands, addresses, parameter-block format, and operation of the KIMD-SHAKE-256 function are identical to those of the KIMD-SHA3-256 function.

Note: A separate function code for KIMD-SHAKE-256 is defined to retain symmetry with the KLMD functions (where the operation of KLMD-SHAKE-256 differs from that of KLMD-SHA3-256).

KIMD-GHASH (Function Code 65)

The locations of the operands and addresses used by the instruction are as shown in Figure 7-208 on page 7-188.

The parameter block used for the KIMD-GHASH function has the following format:

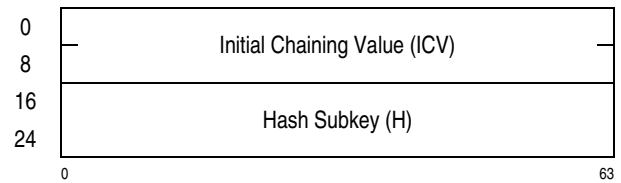

Figure 7-230. Parameter Block for KIMD-GHASH

The initial-chaining value is in byte offsets 0-15 of the parameter block, and the hash subkey is in byte offsets 16-31 of the parameter block.

The GHASH for the 16-byte message blocks (M1, M2, ..., Mn) in operand 2 is computed using the hash subkey and the 128-bit chaining value.

The first message block is exclusive-ORed with the initial chaining value (ICV) in the parameter block. The result of the exclusive-OR operation and the hash subkey (H) are multiplied using a Galois/counter-mode (GCM) multiplication operation over a Galois field ($GF(2^{128})$) to produce the chaining value for the next message block. The process is repeated until all message blocks have been processed, or until a CPU-determined number of message blocks have been processed.

The GHASH, called the output chaining value (OCV), is stored into the Initial-chaining-value field of the parameter block. The operation is shown in Figure 7-231 on page 7-197.

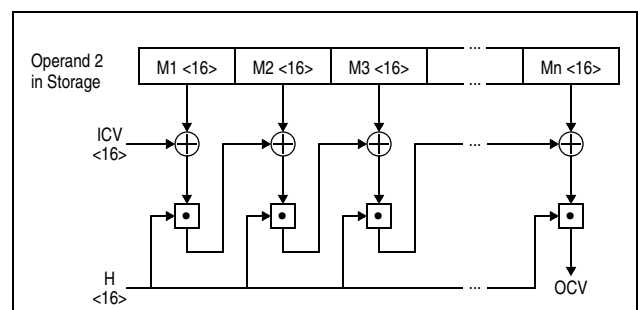

Figure 7-231. KIMD-GHASH

Special Conditions

A specification exception is recognized and no other action is taken if any of the following occurs:

1. Bit 56 of general register 0 is not zero.
2. Bits 57-63 of general register 0 specify an unassigned or uninstalled function code.
3. The R_2 field designates an odd-numbered register or general register 0.
4. The second-operand length is not a multiple of the data block size of the designated function (see Figure 7-207 on page 7-187 for COMPUTE INTERMEDIATE MESSAGE DIGEST functions).

Resulting Condition Code:

- 0 Normal completion
- 1 --
- 2 --
- 3 Partial completion

Program Exceptions:

- Access (fetch, operand 2 and message bit length; fetch and store, chaining value)
- Operation (if the message-security assist is not installed)
- Specification
- Transaction constraint

1.-6.	Exceptions with the same priority as the priority of program-interruption conditions for the general case.
7.A	Access exceptions for second instruction halfword.
7.B	Operation exception.
7.C	Transaction constraint
8.	Specification exception due to invalid function code or invalid register number.
9.	Specification exception due to invalid operand length.
10.	Condition code 0 due to second-operand length originally zero.
11.	Access exceptions for an access to the parameter block or second operand.

Figure 7-232. Priority of Execution: KIMD

12.	Condition code 0 due to normal completion (second-operand length originally nonzero, but stepped to zero).
13.	Condition code 3 due to partial completion (second-operand length still nonzero).

Figure 7-232. Priority of Execution: KIMD

Programming Notes:

1. The performance of the query function (code 0) may be significantly slower than that of simply examining a location in storage. If the program needs to frequently test for the availability of a function, it should perform the query function once during initialization; subsequently it should examine the stored results of the query function in memory with an instruction such as TEST UNDER MASK.
2. Bit 56 of general register 0 is reserved for future extension and should be set to zero.
3. When condition code 3 is set, the second operand address and length in general registers R_2 and $R_2 + 1$, respectively, and the chaining-value in the parameter block are usually updated such that the program can simply branch back to the instruction to continue the operation.

For unusual situations, the CPU protects against endless reoccurrence for the no-progress case. Thus, the program can safely branch back to the instruction whenever condition code 3 is set with no exposure to an endless loop.
4. If the length of the second operand is nonzero initially and condition code 0 is set, the registers are updated in the same manner as for condition code 3; the chaining value in this case is such that additional operands can be processed as if they were part of the same chain.
5. The instructions COMPUTE INTERMEDIATE MESSAGE DIGEST and COMPUTE LAST MESSAGE DIGEST are designed to be used by a security service application programming interface (API). These APIs provide the program with means to compute the digest of messages of almost unlimited size, including those too large to fit in storage all at once. This is accomplished by permitting the program to pass the message to the API in parts. The following programming notes are described in terms of these APIs.

6. Before processing the first part of a message, the program must set the initial values for the chaining-value field. For SHA-1, the initial hexadecimal chaining values are listed as follows:

```
H0 = 6745 2301
H1 = EFCF AB89
H2 = 98BA DCFE
H3 = 1032 5476
H4 = C3D2 E1F0
```

For SHA-256, the initial hexadecimal chaining values are listed as follows:

```
H0 = 6A09 E667
H1 = BB67 AE85
H2 = 3C6E F372
H3 = A54F F53A
H4 = 510E 527F
H5 = 9B05 688C
H6 = 1F83 D9AB
H7 = 5BE0 CD19
```

For SHA-512, the initial hexadecimal chaining value are listed as follows:

```
H0 = 6A09 E667 F3BC C908
H1 = BB67 AE85 84CA A73B
H2 = 3C6E F372 FE94 F82B
H3 = A54F F53A 5F1D 36F1
H4 = 510E 527F ADE6 82D1
H5 = 9B05 688C 2B3E 6C1F
H6 = 1F83 D9AB FB41 BD6B
H7 = 5BE0 CD19 137E 2179
```

For the SHA3 and SHAKE functions, the initial chaining value must be set to all zeros.

7. When computing a message digest, the program may not initially be aware of the total message-bit length; for example, for a message being read from an I/O device, the message-bit length may not be known until the final block is read. When computing a message digest for a message whose length is not known, or for a message where it is known that the last message block is not included in the calculation, COMPUTE INTERMEDIATE MESSAGE DIGEST may be used. When computing a message digest for a message that includes the last block, COMPUTE LAST MESSAGE DIGEST must be used.
8. The SHA-224 algorithm is the same as the SHA-256 algorithm, except that the initial chaining values and the final message digest lengths are different. The program may obtain the SHA-224

message digest using the SHA-256 functions with the following two actions:

- a. The following initial hexadecimal chaining values for SHA-224 are used:

```
H0 = C105 9ED8
H1 = 367C D507
H2 = 3070 DD17
H3 = F70E 5939
H4 = FFC0 0B31
H5 = 6858 1511
H6 = 64F9 8FA7
H7 = BEFA 4FA4
```

- b. The 224-bit message digest is obtained by truncating the final message digest to its leftmost 224 bits.

9. The SHA-384 algorithm is the same as the SHA-512 algorithm, except that the initial chaining values and the final message digest lengths are different. The program may obtain the SHA-384 message digest using the SHA-512 functions with the following two actions:

- a. The following initial hexadecimal chaining values for SHA-384 are used:

```
H0 = CBBB 9D5D C105 9ED8
H1 = 629A 292A 367C D507
H2 = 9159 015A 3070 DD17
H3 = 152F ECD8 F70E 5939
H4 = 6733 2667 FFC0 0B31
H5 = 8EB4 4A87 6858 1511
H6 = DB0C 2E0D 64F9 8FA7
H7 = 47B5 481D BEFA 4FA4
```

- b. The 384-bit message digest is obtained by truncating the final message digest to its leftmost 384 bits.

10. For the SHA3 and SHAKE functions (for both KIMD and KLMD), the KECCAK[c] algorithm uses a 1,600-bit state array in the parameter block. The state array comprises 25 lanes having 64 bits each. The bits of the state array are numbered from 0 to from 1,599, and the bits of each lane are numbered from 0 to 63.

In the parameter block, the bytes of the state array appear in ascending order from left-to-right; but within each byte, the bits appear in descending order from left to right. That is, byte 0 of the parameter block contains (from left to right) bits 7, 6, 5, 4, 3, 2, 1, and 0 of the state array; byte 1

contains bits 15, 14, 13, 12, 11, 10, 9 and 8 of the state array; and so forth. When represented in memory, the bit positions of any individual lane of the state array correspond to powers of two, as shown below.

Byte	0								1								6								7									
Lane Bit	7	6	5	4	3	2	1	0	15	14	13	12	11	10	9	8	...	5	4	3	2	1	0	4	3	2	1	0	5	4	3	2	1	0

The bit ordering of the parameter block described above also applies to the message bytes of the second operand. For the KLMD-SHAKE functions, the results stored in the first operand are similar to that of the parameter block in that the left-to-right ordering of bits within each byte is 7, 6, 5, 4, 3, 2, 1, and 0.

- For the GHASH function, the hash subkey, H, is the result of encrypting a 128-bit zero using the AES encryption algorithm with a 128-bit, 192-bit, or 256-bit cryptographic key.

COMPUTE LAST MESSAGE DIGEST

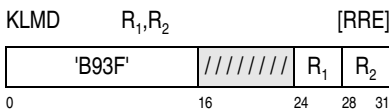

A function specified by the function code in general register 0 is performed.

Bits 16-23 of the instruction are reserved, and for all functions except KLMD-SHAKE-128 and KLMD-SHAKE-256, the R_1 field is reserved. Reserved fields should contain zeros; otherwise, the program may not operate compatibly in the future.

Bit positions 57-63 of general register 0 contain the function code. Figure 7-233 show the assigned function codes. All other function codes are unassigned. Bit 56 of general register 0 must be zero; otherwise, a specification exception is recognized. For the KLMD-SHAKE functions, bit 55 of general register 0 is the padding state; bit 55 of the register is ignored for all other functions. All other bits of general register 0 are ignored.

The assigned function codes are enumerated in Figure 7-233. All other function codes are unassigned.

Code	Function	Parm. Block Size (bytes)	Data Block Size ¹ (bytes)
0	KLMD-Query *	16	—
1	KLMD-SHA-1 *	28	64
2	KLMD-SHA-256 *	40	64
3	KLMD-SHA-512 *	80	128
32	KLMD-SHA3-224	200	144
33	KLMD-SHA3-256	200	136
34	KLMD-SHA3-384	200	104
35	KLMD-SHA3-512	200	72
36	KLMD-SHAKE-128	200	168
37	KLMD-SHAKE-256	200	136

Explanation:

— Not applicable

¹ For all data blocks except the last block. The size of the last data block ranges from 0 to one less than the value shown.

* Function is also defined in the ESA/390 architectural mode and the ESA/390-compatibility mode. It is unpredictable whether other function codes are available in the ESA/390-compatibility mode.

Figure 7-233. Function Codes for COMPUTE LAST MESSAGE DIGEST

General register 1 contains the logical address of the leftmost byte of the parameter block in storage. In the 24-bit addressing mode, the contents of bit positions 40-63 of general register 1 constitute the address, and the contents of bit positions 0-39 are ignored. In the 31-bit addressing mode, the contents of bit positions 33-63 of general register 1 constitute the address, and the contents of bit positions 0-32 are ignored. In the 64-bit addressing mode, the contents of bit positions 0-63 of general register 1 constitute the address.

The query function provides the means of indicating the availability of the other functions. The contents of general registers R_1 , $R_1 + 1$, R_2 and $R_2 + 1$ are ignored for the query function.

For all other functions, the second operand is processed as specified by the function code using an ini-

tial chaining value in the parameter block, and the result replaces the chaining value. For the SHA-1, SHA-256, and SHA-512 functions, the operation also uses a message bit length in the parameter block. The operation proceeds until the end of the second-operand location is reached or a CPU-determined number of bytes have been processed, whichever occurs first.

For the KLMD-SHAKE functions, when the end of the second operand is reached, an extended-output-function (XOF) digest is stored at the first operand location. The operation then proceeds until either the end of the first-operand location is reached or a CPU-determined number of bytes have been stored, whichever occurs first.

The result is indicated in the condition code.

The R_2 field designates an even-odd pair of general registers and must designate an even-numbered register other than general register 0; otherwise, a specification exception is recognized.

The location of the leftmost byte of the second operand is specified by the contents of the R_2 general register. The number of bytes in the second-operand location is specified in general register $R_2 + 1$.

As part of the operation, the address in general register R_2 is incremented by the number of bytes processed from the second operand, and the length in general register $R_2 + 1$ is decremented by the same number. The formation and updating of the address and length is dependent on the addressing mode.

In the 24-bit addressing mode, the contents of bit positions 40-63 of general register R_2 constitute the address of the second operand, and the contents of bit positions 0-39 are ignored; bits 40-63 of the updated address replace the corresponding bits in general register R_2 , carries out of bit position 40 of the updated address are ignored, and the contents of bit positions 32-39 of general register R_2 are set to zeros. In the 31-bit addressing mode, the contents of bit positions 33-63 of general register R_2 constitute the address of the second operand, and the contents of bit positions 0-32 are ignored; bits 33-63 of the updated address replace the corresponding bits in general register R_2 , carries out of bit position 33 of the updated address are ignored, and the content of bit position 32 of general register R_2 is set to zero. In the 64-bit addressing mode, the contents of bit positions 0-63 of general register R_2 constitute the

address of the second operand; bits 0-63 of the updated address replace the contents of general register R_2 and carries out of bit position 0 are ignored.

In both the 24-bit and the 31-bit addressing modes, the contents of bit positions 32-63 of general register $R_2 + 1$ form a 32-bit unsigned binary integer which specifies the number of bytes in the second operand; and the updated value replaces the contents of bit positions 32-63 of general register $R_2 + 1$. In the 64-bit addressing mode, the contents of bit positions 0-63 of general register $R_2 + 1$ form a 64-bit unsigned binary integer which specifies the number of bytes in the second operand; and the updated value replaces the contents of general register $R_2 + 1$.

In the 24-bit or 31-bit addressing mode, the contents of bit positions 0-31 of general registers R_2 and $R_2 + 1$, always remain unchanged.

For the two KLMD-SHAKE functions, the following applies:

- Bit 55 of general register 0 is the padding state (PS). A value of zero indicates that padding of the second operand has not yet been performed. A value of one indicates that padding of the second operand has been performed.

A specification exception is recognized, and the operation is suppressed when the padding state is one and the second-operand length in general register $R_2 + 1$ is nonzero at the beginning of the instruction.

When the remaining second-operand length is zero, the CPU inspects the padding state to determine whether padding of the second operand is to be performed. The padding state is set to one by the CPU when padding of the second operand has been performed.

- The R_1 field designates an even-odd pair of general registers and must designate an even-numbered register other than general register 0 and other than general register R_2 ; otherwise a specification exception is recognized.
- The location of the leftmost byte of the first operand is specified by the contents of general register R_1 . The number of bytes in the first-operand location is specified in general register $R_1 + 1$.
- As a part of the operation, the address in general register R_1 is incremented by the number of

bytes stored into the first operand, and the length in general register $R_1 + 1$ is decremented by the same number. The formation and updating of the address and length is dependent on the addressing mode.

- The addressing-mode characteristics for general registers R_1 and $R_1 + 1$ are identical to those for general registers R_2 and $R_2 + 1$, respectively, as described above.

For functions other than the two KLMD-SHAKE functions, bit 55 of general register 0 and the R_1 field of the instruction are ignored. In this case, a first operand is not present, and general registers R_1 and $R_1 + 1$ are not modified.

Figure 7-234 shows the contents of the general registers just described.

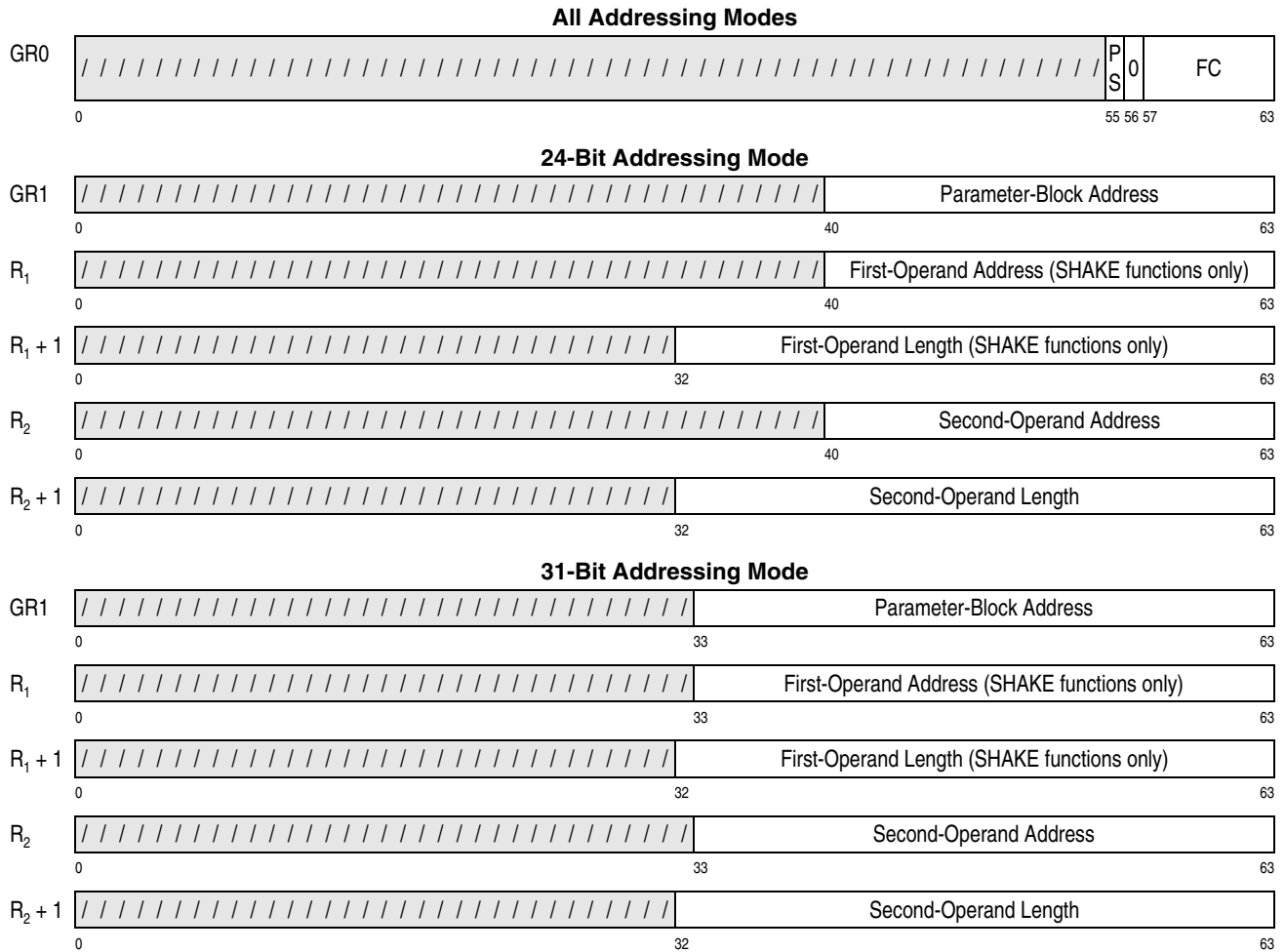

Figure 7-234. General Register Assignment for KLMD (Part 1 of 2)

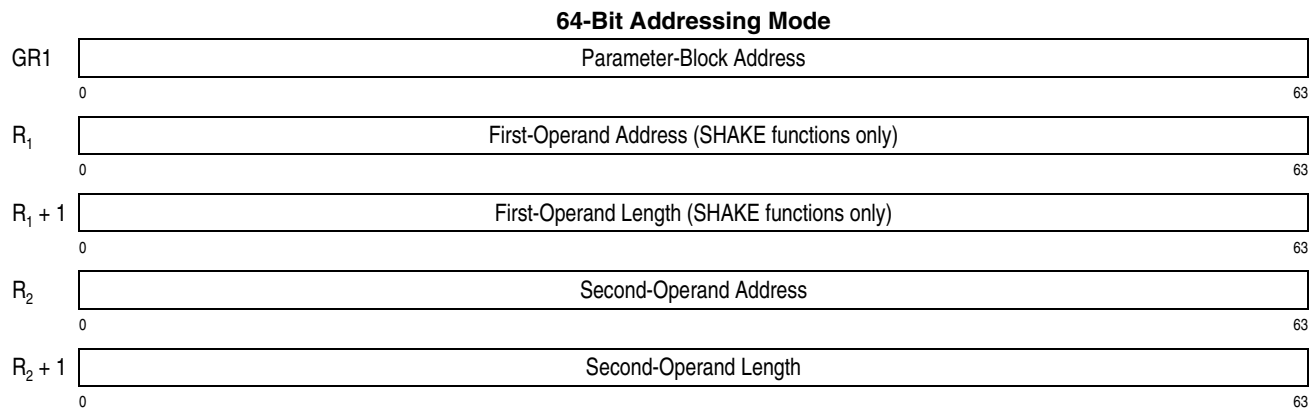

Figure 7-234. General Register Assignment for KLMD (Part 2 of 2)

In the access-register mode, access registers 1 and R₂ specify the address spaces containing the parameter block and second operand, respectively. For the KLMD-SHAKE functions, access register R₁ specifies the address space containing the first operand.

The result is obtained as if processing starts at the left end of the second operand and proceeds to the right, block by block. For all functions except the KLMD-SHAKE functions, the operation is ended when all source bytes in the second operand have been processed (called normal completion), or when a CPU-determined number of blocks that is less than the length of the second operand have been processed (called partial completion). The CPU-determined number of blocks depends on the model, and may be a different number each time the instruction is executed. The CPU-determined number of blocks is usually nonzero. In certain unusual situations, this number may be zero, and condition code 3 may be set with no progress. However, the CPU protects against endless reoccurrence of this no-progress case.

When the chaining-value field overlaps any portion of the first or second operand, the result in the chaining-value field is unpredictable.

For the KLMD-SHA-1, KLMD-SHA-256, and KLMD-SHA-512 functions, after all bytes in the second operand as specified in general register R₂ + 1 have been processed, the padding operation is performed, a final hashing operation is performed on the padded block, and then normal completion occurs. For the KLMD-SHA3 and KLMD-SHAKE functions, after all full blocks of the second operand have been processed, the padding operation is performed on either the remaining partial block or on a null block, a final

hashing operation is performed on the padded block; normal completion then occurs for the KLMD-SHA3 functions.

For the KLMD-SHAKE functions, when padding has been performed, the padding state is set to one in general register 0, and an extended-output-function (XOF) message digest is stored into the first-operand location. XOF message-digest generation is ended when all of the first operand has been stored (called normal completion) or when a CPU-determined number of blocks that is less than the length of the first operand have been stored (called partial completion). The CPU-determined number of blocks depends on the model, and may be a different number each time the instruction is executed. The CPU-determined number of blocks is usually nonzero. In certain unusual situations, this number may be zero, and condition code 3 may be set with no progress. However, the CPU protects against endless reoccurrence of this no-progress case.

When the operation ends due to normal completion, condition code 0 is set, the second-operand address in general register R₂ is updated, and the second-operand length in general register R₂ + 1 is zero; for the KLMD-SHAKE functions, the first-operand address in general register R₁ is updated, and the first-operand length in general register R₁ + 1 is zero.

When the operation ends due to partial completion, condition code 3 is set. For all functions except the KLMD-SHAKE functions, the resulting value in general register R₂ + 1 is nonzero. For the KLMD-SHAKE functions, if the second operand has not been completely processed, the resulting value in general register R₂ + 1 is nonzero, and if the first

operand has not been completely processed, the resulting value in general register R_1 is nonzero.

When the second-operand length is initially zero, the second operand is not accessed, the second-operand address and second-operand length in general registers R_2 and $R_2 + 1$, respectively, are not changed, and condition code 0 is set. Except for the KLMD-SHAKE functions when the padding-state (PS) control is one, the empty block padding operation is performed and the result is stored into the parameter block.

For the KLMD-SHAKE functions, when the first-operand length is initially zero, the first operand is not accessed, and the first-operand address and first-operand length in general registers R_1 and $R_1 + 1$, respectively, are not changed. When the first-operand length is initially zero and the PS control is one, it is model dependent whether the parameter block is updated.

A PER storage-alteration event is recognized, when applicable, for the portion of the parameter block and first-operand location that is stored. A PER zero-address-detection event is recognized, when applicable, for the first-operand location, for the second-operand location and for the parameter block. When PER events are detected for more than one location, it is unpredictable which location is identified in the PER access identification (PAID) and PER ASCE ID (AI).

As observed by this CPU, other CPUs, and channel programs, references to the parameter block and storage operands may be multiple-access references, accesses to these storage locations are not necessarily block-concurrent, and the sequence of these accesses or references is undefined.

Access exceptions may be reported for a larger portion of the first operand (when applicable) and second operand than is processed in a single execution of the instruction; however, access exceptions are not recognized for locations beyond the length of the first or second operand nor for locations more than 4K bytes beyond the current location being processed.

Symbols Used in Function Descriptions

The subsequent description of COMPUTE LAST MESSAGE DIGEST uses the same symbols as

those used in COMPUTE INTERMEDIATE MESSAGE DIGEST, plus the following additional symbols. Further description of the secure hash algorithm may be found in Reference [15.] on page xxx. Further description of the SHA-3 and SHAKE hash algorithms and the KECCAK family of sponge functions may be found in Reference [21.] on page xxx.

Symbol	Explanation for KLMD Function Figures
L	Byte length of operand 2 in storage.
p <n>	n padding bytes; leftmost byte is 80 hex; all other bytes are 00 hex.
z <n>	n padding bytes of zero.
mbl	an 8-byte or 16-byte value specifying the bit length of the total message.
q <64>	a padding block, consisting of 56 bytes of zero followed by an 8-byte mbl.
q <128>	a padding block, consisting of 112 bytes of zero followed by a 16-byte mbl.
sp<n>	n padding bytes used by SHA-3 functions. Bit positions 7, 6, and 5 of the leftmost byte of the pad contain binary 0, 1, and 1, respectively, and bit position 0 of the rightmost byte of the pad contains a binary one. All other bits are zeros. Padding for SHA-3 functions is performed even if the second-operand length is zero.
xp<n>	n padding bytes used by SHAKE functions. Bit positions 3 through 7 of the leftmost byte of the pad all contain binary ones, and bit position 0 of the rightmost pad byte contains a binary one. All other bits are zeros. Padding for SHAKE functions is performed when the padding state (PS, bit 55 of general register 0) is zero and the remaining second-operand length is less than the data-block size.

KLMD-Query (KLMD Function Code 0)

The locations of the operands and addresses used by the instruction are as shown in Figure 7-234 on page 7-202.

The parameter block used for the function has the following format:

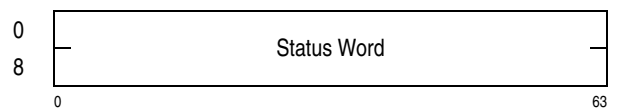

Figure 7-235. Parameter Block for KLMD-Query

A 128-bit status word is stored in the parameter block. Bits 0-127 of this field correspond to function codes 0-127, respectively, of the COMPUTE LAST MESSAGE DIGEST instruction. When a bit is one, the corresponding function is installed; otherwise, the function is not installed.

Condition code 0 is set when execution of the KLMD-Query function completes; condition code 3 is not applicable to this function.

KLMD-SHA-1 (KLMD Function Code 1)

The locations of the operands and addresses used by the instruction are as shown in Figure 7-234 on page 7-202.

The parameter block used for the function has the following format:

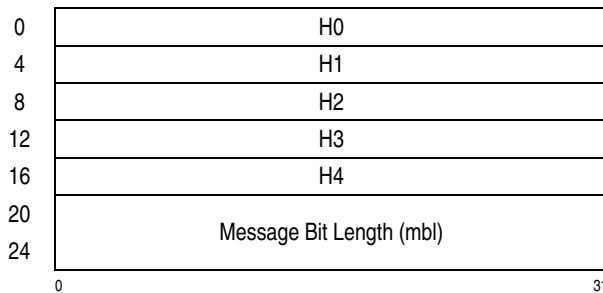

Figure 7-236. Parameter Block for KLMD-SHA-1

The message digest for the message (M) in operand 2 is generated using the SHA-1 algorithm with the chaining value (called H fields) and message-bit-length information in the parameter block.

If the length of the message in operand 2 is equal to or greater than 64 bytes, an intermediate message digest is generated for each 64-byte message block using the SHA-1 block digest algorithm with the 20-byte chaining value in the parameter block, and the generated intermediate message digest, also called the output chaining value (OCV), is stored into the chaining-value field of the parameter block. This operation is shown in Figure 7-237 and repeats until the remaining message is less than 64 bytes or until a CPU-determined number of blocks have been stored.

If the length of the message or the remaining message is zero bytes, then the operation in Figure 7-238 is performed. If the length of the message or the remaining message is between one byte and 55 bytes inclusive, then the operation in Figure 7-239 is

performed; if the length is between 56 bytes and 63 bytes inclusive, then the operation in Figure 7-240 is performed. The message digest, also called the output chaining value (OCV), is stored into the chaining-value field of the parameter block.

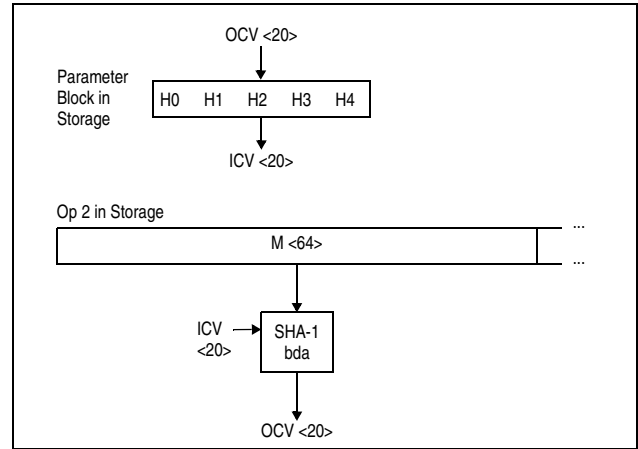

Figure 7-237. KLMD-SHA-1 Full Block ($L \geq 64$)

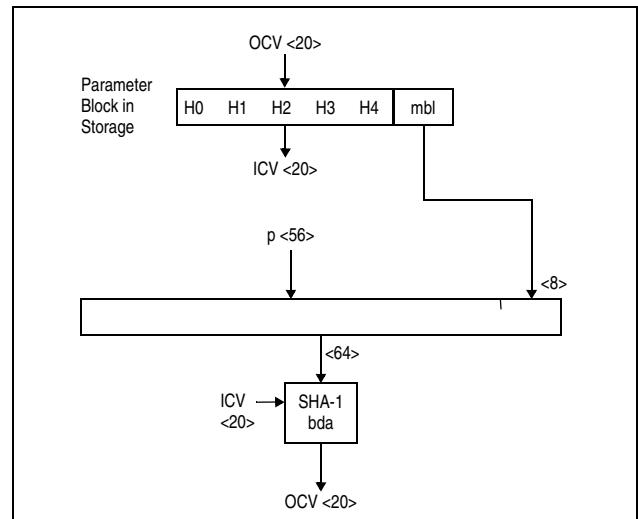

Figure 7-238. KLMD-SHA-1 Empty Block ($L = 0$)

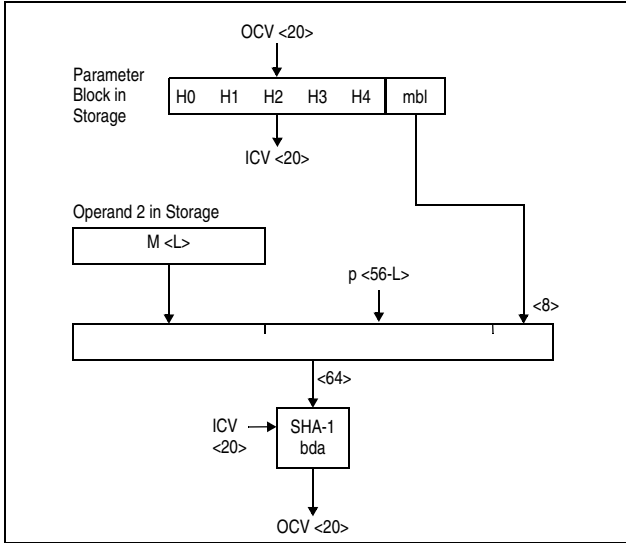

Figure 7-239. KLMD-SHA-1 Partial-Block Case 1 ($1 \leq L \leq 55$)

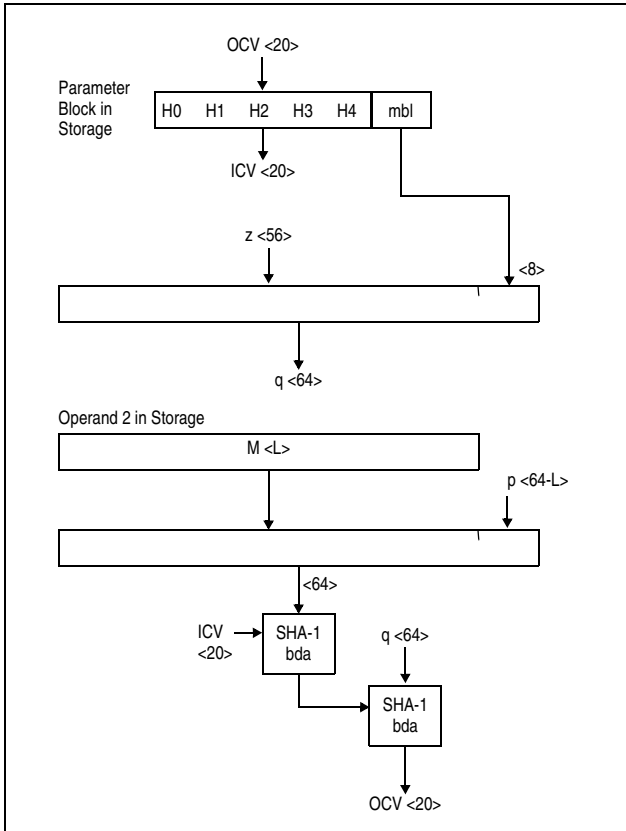

Figure 7-240. KLMD-SHA-1 Partial-Block Case 2 ($56 \leq L \leq 63$)

KLMD-SHA-256 (KLMD Function Code 2)

The locations of the operands and addresses used by the instruction are as shown in Figure 7-234 on page 7-202.

The parameter block used for the function has the following format:

0	H0
4	H1
8	H2
12	H3
16	H4
20	H5
24	H6
28	H7
32	Message Bit Length (mbl)
36	
0	
31	

Figure 7-241. Parameter Block for KLMD-SHA-256

The message digest for the message (M) in operand 2 is generated using the SHA-256 algorithm with the chaining value (called H fields) and message-bit-length information in the parameter block.

If the message in operand 2 is equal to or greater than 64 bytes, an intermediate message digest is generated for each 64-byte message block using the SHA-256 block digest algorithm with the 32-byte chaining value in the parameter block, and the generated intermediate message digest, also called the output chaining value (OCV), is stored into the chaining-value field of the parameter block. This operation is shown in Figure 7-242 and repeats until the remaining message is less than 64 bytes or until a CPU-determined number of blocks have been stored.

If the length of the message or the remaining message is zero bytes, then the operation in Figure 7-243 is performed. If the length of the message or the remaining message is between one byte and 55 bytes inclusive, then the operation in Figure 7-244 is performed; if the length is between 56 bytes and 63 bytes inclusive, then the operation in Figure 7-245 is performed. The message digest, also called the out-

put chaining value (OCV), is stored into the chaining-value field of the parameter block.

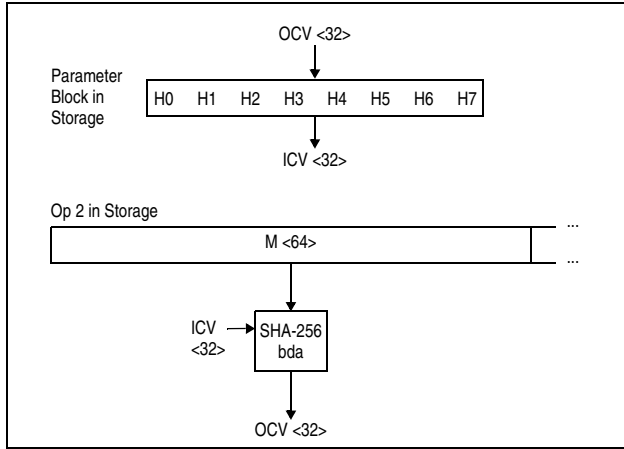

Figure 7-242. KLMD-SHA-256 Full Block ($L \geq 64$)

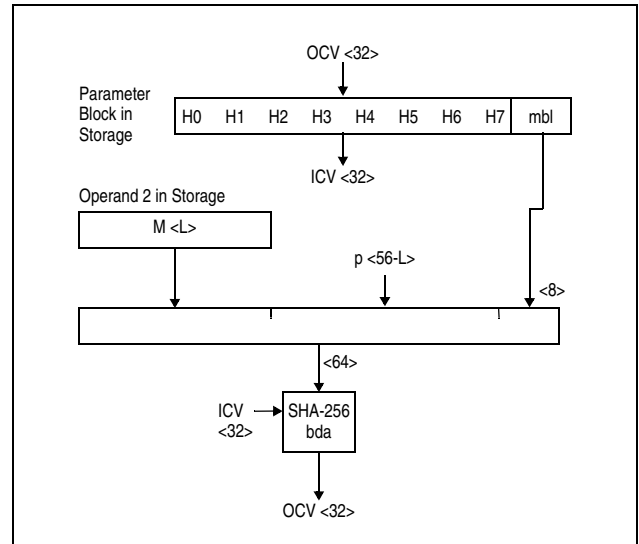

Figure 7-244. KLMD-SHA-256 Partial-Block Case 1 ($1 \leq L \leq 55$)

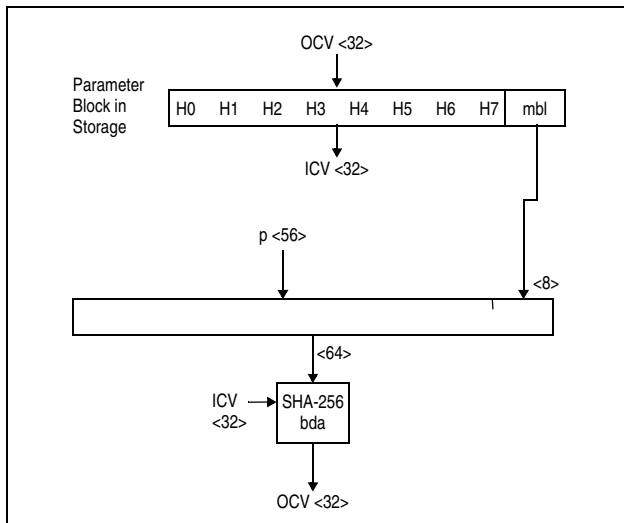

Figure 7-243. KLMD-SHA-256 Empty Block ($L = 0$)

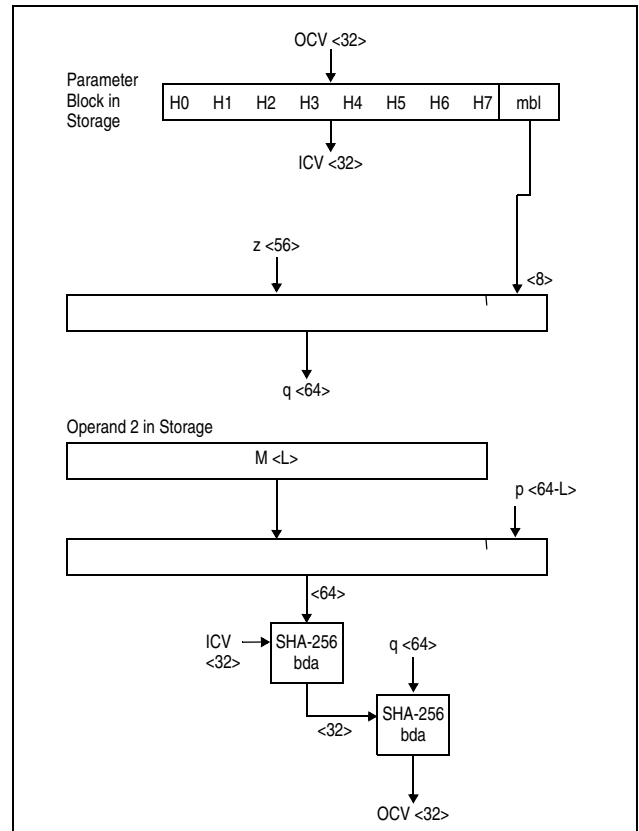

Figure 7-245. KLMD-SHA-256 Partial-Block Case 2 ($56 \leq L \leq 63$)

KLMD-SHA-512 (KLMD Function Code 3)

The locations of the operands and addresses used by the instruction are as shown in Figure 7-234 on page 7-202.

The parameter block used for the function has the following format:

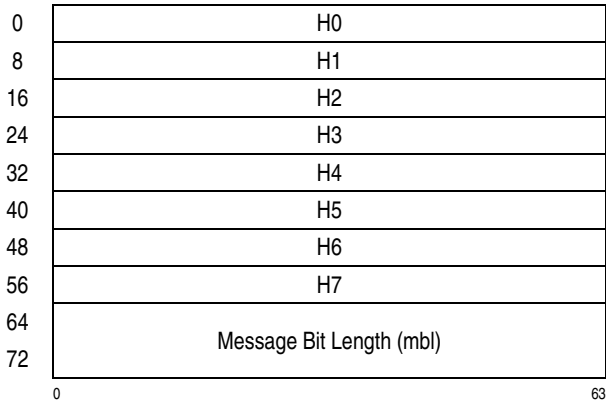

Figure 7-246. Parameter Block for KLMD-SHA-512

The message digest for the message (M) in operand 2 is generated using the SHA-512 algorithm with the chaining value (called H fields) and message-bit-length information in the parameter block.

If the message in operand 2 is equal to or greater than 128 bytes, an intermediate message digest is generated for each 128-byte message block using the SHA-512 block digest algorithm with the 64-byte chaining value in the parameter block, and the generated intermediate message digest, also called the output chaining value (OCV), is stored into the chaining-value field of the parameter block. This operation is shown in Figure 7-247 and repeats until the remaining message is less than 128 bytes or until a CPU-determined number of blocks have been stored.

If the length of the message or the remaining message is zero bytes, then the operation in Figure 7-248 is performed. If the length of the message or the remaining message is between one byte and 111 bytes inclusive, then the operation in Figure 7-249 is performed; if the length is between 112 bytes and 127 bytes inclusive, then the operation in Figure 7-250 is performed. The message digest, also

called the output chaining value (OCV), is stored into the chaining-value field of the parameter block.

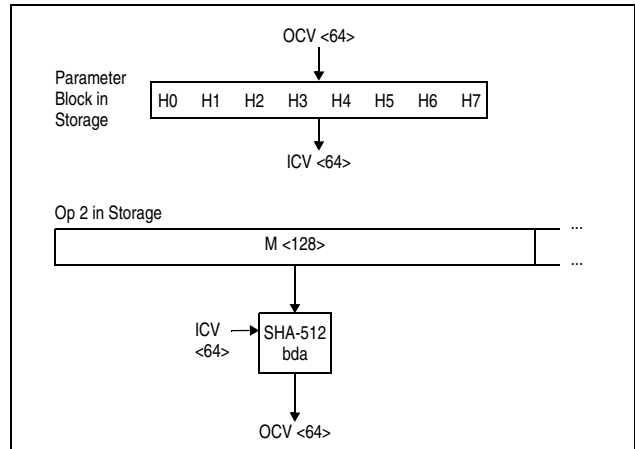

Figure 7-247. KLMD-SHA-512 Full Block (L ≥ 128)

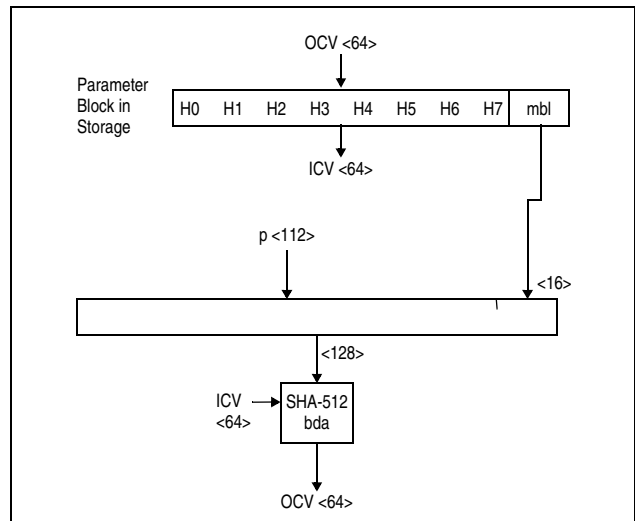

Figure 7-248. KLMD-SHA-512 Empty Block (L = 0)

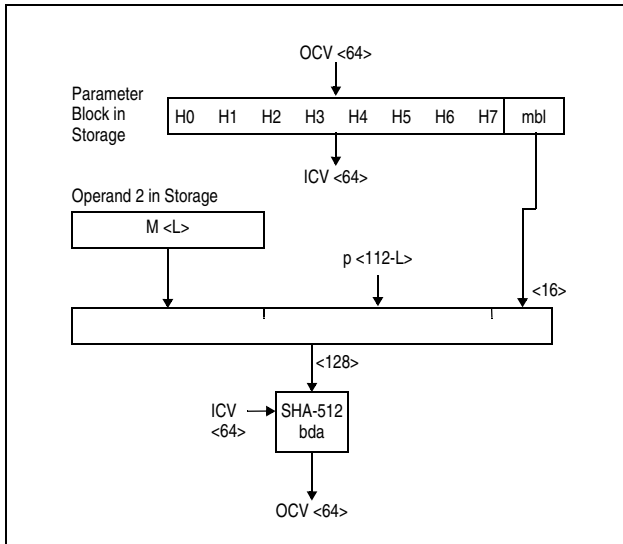

Figure 7-249. KLMD-SHA-512 Partial-Block Case 1 ($1 \leq L \leq 111$)

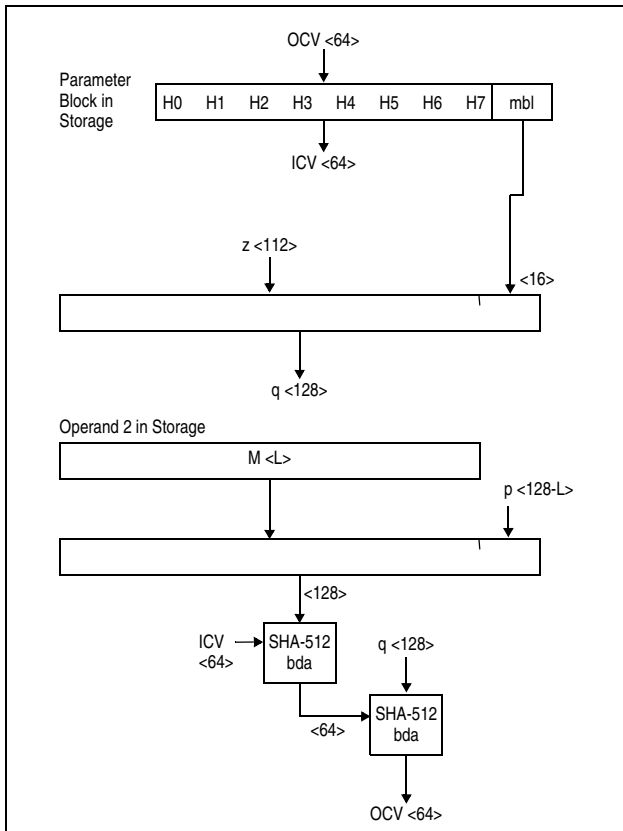

Figure 7-250. KLMD-SHA-512 Partial-Block Case 2 ($112 \leq L \leq 127$)

KLMD-SHA3-224 (KLMD Function Code 32)

The locations of the operands and addresses used by the instruction are as shown in Figure 7-234 on page 7-202.

The parameter block used for the function has the following format:

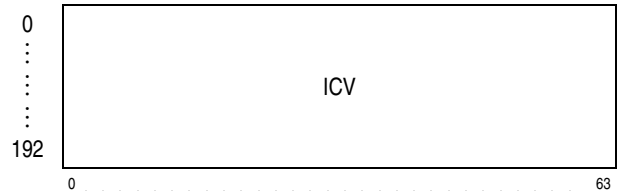

Figure 7-251. Parameter Block for KLMD-SHA3-224

The initial chaining value (ICV) represents the 1600-bit state array used by the KECCAK[c] functions which implement the SHA-3 algorithms described in Reference [21.] on page xxx.

When the length of the second operand in general register $R_2 + 1$ is greater than or equal to 144 bytes, then the operation is identical to that described in the section “KIMD-SHA3-224 (KIMD Function Code 32)” on page 7-192. This operation proceeds until the length of the second operand is less than 144 bytes, at which point the operation continues as described below.

Any remaining bytes of the second operand are padded on the right to form a 144-byte message block as described for the symbol “sp<n>” on page 7-204. Padding occurs even when there are no remaining bytes in the second operand and does not alter the contents of the second operand.

A 224-bit (28-byte) message digest is generated for the padded message block using the KECCAK[c] algorithm with the 200-byte initial chaining value in the parameter block. The message digest is generated regardless of whether the second-operand length is zero. The entire 200-byte output of the KECCAK[c] algorithm, also called the output chaining value (OCV), is stored into the parameter block. The generated message digest is contained in bytes 0-27 of the parameter block. See programming note 10 on page 7-199 regarding the numbering of the bits in the parameter block and second operand as compared with the numbering of the bits in the state array.

The operation is shown in Figure 7-252.

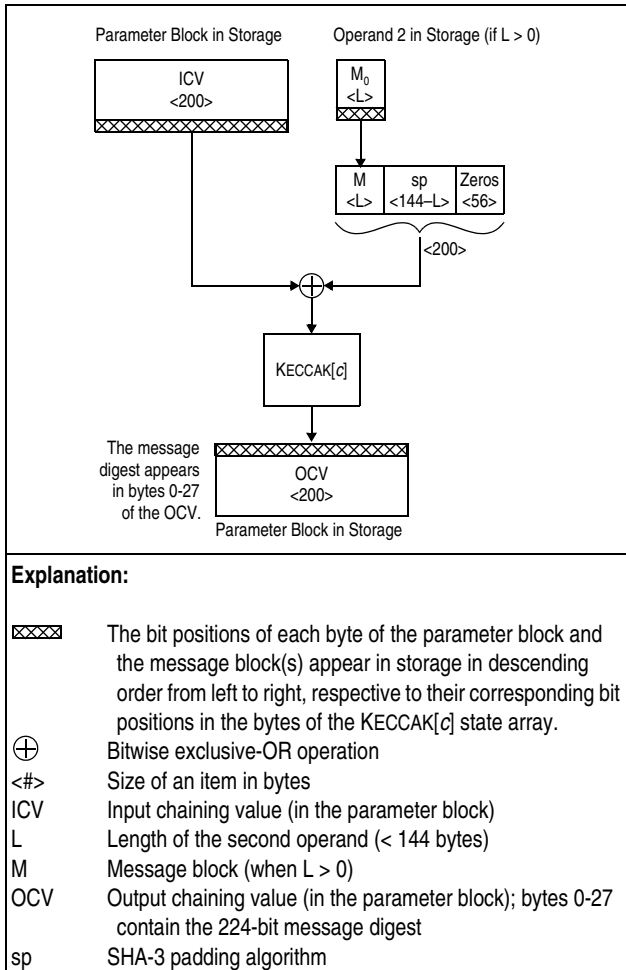

Figure 7-252. KLMD-SHA3-224 Processing ($L < 144$)

KLMD-SHA3-256 (KLMD Function Code 33)

The locations of the operands and addresses used by the instruction are as shown in Figure 7-234 on page 7-202.

The parameter block used for the function has the following format:

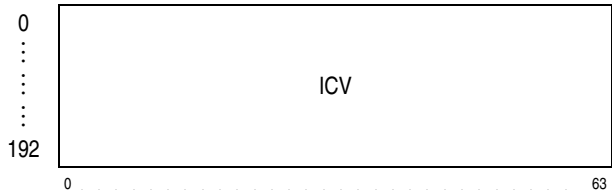

Figure 7-253. Parameter Block for KLMD-SHA3-256

The initial chaining value (ICV) represents the 1600-bit state array used by the KECCAK[*c*] functions which implement the SHA-3 algorithms described in Reference [21.] on page xxx.

When the length of the second operand in general register $R_2 + 1$ is greater than or equal to 136 bytes, then the operation is identical to that described in the section “KIMD-SHA3-256 (KIMD Function Code 33)” on page 7-193. This operation proceeds until the length of the second operand is less than 136 bytes, at which point the operation continues as described below.

Any remaining bytes of the second operand are padded on the right to form a 136-byte message block as described for the symbol “sp<*n*>” on page 7-204. Padding occurs even when there are no remaining bytes in the second operand and does not alter the contents of the second operand.

A 256-bit (32-byte) message digest is generated for the padded message block using the KECCAK[*c*] algorithm with the 200-byte initial chaining value in the parameter block. The message digest is generated regardless of whether the second-operand length is zero. The entire 200-byte output of the KECCAK[*c*] algorithm, also called the output chaining value (OCV), is stored into the parameter block. The generated message digest is contained in bytes 0-31 of the parameter block. See programming note 10 on page page 7-199 regarding the numbering of the bits in the parameter block and second operand as compared with the numbering of the bits in the state array.

The operation is shown in Figure 7-254.

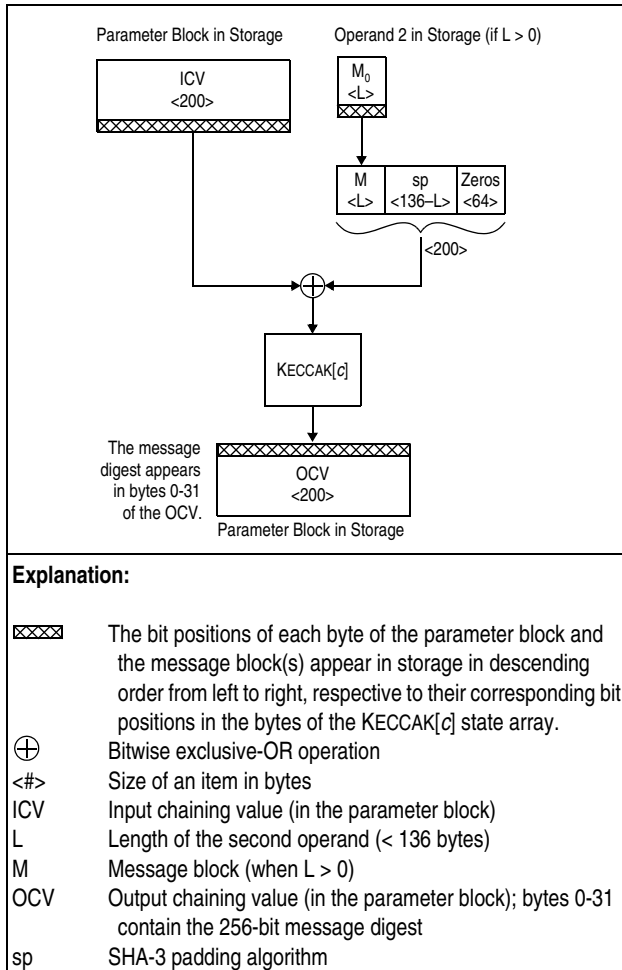

Figure 7-254. KLMD-SHA3-256 Processing (L < 136)

KLMD-SHA3-384 (KLMD Function Code 34)

The locations of the operands and addresses used by the instruction are as shown in Figure 7-234 on page 7-202.

The parameter block used for the function has the following format:

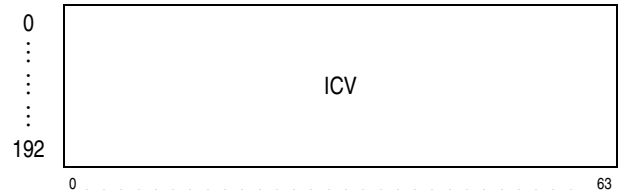

Figure 7-255. Parameter Block for KLMD-SHA3-384

The initial chaining value (ICV) represents the 1600-bit state array used by the KECCAK[c] functions which implement the SHA-3 algorithms described in Reference [21.] on page xxx.

When the length of the second operand in general register $R_2 + 1$ is greater than or equal to 104 bytes, then the operation is identical to that described in the section “KIMD-SHA3-384 (KIMD Function Code 34)” on page 7-194. This operation proceeds until the length of the second operand is less than 104 bytes, at which point the operation continues as described below.

Any remaining bytes of the second operand are padded on the right to form a 104-byte message block as described for the symbol “sp<n>” on page 7-204. Padding occurs even when there are no remaining bytes in the second operand and does not alter the contents of the second operand.

A 384-bit (48-byte) message digest is generated for the padded message block using the KECCAK[c] algorithm with the 200-byte initial chaining value in the parameter block. The message digest is generated regardless of whether the second-operand length is zero. The entire 200-byte output of the KECCAK[c] algorithm, also called the output chaining value (OCV), is stored into the parameter block. The generated message digest is contained in bytes 0-47 of the parameter block. See programming note 10 on page 7-199 regarding the numbering of the bits in the parameter block and second operand as compared with the numbering of the bits in the state array.

The operation is shown in Figure 7-256.

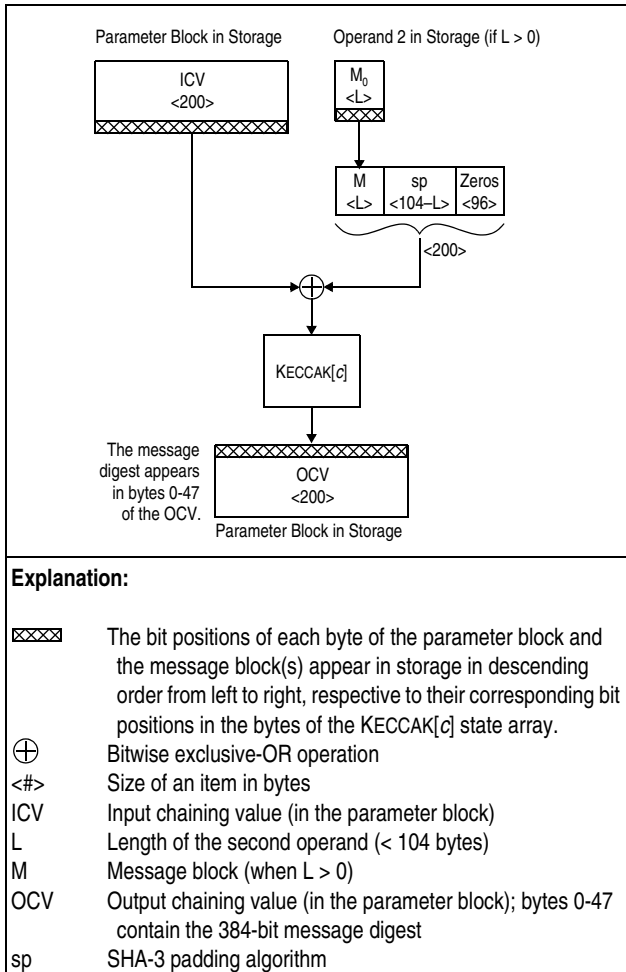

Figure 7-256. KLMD-SHA3-384 Processing (L < 104)

KLMD-SHA3-512 (KLMD Function Code 35)

The locations of the operands and addresses used by the instruction are as shown in Figure 7-234 on page 7-202.

The parameter block used for the function has the following format:

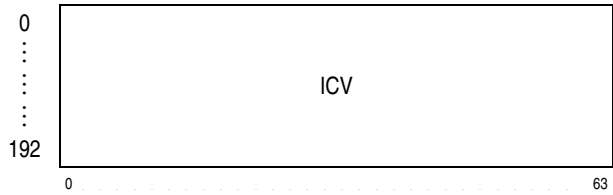

Figure 7-257. Parameter Block for KLMD-SHA3-512

The initial chaining value (ICV) represents the 1600-bit state array used by the KECCAK[c] functions which implement the SHA-3 algorithms described in Reference [21.] on page xxx.

When the length of the second operand in general register R₂ + 1 is greater than or equal to 72 bytes, then the operation is identical to that described in the section “KIMD-SHA3-512 (KIMD Function Code 35)” on page 7-195. This operation proceeds until the length of the second operand is less than 72 bytes, at which point the operation continues as described below.

Any remaining bytes of the second operand are padded on the right to form a 72-byte message block as described for the symbol “sp<n>” on page 7-204. Padding occurs even when there are no remaining bytes in the second operand and does not alter the contents of the second operand.

A 512-bit (64-byte) message digest is generated for the padded message block using the KECCAK[c] algorithm with the 200-byte initial chaining value in the parameter block. The message digest is generated regardless of whether the second-operand length is zero. The entire 200-byte output of the KECCAK[c] algorithm, also called the output chaining value (OCV), is stored into the parameter block. The generated message digest is contained in bytes 0-63 of the parameter block. See programming note 10 on page 7-199 regarding the numbering of the bits in the parameter block and second operand as compared with the numbering of the bits in the state array.

The operation is shown in Figure 7-258.

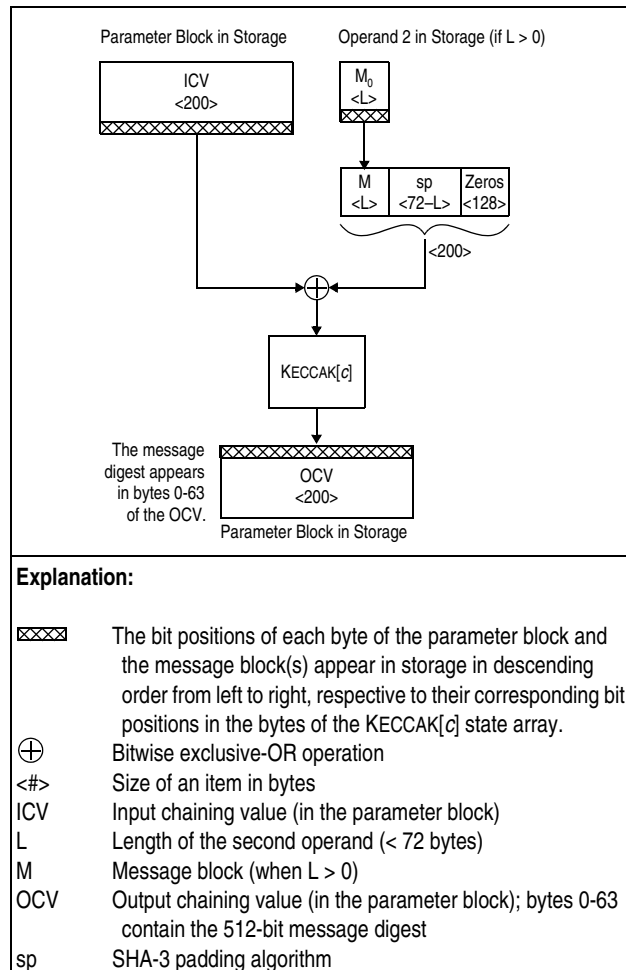

Figure 7-258. KLMD-SHA3-512 Processing ($L < 72$)

KLMD-SHAKE-128 (KLMD Function Code 36)

The locations of the operands and addresses used by the instruction are as shown in Figure 7-234 on page 7-202.

The parameter block used for the function has the following format:

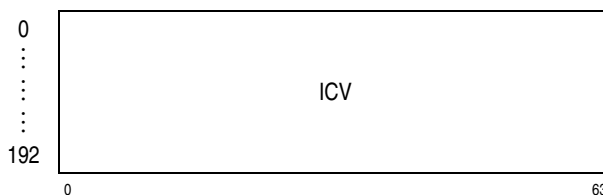

Figure 7-259. Parameter Block for KLMD-SHAKE-128

The initial chaining value (ICV) represents the 1600-bit state array used by the KECCAK[*c*] functions which implement the SHA-3 algorithms described in Reference [21.] on page xxx.

When the length of the second operand in general register $R_2 + 1$ is greater than or equal to 168 bytes, the operation is identical to that described in the section “KIMD-SHAKE-128 (KIMD Function Code 36)” on page 7-196, except that when the remaining second-operand length is zero, processing is as described below.

When the padding state, bit 55 of general register 0 is zero (indicating that padding has not yet been performed), the following occurs:

- Any remaining bytes of the second operand are padded on the right to form a 168-byte message block as described for the symbol “xp<n>” on page 7-204. Padding occurs even when there are no remaining bytes in the second operand and does not alter the contents of the second operand.
- The padding state is set to one, indicating that padding has been performed.
- The second-operand address in general register R_2 is incremented by the number of message bytes processed, and the second-operand length in general register R_2+1 is set to zero.
- The 168-byte padded message, is exclusive ORed with the contents of the leftmost 168 bytes of the state array (from the ICV in the parameter block or from the OCV resulting from the previous block’s processing) to form an output chaining value that is used in the extended-output-function (XOF) processing. The rightmost 32 bytes of the state array are unchanged.

The padding operation is shown in Figure 7-260.

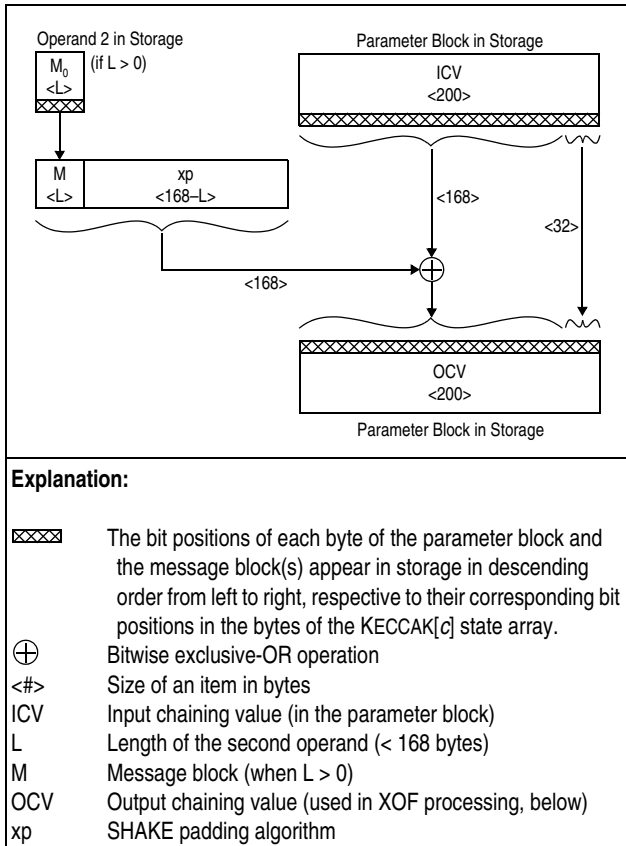

Figure 7-260. KLMD-SHAKE-128 Padding (L < 168)

Depending on the number of second-operand blocks processed when padding is completed, either (a) the output chaining value is stored into the parameter block, and the instruction completes by setting condition code 3 (partial completion), or (b) the operation continues with extended-output-function (XOF) processing, as described below.

When the padding state is one (indicating that padding has been performed for the message, either by the current or a previous execution of the instruction), extended-output-function (XOF) processing is performed as follows.

1. If the first-operand length in general register R₁ + 1 is zero, then the output chaining value is stored into the parameter block, and the instruction completes with condition code 0. If the first-operand length is zero at the beginning of the instruction, then it is model dependent whether the ICV is fetched from the parameter block and stored back unmodified as the OCV.

2. The KECCAK[c] function is invoked using the previous output-chaining value (OCV) as input, and replacing the output-chaining value.
3. General register R₁ contains the current address of the first operand, and general register R₁ + 1 contains the remaining length of the first operand. The number of bytes to be stored, n, is either the remaining first-operand length or 168, whichever is smaller.

The first n bytes of the output-chaining value are stored at the first-operand location. See programming note 10 on page 7-199 regarding the numbering of the bits in the first operand as compared with the numbering of the bits in the state array.

The first-operand address in general register R₁ is incremented by n, and the first-operand length general register R₁ + 1 is decremented by n.

Steps 1-3 of this process are repeated until the first-operand length becomes zero (in which case, the instruction completes with condition code 0) or until a CPU-determined number of bytes have been stored (in which case, the instruction completes with condition code 3). The output-chaining value is stored into bytes 0-199 of the parameter block regardless of whether condition code 0 or 3 is set. Figure 7-261 illustrates the XOF processing described above.

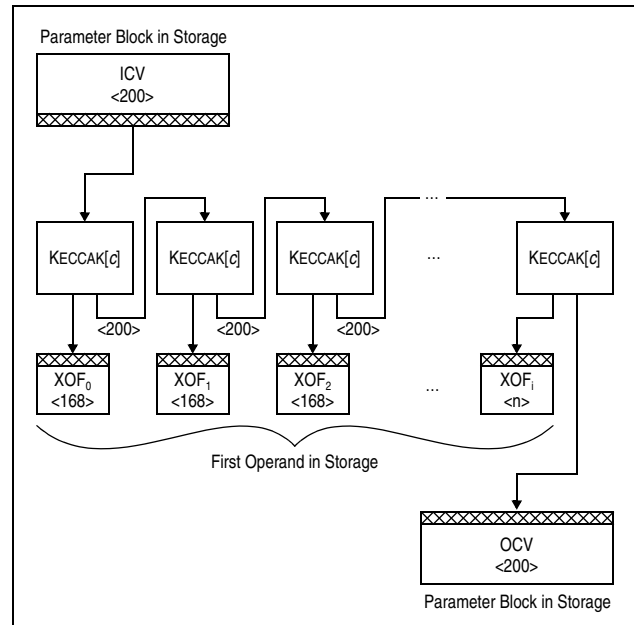

Figure 7-261. KLMD-SHAKE-128 Extended-Output-Function (XOF) Processing

Explanation:	
⊗	The bit positions of each byte of the parameter block and the XOF block(s) appear in storage in descending order from left to right, respective to their corresponding bit positions in the bytes of the KECCAK[c] state array.
<#>	Size of an item in bytes
ICV	Input chaining value (either from the parameter block or from the output of the padding operation).
OCV	Output chaining value; (the final OCV appears in the parameter block)
n	The residual length of the final block of the first operand (less than or equal to 168 bytes)
XOF _i <n>	Block i of the extended-output-function results in the first operand.

Figure 7-261. KLMD-SHAKE-128 Extended-Output-Function (XOF) Processing (Continued)

KLMD-SHAKE-256 (KLMD Function Code 37)

The locations of the operands and addresses used by the instruction are as shown in Figure 7-234 on page 7-202.

The parameter block used for the function has the following format:

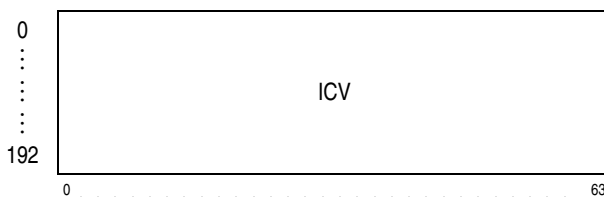

Figure 7-262. Parameter Block for KLMD-SHAKE-256

The initial chaining value (ICV) represents the 1600-bit state array used by the KECCAK[c] functions which implement the SHA-3 algorithms described in Reference [21.] on page xxx.

When the length of the second operand in general register $R_2 + 1$ is greater than or equal to 136 bytes, the operation is identical to that described in the section “KIMD-SHAKE-256 (KIMD Function Code 37)” on page 7-197, except that when the remaining second-operand length is zero, processing is as described below. This operation proceeds until the length of the second operand is less than 136 bytes, at which point the operation continues as described below.

When the padding state, bit 55 of general register 0 is zero (indicating that padding has not yet been performed), the following occurs:

- Any remaining bytes of the second operand are padded on the right to form a 136-byte message block as described for the symbol “xp<n>” on page 7-204. Padding occurs even when there are no remaining bytes in the second operand and does not alter the contents of the second operand.
- The padding state is set to one, indicating that padding has been performed.
- The second-operand address in general register R_2 is incremented by the number of message bytes processed, and the second-operand length in general register R_2+1 is set to zero.
- The 136-byte padded message, is exclusive ORed with the contents of the leftmost 136 bytes of the state array (from the ICV in the parameter block or from the OCV resulting from the previous block’s processing) to form an output chaining value that is used in the extended-output-function (XOF) processing. The rightmost 64 bytes of the state array are unchanged.

The padding operation is shown in Figure 7-263.

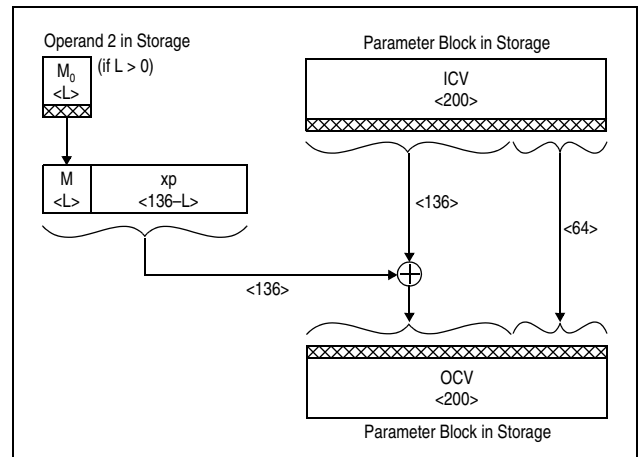

Figure 7-263. KLMD-SHAKE-256 Padding ($L < 136$)

Explanation:	
⊗	The bit positions of each byte of the parameter block and the XOF block(s) appear in storage in descending order from left to right, respective to their corresponding bit positions in the bytes of the KECCAK[c] state array.
⊕	Bitwise exclusive-OR operation
<#>	Size of an item in bytes
ICV	Input chaining value (in the parameter block)
L	Length of the second operand (< 136 bytes)
M	Message block (when L > 0)
OCV	Output chaining value (used in XOF processing, below)
xp	SHAKE padding algorithm

Figure 7-263. KLMD-SHAKE-256 Padding (L < 136)

Depending on the number of second-operand blocks processed when padding is completed, either (a) the output chaining value is stored into the parameter block, and the instruction completes by setting condition code 3 (partial completion), or (b) the operation continues with extended-output-function (XOF) processing, as described below.

When the padding state is one (indicating that padding has been performed for the message, either by the current or a previous execution of the instruction), extended-output-function (XOF) processing is performed as follows.

1. If the first-operand length in general register R₁ + 1 is zero, then the output chaining value is stored into the parameter block, and the instruction completes with condition code 0. If the first-operand length is zero at the beginning of the instruction, then it is model dependent whether the ICV is fetched from the parameter block and stored back unmodified as the OCV.
2. The KECCAK[c] function is invoked using the previous output-chaining value (OCV) as input, and replacing the output-chaining value.
3. General register R₁ contains the current address of the first operand, and general register R₁ + 1 contains the remaining length of the first operand. The number of bytes to be stored, n, is either the remaining first-operand length or 136, whichever is smaller.

The first n bytes of the output-chaining value are stored at the first-operand location. See programming note 10 on page 7-199 regarding the numbering of the bits in the first operand as com-

pared with the numbering of the bits in the state array.

The first-operand address in general register R₁ is incremented by n, and the first-operand length general register R₁ + 1 is decremented by n.

Steps 1-3 of this process are repeated until the first-operand length becomes zero (in which case, the instruction completes with condition code 0) or until a CPU-determined number of bytes have been stored (in which case, the instruction completes with condition code 3). The output-chaining value is stored into bytes 0-199 of the parameter block regardless of whether condition code 0 or 3 is set. Figure 7-264 illustrates the XOF processing described above.

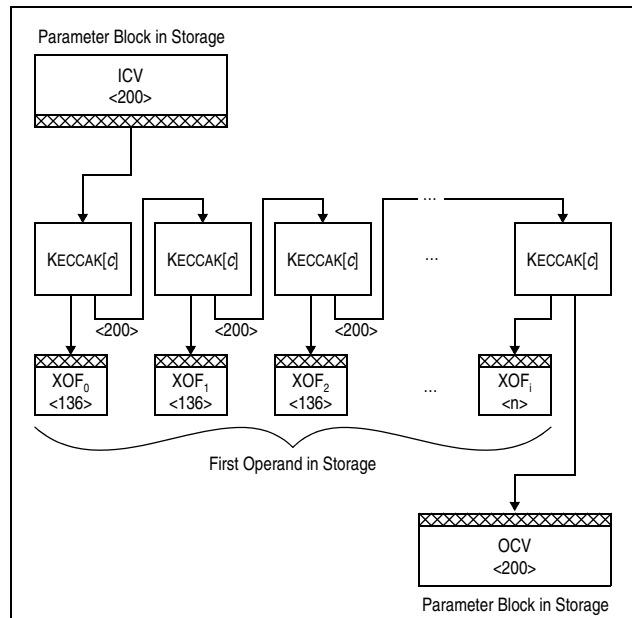

Explanation:	
⊗	The bit positions of each byte of the parameter block and the XOF block(s) appear in storage in descending order from left to right, respective to their corresponding bit positions in the bytes of the KECCAK[c] state array.
<#>	Size of an item in bytes
ICV	Input chaining value (either from the parameter block or from the output of the padding operation).
OCV	Output chaining value; (the final OCV appears in the parameter block)
n	The residual length of the final block of the first operand (less than or equal to 136 bytes)
XOF _i <n>	Block i of the extended-output-function results in the first operand.

Figure 7-264. KLMD-SHAKE-256 Extended-Output-Function (XOF) Processing

Special Conditions

A specification exception is recognized and no other action is taken if any of the following occurs:

- Bit 56 of general register 0 is not zero.
- Bits 57-63 of general register 0 specify an unsigned or uninstalled function code.
- The R_2 field designates an odd-numbered register or general register 0.
- For the KLMD-SHAKE functions, either of the following is true:
 - The R_1 field designates an odd-numbered register, general register 0, or register R_2 .
 - The second-operand length is nonzero, and the padding state is one.

Resulting Condition Code:

- 0 Normal completion
- 1 --
- 2 --
- 3 Partial completion

Program Exceptions:

- Access (fetch, operand 2 and message bit length; fetch and store, chaining value; store, operand 1)
- Operation (if the message-security assist is not installed)
- Specification
- Transaction constraint

1.-6.	Exceptions with the same priority as the priority of program-interruption conditions for the general case.
7.A	Access exceptions for second instruction halfword.
7.B	Operation exception.
7.C	Transaction constraint
8.a	Specification exception due to invalid function code, or invalid register number.
8.b	Specification exception due to nonzero second-operand length when the padding state is one (SHAKE functions only).

Figure 7-265. Priority of Execution: KLMD

9.	Condition code 0 due to second-operand length originally zero.
10.	Access exceptions for an access to the parameter block or second operand.
11.	Access exceptions for an access to the first operand (SHAKE functions only).
12.	Condition code 0 due to normal completion (for functions other than SHAKE, second-operand length originally nonzero, but stepped to zero; for SHAKE functions, second-operand length zero and first-operand length stepped to zero).
13.	Condition code 3 due to partial completion (for functions other than SHAKE, second-operand length still nonzero; for SHAKE functions, either first- or second-operand length still nonzero).

Figure 7-265. Priority of Execution: KLMD (Continued)

Programming Notes:

1. The performance of the query function (code 0) may be significantly slower than that of simply examining a location in storage. If the program needs to frequently test for the availability of a function, it should perform the query function once during initialization; subsequently it should examine the stored results of the query function in memory with an instruction such as TEST UNDER MASK.
2. Programming notes 2-10 for COMPUTE INTERMEDIATE MESSAGE DIGEST are also applicable to COMPUTE LAST MESSAGE DIGEST.
3. For the KLMD-SHAKE functions, when condition code 3 is set during the XOF processing, the first operand address and length in general registers R_1 and $R_1 + 1$, respectively, are updated such that the program can simply branch back to the instruction to continue the operation.

For unusual situations, the CPU protects against endless reoccurrence for the no-progress case. Thus, the program can safely branch back to the instruction whenever condition code 3 is set with no exposure to an endless loop.
4. For the KLMD-SHA-1, KLMD-SHA-256, and KLMD-SHA-512 functions, if the length of the second operand is nonzero initially and condition code 0 is set, the registers are updated in the same manner as for condition code 3; the chaining value in this case is such that additional oper-

ands can be processed as if they were part of the same chain.

5. For the KLMD-SHA-1, KLMD-SHA-256, and KLMD-SHA-512 functions, when processing the last message part, the program must compute the length of the original message in bits and place this length value in the message-bit-length field of the parameter block, and use the COMPUTE LAST MESSAGE DIGEST instruction.
6. The COMPUTE LAST MESSAGE DIGEST instruction does not require the second operand to be a multiple of the data block size. It first processes complete blocks, and may set condition code 3 before processing all blocks. After processing all complete blocks, it then performs the padding operation including the remaining portion of the second operand. This may require one or two iterations of the designated block digest algorithm.
7. The COMPUTE LAST MESSAGE DIGEST instruction provides the SHA padding for messages that are a multiple of eight bits in length. If a SHA function is to be applied to a bit string which is not a multiple of eight bits, the program must perform the SHA padding and use the COMPUTE INTERMEDIATE MESSAGE DIGEST instruction.
8. The following applies to the message-bit length (MBL) in the parameter block of KLMD-SHA-1, KLMD-SHA-256, and KLMD-SHA-512.
 - a. The MBL is completely independent of the second-operand length in general register $R_2 + 1$.
 - b. Regardless of whether the instruction ends with condition code 0 or 3, the MBL is not decremented by the number of bytes processed.
 - c. In normal usage, the MBL is expected to be eight times the total size of the message in bytes. If the program supplies a MBL that is not a multiple of eight, the results will be algorithmically correct, but may not be usable in any practical application.
 - d. The secure-hash algorithm described in Reference [21.] on page xxx allows for message-bit length that are not multiples of eight. COMPUTE LAST MESSAGE DIGEST

requires the message-bit length to be a multiple of eight.

9. For the KLMD-SHAKE functions, the following applies:
 - a. The padding-state, bit 55 of general register 0, should be set to zero prior to the first execution of KLMD for a message, and the padding state should not be altered by the program for any subsequent executions of KLMD for the same message until normal completion occurs.
 - b. If padding of the final (short or null) block of the second operand is performed when the first-operand length is zero, then the padded block is exclusive ORed with the contents of the state array, the result is stored as the output-chaining value in the parameter block, and the instruction completes with condition code 0. The KECCAK[c] function is not invoked in this case.
10. The KLMD SHA-3 and SHAKE functions perform padding according to the adopted NIST SHA-3 specification (see Reference [21.] on page xxx). Earlier draft versions of the SHA-3 specification used different padding bit sequences. Software that was designed according to earlier draft SHA-3 specifications can still benefit from the KLMD SHA-3 and SHAKE functions if the software performs the padding of the last message block.

COMPUTE MESSAGE AUTHENTICATION CODE

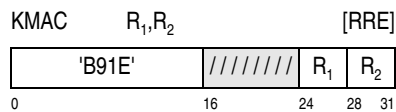

A function specified by the function code in general register 0 is performed.

Bits 16-23 of the instruction and the R_1 field are ignored.

Bit positions 57-63 of general register 0 contain the function code. Figure 7-266 shows the assigned

function codes. All other function codes are unassigned. Bit 56 of general register 0 must be zero; otherwise, a specification exception is recognized. All other bits of general register 0 are ignored.

General register 1 contains the logical address of the leftmost byte of the parameter block in storage. In the 24-bit addressing mode, the contents of bit positions 40-63 of general register 1 constitute the address, and the contents of bit positions 0-39 are ignored. In the 31-bit addressing mode, the contents of bit positions 33-63 of general register 1 constitute the address, and the contents of bit positions 0-32 are ignored. In the 64-bit addressing mode, the contents of bit positions 0-63 of general register 1 constitute the address.

The function codes for COMPUTE MESSAGE AUTHENTICATION CODE are as follows.

Code	Function	Parm. Block Size (bytes)	Data Block Size (bytes)
0	KMAC-Query *	16	—
1	KMAC-DEA *	16	8
2	KMAC-TDEA-128 *	24	8
3	KMAC-TDEA-192 *	32	8
9	KMAC-Encrypted-DEA	40	8
10	KMAC-Encrypted-TDEA-128	48	8
11	KMAC-Encrypted-TDEA-192	56	8
18	KMAC-AES-128	32	16
19	KMAC-AES-192	40	16
20	KMAC-AES-256	48	16
26	KMAC-Encrypted-AES-128	64	16
27	KMAC-Encrypted-AES-192	72	16
28	KMAC-Encrypted-AES-256	80	16
Explanation:			
—	Not applicable		
*	Function is also defined in the ESA/390 architectural mode and the ESA/390-compatibility mode. It is unpredictable whether other function codes are available in the ESA/390-compatibility mode.		

Figure 7-266. Function Codes for COMPUTE MESSAGE AUTHENTICATION CODE

All other function codes are unassigned.

The query function provides the means of indicating the availability of the other functions. The contents of general registers R_2 and $R_2 + 1$ are ignored.

For all other functions, the second operand is processed as specified by the function code using an initial chaining value in the parameter block, and the result replaces the initial chaining value. The operation also uses a cryptographic key in the parameter block. The operation proceeds until the end of the second-operand location is reached or a CPU-determined number of bytes have been processed, whichever occurs first. The result is indicated in the condition code.

The R_2 field designates an even-odd pair of general registers and must designate an even-numbered register other than general register 0; otherwise, a specification exception is recognized.

The location of the leftmost byte of the second operand is specified by the contents of the R_2 general register. The number of bytes in the second-operand location is specified in general register $R_2 + 1$.

As part of the operation, the address in general register R_2 is incremented by the number of bytes processed from the second operand, and the length in general register $R_2 + 1$ is decremented by the same number. The formation and updating of the address and length is dependent on the addressing mode.

In the 24-bit addressing mode, the contents of bit positions 40-63 of general register R_2 constitute the address of the second operand, and the contents of bit positions 0-39 are ignored; bits 40-63 of the updated address replace the corresponding bits in general register R_2 , carries out of bit position 40 of the updated address are ignored and, the contents of bit positions 32-39 of general register R_2 are set to zeros. In the 31-bit addressing mode, the contents of bit positions 33-63 of general register R_2 constitute the address of the second operand, and the contents of bit positions 0-32 are ignored; bits 33-63 of the updated address replace the corresponding bits in general register R_2 , carries out of bit position 33 of the updated address are ignored, and the content of bit position 32 of general register R_2 is set to zero. In the 64-bit addressing mode, the contents of bit positions 0-63 of general register R_2 constitute the address of the second operand; bits 0-63 of the updated address replace the contents of general register R_2 and carries out of bit position 0 are ignored.

In both the 24-bit and the 31-bit addressing modes, the contents of bit positions 32-63 of general register $R_2 + 1$ form a 32-bit unsigned binary integer which specifies the number of bytes in the second operand; and the updated value replaces the contents of bit positions 32-63 of general register $R_2 + 1$. In the 64-bit addressing mode, the contents of bit positions 0-63 of general register $R_2 + 1$ form a 64-bit unsigned binary integer which specifies the number of bytes in

the second operand; and the updated value replaces the contents of general register $R_2 + 1$.

In the 24-bit or 31-bit addressing mode, the contents of bit positions 0-31 of general registers R_2 and $R_2 + 1$, always remain unchanged.

Figure 7-267 shows the contents of the general registers just described.

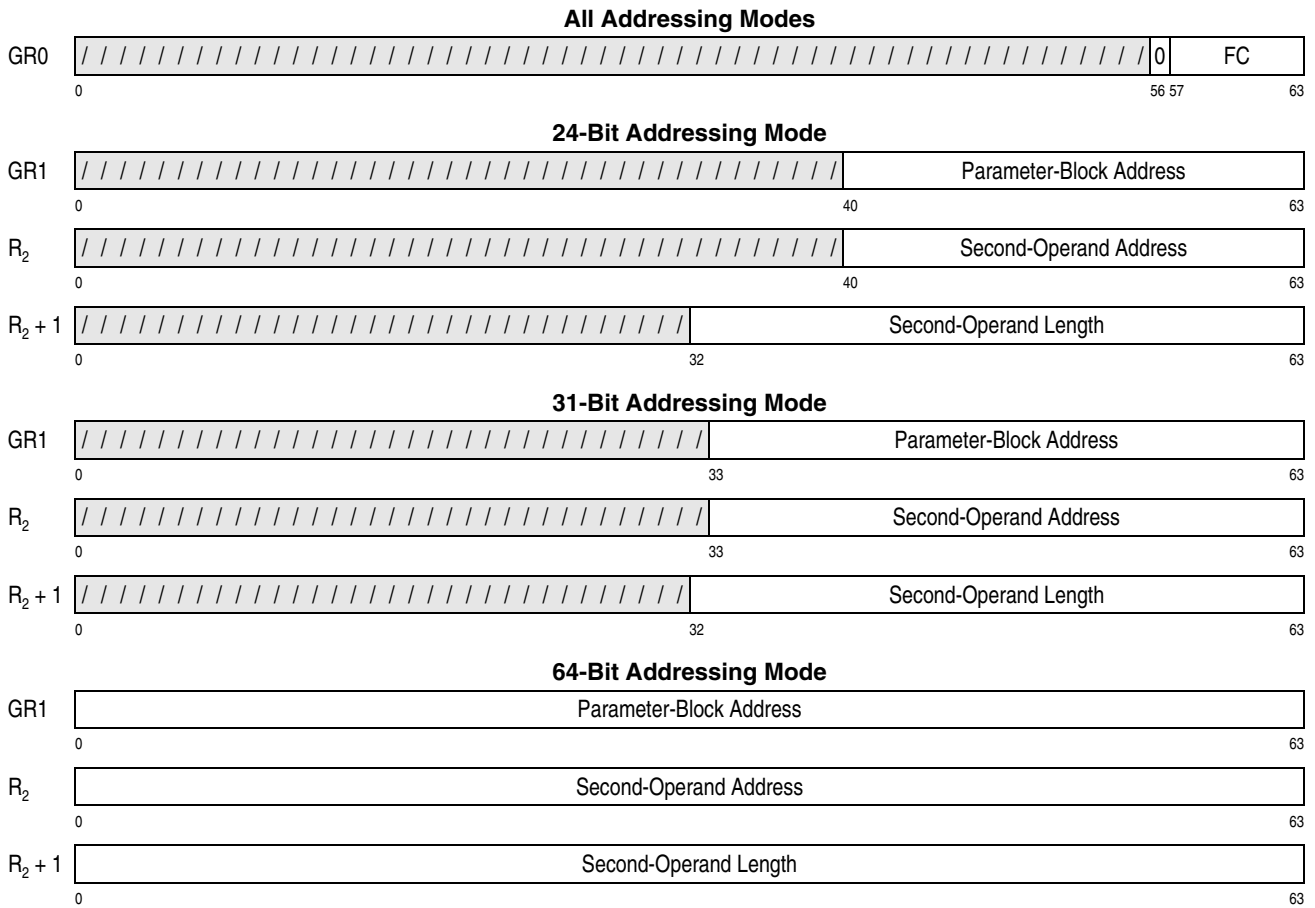

Figure 7-267. General Register Assignment for KMAC

In the access-register mode, access registers 1 and R_2 specify the address spaces containing the parameter block and second operand, respectively.

The result is obtained as if processing starts at the left end of the second operand and proceeds to the right, block by block. The operation is ended when all source bytes in the second operand have been processed (called normal completion), or when a CPU-determined number of blocks that is less than the length of the second operand have been processed (called partial completion). The CPU-determined

number of blocks depends on the model, and may be a different number each time the instruction is executed. The CPU-determined number of blocks is usually nonzero. In certain unusual situations, this number may be zero, and condition code 3 may be set with no progress. However, the CPU protects against endless reoccurrence of this no-progress case.

When the initial-chaining-value field overlaps any portion of the second operand, the result in the chaining-value field is unpredictable.

Normal completion occurs when the number of bytes in the second operand as specified in general register $R_2 + 1$ have been processed.

When the operation ends due to normal completion, condition code 0 is set and the resulting value in $R_2 + 1$ is zero. When the operation ends due to partial completion, condition code 3 is set and the resulting value in $R_2 + 1$ is nonzero.

When the second-operand length is initially zero, the second operand and the parameter block are not accessed, general registers R_2 and $R_2 + 1$ are not changed, and condition code 0 is set.

A PER storage-alteration event may be recognized for the portion of the parameter block that is stored. A PER zero-address-detection event may be recognized for the second-operand location and for the parameter block. When PER events are detected for one or more locations, it is unpredictable which location is identified in the PER access identification (PAID) and PER ASCE ID (AI).

As observed by this CPU, other CPUs, and channel programs, references to the parameter block and storage operand may be multiple-access references, accesses to these storage locations are not necessarily block-concurrent, and the sequence of these accesses or references is undefined.

For functions that perform a comparison of the wrapping-key verification pattern field in the parameter block with the wrapping-key verification-pattern register, it is unpredictable whether access exceptions and PER zero-address-detection events are recognized for the second operand when the comparison results in a mismatch.

Access exceptions may be reported for a larger portion of the second operand than is processed in a single execution of the instruction; however, access exceptions are not recognized for locations beyond the length of the second operand nor for locations more than 4K bytes beyond the current location being processed.

Symbols Used in Function Descriptions

The following symbols are used in the subsequent description of the COMPUTE MESSAGE AUTHENTICATION CODE functions. For data-encryption-algorithm (DEA) functions, the DEA-key-parity bit in each byte of the DEA key is ignored, and the opera-

tion proceeds normally, regardless of the DEA-key parity of the key. Further description of the data-encryption algorithm may be found in Reference [13.] on page xxx. Further description of the AES standard may be found in Reference [14.] on page xxx.

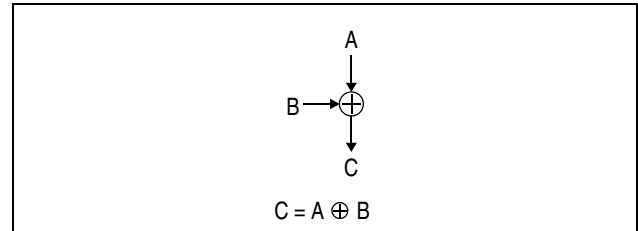

Figure 7-268. Symbol For Bit-Wise Exclusive OR

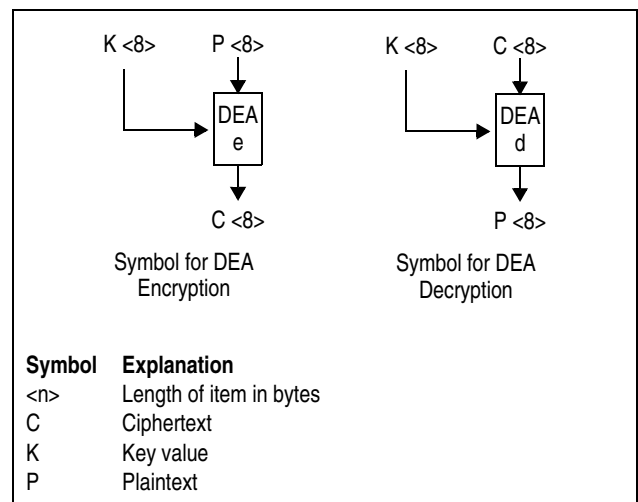

Figure 7-269. Symbols for DEA Encryption and Decryption

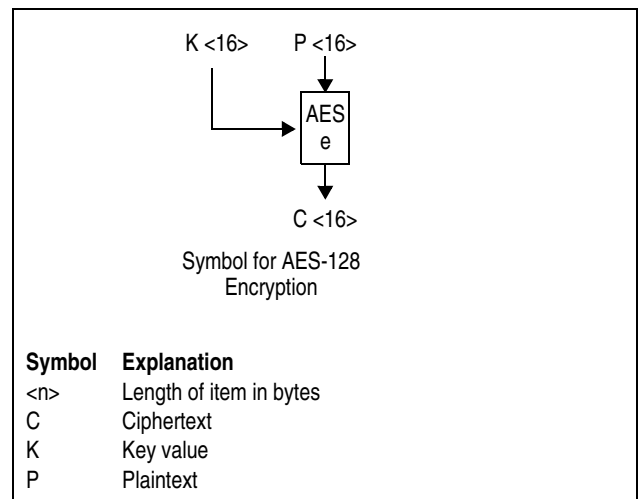

Figure 7-270. Symbols for AES-128 Encryption

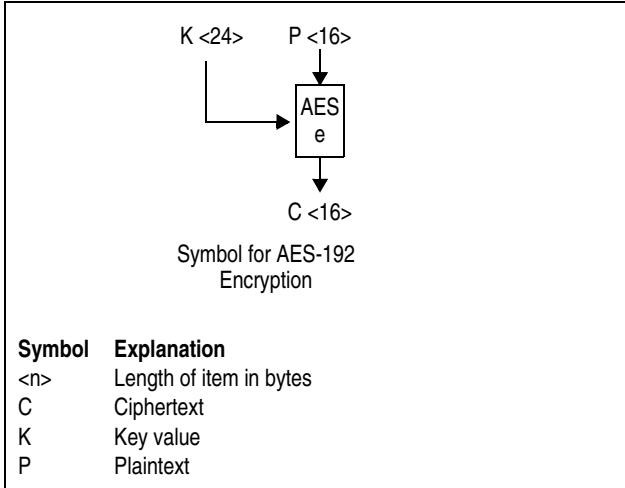

Figure 7-271. Symbols for AES-192 Encryption

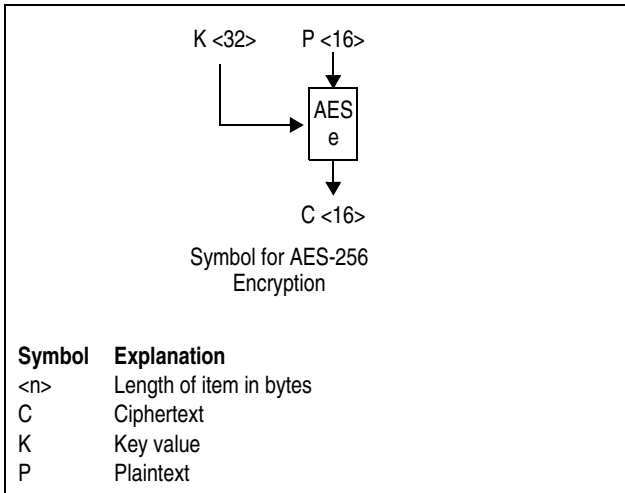

Figure 7-272. Symbols for AES-256 Encryption

KMAC-Query (Function Code 0)

The locations of the operands and addresses used by the instruction are as shown in Figure 7-267 on page 7-220.

The parameter block used for the function has the following format:

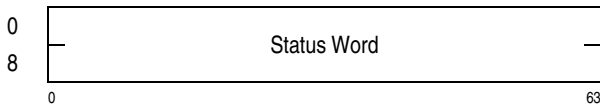

Figure 7-273. Parameter Block for KMAC-Query

A 128-bit status word is stored in the parameter block. Bits 0-127 of this field correspond to function codes 0-127, respectively, of the KMAC instruction.

When a bit is one, the corresponding function is installed; otherwise, the function is not installed.

Condition code 0 is set when execution of the KMAC-Query function completes; condition codes 1 and 3 are not applicable to this function.

KMAC-DEA (Function Code 1)

KMAC-Encrypted-DEA (Function Code 9)

The locations of the operands and addresses used by the instruction are as shown in Figure 7-267 on page 7-220.

The parameter block used for the KMAC-DEA function has the following format:

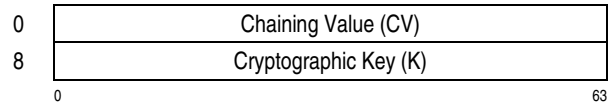

Figure 7-274. Parameter Block for KMAC-DEA

For the KMAC-DEA function, the initial chaining value is in byte offsets 0-7 of the parameter block and the cryptographic key is in byte offsets 8-15 of the parameter block.

The parameter block used for the KMAC-Encrypted-DEA function has the following format:

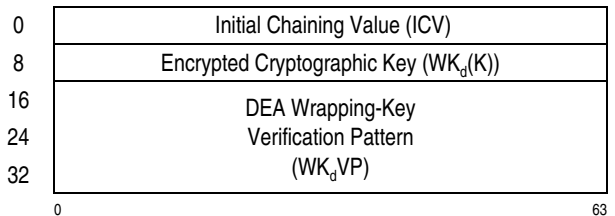

Figure 7-275. Parameter Block for KMAC-Encrypted-DEA

For the KMAC-Encrypted-DEA function, the contents of byte offsets 16-39 of the parameter block are compared with the contents of the DEA wrapping-key verification-pattern register. If they mismatch, the parameter-block location remains unchanged, and the operation is completed by setting condition code 1. If they match, byte offsets 0-7 of the parameter block contain the initial chaining value, and the contents of byte offsets 8-15 of the parameter block are deciphered using the DEA wrapping key to obtain the 64-bit cryptographic key. (See the section, “Protection of Cryptographic Keys” on page 7-431, for details.)

The description in the following paragraph applies to both functions.

The message authentication code for the 8-byte message blocks (M1, M2, ..., Mn) in operand 2 is computed using the DEA algorithm with the 64-bit cryptographic key and the 64-bit initial chaining value.

The message authentication code, also called the output chaining value (OCV), is stored in the initial-chaining-value field of the parameter block. The operation is shown in Figure 7-276.

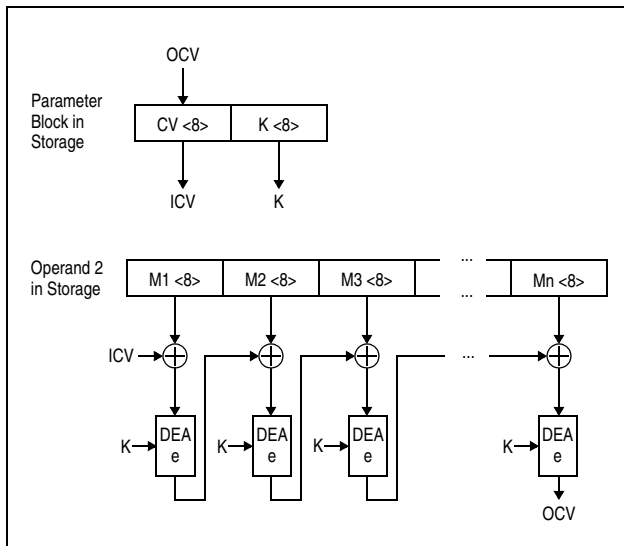

Figure 7-276. MAC Computation Using 64-bit DEA Key

KMAC-TDEA-128 (Function Code 2)

KMAC-Encrypted-TDEA-128 (Function Code 10)

The locations of the operands and addresses used by the instruction are as shown in Figure 7-267 on page 7-220.

The parameter block used for the KMAC-TDEA-128 function has the following format:

0	Initial Chaining Value (CV)
8	Cryptographic Key 1 (K1)
16	Cryptographic Key 2 (K2)
0	63

Figure 7-277. Parameter Block for KMAC-TDEA-128

For the KMAC-TDEA-128 function, the initial chaining value is in byte offsets 0-7 of the parameter block and the cryptographic key is in byte offsets 8-23 of the parameter block.

The parameter block used for the KMAC-Encrypted-TDEA-128 function has the following format:

0	Initial Chaining Value (ICV)
8	Encrypted Cryptographic Key (WK _e (K))
16	DEA Wrapping-Key Verification Pattern (WK _v (VP))
24	
32	
40	
0	63

Figure 7-278. Parameter Block for KMAC-Encrypted-TDEA-128

For the KMAC-Encrypted-TDEA-128 function, the contents of byte offsets 24-47 of the parameter block are compared with the contents of the DEA wrapping-key verification-pattern register. If they mismatch, the parameter-block location remains unchanged, and the operation is completed by setting condition code 1. If they match, byte offsets 0-7 of the parameter block contain the initial chaining value, and the contents of byte offsets 8-23 of the parameter block are deciphered using the DEA wrapping key to obtain the 128-bit cryptographic key, K. (See the section, "Protection of Cryptographic Keys" on page 7-431, for details.)

The description in the following paragraph applies to both functions.

The message authentication code for the 8-byte message blocks (M1, M2, ..., Mn) in operand 2 is computed using the TDEA algorithm with the two 64-bit cryptographic keys and the 64-bit initial chaining value.

The message authentication code, also called the output chaining value (OCV), is stored in the initial-

chaining-value field of the parameter block. The operation is shown in Figure 7-279.

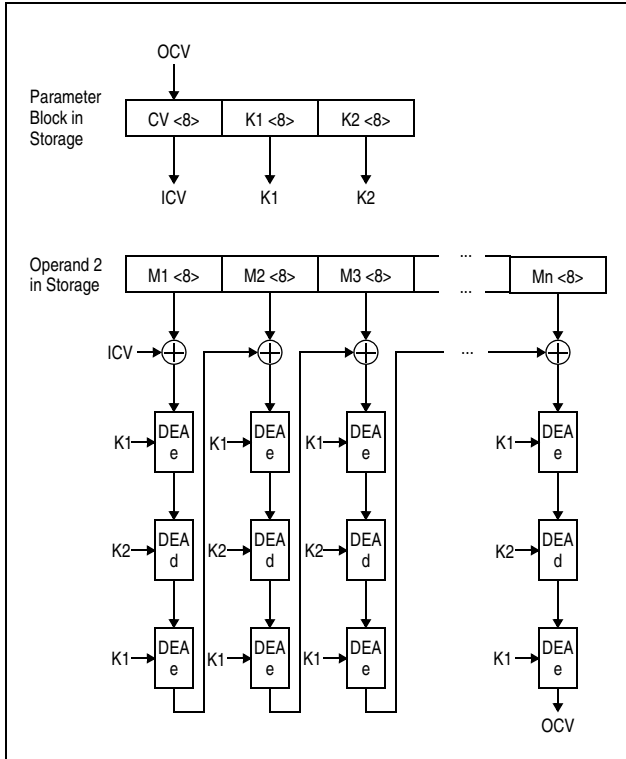

Figure 7-279. MAC Computation Using 128-bit TDEA Key

KMAC-TDEA-192 (Function Code 3)

KMAC-Encrypted-TDEA-192 (Function Code 11)

The locations of the operands and addresses used by the instruction are as shown in Figure 7-267 on page 7-220.

The parameter block used for the KMAC-TDEA-192 function has the following format:

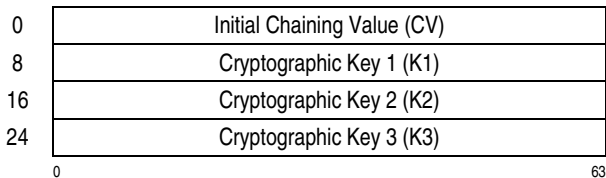

Figure 7-280. Parameter Block for KMAC-TDEA-192

For the KMAC-TDEA-192 function, the initial chaining value is in byte offsets 0-7 of the parameter block and the cryptographic key is in byte offsets 8-31 of the parameter block.

The parameter block used for the KMAC-Encrypted-TDEA-192 function has the following format:

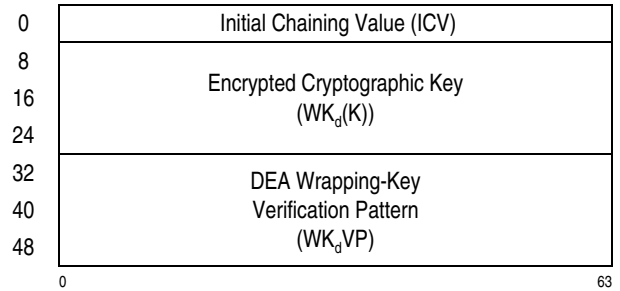

Figure 7-281. Parameter Block for KMAC-Encrypted-TDEA-192

For the KMAC-Encrypted-TDEA-192 function, the contents of byte offsets 32-55 of the parameter block are compared with the contents of the DEA wrapping-key verification-pattern register. If they mismatch, the parameter-block location remains unchanged, and the operation is completed by setting condition code 1. If they match, byte offsets 0-7 of the parameter block contain the initial chaining value, and the contents of byte offsets 8-31 of the parameter block are deciphered using the DEA wrapping key to obtain the 192-bit cryptographic key, K. (See the section, "Protection of Cryptographic Keys" on page 7-431, for details.)

The description in the following paragraph applies to both functions.

The message authentication code for the 8-byte message blocks (M1, M2, ..., Mn) in operand 2 is computed using the TDEA algorithm with the three 64-bit cryptographic keys and the 64-bit chaining value.

The message authentication code, also called the output chaining value (OCV), is stored in the initial-

chaining-value field of the parameter block. The operation is shown in Figure 7-282.

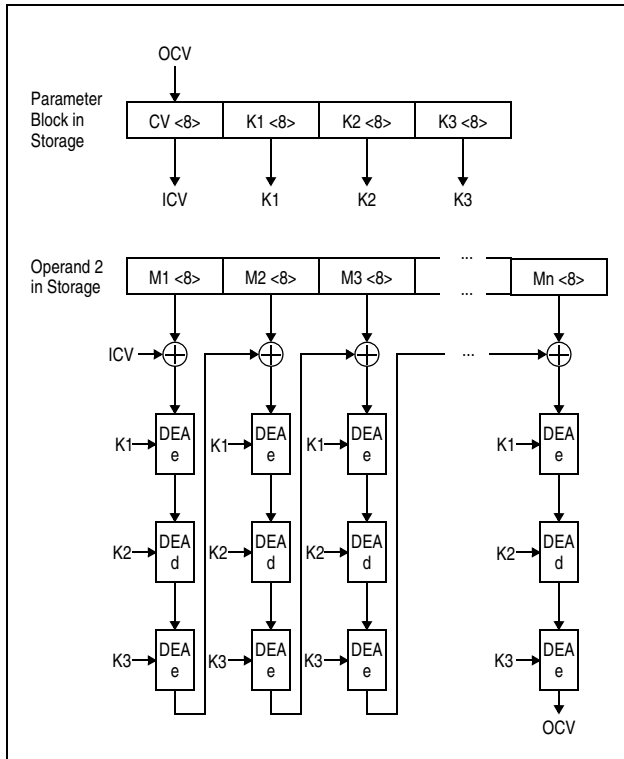

Figure 7-282. MAC Computation Using 192-bit TDEA Key

KMAC-AES-128 (Function Code 18)

KMAC-Encrypted-AES-128 (Function Code 26)

The locations of the operands and addresses used by the instruction are as shown in Figure 7-267 on page 7-220.

The parameter block used for the KMAC-AES-128 function has the following format:

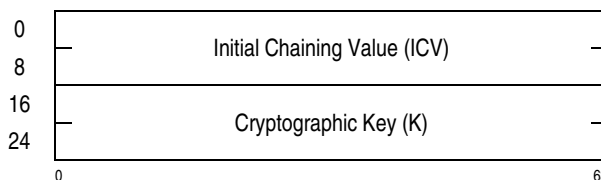

Figure 7-283. Parameter Block for KMAC-AES-128

For the KMAC-AES-128 function, the initial-chaining value is in byte offsets 0-15 of the parameter block and the cryptographic key is in byte offsets 16-31 of the parameter block.

The parameter block used for the KMAC-Encrypted-AES-128 function has the following format:

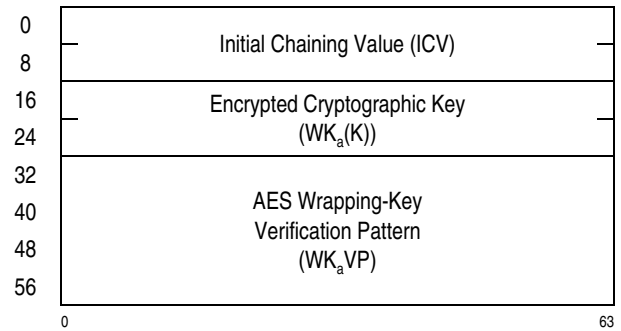

Figure 7-284. Parameter Block for KMAC-Encrypted-AES-128

For the KMAC-Encrypted-AES-128 function, the contents of byte offsets 32-63 of the parameter block are compared with the contents of the AES wrapping-key verification-pattern register. If they mismatch, the parameter-block location remains unchanged, and the operation is completed by setting condition code 1. If they match, byte offsets 0-15 of the parameter block contain the initial chaining value, and the contents of byte offsets 16-31 of the parameter block are deciphered using the AES wrapping key to obtain the 128-bit cryptographic key, K. (See the section “Protection of Cryptographic Keys” on page 7-431 for details.)

The description in the following paragraph applies to both functions.

The message authentication code for the 16-byte message blocks (M1, M2, ..., Mn) in operand 2 is computed using the AES algorithm with the 128-bit cryptographic key and the 128-bit chaining value.

The message authentication code, also called the output chaining value (OCV), is stored in the initial-

chaining-value field of the parameter block. The operation is shown in Figure 7-285.

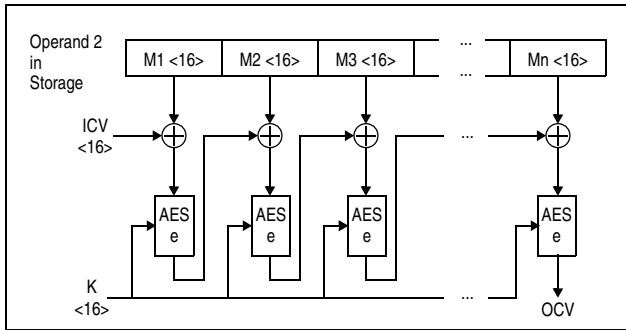

Figure 7-285. KMAC-AES-128

KMAC-AES-192 (Function Code 19)

KMAC-Encrypted-AES-192 (Function Code 27)

The locations of the operands and addresses used by the instruction are as shown in Figure 7-267 on page 7-220.

The parameter block used for the KMAC-AES-192 function has the following format:

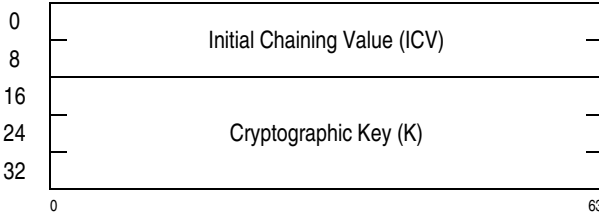

Figure 7-286. Parameter Block for KMAC-AES-192

For the KMAC-AES-192 function, the initial-chaining value is in byte offsets 0-15 of the parameter block and the cryptographic key is in byte offsets 16-39 of the parameter block.

The parameter block used for the KMAC-Encrypted-AES-192 function has the following format:

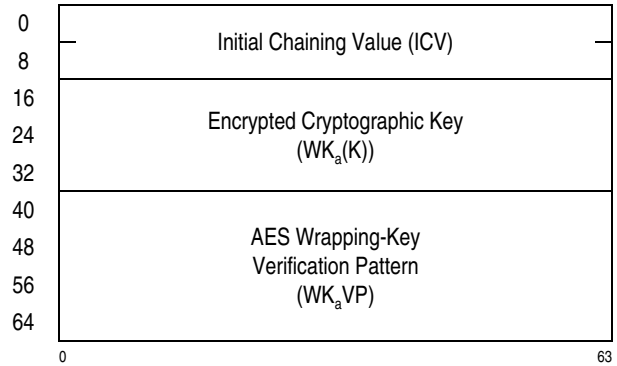

Figure 7-287. Parameter Block for KMAC-Encrypted-AES-192

For the KMAC-Encrypted-AES-192 function, the contents of byte offsets 40-71 of the parameter block are compared with the contents of the AES wrapping-key verification-pattern register. If they mismatch, the parameter-block location remains unchanged, and the operation is completed by setting condition code 1. If they match, byte offsets 0-15 of the parameter block contain the initial chaining value, and the contents of byte offsets 16-39 of the parameter block are deciphered using the AES wrapping key to obtain the 192-bit cryptographic key, K. (See the section “Protection of Cryptographic Keys” on page 7-431 for details.)

The description in the following paragraph applies to both functions.

The message authentication code for the 16-byte message blocks (M1, M2, ..., Mn) in operand 2 is computed using the AES algorithm with the 192-bit cryptographic key and the 128-bit chaining value.

The message authentication code, also called the output chaining value (OCV), is stored in the initial-

chaining-value field of the parameter block. The operation is shown in Figure 7-288.

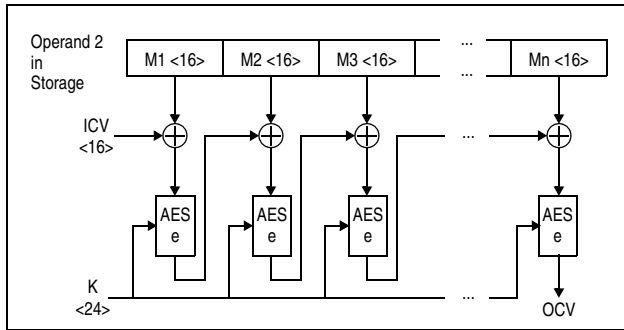

Figure 7-288. KMAC-AES-192

KMAC-AES-256 (Function Code 20)

KMAC-Encrypted-AES-256 (Function Code 28)

The locations of the operands and addresses used by the instruction are as shown in Figure 7-267 on page 7-220.

The parameter block used for the KMAC-AES-256 function has the following format:

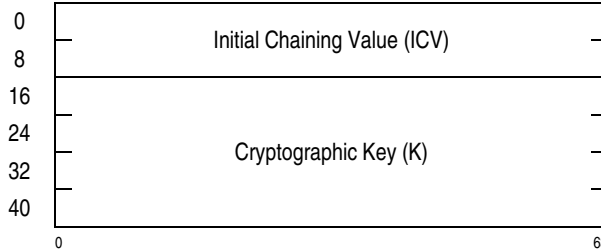

Figure 7-289. Parameter Block for KMAC-AES-256

For the KMAC-AES-256 function, the initial-chaining value is in byte offsets 0-15 of the parameter block and the cryptographic key is in byte offsets 16-47 of the parameter block.

The parameter block used for the KMAC-Encrypted-AES-256 function has the following format:

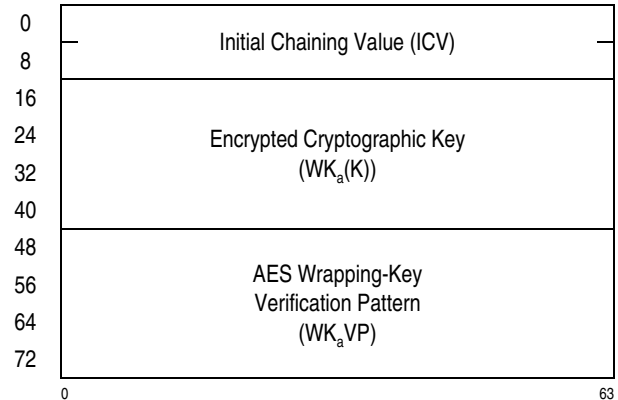

Figure 7-290. Parameter Block for KMAC-Encrypted-AES-256

For the KMAC-Encrypted-AES-256 function, the contents of byte offsets 48-79 of the parameter block are compared with the contents of the AES wrapping-key verification-pattern register. If they mismatch, the parameter-block location remains unchanged, and the operation is completed by setting condition code 1. If they match, byte offsets 0-15 of the parameter block contain the initial chaining value, and the contents of byte offsets 16-47 of the parameter block are deciphered using the AES wrapping key to obtain the 256-bit cryptographic key, K. (See the section “Protection of Cryptographic Keys” on page 7-431 for details.)

The description in the following paragraph applies to both functions.

The message authentication code for the 16-byte message blocks (M1, M2, ..., Mn) in operand 2 is computed using the AES algorithm with the 256-bit cryptographic key and the 128-bit chaining value.

The message authentication code, also called the output chaining value (OCV), is stored in the initial-

chaining-value field of the parameter block. The operation is shown in Figure 7-291.

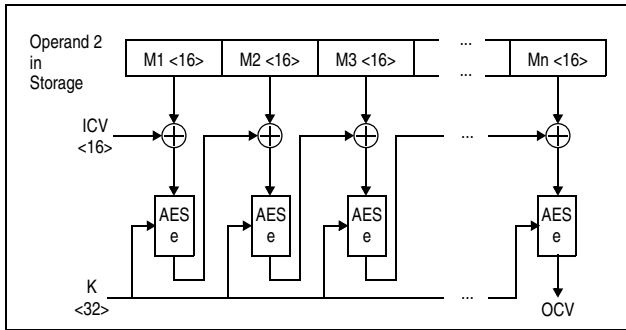

Figure 7-291. KMAC-AES-256

Special Conditions

A specification exception is recognized and no other action is taken if any of the following occurs:

1. Bit 56 of general register 0 is not zero.
2. Bits 57-63 of general register 0 specify an unassigned or uninstalled function code.
3. The R_2 field designates an odd-numbered register or general register 0.
4. The second-operand length is not a multiple of the data block size of the designated function (see Figure 7-266 on page 7-219 to determine the data block size for COMPUTE MESSAGE AUTHENTICATION CODE functions).

Resulting Condition Code:

- 0 Normal completion
- 1 Verification-pattern mismatch
- 2 --
- 3 Partial completion

Program Exceptions:

- Access (fetch, operand 2, cryptographic key, and wrapping-key verification pattern; fetch and store, chaining value)
- Operation (if the message-security assist is not installed)
- Specification

- Transaction constraint

1.-6.	Exceptions with the same priority as the priority of program-interruption conditions for the general case.
7.A	Access exceptions for second instruction halfword.
7.B	Operation exception.
7.C	Transaction constraint
8.	Specification exception due to invalid function code or invalid register number.
9.	Specification exception due to invalid operand length.
10.	Condition code 0 due to second-operand length originally zero.
11.A.1	Access exceptions for an access to the parameter block.
11.A.2.	Condition code 1 due to verification-pattern mismatch.
11.B	Access exceptions for an access to the parameter block or second operand.
12.	Condition code 0 due to normal completion (second-operand length originally nonzero, but stepped to zero).
13.	Condition code 3 due to partial completion (second-operand length still nonzero).

Figure 7-292. Priority of Execution: KMAC

Programming Notes:

1. The performance of the query function (code 0) may be significantly slower than that of simply examining a location in storage. If the program needs to frequently test for the availability of a function, it should perform the query function once during initialization; subsequently it should examine the stored results of the query function in memory with an instruction such as TEST UNDER MASK.
2. When condition code 3 is set, the second operand address and length in general registers R_2 and $R_2 + 1$, respectively, and the initial-chaining-value in the parameter block are usually updated such that the program can simply branch back to the instruction to continue the operation. For unusual situations, the CPU protects against endless reoccurrence for the no-progress case.

Thus, the program can safely branch back to the instruction whenever condition code 3 is set with no exposure to an endless loop.

3. If the length of the second operand is nonzero initially and condition code 0 is set, the registers are updated in the same manner as for condition code 3; the initial chaining value in this case is such that additional operands can be processed as if they were part of the same chain.
4. Before processing the first part of a message, the program must set the initial values for the initial-chaining-value field. To comply with ANSI X9.9, ANSI X9.19, or Reference [17.] on page xxx, the initial chaining value shall be set to all binary zeros.

CONVERT TO BINARY

CVB $R_1, D_2(X_2, B_2)$ [RX-a]

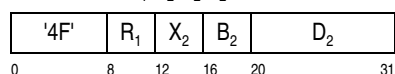

CVBY $R_1, D_2(X_2, B_2)$ [RXY-a]

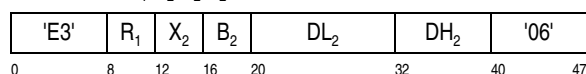

CVBG $R_1, D_2(X_2, B_2)$ [RXY-a]

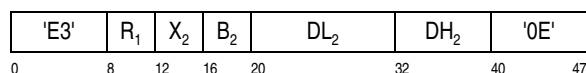

The second operand is changed from decimal to binary, and the result is placed at the first-operand location.

For CONVERT TO BINARY (CVB, CVBY), the second operand occupies eight bytes in storage, and, for CONVERT TO BINARY (CVBG), the second operand occupies sixteen bytes in storage. The second operand has the format of signed-packed-decimal data, as described in Chapter 8, “Decimal Instructions.” It is checked for valid sign and digit codes, and a general-operand data exception is recognized when an invalid code is detected.

For CONVERT TO BINARY (CVB, CVBY), the result of the conversion is a 32-bit signed binary integer, which is placed in bit positions 32-63 of general register R₁. Bits 0-31 of the register remain unchanged.

The maximum positive number that can be converted and still be contained in 32 bit positions is 2,147,483,647; the maximum negative number (the negative number with the greatest absolute value) that can be converted is -2,147,483,648.

For any decimal number outside this range, the operation is completed by placing the 32 rightmost bits of the binary result in the register, and a fixed-point-divide exception is recognized.

For CONVERT TO BINARY (CVBG), the result of the conversion is a 64-bit signed binary integer, which is placed in bit positions 0-63 of general register R₁. The maximum positive number that can be converted and still be contained in a 64-bit register is 9,223,372,036,854,775,807; the maximum negative number (the negative number with the greatest absolute value) that can be converted is -9,223,372,036,854,775,808. For any decimal number outside this range, a fixed-point-divide exception is recognized, and the operation is suppressed.

The displacement for CVB is treated as a 12-bit unsigned binary integer. The displacement for CVBY and CVBG is treated as a 20-bit signed binary integer.

Condition Code: The code remains unchanged.

Program Exceptions:

- Access (fetch, operand 2)
- Data with DXC 0, general operand
- Fixed-point divide
- Operation (CVBY, if the long-displacement facility is not installed)
- Transaction constraint

Programming Notes:

1. An example of the use of the CONVERT TO BINARY instruction is given in Appendix A, “Number Representation and Instruction-Use Examples.”
2. When the second operand is negative, the result is in two’s-complement notation.
3. The storage-operand references for CONVERT TO BINARY may be multiple-access references. (See “Storage-Operand Consistency” on page 5-125.)

CONVERT TO DECIMAL

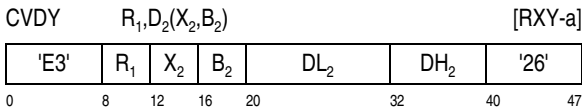
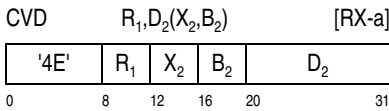

The first operand is changed from binary to decimal, and the result is stored at the second-operand location.

For CONVERT TO DECIMAL (CVD, CVDY), the first operand is treated as a 32-bit signed binary integer, and the result occupies eight bytes in storage. For CONVERT TO DECIMAL (CVDG), the first operand is treated as a 64-bit signed binary integer, and the result occupies sixteen bytes in storage.

The result is in the format for signed-packed-decimal data, as described in Chapter 8, “Decimal Instructions.” The rightmost four bits of the result represent the sign. A positive sign is encoded as 1100; a negative sign is encoded as 1101.

The displacement for CVD is treated as a 12-bit unsigned binary integer. The displacement for CVDY and CVDG is treated as a 20-bit signed binary integer.

Condition Code: The code remains unchanged.

Program Exceptions:

- Access (store, operand 2)
- Operation (CVDY, if the long-displacement facility is not installed)
- Transaction constraint

Programming Notes:

1. An example of the use of the CONVERT TO DECIMAL instruction is given in Appendix A, “Number Representation and Instruction-Use Examples.”

2. For CVD and CVDY, the number to be converted is a 32-bit signed binary integer obtained from a general register. Since 15 decimal digits are available for the result, and the decimal equivalent of 31 bits requires at most 10 decimal digits, an overflow cannot occur. Similarly, for CVDG, 31 decimal digits are available, the decimal equivalent of 63 bits is at most 19 digits, and an overflow cannot occur.

3. The storage-operand references for CONVERT TO DECIMAL may be multiple-access references. (See “Storage-Operand Consistency” on page 5-125.)

CONVERT UTF-16 TO UTF-32

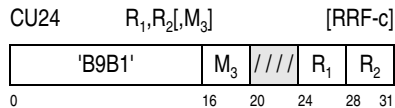

The two-byte UTF-16 (Unicode) characters of the second operand are converted to UTF-32 characters and placed at the first-operand location. The UTF-32 characters are four bytes. The operation proceeds until the end of the first or second operand is reached, a CPU-determined number of characters have been converted, or an invalid Unicode character is encountered, whichever occurs first. The result is indicated in the condition code.

The R₁ and R₂ fields each designate an even-odd pair of general registers and must designate an even-numbered register; otherwise, a specification exception is recognized.

The location of the leftmost byte of the first operand and the second operand is designated by the contents of general registers R₁ and R₂, respectively. In the 24-bit or 31-bit addressing mode, the number of bytes in the first-operand and second-operand locations is specified by the contents of bit positions 32-63 of general registers R₁ + 1 and R₂ + 1, respectively, and those contents are treated as 32-bit unsigned binary integers. In the 64-bit addressing mode, the number of bytes in the first-operand and second-operand locations is specified by the entire contents of general registers R₁ + 1 and R₂ + 1, respectively, and those contents are treated as 64-bit unsigned binary integers.

The handling of the addresses in general registers R_1 and R_2 is dependent on the addressing mode.

In the 24-bit addressing mode, the contents of bit positions 40-63 of general registers R_1 and R_2 constitute the address, and the contents of bit positions 0-39 are ignored. In the 31-bit addressing mode, the

contents of bit positions 33-63 of the registers constitute the address, and the contents of bit positions 0-32 are ignored. In the 64-bit addressing mode, the contents of bit positions 0-63 constitute the address.

The contents of the registers just described are shown in Figure 7-293.

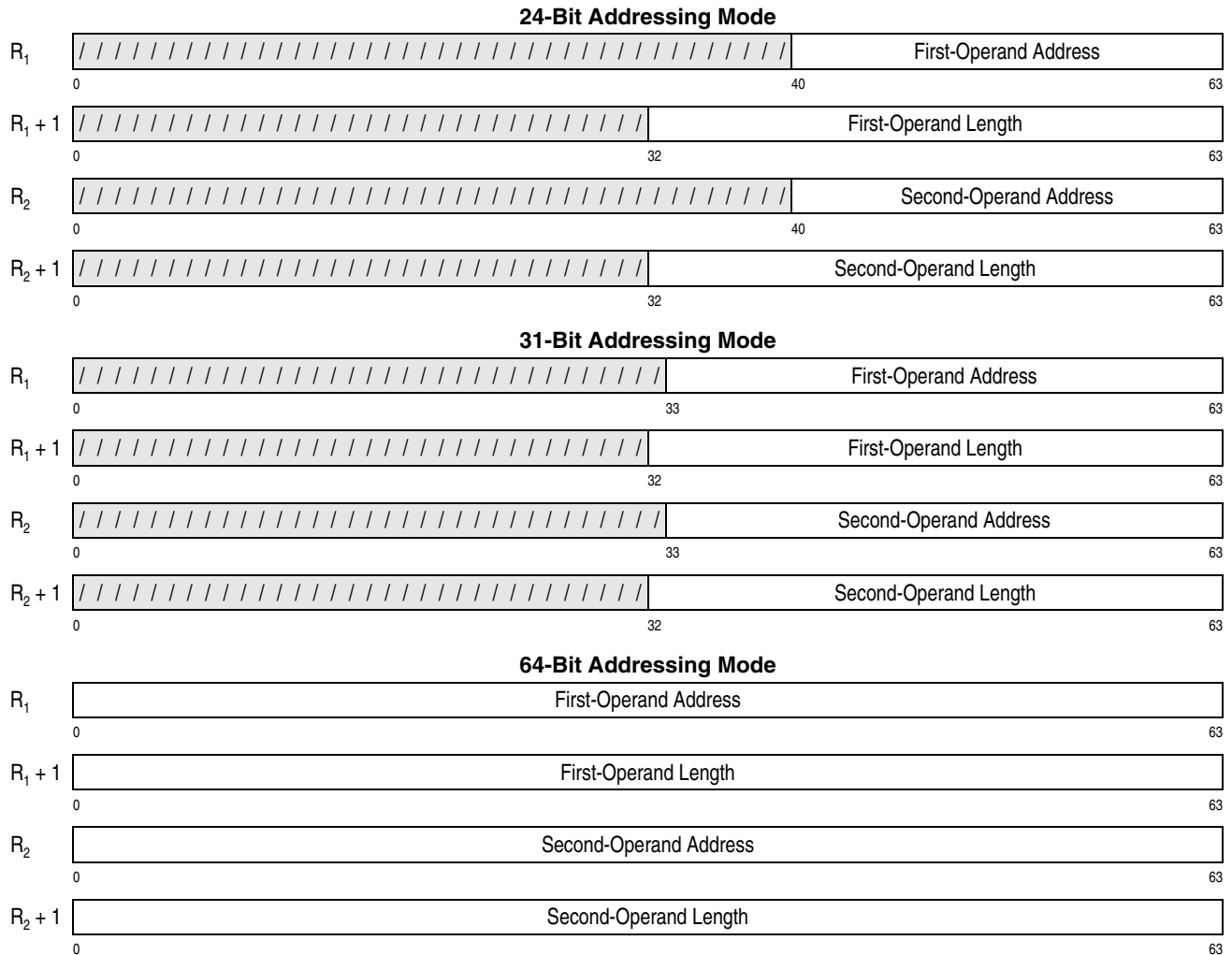
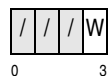

Figure 7-293. Register Contents for CONVERT UTF-16 TO UTF-32

When the ETF3-enhancement facility is installed, the M_3 field has the following format:



The bits of the M_3 field are defined as follows:

- **Unassigned:** Bits 0-2 are unassigned and should contain zeros; otherwise, the program may not operate compatibly in the future.
- **Enhanced Well-Formedness-Checking (W):** The W bit, bit 3 of the M_3 field, controls whether enhanced well-formedness checking of the Unicode characters is performed. When the W bit is zero, enhanced checking is not performed. When the W bit is one, enhanced checking is performed, as described below.

When the ETF3-enhancement facility is not installed, the M_3 field is ignored.

The characters of the second operand are selected one by one for conversion, proceeding left to right. The characters resulting from a conversion are placed at the first-operand location, proceeding left to right. The operation proceeds until the first-operand or second-operand location is exhausted, a CPU-determined number of second-operand characters have been converted, or on some models when the W bit of the M_3 field is one, an invalid Unicode character is detected.

To show the method of converting a UTF-16 character to a UTF-32 character, the bits of a Unicode character are identified by letters as follows:

Unicode Character Bit Numbers	0 1 2 3 4 5 6 7	8 9 10 11 12 13 14 15
Identifying Bit Letters	a b c d e f g h	i j k l m n o p

In the case of a Unicode surrogate pair, which is a character pair consisting of a character called a high surrogate followed by a character called a low surrogate, the bits are identified by letters as follows:

Unicode High Surrogate Bit Numbers	0 1 2 3 4 5 6 7	8 9 10 11 12 13 14 15
Identifying Bit Letters	1 1 0 1 1 0 a b	c d e f g h i j

Unicode Low Surrogate Bit Numbers	16 17 18 19 20 21 22 23	24 25 26 27 28 29 30 31
Identifying Bit Letters	1 1 0 1 1 1 k l	m n o p q r s t

A low surrogate (that is, a Unicode character in the range of DC00 to DFFF hex) that is not immediately preceded by a high surrogate (that is, a Unicode character in the range of D800 to DBFF hex) is called an isolated low surrogate.

Any Unicode character in the range 0000 to D7FF or E000 to FFFF hex is converted to a four-byte UTF-32 character as follows:

Unicode Character	a b c d e f g h	i j k l m n o p		
UTF-32 Character	0 0 0 0 0 0 0 0	0 0 0 0 0 0 0 0	a b c d e f g h	i j k l m n o p

On some models, an isolated low surrogate (that is, a Unicode character in the range of DC00 to DFFF hex) is also converted to a four-byte UTF-32 character

as shown above, regardless of whether the ETF3-enhancement facility is installed and regardless of the W bit of the M_3 field. On other models, when the ETF3-enhancement facility is installed, the W bit of the M_3 field is one, and the next Unicode character is an isolated low surrogate, condition code 2 is set.

Any Unicode surrogate pair starting with a high surrogate in the range D800 to DBFF hex is converted to a four-byte UTF-32 character as follows:

Unicode Characters	1 1 0 1 1 0 a b	c d e f g h i j	1 1 0 1 1 1 k l	m n o p q r s t
UTF-32 Character	0 0 0 0 0 0 0 0	0 0 0 u v w x y	e f g h i j k l	m n o p q r s t
where $uvwx y = abcd + 1$				

When the ETF3-enhancement facility is not installed, or when the W bit of the M_3 field is zero, the first six bits of an expected Unicode low surrogate are ignored. When the ETF3-enhancement facility is installed, and the W bit is one, the first six bits of the Unicode low surrogate must contain 110111 binary; otherwise, the Unicode low surrogate is invalid, and condition code 2 is set.

The second-operand location is considered exhausted when it does not contain at least two remaining bytes or at least four remaining bytes when the first two bytes are a Unicode high surrogate. The first-operand location is considered exhausted when it does not contain at least four remaining bytes.

When the second-operand location is exhausted, condition code 0 is set. When the first-operand location is exhausted, condition code 1 is set, except that condition code 0 is set if the second-operand location also is exhausted. When a CPU-determined number of characters have been converted, condition code 3 is set.

When the conditions for setting condition codes 1 and 2 are both met, condition code 2 is set.

When the operation is completed, the contents of general register $R_2 + 1$ are decremented by the number of bytes converted, and the contents of general register R_2 are incremented by the same number. Also, the contents of general register $R_1 + 1$ are decremented by the number of bytes placed at the first-operand location, and the contents of general register R_1 are incremented by the same number. When general registers R_1 and R_2 are updated in the 24-bit

or 31-bit addressing mode, bits 32-39 of them, in the 24-bit mode, or bit 32, in the 31-bit mode, may be set to zeros or may remain unchanged.

In the 24-bit or 31-bit addressing mode, the contents of bit positions 0-31 of general registers R_1 , $R_1 + 1$, R_2 , and $R_2 + 1$, always remain unchanged.

When condition code 2 is set, the following applies:

- When a Unicode high surrogate immediately precedes an invalid low surrogate, general register R_2 contains the address of the Unicode high surrogate.
- When an isolated Unicode low surrogate is detected, general register R_2 contains the address of the isolated low surrogate.

When condition code 3 is set, the registers have been updated so that the instruction, when reexecuted, resumes at the next byte locations to be processed.

The amount of processing that results in the setting of condition code 3 is determined by the CPU on the basis of improving system performance, and it may be a different amount each time the instruction is executed.

When the R_1 register is the same register as the R_2 register, the results are unpredictable.

When the second operand overlaps the first operand, the results are unpredictable.

Access exceptions for the portions of the operands to the right of the last byte processed may or may not be recognized. For an operand longer than 4K bytes, access exceptions are not recognized for locations more than 4K bytes beyond the last byte processed.

When the length of an operand is zero, no access exceptions are recognized for that operand. Access exceptions are not recognized for an operand if the R field associated with that operand is odd.

Resulting Condition Code:

- 0 Entire second operand processed
- 1 End of first operand reached
- 2 Invalid Unicode low surrogate
- 3 CPU-determined number of characters converted

Program Exceptions:

- Access (fetch, operand 2; store, operand 1)
- Operation (if the extended-translation facility 3 is not installed)
- Specification
- Transaction constraint

Programming Notes:

1. When condition code 3 is set, the program can simply branch back to the instruction to continue the conversion. The program need not determine the number of first-operand or second-operand bytes that were processed.
2. The storage-operand references of CONVERT UTF-16 TO UTF-32 may be multiple-access references. (See “Storage-Operand Consistency” on page 5-125.)
3. The CONVERT UTF-16 TO UTF-32 instruction supports UTF-16 and UTF-32 characters only in the big-endian encoding.
4. As observed by this CPU, other CPUs, and the I/O subsystem, inconsistent results may be briefly stored in the first-operand location. See the section “Effects of CPU Retry” on page 11-3 for further details.
5. Determining that isolated Unicode low surrogates are invalid is a model-dependent behavior that is not available on the IBM z13 and earlier models.

**CONVERT UTF-16 TO UTF-8
CONVERT UNICODE TO UTF-8**

CU21 R_1, R_2, M_3 [RRF-c]
CUUTF R_1, R_2, M_3 [RRF-c]

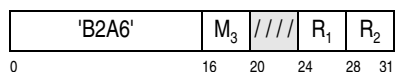

The two-byte Unicode characters of the second operand are converted to UTF-8 characters and placed at the first-operand location. The UTF-8 characters are one, two, three, or four bytes, depending on the Unicode characters that are converted. The operation proceeds until the end of the first or second operand is reached, a CPU-determined number of characters have been converted, or an invalid Unicode character is encountered in the second operand, whichever

occurs first. The result is indicated in the condition code.

The R_1 and R_2 fields each designate an even-odd pair of general registers and must designate an even-numbered register; otherwise, a specification exception is recognized.

The location of the leftmost byte of the first operand and the second operand is designated by the contents of general registers R_1 and R_2 , respectively. In the 24-bit or 31-bit addressing mode, the number of bytes in the first-operand and second-operand locations is specified by the contents of bit positions 32-63 of general registers $R_1 + 1$ and $R_2 + 1$, respectively, and those contents are treated as 32-bit unsigned binary integers. In the 64-bit addressing mode, the number of bytes in the first-operand and second-operand locations is specified by the entire

contents of general registers $R_1 + 1$ and $R_2 + 1$, respectively, and those contents are treated as 64-bit unsigned binary integers.

The handling of the addresses in general registers R_1 and R_2 is dependent on the addressing mode.

In the 24-bit addressing mode, the contents of bit positions 40-63 of general registers R_1 and R_2 constitute the address, and the contents of bit positions 0-39 are ignored. In the 31-bit addressing mode, the contents of bit positions 33-63 of the registers constitute the address, and the contents of bit positions 0-32 are ignored. In the 64-bit addressing mode, the contents of bit positions 0-63 constitute the address.

The contents of the registers just described are shown in Figure 7-294.

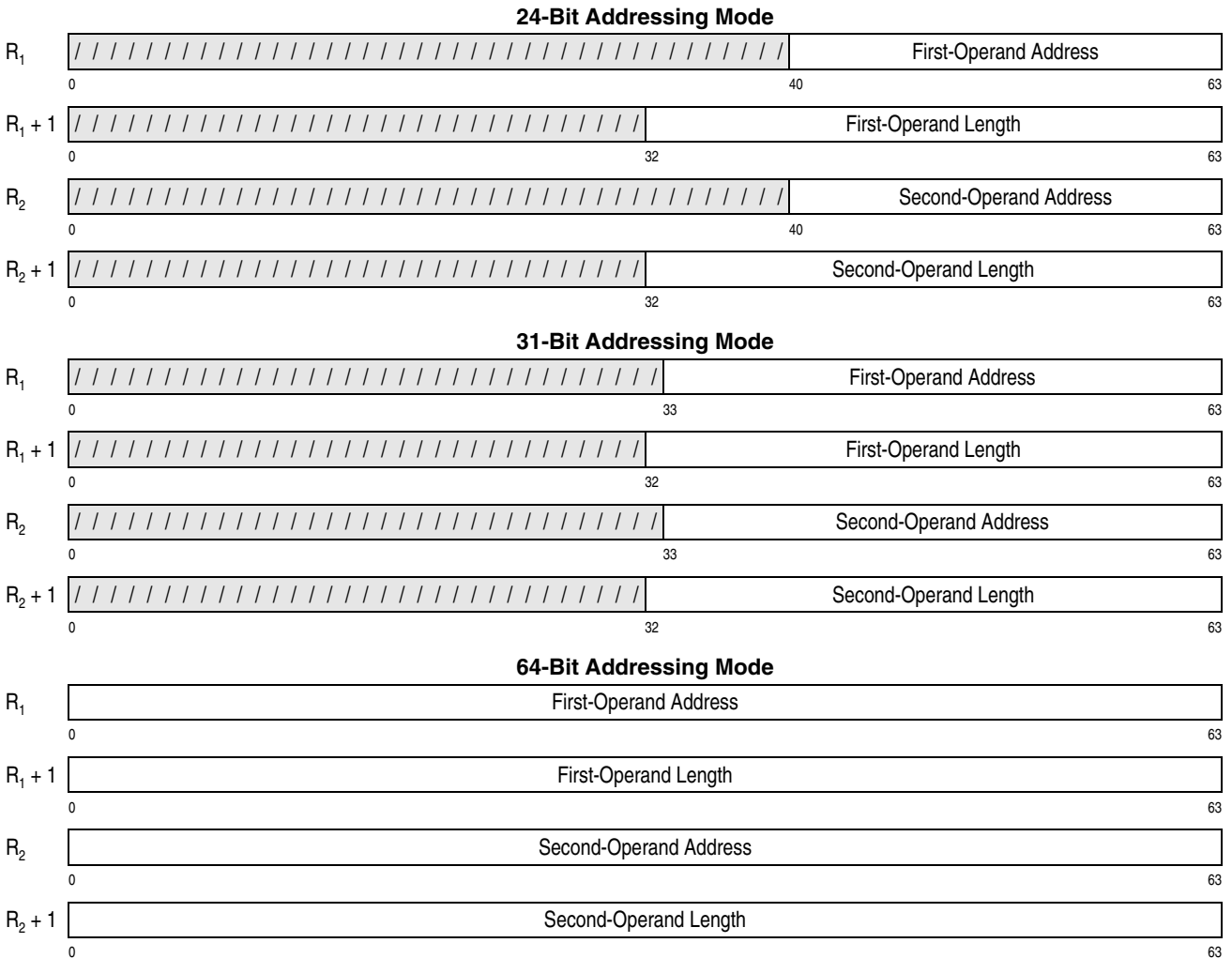
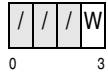

Figure 7-294. Register Contents for CONVERT UTF-16 TO UTF-8

When the ETF3-enhancement facility is installed, the M₃ field has the following format:



The bits of the M₃ field are defined as follows:

- **Unassigned:** Bits 0-2 are unassigned and should contain zeros; otherwise, the program may not operate compatibly in the future.
- **Enhanced Well-Formedness-Checking (W):** The W bit, bit 3 of the M₃ field, controls whether enhanced well-formedness checking of the Unicode characters is performed. When the W bit is zero, enhanced checking is not performed. When the W bit is one, enhanced checking is performed, as described below.

When the ETF3-enhancement facility is not installed, the M₃ field is ignored. When the ETF3-enhancement facility is installed in the z/Architecture architectural mode, it is unpredictable whether the M₃ field is ignored in the ESA/390-compatibility mode.

The characters of the second operand are selected one by one for conversion, proceeding left to right. The bytes resulting from a conversion are placed at the first-operand location, proceeding left to right. The operation proceeds until the first-operand or second-operand location is exhausted, a CPU-determined number of second-operand characters have been converted, or an invalid Unicode character is encountered in the second operand.

To show the method of converting a Unicode character to a UTF-8 character, the bits of a Unicode character are identified by letters as follows:

Unicode Character Bit Numbers	0 1 2 3 4 5 6 7	8 9 10 11 12 13 14 15
Identifying Bit Letters	a b c d e f g h	i j k l m n o p

In the case of a Unicode surrogate pair, which is a character pair consisting of a character called a high

surrogate followed by a character called a low surrogate, the bits are identified by letters as follows:

Unicode High Surrogate Bit Numbers	0 1 2 3 4 5 6 7	8 9 10 11 12 13 14 15
Identifying Bit Letters	1 1 0 1 1 0 a b	c d e f g h i j

Unicode Low Surrogate Bit Numbers	16 17 18 19 20 21 22 23	24 25 26 27 28 29 30 31
Identifying Bit Letters	1 1 0 1 1 1 k l	m n o p q r s t

A low surrogate (that is, a Unicode character in the range of DC00 to DFFF hex) that is not immediately preceded by a high surrogate (that is, a Unicode character in the range of D800 to DBFF hex) is called an isolated low surrogate.

Any Unicode character in the range 0000 to 007F hex is converted to a one-byte UTF-8 character as follows:

Unicode Character	0 0 0 0 0 0 0 0	0 j k l m n o p
UTF-8 Character	0 j k l m n o p	

Any Unicode character in the range 0080 to 07FF hex is converted to a two-byte UTF-8 character as follows:

Unicode Character	0 0 0 0 0 f g h	i j k l m n o p
UTF-8 Character	1 1 0 f g h i j	1 0 k l m n o p

Any Unicode character in the range 0800 to D7FF or E000 to FFFF hex is converted to a three-byte UTF-8 character as follows:

Unicode Character	a b c d e f g h	i j k l m n o p	
UTF-8 Character	1 1 1 0 a b c d	1 0 e f g h i j	1 0 k l m n o p

On some models, an isolated low surrogate (that is, a Unicode character in the range of DC00 to DFFF hex) is also converted to a three-byte UTF-8 character as shown above, regardless of whether the ETF3-enhancement facility is installed and regardless of the W bit of the M₃ field. On other models, when the ETF3-enhancement facility is installed, the W bit of the M₃ field is one, and the next Unicode character is an isolated low surrogate, condition code 2 is set.

Any Unicode surrogate pair starting with a high surrogate in the range D800 to DBFF hex is converted to a four-byte UTF-8 character as follows:

Unicode Characters	1 1 0 1 1 0 a b c d e f g h i j	1 1 0 1 1 1 k l m n o p q r s t
UTF-8 Character	1 1 1 1 0 u v w x y e f g h	1 0 i j k l m n 1 0 o p q r s t
where $uvwx = abcd + 1$		

When the ETF3-enhancement facility is not installed, or when the W bit of the M₃ field is zero, the first six bits of an expected Unicode low surrogate are ignored. When the ETF3-enhancement facility is installed, and the W bit is one, the first six bits of the Unicode low surrogate must contain 110111 binary; otherwise, the Unicode low surrogate is invalid, and condition code 2 is set.

The second-operand location is considered exhausted when it does not contain at least two remaining bytes or at least four remaining bytes when the first two bytes are a Unicode high surrogate. The first-operand location is considered exhausted when it does not contain at least the one, two, three, or four remaining bytes required to contain the UTF-8 character resulting from the conversion of the next second-operand character or surrogate pair.

When the second-operand location is exhausted, condition code 0 is set. When the first-operand location is exhausted, condition code 1 is set, except that condition code 0 is set if the second-operand location also is exhausted. When a CPU-determined number of characters have been converted, condition code 3 is set.

When the conditions for setting condition codes 1 and 2 are both met, condition code 2 is set.

When the operation is completed, the contents of general register R₂ + 1 are decremented by the number of bytes converted, and the contents of general register R₂ are incremented by the same number. Also, the contents of general register R₁ + 1 are decremented by the number of bytes placed at the first-operand location, and the contents of general register R₁ are incremented by the same number. When general registers R₁ and R₂ are updated in the 24-bit or 31-bit addressing mode, bits 32-39 of them, in the 24-bit mode, or bit 32, in the 31-bit mode, may be set to zeros or may remain unchanged.

In the 24-bit or 31-bit addressing mode, the contents of bit positions 0-31 of general registers R₁, R₁ + 1, R₂, and R₂ + 1, always remain unchanged.

When condition code 2 is set, the following applies:

- When a Unicode high surrogate immediately precedes an invalid low surrogate, general register R₂ contains the address of the Unicode high surrogate.
- When an isolated Unicode low surrogate is detected, general register R₂ contains the address of the isolated low surrogate.

When condition code 3 is set, the registers have been updated so that the instruction, when reexecuted, resumes at the next byte locations to be processed.

The amount of processing that results in the setting of condition code 3 is determined by the CPU on the basis of improving system performance, and it may be a different amount each time the instruction is executed.

When the R₁ register is the same register as the R₂ register, the results are unpredictable.

When the second operand overlaps the first operand, the results are unpredictable.

Access exceptions for the portions of the operands to the right of the last byte processed may or may not be recognized. For an operand longer than 4K bytes, access exceptions are not recognized for locations more than 4K bytes beyond the last byte processed.

When the length of an operand is zero, no access exceptions are recognized for that operand. Access exceptions are not recognized for an operand if the R field associated with that operand is odd.

Resulting Condition Code:

- 0 Entire second operand processed
- 1 End of first operand reached
- 2 Invalid Unicode low surrogate
- 3 CPU-determined number of characters converted

Program Exceptions:

- Access (fetch, operand 2; store, operand 1)

- Specification
- Transaction constraint

Programming Notes:

1. When condition code 3 is set, the program can simply branch back to the instruction to continue the conversion. The program need not determine the number of first-operand or second-operand bytes that were processed.
2. The storage-operand references of CONVERT UNICODE TO UTF-8 may be multiple-access references. (See “Storage-Operand Consistency” on page 5-125.)
3. The CONVERT UTF-16 TO UTF-8 (CONVERT UNICODE TO UTF-8) instruction supports UTF-16 characters only in the big-endian encoding.
4. As observed by this CPU, other CPUs, and the I/O subsystem, inconsistent results may be briefly stored in the first-operand location. See the section “Effects of CPU Retry” on page 11-3 for further details.
5. Determining that isolated Unicode low surrogates are invalid is a model-dependent behavior that is not available on the IBM z13 and earlier models.

tion proceeds until the end of the first or second operand is reached, a CPU-determined number of characters have been converted, or an invalid UTF-32 character is encountered, whichever occurs first. The result is indicated in the condition code.

The R_1 and R_2 fields each designate an even-odd pair of general registers and must designate an even-numbered register; otherwise, a specification exception is recognized.

The location of the leftmost byte of the first operand and the second operand is designated by the contents of general registers R_1 and R_2 , respectively. In the 24-bit or 31-bit addressing mode, the number of bytes in the first-operand and second-operand locations is specified by the contents of bit positions 32-63 of general registers $R_1 + 1$ and $R_2 + 1$, respectively, and those contents are treated as 32-bit unsigned binary integers. In the 64-bit addressing mode, the number of bytes in the first-operand and second-operand locations is specified by the entire contents of general registers $R_1 + 1$ and $R_2 + 1$, respectively, and those contents are treated as 64-bit unsigned binary integers.

The handling of the addresses in general registers R_1 and R_2 is dependent on the addressing mode.

In the 24-bit addressing mode, the contents of bit positions 40-63 of general registers R_1 and R_2 constitute the address, and the contents of bit positions 0-39 are ignored. In the 31-bit addressing mode, the contents of bit positions 33-63 of the registers constitute the address, and the contents of bit positions 0-32 are ignored. In the 64-bit addressing mode, the contents of bit positions 0-63 constitute the address.

CONVERT UTF-32 TO UTF-16

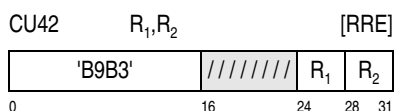

The four-byte UTF-32 characters of the second operand are converted to two-byte UTF-16 characters and placed at the first-operand location. The opera-

The contents of the registers just described are shown in Figure 7-295.

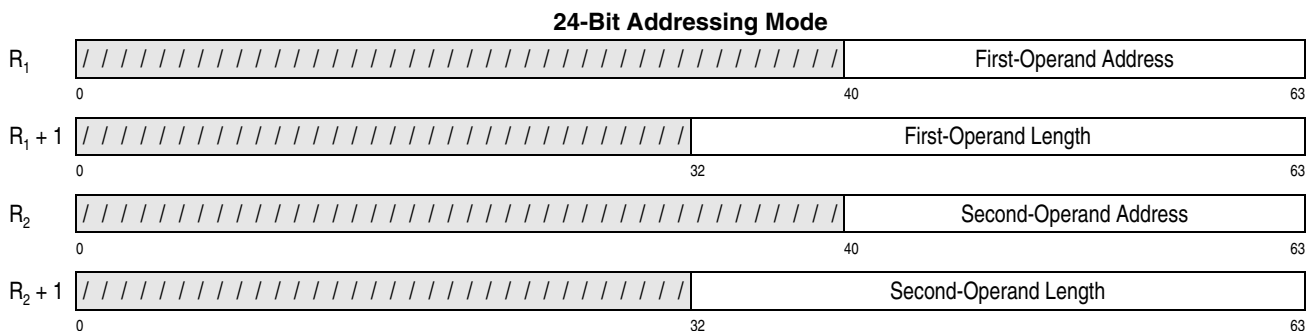

Figure 7-295. Register Contents for CONVERT UTF-32 TO UTF-16 (Part 1 of 2)

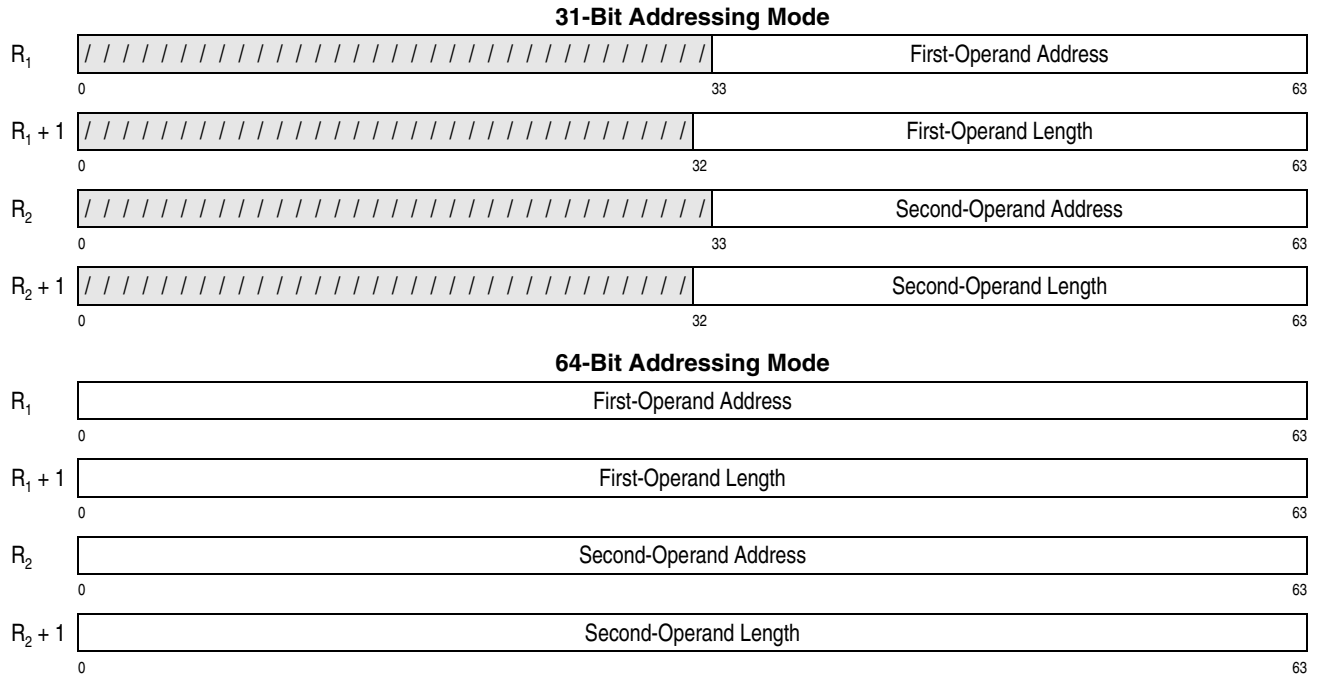

Figure 7-295. Register Contents for CONVERT UTF-32 TO UTF-16 (Part 2 of 2)

The characters of the second operand are selected one by one for conversion, proceeding left to right. The bytes resulting from a conversion are placed at the first-operand location, proceeding left to right. The operation proceeds until the first-operand or second-operand location is exhausted, a CPU-determined number of second-operand characters have been converted, or an invalid UTF-32 character is encountered in the second operand.

To show the method of converting a UTF-32 character to a UTF-16 character, the bits of a UTF-32 character in the range 00000000 to 0000D7FF or 0000DC00 to 0000FFFF hex are identified by letters as follows:

UTF-32 Character			
Bit Numbers	0 1 2 3 4 5 6 7	8 9 10 11 12 13 14 15	
Identifying Bit Letters	0 0 0 0 0 0 0 0	0 0 0 0 0 0 0 0	

UTF-32 Character			
Bit Numbers	16 17 18 19 20 21 22 23	24 25 26 27 28 29 30 31	
Identifying Bit Letters	a b c d e f g h	i j k l m n o p	

The bits of a UTF-32 character in the range 00010000 to 0010FFFF hex are identified by letters as follows:

UTF-32 Character			
Bit Numbers	0 1 2 3 4 5 6 7	8 9 10 11 12 13 14 15	
Identifying Bit Letters	0 0 0 0 0 0 0 0	0 0 0 u v w x y	

UTF-32 Character			
Bit Numbers	16 17 18 19 20 21 22 23	24 25 26 27 28 29 30 31	
Identifying Bit Letters	e f g h i j k l	m n o p q r s t	

The bits of a UTF-16 character in the range 0000 to D7FF or DC00 to FFFF hex are identified by letters as follows:

UTF-16 Character			
Bit Numbers	0 1 2 3 4 5 6 7	8 9 10 11 12 13 14 15	
Identifying Bit Letters	a b c d e f g h	i j k l m n o p	

In the case of a UTF-16 surrogate pair, which is a character pair consisting of a character called a high

surrogate followed by a character called a low surro-

gate, the bits are identified by letters as follows:

UTF-16 High Surrogate Bit Numbers	0 1 2 3 4 5 6 7	8 9 10 11 12 13 14 15
Identifying Bit Letters	1 1 0 1 1 0 a b	c d e f g h i j

UTF-16 Low Surrogate Bit Numbers	16 17 18 19 20 21 22 23	24 25 26 27 28 29 30 31
Identifying Bit Letters	1 1 0 1 1 1 k l	m n o p q r s t

When the contents of the UTF-32 characters are in the range 00000000 to 0000D7FF or 0000E000 to 0000FFFF hex, the character is converted to a two-byte UTF-16 character as follows:

UTF-32 Character	00000000	00000000	a b c d e f g h	i j k l m n o p
UTF-16 Character	a b c d e f g h	i j k l m n o p		

On some models, when the contents of the UTF-32 character are in the range of 0000DC00 to 0000DFFF hex, the character is also converted to a two-byte UTF-16 character as described above.

When the contents of a UTF-32 character are in the range 00010000 to 0010FFFF hex, the character is converted to two two-byte UTF-16 characters (a surrogate pair) as follows:

UTF-32 Character	00000000	000uvwxy	e f g h i j k l	m n o p q r s t
UTF-16 Characters	110110ab	c d e f g h i j	110111kl	m n o p q r s t
where zabcd = uvwxy - 1				

The high order bit (z) produced by the subtract operation is necessarily zero and is ignored.

The second-operand location is considered exhausted when it does not contain at least four remaining bytes. The first-operand location is considered exhausted when it does not contain at least two remaining bytes or at least four remaining bytes in the case when a UTF-32 character in the range 00010000 to 0010FFFF hex is converted.

When the second-operand location is exhausted, condition code 0 is set. When the first-operand location is exhausted, condition code 1 is set, except that condition code 0 is set if the second-operand location also is exhausted. When a CPU-determined number

of characters have been processed, condition code 3 is set.

When the contents of the next UTF-32 character are in the range 0000D800 to 0000DBFF or 00110000 to FFFFFFFF hex, the character is invalid, and condition code 2 is set. On some models, when the contents of the next UTF-32 character are in the range of 0000DC00 to 0000DFFF hex, the character is invalid, and condition code 2 is set.

When the conditions for setting condition codes 1 and 2 are both met, condition code 2 is set.

When the operation is completed, the contents of general register $R_2 + 1$ are decremented by the number of bytes converted, and the contents of general register R_2 are incremented by the same number. Also, the contents of general register $R_1 + 1$ are decremented by the number of bytes placed at the first-operand location, and the contents of general register R_1 are incremented by the same number. When general registers R_1 and R_2 are updated in the 24-bit or 31-bit addressing mode, bits 32-39 of them, in the 24-bit mode, or bit 32, in the 31-bit mode, may be set to zeros or may remain unchanged.

In the 24-bit or 31-bit addressing mode, the contents of bit positions 0-31 of general registers R_1 , $R_1 + 1$, R_2 , and $R_2 + 1$, always remain unchanged.

When condition code 2 is set, general register R_2 contains the address of the invalid UTF-32 character.

When condition code 3 is set, the registers have been updated so that the instruction, when reexecuted, resumes at the next byte locations to be processed.

The amount of processing that results in the setting of condition code 3 is determined by the CPU on the basis of improving system performance, and it may be a different amount each time the instruction is executed.

When the R_1 register is the same register as the R_2 register, the results are unpredictable.

When the second operand overlaps the first operand, the results are unpredictable.

Access exceptions for the portions of the operands to the right of the last byte processed may or may not be recognized. For an operand longer than 4K bytes,

access exceptions are not recognized for locations more than 4K bytes beyond the last byte processed.

When the length of an operand is zero, no access exceptions are recognized for that operand. Access exceptions are not recognized for an operand if the R field associated with that operand is odd.

Resulting Condition Code:

- 0 Entire second operand processed
- 1 End of first operand reached
- 2 Invalid UTF-32 character
- 3 CPU-determined number of characters processed

Program Exceptions:

- Access (fetch, operand 2; store, operand 1)
- Operation (if the extended-translation facility 3 is not installed)
- Specification
- Transaction constraint

Programming Notes:

1. When condition code 3 is set, the program can simply branch back to the instruction to continue the conversion. The program need not determine the number of first-operand or second-operand bytes that were processed.
2. The storage-operand references of CONVERT UTF-32 TO UTF-16 may be multiple-access references. (See “Storage-Operand Consistency” on page 5-125.)
3. The CONVERT UTF-32 TO UTF-16 instruction supports UTF-16 and UTF-32 characters only in the big-endian encoding.
4. As observed by this CPU, other CPUs, and the I/O subsystem, inconsistent results may be briefly stored in the first-operand location. See the section “Effects of CPU Retry” on page 11-3 for further details.
5. Determining that UTF-32 characters in the range of 0000DC00 to 0000DFFF are invalid is a model-dependent behavior that is not available on the IBM z13 and earlier models.

CONVERT UTF-32 TO UTF-8

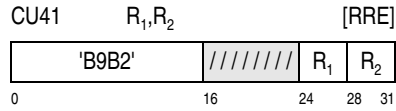

The four-byte UTF-32 characters of the second operand are converted to UTF-8 characters and placed at the first-operand location. The UTF-8 characters are one, two, three, or four bytes, depending on the Unicode characters that are converted. The operation proceeds until the end of the first or second operand is reached or a CPU-determined number of characters have been converted, whichever occurs first. The result is indicated in the condition code.

The R₁ and R₂ fields each designate an even-odd pair of general registers and must designate an even-numbered register; otherwise, a specification exception is recognized.

The location of the leftmost byte of the first operand and the second operand is designated by the contents of general registers R₁ and R₂, respectively. In the 24-bit or 31-bit addressing mode, the number of bytes in the first-operand and second-operand locations is specified by the contents of bit positions 32-63 of general registers R₁ + 1 and R₂ + 1, respectively, and those contents are treated as 32-bit unsigned binary integers. In the 64-bit addressing mode, the number of bytes in the first-operand and second-operand locations is specified by the entire contents of general registers R₁ + 1 and R₂ + 1, respectively, and those contents are treated as 64-bit unsigned binary integers.

The handling of the addresses in general registers R₁ and R₂ is dependent on the addressing mode.

In the 24-bit addressing mode, the contents of bit positions 40-63 of general registers R₁ and R₂ constitute the address, and the contents of bit positions 0-39 are ignored. In the 31-bit addressing mode, the contents of bit positions 33-63 of the registers constitute the address, and the contents of bit positions 0-32 are ignored. In the 64-bit addressing mode, the contents of bit positions 0-63 constitute the address.

The contents of the registers just described are shown in Figure 7-296.

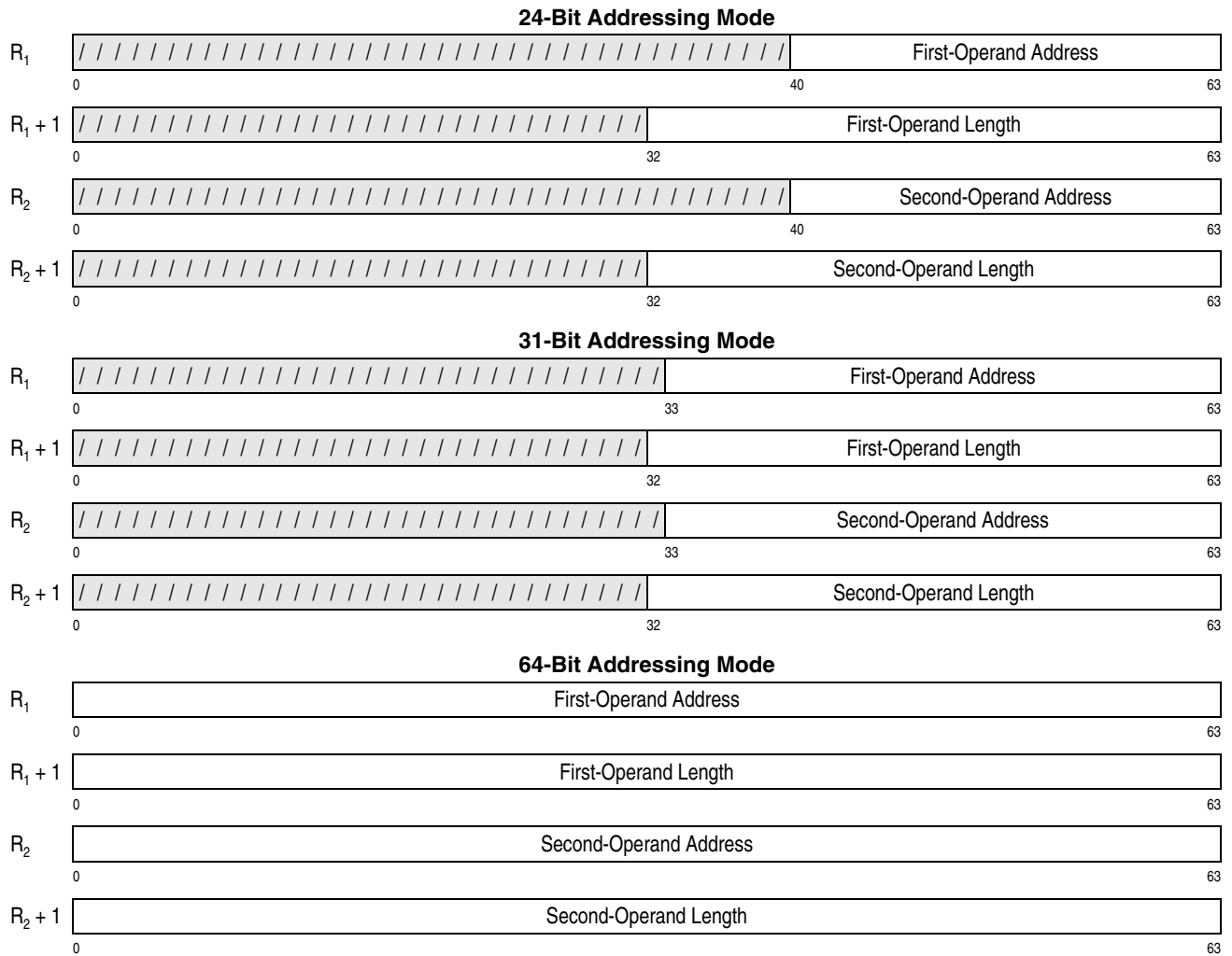

Figure 7-296. Register Contents for CONVERT UTF-32 TO UTF-8

The characters of the second operand are selected one by one for conversion, proceeding left to right. The bytes resulting from a conversion are placed at the first-operand location, proceeding left to right. The operation proceeds until the first-operand or second-operand location is exhausted, a CPU-determined number of second-operand characters have been converted, or on some models, until an invalid Unicode character is detected.

To show the method of converting a UTF-32 character to a UTF-8 character, the bits of a UTF-32 character in the range 00000000 to 0000D7FF or

The bits of a UTF-32 character in the range 00010000 to 0010FFFF hex (UTF-16 surrogate pair)

0000DC00 to 0000FFFF hex are identified by letters as follows:

UTF-32 Character		
Bit Numbers	0 1 2 3 4 5 6 7	8 9 10 11 12 13 14 15
Identifying Bit Letters	0 0 0 0 0 0 0 0	0 0 0 0 0 0 0 0

UTF-32 Character		
Bit Numbers	16 17 18 19 20 21 22 23	24 25 26 27 28 29 30 31
Identifying Bit Letters	a b c d e f g h	i j k l m n o p

are identified by letters as follows:

UTF-32 Character		
Bit Numbers	0 1 2 3 4 5 6 7	8 9 10 11 12 13 14 15
Identifying Bit Letters	0 0 0 0 0 0 0 0	0 0 0 u v w x y

UTF-32 Character		
Bit Numbers	16 17 18 19 20 21 22 23	24 25 26 27 28 29 30 31
Identifying Bit Letters	e f g h i j k l	m n o p q r s t

Any UTF-32 character in the range 00000000 to 0000007F hex is converted to a one-byte UTF-8 character as follows:

UTF-32 Character	0 0 0 0 0 0 0 0	0 0 0 0 0 0 0 0	0 0 0 0 0 0 0 0	0 j k l m n o p
UTF-8 Character	0 j k l m n o p			

Any UTF-32 character in the range 00000080 to 000007FF hex is converted to a two-byte UTF-8 character as follows:

UTF-32 Character	0 0 0 0 0 0 0 0	0 0 0 0 0 0 0 0	0 0 0 0 0 f g h	i j k l m n o p
UTF-8 Character	1 1 0 f g h i j	1 0 k l m n o p		

Any UTF-32 character in the range 00000800 to 0000D7FF or 0000E000 to 0000FFFF hex is converted to a three-byte UTF-8 character as follows:

UTF-32 Character	0 0 0 0 0 0 0 0	0 0 0 0 0 0 0 0	a b c d e f g h	i j k l m n o p
UTF-8 Character	1 1 1 0 a b c d	1 0 e f g h i j	1 0 k l m n o p	

On some models, any UTF-32 character the range of 0000DC00 to 0000DFFF hex is converted to a three-byte UTF-8 character as described above.

Any UTF-32 character in the range 00010000 to 0010FFFF hex is converted to a four-byte UTF-8 character as follows:

UTF-32 Character	0 0 0 0 0 0 0 0	0 0 0 u v w x y	e f g h i j k l	m n o p q r s t
UTF-8 Character	1 1 1 1 0 u v w	1 0 x y e f g h	1 0 i j k l m n	1 0 o p q r s t

The second-operand location is considered exhausted when it does not contain at least four

remaining bytes. The first-operand location is considered exhausted when it does not contain at least the one, two, three, or four remaining bytes required to contain the UTF-8 character resulting from the conversion of the next second-operand character or surrogate pair.

When the second-operand location is exhausted, condition code 0 is set. When the first-operand location is exhausted, condition code 1 is set, except that condition code 0 is set if the second-operand location also is exhausted. When a CPU-determined number of characters have been converted, condition code 3 is set.

When the contents of the next UTF-32 character are in the range 0000D800 to 0000DBFF or 00110000 to FFFFFFFF hex, the character is invalid, and condition code 2 is set. On some models, when the contents of the next UTF-32 character are in the range of 0000DC00 to 0000DFFF hex, the character is invalid, and condition code 2 is set.

When the conditions for setting condition codes 1 and 2 are both met, condition code 2 is set.

When the operation is completed, the contents of general register $R_2 + 1$ are decremented by the number of bytes converted, and the contents of general register R_2 are incremented by the same number. Also, the contents of general register $R_1 + 1$ are decremented by the number of bytes placed at the first-operand location, and the contents of general register R_1 are incremented by the same number. When general registers R_1 and R_2 are updated in the 24-bit or 31-bit addressing mode, bits 32-39 of them, in the 24-bit mode, or bit 32, in the 31-bit mode, may be set to zeros or may remain unchanged.

In the 24-bit or 31-bit addressing mode, the contents of bit positions 0-31 of general registers R_1 , $R_1 + 1$, R_2 , and $R_2 + 1$, always remain unchanged.

When condition code 2 is set, general register R_2 contains the address of the invalid UTF-32 character.

When condition code 3 is set, the registers have been updated so that the instruction, when reexecuted, resumes at the next byte locations to be processed.

The amount of processing that results in the setting of condition code 3 is determined by the CPU on the basis of improving system performance, and it may

be a different amount each time the instruction is executed.

When the R_1 register is the same register as the R_2 register, the results are unpredictable.

When the second operand overlaps the first operand, the results are unpredictable.

Access exceptions for the portions of the operands to the right of the last byte processed may or may not be recognized. For an operand longer than 4K bytes, access exceptions are not recognized for locations more than 4K bytes beyond the last byte processed.

When the length of an operand is zero, no access exceptions are recognized for that operand. Access exceptions are not recognized for an operand if the R field associated with that operand is odd.

Resulting Condition Code:

- 0 Entire second operand processed
- 1 End of first operand reached
- 2 Invalid UTF-32 character.
- 3 CPU-determined number of characters converted

Program Exceptions:

- Access (fetch, operand 2; store, operand 1)
- Operation (if the extended-translation facility 3 is not installed)
- Specification
- Transaction constraint

Programming Notes:

1. When condition code 3 is set, the program can simply branch back to the instruction to continue the conversion. The program need not determine the number of first-operand or second-operand bytes that were processed.
2. The storage-operand references of CONVERT UTF-32 TO UTF-8 may be multiple-access references. (See “Storage-Operand Consistency” on page 5-125.)
3. The CONVERT UTF-32 TO UTF-8 instruction supports UTF-32 characters only in the big-endian encoding.
4. As observed by this CPU, other CPUs, and the I/O subsystem, inconsistent results may be

briefly stored in the first-operand location. See the section “Effects of CPU Retry” on page 11-3 for further details.

5. Determining that UTF-32 characters in the range of 0000DC00 to 0000DFFF are invalid is a model-dependent behavior that is not available on the IBM z13 and earlier models.

**CONVERT UTF-8 TO UTF-16
CONVERT UTF-8 TO UNICODE**

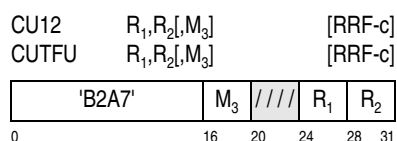

The one-, two-, three-, or four-byte UTF-8 characters of the second operand are converted to two-byte Unicode characters and placed at the first-operand location. The operation proceeds until the end of the first or second operand is reached, a CPU-determined number of characters have been converted, or an invalid UTF-8 character is encountered, whichever occurs first. The result is indicated in the condition code.

The R_1 and R_2 fields each designate an even-odd pair of general registers and must designate an even-numbered register; otherwise, a specification exception is recognized.

The location of the leftmost byte of the first operand and the second operand is designated by the contents of general registers R_1 and R_2 , respectively. In the 24-bit or 31-bit addressing mode, the number of bytes in the first-operand and second-operand locations is specified by the contents of bit positions 32-63 of general registers $R_1 + 1$ and $R_2 + 1$, respectively, and those contents are treated as 32-bit unsigned binary integers. In the 64-bit addressing mode, the number of bytes in the first-operand and second-operand locations is specified by the entire contents of general registers $R_1 + 1$ and $R_2 + 1$, respectively, and those contents are treated as 64-bit unsigned binary integers.

The handling of the addresses in general registers R_1 and R_2 is dependent on the addressing mode.

In the 24-bit addressing mode, the contents of bit positions 40-63 of general registers R_1 and R_2 consti-

tute the address, and the contents of bit positions 0-39 are ignored. In the 31-bit addressing mode, the contents of bit positions 33-63 of the registers constitute the address, and the contents of bit positions

0-32 are ignored. In the 64-bit addressing mode, the contents of bit positions 0-63 constitute the address.

The contents of the registers just described are shown in Figure 7-297.

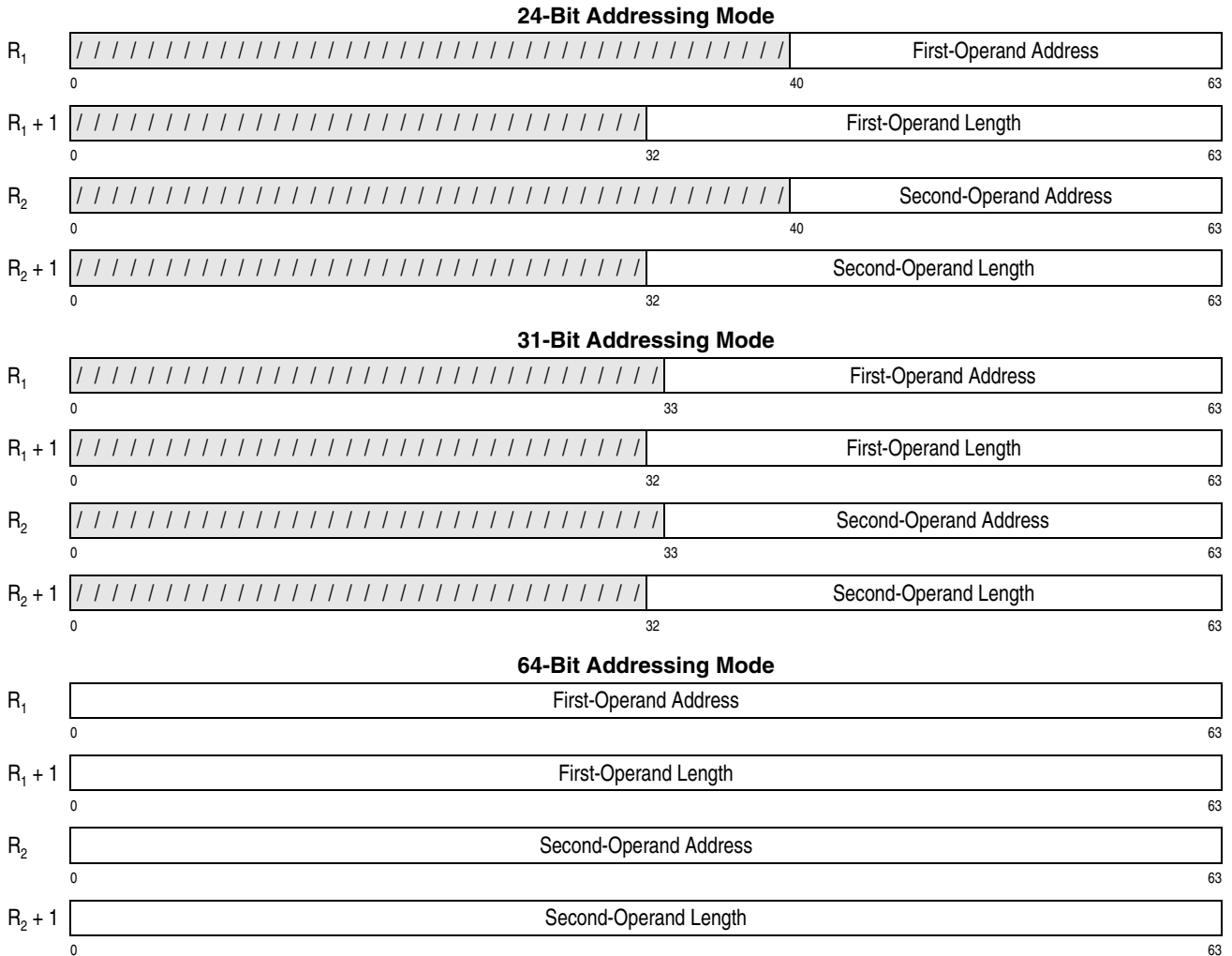
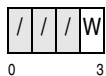

Figure 7-297. Register Contents for CONVERT UTF-8 TO UTF-16

When the ETF3-enhancement facility is installed, the M₃ field has the following format:



The bits of the M₃ field are defined as follows:

- **Unassigned:** Bits 0-2 are unassigned and should contain zeros; otherwise, the program may not operate compatibly in the future.

- **Enhanced Well-Formedness-Checking (W):** The W bit, bit 3 of the M₃ field, controls whether enhanced well-formedness checking of the UTF-8 characters is performed. When the W bit is zero, enhanced checking is not performed. When the W bit is one, enhanced checking is performed, as described below.

When the ETF3-enhancement facility is not installed, the M₃ field is ignored. When the ETF3-enhancement facility is installed in the z/Architecture architectural mode, it is unpredictable whether the M₃ field is ignored in the ESA/390-compatibility mode.

The characters of the second operand are selected one by one for conversion, proceeding left to right. The bytes resulting from a conversion are placed at the first-operand location, proceeding left to right. The operation proceeds until the first-operand or second-operand location is exhausted, a CPU-determined number of second-operand characters have been converted, or an invalid UTF-8 character is encountered in the second operand.

To show the method of converting a UTF-8 character to a Unicode character, the bits of a Unicode character are identified by letters as follows:

Unicode Character Bit Numbers	0 1 2 3 4 5 6 7	8 9 10 11 12 13 14 15
Identifying Bit Letters	a b c d e f g h	i j k l m n o p

In the case of a Unicode surrogate pair, which is a character pair consisting of a character called a high surrogate followed by a character called a low surrogate, the bits are identified by letters as follows:

Unicode High Surrogate Bit Numbers	0 1 2 3 4 5 6 7	8 9 10 11 12 13 14 15
Identifying Bit Letters	1 1 0 1 1 0 a b	c d e f g h i j

Unicode Low Surrogate Bit Numbers	16 17 18 19 20 21 22 23	24 25 26 27 28 29 30 31
Identifying Bit Letters	1 1 0 1 1 1 k l	m n o p q r s t

Conversion of a UTF-8 character to a Unicode character is as follows:

1. When the contents of the first byte of a UTF-8 character are in the range 00 to 7F hex, the character is a one-byte character, and it is converted to a two-byte Unicode character as follows:

UTF-8 Character	0 j k l m n o p
Unicode Character	0 0 0 0 0 0 0 0 0 j k l m n o p

2. When the contents of the first byte of the UTF-8 character are in the range 80 to BF hex, the character is invalid. When the ETF3-enhancement facility is installed, the W bit of the M₃ field is one, and the contents of the first byte of the UTF-8 character are in the range C0 to C1 hex, the character is also invalid.
3. When the ETF3-enhancement facility is not installed or the W bit of the M₃ field is zero, and

the contents of the first byte of the UTF-8 character are in the range of C0 to DF hex; or when the ETF3-enhancement facility is installed, the W bit is one, and the contents of the first byte of the UTF-8 character are in the range of C2 to DF hex; the character is a two-byte character, and it is converted to a two-byte Unicode character as follows:

UTF-8 Character	1 1 0 f g h i j	1 0 k l m n o p
Unicode Character	0 0 0 0 0 f g h	i j k l m n o p

When the ETF3-enhancement facility is not installed or when the W bit of the M₃ field is zero, the first two bits in the second byte of the UTF-8 character are ignored. When the ETF3-enhancement facility is installed and the W bit of the M₃ field is one, the contents of the second byte of the UTF-8 character must be in the range 80 to BF; otherwise the character is invalid.

4. When the contents of the first byte of a UTF-8 character are in the range E0 to EF hex, the character is a three-byte character, and it is converted to a two-byte Unicode character as follows:

UTF-8 Character	1 1 1 0 a b c d	1 0 e f g h i j	1 0 k l m n o p
Unicode Character	a b c d e f g h	i j k l m n o p	

When the ETF3-enhancement facility is not installed or when the W bit of the M₃ field is zero, the first two bits in the second and third bytes of the UTF-8 character are ignored.

When the ETF3-enhancement facility is installed and the W bit of the M₃ field is one, the contents of the second and third bytes of the UTF-8 character must be as follows:

- When the first byte is E0 hex, the second and third bytes must be in the ranges A0 to BF and 80 to BF, respectively.
- When the first byte is in the range E1 to EC hex or EE to EF, the second and third bytes must both be in the range 80 to BF hex.
- When the first byte is ED hex, the second and third bytes must be in the ranges 80 to 9F and 80 to BF, respectively.

Otherwise, the character is invalid.

- When the ETF3-enhancement facility is not installed or the W bit of the M_3 field is zero, and the contents of the first byte of the UTF-8 character are in the range of F0 to F7 hex; or when the ETF3-enhancement facility is installed, the W bit is one, and the contents of the first byte of the UTF-8 character are in the range of F0 to F4 hex; the character is a four-byte character, and it is converted to two two-byte Unicode characters (a surrogate pair) as follows:

UTF-8 Character	11110uvvw	10xyefgh	10ijklmn	10opqrst
Unicode Characters	110110ab	cdefghij	110111kl	mnoqrst
where $zabcd = uvwxy - 1$				

When the ETF3-enhancement facility is not installed or when the W bit of the M_3 field is zero, the first two bits in the second, third, and fourth bytes of the UTF-8 character are ignored, and the high order bit (z) produced by the subtract operation should be zero but is ignored.

When the ETF3-enhancement facility is installed and the W bit of the M_3 field is one, the contents of the second, third, and fourth bytes of the UTF-8 character must be as follows:

- When the first byte is F0 hex, the second, third, and fourth bytes must be in the ranges 90 to BF, 80 to BF, and 80 to BF, respectively.
- When the first byte is in the range F1 to F3, the second, third, and fourth bytes must all be in the range 80 to BF hex.
- When the first byte is F4 hex, the second, third, and fourth bytes must be in the ranges 80 to 8F, 80 to BF, and 80 to BF, respectively.

Otherwise, the character is invalid.

- When the ETF3-enhancement facility is installed, the W bit of the M_3 field is one, and the contents of the first byte of the UTF-8 character are in the range of F5 to F7 hex, the character is invalid.
- When the contents of the first byte of the UTF-8 character are in the range of F8-FF, the character is invalid.

If an invalid character is encountered, condition code 2 is set, and general register R_2 contains the address of the first byte of the invalid UTF-8 character.

The second-operand location is considered exhausted when it does not contain at least one remaining byte or when it does not contain at least the two-, three-, or four-remaining bytes required to contain the two-, three-, or four-byte UTF-8 character indicated by the contents of the first remaining byte. The first-operand location is considered exhausted when it does not contain at least two remaining bytes or at least four remaining bytes in the case when a four byte UTF-8 character is to be converted.

When the second-operand location is exhausted, condition code 0 is set. When the first-operand location is exhausted, condition code 1 is set, except that condition code 0 is set if the second-operand location also is exhausted. When a CPU-determined number of characters have been processed, condition code 3 is set.

When the conditions for setting condition codes 1 and 2 are both met, condition code 2 is set.

When the operation is completed, the contents of general register $R_2 + 1$ are decremented by the number of bytes converted, and the contents of general register R_2 are incremented by the same number. Also, the contents of general register $R_1 + 1$ are decremented by the number of bytes placed at the first-operand location, and the contents of general register R_1 are incremented by the same number. When general registers R_1 and R_2 are updated in the 24-bit or 31-bit addressing mode, bits 32-39 of them, in the 24-bit mode, or bit 32, in the 31-bit mode, may be set to zeros or may remain unchanged.

In the 24-bit or 31-bit addressing mode, the contents of bit positions 0-31 of general registers R_1 , $R_1 + 1$, R_2 , and $R_2 + 1$, always remain unchanged.

When condition code 2 is set, general register R_2 contains the address of the invalid UTF-8 character.

When condition code 3 is set, the registers have been updated so that the instruction, when reexecuted, resumes at the next byte locations to be processed.

The amount of processing that results in the setting of condition code 3 is determined by the CPU on the basis of improving system performance, and it may be a different amount each time the instruction is executed.

When the R_1 register is the same register as the R_2 register, the results are unpredictable.

When the second operand overlaps the first operand, the results are unpredictable.

Access exceptions for the portions of the operands to the right of the last byte processed may or may not be recognized. For an operand longer than 4K bytes, access exceptions are not recognized for locations more than 4K bytes beyond the last byte processed.

When the length of an operand is zero, no access exceptions are recognized for that operand. Access exceptions are not recognized for an operand if the R field associated with that operand is odd.

Resulting Condition Code:

- 0 Entire second operand processed
- 1 End of first operand reached
- 2 Invalid UTF-8 character
- 3 CPU-determined number of characters processed

Program Exceptions:

- Access (fetch, operand 2; store, operand 1)
- Specification
- Transaction constraint

Programming Notes:

1. When condition code 3 is set, the program can simply branch back to the instruction to continue the conversion. The program need not determine the number of first-operand or second-operand bytes that were processed.
2. When the ETF3-enhancement facility is not installed, or when the W bit of the M_3 operand is zero, bits 0 and 1 of the continuation bytes of multiple-byte UTF-8 characters are not checked in order to improve the performance of the conversion. Therefore, invalid continuation bytes are not detected.
3. The storage-operand references of CONVERT UTF-8 TO UTF-16 may be multiple-access references. (See “Storage-Operand Consistency” on page 5-125.)
4. The CONVERT UTF-8 TO UTF-16 (CONVERT UTF-8 TO UNICODE) instruction supports UTF-16 characters only in the big-endian encoding.

5. As observed by this CPU, other CPUs, and the I/O subsystem, inconsistent results may be briefly stored in the first-operand location. See the section “Effects of CPU Retry” on page 11-3 for further details.

CONVERT UTF-8 TO UTF-32



The one-, two-, three-, or four-byte UTF-8 characters of the second operand are converted to four-byte UTF-32 characters and placed at the first-operand location. The operation proceeds until the end of the first or second operand is reached, a CPU-determined number of characters have been converted, or an invalid UTF-8 character is encountered, whichever occurs first. The result is indicated in the condition code.

The R_1 and R_2 fields each designate an even-odd pair of general registers and must designate an even-numbered register; otherwise, a specification exception is recognized.

The location of the leftmost byte of the first operand and the second operand is designated by the contents of general registers R_1 and R_2 , respectively. In the 24-bit or 31-bit addressing mode, the number of bytes in the first-operand and second-operand locations is specified by the contents of bit positions 32-63 of general registers $R_1 + 1$ and $R_2 + 1$, respectively, and those contents are treated as 32-bit unsigned binary integers. In the 64-bit addressing mode, the number of bytes in the first-operand and second-operand locations is specified by the entire contents of general registers $R_1 + 1$ and $R_2 + 1$, respectively, and those contents are treated as 64-bit unsigned binary integers.

The handling of the addresses in general registers R_1 and R_2 is dependent on the addressing mode.

In the 24-bit addressing mode, the contents of bit positions 40-63 of general registers R_1 and R_2 constitute the address, and the contents of bit positions 0-39 are ignored. In the 31-bit addressing mode, the contents of bit positions 33-63 of the registers constitute the address, and the contents of bit positions

0-32 are ignored. In the 64-bit addressing mode, the contents of bit positions 0-63 constitute the address.

The contents of the registers just described are shown in Figure 7-298.

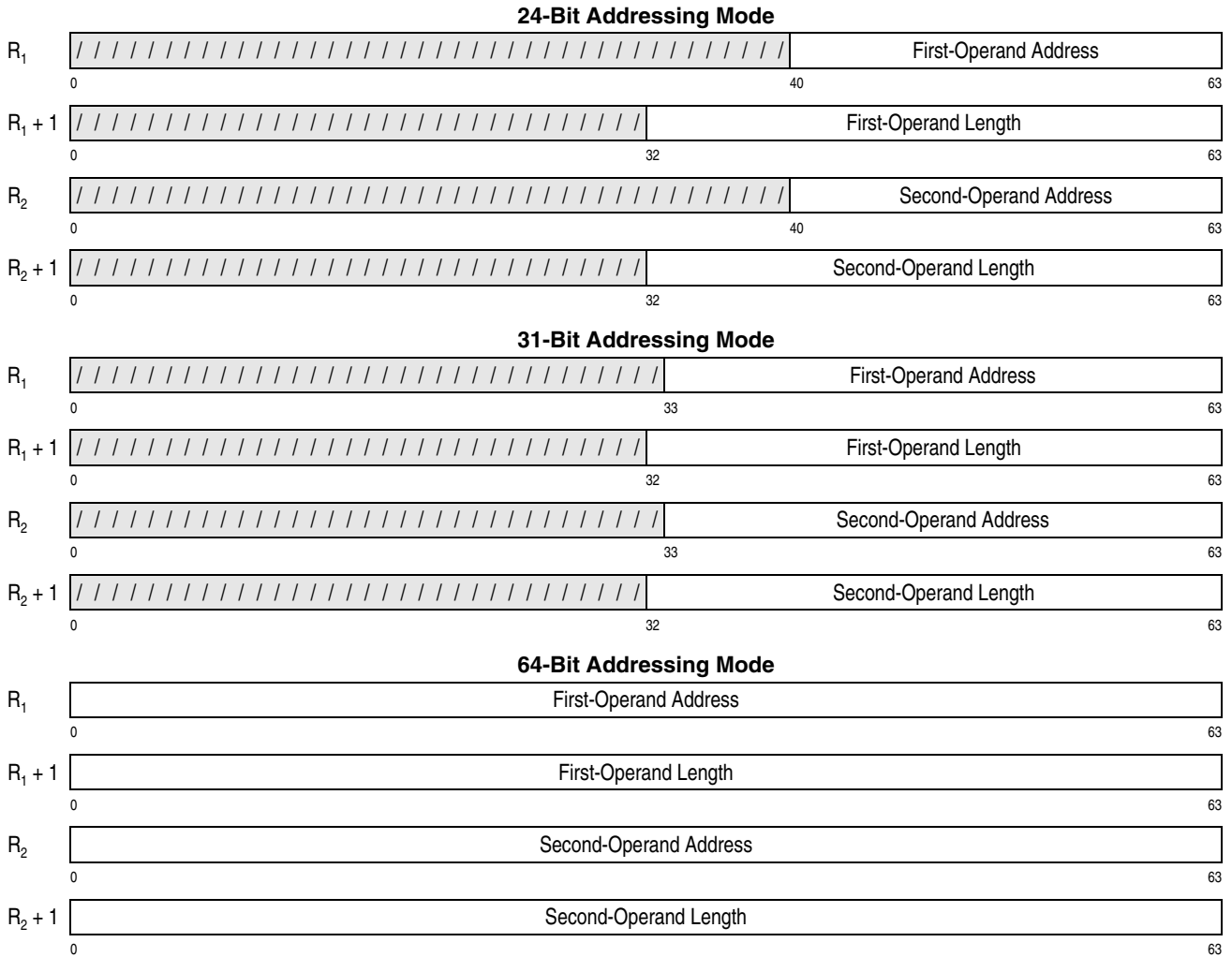
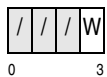

Figure 7-298. Register Contents for CONVERT UTF-8 TO UTF32

When the ETF3-enhancement facility is installed, the M_3 field has the following format:



The bits of the M_3 field are defined as follows:

- **Unassigned:** Bits 0-2 are unassigned and should contain zeros; otherwise, the program may not operate compatibly in the future.
- **Enhanced Well-Formedness-Checking (W):** The W bit, bit 3 of the M_3 field, controls whether enhanced well-formedness checking of the UTF-

8 characters is performed. When the W bit is zero, enhanced checking is not performed. When the W bit is one, enhanced checking is performed, as described below.

When the ETF3-enhancement facility is not installed, the M_3 field is ignored.

The characters of the second operand are selected one by one for conversion, proceeding left to right. The bytes resulting from a conversion are placed at the first-operand location, proceeding left to right. The operation proceeds until the first-operand or second-operand location is exhausted, a CPU-determined number of second-operand characters have

been converted, or an invalid UTF-8 character is encountered in the second operand.

To show the method of converting a UTF-8 character to a UTF-32 character, the bits of a UTF-32 character in the range 00000000 to 0000D7FF or 0000DC00 to 0000FFFF hex are identified by letters as follows:

UTF-32 Character		
Bit Numbers	0 1 2 3 4 5 6 7	8 9 10 11 12 13 14 15
Identifying Bit Letters	0 0 0 0 0 0 0 0	0 0 0 0 0 0 0 0

UTF-32 Character		
Bit Numbers	16 17 18 19 20 21 22 23	24 25 26 27 28 29 30 31
Identifying Bit Letters	a b c d e f g h	i j k l m n o p

The bits of a UTF-32 character in the range 00010000 0010FFFF hex (UTF-16 surrogate pair) are identified by letters as follows:

UTF-32 Character		
Bit Numbers	0 1 2 3 4 5 6 7	8 9 10 11 12 13 14 15
Identifying Bit Letters	0 0 0 0 0 0 0 0	0 0 0 u v w x y

UTF-32 Character		
Bit Numbers	16 17 18 19 20 21 22 23	24 25 26 27 28 29 30 31
Identifying Bit Letters	e f g h i j k l	m n o p q r s t

Conversion of a UTF-8 character to a UTF-32 character is as follows:

1. When the contents of the first byte of a UTF-8 character are in the range 00 to 7F hex, the character is a one-byte character, and it is converted to a four-byte UTF-32 character as follows:

UTF-8 Character	0 j k l m n o p			
UTF-32 Character	0 0 0 0 0 0 0 0	0 0 0 0 0 0 0 0	0 0 0 0 0 0 0 0	0 j k l m n o p

2. When the contents of the first byte of the UTF-8 character are in the range 80 to BF hex, the character is invalid. When the ETF3-enhancement facility is installed, the W bit of the M₃ field is one, and the contents of the first byte of the UTF-8 character are in the range C0 to C1 hex, the character is also invalid.

3. When the ETF3-enhancement facility is not installed or the W bit of the M₃ field is zero, and the contents of the first byte of the UTF-8 character are in the range C0 to DF hex; or when the ETF3-enhancement facility is installed, the W bit is one, and the contents of the first byte of the UTF-8 character are in the range C2 to DF hex; the character is a two-byte character, and it is converted to a four-byte UTF-32 character as follows:

UTF-8 Character	1 1 0 f g h i j	1 0 k l m n o p		
UTF-32 Character	0 0 0 0 0 0 0 0	0 0 0 0 0 0 0 0	0 0 0 0 0 f g h	i j k l m n o p

When the ETF3-enhancement facility is not installed or when the W bit of the M₃ field is zero, the first two bits in the second byte of the UTF-8 character are ignored. When the ETF3-enhancement facility is installed and the W bit of the M₃ field is one, the contents of the second byte of the UTF-8 character must be in the range 80 to BF; otherwise the character is invalid.

4. When the contents of the first byte of a UTF-8 character are in the range E0 to EF hex, the character is a three-byte character, and it is converted to a four-byte UTF-32 character as follows:

UTF-8 Character	1 1 1 0 a b c d	1 0 e f g h i j	1 0 k l m n o p	
UTF-32 Character	0 0 0 0 0 0 0 0	0 0 0 0 0 0 0 0	a b c d e f g h	i j k l m n o p

When the ETF3-enhancement facility is not installed or when the W bit of the M₃ field is zero, the first two bits in the second and third bytes of the UTF-8 character are ignored.

When the ETF3-enhancement facility is installed and the W bit of the M₃ field is one, the contents of the second and third bytes of the UTF-8 character must be as follows:

- When the first byte is E0 hex, the second and third bytes must be in the ranges A0 to BF and 80 to BF, respectively.
- When the first byte is in the range E1 to EC hex or EE to EF, the second and third bytes must both be in the range 80 to BF hex.
- When the first byte is ED hex, the second and third bytes must be in the ranges 80 to 9F and 80 to BF, respectively.

Otherwise, the character is invalid.

- When the ETF3-enhancement facility is not installed or the W bit of the M_3 field is zero, and the contents of the first byte of the UTF-8 character are in the range of F0 to F7 hex; or when the ETF3-enhancement facility is installed, the W bit is one, and the contents of the first byte of the UTF-8 character are in the range of F0 to F4 hex; the character is a four-byte character, and it is converted to a four-byte UTF-32 character (a surrogate pair) as follows:

UTF-8 Character	11110uvw	10xyefgh	10ijklmn	10opqrst
UTF-32 Character	00000000	000uvwxyz	efghijkl	mnopqrst

When the ETF3-enhancement facility is not installed or when the W bit of the M_3 field is zero, the first two bits in the second, third, and fourth bytes of the UTF-8 character are ignored.

When the ETF3-enhancement facility is installed and the W bit of the M_3 field is one, the contents of the second, third, and fourth bytes of the UTF-8 character must be as follows:

- When the first byte is F0 hex, the second, third, and fourth bytes must be in the ranges 90 to BF, 80 to BF, and 80 to BF, respectively.
- When the first byte is in the range F1 to F3, the second, third, and fourth bytes must all be in the range 80 to BF hex.
- When the first byte is F4 hex, the second, third, and fourth bytes must be in the ranges 80 to 8F, 80 to BF, and 80 to BF, respectively.

Otherwise, the character is invalid.

- When the ETF3-enhancement facility is installed, the W bit of the M_3 field is one, and the contents of the first byte of the UTF-8 character are in the range of F5 to F7 hex, the character is invalid.
- When the contents of the first byte of the UTF-8 character are in the range of F8-FF, the character is invalid.

If an invalid character is encountered, condition code 2 is set, and general register R_2 contains the address of the first byte of the invalid UTF-8 character.

The second-operand location is considered exhausted when it does not contain at least one

remaining byte or when it does not contain at least the two-, three-, or four-byte UTF-8 character indicated by the contents of the first remaining byte. The first-operand location is considered exhausted when it does not contain at least four remaining bytes.

When the second-operand location is exhausted, condition code 0 is set. When the first-operand location is exhausted, condition code 1 is set, except that condition code 0 is set if the second-operand location also is exhausted. When a CPU-determined number of characters have been processed, condition code 3 is set.

When the conditions for setting condition codes 1 and 2 are both met, condition code 2 is set.

When the operation is completed, the contents of general register $R_2 + 1$ are decremented by the number of bytes converted, and the contents of general register R_2 are incremented by the same number. Also, the contents of general register $R_1 + 1$ are decremented by the number of bytes placed at the first-operand location, and the contents of general register R_1 are incremented by the same number. When general registers R_1 and R_2 are updated in the 24-bit or 31-bit addressing mode, bits 32-39 of them, in the 24-bit mode, or bit 32, in the 31-bit mode, may be set to zeros or may remain unchanged.

In the 24-bit or 31-bit addressing mode, the contents of bit positions 0-31 of general registers R_1 , $R_1 + 1$, R_2 , and $R_2 + 1$, always remain unchanged.

When condition code 2 is set, general register R_2 contains the address of the invalid UTF-8 character.

When condition code 3 is set, the registers have been updated so that the instruction, when reexecuted, resumes at the next byte locations to be processed.

The amount of processing that results in the setting of condition code 3 is determined by the CPU on the basis of improving system performance, and it may be a different amount each time the instruction is executed.

When the R_1 register is the same register as the R_2 register, the results are unpredictable.

When the second operand overlaps the first operand, the results are unpredictable.

Access exceptions for the portions of the operands to the right of the last byte processed may or may not be recognized. For an operand longer than 4K bytes, access exceptions are not recognized for locations more than 4K bytes beyond the last byte processed.

When the length of an operand is zero, no access exceptions are recognized for that operand. Access exceptions are not recognized for an operand if the R field associated with that operand is odd.

Resulting Condition Code:

- 0 Entire second operand processed
- 1 End of first operand reached
- 2 Invalid UTF-8 character
- 3 CPU-determined number of characters processed

Program Exceptions:

- Access (fetch, operand 2; store, operand 1)
- Operation (if the extended-translation facility 3 is not installed)
- Specification
- Transaction constraint

Programming Notes:

1. When condition code 3 is set, the program can simply branch back to the instruction to continue the conversion. The program need not determine the number of first-operand or second-operand bytes that were processed.
2. When the ETF3-enhancement facility is not installed, or when the W bit of the M₃ operand is zero, bits 0 and 1 of the continuation bytes of multiple-byte UTF-8 characters are not checked in order to improve the performance of the conversion. Therefore, invalid continuation bytes are not detected.
3. The storage-operand references of CONVERT UTF-8 TO UTF-32 may be multiple-access references. (See “Storage-Operand Consistency” on page 5-125.)
4. The CONVERT UTF-8 TO UTF-32 instruction supports UTF-32 characters only in the big-endian encoding.

5. As observed by this CPU, other CPUs, and the I/O subsystem, inconsistent results may be briefly stored in the first-operand location. See the section “Effects of CPU Retry” on page 11-3 for further details.

COPY ACCESS

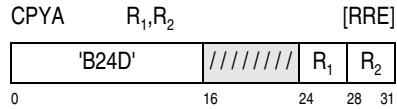

The contents of access register R₂ are placed in access register R₁.

Condition Code: The code remains unchanged.

Program Exceptions:

- Transaction constraint

DIVIDE

Register-and-register format:

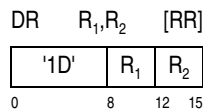

Register-and-storage format:

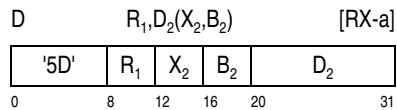

The 64-bit first operand (the dividend) is divided by the 32-bit second operand (the divisor), and the 32-bit remainder and quotient are placed at the first-operand location.

The R₁ field designates an even-odd pair of general registers and must designate an even-numbered register; otherwise, a specification exception is recognized.

The dividend is treated as a 64-bit signed binary integer. The leftmost 32 bits of the dividend are in bit positions 32-63 of general register R₁, and the rightmost 32 bits are in bit positions 32-63 of general register R₁ + 1.

The divisor, remainder, and quotient are treated as 32-bit signed binary integers. For DIVIDE (DR), the divisor is in bit positions 32-63 of general register R_2 . The remainder is placed in bit positions 32-63 of general register R_1 , and the quotient is placed in bit positions 32-63 of general register $R_1 + 1$. Bits 0-31 of the registers remain unchanged.

The sign of the quotient is determined by the rules of algebra, and the remainder has the same sign as the dividend, except that a zero quotient or a zero remainder is always positive.

When the divisor is zero, or when the magnitudes of the dividend and divisor are such that the quotient cannot be expressed by a 32-bit signed binary integer, a fixed-point-divide exception is recognized. This includes the case of division of zero by zero.

Condition Code: The code remains unchanged.

Program Exceptions:

- Access (fetch, operand 2 of D only)
- Fixed-point divide
- Specification
- Transaction constraint

DIVIDE LOGICAL

Register-and-register formats:

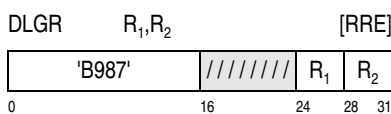
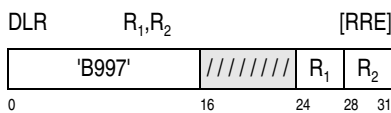

Register-and-storage formats:

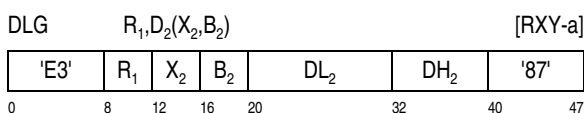

The 64-bit or 128-bit first operand (the dividend) is divided by the 32-bit or 64-bit second operand (the divisor), and the 32-bit or 64-bit remainder and quotient are placed at the first-operand location.

The R_1 field designates an even-odd pair of general registers and must designate an even-numbered register; otherwise, a specification exception is recognized.

For DIVIDE LOGICAL (DLR, DL), the dividend is treated as a 64-bit unsigned binary integer. The leftmost 32 bits of the dividend are in bit positions 32-63 of general register R_1 , and the rightmost 32 bits are in bit positions 32-63 of general register $R_1 + 1$.

The divisor, remainder, and quotient are treated as 32-bit unsigned binary integers. For DIVIDE LOGICAL (DLR), the divisor is in bit positions 32-63 of general register R_2 . The remainder is placed in bit positions 32-63 of general register R_1 , and the quotient is placed in bit positions 32-63 of general register $R_1 + 1$. Bits 0-31 of the registers remain unchanged.

For DIVIDE LOGICAL (DLGR, DLG), the dividend is treated as a 128-bit unsigned binary integer. The leftmost 64 bits of the dividend are in general register R_1 , and the rightmost 64 bits are in general register $R_1 + 1$. The divisor, remainder, and quotient are treated as 64-bit unsigned binary integers. The remainder is placed in general register R_1 , and the quotient is placed in general register $R_1 + 1$.

When the divisor is zero, or when the magnitudes of the dividend and divisor are such that the quotient cannot be expressed as a 32-bit unsigned binary integer for DIVIDE LOGICAL (DLR, DL), or a 64-bit unsigned binary integer for DIVIDE LOGICAL (DLGR, DLG), a fixed-point-divide exception is recognized. This includes the case of division of zero by zero.

Condition Code: The code remains unchanged.

Program Exceptions:

- Access (fetch, operand 2 of DL or DLG only)
- Fixed-point divide
- Specification
- Transaction constraint

DIVIDE SINGLE

Register-and-register formats:

DSGR R_1, R_2 [RRE]

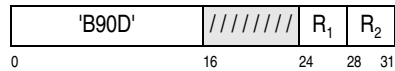

DSGFR R_1, R_2 [RRE]

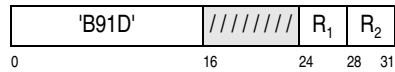

Register-and-storage formats:

DSG $R_1, D_2(X_2, B_2)$ [RXY-a]

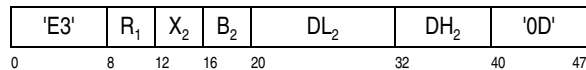

DSGF $R_1, D_2(X_2, B_2)$ [RXY-a]

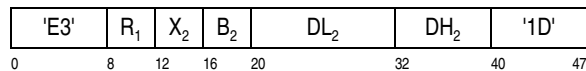

The 64-bit contents of general register $R_1 + 1$ (the dividend) are divided by the 64-bit or 32-bit second operand (the divisor), the 64-bit remainder is placed in general register R_1 , and the 64-bit quotient is placed in general register $R_1 + 1$.

The R_1 field designates an even-odd pair of general registers and must designate an even-numbered register; otherwise, a specification exception is recognized.

The dividend, quotient, and remainder are treated as 64-bit signed binary integers. For DIVIDE SINGLE (DSGR, DSG), the divisor is treated as a 64-bit signed binary integer. For DIVIDE SINGLE (DSGFR, DSGF), the divisor is treated as a 32-bit signed binary integer. For DSGFR, the divisor is in bit positions 32-63 of general register R_2 .

The sign of the quotient is determined by the rules of algebra, and the remainder has the same sign as the dividend, except that a zero quotient or a zero remainder is always positive.

When the divisor is zero, or when the magnitudes of the dividend and divisor are such that the quotient cannot be expressed by a 64-bit signed binary inte-

ger, a fixed-point-divide exception is recognized. This includes the case of division of zero by zero.

Condition Code: The code remains unchanged.

Program Exceptions:

- Access (fetch, operand 2 of DSG and DSGF only)
- Fixed-point divide
- Specification
- Transaction constraint

EXCLUSIVE OR

Register-and-register formats:

XR R_1, R_2 [RR]

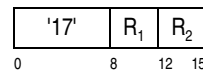

XGR R_1, R_2 [RRE]

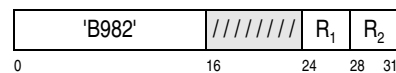

XRK R_1, R_2, R_3 [RRF-a]

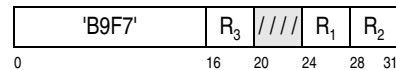

XGRK R_1, R_2, R_3 [RRF-a]

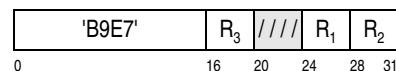

Register-and-storage formats:

X $R_1, D_2(X_2, B_2)$ [RX-a]

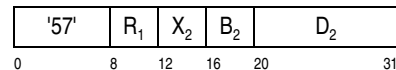

XY $R_1, D_2(X_2, B_2)$ [RXY-a]

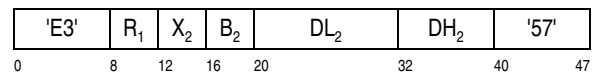

XG $R_1, D_2(X_2, B_2)$ [RXY-a]

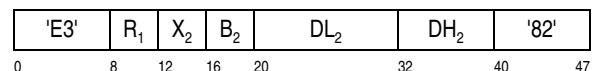

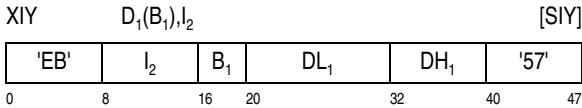
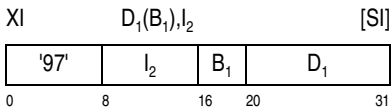
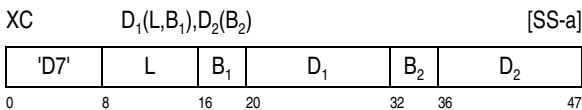
Storage-and-immediate formats:**Storage-and-storage format:**

For X, XC, XG, XGR, XI, XIY, XR, and XY, the EXCLUSIVE OR of the first and second operands is placed at the first-operand location. For XGRK and XRK, the EXCLUSIVE OR of the second and third operands is placed at the first-operand location.

The connective EXCLUSIVE OR is applied to the operands bit by bit. The contents of a bit position in the result are set to one if the bits in the corresponding bit positions in the two operands are unlike; otherwise, the result bit is set to zero.

For EXCLUSIVE OR (XC), each operand is processed left to right. When the operands overlap, the result is obtained as if the operands were processed one byte at a time and each result byte were stored immediately after fetching the necessary operand bytes.

For EXCLUSIVE OR (XI, XIY), the first operand is one byte in length, and only one byte is stored. When the interlocked-access facility 2 is installed, the update of the first operand appears to be an interlocked-update reference as observed by other CPUs and channel programs, and a specific-operand-serialization operation is performed.

For EXCLUSIVE OR (X, XR, XRK, and XY), the operands are 32 bits, and for EXCLUSIVE OR (XG, XGR, and XGRK), they are 64 bits.

The displacements for X, XI, and both operands of XC are treated as 12-bit unsigned binary integers. The displacement for XY, XIY, and XG is treated as a 20-bit signed binary integer.

Resulting Condition Code:

- 0 Result zero
- 1 Result not zero
- 2 --
- 3 --

Program Exceptions:

- Access (fetch, operand 2, X, XY, XG, and XC; fetch and store, operand 1, XI, XIY, and XC)
- Operation (XY and XIY, if the long-displacement facility is not installed; XGRK and XRK, if the distinct-operands facility is not installed)
- Transaction constraint (XC)

Programming Notes:

1. An example of the use of the EXCLUSIVE OR instruction is given in Appendix A, "Number Representation and Instruction-Use Examples."
2. EXCLUSIVE OR may be used to invert a bit, an operation particularly useful in testing and setting programmed binary switches.
3. A field EXCLUSIVE-ORed with itself becomes all zeros.
4. For EXCLUSIVE OR (XR or XGR), the sequence A EXCLUSIVE-OR B, B EXCLUSIVE-OR A, A EXCLUSIVE-OR B results in the exchange of the contents of A and B without the use of an additional general register.
5. Accesses to the first operand of EXCLUSIVE OR (XC) – and, when the interlocked-access facility 2 is not installed, accesses to the first operand of EXCLUSIVE OR (XI, XIY) – consist in fetching a first-operand byte from storage and subsequently storing the updated value. These fetch and store accesses to a particular byte do not necessarily occur one immediately after the other. Thus, these instructions cannot be safely used to update a location in storage if the possibility exists that another CPU or a channel program may also be updating the location. An example of this effect is shown for OR (OI) in "Multiprogramming and Multiprocessing Examples" on page A-45.

When the interlocked-access facility 2 is installed, EXCLUSIVE OR (XI, XIY) can be safely used to update a location in storage, even if the possibility exists that another CPU or a

channel program may also be updating the location.

EXCLUSIVE OR IMMEDIATE

XIHF R_1, I_2 [RIL-a]

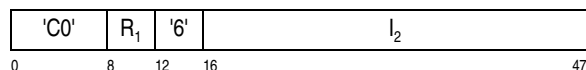

XILF R_1, I_2 [RIL-a]

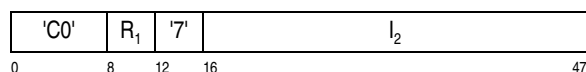

The second operand is EXCLUSIVE ORed with bits of the first operand, and the result replaces those bits of the first operand. The remainder of the first operand remains unchanged.

For each instruction, the bits of the first operand that are EXCLUSIVE ORed with the second operand and then replaced are as follows:

Instruction	Bits Exclusive ORed and Replaced
XIHF	0-31
XILF	32-63

The connective EXCLUSIVE OR is applied to the operands bit by bit. The contents of a bit position in the result are set to one if the bits in the corresponding bit positions in the two operands are unlike; otherwise, the result bit is set to zero.

The condition code is set based on the result of the 32-bit EXCLUSIVE OR operation.

Resulting Condition Code:

0	Result is zero
1	Result is not zero
2	--
3	--

Program Exceptions:

- Operation, if the extended-immediate facility is not installed)

Programming Note: The setting of the condition code is based only on the bits that are exclusive ORed and replaced.

EXECUTE

EX $R_1, D_2(X_2, B_2)$ [RX-a]

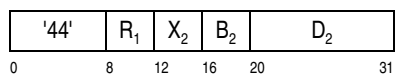

EXECUTE RELATIVE LONG

EXRL R_1, R_2 [RIL-b]

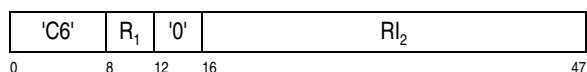

The single instruction at the second-operand address is modified by the contents of general register R_1 , and the resulting instruction, called the target instruction, is executed.

When the R_1 field is not zero, bits 8-15 of the instruction designated by the second-operand address are ORed with bits 56-63 of general register R_1 . The ORing does not change either the contents of general register R_1 or the instruction in storage, and it is effective only for the interpretation of the instruction to be executed. When the R_1 field is zero, no ORing takes place.

The target instruction may be two, four, or six bytes in length. The execution and exception handling of the target instruction are exactly as if the target instruction were obtained in normal sequential operation, except for the instruction address and the instruction-length code.

The instruction address in the current PSW is increased by the length of the execute-type instruction (EXECUTE or EXECUTE RELATIVE LONG). This updated address and the instruction-length code of the execute-type instruction are used, for example, as part of the link information when the target instruction is BRANCH AND LINK. When the target instruction is a successful branching instruction, the instruction address in the current PSW is replaced by the branch address specified by the target instruction.

When the target instruction is any of the following instructions, an execute exception is recognized.

- Another execute-type instruction
- TRANSACTION ABORT
- TRANSACTION BEGIN

- TRANSACTION END

The effective address of EXECUTE must be even; otherwise, a specification exception is recognized.

When the target instruction is two or three halfwords in length but can be executed without fetching its second or third halfword, it is unpredictable whether access exceptions are recognized for the unused halfwords. Access exceptions are not recognized for the second-operand address when the address is odd.

The second-operand address of an execute-type instruction is an instruction address rather than a logical address; thus, the target instruction is fetched from the primary address space when in the primary-space, secondary-space, or access-register mode.

For EXECUTE RELATIVE LONG, the contents of the RI_2 field are a signed binary integer specifying the number of halfwords that is added to the address of the instruction to generate the address of the target instruction in storage.

Condition Code: The code may be set by the target instruction.

Program Exceptions:

- Access (fetch, target instruction)
- Execute
- Operation (EXRL, when the execute-extensions facility is not installed)
- Specification (EX)
- Transaction constraint

Programming Notes:

1. An example of the use of the EXECUTE instruction is given in Appendix A, "Number Representation and Instruction-Use Examples."
2. The ORing of eight bits from the general register with the designated instruction permits the indirect specification of the length, index, mask, immediate-data, register, or extended-op-code field.
3. The fetching of the target instruction is considered to be an instruction fetch for purposes of program-event recording and for purposes of reporting access exceptions.

4. An access or specification exception may be caused by execute-type instructions or by the target instruction, except that EXECUTE RELATIVE LONG cannot cause a specification exception due to a misaligned target operand.
5. When an interruptible instruction is made the target of an execute-type instruction, the program normally should not designate any register updated by the interruptible instruction as the R_1 , X_2 , or B_2 register for EXECUTE or R_1 register for EXECUTE RELATIVE LONG. Otherwise, on resumption of execution after an interruption, or if the instruction is refetched without an interruption, the updated values of these registers will be used in the execution of the execute-type instruction. Similarly, the program should normally not let the destination field in storage of an interruptible instruction include the location of an execute-type instruction, since the new contents of the location may be interpreted when resuming execution.
6. Exception conditions that occur during the execution of EXECUTE or EXECUTE RELATIVE LONG are recognized before exception conditions for the target instruction.

EXTRACT ACCESS

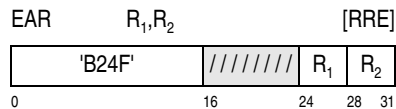

The contents of access register R_2 are placed in bit positions 32-63 of general register R_1 . Bits 0-31 of general register R_1 remain unchanged.

Condition Code: The code remains unchanged.

Program Exceptions: None.

EXTRACT CPU ATTRIBUTE



Information regarding the specified attribute of the CPU or storage subsystem is placed into the first-operand location. The first operand is 64 bits.

The second-operand address is not used to address data; rather, the rightmost 24 bits of the address are treated as a code specifying which attribute is returned in general register R_1 .

The rightmost 24 bits of the second-operand address are defined as follows:

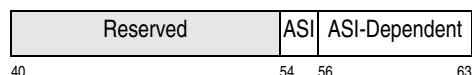

Attribute-Set Indication (ASI): Bit positions 54-55 of the second-operand address contain a 2-bit unsigned binary integer indicating the set of attributes from which an attribute to be extracted is selected. The attribute-set indications are:

- 0 Cache attributes
- 1 CPU attributes

All other attribute-set-indication values are reserved.

Cache-Attribute-Set Operation

The rightmost 24 bits of the second-operand address are defined as follows:

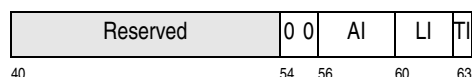

The attribute, level, and type indications for the cache-attribute set are as follows:

Attribute Indication (AI): Bit positions 56-59 of the second-operand address contain a 4-bit unsigned binary integer indicating the cache attribute to be extracted, as follows:

- 0 Extract topology summary
- 1 Extract line size of the cache, in bytes
- 2 Extract total size of the cache, in bytes
- 3 Extract set-associativity level of the cache
- 4-15 Reserved

Level Indication (LI): Bit positions 60-62 of the second-operand address contain a 3-bit unsigned binary integer indicating the level of the cache for which the cache attribute is to be extracted, with 0 indicating the first-level cache, 1 indicating the second-level cache and so forth. If a cache level is not

implemented on a model, its corresponding level indication is reserved.

Type Indication (TI): Bit 63 of the second-operand address indicates the type of cache for which the cache attribute is to be extracted, with 0 indicating the data cache and 1 indicating the instruction cache. When a cache level has a unified data and instruction cache, the same result is returned regardless of the type indication.

When the attribute indication is zero, the level indication (LI) and type indication (TI) are ignored.

CPU-Attribute-Set Operation

The rightmost 24 bits of the second-operand address are defined as follows:

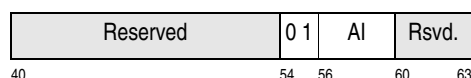

The attribute indication for the CPU-attribute set are as follows:

Attribute Indication (AI): Bit positions 56-59 of the second-operand address contain a 4-bit unsigned binary integer indicating the CPU attribute to be extracted, as follows:

- 0 Extract CPU speed
- 1-15 Reserved

Reserved: Bit positions 60-63 of the second-operand address are reserved and ignored.

Common Operation

Bits 0-39 of the second-operand address are ignored. Bits 40-53 of the second-operand address are reserved and should contain zeros.

Bits 0-63 of general register R_1 are set to ones if any of the following apply:

- A reserved bit position in the second-operand address contains one and is otherwise not specifically designated as ignored.
- A reserved ASI, AI, or, when applicable, LI value is specified and is otherwise not specifically designated as ignored.

- The specified ASI and AI values and, when applicable, the LI value are all valid, but the model does not provide the data.

The contents of general register R_3 are ignored, however the R_3 field should specify register 0; otherwise, the program may not operate compatibly in the future.

Cache-Attribute Results (ASI = 0)

When the cache attribute indication is zero, a summary of each level of cache is returned in general register R_1 . Each summary field is eight bits, where bits 0-7 of the register contain the summary for the first-level cache, bits 8-15 contain the summary for the second-level cache, and so forth. The contents of an eight-bit summary field are as follows:

Bits	Meaning
0-3	Reserved, stored as zeros
4-5	Cache scope, as follows: <ul style="list-style-type: none"> 00 Cache does not exist at this level 01 Cache is private to the CPU 10 Cache may be shared by multiple CPUs 11 Reserved
6-7	When bit positions 4-5 contain a nonzero value, bit positions 6-7 contain the cache type, as follows: <ul style="list-style-type: none"> 00 Separate instruction and data caches exist at this level 01 Only an instruction cache exists at this level 10 Only a data cache exists at this level 11 A unified instruction and data cache exists at this level

When bit positions 4-5 contain zeros, bit positions 6-7 also contain zeros.

When the cache attribute indication is one, two, or three, the attribute value is returned in general register R_1 , as a 64-bit unsigned integer.

CPU-Attribute Results (ASI = 1)

When the CPU attribute indication is zero, the CPU speeds are returned in general register R_1 , specified in the following format:

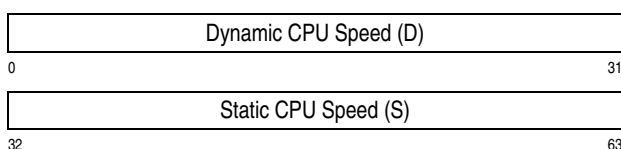

The fields are defined as follows:

Bits	Meaning
0-31	Bit positions 0-31 (D) contain a 32-bit unsigned binary integer whose value represents the dynamic CPU speed, encoded as the approximate number of CPU cycles per microsecond.
32-63	Bit positions 32-63 (S) contain a 32-bit unsigned binary integer whose value represents the static CPU speed, encoded as the approximate number of CPU cycles per microsecond.

The dynamic CPU speed may or may not be the same as the static CPU speed. The static CPU speed reflects a CPU running at its nominal capacity and corresponds to the particular model. The dynamic CPU speed reflects a CPU running at a changed capacity caused by, for example, a manual control set to a power-save position.

Condition Code: The code remains unchanged.

Program Exceptions:

- Operation (if the general-instructions-extension facility is not installed)
- Transaction constraint

Programming Notes:

- Knowledge of the cache line size is useful when determining the placement of PREFETCH DATA and PREFETCH DATA RELATIVE LONG instructions.
- The value placed in the first-operand location is model dependent and may differ significantly from one model to another. For example, the size of the data cache on one model may be smaller or larger than the size of the data cache on another model. To ensure compatible operation across multiple models, the program should not rely on any particular value being returned in the first-operand location.
- When the attribute-set indication is 00 binary and the attribute indication is 0000 binary, bit positions 4-5 of each 8-bit field returned in general register R_1 contain a cache-scope indication. When the cache-scope indication is 10 binary, the cache may be shared by more than one CPU

in the configuration. The System Library publication for the model may provide further explanation of cache topology.

4. When the attribute-set indication is 00 binary and the attribute indication is 0000 binary, the summary indications are returned in contiguous 8-bit fields in general register R₁. Thus if the program scans the resulting summary-indication fields from left to right and encounters an 8-bit field containing all zeros, no further meaningful fields exist.
5. Cache information returned reflects the depth specified by the level indication and the cache information accessible from the issuing CPU. The total sizes and associativity do not include other, parallel cache structures accessible from other CPUs of the configuration.
6. The static CPU speed (S) may be less than, equal to, or greater than the dynamic CPU speed (D), as follows:
 - When the CPU is operating at nominal capacity, the D and S values are equal.
 - The sections “Capacity-Change Reason (CCR)” on page 10-146 and “Capacity-Adjustment Indication (CAI)” on page 10-147 describe various reasons why a CPU may not be operating at nominal capacity, in which case, D may be less than S.
 - Under certain circumstances, D may be greater than S.
7. Depending on the model, the dynamic CPU speed (D) values may be different from one CPU to another. Similarly, the static CPU speed values may be different from one CPU to another.
8. In most cases, the dynamic CPU speed returned for CPU-attribute-indicator zero is the same as would be returned by the QUERY SAMPLING INFORMATION (QSI) instruction of the CPU-measurement facility. The value returned is also

subject to most of the same factors that affect the value returned by QSI.

EXTRACT CPU TIME

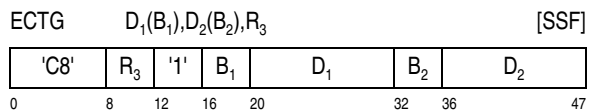

The value of the current CPU timer is subtracted from the first operand, and the difference is placed in general register 0. The second operand is placed unchanged in general register 1. The eight bytes at the third operand location replace the contents of general register R₃.

The first and second operands and the results in general registers 0, 1, and R₃ are treated as 64-bit unsigned binary integers.

In the 24-bit addressing mode, the contents of bit positions 40-63 of general register R₃ constitute the address of the third operand, and the contents of bit positions 0-39 are ignored. In the 31-bit addressing mode, the contents of bit positions 33-63 of the register constitute the address, and the contents of bit positions 0-32 are ignored. In the 64-bit addressing mode, the contents of bit positions 0-63 constitute the address. In the access-register mode, the contents of access register R₃ are used for accessing the third operand.

All operands are fetched before any general register is modified. If the R₃ field designates general register 0, it is unpredictable whether the result placed in the register is the first operand minus the CPU timer or the third operand. If the R₃ field designates general register 1, it is unpredictable whether the result placed in the register is the second operand or the third operand.

The contents of the registers just described are shown in Figure 7-299.

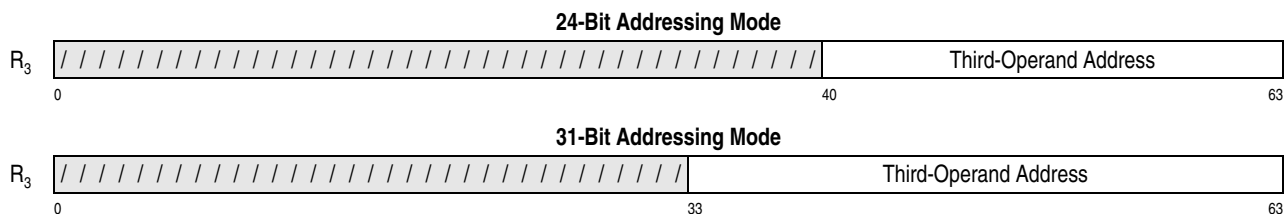

Figure 7-299. General Register Assignment for EXTRACT CPU TIME (Part 1 of 2)

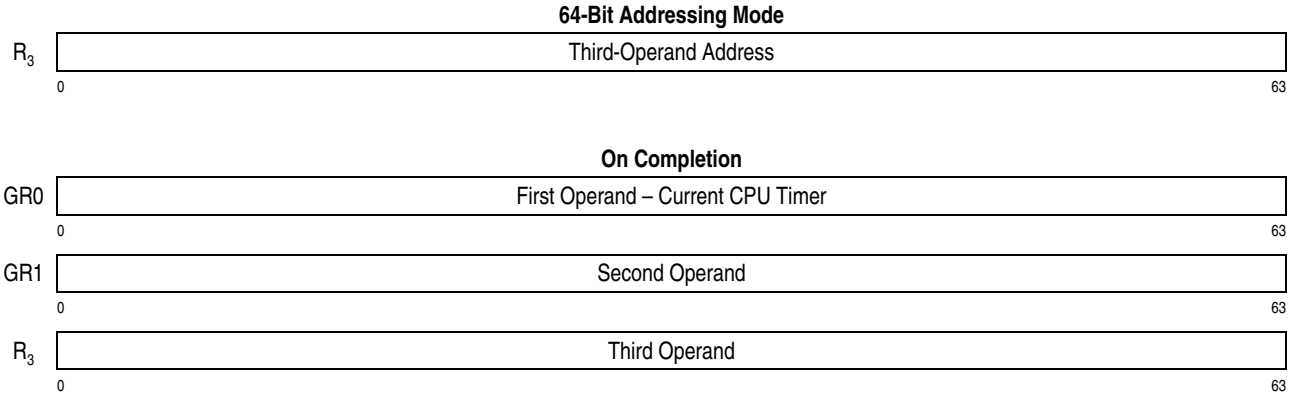

Figure 7-299. General Register Assignment for EXTRACT CPU TIME (Part 2 of 2)

Condition Code: The code remains unchanged.

- Transaction constraint

Program Exceptions:

- Access (fetch, operands 1, 2, and 3)
- Operation (the extract-CPU-time facility is not installed)
- Transaction constraint

EXTRACT TRANSACTION NESTING DEPTH

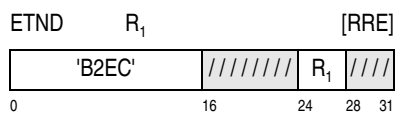

The current transaction nesting depth is placed in bits 48-63 of general register R₁. Bits 0-31 of the register remain unchanged, and bits 32-47 of the register are set to zero, as illustrated below.

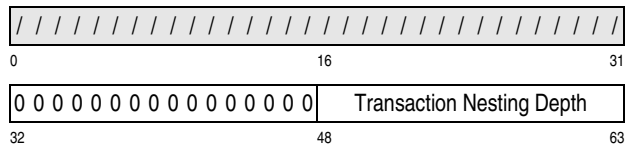

A special-operation exception is recognized and the operation is suppressed if the transactional-execution control, bit 8 of control register 0, is zero.

Condition Code: The code remains unchanged.

Program Exceptions:

- Operation (transactional-execution facility not installed)
- Special operation
- Transaction constraint

Programming Note: A transaction nesting depth of zero indicates that the CPU is not in the transactional-execution mode.

EXTRACT PSW

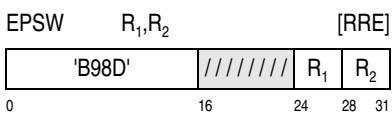

Bits 0-11 and 13-31 of the current PSW are placed in bit positions 32-43 and 45-63 of the first operand, and bits 0-31 of the operand remain unchanged. When the configuration is in the z/Architecture architectural mode, bit 44 of the first operand is set to zero, and when the configuration is in the ESA/390-compatibility mode, bit 44 of the first operand is set to one.

Subsequently, bits 32-63 of the current PSW are placed in bit positions 32-63 of the second operand, and bits 0-31 of the operand remain unchanged. The action associated with the second operand is not performed if the R₂ field is zero.

Bits 0-63 of the 128-bit PSW are illustrated in Figure 4-2 on page 4-5.

Condition Code: The code remains unchanged.

Program Exceptions:

FIND LEFTMOST ONE

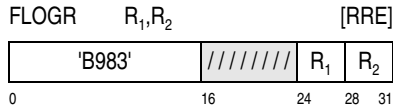

Bits 0-63 of general register R_2 are scanned left to right for the leftmost one bit. A 64-bit binary integer designating the bit position of the leftmost one bit, or 64 if there is no one bit, is placed in general register R_1 . When a one bit is found in the second operand, the original contents of general register R_2 , with the leftmost one bit set to zero, are placed in general register $R_1 + 1$. When a one bit is not found, the contents of general register $R_1 + 1$ are set to zeros.

The condition code indicates whether or not a one bit was found in the second operand.

The R_1 field designates an even-odd pair of general registers and must designate an even-numbered register; otherwise, a specification exception is recognized.

Resulting Condition Code:

- 0 No one bit found
- 1 --
- 2 One bit found
- 3 --

Program Exceptions:

- Operation (if the extended-immediate facility is not installed)
- Specification

Programming Notes:

1. An example of the use of the FIND LEFTMOST ONE instruction is given in Appendix A, "Number Representation and Instruction-Use Examples."
2. When the R_1 and R_2 fields designate the same register, the original contents of general register R_2 are replaced by the resulting bit-position value, or 64 if no one bit was found.
3. When the R_2 field designates general register $R_1 + 1$, the leftmost one bit (if any) of general register R_2 is set to zero; if no one bit is found, the entire register is set to zero.

4. When the R_2 field designates neither the even nor the odd registers designated by the R_1 field, then general register R_2 is not modified.

INSERT CHARACTER

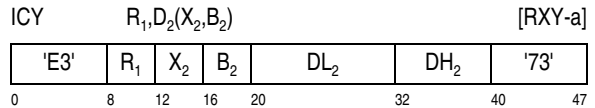
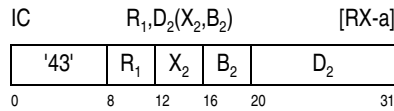

The byte at the second-operand location is inserted into bit positions 56-63 of general register R_1 . The remaining bits in the register remain unchanged.

The displacement for IC is treated as a 12-bit unsigned binary integer. The displacement for ICY is treated as a 20-bit signed binary integer.

Condition Code: The code remains unchanged.

Program Exceptions:

- Access (fetch, operand 2)
- Operation (ICY, if the long-displacement facility is not installed)

INSERT CHARACTERS UNDER MASK

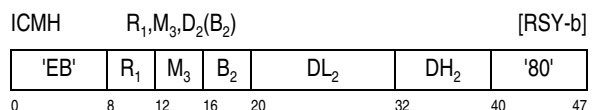
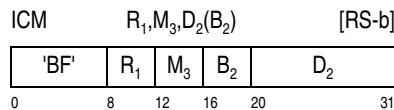

Bytes from contiguous locations beginning at the second-operand address are inserted into general register R_1 under control of a mask.

The contents of the M_3 field are used as a mask. These four bits, left to right, correspond one for one with four bytes, left to right, of general register R_1 . For INSERT CHARACTERS UNDER MASK (ICM, ICMY), the four bytes to which the mask bits correspond are in the low-order half, bit positions 32-63 of general register R_1 . For INSERT CHARACTERS UNDER MASK (ICMH), the four bytes are in the high-order half, bit positions 0-31, of the register. The byte positions corresponding to ones in the mask are filled, left to right, with bytes from successive storage locations beginning at the second-operand address. When the mask is not zero, the length of the second operand is equal to the number of ones in the mask. The bytes in the general register corresponding to zeros in the mask remain unchanged. For ICM and ICMY, bits 0-31 of the register remain unchanged, and, for ICMH, bits 32-63 remain unchanged.

The resulting condition code is based on the mask and on the value of the bits inserted. When the mask is zero or when all inserted bits are zeros, the condition code is set to 0. When the inserted bits are not all zeros, the code is set according to the leftmost bit of the storage operand: if this bit is one, the code is set to 1; if this bit is zero, the code is set to 2.

When the mask is not zero, exceptions associated with storage-operand access are recognized only for the number of bytes specified by the mask. When the mask is zero, access exceptions are recognized for one byte at the second-operand address.

The displacement for ICM is treated as a 12-bit unsigned binary integer. The displacement for ICMY and ICMH is treated as a 20-bit signed binary integer.

Resulting Condition Code:

- 0 All inserted bits zeros, or mask bits all zeros
- 1 Leftmost inserted bit one
- 2 Leftmost inserted bit zero, and not all inserted bits zeros
- 3 --

Program Exceptions:

- Access (fetch, operand 2)
- Operation (ICMY, if the long-displacement facility is not installed)

Programming Notes:

1. Examples of the use of the INSERT CHARACTERS UNDER MASK instruction are given in Appendix A, "Number Representation and Instruction-Use Examples."
2. The condition code for INSERT CHARACTERS UNDER MASK (ICM, ICMY only) is defined such that, when the mask is 1111, the instruction causes the same condition code to be set as for LOAD AND TEST (LTR only) Thus, the instruction may be used as a storage-to-register load-and-test operation.
3. INSERT CHARACTERS UNDER MASK (ICM, ICMY) with a mask of 1111 or 0001 performs a function similar to that of a LOAD (L) or INSERT CHARACTER (IC) instruction, respectively, with the exception of the condition-code setting. However, the performance of INSERT CHARACTERS UNDER MASK may be slower.

INSERT IMMEDIATE

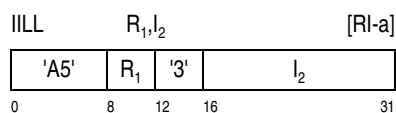
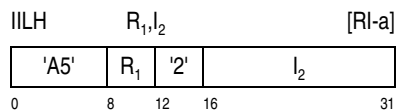
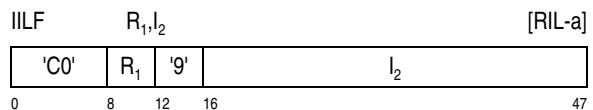
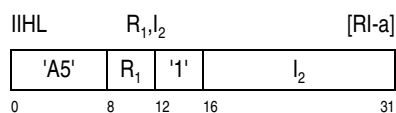
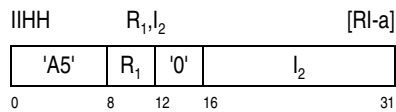
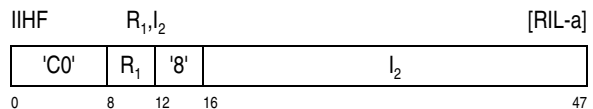

The second operand is placed in bit positions of the first operand. The remainder of the first operand remains unchanged.

For each instruction, the bit positions of the first operand and that are loaded with the second operand are as follows:

Instruction	Bit Positions Loaded
IIHF	0-31
IIHH	0-15
IIHL	16-31
IILF	32-63
IILH	32-47
IILL	48-63

Condition Code: The code remains unchanged.

Program Exceptions:

- Operation (IIHF and IILF, if the extended-immediate facility is not installed)

INSERT PROGRAM MASK



The condition code and program mask from the current PSW are inserted into bit positions 34 and 35 and 36-39, respectively, of general register R_1 . Bits 32 and 33 of the register are set to zeros; bits 0-31 and 40-63 are left unchanged.

Condition Code: The code remains unchanged.

Program Exceptions: None.

LOAD

Register-and-register formats:

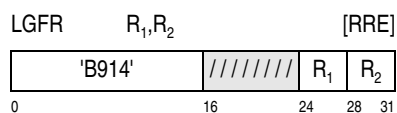
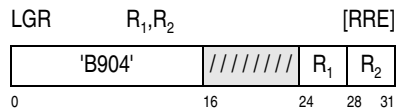
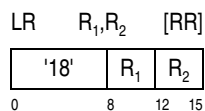

Register-and-storage formats:

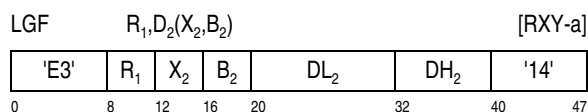
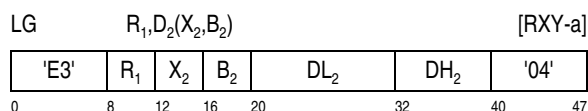
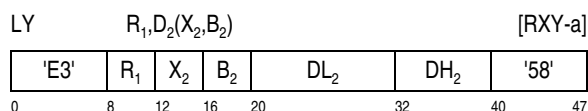
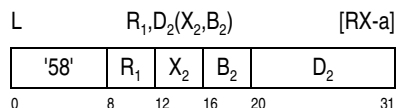

LOAD IMMEDIATE

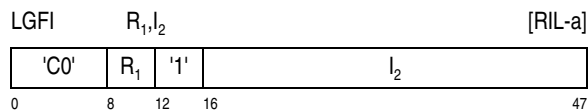

LOAD RELATIVE LONG

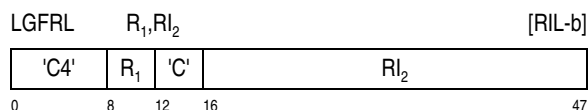
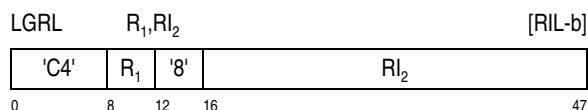
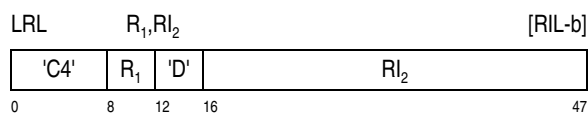

The second operand is placed unchanged at the first-operand location, except that, for LOAD (LGFR, LGF), LOAD IMMEDIATE (LGFI), and LOAD RELATIVE LONG (LGFRL), it is sign extended.

For LOAD (LR, L, LY) and LOAD RELATIVE LONG (LRL), the operands are 32 bits, and, for LOAD (LGR, LG), and LOAD RELATIVE LONG (LGRL), the operands are 64 bits. For LOAD (LGFR, LGF), LOAD IMMEDIATE (LGFI), and LOAD RELATIVE LONG (LGFRL), the second operand is treated as a 32-bit signed binary integer, and the first operand is treated as a 64-bit signed binary integer.

The displacement for L is treated as a 12-bit unsigned binary integer. The displacement for LY, LG, and LGF is treated as a 20-bit signed binary integer.

For LOAD IMMEDIATE, the contents of the I_2 field form the second operand directly.

For LOAD RELATIVE LONG, the contents of the RI_2 field are a signed binary integer specifying the number of halfwords that is added to the address of the instruction to generate the address of the second operand in storage. When DAT is on, the second operand is accessed using the same addressing-space mode as that used to access the instruction. When DAT is off, the second operand is accessed using a real address.

For LOAD RELATIVE LONG (LRL, LGFRL), the second operand must be aligned on a word boundary, and for LOAD RELATIVE LONG (LGRL), the second operand must be aligned on a doubleword boundary; otherwise, a specification exception is recognized.

Condition Code: The code remains unchanged.

Program Exceptions:

- Access (fetch, operand 2 of L, LY, LG, LGF, LRL, LGRL, and LGFRL only)
- Operation (LY, if the long-displacement facility is not installed; LGFI, if the extended-immediate facility is not installed; LRL, LGRL, LGFRL, if the general-instructions-extension facility is not installed)
- Specification (LRL, LGFRL, LGRL only)

Programming Notes:

1. An example of the use of the LOAD instruction is given in Appendix A, “Number Representation and Instruction-Use Examples.”
2. For LOAD RELATIVE LONG, the second operand must be aligned on an integral boundary corresponding to the operand’s size.
3. When LOAD RELATIVE LONG is the target of an execute-type instruction, the second-operand address is relative to the target address.

LOAD ACCESS MULTIPLE

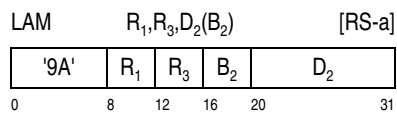

The set of access registers starting with access register R_1 and ending with access register R_3 is loaded from the locations designated by the second-operand address.

The storage area from which the contents of the access registers are obtained starts at the location designated by the second-operand address and continues through as many storage words as the number of access registers specified. The access registers are loaded in ascending order of their register numbers, starting with access register R_1 and continuing up to and including access register R_3 , with access register 0 following access register 15.

The displacement for LAM is treated as a 12-bit unsigned binary integer. The displacement for LAMY is treated as a 20-bit signed binary integer.

The second operand must be designated on a word boundary; otherwise, a specification exception is recognized.

Condition Code: The code remains unchanged.

Program Exceptions:

- Access (fetch, operand 2)

- Operation (LAMY, if the long-displacement facility is not installed)
- Specification
- Transaction constraint

LOAD ADDRESS

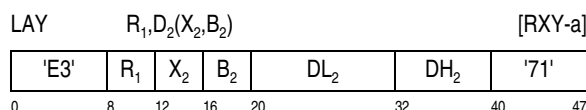
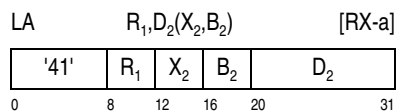

The address specified by the X₂, B₂, and D₂ fields is placed in general register R₁. The address computation follows the rules for address arithmetic.

In the 24-bit addressing mode, the address is placed in bit positions 40-63, bits 32-39 are set to zeros, and bits 0-31 remain unchanged. In the 31-bit addressing mode, the address is placed in bit positions 33-63, bit 32 is set to zero, and bits 0-31 remain unchanged. In the 64-bit addressing mode, the address is placed in bit positions 0-63.

The displacement for LA is treated as a 12-bit unsigned binary integer. The displacement for LAY is treated as a 20-bit signed binary integer.

No storage references for operands take place, and the address is not inspected for access exceptions.

Condition Code: The code remains unchanged.

Program Exceptions:

- Operation (LAY if the long-displacement facility is not installed)

Programming Notes:

1. An example of the use of the LOAD ADDRESS instruction is given in Appendix A, "Number Representation and Instruction-Use Examples."
2. LOAD ADDRESS may be used to increment the rightmost bits of a general register, other than register 0, by the contents of the D₂ field of the instruction. LOAD ADDRESS (LAY) may also be used to decrement the rightmost bits of a regis-

ter, other than register 0. The register to be incremented should be designated by R₁ and by either X₂ (with B₂ set to zero) or B₂ (with X₂ set to zero). The instruction increments 24 bits in the 24-bit addressing mode, 31 bits in the 31-bit addressing mode, and 64 bits in the 64-bit addressing mode.

LOAD ADDRESS EXTENDED

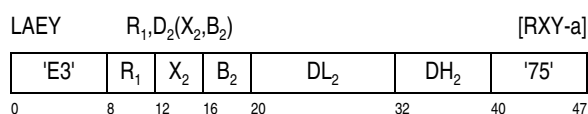
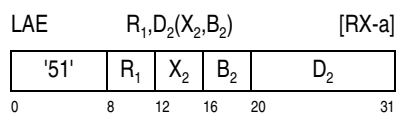

The address specified by the X₂, B₂, and D₂ fields is placed in general register R₁. Access register R₁ is loaded with a value that depends on the current value of the address-space-control bits, bits 16 and 17 of the PSW. If the address-space-control bits are 01 binary, the value placed in the access register also depends on whether the B₂ field is zero or non-zero.

The address computation follows the rules for address arithmetic. In the 24-bit addressing mode, the address is placed in bit positions 40-63 of general register R₁, bits 32-39 are set to zeros, and bits 0-31 remain unchanged. In the 31-bit addressing mode, the address is placed in bit positions 33-63, bit 32 is set to zero, and bits 0-31 remain unchanged. In the 64-bit addressing mode, the address is placed in bit positions 0-63.

The value placed in access register R₁ is as shown in the following table:

PSW Bits 16 and 17	Value Placed in Access Register R ₁
00	00000000 hex (zeros in bit positions 0-31)
10	00000001 hex (zeros in bit positions 0-30 and one in bit position 31)
01	If B ₂ field is zero: 00000000 hex (zeros in bit positions 0-31) If B ₂ field is nonzero: Contents of access register B ₂

**PSW Bits
16 and 17 Value Placed in Access Register R₁**

11	00000002 hex (zeros in bit positions 0-29 and 31, and one in bit position 30)
----	---

However, when PSW bits 16 and 17 are 01 binary and the B₂ field is nonzero, bit positions 0-6 of access register B₂ must contain all zeros; otherwise, the results in general register R₁ and access register R₁ are unpredictable.

The displacement for LAE is treated as a 12-bit unsigned binary integer. The displacement for LAEY is treated as a 20-bit signed binary integer.

No storage references for operands take place, and the address is not inspected for access exceptions.

Condition Code: The code remains unchanged.

Program Exceptions:

- Operation (LAEY; if the general-instructions-extension facility is not installed)
- Transaction constraint

Programming Notes:

1. When DAT is on, the different values of the address-space-control bits correspond to translation modes as follows:

**PSW Bits
16 and 17 Translation Mode**

00	Primary-space mode
10	Secondary-space mode
01	Access-register mode
11	Home-space mode

2. In the access-register mode, the value 00000000 hex in an access register designates the primary address space, and the value 00000001 hex designates the secondary address space. The value 00000002 hex designates the home address space if the control program assigns entry 2 of the dispatchable-unit access list as designating the home address space and places a zero access-list-entry sequence number (ALESN) in that entry.

LOAD ADDRESS RELATIVE LONG

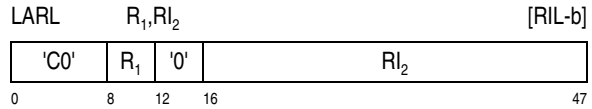

The address specified by the R₁₂ field is placed in general register R₁. The address computation follows the rules for the branch address of BRANCH RELATIVE ON CONDITION LONG and BRANCH RELATIVE AND SAVE LONG.

In the 24-bit addressing mode, the address is placed in bit positions 40-63, bits 32-39 are set to zeros, and bits 0-31 remain unchanged. In the 31-bit addressing mode, the address is placed in bit positions 33-63, bit 32 is set to zero, and bits 0-31 remain unchanged. In the 64-bit addressing mode, the address is placed in bit positions 0-63.

The contents of the R₁₂ field are a signed binary integer specifying the number of halfwords that is added to the address of the instruction to generate the computed address.

No storage references for operands take place, and the address is not inspected for access exceptions.

Condition Code: The code remains unchanged.

Program Exceptions: None.

Programming Notes:

1. Only even addresses (halfword addresses) can be generated. If an odd address is desired, LOAD ADDRESS can be used to add one to an address formed by LOAD ADDRESS RELATIVE LONG.
2. When LOAD ADDRESS RELATIVE LONG is the target of an execute-type instruction, the address produced is relative to the location of the LOAD ADDRESS RELATIVE LONG instruction, not of the execute-type instruction. This is consistent with the operation of the relative-branch instructions.

LOAD AND ADD

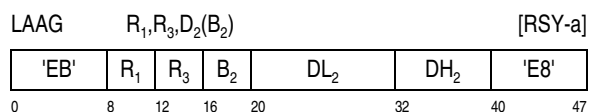
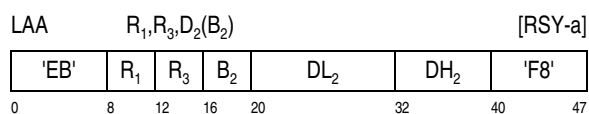

The second operand is added to the third operand, and the sum is placed at the second-operand location. Subsequently, the original contents of the second operand (prior to the addition) are placed unchanged at the first-operand location.

For LAA, the operands are treated as being 32-bit signed binary integers. For LAAG, the operands are treated as being 64-bit signed binary integers.

All accesses to the second-operand location appear to be a block-concurrent interlocked-update reference as observed by other CPUs and the I/O subsystem. A specific-operand-serialization operation is performed.

The displacement is treated as a 20-bit signed binary integer.

The second operand of LAA must be designated on a word boundary. The second operand of LAAG must be designated on a doubleword boundary. Otherwise, a specification exception is recognized.

Resulting Condition Code:

- 0 Result zero; no overflow
- 1 Result less than zero; no overflow
- 2 Result greater than zero; no overflow
- 3 Overflow

Program Exceptions:

- Access (fetch and store, operand 2)
- Fixed-point overflow
- Operation (if the interlocked-access facility 1 is not installed)
- Specification
- Transaction constraint

Programming Notes:

1. Except for the case where the R₁ and R₃ fields designate the same register, general register R₃ is unchanged.
2. The operation of LOAD AND ADD, LOAD AND ADD LOGICAL, LOAD AND AND, LOAD AND EXCLUSIVE OR, and LOAD AND OR may be expressed as follows.

```
temp ← operand_2;
operand_2 ← temp OP operand_3;
operand_1 ← temp;
```

OP represents the arithmetic or logical operation being performed by the instruction.

LOAD AND ADD LOGICAL

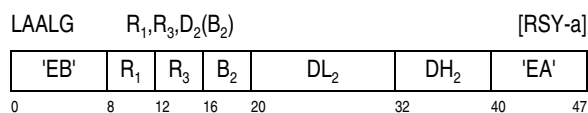
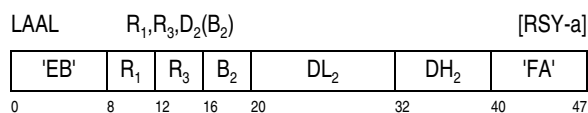

The second operand is added to the third operand, and the sum is placed at the second-operand location. Subsequently, the original contents of the second operand (prior to the addition) are placed unchanged at the first-operand location.

For LAAL, the operands are treated as being 32-bit unsigned binary integers. For LAALG, the operands are treated as being 64-bit unsigned binary integers.

All accesses to the second-operand location appear to be a block-concurrent interlocked-update reference as observed by other CPUs and the I/O subsystem. A specific-operand-serialization operation is performed.

The displacement is treated as a 20-bit signed binary integer.

The second operand of LAAL must be designated on a word boundary. The second operand of LAALG must be designated on a doubleword boundary. Otherwise, a specification exception is recognized.

Resulting Condition Code:

- 0 Result zero; no carry
- 1 Result not zero; no carry
- 2 Result zero; carry
- 3 Result not zero; carry

Program Exceptions:

- Access (fetch and store, operand 2)
- Operation (if the interlocked-access facility 1 is not installed)
- Specification
- Transaction constraint

Programming Note: See the programming notes for LOAD AND ADD.

LOAD AND AND

The AND of the second operand and third operand is placed at the second-operand location. Subsequently, the original contents of the second operand (prior to the AND operation) are placed unchanged at the first-operand location.

For LAN, the operands are 32 bits. For LANG, the operands are 64 bits.

The connective AND is applied to the operands bit by bit. The contents of a bit position in the result are set to one if the corresponding bit positions in both operands contain ones; otherwise, the result bit is set to zero.

All accesses to the second-operand location appear to be a block-concurrent interlocked-update reference as observed by other CPUs and the I/O subsystem. A specific-operand-serialization operation is performed.

The displacement is treated as a 20-bit signed binary integer.

The second operand of LAN must be designated on a word boundary. The second operand of LANG must be designated on a doubleword boundary. Otherwise, a specification exception is recognized.

Resulting Condition Code:

- 0 Result zero
- 1 Result not zero
- 2 --
- 3 --

Program Exceptions:

- Access (fetch and store, operand 2)
- Operation (if the interlocked-access facility 1 is not installed)
- Specification
- Transaction constraint

Programming Note: See the programming notes for LOAD AND ADD.

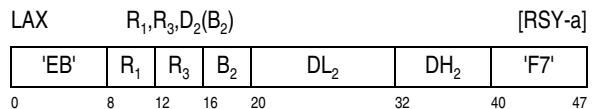
LOAD AND EXCLUSIVE OR

The EXCLUSIVE OR of the second operand and third operand is placed at the second-operand location. Subsequently, the original contents of the second operand (prior to the EXCLUSIVE OR operation) are placed unchanged at the first-operand location.

For LAX, the operands are 32 bits. For LAXG, the operands are 64 bits.

The connective exclusive OR is applied to the operands bit by bit. The contents of a bit position in the result are set to one if the bits in the corresponding bit positions in the two operands are unlike; otherwise, the result bit is set to zero.

All accesses to the second-operand location appear to be a block-concurrent interlocked-update reference as observed by other CPUs and the I/O subsystem.

tem. A specific-operand-serialization operation is performed.

The displacement is treated as a 20-bit signed binary integer.

The second operand of LAX must be designated on a word boundary. The second operand of LAXG must be designated on a doubleword boundary. Otherwise, a specification exception is recognized.

Resulting Condition Code:

- 0 Result zero
- 1 Result not zero
- 2 --
- 3 --

Program Exceptions:

- Access (fetch and store, operand 2)
- Operation (if the interlocked-access facility 1 is not installed)
- Specification
- Transaction constraint

Programming Note: See the programming notes for LOAD AND ADD.

LOAD AND OR

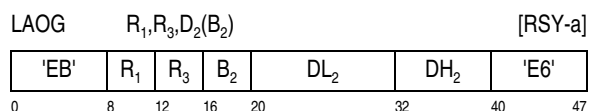
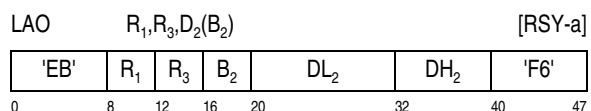

The OR of the second operand and third operand is placed at the second-operand location. Subsequently, the original contents of the second operand (prior to the OR operation) are placed unchanged at the first-operand location.

For LAO, the operands are 32 bits. For LAOG, the operands are 64 bits.

The connective OR is applied to the operands bit by bit. The contents of a bit position in the result are set to one if the corresponding bit position in one or both

operands contains a one; otherwise, the result bit is set to zero.

All accesses to the second-operand location appear to be a block-concurrent interlocked-update reference as observed by other CPUs and the I/O subsystem. A specific-operand-serialization operation is performed.

The displacement is treated as a 20-bit signed binary integer.

The second operand of LAO must be designated on a word boundary. The second operand of LAOG must be designated on a doubleword boundary. Otherwise, a specification exception is recognized.

Resulting Condition Code:

- 0 Result zero
- 1 Result not zero
- 2 --
- 3 --

Program Exceptions:

- Access (fetch and store, operand 2)
- Operation (if the interlocked-access facility 1 is not installed)
- Specification
- Transaction constraint

Programming Note: See the programming notes for LOAD AND ADD.

LOAD AND TEST

Register-and-register formats:

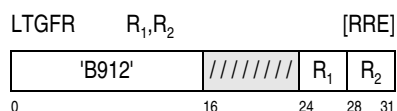
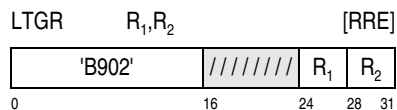
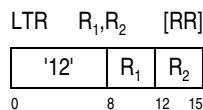

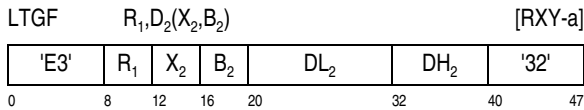
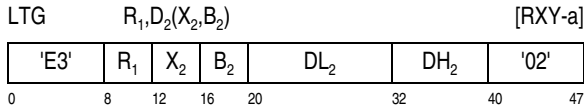
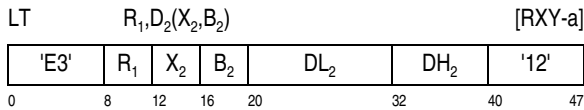
Register-and-storage formats:

The second operand is placed unchanged at the first-operand location, except that, for LTGF and LTGFR, it is sign extended. The sign and magnitude of the second operand, treated as a signed binary integer, are indicated in the condition code.

For LT and LTR, the operands are 32 bits, and, for LTG and LTGR, the operands are 64 bits. For LTGF and LTGFR, the second operand is 32 bits, and the first operand is treated as a 64-bit signed binary integer.

Resulting Condition Code:

- 0 Result zero
- 1 Result less than zero
- 2 Result greater than zero
- 3 --

Program Exceptions:

- Access (fetch, operand 2 of LT, LTG, and LTGF only)
- Operation (LT and LTG, if the extended-immediate facility is not installed; LTGF, if the general-instructions-extension facility is not installed)

Programming Note: For LOAD AND TEST (LTR and LTGR) when the R₁ and R₂ fields designate the same register, the operation is equivalent to a test without data movement.

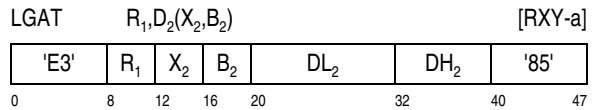
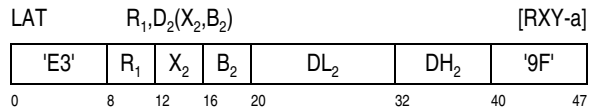
LOAD AND TRAP

The second operand is placed unchanged at the first operand location. If all zeros are placed at the first operand location, a compare-and-trap-instruction data exception is recognized.

For LAT, the second operand is treated as a 32-bit signed integer and placed in bit positions 32-63 of general register R₁, and bit positions 0-31 remain unchanged.

For LGAT, the second operand is treated as a 64-bit signed integer and placed in bit positions 0-63 of general register R₁.

Condition Code: The code remains unchanged.

Program Exceptions:

- Data
- Access (fetch, operand 2)
- Operation (if the load-and-trap facility is not installed)

Programming Note: Possible uses of LOAD AND TRAP include checking for pointers containing zero (null pointer).

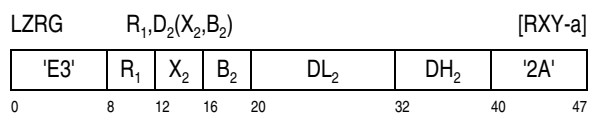
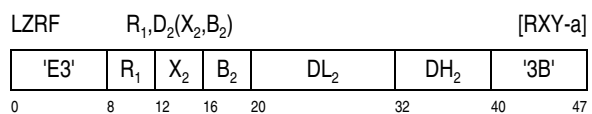
LOAD AND ZERO RIGHTMOST BYTE

The second operand, with the rightmost byte set to zero, is placed at the first-operand location. For LZRF, the first and second operands are 32 bits, and for LZRG, the first and second operands are 64 bits.

The displacement is treated as a 20-bit signed binary integer.

It is unpredictable whether an access exception is recognized for the rightmost byte of the second operand.

Condition Code: The code remains unchanged.

Program Exceptions:

- Access (fetch, operand 2)
- Operation (if the load-and-zero-rightmost-byte facility is not installed)

LOAD BYTE

Register-and-register formats:

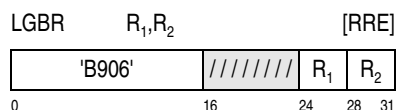
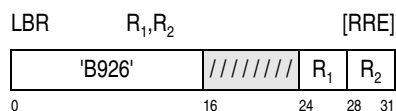

Register-and-storage formats:

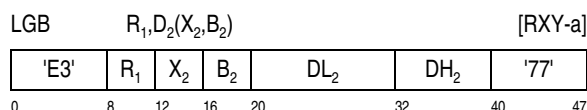

The second operand is sign extended and placed at the first-operand location. The second operand is one byte in length and is treated as an eight-bit signed binary integer. For LOAD BYTE (LB and LGB), the second operand is a byte in storage. For LOAD BYTE (LBR and LGBR), the second operand is in bits 56-63 of general register R_2 .

For LOAD BYTE (LB and LBR), the first operand is treated as a 32-bit signed binary integer. For LOAD BYTE (LGB and LGBR), the first operand is treated as a 64-bit signed binary integer.

The displacement for LB and LGB is treated as a 20-bit signed binary integer.

Condition Code: The code remains unchanged.

Program Exceptions:

- Access (fetch, operand 2 of LB and LGB)
- Operation (LB and LGB, if the long-displacement facility is not installed; LBR and LGBR, if the extended-immediate facility is not installed)

LOAD BYTE HIGH

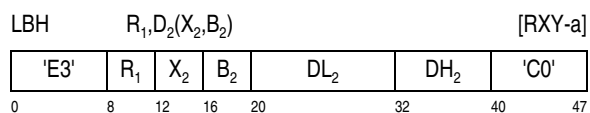

The second operand is sign extended and placed at the first-operand location. The second operand is one byte in length and is treated as an eight-bit signed binary integer.

The first operand is treated as a 32-bit signed binary integer in bits 0-31 of general register R_1 ; bits 32-63 of the register are unchanged.

The displacement is treated as a 20-bit signed binary integer.

Condition Code: The code remains unchanged.

Program Exceptions:

- Access (fetch, operand 2)
- Operation (if the high-word facility is not installed)

LOAD COMPLEMENT

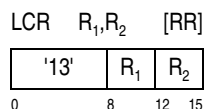

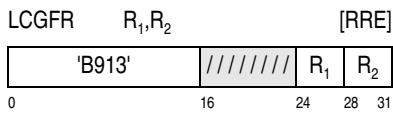
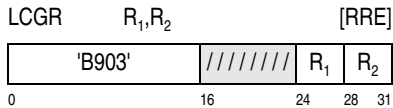

The two's complement of the second operand is placed at the first-operand location. For LOAD COMPLEMENT (LCR), the second operand and result are treated as 32-bit signed binary integers. For LOAD COMPLEMENT (LCGR), they are treated as 64-bit signed binary integers. For LOAD COMPLEMENT (LCGFR), the second operand is treated as a 32-bit signed binary integer, and the result is treated as a 64-bit signed binary integer.

When there is an overflow, the result is obtained by allowing any carry into the sign-bit position and ignoring any carry out of the sign-bit position, and condition code 3 is set. If the fixed-point-overflow mask is one, a program interruption for fixed-point overflow occurs.

Resulting Condition Code:

- 0 Result zero; no overflow
- 1 Result less than zero; no overflow
- 2 Result greater than zero; no overflow
- 3 Overflow

Program Exceptions:

- Fixed-point overflow (LCR and LCGR only)

Programming Note: The operation complements all numbers. Zero remains unchanged. For LCR or LCGR, the maximum negative 32-bit number or 64-bit number, respectively, remains unchanged, and an overflow condition occurs when the number is complemented. LCGFR complements the maximum negative 32-bit number without recognizing overflow.

LOAD COUNT TO BLOCK BOUNDARY

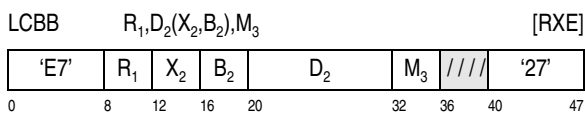

A 32-bit unsigned binary integer containing the number of bytes possible to load from the second operand and location without crossing a specified block boundary, with a maximum of sixteen is placed in the first operand. If the number of bytes is greater than sixteen, sixteen is placed in the first operand.

The displacement is treated as a 12-bit unsigned integer.

The second operand address is not used to address data.

The M_3 field specifies a code that is used to signal the CPU as to the block boundary size to compute the number of possible bytes loaded. If a reserved value is specified then a specification exception is recognized.

Code Boundary

- 0 64 Byte
- 1 128 Byte
- 2 256 Byte
- 3 512 Byte
- 4 1 K-byte
- 5 2 K-Byte
- 6 4 K-Byte
- 7-15 Reserved

Resulting Condition Code:

- 0 Operand one is sixteen
- 1 --
- 2 --
- 3 Operand one is less than sixteen

Program Exceptions:

- Operation (if the vector facility for z/Architecture is not installed)
- Specification

Programming Note: It is expected that LOAD COUNT TO BLOCK BOUNDARY will be used in conjunction with VECTOR LOAD TO BLOCK BOUNDARY to determine the number of bytes that were loaded.

LOAD GUARDED

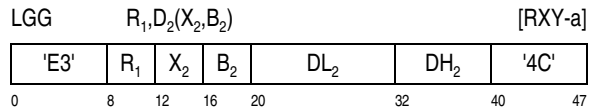

LOAD LOGICAL AND SHIFT GUARDED

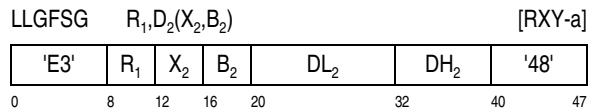

Note: See the section “Guarded-Storage Facility” on page 4-65 for details on the terminology used below.

A 64-bit intermediate result is formed as follows:

- For **LOAD GUARDED**: The second operand is a doubleword in storage. A specification exception is recognized and the operation is suppressed if the second-operand address is not on a doubleword boundary.

In the 24-bit addressing mode, the intermediate result is formed from the concatenation of 40 binary zeros with bits 40-63 of the second operand. In the 31-bit addressing mode, the intermediate result is formed from the concatenation of 33 binary zeros with bits 33-63 of the second operand. In the 64-bit addressing mode, the intermediate result is formed from the entire second operand.

- For **LOAD LOGICAL AND SHIFT GUARDED**: The second operand is a word in storage. A specification exception is recognized and the operation is suppressed if the second-operand address is not on a word boundary.

When the guarded-storage facility is enabled (by means of bit 59 of control register 2), the intermediate result is formed using the guarded-load-shift value (GLS, in bits 53-55 of the guarded-storage-designation register). When the guarded-storage facility is not enabled, the GLS value is assumed to be zero.

In the 24-bit addressing mode, the intermediate result is formed from the concatenation of 40 binary zeros, bits (8+GLS) through 31 of the second operand, and GLS binary zeros. In the 31-bit addressing mode, the intermediate result is formed from the concatenation of 33 binary zeros, bits (1+GLS) through 31 of the second operand, and GLS binary zeros. In the 64-bit addressing mode, the intermediate result is formed from the concatenation of (32-GLS) binary zeros, the entire 32-bit second operand, and GLS binary zeros.

When the guarded-storage facility is enabled, the intermediate result is used as described in “Guarded-Storage-Event Detection” on page 4-70. If a guarded-storage event is recognized, then general register R_1 is not modified, and the instruction is completed as described in “Guarded-Storage-Event Processing” on page 4-71.

When either the guarded-storage facility is not enabled, or the facility is enabled but a guarded-storage event is not recognized, then the 64-bit intermediate result is placed into general register R_1 , and the instruction is completed.

The displacement is treated as a 20-bit signed binary integer.

The guarded-storage-event parameter list (GSEPL) is only accessed when a guarded-storage event is recognized. Store-type accesses apply to the entire GSEPL.

Condition Code: The code remains unchanged.

Program Exceptions:

- Access (fetch, second operand; when a guarded-storage-event is recognized, fetch and store, GSEPL fields)
- Operation (guarded-storage facility not installed)

- Specification

1.-7.	Exceptions with the same priority as the priority of program-interruption conditions for the general case.
8.	Access exceptions for the second operand in storage.
9.	Completion with no guarded-storage-event recognized.
10.	Side-effect access exceptions for the guarded-storage-event parameter list.
11.	Completion with a guarded-storage-event recognized.

Figure 7-300. Priority of Execution: LGG and LLGFSG

Programming Notes:

1. LOAD LOGICAL AND SHIFT GUARDED may be useful in loading what are sometimes referred to as *compressed pointers* in which some number of rightmost bits of the pointer address are absent in storage and assumed to be zeros.
2. When the guarded-storage facility is installed in a configuration, the LOAD GUARDED and LOAD LOGICAL AND SHIFT GUARDED instructions can be executed regardless of the contents of the guarded-storage-facility-enablement control (GSFE, bit 59 of control register 2). However, guarded-storage events are only recognized as a result of executing LGG or LLGFSG when (a) the GSFE control is one, and (b) the GSSM is non-zero. The GSSM cannot be loaded without the GSFE control being one.
3. A guarded-storage event is never recognized when all 64 bits of the guarded-storage selection mask (GSSM) are zero. The program can ensure that guarded-storage events are not recognized by either (a) not loading the guarded-storage controls, in which case the GSSM will contain its reset state of zeros, or (b) loading zeros into the GSSM.

LOAD GUARDED STORAGE CONTROLS

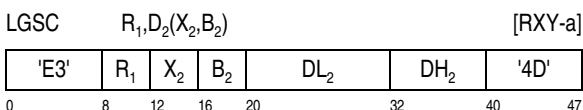

The contents of the guarded-storage control block (GSCB) at the second-operand address are loaded into the three guarded-storage registers. The format of the guarded-storage control block is shown in Figure 4-19 on page 4-67. The R₁ field of the instruction is reserved and should contain zero; otherwise, the program may not operate compatibly in the future.

Access exceptions are recognized for all 32 bytes of the GSCB.

The section “Guarded-Storage-Designation (GSD) Register” on page 4-66 describes the valid values of the GSD register. If either the GLS or GSC fields of the GSD register being loaded contain invalid values, or if reserved bit positions of the register do not contain zeros the results are unpredictable. If the second operand contains either (a) invalid GLS or GSC values, or (b) nonzero values in the reserved bit positions, then it is model dependent whether the CPU replaces the invalid or nonzero values with corrected values. Furthermore, it is unpredictable whether such corrected values are subsequently stored by STORE GUARDED STORAGE CONTROLS.

Special Conditions

A special-operation exception is recognized and the operation is suppressed when the guarded-storage-facility-enablement control, bit 59 of control register 2, is zero.

Condition Code: The code remains unchanged.

Program Exceptions:

- Access (fetch, second operand)
- Operation (if the guarded-storage facility is not installed)
- Special operation
- Transaction constraint

Programming Notes:

1. If the GSC field of the GSD register contains an invalid value, guarded-storage events may not occur or erroneous guarded-storage events may be detected.
2. If the GLS field of the GSD register contains an invalid value, the intermediate result used by LLGFSG may be formed from an unpredictable

range of bits in the second operand, shifted by an unpredictable number of bits.

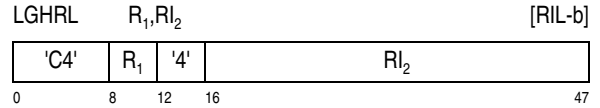

LOAD HALFWORD

Register-and-register formats:

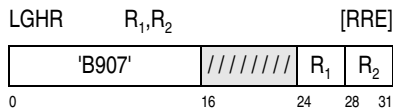
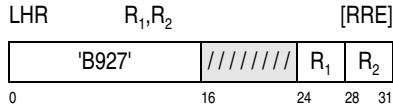

Register-and-storage formats:

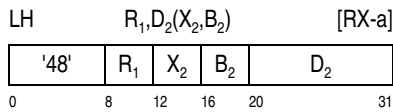

LOAD HALFWORD IMMEDIATE

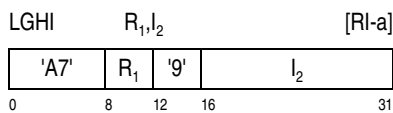
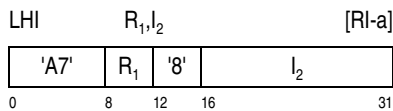

LOAD HALFWORD RELATIVE LONG

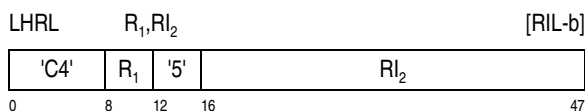

The second operand is sign extended and placed at the first-operand location. The second operand is two bytes in length and is treated as a 16-bit signed binary integer. For LOAD HALFWORD (LH, LHY, and LGH) and LOAD HALFWORD RELATIVE LONG, the second operand is in storage. For LOAD HALFWORD (LHI and LGHI), the second operand is the immediate field of the instruction. For LOAD HALFWORD (LHR and LGHR), the second operand is in bits 48-63 of general register R_2 .

For LOAD HALFWORD (LH, LHR, and LHY), LOAD HALFWORD IMMEDIATE (LHI), and LOAD HALFWORD RELATIVE LONG (LHRL), the first operand is treated as a 32-bit signed binary integer. For LOAD HALFWORD (LGH and LGHR), LOAD HALFWORD IMMEDIATE (LGHI), and LOAD HALFWORD RELATIVE LONG (LGHRL), the first operand is treated as a 64-bit signed binary integer.

The displacement for LH is treated as a 12-bit unsigned binary integer. The displacement for LHY and LGH is treated as a 20-bit signed binary integer.

For LOAD HALFWORD RELATIVE LONG, the contents of the R_2 field are a signed binary integer specifying the number of halfwords that is added to the address of the instruction to generate the address of the second operand in storage. When DAT is on, the second operand is accessed using the same addressing-space mode as that used to access the instruction. When DAT is off, the second operand is accessed using a real address.

Condition Code: The code remains unchanged.

Program Exceptions:

- Access (fetch, operand 2 of LH, LHY, LGH, LHRL and LGHRL)
- Operation (LHY, if the long-displacement facility is not installed; LHR and LGHR, if the extended-immediate facility is not installed; LHRL and LGHRL, if the general-instructions-extension facility is not installed)

Programming Notes:

1. An example of the use of the LOAD HALFWORD instruction is given in Appendix A, “Number Representation and Instruction-Use Examples.”
2. For LOAD HALFWORD RELATIVE LONG, the second operand is necessarily aligned on an integral boundary corresponding to the operand’s size.
3. When LOAD HALFWORD RELATIVE LONG is the target of an execute-type instruction, the second-operand address is relative to the target address.

LOAD HALFWORD HIGH

The second operand is sign extended and placed at the first-operand location. The second operand is two bytes in length and is treated as an 16-bit signed binary integer.

The first operand is treated as a 32-bit signed binary integer in bits 0-31 of general register R₁; bits 32-63 of the register are unchanged.

The displacement is treated as a 20-bit signed binary integer.

Condition Code: The code remains unchanged.

Program Exceptions:

- Access (fetch, operand 2)
- Operation (if the high-word facility is not installed)

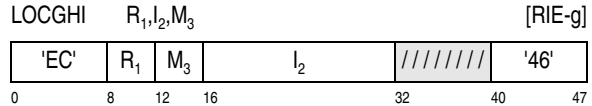
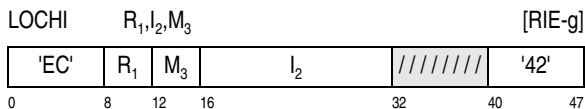
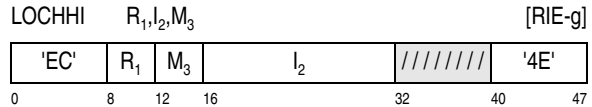
LOAD HALFWORD IMMEDIATE ON CONDITION**LOAD HALFWORD HIGH IMMEDIATE ON CONDITION**

The second operand is sign extended and placed at the first-operand location if the condition code has one of the values specified by M₃; otherwise, the first operand remains unchanged.

For LOAD HALFWORD IMMEDIATE ON CONDITION (LOCHI), the first operand is treated as a 32-bit signed binary integer in bits 32-63 of general register R₁, and bits 0-31 of the register are unchanged. For LOAD HALFWORD HIGH IMMEDIATE ON CONDITION, the first operand is treated as a 32-bit signed binary integer in bits 0-31 of general register R₁, and bits 32-63 of the register are unchanged. For LOAD HALFWORD IMMEDIATE ON CONDITION (LOGCHI), the first operand is treated as a 64-bit signed binary integer in bits 0-63 of general register R₁.

The second operand is the two byte I₂ field of the instruction and is treated as a 16-bit signed binary integer.

The M₃ field is used as a four-bit mask. The four condition codes (0, 1, 2, and 3) correspond, left to right, with the four bits of the mask, as follows:

Condition Code	0	1	2	3
Instruction Bit Number of Mask	12	13	14	15
Mask Position Value	8	4	2	1

The current condition code is used to select the corresponding mask bit. If the mask bit selected by the condition code is one, the load is performed. If the mask bit selected is zero, the load is not performed.

Condition Code: The code remains unchanged.

Program Exceptions:

- Operation (if the load/store-on-condition facility 2 is not installed)

Programming Notes: See programming note 4 on page 7-284 for details on extended mnemonics for the instructions of the load/store-on-condition facilities.

LOAD HIGH

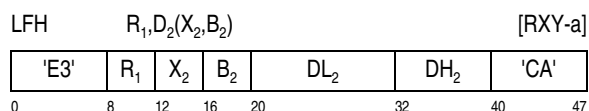

The second operand is placed unchanged at the first-operand location. The second operand is 32 bits, and the first operand is in bits 0-31 of general register R₁; bits 32-63 of the register are unchanged.

The displacement is treated as a 20-bit signed binary integer.

Condition Code: The code remains unchanged.

Program Exceptions:

- Access (fetch, operand 2)
- Operation (if the high-word facility is not installed)

LOAD HIGH AND TRAP

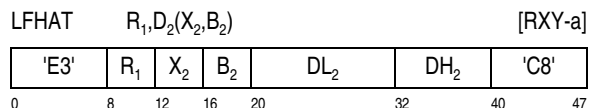

The second operand is treated as a 32-bit signed integer and placed unchanged in bit positions 0-31 of general register R₁, and bit positions 32-63 remain unchanged. If all zeros are placed at the first operand location, a compare-and-trap-instruction data exception is recognized.

Condition Code: The code remains unchanged.

Program Exceptions:

- Data
- Access (fetch, operand 2)
- Operation (if the load-and-trap facility is not installed)

Programming Note: Possible uses of LOAD HIGH AND TRAP include checking for pointers containing zero (null pointer).

LOAD LOGICAL

Register-and-register format:

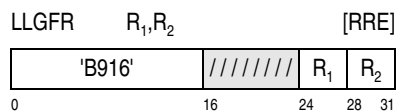

Register-and-storage format:

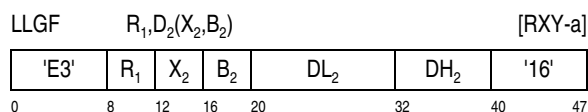

LOAD LOGICAL RELATIVE LONG

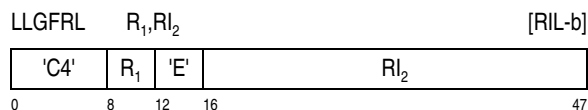

The four-byte second operand is placed in bit positions 32-63 of general register R₁, and zeros are placed in bit positions 0-31 of general register R₁.

For LOAD LOGICAL (LLGFR), the second operand is in bit positions 32-63 of general register R₂.

For LOAD LOGICAL RELATIVE LONG, the contents of the R₂ field are a signed binary integer specifying the number of halfwords that is added to the address of the instruction to generate the address of the second operand in storage. When DAT is on, the second operand is accessed using the same addressing-space mode as that used to access the instruction. When DAT is off, the second operand is accessed using a real address.

For LOAD LOGICAL RELATIVE LONG, the second operand must be aligned on a word boundary; otherwise, a specification exception is recognized.

Condition Code: The code remains unchanged.

Program Exceptions:

- Access (fetch, operand 2 of LLGF and LLGFRL only)
- Operation (LLGFRL, if the general-instructions-extension facility is not installed)
- Specification (LLGFRL only)

LOAD LOGICAL AND TRAP

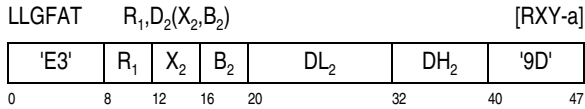

The four-byte second operand is placed unchanged in bit positions 32-63 of general register R₁, and zeros are placed in bit positions 0-31. If all zeros are placed at the first operand location, a compare-and-trap-instruction data exception is recognized.

Condition Code: The code remains unchanged.

Program Exceptions:

- Data
- Access (fetch, operand 2)
- Operation (if the load-and-trap facility is not installed)

Programming Note: Possible uses of LOAD LOGICAL AND TRAP include checking for pointers containing zero (null pointer).

LOAD LOGICAL AND ZERO RIGHTMOST BYTE

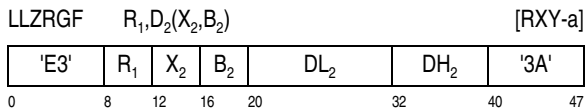

The four-byte second operand, with the rightmost byte set to zero, is placed in bit positions 32-63 of general register R₁, and zeros are placed in bit positions 0-31 of the register.

The displacement is treated as a 20-bit signed binary integer.

It is unpredictable whether an access exception is recognized for the rightmost byte of the second operand.

Condition Code: The code remains unchanged.

Program Exceptions:

- Access (fetch, operand 2)
- Operation (if the load-and-zero-rightmost-byte facility is not installed)

LOAD LOGICAL CHARACTER

Register-and-register formats:

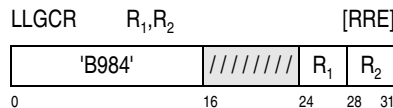
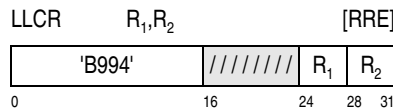

Register-and-storage formats:



The one-byte second operand is placed in bit positions 56-63 of general register R₁. For LOAD LOGICAL CHARACTER (LLGC, LLGCR), zeros are placed in bit positions 0-55 of general register R₁. For LOAD LOGICAL CHARACTER (LLC, LLCR), zeros are placed in bit positions 32-55 of general register R₁; bit positions 0-31 of general register R₁ are unchanged.

For LOAD LOGICAL CHARACTER (LLC, LLGC), the second operand is in storage. For LOAD LOGICAL CHARACTER (LLCR, LLGCR), the second operand is in bits 56-63 of general register R₂.

Condition Code: The code remains unchanged.

Program Exceptions:

- Access (fetch, operand 2 of LLC and LLGC)
- Operation (LLC, LLCR, and LLGCR, if the extended-immediate facility is not installed)

LOAD LOGICAL CHARACTER HIGH

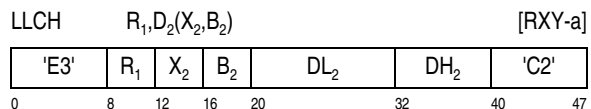

The one-byte second operand is placed in bit positions 24-31 of general register R₁, and zeros are placed in bit positions 0-23 of general register R₁; bit positions 32-63 of general register R₁ are unchanged.

The displacement is treated as a 20-bit signed binary integer.

Condition Code: The code remains unchanged.

Program Exceptions:

- Access (fetch, operand 2)
- Operation (if the high-word facility is not installed)

LOAD LOGICAL HALFWORD

Register-and-register formats:

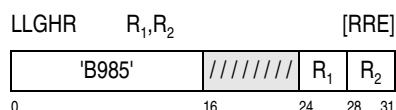
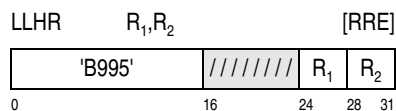

Register-and-storage formats:

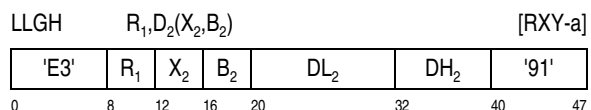
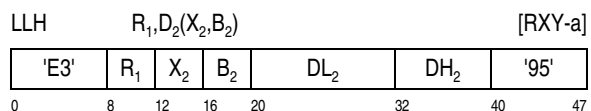

LOAD LOGICAL HALFWORD RELATIVE LONG

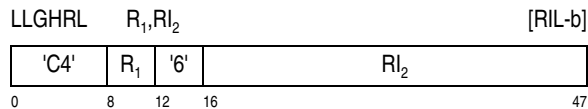
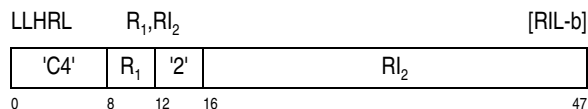

The two-byte second operand is placed in bit positions 48-63 of general register R₁. For LOAD LOGICAL HALFWORD (LLGH, LLGHR) and LOAD LOGICAL HALFWORD RELATIVE LONG (LLGHRL), zeros are placed in bit positions 0-47 of general register R₁. For LOAD LOGICAL HALFWORD (LLH, LLHR) and LOAD LOGICAL HALFWORD RELATIVE LONG (LLHRL), zeros are placed in bit positions 32-47 of general register R₁; bit positions bits 0-31 of general register R₁ are unchanged.

For LOAD LOGICAL HALFWORD (LLGH, LLH) and LOAD LOGICAL HALFWORD RELATIVE LONG, the second operand is in storage. For LOAD LOGICAL HALFWORD (LLGHR, LLHR), the second operand is in bits 48-63 of general register R₂.

For LOAD LOGICAL HALFWORD RELATIVE LONG, the contents of the RI₂ field are a signed binary integer specifying the number of halfwords that is added to the address of the instruction to generate the address of the second operand in storage. When DAT is on, the second operand is accessed using the same addressing-space mode as that used to access the instruction. When DAT is off, the second operand is accessed using a real address.

Condition Code: The code remains unchanged.

Program Exceptions:

- Access (fetch, operand 2 of LLGH, LLH, LLHRL, and LLGHRL)
- Operation (LLGHR, LLH, and LLHR, if the extended-immediate facility is not installed; LLHRL and LLGHRL, if the general-instructions-extension facility is not installed)

Programming Notes:

1. For LOAD LOGICAL HALFWORD RELATIVE LONG, the second operand is necessarily aligned on an integral boundary corresponding to the operand's size.
2. When LOAD LOGICAL HALFWORD RELATIVE LONG is the target of an execute-type instruction, the second-operand address is relative to the target address.

LOAD LOGICAL HALFWORD HIGH

The two-byte second operand is placed in bit positions 16-31 of general register R_1 , and zeros are placed in bit positions 0-15 of general register R_1 ; bit positions 32-63 of general register R_1 are unchanged.

The displacement is treated as a 20-bit signed binary integer.

Condition Code: The code remains unchanged.

Program Exceptions:

- Access (fetch, operand 2)
- Operation (if the high-word facility is not installed)

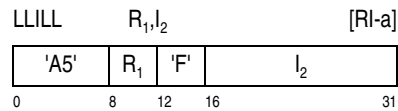
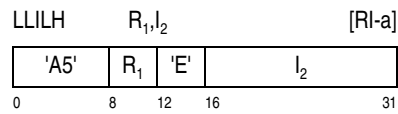
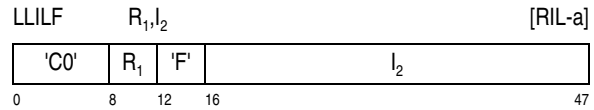
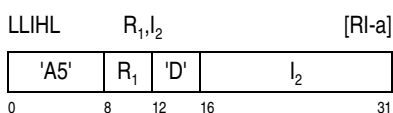
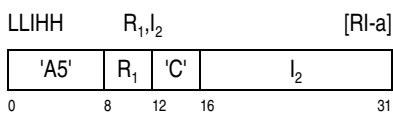
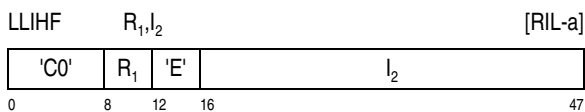
LOAD LOGICAL IMMEDIATE

The second operand is placed in bit positions of the first operand. The remainder of the first operand is set to zeros.

For each instruction, the bit positions of the first operand that are loaded with the second operand are as follows:

Instruction	Bit Positions Loaded
LLIHF	0-31
LLIHH	0-15
LLIHL	16-31
LLILF	32-63
LLILH	32-47
LLILL	48-63

Condition Code: The code remains unchanged.

Program Exceptions:

- Operation (LLIHF and LLILF, if the extended-immediate facility is not installed)

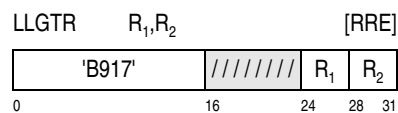
LOAD LOGICAL THIRTY ONE BITS**Register-and-register format:**

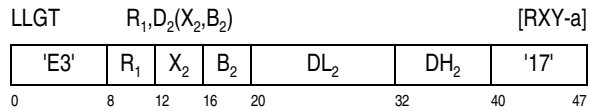
Register-and-storage format:

For LLGTR, bits 33-63 of general register R₂, with 33 zeros appended on the left, are placed in general register R₁. For LLGT, bits 1-31 of the four bytes at the second-operand location, with 33 zeros appended on the left, are placed in general register R₁.

Condition Code: The code remains unchanged.

Program Exceptions:

- Access (fetch, operand 2 of LLGT only)

LOAD LOGICAL THIRTY ONE BITS AND TRAP



Bits 1-31 of the four bytes at the second operand location are placed unchanged in bit positions 33-63 of general register R₁, and zeros are placed in bit positions 0-32. If all zeros are placed at the first operand location, a compare-and-trap-instruction data exception is recognized.

Condition Code: The code remains unchanged.

Program Exceptions:

- Data
- Access (fetch, operand 2)
- Operation (if the load-and-trap facility is not installed)

Programming Note: Possible uses of LOAD LOGICAL THIRTY ONE BITS AND TRAP include checking for pointers containing zero (null pointer).

LOAD MULTIPLE

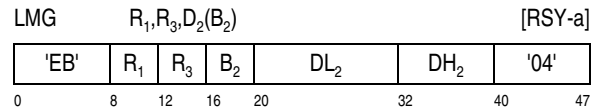
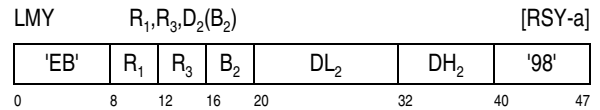
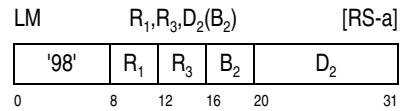

Bit positions of the set of general registers starting with general register R₁ and ending with general register R₃ are loaded from storage beginning at the location designated by the second-operand address and continuing through as many locations as needed.

For LOAD MULTIPLE (LM, LMY), bit positions 32-63 of the general registers are loaded from successive four-byte fields beginning at the second-operand address, and bits 0-31 of the registers remain unchanged. For LOAD MULTIPLE (LMG), bit positions 0-63 of the general registers are loaded from successive eight-byte fields beginning at the second-operand address.

The general registers are loaded in the ascending order of their register numbers, starting with general register R₁ and continuing up to and including general register R₃, with general register 0 following general register 15.

The displacement for LM is treated as a 12-bit unsigned binary integer. The displacement for LMY and LMG is treated as a 20-bit signed binary integer.

Condition Code: The code remains unchanged.

Program Exceptions:

- Access (fetch, operand 2)
- Operation (LMY, if the long-displacement facility is not installed)

Programming Note: All combinations of register numbers specified by R₁ and R₃ are valid. When the register numbers are equal, only four bytes, for LM or

LMY or eight bytes, for LMG, are transmitted. When the number specified by R_3 is less than the number specified by R_1 , the register numbers wrap around from 15 to 0.

LOAD MULTIPLE DISJOINT

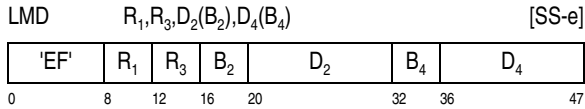

Bit positions 0-31 of the set of general registers starting with general register R_1 and ending with general register R_3 are loaded from storage beginning at the location designated by the second-operand address and continuing through as many locations as needed. Bit positions 32-63 of the same registers are similarly loaded from storage beginning at the location designated by the fourth-operand address.

The general registers are loaded in the ascending order of their register numbers, starting with general register R_1 and continuing up to and including general register R_3 , with general register 0 following general register 15.

Condition Code: The code remains unchanged.

Program Exceptions:

- Access (fetch, operands 2 and 4)
- Transaction constraint

Programming Notes:

1. All combinations of register numbers specified by R_1 and R_3 are valid. When the register numbers are equal, only eight bytes are transmitted. When the number specified by R_3 is less than the number specified by R_1 , the register numbers wrap around from 15 to 0.
2. The second-operand and fourth-operand addresses are computed before the contents of any register are changed.
3. The combination of a LOAD MULTIPLE instruction and a LOAD MULTIPLE HIGH instruction provides equal or better performance than a LOAD MULTIPLE DISJOINT instruction for the same register range. LOAD MULTIPLE DIS-

JOINT is for use when the second or fourth operand must be addressed by means of one of the registers loaded.

LOAD MULTIPLE HIGH

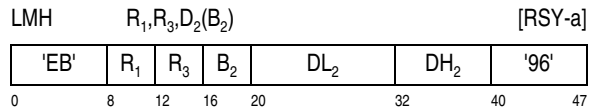

The high-order halves, bit positions 0-31, of the set of general registers starting with general register R_1 and ending with general register R_3 are loaded from storage beginning at the location designated by the second-operand address and continuing through as many locations as needed, that is, bit positions 0-31 are loaded from successive four-byte fields beginning at the second-operand address. Bits 32-63 of the registers remain unchanged.

The general registers are loaded in the ascending order of their register numbers, starting with general register R_1 and continuing up to and including general register R_3 , with general register 0 following general register 15.

Condition Code: The code remains unchanged.

Program Exceptions:

- Access (fetch, operand 2)

Programming Note: All combinations of register numbers specified by R_1 and R_3 are valid. When the register numbers are equal, only four bytes are transmitted. When the number specified by R_3 is less than the number specified by R_1 , the register numbers wrap around from 15 to 0.

LOAD NEGATIVE

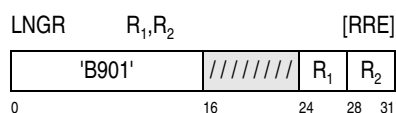
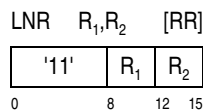

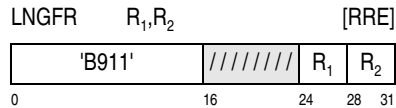

The two's complement of the absolute value of the second operand is placed at the first-operand location. For LOAD NEGATIVE (LNR), the second operand and result are treated as 32-bit signed binary integers, and, for LOAD NEGATIVE (LNGR), they are treated as 64-bit signed binary integers. For LOAD NEGATIVE (LNGFR), the second operand is treated as a 32-bit signed binary integer, and the result is treated as a 64-bit signed binary integer.

Resulting Condition Code:

- 0 Result zero
- 1 Result less than zero
- 2 --
- 3 --

Program Exceptions: None.

Programming Note: The operation complements positive numbers; negative numbers remain unchanged. The number zero remains unchanged.

LOAD ON CONDITION

Register-and-register formats:

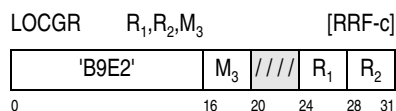
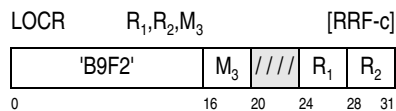

Register-and-storage formats:

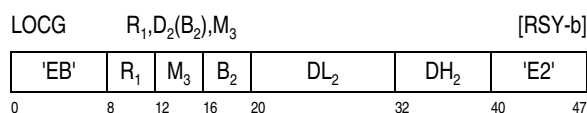
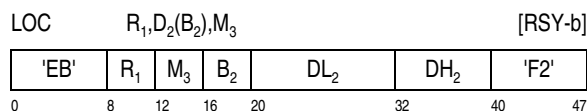

LOAD HIGH ON CONDITION

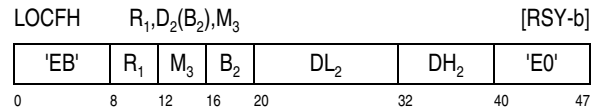
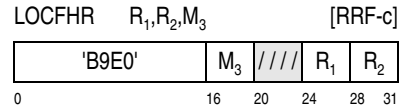

The second operand is placed unchanged at the first-operand location if the condition code has one of the values specified by M₃; otherwise, the first operand remains unchanged.

For LOC, LOCFH, LOCFHR, and LOCR, the first and second operands are 32 bits, and for LOCG and LOCGR, the first and second operands are 64 bits.

For LOC and LOCR, the first operand is in bits 32-63 of general register R₁, and bits 0-31 of the register are unchanged. For LOCFH and LOCFHR, the first operand is in bits 0-31 of general register R₁, and bits 32-63 of the register are unchanged.

For LOCR, the second operand is in bits 32-63 of general register R₂, and bits 0-31 of the register are ignored. For LOCFHR, the second operand is in bits 0-31 of general register R₂, and bits 32-63 of the register are ignored.

The M₃ field is used as a four-bit mask. The four condition codes (0, 1, 2, and 3) correspond, left to right, with the four bits of the mask, as follows:

Condition Code	0	1	2	3
Mask Position Value	8	4	2	1

The current condition code is used to select the corresponding mask bit. If the mask bit selected by the condition code is one, the load is performed. If the mask bit selected is zero, the load is not performed.

The displacement for LOC, LOCFH, and LOCG is treated as a 20-bit signed binary integer.

For LOC, LOCFH, and LOCG, when the condition specified by the M₃ field is not met (that is, the load operation is not performed), it is model dependent whether an access exception or a PER zero-address

detection event is recognized for the second operand.

Condition Code: The code remains unchanged.

Program Exceptions:

- Access (fetch, operand 2 of LOC, LOCFH, and LOCG)
- Operation (LOC, LOCG, LOCGR, LOCR, if the load/store-on-condition facility 1 is not installed; LOCFH, LOCFHR, if the load/store-on-condition facility 2 is not installed)

Programming Notes:

1. When the M_3 field contain all zeros and no exception condition exists, the instruction acts as a NOP. When the M_3 field contains all ones and no exception condition exists, the load operation is always performed. However, these are not the preferred means of implementing a NOP or unconditional load, respectively.
2. For LOC, LOCFH, and LOCG, when the condition specified by the M_3 field is not met, it is model dependent whether the second operand is brought into the cache.
3. LOAD ON CONDITION provides a function similar to that of a separate BRANCH ON CONDITION instruction followed by a LOAD instruction, except that LOAD ON CONDITION does not provide an index register. For example, the following two instruction sequences are equivalent.

```

LOC  15,256(7),8      BC  7,SKIP
                               LG  15,256(0,7)
                               SKIP DS  0H
    
```

On models that implement predictive branching, the combination of the BRANCH ON CONDITION and LOAD instructions may perform somewhat better than the LOAD ON CONDITION instruction when the CPU is able to successfully predict the branch condition. However, on models where the CPU is not able to successfully predict the branch condition, such as when the condition is more random, the LOAD ON CONDITION instruction may provide significant performance improvement.

4. The High-Level Assembler (HLASM) provides the following extended-mnemonic suffixes for the

load/store-on-condition facilities' instructions in place of the M_3 field.

Suffix	Meaning	Effective M_3 Value
E	Equal	B'1000'
L	Low	B'0100'
H	High	B'0010'
NE	Not equal	B'0111'
NL	Not low	B'1011'
NH	Not high	B'1101'

Later versions of HLASM provide the following extended-mnemonic suffixes for the load/store-on-condition facilities' instructions in place of the M_3 field.

Suffix	Meaning	Effective M_3 Value
Z	Zero	B'1000'
M	Minus or mixed	B'0100'
P	Plus	B'0010'
O	Overflow or ones	B'0001'
NZ	Not zero	B'0111'
NM	Not minus or not mixed	B'1011'
NP	Not plus	B'1101'
NO	Not overflow or not ones	B'1110'

When the extended mnemonic is coded, the M_3 field must be omitted.

LOAD PAIR DISJOINT

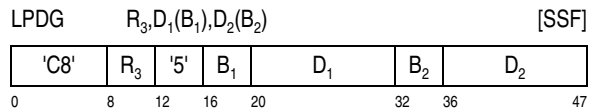
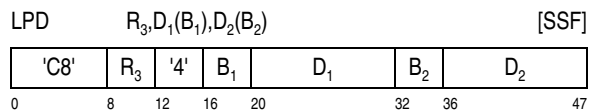

General register R_3 designates the even numbered register of an even/odd register pair.

The first operand is placed unchanged into the even-numbered register of the third operand, and the second operand is placed unchanged into odd-numbered register of the third operand. The condition code indicates whether the first and second oper-

ands appear to be fetched by means of block-concurrent interlocked fetch.

For LPD, the first and second operands are words in storage, and the third operand is in bits 32-63 of general registers R_3 and $R_3 + 1$; bits 0-31 of the registers are unchanged. For LPDG, the first and second operands are doublewords in storage, and the third operand is in bits 0-63 of general registers R_3 and $R_3 + 1$.

When, as observed by other CPUs, the first and second operands appear to be fetched by means of block-concurrent interlocked fetch, condition code 0 is set. When the first and second operands do not appear to be fetched by means of block-concurrent interlocked update, condition code 3 is set. The third operand is loaded regardless of the condition code.

The displacement of the first and second operands is treated as a 12-bit unsigned binary integer.

The first and second operands of LPD must be designated on a word boundary. The first and second operands of LPDG must be designated on a doubleword boundary. General register R_3 must designate the even numbered register. Otherwise, a specification exception is recognized.

Resulting Condition Code:

- | | |
|---|--|
| 0 | Register pair loaded by means of interlocked fetch |
| 1 | -- |
| 2 | -- |
| 3 | Register pair not loaded by means of interlocked fetch |

Program Exceptions:

- Access (fetch, operands 1 and 2)
- Operation (if the interlocked-access facility 1 is not installed)
- Specification
- Transaction constraint

Programming Notes:

1. The setting of the condition code is dependent upon storage accesses by other CPUs in the configuration.
2. When the resulting condition code is 3, the program may branch back to re-execute the LOAD

PAIR DISJOINT instruction. However, after repeated unsuccessful attempts to attain an interlocked fetch, the program should use an alternate means of serializing access to the storage operands. It is recommended that the program re-execute the LOAD PAIR DISJOINT no more than 10 times before branching to the alternate path.

3. The program should be able to accommodate a situation where condition code 0 is never set.

LOAD PAIR FROM QUADWORD

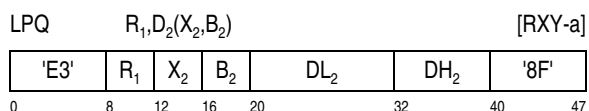

The quadword second operand is loaded into the first-operand location. The second operand appears to be fetched with quadword concurrency as observed by other CPUs. The left doubleword of the quadword is loaded into general register R_1 , and the right doubleword is loaded into general register $R_1 + 1$.

The R_1 field designates an even-odd pair of general registers and must designate an even-numbered register. The second operand must be designated on a quadword boundary. Otherwise, a specification exception is recognized.

Condition Code: The code remains unchanged.

Program Exceptions:

- Access (fetch, operand 2)
- Specification
- Transaction constraint

Programming Notes:

1. The LOAD MULTIPLE (LM or LMG) instruction does not necessarily provide quadword-concurrent access.
2. The performance of LOAD PAIR FROM QUADWORD on some models may be significantly slower than that of LOAD MULTIPLE (LMG). Unless quadword consistency is required, LMG should be used instead of LPQ.

LOAD POSITIVE

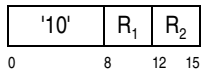
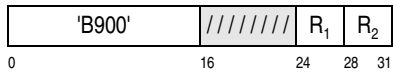
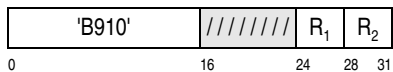
LPR R_1, R_2 [RR]LPGR R_1, R_2 [RRE]LPGFR R_1, R_2 [RRE]

The absolute value of the second operand is placed at the first-operand location. For LOAD POSITIVE (LPR), the second operand and result are treated as 32-bit signed binary integers, and, for LOAD POSITIVE (LPGR), they are treated as 64-bit signed binary integers. For LOAD POSITIVE (LPGFR), the second operand is treated as a 32-bit signed binary integer, and the result is treated as a 64-bit signed binary integer.

When there is an overflow, the result is obtained by allowing any carry into the sign-bit position and ignoring any carry out of the sign-bit position, and condition code 3 is set. If the fixed-point-overflow mask is one, a program interruption for fixed-point overflow occurs.

Resulting Condition Code:

- 0 Result zero; no overflow
- 1 --
- 2 Result greater than zero; no overflow
- 3 Overflow

Program Exceptions:

- Fixed-point overflow (LPR and LPGR only)

Programming Note: The operation complements negative numbers; positive numbers and zero remain unchanged. For LPR or LPGR, an overflow condition occurs when the maximum negative 32-bit number or 64-bit number, respectively, is complemented; the number remains unchanged. LPGFR complements the maximum negative 32-bit number without recognizing overflow.

LOAD REVERSED

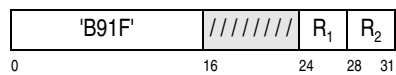
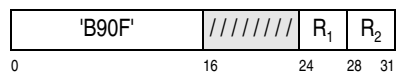
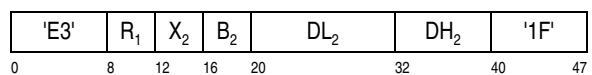
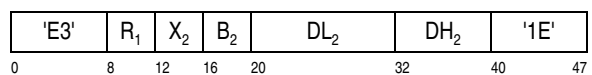
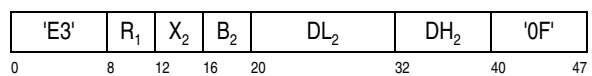
Register-and-register formats:LRVR R_1, R_2 [RRE]LRVGR R_1, R_2 [RRE]**Register-and-storage formats:**LRVH $R_1, D_2(X_2, B_2)$ [RXY-a]LRV $R_1, D_2(X_2, B_2)$ [RXY-a]LRVG $R_1, D_2(X_2, B_2)$ [RXY-a]

The second operand is placed at the first-operand location with the left-to-right sequence of the bytes reversed.

For LOAD REVERSED (LRVH), the second operand is two bytes, the result is placed in bit positions 48-63 of general register R_1 , and bits 0-47 of the register remain unchanged.

For LOAD REVERSED (LRVR, LRV), the second operand is four bytes, the result is placed in bit positions 32-63 of general register R_1 , and bits 0-31 of the register remain unchanged. For LOAD REVERSED (LRVR), the second operand is in bit positions 32-63 of general register R_2 .

For LOAD REVERSED (LRVGR, LRVG), the second operand is eight bytes.

Condition Code: The code remains unchanged.

Program Exceptions:

- Access (fetch, operand 2 of LRVH, LRV, LRVG only)

Programming Notes:

1. The instruction can be used to convert two, four, or eight bytes from a “little-endian” format to a “big-endian” format, or vice versa. In the big-endian format, the bytes in a left-to-right sequence are in the order most significant to least significant. In the little-endian format, the bytes are in the order least significant to most significant. For example, the bytes ABCD in the big-endian format are DCBA in the little-endian format.
2. LOAD REVERSED (LRVR) can be used with a two-byte value already in a register as shown in the following example. In the example, the two bytes of interest are in bit positions 48-63 of the R1 register.

```
LRVR R1,R1
SRA R1,16
```

The LOAD REVERSED instruction places the two bytes of interest in bit positions 32-47 of the register, with the order of the bytes reversed. The SHIFT RIGHT SINGLE (SRA) instruction shifts the two bytes to bit positions 48-63 of the register and extends them on their left, in bit positions 32-47, with their sign bit. The instruction SHIFT RIGHT SINGLE LOGICAL (SRL) should be used, instead, if the two bytes of interest are unsigned.

MONITOR CALL

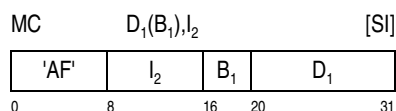

Subject to the control of the monitor class and the monitor masks, a monitor event may be recognized. When the enhanced-monitor facility is not installed, a monitor event results in a monitor-event program interruption. When the enhanced-monitor facility is installed, a monitor event results in either a monitor-event program interruption or a monitor-event counting operation.

Bit positions 12-15 of the instruction (bit positions 4-7 of the I₂ field) contain a 4-bit unsigned binary number specifying the monitor class. The monitor-mask bits are in bit positions 48-63 of control register 8, which correspond to monitor classes 0-15, respectively.

When the monitor-mask bit corresponding to the specified monitor class is one, a monitor event occurs. When the monitor-mask bit corresponding to the specified monitor class is zero, no monitor-event occurs, and the instruction is executed as a no-operation.

When the enhanced-monitor facility is installed, the enhanced-monitor-mask bits are in bit positions 16-31 of control register 8, which correspond to monitor classes 0-15 respectively. When a monitor event occurs and either (a) the enhanced-monitor facility is not installed, or (b) the facility is installed but the enhanced-monitor-mask bit corresponding to the monitor class is zero, then a monitor-event program interruption occurs, as described below. When a monitor event occurs and the enhanced-monitor-mask bit corresponding to the monitor class is one, a monitor-event counting operation is performed.

The first-operand address is not used to address data; instead, the address specified by the B₁ and D₁ fields forms the monitor code. Address computation follows the rules of address arithmetic; in the 24-bit addressing mode, bits 0-39 are set to zeros; in the 31-bit addressing mode, bits 0-32 are set to zeros.

Monitor-Event Program Interruption

When a monitor-event program interruption occurs:

- The monitor code formed by the first-operand address is placed in the doubleword at real location 176.
- The contents of the I₂ field are stored at real location 149, with zeros stored at real location 148.
- Bit 9 of the program-interruption code is set to one.

Monitor-Event Counting Operation

The monitor-event counting operation is described in “Monitor-Event Counting” on page 5-109.

Special Conditions

Bit positions 8-11 of the instruction must contain zeros; otherwise, a specification exception is recognized.

Condition Code: The code remains unchanged.

Program Exceptions:

- Monitor event
- Specification
- Transaction constraint

Programming Notes:

1. The monitor-event program interruption provides the capability for passing control to a monitoring program when selected points are reached in the monitored program. This is accomplished by implanting MONITOR CALL instructions at the desired points in the monitored program. This function may be useful in performing various measurement functions; specifically, tracing information can be generated indicating which programs were executed, counting information can be generated indicating how often particular programs were used, and timing information can be generated indicating the amount of time a particular program required for execution.
2. The monitor masks provide a means of disallowing all monitor events or allowing monitor events for all or selected classes.
3. When used to generate a monitor-event program interruption, the monitor code provides a means of associating descriptive information, in addition to the class number, with each MONITOR CALL.

Without the use of a base register, up to 4,096 distinct monitor codes can be associated with a monitor event. With the base register designated by a nonzero value in the B_1 field, each monitoring interruption can be identified by a 24-bit, 31-bit, or 64-bit code, depending on the addressing mode.

4. A monitor-event counting operation can never occur in the ESA/390-compatibility mode.

MOVE

Storage-and-storage format:

MVC $D_1(L, B_1), D_2(B_2)$ [SS-a]

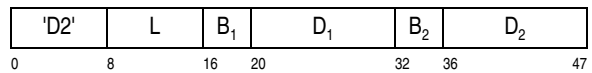

Storage-and-immediate formats:

MVHHI $D_1(B_1), I_2$ [SIL]

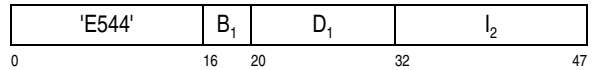

MVHI $D_1(B_1), I_2$ [SIL]

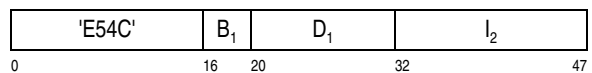

MVGHI $D_1(B_1), I_2$ [SIL]

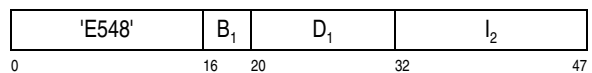

MVI $D_1(B_1), I_2$ [SI]

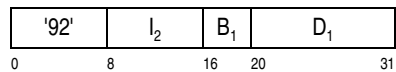

MVIY $D_1(B_1), I_2$ [SIY]

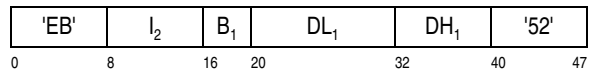

The second operand is placed at the first-operand location.

For MOVE (MVC), each operand is processed left to right. When the operands overlap, the result is obtained as if the operands were processed one byte at a time and each result byte were stored immediately after fetching the necessary operand byte.

For MOVE (MVI, MVIY), the first operand is one byte in length, and only one byte is stored.

For MOVE (MVGHI, MVHHI, and MVHI), the second operand is treated as a 16-bit signed integer, sign-extended as necessary, and placed in the first-operand location. The first operand is two, four, or eight bytes for MVHHI, MVHI, and MVGHI, respectively.

The displacements for MVGHI, MVHHI, MVHI, MVI and both operands of MVC are treated as 12-bit unsigned binary integers. The displacement for MVIY is treated as a 20-bit signed binary integer.

Condition Code: The code remains unchanged.

Program Exceptions:

- Access (fetch, operand 2 of MVC; store, operand 1, MVC, MVGHI, MVHHI, MVHI, MVI, and MVIY)
- Operation (MVIY, if the long-displacement facility is not installed; MVGHI, MVHHI, and MVHI, if the general-instructions-extension facility is not installed)
- Transaction constraint (MVC)

Programming Notes:

1. Examples of the use of the MOVE instruction are given in Appendix A, “Number Representation and Instruction-Use Examples.”
2. For MOVE (MVC), it is possible to propagate one byte through an entire field by having the first operand start one byte to the right of the second operand.

MOVE INVERSE

MVCIN $D_1(L, B_1), D_2(B_2)$ [SS-a]

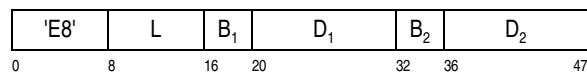

The second operand is placed at the first-operand location with the left-to-right sequence of the bytes inverted.

The first-operand address designates the leftmost byte of the first operand. The second-operand address designates the rightmost byte of the second operand. Both operands have the same length.

The result is obtained as if the second operand were processed from right to left and the first operand from left to right. The second operand may wrap around from location 0 to location $2^{24} - 1$ in the 24-bit addressing mode, to location $2^{31} - 1$ in the 31-bit addressing mode, or to location $2^{64} - 1$ in the 64-bit addressing mode. The first operand may wrap around from location $2^{24} - 1$ to location 0 in the 24-bit addressing mode, from location $2^{31} - 1$ to location 0

in the 31-bit addressing mode, or from location $2^{64} - 1$ to location 0 in the 64-bit addressing mode.

When the operands overlap by more than one byte, the contents of the overlapped portion of the result field are unpredictable.

Condition Code: The code remains unchanged.

Program Exceptions:

- Access (fetch, operand 2; store, operand 1)
- Transaction constraint

Programming Notes:

1. An example of the use of the MOVE INVERSE instruction is given in Appendix A, “Number Representation and Instruction-Use Examples.”
2. The contents of each byte moved remain unchanged.
3. MOVE INVERSE is the only SS-format instruction for which the second-operand address designates the rightmost, instead of the leftmost, byte of the second operand.
4. The storage-operand references for MOVE INVERSE may be multiple-access references. (See “Storage-Operand Consistency” on page 5-125)

MOVE LONG

MVCL R_1, R_2 [RR]

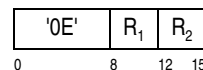

The second operand is placed at the first-operand location, provided overlapping of operand locations would not affect the final contents of the first-operand location. The remaining rightmost byte positions, if any, of the first-operand location are filled with padding bytes.

The R_1 and R_2 fields each designate an even-odd pair of general registers and must designate an even-numbered register; otherwise, a specification exception is recognized.

The location of the leftmost byte of the first operand and second operand is designated by the contents of

general registers R_1 and R_2 , respectively. The number of bytes in the first-operand and second-operand locations is specified by unsigned binary integers in bit positions 40-63 of general registers $R_1 + 1$ and $R_2 + 1$, respectively. Bit positions 32-39 of general register $R_2 + 1$ contain the padding byte. The contents of bit positions 0-39 of general register $R_1 + 1$ and of bit positions 0-31 of general register $R_2 + 1$ are ignored.

The handling of the addresses in general registers R_1 and R_2 is dependent on the addressing mode.

In the 24-bit addressing mode, the contents of bit positions 40-63 of general registers R_1 and R_2 constitute the address, and the contents of bit positions 0-39 are ignored. In the 31-bit addressing mode, the contents of bit positions 33-63 of the registers constitute the address, and the contents of bit positions 0-32 are ignored. In the 64-bit addressing mode, the contents of bit positions 0-63 constitute the address.

The contents of the registers just described are shown in Figure 7-301.

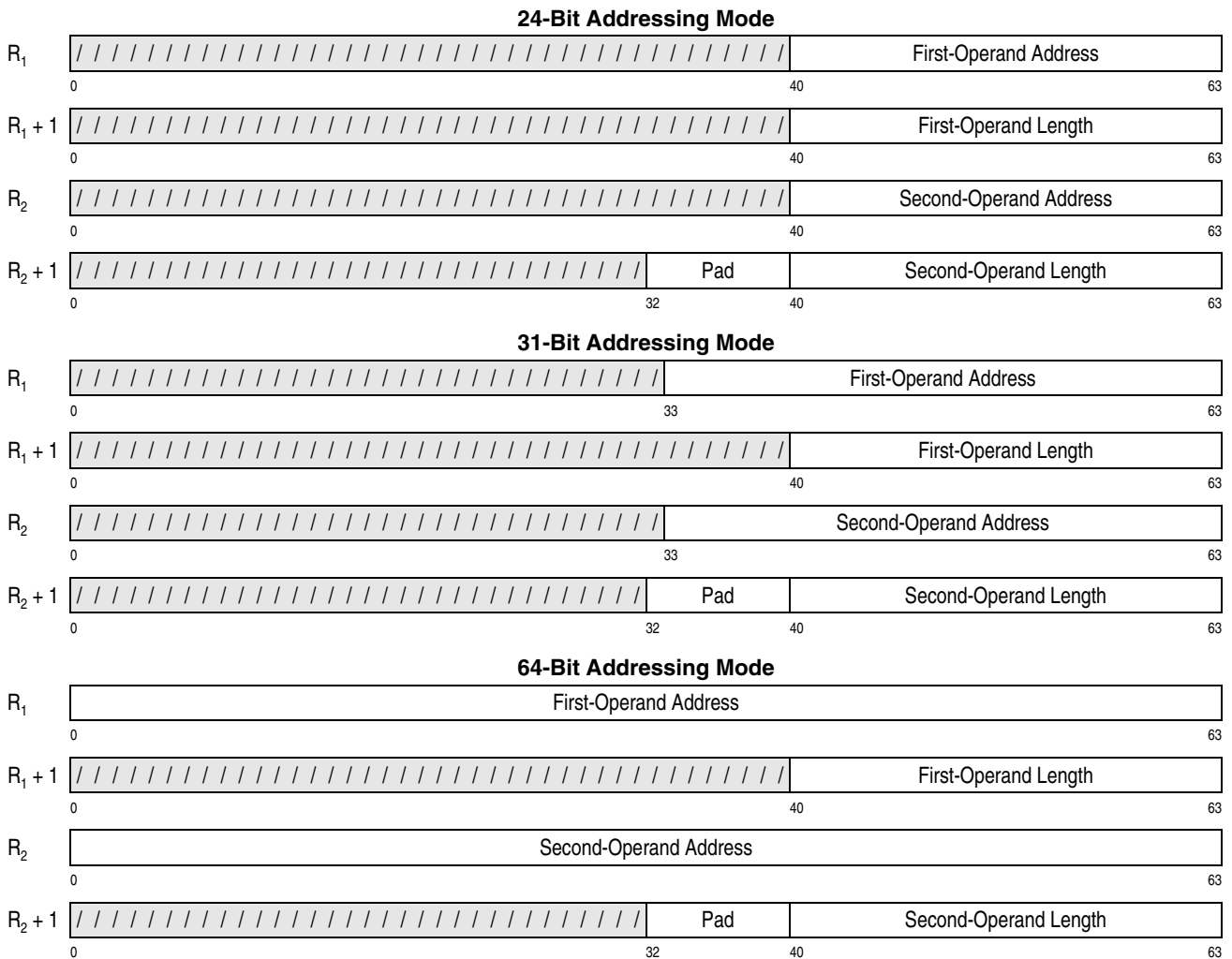

Figure 7-301. Register Contents for MOVE LONG

The result is obtained as if the movement starts at the left end of both fields and proceeds to the right, byte by byte. The operation is ended when the number of bytes specified by bits 40-63 of general register $R_1 + 1$ have been moved into the first-operand location. If the second operand is shorter than the

first operand, the remaining rightmost bytes of the first-operand location are filled with the padding byte.

As part of the execution of the instruction, the values of the two length fields are compared for the setting of the condition code, and a check is made for

destructive overlap of the operands. Operands are said to overlap destructively when the first-operand location is used as a source after data has been moved into it, assuming the inspection for overlap is performed by the use of logical operand addresses. When the operands overlap destructively, no movement takes place, and condition code 3 is set.

Operands do not overlap destructively, and movement is performed, if the leftmost byte of the first operand does not coincide with any of the second-operand bytes participating in the operation other than the leftmost byte of the second operand. When an operand wraps around from location $2^{24} - 1$ (or $2^{31} - 1$ or $2^{64} - 1$) to location 0, operand bytes in locations up to and including $2^{24} - 1$ (or $2^{31} - 1$ or $2^{64} - 1$) are considered to be to the left of bytes in locations from 0 up.

In the 24-bit addressing mode, wraparound is from location $2^{24} - 1$ to location 0; in the 31-bit addressing mode, wraparound is from location $2^{31} - 1$ to location 0; in the 64-bit addressing mode, wraparound is from location $2^{64} - 1$ to location 0.

In the access-register mode, the contents of access register R_1 and access register R_2 are compared. If the R_1 or R_2 field is zero, 32 zeros are used rather than the contents of access register 0. If all 32 bits of the compared values are equal, then the destructive overlap test is made. If all 32 bits of the compared values are not equal, destructive overlap is declared not to exist. If, for this case, the operands actually overlap in real storage, it is unpredictable whether the result reflects the overlap condition.

When the length specified by bits 40-63 of general register $R_1 + 1$ is zero, no movement takes place, and condition code 0 or 1 is set to indicate the relative values of the lengths.

The execution of the instruction is interruptible. When an interruption occurs, other than one that follows termination, the lengths in general registers $R_1 + 1$ and $R_2 + 1$ are decremented by the number of bytes moved, and the addresses in general registers R_1 and R_2 are incremented by the same number, so that the instruction, when reexecuted, resumes at the point of interruption. In the 24-bit or 31-bit addressing mode, the leftmost bits which are not part of the address in bit positions 32-63 of general registers R_1 and R_2 are set to zeros, and the contents of bit positions 0-31 remain unchanged. In any addressing mode, the contents of bit positions 0-39 of general

registers $R_1 + 1$ and $R_2 + 1$ remain unchanged; and the condition code is unpredictable. If the operation is interrupted during padding, the length field in general register $R_2 + 1$ is 0, the address in general register R_2 is incremented by the original length in general register $R_2 + 1$, and general registers R_1 and $R_1 + 1$ reflect the extent of the padding operation.

When the first-operand location includes the location of the instruction or of an execute-type instruction, the instruction may be refetched from storage and reinterpreted even in the absence of an interruption during execution. The exact point in the execution at which such a refetch occurs is unpredictable.

Padding byte values of B0 hex and B8 hex may be used during the nonpadding part of the operation by some models, in certain cases, as an indication of whether the movement should be performed bypassing the cache or using the cache, respectively. Thus, a padding byte of B0 hex indicates no intention to reference the destination area after the move, and a padding byte of B8 hex indicates an intention to reference the destination area.

For the nonpadding part of the operation when the padding byte is not B1 hex, accesses to the operands for MOVE LONG may be multiple-access references, and these accesses do not necessarily appear to occur in a left-to-right direction as observed by other CPUs and by the channel subsystem. When the padding byte is B1 hex, accesses to the operands are single-access references, and these accesses appear to occur in a left-to-right direction as observed by other CPUs and by the channel subsystem. During the nonpadding part of the operation, operands appear to be accessed doubleword concurrent as observed by other CPUs, provided that both operands start on doubleword boundaries, are an integral number of doublewords in length, and do not overlap.

As observed by other CPUs and by the channel subsystem, that portion of the first operand which is filled with the padding byte is not necessarily stored into in a left-to-right direction and may appear to be stored into more than once. During the padding operation, stores by other CPUs or by the channel subsystem into that portion of the first operand which is filled with the padding byte may cause unpredictable results.

At the completion of the operation, the length in general register $R_1 + 1$ is decremented by the number of

bytes stored at the first-operand location, and the address in general register R_1 is incremented by the same amount. The length in general register $R_2 + 1$ is decremented by the number of bytes moved out of the second-operand location, and the address in general register R_2 is incremented by the same amount. In the 24-bit or 31-bit addressing mode, the leftmost bits which are not part of the address in bit positions 32-63 of general registers R_1 and R_2 are set to zeros, even when one or both of the original length values are zeros or when condition code 3 is set. The contents of bit positions 0-31 of the registers remain unchanged. In any addressing mode, the contents of bit positions 0-39 of general registers $R_1 + 1$ and $R_2 + 1$ remain unchanged.

When condition code 3 is set, no exceptions associated with operand access are recognized. When the length of an operand is zero, no access exceptions for that operand are recognized. Similarly, when the second operand is longer than the first operand, access exceptions are not recognized for the part of the second-operand field that is in excess of the first-operand field. For operands longer than 2K bytes, access exceptions are not recognized for locations more than 2K bytes beyond the current location being processed. Access exceptions are not recognized for an operand if the R field associated with that operand is odd. Also, when the R_1 field is odd, PER storage-alteration events are not recognized, and no change bits are set.

Resulting Condition Code:

- 0 Operand lengths equal; no destructive overlap
- 1 First-operand length low; no destructive overlap
- 2 First-operand length high; no destructive overlap
- 3 No movement performed because of destructive overlap

Program Exceptions:

- Access (fetch, operand 2; store, operand 1)
- Specification
- Transaction constraint

Programming Notes:

1. An example of the use of the MOVE LONG instruction is given in Appendix A, "Number Representation and Instruction-Use Examples."
2. MOVE LONG may be used for clearing storage by setting the padding byte to zero and the sec-

ond-operand length to zero. However, the stores associated with this clearing may be multiple-access stores and should not be used to clear an area if the possibility exists that another CPU or a channel program will attempt to access and use the area as soon as it appears to be zero. For more details, see "Storage-Operand Consistency" on page 5-125.

3. When the first-operand length is zero, the operation consists in setting the condition code and, in the 24-bit or 31-bit addressing mode, of setting the leftmost bits in bit positions 32-63 of general registers R_1 and R_2 to zero.
4. When the contents of the R_1 and R_2 fields are the same, the contents of the designated registers are incremented or decremented only by the number of bytes moved, not by twice the number of bytes moved. Condition code 0 is set.
5. The following is a detailed description of those cases in which movement takes place, that is, where destructive overlap does not exist.

In the access-register mode, the contents of the access registers used are called the effective space designations. When the effective space designations are not equal, destructive overlap is declared not to exist and movement occurs. When the effective space designations are the same or when not in the access-register mode, then the following cases apply.

Depending on whether the second operand wraps around from location $2^{24} - 1$ (or $2^{31} - 1$ or $2^{64} - 1$, depending on the addressing mode) to location 0, movement takes place in the following cases:

- a. When the second operand does not wrap around, movement is performed if the leftmost byte of the first operand coincides with or is to the left of the leftmost byte of the second operand, *or* if the leftmost byte of the first operand is to the right of the rightmost second-operand byte participating in the operation.
- b. When the second operand wraps around, movement is performed if the leftmost byte of the first operand coincides with or is to the left of the leftmost byte of the second operand, *and* if the leftmost byte of the first operand is to the right of the rightmost second-operand byte participating in the operation.

The rightmost second-operand byte is determined by using the smaller of the first-operand and second-operand lengths.

When the second-operand length is one or zero, destructive overlap cannot exist.

6. Special precautions should be taken if MOVE LONG is made the target of an execute-type instruction. See the programming note concerning interruptible instructions under EXECUTE.
7. Since the execution of MOVE LONG is interruptible, the instruction cannot be used for situations where the program must rely on uninterrupted execution of the instruction. Similarly, the program should normally not let the first operand of MOVE LONG include the location of the instruction or of an execute-type instruction because the new contents of the location may be interpreted for a resumption after an interruption, or the instruction may be refetched without an interruption.
8. Further programming notes concerning interruptible instructions are included in “Interruptible Instructions” in Chapter 5, “Program Execution.”
9. In the access-register mode, access register 0 designates the primary address space regardless of the contents of access register 0.

MOVE LONG EXTENDED

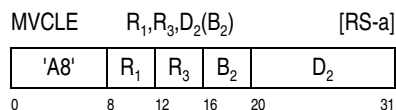

All or part of the third operand is placed at the first-operand location. The remaining rightmost byte positions, if any, of the first-operand location are filled with padding bytes. The operation proceeds until the

end of the first-operand location is reached or a CPU-determined number of bytes have been placed at the first-operand location, whichever occurs first. The result is indicated in the condition code.

The R_1 and R_3 fields each designate an even-odd pair of general registers and must designate an even-numbered register; otherwise, a specification exception is recognized.

The location of the leftmost byte of the first operand and third operand is designated by the contents of general registers R_1 and R_3 , respectively. In the 24-bit or 31-bit addressing mode, the number of bytes in the first-operand and third-operand locations is specified by the contents of bit positions 32-63 of general registers $R_1 + 1$ and $R_3 + 1$, respectively, and those contents are treated as 32-bit unsigned binary integers. In the 64-bit addressing mode, the number of bytes in the first-operand and third-operand locations is specified by the entire contents of general registers $R_1 + 1$ and $R_3 + 1$, respectively, and those contents are treated as 64-bit unsigned binary integers.

The handling of the addresses in general registers R_1 and R_3 is dependent on the addressing mode.

In the 24-bit addressing mode, the contents of bit positions 40-63 of general registers R_1 and R_3 constitute the address, and the contents of bit positions 0-39 are ignored. In the 31-bit addressing mode, the contents of bit positions 33-63 of the registers constitute the address, and the contents of bit positions 0-32 are ignored. In the 64-bit addressing mode, the contents of bit positions 0-63 constitute the address.

The second-operand address is not used to address data; instead, the rightmost eight bits of the second-operand address, bits 56-63, are the padding byte. Bits 0-55 of the second-operand address are ignored.

The contents of the registers and address just described are shown in Figure 7-302.

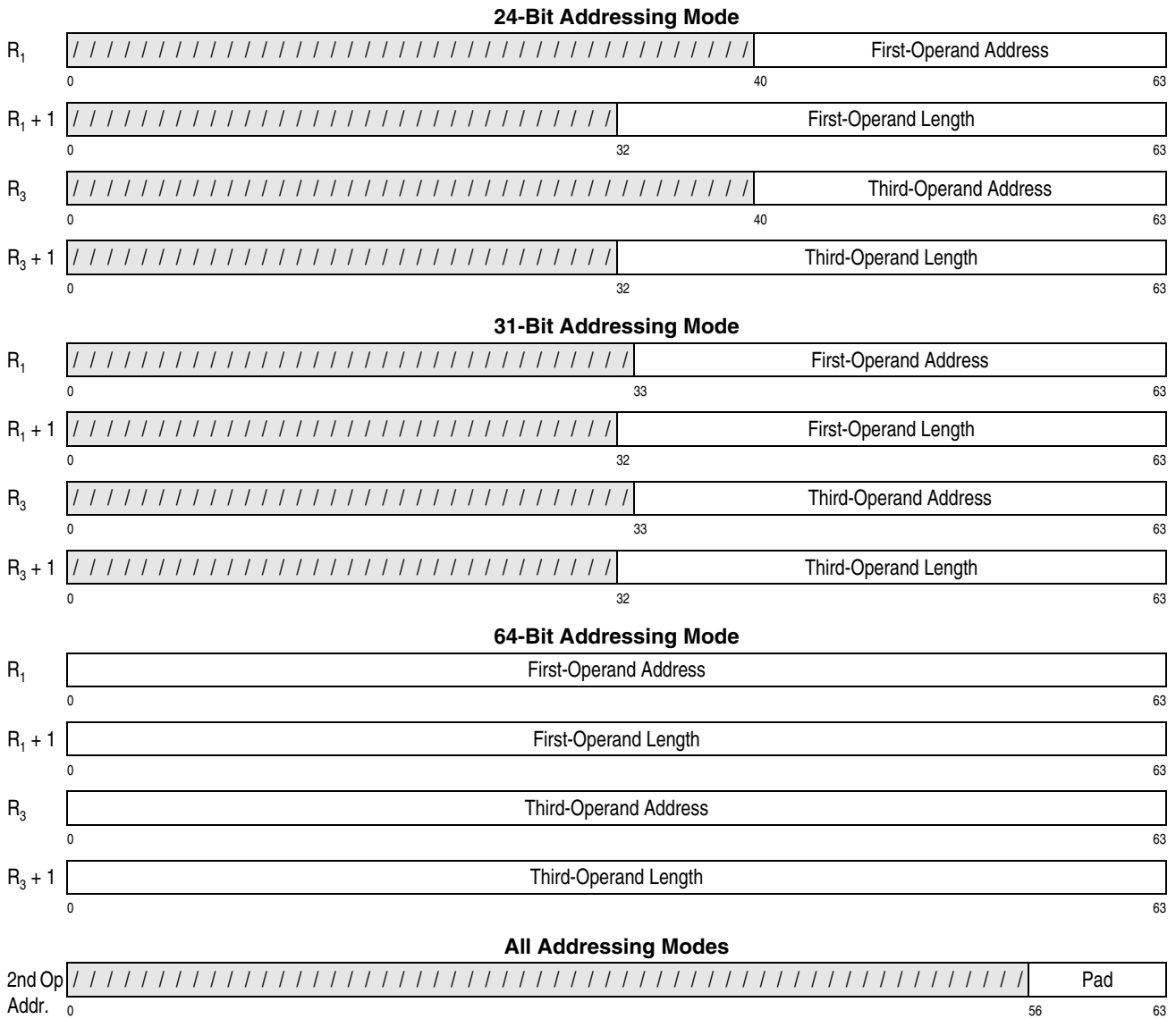

Figure 7-302. Register Contents and Second-Operand Address for MOVE LONG EXTENDED

The result is obtained as if the movement starts at the left end of both fields and proceeds to the right, byte by byte. The operation is ended when the number of bytes specified in general register $R_1 + 1$ have been placed at the first-operand location or when a CPU-determined number of bytes have been placed, whichever occurs first. If the third operand is shorter than the first operand, the remaining rightmost bytes of the first-operand location are filled with the padding byte.

When the operation is completed because the end of the first operand has been reached, the condition code is set to 0 if the two operand lengths are equal, it is set to 1 if the first-operand length is less than the third-operand length, or it is set to 2 if the first-operand length is greater than the third-operand length. When the operation is completed because a CPU-determined number of bytes have been moved without reaching the end of the first operand, condition code 3 is set.

No test is made for destructive overlap, and the results in the first-operand location are unpredictable when destructive overlap exists. Operands are said to overlap destructively when the first-operand location is used as a source after data has been moved into it.

Operands do not overlap destructively if the leftmost byte of the first operand does not coincide with any of the third-operand bytes participating in the operation other than the leftmost byte of the third operand. When an operand wraps around from location $2^{24} - 1$ (or $2^{31} - 1$ or $2^{64} - 1$) to location 0, operand bytes in locations up to and including $2^{24} - 1$ (or $2^{31} - 1$ or $2^{64} - 1$) are considered to be to the left of bytes in locations from 0 up.

In the 24-bit addressing mode, wraparound is from location $2^{24} - 1$ to location 0; in the 31-bit addressing mode, wraparound is from location $2^{31} - 1$ to location 0; and, in the 64-bit addressing mode, wraparound is from location $2^{64} - 1$ to location 0.

When the length specified in general register $R_1 + 1$ is zero, no movement takes place, and condition code 0 or 1 is set to indicate the relative values of the lengths.

Padding byte values of B0 hex and B8 hex may be used during the nonpadding part of the operation by some models, in certain cases, as an indication of whether the movement should be performed bypassing the cache or using the cache, respectively. Thus, a padding byte of B0 hex indicates no intention to reference the destination area after the move, and a padding byte of B8 hex indicates an intention to reference the destination area.

For the nonpadding part of the operation when the padding byte is not B1 hex, accesses to the operands for MOVE LONG EXTENDED may be multiple-access references, and these accesses do not necessarily appear to occur in a left-to-right direction as observed by other CPUs and by the channel subsystem. When the padding byte is B1 hex, accesses to the operands are single-access references, and these accesses appear to occur in a left-to-right direction as observed by other CPUs and by the channel subsystem. During the nonpadding part of the operation, operands appear to be accessed doubleword concurrent as observed by other CPUs, provided that both operands start on doubleword boundaries, are an integral number of doublewords in length, and do not overlap.

As observed by other CPUs and by the channel subsystem, that portion of the first operand which is filled with the padding byte is not necessarily stored into in a left-to-right direction and may appear to be stored into more than once. During the padding operation, stores by other CPUs or by the channel subsystem into that portion of the first operand which is filled with the padding byte may cause unpredictable results.

At the completion of the operation, the length in general register $R_1 + 1$ is decremented by the number of bytes stored at the first-operand location, and the address in general register R_1 is incremented by the same amount. The length in general register $R_3 + 1$ is decremented by the number of bytes moved out of the third-operand location, and the address in general register R_3 is incremented by the same amount.

If the operation is completed because a CPU-determined number of bytes have been moved without reaching the end of the first operand, the lengths in general registers $R_1 + 1$ and $R_3 + 1$ are decremented by the number of bytes moved, and the addresses in general registers R_1 and R_3 are incremented by the same number, so that the instruction, when reexecuted, resumes at the next byte to be moved. If the operation is completed during padding, the length field in general register $R_3 + 1$ is zero, the address in general register R_3 is incremented by the original length in general register $R_3 + 1$, and general registers R_1 and $R_1 + 1$ reflect the extent of the padding operation.

In the 24-bit or 31-bit addressing mode, the contents of bit positions 0-31 of general registers R_1 , $R_1 + 1$, R_3 , and $R_3 + 1$, always remain unchanged.

The padding byte may be formed from $D_2(B_2)$ multiple times during the execution of the instruction, and the registers designated by R_1 and R_3 may be updated multiple times. Therefore, if B_2 equals R_1 , $R_1 + 1$, R_3 , or $R_3 + 1$ and is subject to change during the execution of the instruction, the results are unpredictable.

The amount of processing that results in the setting of condition code 3 is determined by the CPU on the basis of improving system performance, and it may be a different amount each time the instruction is executed. The maximum amount is approximately 4K bytes of either operand.

At the completion of the operation in the 24-bit or 31-bit addressing mode, the leftmost bits which are not part of the address in bit positions 32-63 of general registers R_1 and R_3 may be set to zeros or may remain unchanged from their original values, even when one or both of the original length values are zeros.

When the length of an operand is zero, no access exceptions for that operand are recognized. Similarly, when the third operand is longer than the first operand, access exceptions are not recognized for the part of the third-operand field that is in excess of the first-operand field. For operands longer than 4K bytes, access exceptions are not recognized for locations more than 4K bytes beyond the current location being processed. Access exceptions are not recognized for an operand if the R field associated with that operand is odd. Also, when the R_1 field is odd, PER storage-alteration events are not recognized, and no change bits are set.

Resulting Condition Code:

- 0 All bytes moved, operand lengths equal
- 1 All bytes moved, first-operand length low
- 2 All bytes moved, first-operand length high
- 3 CPU-determined number of bytes moved without reaching end of first operand

Program Exceptions:

- Access (fetch, operand 3; store, operand 1)
- Specification
- Transaction constraint

Programming Notes:

1. MOVE LONG EXTENDED is intended for use in place of MOVE LONG when the operand lengths are specified as 32-bit or 64-bit binary integers and a test for destructive overlap is not required. MOVE LONG EXTENDED sets condition code 3 in cases in which MOVE LONG would be interrupted.
2. When condition code 3 is set, the program can simply branch back to the instruction to continue the movement. The program need not determine the number of bytes that were moved.
3. The function of not processing more than approximately 4K bytes of either operand is intended to permit software polling of a flag that

may be set by a program on another CPU during long operations.

4. MOVE LONG EXTENDED may be used for clearing storage by setting the padding byte to zero and the third-operand length to zero. However, the stores associated with this clearing may be multiple-access stores and should not be used to clear an area if the possibility exists that another CPU or a channel program will attempt to access and use the area as soon as it appears to be zero. For more details, see "Storage-Operand Consistency" on page 5-125.
5. When the contents of the R_1 and R_3 fields are the same, the contents of the designated registers are incremented or decremented only by the number of bytes moved, not by twice the number of bytes moved. The condition code is finally set to 0 after possible settings to 3.
6. In the access-register mode, access register 0 designates the primary address space regardless of the contents of access register 0.

MOVE LONG UNICODE



All or part of the third operand is placed at the first-operand location. The remaining rightmost positions, if any, of the first-operand location are filled with one or more padding bytes, alternating between the even padding byte and the odd padding byte. The operation proceeds until the end of the first-operand location is reached or a CPU-determined number of bytes have been placed at the first-operand location, whichever occurs first. The result is indicated in the condition code.

The R_1 and R_3 fields each designate an even-odd pair of general registers and must designate an even-numbered register; otherwise, a specification exception is recognized.

The location of the leftmost byte of the first operand and third operand is designated by the contents of general registers R_1 and R_3 , respectively. In the 24-bit or 31-bit addressing mode, the number of bytes in the first-operand and third-operand locations is specified by the contents of bit positions 32-63 of

general registers $R_1 + 1$ and $R_3 + 1$, respectively, and those contents are treated as 32-bit unsigned binary integers. In the 64-bit addressing mode, the number of bytes in the first-operand and third-operand locations is specified by the contents of bit positions 0-63 of general registers $R_1 + 1$ and $R_3 + 1$, respectively, and those contents are treated as 64-bit unsigned binary integers.

On some models, the contents of general registers $R_1 + 1$ and $R_3 + 1$ must specify an even number of bytes; otherwise, a specification exception is recognized.

The handling of the addresses in general registers R_1 and R_3 is dependent on the addressing mode.

In the 24-bit addressing mode, the contents of bit positions 40-63 of general registers R_1 and R_3 consti-

tute the address, and the contents of bit positions 0-39 are ignored. In the 31-bit addressing mode, the contents of bit positions 33-63 of the registers constitute the address, and the contents of bit positions 0-32 are ignored. In the 64-bit addressing mode, the contents of bit positions 0-63 of the registers constitute the address.

The second-operand address is not used to address data; instead, the rightmost 16 bits of the second-operand address, bits 48-63, are the two padding bytes; bits 48-55 are the even padding byte, and bits 56-63 are the odd padding byte. Bits 0-47 of the second-operand address are ignored.

The contents of the registers and address just described are shown in Figure 7-303.

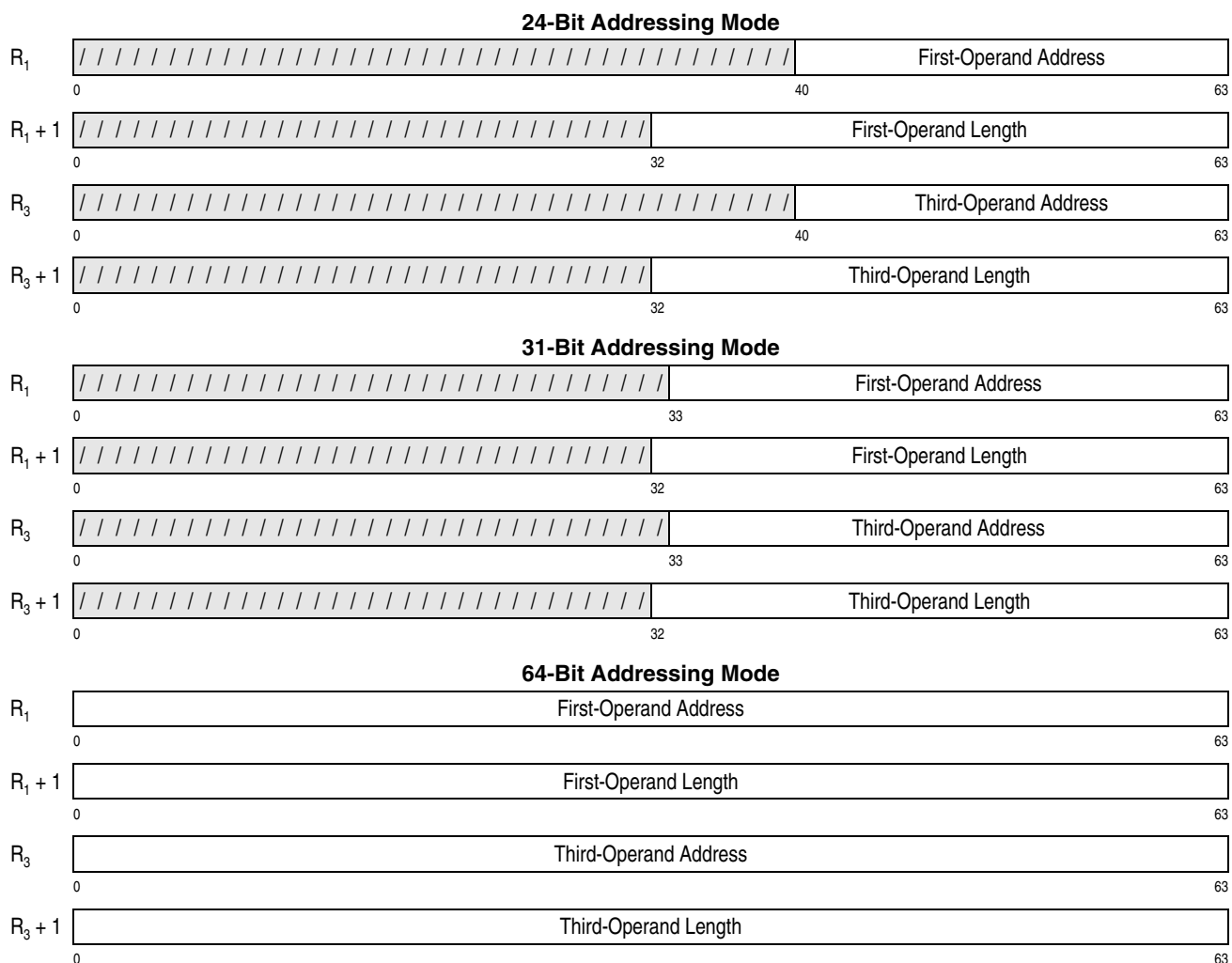

Figure 7-303. Register Contents and Second-Operand Address for MOVE LONG UNICODE (Part 1 of 2)

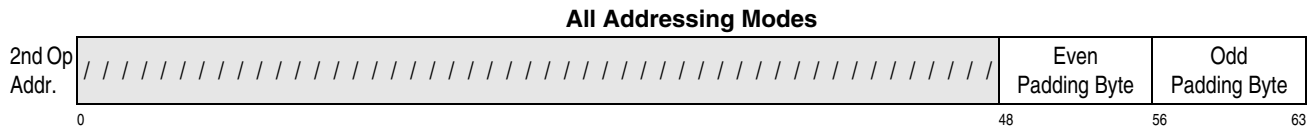

Figure 7-303. Register Contents and Second-Operand Address for MOVE LONG UNICODE (Part 2 of 2)

The result is obtained as if the movement starts at the left end of both fields and proceeds to the right, byte by byte. The operation is ended when the number of bytes specified by the contents of general register $R_1 + 1$ have been placed at the first-operand location or when a CPU-determined number of bytes have been placed, whichever occurs first.

If the third operand is shorter than the first operand, the remaining rightmost positions of the first-operand location are filled with alternating padding bytes. When the number of bytes remaining in the first-operand location is an even number, the even padding byte is placed first; when the number of bytes remaining in the first-operand location is odd, the odd padding byte is placed first.

When the operation is completed because the end of the first operand has been reached, the condition code is set to 0 if the two operand lengths are equal, it is set to 1 if the first-operand length is less than the third-operand length, or it is set to 2 if the first-operand length is greater than the third-operand length. When the operation is completed because a CPU-determined number of bytes have been moved without reaching the end of the first operand, condition code 3 is set.

No test is made for destructive overlap, and the results in the first-operand location are unpredictable when destructive overlap exists. Operands are said to overlap destructively when the first-operand location is used as a source after data has been moved into it.

Operands do not overlap destructively if the leftmost byte of the first operand does not coincide with any of the third-operand bytes participating in the operation other than the leftmost byte of the third operand. When an operand wraps around from location $2^{24} - 1$ (or $2^{31} - 1$ or $2^{64} - 1$) to location 0, operand bytes in locations up to and including $2^{24} - 1$ (or $2^{31} - 1$ or $2^{64} - 1$) are considered to be to the left of bytes in locations from 0 up.

In the 24-bit addressing mode, wraparound is from location $2^{24} - 1$ to location 0; in the 31-bit addressing

mode, wraparound is from location $2^{31} - 1$ to location 0; and, in the 64-bit addressing mode, wraparound is from location $2^{64} - 1$ to location 0.

When the length specified in general register $R_1 + 1$ is zero, no movement takes place, and condition code 0 or 1 is set to indicate the relative values of the lengths.

For the nonpadding part of the operation, accesses to the operands for MOVE LONG UNICODE may be multiple-access references. These accesses do not necessarily appear to occur in a left-to-right direction as observed by other CPUs and by channel programs. During the nonpadding part of the operation, operands appear to be accessed doubleword concurrent as observed by other CPUs, provided that both operands start on doubleword boundaries, are an integral number of doublewords in length, and do not overlap.

As observed by other CPUs and by the channel subsystem, that portion of the first operand which is filled with the padding bytes is not necessarily stored into in a left-to-right direction and may appear to be stored into more than once. During the padding operation, stores by other CPUs or by the channel subsystem into that portion of the first operand which is filled with the padding bytes may cause unpredictable results.

At the completion of the operation, the length in general register $R_1 + 1$ is decremented by the number of bytes stored at the first-operand location, and the address in general register R_1 is incremented by the same amount. The length in general register $R_3 + 1$ is decremented by the number of bytes moved out of the third-operand location, and the address in general register R_3 is incremented by the same amount.

If the operation is completed because a CPU-determined number of bytes have been moved without reaching the end of the first operand, the lengths in general registers $R_1 + 1$ and $R_3 + 1$ are decremented by the number of bytes moved, and the addresses in general registers R_1 and R_3 are incremented by the same number, so that the instruction, when reexe-

cuted, resumes at the next byte to be moved. If the operation is completed during padding, the length field in general register $R_3 + 1$ is zero, the address in general register R_3 is incremented by the number of bytes moved from operand 3, and general registers R_1 and $R_1 + 1$ reflect the extent of the padding operation.

In the 24-bit or 31-bit addressing mode, the contents of bit positions 0-31 of general registers R_1 , $R_1 + 1$, R_2 , and $R_2 + 1$, always remain unchanged.

The padding bytes may be formed from $D_2(B_2)$ multiple times during the execution of the instruction, and the registers designated by R_1 and R_3 may be updated multiple times. Therefore, if B_2 equals R_1 , $R_1 + 1$, R_3 , or $R_3 + 1$ and is subject to change during the execution of the instruction, the results are unpredictable.

The amount of processing that results in the setting of condition code 3 is determined by the CPU on the basis of improving system performance, and it may be a different amount each time the instruction is executed.

At the completion of the operation in the 24-bit or 31-bit addressing mode, the leftmost bits which are not part of the address in bit positions 32-63 of general registers R_1 and R_3 may be set to zeros or may remain unchanged from their original values, including the case when one or both of the original length values are zeros.

When the length of an operand is zero, no access exceptions for that operand are recognized. Similarly, when the third operand is longer than the first operand, access exceptions are not recognized for the part of the third-operand field that is in excess of the first-operand field. For operands longer than 4K bytes, access exceptions are not recognized for locations more than 4K bytes beyond the current location being processed. Access exceptions are not recognized for an operand if the R field associated with that operand is odd. Also, when the R_1 field is odd, PER storage-alteration events are not recognized, and no change bits are set. On models that recognize a specification exception if the length associated with an operand is odd, access exceptions and PER storage-alteration events are not recognized and no change bits are set if the length is odd.

Resulting Condition Code:

- 0 All bytes moved, operand lengths equal
- 1 All bytes moved, first-operand length low
- 2 All bytes moved, first-operand length high
- 3 CPU-determined number of bytes moved without reaching end of first operand

Program Exceptions:

- Access (fetch, operand 3; store, operand 1)
- Operation (if the extended-translation facility 2 is not installed)
- Specification
- Transaction constraint

Programming Notes:

1. MOVE LONG UNICODE is intended for use in place of MOVE LONG or MOVE LONG EXTENDED when padding with double-byte characters. The character may be a Unicode character or any other double-byte character. MOVE LONG UNICODE may set condition code 3 in cases in which MOVE LONG would be interrupted.
2. When condition code 3 is set, the program can simply branch back to the instruction to continue the movement. The program need not determine the number of bytes that were moved.
3. MOVE LONG UNICODE may be used for filling storage with padding bytes by placing the padding bytes in the second-operand address and setting the third-operand length to zero. However, the stores associated with this clearing may be multiple-access stores and should not be used to clear an area if the possibility exists that another CPU or a channel program will attempt to access and use the area as soon as it appears to be zero. For more details, see "Storage-Operand Consistency" on page 5-125.
4. When the contents of the R_1 and R_3 fields are the same, the contents of the designated registers are incremented or decremented only by the number of bytes moved, not by two times the number of bytes moved. The condition code is finally set to 0 after possible settings to 3.
5. In the access-register mode, access register 0 designates the primary address space regardless of the contents of access register 0.

6. The padding bytes may be represented in the displacement field of the instruction. The following example illustrates padding with a Unicode space character.

```
MVCLU 6,8,X'0020'
```

When the B_2 field of the instruction designates general register 0, and the long-displacement facility is not installed, the padding bytes are limited to a character whose representation is less than or equal to 0FFF hex.

7. MOVE LONG UNICODE is intended to be used to move and pad pairs of bytes. Although some models allow the first- and third-operand length registers to designate an odd length, without recognizing a specification exception, the program should always be coded to provide an even length. This ensures that the program will operate compatibly in configurations that recognize a specification exception for an odd length value.

MOVE NUMERICS

MVN $D_1(L,B_1),D_2(B_2)$ [SS-a]

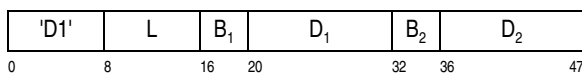

The rightmost four bits of each byte in the second operand are placed in the rightmost bit positions of the corresponding bytes in the first operand. The leftmost four bits of each byte in the first operand remain unchanged.

Each operand is processed left to right. When the operands overlap, the result is obtained as if the operands were processed one byte at a time and each result byte were stored immediately after fetching the necessary operand bytes.

Condition Code: The code remains unchanged.

Program Exceptions:

- Access (fetch, operand 2; fetch and store, operand 1)
- Transaction constraint

Programming Notes:

1. An example of the use of the MOVE NUMERICS instruction is given in Appendix A, "Number Representation and Instruction-Use Examples."
2. MOVE NUMERICS moves the numeric portion of a decimal-data field that is in the zoned format. The zoned-decimal format is described in Chapter 8, "Decimal Instructions." The operands are not checked for valid sign and digit codes.
3. Accesses to the first operand of MOVE NUMERICS consist in fetching the leftmost four bits of each byte in the first operand and subsequently storing the updated value of the byte. These fetch and store accesses to a particular byte do not necessarily occur one immediately after the other. Thus, this instruction cannot be safely used to update a location in storage if the possibility exists that another CPU or a channel program may also be updating the location. An example of this effect is shown for OR (OI) in "Multiprogramming and Multiprocessing Examples" in Appendix A, "Number Representation and Instruction-Use Examples."

MOVE RIGHT TO LEFT

MVCRL $D_1(B_1),D_2(B_2)$ [SSE]

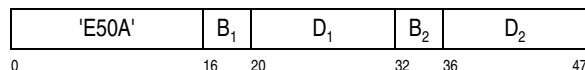

The second operand is placed at the first-operand location by moving bytes in a right-to-left sequence, beginning with the rightmost byte of each operand.

Both operand addresses designate the leftmost byte of their respective operands. The displacements for both operands are treated as 12-bit unsigned binary integers.

The first and second operands are of the same length, which is specified by bits 56-63 of general register 0. Bits 32-55 of general register 0 should contain zeros; otherwise, the program may not operate compatibly in the future. Bits 0-31 of general reg-

ister 0 are ignored. The contents of general register 0 are shown below:

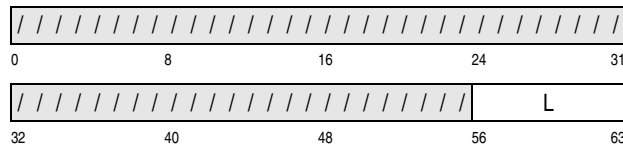

L specifies the number of bytes to the right of the first byte of each operand. Therefore, the length in bytes of each operand is 1-256, corresponding to a length code in L of 0-255.

The result is obtained as if both operands are processed from right to left. However, as observed by other CPUs and channel programs, the sequence of accesses to the operands is undefined. Either operand may wrap around from location $2^{24} - 1$ to 0 in the 24-bit addressing mode, from location $2^{31} - 1$ to 0 in the 31-bit addressing mode, or from location $2^{64} - 1$ to 0 in the 64-bit addressing mode.

Destructive overlap occurs and results are unpredictable when the byte location designated by the second-operand address (the leftmost byte of the source) overlaps with any byte location of the first operand, other than the byte location designated by the first-operand address (the leftmost byte of the target).

Condition Code: The code remains unchanged.

Program Exceptions:

- Access (fetch, operand 2; store, operand 1)
- Operation (if the miscellaneous-instruction-extensions facility 3 is not installed)
- Transaction Constraint

Programming Notes:

1. MOVE RIGHT TO LEFT can be used to open a hole in an array, for subsequent insertion of an element, by moving the original element and all higher elements to the right. The MVC instruction, which moves left to right, can not be used in this case since it would destructively overwrite array elements.
2. For most other instructions with more than one storage operand, destructive overlap occurs when the leftmost byte of the destination oper-

and lies within the source operand and the two operands do not perfectly overlap. However, for MOVE RIGHT TO LEFT, destructive overlap occurs when the rightmost byte of the destination operand lies within the source operand and does not perfectly overlap the source operand. Therefore, the scenario described in programming note 1 is not destructive overlap for MVCRL but would be if MVC were used. If there is no overlap of any type between the operands, MVC and MVCRL perform similarly, as observed by this CPU, except that the manner the length is specified is different.

3. Since results are unpredictable if destructive overlap exists on MOVE RIGHT TO LEFT, this instruction can not be used to replicate data from higher addresses to lower addresses. However, MVC which has precisely defined left to right behavior with destructive overlap, can be used for the purpose of replicating data from lower addresses to higher addresses.

MOVE STRING

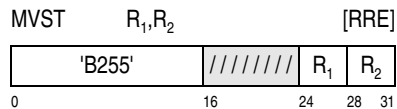

All or part of the second operand is placed in the first-operand location. The operation proceeds until the end of the second operand is reached or a CPU-determined number of bytes have been moved, whichever occurs first. The CPU-determined number is at least one. The result is indicated in the condition code.

The location of the leftmost byte of the first operand and second operand is designated by the contents of general registers R₁ and R₂, respectively.

The handling of the addresses in general registers R₁ and R₂ is dependent on the addressing mode. In the 24-bit addressing mode, the contents of bit positions 40-63 of general registers R₁ and R₂ constitute the address, and the contents of bit positions 0-39 are ignored. In the 31-bit addressing mode, the contents of bit positions 33-63 of the registers constitute the address, and the contents of bit positions 0-32 are ignored. In the 64-bit addressing mode, the contents of bit positions 0-63 constitute the address.

The end of the second operand is indicated by an ending character in the last byte position of the operand. The ending character to be used to determine the end of the second operand is specified in bit positions 56-63 of general register 0. Bit positions 32-55 of general register 0 are reserved for possible future extensions and must contain all zeros; otherwise, a specification exception is recognized.

The operation proceeds left to right and ends as soon as the second-operand ending character has been moved or a CPU-determined number of second-operand bytes have been moved, whichever occurs first. The CPU-determined number is at least one. When the ending character is in the first byte position of the second operand, only the ending character is moved. When the ending character has been moved, condition code 1 is set. When a CPU-determined number of second-operand bytes not including an ending character have been moved, condition code 3 is set. Destructive overlap is not recognized. If the second operand is used as a source after it has been used as a destination, the results are unpredictable.

When condition code 1 is set, the address of the ending character in the first operand is placed in general register R_1 , and the contents of general register R_2 remain unchanged. When condition code 3 is set, the address of the next byte to be processed in the first and second operands is placed in general registers R_1 and R_2 , respectively. Whenever an address is placed in a general register, bits 32-39 of the register, in the 24-bit addressing mode, or bit 32, in the 31-bit addressing mode, are set to zeros. Bits 0-31 of the R_1 and R_2 registers always remain unchanged in the 24-bit or 31-bit mode.

The amount of processing that results in the setting of condition code 3 is determined by the CPU on the basis of improving system performance, and it may be a different amount each time the instruction is executed.

Access exceptions for the first and second operands are recognized only for that portion of the operand that is necessarily used in the operation.

The storage-operand-consistency rules are the same as for the MOVE (MVC) instruction, except that destructive overlap is not recognized.

Resulting Condition Code:

- 0 --
- 1 Entire second operand moved; general register R_1 updated with address of ending character in first operand; general register R_2 unchanged
- 2 --
- 3 CPU-determined number of bytes moved; general registers R_1 and R_2 updated with addresses of next bytes

Program Exceptions:

- Access (fetch, operand 2; store, operand 1)
- Specification
- Transaction constraint

Programming Notes:

1. An example of the use of the MOVE STRING instruction is given in Appendix A, "Number Representation and Instruction-Use Examples."
2. When condition code 3 is set, the program can simply branch back to the instruction to continue the data movement. The program need not determine the number of bytes that were moved.
3. R_1 or R_2 may be zero, in which case general register 0 is treated as containing an address and also the ending character.
4. In the access-register mode, access register 0 designates the primary address space regardless of the contents of access register 0.
5. If the second operand is used as a source after it has been used as a destination, an ending character in the second operand may not be recognized.

MOVE WITH OFFSET

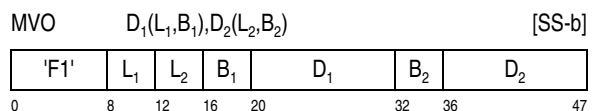

The second operand is placed to the left of and adjacent to the rightmost four bits of the first operand.

The rightmost four bits of the first operand are attached as the rightmost bits to the second operand, the second-operand bits are offset by four bit posi-

tions, and the result is placed at the first-operand location.

The result is obtained as if the operands were processed right to left. When necessary, the second operand is considered to be extended on the left with zeros. If the first operand is too short to contain all of the second operand, the remaining leftmost portion of the second operand is ignored. Access exceptions for the unused portion of the second operand may or may not be indicated.

When the operands overlap, the result is obtained as if the operands were processed one byte at a time, as if each result byte were stored immediately after fetching the necessary operand bytes, and as if the left digit of each second-operand byte were to remain available for the next result byte and need not be refetched.

Condition Code: The code remains unchanged.

Program Exceptions:

- Access (fetch, operand 2; fetch and store, operand 1)
- Transaction constraint

Programming Notes:

1. An example of the use of the MOVE WITH OFFSET instruction is given in Appendix A, “Number Representation and Instruction-Use Examples.”
2. MOVE WITH OFFSET may be used to shift packed decimal data by an odd number of digit positions. The packed-decimal format is described in Chapter 8, “Decimal Instructions.” The operands are not checked for valid sign and digit codes. In many cases, however, SHIFT AND ROUND DECIMAL may be more convenient to use.
3. Access to the rightmost byte of the first operand of MOVE WITH OFFSET consists in fetching the rightmost four bits and subsequently storing the updated value of this byte. These fetch and store accesses to the rightmost byte of the first operand do not necessarily occur one immediately after the other. Thus, this instruction cannot be safely used to update a location in storage if the possibility exists that another CPU or a channel program may also be updating the location. An example of this effect is shown for OR (OI) in

“Multiprogramming and Multiprocessing Examples” in Appendix A, “Number Representation and Instruction-Use Examples.”

4. The storage-operand references for MOVE WITH OFFSET may be multiple-access references. (See “Storage-Operand Consistency” on page 5-125.)

MOVE ZONES

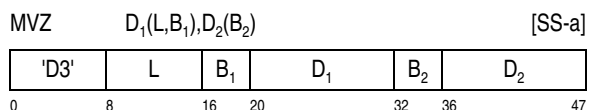

The leftmost four bits of each byte in the second operand are placed in the leftmost four bit positions of the corresponding bytes in the first operand. The rightmost four bits of each byte in the first operand remain unchanged.

Each operand is processed left to right. When the operands overlap, the result is obtained as if the operands were processed one byte at a time and each result byte were stored immediately after the necessary operand byte is fetched.

Condition Code: The code remains unchanged.

Program Exceptions:

- Access (fetch, operand 2; fetch and store, operand 1)
- Transaction constraint

Programming Notes:

1. An example of the use of the MOVE ZONES instruction is given in Appendix A, “Number Representation and Instruction-Use Examples.”
2. MOVE ZONES moves the zoned portion of a decimal field in the zoned format. The zoned format is described in Chapter 8, “Decimal Instructions.” The operands are not checked for valid sign and digit codes.
3. Accesses to the first operand of MOVE ZONES consist in fetching the rightmost four bits of each byte in the first operand and subsequently storing the updated value of the byte. These fetch and store accesses to a particular byte do not necessarily occur one immediately after the

other. Thus, this instruction cannot be safely used to update a location in storage if the possibility exists that another CPU or a channel program may also be updating the location. An example of this effect is shown for the OR (OI) instruction in “Multiprogramming and Multiprocessing Examples” in Appendix A, “Number Representation and Instruction-Use Examples.”

MULTIPLY

Register-and-register format:

MR R_1, R_2 [RR]

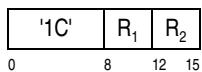

MGRK R_1, R_2, R_3 [RRF-a]

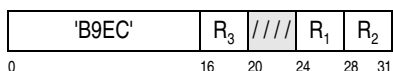

Register-and-storage formats:

M $R_1, D_2(X_2, B_2)$ [RX-a]

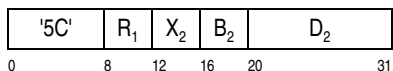

MFY $R_1, D_2(X_2, B_2)$ [RXY-a]

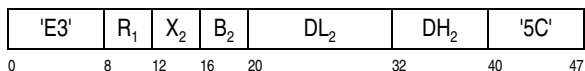

MG $R_1, D_2(X_2, B_2)$ [RXY-a]

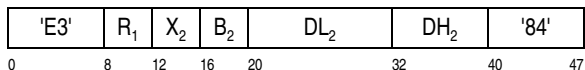

For M, MFY, and MR, the 32-bit first operand (the multiplicand) is multiplied by the 32-bit second-operand (the multiplier), and the 64-bit product is placed at the first-operand location. For MG, the 64-bit first operand (the multiplicand) is multiplied by the 64-bit second-operand (the multiplier), and the 128-bit product is placed at the first-operand location. For MGRK, the 64-bit third operand (the multiplicand) is multiplied by the 64-bit second-operand (the multiplier), and the 128-bit product is placed at the first-operand location.

The R_1 field designates an even-odd pair of general registers and must designate an even-numbered reg-

ister; otherwise, a specification exception is recognized.

The following applies to M, MFY, and MR:

- Both the multiplicand and multiplier are treated as 32-bit signed binary integers.
- The multiplicand is in bit positions 32-63 of general register $R_1 + 1$.
- For MULTIPLY (MR), the multiplier is in bit positions 32-63 of general register R_2 . The contents of general register R_1 and of bit positions 0-31 of general register $R_1 + 1$ and, for MR, of general register R_2 are ignored.

For M and MY, the multiplier is at the second-operand location in storage.

- The product is a 64-bit signed binary integer. Bits 0-31 of the product replace bits 32-63 of general register R_1 . Bits 32-63 of the product replace bits 32-63 of general register $R_1 + 1$. Bits 0-31 of general registers R_1 and $R_1 + 1$ remain unchanged.

The following applies to MG and MGRK:

- Both the multiplicand and multiplier are treated as 64-bit signed binary integers.
- For MG, the multiplicand is in bit positions 0-63 of general register $R_1 + 1$, and the contents of general register R_1 are ignored. For MGRK, the multiplicand is in bit positions 0-63 of general register R_3 , and the contents of general registers R_1 and $R_1 + 1$ are ignored.
- For MG, the multiplier is at the second-operand location in storage. For MGRK, the multiplier is in bit positions 0-63 of general register R_2 .
- For both MG and MGRK, the product is a 128-bit signed binary integer. Bits 0-63 of the product replace bits 0-63 of general register R_1 . Bits 64-127 of the product replace bits 0-63 of general register $R_1 + 1$.

The sign of the product is determined by the rules of algebra from the multiplier and multiplicand sign, except that a zero result is always positive. An overflow cannot occur.

The displacement for M is treated as a 12-bit unsigned binary integer. The displacement for MFY and MG is treated as a 20-bit signed binary integer.

Condition Code: The code remains unchanged.

Program Exceptions:

- Access (fetch, operand 2 of M, MFY, and MG only)
- Operation (MFY, if the general-instructions-extension facility is not installed; MG, MGRK, if the miscellaneous-instruction-extensions facility 2 is not installed)
- Specification

Programming Notes:

1. An example of the use of the MULTIPLY instruction is given in Appendix A, "Number Representation and Instruction-Use Examples."
2. For M, MFY, and MR, the significant part of the product usually occupies 62 bit positions or fewer. Only when two maximum 32-bit negative numbers are multiplied are 63 significant product bits formed.

Similarly, for MG and MGRK, the significant part of the product usually occupies 126 bit positions or fewer. Only when two maximum 64-bit negative numbers are multiplied are 127 significant product bits formed.

3. Care should be taken not to confuse the mnemonic for MULTIPLY UNNORMALIZED (MY) with the mnemonic for MULTIPLY (MFY).

MULTIPLY HALFWORD

MH $R_1, D_2(X_2, B_2)$ [RX-a]

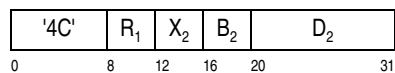

MHY $R_1, D_2(X_2, B_2)$ [RXY-a]

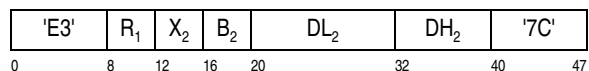

MGH $R_1, D_2(X_2, B_2)$ [RXY-a]

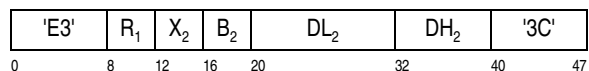

MULTIPLY HALFWORD IMMEDIATE

MHI R_1, I_2 [RI-a]

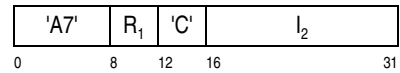

MGHI R_1, I_2 [RI-a]

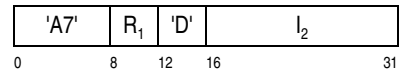

The 32-bit or 64-bit first operand (the multiplicand) is multiplied by the 16-bit second operand (the multiplier), and the rightmost 32 or 64 bits of the product are placed at the first-operand location. The second operand is two bytes in length and is treated as a 16-bit signed binary integer.

For MULTIPLY HALFWORD (MH, MHY) and MULTIPLY HALFWORD IMMEDIATE (MHI), the multiplicand is treated as a 32-bit signed binary integer in bit positions 32-63 of general register R₁, and it is replaced by the rightmost 32 bits of the signed-binary-integer product. The bits to the left of the 32 rightmost bits of the product are not tested for significance; no overflow indication is given. Bits 0-31 of general register R₁ are ignored and remain unchanged.

For MULTIPLY HALFWORD (MGH) and MULTIPLY HALFWORD IMMEDIATE (MGHI), the multiplicand is treated as a 64-bit signed binary integer in bit positions 0-63 of general register R₁, and it is replaced by the rightmost 64 bits of the signed-binary-integer product. The bits to the left of the 64 rightmost bits of the product are not tested for significance; no overflow indication is given.

The sign of the product is determined by the rules of algebra from the multiplier and multiplicand sign, except that a zero result is always positive.

The displacement for MH is treated as a 12-bit unsigned binary integer. The displacement for MHY and MGH is treated as a 20-bit signed binary integer.

Condition Code: The code remains unchanged.

Program Exceptions:

- Access (fetch, operand 2 of MH, MHY, and MGH only)

- Operation (MHY; if the general-instructions-extension facility is not installed; MGH, if the miscellaneous-instruction-extensions facility 2 is not installed)

Programming Notes:

1. An example of the use of the MULTIPLY HALF-WORD instruction is given in Appendix A, “Number Representation and Instruction-Use Examples.”
2. For MH, MHY, and MHI, the significant part of the product usually occupies 46 bit positions or fewer. Only when two maximum negative numbers are multiplied are 47 significant product bits formed. Since the rightmost 32 bits of the product are placed unchanged at the first-operand location, ignoring all bits to the left, the sign bit of the result may differ from the true sign of the product in the case of overflow. For a negative product, the 32 bits placed in register R₁ are the rightmost part of the product in two's-complement notation.

Similarly, for MGH and MGHI, the significant part of the product usually occupies 78 bit positions or fewer, but may occupy 79 bits when two maximum negative numbers are multiplied. Since the rightmost 64 bits of the product are placed unchanged at the first-operand location, the sign of the result may differ from the true sign of the 80-bit product in the case of overflow.

MULTIPLY LOGICAL

Register-and-register formats:

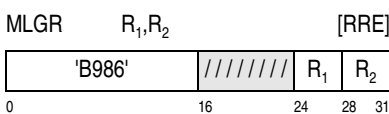
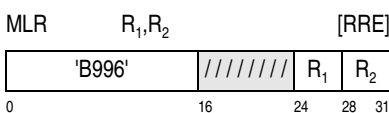

Register-and-storage formats:

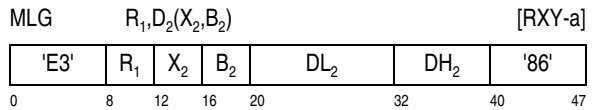
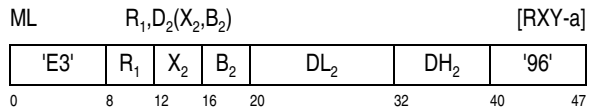

The 32-bit or 64-bit first operand (the multiplicand) is multiplied by the 32-bit or 64-bit second operand (the multiplier), and the 64-bit or 128-bit product is placed at the first-operand location.

The R₁ field designates an even-odd pair of general registers and must designate an even-numbered register; otherwise, a specification exception is recognized.

For MULTIPLY LOGICAL (MLR, ML), both the multiplicand and the multiplier are treated as 32-bit unsigned binary integers. The multiplicand is in bit positions 32-63 of general register R₁ + 1. For MULTIPLY LOGICAL (MLR), the multiplier is in bit positions 32-63 of general register R₂. The contents of general register R₁ and of bit positions 0-31 of general register R₁ + 1 and, for MLR, of general register R₂ are ignored. The product is a 64-bit unsigned binary integer. Bits 0-31 of the product replace bits 32-63 of general register R₁, and bits 32-63 of the product replace bits 32-63 of general register R₁ + 1. Bits 0-31 of general registers R₁ and R₁ + 1 remain unchanged. An overflow cannot occur.

For MULTIPLY LOGICAL (MLGR, MLG), the multiplicand and the multiplier are treated as 64-bit unsigned binary integers. The multiplicand is in general register R₁ + 1. The contents of general register R₁ are ignored. The product is a 128-bit unsigned binary integer. Bits 0-63 of the product replace the contents of general register R₁, and bits 64-127 of the product replace the contents of general register R₁ + 1. An overflow cannot occur.

Condition Code: The code remains unchanged.

Program Exceptions:

- Access (fetch, operand 2 of ML and MLG only)
- Specification

MULTIPLY SINGLE

Register-and-register formats:

MSR R_1, R_2 [RRE]

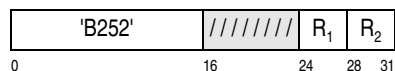

MSRKC R_1, R_2, R_3 [RRF-a]

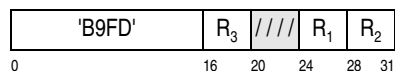

MSGR R_1, R_2 [RRE]

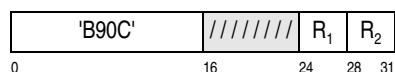

MSGRKC R_1, R_2, R_3 [RRF-a]

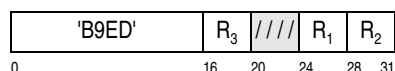

MSGFR R_1, R_2 [RRE]

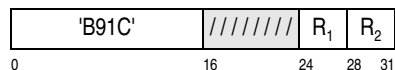

Register-and-storage formats:

MS $R_1, D_2(X_2, B_2)$ [RX-a]

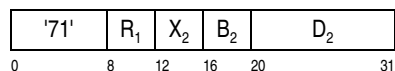

MSC $R_1, D_2(X_2, B_2)$ [RXY-a]

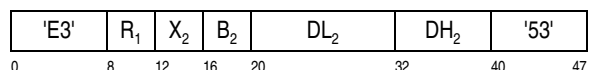

MSY $R_1, D_2(X_2, B_2)$ [RXY-a]

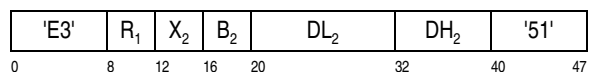

MSG $R_1, D_2(X_2, B_2)$ [RXY-a]

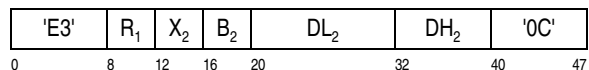

MSGC $R_1, D_2(X_2, B_2)$ [RXY-a]

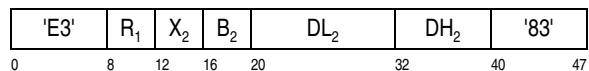

MSGF $R_1, D_2(X_2, B_2)$ [RXY-a]

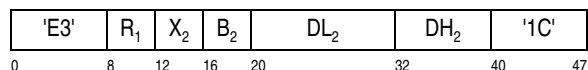

MULTIPLY SINGLE IMMEDIATE

MSFI R_1, I_2 [RIL-a]

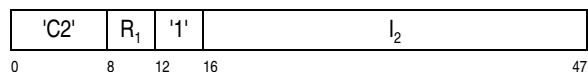

MSGFI R_1, I_2 [RIL-a]

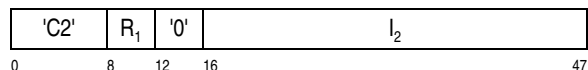

The multiplicand is multiplied by the second operand (multiplier), and the rightmost 32 or 64 bits of the product are placed at the first-operand location. Depending on the instruction format, the multiplicand is in either general register R_1 or R_3 .

The following applies to MULTIPLY (MS, MSC, MSR, MSRKC, MSY) and to MULTIPLY SINGLE IMMEDIATE (MSFI) – that is, to those operations which produce a 32-bit result:

- The multiplicand is a 32-bit signed binary integer. For MS, MSC, MSFI, MSR, and MSY, the multiplicand is in bit positions 32-63 of general register R_1 . For MSRKC, the multiplicand is in bit positions 32-63 of general register R_3 .
- The multiplier is a 32-bit signed binary integer. For MSR and MSRKC, the multiplier is in bit positions 32-63 of general register R_2 . For MSFI, the multiplier is in the I_2 field of the instruction. For MS, MSC, and MSY, the multiplier is at the second-operand location in storage.
- The rightmost 32 bits of the signed-binary-integer product replace bits 32-63 of general register R_1 , and bits 0-31 of the register remain unchanged. For MS, MSFI, MSR, and MSY, the bits to the left of the 32 rightmost bits of the product are not tested for significance.

For MSC and MSRKC, an overflow condition exists when the leftmost 33 bits of an intermediate 64-bit product are neither all zeros nor all ones. Condition code 3 is set. If the fixed-point-overflow mask in the PSW is one, a program interruption for fixed-point overflow occurs.

The following applies to MULTIPLY SINGLE (MSG, MSGC, MSGF, MSGFR, MSGR, MSGRKC) and to MULTIPLY SINGLE IMMEDIATE (MSGFI) – that is, to those operations which produce a 64-bit result:

- The multiplicand is a 64-bit signed binary integer. For MSG, MSGC, MSGF, MSGFI, MSGR, and MSGFR, the multiplicand is in bit positions 0-63 of general register R_1 . For MSGRKC, the multiplicand is in bit positions 0-63 of general register R_3 .
- For MSGR and MSGRKC, the multiplier is a 64-bit signed binary integer in bit positions 0-63 of general register R_2 . For MSGFR, the multiplier is a 32-bit signed-binary integer in bit positions 32-63 of general register R_2 . For MSGFI, the multiplier is a 32-bit signed-binary integer in the I_2 field of the instruction. For MSG and MSGC, the multiplier is a 64-bit signed binary integer at the second-operand location in storage. For MSGF, the multiplier is a 32-bit signed binary integer at the second-operand location in storage.
- The rightmost 64 bits of the signed-binary-integer product replace bits 0-63 of general register R_1 . For MSG, MSGF, MSGFR, MSGR, MSGFI, the bits to the left of the 64 rightmost bits of the product are not tested for significance.

For MSGC and MSGRKC, an overflow condition exists when the leftmost 65 bits of an intermediate 128-bit product are neither all zeros or all ones. Condition code 3 is set. If the fixed-point-overflow mask in the PSW is one, a program interruption for fixed-point overflow occurs.

The sign of the product is determined by the rules of algebra from the multiplier and multiplicand sign, except that a zero result is always positive.

The displacement for MS is treated as a 12-bit unsigned binary integer. The displacement for MSC, MSG, MSGF, and MSY is treated as a 20-bit signed binary integer.

Resulting Condition Code: For MSC, MSGC, MSGRKC, and MSRKC, the condition code is set as follows:

- 0 Result zero; no overflow
- 1 Result less than zero; no overflow
- 2 Result greater than zero; no overflow
- 3 Overflow

For all other operations, the condition code remains unchanged, and no overflow indication is provided.

Program Exceptions:

- Access (fetch, operand 2 of MS, MSC, MSG, MSGC, MSGF, MSY only)
- Fixed-point overflow (MSC, MSGC, MSGRKC, MSRKC only)
- Operation (MSY, if the long-displacement facility is not installed; MSFI, MSGFI, if the general-instructions-extension facility is not installed; MSC, MSGC, MSGRKC, MSRKC, if the miscellaneous-instruction-extensions facility 2 is not installed.)

NAND

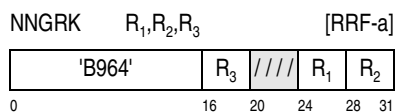
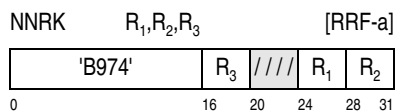

The one's complement of the AND of the second and third operands is placed at the first-operand location.

The connective NAND is applied to the operands bit-by-bit. The contents of a bit position in the result are set to zero if the corresponding bit positions in both source operands contain ones; otherwise, the result bit is set to one.

For NNRK, the operands are 32 bits, and for NNGRK, they are 64 bits.

Resulting Condition Code:

- 0 Result zero
- 1 Result not zero
- 2 --
- 3 --

Program Exceptions:

- Operation (if the miscellaneous-instruction-extensions facility 3 is not installed)

NEXT INSTRUCTION ACCESS INTENT

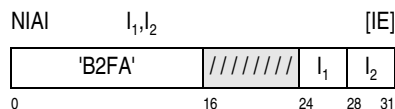

Note: In this instruction definition, the term primary-access operand means the lowest numbered storage operand of an instruction. Similarly, the term secondary-access operand means the next-lowest numbered storage operand of the instruction. These terms do not have the same meaning as the terms first operand and second operand, even though there may be some correlation. For example, for the MOVE instruction the first operand is the primary-access operand and the second operand is the secondary-access operand. However, for the LOAD MULTIPLE DISJOINT instruction, the second operand is the primary-access operand and the fourth operand is the secondary-access operand.

Subject to the controls in the I_1 and I_2 fields, the CPU is signaled the future access intent for either or both the primary-access and secondary-access operands of the next-sequential instruction. The I_1 field contains a code to signal the CPU the access intent for the primary-access operand of the next-sequential instruction. The I_2 field contains a code to signal the CPU the access intent for the secondary-access operand of the next-sequential instruction. When the next-sequential instruction has only a single storage operand, the I_2 field is ignored.

The I_1 and the I_2 fields have the following format:

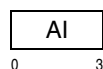

Access Intent (AI): Bits 0-3 of the I_1 and I_2 fields contain an unsigned integer that is used as a code to signal the CPU the access intent for the corresponding operand of the next-sequential instruction as follows:

Code Meaning

- | | |
|---|---|
| 0 | The corresponding operand of the next-sequential instruction may or may not be accessed as an instruction operand by subsequent instructions. |
|---|---|

Code Meaning

- | | |
|------|---|
| 1 | The corresponding operand of the next-sequential instruction will be accessed by subsequent instructions for operand store access, and may also be accessed for operand fetch access. |
| 2 | The corresponding operand of the next-sequential instruction will be accessed by subsequent instructions for operand fetch access. |
| 3 | The corresponding operand of the next-sequential instruction will not be accessed as an instruction operand by subsequent instructions. |
| 4-15 | Reserved. |

Reserved access-intent codes should not be specified; otherwise, the program may not operate compatibly in the future.

Depending on the model, the CPU may not recognize all of the access intents for an operand. For access intents that are not recognized by the CPU, the instruction acts as a no-operation. If the instruction has more than two storage operands, no access intent is specified for the additional operands.

Depending on the model, the CPU may not recognize access intents for a particular instruction. For such cases, the instruction acts as a no-operation.

The NEXT INSTRUCTION ACCESS INTENT instruction only affects subsequent instruction's operand accesses; it does not affect subsequent instruction fetches.

No references to storage are made.

Condition Code: The code remains unchanged.

Program Exceptions:

- Operation (if the execution-hint facility is not installed)

Programming Notes:

1. NEXT INSTRUCTION ACCESS INTENT signals the CPU of the future access intent for the storage operands of the next-sequential instruction, but it does not guarantee that the CPU will necessarily retain or use this information.

2. Specifying an incorrect access intent or an access intent for a non-existent operand may lead to performance degradation.
3. Caches are managed on a cache-line-size granularity. Therefore, when a corresponding storage operand specifies any portion of a cache line, the access intent is signaled for the entire cache line. The cache line size can be determined by executing the EXTRACT CPU ATTRIBUTE instruction.
4. When a corresponding storage operand specifies crossing one or more cache-line boundaries, it is model dependent whether the access intent is signaled for one or multiple cache lines.

It is anticipated a program may use access-intent values of one, two, or three, with corresponding storage operands that may cross one or more cache-line boundaries.

5. Specifying an access-intent value of three does not signal the CPU to actively release the cache line from the cache for the specified operand. Instead, it signals the CPU that it should not actively try to retain that line in the cache.
6. Specifying an access-intent value of zero to a single operand instruction is not encouraged and not necessary. However, in the case where an instruction has two operands and access intent is known for one operand, but not the other, the access intent value of zero can be used for the operand of unknown intent.
7. If an interruption occurs after the execution of NEXT INSTRUCTION ACCESS INTENT and before the execution of the next-sequential instruction, NEXT INSTRUCTION ACCESS INTENT acts as a no-operation and the specified access intent is ignored.
8. If the next sequential instruction after NEXT INSTRUCTION ACCESS INTENT is a PREFETCH DATA (RELATIVE LONG) instruction, it is unpredictable what the CPU will do with data prefetching.
9. When the next-sequential instruction after NEXT INSTRUCTION ACCESS INTENT is an execute-type instruction (EX or EXRL), the following applies:
 - Access-intent codes are not associated with the execute-type instruction. The second

operand of an execute-type instruction corresponds to an instruction fetch.

- Depending on the model, access-intent codes may be associated with the target instruction of the execute-type instruction.

NONTRANSACTIONAL STORE



The 64-bit first operand is nontransactionally placed unchanged at the second-operand location.

The displacement is treated as a 20-bit signed binary integer.

The second operand must be aligned on a doubleword boundary; otherwise, a specification exception is recognized and the operation is suppressed.

Condition Code: The code remains unchanged.

Program Exceptions:

- Access (store, second operand)
- Operation (transactional-execution facility not installed)
- Specification
- Transaction constraint

Programming Notes:

1. NONTRANSACTIONAL STORE provides a means by which a program executing in the non-constrained transactional-execution mode can perform stores that will be retained, even if the transaction aborts. This may facilitate debugging of the transaction if it is aborted.
2. When the CPU is not in the transactional-execution mode, the operation of NONTRANSACTIONAL STORE is identical to that of STORE (STG), except that the second operand of NONTRANSACTIONAL STORE is required to be on a doubleword boundary (regardless of transactional-execution mode) whereas the second operand of STG has no alignment requirements.
3. Depending on the model, the performance of NONTRANSACTIONAL STORE may be slower than that of STORE (STG).

4. If a CPU makes transactional and non-transactional stores to the same storage location within a transaction, and the transaction then aborts, the content of all storage locations altered by either the transactional or nontransactional store are unpredictable.
5. On some models, attempting to execute a non-transactional store and a transactional store in a transaction when both designate any locations within the same cache line results in the transaction being aborted with abort code 16 (cache other condition) and condition code 3 set. This occurs even if the nontransactional store does not overlap the transactional store. The cache line size may be determined by the EXTRACT CPU ATTRIBUTES (ECAG) instruction.

NOR

NORK R_1, R_2, R_3 [RRF-a]

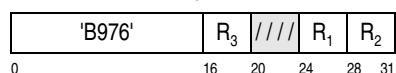

NOGRK R_1, R_2, R_3 [RRF-a]

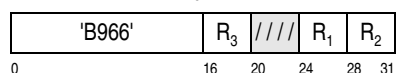

The one's complement of the OR of the second and third operands is placed at the first-operand location.

The connective NOR is applied to the operands bit-by-bit. The contents of a bit position in the result are set to one if the corresponding bit positions in both source operands contain zero; otherwise, the result bit is set to zero.

For NORK, the operands are 32 bits, and for NOGRK, they are 64 bits.

Resulting Condition Code:

- 0 Result zero
- 1 Result not zero
- 2 --
- 3 --

Program Exceptions:

- Operation (if the miscellaneous-instruction-extensions facility 3 is not installed)

Programming Note: NOR can be used to provide the functionality of a bit-wise NOT operation by specifying the same general register for R₂ and R₃. The high-level assembler (HLASM) provides the extended-mnemonic forms shown below.

Extended Mnemonics:

Extended Mnemonic	Base Mnemonic
NOTR R_1, R_2	NORK R_1, R_2, R_2
NOTGR R_1, R_2	NOGRK R_1, R_2, R_2

NOT EXCLUSIVE OR

NXRK R_1, R_2, R_3 [RRF-a]

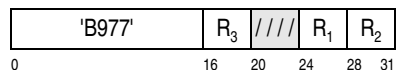

NXGRK R_1, R_2, R_3 [RRF-a]

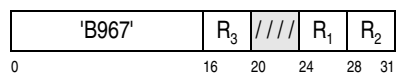

The one's complement of the EXCLUSIVE OR of the second and third operands is placed at the first-operand location.

The connective EXCLUSIVE OR and complementation is applied to the operands bit-by-bit. The contents of a bit position in the result are set to zero if the bits in the corresponding bit positions in the two source operands are unlike; otherwise, the result bit is set to one.

For NXRK, the operands are 32 bits, and for NXGRK, they are 64 bits

Resulting Condition Code:

- 0 Result zero
- 1 Result not zero
- 2 --
- 3 --

Program Exceptions:

- Operation (if the miscellaneous-instruction-extensions facility 3 is not installed)

OR

Register-and-register formats:

OR R_1, R_2 [RR]

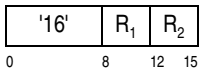

OGR R_1, R_2 [RRE]

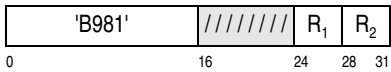

ORK R_1, R_2, R_3 [RRF-a]

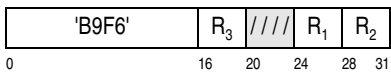

OGRK R_1, R_2, R_3 [RRF-a]

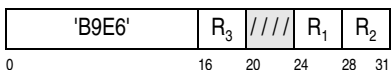

Register-and-storage formats:

O $R_1, D_2(X_2, B_2)$ [RX-a]

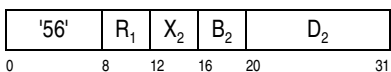

OY $R_1, D_2(X_2, B_2)$ [RXY-a]

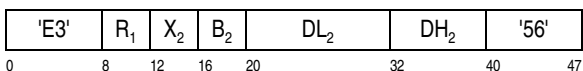

OG $R_1, D_2(X_2, B_2)$ [RXY-a]

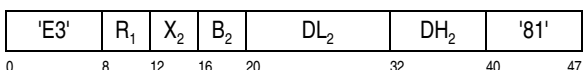

Storage-and-immediate formats:

OI $D_1(B_1), I_2$ [SI]

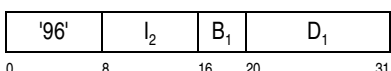

OIY $D_1(B_1), I_2$ [SIY]

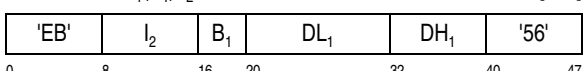

Storage-and-storage format:

OC $D_1(L, B_1), D_2(B_2)$ [SS-a]

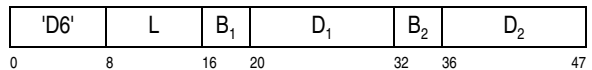

For O, OC, OG, OGR, OI, OIY, OR, and OY, the OR of the first and second operands is placed at the first-operand location. For OGRK and ORK, the OR of the second and third operands is placed at the first-operand location.

The connective OR is applied to the operands bit by bit. The contents of a bit position in the result are set to one if the corresponding bit position in one or both operands contains a one; otherwise, the result bit is set to zero.

For OR (OC), each operand is processed left to right. When the operands overlap, the result is obtained as if the operands were processed one byte at a time and each result byte were stored immediately after fetching the necessary operand bytes.

For OR (OI, OIY), the first operand is one byte in length, and only one byte is stored. When the interlocked-access facility 2 is installed, the update of the first operand appears to be an interlocked-update reference as observed by other CPUs and channel programs, and a specific-operand-serialization operation is performed.

For OR (O, OR, ORK, and OY), the operands are 32 bits, and for OR (OG, OGR, and OGRK), they are 64 bits.

The displacements for O, OI, and both operands of OC are treated as 12-bit unsigned binary integers. The displacement for OY, OIY, and OG is treated as a 20-bit signed binary integer.

Resulting Condition Code:

- 0 Result zero
- 1 Result not zero
- 2 --
- 3 --

Program Exceptions:

- Access (fetch, operand 2, O, OY, OG, and OC; fetch and store, operand 1, OI, OIY, and OC)

- Operation (OY and OIY, if the long-displacement facility is not installed; OGRK and ORK, if the distinct-operands facility is not installed)
- Transaction constraint (OC)

Programming Notes:

1. Examples of the use of the OR instruction are given in Appendix A, “Number Representation and Instruction-Use Examples.”
2. OR may be used to set a bit to one.
3. Accesses to the first operand of OR (OC) – and, when the interlocked-access facility 2 is not installed, accesses to the first operand of OR (OI, OIY) – consist in fetching a first-operand byte from storage and subsequently storing the updated value. These fetch and store accesses to a particular byte do not necessarily occur one immediately after the other. Thus, these instructions cannot be safely used to update a location in storage if the possibility exists that another CPU or a channel program may also be updating the location. An example of this effect is shown in “Multiprogramming and Multiprocessing Examples” on page A-45.

When the interlocked-access facility 2 is installed, OR (OI, OIY) can be safely used to update a location in storage, even if the possibility exists that another CPU or a channel program may also be updating the location.

OR IMMEDIATE

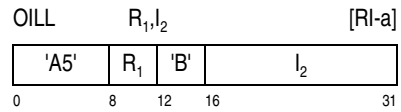
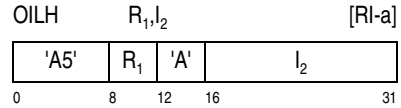
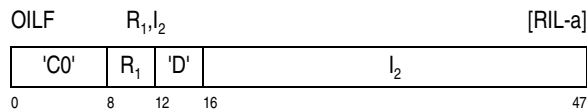
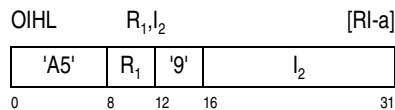
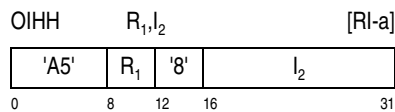
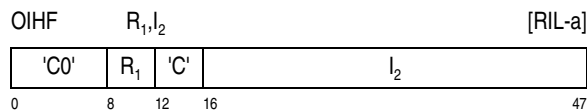

The second operand is ORed with bits of the first operand, and the result replaces those bits of the first operand. The remainder of the first operand remains unchanged.

For each instruction, the bits of the first operand that are ORed with the second operand and then replaced are as follows:

Instruction	Bits ORed and Replaced
OIHF	0-31
OIHH	0-15
OIHL	16-31
OILF	32-63
OILH	32-47
OILL	48-63

The connective OR is applied to the operands bit by bit. The contents of a bit position in the result are set to one if the corresponding bit position in one or both operands contains a one; otherwise, the result bit is set to zero.

Resulting Condition Code:

- 0 Result is zero
- 1 Result is not zero
- 2 --
- 3 --

Program Exceptions:

- Operation (OIHF and OILF, if the extended-immediate facility is not installed)

Programming Note: The setting of the condition code is based only on the bits that are ORed and replaced.

OR WITH COMPLEMENT

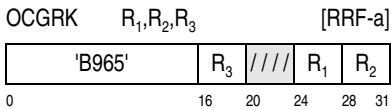
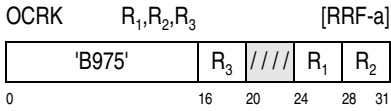

The second operand is ORed with the bit-wise complement of the third operand and the result is placed in the first-operand location.

The connective OR is applied to the second operand and bit-wise complemented third operand, bit by bit. The contents of a bit position in the result are set to zero if the corresponding bit positions in the second and third operands contain zero and one, respectively; otherwise, the result bit is set to one.

For OCRK, the operands are 32 bits, and for OCGRK, they are 64 bits.

Resulting Condition Code:

- 0 Result zero
- 1 Result not zero
- 2 --
- 3 --

Program Exceptions:

- Operation (if the miscellaneous-instruction-extensions facility 3 is not installed)

PACK

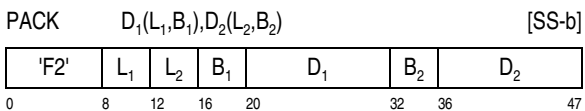

The format of the second operand is changed from zoned to signed-packed-decimal, and the result is placed at the first-operand location. The zoned and signed-packed-decimal formats are described in Chapter 8, "Decimal Instructions."

The second operand is treated as having the zoned format. The numeric bits of each byte are treated as

a digit. The zone bits are ignored, except the zone bits in the rightmost byte, which are treated as a sign.

The sign and digits are moved unchanged to the first operand and are not checked for valid codes. The sign is placed in the rightmost four bit positions of the rightmost byte of the result field, and the digits are placed adjacent to the sign and to each other in the remainder of the result field.

The result is obtained as if the operands were processed right to left. When necessary, the second operand is considered to be extended on the left with zeros. If the first operand is too short to contain all digits of the second operand, the remaining leftmost portion of the second operand is ignored. Access exceptions for the unused portion of the second operand may or may not be indicated.

When the operands overlap, the result is obtained as if each result byte were stored immediately after fetching the necessary operand bytes. Two second-operand bytes are needed for each result byte, except for the rightmost byte of the result field, which requires only the rightmost second-operand byte.

Condition Code: The code remains unchanged.

Program Exceptions:

- Access (fetch, operand 2; store, operand 1)
- Transaction constraint

Programming Notes:

1. An example of the use of the PACK instruction is given in Appendix A, "Number Representation and Instruction-Use Examples."
2. PACK may be used to interchange the two hexadecimal digits in one byte by specifying a zero in the L_1 and L_2 fields and the same address for both operands.
3. To remove the zone bits of all bytes of a field, including the rightmost byte, both operands should be extended on the right with a dummy byte, which subsequently should be ignored in the result field.
4. The storage-operand references for PACK may be multiple-access references. (See "Storage-Operand Consistency" on page 5-125.)

PACK ASCII

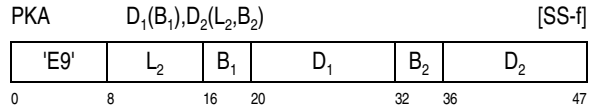

The format of the second operand is changed from ASCII to signed-packed-decimal, and the result is placed at the first-operand location. The signed-packed-decimal format is described in Chapter 8, "Decimal Instructions."

The second-operand bytes are treated as containing decimal digits, having the binary encoding 0000-1001 for 0-9, in their rightmost four bit positions. The leftmost four bit positions of a byte are ignored. The second operand is considered to be positive.

The implied positive sign (1100 binary) and the source digits are placed at the first-operand location. The source digits are moved unchanged and are not checked for valid codes. The sign is placed in the rightmost four bit positions of the rightmost byte of the result field, and the digits are placed adjacent to the sign and to each other in the remainder of the result field.

The result is obtained as if the operands were processed right to left. When necessary, the second operand is considered to be extended on the left with zeros.

The length of the first operand is 16 bytes.

The length of the second operand is designated by the contents of the L₂ field. The second-operand length must not exceed 32 bytes (L₂ must be less than or equal to 31); otherwise, a specification exception is recognized.

When the length of the second operand is 32 bytes, the leftmost byte is ignored.

The results are unpredictable if the first and second operands overlap in any way.

As observed by other CPUs and by channel programs, the first-operand location is not necessarily stored into in any particular order.

Condition Code: The code remains unchanged.

Program Exceptions:

- Access (fetch, operand 2; store, operand 1)
- Operation (if the extended-translation facility 2 is not installed)
- Specification
- Transaction constraint

Programming Notes:

1. Although PACK ASCII is primarily intended to change the format of ASCII decimal digits, its use is not restricted to ASCII since the leftmost four bits of each byte are ignored.
2. The following example illustrates the use of the instruction to pack ASCII digits:

```

ASDIGITS DS 0CL31
          DC X'3132333435'
          DC X'3637383930'
          DC X'3132333435'
          DC X'3637383930'
          DC X'3132333435'
          DC X'3637383930'
          DC X'31'
PKDIGITS DS PL16
          :
          PKA PKDIGITS,ASDIGITS(31)

```

3. The instruction can also be used to pack EBCDIC digits, which is especially useful when the length of the second operand is greater than the 16-byte second-operand limit of PACK.

```

EBDIGITS DS 0CL31
          DC X'F1F2F3F4F5'
          DC X'F6F7F8F9F0'
          DC X'F1F2F3F4F5'
          DC X'F6F7F8F9F0'
          DC X'F1F2F3F4F5'
          DC X'F6F7F8F9F0'
          DC X'F1'
PKDIGITS DS PL16
          :
          PKA PKDIGITS,EBDIGITS(31)

```

4. The storage-operand references for PACK ASCII may be multiple-access references. (See "Storage-Operand Consistency" on page 5-125.)

PACK UNICODE

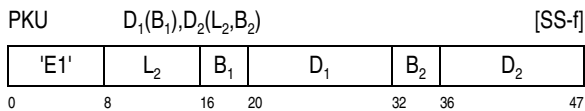

The format of the second operand is changed from Unicode to signed-packed-decimal, and the result is placed at the first-operand location. The signed-packed-decimal format is described in Chapter 8, “Decimal Instructions.”

The two-byte second-operand characters are treated as Unicode Basic Latin characters containing decimal digits, having the binary encoding 0000-1001 for 0-9, in their rightmost four bit positions. The leftmost 12 bit positions of a character are ignored. The second operand is considered to be positive.

The implied positive sign (1100 binary) and the source digits are placed at the first-operand location. The source digits are moved unchanged and are not checked for valid codes. The sign is placed in the rightmost four bit positions of the rightmost byte of the result field, and the digits are placed adjacent to the sign and to each other in the remainder of the result field.

The result is obtained as if the operands were processed right to left. When necessary, the second operand is considered to be extended on the left with zeros.

The length of the first operand is 16 bytes.

The byte length of the second operand is designated by the contents of the L₂ field. The second-operand length must not exceed 32 characters or 64 bytes, and the byte length must be even (L₂ must be less than or equal to 63 and must be odd); otherwise, a specification exception is recognized.

When the length of the second operand is 32 characters (64 bytes), the leftmost character is ignored.

The results are unpredictable if the first and second operands overlap in any way.

As observed by other CPUs and by channel programs, the first-operand location is not necessarily stored into in any particular order.

Condition Code: The code remains unchanged.

Program Exceptions:

- Access (fetch, operand 2; store, operand 1)
- Operation (if the extended-translation facility 2 is not installed)
- Specification
- Transaction constraint

Programming Notes:

1. The following example illustrates the use of PACK UNICODE to pack European numbers:

```

UNDIGITS DS    0CL62
          DC    X'00310032003300340035'
          DC    X'00360037003800390030'
          DC    X'00310032003300340035'
          DC    X'00360037003800390030'
          DC    X'00310032003300340035'
          DC    X'00360037003800390030'
          DC    X'0031'
PKDIGITS DS    PL16
          :
          PKU   PKDIGITS,UNDIGITS(62)

```

2. Because the leftmost 12 bits of each character are ignored, those Unicode decimal digits where the digit zero has four rightmost zero bits can also be packed by the instruction. For example, for Thai digits:

```

UNDIGITS DS    0CL62
          DC    X'0E510E520E530E540E55'
          DC    X'0E560E570E580E590E50'
          DC    X'0E510E520E530E540E55'
          DC    X'0E560E570E580E590E50'
          DC    X'0E510E520E530E540E55'
          DC    X'0E560E570E580E590E50'
          DC    X'0E51'
PKDIGITS DS    PL16
          :
          PKU   PKDIGITS,UNDIGITS(62)

```

3. The storage-operand references for PACK UNICODE may be multiple-access references. (See “Storage-Operand Consistency” on page 5-125.)

PERFORM CRYPTOGRAPHIC COMPUTATION



A function specified by the function code in general register 0 is performed.

Bits 16-31 of the instruction are ignored.

Bit positions 57-63 of general register 0 contain the function code. Figure 7-304 on page 7-317 shows the assigned function codes. All other function codes are unassigned. Bit 56 of general register 0 must be zero; otherwise, a specification exception is recognized. All other bits of general register 0 are ignored.

General register 1 contains the logical address of the leftmost byte of the parameter block in storage. In the 24-bit addressing mode, the contents of bit positions 40-63 of general register 1 constitute the address, and the contents of bit positions 0-39 are ignored. In the 31-bit addressing mode, the contents of bit positions 33-63 of general register 1 constitute the address, and the contents of bit positions 0-32 are ignored. In the 64-bit addressing mode, the contents of bit positions 0-63 of general register 1 constitute the address.

If the message-security-assist extension 9 is installed, elliptic curve scalar multiply is supported in PCC-Scalar-Multiply function codes 64, 65, 66, 72, 73, 80, and 81.

The function codes for PERFORM CRYPTOGRAPHIC COMPUTATION are as follows.

Code	Function	Parm. Block Size (bytes)	Data Block Size (bytes)
0	PCC-Query	16	—
1	PCC-Compute-Last-Block-CMAC-Using-DEA	32	8
2	PCC-Compute-Last-Block-CMAC-Using-TDEA-128	40	8
3	PCC-Compute-Last-Block-CMAC-Using-TDEA-192	48	8
9	PCC-Compute-Last-Block-CMAC-Using-Encrypted-DEA	56	8
10	PCC-Compute-Last-Block-CMAC-Using-Encrypted-TDEA-128	64	8

Figure 7-304. Function Codes for PERFORM CRYPTOGRAPHIC COMPUTATION (Part 1 of 2)

Code	Function	Parm. Block Size (bytes)	Data Block Size (bytes)
11	PCC-Compute-Last-Block-CMAC-Using-Encrypted-TDEA-192	72	8
18	PCC-Compute-Last-Block-CMAC-Using-AES-128	56	16
19	PCC-Compute-Last-Block-CMAC-Using-AES-192	64	16
20	PCC-Compute-Last-Block-CMAC-Using-AES-256	72	16
26	PCC-Compute-Last-Block-CMAC-Using-Encrypted-AES-128	88	16
27	PCC-Compute-Last-Block-CMAC-Using-Encrypted-AES-192	96	16
28	PCC-Compute-Last-Block-CMAC-Using-Encrypted-AES-256A	104	16
50	PCC-Compute-XTS-Parameter-Using-AES-128	80	16
52	PCC-Compute-XTS-Parameter-Using-AES-256	96	16
58	PCC-Compute-XTS-Parameter-Using-Encrypted-AES-128	112	16
60	PCC-Compute-XTS-Parameter-Using-Encrypted-AES-256	128	16
64	PCC-Scalar-Multiply-P256	4096	—
65	PCC-Scalar-Multiply-P384	4096	—
66	PCC-Scalar-Multiply-P521	4096	—
72	PCC-Scalar-Multiply-Ed25519	4096	—
73	PCC-Scalar-Multiply-Ed448	4096	—
80	PCC-Scalar-Multiply-X25519	4096	—
81	PCC-Scalar-Multiply-X448	4096	—

Explanation:
 — Not applicable

Figure 7-304. Function Codes for PERFORM CRYPTOGRAPHIC COMPUTATION (Part 2 of 2)

All other function codes are unassigned.

The query function provides the means of indicating the availability of the other functions.

Figure 7-305 shows the contents of general registers 0 and 1.

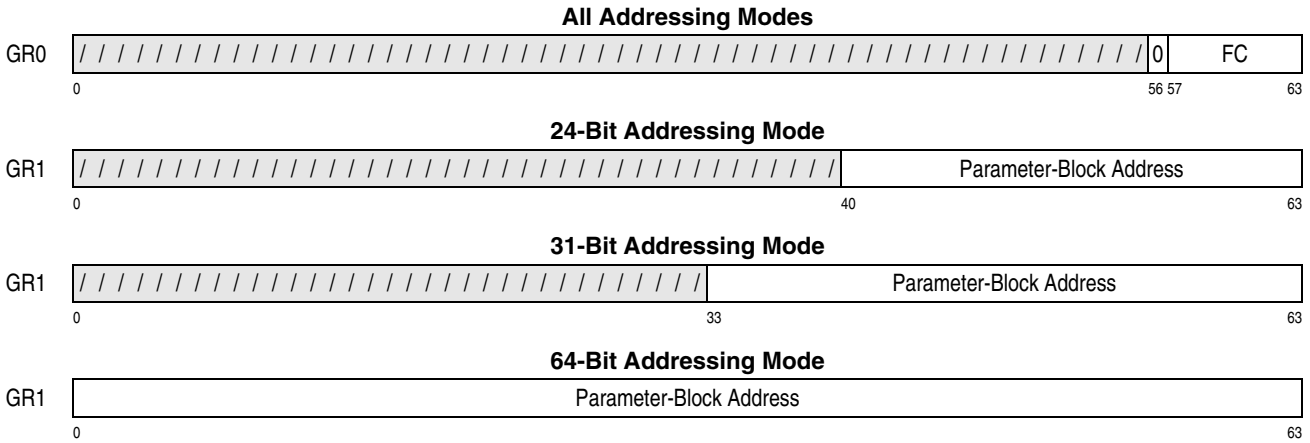

Figure 7-305. General Register Assignment for PCC

In the access-register mode, access register 1 specifies the address space containing the parameter block.

As observed by this CPU, other CPUs, and channel programs, reference to the parameter block may be multiple-access references, accesses to these storage locations are not necessarily block-concurrent, and the sequence of these accesses or references is undefined.

Symbols Used in Function Descriptions

The following symbols are used in the subsequent description of the PERFORM CRYPTOGRAPHIC COMPUTATION functions. Further description of the AES standard may be found in Reference [14.] on page xxx. The XTS multiplication operation is the same as the GCM (Galois/counter mode) multiplication operation. Further description of the GCM multiplication over $GF(2^{128})$ may be found in Reference [17.] on page xxx.

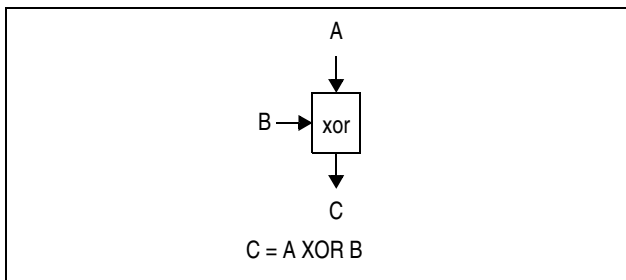

Figure 7-306. Symbol For Bit-Wise Exclusive OR

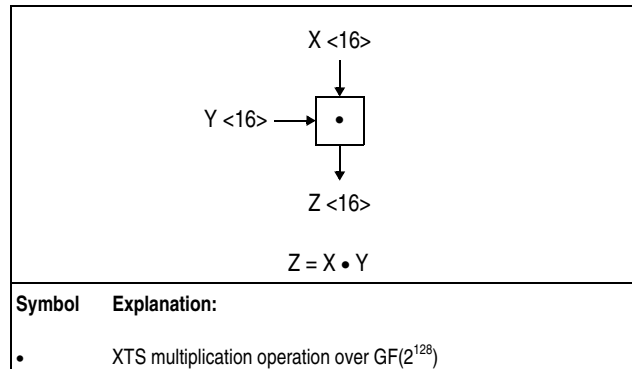

Figure 7-307. Symbol For XTS Multiplication Operation Over $GF(2^{128})$

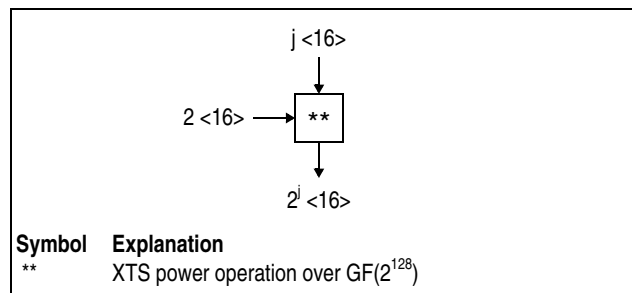

Figure 7-308. Symbol For XTS Power Operation Over $GF(2^{128})$

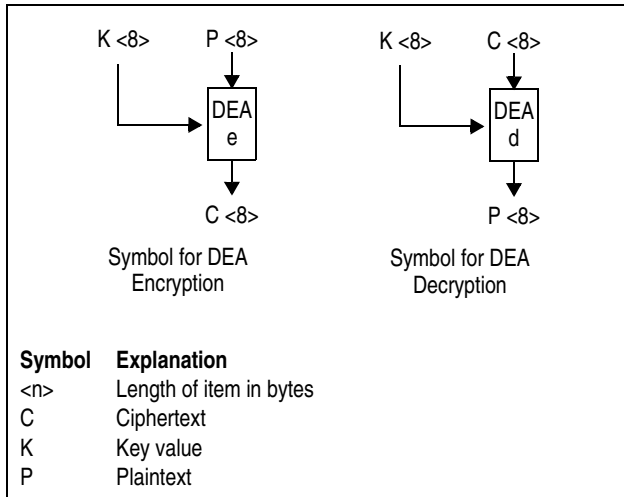

Figure 7-309. Symbols for DEA Encryption and Decryption

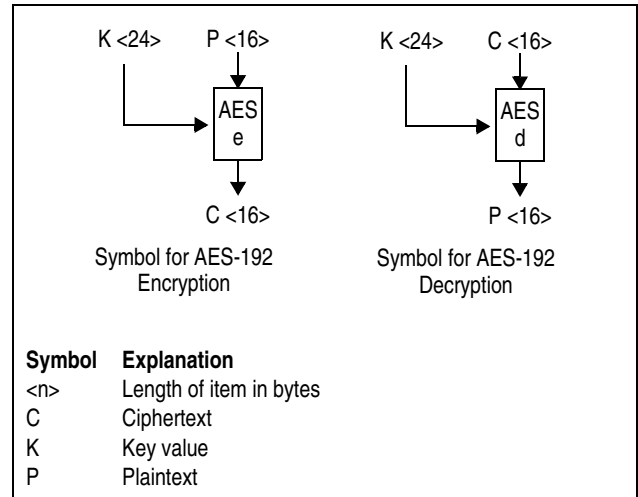

Figure 7-311. Symbols for AES-192 Encryption and Decryption

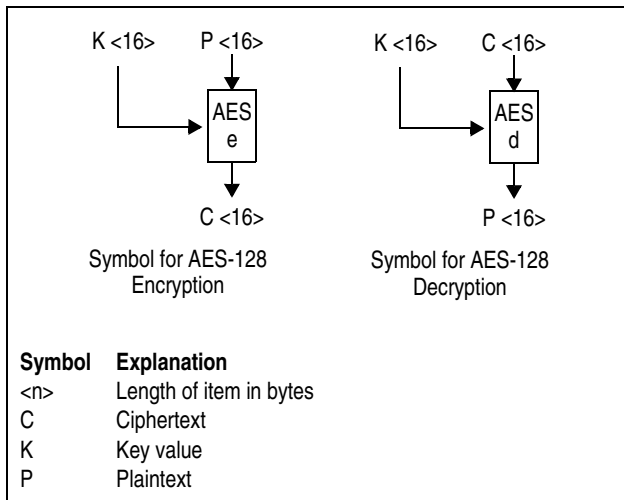

Figure 7-310. Symbols for AES-128 Encryption and Decryption

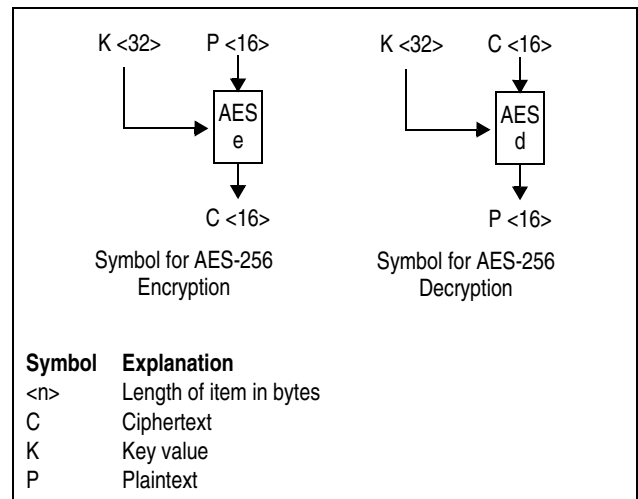

Figure 7-312. Symbols for AES-256 Encryption and Decryption

PCC-Query (Function Code 0)

The locations of the operands and addresses used by the instruction are as shown in Figure 7-305 on page 7-318.

The parameter block used for the function has the following format:

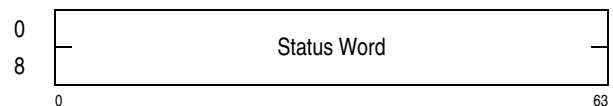

Figure 7-313. Parameter Block for PCC-Query

A 128-bit status word is stored in the parameter block. Bits 0-127 of this field correspond to function

codes 0-127, respectively, of the PCC instruction. When a bit is one, the corresponding function is installed; otherwise, the function is not installed.

Condition code 0 is set when execution of the PCC-Query function completes; condition codes 1, 2, and 3 are not applicable to this function.

PCC-Compute-Last-Block-CMAC-Using-DEA (Function Code 1)

PCC-Compute-Last-Block-CMAC-Using-Encrypted-DEA (Function Code 9)

The locations of the operands and addresses used by the instruction are as shown in Figure 7-305 on page 7-318.

The parameter block used for the PCC-Compute-Last-Block-CMAC-Using-DEA function has the following format:

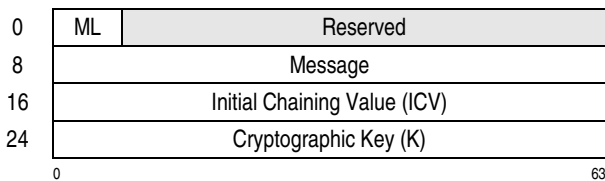

Figure 7-314. Parameter Block for PCC-Compute-Last-Block-CMAC-Using-DEA

For the PCC-Compute-Last-Block-CMAC-Using-DEA function, the initial-chaining value is in byte offsets 16-23 of the parameter block and the cryptographic key is in byte offsets 24-31 of the parameter block.

The parameter block used for the PCC-Compute-Last-Block-CMAC-Using-Encrypted-DEA function has the following format:

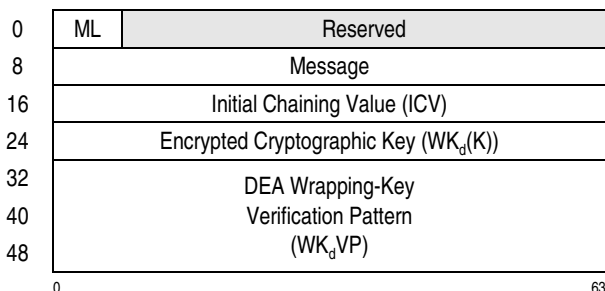

Figure 7-315. Parameter Block for PCC-Compute-Last-Block-CMAC-Using-Encrypted-DEA

K. The subkey generation algorithm is shown in the

For the PCC-Compute-Last-Block-CMAC-Using-Encrypted-DEA function, the contents of byte offsets 32-55 of the parameter block are compared with the contents of the DEA wrapping-key verification-pattern register. If they mismatch, the parameter-block location remains unchanged, and the operation is completed by setting condition code 1. If they match, byte offsets 16-23 of the parameter block contain the initial chaining value, and the contents of byte offsets 24-31 of the parameter block are deciphered using the DEA wrapping key to obtain the 64-bit cryptographic key, K . (See the section “Protection of Cryptographic Keys” on page 7-431 for details.)

The description in the following paragraphs applies to both functions.

The bit length of the message in byte offsets 8-15 of the parameter block is specified by an 8-bit unsigned binary integer in the message-length (ML) field at byte offset 0. When the ML field contains a value greater than 64, the operation is completed by setting condition code 2. Otherwise, the ML field specifies the number of leftmost bits in byte offsets 8-15 that constitute the message. All other bits in byte offsets 8-15 are ignored.

When the ML field specifies a value of 0, a 64-bit message block is formed by setting the leftmost bit to one and all other bits to zero; when the ML field specifies a value of 64, the contents of byte offsets 8-15 form the 64-bit message block; when the ML field specifies a value of 63, the leftmost 63 bits in byte offsets 8-15 padded with a bit of one on the right form the 64-bit message block; when the ML field specifies a value in the range between 1 and 62, inclusively, the specified number of leftmost bits in byte offsets 8-15 padded on the right with a bit of one followed by the necessary number of bits of zero form a 64-bit message block.

When the ML field specifies the value of 64, a 64-bit subkey, K_x , is derived using the 64-bit cryptographic key, K . When the ML field specifies a value in the range between 0 and 63, inclusively, a different subkey, K_y , is derived using the 64-bit cryptographic key,

following figure.

Steps:	
1.	$L = CIPH_K(0)$
2.	If MSB(L) = 0, then $K_X = L \ll 1$; Else, $K_X = (L \ll 1) \text{ XOR } (R_{64})$
3.	If MSB(K_X) = 0, then $K_Y = K_X \ll 1$; Else $K_Y = (K_X \ll 1) \text{ XOR } (R_{64})$
Explanation:	
$CIPH_K(0)$	Encryption of the value zero using a 64-bit key and the DEA encryption algorithm.
MSB(A)	Most significant (leftmost) bit of A
$B \ll 1$	The bit string that results from discarding the leftmost bit of B and appending a '0' bit on the right.
XOR	Bit-wise exclusive OR.
R_{64}	A 64-bit value of 27.

Figure 7-316. Subkey Generation Algorithm

When the ML field specifies the value of 64, the 64-bit message block is exclusive-ORed with the subkey K_X . The result of the exclusive-OR operation is then exclusive-ORed with initial-chaining value. The result of the second exclusive-OR operation is then enciphered using the 64-bit cryptographic key, K, and the DEA encryption algorithm. The result of the encryption operation is the CMAC and is placed in byte offsets 16-23 of the parameter block.

When the ML field specifies a value in the range between 0 and 63, inclusively, the 64-bit message block is exclusive-ORed with the subkey K_Y . The result of the exclusive-OR operation is then exclusive-ORed with initial-chaining value. The result of the second exclusive-OR operation is then enciphered using the 64-bit cryptographic key, K, and the DEA encryption algorithm. The result of the encryption operation is the CMAC and is placed in byte offsets 16-23 of the parameter block.

When the ML field specifies a value in the range between 0 and 64, inclusively, condition code 0 is set when execution of the function completes. Condition code 3 is not applicable to either function; condition code 1 is not applicable to the PCC-Compute-Last-Block-CMAC-Using-DEA function.

PCC-Compute-Last-Block-CMAC-Using-TDEA-128 (Function Code 2)

PCC-Compute-Last-Block-CMAC-Using-Encrypted-TDEA-128 (Function Code 10)

The locations of the operands and addresses used by the instruction are as shown in Figure 7-305 on page 7-318.

The parameter block used for the PCC-Compute-Last-Block-CMAC-Using-TDEA-128 function has the following format:

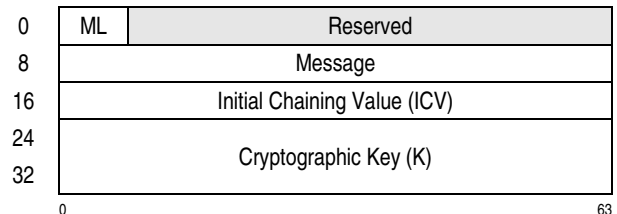

Figure 7-317. Parameter Block for PCC-Compute-Last-Block-CMAC-Using-TDEA-128

For the PCC-Compute-Last-Block-CMAC-Using-TDEA-128 function, the initial-chaining value is in byte offsets 16-23 of the parameter block and the cryptographic key is in byte offsets 24-39 of the parameter block.

The parameter block used for the PCC-Compute-Last-Block-CMAC-Using-Encrypted-TDEA-128 function has the following format:

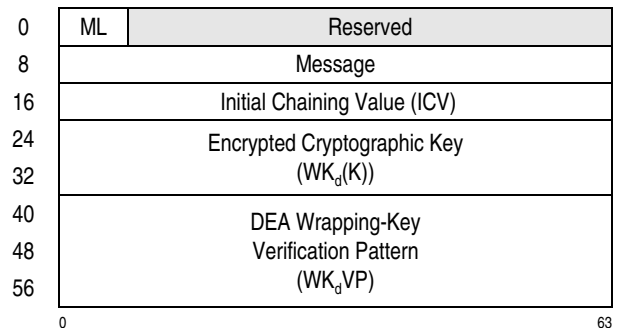

Figure 7-318. Parameter Block for PCC-Compute-Last-Block-CMAC-Using-Encrypted-TDEA-128

For the PCC-Compute-Last-Block-CMAC-Using-Encrypted-TDEA-128 function, the contents of byte offsets 40-63 of the parameter block are compared with the contents of the DEA wrapping-key verification-pattern register. If they mismatch, the parameter-block location remains unchanged, and the operation

is completed by setting condition code 1. If they match, byte offsets 16-23 of the parameter block contain the initial chaining value, and the contents of byte offsets 24-39 of the parameter block are deciphered using the DEA wrapping key to obtain the 128-bit cryptographic key, K . (See the section “Protection of Cryptographic Keys” on page 7-431 for details.)

The description in the following paragraphs applies to both functions.

The bit length of the message in byte offsets 8-15 of the parameter block is specified by an 8-bit unsigned binary integer in the message-length (ML) field at byte offset 0. When the ML field contains a value greater than 64, the operation is completed by setting condition code 2. Otherwise, the ML field specifies the number of leftmost bits in byte offsets 8-15 that constitute the message. All other bits in byte offsets 8-15 are ignored.

When the ML field specifies a value of 0, a 64-bit message block is formed by setting the leftmost bit to one and all other bits to zero; when the ML field specifies a value of 64, the contents of byte offsets 8-15 form the 64-bit message block; when the ML field specifies a value of 63, the leftmost 63 bits in byte offsets 8-15 padded with a bit of one on the right form the 64-bit message block; when the ML field specifies a value in the range between 1 and 62, inclusively, the specified number of leftmost bits in byte offsets 8-15 padded on the right with a bit of one followed by the necessary number of bits of zero form a 64-bit message block.

When the ML field specifies the value of 64, a 64-bit subkey, K_x , is derived using the 128-bit cryptographic key, K . When the ML field specifies a value in the range between 0 and 63, inclusively, a different subkey, K_y , is derived using the 128-bit cryptographic key, K . The subkey generation algorithm is shown in the following figure.

Steps:	
1.	$L = \text{CIPH}_K(0)$
2.	If $\text{MSB}(L) = 0$, then $K_x = L \ll 1$; Else, $K_x = (L \ll 1) \text{ XOR } (R_{64})$
3.	If $\text{MSB}(K_x) = 0$, then $K_y = K_x \ll 1$; Else $K_y = (K_x \ll 1) \text{ XOR } (R_{64})$

Figure 7-319. Subkey Generation Algorithm

Explanation:

$\text{CIPH}_K(0)$	Encryption of the value zero using a 128-bit key and the TDEA-128 encryption algorithm.
$\text{MSB}(A)$	Most significant (leftmost) bit of A
$B \ll 1$	The bit string that results from discarding the leftmost bit of B and appending a '0' bit on the right.
XOR	Bit-wise exclusive OR.
R_{64}	A 64-bit value of 27.

Figure 7-319. Subkey Generation Algorithm (Continued)

When the ML field specifies the value of 64, the 64-bit message block is exclusive-ORed with the subkey K_x . The result of the exclusive-OR operation is then exclusive-ORed with initial-chaining value. The result of the second exclusive-OR operation is then enciphered using the 128-bit cryptographic key, K , and the TDEA-128 encryption algorithm. The result of the encryption operation is the CMAC and is placed in byte offsets 16-23 of the parameter block.

When the ML field specifies a value in the range between 0 and 63, inclusively, the 64-bit message block is exclusive-ORed with the subkey K_y . The result of the exclusive-OR operation is then exclusive-ORed with initial-chaining value. The result of the second exclusive-OR operation is then enciphered using the 128-bit cryptographic key, K , and the TDEA-128 encryption algorithm. The result of the encryption operation is the CMAC and is placed in byte offsets 16-23 of the parameter block.

When the ML field specifies a value in the range between 0 and 64, inclusively, condition code 0 is set when execution of the function completes. Condition code 3 is not applicable to either function; condition code 1 is not applicable to the PCC-Compute-Last-Block-CMAC-Using-TDEA-128 function.

PCC-Compute-Last-Block-CMAC-Using-TDEA-192 (Function Code 3)

PCC-Compute-Last-Block-CMAC-Using-Encrypted-TDEA-192 (Function Code 11)

The locations of the operands and addresses used by the instruction are as shown in Figure 7-305 on page 7-318.

The parameter block used for the PCC-Compute-Last-Block-CMAC-Using-TDEA-192 function has the following format:

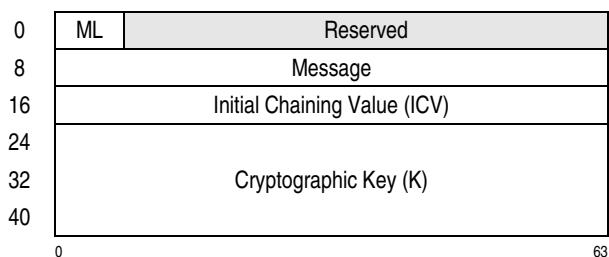

Figure 7-320. Parameter Block for PCC-Compute-Last-Block-CMAC-Using-TDEA-192

For the PCC-Compute-Last-Block-CMAC-Using-TDEA-192 function, the initial-chaining value is in byte offsets 16-23 of the parameter block and the cryptographic key is in byte offsets 24-47 of the parameter block.

The parameter block used for the PCC-Compute-Last-Block-CMAC-Using-Encrypted-TDEA-192 function has the following format:

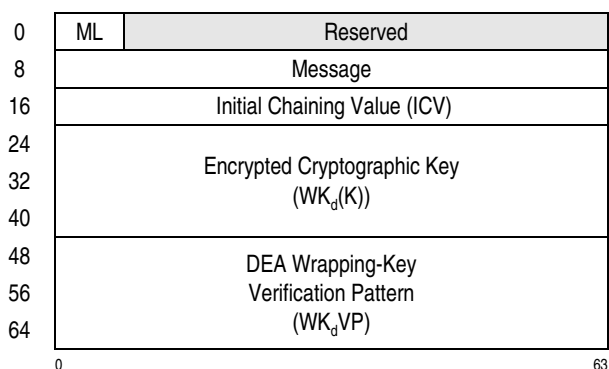

Figure 7-321. Parameter Block for PCC-Compute-Last-Block-CMAC-Using-Encrypted-TDEA-192

For the PCC-Compute-Last-Block-CMAC-Using-Encrypted-TDEA-192 function, the contents of byte offsets 48-71 of the parameter block are compared with the contents of the DEA wrapping-key verification-pattern register. If they mismatch, the parameter-block location remains unchanged, and the operation is completed by setting condition code 1. If they match, byte offsets 16-23 of the parameter block contain the initial chaining value, and the contents of byte offsets 24-47 of the parameter block are deciphered using the DEA wrapping key to obtain the 192-bit cryptographic key, K. (See the section “Pro-

tection of Cryptographic Keys” on page 7-431 for details.)

The description in the following paragraphs applies to both functions.

The bit length of the message in byte offsets 8-15 of the parameter block is specified by an 8-bit unsigned binary integer in the message-length (ML) field at byte offset 0. When the ML field contains a value greater than 64, the operation is completed by setting condition code 2. Otherwise, the ML field specifies the number of leftmost bits in byte offsets 8-15 that constitute the message. All other bits in byte offsets 8-15 are ignored.

When the ML field specifies a value of 0, a 64-bit message block is formed by setting the leftmost bit to one and all other bits to zero; when the ML field specifies a value of 64, the contents of byte offsets 8-15 form the 64-bit message block; when the ML field specifies a value of 63, the leftmost 63 bits in byte offsets 8-15 padded with a bit of one on the right form the 64-bit message block; when the ML field specifies a value in the range between 1 and 62, inclusively, the specified number of leftmost bits in byte offsets 8-15 padded on the right with a bit of one followed by the necessary number of bits of zero form a 64-bit message block.

When the ML field specifies the value of 64, a 64-bit subkey, K_x , is derived using the 192-bit cryptographic key, K. When the ML field specifies a value in the range between 0 and 63, inclusively, a different subkey, K_y , is derived using the 192-bit cryptographic key, K. The subkey generation algorithm is shown in the following figure.

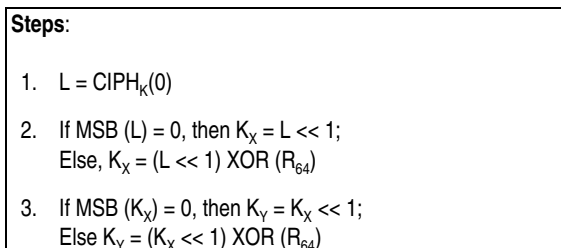

Figure 7-322. Subkey Generation Algorithm

Explanation:	
$CIPH_K(0)$	Encryption of the value zero using a 192-bit key and the TDEA-192 encryption algorithm.
MSB(A)	Most significant (leftmost) bit of A
$B \ll 1$	The bit string that results from discarding the leftmost bit of B and appending a '0' bit on the right.
XOR	Bit-wise exclusive OR.
R_{64}	A 64-bit value of 27.

Figure 7-322. Subkey Generation Algorithm (Continued)

When the ML field specifies the value of 64, the 64-bit message block is exclusive-ORed with the subkey K_x . The result of the exclusive-OR operation is then exclusive-ORed with initial-chaining value. The result of the second exclusive-OR operation is then enciphered using the 192-bit cryptographic key, K, and the TDEA-192 encryption algorithm. The result of the encryption operation is the CMAC and is placed in byte offsets 16-23 of the parameter block.

When the ML field specifies a value in the range between 0 and 63, inclusively, the 64-bit message block is exclusive-ORed with the subkey K_y . The result of the exclusive-OR operation is then exclusive-ORed with initial-chaining value. The result of the second exclusive-OR operation is then enciphered using the 192-bit cryptographic key, K, and the TDEA-192 encryption algorithm. The result of the encryption operation is the CMAC and is placed in byte offsets 16-23 of the parameter block.

When the ML field specifies a value in the range between 0 and 64, inclusively, condition code 0 is set when execution of the function completes. Condition code 3 is not applicable to either function; condition code 1 is not applicable to the PCC-Compute-Last-Block-CMAC-Using-TDEA-192 function.

PCC-Compute-Last-Block-CMAC-Using-AES-128 (Function Code 18)

PCC-Compute-Last-Block-CMAC-Using-Encrypted-AES-128 (Function Code 26)

The locations of the operands and addresses used by the instruction are as shown in Figure 7-305 on page 7-318.

The parameter block used for the PCC-Compute-Last-Block-CMAC-Using-AES-128 function has the following format:

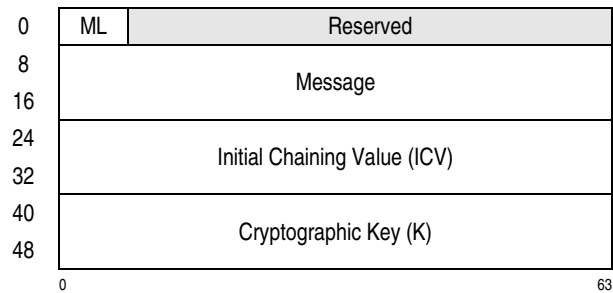

Figure 7-323. Parameter Block for PCC-Compute-Last-Block-CMAC-Using-AES-128

For the PCC-Compute-Last-Block-CMAC-Using-AES-128 function, the initial-chaining value is in byte offsets 24-39 of the parameter block and the cryptographic key is in byte offsets 40-55 of the parameter block.

The parameter block used for the PCC-Compute-Last-Block-CMAC-Using-Encrypted-AES-128 function has the following format:

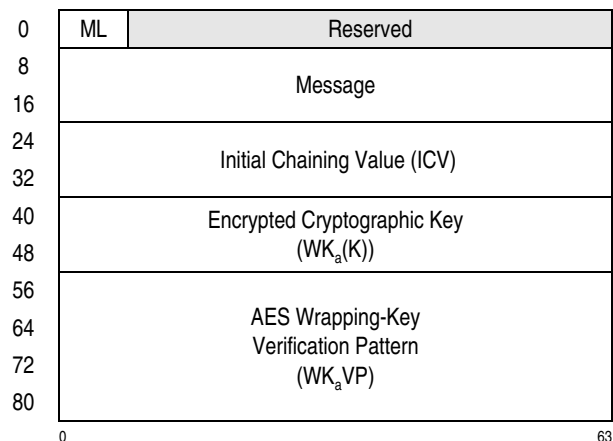

Figure 7-324. Parameter Block for PCC-Compute-Last-Block-CMAC-Using-Encrypted-AES-128

For the PCC-Compute-Last-Block-CMAC-Using-Encrypted-AES-128 function, the contents of byte offsets 56-87 of the parameter block are compared with the contents of the AES wrapping-key verification-pattern register. If they mismatch, the parameter-block location remains unchanged, and the operation is completed by setting condition code 1. If they match, byte offsets 24-39 of the parameter block contain the initial chaining value, and the contents of byte offsets 40-55 of the parameter block are deci-

phered using the AES wrapping key to obtain the 128-bit cryptographic key, K. (See the section “Protection of Cryptographic Keys” on page 7-431 for details.)

The description in the following paragraphs applies to both functions.

The bit length of the message in byte offsets 8-23 of the parameter block is specified by an 8-bit unsigned binary integer in the message-length (ML) field at byte offset 0. When the ML field contains a value greater than 128, the operation is completed by setting condition code 2. Otherwise, the ML field specifies the number of leftmost bits in byte offsets 8-23 that constitute the message. All other bits in byte offsets 8-23 are ignored.

When the ML field specifies a value of 0, a 128-bit message block is formed by setting the leftmost bit to one and all other bits to zero; when the ML field specifies a value of 128, the contents of byte offsets 8-23 form the 128-bit message block; when the ML field specifies a value of 127, the leftmost 127 bits in byte offsets 8-23 padded with a bit of one on the right form the 128-bit message block; when the ML field specifies a value in the range between 1 and 126, inclusively, the specified number of leftmost bits in byte offsets 8-23 padded on the right with a bit of one followed by the necessary number of bits of zero form a 128-bit message block.

When the ML field specifies the value of 128, a 128-bit subkey, K_x , is derived using the 128-bit cryptographic key, K. When the ML field specifies a value in the range between 0 and 127, inclusively, a different subkey, K_y , is derived using the 128-bit cryptographic key, K. The subkey generation algorithm is shown in the following figure.

Steps:	
1.	$L = \text{CIPH}_k(0)$
2.	If $\text{MSB}(L) = 0$, then $K_x = L \ll 1$; Else, $K_x = (L \ll 1) \text{ XOR } (R_{128})$
3.	If $\text{MSB}(K_x) = 0$, then $K_y = K_x \ll 1$; Else $K_y = (K_x \ll 1) \text{ XOR } (R_{128})$

Figure 7-325. Subkey Generation Algorithm

Explanation:

$\text{CIPH}_k(0)$	Encryption of the value zero using a 128-bit key and the AES-128 encryption algorithm.
$\text{MSB}(A)$	Most significant (leftmost) bit of A
$B \ll 1$	The bit string that results from discarding the leftmost bit of B and appending a '0' bit on the right.
XOR	Bit-wise exclusive OR.
R_{128}	A 128-bit value of 135.

Figure 7-325. Subkey Generation Algorithm (Continued)

When the ML field specifies the value of 128, the 128-bit message block is exclusive-ORed with the subkey K_x . The result of the exclusive-OR operation is then exclusive-ORed with initial-chaining value. The result of the second exclusive-OR operation is then enciphered using the 128-bit cryptographic key, K, and the AES-128 encryption algorithm. The result of the encryption operation is the CMAC and is placed in byte offsets 24-39 of the parameter block.

When the ML field specifies a value in the range between 0 and 127, inclusively, the 128-bit message block is exclusive-ORed with the subkey K_y . The result of the exclusive-OR operation is then exclusive-ORed with initial-chaining value. The result of the second exclusive-OR operation is then enciphered using the 128-bit cryptographic key, K, and the AES-128 encryption algorithm. The result of the encryption operation is the CMAC and is placed in byte offsets 24-39 of the parameter block.

When the ML field specifies a value in the range between 0 and 128, inclusively, condition code 0 is set when execution of the function completes. Condition code 3 is not applicable to either function; condition code 1 is not applicable to the PCC-Compute-Last-Block-CMAC-Using-AES-128 function.

PCC-Compute-Last-Block-CMAC-Using-AES-192 (Function Code 19)

PCC-Compute-Last-Block-CMAC-Using-Encrypted-AES-192 (Function Code 27)

The locations of the operands and addresses used by the instruction are as shown in Figure 7-305 on page 7-318.

The parameter block used for the PCC-Compute-Last-Block-CMAC-Using-AES-192 function has the following format:

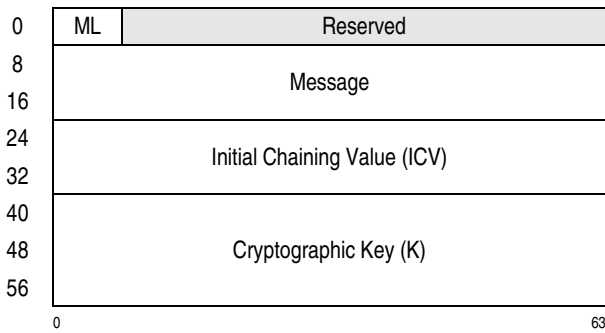

Figure 7-326. Parameter Block for PCC-Compute-Last-Block-CMAC-Using-AES-192

For the PCC-Compute-Last-Block-CMAC-Using-AES-192 function, the initial-chaining value is in byte offsets 24-39 of the parameter block and the cryptographic key is in byte offsets 40-63 of the parameter block.

The parameter block used for the PCC-Compute-Last-Block-CMAC-Using-Encrypted-AES-192 function has the following format:

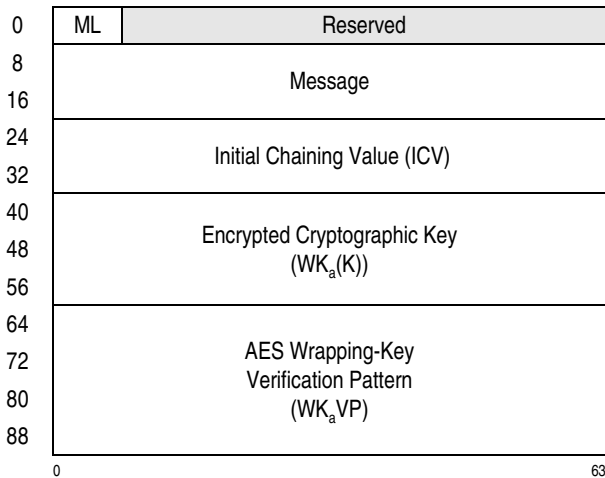

Figure 7-327. Parameter Block for PCC-Compute-Last-Block-CMAC-Using-Encrypted-AES-192

For the PCC-Compute-Last-Block-CMAC-Using-Encrypted-AES-192 function, the contents of byte offsets 64-95 of the parameter block are compared with the contents of the AES wrapping-key verification-pattern register. If they mismatch, the parameter-block location remains unchanged, and the operation is completed by setting condition code 1. If they match, byte offsets 24-39 of the parameter block con-

tain the initial chaining value, and the contents of byte offsets 40-63 of the parameter block are deciphered using the AES wrapping key to obtain the 192-bit cryptographic key, K. (See the section “Protection of Cryptographic Keys” on page 7-431 for details.)

The description in the following paragraphs applies to both functions.

The bit length of the message in byte offsets 8-23 of the parameter block is specified by an 8-bit unsigned binary integer in the message-length (ML) field at byte offset 0. When the ML field contains a value greater than 128, the operation is completed by setting condition code 2. Otherwise, the ML field specifies the number of leftmost bits in byte offsets 8-23 that constitute the message. All other bits in byte offsets 8-23 are ignored.

When the ML field specifies a value of 0, a 128-bit message block is formed by setting the leftmost bit to one and all other bits to zero; when the ML field specifies a value of 128, the contents of byte offsets 8-23 form the 128-bit message block; when the ML field specifies a value of 127, the leftmost 127 bits in byte offsets 8-23 padded with a bit of one on the right form the 128-bit message block; when the ML field specifies a value in the range between 1 and 126, inclusively, the specified number of leftmost bits in byte offsets 8-23 padded on the right with a bit of one followed by the necessary number of bits of zero form a 128-bit message block.

When the ML field specifies the value of 128, a 128-bit subkey, K_x , is derived using the 192-bit cryptographic key, K. When the ML field specifies a value in the range between 0 and 127, inclusively, a different subkey, K_y , is derived using the 192-bit cryptographic key, K. The subkey generation algorithm is shown in the following figure.

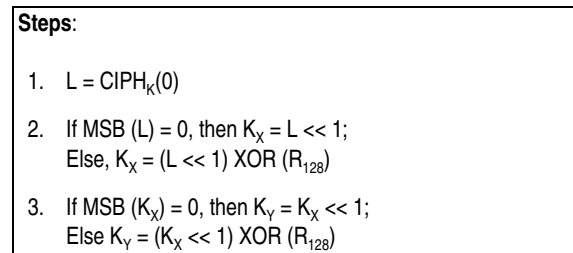

Figure 7-328. Subkey Generation Algorithm

Explanation:	
$CIPH_K(0)$	Encryption of the value zero using a 192-bit key and the AES-192 encryption algorithm.
$MSB(A)$	Most significant (leftmost) bit of A
$B \ll 1$	The bit string that results from discarding the leftmost bit of B and appending a '0' bit on the right.
XOR	Bit-wise exclusive OR.
R_{128}	A 128-bit value of 135.

Figure 7-328. Subkey Generation Algorithm (Continued)

When the ML field specifies the value of 128, the 128-bit message block is exclusive-ORed with the subkey K_x . The result of the exclusive-OR operation is then exclusive-ORed with initial-chaining value. The result of the second exclusive-OR operation is then enciphered using the 192-bit cryptographic key, K, and the AES-192 encryption algorithm. The result of the encryption operation is the CMAC and is placed in byte offsets 24-39 of the parameter block.

When the ML field specifies a value in the range between 0 and 127, inclusively, the 128-bit message block is exclusive-ORed with the subkey K_y . The result of the exclusive-OR operation is then exclusive-ORed with initial-chaining value. The result of the second exclusive-OR operation is then enciphered using the 192-bit cryptographic key, K, and the AES-192 encryption algorithm. The result of the encryption operation is the CMAC and is placed in byte offsets 24-39 of the parameter block.

When the ML field specifies a value in the range between 0 and 128, inclusively, condition code 0 is set when execution of the function completes. Condition code 3 is not applicable to either function; condition code 1 is not applicable to the PCC-Compute-Last-Block-CMAC-Using-AES-192 function.

PCC-Compute-Last-Block-CMAC-Using-AES-256 (Function Code 20)

PCC-Compute-Last-Block-CMAC-Using-Encrypted-AES-256(Function Code 28)

The locations of the operands and addresses used by the instruction are as shown in Figure 7-305 on page 7-318.

The parameter block used for the PCC-Compute-Last-Block-CMAC-Using-AES-256 function has the following format:

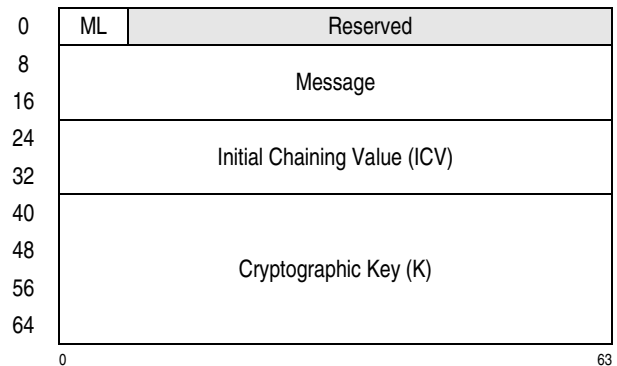

Figure 7-329. Parameter Block for PCC-Compute-Last-Block-CMAC-Using-AES-256

For the PCC-Compute-Last-Block-CMAC-Using-AES-256 function, the initial-chaining value is in byte offsets 24-39 of the parameter block and the cryptographic key is in byte offsets 40-71 of the parameter block.

The parameter block used for the PCC-Compute-Last-Block-CMAC-Using-Encrypted-AES-256 function has the following format:

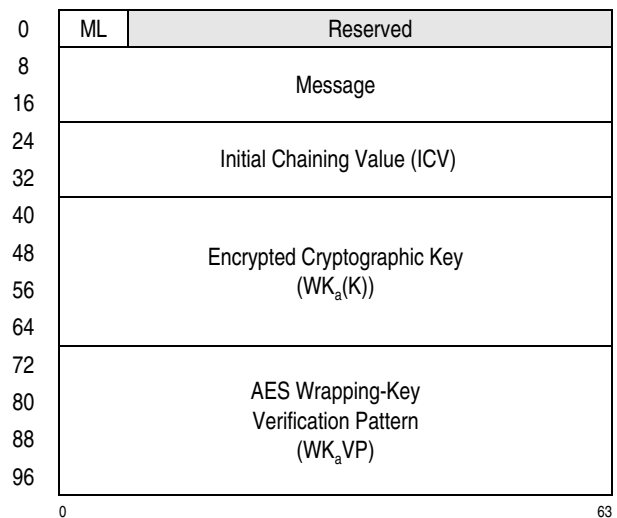

Figure 7-330. Parameter Block for PCC-Compute-Last-Block-CMAC-Using-Encrypted-AES-256

For the PCC-Compute-Last-Block-CMAC-Using-Encrypted-AES-256 function, the contents of byte offsets 72-103 of the parameter block are compared with the contents of the AES wrapping-key verification-pattern register. If they mismatch, the parameter-

block location remains unchanged, and the operation is completed by setting condition code 1. If they match, byte offsets 24-39 of the parameter block contain the initial chaining value, and the contents of byte offsets 40-71 of the parameter block are deciphered using the AES wrapping key to obtain the 256-bit cryptographic key, K . (See the section “Protection of Cryptographic Keys” on page 7-431 for details.)

The description in the following paragraphs applies to both functions.

The bit length of the message in byte offsets 8-23 of the parameter block is specified by an 8-bit unsigned binary integer in the message-length (ML) field at byte offset 0. When the ML field contains a value greater than 128, the operation is completed by setting condition code 2. Otherwise, the ML field specifies the number of leftmost bits in byte offsets 8-23 that constitute the message. All other bits in byte offsets 8-23 are ignored.

When the ML field specifies a value of 0, a 128-bit message block is formed by setting the leftmost bit to one and all other bits to zero; when the ML field specifies a value of 128, the contents of byte offsets 8-23 form the 128-bit message block; when the ML field specifies a value of 127, the leftmost 127 bits in byte offsets 8-23 padded with a bit of one on the right form the 128-bit message block; when the ML field specifies a value in the range between 1 and 126, inclusively, the specified number of leftmost bits in byte offsets 8-23 padded on the right with a bit of one followed by the necessary number of bits of zero form a 128-bit message block.

When the ML field specifies the value of 128, a 128-bit subkey, K_x , is derived using the 256-bit cryptographic key, K . When the ML field specifies a value in the range between 0 and 127, inclusively, a different subkey, K_y , is derived using the 256-bit cryptographic key, K . The subkey generation algorithm is shown in the following figure.

Steps:	
1.	$L = \text{CIPH}_k(0)$
2.	If $\text{MSB}(L) = 0$, then $K_x = L \ll 1$; Else, $K_x = (L \ll 1) \text{ XOR } (R_{128})$
3.	If $\text{MSB}(K_x) = 0$, then $K_y = K_x \ll 1$; Else $K_y = (K_x \ll 1) \text{ XOR } (R_{128})$

Figure 7-331. Subkey Generation Algorithm

Explanation:

$\text{CIPH}_k(0)$	Encryption of the value zero using a 256-bit key and the AES-256 encryption algorithm.
$\text{MSB}(A)$	Most significant (leftmost) bit of A
$B \ll 1$	The bit string that results from discarding the leftmost bit of B and appending a '0' bit on the right.
XOR	Bit-wise exclusive OR.
R_{128}	A 128-bit value of 135.

Figure 7-331. Subkey Generation Algorithm (Continued)

When the ML field specifies the value of 128, the 128-bit message block is exclusive-ORed with the subkey K_x . The result of the exclusive-OR operation is then exclusive-ORed with initial-chaining value. The result of the second exclusive-OR operation is then enciphered using the 256-bit cryptographic key, K , and the AES-256 encryption algorithm. The result of the encryption operation is the CMAC and is placed in byte offsets 24-39 of the parameter block.

When the ML field specifies a value in the range between 0 and 127, inclusively, the 128-bit message block is exclusive-ORed with the subkey K_y . The result of the exclusive-OR operation is then exclusive-ORed with initial-chaining value. The result of the second exclusive-OR operation is then enciphered using the 256-bit cryptographic key, K , and the AES-256 encryption algorithm. The result of the encryption operation is the CMAC and is placed in byte offsets 24-39 of the parameter block.

When the ML field specifies a value in the range between 0 and 128, inclusively, condition code 0 is set when execution of the function completes. Condition code 3 is not applicable to either function; condition code 1 is not applicable to the PCC-Compute-Last-Block-CMAC-Using-AES-256 function.

PCC-Compute-XTS-Parameter-Using-AES-128 (Function Code 50)

PCC-Compute-XTS-Parameter-Using-Encrypted-AES-128 (Function Code 58)

The locations of the operands and addresses used by the instruction are as shown in Figure 7-305 on page 7-318.

The parameter block used for the PCC-Compute-XTS-Parameter-Using-AES-128 function has the following format:

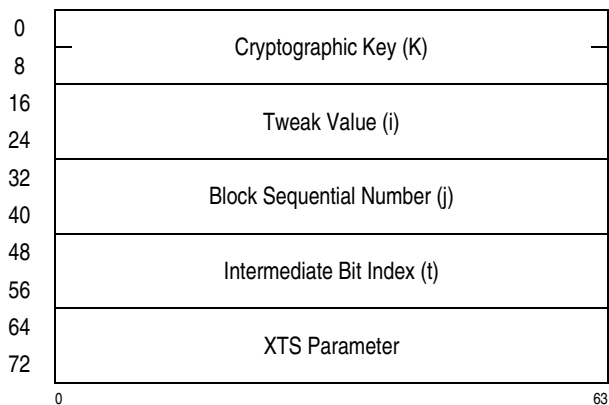

Figure 7-332. Parameter Block for PCC-Compute-XTS-Parameter-Using-AES-128

For the PCC-Compute-XTS-Parameter-Using-AES-128 function, the cryptographic key is in byte offsets 0-15 of the parameter block; the 128-bit tweak value (i) and the 128-bit block sequential number (j) are in byte offsets 16-31 and 32-47, respectively, of the parameter block. When the block sequential number is zero, the contents of byte offsets 48-79 of the parameter block are ignored, the encrypted tweak value is placed in byte offsets 64-79 of the parameter block, and the operation is completed by setting condition code 0. When the block sequential number is nonzero, byte offsets 48-63 of the parameter block contain the index of the next bit in j to be processed. In this case, if the contents of byte offsets 48-63 are zero, then it is the initial execution of the computation, and the contents of byte offsets 64-79 of the parameter block are ignored; if the contents of byte offsets 48-63 are in the range between 1 and 127, inclusively, then byte offsets 64-79 contain the partial XTS parameter computed by a previous iteration; if byte offsets 48-63 of the parameter block contain a value greater than 127, the operation is completed by setting condition code 2.

The parameter block used for the PCC-Compute-XTS-Parameter-Using-Encrypted-AES-128 function has the following format:

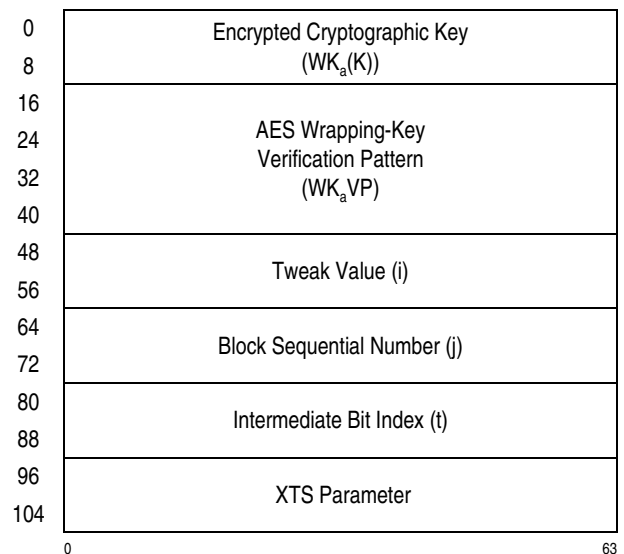

Figure 7-333. Parameter Block for PCC-Compute-XTS-Parameter-Using-Encrypted-AES-128

For the PCC-Compute-XTS-Parameter-Using-Encrypted-AES-128 function, the contents of byte offsets 16-47 of the parameter block are compared with the contents of the AES wrapping-key verification-pattern register. If they mismatch, the parameter-block location remains unchanged, and the operation is completed by setting condition code 1. If they match, the contents of byte offsets 0-15 of the parameter block are deciphered using the AES wrapping key to obtain the 128-bit cryptographic key, K. (See the section “Protection of Cryptographic Keys” on page 7-431 for details.) The 128-bit tweak value (i) and the 128-bit block sequential number (j) are in byte offsets 48-63 and 64-79, respectively, of the parameter block. When the block sequential number is zero, the contents of byte offsets 80-111 of the parameter block are ignored, the encrypted tweak value is placed in byte offsets 96-111 of the parameter block, and the operation is completed by setting condition code 0. When the block sequential number is nonzero, byte offsets 80-95 of the parameter block contain the index of the next bit in j to be processed. In this case, if the contents of byte offsets 80-95 are zero, then it is the initial execution of the computation, and the contents of byte offsets 96-111 of the parameter block are ignored; if the contents of byte offsets 80-95 are in the range between 1 and 127, inclusively, then byte offsets 96-111 contain the partial XTS parameter computed by a previous iteration;

if byte offsets 80-95 of the parameter block contain a value greater than 127, the operation is completed by setting condition code 2.

The following description applies to both functions.

The 128-bit XTS parameter is the result of multiplying the encrypted tweak value by the value of 2 raised to the power of the block sequential number (j). Both the power and multiplication operations are performed over $GF(2^{128})$. The 128-bit tweak value (i) is encrypted using the 128-bit cryptographic key and the AES encryption algorithm. The operation is shown in Figure 7-334.

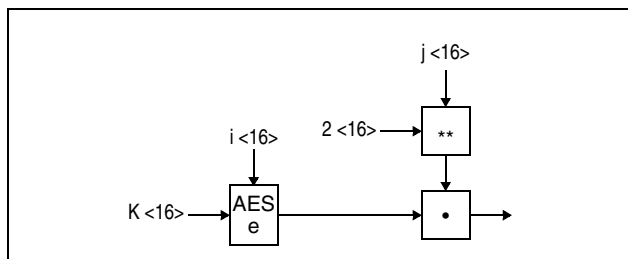

Figure 7-334. Compute XTS Parameter Using AES 128

The value of 2 raised to the power of j is computed as follows: For each bit in j, the value of 2 raised to the power of an exponent, that is a 128-bit unsigned binary integer with an one in that bit and zeros in all other bits, is pre-computed. To obtain the value of 2 raised to the power of j, the pre-computed values that correspond to a bit of one in j are multiplied together. The power and multiplication operations are performed over $GF(2^{128})$.

For a nonzero j, bits in j are processed from left to right, with an index of 0 for the leftmost bit and an index of 127 for the right most bit. The operation is ended when all bits in j have been processed (called normal completion) or when a CPU-determined number of bits that is less than the total number of bits in j have been processed (called partial completion). The CPU-determined number of bits depends on the model, and may be a different number each time the instruction is executed. The CPU-determined number of bits is usually nonzero. In certain unusual situations, this number may be zero, and condition code 3 may be set with no progress. However, the CPU protects against endless reoccurrence of this no-progress case.

When the operation ends due to normal completion, condition code 0 is set and the intermediate bit index field (t) in the parameter block is set to 128. When the

operation ends due to partial completion, condition code 3 is set and the intermediate bit index field (t) in the parameter block is set to the index of the next bit in j to be processed. For the Compute-XTS-Parameter-Using-AES-128 function, the computed XTS parameter or partial XTS parameter is placed in byte offsets 64-79 of the parameter block. For the Compute-XTS-Parameter-Using-Encrypted-AES-128 function, the computed XTS parameter or partial XTS parameter is placed in byte offsets 96-111 of the parameter block.

Condition code 1 is not applicable to the PCC-Compute-XTS-Parameter-Using-AES-128 function.

PCC-Compute-XTS-Parameter-Using-AES-256 (Function Code 52)

PCC-Compute-XTS-Parameter-Using-Encrypted-AES-256 (Function Code 60)

The locations of the operands and addresses used by the instruction are as shown in Figure 7-305 on page 7-318.

The parameter block used for the PCC-Compute-XTS-Parameter-Using-AES-256 function has the following format:

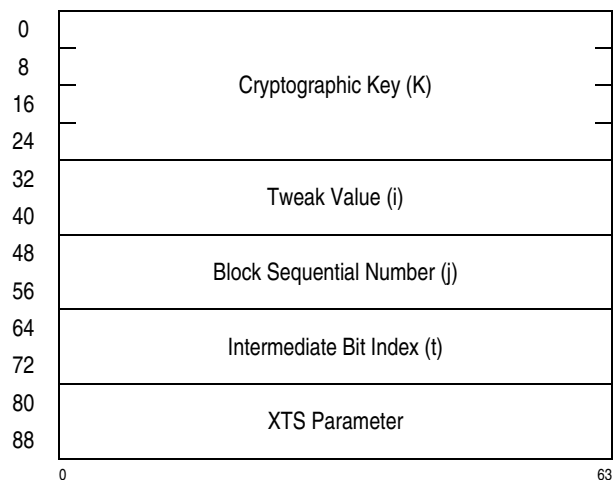

Figure 7-335. Parameter Block for PCC-Compute-XTS-Parameter-Using-AES-256

For the PCC-Compute-XTS-Parameter-Using-AES-256 function, the cryptographic key is in byte offsets 0-31 of the parameter block; the 128-bit tweak value (i) and the 128-bit block sequential number (j) are in byte offsets 32-47 and 48-63, respectively, of the parameter block. When the block sequential number

is zero, the contents of byte offsets 64-95 of the parameter block are ignored, the encrypted tweak value is placed in byte offsets 80-95 of the parameter block, and the operation is completed by setting condition code 0. When the block sequential number is nonzero, byte offsets 64-79 of the parameter block contain the index of the next bit in j to be processed. In this case, if the contents of byte offsets 64-79 are zero, then it is the initial execution of the computation, and the contents of byte offsets 80-95 of the parameter block are ignored; if the contents of byte offsets 64-79 are in the range between 1 and 127, inclusively, then byte offsets 80-95 contain the partial XTS parameter computed by a previous iteration; if byte offsets 64-79 of the parameter block contain a value greater than 127, the operation is completed by setting condition code 2.

The parameter block used for the PCC-Compute-XTS-Parameter-Using-Encrypted-AES-256 function has the following format:

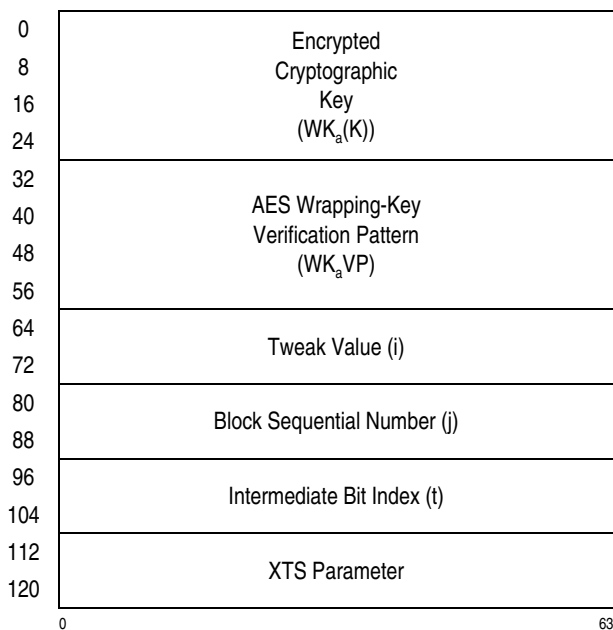

Figure 7-336. Parameter Block for PCC-Compute-XTS-Parameter-Using-Encrypted-AES-256

For the PCC-Compute-XTS-Parameter-Using-Encrypted-AES-256 function, the contents of byte offsets 32-63 of the parameter block are compared with the contents of the AES wrapping-key verification-pattern register. If they mismatch, the parameter-block location remains unchanged, and the operation is completed by setting condition code 1. If they match, the contents of byte offsets 0-31 of the parameter block are deciphered using the AES wrap-

ping key to obtain the 256-bit cryptographic key, K . (See the section “Protection of Cryptographic Keys” on page 7-431 for details.) The 128-bit tweak value (i) and the 128-bit block sequential number (j) are in byte offsets 64-79 and 80-95, respectively, of the parameter block. When the block sequential number is zero, the contents of byte offsets 96-127 of the parameter block are ignored, the encrypted tweak value is placed in byte offsets 112-127 of the parameter block, and the operation is completed by setting condition code 0. When the block sequential number is nonzero, byte offsets 96-111 of the parameter block contain the index of the next bit in j to be processed. In this case, if the contents of byte offsets 96-111 are zero, then it is the initial execution of the computation, and the contents of byte offsets 112-127 of the parameter block are ignored; if the contents of byte offsets 96-111 are in the range between 1 and 127, inclusively, then byte offsets 112-127 contain the partial XTS parameter computed by a previous iteration; if byte offsets 96-111 of the parameter block contain a value greater than 127, the operation is completed by setting condition code 2.

The following description applies to both functions.

The 128-bit XTS parameter is the result of multiplying the encrypted tweak value by the value of 2 raised to the power of the block sequential number (j). Both the power and multiplication operations are performed over $GF(2^{128})$. The 128-bit tweak value (i) is encrypted using the 256-bit cryptographic key and the AES encryption algorithm. The operation is shown in Figure 7-337.

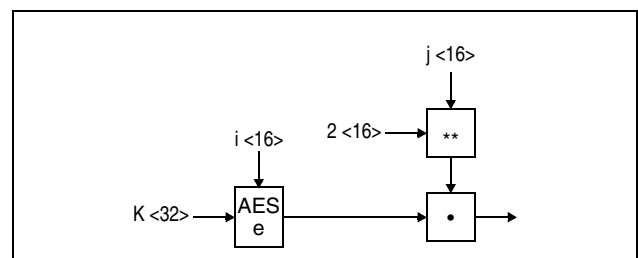

Figure 7-337. Compute XTS Parameter Using AES 256

The value of 2 raised to the power of j is computed as follows: For each bit in j , the value of 2 raised to the power of an exponent, that is a 128-bit unsigned binary integer with an one in that bit and zeros in all other bits, is pre-computed. To obtain the value of 2 raised to the power of j , the pre-computed values that correspond to a bit of one in j are multiplied together. The power and multiplication operations are performed over $GF(2^{128})$.

For a nonzero j , bits in j are processed from left to right, with an index of 0 for the leftmost bit and an index of 127 for the right most bit. The operation is ended when all bits in j have been processed (called normal completion) or when a CPU-determined number of bits that is less than the total number of bits in j have been processed (called partial completion). The CPU-determined number of bits depends on the model, and may be a different number each time the instruction is executed. The CPU-determined number of bits is usually nonzero. In certain unusual situations, this number may be zero, and condition code 3 may be set with no progress. However, the CPU protects against endless reoccurrence of this no-progress case.

When the operation ends due to normal completion, condition code 0 is set and the intermediate bit index field (t) in the parameter block is set to 128. When the operation ends due to partial completion, condition code 3 is set and the intermediate bit index field (t) in the parameter block is set to the index of the next bit in j to be processed. For the Compute-XTS-Parameter-Using-AES-256 function, the computed XTS parameter or partial XTS parameter is placed in byte offsets 80-95 of the parameter block. For the Compute-XTS-Parameter-Using-Encrypted-AES-256 function, the computed XTS parameter or partial XTS parameter is placed in byte offsets 112-127 of the parameter block.

Condition code 1 is not applicable to the PCC-Compute-XTS-Parameter-Using-AES-256 function.

PCC-Scalar-Multiply (Function Codes 64, 65, 66, 72, and 73)

Note: The description of the PCC-Scalar-Multiply instruction assumes that the reader is familiar with the Elliptic Curve Digital Signal Algorithm (ECDSA) described in Reference [24.] on page xxx. This section illustrates the operation for five PCC-Scalar-Multiply functions:

- PCC-Scalar-Multiply-P256 (function code 64)
- PCC-Scalar-Multiply-P384 (function code 65)
- PCC-Scalar-Multiply-P521 (function code 66)
- PCC-Scalar-Multiply-Ed25519 (function code 72)
- PCC-Scalar-Multiply-Ed448 (function code 73)

The three functions with P256, P384, and P521 use NIST curves from Reference [24.] on page xxx. Also see Reference [27.] on page xxx section 5.4 p.17-18 for algorithm details and see D.1.2.3-5 in Reference [24.] on page xxx p.100 for the curve parameter values including the prime modulus, the order, the coefficient, the base point x coordinate, and the base point y coordinate used by these functions.

Two functions, PCC-Scalar-Multiply Ed25519 and Ed448 use twisted Edwards Curves using the EdDSA algorithm, see Reference [25.] on page xxx for algorithm details and curve parameter values, section 5.1 and 5.2 detail curve parameters for Ed25519 and Ed448 respectively.

The PCC-Scalar-Multiply function implements a scalar multiply of point on an elliptic curve as shown by the following:

- $(X_r, Y_r) \leftarrow d * (X_s, Y_s)$

where the input point is represented by the coordinates, X_s and Y_s , is multiplied by a scalar, d , and results in the point represented by the coordinates X_r and Y_r . The scalar multiply of a point can be accomplished by a series of point additions and point doublings along the elliptic curve. The bits of d are scanned from most significant to least significant. For every bit equal to one in the scalar, d , a point addition occurs and after each bit scanned a point doubling occurs and terminates on the scanning of the least significant bit and its possible point addition.

d equal to zero is a special case of point multiplication and results in infinity which can't be represented with the two (Affine) coordinates X_r and Y_r and instead is represented by setting condition code two and leaving the result unchanged.

The parameter block for PCC-Scalar-Multiply-P256 and Ed25519 functions is shown in Figure 7-338, below.

Offset	Dec	Hex	
	00	00	Result X component(Xr)
	32	20	Result Y component(Yr)
	64	40	Source X component(Xs)
	96	60	Source Y component(Ys)
	128	80	Scalar(d)
	160	A0	C RIBM
	168	A8	Continuation State Buffer(CSB)
	4088	FF8	

0 4 32 63

Figure 7-338. Parameter Block for PCC-Scalar-Multiply-P256 and Ed25519, Function

The parameter block for PCC-Scalar-Multiply-P384 function is shown in Figure 7-339, below.

Offset	Dec	Hex	
	00	00	Result X component(Xr)
	48	30	Result Y component(Yr)
	96	60	Source X component(Xs)
	144	90	Source Y component(Ys)
	192	C0	Scalar(d)
	240	F0	C RIBM
	248	F8	Continuation State Buffer(CSB)
	4088	FF8	

0 4 32 63

Figure 7-339. Parameter Block for PCC-Scalar-Multiply-P384 Function

The parameter block for PCC-Scalar-Multiply-P521 function is shown in Figure 7-340, below. The left

Offset	Dec	Hex	
	00	00	Result X component(Xr)
	80	50	Result Y component(Yr)
	160	A0	Source X component(Xs)
	240	F0	Source Y component(Ys)
	320	140	Scalar(d)
	400	190	C RIBM
	408	198	Continuation State Buffer(CSB)
	4088	FF8	

0 4 32 63

Figure 7-340. Parameter Block for PCC-Scalar-Multiply-P521 Function

most 14 bytes of the source operands are ignored, and for the result operands are not updated.

The parameter block for PCC-Scalar-Multiply-Ed448 function is shown in Figure 7-341, below. The left

Offset	Dec	Hex	
	00	00	Result X component(Xr)
	64	40	Result Y component(Yr)
	128	80	Source X component(Xs)
	192	C0	Source Y component(Ys)
	256	100	Scalar(d)
	320	140	C RIBM
	328	148	Continuation State Buffer(CSB)
	4088	FF8	

0 32 63

Figure 7-341. Parameter Block for PCC-Scalar-Multiply-Ed448 Function

most 8 bytes of each source operand is ignored and of each result operand is not updated.

Note that all fields are considered to be multiple bytes in width including Ed25519 and P521. The operands are right aligned within these bytes. And the most significant bits should be zero filled including 1 bit for Ed25519 format and 7 bits for P521 format. If these bits in the source operands are non-zero then the condition code is set to 1. The fields of the parameter block for all PCC-Scalar-Multiply function are as follows:

Result X component (Xr): This is the X component of the point on elliptic curve resulting from the multiply of scalar times the source point on curve. It is an integer greater than or equal to zero and less than the prime of the function and right aligned in this field. For P256, P384, and P521, are in Weierstrass form and for Ed25519 and Ed448 this coordinate is on an Edwards curve. Part of the result of PCC-Scalar-Multiply is stored to this field in the parameter block.

Result Y component (Yr): This is the Y component of the point on elliptic curve resulting from the multiply of scalar times the source point on curve. For P256, P384, and P521 this coordinate is on a Weierstrass curve and for Ed25519 and Ed448 this coordinate is on an Edwards curve. It is an integer greater than or equal to zero and less than the prime of the function and is right aligned in this field. Part of the result of PCC-Scalar-Multiply is stored to this field in the parameter block.

Source X component (Xs): This is the X component of the point on elliptic curve which is the source of the scalar multiply. For P256, P384, and P521, are in Weierstrass form and for Ed25519 and Ed448 this coordinate is on an Edwards curve. Xs is right aligned in this field and bytes to the left are ignored. Xs is an integer greater than or equal to zero and less than the prime of the function. For P256, P384, P521, Ed25519, and Ed448, if Xs is greater than or equal to the prime, the condition code is set to 1, or if the point is not on the curve.

Source Y component (Ys): This is the Y component of the point on elliptic curve which is the source of the scalar multiply. For P256, P384, and P521 this coordinate is in Weierstrass form, and for Ed25519 and Ed448 this coordinate is on an Edwards curve. Ys is right aligned in this field and bytes to the left are ignored and can be random values. Ys is an integer less than the prime of the function. If it is greater than or equal to the prime, the condition code is set to 1, or if the point is not on the curve.

Scalar (d): This is the source scalar to PCC-Scalar-Multiply function. d which is right aligned and bytes to the left are ignored. d is an unsigned integer. For P256, P384, and P521 the scalar has to be less than the order of the curve otherwise the condition code is set to 1. For Ed25519 the most significant bit of the most significant byte must be zero, for P521 the most significant 7 bits of the most significant byte must be zero otherwise the condition code is set to 1. For Ed448 the scalar can have any value. If d equals zero then the condition code is set to 2 to represent infinity.

Reserved for IBM use (RIBM), informational Code (C) and Continuation State Buffer (CSB): The C and RIBM must be initialized to zero prior to the first invocation of the instruction. The RIBM contains status and control information and continuation state buffer (CSB) is provided to hold intermediate results for partial completion reported by setting the condition code equal to 3. The CSB should not be altered by the programmer after partial completion and before subsequent invocation, otherwise intermediate results may be discarded causing long execution times. The CSB after a restart is cleared by the CPU of any intermediate state. The informational code, C, is reserved for future use.

Store-type access exceptions may be recognized for any location in the parameter block, even though only the Xr, Yr, RIBM, and CSB are stored by the instruction.

For P256, P384, P521, Ed25519, and Ed448 if Xs and Ys are zero or greater than or equal to the prime modulus, or not on the specified curve, or if P256, P384, or P521 and d is greater than or equal to the order of the curve, the condition code is set to 1 and the result is not updated. If d is equal to zero, the result is infinity which can not be represented with two coordinates, so the condition code is set to 2 and the result is not updated. Condition code 3 is set if the operation ends in partial completion and the parameter block may be updated. If none of these cases, Xr and Yr are updated and the condition code is set to 0.

PCC-Scalar-Multiply-Montgomery Form (Function Codes 80 and 81)

Note: The description of the PCC-Scalar Multiply for Montgomery Form function assumes that the reader

is familiar with the Elliptic Curve Diffie-Hellman key exchange described in Reference [40.] on page xxxi.

This section illustrates the operation for two PCC-Scalar-Multiply functions using the Montgomery form of the curves:

- PCC-Scalar-Multiply-X25519 (function code 80)
- PCC-Scalar-Multiply-X448 (function code 81)

The two functions, PCC-Scalar-Multiply-X25519 and PCC-Scalar-Multiply-X448 use the ECDH algorithm and use curves defined in RFC-7748. Reference [40.] on page xxxi gives algorithm details and curve parameter values, section 4.1 and 4.2 gives curve parameters for X25519 and X448 respectively, which are used by these function codes. In Reference [40.] on page xxxi point coordinates are given on a Montgomery curve as (U, V) and on a twisted Edwards curve as (X, Y). For the PCC-Scalar-Multiply-X25519 and X448 functions the source and result coordinates are defined to be on the Montgomery form of the curve which uses the U and V coordinate naming in RFC-7748. The scalar multiplication function as defined in RFC-7748 has as input the scalar, d, and the U coordinate of a point, and the V coordinate is implied. The result is the U coordinate of the point produced. PCC-Scalar-Multiply-X25519 and X448 support this definition and the source and result V components do not appear in the parameter block. Also the source U component is assumed to be less than prime of the field.

The PCC-Scalar-Multiply function implements a scalar multiply of a point on an elliptic curve as shown by the following:

- $(U_r, V_r) \leftarrow d * (U_s, V_s)$

where the input point represented by the coordinates, U_s and V_s , is multiplied by a scalar, d, and results in the point represented by the coordinates U_r and V_r , where V_s and V_r are implied. The scalar multiply of a point can be accomplished by a series of point additions and point doublings along the elliptic curve. RFC-7748 gives a faster algorithm than using point additions and point doublings for special values of d. The scalar d must be of the form $2^{254} + 8*k$ where k is between 0 and $2^{251} - 1$ inclusive for X25519, and of the form $2^{447} + 4*k$ where k is between 0 and $2^{445} - 1$ inclusive for X448. PCC-Scalar-Multiply-X25519 and X448 are unpredictable if the scalar d is not in this form or the U coordinate not less than the prime.

The parameter block for PCC-Scalar-Multiply-X25519 function is shown in Figure 7-342, below.

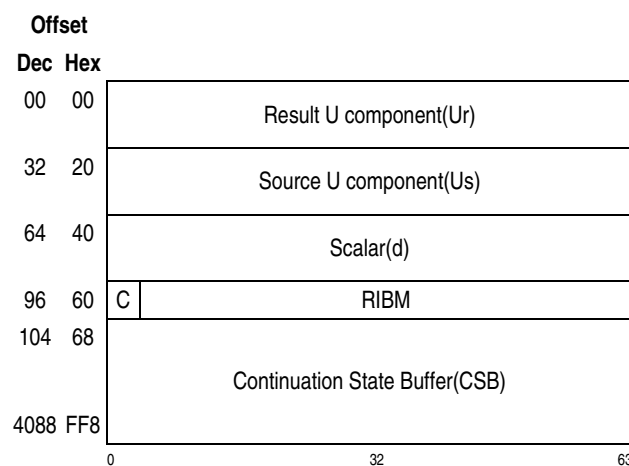

Figure 7-342. Parameter Block for PCC-Scalar-Multiply-X25519 Function

For X448 bytes 0 through 7 of the input operands are ignored. For both X25519 and X448 if U_s is zero or greater than the prime modulus the condition code is set to 1, and the result is not updated; otherwise, U_r is updated and the condition code is set to 0.

The parameter block for PCC-Scalar-Multiply-X448 function is shown in Figure 7-343, below.

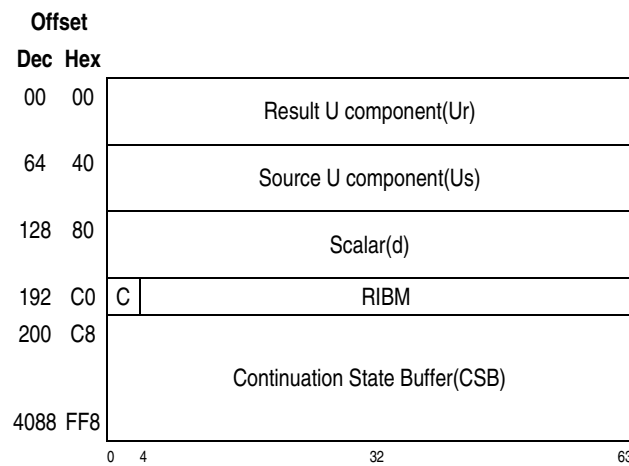

Figure 7-343. Parameter Block for PCC-Scalar-Multiply-X448 Function

Note that all the fields are considered to be multiple bytes in width including X25519 format. The most significant bit in X25519 is considered significant and should be zero otherwise the condition code is set to 1. The fields of the parameter block for all PCC-Scalar-Multiply functions are as follows:

Result U component (Ur): This is the U component of the point on the Montgomery form of the elliptic curve resulting from the multiply of scalar times the source point on curve. It is an integer greater than or equal to zero and less than the prime of the functions and right aligned in this field. The result of PCC-Scalar-Multiply is stored to this field in the parameter block. For X448 bytes 0 through 7 are not updated.

Source U component (Us): This is the U component of the point on the Montgomery form of the elliptic curve which is the source of the scalar multiply. Us is right aligned in this field and bytes to the left are ignored. Us is an integer less than the prime of the functions. If Us is greater than or equal to the prime, the condition code is set to 1. Note for X448 bytes 0 through 7 are ignored, though the most significant bit of X25519 format is significant and should be zero otherwise the condition code is set to 1.

Scalar (d): This is the source scalar to PCC-Scalar-Multiply function. d which is an unsigned integer and is right aligned and bytes to the left are ignored and can be random values. Note for X448 bytes 0 through 7 are ignored. Results are unpredictable if d is not of the form $2^{254} + 8^*k$ where k is between 0 and $2^{251} - 1$ inclusive for X25519, and of the form $2^{447} + 4^*k$ where k is between 0 and $2^{445} - 1$ inclusive for X448. d should not be equal to zero.

Reserved for IBM use (RIBM), informational Code (C), and Continuation State Buffer (CSB): The C and RIBM must be initialized to zero prior to the first invocation of the instruction. The RIBM contains status and control information and continuation state buffer (CSB) is provided to hold intermediate results for partial completion reported by setting the condition code equal to 3. The parameter block should not be altered by the programmer after partial completion and before subsequent invocation, otherwise the CPU may clear the CSB of intermediate status and results and end in partial completion which will allow a clean re-execution of the instruction. This results in longer execution. The CSB after a restart is cleared by the CPU of any intermediate state. The informational code (C) is reserved for future use on this instruction.

If Us is greater than or equal to the prime, condition code one is set and the result remains unchanged. Condition code 3 is set if the operation results in partial completion and the parameter block may be updated. If none of the above conditions, the result is

updated and condition code zero is set. If d is not in the proper form the results are unpredictable.

Store-type access exceptions may be recognized for any location in the parameter block.

Special Conditions

A specification exception is recognized and no other action is taken if any of the following occurs:

1. Bit 56 of general register 0 is not zero.
2. Bits 57-63 of general register 0 specify an unassigned or uninstalled function code.

Resulting Condition Code:

- 0 Normal completion
- 1 Verification-pattern mismatch or source operand out of range
- 2 Invalid bit index or message length, or for Scalar Multiply result is infinity for d equal to zero
- 3 Partial completion

Program Exceptions:

- Access (fetch, parameter block; fetch and store, intermediate bit index, XTS parameter, initial chaining value)
- Operation (if the message-security-assist extension 4 is not installed)
- Specification
- Transaction constraint

1.-6.	Exceptions with the same priority as the priority of program-interruption conditions for the general case.
7.A	Access exceptions for second instruction halfword.
7.B	Operation exception.
7.C	Transaction constraint
8.	Specification exception due to invalid function code or bit 56 of general register 0 is not zero.
9.	Condition code 0 due to message length originally zero.
10.	Access exceptions for an access to the parameter block.

Figure 7-344. Priority of Execution: PCC

11.A	Condition code 1 due to verification-pattern mismatch or source point U_s , X_s , Y_s coordinates out of range or (X_s, Y_s) not on the curve. For scalar-multiply P256, P384, or P521 and scalar (d) greater than or equal to the order of the curve, condition code 1 is set. For scalar-multiply Ed25519 if bit 0 of d is 1 then condition code 1 is set.
11.B	Condition code 2 due to invalid bit index or message length.
12.	Condition code 2 due to scalar (d) equal to zero for scalar-multiply functions (infinity case).
13.	Condition code 0 due to normal completion (message length originally nonzero, but stepped to zero).
14.	Condition code 3 due to partial completion (message length still nonzero).

Figure 7-344. Priority of Execution: PCC (Continued)

Programming Notes:

1. The performance of the query function (code 0) may be significantly slower than that of simply examining a location in storage. If the program needs to frequently test for the availability of a function, it should perform the query function once during initialization; subsequently it should examine the stored results of the query function in memory with an instruction such as TEST UNDER MASK.
2. For the initial execution of a PCC Compute-XTS-Parameter function, the contents of the intermediate-bit-index (t) field in the parameter block shall be set to zeros.

Engineering Notes:

PERFORM LOCKED OPERATION

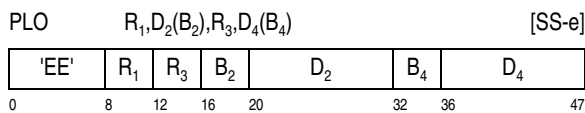

After the lock specified in general register 1 has been obtained, the operation specified by the function code in general register 0 is performed, and then the lock is released. However, as observed by other CPUs: (1) storage operands, including fields in a

parameter list that may be used, may be fetched, and may be tested for store-type access exceptions if a store at a tested location is possible, before the lock is obtained, and (2) operands may be stored in the parameter list after the lock has been released. If an operand not in the parameter list is fetched before the lock is obtained, it is fetched again after the lock has been obtained.

The function code can specify any of six operations: compare and load, compare and swap, double compare and swap, compare and swap and store, compare and swap and double store, or compare and swap and triple store.

A test bit in general register 0 specifies, when one, that a lock is not to be obtained and none of the six operations is to be performed but, instead, the validity of the function code is to be tested. This will be useful if additional function codes for additional operations are assigned in the future. This definition is written as if the test bit is zero except when stated otherwise.

If compare and load is specified, the first-operand comparison value and the second operand are compared. If they are equal, the fourth operand is placed in the third-operand location. If the comparison indicates inequality, the second operand is placed in the first-operand-comparison-value location as a new first-operand comparison value.

If compare and swap is specified, the first-operand comparison value and the second operand are compared. If they are equal, the first-operand replacement value is stored at the second-operand location. If the comparison indicates inequality, the second operand is placed in the first-operand-comparison-value location as a new first-operand comparison value.

If double compare and swap is specified, the first-operand comparison value and the second operand are compared. If they are equal, the third-operand comparison value and the fourth operand are compared. If both comparisons indicate equality, the first-operand and third-operand replacement values are stored at the second-operand location and fourth-operand location, respectively. If the first comparison indicates inequality, the second operand is placed in the first-operand-comparison-value location as a new first-operand comparison value. If the first comparison indicates equality but the second does not, the fourth operand is placed in the third-operand-com-

parison-value location as a new third-operand comparison value.

If compare and swap and store, double store, or triple store is specified, the first-operand comparison value and the second operand are compared. If they are equal, the first-operand replacement value is stored at the second-operand location, and the third operand is stored at the fourth-operand location. Then, if the operation is the double-store or triple-store operation, the fifth operand is stored at the sixth-operand location, and, if it is the triple-store operation, the seventh operand is stored at the eighth-operand location. If the first-operand comparison indicates inequality, the second operand is placed in the first-operand-comparison-value location as a new first-operand comparison value.

After any of the six operations, the result of the comparison or comparisons is indicated in the condition code.

The function code (FC) is in bit positions 56-63 of general register 0. The function code specifies not only the operation to be performed but also the length of the operands and whether the first-operand comparison and replacement values and the third operand or third-operand comparison and replacement values, which are referred to collectively simply as the first and third operands, are in general registers or a parameter list. The pattern of the function codes is as follows:

- A function code that is a multiple of 4 (including 0) specifies a 32-bit length with the first and third operands in bit positions 32-63 of general registers.
- A function code that is one more than a multiple of 4 specifies a 64-bit length with the first and third operands in a parameter list.
- A function code that is 2 more than a multiple of 4 specifies a 64-bit length with the first and third operands in bit positions 0-63 of general registers.
- A function code that is 3 more than a multiple of 4 specifies a 128-bit length with the first and third operands in a parameter list.

Figure 7-345 on page 7-338 shows the function codes, operation names, and operand lengths, and also symbols that may be used to refer to the operations in discussions. For example, PLO.DCS may be

used to mean PERFORM LOCKED OPERATION with function code 8. In the symbols, the letter “G” indicates a 64-bit operand length, the letter “R” indicates that some or all 64-bit operands are in general registers, and the letter “X” indicates a 128-bit operand length.

Function Code	Operation	Operand Length (Bits)	Function Symbol
0	Compare and load	32	CL
1	Same as 0	64	CLG
2	Same as 0	64	CLGR
3	Same as 0	128	CLX
4	Compare and swap	32	CS
5	Same as 4	64	CSG
6	Same as 4	64	CSGR
7	Same as 4	128	CSX
8	Double compare and swap	32	DCS
9	Same as 8	64	DCSG
10	Same as 8	64	DCSGR
11	Same as 8	128	DCSX
12	Compare and swap and store	32	CSST
13	Same as 12	64	CSSTG
14	Same as 12	64	CSSTGR
15	Same as 12	128	CSSTX
16	Compare and swap and double store	32	CSDST
17	Same as 16	64	CSDSTG
18	Same as 16	64	CSDSTGR
19	Same as 16	128	CSDSTX
20	Compare and swap and triple store	32	CSTST
21	Same as 20	64	CSTSTG
22	Same as 20	64	CSTSTGR
23	Same as 20	128	CSTSTX

Figure 7-345. PERFORM LOCKED OPERATION Function Codes and Operations

In the z/Architecture architectural mode, the CPU can perform all of the operations specified by the function codes listed in Figure 7-345. Function codes specifying operations that the CPU can perform are called valid. Function codes that have not been assigned to operations or that specify operations that the CPU cannot perform because the operations are not implemented (installed) are called invalid. In the ESA/390-compatibility mode, it is unpredictable whether the CPU can perform operations that are

unique to the z/Architecture architectural mode (that is, function codes 2, 3, 6, 7, 10, 11, 14, 15, 18, 19, 22 and 23).

Bit 55 of general register 0 is the test bit (T). When bit 55 is zero, the function code in general register 0 must be valid; otherwise, a specification exception is recognized. When bit 55 is one, the condition code is set to 0 if the function code is valid or to 3 if the function code is invalid, and no other operation is performed. When the test operation is performed in the ESA/390-compatibility mode, function codes 2, 3, 6, 7, 10, 11, 14, 15, 18, 19, 22 and 23 result in condition code 3 being set.

Bits 32-54 of general register 0 must be all zeros; otherwise, a specification exception is recognized.

When bit 55 of the register is one, this is the only exception that can be recognized. Bits 0-31 of general register 0 are ignored.

The lock to be used is represented by a program lock token (PLT) whose logical address is specified in general register 1. In the 24-bit addressing mode, the PLT address is bits 40-63 of general register 1, and bits 0-39 of the register are ignored. In the 31-bit addressing mode, the PLT address is bits 33-63 of the register, and bits 0-32 of the register are ignored. In the 64-bit addressing mode, the PLT address is bits 0-63 of the register.

The contents of general registers 0 and 1 described above are shown in Figure 7-346.

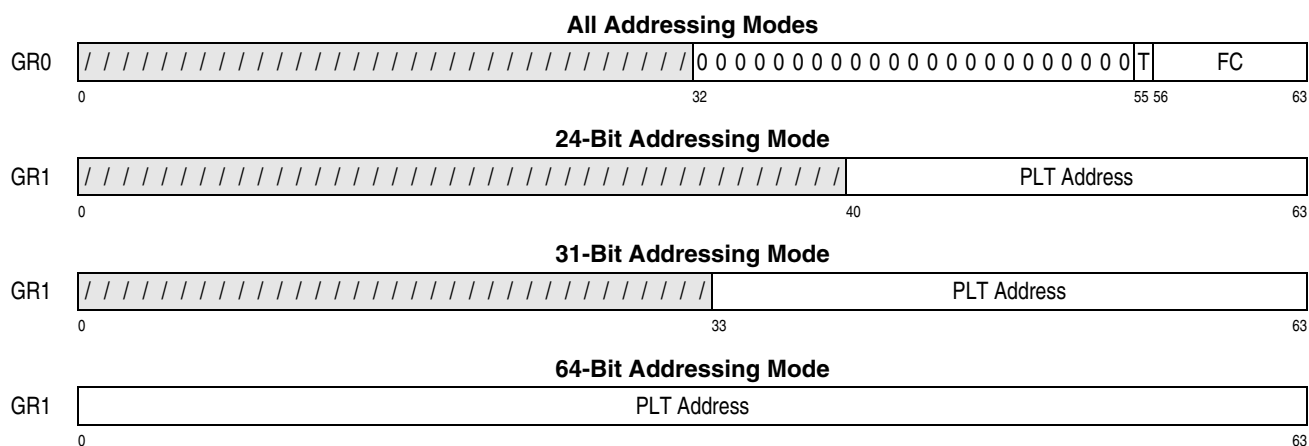

Figure 7-346. General Register Assignment for PLO

For the even-numbered function codes, including 0, the first-operand comparison value is in general register R_1 . For the even-numbered function codes beginning with 4, the first-operand replacement value is in general register $R_1 + 1$, and R_1 designates an even-odd pair of registers and must designate an even-numbered register; otherwise, a specification exception is recognized. For function codes 0 and 2, R_1 can be even or odd.

For function codes 0, 2, 12, and 14, the third operand is in general register R_3 , and R_3 can be even or odd.

For function codes 8 and 10, the third-operand comparison value is in general register R_3 , the third-operand replacement value is in general register $R_3 + 1$, and R_3 designates an even-odd pair of registers and must designate an even-numbered register; otherwise, a specification exception is recognized.

For all function codes, the B_2 and D_2 fields of the instruction specify the second-operand address.

For function codes 0, 2, 8, 10, 12, and 14, the B_4 and D_4 fields of the instruction specify the fourth-operand address.

For function codes 1, 3, 5, 7, 9, 11, 13, 15, and 16-23, the B_4 and D_4 fields of the instruction specify the address of a parameter list that is used by the instruction, and this address is not called the fourth-operand address. The parameter list contains odd-numbered operands, including comparison and replacement values, and addresses of even-numbered operands other than the second operand. In the access-register mode, the parameter list also contains access-list-entry tokens (ALETs) associated with the even-numbered-operand addresses.

In the access-register mode, for function codes that cause use of a parameter list containing an ALET, R_3 must not be zero; otherwise, a specification exception is recognized.

The rules about R_1 and R_3 , and the use of the address specified by B_4 and D_4 , are summarized in Figure 7-347 on page 7-340.

Function Codes	Operation	R_1	R_3	$D_4(B_4)$
0 and 2	Compare and load	EO	EO	Op4a
1 and 3	Compare and load	-	NZ	PLa
4 and 6	Compare and swap	E	-	-
5 and 7	Compare and swap	-	-	PLa
8 and 10	Double compare and swap	E	E	Op4a
9 and 11	Double compare and swap	-	NZ	PLa
12 and 14	Compare and swap and store	E	EO	Op4a
13 and 15	Compare and swap and store	-	NZ	PLa
16 and 18	Compare and swap and double store	E	NZ	PLa
17 and 19	Compare and swap and double store	-	NZ	PLa
20 and 22	Compare and swap and triple store	E	NZ	PLa
21 and 23	Compare and swap and triple store	-	NZ	PLa

Explanation:

- Ignored.
- E Must be even.
- EO Can be even or odd.
- NZ Must be nonzero in the access-register mode. Ignored otherwise.
- Op4a $D_4(B_4)$ is operand-4 address.
- PLa $D_4(B_4)$ is parameter-list address.

Figure 7-347. Register Rules and $D_4(B_4)$ Usage for PERFORM LOCKED OPERATION

Figure 7-348 on page 7-341 shows the locations of the operands (including operand comparison and replacement values), operand addresses, and parameter-list address used by the instruction.

Operand addresses in a parameter list, if used, are in doublewords in the list. In the 24-bit addressing mode, an operand address is bits 40-63 of a double-

word, and bits 0-39 of the doubleword are ignored. In the 31-bit addressing mode, an operand address is bits 33-63 of a doubleword, and bits 0-32 of the doubleword are ignored. In the 64-bit addressing mode, an operand address is bits 0-63 of a doubleword.

In the access-register mode, access register 1 specifies the address space containing the program lock token (PLT), access register B_2 specifies the address space containing the second operand, and access register B_4 specifies the address space containing a fourth operand or a parameter list as shown in Figure 7-348 on page 7-341. Also, for an operand whose address is in the parameter list, an access-list-entry token (ALET) is in the list along with the address and is used in the access-register mode to specify the address space containing the operand.

In the access-register mode, if an access exception or PER storage-alteration event is recognized for an operand whose address is in the parameter list, the associated ALET in the parameter list is loaded into access register R_3 when the exception or event is recognized. Then, during the resulting program interruption, if a value is due to be stored as the exception access identification at real location 160 or the PER access identification at real location 161, R_3 is stored. If the instruction execution is completed without the recognition of an exception or event, the contents of access register R_3 are unpredictable. When not in the access-register mode, or when a parameter list containing an ALET is not used, the contents of access register R_3 remain unchanged.

Storage operand 2, and, when present, storage operands 4, 6, and 8 must be designated on an integral boundary, which is a word boundary for function codes that are a multiple of 4, a doubleword boundary for function codes that are one or 2 more than a multiple of 4, or a quadword boundary for function codes that are 3 more than a multiple of 4. A parameter list, if used, must be designated on a doubleword boundary. Otherwise, a specification exception is recognized. The program-lock-token (PLT) address in general register 1 does not have a boundary-alignment requirement.

All unused fields in a parameter list should contain all zeros; otherwise, the program may not operate compatibly in the future.

A serialization function is performed immediately after the lock is obtained and again immediately before it is released. However, values fetched from

Function Codes ¹	Operation	Op1c	Op1r	Op2a	Op3 or		Op4a	Op5 and Op6a	Op7 and Op8a	PLa
					Op3c	Op3r				
0 and 2	Compare and load	R ₁	-	D ₂ (B ₂)	R ₃		D ₄ (B ₄)	-	-	-
1 and 3	Compare and load	PL	-	D ₂ (B ₂)	PL		PL	-	-	D ₄ (B ₄)
4 and 6	Compare and swap	R ₁	R ₁ +1	D ₂ (B ₂)	-		-	-	-	-
5 and 7	Compare and swap	PL	PL	D ₂ (B ₂)	-		-	-	-	D ₄ (B ₄)
8 and 10	Double compare and swap	R ₁	R ₁ +1	D ₂ (B ₂)	R ₃	R ₃ +1	D ₄ (B ₄)	-	-	-
9 and 11	Double compare and swap	PL	PL	D ₂ (B ₂)	PL	PL	PL	-	-	D ₄ (B ₄)
12 and 14	Compare and swap and store	R ₁	R ₁ +1	D ₂ (B ₂)	R ₃		D ₄ (B ₄)	-	-	-
13 and 15	Compare and swap and store	PL	PL	D ₂ (B ₂)	PL		PL	-	-	D ₄ (B ₄)
16 and 18	Compare and swap and double store	R ₁	R ₁ +1	D ₂ (B ₂)	PL		PL	PL	-	D ₄ (B ₄)
17 and 19	Compare and swap and double store	PL	PL	D ₂ (B ₂)	PL		PL	PL	-	D ₄ (B ₄)
20 and 22	Compare and swap and triple store	R ₁	R ₁ +1	D ₂ (B ₂)	PL		PL	PL	PL	D ₄ (B ₄)
21 and 23	Compare and swap and triple store	PL	PL	D ₂ (B ₂)	PL		PL	PL	PL	D ₄ (B ₄)

Explanation:

¹ For function codes that are a multiple of 4 (including 0) or one more than a multiple of 4, operands in general registers are in bit positions 32-63 of the registers, and bits 0-31 of the registers are ignored and remain unchanged. For function codes that are two more than a multiple of 4, operands in general registers are in bit positions 0-63 of the registers.

- Operand, value, or address is not used in the operation.

OpNc Operand-N comparison value.

OpNr Operand-N replacement value.

OpNa Operand-N address.

PL Operand, value, or address is in the parameter list.

PLa Parameter-list address.

Figure 7-348. Operand and Address Locations for PERFORM LOCKED OPERATION

the parameter list before the lock is obtained are not necessarily refetched. A serialization function is not performed if the test bit, bit 55 of general register 0, is one.

In the following figures showing the parameter lists for the different function codes, the offsets shown on the left are byte values.

Function Codes 0-3 (Compare and Load)

The locations of the operands and addresses used by the instruction are as shown in Figure 7-348 on page 7-341.

The parameter list used for function code 1 has the following format:

0	
8	Operand-1 Comparison Value
16	
24	
32	
40	Operand 3
48	
56	
64	Operand-4 ALET
72	Operand-4 Address

The parameter list used for function code 3 has the following format:

0	Operand-1 Comparison Value
8	Operand-1 Comparison Value (continued)
16	
24	
32	Operand 3
40	Operand 3 (continued)
48	
56	
64	Operand-4 ALET
72	Operand-4 Address

The first-operand comparison value is compared to the second operand. When the first-operand comparison value is equal to the second operand, the third operand is replaced by the fourth operand, and condition code 0 is set.

When the first-operand comparison value is not equal to the second operand, the first-operand com-

parison value is replaced by the second operand, and condition code 1 is set.

Function Codes 4-7 (Compare and Swap)

The locations of the operands and addresses used by the instruction are as shown in Figure 7-348 on page 7-341.

The parameter list used for function code 5 has the following format:

0	
8	Operand-1 Comparison Value
16	
24	Operand-1 Replacement Value

The parameter list used for function code 7 has the following format:

0	Operand-1 Comparison Value
8	Operand-1 Comparison Value (continued)
16	Operand-1 Replacement Value
24	Operand-1 Replacement Value (continued)

The first-operand comparison value is compared to the second operand. When the first-operand comparison value is equal to the second operand, the first-operand replacement value is stored at the second-operand location, and condition code 0 is set.

When the first-operand comparison value is not equal to the second operand, the first-operand comparison value is replaced by the second operand, and condition code 1 is set.

Function Codes 8-11 (Double Compare and Swap)

The locations of the operands and addresses used by the instruction are as shown in Figure 7-348 on page 7-341.

The parameter list used for function code 9 has the following format:

Parameter List for Function Code 9

0	
8	Operand-1 Comparison Value
16	
24	Operand-1 Replacement Value
32	
40	Operand-3 Comparison Value
48	
56	Operand-3 Replacement Value
64	Operand-4 ALET
72	Operand-4 Address

The parameter list used for function code 11 has the following format:

Parameter List for Function Code 11

0	Operand-1 Comparison Value
8	Operand-1 Comparison Value (continued)
16	Operand-1 Replacement Value
24	Operand-1 Replacement Value (continued)
32	Operand-3 Comparison Value
40	Operand-3 Comparison Value (continued)
48	Operand-3 Replacement Value
56	Operand-3 Replacement Value (continued)
64	Operand-4 ALET
72	Operand-4 Address

The first-operand comparison value is compared to the second operand. When the first-operand comparison value is equal to the second operand, the third-operand comparison value is compared to the fourth operand. When the third-operand comparison value is equal to the fourth operand (after the first-operand comparison value has been found equal to the second operand), the first-operand replacement value is stored at the second-operand location, the third-operand replacement value is stored at the fourth-operand location, and condition code 0 is set.

When the first-operand comparison value is not equal to the second operand, the first-operand comparison value is replaced by the second operand, and condition code 1 is set.

When the third-operand comparison value is not equal to the fourth operand (after the first-operand comparison value has been found equal to the second operand), the third-operand comparison value is replaced by the fourth operand, and condition code 2 is set.

Function Codes 12-15 (Compare and Swap and Store)

The locations of the operands and addresses used by the instruction are as shown in Figure 7-348 on page 7-341.

The parameter list used for function code 13 has the following format:

Parameter List for Function Code 13

0	
8	Operand-1 Comparison Value
16	
24	Operand-1 Replacement Value
32	
40	
48	
56	Operand 3
64	Operand-4 ALET
72	Operand-4 Address

The parameter list used for function code 15 has the following format:

Parameter List for Function Code 15

0	Operand-1 Comparison Value
8	Operand-1 Comparison Value (continued)
16	Operand-1 Replacement Value
24	Operand-1 Replacement Value (continued)
32	
40	
48	Operand 3
56	Operand 3 (continued)
64	Operand-4 ALET
72	Operand-4 Address

The first-operand comparison value is compared to the second operand. When the first-operand comparison value is equal to the second operand, the first-operand replacement value is stored at the second-

operand location, the third operand is stored at the fourth-operand location, and condition code 0 is set.

When the first-operand comparison value is not equal to the second operand, the first-operand comparison value is replaced by the second operand, and condition code 1 is set.

Function Codes 16-19 (Compare and Swap and Double Store)

The locations of the operands and addresses used by the instruction are as shown in Figure 7-348 on page 7-341.

The parameter list used for function code 16 has the following format:

Parameter List for Function Code 16

0	
8	
16	
24	
32	
40	
48	
56	Operand 3
64	Operand-4 ALET
72	Operand-4 Address
80	
88	Operand 5
96	Operand-6 ALET
104	Operand-6 Address

The parameter list used for function code 17 has the following format:

Parameter List for Function Code 17

0	
8	Operand-1 Comparison Value
16	
24	Operand-1 Replacement Value
32	
40	
48	
56	Operand 3
64	Operand-4 ALET
72	Operand-4 Address
80	
88	Operand 5
96	Operand-6 ALET
104	Operand-6 Address

The parameter list used for function code 18 has the following format:

Parameter List for Function Code 18

0	
8	
16	
24	
32	
40	
48	
56	Operand 3
64	Operand-4 ALET
72	Operand-4 Address
80	
88	Operand 5
96	Operand-6 ALET
104	Operand-6 Address

The parameter list used for function code 19 has the following format:

0	Operand-1 Comparison Value	
8	Operand-1 Comparison Value (continued)	
16	Operand-1 Replacement Value	
24	Operand-1 Replacement Value (continued)	
32		
40		
48	Operand 3	
56	Operand 3 (continued)	
64		Operand-4 ALET
72	Operand-4 Address	
80	Operand 5	
88	Operand 5 (continued)	
96		Operand-6 ALET
104	Operand-6 Address	

The first-operand comparison value is compared to the second operand. When the first-operand comparison value is equal to the second operand, the first-operand replacement value is stored at the second-operand location, the third operand is stored at the fourth-operand location, the fifth operand is stored at the sixth-operand location, and condition code 0 is set.

When the first-operand comparison value is not equal to the second operand, the first-operand comparison value is replaced by the second operand, and condition code 1 is set.

Function Codes 20-23 (Compare and Swap and Triple Store)

The locations of the operands and addresses used by the instruction are as shown in Figure 7-348 on page 7-341.

The parameter list used for function code 20 has the following format:

0		
8		
16		
24		
32		
40		
48		
56		Operand 3
64		Operand-4 ALET
72	Operand-4 Address	
80		
88		Operand 5
96		Operand-6 ALET
104	Operand-6 Address	
112		
120		Operand 7
128		Operand-8 ALET
136	Operand-8 Address	

The parameter list used for function code 21 has the following format:

Parameter List for Function Code 21

0	
8	Operand-1 Comparison Value
16	
24	Operand-1 Replacement Value
32	
40	
48	
56	Operand 3
64	Operand-4 ALET
72	Operand-4 Address
80	
88	Operand 5
96	Operand-6 ALET
104	Operand-6 Address
112	
120	Operand 7
128	Operand-8 ALET
136	Operand-8 Address

The parameter list used for function code 22 has the following format:

Parameter List for Function Code 22

0	
8	
16	
24	
32	
40	
48	
56	Operand 3
64	Operand-4 ALET
72	Operand-4 Address
80	
88	Operand 5
96	Operand-6 ALET
104	Operand-6 Address
112	
120	Operand 7
128	Operand-8 ALET
136	Operand-8 Address

The parameter list used for function code 23 has the following format:

0	Operand-1 Comparison Value	
8	Operand-1 Comparison Value (continued)	
16	Operand-1 Replacement Value	
24	Operand-1 Replacement Value (continued)	
32		
40		
48	Operand 3	
56	Operand 3 (continued)	
64		Operand-4 ALET
72	Operand-4 Address	
80	Operand 5	
88	Operand 5 (continued)	
96		Operand-6 ALET
104	Operand-6 Address	
112	Operand 7	
120	Operand 7 (continued)	
128		Operand-8 ALET
136	Operand-8 Address	

The first-operand comparison value is compared to the second operand. When the first-operand comparison value is equal to the second operand, the first-operand replacement value is stored at the second-operand location, the third operand is stored at the fourth-operand location, the fifth operand is stored at the sixth-operand location, the seventh operand is stored at the eighth-operand location, and condition code 0 is set.

When the first-operand comparison value is not equal to the second operand, the first-operand comparison value is replaced by the second operand, and condition code 1 is set.

Locking

A lock is obtained at the beginning of the operation and released at the end of the operation. The lock obtained is represented by a program lock token (PLT) whose logical address is specified in general register 1 as already described.

A PLT is a value produced by a model-dependent transformation of the PLT logical address. Depending on the model, the PLT may be derived directly from

the PLT logical address or, when DAT is on, from the real address that results from transformation of the PLT logical address by DAT. If DAT is used, access-register translation (ART) precedes DAT in the access-register mode.

A PLT selects one of a model-dependent number of locks within the configuration. Programs being executed by different CPUs can be assured of specifying the same lock only by specifying PLT logical addresses that are the same and that can be transformed to the same real address by the different CPUs.

Since a model may or may not use ART and DAT when forming a PLT, access-exception conditions that can be encountered during ART and DAT may or may not be recognized as exceptions. There is no accessing of a location designated by a PLT, but an addressing exception may be recognized for the location. A protection exception is not recognized for any reason during processing of a PLT logical address.

The CPU can hold one lock at a time.

When PERFORM LOCKED OPERATION is executed by this CPU and is to use a lock that is already held by another CPU due to the execution of a PERFORM LOCKED OPERATION instruction by the other CPU, the execution by this CPU is delayed until the lock is no longer held. An excessive delay can be caused only by a machine malfunction and is a machine-check condition.

The order in which multiple requests for the same lock are satisfied is undefined.

A nonrecoverable failure of a CPU while holding a lock may result in a machine check, entry into the check-stop state, or system check stop. The machine check is processing backup if all operands are undamaged or processing damage if register operands are damaged. If a machine check or the check-stop state is the result, either no storage operands have been changed or else all storage operands that were due to be changed have been correctly changed, and, in either case, the lock has been released. If the storage operands are not in either their correct original state or their correct final state, the result is system check stop.

Storage-Operand References

The accesses to the even-numbered storage operands appear to be word concurrent, as observed by other CPUs, for function codes that are a multiple of 4 or doubleword concurrent for function codes that are one, 2, or 3 more than a multiple of 4. The accesses to the doublewords in the parameter list appear to be doubleword concurrent, as observed by other CPUs, regardless of the function code.

As observed by other CPUs, all storage operands may be tested for access exceptions before a lock is obtained. (A channel program cannot observe a lock.)

As observed by other CPUs, in all operations except the compare-and-swap operation (which does not have a fourth operand), the fourth operand is accessed while the lock is held only if a comparison of the first-operand comparison value to the second operand while the lock is held has indicated equality. In these operations, the fourth operand is accessed before the lock is held only if a comparison of the first-operand comparison value to the second operand has indicated equality and only if, when DAT is on, an INVALIDATE PAGE TABLE ENTRY instruction executed by another CPU after the fetch of the second operand will not be the cause of a page-translation exception recognized for the fourth operand, which it will if it sets to one the page-invalid bit in the page-table entry for the fourth operand when this CPU does not have a TLB entry corresponding to that page-table entry. In the compare-and-swap-and-double-store and compare-and-swap-and-triple-store operations, the sixth operand, and also the eighth operand in the triple-store operation, are treated the same as the fourth operand described above. The reason for this specification about INVALIDATE PAGE TABLE ENTRY is given in programming note 7.

Provided that accessing of an operand is not prohibited as described in the preceding paragraph, store-type access exceptions may be recognized for the fourth, sixth, or eighth operands even when a store does not occur because of the results of a comparison. A storage-alteration PER event is recognized, and a change bit is set, only if a store occurs.

When a comparison is made between an operand comparison value and an operand before the lock is obtained and indicates inequality, the lock still is obtained. The condition code is set only as a result of a comparison made while the lock is held. When con-

dition code 1 or 2 is set, the first-operand comparison value or third-operand comparison value is replaced only by means of a fetch of the second operand or fourth operand, respectively, made while the lock is held, as observed by other CPUs.

In those cases when a store is performed to the second-operand location and one or more of the fourth-, sixth-, and eighth-operand locations, the store to the second-operand location is always performed last, as observed by other CPUs and by channel programs.

Stores into the parameter list may be performed while the lock is held or after it has been released.

Access exceptions may be recognized for parameter-list locations even when the locations are not required in the operation. The locations are those beginning at offset 0 and extending up through the last location defined for the function code used.

For the compare-and-load and compare-and-swap operations, the operation is suppressed on all addressing and protection exceptions.

When a nonrecoverable failure of a CPU while holding a lock results in a machine check or entry into the check-stop state, either no storage operands have been changed or else all storage operands that were due to be changed have been correctly changed. The latter may be accomplished by repeating stores that were performed successfully before the failure. Therefore, there may be two single-access store references (possibly the store part of an update reference and then a store reference) to the store-type operands, with the first value stored equal to the second value stored.

Resulting Condition Code:

When test bit is zero:

- 0 All comparisons equal; replacement value or values stored or loaded
- 1 First-operand comparison not equal; first-operand comparison value replaced
- 2 -- (all operations except double compare and swap)
- 2 First-operand comparison equal but third-operand comparison not equal; third-operand comparison value replaced (double compare and swap)
- 3 --

When test bit is one:

- 0 Function code valid
- 1 --
- 2 --
- 3 Function code invalid

Program Exceptions:

- Access (for all function codes, fetch, except addressing and protection for PLT location, program lock token, model-dependent; for function codes 0-3, fetch, operand 2; for function codes 4-23, fetch and store, operand 2; for odd-numbered function codes, fetch and store, parameter list; for function codes 16, 18, 20, and 22, fetch, parameter list; for function codes 0-3, fetch, operand 4; for function codes 8-11, fetch and store, operand 4; for function codes 12-23, store, operand 4; for function codes 16-23, store, operand 6; for function codes 20-23, store, operand 8)
- Specification
- Transaction constraint

Programming Notes:

1. In configurations that support the transactional-execution facility, a transaction may provide benefits over the use of PERFORM LOCKED OPERATION, as follows:
 - a. Transactional execution may provide improved performance over an equivalent code path that uses PLO.
 - b. Transactional execution does not require the specification of a program lock token in general register 1.
 - c. Transactional execution does not require the use of a parameter list for more complex operations.
 - d. Transactional execution provides a much broader scope of operations that can be performed, all of which appear to execute in a block-concurrent manner as observed by other CPUs and the channel subsystem.
 - e. The use of classic interlocked-access techniques on one CPU can correctly coexist with transactional execution on another CPU. This coexistence is not possible using PLO, as explained in programming note 4, below.

If a program that uses PLO is changed to use transactional execution, then all occurrences of PLO that designate the same storage locations as the transaction should be changed to use transactional accesses to those locations if predictable storage results are to be obtained.

2. An example of the use of the PERFORM LOCKED OPERATION instruction is given in Appendix A, "Number Representation and Instruction-Use Examples."
3. When the contents of storage locations are changed by PERFORM LOCKED OPERATION instructions that are executed concurrently by different CPUs and that use the same lock, the changes to operands not in the parameter list will be completed by one of the CPUs before they are begun by the other CPU, depending on which CPU first obtains the lock.
4. The compare-and-swap functions of PERFORM LOCKED OPERATION are not performed by means of interlocked-update references. Concurrent store references by another CPU to the storage operands, even if they are interlocked-update references, will interfere unpredictably, in terms of the resulting register and storage contents, with the intended operation of PERFORM LOCKED OPERATION. All changes to the contents of the storage locations must be made by PERFORM LOCKED OPERATION instructions that use the same lock, if predictable storage results are to be obtained.
5. Because a nonrecoverable failure of a CPU while executing PERFORM LOCKED OPERATION may cause two stores of the same value to a store-type operand, a concurrent store made by another CPU to the same operand but not by executing PERFORM LOCKED OPERATION may be lost.
6. When programs in different address spaces are using the same lock when DAT is on, the programs must ensure that they are using PLT logical addresses that are the same and that will be translated to the same real address regardless of the address space in which a translation occurs. Otherwise, the programs may in fact use different locks.
7. The section "Storage-Operand References" on page 7-347 contains a specification concerning the INVALIDATE PAGE TABLE ENTRY (IPTE) instruction. The need for the specification is

shown by the following example that is possible without the specification.

- a. CPU 1 begins to execute a PERFORM LOCKED OPERATION instruction with function code 8, which is referred to as PLO.DCS. Operand 2 is a location, Qtail, containing the address (the first-operand comparison value) of the last element, element X, on a queue, and operand 4 is a location in that element containing the address (0, the third-operand comparison value) of the next (nonexisting) element on the queue. The purpose of the PLO instruction is to enqueue an element by placing the address of the element (the first-operand and third-operand replacement values) in both operand 2 and operand 4. With the lock not held, the PLO instruction fetches operand 2 and compares it, with an equal result, to the first-operand comparison value.
 - b. CPU 2 completely executes a PLO.DCS instruction to dequeue element X, which is the only element on the queue, from the queue. The PLO instruction stores 0 in Qtail and also in Qhead, which is a location containing the address of the first element on the queue. The program on CPU 2 processes the dequeued element and then invokes the freemain service of the control program to deallocate the storage containing the element. The freemain service uses IPTE to set the page-invalid bit to one in the page-table entry for the page containing element X. The IPTE instruction immediately sets the page-invalid bit to one, and then it waits for the signal that all other CPUs have cleared their TLBs of entries corresponding to the page.
 - c. CPU 1 attempts to fetch operand 4. CPU 1 does not have a TLB entry for the operand-4 page. CPU 1 signals CPU 2 that the CPU 2 IPTE instruction may proceed.
 - d. CPU 2 completes its IPTE instruction. The program on CPU 2 sets a software bit in the page-table entry to one to indicate that the page has been freemained and that, therefore, a reference to the page should result in presentation by the control program of an addressing exception to the program making the reference.
 - e. CPU 1 attempts to do DAT for operand 4 and sees that the page-invalid bit is one. CPU 1 performs a program interruption indicating a page-translation exception. The exception handler sees that the software bit indicating freemained is one, and it presents an addressing exception to the CPU 1 program, which causes an abend of the program.
- If CPU 1 had had a TLB entry for the page, its PLO instruction would not have been interrupted, and the comparison of the first-operand comparison value to the second operand while the lock was held would indicate that CPU 2 had changed the second operand. The PLO instruction would set condition code 1. If CPU 1 did not have a TLB entry but IPTE could not set the page-invalid bit to one while CPU 1 was executing an instruction, CPU 1 could successfully translate the operand-4 address and, again, discover while the lock was held that operand 2 had changed. The case when operand 2 points to element X but the freemained bit for the element-X page is one is a programming error.
8. For functions that use a parameter list in the access register mode, the value in the R_3 field of the instruction should be different from that of the B_2 and B_4 fields. Because access register R_3 is modified as a result of an access exception, subsequent re-execution of the instruction (for example, following the resolution of a page-translation exception) may yield unpredictable results if the R_3 field designates the same access register as that of the second operand or parameter list.

9. "Summary of PERFORM LOCKED OPERATION Results" on page 7-351 summarizes the results of the operation.

Op1c=Op2	Op3c=Op4	Cond Code	Action
Function Codes 0-3 (Compare and Load)			
No	-	1	Op2 → Op1c
Yes	-	0	Op4 → Op3
Function Codes 4-7 (Compare and Swap)			
No	-	1	Op2 → Op1c
Yes	-	0	Op1r → Op2
Function Codes 8-11 (Double Compare and Swap)			
No	-	1	Op2 → Op1c
Yes	No	2	Op4 → Op3c
Yes	Yes	0	Op1r → Op2 Op3r → Op4
Function Codes 12-15 (Compare and Swap and Store)			
No	-	1	Op2 → Op1c
Yes	-	0	Op1r → Op2 Op3 → Op4
Function Codes 16-19 (Compare and Swap and Double Store)			
No	-	1	Op2 → Op1c
Yes	-	0	Op1r → Op2 Op3 → Op4 Op5 → Op6
Function Codes 20-23 (Compare and Swap and Triple Store)			
No	-	1	Op2 → Op1c
Yes	-	0	Op1r → Op2 Op3 → Op4 Op5 → Op6 Op7 → Op8
Explanation:			
- Not applicable.			
OpNc Operand-N comparison value.			
OpNr Operand-N replacement value.			

Figure 7-349. Summary of PERFORM LOCKED OPERATION Results

PERFORM PROCESSOR ASSIST

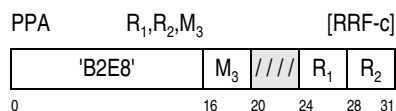

The M₃ field contains a 4-bit unsigned binary integer function code specifying the processor-assist func-

tion to be performed. The function codes for PERFORM PROCESSOR ASSIST are as follows.

Code	Meaning
0	Reserved
1	Transaction-abort assist
2-14	Reserved
15	In-order-execution assist

The operation of each assist function, and the registers used by the function are as follows:

Transaction-Abort Assist: When the function code in the M₃ field is 1 and the processor-assist facility is installed, the processor is requested to assist following an aborted nonconstrained transaction.

The program is expected to provide an unsigned 32-bit binary integer in bits 32-63 of general register R₁, specifying the number of times the nonconstrained transaction has been repeatedly aborted. Depending on the value of this integer, the processor may take escalating actions to increase the likelihood of successful completion of the transaction in a subsequent execution.

Bits 0-31 of general register R₁ are ignored, and bits 32-63 of the register are unchanged. General register R₂ is ignored, however the R₂ field of the instruction should contain zeros; otherwise, the program may not operate compatibly in the future.

In-order-execution assist: When the function code in the M₃ field is 15 and the PPA-in-order facility is installed, the processor is requested to complete processing all instructions prior to this PPA instruction, as observed by this CPU, before attempting storage-operand references for any instruction after this PPA instruction.

The R₁ and R₂ fields are ignored and the instruction is executed as a no-operation.

The in-order-execution assist does not necessarily perform any of the steps for architectural serialization described in the section “CPU Serialization” on page 5-130.

Reserved: Reserved function codes should not be specified; otherwise, the program may not operate compatibly in the future.

Condition Code: The code remains unchanged.

Program Exceptions:

- Operation (neither the PPA-in-order facility nor the processor-assist facility is installed)
- Transaction constraint

Programming Notes:

1. For the transaction-abort-assist function, a larger value in general register R₁ does not necessarily guarantee successful completion when the transaction is reexecuted, and it may unnecessarily delay the CPU. Therefore, the program should provide an accurate count of the number of times a transaction has been aborted in the register.

A value of one in bits 32-63 of general register R₁ means that the transaction has been aborted once, a value of two means the transaction has been aborted twice, and so forth.

2. An example of the use of PERFORM PROCESSOR ASSIST is shown in programming note 2 on page 5-106.
3. The processor-assist facility is indicated by facility bit 49.
4. The in-order-execution assist is designed to be used to prevent the out of order execution of conditional paths.

PERFORM RANDOM NUMBER OPERATION

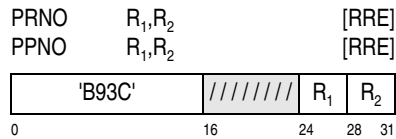

A function specified by the function code in general register 0 is performed.

Bits 16-23 of the instruction are reserved and should contain zeros; otherwise, the instruction may not operate compatibly in the future.

Bit positions 57-63 of general register 0 contain the function code. Figure 7-350 shows the assigned function codes for PERFORM RANDOM NUMBER OPERATION. All other function codes are unassigned.

Code	Function	Parameter Block Size (bytes)
0	PRNO Query	16
3	PRNO-SHA-512-DRNG	240
112	PRNO-TRNG-Query-Raw-to-Conditioned-Ratio	8
114	PRNO-TRNG	—
Explanation:		
—	Not applicable to the function.	
DRNG	Deterministic random-number generation.	
TRNG	True random-number generation.	

Figure 7-350. Function Codes for PERFORM RANDOM NUMBER OPERATION

If bits 57-63 of general register 0 designate an unassigned or uninstalled function code, a specification exception is recognized.

The PRNO-query function provides the means of indicating the availability of the other functions.

For the PRNO-SHA-512-DRNG function, bit 56 of general register 0 is the modifier bit. When the modifier bit is zero, a generate operation is performed, and when the modifier bit is one, a seed operation is performed. The modifier bit is ignored for all other functions. All other bits of general register 0 are ignored.

Depending on the function, a parameter block, first operand, and second operand in storage may be accessed by the instruction. When applicable, general register 1 contains the address of the leftmost byte of the parameter block in storage. When applicable, general registers R_1 and R_2 designate an even-odd pair of general registers corresponding to the first and second operands, respectively. The even-numbered register contains the address of the operand in storage, and the odd-numbered register contains the length of the operand. The storage location corresponding to an operand is only accessed when the length of the corresponding operand is nonzero.

All general registers that contain an address are subject to the current addressing mode. In the 24-bit addressing mode, the contents of bit positions 40-63 of the register constitute the address of the storage location, and the contents of bit positions 0-39 are ignored. In the 31-bit addressing mode, the contents of bit positions 33-63 of the register constitute the address of the storage location, and the contents of bit positions 0-32 are ignored. In the 64-bit addressing mode, the contents of bit positions 0-63 of the register constitute the address of the storage location. In the access register mode, general register 1, R_1 , and R_2 specifies the address space containing the parameter block, first operand, and second operand, respectively.

The odd-numbered registers containing an operand's length are also subject to the current addressing mode. In either the 24- or 31-bit addressing mode, the contents of bit positions 32-63 of the register form a 32-bit unsigned binary integer which specifies the

number of bytes in the storage operand, and bit positions 0-31 are ignored. In the 64-bit addressing mode, the contents of bit positions 0-63 of the register form a 64-bit unsigned binary integer which specifies the number of bytes in the storage operand.

For the PRNO-SHA-512-DRNG function's generate operation, the first-operand length is updated in general register $R_1 + 1$ at the completion of the instruction. The first-operand address in general register R_1 is not updated by the PRNO-SHA-512-DRNG function; however in the 24-bit addressing mode, bits 32-39 may be set to zero or remain unchanged, and in the 31-bit addressing mode, bit 32 may be set to zero or remain unchanged, regardless of the first-operand length.

For the PRNO-TRNG function, the first-operand address, first-operand length, second-operand address, and second-operand length in general registers R_1 , $R_1 + 1$, R_2 , and $R_2 + 1$, respectively, are updated at the completion of the instruction. In the 24-bit addressing mode, bits 40-63 of the even-numbered register are incremented by the number of bytes processed for the respective operand, bits 0-31 of the register remain unchanged, and regardless of the operand's length, bits 32-39 of the register may be set to zero or may remain unchanged. In the 31-bit addressing mode, bits 33-63 of the even-numbered register are incremented by the number of bytes processed for the respective operand, bits 0-31 of the register remain unchanged, and regardless of the operand's length, bit 32 of the register may be set to zero or may remain unchanged. In the 64-bit addressing mode, bits 0-63 of the even-numbered register are incremented by the number of bytes processed for the respective operand. In either the 24- or 31-bit addressing mode, bits 32-63 of the odd-numbered register are decremented by the number of bytes processed for the respective operand, and bits 0-31 of the register remain unchanged. In the 64-bit addressing mode, bits 0-63 of the odd-numbered register are decremented by the number of bytes processed for the respective operand.

Figure 7-351 shows the contents of the general registers just described.

Depending on the function code in general register 0, one or more registers designating the parameter block, first operand, or second operand may not be

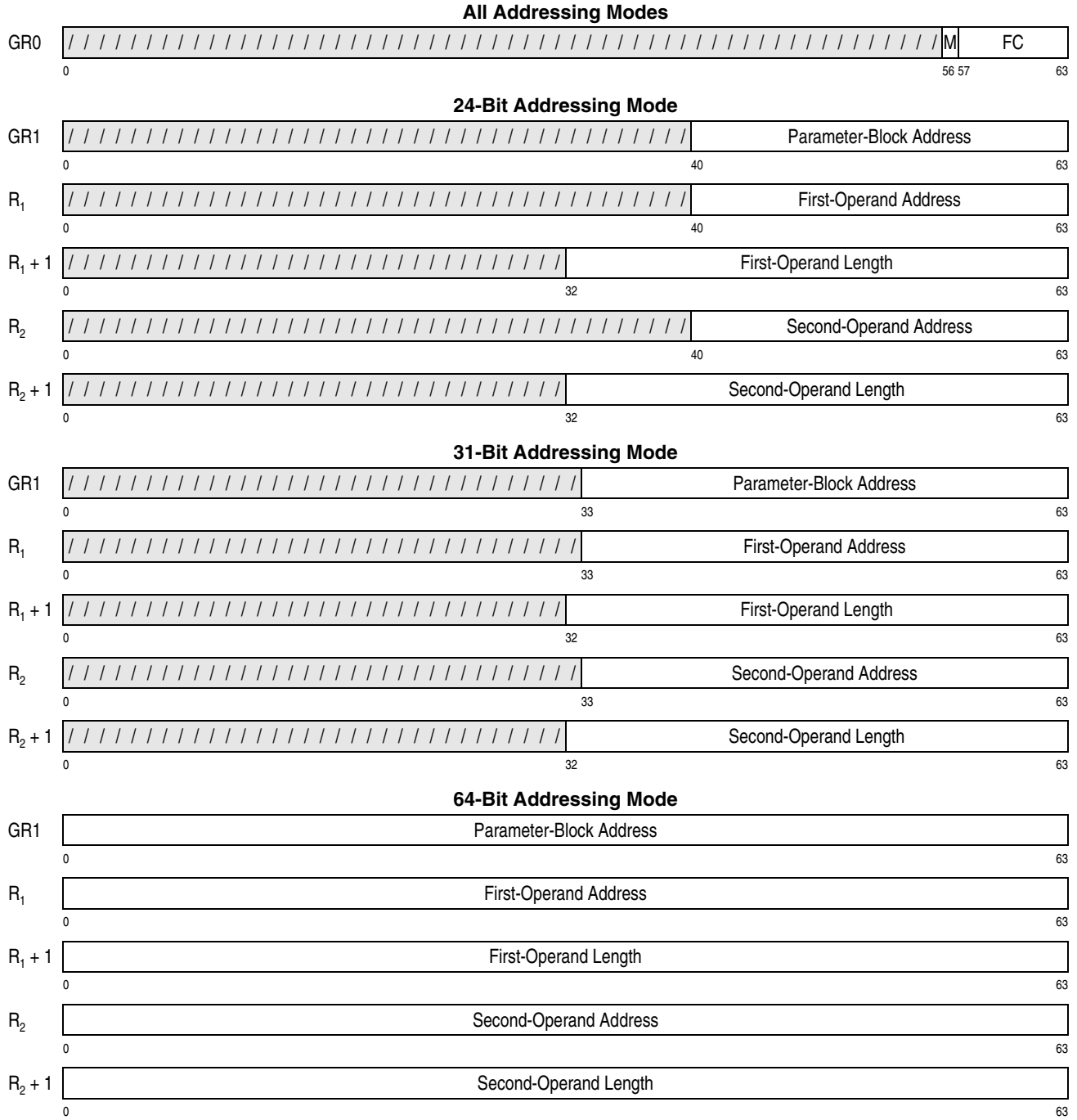

Explanation:

- FC Function code.
- M Modifier bit determining whether a seed or generate operation is performed.

Figure 7-351. General Register Assignment for PERFORM RANDOM NUMBER OPERATION

used by the function. Figure 7-352 summarizes the registers that are used by the various functions.

Function (Operation)	GR1	R ₁	R ₁ + 1	R ₂	R ₂ + 1
PRNO_Query	PBA (S)	—	—	—	—
PRNO-SHA-512-DRNG (Seed)	PBA (F,S)	—	—	O ₂ A (F)	O ₂ L
PRNO-SHA-512-DRNG (Generate)	PBA (F,S)	O ₁ A (S)	O ₁ L (D)	—	—
PRNO-TRNG-Query_Raw- to-Conditioned-Ratio	PBA (S)	—	—	—	—
PRNO-TRNG	—	O ₁ A (S,I)	O ₁ L (D)	O ₂ A (S,I)	O ₂ L (D)

Explanation:

— Not applicable to the function or operation. Storage location not accessed; register not modified.

D The register is decremented by the number of bytes processed by the instruction.

F Fetch access

I The register is incremented by the number of bytes processed by the instruction. Note, general register R₁ is not incremented for PRNO-SHA-512-DRNG generate operation.

O₁A When the first-operand length is nonzero, the address of the leftmost byte of the first operand; otherwise, not applicable.

O₁L First-operand length.

O₂A When the second-operand length is nonzero, the address of the leftmost byte of the second operand; otherwise, not applicable.

O₂L Second-operand length.

PBA Address of the leftmost byte of the parameter block.

S Store access.

Figure 7-352. Summary of Register Usage for PRNO Functions

When the parameter block overlaps any portion of the storage operands, the results are unpredictable.

When the R₁ or R₂ field is not applicable to a function (as shown in Figure 7-352), any storage location designated by the respective operand is not accessed, and access exceptions and PER zero-address-detection events are not recognized for the location. When an applicable storage-operand length is zero, access exceptions for the storage-operand location are not recognized. However, for functions that

access the parameter block, the parameter block is accessed even when the storage-operand length is zero.

As observed by other CPUs and the I/O subsystem, references to the parameter block and storage operands may be multiple-access references, accesses to these locations are not necessarily block-concurrent, and the sequence of these accesses or references is undefined.

A PER storage-alteration event is recognized only for the portion of the parameter block that is stored. For functions that store to the first- or second-operand locations, when a PER storage-alteration event is recognized, fewer than 4K additional bytes are stored into the respective locations before the event is reported. When a PER storage-alteration event is recognized for any combination of the first-operand location, the second-operand location, and the portion of the parameter block that is stored, it is unpredictable which of these locations is indicated in the PER access identification (PAID) and PER ASCE ID (AI). Similarly, when a PER zero-address-detection event is recognized for any combination of the first-operand location, the second-operand location, and the parameter block, it is unpredictable which of these locations is identified in the PAID and AI.

PRNO-Query (PRNO Function Code 0)

The contents of general registers R₁, R₁ + 1, R₂, and R₂ + 1 are ignored by the query function.

The locations of the operands and addresses used by the instruction are as shown in Figure 7-351 on page 7-354.

The parameter block used for the function has the following format:

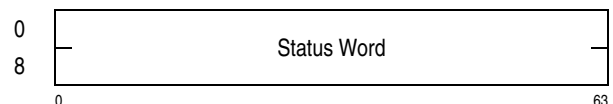

Figure 7-353. Parameter Block for PRNO-Query

A 128-bit status word is stored in the parameter block. Bits 0-127 of this field correspond to function codes 0-127, respectively, of the PERFORM RANDOM NUMBER OPERATION instruction. When a bit is one, the corresponding function is installed; otherwise, the function is not installed.

Condition code 0 is set when execution of the PRNO-Query function completes; condition code 3 is not applicable to this function.

PRNO-SHA-512-DRNG (PRNO Function Code 3)

Depending on the modifier bit, bit 56 of general register 0, the PRNO-SHA-512-DRNG function performs either a deterministic pseudorandom-number generate operation or a deterministic pseudorandom-number seed operation using the 512-bit secure-hash algorithm (SHA-512).

Deterministic pseudorandom-number generation, also known as deterministic random-bit generation, is defined in Reference [18.] on page xxx; refer to this publication for further description on terms used in this definition. Further description of the secure hash algorithm may be found in Reference [15.] on page xxx.

The locations of the operands and addresses used by the instruction are as shown in Figure 7-351 on page 7-354.

The parameter block used for the function represents the internal state of a deterministic random-number generator and has the following format:

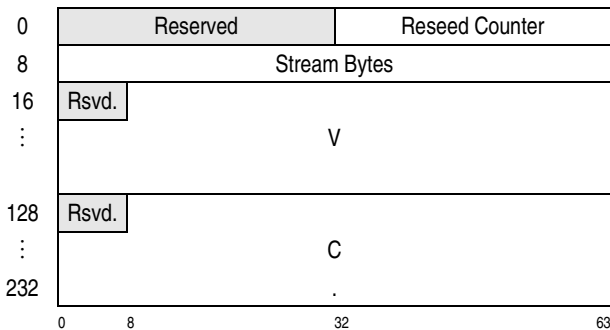

Figure 7-354. Parameter Block for PRNO-SHA-512-DRNG Function

The same parameter block format is used by both the generate operation and the seed operation (including instantiation and reseeding). A parameter block containing all zeros is considered to be not instantiated. The program should zero the parameter block prior to issuing the seed operation to instantiate the parameter block, and subsequently, the program should not alter the contents of the parameter block except to zero it; otherwise, unpredictable results may be produced by the instruction.

Reserved: Bytes 0-3, 16, and 128 of the parameter block are reserved. As observed by other CPUs and the I/O subsystem, the contents of byte 16 may appear to change during the execution of the instruction; however, byte 16 will contain zero when the instruction completes with condition code 0. As observed by other CPUs and the I/O subsystem, the contents of byte 128 may appear to change during the execution of the seed operation, however, byte 128 will contain zero at the completion of the seed operation.

Reseed Counter: Bytes 4-7 of the parameter block contain a 32-bit unsigned binary integer indicating the number of times that the instruction has completed with condition code 0 since the parameter block was last instantiated or reseeded.

When the reseed counter contains zero, the parameter block is considered to be not instantiated, and the following applies:

- Execution of the seed operation causes the parameter block to be instantiated with initial values, including setting the reseed counter to a value of one.
- Execution of the generate operation results in a general-operand data exception being recognized.

When the reseed counter contains a nonzero value, the parameter block is considered to be instantiated, and the following applies:

- Execution of the seed operation causes the parameter block to be reseeded, including resetting the reseed counter to a value of one.
- Execution of a generate operation that results in condition code 0 causes the reseed counter to be incremented by one; any carry out of bit position 0 of the reseed-counter field is ignored.

Stream Bytes: Bytes 8-15 of the parameter block contain a 64-bit unsigned binary integer. The stream-bytes field is set to zero by the execution of the seed operation when instantiating the parameter block (that is, when the reseed counter is zero); the field is not changed by the execution of the seed operation when the parameter block is already instantiated.

Partial or full completion of a generate operation causes the contents of the stream-bytes field to be

incremented by the number of bytes stored into the first operand; any carry out of bit position 0 of the stream-bytes field is ignored.

Value (V): Bytes 17-127 of the parameter block contains an 888-bit value indicating the internal state of the random-number generator represented by the parameter block. V is initialized by the execution of the seed operation when instantiating the parameter block. V is updated by either (a) the execution of the seed operation when the reseed counter is nonzero, or (b) the execution of the generate operation that ends in condition code 0.

Constant (C): Bytes 129-239 of the parameter block contain an 888-bit value indicating the internal state of the random-number generator represented by the block. C is initialized by the execution of the seed operation, and inspected by the generate operation.

PRNO-SHA-512-DRNG Seed Operation

The PRNO-SHA-512-DRNG seed operation instantiates or reseeds a deterministic-pseudorandom-number-generation parameter block using the 512-bit secure-hash algorithm.

Depending on whether the reseed counter in bytes 4-7 of the parameter block is zero or nonzero, an instantiation or reseeding operation is performed, respectively.

- For the instantiation operation, the second operand in storage contains entropy input, nonce, and an optional personalization string, used to form seed material.
- For the reseed operation, the second operand in storage contains entropy input and optional additional input, used to form the seed material.

See Reference [18.] on page xxx for the definition and usage of entropy input, nonce, personalization string, and additional input, and for details on the algorithms used. The length of the second operand in general register $R_2 + 1$ must not exceed 512 bytes, otherwise, a specification exception is recognized.

When performing an instantiation operation, seed material is formed using only the second operand. When performing a reseeding operation, seed material is formed from a concatenation of the value 01

hex, the V field of the parameter block, and the second operand. The formation of the seed material is illustrated in Figure 7-355.

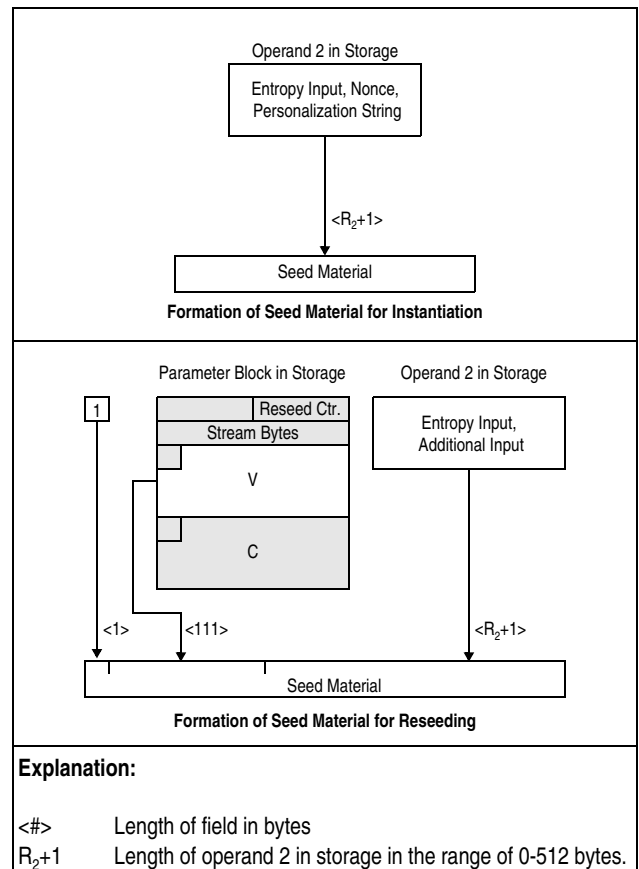
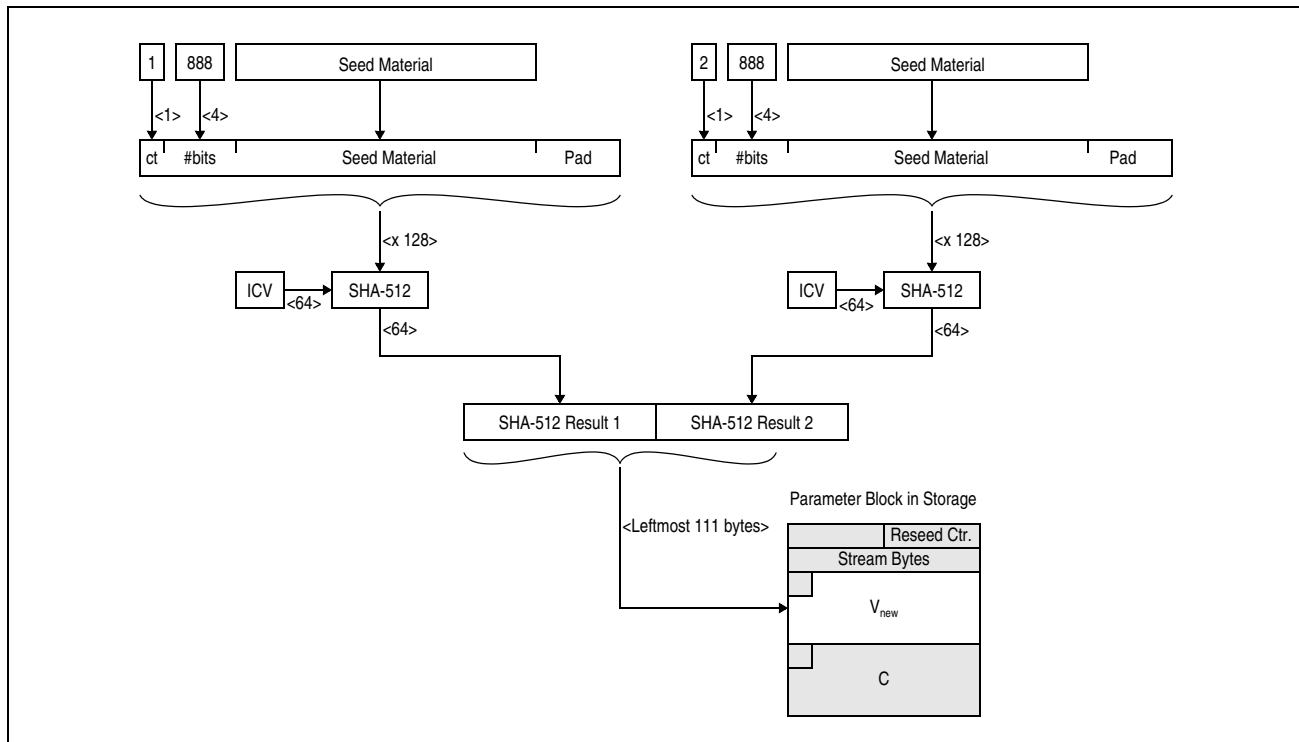

Figure 7-355. PRNO-SHA-512-DRNG Function's Seed Operation Generation of Seed Material

For either the instantiation or reseeding operation, a new value field (V_{new}) is formed as follows: A one byte counter, four-byte value of 888, the seed material, and padding are used as input to the SHA-512 algorithm. The padding consists of a value of 80 hex, concatenated with 0-127 bytes of zeros, concatenated with a 16-byte binary integer designating the length in bits of the input to the SHA-512 algorithm not including the padding (that is, the length of the one-byte counter, four-byte value of 888, and the seed material). The SHA-512 algorithm is invoked twice to form two 64-bit hashed results; the one-byte counter contains the value 1 for the first invocation of the SHA-512 algorithm, and it contains the value 2 for the second invocation. The two 64-byte hashed results are concatenated together, and the leftmost 111 bytes of the 128-byte concatenation form the

new value field (V_{new}) in the parameter block. The generation of V_{new} is illustrated in Figure 7-356.



Explanation:

#bits	32-bit count of bits to be produced by the SHA-512 algorithm: 888 bits (378 hex)
<#>	Length of the field in bytes.
<x #>	Length of the field is a multiple of # bytes.
ct	8-bit counter used by the hash-derivation function (hash_df, defined in Reference [18.] on page xxx).
ICV	Initial chaining value used for the SHA-512 algorithm (initial chaining values are described in programming note 6 for KLMD on page 7-199).
Pad	Variable number of pad bytes, beginning with 80 hex, followed by 0-127 bytes of zeros, followed by a 16-byte binary integer representing the length in bits of the input to the SHA-512 algorithm not including the padding. An appropriate number of zero bytes are inserted such that the length of the input to the SHA-512 algorithm is a multiple of 128 bytes.

Figure 7-356. PRNO-SHA-512-DRNG Function's Seed Operation Formation of New Value (V_{new})

Similar to the formation of the V_{new} field, the new constant field (C_{new}) is formed during both the instantiation or reseeding operation. A one byte counter, four-byte value of 888, one byte value of zero, the V_{new} field, and padding are concatenated to form input to the SHA-512 algorithm. The padding consists of a value of 80 hex, concatenated with 122 bytes of zeros, concatenated with a 16-byte binary integer designating the length in bits of the input to the SHA-512 algorithm not including the padding (that is, the length of the one-byte counter, four-byte value of 888, one-byte value of zero, and the V_{new} field). The SHA-512 algorithm is invoked twice to form two 64-bit hashed results; the one-byte counter contains the

value 1 for the first invocation of the SHA-512 algorithm, and it contains the value 2 for the second invocation. The two 64-byte hashed results are concatenated together, and the leftmost 111 bytes of the 128-byte concatenation form the new constant field (C_{new}) in the parameter block.

For either the instantiate or reseeding operation, the reseed-counter field in the parameter block is set to a value of one. For the instantiate operation only, the stream-bytes field in the parameter block is set to zeros; the stream-bytes field remains unchanged by a reseeding operation.

The generation of C_{new} and the initialization of the reseed-counter and stream-bytes fields is illustrated in Figure 7-357.

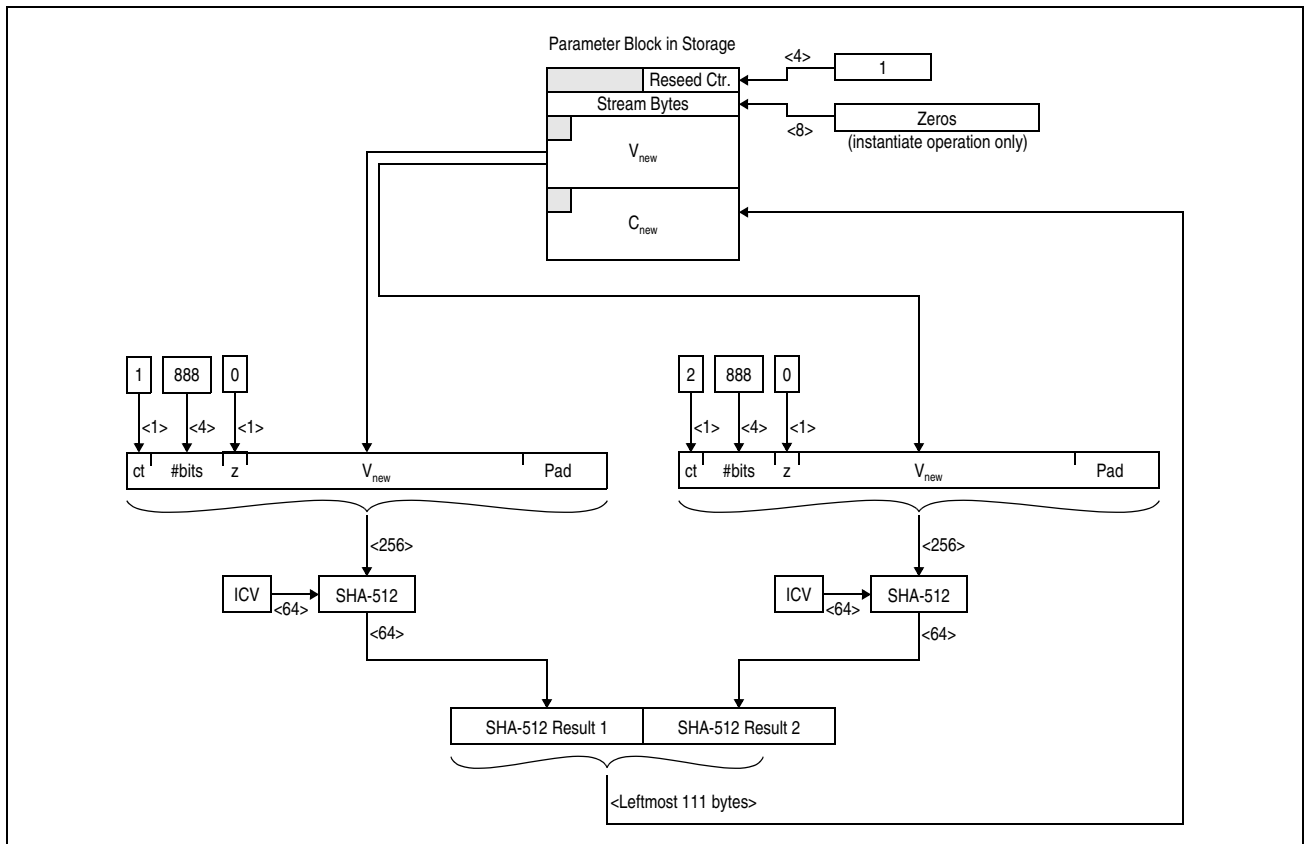

Explanation:

- #bits 32-bit count of bits to be produced by the SHA-512 algorithm: 888 bits (378 hex)
- <#> Length of field in bytes.
- ct 8-bit counter used by the hash-derivation function (hash_df, defined in Reference [18.] on page xxx).
- ICV Initial chaining value used for the SHA-512 algorithm (initial chaining values are described in programming note 6 for KLMD on page 7-199).
- Pad Pad bytes, beginning with 80 hex, followed 122 bytes of zeros, followed by a 16-byte binary integer representing the length of the input to the SHA-512 algorithm not including the padding.
- z 8-bit field of zeros.

Figure 7-357. PRNO-SHA-512-DRNG Function's Seed Operation Formation of New Constant (C_{new}) and Initialization of the Reseed-Counter and Stream-Bytes Fields

Condition code 0 is set when execution of the PRNO-SHA-512-DRNG function's seed operation completes; condition code 3 is not applicable to the seed operation.

PRNO-SHA-512-DRNG Generate Operation

If the reseed counter in the parameter block is zero, a general-operand data exception is recognized and the operation is suppressed.

General register R_1 contains the address of the *left-most* byte of the first operand. When the first-operand length in general register $R_1 + 1$ is nonzero, the first operand is formed in right-to-left order in units of 64-byte blocks, except that the rightmost block may contain fewer than 64 bytes. The number of blocks to be stored, including any partial rightmost block, is determined by rounding the first-operand length in general register $R_1 + 1$ up to a multiple of 64 and dividing this value by 64. The blocks of the first oper-

and are numbered from left to right as 0 to $n-1$, where $n-1$ represents the rightmost block. The following procedure is performed for each block of the first-operand location, beginning with the rightmost ($n-1$) block and proceeding to the left.

1. The value (V) from the parameter block is added to the block number being processed, with any overflow from the addition ignored.
2. The 111-byte sum of this addition, concatenated with 17 bytes of padding, are used as input to the SHA-512 algorithm, resulting in a 64-byte hashed value. The 17-byte padding provided to the SHA-512 algorithm consists of a value of 80 hex followed by a 16-byte binary integer value of 888 (the length of V in bits).
3. If the first-operand length in general register $R_1 + 1$ is a multiple of 64, then the resulting 64-byte hashed value is stored in the respective block of the first-operand location, and the length in general register $R_1 + 1$ is decremented by 64.

If the first-operand length is not a multiple of 64, then the leftmost m bytes of the resulting 64-byte hashed value is stored in the rightmost partial

block of the first operand, where m represents the remainder of the first-operand length divided by 64. In this case, the length in general register $R_1 + 1$ is decremented by m .

4. Regardless of whether a full or partial block is stored, the stream-bytes field in bytes 8-15 of the parameter block is incremented by the number of bytes stored into the first-operand location.

The above process is repeated until either the first-operand length in general register $R_1 + 1$ is zero (called normal completion) or a CPU-determined number of blocks has been processed (called partial completion). The CPU-determined number of blocks depends on the model, and may be a different number each time the instruction is executed. The CPU-determined number of blocks is usually nonzero. In certain unusual situations, this number may be zero, and condition code 3 may be set with no progress. However, the CPU protects against endless reoccurrence of this no-progress case.

The process of generating the deterministic pseudo-random numbers in the first operand is shown in Figure 7-358.

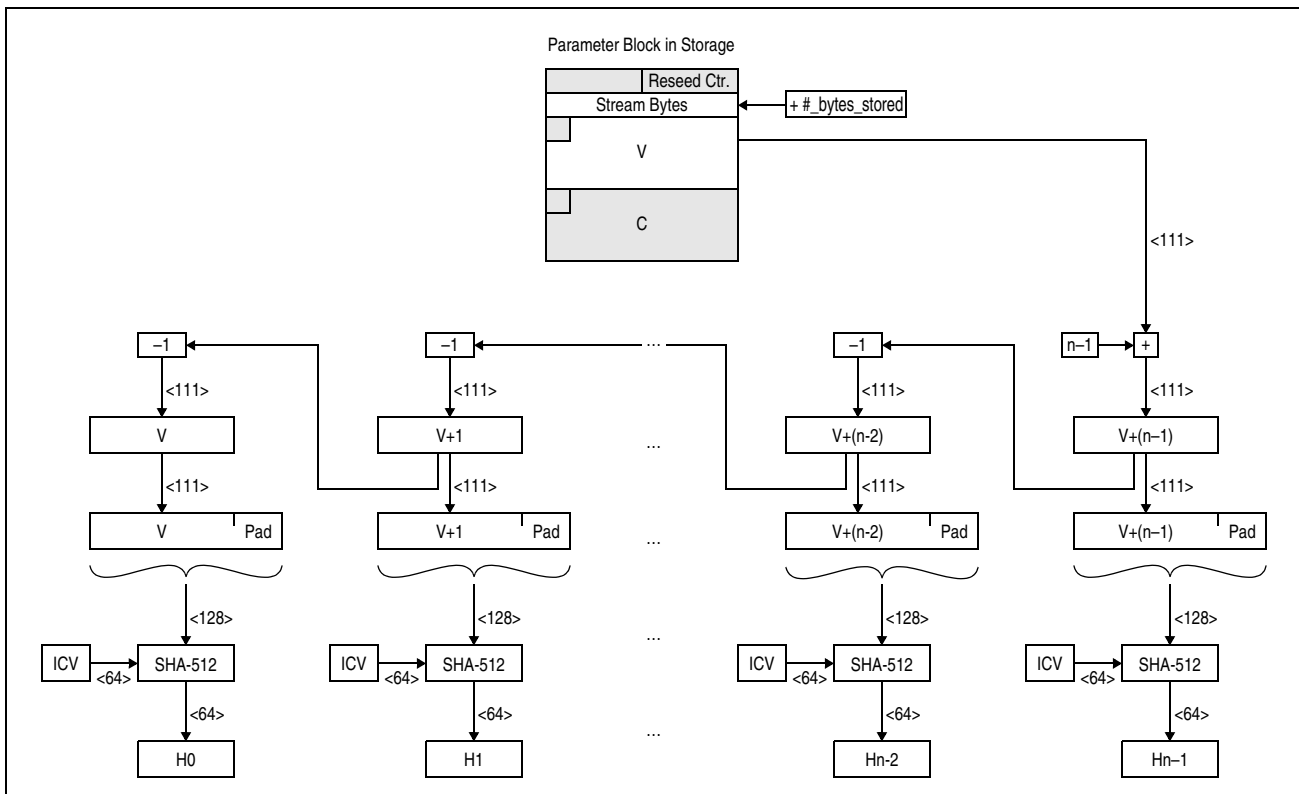

Figure 7-358. PRNO-SHA-512-DRNG Function's Generate Operation Generation of Deterministic Pseudorandom Numbers (Part 1 of 2)

Explanation:	
<#>	Length of field in bytes.
Hn	64-byte hashed value stored in the first-operand location; the rightmost value (Hn-1) may contain fewer than 64 bytes.
ICV	Initial chaining value used for the SHA-512 algorithm (initial chaining values are described in programming note 6 for KLMD on page 7-199).
n	Number of 64-byte blocks in the first operand; n is equal to the integer quotient of $((\text{length in general register } R_1 + 1) + 63) \div 64$.
Pad	Pad bytes, beginning with 80 hex, followed by a 16-byte unsigned binary integer representing the length of V in bits: 888 (378 hex).

Figure 7-358. PRNO-SHA-512-DRNG Function's Generate Operation Generation of Deterministic Pseudorandom Numbers (Part 2 of 2)

When the first-operand length in general register $R_1 + 1$ is initially zero, normal completion occurs without storing into the first-operand location; however, the parameter block is updated as described below.

When the pseudorandom-number-generation process ends due to normal completion, the parameter block is updated as described below.

1. A one byte value of 03 hex, 111-byte value (V) from the parameter block, and 144 bytes of padding are used as input to the SHA-512 algorithm, resulting in a 64-byte hashed value. The padding consists of a value of 80 hex, concatenated with 127 bytes of zeros, concatenated with a 16-byte binary integer designating the length in bits of the input to the SHA-512 algorithm not including the padding (that is, the length of the one-byte value of 03 hex and the V field). The values of the 4-byte reseed-counter field and the 111-byte value (V) and constant (C) fields in the parameter block, and the 64-byte hashed value (from the above computation) are added. For the purposes of this addition, each value is treated as an unsigned binary integer, extended to the left with zeros as necessary. Any overflow from the addition is ignored, and the resulting 111-byte sum replaces the value field in the parameter block (V_{new}).
2. The 4-byte reseed-counter field in the parameter block is incremented by one.
3. Condition code 0 is set.

Steps 1 and 2 of the normal completion processing are illustrated in Figure 7-359.

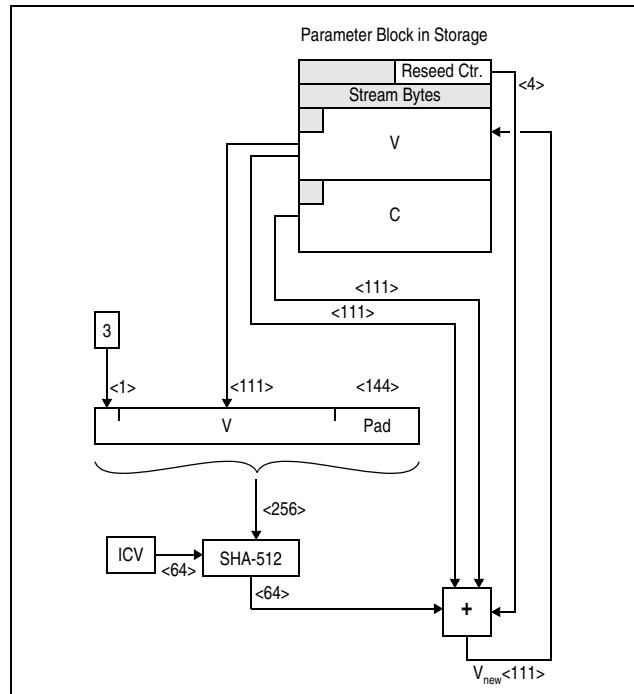

Explanation:	
<#>	Length of field in bytes
ICV	Initial chaining value used for the SHA-512 algorithm (initial chaining values are described in programming note 6 for KLMD on page 7-199).
Pad	Pad bytes, beginning with 80 hex, followed 127 bytes of zeros, followed by a 16-byte unsigned binary integer representing the length of the input to the SHA-512 algorithm not including the padding.

Figure 7-359. PRNO-SHA-512-DRNG Function's Generate Operation Normal Completion

When the pseudorandom-number-generation process ends due to partial completion, the first-operand length in general register $R_1 + 1$ contains a nonzero multiple of 64, the reseed-counter and value (V) fields in the parameter block are not updated, and condition code 3 is set.

For a generate operation, access exceptions may be reported for a larger portion of the first operand than is processed in a single execution of the instruction. However, access exceptions are not recognized for locations that do not encompass the first operand nor for locations more than 4K bytes from the current location being processed.

For a generate operation, when the operation ends due to normal completion, condition code 0 is set and the resulting value in general register $R_1 + 1$ is zero. When the operation ends due to partial completion, condition code 3 is set and the resulting value in general register $R_1 + 1$ is nonzero.

PRNO-TRNG-Query-Raw-to-Conditioned Ratio (PRNO Function Code 112)

The PRNO-TRNG-query-raw-to-conditioned ratio function may be used to determine the ratio of raw to conditioned entropy produced when both types of entropy are requested by the PRNO-TRNG function. See Reference [19.] on page xxx for a description of these terms.

The parameter block is stored with two 32-bit unsigned binary integers indicating the ratio of raw entropy to conditioned entropy produced by the PRNO-TRNG function.

The locations of the operands and addresses used by the instruction are as shown in Figure 7-351 on page 7-354. The contents of general registers R_1 , $R_1 + 1$, R_2 , and $R_2 + 1$ are ignored by the function.

The parameter block used for the function has the following format:

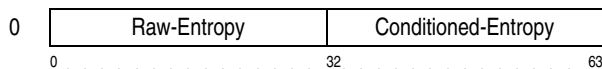

Figure 7-360. Parameter Block for PRNO-TRNG-Query-Raw-to-Conditioned Ratio

The fields of the parameter block are as follows:

Raw Entropy: The numerator in a fraction designating the ratio of raw entropy to conditioned entropy produced by the PRNO-TRNG function.

Conditioned Entropy: The denominator in a fraction designating the ratio of raw entropy to conditioned entropy produced by the PRNO-TRNG function.

The raw-entropy to conditioned-entropy ratio indicates the relative sizes of the first and second operands stored by the PRNO-TRNG function when the operands contain a proportionate number of raw and conditioned bits.

Condition code 0 is set when execution of the PRNO-TRNG-query-raw-to-conditioned function completes; condition code 3 is not applicable to this function.

PRNO-TRNG (PRNO Function Code 114)

A series of hardware-generated random numbers is stored at either or both the first- and second-operand locations. The locations of the operands and addresses used by the instruction are as shown in Figure 7-351 on page 7-354. A parameter block is not used by the PRNO-TRNG function, and general register 1 is ignored.

The R_1 field designates an even-odd pair of general registers. The even-numbered register contains the address of the leftmost byte of the first operand, and the odd-numbered register contains the length of the first operand. The first operand comprises random numbers in the form of raw entropy, produced directly by a hardware source.

The R_2 field designates an even-odd pair of general registers. The even-numbered register contains the address of the leftmost byte of the second operand, and the odd-numbered register contains the length of the second operand. The second operand comprises random numbers extracted from the raw entropy source and then conditioned by an approved algorithm (section 6.4.2 of Reference [19.] on page xxx describes approved algorithms).

The ratio of raw-entropy bits needed to produce conditioned-entropy bits can be determined by the PRNO-TRNG-query-raw-to-conditioned-ratio function. When the lengths of both the first and second operands are nonzero, the raw and conditioned entropy are stored at the first- and second-operand locations, respectively, in the raw-to-conditioned ratio. The number of bytes stored in a single unit of operation is model dependent, and may vary from one execution of the instruction to another.

When the length of the first operand is nonzero but the length of the second operand is zero, the process continues with storing the raw entropy in the first operand only. Similarly, when the length of the second operand is nonzero but the length of the first

operand is zero, the process continues with storing the conditioned entropy in the second operand only.

Access exceptions may be reported for a larger portion of the first and second operands than is processed in a single execution of the instruction. However, access exceptions are not recognized for locations that do not encompass the first or second operand nor for locations more than 4K bytes from the current location being processed.

The process continues either until both operand lengths are zero (called normal completion), or until a CPU-determined number of bytes have been stored (called partial completion), whichever occurs first. When the operation ends due to normal completion, condition code 0 is set. When the operation ends due to partial completion, condition code 3 is set. The CPU-determined number of bytes depends on the model, and may be a different number each time the instruction is executed. The CPU-determined number of bytes is usually nonzero. In certain unusual situations, this number may be zero, and condition code 3 may be set with no progress. However, the CPU protects against endless recurrence of this no-progress case.

Regardless of whether the operation ends due to normal or partial completion, general registers R_1 and $R_1 + 1$ are incremented and decremented, respectively, by the number of bytes stored into the first operand, and general registers R_2 and $R_2 + 1$ are incremented and decremented, respectively, by the number of bytes stored into the second operand.

If the first and second operands overlap, the results are unpredictable.

Special Conditions

A specification exception is recognized and no other action is taken if any of the following conditions exist:

1. Bits 57-63 of general register 0 specify an unassigned or uninstalled function code.
2. The R_1 or R_2 fields designate an odd-numbered register or general register 0. This exception is recognized regardless of the function code.
3. For the PRNO-SHA-512-DRNG function's seed operation, the length in general register $R_2 + 1$ is greater than 512.

For the PRNO-SHA-512-DRNG function's generate operation, a general-operand data exception is recognized if the reseed counter in the parameter block is zero.

Condition Code:

- | | |
|---|--------------------|
| 0 | Normal completion |
| 1 | -- |
| 2 | -- |
| 3 | Partial completion |

Program Exceptions:

- Access (store, operand 1; fetch and store, operand 2 and parameter block)
- Data with DXC 0, general operand
- Operation (if the message-security-assist extension 5 is not installed)
- Specification
- Transaction constraint

Programming Notes:

1. The performance of the query function (code 0) may be significantly slower than that of simply examining a location in storage. If the program needs to frequently test for the availability of a function, it should perform the query function once during initialization; subsequently it should examine the stored results of the query function in memory with an instruction such as TEST UNDER MASK.
2. With the advent of the message-security-assist extension 7, the instruction is capable of producing both true and deterministic random numbers. Thus, the former PERFORM PSEUDORANDOM NUMBER OPERATION (PPNO) instruction is renamed to PERFORM RANDOM NUMBER OPERATION (PRNO) to encompass both types of numbers. Although it is now deprecated, the mnemonic PPNO is retained for compatibility.
3. The following considerations apply to the PRNO-SHA-512-DRNG function:
 - a. For the generate operation, when condition code 3 is set, the first operand length in general register $R_1 + 1$ is updated such that the program can simply branch back to the instruction to continue the operation.

- b. The seed operation (instantiation and reseeding) and generate operation correspond to the following algorithm specifications in Reference [19.] on page xxx:
 - Section 10.1.1.2: Instantiation of Hash_DRBG
 - Section 10.1.1.3: Reseeding a Hash_DRBG Instantiation
 - Section 10.1.1.4: Generating Pseudorandom Bits Using Hash_DRBG (steps 3–7)
 - c. If a carry out of bit position 0 of the reseed-counter field occurs during a generate operation, then the counter wraps around to zero; in this case, the parameter block is considered not to be instantiated. Unless a seed operation is performed to reinstantiate the parameter block, a subsequent generate operation will result in a general-operand data exception being recognized.
 - d. The PRNO-SHA-512-DRNG function does not implement the testing and uninstantiation functions described in Reference [19.] on page xxx. As the parameter block exists in program storage, the program can effect the testing function by directly inspecting the parameter block; similarly, the program can effect the uninstantiation function by zeroing the parameter block.
 - e. The program is responsible for reseeding the parameter block depending on policy and pseudorandom-number-generation state. For example, reseeding may be required after each generate operation if prediction resistance is required. Reseeding may be appropriate after a preset number of stream bytes is produced. See Reference [18.] on page xxx for further explanation.
 - f. Even though the generate operation processes the blocks of the first operand in right to left order, it is the address of the leftmost byte of the operand in general register R_1 that is used for PER zero-address detection. If the first-operand address is nonzero, and length of the operand is such that the operand wraps around to location zero, stores to the first-operand location – including stores to location zero – will not result in the recognition of a PER zero-address-detection event.
 - g. The length in bits of the input to the SHA-512 algorithm is implicitly determined by the instruction; this length is described as occupying the rightmost 16 bytes of the padding field. This differs from the KLMD-SHA-512 function of the COMPUTE LAST MESSAGE DIGEST instruction where the message-bit length (mbl) is explicitly specified in the parameter block, and the padding (p) and mbl are described separately.
 - h. The initial chaining value (ICV) is described as the initial-hash value (IHV) in Reference [18.] on page xxx.
 - i. The program may issue a seed operation with the second-operand length in general register $R_2 + 1$ set to zero. However, the results in this case will always be deterministic.
4. The following considerations apply to the PRNO-TRNG function:
- a. Depending on the model, significant performance degradation may be experienced either by requesting excessively large results or by frequently-repeated executions of the instruction.
 - b. The PRNO-TRNG function may be useful when implementing a hybrid random-number generator, using the conditioned entropy source from PRNO-TRNG to periodically reseed a deterministic random-number generation (such as that provided by the PRNO-SHA-512-DRNG function).
 - c. The conditioned entropy provided by the PRNO-TRNG function may be shared by multiple, independently-seeded deterministic random number generators. Independence may be achieved by a unique program-supplied entropy, nonce, or personalization string when seeding a deterministic random number generator.
 - d. The raw entropy provided by the first operand is intended for use by diagnostic programs that test the quality of entropy provided by the function. It is recommended that for normal usage, the first-operand length be set to zero.

- e. The ratio of raw-to-conditioned entropy provided by the function is constant across all processors of the same model type. Therefore, once the program has determined the ratio, it need not re-execute the PRNO-TRNG-query-raw-to-conditioned-ratio function unless it is relocated to another model type.
 - f. Although entropy is produced by the PRNO-TRNG function in the raw-to-conditioned ratio reported by the PRNO-TRNG-query-raw-to-conditioned-ratio function, the program is in no way obliged to request raw and conditioned entropy in that ratio.
5. As observed by this CPU, other CPUs, and the I/O subsystem, inconsistent results may be briefly stored in a location defined to be stored for a particular function. See the section “Effects of CPU Retry” on page 11-3 for further details.

POPULATION COUNT

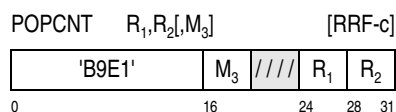

A count of the number of bits in the second operand containing a value of one, is placed into the first operand.

When the miscellaneous-instruction-extensions facility 3 is not installed or bit 0 of the M₃ field is zero, a count of the number of one bits in each of the eight bytes of general register R₂ is placed into the corresponding byte of general register R₁. Each byte of general register R₁ is an 8-bit binary integer in the range of 0-8.

When the miscellaneous-instruction-extensions facility 3 is installed and bit 0 of the M₃ field is one, a count of the total number of one bits in the 64-bit general register R₂ is placed into general register R₁. The result is a 64-bit unsigned integer in the range 0 to 64.

Bits 1-3 of the M₃ field are reserved and should contain zeros; otherwise, the program may not operate compatibly in the future. If the miscellaneous-instruction-extensions facility 3 is not installed, bit 0 of the M₃ field should also contain zero.

Resulting Condition Code:

- 0 Result zero
- 1 Result not zero
- 2 --
- 3 --

Program Exceptions:

- Operation (if the population-count facility is not installed)

Programming Notes:

1. The condition code is set based on all 64 bits of general register R₁.
2. If the miscellaneous-instruction-extensions facility 3 is installed, bit 0 of the M₃ field should be set to one to compute the total number of one bits in a general register. If the facility is not installed, the total number of one bits in a general register can be computed as shown below. In this example, general register 15 contains the bits to be counted; the result containing the total number of one bits in general register 15 is placed in general register 8. (General register 9 is used as a work register and contains residual values on completion.)

POPCNT	8,15
AHHLR	8,8,8
SLLG	9,8,16
ALGR	8,9
SLLG	9,8,8
ALGR	8,9
SRLG	8,8,56

If there is a high probability that the results of the POPCNT instruction are zero, a conditional branch instruction may be inserted to skip the adding and shifting operations based on the condition code set by POPCNT.

3. Using techniques similar to that shown in programming note 2, the number of one bits in a word, halfword, or discontinuous bytes of the second operand may be determined.

PREFETCH DATA

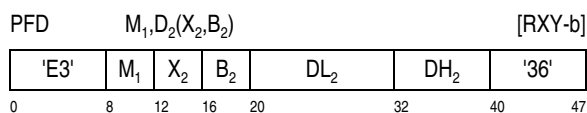

PREFETCH DATA RELATIVE LONG

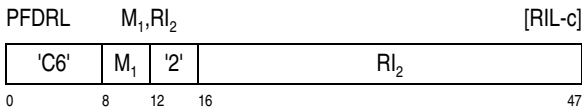

Note: In this instruction definition, the name “PREFETCH DATA (RELATIVE LONG)” refers to both the PREFETCH DATA instruction and the PREFETCH DATA RELATIVE LONG instruction.

Subject to the controls specified in the M₁ field, the CPU is signaled to perform one of the following operations:

- Prefetch the second operand into a cache line.
- Release a cache line containing the second operand.

The second operand designates a logical address.

The M₁ field contains a 4-bit unsigned binary integer that is used as a code to signal the CPU as to the intended use of the second operand. The codes are as follows:

Code	Function Performed
1	Prefetch the data at the second-operand address into a cache line for fetch access.
2	Prefetch the data at the second-operand address into a cache line for store access.
6	Release the cache line containing the second operand from store access; retain the data in the cache line for fetch access.
7	Release the cache line containing the second operand from all accesses

All other codes are reserved. Depending on the model, the CPU may not implement all of the prefetch functions. For functions that are not implemented by the CPU, and for reserved functions, the instruction acts as a no-op. Code 0 always acts as a no-op.

No access exceptions or PER storage-alteration events are recognized for the second operand.

Code 2 has no effect on the change bit for the second operand. For all codes, it is model dependent whether any TLB entry is formed for the data that is prefetched.

For PREFETCH DATA, the displacement is treated as a 20-bit signed binary integer.

For PREFETCH DATA RELATIVE LONG, the contents of the RI₂ field are signed binary integer specifying the number of halfwords that is added to the address of the instruction to generate the address of the second operand. When DAT is on, the second operand is accessed using the same addressing-space mode as that used to access the instruction. When DAT is off, the second operand is accessed using a real address.

When PREFETCH DATA (RELATIVE LONG) is attempted in a nonconstrained transaction, and the code in the M₁ field is 6 or 7, it is model dependent whether the instruction is restricted; if the instruction is not restricted, it is unpredictable whether the transaction is aborted due to abort code 16. When PREFETCH DATA (RELATIVE LONG) is attempted in a constrained transaction, a transaction-constraint program interruption is recognized, and the transaction is aborted with abort code 4.

Condition Code: The code remains unchanged.

Program Exceptions:

- Operation (if the general-instructions-extension facility is not installed)
- Transaction constraint

Programming Notes:

1. PREFETCH DATA (RELATIVE LONG) signals the CPU to perform the specified operation, but it does not guarantee that the CPU will necessarily honor the request.
2. There is no guarantee that storage location will still be in the cache when a subsequent instruction references the location. Likewise, there is no guarantee that when a cache line is released, that the CPU will not subsequently refetch it (independent of any prefetching operations). Rather, PREFETCH DATA (RELATIVE LONG) simply provides hints as to the program’s anticipated use of storage areas.
3. If an exception condition would otherwise be recognized when accessing the second operand, PREFETCH DATA (RELATIVE LONG) is completed with no indication of the exception provided to the program, however, the performance

of PREFETCH DATA (RELATIVE LONG) may be significantly slower than if the exception condition did not exist.

4. A significant delay may be experienced if a storage location has been prefetched and then released, and then a subsequent instruction references the same storage location. Similarly, a delay may be experienced if a storage location has been prefetched for fetch access, and then a subsequent instruction references the same location for storing.
5. On models that implement a unified data and instruction cache, the function performed may affect both subsequent operand accesses and instruction fetches from the second-operand location. On such models, a significant delay may be experienced if the code 7 is used to release data in a cache line from which an instruction is subsequently fetched.
6. On models that implement separate data and instruction caches, codes 1 and 2 cause the second operand to be prefetched into the data cache. Similarly, on such models, codes 6 and 7 cause the second operand to be released from the data cache. However, on certain models with separate data and instruction caches, code 7 may also cause the second operand to be released from the instruction cache, in addition to being released from the data cache.
7. On models that implement separate data and instruction caches, the use of code 2 to prefetch (for storing) a cache line from which instructions will subsequently be fetched may cause significant delays. Similar delays may be experienced for any store operation into a cache line from which instructions are subsequently fetched.
8. The use of PREFETCH DATA (RELATIVE LONG) to prefetch operands that are frequently updated in a multiprocessing environment may actually degrade performance by causing unnecessary contention for the cache line.
9. A prefetch operation consists of fetching a cache line on an integral boundary. The cache line size (and corresponding integral boundary) may be determined by executing EXTRACT CPU ATTRIBUTE.
10. The second operand is fetched into the cache line in model-dependent units, on an integral boundary, the minimum size of which is a double-

word. Thus, at least the rightmost three bits of the second-operand address are assumed to contain zeros, regardless of what is specified by the program.

11. On most models, the unit directly addressed by the second-operand address is prefetched first. The order in which the remaining units of the cache line are prefetched is also model dependent.
12. When PREFETCH DATA RELATIVE LONG is the target of an execute-type instruction, the second-operand address is relative to the target address.

ROTATE LEFT SINGLE LOGICAL

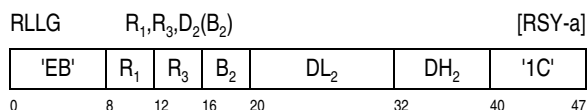
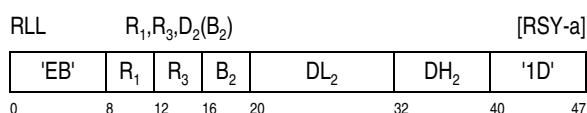

The 32-bit or 64-bit third operand is rotated left the number of bits specified by the second-operand address, and the result is placed at the first-operand location. Except for when the R₁ and R₃ fields designate the same register, the third operand remains unchanged in general register R₃. For ROTATE LEFT SINGLE LOGICAL (RLL), bits 0-31 of general registers R₁ and R₃ remain unchanged.

The second-operand address is not used to address data; its rightmost six bits indicate the number of bit positions to be rotated. The remainder of the address is ignored.

For RLL, the first and third operands are in bit positions 32-63 of general registers R₁ and R₃, respectively. For RLLG, the operands are in bit positions 0-63 of the registers.

All 32 or 64 bits of the third operand participate in a left shift. Each bit shifted out of the leftmost bit position of the operand is placed in the rightmost bit position of the operand.

Condition Code: The code remains unchanged.

Program Exceptions: None.

ROTATE THEN AND SELECTED BITS

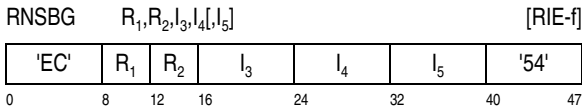

ROTATE THEN EXCLUSIVE OR SELECTED BITS

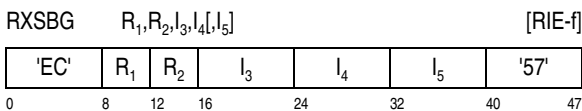

ROTATE THEN OR SELECTED BITS

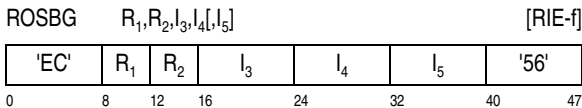

The second operand is rotated left by the number of bits specified in the fifth operand. Each bit shifted out of the leftmost bit position of the operand is placed in the rightmost bit position of the operand. Depending on the instruction, the selected bits of the rotated second operand are logically ANDed, exclusive ORed, or ORed with the corresponding bits of the first operand, and the results of the logical operation may replace the selected bits of the first operand. The result is indicated by the condition code.

The second operand remains unchanged in general register R_2 .

Bits 2-7 of the I_3 field (bits 18-23 of the instruction) contain an unsigned binary integer specifying the starting bit position of the selected range of bits in the first operand and in the second operand after rotation. Bits 2-7 of the I_4 field (bits 26-31 of the instruction) contain an unsigned binary integer specifying the ending bit position (inclusive) of the selected range of bits. When the ending bit position is less than the starting bit position, the range of bits wraps around from bit 63 to bit 0.

Bits 2-7 of the I_5 field (bits 34-39 of the instruction) contain an unsigned binary integer specifying the number of bits that the second operand is rotated to the left.

Bit 0 of the I_3 field (bit 16 of the instruction) contains the test-results control (T). When the T bit is zero, the results of the logical operation replace the selected bits of the first operand, and the remaining bits of the first operand are unchanged. When the T bit is one, the entire first operand is unchanged.

The condition code is set based on the results of the logical operation, regardless of the setting of the T bit. Only the selected range of bits is used to determine the condition code.

The immediate fields just described are as follows:

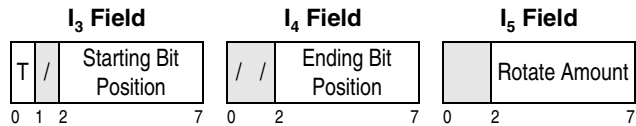

Bit 1 of the I_3 field and bits 0-1 of the I_4 field (bits 17 and 24-25 of the instruction) are reserved and should contain zeros; otherwise, the program may not operate compatibly in the future. Bits 0-1 of the I_5 field (bits 32-33 of the instruction) are ignored.

Resulting Condition Code:

- 0 Result is zero
- 1 Result is not zero
- 2 --
- 3 --

Program Exceptions:

- Operation (if the general-instructions-extension facility is not installed)

Programming Notes:

1. Although the bits 2-7 of the I_5 field are defined to contain an unsigned binary integer specifying the number of bits that the second operand is rotated to the left, a negative value may be coded which effectively specifies a rotate-right amount.
2. The first operand is always used in its unrotated form. When the R_1 and R_2 fields designate the same register, the contents of the register are first rotated, and then the selected bits of the

rotated value logically operate upon the corresponding bits of the unrotated register contents.

- Examples of the use of ROTATE THEN EXCLUSIVE OR SELECTED BITS, and ROTATE THEN OR SELECTED BITS are given in “Number Representation and Instruction-Use Examples” on page A-1.
- In the assembler syntax, the I_5 operand containing the rotate amount is considered to be optional. When the I_5 field is not coded, a rotate amount of zero is implied.
- The I_3 field contains both the test-results control (in bit 0) and the starting bit position value (in bits 2-7). For example, to AND bits 40-43 of register 5 with the corresponding bits of register 7 (no rotation) and simply test the results, the programmer might code:

```
RNSBG R5,R7,X'80'+40,43,0
```

The X'80' represents the test-results control which is added to the starting-bit position to form the I_3 field.

The high-level assembler (HLASM) provides alternative mnemonics for the test versions of these instructions, as shown below:

```
RNSBGT R5,R7,40,43,0
```

The “T” suffix to the mnemonic indicates that the specified I_3 field is ORed with a value of X'80' when generating the object code. The T mnemonic suffix also applies to ROSBG and RXSBG.

- The High-Level Assembler implements various high-word logical operations by providing extended-mnemonics for the RNSBG, ROSBG, and RXSBG instructions, as shown in Figure 7-361.

Instruction Name	Extended-Mnemonic Syntax	RxSBG Equivalent
AND HIGH (HIGH ← HIGH)	NHHR R_1, R_2	RNSBG $R_1, R_2, 0, 31$
AND HIGH (HIGH ← LOW)	NHLR R_1, R_2	RNSBG $R_1, R_2, 0, 31, 32$
AND HIGH (LOW ← HIGH)	NLHR R_1, R_2	RNSBG $R_1, R_2, 32, 63, 32$
EXCLUSIVE OR HIGH (HIGH ← HIGH)	XHHR R_1, R_2	RXSBG $R_1, R_2, 0, 31$
EXCLUSIVE OR HIGH (HIGH ← LOW)	XHLR R_1, R_2	RXSBG $R_1, R_2, 0, 31, 32$
EXCLUSIVE OR HIGH (LOW ← HIGH)	XLHR R_1, R_2	RXSBG $R_1, R_2, 32, 63, 32$
OR HIGH (HIGH ← HIGH)	OHHR R_1, R_2	ROSBG $R_1, R_2, 0, 31$
OR HIGH (HIGH ← LOW)	OHLR R_1, R_2	ROSBG $R_1, R_2, 0, 31, 32$
OR HIGH (LOW ← HIGH)	OLHR R_1, R_2	ROSBG $R_1, R_2, 32, 63, 32$

Figure 7-361. Extended-Mnemonics Formed Using RNSBG, RXSBG, and ROSBG

ROTATE THEN INSERT SELECTED BITS

```
RISBG  $R_1, R_2, I_3, I_4, I_5$  [RIE-f]
```

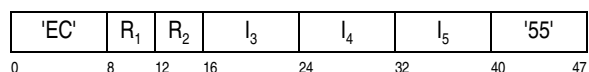

```
RISBGN  $R_1, R_2, I_3, I_4, I_5$  [RIE-f]
```

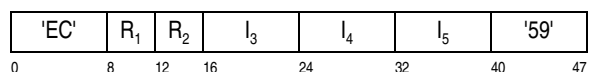

The second operand is rotated left by the number of bits specified in the fifth operand. Each bit shifted out of the leftmost bit position of the operand is placed in the rightmost bit position of the operand. The selected bits of the rotated second operand replace

the contents of the corresponding bit positions of the first operand. For RISBG, the result is indicated by the condition code.

The second operand remains unchanged in general register R_2 .

Bits 2-7 of the I_3 field (bits 18-23 of the instruction) contain an unsigned binary integer specifying the starting bit position of the selected range of bits in the first operand and in the second operand after rotation. Bits 2-7 of the I_4 field (bits 26-31 of the instruction) contain an unsigned binary integer specifying the ending bit position (inclusive) of the selected range of bits. When the ending bit position is less than the starting bit position, the range of bits wraps around from bit 63 to bit 0.

Bits 2-7 of the I_5 field (bits 34-39 of the instruction) contain an unsigned binary integer specifying the number of bits that the second operand is rotated to the left.

Bit 0 of the I_4 field (bit 24 of the instruction) contains the zero-remaining-bits control (Z). The Z bit controls how the remaining bits of the first operand are set (that is, those bits, if any, that are outside of the specified range). When the Z bit is zero, the remaining bits of the first operand are unchanged. When the Z bit is one, the remaining bits of the first operand are set to zeros.

The immediate fields just described are as follows:

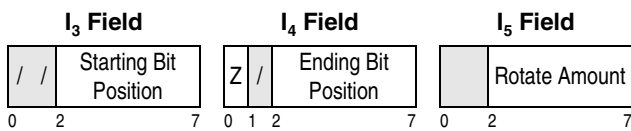

Bits 0-1 of the I_3 field and bit 1 of the I_4 field (bits 16-17 and 25 of the instruction) are reserved and should contain zeros; otherwise, the program may not operate compatibly in the future. Bits 0-1 of the I_5 field (bits 32-33 of the instruction) are ignored.

For the purposes of setting the condition code for RISBG, the result in general register R_1 is treated as being a 64-bit signed binary integer.

Resulting Condition Code:

For RISBG, the condition code is set as follows:

- 0 Result is zero
- 1 Result is less than zero
- 2 Result is greater than zero
- 3 --

For RISBGN, the condition code remains unchanged.

Program Exceptions:

- Operation (RISBG, if the general-instructions-extension facility is not installed; RISBGN, if the miscellaneous-instruction-extensions facility 1 is not installed)

Programming Notes:

1. Although the bits 2-7 of the I_5 field are defined to contain an unsigned binary integer specifying the number of bits that the second operand is rotated to the left, a negative value may be coded which effectively specifies a rotate-right amount.
2. When used with the zero-remaining-bits control, ROTATE THEN INSERT SELECTED BITS provides a means of effecting a shift operation.
3. When the R_1 and R_2 fields designate the same register and the Z bit is one, ROTATE THEN INSERT SELECTED BITS may be used to zero a selected range of bits in a register. Note, this technique cannot be used to zero all 64 bits of the register.
4. The first operand is always used in its unrotated form. When the R_1 and R_2 fields designate the same register, the contents of the register are first rotated, and then the selected bits of the rotated value are inserted into the corresponding bits of the unrotated register contents.
5. Examples of the use of ROTATE THEN INSERT SELECTED BITS are given in "Number Representation and Instruction-Use Examples" on page A-1.
6. In the assembler syntax, the I_5 operand containing the rotate amount is considered to be optional. When the I_5 field is not coded, a rotate amount of zero is implied.
7. The I_4 field contains both the zero-remaining-bits control (in bit 0) and the ending bit position value (in bits 2-7). For example, to insert bits 40-43 of register 7 into the corresponding bits of register 5 (no rotation) and zero the remaining bits in register 5, the programmer might code:

```
RISBG  R5,R7,40,X'80'+43,0
RISBGN R5,R7,40,X'80'+43,0
```

The X'80' represents the zero-remaining-bits control which is added to the ending-bit position to form the I_4 field.

The high-level assembler (HLASM) provides an alternative mnemonic for the zero-remaining-bits versions of the instruction, as shown below:

```
RISBGZ R5,R7,40,43,0
RISBGNZ R5,R7,40,43,0
```

The “Z” suffix to the mnemonic indicates that the specified I_4 field is ORed with a value of X'80' when generating the object code.

ROTATE THEN INSERT SELECTED BITS HIGH

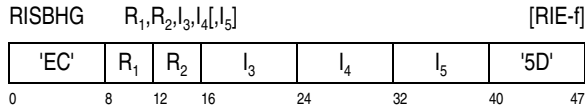

ROTATE THEN INSERT SELECTED BITS LOW

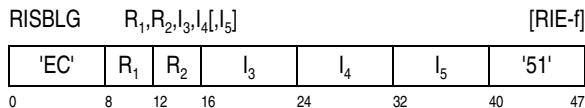

The 64-bit second operand is rotated left by the number of bits specified in the fifth operand. Each bit shifted out of the leftmost bit position of the operand is placed in the rightmost bit position of the operand. The selected bits of the rotated second operand replace the contents of the corresponding bit positions of the first operand.

For ROTATE THEN INSERT SELECTED BITS HIGH, the first operand is in bits 0-31 of general register R_1 , and bits 32-63 of the register are unchanged. For ROTATE THEN INSERT SELECTED BITS LOW, the first operand is in bits 32-63 of general register R_1 , and bits 0-31 of the register are unchanged.

The second operand remains unchanged in general register R_2 .

For ROTATE THEN INSERT SELECTED BITS HIGH, bits 3-7 of the I_3 and I_4 fields (bits 19-23 and 27-31 of the instruction, respectively), with a binary zero appended on the left of each, form six-bit unsigned binary integers specifying the starting and ending bit positions (inclusive) of the selected range of bits in the first operand and in the second operand after rotation. When the ending bit position is less than the starting bit position, the range of selected bits wraps around from bit 31 to bit 0. Thus, the starting and ending bit positions of the selected range of bits are always between 0 and 31.

For ROTATE THEN INSERT SELECTED BITS LOW, bits 3-7 of the I_3 and I_4 fields, with a binary one appended on the left of each, form six-bit unsigned binary integers specifying the starting and ending bit positions (inclusive) of the selected range of bits in the first operand and in the second operand after rotation. When the ending bit position is less than the starting bit position, the range of selected bits wraps around from bit 63 to bit 32. Thus, the starting and ending bit positions of the selected range of bits are always between 32 and 63.

Bits 2-7 of the I_5 field (bits 34-39 of the instruction) contain an unsigned binary integer specifying the number of bits that the second operand is rotated to the left.

Bit 0 of the I_4 field (bit 24 of the instruction) contains the zero-remaining-bits control (Z). The Z bit controls how the remaining bits of the first operand are set (that is, those bits, if any, that are outside of the specified range). When the Z bit is zero, the remaining bits of the first operand are unchanged. When the Z bit is one, the remaining bits of the first operand are set to zeros.

The immediate fields just described are as follows:

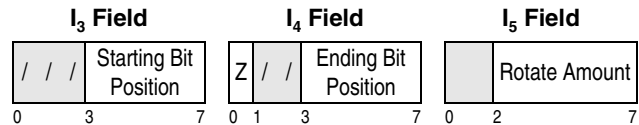

Bits 0-2 of the I_3 field and bits 1-2 of the I_4 field (bits 16-19 and 25-26 of the instruction) are reserved and should contain zeros; otherwise, the program may not operate compatibly in the future. Bits 0-1 of the I_5 field (bits 32-33 of the instruction) are ignored.

Condition Code: The code remains unchanged

Program Exceptions:

- Operation (if the high-word facility is not installed)

Programming Notes:

1. Although the bits 2-7 of the I_5 field are defined to contain an unsigned binary integer specifying the number of bits that the second operand is rotated to the left, a negative value may be coded which effectively specifies a rotate-right amount.

- The first operand is always used in its unrotated form. When the R_1 and R_2 fields designate the same register, the value contained in the register is first rotated, and then the selected bits of the rotated value are inserted into the corresponding bits of the unrotated register contents.
- In the assembler syntax, the I_5 operand containing the rotate amount is considered to be optional. When the I_5 field is not coded, a rotate amount of zero is implied.
- The I_4 field contains both the zero-remaining-bits control (in bit 0) and the ending bit position value (in bits 2-7). For example, to insert bits 40-43 of register 7 into the corresponding bits of register 5 (no rotation) and zero the remaining bits in the right half of register 5, the programmer might code:

```
RISBLG R5,R7,40,X'80'+43,0
```

The X'80' represents the zero-remaining-bits control which is added to the ending-bit position to form the I_4 field.

The High-Level Assembler (HLASM) provides alternative mnemonics for the zero-remaining-

bits versions of RISBHG and RISBLG in the form of RISBHGZ and RISBLGZ, respectively. The "Z" suffix to the mnemonic indicates that the specified I_4 field is ORed with a value of X'80' when generating the object code.

An equivalent to the example shown above using the Z-suffixed mnemonic is as follows:

```
RISBLGZ R5,R7,40,43,0
```

- On some models, improved performance of RISBHG and RISBLG may be realized by setting the zero-remaining-bits control to one (or using the Z mnemonic suffix).
- Unlike ROTATE THEN INSERT SELECTED BITS which sets the condition code, ROTATE THEN INSERT SELECTED BITS HIGH and ROTATE THEN INSERT SELECTED BITS LOW do not set the condition code.
- The High-Level Assembler implements various high-word logical operations by providing extended-mnemonics for the RISBHG and RISBLG instructions, as shown in Figure 7-362.

Instruction Name	Extended-Mnemonic Syntax	RISBHG / RISBLG Equivalent
LOAD (HIGH ← HIGH)	LHHR R_1, R_2	RISBHGZ $R_1, R_2, 0, 31$
LOAD (HIGH ← LOW)	LHLR R_1, R_2	RISBHGZ $R_1, R_2, 0, 31, 32$
LOAD (LOW ← HIGH)	LLHFR R_1, R_2	RISBLGZ $R_1, R_2, 0, 31, 32$
LOAD LOGICAL HALFWORD (HIGH ← HIGH)	LLHHHR R_1, R_2	RISBHGZ $R_1, R_2, 16, 31$
LOAD LOGICAL HALFWORD (HIGH ← LOW)	LLHHLR R_1, R_2	RISBHGZ $R_1, R_2, 16, 31, 32$
LOAD LOGICAL HALFWORD (LOW ← HIGH)	LLHLHR R_1, R_2	RISBLGZ $R_1, R_2, 16, 31, 32$
LOAD LOGICAL CHARACTER (HIGH ← HIGH)	LLCHHR R_1, R_2	RISBHGZ $R_1, R_2, 24, 31$
LOAD LOGICAL CHARACTER (HIGH ← LOW)	LLCHLR R_1, R_2	RISBHGZ $R_1, R_2, 24, 31, 32$
LOAD LOGICAL CHARACTER (LOW ← HIGH)	LLCLHR R_1, R_2	RISBLGZ $R_1, R_2, 24, 31, 32$

Figure 7-362. Extended Mnemonics Formed Using RISBHG and RISBLG

SEARCH STRING

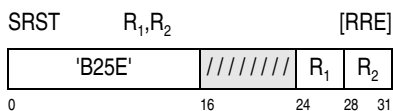

The second operand is searched until a specified character is found, the end of the second operand is reached, or a CPU-determined number of bytes have been searched, whichever occurs first. The CPU-determined number is at least 256. The result is indicated in the condition code.

The location of the first byte of the second operand is designated by the contents of general register R_2 . The location of the first byte after the second operand is designated by the contents of general register R_1 .

The handling of the addresses in general registers R_1 and R_2 is dependent on the addressing mode. In the 24-bit addressing mode, the contents of bit positions 40-63 of general registers R_1 and R_2 constitute the address, and the contents of bit positions 0-39 are ignored. In the 31-bit addressing mode, the contents of bit positions 33-63 of the registers constitute the address, and the contents of bit positions 0-32 are

ignored. In the 64-bit addressing mode, the contents of bit positions 0-63 constitute the address.

In the access-register mode, the address space containing the second operand is specified only by means of access register R_2 . The contents of access register R_1 are ignored.

The character for which the search occurs is specified in bit positions 56-63 of general register 0. Bit positions 32-55 of general register 0 are reserved for possible future extensions and must contain all zeros; otherwise, a specification exception is recognized.

The operation proceeds left to right and ends as soon as the specified character has been found in the second operand, the address of the next second-operand byte to be examined equals the address in general register R_1 , or a CPU-determined number of second-operand bytes have been examined, whichever occurs first. The CPU-determined number is at least 256. When the specified character is found, condition code 1 is set. When the address of the next second-operand byte to be examined equals the address in general register R_1 , condition code 2 is set. When a CPU-determined number of second-operand bytes have been examined, condition code 3 is set. When the CPU-determined number of second-operand bytes have been examined and the address of the next second-operand byte is in general register R_1 , it is unpredictable whether condition code 2 or 3 is set.

When condition code 1 is set, the address of the specified character found in the second operand is placed in general register R_1 , and the contents of general register R_2 remain unchanged. When condition code 3 is set, the address of the next byte to be processed in the second operand is placed in general register R_2 , and the contents of general register R_1 remain unchanged. When condition code 2 is set, the contents of general registers R_1 and R_2 remain unchanged. Whenever an address is placed in a general register, bits 32-39 of the register, in the 24-bit addressing mode, or bit 32, in the 31-bit addressing mode, are set to zeros. Bits 0-31 of the R_1 and R_2 registers always remain unchanged in the 24-bit or 31-bit mode.

When the address in general register R_1 equals the address in general register R_2 , condition code 2 is set immediately, and access exceptions are not recognized. When the address in general register R_1 is

less than the address in general register R_2 , condition code 2 can be set only if the operand wraps around from the top of storage to location 0.

The amount of processing that results in the setting of condition code 3 is determined by the CPU on the basis of improving system performance, and it may be a different amount each time the instruction is executed.

Access exceptions for the second operand are recognized only for that portion of the operand that is necessarily examined.

The storage-operand-consistency rules are described in the section "Storage-Operand Consistency" on page 5-125.

Resulting Condition Code:

- 0 --
- 1 Specified character found; general register R_1 updated with address of character; general register R_2 unchanged
- 2 Specified character not found in entire second operand; general registers R_1 and R_2 unchanged
- 3 CPU-determined number of bytes searched; general register R_1 unchanged; general register R_2 updated with address of next byte

Program Exceptions:

- Access (fetch, operand 2)
- Specification
- Transaction constraint

Programming Notes:

1. Examples of the use of the SEARCH STRING instruction are given in Appendix A, "Number Representation and Instruction-Use Examples."
2. When condition code 3 is set, the program can simply branch back to the instruction to continue the search. The program need not determine the number of bytes that were searched.
3. The R_1 or R_2 fields may designate general register 0, in which case general register 0 is treated as containing an address and also the specified character.

However, if the program branches back to the SEARCH STRING instruction following condition code 3, specifying R_2 as register 0 is imprac-

tical. This is because bits 32-55 of the register will have been altered to a nonzero value, thus resulting in a specification exception on the subsequent execution. The search character in bit positions 56-63 of the register also may have been altered.

4. When it is desired to search a string of unknown length for its ending character, and assuming that the specified character in general register 0 need not be preserved, then the R_1 field can designate general register 0 in order to have SEARCH STRING use only two general registers instead of three. In this case, the rightmost portion of general register 0 containing the required zeros and the 8-bit search character is also used to form the address of the first byte after the second operand.
5. If the program branches back to the SEARCH STRING instruction when condition code 3 is set, and a subsequent execution results in condition code 1 or 2, general register R_2 will have changed from its initial value, even though the definition states that the register is unchanged when the character is found.
6. If the length of the string (as determined by the difference between the addresses in general registers R_1 and R_2) is 255 characters or less, condition code 3 will never be set, and branching on that condition is not necessary. However, if the length of the string is 256 or more characters, condition code 3 may be set – even if condition code 2 also applies.

SEARCH STRING UNICODE

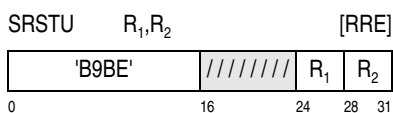

The second operand is searched until a specified two-byte character is found, the end of the second operand is reached, or a CPU-determined number of two-byte characters have been searched, whichever occurs first. The CPU-determined number is at least 256 two-byte characters. The result is indicated in the condition code.

The location of the first two-byte character of the second operand is designated by the contents of general register R_2 . When the contents of bit position 63 of

general registers R_1 and R_2 are identical (that is, when both addresses are even or both addresses are odd), the location of the first two-byte character after the second operand is designated by the contents of general register R_1 . When the contents of bit position 63 of general registers R_1 and R_2 differ (that is, when one address is even and the other is odd), the location of the first two-byte character after the second operand is one more than the contents of general register R_1 .

The handling of the addresses in general registers R_1 and R_2 is dependent on the addressing mode. In the 24-bit addressing mode, the contents of bit positions 40-63 of general registers R_1 and R_2 constitute the address, and the contents of bit positions 0-39 are ignored. In the 31-bit addressing mode, the contents of bit positions 33-63 of the registers constitute the address, and the contents of bit positions 0-32 are ignored. In the 64-bit addressing mode, the contents of bit positions 0-63 constitute the address.

In the access-register mode, the address space containing the second operand is specified only by means of access register R_2 . The contents of access register R_1 are ignored.

The two-byte character for which the search occurs is specified in bit positions 48-63 of general register 0. Bit positions 32-47 of general register 0 are reserved for possible future extensions and must contain all zeros; otherwise, a specification exception is recognized.

Except for the case when the address in general register R_1 equals the address in general register R_2 , the operation proceeds from left to right in steps of two bytes and ends as soon as the specified two-byte character has been found in the second operand, the address of the next second-operand two-byte character to be examined (excluding the first two-byte character) is equal to the address of the first two-byte character after the second operand (as designated by general register R_1), or a CPU-determined number of second-operand two-byte characters have been examined, whichever occurs first. The CPU-determined number is at least 256. When the specified two-byte character is found, condition code 1 is set. When the address of the next second-operand two-byte character to be examined (excluding the first two-byte character) is equal to the address of the first two-byte character after the second operand, condition code 2 is set. When a CPU-determined number of second-operand two-byte characters have

been examined, condition code 3 is set, except that condition code 2 is set if the conditions for setting it also apply.

When condition code 1 is set, the address of the specified two-byte character found in the second operand is placed in general register R_1 , and the contents of general register R_2 remain unchanged. When condition code 3 is set, the address of the next two-byte character to be processed in the second operand is placed in general register R_2 , and the contents of general register R_1 remain unchanged. When condition code 2 is set, the contents of general registers R_1 and R_2 remain unchanged. Whenever an address is placed in a general register, bits 32-39 of the register, in the 24-bit addressing mode, or bit 32, in the 31-bit addressing mode, are set to zeros. Bits 0-31 of the R_1 and R_2 registers always remain unchanged in the 24-bit or 31-bit mode.

When the address in general register R_1 equals the address in general register R_2 , condition code 2 is set immediately, and access exceptions are not recognized. When the address in general register R_1 is less than the address in general register R_2 , condition code 2 can be set only if the operand wraps around from the top of storage to location 0.

The amount of processing that results in the setting of condition code 3 is determined by the CPU on the basis of improving system performance, and it may be a different amount each time the instruction is executed.

Access exceptions for the second operand are recognized only for that portion of the operand that is necessarily examined.

The storage-operand-consistency rules are described in the section "Storage-Operand Consistency" on page 5-125.

Resulting Condition Code:

- 0 --
- 1 Specified two-byte character found; general register R_1 updated with address of character; general register R_2 unchanged
- 2 Specified two-byte character not found in entire second operand; general registers R_1 and R_2 unchanged
- 3 CPU-determined number of two-byte characters searched; general register R_1 unchanged; gen-

eral register R_2 updated with address of next two-byte character

Program Exceptions:

- Access (fetch, operand 2)
- Operation (if the extended-translation facility 3 is not installed)
- Specification
- Transaction constraint

Programming Notes:

1. When condition code 3 is set, the program can simply branch back to the instruction to continue the search. The program need not determine the number of two-byte characters that were searched.
2. The R_1 or R_2 fields may designate general register 0, in which case general register 0 is treated as containing an address and also the specified character.

However, if the program branches back to the SEARCH STRING UNICODE instruction following condition code 3, specifying R_2 as register 0 is impractical. This is because bits 32-47 of the register may have been altered to a nonzero value, thus resulting in a specification exception on the subsequent execution. The search character in bit positions 48-63 of the register also may have been altered.

3. When it is desired to search a string of unknown length for its ending two-byte character, and assuming that the specified two-byte character in general register 0 need not be preserved, then the R_1 field can designate general register 0 in order to have SEARCH STRING UNICODE use only two general registers instead of three. In this case, the rightmost portion of general register 0 containing the required zeros and the 16-bit search character is also used to form the address of the first byte after the second operand.
4. If the program branches back to the SEARCH STRING UNICODE instruction when condition code 3 is set, and a subsequent execution results in condition code 1 or 2, general register R_2 will have changed from its initial value, even though the definition states that the register is unchanged when the two-byte character is found.

- If the length of the string (as determined by the difference between the addresses in general registers R_1 and R_2) is 256 two-byte characters or less, condition code 3 will never be set, and branching on that condition is not necessary. However, if the length of the string is 257 or more two-byte characters, condition code 3 may be set.

SELECT

SELR R_1, R_2, R_3, M_4 [RRF-a]

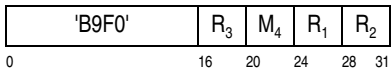

SELGR R_1, R_2, R_3, M_4 [RRF-a]

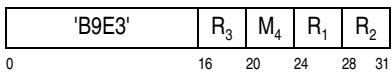

SELECT HIGH

SELFHR R_1, R_2, R_3, M_4 [RRF-a]

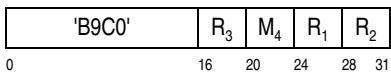

The second operand is placed unchanged at the first-operand location if the condition code has one of the values specified by M_4 ; otherwise, the third operand is placed unchanged at the first operand location.

For SELR, all operands are in bits 32-63 in their respective general registers; bits 0-31 of general register R_1 are unchanged. For SELGR, all operands are in bits 0-63 in their respective general registers. For SELFHR, all operands are in bits 0-31 in their respective general registers; bits 32-63 of general register R_1 are unchanged.

The M_4 field is used as a four-bit mask. The four condition codes (0, 1, 2, and 3) correspond, left to right, with the four bits of the mask, as follows:

Condition Code	Mask Position Value
0	8
1	4
2	2
3	1

The current condition code is used to select the corresponding mask bit. If the mask bit selected by the condition code is one, the second operand is loaded. If the mask bit selected is zero, the third operand is loaded.

Condition Code: The code remains unchanged.

Program Exceptions:

- Operation (if the miscellaneous-instruction-extensions facility 3 is not installed)

Programming Notes:

- SELECT may be used to provide better performance when it is difficult for the CPU to predict the branch condition and also uses fewer instructions. For example, the following two instruction sequences are equivalent.

```

SELR 4,5,6,7          BRC 7,REG5
                               LR 4,6
                               BRC 15,FIN
                               REG5 LR 4,5
                               FIN DS 0H
    
```

- The High-Level Assembler (HLASM) provides the following extended-mnemonic suffixes for the SELECT instructions in place of the M_4 field.

Suffix	Meaning	Effective M_4 Value
E	Equal	B'1000'
L	Low	B'0100'
H	High	B'0010'
NE	Not equal	B'0111'
NL	Not low	B'1011'
NH	Not high	B'1101'
Z	Zero	B'1000'
M	Minus or mixed	B'0100'
P	Plus	B'0010'
O	Overflow or ones	B'0001'
NZ	Not zero	B'0111'
NM	Not minus or not mixed	B'1011'
NP	Not plus	B'1101'
NO	Not overflow or not ones	B'1110'

When the extended mnemonic is coded, the M_4 field must be omitted.

SET ACCESS

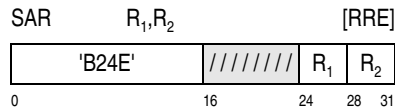

The contents of bit positions 32-63 of general register R₂ are placed in access register R₁.

Condition Code: The code remains unchanged.

Program Exceptions:

- Transaction constraint

SET ADDRESSING MODE

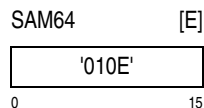
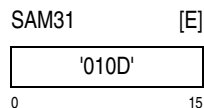
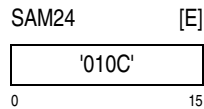

The addressing mode is set by setting the extended-addressing-mode bit, bit 31 of the current PSW, and the basic-addressing-mode bit, bit 32 of the current PSW, as follows:

Instruction	PSW Bit 31	PSW Bit 32	Resulting Addressing Mode
SAM24	0	0	24-bit
SAM31	0	1	31-bit
SAM64	1	1	64-bit

The instruction address in the PSW is updated under the control of the new addressing mode, as follows. The value 2 (the instruction length) is added to the contents of bit positions 64-127 of the PSW, or the value 4 is added if the instruction is the target of EXECUTE, or the value 6 is added if the instruction is

the target of EXECUTE RELATIVE LONG. In any case, a carry out of bit position 0 is ignored. Then bits 64-103 of the PSW are set to zeros if the new addressing mode is the 24-bit mode, or bits 64-96 are set to zeros if the new addressing mode is the 31-bit mode.

The instruction is completed only if the new addressing mode and the unupdated instruction address in the PSW are a valid combination. When the new addressing mode is to be the 24-bit mode, bits 64-103 of the unupdated PSW must be all zeros, or, when the new addressing mode is to be the 31-bit mode, bits 64-96 of the unupdated PSW must be all zeros; otherwise, a specification exception is recognized.

In the ESA/390-compatibility mode, it is unpredictable whether SAM64 is supported. If not supported, attempted execution of SAM64 results in an operation exception.

Condition Code: The code remains unchanged.

Program Exceptions:

- Operation (SAM64, in the ESA/390-compatibility mode)
- Specification (SAM24 and SAM31 only)
- Trace
- Transaction constraint

Programming Note: Checking the unupdated instruction address prevents completion in two major cases: the instruction is located at address 2^{24} or above and the new addressing mode is to be the 24-bit mode, or the instruction is located at address 2^{31} or above and the new addressing mode is to be the 24-bit or 31-bit mode. In these cases, if the instruction were completed, the updating of the instruction address under the control of the new addressing mode would cause one or more leftmost bits of the address to be set to zeros, which would cause the next instruction to be fetched from other than the next sequential location. This action is sometimes called a “wild branch.” A wild branch still can occur if the instruction is located at $2^{24} - 2$ or $2^{31} - 2$, or at $2^{24} - 4$ or $2^{31} - 4$ if EXECUTE or EXECUTE RELATIVE LONG is used, or at $2^{24} - 6$ or $2^{31} - 6$ if EXECUTE RELATIVE LONG is used.

SET PROGRAM MASK

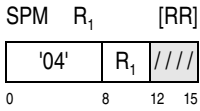

The first operand is used to set the condition code and the program mask of the current PSW.

Bits 34 and 35 of general register R_1 replace the condition code, and bits 36-39 replace the program mask. Bits 0-33 and 40-63 of general register R_1 are ignored.

Resulting Condition Code:

The code is set as specified by bits 34 and 35 of general register R_1 .

Program Exceptions: None.

Programming Notes:

1. Bits 34-39 of the general register may have been loaded from the PSW by execution of BRANCH AND LINK in the 24-bit addressing mode or by execution of INSERT PROGRAM MASK in any addressing mode.
2. SET PROGRAM MASK permits setting of the condition code and the mask bits in either the problem state or the supervisor state.
3. The program should take into consideration that the setting of the program mask can have a significant effect on subsequent execution of the program. Not only do the four mask bits control whether the corresponding interruptions occur, but the HFP-exponent-underflow and HFP-significance masks also determine the result which is obtained.

SHIFT LEFT DOUBLE

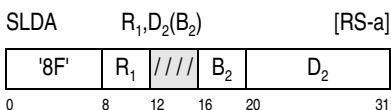

The 63-bit numeric part of the signed first operand is shifted left the number of bits specified by the second-operand address, and the result is placed at the first-operand location. The first operand consists of

bits 32-63 of general register R_1 followed on the right by bits 32-63 of general register $R_1 + 1$.

The R_1 field designates an even-odd pair of general registers and must designate an even-numbered register; otherwise, a specification exception is recognized.

The second-operand address is not used to address data; its rightmost six bits indicate the number of bit positions to be shifted. The remainder of the address is ignored.

The first operand is treated as a 64-bit signed binary integer. The sign bit of the first operand, bit 32 of the even-numbered register, remains unchanged. Bit position 32 of the odd-numbered register contains a numeric bit, which participates in the shift in the same manner as the other numeric bits. Zeros are supplied to the vacated bit positions on the right. Bits 0-31 of general registers R_1 and $R_1 + 1$ remain unchanged.

If one or more bits unlike the sign bit are shifted out of bit position 33 of the even-numbered register, an overflow occurs, and condition code 3 is set. If the fixed-point-overflow mask bit is one, a program interruption for fixed-point overflow occurs.

Resulting Condition Code:

- | | |
|---|---------------------------------------|
| 0 | Result zero; no overflow |
| 1 | Result less than zero; no overflow |
| 2 | Result greater than zero; no overflow |
| 3 | Overflow |

Program Exceptions:

- Fixed-point overflow
- Specification

Programming Notes:

1. An example of the use of the SHIFT LEFT DOUBLE instruction is given in Appendix A, "Number Representation and Instruction-Use Examples."
2. The eight shift instructions that are in both ESA/390 and z/Architecture provide the following three pairs of alternatives for 32 bits in one general register or, for double, in each of two general registers: left or right, single or double, and signed or logical. The four additional shift instructions in z/Architecture provide left or right, signed

or logical shifts of 64 bits in one general register. The signed shifts differ from the logical shifts in that, in the signed shifts, overflow is recognized, the condition code is set, and the leftmost bit participates as a sign.

- A zero shift amount in the two signed double-shift operations provides a double-length sign and magnitude test.
- The base register participating in the generation of the second-operand address permits indirect specification of the shift amount by means of placement of the shift amount in the base register. A zero in the B_2 field indicates the absence of indirect shift specification.

SHIFT LEFT DOUBLE LOGICAL

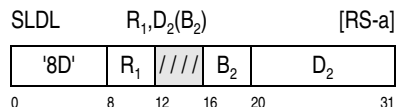

The 64-bit first operand is shifted left the number of bits specified by the second-operand address, and the result is placed at the first-operand location. The first operand consists of bits 32-63 of general register R_1 followed on the right by bits 32-63 of general register $R_1 + 1$.

The R_1 field designates an even-odd pair of general registers and must designate an even-numbered register; otherwise, a specification exception is recognized.

The second-operand address is not used to address data; its rightmost six bits indicate the number of bit positions to be shifted. The remainder of the address is ignored.

All 64 bits of the first operand participate in the shift. Bits shifted out of bit position 32 of the even-numbered register are not inspected and are lost. Zeros are supplied to the vacated bit positions on the right. Bits 0-31 of general registers R_1 and $R_1 + 1$ remain unchanged.

Condition Code: The code remains unchanged.

Program Exceptions:

- Specification

SHIFT LEFT SINGLE

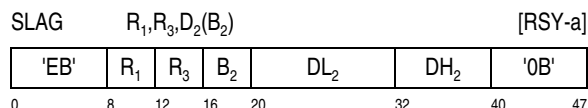
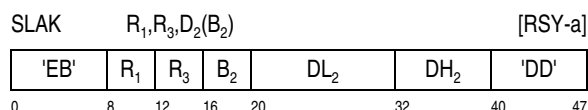
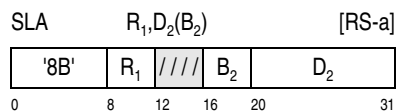

For SLA, the 31-bit numeric part of the signed first operand is shifted left the number of bits specified by the second-operand address, and the result is placed at the first-operand location. Bits 0-31 of general register R_1 remain unchanged.

For SLAK, the 31-bit numeric part of the signed third operand is shifted left the number of bits specified by the second-operand address, and the result, with the sign bit of the third operand appended on its left, is placed at the first-operand location. Bits 0-31 of general register R_1 remain unchanged. Except for when the R_1 and R_3 fields designate the same register, the third operand remains unchanged in general register R_3 .

For SLAG, the 63-bit numeric part of the signed third operand is shifted left the number of bits specified by the second-operand address, and the result, with the sign bit of the third operand appended on its left, is placed at the first-operand location. Except for when the R_1 and R_3 fields designate the same register, the third operand remains unchanged in general register R_3 .

The second-operand address is not used to address data; its rightmost six bits indicate the number of bit positions to be shifted. The remainder of the address is ignored.

For SLA, the first operand is treated as a 32-bit signed binary integer in bit positions 32-63 of general register R_1 . The sign of the first operand remains unchanged. All 31 numeric bits of the operand participate in the left shift.

For SLAK, the first and third operands are treated as 32-bit signed binary integers in bit positions 32-63 of general registers R_1 and R_3 , respectively. The sign of the first operand is set equal to the sign of the third operand. All 31 numeric bits of the third operand participate in the left shift.

For SLAG, the first and third operands are treated as 64-bit signed binary integers in bit positions 0-63 of general registers R_1 and R_3 , respectively. The sign of the first operand is set equal to the sign of the third operand. All 63 numeric bits of the third operand participate in the left shift.

For SLA, SLAG, or SLAK, zeros are supplied to the vacated bit positions on the right.

If one or more bits unlike the sign bit are shifted out of bit position 33, for SLA or SLAK, or 1, for SLAG, an overflow occurs, and condition code 3 is set. If the fixed-point-overflow mask bit is one, a program interruption for fixed-point overflow occurs.

Resulting Condition Code:

- 0 Result zero; no overflow
- 1 Result less than zero; no overflow
- 2 Result greater than zero; no overflow
- 3 Overflow

Program Exceptions:

- Fixed-point overflow
- Operation (SLAK, if the distinct-operands facility is not installed)

Programming Notes:

1. An example of the use of the SHIFT LEFT SINGLE instruction is given in Appendix A, "Number Representation and Instruction-Use Examples."
2. For SHIFT LEFT SINGLE (SLA and SLAK), for numbers with a value greater than or equal to -2^{30} and less than 2^{30} , a left shift of one bit position is equivalent to multiplying the number by 2. For SHIFT LEFT SINGLE (SLAG), the comparable values are -2^{62} and 2^{62} .
3. For SHIFT LEFT SINGLE (SLA and SLAK), shift amounts from 31 to 63 cause the entire numeric part to be shifted out of the register, leaving a result of the maximum negative number or zero, depending on whether or not the initial contents

were negative. For SHIFT LEFT SINGLE (SLAG), a shift amount of 63 causes the same effect.

SHIFT LEFT SINGLE LOGICAL

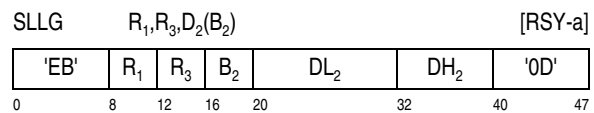
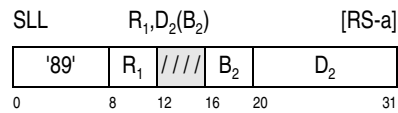

For SLL, the 32-bit first operand is shifted left the number of bits specified by the second-operand address, and the result is placed at the first-operand location. Bits 0-31 of general register R_1 remain unchanged.

For SLLK, the 32-bit third operand is shifted left the number of bits specified by the second-operand address, and the result is placed at the first-operand location. Bits 0-31 of general register R_1 remain unchanged. Except for when the R_1 and R_3 fields designate the same register, the third operand remains unchanged in general register R_3 .

For SLLG, the 64-bit third operand is shifted left the number of bits specified by the second-operand address, and the result is placed at the first-operand location. Except for when the R_1 and R_3 fields designate the same register, the third operand remains unchanged in general register R_3 .

The second-operand address is not used to address data; its rightmost six bits indicate the number of bit positions to be shifted. The remainder of the address is ignored.

For SLL, the first operand is in bit positions 32-63 of general register R_1 . All 32 bits of the operand participate in the left shift.

For SLLK, the first and third operands are in bit positions 32-63 of general registers R_1 and R_3 , respec-

tively. All 32 bits of the third operand participate in the left shift.

For SLLG, the first and third operands are in bit positions 0-63 of general registers R_1 and R_3 , respectively. All 64 bits of the third operand participate in the left shift.

For SLL, SLLG, or SLLK, zeros are supplied to the vacated bit positions on the right.

Condition Code: The code remains unchanged.

Program Exceptions:

- Operation (SLLK, if the distinct-operands facility is not installed)

Programming Note: The rightmost six bits of the second-operand address are treated as a 6-bit unsigned binary integer specifying the number of bit positions to be shifted to the left. Thus, the number of bit positions to be shifted is the value of the second-operand address, modulo 64.

When the number of bit positions to be shifted is between 32 and 63, SLL and SLLK can be used to zero the rightmost 32 bits of the result in general register R_1 . However, because of the modulo 64 behavior, it is not true that any second-operand-address value greater than 32 produces a result of zero.

Because the number of shifted bit positions is limited to 63, SLLG cannot be used to zero all 64 bits of the result.

SHIFT RIGHT DOUBLE

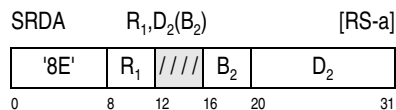

The 63-bit numeric part of the signed first operand is shifted right the number of bits specified by the second-operand address, and the result is placed at the first-operand location. The first operand consists of bits 32-63 of general register R_1 followed on the right by bits 32-63 of general register $R_1 + 1$.

The R_1 field designates an even-odd pair of general registers and must designate an even-numbered reg-

ister; otherwise, a specification exception is recognized.

The second-operand address is not used to address data; its rightmost six bits indicate the number of bit positions to be shifted. The remainder of the address is ignored.

The first operand is treated as a 64-bit signed binary integer. The sign bit of the first operand, bit 32 of the even-numbered register, remains unchanged. Bit position 32 of the odd-numbered register contains a numeric bit, which participates in the shift in the same manner as the other numeric bits. Bits shifted out of bit position 63 of the odd-numbered register are not inspected and are lost. Bits equal to the sign are supplied to the vacated bit positions on the left. Bits 0-31 of general registers R_1 and $R_1 + 1$ remain unchanged.

Resulting Condition Code:

- 0 Result zero
- 1 Result less than zero
- 2 Result greater than zero
- 3 --

Program Exceptions:

- Specification

SHIFT RIGHT DOUBLE LOGICAL

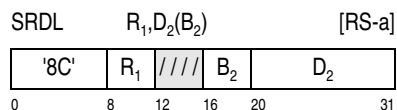

The 64-bit first operand is shifted right the number of bits specified by the second-operand address, and the result is placed at the first-operand location. The first operand consists of bits 32-63 of general register R_1 followed on the right by bits 32-63 of general register $R_1 + 1$.

The R_1 field designates an even-odd pair of general registers and must designate an even-numbered register; otherwise, a specification exception is recognized.

The second-operand address is not used to address data; its rightmost six bits indicate the number of bit

positions to be shifted. The remainder of the address is ignored.

All 64 bits of the first operand participate in the shift. Bits shifted out of bit position 63 of the odd-numbered register are not inspected and are lost. Zeros are supplied to the vacated bit positions on the left. Bits 0-31 of general registers R_1 and $R_1 + 1$ remain unchanged.

Condition Code: The code remains unchanged.

Program Exceptions:

- Specification

SHIFT RIGHT SINGLE

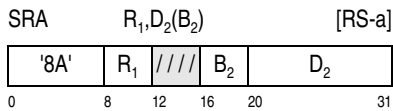

For SRA, The 31-bit numeric part of the signed first operand is shifted right the number of bits specified by the second-operand address, and the result is placed at the first-operand location. Bits 0-32 of general register R_1 remain unchanged.

For SRAK, the 31-bit numeric part of the signed third operand is shifted right the number of bits specified by the second-operand address, and the result, with the sign bit of the third operand appended on its left, is placed at the first-operand location. Bits 0-31 of general register R_1 remain unchanged. Except for when the R_1 and R_3 fields designate the same register, the third operand remains unchanged in general register R_3 .

For SHIFT RIGHT SINGLE (SRAG), the 63-bit numeric part of the signed third operand is shifted right the number of bits specified by the second-operand address, and the result, with the sign bit of the third operand appended on its left, is placed at the

first-operand location. Except for when the R_1 and R_3 fields designate the same register, the third operand remains unchanged in general register R_3 .

The second-operand address is not used to address data; its rightmost six bits indicate the number of bit positions to be shifted. The remainder of the address is ignored.

For SRA, The first operand is treated as a 32-bit signed binary integer in bit positions 32-63 of general register R_1 . The sign of the first operand remains unchanged. All 31 numeric bits of the operand participate in the right shift.

For SRAK, the first and third operands are treated as 32-bit signed binary integers in bit positions 32-63 of general registers R_1 and R_3 , respectively. The sign of the first operand is set equal to the sign of the third operand. All 31 numeric bits of the third operand participate in the right shift.

For SRAG, the first and third operands are treated as 64-bit signed binary integers in bit positions 0-63 of general registers R_1 and R_3 , respectively. The sign of the first operand is set equal to the sign of the third operand. All 63 numeric bits of the third operand participate in the right shift.

For SRA, SRAG, or SRAK, bits shifted out of bit position 63 are not inspected and are lost. Bits equal to the sign are supplied to the vacated bit positions on the left.

Resulting Condition Code:

- 0 Result zero
- 1 Result less than zero
- 2 Result greater than zero
- 3 --

Program Exceptions:

- Operation (SRAK, if the distinct-operands facility is not installed)

Programming Notes:

1. A right shift of one bit position is equivalent to division by 2 with rounding downward. When an even number is shifted right one position, the result is equivalent to dividing the number by 2. When an odd number is shifted right one position, the result is equivalent to dividing the *next*

lower number by 2. For example, +5 shifted right by one bit position yields +2, whereas -5 yields -3.

- For SRA and SRAK, shift amounts from 31 to 63 cause the entire numeric part to be shifted out of the register, leaving a result of -1 or zero, depending on whether or not the initial contents were negative. For SHIFT RIGHT SINGLE (SRAG), a shift amount of 63 causes the same effect.

SHIFT RIGHT SINGLE LOGICAL

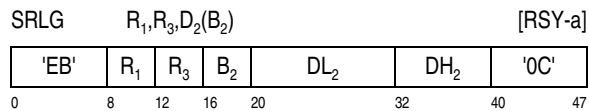
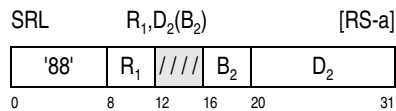

For SRL, the 32-bit first operand is shifted right the number of bits specified by the second-operand address, and the result is placed at the first-operand location. Bits 0-31 of general register R₁ remain unchanged.

For SRLK, the 32-bit third operand is shifted right the number of bits specified by the second-operand address, and the result is placed at the first-operand location. Bits 0-31 of general register R₁ remain unchanged. Except for when the R₁ and R₃ fields designate the same register, the third operand remains unchanged in general register R₃.

For SRLG, the 64-bit third operand is shifted right the number of bits specified by the second-operand address, and the result is placed at the first-operand location. Except for when the R₁ and R₃ fields designate the same register, the third operand remains unchanged in general register R₃.

The second-operand address is not used to address data; its rightmost six bits indicate the number of bit

positions to be shifted. The remainder of the address is ignored.

For SRL, the first operand is in bit positions 32-63 of general register R₁. All 32 bits of the operand participate in the right shift.

For SRLK, the first and third operands are in bit positions 32-63 of general registers R₁ and R₃, respectively. All 32 bits of the third operand participate in the right shift.

For SRLG, the first and third operands are in bit positions 0-63 of general registers R₁ and R₃, respectively. All 64 bits of the third operand participate in the right shift.

For SRL, SRLG, or SRLK, bits shifted out of bit position 63 are not inspected and are lost. Zeros are supplied to the vacated bit positions on the left.

Condition Code: The code remains unchanged.

Program Exceptions:

- Operation (SRLK, if the distinct-operands facility is not installed)

Programming Note: The rightmost six bits of the second-operand address are treated as a 6-bit unsigned binary integer specifying the number of bit positions to be shifted to the right. Thus, the number of bit positions to be shifted is the value of the second-operand address, modulo 64.

When the number of bit positions to be shifted is between 32 and 63, SRL and SRLK can be used to zero the rightmost 32 bits of the result in general register R₁. However, because of the modulo 64 behavior, it is not true that any second-operand-address value greater than 32 produces a result of zero.

Because the number of shifted bit positions is limited to 63, SRLG cannot be used to zero all 64 bits of the result.

STORE

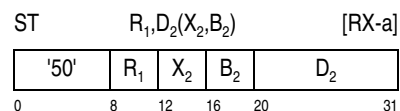

STY $R_1, D_2(X_2, B_2)$ [RXY-a]

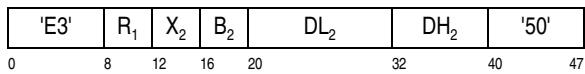

STG $R_1, D_2(X_2, B_2)$ [RXY-a]

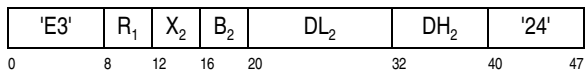

STORE RELATIVE LONG

STRL R_1, RI_2 [RIL-b]

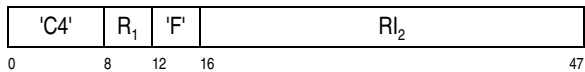

STGRL R_1, RI_2 [RIL-b]

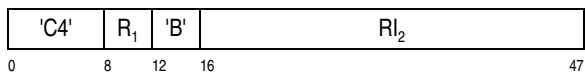

The first operand is placed unchanged at the second-operand location.

For STORE (ST, STY) and STORE RELATIVE LONG (STRL), the operands are 32 bits, and, for STORE (STG) and STORE RELATIVE LONG (STGRL), the operands are 64 bits.

The displacement for ST is treated as a 12-bit unsigned binary integer. The displacement for STY and STG is treated as a 20-bit signed binary integer.

For STORE RELATIVE LONG, the contents of the RI₂ field are a signed binary integer specifying the number of halfwords that is added to the address of the instruction to generate the address of the second operand in storage. When DAT is on, the second operand is accessed using the same addressing-space mode as that used to access the instruction. When DAT is off, the second operand is accessed using a real address.

For STORE RELATIVE LONG (STRL), the second operand must be aligned on a word boundary, and for STORE RELATIVE LONG (STGRL), the second operand must be aligned on a doubleword boundary; otherwise, a specification exception is recognized.

Condition Code: The code remains unchanged.

Program Exceptions:

- Access (store, operand 2)
- Operation (STY, if the long-displacement facility is not installed; STRL and STGRL, if the general-instructions-extension facility is not installed)
- Specification (STRL, STGRL only)

Programming Notes:

1. For STORE RELATIVE LONG, the second operand must be aligned on an integral boundary corresponding to the operand's size.
2. When STORE RELATIVE LONG is the target of an execute-type instruction, the second-operand address is relative to the target address.
3. Significant delay may be incurred if the program stores into the same cache line as that containing the storing instruction or into the cache line from which a subsequent instruction may be fetched. The EXTRACT CPU ATTRIBUTE instruction may be used to determine the cache-line size.

STORE ACCESS MULTIPLE

STAM $R_1, R_3, D_2(B_2)$ [RS-a]

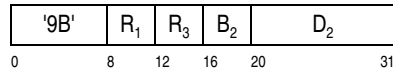

STAMY $R_1, R_3, D_2(B_2)$ [RSY-a]

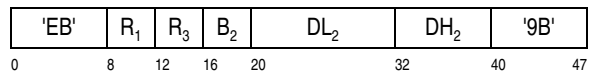

The contents of the set of access registers starting with access register R₁ and ending with access register R₃ are stored at the locations designated by the second-operand address.

The storage area where the contents of the access registers are placed starts at the location designated by the second-operand address and continues through as many storage words as the number of access registers specified. The contents of the access registers are stored in ascending order of their register numbers, starting with access register R₁ and continuing up to and including access register R₃, with access register 0 following access register 15. The contents of the access registers remain unchanged.

The displacement for STAM is treated as a 12-bit unsigned binary integer. The displacement for STAMY is treated as a 20-bit signed binary integer.

The second operand must be designated on a word boundary; otherwise, a specification exception is recognized.

Condition Code: The code remains unchanged.

Program Exceptions:

- Access (store, operand 2)
- Operation (STAMY, if the long-displacement facility is not installed)
- Specification

STORE CHARACTER

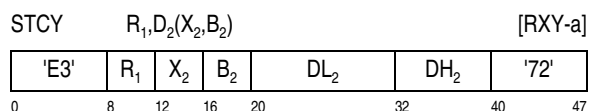
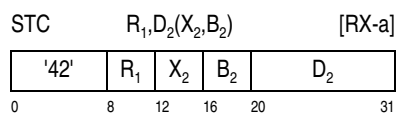

Bits 56-63 of general register R₁ are placed unchanged at the second-operand location. The second operand is one byte in length.

The displacement for STC is treated as a 12-bit unsigned binary integer. The displacement for STCY is treated as a 20-bit signed binary integer.

Condition Code: The code remains unchanged.

Program Exceptions:

- Access (store, operand 2)
- Operation (STCY, if the long-displacement facility is not installed)

STORE CHARACTER HIGH

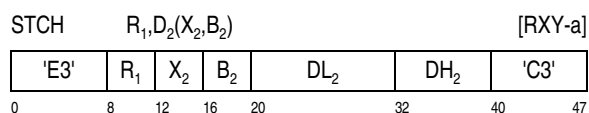

Bits 24-31 of general register R₁ are placed unchanged at the second-operand location. The second operand is one byte in length.

The displacement is treated as a 20-bit signed binary integer.

Condition Code: The code remains unchanged.

Program Exceptions:

- Access (store, operand 2)
- Operation (if the high-word facility is not installed)

STORE CHARACTERS UNDER MASK

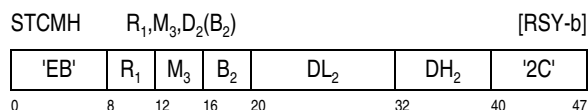
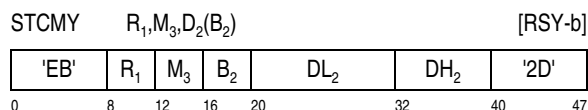
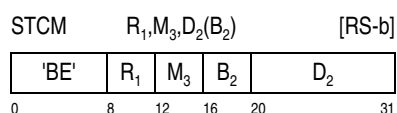

Bytes selected from general register R₁ under control of a mask are placed at contiguous byte locations beginning at the second-operand address.

The contents of the M₃ field are used as a mask. These four bits, left to right, correspond one for one with four bytes, left to right, of general register R₁. For STORE CHARACTERS UNDER MASK (STCM, STCMY), the four bytes to which the mask bits correspond are in bit positions 32-63 of general register R₁. For STORE CHARACTERS UNDER MASK (STCMH), the four bytes are in the high-order half, bit positions 0-31, of the register. The bytes corresponding to ones in the mask are placed in the same order at successive and contiguous storage locations beginning at the second-operand address. When the mask is not zero, the length of the second operand is equal to the number of ones in the mask. The contents of the general register remain unchanged.

When the mask is not zero, exceptions associated with storage-operand accesses are recognized only for the number of bytes specified by the mask.

When the mask is zero, the single byte designated by the second-operand address remains unchanged. However, on some models, an access exception may be recognized for the location. If accessible, (a) a PER zero-address-detection event may be recognized for the location, and (b) the contents may be fetched and subsequently stored back unchanged at the same storage location; this update appears to be an interlocked-update reference as observed by other CPUs.

The displacement for STCM is treated as a 12-bit unsigned binary integer. The displacement for STCMY and STCMH is treated as a 20-bit signed binary integer.

When STORE CHARACTERS UNDER MASK (STCMH) is attempted in a nonconstrained transaction, the M_3 field is 0, and the code in the R_1 field is 6 or 7, it is model dependent whether the instruction is restricted; if the instruction is not restricted, it is unpredictable whether the transaction is aborted due to abort code 16. When STORE CHARACTER UNDER MASK (STCMH) is attempted in a constrained transaction and the M_3 field is 0, a transaction-constraint program interruption is recognized, and the transaction is aborted with abort code 4.

Condition Code: The code remains unchanged.

Program Exceptions:

- Access (store, operand 2)
- Operation (STCMY, if the long-displacement facility is not installed)
- Transaction constraint (STCMH)

Programming Notes:

1. An example of the use of the STORE CHARACTERS UNDER MASK instruction is given in Appendix A, "Number Representation and Instruction-Use Examples."
2. STORE CHARACTERS UNDER MASK (STCM, STCMY), with a mask of 0111 binary may be used to store a three-byte address, for example, in modifying the address in a format-0 CCW.

3. STORE CHARACTERS UNDER MASK (STCM, STCMY) with a mask of 1111, 0011, or 0001 binary performs the same function as STORE (ST), STORE HALFWORD, or STORE CHARACTER, respectively.

4. Using STORE CHARACTERS UNDER MASK with a zero mask may cause any of the following to occur for the byte designated by the second-operand address: a PER storage-alteration event may be recognized; access exceptions may be recognized; and, provided no access exceptions exist, the change bit may be set to one. Because the contents of storage remain unchanged, the change bit may or may not be one when a PER storage-alteration event is recognized.

5. On certain models, STORE CHARACTERS UNDER MASK with mask field that specifies discontinuous bytes may perform slower than when the mask specifies contiguous bytes.

STORE CLOCK

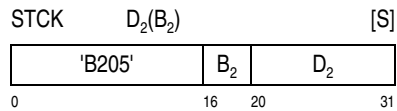

STORE CLOCK FAST

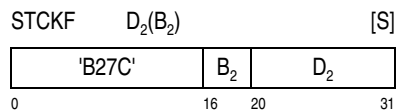

The current value of bits 0-63 of the TOD clock is stored in the eight-byte field designated by the second-operand address, provided the clock is in the set, stopped, or not-set state.

When the clock is stopped, zeros are stored in positions to the right of the rightmost bit position that is incremented when the clock is running. For STORE CLOCK, when the value of a running clock is stored, nonzero values may be stored in positions to the right of the rightmost incremented bit; this is to ensure that a unique value is stored. For STORE CLOCK FAST, when the value of a running clock is stored, bits to the right of the rightmost bit that is incremented are stored as zeros.

Zeros are stored at the operand location when the clock is in the error state or the not-operational state.

The quality of the clock value stored by the instruction is indicated by the resultant condition-code setting.

For STORE CLOCK, a serialization function is performed before the value of the clock is fetched and again after the value is placed in storage.

Resulting Condition Code:

- 0 Clock in set state
- 1 Clock in not-set state
- 2 Clock in error state
- 3 Clock in stopped state or not-operational state

Program Exceptions:

- Access (store, operand 2)
- Operation (STCKF, if the store-clock-fast facility is not installed)
- Transaction constraint

Programming Notes:

1. Bit position 31 of the clock is incremented every 1.048576 seconds; hence, for timing applications involving human responses, the leftmost clock word may provide sufficient resolution.
2. Condition code 0 normally indicates that the clock has been set by the control program. Accordingly, the value may be used in elapsed-time measurements and as a valid time-of-day and calendar indication. Condition code 1 indicates that the clock value is the elapsed time since the power for the clock was turned on. In this case, the value may be used in elapsed-time measurements but is not a valid time-of-day indication. Condition codes 2 and 3 mean that the value provided by STORE CLOCK cannot be used for time measurement or indication.
3. Condition code 3 indicates that the clock is in either the stopped state or the not-operational state. These two states can normally be distinguished because an all-zero value is stored when the clock is in the not-operational state.
4. If a problem program written for z/Architecture is to be executed also on a system in the System/370 mode, then the program should take into account that, in the System/370 mode, the value

stored when the condition code is 2 is not necessarily zero.

5. Two executions of STORE CLOCK FAST, or an execution of STORE CLOCK FAST and STORE CLOCK, either on the same or different CPUs, do not necessarily return different values of the clock if the clock is running. Similarly, an execution of STORE CLOCK FAST and STORE CLOCK EXTENDED, either on the same or different CPUs, do not necessarily return different values of TOD clock bits 0-63 if the clock is running.

Two executions of STORE CLOCK FAST, an execution of STORE CLOCK FAST and STORE CLOCK, or an execution of STORE CLOCK FAST and STORE CLOCK EXTENDED on different CPUs, may produce results that make it appear that the TOD clock is running backwards (see Figure 4-13 on page 4-51 for details).

6. When the TOD-clock-steering facility is installed, and assuming a valid operating system, then, for the problem program, the TOD clock is always in the set state and there is no need to test the condition code after issuing STORE CLOCK or STORE CLOCK FAST.
7. Using the standard epoch beginning January 1, 1900, the TOD clock provided by STORE CLOCK and STORE CLOCK FAST will wrap around to zero on September 17, 2042 at 23:53:57.370496 TAI. When the multiple-epoch facility is installed, the STORE CLOCK EXTENDED instruction provides an extended result that does not wrap around to zero at the end of an epoch.

STORE CLOCK EXTENDED

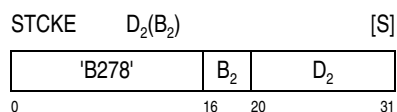

Provided that the clock is in the set, stopped, or not-set state, the following are stored into the 16-byte second operand:

- When the multiple-epoch facility (MEF) is not installed in the configuration, it is unpredictable whether the epoch index or zeros are stored in byte position 0. When the multiple epoch facility

is installed in the configuration, the epoch index is stored in byte position 0.

- The current value of the TOD clock is stored in byte positions 1-13.
- The TOD programmable field, bits 16-31 of the TOD programmable register, is stored in byte positions 14 and 15.

The operand just described has the following format:

Epoch Index	TOD Clock	Programmable Field
0	8	112
		127

When the clock is stopped, zeros are stored in the clock value in positions to the right of the rightmost bit position that is incremented when the clock is running. The programmable field still is stored.

When the value of a running clock is stored, the value in bit positions 64-103 of the clock (bit positions 72-111 of the storage operand) is always nonzero; this ensures that values stored by STORE CLOCK EXTENDED are unique when compared with values stored by STORE CLOCK and extended with zeros.

Zeros are stored at the operand location when the clock is in the error state or the not-operational state.

The quality of the clock value stored by the instruction is indicated by the resultant condition-code setting.

A serialization function is performed before the value of the clock is fetched and again after the value is placed in storage.

Resulting Condition Code:

- 0 Clock in set state
- 1 Clock in not-set state
- 2 Clock in error state
- 3 Clock in stopped state or not-operational state

Program Exceptions:

- Access (store, operand 2)
 - Transaction constraint
1. Condition code 0 normally indicates that the clock has been set by the control program. Accordingly, the value may be used in elapsed-

time measurements and as a valid time-of-day and calendar indication. Condition code 1 indicates that the clock value is the elapsed time since the power for the clock was turned on. In this case, the value may be used in elapsed-time measurements but is not a valid time-of-day indication. Condition codes 2 and 3 mean that the value provided by STORE CLOCK EXTENDED cannot be used for time measurement or indication.

2. When the TOD-clock-steering facility is installed, and assuming a valid operating system, then, for the problem program, the TOD clock is always in the set state and there is no need to test the condition code after issuing STORE CLOCK EXTENDED.
3. Programming notes 7-9 beginning on page 4-53 show hex values related to the value of the TOD clock as it is stored by the STORE CLOCK instruction. Notes 4-6, below, are repetitions of those notes except with the text and hex values adjusted so they apply to bits 0-71 of the value stored by STORE CLOCK EXTENDED.
4. The following chart shows the time interval between instants at which various bits of the TOD-clock value stored by STORE CLOCK EXTENDED are stepped. This time value may also be considered as the weighted time value that the bit, when one, represents. The bit numbers are those of the STORE CLOCK EXTENDED operand.

STCKE Bit	Stepping Interval			
	Days	Hours	Min.	Seconds
59				0.000 001
55				0.000 016
51				0.000 256
47				0.004 096
43				0.065 536
39				1.048 576
35				16.777 216
31			4	28.435 456
27		1	11	34.967 296
23		19	5	19.476 736
19	12	17	25	11.627 776
15	203	14	43	6.044 416
11	3257	19	29	36.710 656

5. The following chart shows the setting of bits 0-63 of the STORE CLOCK EXTENDED operand for 00:00:00 (0 am), UTC time, for several dates: January 1, 1900, January 1, 1972, and for that instant in time just after each of the 27 leap seconds that will have occurred through January, 2017. Each of these leap seconds is inserted in the UTC time scale beginning at 23:59:60 UTC of the day previous to the one listed and ending at 00:00:00 UTC of the day listed.

Year	Month	Day	Leap Sec.	STCKE Value (Hex) Bits 0-63
1900	1	1		0000 0000 0000 0000
1972	1	1		0081 26D6 0E46 0000
1972	7	1	1	0082 0BA9 811E 2400
1973	1	1	2	0082 F300 AEE2 4800
1974	1	1	3	0084 BDE9 7114 6C00
1975	1	1	4	0086 88D2 3346 9000
1976	1	1	5	0088 53BA F578 B400
1977	1	1	6	008A 1FE5 9520 D800
1978	1	1	7	008B EACE 5752 FC00
1979	1	1	8	008D B5B7 1985 2000
1980	1	1	9	008F 809F DBB7 4400
1981	7	1	10	0092 305C 0FCD 6800
1982	7	1	11	0093 FB44 D1FF 8C00
1983	7	1	12	0095 C62D 9431 B000
1985	7	1	13	0099 5D40 F517 D400
1988	1	1	14	009D DA69 A557 F800
1990	1	1	15	00A1 717D 063E 1C00
1991	1	1	16	00A3 3C65 C870 4000
1992	7	1	17	00A5 EC21 FC86 6400
1993	7	1	18	00A7 B70A BEB8 8800
1994	7	1	19	00A9 81F3 80EA AC00
1996	1	1	20	00AC 3433 6FEC D000
1997	7	1	21	00AE E3EF A402 F400
1999	1	1	22	00B1 962F 9305 1800
2006	1	1	23	00BE 2510 9797 3C00
2009	1	1	24	00C3 870C B9BB 6000
2012	7	1	25	00C9 CC9A 704D 8400
2015	7	1	26	00CF 2D54 B4FB A800
2017	1	1	27	00D1 E0D6 8173 CC00

6. The stepping value of TOD-clock bit position 63, if implemented, is 2^{-12} microseconds, or approximately 244 picoseconds. This value is called a clock unit.

The following chart shows various time intervals in clock units expressed in hexadecimal notation. The chart shows the values stored in bit positions 0-71 of the STORE CLOCK EXTENDED

operand. Bit 71 of the operand represents a clock unit.

Interval	Clock Units (Hex) Bits 0-71
1 microsecond	0010 00
1 millisecond	3E80 00
1 second	00F4 2400 00
1 minute	3938 7000 00
1 hour	000D 693A 4000 00
1 day	0141 DD76 0000 00
365 days	0001 CAE8 C13E 0000 00
366 days	0001 CC2A 9EB4 0000 00
1,461 days*	0007 2CE4 E26E 0000 00

* Number of days in four years, including a leap year. Note that the year 1900 was not a leap year. Thus, the four-year span starting in 1900 has only 1,460 days.

STORE FACILITY LIST EXTENDED

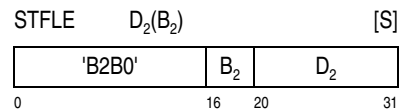

A list of bits providing information about facilities is stored beginning at the doubleword specified by the second operand address.

For the leftmost doublewords in which facility bits are assigned, the reserved bits are stored as zeros. Doublewords to the right of the doubleword in which the highest-numbered facility bit is assigned for a model may or may not be stored. Access exceptions and PER events are not recognized for doublewords that are not stored.

The size of the second operand, in doublewords, is one more than the value specified in bits 56-63 of general register 0. The remaining bits of general register 0 are unassigned and should contain zeros; otherwise, the program may not operate compatibly in the future.

When the size of the second operand is large enough to contain all of the facility bits assigned for a model, then the complete facility list is stored in the second operand location, bits 56-63 of general register 0 are updated to contain one less than the number of dou-

blewords needed to contain all of the facility bits assigned for the model, and condition code 0 is set.

When the size of the second operand is not large enough to contain all of the facility bits assigned for a model, then only the number of doublewords specified by the second-operand size are stored, bits 56-63 of general register 0 are updated to contain one less than the number of doublewords needed to contain all of the facility bits assigned for the model, and condition code 3 is set.

Figure 4-36, “Assigned Facility Bits” on page 4-99 shows the meanings of the assigned facility bits.

Special Conditions

The second operand must be designated on a doubleword boundary; otherwise, a specification exception is recognized.

Resulting Condition Code:

- | | |
|---|---------------------------------|
| 0 | Complete facility list stored |
| 1 | -- |
| 2 | -- |
| 3 | Incomplete facility list stored |

Program Exceptions:

- Access (store, second operand)
- Operation (if the store-facility-list-extended facility is not installed)
- Specification
- Transaction constraint

Programming Notes:

1. The performance of STORE FACILITY LIST EXTENDED may be significantly slower than that of simply testing a byte in storage. Programs that need to frequently test for the presence of a facility — for example, dual-path code in which the facility is used in one path but not another — should execute the STORE FACILITY LIST EXTENDED instruction once during initialization. Subsequently, the program may test for the presence of the facility by examining the stored result, using an instruction such as TEST UNDER MASK.
2. When condition code 0 is set, bits 56-63 of general register 0 are updated to contain a value that

is one less than the number of doublewords stored. If the program chooses to ignore the results in general register 0, then it should ensure that the entire second operand in storage is set to zero prior to executing STORE FACILITY LIST EXTENDED.

STORE GUARDED STORAGE CONTROLS



The contents of the three guarded-storage registers are stored at the second-operand location. The second operand has the format of a guarded-storage control block (GSCB), as shown in Figure 4-19 on page 4-67.

Access exceptions are recognized for all 32 bytes of the GSCB.

The R_1 field of the instruction is reserved and should contain zero; otherwise, the program may not operate compatibly in the future.

Special Conditions

A special-operation exception is recognized and the instruction is suppressed if the guarded-storage-facility-enablement control, bit 59 of control register 2, is zero.

Condition Code: The code remains unchanged.

Program Exceptions:

- Access (store, second operand)
- Operation (if the guarded-storage facility is not installed)
- Special operation
- Transaction constraint

STORE HALFWORD

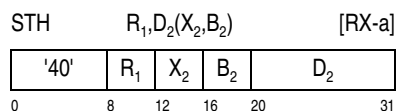

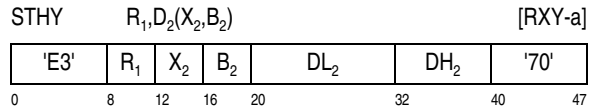

STORE HALFWORD RELATIVE LONG

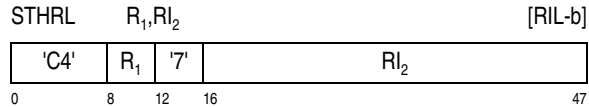

Bits 48-63 of general register R_1 are placed unchanged at the second-operand location. The second operand is two bytes in length.

The displacement for STH is treated as a 12-bit unsigned binary integer. The displacement for STHY is treated as a 20-bit signed binary integer.

For STORE HALFWORD RELATIVE LONG, the contents of the R_2 field are a signed binary integer specifying the number of halfwords that is added to the address of the instruction to generate the address of the second operand in storage. When DAT is on, the second operand is accessed using the same addressing-space mode as that used to access the instruction. When DAT is off, the second operand is accessed using a real address.

Condition Code: The code remains unchanged.

Program Exceptions:

Access (store, operand 2)

Operation (STHY if the long-displacement facility is not installed; STHRL, if the general-instructions-extension facility is not installed.)

Programming Notes:

1. For STORE HALFWORD RELATIVE LONG, the second operand is necessarily aligned on an integral boundary corresponding to the operand's size.
2. When STORE HALFWORD RELATIVE LONG is the target of an execute-type instruction, the sec-

ond-operand address is relative to the target address.

3. Significant delay may be incurred if the program stores into the same cache line as that containing the storing instruction. The EXTRACT CPU ATTRIBUTE instruction may be used to determine the cache-line size.

STORE HALFWORD HIGH

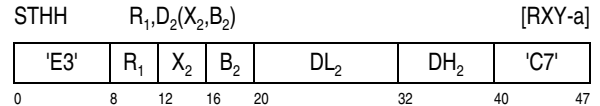

Bits 16-31 of general register R_1 are placed unchanged at the second-operand location. The second operand is two bytes in length.

The displacement is treated as a 20-bit signed binary integer.

Condition Code: The code remains unchanged.

Program Exceptions:

- Access (store, operand 2)
- Operation (if the high-word facility is not installed)

STORE HIGH

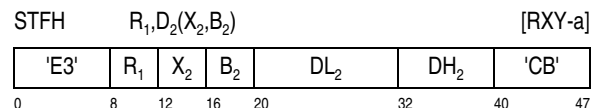

The first operand is placed unchanged at the second-operand location. The first operand is in bits 0-31 of general register R_1 , and the second operand is 32 bits in storage.

The displacement is treated as a 20-bit signed binary integer.

Condition Code: The code remains unchanged.

Program Exceptions:

- Access (store, operand 2)
- Operation (if the high-word facility is not installed)

STORE MULTIPLE

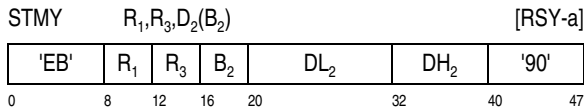
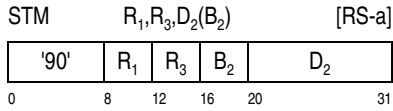

The contents of bit positions of the set of general registers starting with general register R₁ and ending with general register R₃ are placed in the storage area beginning at the location designated by the second-operand address and continuing through as many locations as needed.

For STORE MULTIPLE (STM, STMY), the contents of bit positions 32-63 of the general registers are stored in successive four-byte fields beginning at the second-operand address. For STORE MULTIPLE (STMG), the contents of bit positions 0-63 of the general registers are stored in successive eight-byte fields beginning at the second-operand address.

The general registers are stored in the ascending order of their register numbers, starting with general register R₁ and continuing up to and including general register R₃, with general register 0 following general register 15.

The displacement for STM is treated as a 12-bit unsigned binary integer. The displacement for STMY and STMG is treated as a 20-bit signed binary integer.

Condition Code: The code remains unchanged.

Program Exceptions:

- Access (store, operand 2)
- Operation (STMY, if the long-displacement facility is not installed)

Programming Note: An example of the use of the STORE MULTIPLE instruction is given in

Appendix A, "Number Representation and Instruction-Use Examples."

STORE MULTIPLE HIGH

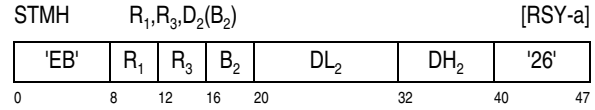

The contents of the high-order halves, bit positions 0-31, of the set of general registers starting with general register R₁ and ending with general register R₃ are placed in the storage area beginning at the location designated by the second-operand address and continuing through as many locations as needed, that is, the contents of bit positions 0-31 are stored in successive four-byte fields beginning at the second-operand address. Bits 32-63 of the registers are ignored.

The general registers are stored in the ascending order of their register numbers, starting with general register R₁ and continuing up to and including general register R₃, with general register 0 following general register 15.

Condition Code: The code remains unchanged.

Program Exceptions:

- Access (store, operand 2)

Programming Note: All combinations of register numbers specified by R₁ and R₃ are valid. When the register numbers are equal, only four bytes are transmitted. When the number specified by R₃ is less than the number specified by R₁, the register numbers wrap around from 15 to 0.

STORE ON CONDITION

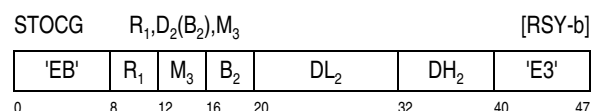

STORE HIGH ON CONDITION



The first operand is placed unchanged at the second-operand location if the condition code has one of the values specified by M_3 ; otherwise, the second operand remains unchanged.

For STOC and STOCFH, the first and second operands are 32 bits, and for STOCG, the first and second operands are 64 bits. For STOC, the first operand is in bits 32-63 of general register R_1 , and bits 0-31 of the register are ignored. For STOCFH, the first operand is in bits 0-31 of general register R_1 , and bits 32-63 of the register are ignored.

The M_3 field is used as a four-bit mask. The four condition codes (0, 1, 2, and 3) correspond, left to right, with the four bits of the mask, as follows:

Condition Code	0	1	2	3
Instruction Bit Number of Mask	12	13	14	15
Mask Position Value	8	4	2	1

The current condition code is used to select the corresponding mask bit. If the mask bit selected by the condition code is one, the store is performed. If the mask bit selected is zero, the store is not performed.

The displacement is treated as a 20-bit signed binary integer.

When the condition specified by the M_3 field is not met (that is, store operation is not performed), it is model dependent whether any or all of the following occur for the second operand: (a) an access exception is recognized, (b) the change bit is set, or (c) a PER storage-alteration or zero-address-detection event is recognized.

Condition Code: The code remains unchanged.

Program Exceptions:

- Access (store, operand 2)
- Operation (if the load/store-on-condition facility 1 is not installed; STOCFH, if the load/store-on-condition facility 2 is not installed)

Programming Notes:

1. When the M_3 field contain all zeros and no exception condition exists, the instruction acts as a NOP. When the M_3 field contains all ones and no exception condition exists, the store operation is always performed. However, these are not the preferred means of implementing a NOP or unconditional store, respectively.
2. When the condition specified by the M_3 field is not met, it is model dependent whether the second operand is brought into the cache.
3. STORE ON CONDITION provides a function similar to that of a separate BRANCH ON CONDITION instruction followed by a STORE instruction, except that STORE ON CONDITION does not provide an index register. For example, assuming the storage location is accessible, the following two instruction sequences are equivalent.

STOCG	15,256(7),8	BC	7,SKIP
		STG	15,256(0,7)
		SKIP DS	0H

On models that implement predictive branching, the combination of the BRANCH ON CONDITION and STORE instructions may perform somewhat better than the STORE ON CONDITION instruction when the CPU is able to successfully predict the branch condition. However, on models where the CPU is not able to successfully predict the branch condition, such as when the condition is more random, the STORE ON CONDITION instruction may provide significant performance improvement.

4. See programming note 4 on page 7-284 for details on extended mnemonics for the instructions of the load/store-on-condition facilities.

STORE PAIR TO QUADWORD

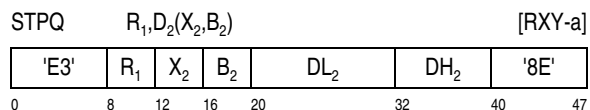

The quadword first operand is stored at the second-operand location. The store at the second-operand location appears to be quadword concurrent as observed by other CPUs. The left doubleword of the

first operand is in general register R_1 , and the right doubleword is in general register $R_1 + 1$.

The R_1 field designates an even-odd pair of general registers and must designate an even-numbered register. The second operand must be designated on a quadword boundary. Otherwise, a specification exception is recognized.

Condition Code: The code remains unchanged.

Program Exceptions:

- Access (store, operand 2)
- Specification
- Transaction constraint

Programming Notes:

1. The STORE MULTIPLE (STM or STMG) instruction does not necessarily provide quadword-concurrent access.
2. The performance of STORE PAIR TO QUADWORD on some models may be significantly slower than that of STORE MULTIPLE (STMG). Unless quadword consistency is required, STMG should be used instead of STPQ.

STORE REVERSED

STRVH $R_1, D_2(X_2, B_2)$ [RXY-a]

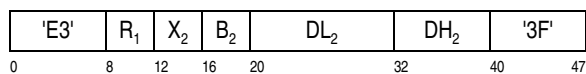

STRV $R_1, D_2(X_2, B_2)$ [RXY-a]

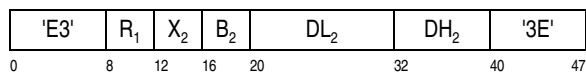

STRVG $R_1, D_2(X_2, B_2)$ [RXY-a]

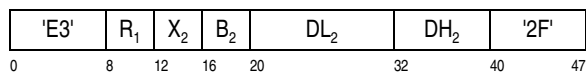

The first operand is placed at the second-operand location with the left-to-right sequence of the bytes reversed.

For STORE REVERSED (STRVH), the first operand is two bytes in bit positions 48-63 of general register

R_1 . For STORE REVERSED (STRV), the first operand is four bytes in bit positions 32-63 of general register R_1 . For STORE REVERSED (STRVG), the first operand is eight bytes in bit positions 0-63 of general register R_1 .

Condition Code: The code remains unchanged.

Program Exceptions:

- Access (store, operand 2)

Programming Notes:

1. The instruction can be used to convert two, four, or eight bytes from a "little-endian" format to a "big-endian" format, or vice versa. In the big-endian format, the bytes in a left-to-right sequence are in the order most significant to least significant. In the little-endian format, the bytes are in the order least significant to most significant. For example, the bytes ABCD in the big-endian format are DCBA in the little-endian format.

SUBTRACT

Register-and-register formats:

SR R_1, R_2 [RR]

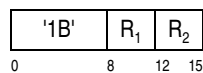

SGR R_1, R_2 [RRE]

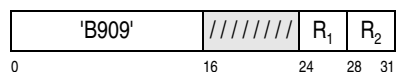

SGFR R_1, R_2 [RRE]

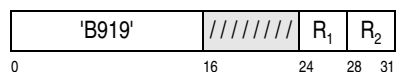

SRK R_1, R_2, R_3 [RRF-a]

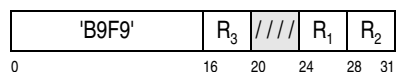

SGRK R_1, R_2, R_3 [RRF-a]

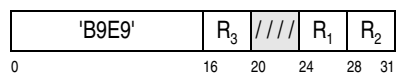

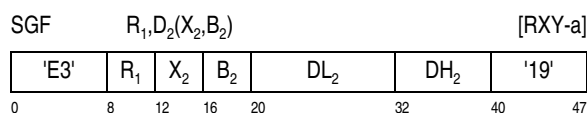
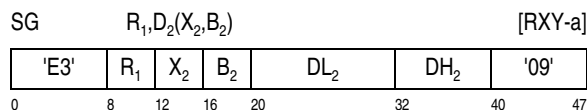
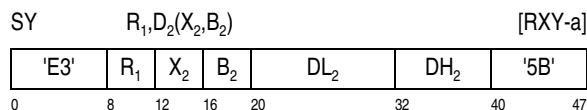
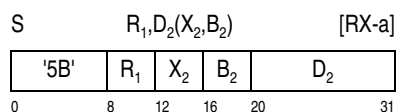
Register-and-storage formats:

For S, SG, SGF, SGFR, SGR, SR, and SY, the second operand is subtracted from the first operand, and the difference is placed at the first-operand location. For SGRK and SRK, the third operand is subtracted from the second operand, and the difference is placed at the first-operand location.

For S, SR, SRK, and SY, the operands and the difference are treated as 32-bit signed binary integers. For SG, SGR, and SGRK, they are treated as 64-bit signed binary integers. For SGFR and SGF, the second operand is treated as a 32-bit signed binary integer, and the first operand and the difference are treated as 64-bit signed binary integers.

When there is an overflow, the result is obtained by allowing any carry into the sign-bit position and ignoring any carry out of the sign-bit position, and condition code 3 is set. If the fixed-point-overflow mask is one, a program interruption for fixed-point overflow occurs.

The displacement for S is treated as a 12-bit unsigned binary integer. The displacement for SY, SG, and SGF is treated as a 20-bit signed binary integer.

Resulting Condition Code:

- 0 Result zero; no overflow
- 1 Result less than zero; no overflow
- 2 Result greater than zero; no overflow
- 3 Overflow

Program Exceptions:

- Access (fetch, operand 2 of S, SY, SG, and SGF only)
- Fixed-point overflow
- Operation (SY, if the long-displacement facility is not installed; SRK, SGRK, if the distinct-operands facility is not installed)

Programming Notes:

1. For SR and SGR, when R₁ and R₂ designate the same register, subtracting is equivalent to clearing the register.
2. Subtracting a maximum negative number from itself gives a zero result and no overflow.

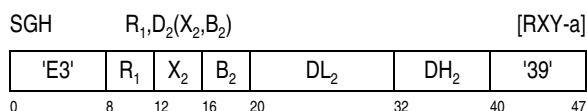
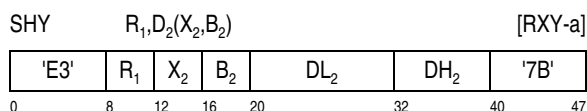
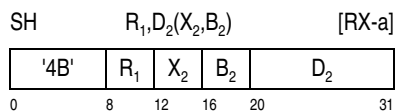
SUBTRACT HALFWORD

The second operand is subtracted from the first operand, and the difference is placed at the first-operand location. The second operand is two bytes in length and is treated as a 16-bit signed binary integer. The first operand and the difference are treated as 32-bit signed binary integers. For SGH, the first operand and the difference are treated as 64-bit signed binary integers.

When there is an overflow, the result is obtained by allowing any carry into the sign-bit position and ignoring any carry out of the sign-bit position, and condition code 3 is set. If the fixed-point-overflow mask is one, a program interruption for fixed-point overflow occurs.

The displacement for SH is treated as a 12-bit unsigned binary integer. The displacement for SGH and SHY is treated as a 20-bit signed binary integer.

Resulting Condition Code:

- 0 Result zero; no overflow
- 1 Result less than zero; no overflow
- 2 Result greater than zero; no overflow
- 3 Overflow

Program Exceptions:

- Access (fetch, operand 2)
- Fixed-point overflow
- Operation (SHY, if the long-displacement facility is not installed; SGH, if the miscellaneous-instruction-extensions facility 2 is not installed)

Programming Note: The function of a SUBTRACT HALFWORD IMMEDIATE instruction, which is an instruction not provided, can be obtained by using an ADD HALFWORD IMMEDIATE instruction with a negative I_2 field.

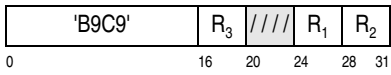
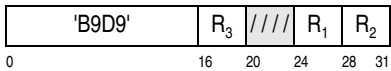
SUBTRACT HIGHSHHHR R_1, R_2, R_3 [RRF-a]SHHLR R_1, R_2, R_3 [RRF-a]

The third operand is subtracted from the second operand, and the difference is placed at the first-operand location. The operands and the difference are treated as 32-bit signed binary integers.

The first and second operands are in bits 0-31 of general registers R_1 and R_2 , respectively; bits 32-63 of general register R_1 are unchanged, and bits 32-63 of general register R_2 are ignored. For SHHHR, the third operand is in bits 0-31 of general register R_3 ; bits 32-63 of the register are ignored. For SHHLR, the third operand is in bits 32-63 of general register R_3 ; bits 0-31 of the register are ignored.

When there is an overflow, the result is obtained by allowing any carry into the sign-bit position and ignoring any carry out of the sign-bit position, and condition code 3 is set. If the fixed-point-overflow mask is one, a program interruption for fixed-point overflow occurs.

Resulting Condition Code:

- 0 Result zero; no overflow
- 1 Result less than zero; no overflow
- 2 Result greater than zero; no overflow
- 3 Overflow

Program Exceptions:

- Fixed-point overflow
- Operation (if the high-word facility is not installed)

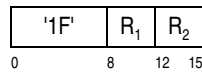
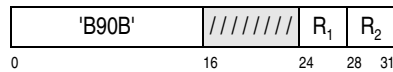
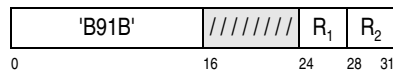
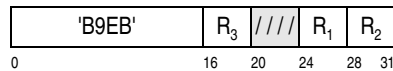
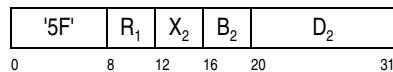
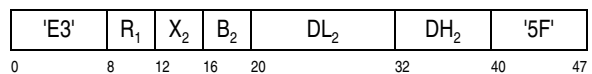
SUBTRACT LOGICAL**Register-and-register formats:**SLR R_1, R_2 [RR]SLGR R_1, R_2 [RRE]SLGFR R_1, R_2 [RRE]SLRK R_1, R_2, R_3 [RRF-a]SLGRK R_1, R_2, R_3 [RRF-a]**Register-and-storage formats:**SL $R_1, D_2(X_2, B_2)$ [RX-a]SLY $R_1, D_2(X_2, B_2)$ [RXY-a]

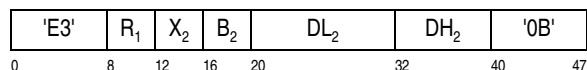
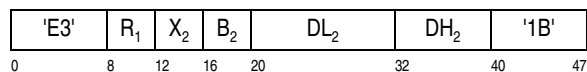
SLG $R_1, D_2(X_2, B_2)$ [RXY-a]SLGF $R_1, D_2(X_2, B_2)$ [RXY-a]

SUBTRACT LOGICAL IMMEDIATE

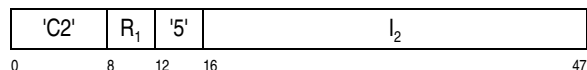
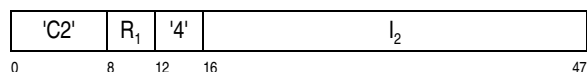
SLFI R_1, I_2 [RIL-a]SLGFI R_1, I_2 [RIL-a]

For SUBTRACT LOGICAL (SL, SLG, SLGF, SLGFR, SLGR, SLR, SLY) and for SUBTRACT LOGICAL IMMEDIATE, the second operand is subtracted from the first operand, and the difference is placed at the first-operand location. For SUBTRACT LOGICAL (SLGRK and SLRK), the third operand is subtracted from the second operand, and the difference is placed at the first-operand location.

For SUBTRACT LOGICAL (SL, SLR, SLRK, and SLY) and for SUBTRACT LOGICAL IMMEDIATE (SLFI), the operands and the difference are treated as 32-bit unsigned binary integers. For SUBTRACT LOGICAL (SLG, SLGR, and SLGRK), they are treated as 64-bit unsigned binary integers. For SUBTRACT LOGICAL (SLGFR, SLGF) and for SUBTRACT LOGICAL IMMEDIATE (SLGFI), the second operand is treated as a 32-bit unsigned binary integer, and the first operand and the difference are treated as 64-bit unsigned binary integers.

The displacement for SL is treated as a 12-bit unsigned binary integer. The displacement for SLY, SLG, and SLGF is treated as a 20-bit signed binary integer.

Resulting Condition Code:

- 0 --
- 1 Result not zero; borrow
- 2 Result zero; no borrow
- 3 Result not zero; no borrow

Program Exceptions:

- Access (fetch, operand 2 of SL, SLY, SLG, and SLGF only)
- Operation (SLY, if the long-displacement facility is not installed; SLFI and SLGFI, if the extended-immediate facility is not installed; SLRK and SLGRK, if the distinct-operands facility is not installed)

Programming Notes:

1. Logical subtraction is performed by adding the one's complement of the second operand and a value of one to the first operand. The use of the one's complement and the value of one instead of the two's complement of the second operand results in a carry when the second operand is zero.
2. SUBTRACT LOGICAL differs from SUBTRACT only in the meaning of the condition code and in the absence of the interruption for overflow.
3. A zero difference is always accompanied by a carry out of bit position 0 for 64-bit results or bit position 32 for 32-bit results, and, therefore, no borrow.
4. The condition-code setting for SUBTRACT LOGICAL can also be interpreted as indicating the presence or absence of a carry, as follows:

- 1 Result not zero; no carry
- 2 Result zero; carry
- 3 Result not zero; carry

SUBTRACT LOGICAL HIGH

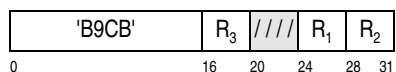
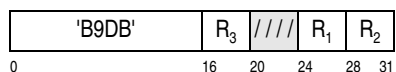
SLHHR R_1, R_2, R_3 [RRF-a]SLHLR R_1, R_2, R_3 [RRF-a]

The third operand is subtracted from the second operand, and the difference is placed at the first-operand location. The operands and the difference are treated as 32-bit unsigned binary integers.

The first and second operands are in bits 0-31 of general registers R_1 and R_2 , respectively; bits 32-63 of general register R_1 are unchanged, and bits 32-63 of general register R_2 are ignored. For SLHHHR, the third operand is in bits 0-31 of general register R_3 ; bits 32-63 of the register are ignored. For SLHHLR, the third operand is in bits 32-63 of general register R_3 ; bits 0-31 of the register are ignored.

Resulting Condition Code:

- 0 --
- 1 Result not zero; borrow
- 2 Result zero; no borrow
- 3 Result not zero; no borrow

Program Exceptions:

- Operation (if the high-word facility is not installed)

SUBTRACT LOGICAL WITH BORROW

Register-and-register formats:

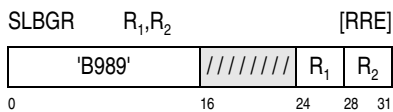
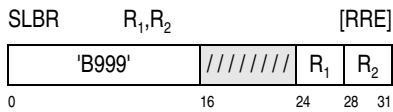

Register-and-storage formats:

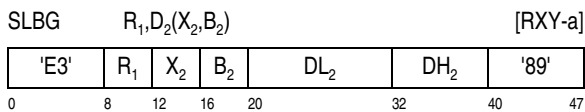
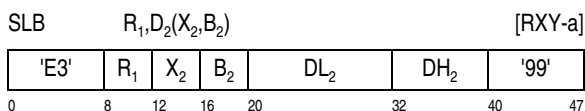

The second operand and the borrow are subtracted from the first operand, and the difference is placed at the first-operand location. For SUBTRACT LOGICAL WITH BORROW (SLBR, SLB), the operands, the borrow, and the difference are treated as 32-bit

unsigned binary integers. For SUBTRACT LOGICAL WITH BORROW (SLBGR, SLBG), they are treated as 64-bit unsigned binary integers.

Resulting Condition Code:

- 0 Result zero; borrow
- 1 Result not zero; borrow
- 2 Result zero; no borrow
- 3 Result not zero; no borrow

Program Exceptions:

- Access (fetch, operand 2 of SLB and SLBG only)

Programming Notes:

1. A borrow is represented by a zero value of bit 18 of the current PSW. Bit 18 is the leftmost bit of the two-bit condition code in the PSW. Bit 18 is set to zero by an execution of a SUBTRACT LOGICAL or SUBTRACT LOGICAL WITH BORROW instruction that produces a borrow into the leftmost bit position of the 32-bit or 64-bit result.
2. Logical subtraction with borrow is performed by adding the one's complement of the second operand and bit 18 of the current PSW to the first operand. Therefore, when bit 18 is one, indicating no borrow, the addition is the same as for SUBTRACT LOGICAL.
3. Condition code zero is set for SUBTRACT LOGICAL WITH BORROW (SLBR, SLB), when the maximum 32-bit unsigned binary integer, $2^{32} - 1$, is subtracted from zero when PSW bit 18 indicates a borrow. For SUBTRACT LOGICAL WITH BORROW (SLBGR, SLBG) condition code zero is set when the maximum 64-bit unsigned binary integer, $2^{64} - 1$, is subtracted from zero when PSW bit 18 indicates a borrow.
4. SUBTRACT and SUBTRACT LOGICAL may provide better performance than SUBTRACT LOGICAL WITH BORROW, depending on the model.

SUPERVISOR CALL

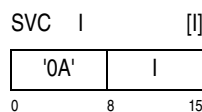

The instruction causes a supervisor-call interruption, with the I field of the instruction providing the right-most byte of the interruption code.

Bits 8-15 of the instruction, with eight zeros appended on the left, are placed in the supervisor-call interruption code that is stored in the course of the interruption. See “Supervisor-Call Interruption” on page 6-57.

A serialization and checkpoint-synchronization function is performed.

Condition Code: The code remains unchanged and is saved as part of the old PSW. A new condition code is loaded as part of the supervisor-call interruption.

Program Exceptions:

- Transaction constraint

TEST ADDRESSING MODE

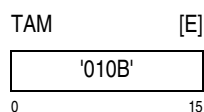

The extended-addressing-mode bit and basic-addressing-mode bit, bits 31 and 32 of the current PSW, respectively, are tested, and the result is indicated in the condition code.

Resulting Condition Code:

- | | |
|---|--|
| 0 | PSW bits 31 and 32 zeros (indicating 24-bit addressing mode) |
| 1 | PSW bit 31 zero and bit 32 one (indicating 31-bit addressing mode) |
| 2 | -- |
| 3 | PSW bits 31 and 32 ones (indicating 64-bit addressing mode) |

Program Exceptions:

- Transaction constraint

Programming Note: The case when PSW bit 31 is one and bit 32 is zero causes an early PSW specification exception to be recognized.

TEST AND SET

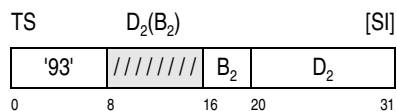

The leftmost bit (bit position 0) of the byte located at the second-operand address is used to set the condition code, and then the byte is set to all ones.

Bits 8-15 of the instruction are ignored.

The byte in storage is set to all ones as it is fetched for the testing of bit 0. This update appears to be an interlocked-update reference as observed by other CPUs.

A serialization function is performed before the byte is fetched and again after the storing of all ones.

Resulting Condition Code:

- | | |
|---|-------------------|
| 0 | Leftmost bit zero |
| 1 | Leftmost bit one |
| 2 | -- |
| 3 | -- |

Program Exceptions:

- Access (fetch and store, operand 2)
- Transaction constraint

Programming Notes:

1. TEST AND SET may be used for controlled sharing of a common storage area by programs operating on different CPUs. This instruction is provided primarily for compatibility with programs written for System/360. The instructions COMPARE AND SWAP and COMPARE DOUBLE AND SWAP provide functions which are more suitable for sharing among programs on a single CPU or for programs that may be interrupted. See the description of these instructions and the associated programming notes for details.
2. TEST AND SET does not interlock against storage accesses by channel programs. Therefore, the instruction should not be used to update a location into which a channel program may store, since the channel-program data may be lost.

TEST UNDER MASK (TEST UNDER MASK HIGH, TEST UNDER MASK LOW)

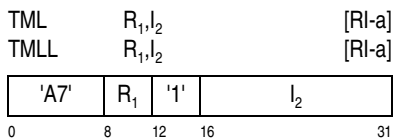
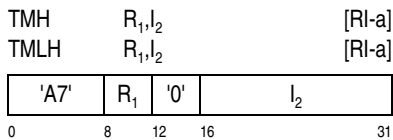
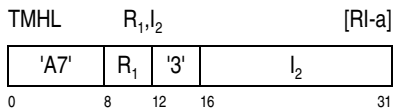
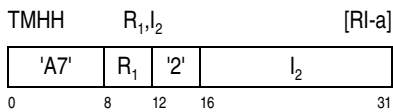
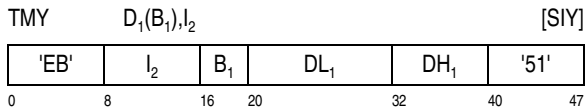
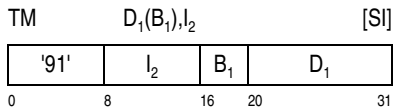

A mask is used to select bits of the first operand, and the result is indicated in the condition code.

TEST UNDER MASK is a new name of, and TMLH and TMLL are new mnemonics for, the ESA/390 instructions TEST UNDER MASK HIGH (TMH) and TEST UNDER MASK LOW (TML), respectively.

In TEST UNDER MASK (TM, TMY), the byte of immediate data, I_2 , is used as an eight-bit mask. The bits of the mask are made to correspond one for one with the bits of the byte in storage designated by the first-operand address.

A mask bit of one indicates that the storage bit is to be tested. When the mask bit is zero, the storage bit is ignored. When all storage bits thus selected are zero, condition code 0 is set. Condition code 0 is also

set when the mask is all zeros. When the selected bits are all ones, condition code 3 is set; otherwise, condition code 1 is set.

Access exceptions associated with the storage operand are recognized for one byte even when the mask is all zeros.

In TEST UNDER MASK (TMHH, TMHL, TMLH, TMLL), the contents of the I_2 field are used as a 16-bit mask. For each instruction, the bits of the mask are made to correspond one for one with 16 bits of the first operand as follows:

Instruction	Bits Tested
TMHH	0-15
TMHL	16-31
TMLH (or TMH)	32-47
TMLL (or TML)	48-63

A mask bit of one indicates that the first-operand bit is to be tested. When the mask bit is zero, the first-operand bit is ignored. When all first-operand bits thus selected are zero, condition code 0 is set. Condition code 0 is also set when the mask is all zeros. When the selected bits are mixed zeros and ones, condition code 1 is set if the leftmost selected bit is zero, or condition code 2 is set if the leftmost selected bit is one. When the selected bits are all ones, condition code 3 is set.

The displacement for TM is treated as a 12-bit unsigned binary integer. The displacement for TMY is treated as a 20-bit signed binary integer.

Resulting Condition Code:

- 0 Selected bits all zeros; or mask bits all zeros
- 1 Selected bits mixed zeros and ones (TM and TMY only)
- 1 Selected bits mixed zeros and ones, and leftmost is zero (TMHH, TMHL, TMLH, TMLL)
- 2 -- (TM and TMY only)
- 2 Selected bits mixed zeros and ones, and leftmost is one (TMHH, TMHL, TMLH, TMLL)
- 3 Selected bits all ones

Program Exceptions:

- Access (fetch, operand 1, TM and TMY only)
- Operation (TMY, if the long-displacement facility is not installed)

Programming Notes:

1. An example of the use of the TEST UNDER MASK (TM) instruction is given in Appendix A, "Number Representation and Instruction-Use Examples."
2. When the mask for TMHH, TMHL, TMLH, or TMLL selects exactly two bits, the two selected bits effectively are loaded into the condition code.

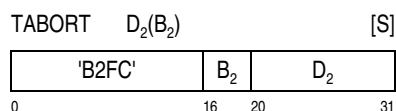
TRANSACTION ABORT

If the CPU is in the nonconstrained transactional-execution mode, the transaction is aborted.

The second-operand address is not used to address data; instead, the address specified by the B_2 and D_2 fields forms the transaction abort code which is placed in the transaction diagnostic block during abort processing. Address computation for the second-operand address follows the rules of address arithmetic; in the 24-bit addressing mode, bits 0-39 are set to zeros; in the 31-bit addressing mode, bits 0-32 are set to zeros.

Aborting of a transaction by the TABORT instruction consists of performing steps 1-7 of the section "Transaction Abort Processing" on page 5-102. The condition code in the transaction-abort PSW is set to either 2 or 3, depending on whether bit 63 of the second-operand address is zero or one, respectively.

A serialization function is implicitly performed by the abort processing.

When TRANSACTION ABORT is the target of an execute-type instruction, the operation is suppressed and an execute exception is recognized.

A specification exception is recognized and the operation is suppressed if the second-operand address is between 0 and 255.

A special-operation exception is recognized and the operation is suppressed if the CPU is not in the transactional-execution mode at the beginning of the instruction.

If the CPU is in the constrained transactional-execution mode, a transaction-constraint program exception condition is recognized.

Condition Code: The code remains unchanged. However, the condition code of the transaction-abort PSW will be set by the subsequent transaction-abort processing.

Program Exceptions:

- Execute
- Operation (transactional-execution facility not installed)
- Special-operation
- Specification
- Transaction constraint

Programming Notes:

1. If the transactional-execution control, bit 8 of control register 0, is zero, the CPU cannot be in the transactional-execution mode; Attempted execution of a TRANSACTION ABORT in this case results in a special-operation exception.
2. Abort codes 0-255 are reserved for transactions that are implicitly aborted by the CPU. See "Transaction Abort Conditions" on page 5-100 for details.
3. Program interruptions are subject to the effective program-interruption filtering control.
4. Execution of TABORT may result in significant performance degradation, potentially causing high contention which, in turn, can lead to other abort conditions.
5. Following the TABORT instruction, program execution continues at the instruction designated by the transaction-abort PSW.

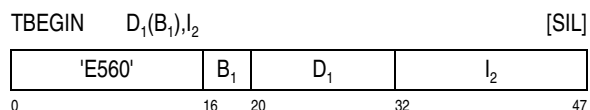
TRANSACTION BEGIN (TBEGIN)

Execution of the TRANSACTION BEGIN (TBEGIN) instruction causes the CPU either to enter or to remain in the nonconstrained transactional-execution mode.

When the B_1 field is nonzero, the following applies;

- When the transaction nesting depth is initially zero, the first-operand address designates the location of the 256-byte transaction diagnostic block, called the TBEGIN-specified TDB, into which various diagnostic information may be stored if the transaction is aborted (see “Transaction Diagnostic Block (TDB)” on page 5-93). When the CPU is in the primary-space mode or access-register mode, the first-operand address designates a location in the primary address space. When the CPU is in the secondary-space or home-space mode, the first-operand address designates a location in the secondary or home address space, respectively. When DAT is off, the TDBA designates a location in real storage.

Store accessibility to the first operand is determined. If accessible, the logical address of the operand is placed into the transaction-diagnostic-block address (TDBA), and the TDBA is valid.

- When the CPU is already in the nonconstrained transactional-execution mode, the TDBA is not modified, and it is unpredictable whether the first operand is tested for accessibility.

When the B_1 field is zero, no access exceptions are detected for the first operand, and, for the outermost TBEGIN instruction, the TDBA is invalid.

The I_2 field contains various controls for the instruction and has the following format:

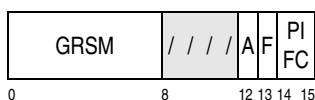

The bits of the I_2 field are defined as follows:

General Register Save Mask (GRSM): Bits 0-7 of the I_2 field contain the general register save mask (GRSM). Each bit of the GRSM represents an even-odd pair of general registers, where bit 0 represents registers 0 and 1, bit 1 represents registers 2 and 3, and so forth. When a bit in the GRSM of the outermost TBEGIN instruction is zero, the corresponding register pair is not saved. When a bit in the GRSM of the outermost TBEGIN instruction is one, the corresponding register pair is saved in a model-dependent location that is not directly accessible by the program.

If the transaction aborts, saved register pairs are restored to their contents when the outermost TBEGIN instruction was executed. The contents of all other (unsaved) general registers are not restored when a transaction aborts.

The general register save mask is ignored on all TBEGINs except for the outermost one.

Allow AR Modification (A): The A control, bit 12 of the I_2 field, controls whether the transaction is allowed to modify an access register. The effective allow-AR-modification control is the logical AND of the A control in the TBEGIN instruction for the current nesting level and for all outer levels.

If the effective A control is zero, the transaction will be aborted with abort code 11 (restricted instruction) if an attempt is made to modify any access register. If the effective A control is one, the transaction will not be aborted if an access register is modified (absent of any other abort condition).

Allow Floating-Point Operation (F): The F control, bit 13 of the I_2 field, controls whether the transaction is allowed to execute any floating-point instruction (that is, any instruction defined in Chapters 9, 18, 19, or 20) or any vector instruction (that is, any instruction defined in Chapters 21, 22, 23, 24, or 25). The effective allow-floating-point-operation control is the logical AND of the F control in the TBEGIN instruction for the current nesting level and for all outer levels.

If the effective F control is zero, then (a) the transaction will be aborted with abort code 11 (restricted instruction) if an attempt is made to execute a floating-point or vector instruction, and (b) the data-exception code (DXC) in byte 2 of the floating-point control register (FPCR) will not be set by any data-exception program-exception condition. If the effective F control is one, then (a) the transaction will not be aborted if an attempt is made to execute a floating-point or vector instruction (absent any other abort condition), and (b) the DXC or VXC in the FPCR may be set by a data-exception or vector-exception program-exception condition.

Program-Interruption-Filtering Control (PIFC): Bits 14-15 of the I_2 field are the program-interruption-filtering control (PIFC). The PIFC controls whether certain classes of program-exception conditions that occur while the CPU is in the transactional-execution mode result in an interruption. See “Program-Inter-

ruption Filtering on a Transaction Abort” on page 5-104 for a description of these classes.

The effective PIFC is the highest value of the PIFC in the TBEGIN instruction for the current nesting level and for all outer levels. When the effective PIFC is zero, all program-exception conditions result in an interruption. When the effective PIFC is one, program-exception conditions having a transactional-execution class of 1 and 2 result in an interruption. When the effective PIFC is two, program-exception conditions having a transactional-execution class of 1 result in an interruption. A PIFC of 3 is reserved.

Bits 8-11 of the I_2 field (bits 40-43 of the instruction) are reserved and should contain zeros; otherwise, the program may not operate compatibly in the future.

TRANSACTION BEGIN (TBEGIN) Processing

Execution of the TRANSACTION BEGIN (TBEGIN) instruction consists of the following steps: Note, exception checking does not necessarily need to occur in the order listed below. See Figure 7-363 on page 7-404 for the precise ordering requirements for exception checking.

1. A serialization function is performed.
 2. A special-operation exception is recognized and the operation is suppressed if the transactional-execution control, bit 8 of control register 0, is zero.
 3. A specification exception is recognized and the operation is suppressed if either of the following is true.
 - a. The program-interruption-filtering control, bits 14-15 of I_2 field of the instruction, contains the value 3.
 - b. The first-operand address does not designate a doubleword boundary. It is model dependent whether a specification exception is recognized when the first-operand address does not designate a doubleword boundary if either the B_1 field is zero or the transaction-nesting depth is nonzero.
 4. If the CPU is in the constrained transactional-execution mode, then a transaction-constraint-exception program exception is recognized and the operation is suppressed.
 5. When the B_1 field is nonzero, the following applies:
 - If the CPU is not in the transactional-execution mode (that is, the transaction nesting depth is zero), then the following occurs:
 - Store accessibility to the first operand is determined. If the first operand cannot be accessed for stores, then an access exception is recognized and the operation is either nullified, suppressed, or terminated, depending on the specific access-exception condition.
 - Any PER storage-alteration or zero-address-detection event for the first operand is recognized.
 - If the CPU is already in the transactional-execution mode, it is unpredictable whether (a) store accessibility to the first operand is determined, and (b) PER storage-alteration or zero-address-detection events are detected for the first operand.
- If the B_1 field is zero, then the first operand is not accessed.
6. If the transaction nesting depth, when incremented by one, would exceed a model-dependent maximum transaction nesting depth, the transaction is aborted with abort code 13. See “Transaction Abort Processing” on page 5-102 for details on the handling of a transaction abort.
 7. If the CPU is not in the transactional-execution mode, the following occurs:
 - a. If the B_1 field is nonzero, the first-operand address is placed in the transaction-diagnostic-block address, and the transaction-diagnostic-block address is valid. If the B_1 field is zero, the transaction-diagnostic-block address is invalid.
 - b. The transaction-abort PSW is set from the contents of the current PSW. The instruction address of the transaction-abort PSW designates the next-sequential instruction (that is, the instruction following the outermost TBEGIN).
 8. An effective value of the allow-AR-modification (A) control, bit 12 of the I_2 field of the instruction, is determined. The effective A control is the logi-

cal AND of the A control in the TBEGIN instruction for the current level and for all outer levels.

9. An effective value of the allow-floating-point-operation (F) control, bit 13 of the I_2 field of the instruction, is determined. The effective F control is the logical AND of the F control in the TBEGIN instruction for the current level and for all outer levels.
10. An effective value of the program-interruption-filtering control (PIFC), bits 14-15 of the I_2 field of the instruction, is determined. The effective PIFC value is highest value in the TBEGIN instruction for the current level and for all outer levels.
11. If the CPU is not in the transactional-execution mode, the contents of the general register pairs designated by the general-register save mask are saved in a model-dependent location that is not directly accessible by the program.
12. A value of one is added to the transaction nesting depth, and the instruction completes by setting condition code 0. If the transaction nesting depth transitions from zero to one, the CPU enters the nonconstrained transactional-execution mode; otherwise, the CPU remains in the nonconstrained transactional-execution mode.

When TBEGIN is the target of an execute-type instruction, the operation is suppressed and an execute exception is recognized.

See “Event-Suppression Control (ES)” on page 4-28 for additional details on the recognition of PER instruction-fetching events during the execution of TRANSACTION BEGIN.

Resulting Condition Code:

- 0 Transaction initiation successful
- 1 – (see programming notes 3 and 4)
- 2 – (see programming notes 3 and 4)
- 3 – (see programming notes 3 and 4)

Program Exceptions:

- Access (store, first operand)
- Execute
- Operation (transactional-execution facility not installed)
- Special operation
- Specification
- Transaction constraint

1.-7	Exceptions with the same priority as the priority of program-interruption conditions for the general case.
8.A	Specification exception due to reserved PIFC value.
8.B	Specification exception due to first-operand address not on a doubleword boundary.
8.C	Access exception (when B_1 field is nonzero).
8.D	Abort due to exceeding maximum transaction nesting depth.
9	Condition code 0 due to normal completion.

Figure 7-363. Priority of Execution: TRANSACTION BEGIN (TBEGIN)

Programming Notes:

1. When the B_1 field is nonzero, the following applies:
 - An accessible transaction diagnostic block (TDB) must be provided when an outermost transaction is initiated – even if the transaction never aborts.
 - Since it is unpredictable whether accessibility of the TDB is tested for nested transactions, an accessible TDB should be provided for any nested TBEGIN instruction.
 - The performance of any TBEGIN in which the B_1 field is nonzero, and the performance of any abort processing that occurs for a transaction that was initiated by an outermost TBEGIN in which the B_1 field is nonzero, may be slower than when the B_1 field is zero.
2. Registers designated to be saved by the general register save mask are only restored if the transaction aborts, not when the transaction ends normally by means of TRANSACTION END. Only the registers designated by the GRSM of the outermost TRANSACTION BEGIN instruction are restored on abort.

The I_2 field should designate all register pairs that provide input values that are changed by the transaction. Thus, if the transaction is aborted, the input register values will be restored to their

original contents when the abort handler is entered.

3. The TRANSACTION BEGIN (TBEGIN) instruction is expected to be followed by a conditional branch instruction that will determine whether the transaction was successfully initiated. See programming note 3 on page 5-103 for a complete explanation of each condition code.
4. If a transaction is aborted due to conditions that do not result in an interruption, the instruction designated by the transaction-abort PSW receives control (that is, the instruction following the outermost TRANSACTION BEGIN [TBEGIN]). In addition to the condition code set by the TRANSACTION BEGIN (TBEGIN) instruction, condition codes 1-3 are also set when a transaction aborts.

Therefore, the instruction sequence following the outermost TRANSACTION BEGIN (TBEGIN) instruction should be able to accommodate all four condition codes, even though the TBEGIN instruction only sets code 0. See the explanation of abort condition codes in programming note 3 on page 5-103.

5. On most models, improved performance may be realized, both on TRANSACTION BEGIN and when a transaction aborts, by specifying the minimum number of registers needed to be saved and restored in the general-register save mask.
6. While in the nonconstrained transactional-execution mode, a program may call a service function which may alter access registers, floating-point registers (including the floating-point control register), or vector registers. Although such a service routine may save the altered registers on entry and restore them at exit, the transaction may be aborted prior to normal exit of the routine. If the calling program makes no provision for preserving these registers while the CPU is in the nonconstrained transactional-execution mode, it may not be able to tolerate the service function's alteration of the registers.

To prevent inadvertent alteration of access registers while in the nonconstrained transactional-execution mode, the program can set the allow-AR-modification control, bit 12 of the I_2 field of the TRANSACTION BEGIN instruction, to zero. Similarly, to prevent the inadvertent alteration of the floating-point registers or vector registers, the program can set the allow-floating-point-opera-

tion control, bit 13 of the I_2 field of the TBEGIN instruction, to zero.

7. Program-interruption conditions recognized during the execution of TRANSACTION BEGIN (TBEGIN) instruction are subject to the effective program-interruption filtering control set by any outer TBEGIN instructions. Program-interruption conditions recognized during the execution of the outermost TBEGIN instruction are not subject to filtering.
8. In order to update multiple storage locations in a serialized manner, conventional code sequences may employ a lock word (semaphore). If (a) transactional execution is used to implement updates of multiple storage locations, (b) the program also provides a "fall-back" path to be invoked if the transaction aborts, and (c) the fall-back path employs a lock word, then the transactional-execution path should also test for the availability of the lock, and, if the lock is unavailable, end the transaction by means of the TRANSACTION END instruction and branch to the fall-back path. This ensures consistent access to the serialized resources, regardless of whether they are updated transactionally.

Alternatively, the program could abort if the lock is unavailable, however the abort processing may be significantly slower than simply ending the transaction via TEND.

9. If the effective program-interruption filtering control (PIFC) is greater than zero, the CPU filters most data-exception program interruptions. If the effective allow-floating-point-operation (F) control is zero, the data-exception code (DXC) will not be set in the floating-point control register as a result of an abort due to a data-exception program-exception condition. In this scenario (filtering applies and the effective F control is zero), the only location in which the DXC can be inspected is in the TBEGIN-specified TDB. If the program's abort handler needs to inspect the DXC in such a situation, general register B_1 should be nonzero, such that a valid transaction-diagnostic-block address (TDBA) is set.
10. If a PER storage-alteration or zero-address-detection condition exists for the TBEGIN-specified TDB of the outermost TBEGIN instruction, and PER event suppression does not apply, the PER event will be recognized during the execution of the instruction, thus causing the transac-

tion to be aborted immediately, regardless of whether any other abort condition exists.

TRANSACTION BEGIN (TBEGINC)

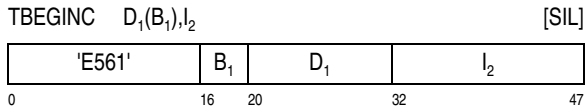

Execution of the TRANSACTION BEGIN (TBEGINC) instruction causes the CPU to enter the constrained transactional-execution mode or remain in the non-constrained transactional-execution mode.

The first-operand address is not used to access storage. The B_1 field, bits 16-19 of the instruction, must contain zeros; otherwise, a specification exception is recognized.

The I_2 field contains various controls for the instruction and has the following format:

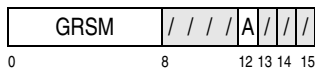

The bits of the I_2 field are defined as follows:

General Register Save Mask (GRSM): Bits 0-7 of the I_2 field contain the general register save mask (GRSM). Each bit of the GRSM represents an even-odd pair of general registers, where bit 0 represents registers 0 and 1, bit 1 represents registers 2 and 3, and so forth. When a bit in the GRSM is zero, the corresponding register pair is not saved. When a bit in the GRSM is one, the corresponding register pair is saved in a model-dependent location that is not directly accessible by the program.

If the transaction aborts, saved register pairs are restored to their contents when the outermost TRANSACTION BEGIN instruction was executed. The contents of all other (unsaved) general registers are not restored when a constrained transaction aborts.

When TBEGINC is used to continue execution in the nonconstrained transactional-execution mode, the general register save mask is ignored.

Allow AR Modification (A): The A control, bit 12 of the I_2 field, controls whether the transaction is allowed to modify an access register. The effective

allow-AR-modification control is the logical AND of the A control in the TBEGINC instruction for the current nesting level and for any outer TBEGIN or TBEGINC instructions.

If the effective A control is zero, the transaction will be aborted with abort code 11 (restricted instruction) if an attempt is made to modify any access register. If the effective A control is one, the transaction will not be aborted if an access register is modified (absent of any other abort condition).

Bits 8-11 and 13-15 of the I_2 field (bits 40-43 and 45-47 of the instruction) are reserved and should contain zeros; otherwise, the program may not operate compatibly in the future.

TRANSACTION BEGIN (TBEGINC) Processing

Execution of the TRANSACTION BEGIN (TBEGINC) instruction consists of the following steps: Note, exception checking does not necessarily need to occur in the order listed below. See Figure 7-364 on page 7-407 for the precise ordering requirements for exception checking.

1. A serialization function is performed.
2. A special-operation exception is recognized and the operation is suppressed if the transactional-execution control, bit 8 of control register 0, is zero.
3. A specification exception is recognized and the operation is suppressed if the B_1 field, bits 16-19 of the instruction, is nonzero.
4. If the CPU is already in the constrained transactional-execution mode, then a transaction-constraint-exception program exception is recognized and the operation is suppressed.
5. If the transaction nesting depth, when incremented by one, would exceed a model-dependent maximum transaction nesting depth, the transaction is aborted with abort code 13. See "Transaction Abort Processing" on page 5-102 for details on the handling of a transaction abort.
6. If the transaction nesting depth is zero, then the following is performed:
 - a. The transaction-diagnostic-block address is considered to be invalid.

- b. The transaction-abort PSW is set from the contents of the current PSW, except that the instruction address of the transaction-abort PSW designates the TBEGINC instruction (rather than the next-sequential instruction).
- c. The contents of the general register pairs designated by the general-register save mask are saved in a model-dependent location that is not directly accessible by the program.
7. An effective value of the allow-AR-modification (A) control, bit 12 of the I_2 field of the instruction, is determined. The effective A control is the logical AND of the A control in the TBEGINC instruction for the current level and for any outer TRANSACTION BEGIN instructions.
8. If the transaction nesting depth is zero, then it is set to one, and the CPU enters the constrained transactional-execution mode. The effective allow-floating-point-operation and program-interruption-filtering controls (F and PIFC, respectively) are set to zero.

If the transaction nesting depth is nonzero, then it is incremented by one, and the CPU remains in the nonconstrained transactional-execution mode. In this case, the effective value of the allow-floating-point-operation control is set to zero, and the effective value of the program-interruption-filtering control is unchanged. See “Allow Floating-Point Operation (F)” on page 7-402 and “Program-Interruption-Filtering Control (PIFC)” on page 7-402 for a description of these controls.

9. The instruction completes by setting condition code 0.

When TBEGINC is the target of an execute-type instruction, the operation is suppressed and an execute exception is recognized.

See “Event-Suppression Control (ES)” on page 4-28 for additional details on the recognition of PER instruction-fetching events during the execution of TRANSACTION BEGIN.

Resulting Condition Code:

- | | |
|---|-----------------------------------|
| 0 | Transaction initiation successful |
| 1 | – |
| 2 | – |
| 3 | – |

Program Exceptions:

- Execute
- Operation (constrained transactional-execution facility not installed)
- Special operation
- Specification
- Transaction constraint

1.-7	Exceptions with the same priority as the priority of program-interruption conditions for the general case.
8.A	Specification exception due to the B_1 field containing a nonzero value.
8.B	Abort due to exceeding transaction nesting depth.
9	Condition code 0 due to normal completion.

Figure 7-364. Priority of Execution: TRANSACTION BEGIN (TBEGINC)

Programming Notes:

1. Registers designated to be saved by the general register save mask are only restored if the transaction aborts, not when the transaction ends normally by means of TRANSACTION END. Only the registers designated by the GRSM of the outermost TRANSACTION BEGIN instruction are restored on abort.

The I_2 field should designate all register pairs that provide input values that are changed by a constrained transaction. Thus, if the transaction is aborted, the input register values will be restored to their original contents when constrained transaction is reexecuted.

2. On most models, improved performance may be realized, both on TRANSACTION BEGIN and when a transaction aborts, by specifying the minimum number of registers needed to be saved and restored in the general-register save mask.
3. Figure 7-365 on page 7-408 illustrates the results of the TRANSACTION BEGIN instruction (both TBEGIN and TBEGINC) based on the current transaction nesting depth and, when the TND is nonzero, whether the CPU is in the non-

constrained or constrained transactional-execution mode.

Instruction	TND = 0	TND > 0	
		NTX Mode	CTX Mode
TBEGIN	Enter the nonconstrained transactional-execution mode	Continue in the nonconstrained transactional-execution mode	Transaction-constraint exception
TBEGINC	Enter the constrained transactional-execution mode	Continue in the nonconstrained transactional-execution mode	Transaction-constraint exception
Explanation:			
CTX	CPU is in the constrained transactional-execution mode		
NTX	CPU is in the nonconstrained transactional-execution mode		
TND	Transaction nesting depth at the beginning of the instruction		

Figure 7-365. Operation of TRANSACTION BEGIN based on Transaction Nesting Depth and Transactional-Execution Mode

TRANSACTION END

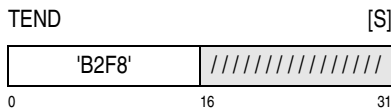

If the CPU is in the transactional-execution mode, the transaction nesting depth is decremented. If the transactional nesting depth is zero following the decrementing, all store accesses made by the transaction are committed, the CPU leaves the transactional-execution mode, and the instruction completes.

The effective allow-floating-point-operation (F) control, allow-AR-modification (A) control, and program-interruption-filtering control (PIFC) are reset to their respective values prior to the TRANSACTION BEGIN instruction that initiated the level being ended.

If the CPU is in the transactional-execution mode at the beginning the operation, the condition code is set to 0; otherwise, the condition code is set to 2.

A serialization function is performed at the completion of the operation.

When TRANSACTION END is the target of an execute-type instruction, the operation is suppressed and an execute exception is recognized.

A special-operation exception is recognized and the operation is suppressed if the transactional-execution control, bit 8 of control register 0, is zero.

Resulting Condition Code:

- 0 CPU in the transactional-execution mode at the beginning of the operation
- 1 -
- 2 CPU not in the transactional-execution mode at the beginning of the operation
- 3 -

Program Exceptions:

- Execute
- Operation (transactional-execution facility not installed)
- Special operation

Programming Notes:

1. If the transactional-execution control, bit 8 of control register 0, is zero, the CPU cannot be in the transactional-execution mode. Attempted execution of a TRANSACTION END in this case results in a special-operation exception.
2. PER instruction-fetching and transaction-end events that are recognized at the completion of the outermost TRANSACTION END instruction do not result in the transaction being aborted. See “Event-Suppression Control (ES)” on page 4-28 for additional details on the recognition of PER instruction-fetching events during the execution of TRANSACTION END.

TRANSLATE

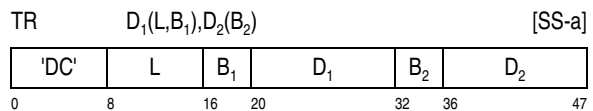

The bytes of the first operand are used as eight-bit arguments to reference a list designated by the second-operand address. Each function byte selected from the list replaces the corresponding argument in the first operand.

The L field specifies the length of only the first operand.

The bytes of the first operand are selected one by one for translation, proceeding left to right. Each argument byte is added to the initial second-operand address. The addition is performed following the rules for address arithmetic, with the argument byte treated as an eight-bit unsigned binary integer and extended with zeros on the left. The sum is used as the address of the function byte, which then replaces the original argument byte.

The operation proceeds until the first-operand field is exhausted. The list is not altered unless an overlap occurs.

When the operands overlap, the result is obtained as if each result byte were stored immediately after fetching the corresponding function byte.

Access exceptions are recognized only for those bytes in the second operand which are actually required.

Condition Code: The code remains unchanged.

Program Exceptions:

- Access (fetch, operand 2; fetch and store, operand 1)
- Transaction constraint

Programming Notes:

1. An example of the use of the TRANSLATE instruction is given in Appendix A, “Number Representation and Instruction-Use Examples.”
2. TRANSLATE may be used to convert data from one code to another code.
3. The instruction may also be used to rearrange data. This may be accomplished by placing a pattern in the destination area, by designating the pattern as the first operand of TRANSLATE, and by designating the data that is to be rearranged as the second operand. Each byte of the pattern contains an eight-bit number specifying the byte destined for this position. Thus, when the instruction is executed, the pattern selects the bytes of the second operand in the desired order.

4. Because each eight-bit argument byte is added to the initial second-operand address to obtain the address of a function byte, the list may contain 256 bytes. In cases where it is known that not all eight-bit argument values will occur, it is possible to reduce the size of the list.
5. Significant performance degradation is possible when the second-operand address of TRANSLATE designates a location that is less than 256 bytes to the left of a 4 K-byte boundary. This is because the machine may perform a trial execution of the instruction to determine if the second operand actually crosses the boundary.
6. The fetch and subsequent store accesses to a particular byte in the first-operand field do not necessarily occur one immediately after the other. Thus, this instruction cannot be safely used to update a location in storage if the possibility exists that another CPU or a channel program may also be updating the location. An example of this effect is shown for OR (OI) in “Multiprogramming and Multiprocessing Examples” in Appendix A, “Number Representation and Instruction-Use Examples.”
7. The storage-operand references of TRANSLATE may be multiple-access references. (See “Storage-Operand Consistency” on page 5-125.)

TRANSLATE AND TEST

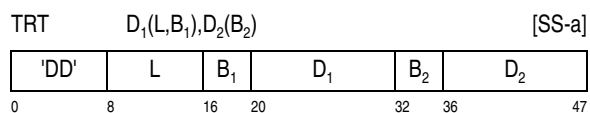

The bytes of the first operand are used as eight-bit arguments to select function bytes from a list designated by the second-operand address. The first non-zero function byte is inserted in general register 2, and the related argument address in general register 1.

The L field specifies the length of only the first operand.

The bytes of the first operand are selected one by one for translation, proceeding left to right. The first operand remains unchanged in storage. Calculation of the address of the function byte is performed as in the TRANSLATE instruction. The function byte retrieved from the list is inspected for a value of zero.

When the function byte is zero, the operation proceeds with the next byte of the first operand. When the first-operand field is exhausted before a nonzero function byte is encountered, the operation is completed by setting condition code 0. The contents of general registers 1 and 2 remain unchanged.

When the function byte is nonzero, the operation is completed by inserting the function byte in general register 2 and the related argument address in general register 1. This address points to the argument byte last translated. The function byte replaces bits 56-63 of general register 2, and bits 0-55 of this register remain unchanged. In the 24-bit addressing mode, the address replaces bits 40-63 of general register 1, and bits 0-39 of this register remain unchanged. In the 31-bit addressing mode, the address replaces bits 33-63 of general register 1, bit 32 of this register is set to zero, and bits 0-31 of the register remain unchanged. In the 64-bit addressing mode, the address replaces bits 0-63 of general register 1.

When the function byte is nonzero, either condition code 1 or 2 is set, depending on whether the argument byte is the rightmost byte of the first operand. Condition code 1 is set if one or more argument bytes remain to be translated. Condition code 2 is set if no more argument bytes remain.

The contents of access register 1 always remain unchanged.

Access exceptions are recognized only for those bytes in the second operand which are actually required. Access exceptions are not recognized for those bytes in the first operand which are to the right of the first byte for which a nonzero function byte is obtained.

Resulting Condition Code:

- 0 All function bytes zero
- 1 Nonzero function byte; first-operand field not exhausted
- 2 Nonzero function byte; first-operand field exhausted
- 3 --

Program Exceptions:

- Access (fetch, operands 1 and 2)
- Transaction constraint

Programming Notes:

1. An example of the use of the TRANSLATE AND TEST instruction is given in Appendix A, "Number Representation and Instruction-Use Examples."
2. TRANSLATE AND TEST may be used to scan the first operand for characters with special meaning. The second operand, or list, is set up with all-zero function bytes for those characters to be skipped over and with nonzero function bytes for the characters to be detected.

TRANSLATE AND TEST EXTENDED

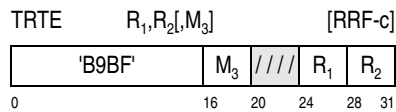

TRANSLATE AND TEST REVERSE EXTENDED

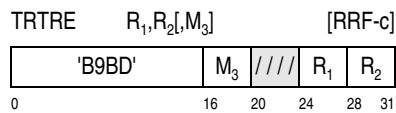

The argument characters of the first operand are used to select function codes from a function-code table designated by general register 1. For TRANSLATE AND TEST EXTENDED, the argument characters are processed in a left-to-right direction; for TRANSLATE AND TEST REVERSE EXTENDED, the argument characters are processed in a right-to-left direction. When a nonzero function code is selected, it is inserted in general register R₂, the related argument address is placed in general register R₁, and the first-operand length in general register R₁ + 1 is decremented by the number of bytes processed. The operation proceeds until a nonzero function code is encountered, the end of the first operand is reached, or a CPU-determined number of characters have been processed, whichever occurs first. The result is indicated in the condition code.

The R₁ field designates an even-odd pair of general registers and must designate an even-numbered register; otherwise, a specification exception is recognized.

General register $R_1 + 1$ contains the length of the first operand in bytes.

Operation of the instruction is subject to controls specified in the M_3 field, bits 16-19 of the instruction. The M_3 field has the following format:



The bits of the M field are defined as follows:

- **Argument-Character Control (A):** The A bit, bit 0 of the M_3 field, controls the size of the argument characters in the first operand. When the A bit is zero, the argument characters are one byte in length. When the A bit is one, the argument characters are two bytes in length.

When the A bit is one, the first-operand length in general register $R_1 + 1$ must specify an even number of bytes; otherwise, a specification exception is recognized.

- **Function-Code Control (F):** The F bit, bit 1 of the M_3 field, controls the size of the function codes in the function-code table designated by general register 1. When the F bit is zero, a function code is one byte in length. When the F bit is one, a function code is two bytes in length.
- **Argument-Character Limit (L):** The L bit, bit 2 of the M_3 field, controls whether argument characters with a value greater than 255 are used to select function codes. When the L bit is zero, argument character values are unlimited. When the L bit is one, an argument character with a value greater than 255 is not used to select a function code; rather, the function code is assumed to contain zeros.

When the A bit of the M_3 field is zero, the L bit is ignored.

- **Unassigned:** Bit 3 of the M_3 field is unassigned and should contain zero; otherwise, the program may not operate compatibly in the future.

Figure 7-366 summarizes the size of the function-code table based on the A, F, and L bits.

The location of the first argument character in the first operand is designated by the contents of general register R_1 . The location of the leftmost byte of the function-code table is designated by the contents of

A bit	F bit	L bit	Table Size (bytes)
0	0	–	256
0	1	–	512
1	0	0	65,536
1	1	0	131,072
1	0	1	256
1	1	1	512

Explanation:

– Not applicable

Figure 7-366. Function-Code Table Size

general register 1. In the 24-bit or 31-bit addressing mode, the number of bytes in the first-operand location is specified by the contents of bit positions 32-63 of general register $R_1 + 1$, and those contents are treated as a 32-bit unsigned binary integer. In the 64-bit addressing mode, the number of bytes in the first-operand location is specified by the entire contents of general register $R_1 + 1$, and those contents are treated as a 64-bit unsigned binary integer.

The handling of the argument-character address in general register R_1 is dependent on the addressing mode. In the 24-bit addressing mode, the contents of bit positions 40-63 of the register constitute the address, and the contents of bit positions 0-39 are ignored. In the 31-bit addressing mode, the contents of bit positions 33-63 of the register constitute the address, and the contents of bit positions 0-32 are ignored. In the 64-bit addressing mode, the contents of bit positions 0-63 constitute the address.

The function-code table is treated as being on a doubleword boundary. The handling of the function-code-table address in general register 1 is dependent on the addressing mode. In the 24-bit addressing mode, the contents of bit positions 40-60 of the register constitute the address, and the contents of bit positions 0-39 are ignored. In the 31-bit addressing mode, the contents of bit positions 33-60 of the register constitute the address, and the contents of bit positions 0-32 are ignored. In the 64-bit addressing mode, the contents of bit positions 0-60 of the register constitute the address. In all addressing modes, bit positions 61-63 are reserved and should contain zeros; otherwise, the program may not operate compatibly in the future.

When a nonzero function code is selected, it is inserted into either bits 56-63 or bits 48-63 of general register R_2 , depending on whether the F bit of the M_3

field is zero or one, respectively. In the 24-bit or 31-bit addressing mode, bits 0-31 of general register R_2 are unchanged, and bits 32-55 (F=0) or 32-47 (F=1) of the register are set to zero. In the 64-bit addressing mode, bits 0-55 (F=0) or 0-47 (F=1) are set to zero.

The contents of the registers just described are shown in Figure 7-367.

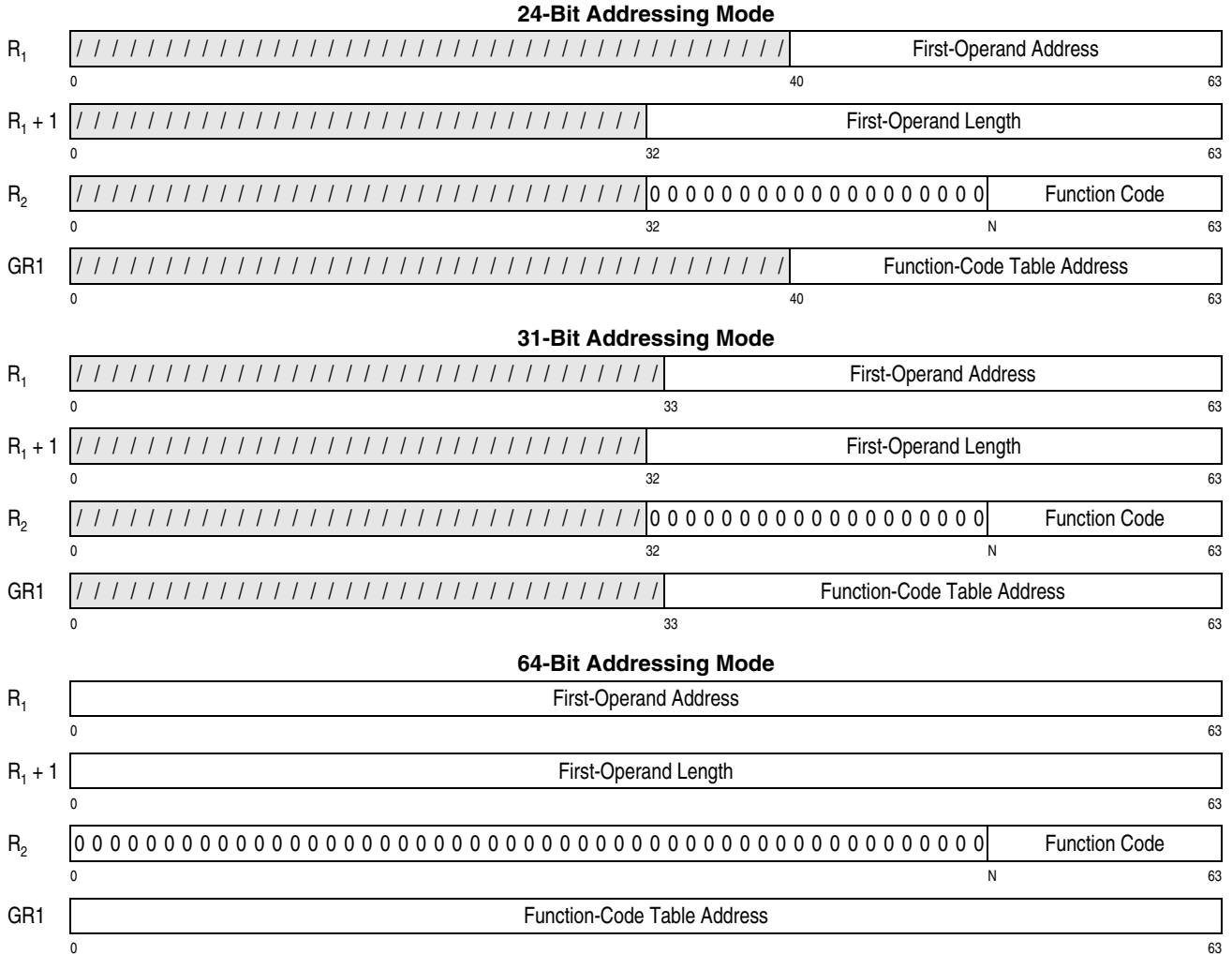

Explanation:

N 56 when the F-bit = 0; 48 when the F-bit = 1

Figure 7-367. Register Contents for TRANSLATE AND TEST EXTENDED and TRANSLATE AND TEST REVERSE EXTENDED

The argument characters of the first operand are selected one by one for processing, proceeding in a left-to-right direction for TRANSLATE AND TEST EXTENDED, or in a right-to-left direction for TRANSLATE AND TEST REVERSE EXTENDED. Depending on the A bit of the M_3 field, the argument characters are treated as either eight-bit or sixteen-bit unsigned binary integers, extended with zeros on the left.

When the F bit of the M_3 field is zero, the argument character is added to the function-code-table address in general register 1 to form the address of the selected 8-bit function code. When the F bit is one, the argument character, extended on the right with a binary 0, is added to the function-code-table address in general register 1 to form the address of the selected 16-bit function code. These additions follow the rules for address arithmetic.

When both the A and L bits are one, and the value of the argument character is greater than 255, then the function-code table is not accessed. The function code is assumed to contain zero in this case.

When the selected function code contains zero, or when the function code is assumed to contain zero, processing continues with the next argument character in the first operand. The operation proceeds until a nonzero function code is selected, the first-operand location is exhausted, or a CPU-determined number of first-operand bytes have been processed.

When the first-operand location is exhausted without having selected a nonzero function code, general register R_1 is either incremented or decremented by the first operand length in general register $R_1 + 1$; general register $R_1 + 1$ is set to zero; general register R_2 is set as though a function code of zero was selected; and condition code 0 is set. For TRANSLATE AND TEST EXTENDED, general register R_1 is incremented by the first operand length; for TRANSLATE AND TEST REVERSE EXTENDED, general register R_1 is decremented by the first operand length. In the 24-bit or 31-bit addressing mode, bits 0-31 of general register R_2 are unchanged, and bits 32-63 of the register are set to zeros; in the 64-bit addressing mode, bits 0-63 of general register R_2 are set to zeros.

When a nonzero function code is selected, the function code replaces bits 56-63 or bits 48-63 of general register R_2 , depending on whether the F bit is zero or one, respectively; depending on the addressing mode, the remaining bits in general register R_2 are set to zeros; the address of the argument character used to select the nonzero function code is placed in general register R_1 ; general register $R_1 + 1$ is decremented by the number of first-operand bytes processed prior to selecting the nonzero function byte; and condition code 1 is set. In the 24-bit or 31-bit addressing mode, bits 0-31 of general register R_2 are unchanged, and bits 32-55 (F=0) or 32-47 (F=1) are set to zero; in the 64-bit addressing mode, bits 0-55 (F=0) or 0-47 (F=1) are set to zeros.

When a CPU-determined number of bytes have been processed, general register R_1 is either incremented or decremented by the number of bytes in the first operand that were processed, general register $R_1 + 1$ is decremented by this number, and condition code 3 is set. For TRANSLATE AND TEST EXTENDED, general register R_1 is incremented by the number of bytes processed; for TRANSLATE AND TEST

REVERSE EXTENDED, general register R_1 is decremented by the number of bytes processed. Condition code 3 may be set even when the first-operand location is exhausted or when the next argument character to be processed selects a nonzero function byte. In these cases, condition code 0 or 1 will be set when the instruction is executed again.

When the R_2 field designates the same register as register R_1 , the updated first-operand address is placed in the register. When the R_2 field designates the same register as register $R_1 + 1$, the updated first-operand length is placed in the register.

When general register R_1 is updated in the 24-bit or 31-bit addressing mode, bits 32-39, in the 24-bit mode, or bit 32, in the 31-bit mode, may be set to zeros or may remain unchanged from their original values.

In the 24-bit or 31-bit addressing mode, the contents of bit positions 0-31 of general registers R_1 , $R_1 + 1$, and R_2 always remain unchanged.

The amount of processing that results in the setting of condition code 3 is determined by the CPU on the basis of improving system performance, and it may be a different amount each time the instruction is executed.

Access exceptions for the portion of the first operand beyond the last byte processed may or may not be recognized. For an operand longer than 4K bytes, access exceptions are not recognized for locations more than 4K bytes beyond the last byte processed. When the length of the first operand is zero, no access exceptions for the first operand are recognized.

Access exceptions for any byte of the function-code table specified by general register 1 may be recognized, even if not all bytes are used.

Special Conditions

A specification exception is recognized for any of the following conditions:

1. The R_1 field designates an odd-numbered register.
2. The A bit of the M_3 field is one and the first operand length in general register $R_1 + 1$ is odd.

Resulting Condition Code:

- 0 Entire first operand processed without selecting a nonzero function code
- 1 Nonzero function code selected
- 2 --
- 3 CPU-determined number of bytes processed

Program Exceptions:

- Access (fetch, operand 1 and the function-code table)
- Operation (if the parsing-enhancement facility is not installed)
- Specification
- Transaction constraint

Programming Notes:

1. When condition code 3 is set, the program can simply branch back to the instruction to continue processing. The program need not determine the number of bytes that were processed.
2. The storage-operand references of TRANSLATE AND TEST EXTENDED and TRANSLATE AND TEST REVERSE EXTENDED may be multiple-access references. (See “Storage-Operand Consistency” on page 5-125.)
3. The following example illustrates the use of TRANSLATE AND TEST EXTENDED to parse a buffer of 16-bit Unicode argument characters for delimiters such as those used in common markup languages. Because the Unicode representation of such delimiters is in the range of 0000 - 00FF hex, a limited function-code table is used (the L bit of the M₃ field is one).

In this example, the variable BUFFER is used to hold the 16-bit characters to be parsed. If a delimiting character is not found, control passes to the label NOTFND. If a delimiting character is found, the function code placed in general register R₂ is used as an index to the branch table that

passes control to a specific processing routine (not shown).

	LARL	1, TABLE	Point to func-code table.
	LARL	2, BUFFER	Point to buffer.
	LAY	3, L'BUFFER	Load length of buffer.
RETRY	TRTE	2, 15, B'1010'	Parse the buffer.
	BO	RETRY	Retry on CC3.
	B	BR_TBL(15)	Br. based on func. code:
BR_TBL	B	NOT_FND	- 00 (CC0, not found).
	B	NULL	- 04
	B	DOUBLE_QUOTE	- 08
	B	AMPERSAND	- 0C
	B	SINGLE_QUOTE	- 10
	B	SLASH	- 14
	B	LESS_THAN	- 18
	B	EQUALS	- 1C
	B	GREATER_THAN	- 20
	B	QUESTION_MARK	- 24
	...		
NOT_FND	DS	0H	No delimiters found.
	...		
	DC	X'04,00,00,00,00,00,00,00'	00-07
	DC	X'00,00,00,00,00,00,00,00'	08-0F
	DC	X'00,00,00,00,00,00,00,00'	10-17
	DC	X'00,00,00,00,00,00,00,00'	18-1F
	DC	X'00,00,08,00,00,00,0C,10'	20-27
	DC	X'00,00,00,00,00,00,00,14'	28-2F
	DC	X'00,00,00,00,00,00,00,00'	30-37
	DC	X'00,00,00,00,18,1C,20,24'	38-3F
	DC	192X'00'	40-FF
BUFFER	DS	CL8192	Buffer of 16-bit chars.

Note, the branch to label NOT_FND does not result from a function-code-table entry of zeros. Rather, the branch is taken when the first operand is exhausted without selecting a nonzero function-code-table entry.

4. As an alternative to treating the selected function-code value as a table index (as shown in programming note 3, above), the function-code value may be used directly as a branch offset.
5. The performance of TRANSLATE AND TEST EXTENDED and TRANSLATE AND TEST REVERSE EXTENDED may be significantly slower if the program modifies the function-code table prior to execution of the instruction.
6. In the assembler syntax, the M₃ operand is considered to be optional. When the M₃ field is not coded, it is considered to contain zeros by the assembler.

TRANSLATE AND TEST REVERSE

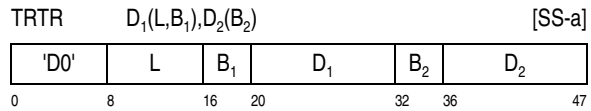

The bytes of the first operand are used as eight-bit arguments to select function bytes from a list designated by the second-operand address. The first-operand address designates the rightmost byte of the first operand. The first nonzero function byte is inserted in general register 2, and the related argument address in general register 1.

The L field specifies the length of only the first operand.

The bytes of the first operand are selected one by one for translation, proceeding from right to left. The first operand remains unchanged in storage. Calculation of the address of the function byte is performed as in the TRANSLATE instruction. The function byte retrieved from the list is inspected for a value of zero.

When the function byte is zero, the operation proceeds with the preceding byte of the first operand. When the first-operand field is exhausted before a nonzero function byte is encountered, the operation is completed by setting condition code 0. The contents of general registers 1 and 2 remain unchanged.

When the function byte is nonzero, the operation is completed by inserting the function byte in general register 2 and the related argument address in general register 1. This address points to the argument byte last translated. The function byte replaces bits 56-63 of general register 2, and bits 0-55 of this register remain unchanged. In the 24-bit addressing mode, the address replaces bits 40-63 of general register 1, and bits 0-39 of this register remain unchanged. In the 31-bit addressing mode, the address replaces bits 33-63 of general register 1, and bits 0-32 of this register remain unchanged. In the 64-bit addressing mode, the address replaces bits 0-63 of general register 1.

When the function byte is nonzero, either condition code 1 or 2 is set, depending on whether the argument byte is the leftmost byte of the first operand. Condition code 1 is set if one or more argument bytes remain to be translated. Condition code 2 is set if no more argument bytes remain.

The contents of access register 1 always remain unchanged.

Access exceptions can be recognized for any byte in either the first or in the second operand.

Resulting Condition Code:

- 0 All function bytes zero
- 1 Nonzero function byte; first-operand field not exhausted
- 2 Nonzero function byte; first-operand field exhausted
- 3 --

Program Exceptions:

- Access (fetch, operands 1 and 2)
- Operation (if the extended-translation facility 3 is not installed)
- Transaction constraint

Programming Note:

TRANSLATE AND TEST REVERSE may be used to scan the first operand for characters with special meaning. The second operand, or list, is set up with all-zero function bytes for those characters to be skipped over and with nonzero function bytes for the characters to be detected.

TRANSLATE EXTENDED

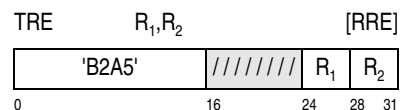

The bytes of the first operand are compared to a test byte in general register 0 and, unless an equal comparison occurs, are used as eight-bit arguments to reference a 256-byte translation table designated by the second-operand address. Each function byte selected from the second operand replaces the corresponding argument in the first operand. The operation proceeds until a first-operand byte equal to the test byte is encountered, the end of the first operand is reached, or a CPU-determined number of bytes have been processed, whichever occurs first. The result is indicated in the condition code.

The R₁ field designates an even-odd pair of general registers and must designate an even-numbered reg-

ister; otherwise, a specification exception is recognized.

The location of the leftmost byte of the first operand and second operand is designated by the contents of general registers R_1 and R_2 , respectively. In the 24-bit or 31-bit addressing mode, the number of bytes in the first-operand location is specified by the contents of bit positions 32-63 of general register $R_1 + 1$, and those contents are treated as a 32-bit unsigned binary integer. In the 64-bit addressing mode, the number of bytes in the first-operand location is specified by the entire contents of general register $R_1 + 1$, and those contents are treated as a 64-bit unsigned binary integer.

The handling of the addresses in general registers R_1 and R_2 is dependent on the addressing mode.

In the 24-bit addressing mode, the contents of bit positions 40-63 of general registers R_1 and R_2 constitute the address, and the contents of bit positions 0-39 are ignored. In the 31-bit addressing mode, the contents of bit positions 33-63 of the registers constitute the address, and the contents of bit positions 0-32 are ignored. In the 64-bit addressing mode, the contents of bit positions 0-63 constitute the address.

The test byte is in bit positions 56-63 of general register 0, and the contents of bit positions 0-55 of this register are ignored.

The contents of the registers just described are shown in Figure 7-368.

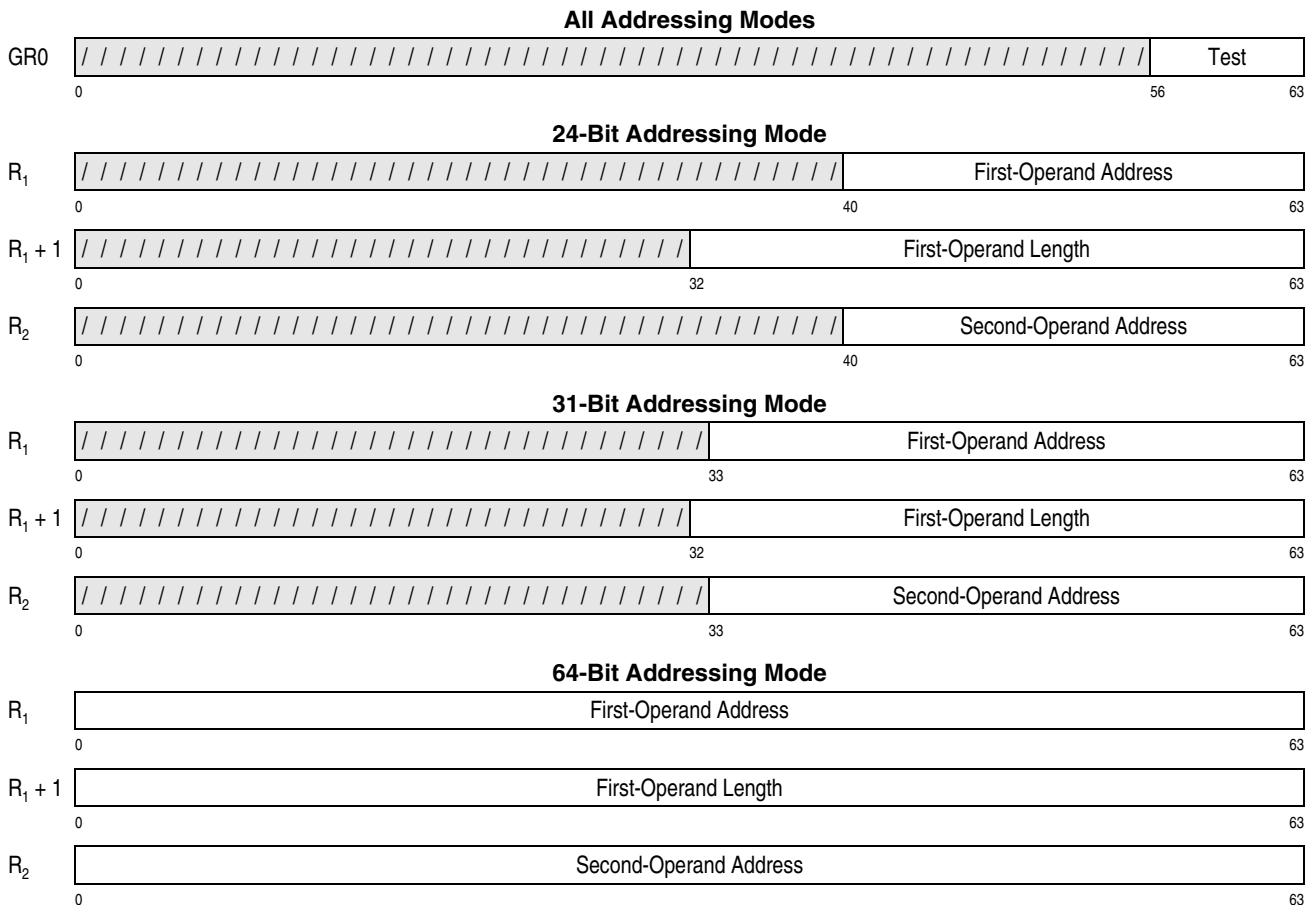

Figure 7-368. Register Contents for TRANSLATE EXTENDED

The bytes of the first operand are selected one by one for translation, proceeding left to right. Each argument byte is first compared to the test byte in

general register 0. If the result is an equal comparison, the operation is completed. If the argument byte is not equal to the test byte, the argument byte is

added to the initial second-operand address. The addition is performed following the rules for address arithmetic, with the argument byte treated as an eight-bit unsigned binary integer and extended with zeros on the left. The sum is used as the address of the function byte, which then replaces the original argument byte. The second operand is not altered unless an overlap occurs.

The operation proceeds until a first-operand byte equal to the test byte is encountered, the first-operand location is exhausted, or a CPU-determined number of first-operand bytes have been processed.

When the first-operand location is exhausted without finding a byte equal to the test byte, condition code 0 is set. When a first-operand byte equal to the test byte is encountered, condition code 1 is set. When a CPU-determined number of bytes have been processed, condition code 3 is set. Condition code 3 may be set even when the first-operand location is exhausted or when the next byte to be processed is equal to the test byte. In these cases, condition code 0 or 1, respectively, will be set when the instruction is executed again.

If the operation is completed with condition code 0, the contents of general register R_1 are incremented by the contents of general register $R_1 + 1$, and then the contents of general register $R_1 + 1$ are set to zero. If the operation is completed with condition code 1, the contents of general register $R_1 + 1$ are decremented by the number of bytes processed before the first-operand byte equal to the test byte was encountered, and the contents of general register R_1 are incremented by the same number, so that general register R_1 contains the address of the equal byte. If the operation is completed with condition code 3, the contents of general register $R_1 + 1$ are decremented by the number of bytes processed, and the contents of general register R_1 are incremented by the same number, so that the instruction, when reexecuted, resumes at the next byte to be processed. When general register R_1 is updated in the 24-bit or 31-bit addressing mode, bits 32-39 of it, in the 24-bit mode, or bit 32, in the 31-bit mode, may be set to zeros or may remain unchanged from their original values.

In the 24-bit or 31-bit addressing mode, the contents of bit positions 0-31 of general registers R_1 and $R_1 + 1$ always remain unchanged.

The amount of processing that results in the setting of condition code 3 is determined by the CPU on the basis of improving system performance, and it may be a different amount each time the instruction is executed.

When the R_2 register is the same register as the R_1 or $R_1 + 1$ register, the results are unpredictable.

When R_1 or R_2 is zero, the results are unpredictable.

When the second operand overlaps the first operand, the results are unpredictable.

Access exceptions for the portion of the first operand to the right of the last byte processed may or may not be recognized. For an operand longer than 4K bytes, access exceptions are not recognized for locations more than 4K bytes beyond the last byte processed.

Access exceptions for all 256 bytes of the second operand may be recognized, even if not all bytes are used.

Access exceptions are not recognized if the R_1 field is odd. When the length of the first operand is zero, no access exceptions for the first operand are recognized.

Resulting Condition Code:

- 0 Entire first operand processed without finding a byte equal to the test byte
- 1 First-operand byte is equal to the test byte
- 2 --
- 3 CPU-determined number of bytes processed

Program Exceptions:

- Access (fetch, operand 2; store, operand 1)
- Specification
- Transaction constraint

Programming Notes:

1. When condition code 3 is set, the program can simply branch back to the instruction to continue the translation. The program need not determine the number of bytes that were translated.
2. The instruction can improve performance by being used in place of a TRANSLATE AND TEST instruction that locates an escape character, fol-

lowed by a TRANSLATE instruction that translates the bytes preceding the escape character.

- The storage-operand references of TRANSLATE EXTENDED may be multiple-access references. (See “Storage-Operand Consistency” on page 5-125.)

TRANSLATE ONE TO ONE

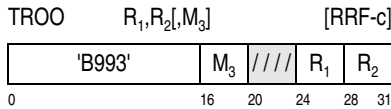

TRANSLATE ONE TO TWO

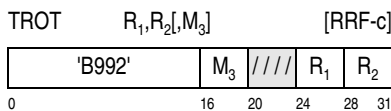

TRANSLATE TWO TO ONE

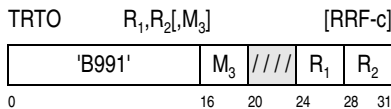

TRANSLATE TWO TO TWO

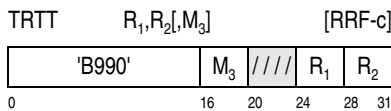

The characters of the second operand are used as arguments to select function characters from a translation table designated by the address in general register 1.

When the ETF2-enhancement facility is not installed, or when the test-character-comparison control is zero, each function character selected from the translation table is compared to a test character in general register 0, and, unless an equal comparison occurs, is placed at the first-operand location. The operation proceeds until a selected function character equal to the test character is encountered, the end of the second operand is reached, or a CPU-determined number of characters have been processed, whichever occurs first.

When the ETF2-enhancement facility is installed and the test-character-comparison control is one, test-character comparison is not performed. Each function character selected from the translation table is placed at the first operation location. The operation proceeds until the end of the second operand is reached, or a CPU-determined number of characters have been processed, whichever occurs first.

The result is indicated in the condition code.

When the ETF2-enhancement facility is installed, the M₃ field has the following format:

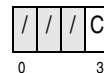

The bits of the M₃ field are defined as follows:

- Unassigned:** Bits 0-2 are unassigned and should contain zeros; otherwise, the program may not operate compatibly in the future.
- Test-Character-Comparison Control (C):** The C bit, bit 3 of the M₃ field, controls test-character comparison. When the C bit is zero, test-character comparison is performed. When the C bit is one, test-character comparison is not performed.

When the ETF2-enhancement facility is not installed, the M₃ field is ignored. When the ETF2-enhancement facility is installed in the z/Architecture architectural mode, it is unpredictable whether the M₃ field is ignored in the ESA/390-compatibility mode.

The lengths of the operand and test characters are as follows:

- For TRANSLATE ONE TO ONE, the second-operand, first-operand, and test characters are single bytes.
- For TRANSLATE ONE TO TWO, the second-operand characters are single bytes, and the first-operand and test characters are double bytes.
- For TRANSLATE TWO TO ONE, the second-operand characters are double bytes, and the first-operand and test characters are single bytes.

- For TRANSLATE TWO TO TWO, the second-operand, first-operand, and test characters are double bytes.

For TRANSLATE ONE TO ONE and TRANSLATE TWO TO ONE, the test character is in bit positions 56-63 of general register 0. For TRANSLATE ONE TO TWO and TRANSLATE TWO TO TWO, the test character is in bit positions 48-63 of general register 0.

The R_1 field designates an even-odd pair of general registers and must designate an even-numbered register; otherwise, a specification exception is recognized.

The location of the leftmost byte of the first operand and second operand is designated by the contents of general registers R_1 and R_2 , respectively. In the 24-bit or 31-bit addressing mode, the number of bytes in the second-operand location is specified by the contents of bit positions 32-63 of general register $R_1 + 1$, and those contents are treated as a 32-bit unsigned binary integer. In the 64-bit addressing mode, the number of bytes in the second-operand location is specified by the contents of bit positions 0-63 of general register $R_1 + 1$, and those contents are treated as a 64-bit unsigned binary integer. The length of the first-operand location is considered to be the same as that of the second operand for TRANSLATE ONE TO ONE and TRANSLATE TWO TO TWO, twice that for TRANSLATE ONE TO TWO, and one half that for TRANSLATE TWO TO ONE.

For TRANSLATE TWO TO ONE and TRANSLATE TWO TO TWO, the length in general register $R_1 + 1$ must be an even number of bytes; otherwise, a specification exception is recognized.

The translation table is treated as being on a double-word boundary for TRANSLATE ONE TO ONE and TRANSLATE ONE TO TWO. For TRANSLATE TWO TO ONE and TRANSLATE TWO TO TWO, the translation table is treated as follows:

- When the ETF2-enhancement facility is not installed, the translation table is treated as being on a 4 K-byte boundary.
- When the ETF2-enhancement facility is installed, the translation table is treated as being on a doubleword boundary.

The rightmost bits of the register that are not used to form the address, which are bits 61-63 in the double-word case and bits 52-63 in the 4 K-byte case, are ignored but should contain zeros; otherwise, the program may not operate compatibly in the future.

The handling of the addresses in general registers R_1 , R_2 , and 1 is dependent on the addressing mode.

In the 24-bit addressing mode, the contents of bit positions 40-63 of general registers R_1 and R_2 and 40-60 or 40-51 of 1 constitute the address, and the contents of bit positions 0-39 are ignored. In the 31-bit addressing mode, the contents of bit positions 33-63 of registers R_1 and R_2 and 33-60 or 33-51 of 1 constitute the address, and the contents of bit positions 0-32 are ignored. In the 64-bit addressing mode, the contents of bit positions 0-63 of registers R_1 and R_2 and 0-60 or 0-51 of 1 constitute the address.

The contents of the registers just described are shown in Figure 7-369.

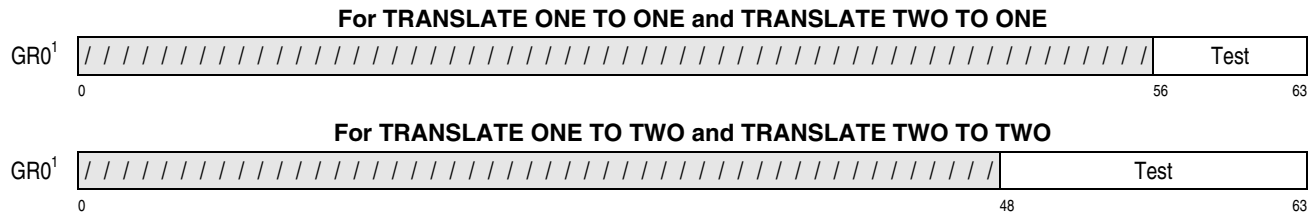
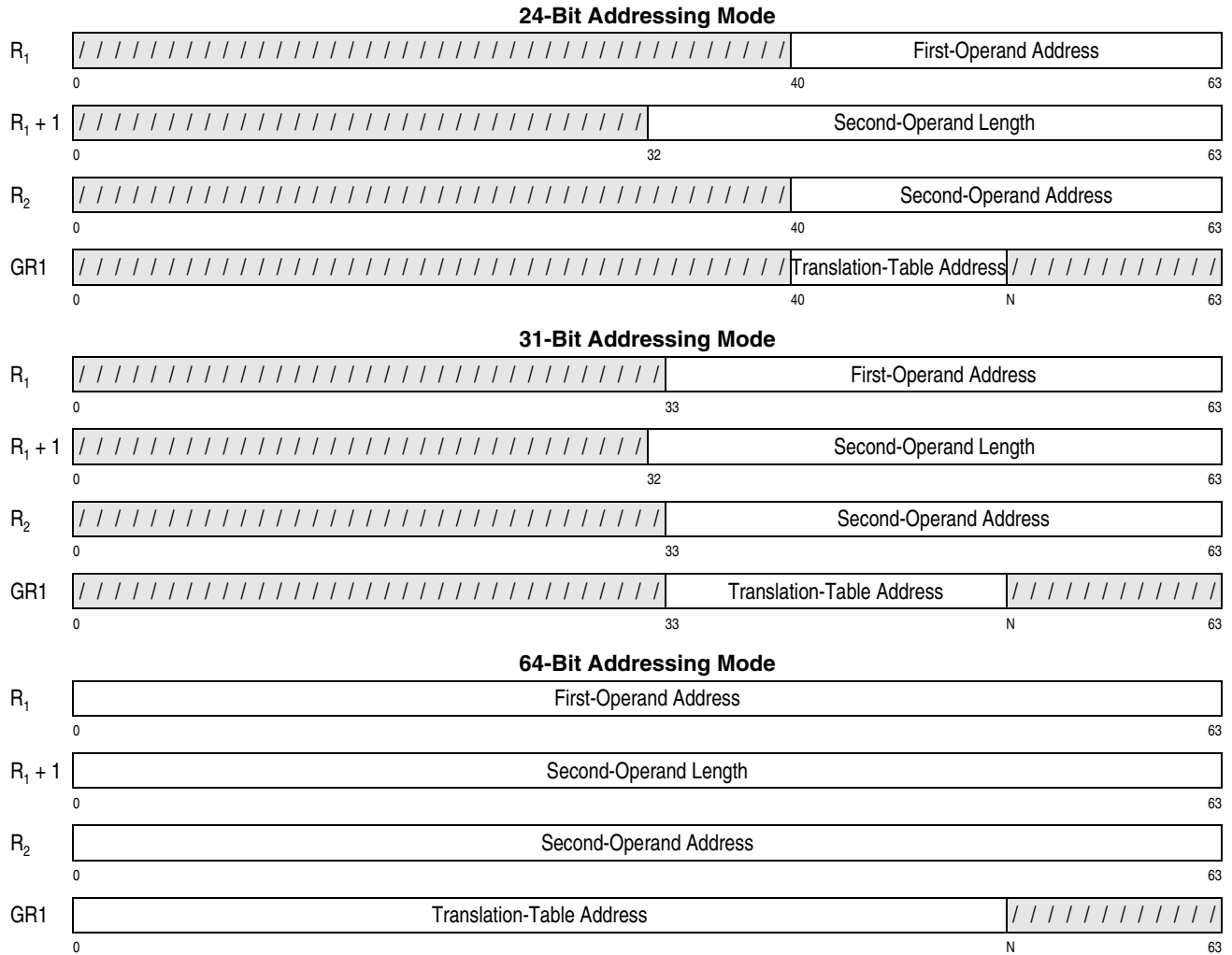

Figure 7-369. Register Contents for TRANSLATE ONE TO ONE, TRANSLATE ONE TO TWO, TRANSLATE TWO TO ONE, and TRANSLATE TWO TO TWO (Part 1 of 2)



Explanation:

- ¹ When the ETF2-enhancement facility is not installed, or when the C bit, bit 3 of the M3 field, is zero, test-character comparison is performed. When the ETF2-enhancement facility is installed and the C bit is one, test-character comparison is not performed, and general register 0 is ignored.
- ^N When the ETF2-enhancement facility is not installed, N is 61 for TRANSLATE ONE TO ONE and TRANSLATE ONE TO TWO, and N is 52 for TRANSLATE TWO TO ONE and TRANSLATE TWO TO TWO. When the ETF2-enhancement facility is installed, N is 61.

Figure 7-369. Register Contents for TRANSLATE ONE TO ONE, TRANSLATE ONE TO TWO, TRANSLATE TWO TO ONE, and TRANSLATE TWO TO TWO (Part 2 of 2)

In the access-register mode, the contents of access registers R_1 , R_2 , and 1 are used for accessing the first operand, second operand, and translation table, respectively.

The length of the translation table designated by the address contained in general register 1 is as follows:

- For TRANSLATE ONE TO ONE, the translation-table length is 256 bytes; each of the 256 function characters is a single byte.
- For TRANSLATE TWO TO TWO, the translation-table length is 131,072 (128K) bytes; each of the 64K function characters is a double byte.
- For TRANSLATE TWO TO ONE, the translation-table length is 65,536 (64K) bytes; each of the 64K function characters is a single byte.
- For TRANSLATE ONE TO TWO, the translation-table length is 512 bytes; each of the 256 function characters is a double byte.

The characters of the second operand are selected one by one for translation, proceeding left to right. Each argument character is added to the initial translation-table address. The addition is performed following the rules for address arithmetic, with the argument character treated as follows:

- For TRANSLATE ONE TO ONE, the argument character is treated as an eight-bit unsigned binary integer extended on the left with 56 zeros.
- For TRANSLATE ONE TO TWO, the argument character is treated as an eight-bit unsigned binary integer extended on the right with a zero and on the left with 55 zeros.
- For TRANSLATE TWO TO ONE, the argument character is treated as a 16-bit unsigned binary integer extended on the left with 48 zeros.
- For TRANSLATE TWO TO TWO, the argument character is treated as a 16-bit unsigned binary integer extended on the right with a zero and on the left with 47 zeros.

The rightmost bits of the translation-table address that are ignored (61-63 or 52-63) are treated as zeros during this addition.

The sum is used as the address of the function character.

When the ETF2-enhancement facility is not installed, or when the test-character-comparison control is zero, processing is as follows. Each function character selected as described above is first compared to the test character in general register 0. If the result is an equal comparison, the operation is completed. If the function character is not equal to the test character, the function character is placed in the next available character position in the first operand, that is, the first function character is placed at the beginning of the first-operand location, and each successive function character is placed immediately to the right of the preceding character. The second operand and the translation table are not altered unless an overlap occurs.

The operation proceeds until a selected function character equal to the test character is encountered, the second-operand location is exhausted, or a CPU-determined number of second-operand characters have been processed.

When the ETF2-enhancement facility is installed and the test-character-comparison control is one, processing is as described above, except that no test-character comparison is performed.

When a selected function character equal to the test character is encountered, condition code 1 is set. When the second-operand location is exhausted without finding a selected function character equal to the test character, condition code 0 is set. When a CPU-determined number of characters have been processed, condition code 3 is set. Condition code 3 may be set even when the next character to be processed results in a function character equal to the test character or when the second-operand location is exhausted. In these cases, condition code 1 or 0, respectively, will be set when the instruction is executed again. When the ETF2-enhancement facility is installed and the test-character-comparison control is one, condition code 1 does not apply.

If the operation is completed with condition code 0, the contents of general register R_2 are incremented by the contents of general register $R_1 + 1$, and the contents of general register R_1 are incremented as follows:

- For TRANSLATE ONE TO ONE and TRANSLATE TWO TO TWO, the same as for general register R_2 .
- For TRANSLATE ONE TO TWO, by twice the amount for general register R_2 .
- For TRANSLATE TWO TO ONE, by one half the amount for general register R_2 .

The contents of general register $R_1 + 1$ are then set to zero.

If the operation is completed with condition code 1, the contents of general register $R_1 + 1$ are decremented by the number of second-operand bytes processed before the character that selected a function character equal to the test character was encountered, and the contents of general register R_2 are incremented by the same number, so that general register R_2 contains the address of the character that selected a function character equal to the test character. The contents of general register R_1 are incremented by the same, twice, or one half the number, as described above for condition code 0.

If the operation is completed with condition code 3, the contents of general register $R_1 + 1$ are decremented by the number of second-operand bytes processed, and the contents of general register R_2 are incremented by the same number, so that the instruction, when reexecuted, contains the address of the next character to be processed. The contents of general register R_1 are incremented by the same, twice, or one half the number, as described above for condition code 0.

When general registers R_1 and R_2 are updated in the 24-bit or 31-bit addressing mode, the bits in bit positions 32-39 of them that are not part of the address may be set to zeros or may remain unchanged from their original values. In the 24-bit or 31-bit addressing mode, the contents of bit positions 0-31 of general registers R_1 , $R_1 + 1$, and R_2 always remain unchanged.

The contents of general registers 0 and 1 remain unchanged.

The amount of processing that results in the setting of condition code 3 is determined by the CPU on the basis of improving system performance, and it may be a different amount each time the instruction is executed.

When any of the following conditions are true, the results are unpredictable:

- Either the R_1 or $R_1 + 1$ registers are the same register as the R_2 register.
- The R_1 register is register 0,
- The R_2 register is register 0, and either the ETF2-enhancement facility is not installed, or the facility is installed and the C bit is zero.
- The R_2 register is register 1.
- Any of the first and second operands and the translation table overlaps another of them.

Access exceptions for the portion of the first or second operand to the right of the last character processed may or may not be recognized. For an operand longer than 4K bytes, access exceptions are not recognized for locations more than 4K bytes beyond the last character processed.

Access exceptions for all characters of the translation table may be recognized even if not all characters are used.

Access exceptions are not recognized if the R_1 field is odd. When the length of the second operand is zero, no access exceptions for the first or second operand are recognized, and access exceptions for the translation table may or may not be recognized.

Resulting Condition Code:

- 0 Entire second operand processed; if test-character comparison was performed, no resulting function character was equal to the test character
- 1 Second-operand character found resulting in a function character equal to the test character (applicable only when test-character comparison is performed)
- 2 --
- 3 CPU-determined number of characters processed

Program Exceptions:

- Access (fetch, operand 2 and translation table; store, operand 1)
- Operation (if the extended-translation facility 2 is not installed)
- Specification
- Transaction constraint

Programming Notes:

1. These instructions differ from the TRANSLATE EXTENDED instruction by having the following attributes:
 - Depending on the instruction used, the sets of argument characters and function characters each can contain single-byte or double-byte characters.
 - The test character is compared to a resulting function character instead of to an argument character.
 - The argument (source) and function (destination) operands are different operands.
2. When condition code 3 is set, the program can simply branch back to the instruction to continue the translation. The program need not determine the number of characters that were translated.

- The storage operand references of these instructions may be multiple-access references. (See “Storage-Operand Consistency” on page 5-125.)
- As observed by this CPU, other CPUs, and the I/O subsystem, inconsistent results may be briefly stored in the first-operand location. See the section “Effects of CPU Retry” on page 11-3 for further details.

UNPACK

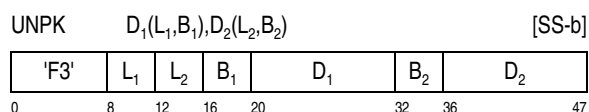

The format of the second operand is changed from signed-packed-decimal to zoned, and the result is placed at the first-operand location. The signed-packed-decimal and zoned formats are described in Chapter 8, “Decimal Instructions.”

The second operand is treated as having the signed-packed-decimal format. Its digits and sign are placed unchanged in the first-operand location, using the zoned format. Zone bits with coding of 1111 are supplied for all bytes except the rightmost byte, the zone of which receives the sign of the second operand. The sign and digits are not checked for valid codes.

The result is obtained as if the operands were processed right to left. When necessary, the second operand is considered to be extended on the left with zeros. If the first-operand field is too short to contain all digits of the second operand, the remaining leftmost portion of the second operand is ignored. Access exceptions for the unused portion of the second operand may or may not be indicated.

When the operands overlap, the result is obtained as if the operands were processed one byte at a time and as if the first result byte were stored immediately after fetching the first operand byte. The entire rightmost second-operand byte is used in forming the first result byte. For the remainder of the field, information for two result bytes is obtained from a single second-operand byte, and execution proceeds as if the leftmost four bits of the byte were to remain available for the next result byte and need not be refetched. Thus, the result is as if two result bytes were to be stored immediately after fetching a single operand byte.

Condition Code: The code remains unchanged.

Program Exceptions:

- Access (fetch, operand 2; store, operand 1)
- Transaction constraint

Programming Notes:

- An example of the use of the UNPACK instruction is given in Appendix A, “Number Representation and Instruction-Use Examples.”
- A field that is to be unpacked can be destroyed by improper overlapping. To save storage space for unpacking by overlapping the operands, the rightmost byte of the first operand must be to the right of the rightmost byte of the second operand by the number of bytes in the second operand minus 2. If only one or two bytes are to be unpacked, the rightmost bytes of the two operands may coincide.
- The storage-operand references of UNPACK may be multiple-access references. (See “Storage-Operand Consistency” on page 5-125.)

UNPACK ASCII

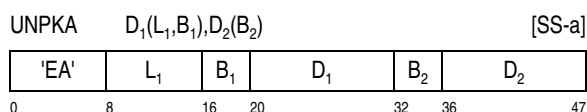

The format of the second operand is changed from signed-packed-decimal to ASCII, and the result is placed at the first-operand location. The signed-packed-decimal format is described in Chapter 8, “Decimal Instructions.”

The second operand is treated as having the signed-packed-decimal format. Its digits are converted to ASCII characters by extending them on the left with 0011 binary, and the ASCII characters are then placed at the first operand location. The digits are not checked for valid codes.

The sign of the second operand is not transferred to the first operand but is checked for validity and determines the condition code. If the sign is 1010, 1100, 1110 or 1111 binary (plus), condition code 0 is set. If the sign is 1011 or 1101 binary (minus), condition code 1 is set. If the sign is not one of the codes for plus or minus, condition code 3 is set.

The converted last digit is placed in the rightmost byte position of the result field, and the other converted digits are placed adjacent to the last and to each other in the remainder of the result field.

The result is obtained as if the operands were processed right to left.

The length of the second operand is 16 bytes. The second operand consists of 31 digits and a sign.

The length of the first operand is designated by the contents of the L_1 field. The first-operand length must not exceed 32 bytes (L_1 must be less than or equal to 31); otherwise, a specification exception is recognized.

If the first operand is too short to contain all digits of the second operand, the remaining leftmost portion of the second operand is ignored. Access exceptions for the unused portion of the second operand may or may not be indicated.

When the length of the first operand is 32 bytes, the leftmost byte is set to ASCII zero, 30 hex.

The results are unpredictable if the first and second operands overlap in any way.

As observed by other CPUs and by channel programs, the first operand is not necessarily stored into in any particular order.

Resulting Condition Code:

- 0 Sign is plus
- 1 Sign is minus
- 2 --
- 3 Sign is invalid

Program Exceptions:

- Access (fetch, operand 2; store, operand 1)
- Operation (if the extended-translation facility 2 is not installed)
- Specification
- Transaction constraint

Programming Note:

1. The following example illustrates the use of the instruction to unpack to ASCII digits:

```
ASDIGITS DS CL31
PKDIGITS DS 0PL16
          DC X'1234567890'
          DC X'1234567890'
          DC X'1234567890'
          DC X'1C'
          :
          UNPKA ASDIGITS(31),PKDIGITS
```

2. The storage-operand references of UNPACK ASCII may be multiple-access references. (See "Storage-Operand Consistency" on page 5-125.)
3. The UNPACK ASCII and UNPACK UNICODE instructions set condition code 0 to indicate a positive sign, and these instructions provide no indication of a zero result. In all other instructions that indicate a signed result, condition code 0 indicates a result of zero, and condition code 2 indicates a positive result.

UNPACK UNICODE

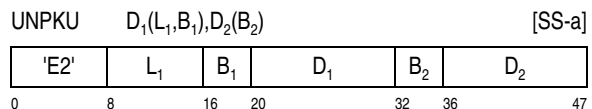

The format of the second operand is changed from signed-packed-decimal to Unicode Basic Latin, and the result is placed at the first-operand location. The signed-packed-decimal format is described in Chapter 8, "Decimal Instructions."

The second operand is treated as having the signed-packed-decimal format. Its digits are converted to two-byte Unicode characters by extending them on the left with 00000000011 binary (003 hex), and the Unicode characters are then placed at the first operand location. The digits are not checked for valid codes. The sign of the second operand is not transferred to the first operand but is checked for validity and determines the condition code. If the sign is 1010, 1100, 1110 or 1111 binary (plus), condition code 0 is set. If the sign is 1011 or 1101 binary (minus), condition code 1 is set. If the sign is not one of the codes for plus or minus, condition code 3 is set.

The converted last digit is placed in the rightmost character position of the result field, and the other

converted digits are placed adjacent to the last and to each other in the remainder of the result field.

The result is obtained as if the operands were processed right to left.

The length of the second operand is 16 bytes; the second operand consists of 31 digits and a sign.

The length of the first operand is designated by the contents of the L_1 field. The first-operand length must not exceed 32 characters or 64 bytes (L_1 must be less than or equal to 63 and must be odd); otherwise a specification exception is recognized.

If the first operand is too short to contain all digits of the second operand, the remaining leftmost portion of the second operand is ignored. Access exceptions for the unused portion of the second operand may or may not be indicated.

When the length of the first operand is 32 characters, the leftmost character is set to Unicode Basic Latin zero, 0030 hex.

The results are unpredictable if the first and second operands overlap in any way.

As observed by other CPUs and by channel programs, the first operand is not necessarily stored into in any particular order.

Resulting Condition Code:

- 0 Sign is plus
- 1 Sign is minus
- 2 --
- 3 Sign is invalid

Program Exceptions:

- Access (fetch, operand 2; store, operand 1)
- Operation (if the extended-translation facility 2 is not installed)
- Specification
- Transaction constraint

Programming Notes:

1. The following example illustrates the use of the instruction to unpack to European numbers:

```

UNDIGITS DS CL62
PKDIGITS DS 0PL16
DC X'1234567890'
DC X'1234567890'
DC X'1234567890'
DC X'1C'
UNPKU UNDIGITS(62),PKDIGITS

```

2. The storage-operand references of UNPACK UNICODE may be multiple-access references. (See "Storage-Operand Consistency" on page 5-125.)
3. The UNPACK ASCII and UNPACK UNICODE instructions set condition code 0 to indicate a positive sign, and these instructions provide no indication of a zero result. In all other instructions that indicate a signed result, condition code 0 indicates a result of zero, and condition code 2 indicates a positive result.

UPDATE TREE

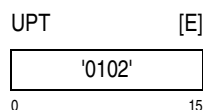

The nodes of a tree in storage are examined successively on a path toward the base of the tree, and contents of general register 0, conceptually followed on the right by contents of general register 1, are conditionally interchanged with the contents of the nodes so as to give a unique maximum logical value in general register 0. The first half of a node and general register 0 contain a codeword, which is for use in sort/merge algorithms.

If the codeword in general register 0 equals the codeword in a node, the contents of the node are placed in general registers 2 and 3.

General register 4 contains the base address of the tree, and general register 5 contains the index of a node whose parent node will be examined first.

In the access-register mode, access register 4 specifies the address space containing the tree.

This instruction may be interrupted between units of operation. The condition code is unpredictable if the instruction is interrupted.

The size of a node, the size of a codeword, and the participation of bits 0-31 of general registers 1-5 in the operation depend on the addressing mode. In the 24-bit or 31-bit addressing mode, a node is eight bytes, a codeword is four bytes, and bits 0-31 are ignored and remain unchanged. In the 64-bit addressing mode, a node is 16 bytes, a codeword is eight bytes, and bits 0-31 are used in and may be changed by the operation.

Operation in the 24-Bit or 31-Bit Addressing Mode

In the 24-bit or 31-bit addressing mode, the doubleword nodes of a tree in storage are examined successively on a path toward the base of the tree, and the contents of bit positions 32-63 of general register 0, conceptually followed on the right by the contents of bit positions 32-63 of general register 1, are conditionally interchanged with the contents of the nodes so as to give a unique maximum logical value in bit positions 32-63 of general register 0.

Bit positions 32-63 of general register 4 contain the base address of the tree, and bit positions 32-63 of general register 5 contain the index of a node whose parent node will be examined first. The base address is eight less than the address of the root node of the tree. The initial contents of bit positions 32-63 of general registers 4 and 5 must be a multiple of 8; otherwise, a specification exception is recognized.

A unit of operation begins by shifting the contents of bit positions 32-63 of general register 5 right logically one position and then setting bit 61 to zero. However, bits 32-63 of general register 5 remain unchanged if the execution of a unit of operation is nullified or suppressed. If after shifting and setting bit 61 to zero, bits 32-63 of general register 5 are all zeros, the instruction is completed, and condition code 1 is set; otherwise, the unit of operation continues.

Bit 32 of general register 0 is tested. If bit 32 of general register 0 is one, the instruction is completed, and condition code 3 is set.

If bit 32 of general register 0 is zero, the sum of bits 32-63 of general registers 4 and 5 is used as the

intermediate value for normal operand address generation. The generated address is the address of a node in storage.

Bits 32-63 of general register 0 are logically compared with the contents of the first word of the currently addressed node. If the register operand is low, the contents of bit positions 32-63 of general registers 0 and 1 are interchanged with those of the node, and a unit of operation is completed. If the register operand is high, no additional action is taken, and the unit of operation is completed. If the compare values are equal, bit positions 32-63 of general register 2, conceptually followed on the right by bit positions 32-63 of general register 3, are loaded from the currently addressed node, the instruction is completed, and condition code 0 is set.

In those cases when the value in the first word of the node is less than or equal to the value in bit positions 32-63 of the register, the contents of the node remain unchanged. However, in some models, these contents may be fetched and subsequently stored back.

Operation in the 64-Bit Addressing Mode

In the 64-bit addressing mode, the quadword nodes of a tree in storage are examined successively on a path toward the base of the tree, and the contents of general register 0, conceptually followed on the right by the contents of general register 1, are conditionally interchanged with the contents of the nodes so as to give a unique maximum logical value in general register 0.

General register 4 contains the base address of the tree, and general register 5 contain the index of a node whose parent node will be examined first. The base address is 16 less than the address of the root node of the tree. The initial contents of general registers 4 and 5 must be a multiple of 16; otherwise, a specification exception is recognized.

A unit of operation begins by shifting the contents of general register 5 right logically one position and then setting bit 60 to zero. However, general register 5 remains unchanged if the execution of a unit of operation is nullified or suppressed. If after shifting and setting bit 60 to zero, the contents of general register 5 are zero, the instruction is completed, and condition code 1 is set; otherwise, the unit of operation continues.

Bit 0 of general register 0 is tested. If bit 0 of general register 0 is one, the instruction is completed, and condition code 3 is set.

If bit 0 of general register 0 is zero, the sum of the contents of general registers 4 and 5 is used as the intermediate value for normal operand address generation. The generated address is the address of a node in storage.

The contents of general register 0 are logically compared with the contents of the first doubleword of the currently addressed node. If the register operand is low, the contents of general registers 0 and 1 are interchanged with those of the node, and a unit of operation is completed. If the register operand is high, no additional action is taken, and the unit of operation is completed. If the compare values are equal, general registers 2 and 3 are loaded from the currently addressed node, the instruction is completed, and condition code 0 is set.

In those cases when the value in the first doubleword of the node is less than or equal to the value in the register, the contents of the node remain unchanged. However, in some models, these contents may be fetched and subsequently stored back.

Specifications Independent of Addressing Mode

Access exceptions are recognized only for one node at a time. Access exceptions, change-bit action, and PER storage alteration do not occur for subsequent nodes until the previous node has been successfully compared and updated, and they also do not occur if a specification-exception condition exists.

Resulting Condition Code:

- 0 Equal compare values at currently addressed node
- 1 No equal compare values found on path, or no comparison made
- 2 --
- 3 In 24-bit or 31-bit mode, bits 32-63 of general register 5 nonzero and bits 32-63 of general register 0 negative; in 64-bit mode, general register 5 nonzero and general register 0 negative

Program Exceptions:

- Access (fetch and store, nodes of tree)
- Specification
- Transaction constraint

Programming Notes:

1. An example of the use of UPDATE TREE is given in “Sorting Instructions” in Appendix A, “Number Representation and Instruction-Use Examples.”
2. For use in sorting in the 24-bit or 31-bit addressing mode, when equal compare values have been found, the contents of bit positions 32-63 of general registers 1 and 3 can be appropriate (depending on the contents of the tree) for the subsequent execution of COMPARE AND FORM CODEWORD. The contents of bit positions 32-63 of general register 2, shifted right 16 bit positions, can be similarly appropriate, and they can provide for minimal recomparison of partially equal keys. The same applies in the 64-bit addressing mode except to the contents of bit positions 0-63 of the registers and with the contents of bit positions 0-63 of general register 2 shifted right 48 bit positions. Refer to “Sorting Instructions” on page A-53 for a discussion of trees and their use in sorting.
3. The program should avoid placing a nonzero value in bit positions 32-38 of general register 5 when in the 24-bit addressing mode. If any bit in bit positions 32-38 is a one, the nodes of the tree will not be examined successively.
4. When bits 32-63 of general register 0 are negative in the 24-bit or 31-bit addressing mode, or when bits 0-63 are negative in the 64-bit mode, and provided that the tree has been updated properly previously, the node represented by general registers 0 and 1 either is the node or is equal to the node (equal keys) that would be selected if the unit of operation continued. In this case, ending the unit of operation and setting condition code 3 is a faster means of selecting an appropriate node because it does not require further examination and updating of the tree.
5. Setting condition code 3 provides improved performance when the replacement record is equal to the old winner and, more importantly (since the first case can be detected by means of the condition code of CFC), when the update path contains a negative codeword, indicating equality with the old winner.
6. In those cases when the codeword in the node is less than or equal to the codeword in general register 0, depending on the model, the contents of the node may be fetched and subsequently

stored back. As a result, any of the following may occur for the storage location containing the node: a PER storage-alteration event may be recognized; a protection exception for storing may be recognized; and, provided no access exceptions exist, the change bit may be set to one. Because the contents of storage remain unchanged, the change bit may or may not be one when a PER storage-alteration event is recognized.

7. Special precautions should be taken when UPDATE TREE is made the target of an execute-type instruction. See the programming note con-

cerning interruptible instructions under EXECUTE.

8. Further programming notes concerning interruptible instructions are included in “Interruptible Instructions” on page 5-24.
9. The storage-operand references for UPDATE TREE may be multiple-access references. (See “Storage-Operand Consistency” on page 5-125.)
10. Figure 7-370 on page 7-429 is a summary of the operation of UPDATE TREE in the 24-bit or 31-bit addressing mode, and Figure 7-371 on page 7-430 is a summary of the operation in the 64-bit addressing mode.

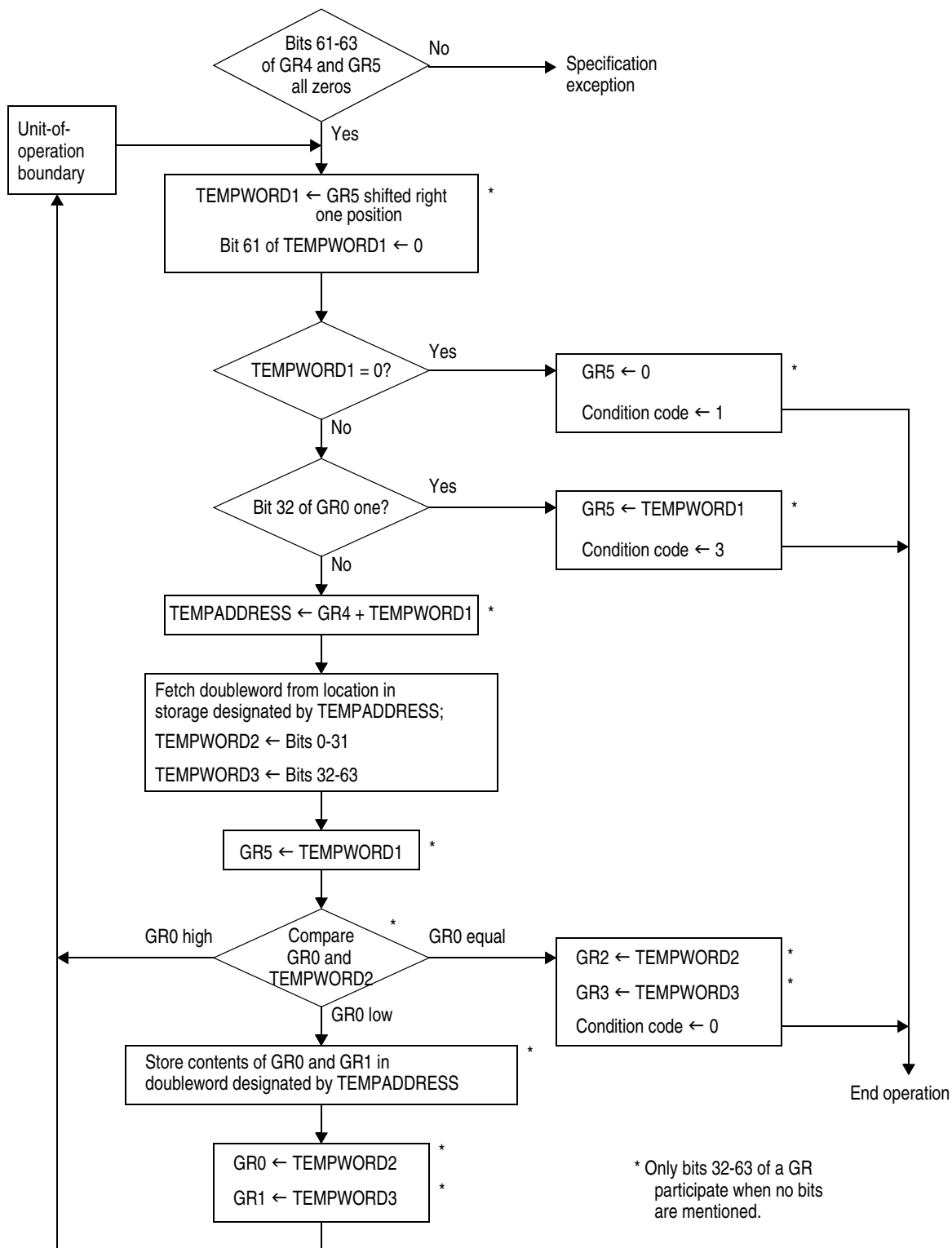

Figure 7-370. Execution of UPDATE TREE in the 24-Bit or 31-Bit Addressing Mode

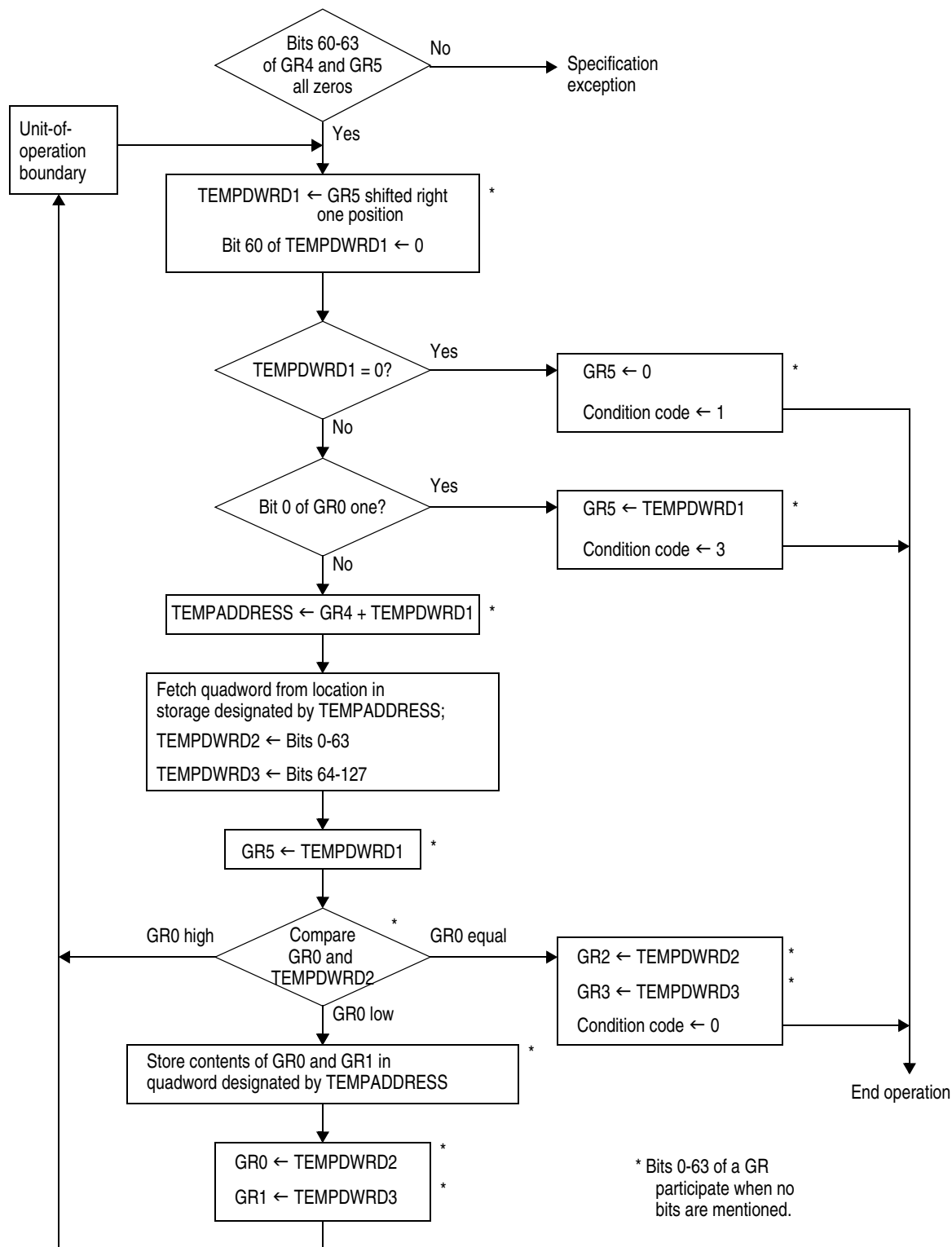

Figure 7-371. Execution of UPDATE TREE in the 64-Bit Addressing Mode

Protection of Cryptographic Keys

When the message-security-assist extension 3 is installed, two wrapping-key registers and two wrapping-key-verification-pattern registers are provided for each configuration. The two wrapping-key registers consist of a 192-bit DES wrapping-key (WK_d) register and a 256-bit AES wrapping-key (WK_a) register. The two wrapping-key-verification-pattern registers consist of a 192-bit DES wrapping-key-verification-pattern (WK_dVP) register and a 256-bit AES wrapping-key-verification-pattern (WK_aVP) register.

WK_d is used to protect user DES or TDES keys, and WK_dVP is used to verify the value of WK_d . WK_a is used to protect user AES keys, and WK_aVP is used to verify the value of WK_a . Whenever the contents of the WK_d or WK_a register are changed, the contents of the corresponding verification-pattern register are also changed.

When the message-security-assist extension 9 is installed, the 256-bit AES wrapping key (WK_a) register and the 256-bit AES wrapping-key-verification-pattern (WK_aVP) register are also used to protect ECC keys.

Each time a clear reset is performed, a new set of wrapping keys and their associated verification patterns are generated. The contents of the two wrapping-key registers are kept internal to the model so that no program, including the operating system, can directly observe their clear value.

The following instructions provide functions supporting encrypted cryptographic keys:

- CIPHER MESSAGE
- CIPHER MESSAGE WITH AUTHENTICATION
- CIPHER MESSAGE WITH CHAINING
- CIPHER MESSAGE WITH CIPHER FEEDBACK
- CIPHER MESSAGE WITH COUNTER
- CIPHER MESSAGE WITH OUTPUT FEEDBACK
- COMPUTE DIGITAL SIGNATURE AUTHENTICATION
- COMPUTE MESSAGE AUTHENTICATION CODE
- PERFORM CRYPTOGRAPHIC COMPUTATION

For each of these instructions, a program-specified DES or AES wrapping-key-verification-pattern in the parameter block is compared with the respective wrapping-key-verification-pattern register. The instruction completes with condition code 1 if the two do not match.

A privileged program may use the PERFORM CRYPTOGRAPHIC KEY MANAGEMENT OPERATION (PCKMO) instruction to encrypt DES or TDES keys using WK_d or to encrypt AES or ECC keys using WK_a . A privileged program may also use PCKMO to inspect the current DES or AES wrapping-key-verification pattern used to encrypt the respective key.

Programming Notes:

1. Upon condition code 1, the program should re-import the cryptographic key for encrypting it under the appropriate wrapping key before the operation is resumed.
2. Even though the architecture defines that a new set of wrapping keys are generated upon a clear reset, condition code 1 could occur at any time for message-security-assist functions using an encrypted key because the application may be relocated to another system with a different set of wrapping keys.
3. The sections “Protection of DES Keys” on page 7-432, “Protection of AES Keys” on page 7-434, and “Protection of ECC Keys” on page 7-436 illustrate encryption and decryption algorithms in support of encrypted cryptographic keys. The encryption algorithms are used by the PERFORM CRYPTOGRAPHIC KEY MANAGEMENT OPERATION instruction when encrypting a cryptographic key, and the decryption algorithms are used by the various message-security-assist instructions that support the use of encrypted keys.

Symbols Used in Subsequent Descriptions

The following symbols are used in the subsequent description. For data-encryption-algorithm (DEA) functions, the DEA-key-parity bit in each byte of the DEA key is ignored, and the operation proceeds normally, regardless of the DEA-key parity of the key.

Further description of the data-encryption algorithm may be found in Reference [13.] on page xxx. Further

description of the AES standard may be found in Reference [14.] on page xxx.

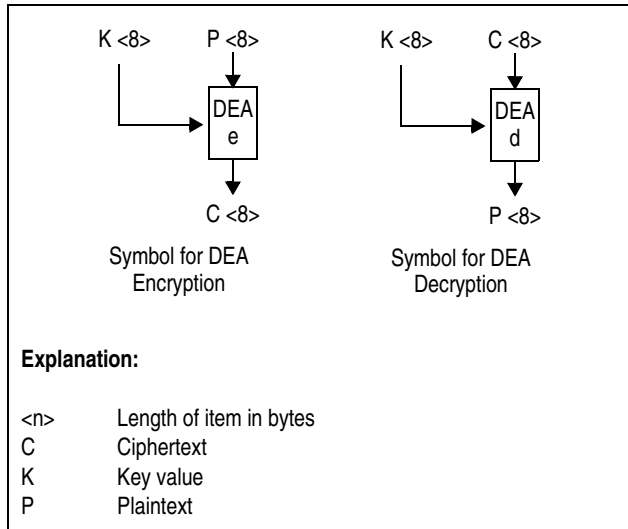

Figure 7-372. Symbols for DEA Encryption and Decryption

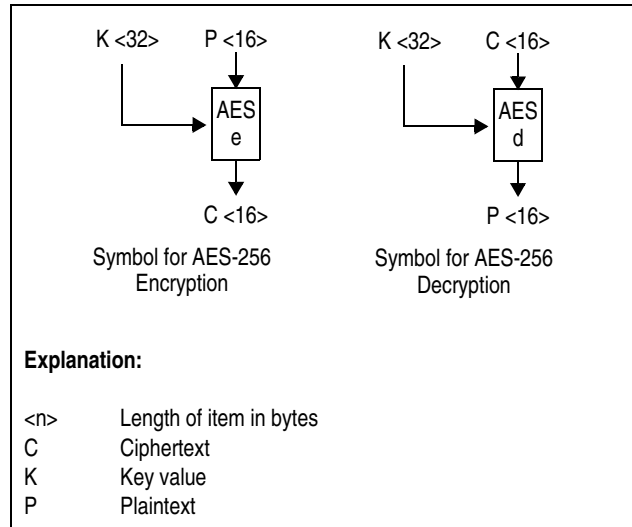

Figure 7-373. Symbols for AES-256 Encryption and Decryption

Protection of DES Keys

When the message-security-assist extension 3 is installed, user DEA or TDEA keys may be protected under the 192-bit DEA wrapping key.

Figure 7-374 illustrates encryption of a 64-bit DEA key, a 128-bit TDEA key, and a 192-bit TDEA key, each encryption using the 192-bit DEA wrapping key.

Figure 7-375 on page 7-434 illustrates decryption of an encrypted 64-bit DEA key, an encrypted 128-bit

TDEA key, and an encrypted 192-bit TDEA key, each decryption using the 192-bit DEA wrapping key.

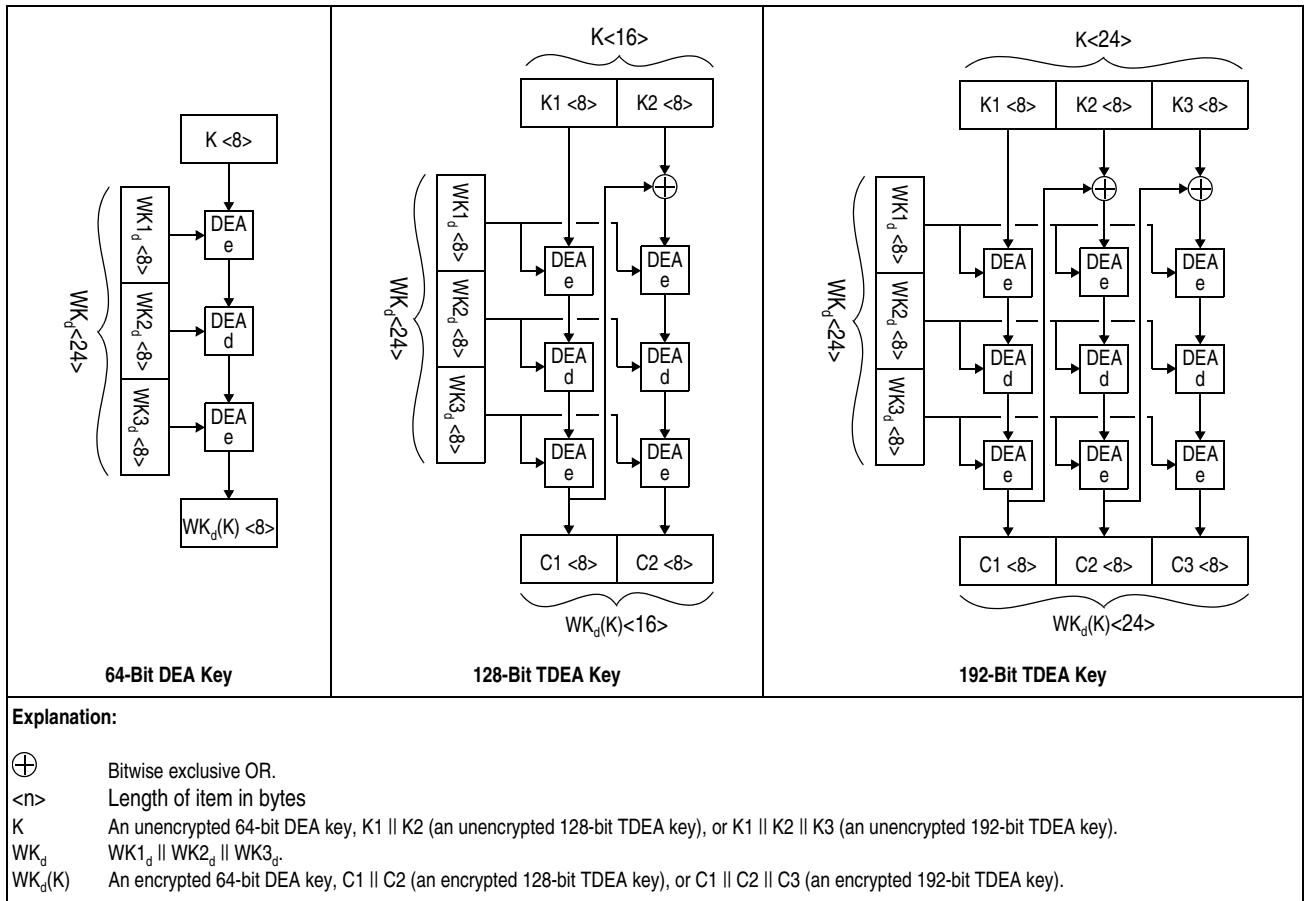

Figure 7-374. Encryption of DEA or TDEA Key Using WK_d

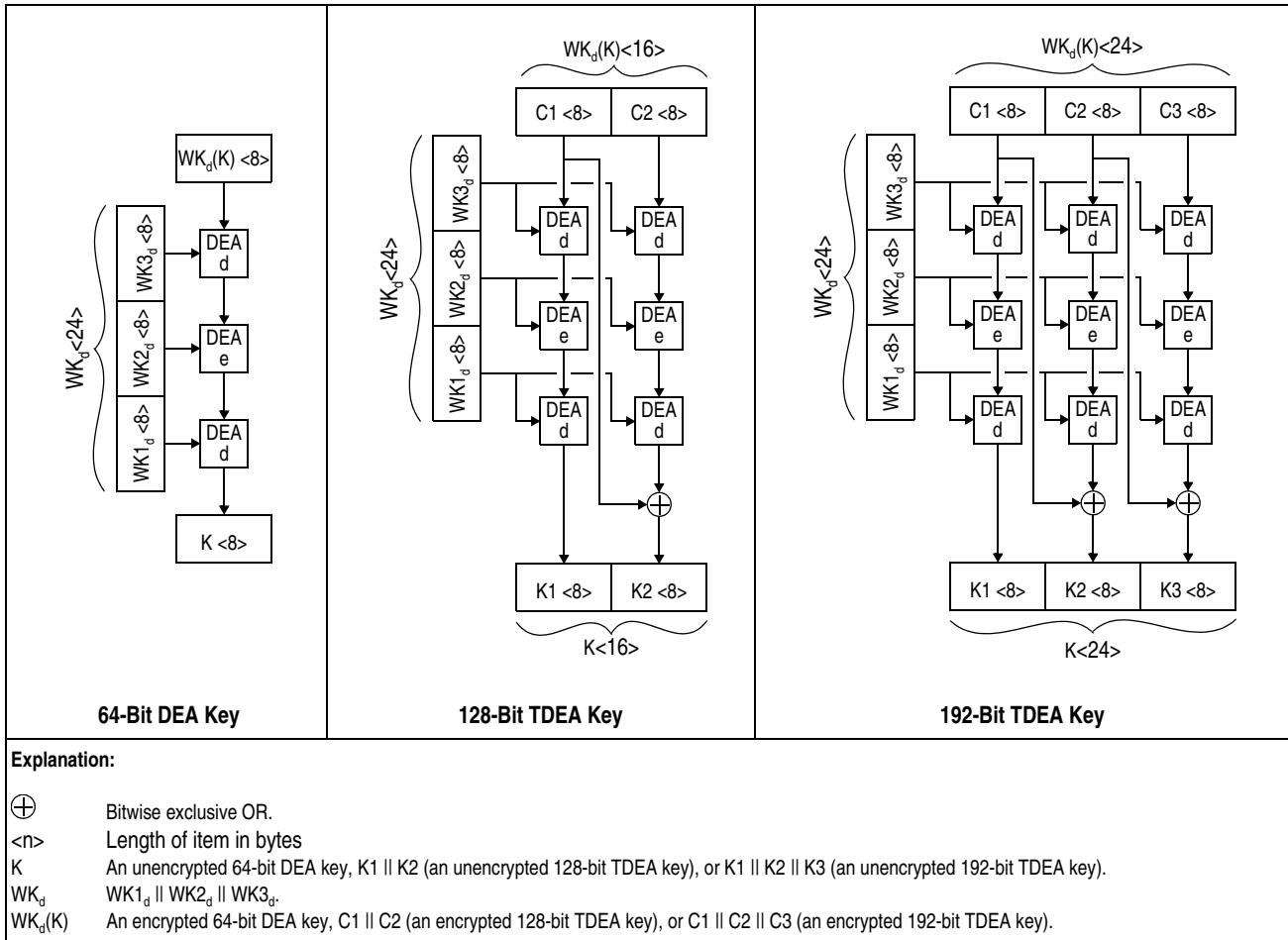

Figure 7-375. Decryption of DEA or TDEA Key Using WK_d

Protection of AES Keys

When the message-security-assist extension 3 is installed, user AES keys may be protected under the 256-bit AES wrapping key.

Figure 7-376 on page 7-435 shows the encryption of a 128-bit AES key, a 192-bit AES key, and a 256-bit

AES key, each encryption using the 256-bit AES wrapping key.

Figure Figure 7-377 on page 7-436 shows the decryption of an encrypted 128-bit AES key, an encrypted 192-bit AES key, and an encrypted AES 256-bit key, each decryption using the 256-bit AES wrapping key.

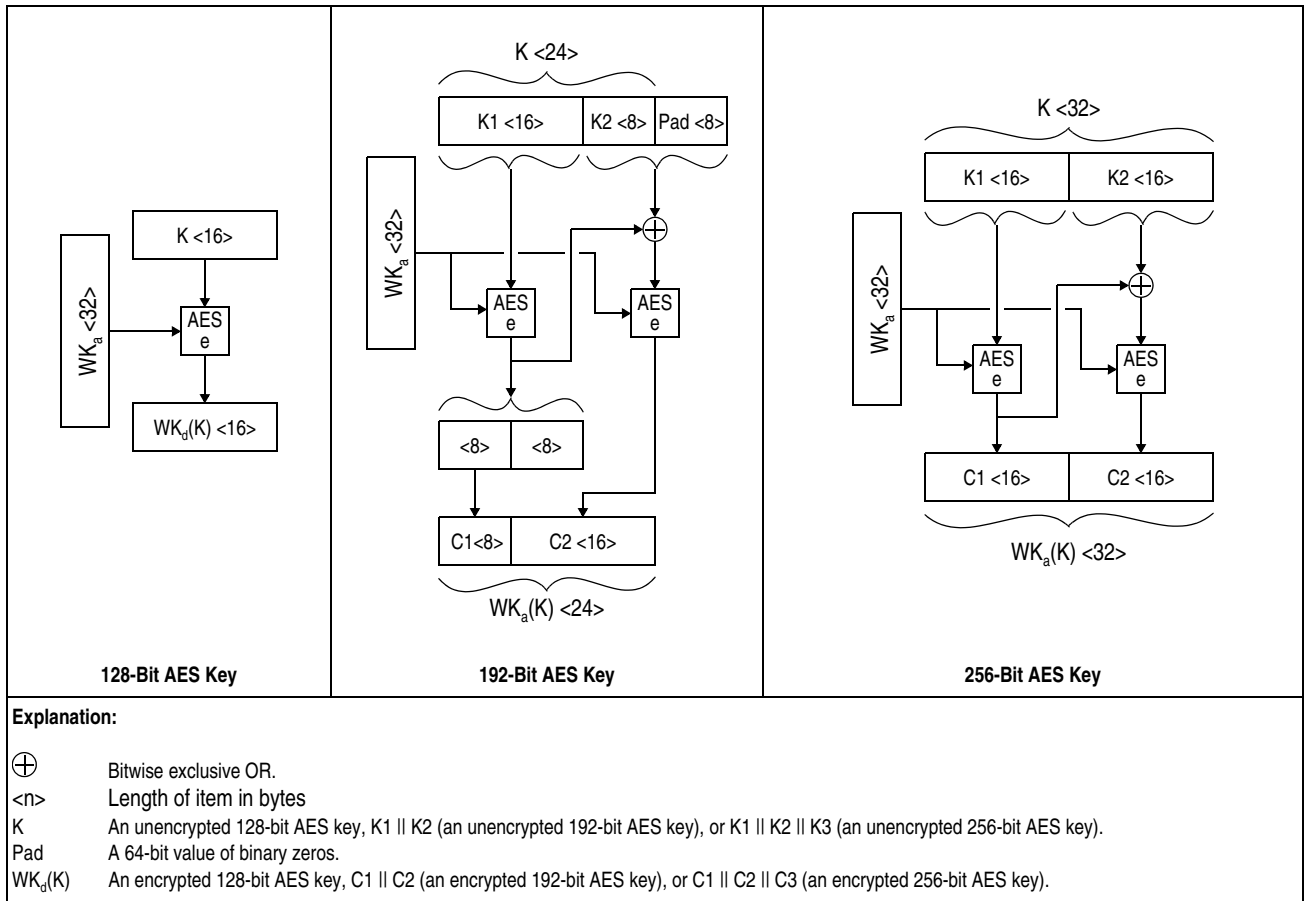

Figure 7-376. Encryption of AES Keys Using WK_a

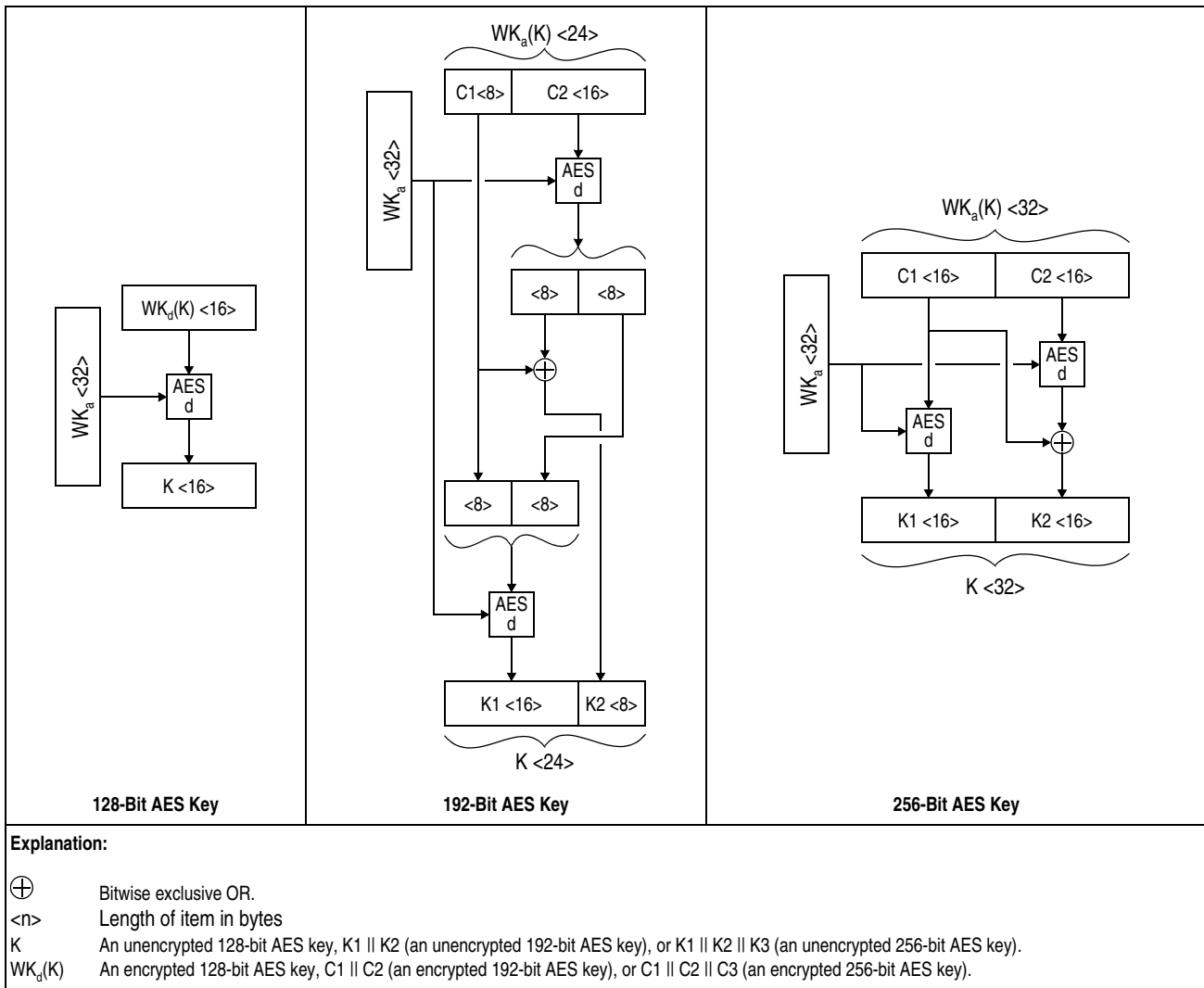
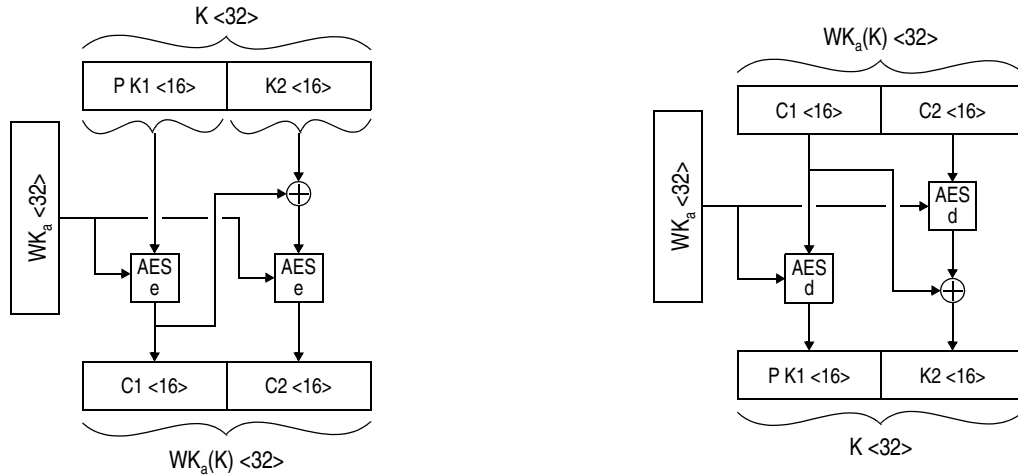

Figure 7-377. Decryption of AES Keys Using WK_d

Protection of ECC Keys

When the message-security-assist extension 9 is installed, user ECC keys may be protected using the 256-bit AES wrapping key. ECC keys and any necessary padding are encrypted together.

Figure 7-378 on page 7-437 shows the encryption and decryption for ECC P256 and Ed25519 keys. On the left hand side of the figure encryption of a 256-bit (P256), or 255-bit key and 1 bit zero pad (Ed25519) is encrypted to a 256-bit encrypted key. On the right hand side decryption of the 256-bit key is shown. Encryption and decryption uses the 256-bit AES wrapping key. The Ed25519 key is right aligned in the 256-bit field and padded with 1 bit zero on the left.



Explanation:

- ⊕ Bitwise exclusive OR.
- <n> Length of item in bytes
- K An unencrypted 256-bit ECC key, K1 || K2 (an unencrypted 256-bit for P256 or 255-bit ECC key and 1 bit pad on the left for Ed25519)
- P Note K1 has 1 bit of padding on the left for Ed25519
- WK_a(K) An encrypted 256-bit key, C1 || C2 (an encrypted 256-bit ECC key).

Figure 7-378. Encryption and Decryption of ECC Keys for P256 and Ed25519 Using WK_a

Figure 7-379 on page 7-438 shows the encryption of an ECC P384 384-bit key using the 256-bit AES wrapping key. It also shows decryption of an encrypted 384-bit P348 key, decryption using the 256-bit AES wrapping key.

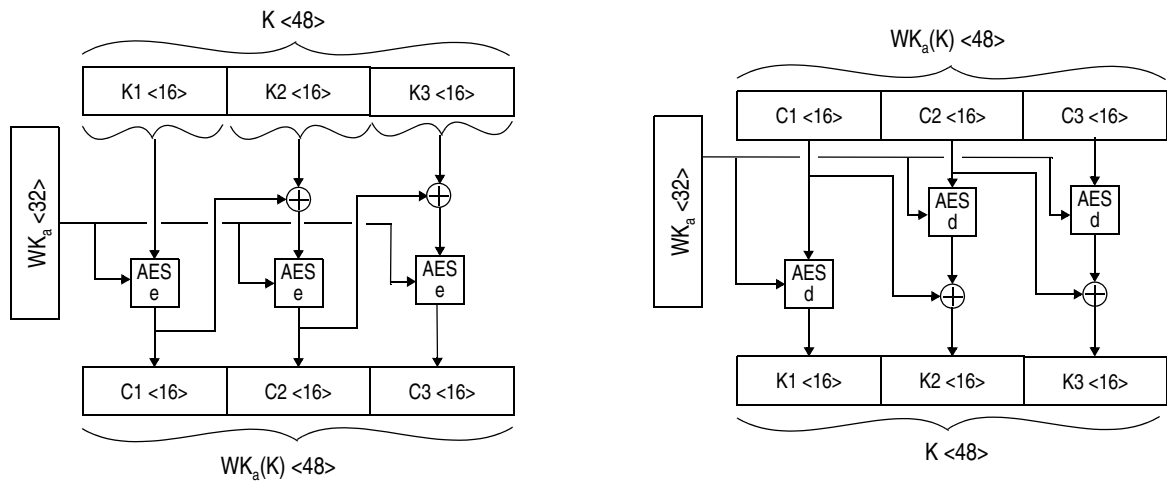

Explanation:

- \oplus Bitwise exclusive OR.
- $<n>$ Length of item in bytes
- K An unencrypted 384-bit ECC key, $K1 \parallel K2 \parallel K3$ (an unencrypted 384-bit ECC key)
- $WK_a(K)$ An encrypted 384-bit key, $C1 \parallel C2 \parallel C3$ (an encrypted 384-bit ECC key).

Figure 7-379. Encryption and Decryption of ECC Keys for P384 Using WK_a

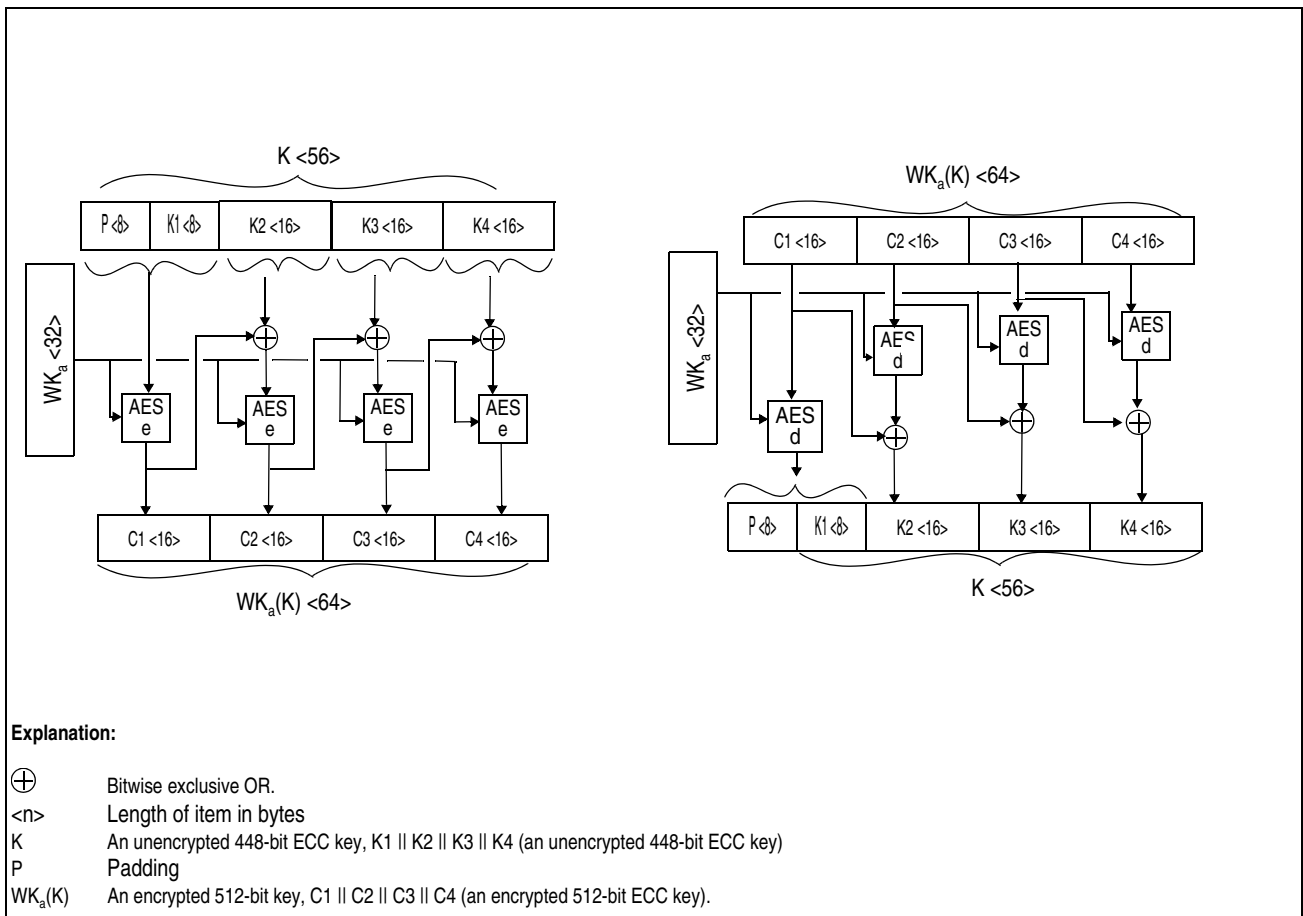

Figure 7-380. Encryption and Decryption of ECC Keys for Ed448 Using WK_a

Figure 7-380 on page 7-439 shows the encryption and decryption of the ECC Ed448 448-bit key using the 256-bit AES wrapping key. On the left hand side the encryption is shown. The right-aligned 448-bit key with a 64-bit padding is encrypted to 512-bit encrypted key. On the right hand side of the figure, decryption of the 512-bit encrypted key to a 448-bit key right aligned with a 64-bit padding to the left is shown also using the 256-bit AES wrapping key. The padding can take on any value.

Figure 7-381 on page 7-440 shows the decryption and encryption of the ECC P521 521-bit key using the 256-bit AES wrapping key. On the left hand side the encryption is shown. The key is padded on the left side to create an 80 byte field from the 521-bit key. The 80 bytes are encrypted using the 256-bit AES wrapping key to create an 80 byte encrypted key. On the right hand side of the figure the 80 byte key is decrypted using the 256-bit AES wrapping key to form the 521-bit P521 key and 7 bits of zero padding and 112 bits of padding.

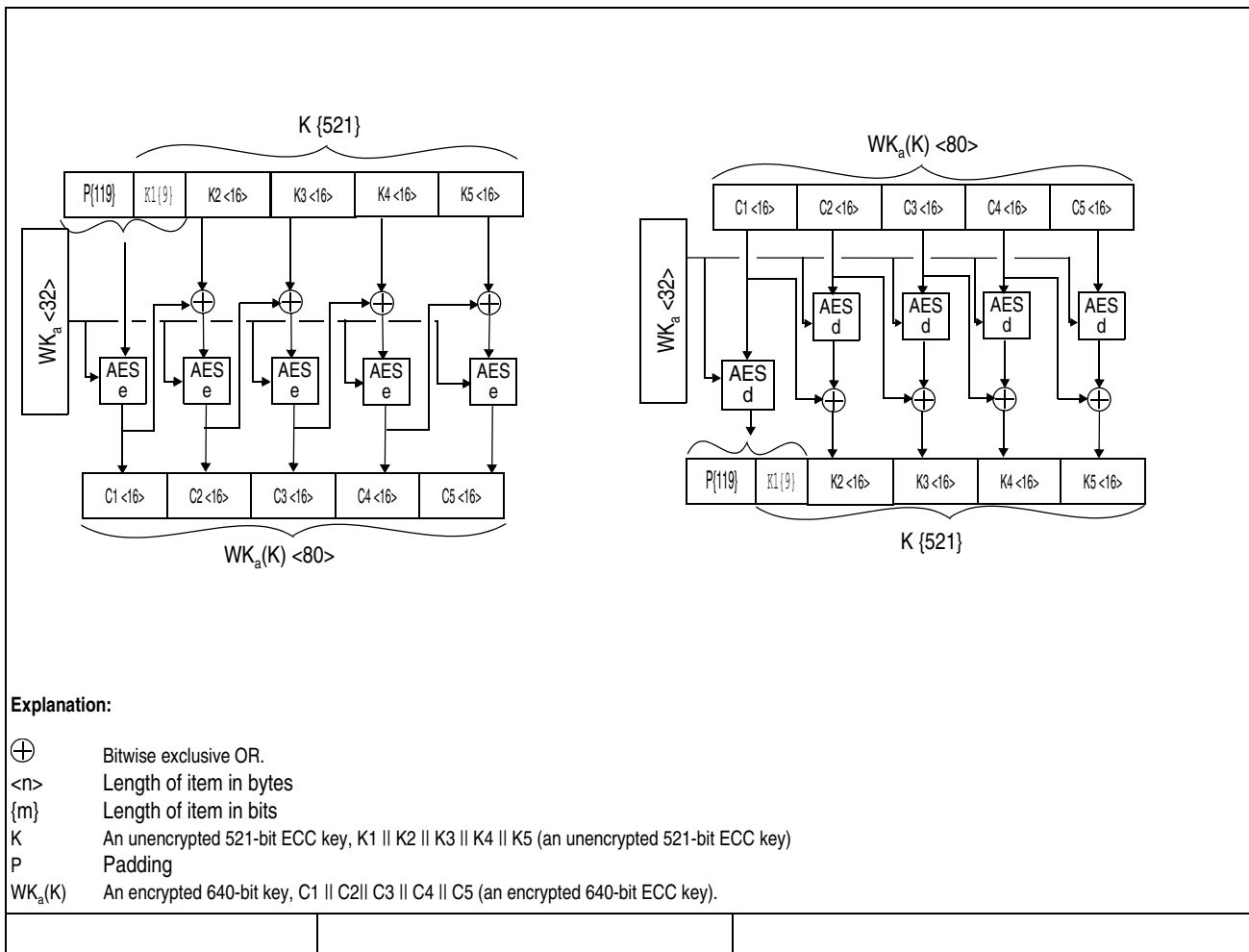

Figure 7-381. Encryption and Decryption of ECC Keys for P521 Using WK_a

Chapter 8. Decimal Instructions

Decimal-Number Formats	8-1	Instructions	8-5
Zoned Format	8-1	ADD DECIMAL	8-6
Packed-Decimal Formats	8-1	COMPARE DECIMAL	8-7
Signed-Packed-Decimal Format	8-2	DIVIDE DECIMAL	8-7
Unsigned-Packed-Decimal Format	8-2	EDIT	8-8
Decimal Codes	8-2	EDIT AND MARK	8-11
Decimal Operations	8-3	MULTIPLY DECIMAL	8-12
Decimal-Arithmetic Instructions	8-3	SHIFT AND ROUND DECIMAL	8-12
Editing Instructions	8-4	SUBTRACT DECIMAL	8-13
Execution of Decimal Instructions	8-4	TEST DECIMAL	8-14
Other Instructions for Decimal Operands	8-4	ZERO AND ADD	8-14
General-Operand Data Exception	8-5		

The decimal instructions of this chapter perform arithmetic and editing operations on decimal data. Additional operations on decimal data are also provided by several instructions in Chapter 7, “General Instructions,” several instructions in Chapter 20, “Decimal-Floating-Point Instructions,” and several instructions in Chapter 25, “Vector Decimal Instructions.” Generally, decimal operands reside in storage. For some of the instructions described in Chapter 20, decimal operands may reside in a general register or general register pair. For some of the instructions described in Chapter 25, decimal operands may reside in a vector register. The storage fields for decimal operands residing in storage may start on any byte boundary and may have variable lengths. The decimal operands residing in general registers and vector registers have fixed lengths.

Decimal-Number Formats

Decimal numbers may be represented in several formats, including zoned, signed-packed-decimal and unsigned-packed-decimal. These formats are of variable length; most instructions used to operate on these formats specify the length of their operands and results. Each byte of a format consists of a pair of four-bit codes; the four-bit codes include decimal-digit codes, sign codes, and a zone code.

Zoned Format

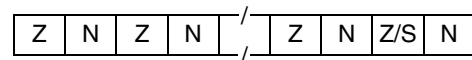

In the zoned format, the rightmost four bits of a byte are called the numeric bits (N) and normally consist of a code representing a decimal digit. The leftmost four bits of a byte are called the zone bits (Z), except for the rightmost byte of a decimal operand, where these bits may be treated either as a zone or as a sign (S).

Decimal digits in the zoned format may be part of a larger character set, which includes also alphabetic and special characters. The zoned format is, therefore, suitable for input, editing, and output of numeric data in human-readable form. There are no decimal-arithmetic instructions which operate directly on decimal numbers in the zoned format; such numbers must first be converted to the signed-packed-decimal format or one of the DFP formats.

The editing instructions produce a result of up to 256 bytes; each byte may be a decimal digit in the zoned format, a message byte, or a fill byte.

Packed-Decimal Formats

There are two packed-decimal formats, signed-packed, and unsigned-packed.

Signed-Packed-Decimal Format

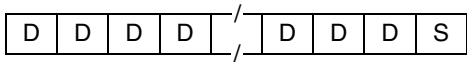

In the signed-packed-decimal format, each byte contains two decimal digits (D), except for the rightmost byte, which contains a sign (S) to the right of a decimal digit. Decimal arithmetic is performed with operands in the signed-packed-decimal format and generates results in the signed-packed-decimal format.

The signed-packed-decimal operands and results of decimal-arithmetic instructions may be up to 16 bytes (31 digits and sign), except that the maximum length of a multiplier or divisor is eight bytes (15 digits and sign). In division, the sum of the lengths of the quotient and remainder may be from two to 16 bytes. The editing instructions can fetch as many as 256 decimal digits from one or more decimal numbers of variable length, each in the signed-packed-decimal format. CONVERT FROM PACKED and CONVERT TO PACKED may have signed-packed-decimal operands up to 18 bytes (34 digits and sign).

Unsigned-Packed-Decimal Format

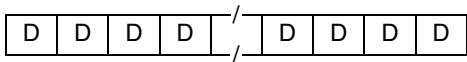

In the unsigned-packed-decimal format, each byte contains two decimal digits (D) and there is no sign. The unsigned-packed-decimal format can be used as the source operand of the editing instructions, as the second operand of MOVE WITH OFFSET, and is also used by the decimal floating-point (DFP) instructions CONVERT FROM PACKED, CONVERT FROM UNSIGNED PACKED, CONVERT TO PACKED, and CONVERT TO UNSIGNED PACKED.

Decimal Codes

The decimal digits 0-9 have the binary encoding 0000-1001.

The preferred sign codes are 1100 for plus and 1101 for minus. These are the sign codes generated for the results of the decimal-arithmetic instructions and the CONVERT TO DECIMAL instruction. The instructions PACK ASCII and PACK UNICODE supply an implied positive sign (1100 binary). The DFP instructions CONVERT TO PACKED, CONVERT TO SIGNED PACKED, and CONVERT TO ZONED

include a plus sign-code selection bit. The plus sign can be encoded as either 1100 or 1111. The sign codes generated for vector decimal instruction results are either preferred sign codes 1100 for positive and 1101 for negative or can be forced to positive with sign code 1111.

Alternate sign codes are also recognized as valid in the sign position: 1010, 1110, and 1111 are alternate codes for plus, and 1011 is an alternate code for minus. Alternate sign codes are accepted for any decimal source operand, but are not generated in the completed result of a decimal-arithmetic instruction, vector decimal-arithmetic instruction, CONVERT TO DECIMAL, or VECTOR CONVERT TO DECIMAL. This is true even when an operand remains otherwise unchanged, such as when adding zero to a number. An alternate sign code is, however, left unchanged by MOVE NUMERICS, MOVE WITH OFFSET, MOVE ZONES, PACK, UNPACK, VECTOR PACK ZONED and VECTOR UNPACK ZONED.

When an invalid sign or digit code is detected, a general-operand data exception is recognized. For CONVERT TO BINARY, the decimal-arithmetic instructions, the decimal floating-point instructions CONVERT FROM PACKED, CONVERT FROM SIGNED PACKED, CONVERT FROM UNSIGNED PACKED, and CONVERT FROM ZONED, the vector decimal-arithmetic instructions, and the vector decimal instruction VECTOR CONVERT TO BINARY, the operation is suppressed.

For the editing instructions EDIT and EDIT AND MARK, an invalid sign code is not recognized. It is model dependent whether the operation is suppressed or terminated for a general-operand data exception due to an invalid digit code. No validity checking is performed by MOVE NUMERICS, MOVE WITH OFFSET, MOVE ZONES, PACK, PACK ASCII, PACK UNICODE, and UNPACK. The instructions UNPACK ASCII and UNPACK UNICODE do not check for invalid digit codes; invalid sign codes are recognized, but are not reported as a general-operand data exception, instead condition code 3 is set.

The zone code 1111 is generated in the left four bit positions of each byte representing a zone and a decimal digit in zoned-format results. Zoned-format results are produced by EDIT, EDIT AND MARK, and UNPACK. For EDIT and EDIT AND MARK, each result byte representing a zoned-format decimal digit contains the zone code 1111 in the left four bit positions and the decimal-digit code in the right four bit

positions. For UNPACK, zone bits with a coding of 1111 are supplied for all bytes except the rightmost byte, the zone of which receives the sign.

The zone code 0011 is generated in the leftmost four bit positions of each byte representing a zone for a decimal digit in ASCII format. ASCII formats are produced by CONVERT TO ZONED when the zone-control bit is one and by UNPACK ASCII.

The meaning of the decimal codes is summarized in Figure 8-1.

Code (Binary)	Recognized As	
	Digit	Sign
0000	0	Invalid
0001	1	Invalid
0010	2	Invalid
0011	3	Invalid *
0100	4	Invalid
0101	5	Invalid
0110	6	Invalid
0111	7	Invalid
1000	8	Invalid
1001	9	Invalid
1010	Invalid	Plus
1011	Invalid	Minus
1100	Invalid	Plus (preferred)
1101	Invalid	Minus (preferred)
1110	Invalid	Plus
1111	Invalid	Plus (zone)

Explanation:

* The zone code 0011 binary is generated in the leftmost four bit positions of each byte representing a decimal digit in the ASCII format.

Figure 8-1. Summary of Digit and Sign Codes

Programming Note: Since 1111 is both the zone code and an alternate code for plus, unsigned (positive) decimal numbers may be represented in the zoned format with 1111 zone codes in all byte positions. The result of the PACK instruction converting such a number to the signed-packed-decimal format may be used directly as an operand for decimal instructions.

Decimal Operations

The decimal instructions in this chapter consist of two classes, the decimal-arithmetic instructions and the editing instructions.

Decimal-Arithmetic Instructions

The decimal-arithmetic instructions perform addition, subtraction, multiplication, division, comparison, and shifting.

Operands of the decimal-arithmetic instructions are in the signed-packed-decimal format and are treated as signed decimal integers. A decimal integer is represented in true form as an absolute value with a separate plus or minus sign. It contains an odd number of decimal digits, from one to 31, and the sign; this corresponds to an operand length of one to 16 bytes.

A decimal zero normally has a plus sign, but multiplication, division, and overflow may produce a zero value with a minus sign. Such a negative zero is a valid operand and is treated as equal to a positive zero by COMPARE DECIMAL.

The lengths of the two operands specified in the instruction need not be the same. If necessary, the shorter operand is considered to be extended with zeros on the left. Results, however, cannot exceed the first-operand length as specified in the instruction.

When a carry or leftmost nonzero digits of the result are lost because the first-operand field is too short, the result is obtained by ignoring the overflow digits, condition code 3 is set, and, if the decimal-overflow mask bit is one, a program interruption for decimal overflow occurs. The operand lengths alone are not an indication of overflow; nonzero digits must have been lost during the operation.

The operands of decimal-arithmetic instructions should not overlap at all or should have coincident rightmost bytes. In ZERO AND ADD, the operands may also overlap in such a manner that the rightmost byte of the first operand (which becomes the result) is to the right of the rightmost byte of the second operand. For these cases of proper overlap, the result is obtained as if operands were processed right to left. Because the codes for digits and signs are verified during the performance of the arithmetic, improperly overlapping operands are recognized as general-operand data exceptions. However, in ZERO AND ADD when the rightmost byte of the first operand is to the left of the rightmost byte of the second operand, the entire second operand may be fetched, depending on the model, before any storing occurs,

which will cause a general-operand data exception not to be recognized. See “Interlocks within a Single Instruction” on page 5-116 for how overlap is detected in the access-register mode.

Programming Note: A signed-packed-decimal number in storage may be designated as both the first and second operand of ADD DECIMAL, COMPARE DECIMAL, DIVIDE DECIMAL, MULTIPLY DECIMAL, SUBTRACT DECIMAL, or ZERO AND ADD. Thus, a decimal number may be added to itself, compared with itself, and so forth; SUBTRACT DECIMAL may be used to set a decimal field in storage to zero; and, for MULTIPLY DECIMAL, a decimal number may be squared in place. In these cases, the lengths of the two operands are not necessarily equal and may, depending on the instruction, be prohibited from being equal.

Editing Instructions

The editing instructions are EDIT and EDIT AND MARK. For these instructions, only the first operand (the pattern) has an explicitly specified length. The second operand (the source) is considered to have as many digits as necessary for the completion of the operation.

Overlapping operands for the editing instructions yield unpredictable results.

Execution of Decimal Instructions

During the execution of a decimal instruction, all bytes of the operands are not necessarily accessed concurrently, and the fetch and store accesses to a single location do not necessarily occur one immediately after the other. Furthermore, for decimal instructions, data in source fields may be accessed more than once, and intermediate values may be placed in the result field that may differ from the original operand and final result values. (See “Storage-Operand Consistency” on page 5-125.) Thus, in a multiprocessing configuration, an instruction such as ADD DECIMAL cannot be safely used to update a shared storage location when the possibility exists that another CPU may also be updating that location.

Other Instructions for Decimal Operands

In addition to the decimal-arithmetic instructions in this chapter, (which operate on decimal numbers in the signed-packed-decimal format) several other instructions are provided for operating on decimal data in the zoned, signed-packed-decimal, or unsigned-packed-decimal format.

The editing instructions (described in this chapter) convert decimal numbers in either the signed-packed-decimal or unsigned-packed-decimal format to the zoned format. Zoned results of up to 256 bytes in length can be produced.

CONVERT TO DECIMAL and CONVERT TO BINARY (described in Chapter 7) provide conversion between signed-binary-integer formats and decimal numbers in the signed-packed-decimal format. Signed-packed-decimal operands of up to 16 bytes in length (31 digits and a sign) can be processed.

CONVERT TO SIGNED PACKED and CONVERT FROM SIGNED PACKED (described in Chapter 20) provide conversion between decimal floating point (DFP) formats and the signed-packed-decimal format. Signed-packed-decimal operands of up to 16 bytes in length (31 digits and a sign) can be processed.

CONVERT TO UNSIGNED PACKED and CONVERT FROM UNSIGNED PACKED (described in Chapter 20) provide conversion between decimal floating point (DFP) formats and the unsigned-packed-decimal format. Unsigned-packed-decimal operands of up to 16 bytes in length (32 digits) can be processed.

MOVE WITH OFFSET (described in Chapter 7) operates on data in the packed format. (The first operand is treated as signed-packed decimal and the second operand as unsigned-packed decimal.) Operands are not checked for valid codes. Signed-packed-decimal operands of up to 16 bytes in length (31 digits and a sign) can be processed.

PACK, UNPACK, PACK ASCII, UNPACK ASCII, PACK UNICODE, and UNPACK UNICODE provide conversion between zoned or character data and signed-packed-decimal data. Operands are not checked for valid codes. Signed-packed-decimal operands of up to 16 bytes in length (31 digits and a sign) can be processed.

MOVE NUMERICS and MOVE ZONES (described in Chapter 7) operate on data in the zoned format. Operands are not checked for valid codes. Zoned operands of up to 256 bytes in length can be processed.

The vector decimal instructions (described in Chapter 25) provide register-to-register decimal-arithmetic operations of addition, subtraction, multiplication, division, comparison, and shifting of data in the packed-decimal format.

VECTOR CONVERT TO BINARY and VECTOR CONVERT TO DECIMAL (described in Chapter 25) provide register-to-register conversion between signed-packed-decimal format and binary-integer (signed and unsigned) format numbers. Signed-packed-decimal operands of up to 16 bytes in length (31 digits and a sign) can be processed.

VECTOR PACK ZONED and VECTOR UNPACK ZONED (described in Chapter 25) provide conversion between a zoned format storage operand and a signed-packed-decimal format register operand. Operands are not checked for valid codes. Signed-packed-decimal operands of up to 16 bytes in length (31 digits and a sign) can be processed.

General-Operand Data Exception

A general-operand data exception is recognized when any of the following is true:

1. The sign or digit codes are invalid in the operands of the decimal instructions, vector decimal-arithmetic instructions, or in CONVERT TO BINARY (described in Chapter 7, “General Instructions”), in CONVERT FROM PACKED, CONVERT FROM SIGNED PACKED, CONVERT FROM UNSIGNED PACKED, and CONVERT FROM ZONED (described in Chapter 20, “Decimal-Floating-Point Instructions”), or in VECTOR CONVERT TO BINARY (described in Chapter 25, “Vector Decimal Instructions”).
2. The operand fields in ADD DECIMAL, COMPARE DECIMAL, DIVIDE DECIMAL, MULTIPLY DECIMAL, and SUBTRACT DECIMAL overlap in a way other than with coincident rightmost bytes; or operand fields in ZERO AND ADD overlap, and the rightmost byte of the second operand is

to the right of the rightmost byte of the first operand. On some models, the improper overlap of operands for ZERO AND ADD is not recognized as a general-operand data exception; instead, the operation is performed as if the entire second operand were fetched before any byte of the result is stored.

3. The multiplicand in MULTIPLY DECIMAL has an insufficient number of leftmost zeros.
4. COMPRESSION CALL encounters errors in its dictionaries.
5. The reseed counter is zero for a PERFORM RANDOM NUMBER OPERATION instruction’s PRNO-SHA-512-DRNG generate operation.

A general-operand data exception causes the operation to be suppressed, except that, for EDIT and EDIT AND MARK, and COMPRESSION CALL, the operation may be suppressed or terminated. In the case of EDIT and EDIT AND MARK, and COMPRESSION CALL, an invalid sign code cannot occur.

Note: In earlier versions of the architecture, the general-operand data exception was known as the decimal-operand data exception.

Instructions

The decimal instructions and their mnemonics, formats, and operation codes are listed in Figure 8-2 on page 8-6. The figure also indicates when the condition code is set, the instruction fields that designate access registers, and the exceptional conditions in operand designations, data, or results that cause a program interruption.

Note: In the detailed descriptions of the individual instructions, the mnemonic and the symbolic operand designation for the assembler language are shown with each instruction. For ADD DECIMAL, for example, AP is the mnemonic and $D_1(L_1, B_1), D_2(L_2, B_2)$ the operand designation.

Programming Note: The decimal instruction TEST DECIMAL is available when the extended-translation facility 2 is installed.

Name	Mnemonic	Characteristics						Op Code	Page		
ADD DECIMAL	AP	SS-b	C	α^9	A	Dg	DF	ST	B ₁ B ₂	FA	8-6
COMPARE DECIMAL	CP	SS-b	C	α^9	A	Dg			B ₁ B ₂	F9	8-7
DIVIDE DECIMAL	DP	SS-b		α^9	A	SP	DK	ST	B ₁ B ₂	FD	8-7
EDIT	ED	SS-a	C	α^9	A	Dg		ST	B ₁ B ₂	DE	8-8
EDIT AND MARK	EDMK	SS-a	C	α^9	A	Dg	G1	ST	B ₁ B ₂	DF	8-11
MULTIPLY DECIMAL	MP	SS-b		α^9	A	SP	Dg	ST	B ₁ B ₂	FC	8-12
SHIFT AND ROUND DECIMAL	SRP	SS-c	C	α^9	A	Dg	DF	ST	B ₁ B ₂	F0	8-12
SUBTRACT DECIMAL	SP	SS-b	C	α^9	A	Dg	DF	ST	B ₁ B ₂	FB	8-13
TEST DECIMAL	TP	RSL-a	C E2	α^9	A				B ₁ B ₂	EBC0	8-14
ZERO AND ADD	ZAP	SS-b	C	α^9	A	Dg	DF	ST	B ₁ B ₂	F8	8-14

Explanation:

α^9 Restricted in the constrained transactional-execution mode; a transaction-constraint program exception may be recognized.

A Access exceptions for logical addresses.

B₁ B₁ field designates an access register in the access-register mode.

B₂ B₂ field designates an access register in the access-register mode.

C Condition code is set.

DF Decimal-overflow exception.

Dg General-operand data exception.

DK Decimal-divide exception.

E2 Extended-translation facility 2.

G1 Instruction execution includes the implied use of general register 1.

RSL RSL instruction format.

SP Specification exception.

SS SS instruction format.

ST PER storage-alteration event.

Figure 8-2. Summary of Decimal Instructions

ADD DECIMAL

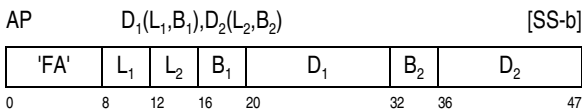

The second operand is added to the first operand, and the resulting sum is placed at the first-operand location. The operands and result are in the signed-packed-decimal format.

Addition is algebraic, taking into account the signs and all digits of both operands. All sign and digit codes are checked for validity.

If the first operand is too short to contain all leftmost nonzero digits of the sum, decimal overflow occurs. The operation is completed. The result is obtained by ignoring the overflow digits, and condition code 3 is set. If the decimal-overflow mask is one, a program interruption for decimal overflow occurs.

The sign of the sum is determined by the rules of algebra. In the absence of overflow, the sign of a zero result is made positive. If overflow occurs, a zero result is given either a positive or negative sign, as determined by what the sign of the correct sum would have been.

Resulting Condition Code:

- 0 Result zero; no overflow
- 1 Result less than zero; no overflow
- 2 Result greater than zero; no overflow
- 3 Overflow

Program Exceptions:

- Access (fetch, operand 2; fetch and store, operand 1)
- Data with DXC 0, general operand
- Decimal overflow
- Transaction constraint

Programming Note: An example of the use of the ADD DECIMAL instruction is given in Appendix A, “Number Representation and Instruction-Use Examples.”

COMPARE DECIMAL

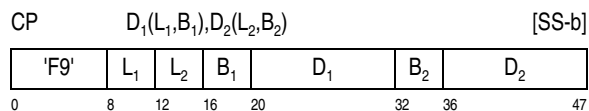

The first operand is compared with the second operand, and the result is indicated in the condition code. The operands are in the signed-packed-decimal format.

Comparison is algebraic and follows the procedure for decimal subtraction, except that both operands remain unchanged. When the difference is zero, the operands are equal. When a nonzero difference is positive or negative, the first operand is high or low, respectively.

Overflow cannot occur because the difference is discarded.

All sign and digit codes are checked for validity.

Resulting Condition Code:

- 0 Operands equal
- 1 First operand low
- 2 First operand high
- 3 --

Program Exceptions:

- Access (fetch, operands 1 and 2)
- Data with DXC 0, general operand
- Transaction constraint

Programming Notes:

1. An example of the use of the COMPARE DECIMAL instruction is given in Appendix A, “Number Representation and Instruction-Use Examples.”
2. The preferred and alternate sign codes for a particular sign are treated as equivalent for comparison purposes.
3. A negative zero and a positive zero compare equal.

DIVIDE DECIMAL

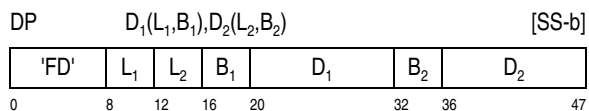

The first operand (the dividend) is divided by the second operand (the divisor). The resulting quotient and remainder are placed at the first-operand location. The operands and results are in the signed-packed-decimal format.

The quotient is placed leftmost in the first-operand location. The number of bytes in the quotient field is equal to the difference between the dividend and divisor lengths (L₁ - L₂). The remainder is placed rightmost in the first-operand location and has a length equal to the divisor length. Together, the quotient and remainder fields occupy the entire first operand; therefore, the address of the quotient is the address of the first operand.

The divisor length cannot exceed 15 digits and sign (L₂ not greater than seven) and must be less than the dividend length (L₂ less than L₁); otherwise, a specification exception is recognized.

The dividend, divisor, quotient, and remainder are each signed decimal integers in the signed-packed-decimal format and are right-aligned in their fields. All sign and digit codes of the dividend and divisor are checked for validity.

The sign of the quotient is determined by the rules of algebra from the dividend and divisor signs. The sign of the remainder has the same value as the dividend sign. These rules hold even when the quotient or remainder is zero.

Overflow cannot occur. If the divisor is zero or the quotient is too large to be represented by the number of digits specified, a decimal-divide exception is recognized. This includes the case of division of zero by zero. The decimal-divide exception is indicated only if the sign codes of both the dividend and divisor are valid, and only if the digit or digits used in establishing the exception are valid.

Condition Code: The code remains unchanged.

Program Exceptions:

- Access (fetch, operand 2; fetch and store, operand 1)
- Data with DXC 0, general operand
- Decimal divide
- Specification
- Transaction constraint

Programming Notes:

1. An example of the use of the DIVIDE DECIMAL instruction is given in Appendix A, "Number Representation and Instruction-Use Examples."
2. The dividend cannot exceed 31 digits and sign. Since the remainder cannot be shorter than one digit and sign, the quotient cannot exceed 29 digits and sign.
3. The condition for a decimal-divide exception can be determined by a trial comparison. The leftmost digit of the divisor is aligned one digit to the right of the leftmost dividend digit, with rightmost zeros appended up to the length of the dividend. When the divisor, so aligned, is less than or equal to the dividend, ignoring signs, a divide exception is indicated.
4. If a general-operand data exception does not exist, a decimal-divide exception occurs when the leftmost dividend digit is not zero.

EDIT

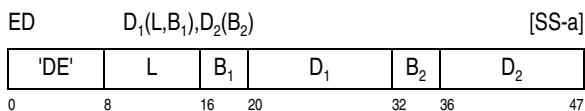

The second operand (the source), which normally contains one or more decimal numbers in the signed-packed-decimal or unsigned-packed-decimal format, is changed to the zoned format and modified under the control of the first operand (the pattern). The edited result replaces the first operand.

The length field specifies the length of the first operand, which may contain bytes of any value.

The length of the source is determined by the operation according to the contents of the pattern. The source normally consists of one or more decimal numbers, each in the signed-packed-decimal or unsigned-packed-decimal format. The leftmost four bits of each source byte must specify a decimal-digit

code (0000-1001); a sign code (1010-1111) is recognized as a general-operand data exception. The rightmost four bits may specify either a sign code or a decimal-digit code. Access and data exceptions and PER zero-address-detection events are recognized only for those bytes in the second operand which are actually required.

The result is obtained as if both operands were processed left to right one byte at a time. Overlapping pattern and source fields give unpredictable results.

During the editing process, each byte of the pattern is affected in one of three ways:

1. It is left unchanged.
2. It is replaced by a source digit expanded to the zoned format.
3. It is replaced by the first byte in the pattern, called the fill byte.

Which of the three actions takes place is determined by one or more of the following: the type of the pattern byte, the state of the significance indicator, and whether the source digit examined is zero.

Pattern Bytes: There are four types of pattern bytes: digit selector, significance starter, field separator, and message byte. Their coding is as follows:

Name	Code	
	(Binary)	(Hex)
Digit Selector	0010 0000	20
Significance starter	0010 0001	21
Field separator	0010 0010	22
Message byte	Any other	Any other

The detection of either a digit selector or a significance starter in the pattern causes an examination to be made of the significance indicator and of a source digit. As a result, either the expanded source digit or the fill byte, as appropriate, is selected to replace the pattern byte. Additionally, encountering a digit selector or a significance starter may cause the significance indicator to be changed.

The field separator identifies individual fields in a multiple-field editing operation. It is always replaced in the result by the fill byte, and the significance indicator is always off after the field separator is encountered.

Message bytes in the pattern are either replaced by the fill byte or remain unchanged in the result, depending on the state of the significance indicator. They may thus be used for padding, punctuation, or text in the significant portion of a field or for the insertion of sign-dependent symbols.

Fill Byte: The first byte of the pattern is used as the fill byte. The fill byte can have any code and may concurrently specify a control function. If this byte is a digit selector or significance starter, the indicated editing action is taken after the code has been assigned to the fill byte.

Source Digits: Each time a digit selector or significance starter is encountered in the pattern, a new source digit is examined for placement in the pattern field. Either the source digit is disregarded, or it is expanded to the zoned format, by appending the zone code 1111 on the left, and stored in place of the pattern byte.

Execution is as if the source digits were selected one byte at a time. The leftmost four bits of each byte are examined first, and the rightmost four bits, when they represent a decimal-digit code, remain available for the next pattern byte that calls for a digit examination. When the leftmost four bits contain an invalid digit code, a general-operand data exception is recognized, and the operation is either suppressed or terminated.

At the time the left digit of a source byte is examined, the rightmost four bits are checked for the existence of a sign code. When a sign code is encountered in the rightmost four bit positions, these bits are not treated as a decimal-digit code, and a new source byte is fetched from storage when the next pattern byte calls for a source-digit examination.

When the pattern contains no digit selector or significance starter, no source bytes are fetched and examined.

Significance Indicator: The significance indicator is turned on or off to indicate the significance or non-significance, respectively, of subsequent source digits or message bytes. Significant source digits replace their corresponding digit selectors or significance starters in the result. Significant message bytes remain unchanged in the result.

The significance indicator, by its on or off state, indicates also the negative or positive value, respec-

tively, of a completed source field and is used as one factor in the setting of the condition code.

The significance indicator is set to off at the start of the editing operation, after a field separator is encountered, or after a source byte is examined that has a plus code in the rightmost four bit positions.

The significance indicator is set to on when a significance starter is encountered whose source digit is a valid decimal digit, or when a digit selector is encountered whose source digit is a nonzero decimal digit, provided that in both instances the source byte does not have a plus code in the rightmost four bit positions.

In all other situations, the significance indicator is not changed. A minus sign code has no effect on the significance indicator.

Result Bytes: The result of an editing operation replaces and is equal in length to the pattern. It is composed of pattern bytes, fill bytes, and zoned source digits.

If the pattern byte is a message byte and the significance indicator is on, the message byte remains unchanged in the result. If the pattern byte is a field separator or if the significance indicator is off when a message byte is encountered in the pattern, the fill byte replaces the pattern byte in the result.

If the digit selector or significance starter is encountered in the pattern with the significance indicator off and the source digit zero, the source digit is considered nonsignificant, and the fill byte replaces the pattern byte. If the digit selector or significance starter is encountered either with the significance indicator on or with a nonzero decimal source digit, then the source digit (a) is considered significant, (b) is changed to the zoned format, and (c) replaces the pattern byte in the result. Examination of the significance indicator occurs prior to the processing of the source digit (which might change the significance indicator).

Condition Code: The sign and magnitude of the last field edited are used to set the condition code. The term "last field" refers to those source digits, if any, in the second operand selected by digit selectors or significance starters after the last field separator; if the pattern contains no field separator, there is only one field, which is considered to be the last field.

If no such source digits are selected, the last field is considered to be of zero length.

Condition code 0 is set when the last field edited is zero or of zero length.

Condition code 1 is set when the last field edited is nonzero and the significance indicator is on. (This indicates a result less than zero if the last source byte examined contained a sign code in the rightmost four bits.)

Condition code 2 is set when the last field edited is nonzero and the significance indicator is off. (This indicates a result greater than zero if the last source

byte examined contained a sign code in the rightmost four bits.)

For the purposes of setting condition code 2, the significance indicator is examined after the processing of the last source digit.

Figure 8-3 on page 8-10 summarizes the functions of the EDIT and EDIT AND MARK operations. The leftmost four columns list all the significant combinations of the four conditions that can be encountered in the execution of an editing operation. The rightmost two columns list the action taken for each case — the type of byte placed in the result field and the new setting of the significance indicator.

Conditions				Results	
Pattern Byte	Previous State of Significance Indicator	Source Digit	Right Four Source Bits Are Plus Code	Result Byte	State of Significance Indicator at End of Digit Examination
Digit selector	Off	0	*	Fill byte	Off
		1-9	No	Source digit#	On
	Yes		Source digit#	Off	
	On	0-9	No	Source digit	On
Yes			Source digit	Off	
Significance starter	Off	0	No	Fill byte	On
			Yes	Fill byte	Off
	1-9	No	Source digit#	On	
		Yes	Source digit#	Off	
On	0-9	No	Source digit	On	
		Yes	Source digit	Off	
Field separator	*	**	**	Fill byte	Off
Message byte	Off	**	**	Fill byte	Off
	On	**	**	Message byte	On
Explanation:					
* No effect on result byte or on new state of significance indicator.					
** Not applicable because source is not examined.					
# For EDIT AND MARK only, the address of the rightmost such result byte is placed in general register 1.					

Figure 8-3. Summary of Editing Functions

Resulting Condition Code:

- 0 Last field zero or zero length
- 1 Last field less than zero
- 2 Last field greater than zero
- 3 --

Program Exceptions:

- Access (fetch, operand 2; fetch and store, operand 1)
- Data with DXC 0, general operand
- Transaction constraint

Programming Notes:

1. Examples of the use of the EDIT instruction are given in Appendix A, "Number Representation and Instruction-Use Examples."

2. Editing includes sign and punctuation control, and the suppression of leading zeros by replacing them with blanks, or the protection of leading zeros from malicious alteration by replacing them with asterisks or other characters. It also facilitates programmed blanking of all-zero fields. Several fields may be edited in one operation, and numeric information may be combined with text.
3. In most cases, the source is shorter than the pattern because each four-bit source digit produces an eight-bit byte in the result.
4. The total number of digit selectors and significance starters in the pattern always equals the number of source digits edited.
5. If the fill byte is a blank, if no significance starter exists in the pattern, and if the source digit examined for each digit selector is zero, the editing operation blanks the result field.
6. The resulting condition code indicates whether or not the last field is all zeros and, if nonzero, reflects the state of the significance indicator. The significance indicator reflects the sign of the source field only if the last source byte examined contains a sign code in the rightmost four bits. For multiple-field editing operations, the condition code reflects the sign and value only of the field following the last field separator.
7. Significant performance degradation is possible when the second-operand address of an EDIT instruction designates a location that is closer to the left of an access boundary than the length of the first operand of that instruction (for the purposes of this discussion, an access boundary is 4 K-bytes, except when fetch-protection override applies in which case it is 2 K-bytes). This is because the machine may perform a trial execution of the instruction to determine if the second operand actually crosses the boundary. The second operand of EDIT, while normally shorter than the first operand, can in the extreme case have the same length as the first.

The second operand (the source), which normally contains one or more decimal numbers in the signed-packed-decimal or unsigned-packed-decimal format, is changed to the zoned format and modified under the control of the first operand (the pattern). The address of the first significant result byte of the rightmost (or only) field is inserted in general register 1. The edited result replaces the pattern.

EDIT AND MARK is identical to EDIT, except for the additional function of inserting the address of the result byte in general register 1 if the result byte is a zoned source digit and the significance indicator was off before the examination of the source bytes. If no result byte meets the criteria, general register 1 remains unchanged; if more than one result byte meets the criteria, the address of the rightmost such result byte is inserted.

In the 24-bit addressing mode, the address replaces bits 40-63 of general register 1, and bits 0-39 of the register are not changed. In the 31-bit addressing mode, the address replaces bits 33-63 of general register 1, bit 32 of the register is set to zero, and bits 0-31 of the register remain unchanged. In the 64-bit addressing mode, the address replaces bits 0-63 of general register 1.

The contents of access register 1 remain unchanged.

See Figure 8-3 on page 8-10 for a summary of the EDIT and EDIT AND MARK operations.

Resulting Condition Code:

- 0 Last field zero or zero length
- 1 Last field less than zero
- 2 Last field greater than zero
- 3 --

Program Exceptions:

- Access (fetch, operand 2; fetch and store, operand 1)
- Data
- Transaction constraint

Programming Notes:

1. Examples of the use of the EDIT AND MARK instruction are given Appendix A, "Number Representation and Instruction-Use Examples."

EDIT AND MARK

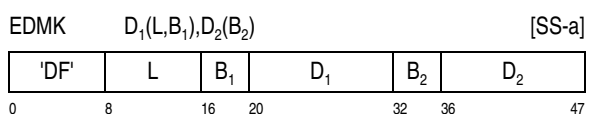

2. EDIT AND MARK facilitates the programming of floating currency-symbol insertion. Using appropriate source and pattern data, the address inserted in general register 1 is one greater than the address where a floating currency-sign would be inserted.
3. No address is inserted in general register 1 when the significance indicator is turned on as a result of encountering a significance starter with the corresponding source digit zero. To ensure that general register 1 contains a proper address when this occurs, the address of the pattern byte that immediately follows the appropriate significance starter could be placed in the register beforehand.
4. When multiple fields are edited with one execution of the EDIT AND MARK instruction, the address, if any, inserted in general register 1 applies to the rightmost field edited for which the criteria were met.
5. See also the programming note under EDIT regarding performance degradation due to a possible trial execution.

MULTIPLY DECIMAL

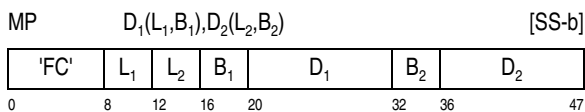

The product of the first operand (the multiplicand) and the second operand (the multiplier) is placed at the first-operand location. The operands and result are in the signed-packed-decimal format.

The multiplier length cannot exceed 15 digits and sign (L₂ not greater than seven) and must be less than the multiplicand length (L₂ less than L₁); otherwise, a specification exception is recognized.

The multiplicand must have at least as many bytes of leftmost zeros as the number of bytes in the multiplier; otherwise, a general-operand data exception is recognized. This restriction ensures that no product overflow occurs.

The multiplicand, multiplier, and product are each signed decimal integers in the signed-packed-decimal format and are right-aligned in their fields. All

sign and digit codes of the multiplicand and multiplier are checked for validity. The sign of the product is determined by the rules of algebra from the multiplier and multiplicand signs, even if one or both operands are zeros.

Condition Code: The code remains unchanged.

Program Exceptions:

- Access (fetch, operand 2; fetch and store, operand 1)
- Data with DXC 0, general operand
- Specification
- Transaction constraint

Programming Notes:

1. An example of the use of the MULTIPLY DECIMAL instruction is given Appendix A, "Number Representation and Instruction-Use Examples."
2. The product cannot exceed 31 digits and sign. The leftmost digit of the product is always zero.

SHIFT AND ROUND DECIMAL

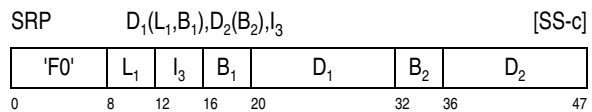

The first operand is shifted in the direction and for the number of decimal-digit positions specified by the second-operand address, and, when shifting to the right is specified, the absolute value of the first operand is rounded by the rounding digit, I₃. The first operand and the result are in the signed-packed-decimal format.

The first operand is considered to be in the signed-packed-decimal format. Only its digit portion is shifted; the sign position does not participate in the shifting. Zeros are supplied for the vacated digit positions. The result replaces the first operand. Nothing is stored outside of the specified first-operand location.

The second-operand address, specified by the B₂ and D₂ fields, is not used to address data; bits 58-63 of that address are the shift value, and the leftmost bits of the address are ignored.

The shift value is a six-bit signed binary integer, indicating the direction and the number of decimal-digit positions to be shifted. Positive shift values specify shifting to the left. Negative shift values, which are represented in two's complement notation, specify shifting to the right. The following are examples of the interpretation of shift values:

Shift Value (Binary)	Amount and Direction
011111	31 digits to the left
000001	One digit to the left
000000	No shift
111111	One digit to the right
100000	32 digits to the right

For a right shift, the I_3 field, bits 12-15 of the instruction, is used as a decimal rounding digit. The first operand, which is treated as positive by ignoring the sign, is rounded by decimally adding the rounding digit to the leftmost of the digits to be shifted out and by propagating the carry, if any, to the left. The result of this addition is then shifted right. Except for validity checking and the participation in rounding, the digits shifted out of the rightmost decimal-digit position are ignored and are lost.

If one or more nonzero digits are shifted out during a left shift, decimal overflow occurs. The operation is completed. The result is obtained by ignoring the overflow digits, and condition code 3 is set. If the decimal-overflow mask is one, a program interruption for decimal overflow occurs. Overflow cannot occur for a right shift, with or without rounding, or when no shifting is specified.

In the absence of overflow, the sign of a zero result is made positive. If overflow occurs, the sign of the result is the same as the original sign but with the preferred sign code.

A general-operand data exception is recognized when the first operand does not have valid sign and digit codes or when the rounding digit is not a valid digit code. The validity of the first-operand codes is checked even when no shift is specified, and the validity of the rounding digit is checked even when no addition for rounding takes place.

Resulting Condition Code:

- 0 Result zero; no overflow
- 1 Result less than zero; no overflow
- 2 Result greater than zero; no overflow

3 Overflow

Program Exceptions:

- Access (fetch and store, operand 1)
- Data with DXC 0, general operand
- Decimal overflow
- Transaction constraint

Programming Notes:

1. Examples of the use of the SHIFT AND ROUND DECIMAL instruction are given in Appendix A, "Number Representation and Instruction-Use Examples."
2. SHIFT AND ROUND DECIMAL can be used for shifting up to 31 digit positions left and up to 32 digit positions right. This is sufficient to clear all digits of any decimal number even with rounding.
3. For right shifts, the rounding digit 5 provides conventional rounding of the result. The rounding digit 0 specifies truncation without rounding.
4. When the B_2 field is zero, the six-bit shift value is obtained directly from bits 42-47 of the instruction.

SUBTRACT DECIMAL

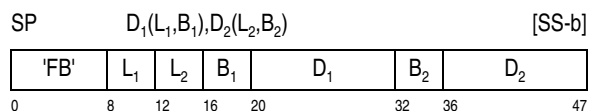

The second operand is subtracted from the first operand, and the resulting difference is placed at the first-operand location. The operands and result are in the signed-packed-decimal format.

SUBTRACT DECIMAL is executed the same as ADD DECIMAL, except that the second operand is considered to have a sign opposite to the sign in storage. The second operand in storage remains unchanged.

Resulting Condition Code:

- 0 Result zero; no overflow
- 1 Result less than zero; no overflow
- 2 Result greater than zero; no overflow
- 3 Overflow

Program Exceptions:

- Access (fetch, operand 2; fetch and store, operand 1)
- Data with DXC 0, general operand
- Decimal overflow
- Transaction constraint

TEST DECIMAL

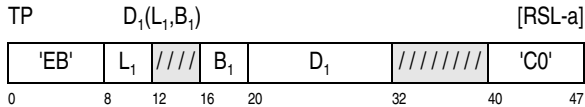

The first operand is tested for valid decimal digits and a valid sign code, and the result is indicated in the condition code. The operand is in the signed-packed-decimal format.

Resulting Condition Code:

- 0 All digit codes and the sign valid
- 1 All digit codes valid and sign invalid
- 2 At least one digit code invalid and sign valid
- 3 At least one digit code invalid and sign invalid

Program Exceptions:

- Access (fetch, operand 1)
- Operation (if the extended-translation facility 2 is not installed)
- Transaction constraint

ZERO AND ADD

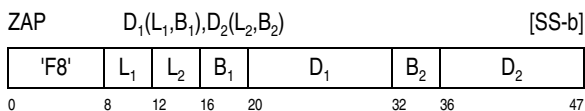

The second operand is placed at the first-operand location. The operation is equivalent to an addition to zero. The operand and result are in the signed-packed-decimal format.

Only the second operand is checked for valid sign and digit codes. Extra zeros are supplied on the left for the shorter operand if needed.

If the first operand is too short to contain all leftmost nonzero digits of the second operand, decimal overflow occurs. The operation is completed. The result is obtained by ignoring the overflow digits, and condition code 3 is set. If the decimal-overflow mask is one, a program interruption for decimal overflow occurs.

In the absence of overflow, the sign of a zero result is made positive. If overflow occurs, a zero result is given the sign of the second operand but with the preferred sign code.

The two operands may overlap, provided the rightmost byte of the first operand is coincident with or to the right of the rightmost byte of the second operand. In this case, the result is obtained as if the operands were processed right to left. When the operands overlap and the rightmost byte of the first operand is to the left of the rightmost byte of the second operand, then, depending on the model, either a general-operand data exception is recognized or the result is obtained as if the entire second operand were fetched before any byte of the result is stored.

Resulting Condition Code:

- 0 Result zero; no overflow
- 1 Result less than zero; no overflow
- 2 Result greater than zero; no overflow
- 3 Overflow

Program Exceptions:

- Access (fetch, operand 2; store, operand 1)
- Data with DXC 0, general operand
- Decimal overflow
- Transaction constraint

Programming Note: An example of the use of the ZERO AND ADD instruction is given in Appendix A, "Number Representation and Instruction-Use Examples."

Chapter 9. Floating-Point Overview and Support Instructions

Sign Bit	9-2	Voting Digit and Common-Rounding- Point View	9-13
Finite Floating-Point Numbers	9-2	Rounding Methods	9-14
Infinities	9-2	Explicit Rounding Methods	9-17
Not-A-Number (NaN)	9-2	Summary of Rounding Action	9-17
Signaling and Quiet NaNs	9-2	IEEE Exceptions	9-18
Payload	9-2	Concurrent IEEE Exceptions.	9-18
Propagation of NaNs	9-3	IEEE Invalid Operation	9-19
Default QNaN	9-3	IEEE Division-By-Zero	9-19
Floating-Point Number Representations	9-3	IEEE Overflow.	9-19
Hexadecimal-Floating-Point (HFP)	9-3	IEEE Underflow.	9-20
Binary Floating-Point (BFP)	9-4	IEEE Inexact	9-20
Decimal Floating-Point (DFP)	9-4	Quantum Exception.	9-21
Canonical DFP Data	9-4	Suppression of Certain IEEE Exceptions	9-23
Comparison of Floating-Point Number Representations	9-5	IEEE Same-Radix Format Conversion	9-23
Floating-Point Number Ranges	9-5	IEEE Comparison	9-24
Equivalent Floating-Point Number Representations.	9-5	Condition Codes for IEEE Instructions	9-24
Effective Width	9-7	Instructions	9-24
Floating-Point Data in Storage.	9-8	CONVERT BFP TO HFP	9-27
Registers And Controls	9-8	CONVERT HFP TO BFP	9-28
Floating-Point Registers	9-8	COPY SIGN	9-30
Additional Floating-Point (AFP) Registers	9-9	EXTRACT FPC	9-30
Valid Floating-Point-Register Designations	9-9	LOAD	9-31
Floating-Point-Control (FPC) Register.	9-9	LOAD COMPLEMENT	9-31
IEEE Masks and Flags	9-10	LOAD FPC	9-31
FPC DXC Byte	9-10	LOAD FPC AND SIGNAL	9-32
Operations on the FPC Register	9-10	LOAD FPR FROM GR	9-34
AFP-Register-Control Bit	9-11	LOAD GR FROM FPR	9-34
IEEE Computational Operations	9-11	LOAD NEGATIVE.	9-34
Intermediate Values.	9-12	LOAD POSITIVE.	9-34
Precise Intermediate Value	9-12	LOAD ZERO	9-35
Precision-Rounded Value	9-12	PERFORM FLOATING-POINT OPERATION.	9-35
Denormalized Value	9-12	SET BFP ROUNDING MODE.	9-47
Functionally-Rounded Value	9-12	SET DFP ROUNDING MODE	9-47
Rounded Intermediate Value	9-12	SET FPC.	9-47
Scaled Value	9-12	SET FPC AND SIGNAL	9-48
Scale Factor (Ψ)	9-12	STORE	9-48
Unsigned Scaling Exponent (α)	9-12	STORE FPC	9-49
Signed Scaling Exponent (Ω)	9-13	Summary of All Floating-Point Instructions.	9-49
IEEE Rounding	9-13	Impacts on ESA/390 and ESA/390-Compatibility Mode	9-52
Permissible Set	9-13	Impacts of the Decimal-Floating-Point Facility 9-52	
Selection of Candidates.	9-13	Impacts of the Floating-Point Extension Facility.	9-53
Ties	9-13		

Floating-point instructions are used to perform calculations on operands having a wide range of magni-

tude and to obtain results scaled to preserve precision.

Floating-point operands have formats based on three radices: 2, 10, or 16. These radix values lead to the terminology “binary,” “decimal,” and “hexadecimal” floating point (BFP, DFP, and HFP), respectively. The formats are also based on three operand lengths: short (32 bits), long (64 bits), and extended (128 bits). Short operands require less storage than long or extended operands. On the other hand, long and extended operands permit greater precision in computation.

Sign Bit

All floating-point data have a sign bit. The sign bit is zero for plus and one for minus.

Finite Floating-Point Numbers

A finite floating-point number has three components: a sign bit, an exponent, and a significand. The magnitude (an unsigned value) of the number is the product of the significand and the radix raised to the power of the exponent. The number is positive or negative depending on whether the sign bit is zero or one, respectively.

The significand consists of a string of digits, where each digit is an integral value from zero to one less than the radix (2, 10, or 16). (Thus, a BFP digit is one bit, an HFP digit is four bits, and a DFP digit is a value from zero to nine.) The number of digit positions in the significand is called the precision of the floating-point number. The significand has an implied radix point, which, depending on the view, may be considered to be on the left, to the right of the leftmost digit, on the right, or elsewhere.

The exponent, a signed value, is represented as an unsigned binary value by adding a bias; the result, for BFP and DFP, is called the biased exponent; for HFP, it is called the characteristic. The value of the bias depends on the view. In the *fraction view*, the radix point is considered to be the left of the significand. In the *left-units view*, the radix point is considered to be to the right of the leftmost digit. In the *right-units view*, the radix point is considered to be on the right of the significand. By choosing the appropriate bias, any finite floating-point number can be considered in any of these views, or even in another view. For the first three of these views, the bias is called the *fraction-view bias*, *left-units-view bias*, and *right-units-view bias*, respectively. Except where otherwise indicated, HFP is defined in terms of the fraction view, BFP terms of the left-units view, and DFP in terms of the right-units view.

For HFP, the significand is considered to be a fraction with the implied radix point on the left. In this view, the significand is referred to as the fraction. For BFP, the significand consists of an implicit unit digit to the left of an implied radix point and an explicit fraction field to the right. For DFP, the significand is considered to be an integer with the implied radix point on the right.

Infinities

BFP and DFP data include an infinite numeric datum, called infinity. Infinities can participate in most arithmetic operations and give a consistent result, usually infinity. An infinity has a sign bit. In comparisons, infinities of the same sign compare equal, $+\infty$ compares greater than any finite number, and $-\infty$ compares less than any finite number.

Not-A-Number (NaN)

BFP and DFP data types include a nonnumeric datum, called not-a-number (or NaN). A NaN is produced in place of a numeric result after an invalid operation when there is no IEEE trap action. NaNs may also be used by the program to flag special operands, such as the contents of an uninitialized storage area. A NaN has a sign bit, a NaN-type bit, and a payload.

Signaling and Quiet NaNs

There are two types of NaNs, signaling and quiet. A signaling NaN (SNaN) is distinguished from the corresponding quiet NaN (QNaN) by the NaN-type bit.

For BFP, the NaN-type bit is the leftmost bit of the fraction field, and is called the QNaN bit: a BFP NaN is an SNaN, or a QNaN, depending on whether the QNaN bit is zero, or one, respectively. For DFP, the NaN-type bit is in bit position 6 in all three formats, and is called the SNaN bit: a DFP NaN is a QNaN, or an SNaN, depending on whether the SNaN bit is zero, or one, respectively.

Payload

NaNs include diagnostic information called the payload. For BFP, the payload has two fewer bits than the precision and is considered to be a left-aligned bit-reversed binary integer. For DFP, the payload has one fewer digit than the precision and is considered to be a right-aligned decimal integer.

For both BFP and DFP the payload of a NaN is considered to be an unsigned integer. Let p represent the precision, in digits, of a particular format. For DFP, bit 6 of the format is called the SNaN bit and the $p-1$ digits in the trailing significand field are the numeric value of the payload. For BFP, the leftmost bit in the fraction field is called the QNaN bit and the remaining $p-2$ bits of the fraction field are the numeric value of the payload.

The numeric value of the BFP NaN payload is bit-reversed. That is, the first bit to the right of the QNaN bit is considered to have a value of one, the next bit a value of two, and so on, with each bit having a value of twice the value of the bit to its left.

Propagation of NaNs

Normally, QNaNs are just propagated during computations so that they will remain visible at the end; while an SNaN operand causes an IEEE-invalid-operation exception. If the IEEE-invalid-operation mask (FPC 0.0) is zero, the result is the corresponding QNaN, which is produced by inverting the NaN-type bit, and setting the IEEE-invalid-operation flag (FPC 1.0) is set to one. If the IEEE-invalid-operation mask (FPC 0.0) is one, the operation is suppressed, and a data exception for IEEE-invalid operation occurs.

Where applicable, the propagation of NaNs is illustrated in the action figure for an instruction.

Default QNaN

A special QNaN is supplied as the default result for an IEEE-invalid-operation exception; it has a plus sign and a payload of zeros.

Programming Notes:

1. The program can generate and assign values to the payload of a NaN. The CPU propagates those values unchanged, except that an SNaN is changed to the corresponding QNaN if the IEEE-invalid-operation mask bit is zero, and conversion to a narrower format truncates digits from the payload. For BFP, bits are truncated on the right; for DFP, digits are truncated on the left. For the PFPO-convert-floating-point-radix operation, payloads are preserved, except that payloads larger than the capacity of the target format are replaced by the default QNaN (payload zero).

2. Depending on the application, the program may or may not desire that an SNaN signal the IEEE invalid-operation exception. The sign-handling instructions LOAD COMPLEMENT, LOAD NEGATIVE, and LOAD POSITIVE do not signal the invalid-operation exception but, instead, treat SNaNs like any other data. LOAD AND TEST signals the invalid-operation exception when the operand is an SNaN. This instruction, in conjunction with the above instructions, gives the program the choice of either option.
3. The instructions LOAD LENGTHENED and LOAD ROUNDED change the precision of a floating-point datum. The BFP versions of these instructions signal the invalid-operation exception when the operand is an SNaN. The DFP instructions have a modifier bit to control whether the exception is signaled.

Floating-Point Number Representations

Hexadecimal-Floating-Point (HFP)

Hexadecimal-floating-point (HFP) operands have formats which provide for exponents that specify powers of the radix 16 and significands that are hexadecimal numbers. The exponent range is the same for the short, long, and extended formats.

The results of most operations on HFP data are truncated to fit into the target format, but there are instructions available to round the result when converting to a narrower format. Additionally, the PERFORM FLOATING POINT OPERATION instruction provides rounding methods when converting to an HFP format from BFP or DFP.

For HFP operands, the implicit unit digit of the significand is always zero. Since the value of the significand and fraction are the same, HFP operations are described in terms of the fraction, and the term significand is not used.

Either normalized or unnormalized numbers may be used as operands for any HFP or DFP operation, where, for HFP, a normalized number is one having a nonzero leftmost fraction digit, or, for DFP, a normalized number is one having a nonzero leftmost significand digit. Most HFP instructions generate

normalized results for greatest precision. HFP add and subtract instructions that generate unnormalized results are also available. When the HFP-unnormalized-extensions facility is installed, the MULTIPLY UNNORMALIZED and MULTIPLY AND ADD UNNORMALIZED instructions also generate unnormalized results.

Binary Floating-Point (BFP)

Binary-floating-point (BFP) operands have formats which provide for exponents that specify powers of the radix 2 and significands that are binary numbers. The exponent range differs for different formats, the range being greater for the longer formats. In the long and extended formats, the exponent range is significantly greater for BFP data than for HFP data.

The results of operations performed on BFP data are rounded automatically to fit into the target format. The manner of rounding is determined by a program-settable BFP rounding mode; however, explicit rounding modes may be specified in various BFP instructions.

There are no unnormalized operands for BFP operations. For normal BFP numbers, the implicit unit digit of the significand is one. For values too small in magnitude to be represented in normalized form, the implicit unit digit is zero. These numbers are called *subnormal* numbers.¹ Unlike the HFP and DFP formats, where the same value can have multiple representations in a given format because of the possibility of unnormalized numbers, the BFP format does not allow such redundancy.

Decimal Floating-Point (DFP)

Decimal-floating-point (DFP) operands have formats which provide for exponents that specify powers of the radix 10 and significands that are decimal numbers. The exponent range differs for different formats, the range being greater for the longer formats. The exponent range is greater for DFP data than for BFP data.

The results of operations performed on DFP data are rounded automatically to fit into the target format. The manner of rounding is determined by a program-settable DFP rounding mode; however, explicit

rounding modes may be specified in various DFP instructions.

Like HFP, DFP numbers can be normalized or unnormalized. Either normalized or unnormalized numbers may be used as operands for any DFP operation. For DFP, a normalized number is one having a nonzero leftmost significand digit. Because of the possibility of unnormalized numbers, the same value can have multiple representations in a given DFP format. The representations having the same value are called members of a cohort. Unlike HFP, DFP instructions generate normalized results for greater precision only when the result is inexact. When the result is exact, most DFP instructions produce a value in the form that preserves information called the quantum.

Canonical DFP Data

A *canonical DFP number* has only canonical declets, that is, the digits in the trailing-significand field are encoded using only the preferred DPD codes.

A *canonical DFP infinity* has bit 6 and all bits to the right of this in the format set to zeros.

A *canonical DFP NaN* has zeros in all bits to the right of the NaN-type bit in the combination field and only canonical declets in the trailing significand field.

Noncanonical DFP numbers, infinities, and NaNs are accepted as source operands, but all DFP results are canonical.

Comparison of Floating-Point Number Representations

Floating-Point Number Ranges

Figure 9-1 shows the range of numbers, in decimal form, that can be represented in different floating-point formats.

	Type	Short	Long	Extended
Nmax	HFP	$\pm 7.2 \times 10^{+75}$	$\pm 7.2 \times 10^{+75}$	$\pm 7.2 \times 10^{+75}$
	BFP	$\pm 3.4 \times 10^{+38}$	$\pm 1.8 \times 10^{+308}$	$\pm 1.2 \times 10^{+4932}$
	DFP	$\pm 1.0 \times 10^{+97}$	$\pm 1.0 \times 10^{+385}$	$\pm 1.0 \times 10^{+6145}$

Figure 9-1. Decimal Approximations of Number Ranges for HFP, BFP, and DFP Formats

1. Subnormal numbers were previously called *denormalized* numbers.

	Type	Short	Long	Extended
Nmin	HFP	$\pm 5.4 \times 10^{-79}$	$\pm 5.4 \times 10^{-79}$	$\pm 5.4 \times 10^{-79}$
	BFP	$\pm 1.2 \times 10^{-38}$	$\pm 2.2 \times 10^{-308}$	$\pm 3.4 \times 10^{-4932}$
	DFP	$\pm 1.0 \times 10^{-95}$	$\pm 1.0 \times 10^{-383}$	$\pm 1.0 \times 10^{-6143}$
Dmin	HFP	$\pm 5.1 \times 10^{-85}$	$\pm 1.2 \times 10^{-94}$	$\pm 1.7 \times 10^{-111}$
	BFP	$\pm 1.4 \times 10^{-45}$	$\pm 4.9 \times 10^{-324}$	$\pm 6.5 \times 10^{-4966}$
	DFP	$\pm 1.0 \times 10^{-101}$	$\pm 1.0 \times 10^{-398}$	$\pm 1.0 \times 10^{-6176}$
Explanation:				
Dmin	Smallest (in magnitude) representable subnormal (BFP or DFP) or nonzero unnormalized (HFP) number.			
Nmax	Largest (in magnitude) representable number.			
Nmin	Smallest (in magnitude) representable normal (BFP or DFP) or normalized (HFP) number.			
Values are decimal approximations for all of the HFP, BFP, and DFP formats.				

Figure 9-1. Decimal Approximations of Number Ranges for HFP, BFP, and DFP Formats

Equivalent Floating-Point Number Representations

The exponent of an HFP number is represented in the format as an unsigned seven-bit binary integer called the characteristic. The characteristic is obtained by adding 64 to the exponent value (excess-64 notation). The range of the characteristic is 0 to 127, which corresponds to an exponent range of -64 to +63.

The exponent of a BFP or DFP datum is represented in the format as an unsigned binary integer called the

biased exponent. The biased exponent is obtained by adding a bias to the exponent value. The number of bit positions containing the biased exponent, the value of the bias, and the exponent range depend on the data format (short, long, or extended) and are shown for the three formats in Figure 19-4 on page 19-3 and the three DFP formats in Figure 20-3 on page 20-6. Biased exponents are similar to the characteristics of the HFP format, except that, for BFP, special meanings are attached to biased exponents of all zeros and all ones. This is discussed in the section “Classes of BFP Data” on page 19-4.

In each of the three BFP or HFP formats, the binary or hexadecimal point of a number, respectively, is considered to be to the left of the leftmost fraction digit. To the left of the point there is an implied unit digit, which is considered to be zero for HFP numbers or, for BFP numbers, one for normal numbers and zero for zeros and subnormal numbers.

Figure 9-2 on page 9-6 and Figure 9-3 on page 9-7 give examples of the closest representation of the same numbers in the BFP, DFP, and HFP formats, with BFP and DFP values being rounded to nearest and HFP values being truncated.

The figures do not necessarily show the results of conversions exactly. Rounding errors may make a small difference. Also, Figure 9-2 on page 9-6 shows corresponding rounded short-format numbers, not the long HFP results of conversion from short BFP operands.

Value	S	BE or C	Trailing Significand	
1.0	B	0 011 1111 1	000 0000 0000 0000 0000 0000	
	H	0 100 0001	0001 0000 0000 0000 0000 0000	
	D	0 010 0010 0100	0000 0000 0000 0001 0000 [10×10 ⁻¹]	
0.5	B	0 011 1111 0	000 0000 0000 0000 0000 0000	
	H	0 100 0000	1000 0000 0000 0000 0000 0000	
	D	0 010 0010 0100	0000 0000 0000 0000 0000 0101 [5×10 ⁻¹]	
1/64	B	0 011 1100 1	000 0000 0000 0000 0000 0000	
	H	0 011 1111	0100 0000 0000 0000 0000 0000	
	D	0 010 0001 1111	0000 0101 0111 0010 0101 [15625×10 ⁻⁶]	
+0	B	0 000 0000 0	000 0000 0000 0000 0000 0000	
	H	0 000 0000	0000 0000 0000 0000 0000 0000	
	D	0 010 0010 0101	0000 0000 0000 0000 0000 0000 [+0×10 ⁰]	
-0	B	1 000 0000 0	000 0000 0000 0000 0000 0000	
	H	1 000 0000	0000 0000 0000 0000 0000 0000	
	D	1 010 0010 0101	0000 0000 0000 0000 0000 0000 [-0×10 ⁰]	
-15.0	B	1 100 0001 0	111 0000 0000 0000 0000 0000	
	H	1 100 0001	1111 0000 0000 0000 0000 0000	
	D	1 010 0010 0100	0000 0000 0000 1101 0000 [-150×10 ⁻¹]	
20/7	B	0 100 0000 0	011 0110 1101 1011 0110 1110	
	H	0 100 0001	0010 1101 1011 0110 1101 1011	
	D	0 010 1001 1111	1101 0111 0100 1100 0011 [2857143×10 ⁻⁶]	
2 ⁻¹²⁶	B	0 000 0000 1	000 0000 0000 0000 0000 0000	
	H	0 010 0001	0100 0000 0000 0000 0000 0000	
	D	0 000 0111 1001	0011 1101 0110 0101 1010 [1175494×10 ⁻⁴⁴]	
2 ⁻¹⁴⁹	B	0 000 0000 0	000 0000 0000 0000 0000 0001	
	H	0 001 1011	1000 0000 0000 0000 0000 0000	
	D	0 000 0111 0010	1000 0000 0101 0101 1110 [1401298×10 ⁻⁵¹]	
2 ¹²⁸ ×F F=1-2 ⁻²⁴	B	0 111 1111 0	111 1111 1111 1111 1111 1111	
	H	0 110 0000	1111 1111 1111 1111 1111 1111	
	D	0 100 1100 0101	1000 0000 1001 0010 1101 [3402823×10 ⁻³²]	
2 ⁻²⁶⁰	B	Zero (number too small)		
	H	0 000 0000	0001 0000 0000 0000 0000 0000	
	D	0 001 0101 0000	0111 1110 1111 0000 0101 [5397605×10 ⁻⁸⁵]	
2 ²⁴⁸ ×F F=1-2 ⁻²⁴	B	Not representable		
	H	0 111 1110	1111 1111 1111 1111 1111 1111	
	D	0 101 0010 1001	1010 1000 1100 1010 1000 [4523128×10 ⁺⁶⁸]	
Explanation:				
B	BFP.			
BE or C	Biased exponent of BFP number, combination field of DFP number, or characteristic of HFP number.			
D	DFP.			
H	HFP.			
S	Sign.			

Figure 9-2. Examples of Floating-Point Numbers in Short Format

Value	S	BE or C	Trailing Significand	
1.0	B	0 011 1111 1111	0000 0000 0000 0000 0000 0000 0000 0000 0000 0000 0000 0000 0000 0000 0000 0000	
	H	0 100 0001	0001 0000 0000 0000 0000 0000 0000 0000 0000 0000 0000 0000 0000 0000 0000 0000	
	D	0 010 0010 0011 01	00 0000 0000 0000 0000 0000 0000 0000 0000 0000 0000 0000 0000 0001 0000 [10×10 ⁻¹]	
0.5	B	0 011 1111 1110	0000 0000 0000 0000 0000 0000 0000 0000 0000 0000 0000 0000 0000 0000 0000 0000	
	H	0 100 0000	1000 0000 0000 0000 0000 0000 0000 0000 0000 0000 0000 0000 0000 0000 0000 0000	
	D	0 010 0010 0011 01	00 0000 0000 0000 0000 0000 0000 0000 0000 0000 0000 0000 0000 0000 0101 [5×10 ⁻¹]	
1/64	B	0 011 1111 1001	0000 0000 0000 0000 0000 0000 0000 0000 0000 0000 0000 0000 0000 0000 0000 0000	
	H	0 011 1111	0100 0000 0000 0000 0000 0000 0000 0000 0000 0000 0000 0000 0000 0000 0000 0000	
	D	0 010 0010 0010 00	00 0000 0000 0000 0000 0000 0000 0000 0000 0000 0000 0101 0111 0010 0101 [15625×10 ⁻⁶]	
+0	B	0 000 0000 0000	0000 0000 0000 0000 0000 0000 0000 0000 0000 0000 0000 0000 0000 0000 0000 0000	
	H	0 000 0000	0000 0000 0000 0000 0000 0000 0000 0000 0000 0000 0000 0000 0000 0000 0000 0000	
	D	0 010 0010 0011 10	00 0000 0000 0000 0000 0000 0000 0000 0000 0000 0000 0000 0000 0000 0000 [+0×10 ⁰]	
-0	B	1 000 0000 0000	0000 0000 0000 0000 0000 0000 0000 0000 0000 0000 0000 0000 0000 0000 0000 0000	
	H	1 000 0000	0000 0000 0000 0000 0000 0000 0000 0000 0000 0000 0000 0000 0000 0000 0000 0000	
	D	1 010 0010 0011 10	00 0000 0000 0000 0000 0000 0000 0000 0000 0000 0000 0000 0000 0000 0000 [-0×10 ⁰]	
-15.0	B	1 100 0000 0010	1110 0000 0000 0000 0000 0000 0000 0000 0000 0000 0000 0000 0000 0000 0000 0000	
	H	1 100 0001	1111 0000 0000 0000 0000 0000 0000 0000 0000 0000 0000 0000 0000 0000 0000 0000	
	D	1 010 0010 0011 01	00 0000 0000 0000 0000 0000 0000 0000 0000 0000 0000 0000 0000 1101 0000 [-150×10 ⁻¹]	
20/7	B	0 100 0000 0000	0110 1101 1011 0110 1101 1101 1011 0110 1101 1011 0110 1101 1011 0110 1101 0111	
	H	0 100 0001	0010 1101 1011 0110 1101 1011 0110 1101 1011 0110 1101 1011 0110 1101 0110 1101	
	D	0 010 1001 1111 11	11 0101 1101 0011 0000 1011 0101 1101 0011 0000 1011 0101 1101 0111 0101 [2857142857142857×10 ⁻¹⁵]	
2 ⁻¹⁰²²	B	0 000 0000 0001	0000 0000 0000 0000 0000 0000 0000 0000 0000 0000 0000 0000 0000 0000 0000 0000	
	H	Zero (number too small)		
	D	0 000 1001 0010 11	01 0010 0101 0001 1100 1110 0011 1110 1010 0001 1101 0000 0001 [2225073858507201×10 ⁻³²³]	
2 ⁻¹⁰⁷⁴	B	0 000 0000 0000	0000 0000 0000 0000 0000 0000 0000 0000 0000 0000 0000 0000 0000 0000 0000 0001	
	H	Zero (number too small)		
	D	0 001 0000 1110 11	00 1100 1100 1101 0101 1010 0101 1000 1000 0100 1010 0110 0101 [4940656458412465×10 ⁻³³⁹]	
2 ¹⁰²⁴ XF F=1-2 ⁻⁵³	B	0 111 1111 1110	1111 1111 1111 1111 1111 1111 1111 1111 1111 1111 1111 1111 1111 1111 1111 1111	
	H	Not representable		
	D	0 100 0110 1100 11	11 1111 1011 1100 1110 1100 1011 0100 0101 1011 0001 1001 0110 [1797693134862316×10 ⁺²⁹³]	
2 ⁻²⁶⁰	B	0 010 1111 1011	0000 0000 0000 0000 0000 0000 0000 0000 0000 0000 0000 0000 0000 0000 0000 0000	
	H	0 000 0000	0001 0000 0000 0000 0000 0000 0000 0000 0000 0000 0000 0000 0000 0000 0000 0000	
	D	0 011 0100 1100 00	01 1111 1011 1100 0001 0101 1100 0110 1010 1111 0000 0010 1000 [5397605346934×10 ⁻⁹⁴]	
2 ²⁴⁸ XF F=1-2 ⁻⁵⁶	B	0 100 1111 0111	0000 0000 0000 0000 0000 0000 0000 0000 0000 0000 0000 0000 0000 0000 0000 0000	
	H	0 111 1110	1111 1111 1111 1111 1111 1111 1111 1111 1111 1111 1111 1111 1111 1111 1111 1111	
	D	0 011 0011 0010 01	10 1010 0011 0010 1010 0010 0100 1011 0100 1111 0011 0110 0100 [4523128485832664×10 ⁺⁵⁹]	
Explanation:				
B	BFP.			
BE or C	Biased exponent of BFP number, combination field of DFP number, or characteristic of HFP number.			
D	DFP.			
H	HFP.			
S	Sign.			

Figure 9-3. Examples of Floating-Point Numbers in Long Format

Effective Width

The resolution of a floating-point format may be described in terms of the spacing between adjacent representable numbers in the format. This is called an ulp (unit in the last place). Thus, for example, when rounding to nearest, the maximum error is 1/2 ulp. The magnitude of an ulp is directly related to the precision of the format. Another way to measure the resolution of the format in the vicinity of a particular

value is in terms of relative spacing, which is simply the value of an ulp divided by the value of the number. Relative spacing may be converted to a form called effective width, which is very similar to precision. The *effective width* (W_x) for any particular normalized floating-point value, v , is defined as:

$$W_x(v) = \log_x(v/ulp)$$

Where:

- u Value of a unit in the last position (ulp).
- v Value of the number.
- W_x Effective width represented in base x.
- x Any arbitrary base.

When effective width is measured using the native base for a particular format, it differs from the precision (p) of the format as shown in the following relation:

$$p-1 \leq W_b \leq p$$

Where:

- b Native base of a particular format.
- p Precision of the format.
- W_b Effective width for any normalized value represented in the native base b of the format.

The following figure shows the maximum and minimum values of the effective width for normalized numbers for all supported floating-point formats.

Length	Radix	W_2		W_{10}	
		Max	Min	Max	Min
Short	HFP	24.00	20.00	7.22	6.02
	BFP	24.00	23.00	7.22	6.92
	DFP	23.25	19.93	7.00	6.00
Long	HFP	56.00	52.00	16.86	15.65
	BFP	53.00	52.00	15.95	15.65
	DFP	53.15	49.83	16.00	15.00
Extended	HFP	112.00	108.00	33.72	32.51
	BFP	113.00	112.00	34.02	33.72
	DFP	112.95	109.62	34.00	33.00

Explanation:

W_2 effective width represented in base 2.
 W_{10} effective width represented in base 10.

Figure 9-4. Maximum and Minimum Effective Width

Programming Note: The following example using a 3-digit decimal significand, may be helpful in understanding the concept of effective width and the maximum and minimum values. Consider the three adjacent representable numbers, Va, Vb, and Vc, as shown in the following figure:

Symbol or Formula	Value
Va	9.99
Vb	10.0
Vc	10.1
Vb-Va	0.01
Vc-Vb	0.1

The distance between points Va and Vb (Vb-Va) represents a resolution of one part in a thousand; whereas, the distance between points Vb and Vc (Vc-Vb) represents a resolution of one part in a hundred. In the first case, the effective width is three digits; in the second case, it is only two digits. For other values in the format, the effective width lies between these two extremes.

Floating-Point Data in Storage

All floating-point data formats appear in storage in the same left-to-right sequence as all other data formats. Bits of a data format that are numbered 0-7 constitute the byte in the leftmost (lowest-numbered) byte location in storage, bits 8-15 form the byte in the next sequential location, and so on. (See also the section "Storage Addressing" on page 3-2.)

Most of the floating-point instructions are defined in detail in this publication in Chapter 18, "Hexadecimal-Floating-Point Instructions," Chapter 19, "Binary-Floating-Point Instructions," and Chapter 20, "Decimal-Floating-Point Instructions." This chapter, Chapter 9, defines in detail instructions called floating-point-support (FPS) instructions. The FPS instructions either have operands that may be in any floating-point format or have the function of converting between formats. This chapter also provides summary information about all of the floating-point instructions.

Registers And Controls

Floating-Point Registers

All floating-point instructions (FPS, BFP, DFP, and HFP) use the same 16 floating-point registers. The floating-point registers are identified by the numbers 0-15 and are designated by a four-bit R field in float-

ing-point instructions. Each floating-point register is 64 bits long and can contain either a short (32-bit) or a long (64-bit) floating-point operand.

A short floating-point datum requires only the left-most 32 bit positions of a floating-point register. The rightmost 32 bit positions of the register are ignored when the register is the source of an operand in the short format, and they remain unchanged when a short result is placed in the register.

A datum in the extended (128-bit) format occupies a register pair. Register pairs are formed by coupling the 16 registers as follows: 0 and 2, 4 and 6, 8 and 10, 12 and 14, 1 and 3, 5 and 7, 9 and 11, and 13 and 15.

Each of the eight pairs is referred to by the number of the lower-numbered register of the pair.

Additional Floating-Point (AFP) Registers

Floating-point registers 0, 2, 4, and 6 are ones that were originally available on ESA/390 models. The remaining 12 floating-point registers (1, 3, 5, and 7-15) were added to ESA/390 and are referred to as the additional floating-point (AFP) registers. The AFP registers can be used only if bit 45 of control register 0, the AFP-register-control bit, is one. Attempting to use an AFP register when the AFP-register-control bit is zero results in an AFP-register data exception (DXC 1).

Valid Floating-Point-Register Designations

Any installed register may be designated by an instruction to specify the register location of a short or long floating-point operand.

An instruction specifying a floating-point operand in the extended format must designate register 0, 1, 4, 5, 8, 9, 12, or 13; otherwise, a specification exception is recognized.

Floating-Point-Control (FPC) Register

The floating-point-control (FPC) register is a 32-bit register that contains mask bits, flag bits, a data-exception code, and two rounding-mode fields. An overview of the FPC register is shown in Figure 9-5.

Details are shown in Figure 9-6 and in Figure 9-8. (In Figure 9-6, the abbreviations “IM” and “SF” are based on the terms “interruption mask” and “status flag,” respectively.)

The bits of the FPC register are often referred to as, for example, FPC 1.0, meaning bit 0 of byte 1 of the register.

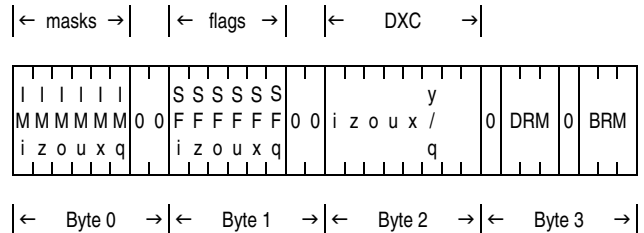

Figure 9-5. FPC Register Overview

Byte	Bit(s)	Name	Abbr.
0	0	IEEE-invalid-operation mask	IMi
0	1	IEEE-division-by-zero mask	IMz
0	2	IEEE-overflow mask	IMo
0	3	IEEE-underflow mask	IMu
0	4	IEEE-inexact mask	IMx
0	5	Quantum-exception mask	IMq
0	6-7	(Unassigned)	0
1	0	IEEE-invalid-operation flag	SFi
1	1	IEEE-division-by-zero flag	SFz
1	2	IEEE-overflow flag	SFo
1	3	IEEE-underflow flag	SFu
1	4	IEEE-inexact flag	SFx
1	5	Quantum-exception flag	SFq
1	6-7	(Unassigned)	0
2	0-7	Data-exception code	DXC
3	0	(Unassigned)	0
3	1-3	DFP rounding mode	DRM
3	4	(Unassigned)	0
3	5-7	BFP rounding mode	BRM

Figure 9-6. FPC-Register Bit Assignments

FPC Byte 3 Bits 1-3	Rounding Method
000	Round to nearest with ties to even
001	Round toward 0
010	Round toward $+\infty$
011	Round toward $-\infty$
100	Round to nearest with ties away from 0
101	Round to nearest with ties toward 0
110	Round away from 0
111	Round to prepare for shorter precision

Figure 9-7. DFP Rounding Mode

FPC Byte 3		Rounding Method
Bits 6-7 ¹	Bits 5-7 ²	
00	000	Round to nearest with ties to even
01	001	Round toward 0
10	010	Round toward $+\infty$
11	011	Round toward $-\infty$
—	100	Reserved / Invalid
—	101	Reserved / Invalid
—	110	Reserved / Invalid
—	111	Round to prepare for shorter precision
Explanation:		
1	Used when the floating-point extension facility is not installed.	
2	Used when the floating-point extension facility is installed. However, bits 5-7 may be used by the other architecture mode of the configuration. (See the section, "Impacts on ESA/390 and ESA/390-Compatibility Mode", for details.)	
—	Does not apply	

Figure 9-8. BFP Rounding Mode

IEEE Masks and Flags

When the floating-point extension facility is installed, the FPC register contains six IEEE mask bits and six IEEE flag bits that each correspond to one of the six IEEE exceptions that may be recognized when an IEEE computational instruction is executed. When the floating-point extension facility is not installed, the quantum exception is not recognized; the mask bit FPC 0.5 and the status flag bit FPC 1.5 corresponding to the quantum exception are unsupported and are zeros.

The mask bits, when one, in the FPC register cause an interruption to occur if an exception is recognized. If the mask bit for an exception is zero, the recognition of the exception causes the corresponding flag

bit to be set to one. Thus, a flag bit indicates whether the corresponding exception has been recognized at least once since the program last set the flag bit to zero. Except for PFPO, the mask bits are ignored, and the flag bits remain unchanged, when exceptions are recognized for floating-point-support (FPS) and HFP instructions.

The IEEE flag bits in the FPC register are set to zero only by explicit program action, initial CPU reset, clear reset, or power-on reset.

Note: The quantum exception is not part of the IEEE Standard 754-2008 (see Reference [20.] on page xxx). However, since this data exception with its mask and status flag in the FPC is handled very much like the five IEEE exceptions, this architecture lists the quantum exception among the IEEE exceptions.

FPC DXC Byte

Byte 2 of the FPC register contains the data-exception code (DXC), which is an eight-bit code indicating the specific cause of a data exception. When the AFP-register-control bit, bit 45 of control register 0, is one and a program interruption causes the DXC to be placed at real location 147, the DXC is also placed in the DXC field of the FPC register. The DXC field in the FPC register remains unchanged when the AFP-register-control bit is zero or when any other program exception is reported. The DXC is described in "Data-Exception Code (DXC)" on page 6-17.

The DXC is a code, meaning it should be treated as an integer rather than as individual bits. However, when bits 6 and 7 are zero, bits 0-5 are bit significant; bits 0-4 (i, z, o, u, and x) are trap flags and correspond to the same bits in bytes 0 and 1 of the FPC register (IEEE masks and IEEE flags), and bit 5 (y) is used in conjunction with bit 4, inexact (x), to indicate that the result has been incremented in magnitude. When the floating-point extension facility is installed, DXC bit 5 (q) is also the quantum-exception trap flag. The trap flag for an exception, instead of the IEEE flag, is set to one when an interruption for the exception is enabled by the corresponding IEEE mask bit.

Operations on the FPC Register

The following unprivileged instructions allow problem-state programs to operate on the FPC register:

```
EXTRACT FPC (DXC 2)
LOAD FPC (DXC 2)
```

LOAD FPC AND SIGNAL (DXC 3)
SET BFP ROUNDING MODE (DXC 2)
SET DFP ROUNDING MODE (DXC 3)
SET FPC (DXC 2)
SET FPC AND SIGNAL (DXC 3)
STORE FPC (DXC 2)

These instructions are subject to the AFP-register-control bit, bit 45 of control register 0. An attempt to execute any of the above instructions when the AFP-register-control bit is zero results in a data exception. The term (DXC 2) or (DXC 3) after the name indicates the type of exception: that is, BFP-instruction data exception, (DXC 2), or DFP-instruction data exception, (DXC 3), respectively.

Programming Note: The use of DXC 2 and DXC 3 for these floating-point-support (FPS) instructions is rather arbitrary, but assuming a valid operating system, these exceptions are never reported to the user, as the operating system will set bit 45 of control register 0 to one and re-issue the instruction.

AFP-Register-Control Bit

Bit 45 of control register 0 is the AFP-register-control bit. The AFP registers, the BFP instructions, the DFP instructions, and PFPO can be used successfully only when the AFP-register-control bit is one. Attempting to use one of the 12 additional floating-point registers or executing PFPO when the AFP-register-control bit is zero results in an AFP-register data exception (DXC 1). Attempting to execute any BFP instruction when the AFP-register-control bit is zero results in a BFP-instruction data exception (DXC 2). Attempting to execute any DFP instruction when the AFP-register-control bit is zero results in a DFP-instruction data exception (DXC 3).

DXC 2 and 3 are mutually exclusive and are of higher priority than any other DXC. Thus, for example, DXC 2 (BFP instruction) takes precedence over any IEEE exception; and DXC 3 (DFP instruction) takes precedence over any IEEE exception. As another example, if the conditions for both DXC 3 (DFP instruction) and DXC 1 (AFP register) exist, DXC 3 is reported.

If the conditions for both a data exception and a specification exception exist, it is unpredictable which exception is reported.

The initial value of the AFP-register-control bit is zero.

IEEE Computational Operations

Notes:

1. The following section primarily discusses the BFP and DFP formats, however the topics on rounding also discuss the HFP format, as indicated in the text.
2. The description of binary-floating-point operations in this document is based on the original *IEEE Standard for Binary Floating-Point Arithmetic* (IEEE Std. 754-1985). The current *IEEE Standard for Floating-Point Arithmetic* (see Reference [20.] on page xxx), which encompasses both binary and decimal floating point operations, made various terminology changes from the original standard, as follows:

- The term *subnormal* replaces the term *denormalized*.
- The term *exception* functionally replaces the former term *trap*. The term *default handling* (or *default non-stop execution handling*) correspond to the former *nontrap* action. and the term *alternate exception handling* encompasses the former *trap* action, as well as other actions.
- The term *loss* (as in *loss of accuracy* or *denormalization loss*) is no longer used.

Because of their pervasive use in the original description of binary floating point, the terms *denormalized*, *trap*, and *nontrap* still appear in this document. It is understood that they refer to the equivalent newer terms. A program-exception condition represents the only IEEE-defined alternate exception handling.

Instructions which operate on BFP or DFP source operands or produce BFP or DFP results and recognize IEEE exceptions are called IEEE computational operations, and the associated operands and results are sometimes referred to as IEEE operands and IEEE results, respectively.

Execution of IEEE computational operations normally follows a certain pattern. Source operands are first tested for special cases and then processed to form a result. The priority for testing of special cases is SNaN, QNaN, infinity, and then finite number.

If a source operand is an SNaN, an IEEE-invalid-operation exception is recognized; and, in the non-trap case, the result is set to the corresponding QNaN.

In the absence of a source SNaN, if a source operand is a QNaN the result is set to that QNaN.

Handling of the case when more than one source operand is a NaN is covered in the individual instruction descriptions.

In the absence of a NaN, if an operand is an infinity, special “infinity arithmetic” rules are followed to produce the result.

Programming Note: PERFORM FLOATING-POINT OPERATION is an IEEE computational operation.

Intermediate Values

In the normal case (when all source operands are finite numbers), first, a *precise intermediate value* is produced, then a *rounded intermediate value*. In the absence of trapped overflow and trapped underflow, the rounded intermediate value is used as the *delivered value*. For trapped overflow and trapped underflow, the rounded intermediate value is divided by a *scale factor* to produce a *scaled value*, which is used as the delivered value. Finally, the delivered value is placed in the target location. For DFP, since the cohort for the delivered value may have multiple members, one member from the cohort must be selected. Selection is performed by choosing the member having a quantum closest to the *preferred quantum* (or for trapped overflow and trapped underflow, a *scaled preferred quantum*).

Precise Intermediate Value

Every IEEE computational operation producing a numeric result computes a value called the *precise intermediate value*. This is the value that would have been computed were both the precision and exponent range unbounded.

Precision-Rounded Value

Except when otherwise specified, the precise intermediate value is rounded to the precision of the target format, but with unbounded exponent range. This process is called *target-precision-constrained rounding*, and the value selected by this type of rounding is called the *precision-rounded value*.

Denormalized Value

For IEEE targets, when the IEEE-underflow trap is disabled and the tininess condition exists, the precise intermediate value is rounded to fit in the destination format (that is, with both precision and exponent range of the target format). This process is called *denormalization rounding* and the value selected by this type of rounding is called the *denormalized value*.

Functionally-Rounded Value

The instructions CONVERT TO FIXED, LOAD FP INTEGER, QUANTIZE, and REROUND, as an integral part of the function, take a source operand and modify it to fit in a subset of the destination format. This process is called *functionally-constrained rounding* and the value selected by this type of rounding is called the *functionally-rounded value*.

Rounded Intermediate Value

In any particular instance, only one of the three rounding processes is performed and the value selected (precision-rounded value, denormalized value, or functionally-rounded value) is generically referred to as the *rounded intermediate value*.

Scaled Value

For both overflow and underflow when the associated trap is enabled, the precision-rounded value is scaled to bring it into the representable exponent range of the target. This is called the *scaled value* and is derived as explained in the next section.

Scale Factor (Ψ)

IEEE-overflow trap action and IEEE-underflow trap action produce a *scaled value* using a *scale factor*. The scaled value (z) is computed from the precision-rounded value (g) using the scale factor (Ψ) as follows:

$$z = g \div \Psi$$

Unsigned Scaling Exponent (α)

For BFP and DFP instructions, the scale factor (Ψ) is computed using the unsigned scaling exponent (α) and different formulas are used for overflow and underflow.

For overflow:

$$\Psi = b^{+\alpha}$$

For underflow:

$$\Psi = b^{-\alpha}$$

where b is the radix of the target (2 for BFP and 10 for DFP). The unsigned scaling exponent (α) depends on the type of operation and operand format.

For all BFP operations except LOAD ROUNDED, α depends on the target format and is 192 for short, 1536 for long, and 24576 for extended. For BFP LOAD ROUNDED, α depends on the source format, and is 512 for long and 8192 for extended.

For all DFP operations except LOAD ROUNDED, α depends on the target format and is 576 for long and 9216 for extended. For DFP LOAD ROUNDED, α depends on the source format, and is 192 for long and 3072 for extended.

Signed Scaling Exponent (Ω)

For PFPO convert floating-point radix, the scale factor (Ψ) is computed using the signed scaling exponent (Ω) and the formula for the scale factor (Ψ) is the same for overflow and underflow:

$$\Psi = b^{\Omega}$$

Where b is the radix (2, 10, and 16) for BFP, DFP and HFP, respectively. Thus, for overflow, the signed scaling exponent (Ω) is a positive value, and for underflow it is a negative value.

IEEE Rounding

Rounding takes an input value, and, using the effective rounding method, selects a value from a permissible set. The input value, considered to be infinitely-precise, may be an operand of an instruction or the numeric output from an arithmetic operation. The effective rounding method may be the current rounding method specified in the BFP-rounding-mode or DFP-rounding-mode field of the FPC register; or, for some instructions, an explicit rounding method is specified by a modifier field. For the PFPO-convert-floating-point-radix operation, rounding is specified by a field in an implicit register.

For target-precision-constrained rounding and denormalization rounding, the input is the precise intermediate value. For functionally-constrained rounding, the input is a source operand.

Permissible Set

Rounding selects a value from the permissible set. A permissible set is a set of values, and not representations; thus, for DFP, the selection of a member from the cohort is considered to be performed after rounding. A permissible set differs from the values representable in a particular format in the following ways:

1. A permissible set does not include infinity. Infinity is handled as a special case.
2. For target-precision-constrained rounding, the permissible set is considered to have an unbounded exponent range.
3. For denormalization rounding, the permissible set is limited to the values representable in a particular format.
4. For LOAD FP INTEGER, the permissible set contains only integral values.
5. For QUANTIZE, the permissible set is similar to LOAD FP INTEGER, containing only those values which are integral multiples of the requested quantum.
6. For REROUND, the permissible set contains only those values which can be represented within the requested precision.

Selection of Candidates

If a member of the permissible set is equal in value to the input value, then that member is selected; otherwise, two adjacent candidates with the same sign as the input value are chosen from the permissible set. One candidate, called TZ (toward zero), is the member of the permissible set nearest to and smaller in magnitude than the input value; the other candidate, called AZ (away from zero), is the member of the permissible set nearest to and larger in magnitude than the input value. Which of the two candidates is selected depends on the rounding method.

Ties

Three rounding methods depend on a condition called a “tie.” This condition exists when the two candidates are equidistant from the input value.

Voting Digit and Common-Rounding-Point View

Two rounding methods depend on the value of the voting digit of each candidate. (Each “digit” is an integral value from zero to one less than the radix. Thus,

a BFP digit is one bit, an HFP digit is four bits, and a DFP digit is a value from zero to nine.) The voting digit is the units digit of the significand when considered in the common-rounding-point view.

Without changing the value of a floating-point number, the significand may be viewed with the implied radix point in different positions, provided a corresponding adjustment is made to the exponent. In the common-rounding-point view, an implied radix point (called the common rounding point) and an associated exponent are selected for the input value and the two candidates, TZ and AZ. The common-rounding point is selected to satisfy the following requirements:

1. The input value and the two candidates all have the same exponent.
2. The significand of TZ is equal to the significand of the input value truncated at the rounding point.
3. The significand of AZ is one greater in magnitude than the significand of TZ.

Rounding Methods

Figure 9-8 and Figure 9-7 on page 9-10 show the implicit rounding methods available for BFP and DFP operations respectively. The section “Explicit Rounding Methods” on page 9-17 describes rounding methods that may be explicitly specified in an instruction, overriding the implicit rounding method. The rounding methods are as follows:

Round to nearest with ties to even: The candidate nearest to the input value is selected. In case of a tie, the candidate selected is the one whose voting digit has an even value.

Round toward 0: The candidate that is smaller in magnitude is selected.

Round toward $+\infty$: The candidate that is algebraically greater is selected.

Round toward $-\infty$: The candidate that is algebraically less is selected.

Round to nearest with ties away from 0: The candidate nearest to the input value is selected. In case of a tie, the candidate selected is the one that is larger in magnitude.

Round to nearest with ties toward 0: The candidate nearest to the input value is selected. In case of a tie, the candidate selected is the one that is smaller in magnitude.

Round away from 0: The candidate that is greater in magnitude is selected.

Round to prepare for shorter precision: For a BFP or HFP permissible set, the candidate selected is the one whose voting digit has an odd value. For a DFP permissible set, the candidate that is smaller in magnitude is selected, unless its voting digit has a value of either 0 or 5; in that case, the candidate that is greater in magnitude is selected.

Programming Notes:

1. The two candidates are defined as: “nearest to and smaller” and “nearest to and larger”. Note that the simpler definition, “the two closest values,” is incorrect, as it is possible that the two closest values to the input value can be on the same side (toward zero). To illustrate this, Figure 9-9 on page 9-15 gives an example of rounding the integer value 10,000,003 to DFP short. Several members in the permissible set near this value are shown in three views: left-units view, right-units view, and integer view. The fourth column shows the distance of each member from the input value. In this example, the four closest members are all smaller in magnitude than the input value. Although the example is shown using DFP, corresponding examples can be shown for both BFP and HFP. In the extreme case, the number of members in the permissible set which are closer than candidate AZ, is 2, 10, and 16, for BFP, DFP, and HFP, respectively.
2. Except for rounding methods using the voting digit, rounding can normally be considered to be performed using values independent of the representation and the view. Figure 9-10 on page 9-16 is an example, using the instruction LOAD FP INTEGER, to illustrate the concepts of different representations, views, rounding point, common-rounding-point view, and voting digit. In the example, the input value (source operand) is 29.5 and the two candidates are 29 and 30. The figure shows all three of these values using the left-units, right-units, and common-rounding-point views in both decimal and binary representations. Note that as shown in the left-units and right-units view columns, the rightmost digit is

odd for both TZ and AZ. (But as represented in all BFP formats, these values would have an even rightmost digit; and as represented in DFP formats, these values could have an even or odd rightmost digit, depending on the quantum.) The voting digit can be identified in the common-rounding-point view as the digit to the immediate left of the rounding point. In both the decimal and binary representations, candidate TZ has an odd voting digit and candidate AZ has an even voting digit.

LOAD FP INTEGER produces consistent results between decimal and binary for five of the six rounding methods currently supported by the BFP instruction; for the round-to-prepare-for-shorter-precision rounding method, this is not always the case. Figure 9-11 on page 9-16 shows results of LOAD FP INTEGER for several input values for all eight rounding methods. Only in the round-to-prepare-for-shorter-precision method are the results different for decimal and binary.

3. An example of LOAD ROUNDED (long to short DFP) is shown in Figure 9-12 on page 9-16. In this example, the integer 99,999,995 is rounded from DFP long to DFP short. The cohort for candidate TZ in this case, has only one member and is odd. The cohort of candidate AZ has seven members, one of which is odd and the other six are even. The common-rounding-point view makes it clear that in this case, candidate AZ should be considered to be even.
4. The rightmost digit and the voting digit of a candidate are not necessarily the same digit. Figure 9-13 on page 9-16 and Figure 9-14 on page 9-17 give two examples using the instruction REROUND (long DFP). In both examples, the requested significance is one (Result Digits=1). The input value is 95 in the first example and 150 in the second example. Note that candidate AZ in the first example is the same value as candidate TZ in the second example. In the first example, this member is considered to be even, and in the second example it is considered to be odd.

Value in Permissible Set			Distance from 10000003	Notes
Left-Units View	Right-Units View	Integer View		
9.999996×10^6	9999996×10^0	9999996	-7	
9.999997×10^6	9999997×10^0	9999997	-6	*
9.999998×10^6	9999998×10^0	9999998	-5	*
9.999999×10^6	9999999×10^0	9999999	-4	*
1.000000×10^7	1000000×10^1	10000000	-3	TZ
1.000001×10^7	1000001×10^1	10000010	+7	AZ
1.000002×10^7	1000002×10^1	10000020	+17	
Explanation:				
*	Closer than AZ.			
AZ	Selected as candidate AZ (away from zero).			
TZ	Selected as candidate TZ (toward zero).			

Figure 9-9. Choosing Candidates (short DFP)

Participant	Decimal			Binary ¹		
	Left-Units View	Right-Units View	Common-Rounding-Point View	Left-Units View	Right-Units View	Common-Rounding-Point View
Input Value	2.95×10^1	295×10^{-1}	29.5×10^0	1.11011×2^4	111011×2^{-1}	11101.1×2^0
Candidate TZ	2.9×10^1	29×10^0	29.0×10^0	1.1101×2^4	11101×2^0	11101.0×2^0
Candidate AZ	3.0×10^1	3×10^1	30.0×10^0	1.111×2^4	1111×2^1	11110.0×2^0

Explanation:

¹ Significand is shown in binary, exponent in decimal.

Figure 9-10. LOAD FP INTEGER - Decimal and Binary

Input Value	Result When Effective Rounding Method Is								
	RNTE	RZ	RP	RM	RNTA	RNTZ	RA	RFS	
								Dec	Bin
-9.5	-10	-9	-9	-10	-10	-9	-10	-9	-9
-5.5	-6	-5	-5	-6	-6	-5	-6	-6	-5
-2.5	-2	-2	-2	-3	-3	-2	-3	-2	-3
-1.5	-2	-1	-1	-2	-2	-1	-2	-1	-1
-0.5	-0	-0	-0	-1	-1	-0	-1	-1	-1
+0.5	+0	+0	+1	+0	+1	+0	+1	+1	+1
+1.5	+2	+1	+2	+1	+2	+1	+2	+1	+1
+2.5	+2	+2	+3	+2	+3	+2	+3	+2	+3
+5.5	+6	+5	+6	+5	+6	+5	+6	+6	+5
+9.5	+10	+9	+10	+9	+10	+9	+10	+9	+9

Explanation:

RNTE Round to nearest with ties to even
RZ Round toward 0
RP Round toward $+\infty$
RM Round toward $-\infty$
RNTA Round to nearest with ties away from 0
RNTZ Round to nearest with ties toward 0
RA Round away from 0
RFS Round to prepare for shorter precision

Figure 9-11. LOAD FP INTEGER Examples for All Rounding Methods

Participant	Left-Units View	Right-Units View	Common-Rounding-Point View
Input Value	9.9999995×10^7	99999995×10^0	9999999.5×10^1
Candidate TZ	9.999999×10^7	9999999×10^0	9999999.0×10^1
Candidate AZ	1.0×10^8	1×10^8	10000000.0×10^1

Figure 9-12. LOAD ROUNDED (long to short DFP)

Participant	Left-Units View	Right-Units View	Common-Rounding-Point View
Input Value	9.5×10^1	95×10^0	9.5×10^1
Candidate TZ	9.0×10^1	9×10^1	9.0×10^1
Candidate AZ	1.0×10^2	1×10^2	10.0×10^1

Figure 9-13. REROUND (long DFP), Result Digits=1, Input Value=95

Participant	Left-Units View	Right-Units View	Common-Rounding-Point View
Input Value	1.5×10^2	15×10^1	1.5×10^2
Candidate TZ	1.0×10^2	1×10^2	1.0×10^2
Candidate AZ	2.0×10^2	2×10^2	2.0×10^2

Figure 9-14. REROUND (long DFP), Result Digits=1, Input Value=150

Explicit Rounding Methods

The floating-point-support instruction CONVERT HFP TO BFP includes an M_3 modifier field which can specify any of six rounding methods. One HFP instruction (CONVERT TO FIXED); three BFP instructions (CONVERT TO FIXED, DIVIDE TO INTEGER, and LOAD FP INTEGER); and five DFP instructions (CONVERT TO FIXED, LOAD FP INTEGER, LOAD ROUNDED, QUANTIZE, and REROUND) also include either an M_3 modifier field or a similar M_4 modifier field. When the floating-point extension facility is installed, four more BFP instructions (CONVERT FROM FIXED, CONVERT FROM LOGICAL, CONVERT TO LOGICAL, and LOAD ROUNDED) and seven more DFP instructions (ADD, CONVERT FROM FIXED, CONVERT FROM LOGICAL, CONVERT TO LOGICAL, DIVIDE, MULTIPLY, and SUBTRACT) also include an M_3 or M_4 modifier field.

The handling of an M_3 or M_4 value of zero depends on the type of instruction. For BFP instructions, an M_3 or M_4 value of zero causes rounding to be performed according to the current BFP rounding mode specified in the FPC register. For DFP instructions, an M_3 or M_4 value of zero causes rounding to be performed according to the current DFP rounding mode specified in the FPC register. The floating-point-support instruction CONVERT HFP TO BFP and the HFP instruction CONVERT TO FIXED treat an M_3 value of zero the same as five; that is, round toward zero.

For PERFORM FLOATING POINT OPERATION (PFPO), any of the rounding methods described in this section may be explicitly specified, or the program may specify the current BFP or DFP rounding method (in the floating-point-control register). The program-specified rounding method is used by PFPO regardless of whether the target-operand format is BFP, DFP or HFP.

Summary of Rounding Action

Figure 9-15 on page 9-17 summarizes the rounding action for floating-point-support (FPS), BFP, DFP, and HFP instructions.

Instruction	Rounding Action For			
	FPS Inst.	HFP Inst.	BFP Inst.	DFP Inst.
ADD	—	—	CBRM	MDD
ADD NORMALIZED	—	GD	—	—
ADD UNNORMALIZED	—	GD	—	—
CONVERT BFP TO HFP	E	—	—	—
CONVERT FROM FIXED	—	RTZ	MBB	MDD
CONVERT FROM LOGICAL	—	—	MA	MD
CONVERT HFP TO BFP	MC	—	—	—
CONVERT TO FIXED	—	M	MB	MD
CONVERT TO LOGICAL	—	—	MA	MD
DIVIDE	—	RTZ	CBRM	MDD
DIVIDE TO INTEGER	—	—	MB	—
HALVE	—	RTZ	—	—
LOAD FP INTEGER	—	RTZ	MB	MD
LOAD ROUNDED	—	RNTA	MBB	MD
MULTIPLY	—	RTZ	CBRM	MDD
MULTIPLY AND ADD	—	RTZ	CBRM	—
MULTIPLY AND ADD UNNORMALIZED	—	RTZ	—	—
MULTIPLY AND SUBTRACT	—	RTZ	CBRM	—
MULTIPLY UNNORMALIZED	—	RTZ	—	—
PERFORM FLOATING-POINT OPERATION	MBD	—	—	—
QUANTIZE	—	—	—	MD
REROUND	—	—	—	MD
SQUARE ROOT	—	RNTA	CBRM	—
SUBTRACT	—	—	CBRM	MDD
SUBTRACT NORMALIZED	—	GD	—	—
SUBTRACT UNNORMALIZED	—	GD	—	—
Explanation:				
CBRM	Rounded according to current BFP rounding mode.			
E	Result is exact, no rounding is required.			
GD	Round using a guard digit; see the instruction definition. This is almost, but not quite, round toward 0.			
M	Rounding is specified by a modifier field in the instruction. Five rounding methods are supported.			

Figure 9-15. Comparison of Rounding Action (Part 1 of 2)

	Instruction	Rounding Action For			
		FPS Inst.	HFP Inst.	BFP Inst.	DFP Inst.
MA	Rounding is specified by a modifier field in the instruction. Six rounding methods are supported; current BFP rounding mode can also be specified.				
MB	Rounding is specified by a modifier field in the instruction. When the floating-point extension facility is not installed, five rounding methods are supported; when the floating-point extension facility is installed, six rounding modes are supported; current BFP rounding mode can also be specified.				
MBB	When the floating-point extension facility is not installed, rounding is specified by the current BFP rounding mode; four rounding modes are supported. When the floating-point extension facility is installed, rounding is specified by a modifier field in the instruction; six rounding modes are supported; current BFP rounding mode can also be specified.				
MBD	Rounding is specified by a field in general register 0. Eight rounding methods are supported; current BFP rounding mode and current DFP rounding mode can also be specified.				
MC	Rounding is specified by a modifier field in the instruction. When the floating-point extension facility is not installed, five rounding methods are supported; when the floating-point extension facility is installed, six rounding modes are supported; current BFP rounding mode cannot be specified.				
MD	Rounding is specified by a modifier field in the instruction. Eight rounding methods are supported; current DFP rounding mode can also be specified.				
MDD	When the floating-point extension facility is not installed, rounding is specified by the current DFP rounding mode. When the floating-point extension facility is installed, rounding is specified by a modifier field in the instruction; eight rounding modes are supported; current DFP rounding mode can also be specified.				
RNTA	Round to nearest with ties away from 0.				
RTZ	Round toward 0.				

Figure 9-15. Comparison of Rounding Action (Part 2 of 2)

IEEE Exceptions

This section defines handling of IEEE exceptions for most IEEE computational operations. For some instructions the action may differ from the general rules; including, for example, a special controls to suppress recognition of certain IEEE exceptions. These differences are described in the individual instruction descriptions.

The action taken for each IEEE exception is controlled by a mask bit in the FPC register. When an IEEE exception is recognized, one of two actions is taken:

- If the corresponding mask bit in the FPC register is zero, a default action, called IEEE nontrap action, is taken, as specified for each condition, and the corresponding flag bit in the FPC register is set to one. Program execution then continues normally.
- If the corresponding mask bit in the FPC register is one, an action, called IEEE trap action, is taken for that exception, a program interruption for a data exception occurs, and the operation is suppressed or completed, depending on the exception, and the data-exception code (DXC) assigned for that exception is provided. For PFPO, a control bit in GR0 can select alternate exception handling, where overflow or underflow can be reflected by completion with a distinguished condition code, avoiding the interruption.

Concurrent IEEE Exceptions

IEEE-overflow or IEEE-underflow exception, IEEE-inexact exception, and quantum exception can coincide concurrently.

When the action for IEEE overflow (or underflow) is a nontrap action, the IEEE-overflow (or IEEE-underflow) flag bit in the FPC register is set to one and then the action for IEEE inexact (which could be a nontrap or trap action) occurs.

When the action for IEEE overflow (or underflow) is a trap action, the inexact exception is not recognized and not reported directly; instead, the DXC is set to indicate whether the result is exact, inexact and truncated, or inexact and incremented.

When the action for all concurrent IEEE exceptions, except the quantum exception, is a nontrap action, the flag bits in the FPC register corresponding to these nontrap concurrent exceptions are set to one, and then the action for the quantum exception (which could be a nontrap or trap action) occurs.

When the action for any concurrent IEEE exception, except the quantum exception, is a trap action, the quantum exception is not recognized, not reported directly, and not indicated in the DXC.

IEEE Invalid Operation

An IEEE-invalid-operation exception is recognized when, in the execution of an IEEE computational operation, any of the following occurs:

1. An SNaN is encountered in an IEEE computational operation.
2. A QNaN is encountered in an unordered-signaling comparison (COMPARE AND SIGNAL with a QNaN operand).
3. An IEEE difference is undefined (addition of infinities of opposite sign, or subtraction of infinities of like sign).
4. An IEEE product is undefined (zero times infinity).
5. An IEEE quotient is undefined (DIVIDE instruction with both operands zero or both operands infinity).
6. A BFP remainder is undefined (DIVIDE TO INTEGER with a dividend of infinity or a divisor of zero).
7. A BFP square root is undefined (negative non-zero operand).
8. Any other IEEE computational operation whose result is either undefined or not representable in the target format.

Even though an invalid-operation condition exists, the exception is not recognized if recognition of the exception is suppressed by means of an IEEE-invalid-operation-exception control (XiC).

IEEE-Invalid-Operation Nontrap Action: IEEE-invalid-operation nontrap action occurs when the IEEE-invalid-operation exception is recognized and the IEEE-invalid-operation mask bit in the FPC register is zero. The operation is completed and the IEEE-invalid-operation flag bit in the FPC register is set to one. The result of the operation depends on the type of operation and the operands.

If the instruction performs a comparison, the comparison result is *unordered*.

If the instruction is one that produces an IEEE result and none of the operands is a NaN, the result is the default QNaN.

If the instruction is one that produces an IEEE result and one of the operands is a NaN, that operand becomes the result unchanged, except that an SNaN is first converted to the corresponding QNaN and, for DFP, NaNs are canonicalized.

IEEE-Invalid-Operation Trap Action: IEEE-invalid-operation trap action occurs when the IEEE-invalid-operation exception is recognized and the IEEE-invalid-operation mask bit in the FPC register is one. The operation is suppressed, and the exception is reported as a program interruption for a data exception with DXC 80 hex.

IEEE Division-By-Zero

An IEEE-division-by-zero exception is recognized when in IEEE division the divisor is zero and the dividend is a nonzero finite number.

IEEE-Division-By-Zero Nontrap Action: IEEE-division-by-zero nontrap action occurs when the IEEE-division-by-zero exception is recognized and the IEEE-division-by-zero mask bit in the FPC register is zero. The operation is completed and the IEEE-division-by-zero flag bit in the FPC register is set to one. The result is set to an infinity with a sign that is the exclusive or of the dividend and divisor signs.

IEEE-Division-By-Zero Trap Action: IEEE-division-by-zero trap action occurs when the IEEE-division-by-zero exception is recognized and the IEEE-division-by-zero mask bit in the FPC register is one. The operation is suppressed, and the exception is reported as a program interruption for a data exception with DXC 40 hex.

IEEE Overflow

An IEEE-overflow exception is recognized for an IEEE target when the precision-rounded value of an IEEE computational operation is greater in magnitude than the largest finite number (Nmax) representable in the target format.

IEEE-Overflow Nontrap Action: IEEE-overflow nontrap action occurs when the IEEE-overflow exception is recognized and the IEEE-overflow mask bit in the FPC register is zero.

The operation is completed and the IEEE-overflow flag bit in the FPC register is set to one. The result of the operation depends on the sign of the precise intermediate value and on the effective rounding method:

1. For all round-to-nearest methods and round-away-from-0, the result is infinity with the sign of the precise intermediate value.
2. For round-toward-0 and round-to-prepare-for-shorter-precision, the result is the largest finite number of the format, with the sign of the precise intermediate value.
3. For round toward $+\infty$, the result is $+\infty$, if the sign is plus, or it is the negative finite number with the largest magnitude if the sign is minus.
4. For round toward $-\infty$, the result is the largest positive finite number if the sign is plus or $-\infty$, if the sign is minus.

IEEE-Overflow Trap Action: IEEE-overflow trap action occurs when the IEEE-overflow exception is recognized and the IEEE-overflow mask bit in the FPC register is one.

The operation is completed by setting the result to the scaled value and the exception is reported as a program interruption for a data exception with DXC 20, 28, or 2C hex, depending on whether the delivered value is exact, inexact and truncated, or inexact and incremented, respectively.

The result of the operation is derived from the precision-rounded value, the scale factor, and, for DFP, on the scaled preferred quantum. The value of the scale factor depends on the type of operation and operand format. The scaled preferred quantum for a particular operation is equal to the preferred quantum for that operation divided by the scale factor for that operation.

The delivered value is equal to the precision-rounded value divided by the scale factor. For DFP targets, the cohort member with the quantum nearest to the scaled preferred quantum is selected.

IEEE Underflow

An IEEE-underflow exception is recognized for an IEEE target when the tininess condition exists and either: (1) the IEEE-underflow mask bit in the FPC register is zero and the result value is inexact, or (2) the IEEE-underflow mask bit in the FPC register is one.

The tininess condition exists when the precise intermediate value of an IEEE computational operation is nonzero and smaller in magnitude than the smallest

normal number (Nmin) representable in the target format.

The result value is inexact if it is not equal to the precise intermediate value.

IEEE-Underflow Nontrap Action: IEEE-underflow nontrap action occurs when the IEEE-underflow exception is recognized and the IEEE-underflow mask bit in the FPC register is zero.

The operation is completed and the IEEE-underflow flag bit in the FPC register is set to one. The result is set to the denormalized value or Nmin. For DFP targets, the cohort member with the smallest quantum is selected.

IEEE-Underflow Trap Action: IEEE-underflow trap action occurs when the IEEE-underflow exception is recognized and the IEEE-underflow mask bit in the FPC register is one.

The operation is completed by setting the result to the scaled value and the exception is reported as a program interruption for a data exception with DXC 10, 18, or 1C hex, depending on whether the delivered value is exact, inexact and truncated, or inexact and incremented, respectively.

The result of the operation is derived from the precision-rounded value, the scale factor and, for DFP, on the scaled preferred quantum. The value of the scale factor depends on the type of operation and operand format. The scaled preferred quantum for a particular operation is equal to the preferred quantum for that operation divided by the scale factor for that operation.

The result is set to the precision-rounded value divided by the scale factor. For DFP targets, the cohort member with the quantum nearest to the scaled preferred quantum is selected.

IEEE Inexact

An IEEE-inexact exception is recognized when, for an IEEE computational operation, an inexact condition exists, recognition of the exception is not suppressed, and neither IEEE-overflow trap action nor IEEE-underflow trap action occurs.

In the absence of an IEEE-invalid-operation condition, an inexact condition exists when the rounded intermediate value differs from the precise intermedi-

ate value. The condition also exists when IEEE-overflow nontrap action occurs. When the inexact condition exists, the delivered value and the result are said to be inexact.

Even though an inexact condition exists, the IEEE-inexact exception is not recognized if recognition of the exception is suppressed by means of an IEEE-inexact-exception control (XxC) or if IEEE overflow or IEEE underflow trap action occurs. When an inexact condition exists and the conditions for an IEEE-overflow trap action or IEEE-underflow trap action also apply, the trap action takes precedence and the inexact condition is reported in the DXC.

IEEE-Inexact Nontrap Action: IEEE-inexact nontrap action occurs when the IEEE-inexact exception is recognized and the IEEE-inexact mask bit in the FPC register is zero.

In the absence of another IEEE nontrap action, the operation is completed using the rounded intermediate value and the IEEE-inexact flag bit in the FPC register is set to one. For DFP targets, except for QUANTIZE and REROUND, the cohort member with the smallest quantum is selected.

When an IEEE-inexact nontrap action and another IEEE nontrap action coincide, the operation is completed using the result specified for the other exception and the flag bits for both exceptions are set to one.

IEEE-Inexact Trap Action: IEEE-inexact trap action occurs when the IEEE-inexact exception is recognized and the IEEE-inexact mask bit in the FPC register is one. The operation is completed and the exception is reported as a program interruption for a data exception with DXC 08 or 0C hex, depending on whether the result is inexact and truncated or inexact and incremented, respectively.

In the absence of a coincident IEEE nontrap action, the delivered value is set to the rounded intermediate value. For DFP targets, the cohort member with the smallest quantum is selected.

When the IEEE-inexact trap action coincides with an IEEE nontrap action, the operation is completed using the result specified for the IEEE nontrap action, the flag bit for the nontrap exception is set to one, and the IEEE-inexact trap action takes place.

Quantum Exception

A quantum exception is recognized when floating-point extension facility is installed and when, for an IEEE computational operation, a quantum-exception condition exists, recognition of the exception is not suppressed, and none of IEEE-overflow trap action, IEEE-underflow trap action, and IEEE-inexact trap action occurs.

For computational operations except DIVIDE, LOAD FP INTEGER, PERFORM FLOATING-POINT OPERATION, QUANTIZE, and REROUND, a quantum-exception condition exists when the delivered DFP result is inexact, or when the delivered DFP result is exact and finite, but the delivered quantum is different from the preferred quantum.

For DIVIDE, a quantum-exception condition exists (1) when the delivered DFP result is inexact, or (2) when the dividend is a finite number and the divisor is an infinity, or (3) when the delivered DFP result is exact and is a finite number, the delivered quantum is the maximum quantum and is not the preferred quantum, and the rightmost significand digit is zero, or (4) when the delivered DFP result is exact and is a finite number, the delivered quantum is the minimum quantum and is greater than the preferred quantum. Note that the maximum quantum is the value of $1 \times 10^{Q_{max}}$ and the minimum quantum is the value of $1 \times 10^{Q_{min}}$, where Q_{max} and Q_{min} are the maximum and minimum right-units-view exponents, respectively.

For LOAD FP INTEGER, QUANTIZE, and REROUND, a quantum-exception condition exists when the delivered DFP result is a finite number, but the delivered quantum is different from the quantum of the source operand (the second operand for LOAD FP INTEGER, and the third operand for QUANTIZE and REROUND).

For PERFORM FLOATING-POINT OPERATION, a quantum-exception condition exists when the delivered quantum exceeds the preferred quantum of 1.

When floating-point extension facility is not installed, no quantum exception is recognized by executing any instruction.

Even though a quantum-exception condition exists, the exception is not recognized if recognition of the exception is suppressed or if IEEE-overflow, IEEE-underflow, or IEEE-inexact trap action occurs. When a quantum-exception condition exists and the conditions for an IEEE-overflow, IEEE-underflow, or IEEE-

inexact trap action also apply, the trap action takes precedence and the quantum-exception condition is not reported.

Quantum-Exception Nontrap Action: Quantum-exception nontrap action occurs when the quantum exception is recognized and the quantum-exception mask bit in the FPC register is zero.

In the absence of another IEEE nontrap action, the operation is completed using the rounded intermediate value and the quantum-exception flag bit in the FPC register is set to one. The delivered result, if it is a finite number, is the cohort member with the quantum closest to the preferred quantum.

When a quantum-exception nontrap action and other concurrent IEEE nontrap actions coincide, the operation is completed using the result specified for the other exceptions and the flag bits for all exceptions are set to one.

Quantum-Exception Trap Action: Quantum-exception trap action occurs when the quantum-exception is recognized and the quantum-exception mask bit in the FPC register is one. The operation is completed and the exception is reported as a program interruption for a data exception with DXC 04 hex.

In the absence of a coincident IEEE nontrap action, the delivered value is set to the rounded intermediate value, and the delivered result, if it is a finite number, is the cohort member with the quantum closest to the preferred quantum.

When the quantum-exception trap action coincides with other IEEE nontrap actions, the operation is completed using the result specified for the other IEEE nontrap actions, the flag bits for the other IEEE nontrap exceptions are set to one, and the quantum-exception trap action takes place.

Programming Notes:

1. IEEE traps are reported by means of a program interruption for a data exception with a data-exception code.¹ The use of data exception provides the application program with a convenient interface since this exception is one of the original 15 exceptions in the System/360 architecture

1. PFPO provides an option for trap action without the program interruption.

and is supported by most control programs that support the z/Architecture.

2. ANSI/IEEE Standard 754-2008 includes recommendations for the trap handler (see Reference [20.] on page xxx). When a system traps, the trap handler should be able to determine:
 - a. Which exception(s) were recognized on this operation.
 - b. The kind of operation that was being performed.
 - c. The destination's format.
 - d. For overflow, underflow, and inexact exceptions, the correctly rounded result, including information that might not fit in the destination's format.
 - e. For invalid-operation and divide-by-zero exceptions, the operand values.

Items a and d are supplied as part of the interruption action. Items b, c, and e can be obtained starting with the instruction address in the old PSW and from this finding the instruction (which indicates the operation and format) and then the operands.

3. The description of underflow is one of the most difficult parts of the standard to understand. This is because:
 - a. For tininess, ANSI/IEEE Standard 754-2008 provides two options for detection for BFP formats: "after rounding" or "before rounding". For DFP formats, tininess detection occurs before rounding.
 - b. Implementation of the trap is optional.
 - c. The conditions to signal underflow are different depending on whether or not the trap is taken.

Each of the above items is discussed below.

- a. Detection of tininess after or before rounding differs only for the case when "rounding" would increase the magnitude of the result to exactly $\pm N_{\min}$. It must be noted, however, that the action which ANSI/IEEE Standard 754-2008 here calls "rounding" is not the rounding to produce the delivered result but

rounding to compute an intermediate value having the precision of the result but “as though the exponent range were unbounded”. In fact, it is possible that the delivered result may not be tiny even though the intermediate value “after rounding” is tiny.

The option selected in the z/Architecture (and the Power architecture) is to detect tininess before rounding.

- b. Although ANSI/IEEE Standard 754-2008 does not require traps to be implemented for underflow or the other IEEE exceptions, it does state that “with each exception should be associated a trap under user control”. Since it also defines “should” as “that which is strongly recommended as being in keeping with the intent of the standard”, the z/Architecture provides traps by means of program interruptions.
- c. When the underflow trap is enabled, underflow is to be signaled when tininess is detected regardless of loss of accuracy. When the underflow trap is not enabled, the underflow flag bit is to be set only when both tininess and loss of accuracy have been detected. Add and subtract can result in tiny or inexact results, but not both. Thus, when underflow is disabled, add and subtract never set the underflow flag bit.

Suppression of Certain IEEE Exceptions

For IEEE-invalid-operation exception, IEEE-inexact exception, and quantum exception, a special control may be provided for an IEEE computational operation to control whether recognition of the exception is suppressed. These controls are called IEEE-invalid-operation-exception control (XiC), IEEE-inexact-exception control (XxC), and quantum-exception control (XqC), respectively.

When a special control is zero, recognition of the designated exception is not suppressed, and normal handling of the exception is performed. And, when the exception is recognized, it further depends on the mask bit in the FPC register to determine if a trap action occurs.

When a special control is one, recognition of the designated exception is suppressed, and no trap or non-trap action for the exception occurs. This suppression affects only recognition of the exception for setting the status flag or for causing the trap action. For example, the IEEE-inexact-exception control (XxC) has no effect on the DXC; that is, the DXC for IEEE-overflow or IEEE-underflow exceptions along with the detail for exact, inexact and truncated, or inexact and incremented, is reported according to the actual condition. Also, it has no effect on recognition of a quantum exception, which may depend on the actual inexact condition regardless of the setting of IEEE-inexact-exception control.

Multiple exception controls may be provided to a single IEEE computational operation. In this case, the effect and setting of each control is independent of other controls. The specific exception controls that are provided are described in the individual instruction descriptions.

IEEE Same-Radix Format Conversion

The instructions LOAD LENGTHENED and LOAD ROUNDED perform conversions of data between the short, long, and extended formats, where the source and target operands are in the same radix. (For mixed-radix conversions, see PFPO.) For BFP and DFP formats, same-radix conversion involves adjustments to both the significand and the biased exponent. Conversion to a narrower format requires rounding of the significand and an IEEE-inexact exception may result.

When converting to a narrower format, adjustment of the biased exponent causes IEEE underflow if the resultant left-units-view (LUV) exponent would be less than the minimum LUV exponent (E_{min}), or IEEE overflow if the resultant LUV exponent would be greater than the maximum LUV exponent (E_{max}) for the new format.

Programming Notes:

1. When a NaN is converted to a narrower format, for BFP the appropriate number of payload bits on the right (or for DFP, the appropriate number of payload digits on the left) are simply dropped with no indication. This is unlike the conversion of nonzero numbers, where the loss of nonzero sig-

nificand digits causes an IEEE-inexact exception. Thus, programs which encode NaN payloads for specific purposes must ensure that the distinguishing bits (or digits) are placed in the left part of the payload for BFP and in the right part of the payload for DFP.

- For BFP, converting a NaN to a narrower format cannot turn the NaN into an infinity because an SNaN either causes an interruption or turns into a QNaN, and all QNaNs have a leftmost fraction bit of one.

IEEE Comparison

Comparisons are always exact and cannot cause IEEE-overflow or IEEE-underflow exceptions.

Comparison ignores the sign of zero, that is, $+0$ equals -0 .

Infinities with like sign compare equal, that is, $+\infty$ equals $+\infty$, and $-\infty$ equals $-\infty$.

A NaN compares as *unordered* with any other operand, whether a finite number, an infinity, or another NaN, including itself.

Two sets of instructions are provided: COMPARE and COMPARE AND SIGNAL. In the absence of QNaNs, these instructions work the same. These instructions work differently only when both of the following are true:

- Neither operand of the instruction is an SNaN
- At least one operand of the instruction is a QNaN

In this case, COMPARE simply sets condition code 3, but COMPARE AND SIGNAL recognizes the IEEE-invalid-operation exception. If any operand is an SNaN, both instructions recognize the IEEE-invalid-operation exception.

The action when the IEEE-invalid-operation exception is recognized depends on the IEEE-invalid-operation mask bit in the FPC register. If the mask bit is zero, then the instruction execution is completed by setting condition code 3, and the IEEE-invalid-operation flag in the FPC register is set to one. If the mask bit is one, then the exception is reported as a program interruption for a data exception with DXC 80 hex (IEEE invalid operation).

Programming Note: A compiler can select either COMPARE or COMPARE AND SIGNAL for a comparison, depending on whether it is desired that a QNaN to be recognized as an exception.

Condition Codes for IEEE Instructions

For those operations which set the condition code to indicate the value of an IEEE result, condition codes 0, 1, and 2 are set to indicate that the result is a zero of either sign, less than zero, or greater than zero, respectively. The condition-code setting depends only on an inspection of the rounded result. For comparison operations, condition codes 0, 1, and 2 indicate equal, low, or high, respectively. These settings are the same as for the HFP instructions.

Condition code 3 can also be set. After an arithmetic operation, condition code 3 indicates a NaN result of either sign. After a comparison, it indicates that a NaN was involved in the comparison (the unordered condition). See Figure 9-16.

CC	Arithmetic	Comparison
0	± 0	Equal
1	< 0	Low
2	> 0	High
3	$\pm \text{NaN}$	Unordered

Figure 9-16. Condition Codes

Instructions

The floating-point-support instructions and their mnemonics and operation codes are listed in Figure 9-17 on page 9-25. The figure indicates, in the column labeled "Characteristics", the instruction format, when the condition code is set, the instruction fields that designate access registers, and the exceptional conditions in operand designations, data, or results that cause a program interruption.

All floating-point-support instructions are subject to the AFP-register-control bit, bit 45 of control register 0. The AFP-register-control bit must be one when an AFP register is specified as an operand location; otherwise, an AFP-register data exception, DXC 1, is recognized.

Mnemonics for the floating-point instructions have an R as the last letter when the instruction is in the RR, RRE, or RRF format. Certain letters are used for floating-point instructions to represent operand-format length, as follows:

- D Long
- E Short
- X Extended

Note: In the detailed descriptions of the individual instructions, the mnemonic and the symbolic operand designation for the assembler language are shown with each instruction. For a register-to-register operation using LOAD (short), for example, LER is the mnemonic and R₁,R₂ the operand designation.

Programming Notes:

1. The following additional floating-point-support instruction is available when the decimal-floating-point facility is installed:
 - SET DFP ROUNDING MODE (SRNMT)
2. The following additional floating-point-support instructions are available when the floating-point-support-sign-handling facility is installed:
 - COPY SIGN (CPSDR)
 - LOAD COMPLEMENT (LCDFR)
 - LOAD NEGATIVE (LNDFR)
 - LOAD POSITIVE (LPDFR)
3. The following additional floating-point-support instructions are available when the FPR-GR-transfer facility is installed:
 - LOAD FPR FROM GR (LDGR)
 - LOAD GR FROM FPR (LGDR)
4. The following additional floating-point-support instructions are available when the IEEE-exception-simulation facility is installed:
 - LOAD FPC AND SIGNAL (LFAS)
 - SET FPC AND SIGNAL (SFASR)

5. The following additional floating-point-support instructions are available when the long-displacement facility is installed:
 - LOAD (LDY, LEY)
 - STORE (STDY, STEY)
6. The following additional floating-point-support instruction is available when the PFPO facility is installed:
 - PERFORM FLOATING POINT OPERATION (PFPO)
7. The following additional floating-point-support instruction and features are available when the floating-point extension facility is installed:
 - A new floating-point-support instruction, SET BFP ROUNDING MODE (SRNMB), is added.
 - A new exception, the quantum exception, is defined for some computational operations.
 - Bit 5 of the floating-point-control (FPC) register is assigned to the quantum-exception mask
 - Bit 13 of the FPC register is assigned to the quantum-exception flag.
 - Data-exception code (DXC) 04 (hex) is assigned to the quantum exception.
 - DXC 07 (hex) is assigned to the simulated quantum exception.
 - The BFP-rounding-mode field in the FPC register is changed to 3 bits to support one additional BFP rounding mode, round to prepare for shorter precision.
 - One new value of the effective rounding method field is assigned to support the round to prepare for shorter precision rounding method for CONVERT HFP TO BFP.
 - For PFPO with a DFP result, bit 58 of general register 0 is assigned to be the DFP quantum-permission control.

Name	Mnemonic	Characteristics				Op Code	Page
CONVERT BFP TO HFP (long)	THDR	RRE	C	D ^{7,9}	Da	B359	9-27
CONVERT BFP TO HFP (short to long)	THDER	RRE	C	D ^{7,9}	Da	B358	9-27
CONVERT HFP TO BFP (long)	TBDR	RRF-e	C	D ^{7,9}	SP Da	B351	9-28
CONVERT HFP TO BFP (long to short)	TBEDR	RRF-e	C	D ^{7,9}	SP Da	B350	9-28
COPY SIGN (long)	CPSDR	RRF-b	FS	D ^{7,9}	Da	B372	9-30

Figure 9-17. Summary of Floating-Point-Support Instructions (Part 1 of 3)

Name	Mnemonic	Characteristics						Op Code	Page
EXTRACT FPC	EFPC	RRE		$\alpha^{7,9}$			Db	B38C	9-30
LOAD (extended)	LXR	RRE		$\alpha^{7,9}$	SP		Da	B365	9-31
LOAD (long)	LDR	RR		$\alpha^{7,9}$			Da	28	9-31
LOAD (long)	LD	RX-a		$\alpha^{7,9}$	A		Da	B ₂ 68	9-31
LOAD (long)	LDY	RXY-a	LD	$\alpha^{7,9}$	A		Da	B ₂ ED65	9-31
LOAD (short)	LER	RR		$\alpha^{7,9}$			Da	38	9-31
LOAD (short)	LE	RX-a		$\alpha^{7,9}$	A		Da	B ₂ 78	9-31
LOAD (short)	LEY	RXY-a	LD	$\alpha^{7,9}$	A		Da	B ₂ ED64	9-31
LOAD COMPLEMENT (long)	LCDFR	RRE	FS	$\alpha^{7,9}$			Da	B373	9-31
LOAD FPC	LFPC	S		$\alpha^{7,9}$	A SP		Db	B ₂ B29D	9-31
LOAD FPC AND SIGNAL	LFAS	S	XF	$\alpha^{7,9}$	A SP		Dt Xg	B ₂ B2BD	9-32
LOAD FPR FROM GR (64 to long)	LDGR	RRE	FG	$\alpha^{7,9}$			Da	B3C1	9-34
LOAD GR FROM FPR (long to 64)	LGDR	RRE	FG	$\alpha^{7,9}$			Da	B3CD	9-34
LOAD NEGATIVE (long)	LNDFR	RRE	FS	$\alpha^{7,9}$			Da	B371	9-34
LOAD POSITIVE (long)	LPDFR	RRE	FS	$\alpha^{7,9}$			Da	B370	9-34
LOAD ZERO (extended)	LZXR	RRE		$\alpha^{7,9}$	SP		Da	B376	9-35
LOAD ZERO (long)	LZDR	RRE		$\alpha^{7,9}$			Da	B375	9-35
LOAD ZERO (short)	LZER	RRE		$\alpha^{7,9}$			Da	B374	9-35
PERFORM FLOATING-POINT OPERATION	PFPO	E	PF	$\alpha^{7,8,9}$	SP		Da Xi Xo GM Xu Xx Xq	010A	9-35
SET BFP ROUNDING MODE (2 bit)	SRNM	S		$\alpha^{7,9}$			Db	B299	9-47
SET BFP ROUNDING MODE (3 bit)	SRNMB	S	F	$\alpha^{7,9}$	SP		Db	B2B8	9-47
SET DFP ROUNDING MODE	SRNMT	S	TR	$\alpha^{7,9}$			Dt	B2B9	9-47
SET FPC	SFPC	RRE		$\alpha^{7,9}$	SP		Db	B384	9-47
SET FPC AND SIGNAL	SFASR	RRE	XF	$\alpha^{7,9}$	SP		Dt Xg	B385	9-48
STORE (long)	STD	RX-a		$\alpha^{7,9}$	A		Da	ST B ₂ 60	9-48
STORE (long)	STDY	RXY-a	LD	$\alpha^{7,9}$	A		Da	ST B ₂ ED67	9-49
STORE (short)	STE	RX-a		$\alpha^{7,9}$	A		Da	ST B ₂ 70	9-48
STORE (short)	STEY	RXY-a	LD	$\alpha^{7,9}$	A		Da	ST B ₂ ED66	9-49
STORE FPC	STFPC	S		$\alpha^{7,9}$	A		Db	ST B ₂ B29C	9-49

Explanation:

- α^7 Restricted from transactional execution when the effective allow-floating-point-operation control is zero.
- α^8 May be restricted from transactional execution depending on machine conditions.
- α^9 Restricted in the constrained transactional-execution mode; a transaction-constraint program exception may be recognized.
- A Access exceptions for logical addresses.
- B₂ B₂ field designates an access register in the access-register mode.
- C Condition code is set.
- Da AFP-register data exception.
- Db BFP-instruction data exception.
- Dt DFP-instruction data exception.
- F Floating-point extension facility.
- FG FPR-GR-transfer facility.
- FS Floating-point-support-sign-handling facility.
- GM Instruction execution includes the implied use of general registers 0 and 1.
- LD Long-displacement facility.
- PF PFPO facility.
- RR RR instruction format.
- RRE RRE instruction format.

Figure 9-17. Summary of Floating-Point-Support Instructions (Part 2 of 3)

Name	Mnemonic	Characteristics	Op Code	Page
RRF	RRF instruction format.			
RX	RX instruction format.			
RXY	RXY instruction format.			
SP	Specification exception.			
ST	PER storage-alteration event.			
TR	Decimal-floating-point-rounding facility.			
XF	IEEE-exception-simulation facility.			
Xg	Simulated IEEE exception.			
Xi	IEEE invalid-operation exception.			
Xo	IEEE overflow exception.			
Xq	Quantum exception, if the floating-point extension facility is installed.			
Xu	IEEE underflow exception.			
Xx	IEEE inexact exception.			

Figure 9-17. Summary of Floating-Point-Support Instructions (Part 3 of 3)

CONVERT BFP TO HFP

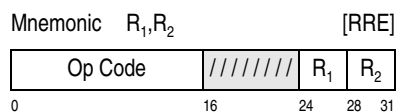

Mnemonic	Op Code	Operands
THDER	'B358'	Short BFP operand, long HFP result
THDR	'B359'	Long BFP operand, long HFP result

The second operand (the source operand) is converted from the binary-floating-point (BFP) format to the hexadecimal-floating-point (HFP) format, and the normalized result is placed at the first-operand location. The sign and magnitude of the source operand are tested to determine the setting of the condition code.

For numeric operands, the sign of the result is the sign of the source operand. If the source operand has a sign bit of one and all other operand bits are zeros, the result also is a one followed by all zeros.

When, for THDR, the characteristic of the result would be negative, the result is made all zeros but with the same sign as that of the source operand, and condition code 1 or 2 is set to indicate the sign of the source operand.

When, for THDR, the characteristic of the hexadecimal intermediate result is too large to fit into the target format, the result is set to all ones (that is, the largest-in-magnitude representable finite number) but with the same sign as that of the source operand, and condition code 3 is set.

See Figure 9-18 for a detailed description of the results of this instruction.

Resulting Condition Code:

- 0 Source was zero
- 1 Source was less than zero
- 2 Source was greater than zero
- 3 Special case

Program Exceptions:

- Data with DXC 1, AFP register
- Transaction constraint

Programming Notes:

1. The BFP-to-HFP conversion instructions are summarized in Figure 9-19.
2. CONVERT BFP TO HFP (THDER) converts BFP operands in the short format to HFP operands in the long format, rather than converting short to short, to retain full precision. Using this long HFP

result subsequently as a short operand requires no extra conversion steps.

Source Operand (a)	Results
$-\infty \leq a < -H_{max}$	T(-Hmax), cc3
$-H_{max} \leq a \leq -H_{min}$	T(r), cc1
$-H_{min} < a < 0$	T(-0) ¹ , cc1
-0	T(-0), cc0
+0	T(+0), cc0
$0 < a < +H_{min}$	T(+0) ² , cc2
$+H_{min} \leq a \leq +H_{max}$	T(r), cc2
$+H_{max} < a \leq +\infty$	T(+Hmax), cc3
NaN	T(+Hmax), cc3

Explanation:

¹ Condition code 1 is set to indicate the source was less than zero.

² Condition code 2 is set to indicate the source was greater than zero.

ccn Condition code is set to n.

r The value derived when the BFP source value a is converted to the HFP format. This result is always exact.

Hmax Largest (in magnitude) representable number in the target HFP format.

Hmin Smallest (in magnitude) representable normalized number in the target HFP format.

T(x) The value x is placed at the target operand location.

Figure 9-18. Results: CONVERT BFP TO HFP

Instruction	Mnemonic	Source		Target			Overflow, Underflow Possible
		Format	Significant Bits	Format	Significant Bits	Result	
CONVERT BFP TO HFP	THDER	BFP short	24	HFP long	53-56	Exact	No
	THDR	BFP long	53	HFP long	53-56	Exact	Yes
CONVERT HFP TO BFP	TBEDR	HFP long	53-56	BFP short	24	Rounded	Yes
	TBDR	HFP long	53-56	BFP long	53	Rounded	No

Figure 9-19. Summary of BFP-to/from-HFP Conversion Instructions

CONVERT HFP TO BFP

Mnemonic R₁,M₃,R₂ [RRF-e]

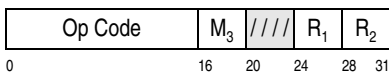

Mnemonic	Op Code	Operands
TBEDR	'B350'	Long HFP operand, short BFP result
TBDR	'B351'	Long HFP operand, long BFP result

The second operand (the source operand) is converted from the hexadecimal-floating-point (HFP) format to the binary-floating-point (BFP) format, and the result rounded according to the rounding method specified by the M₃ field is placed at the first-operand location. The sign and magnitude of the source operand are tested to determine the setting of the condition code.

The M_3 field contains a modifier specifying a rounding method, as follows:

M_3 Effective Rounding Method

- 0 Round toward 0
- 1 Round to nearest with ties away from 0
- 3 Round to prepare for shorter precision
- 4 Round to nearest with ties to even
- 5 Round toward 0
- 6 Round toward $+\infty$
- 7 Round toward $-\infty$

A modifier other than 0, 1, or 3-7 is invalid. If the floating-point extension facility is not installed, an M_3 modifier of 3 is also invalid.

The sign of the result is the sign of the second operand. If the second operand has a sign bit of one and all other operand bits are zeros, the result also is a one followed by all zeros.

See Figure 9-20 on page 9-29 for a detailed description of the results of this instruction.

If the M_3 field designates any of the following invalid modifier values: 2 and 8-15, then a specification exception is recognized. When the floating-point extension facility is not installed, if the M_3 field designates the invalid value 3, it is undefined whether a specification exception is recognized or an unpredictable rounding method is performed.

Resulting Condition Code:

- 0 Source was zero
- 1 Source was less than zero
- 2 Source was greater than zero
- 3 Overflow

IEEE Exceptions: None.

Program Exceptions:

- Data with DXC 1, AFP register
- Specification
- Transaction constraint

Programming Notes:

1. The HFP-to-BFP conversion instructions are summarized in Figure 9-19 on page 9-28.
2. Conversion to short BFP data requires HFP operands in the long format; a short HFP operand should be extended to long by ensuring that the right half of the register is cleared. Thus, the entire register should be cleared before loading a short HFP operand into it for conversion to BFP. This avoids unrepeatably rounding errors in the BFP result due to data left over from previous use.

Precision Rounded Source Operand (g)	Results
$g < -N_{max}$	See Part 2 of this figure.
$-N_{max} \leq g \leq -N_{min}$	T(r), cc1
$-N_{min} < g \leq -D_{min}$	T(d*), cc1
$-D_{min} < g < 0$	T(d) ¹ , cc1
-0	T(-0), cc0
+0	T(+0), cc0
$0 < g < +D_{min}$	T(d) ² , cc2
$+D_{min} \leq g < +N_{min}$	T(d*), cc2
$+N_{min} \leq g \leq +N_{max}$	T(r), cc2
$+N_{max} < g$	See Part 2 of this figure.

Figure 9-20. (Part 1 of 2) Results: CONVERT HFP to BFP

Precision Rounded Source Operand (g)	Results for Rounding Method Specified in M_3					
	Round to Nearest with Ties away from 0	Round to Nearest with Ties to Even	Round to Prepare for Shorter Precision	Round toward 0	Round toward $+\infty$	Round toward $-\infty$
$g < -N_{max}$	T($-\infty$), cc3	T($-\infty$), cc3	T($-N_{max}$), cc3	T($-N_{max}$), cc3	T($-N_{max}$), cc3	T($-\infty$), cc3
$+N_{max} < g$	T($+\infty$), cc3	T($+\infty$), cc3	T($+N_{max}$), cc3	T($+N_{max}$), cc3	T($+\infty$), cc3	T($+N_{max}$), cc3

Figure 9-20. (Part 2 of 2) Results: CONVERT HFP to BFP

Precision Rounded Source Operand (g)	Results for Rounding Method Specified in M_3					
	Round to Nearest with Ties away from 0	Round to Nearest with Ties to Even	Round to Prepare for Shorter Precision	Round toward 0	Round toward $+\infty$	Round toward $-\infty$
Explanation:						
¹	Condition code 1 is set for this case, even when the rounded result is zero.					
²	Condition code 2 is set for this case, even when the rounded result is zero.					
*	The rounded value, in the extreme case, may be Nmin.					
ccn	Condition code is set to n.					
d	The denormalized value derived when the HFP source value a is rounded to the format of the target using the rounding method specified in the M_3 field.					
g	The precision-rounded value. The value derived when the HFP source value is rounded to the precision of the target, but assuming an unbounded exponent range.					
r	The value derived when the HFP source value is rounded to the format of the target using the rounding method specified in the M_3 field.					
Dmin	Smallest (in magnitude) representable subnormal number in the target BFP format.					
Nmax	Largest (in magnitude) representable finite number in the target BFP format.					
Nmin	Smallest (in magnitude) representable normal number in the target BFP format.					
T(x)	The value x is placed at the target operand location.					

Figure 9-20. (Part 2 of 2) Results: CONVERT HFP to BFP

COPY SIGN

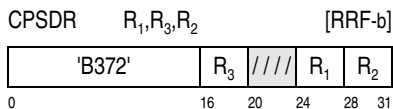

The second operand is placed at the first-operand location with the sign bit set to the sign of the third operand. The first, second, and third operands are each in a 64-bit floating-point register. The sign bit of the second operand and bits 1-63 of the third operand are ignored.

Condition Code: The code remains unchanged.

Program Exceptions:

- Data with DXC 1, AFP register
- Operation (if the floating-point-support-sign-handling facility is not installed)
- Transaction constraint

Programming Notes:

1. COPY SIGN is radix independent and can be used to operate on HFP, BFP, or DFP operands or even to copy the sign between operands having different radices.

2. Since the sign is in the same bit position (the left-most bit) in all widths for all radices, the third operand can be a short, long, or extended format.
3. COPY SIGN can be used in conjunction with LOAD (LDR) to copy the sign of an operand in the extended format.

EXTRACT FPC

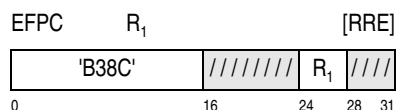

The contents of the FPC (floating-point-control) register are placed in bit positions 32-63 of the general register designated by R_1 . Bit positions 0-31 of the general register remain unchanged.

Condition Code: The code remains unchanged.

IEEE Exceptions: None.

Program Exceptions:

- Data with DXC 2, BFP instruction
- Transaction constraint

LOAD

Mnemonic1 R₁,R₂ [RR]

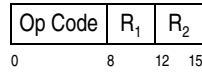

Mnemonic1	Op Code	Operands
LER	'38'	Short
LDR	'28'	Long

Mnemonic2 R₁,R₂ [RRE]

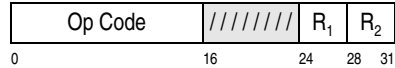

Mnemonic2	Op Code	Operands
LXR	'B365'	Extended

Mnemonic3 R₁,D₂(X₂,B₂) [RX-a]

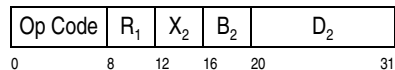

Mnemonic3	Op Code	Operands
LE	'78'	Short
LD	'68'	Long

Mnemonic4 R₁,D₂(X₂,B₂) [RXY-a]

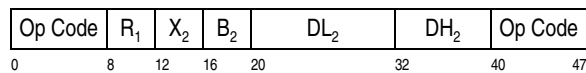

Mnemonic4	Op Code	Operands
LEY	'ED64'	Short
LDY	'ED65'	Long

The second operand is placed unchanged at the first-operand location.

The operation is performed without inspecting the contents of the second operand; no arithmetic exceptions are recognized.

For LXR, the R fields must designate valid floating-point-register pairs; otherwise, a specification exception is recognized.

The displacement for LE and LD is treated as a 12-bit unsigned binary integer. The displacement for LEY and LDY is treated as a 20-bit signed binary integer.

Condition Code: The code remains unchanged.

Program Exceptions:

- Access (fetch, operand 2 of LE, LD, LEY, and LDY)

- Data with DXC 1, AFP register
- Operation (LEY and LDY, if the long-displacement facility is not installed)
- Specification (LXR only)
- Transaction constraint

Programming Note: Data can be loaded into the vector registers from the little endian format using the extended mnemonics LERV and LDRV for the VLLE-BRZ instruction (see page 21-8).

LOAD COMPLEMENT

LCDFR R₁,R₂ [RRE]

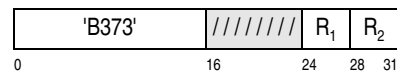

The second operand is placed at the first-operand location with the sign bit inverted. Both the first and second operands are each in a 64-bit floating-point register.

Condition Code: The code remains unchanged.

Program Exceptions:

- Data with DXC 1, AFP register
- Operation (if the floating-point-support-sign-handling facility is not installed)
- Transaction constraint

Programming Notes:

- LOAD COMPLEMENT (LCDFR) is radix independent and can be used to operate on HFP, BFP, or DFP operands.
- LOAD COMPLEMENT (LCDFR) can be used in conjunction with LOAD (LDR) to set the sign of an operand in the extended format.

LOAD FPC

LFPC D₂(B₂) [S]

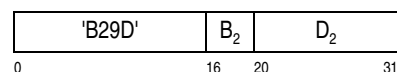

The four-byte second operand in storage is loaded into the FPC (floating-point-control) register.

Bits corresponding to unsupported bit positions in the FPC register must be zero; otherwise, a specification exception is recognized. For purposes of this checking, a bit position is considered to be unsupported only if it is either unassigned or assigned to a facility which is not installed in any architectural mode of the configuration.

When the floating-point extension facility is installed, the bits corresponding to the BFP rounding mode must specify a valid rounding mode; otherwise, a specification exception is recognized.

Condition Code: The code remains unchanged.

IEEE Exceptions: None.

Program Exceptions:

- Access (fetch, operand 2)
- Data with DXC 2, BFP instruction
- Specification
- Transaction constraint

Programming Notes:

1. When the architectural mode of a CPU is changed without resetting the FPC register (by means of the set architecture signal-processor order, for example) the entire contents of the FPC register are preserved. This is true even when some of these bits are associated with a facility which is not available in both architectural modes. Checking for unsupported bit positions of the FPC register is performed independently of the current architectural mode of the CPU; thus, it is always safe to restore the FPC register from a value previously saved on this CPU, even after the architectural mode has changed.
2. When the floating-point extension facility is installed, bits 29-31 of the second operand must specify a valid BFP rounding mode and bits 6-7, 14-15, 24, and 28 must be zero; otherwise, a specification exception is recognized.
3. When the floating-point extension facility is not installed, bits 5-7, 13-15, 24, and 28-29 are unassigned and must be zero; otherwise, a specification exception is recognized.

LOAD FPC AND SIGNAL

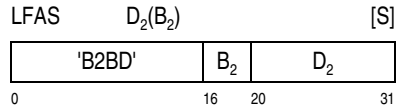

First, flags of byte 1 of the floating-point-control (FPC) register at the beginning of the operation are preserved to be used as signaling flags. Next, the contents of the source operand are placed in the FPC register; then the flags in the FPC register are set to the logical OR of the signaling flags and the source flags. Finally, the conditions for simulated-IEEE-exception trap action are examined.

The source operand is the second operand in storage.

If any signaling flag is one and the corresponding source mask is also one, simulated-IEEE-exception trap action occurs. The data-exception code (DXC) in the FPC register is updated to indicate the specific cause of the interruption and a data-exception program interruption occurs at completion of the instruction execution. The DXC for the interruption is shown in Figure 9-21.

If no signaling flag is enabled, the DXC in the FPC register remains as loaded from the source and instruction execution completes with no trap action.

See Figure 9-22 for a detailed description of the result of this instruction.

Bits in the source operand that correspond to unsupported bit positions in the FPC register must be zero; otherwise, a specification exception is recognized. For purposes of this checking, a bit position is considered to be unsupported only if it is either unassigned or assigned to a facility which is not installed in any architectural mode of the configuration.

When the floating-point extension facility is installed, the bits corresponding to the BFP rounding mode must specify a valid rounding mode; otherwise, a specification exception is recognized.

Condition Code: The code remains unchanged.

Program Exceptions:

- Access (fetch, operand 2)
- Data with DXC 3, DFP instruction

- Data with DXC for simulated IEEE exception
- Operation (if the IEEE-exception-simulation facility is not installed)
- Specification
- Transaction constraint

Enabled ¹ Signaling Flags Bit 0 1 2 3 4 5	DXC (Binary)
1 - - - - -	1000 0011
0 1 - - - - -	0100 0011
0 0 1 - - - -	0010 w011
0 0 0 1 - - -	0001 w011
0 0 0 0 1 - -	0000 1011
0 0 0 0 0 1	0000 0111 ²

Explanation:

¹ The logical AND of the corresponding bit in the source masks and the signaling flags.

² Is only supported when the floating-point extension facility is installed.

- Don't care.

w Bit 4 of the signaling flags.

Figure 9-21. DXC for Simulated-IEEE-Exception Trap Action

Trap	Resulting FPC Register Contents				
	Masks	Flags	DXC	DRM	BRM
No	S	OR	S	S	S
Yes	S	OR	Xg	S	S

Explanation:

BRM BFP rounding mode

DRM DFP rounding mode

DXC Data-exception code

OR Set to the logical OR of signaling flags and source flags.

S Set to the contents of the corresponding field in the source operand.

Trap Simulated-IEEE-exception trap action. This action occurs when the logical AND of the signaling flags and source masks is nonzero.

Xg DXC for simulated IEEE exception. See Figure 9-21

Figure 9-22. Result: LFAS and SFASR

Programming Notes:

1. When the floating-point extension facility is installed, bits 29-31 of the second operand must specify a valid BFP rounding mode and bits 6-7, 14-15, 24, and 28 must be zero; otherwise, a specification exception is recognized.

2. When the floating-point extension facility is not installed, bits 5-7, 13-15, 24, and 28-29 are unassigned and must be zero; otherwise, a specification exception is recognized.
3. The IEEE-exception-simulation instructions (LOAD FPC AND SIGNAL and SET FPC AND SIGNAL) are provided to facilitate program simulation of IEEE operations not provided directly in the machine. These instructions permit the simulation routine to restore the caller's masks, flags, and rounding modes; and, when appropriate, to simulate IEEE exceptions, including traps when enabled.
4. On entry, the simulation routine should first save the FPC register contents (containing the caller's masks, flags, and rounding modes), disable all traps, clear all flags, establish appropriate rounding modes, and then perform the necessary floating-point operations. Finally, the routine should set the current flags (called signaling flags) appropriately, and invoke either LOAD FPC AND SIGNAL or SET FPC AND SIGNAL.
5. When a program interruption for a data exception occurs, and both bit 6 and 7 of the DXC are ones, it indicates to the trap handler that the interruption was caused by a simulated-IEEE-exception trap action. The remaining bits of the DXC indicate the type of IEEE exception. Additional information required by the trap handler can be determined by the contents of a trap-information block, located by convention, at a fixed offset from the location where the instruction causing the trap resides.

The following shows an example of this scheme. The block and the code below are inserted at an appropriate place where a trap can occur. In this example, the LOAD FPC AND SIGNAL instruction is used, and the caller's FPC register contents are at the location, SAVDFPC.

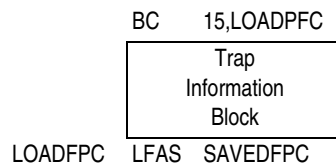

The trap information block can contain the designation of floating-point registers and general registers containing the information (or addresses of the information) for the following types of items:

- The operation being simulated
- Format and values of source operands
- Format and value of the result
- Any additional information useful to the trap handler.

LOAD FPR FROM GR

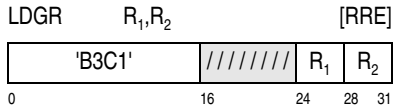

The second operand is placed at the first-operand location. The second operand is in a general register, and the first operand is in a floating-point register.

Condition Code: The code remains unchanged.

Program Exceptions:

- Data with DXC 1, AFP register
- Operation (if the FPR-GR-transfer facility is not installed)
- Transaction constraint

LOAD GR FROM FPR

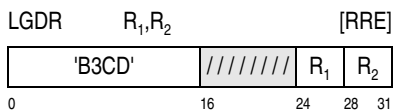

The second operand is placed at the first-operand location. The second operand is in a floating-point register, and the first operand is in a general register.

Condition Code: The code remains unchanged.

Program Exceptions:

- Data with DXC 1, AFP register
- Operation (if the FPR-GR-transfer facility is not installed)
- Transaction constraint

LOAD NEGATIVE

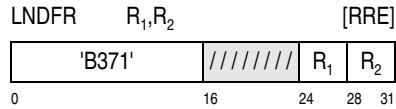

The second operand is placed at the first-operand location with the sign bit set to one. Both the first and second operands are each in a 64-bit floating-point register.

Condition Code: The code remains unchanged.

Program Exceptions:

- Data with DXC 1, AFP register
- Operation (if the floating-point-support-sign-handling facility is not installed)
- Transaction constraint

Programming Notes:

- LOAD NEGATIVE (LNDFR) is radix independent and can be used to operate on HFP, BFP, or DFP operands.
- LOAD NEGATIVE (LNDFR) can be used in conjunction with LOAD (LDR) to set the sign of an operand in the extended format.

LOAD POSITIVE

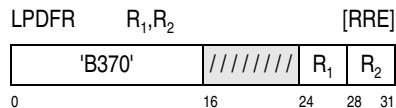

The second operand is placed at the first-operand location with the sign bit set to zero. Both the first and second operands are each in a 64-bit floating-point register.

Condition Code: The code remains unchanged.

Program Exceptions:

- Data with DXC 1, AFP register
- Operation (if the floating-point-support-sign-handling facility is not installed)
- Transaction constraint

Programming Notes:

1. LOAD POSITIVE (LPDFR) is radix independent and can be used to operate on HFP, BFP, or DFP operands.
2. LOAD POSITIVE (LPDFR) can be used in conjunction with LOAD (LDR) to set the sign of an operand in the extended format.

LOAD ZERO

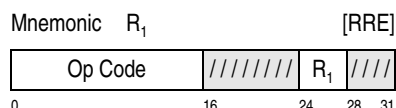

Mnemonic	Op Code	Operands
LZER	'B374'	Short
LZDR	'B375'	Long
LZXR	'B376'	Extended

All bits of the first operand are set to zeros.

For LZXR, The R₁ field must designate a valid floating-point-register pair; otherwise, a specification exception is recognized.

Condition Code: The code remains unchanged.

Program Exceptions:

- Data with DXC 1, AFP register
- Specification (LZXR only)
- Transaction constraint

Programming Note: LOAD ZERO sets all bits of a register to zeros, which produces a positive zero value in the BFP, DFP, and HFP formats. For DFP, addition of an all-zero value to any normal value, X, normalizes X.

PERFORM FLOATING-POINT OPERATION

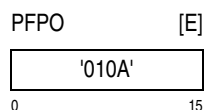

The operation specified by the function code in general register 0 is performed and the condition code is

set to indicate the result. When there are no exceptional conditions, condition code 0 is set. When an IEEE nontrap exception is recognized, condition code 1 is set. When an IEEE trap exception with alternate action is recognized, condition code 2 is set. In the absence of suppression, a 32-bit return code is placed in bits 32-63 of general register 1; bits 0-31 of general register 1 remain unchanged.

The PERFORM FLOATING-POINT OPERATION (PFPO) instruction is subject to the AFP-register-control bit, bit 45 of control register 0. For PFPO to be executed successfully, the AFP-register-control bit must be one; otherwise, an AFP-register data exception, DXC 1, is recognized.

Bit 32 of general register 0 is the test bit. When bit 32 is zero, the function specified by bits 33-63 of general register 0 is performed; each field in bits 33-63 must be valid and the combination must be a valid and installed function; otherwise a specification exception is recognized. When bit 32 is one, the function specified by bits 33-63 is not performed; rather, the condition code is set to indicate whether these bits specify a valid and installed function; the condition code is set to 0 if the function is valid and installed, or to 3 if the function is invalid or not installed. This definition is written as if the test bit is zero except when stated otherwise.

Bits 33-39 of GR0 specify the operation type. Only one operation type is currently defined: 01, hex, is the PFPO-convert-floating-point-radix operation.

For the PFPO-convert-floating-point-radix operation, other fields in general register 0 include first-operand format, second operand format, control flags, and rounding method. The second operand is converted to the format of the first operand and placed at the first-operand location, a return code is placed in bits 32-63 of general register 1, and the condition code is set to indicate whether an exceptional condition was recognized. Alternatively, an exceptional condition may be indicated by the recognition of a data exception resulting in either completion or suppression.

The first and second operands are in implicit floating-point registers. The first operand is in floating-point register 0 (paired with floating-point register 2 for extended). The second operand is in floating-point register 4 (paired with floating-point register 6 for extended).

General Register 0 (GR0)

Figure 9-23 illustrates the contents of general register 0; bits 0-31 of the register are ignored.

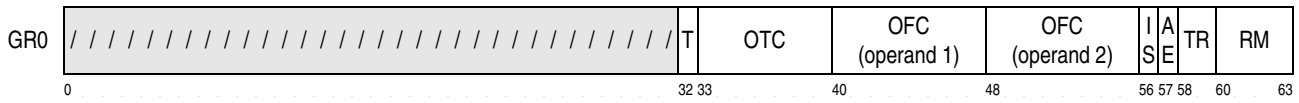

Explanation:

- / Ignored
- T Test bit (bit 32)
- OTC PFPO-operation-type code (bits 33-39)
- OFC PFPO-operand format code (bits 40-47 for operand 1, bits 48-55 for operand 2)
- IS Inexact-suppression control (bit 56)
- AE Alternate-exception-action control (bit 57)
- TR Target-radix-dependent controls (bits 58-59)
- RM PFPO rounding method (bits 60-63)

Figure 9-23. General Register 0 for PERFORM FLOATING POINT OPERATION

Figure 9-24 illustrates the contents of the PFPO-operation-type code in bits 33-32 of general register 0.

Op Type Code (hex)	Operation
00	Reserved/Invalid
01	PFPO Convert Floating-Point Radix
02-7F	Reserved/Invalid

Figure 9-24. PFPO-Operation-Type Code (GR0 bits 33-39)

Figure 9-25 illustrates the contents of the PFPO-operand-format codes for the first and second operands (in bits 40-47 and 48-55 of general register 0, respectively).

Code (hex)	Format
00	HFP short
01	HFP long
02	HFP extended
03	Reserved/Invalid
04	Reserved/Invalid
05	BFP short
06	BFP long
07	BFP extended
08	DFP short
09	DFP long
0A	DFP extended
0B-FF	Reserved/Invalid

Figure 9-25. PFPO-Operand-Format Codes (GR0 bits 40-47 and 48-55)

Figure 9-26 illustrates the contents of the PFPO-target-radix-dependent controls in bits 58-59 of general register 0.

Radix of Target	GR0 Bit	Meaning
HFP	58	HFP-overflow control
HFP	59	HFP-underflow control
BFP	58	Reserved, must be zero
BFP	59	Reserved, must be zero
DFP	58	Reserved, must be zero when the floating-point extension facility is not installed; it is the DFP quantum-permission control (DQPC) when the facility is installed.
DFP	59	DFP preferred-quantum control (DPQC)

Figure 9-26. PFPO-Target-Radix-Dependent Controls (GR0, bits 58-59)

Figure 9-27 illustrates the PFPO-rounding-method codes in bits 60-63 of general register 0.

Value	Method*
0	According to current DFP rounding mode in bits 25-27 of the floating-point-control register
1	According to current BFP rounding mode in bits 29-31 of the floating-point-control register
2-7	Reserved/Invalid
8	Round to nearest with ties to even
9	Round toward 0
10	Round toward $+\infty$
11	Round toward $-\infty$
12	Round to nearest with ties away from 0
13	Round to nearest with ties toward 0
14	Round away from 0
15	Round to prepare for shorter precision
* All rounding methods, other than those listed as reserved, are valid for any conversion function, regardless of the radix of the result.	

Figure 9-27. PFPO-Rounding Method (GR0 bits 60-63)

Figure 9-28 shows the basic PFPO functions. PFPO basic functions comprise the set of combinations of the operation-type, first-operand-format, and second-operand-format fields which are valid when the PFPO instruction is installed. Other combinations of operation type and format are not valid and will result in either a specification exception being recognized (when the test bit is zero) or condition code 3 (when the test bit is one).

GR0 bits 33-55 (hex)	Function	Exceptions
010500	Convert HFP short to BFP short	SP Da Xo Xu Xx
010600	Convert HFP short to BFP long	SP Da
010700	Convert HFP short to BFP extended	SP Da
010800	Convert HFP short to DFP short	SP Da Xx Xq
010900	Convert HFP short to DFP long	SP Da Xx Xq
010A00	Convert HFP short to DFP extended	SP Da Xx Xq
010501	Convert HFP long to BFP short	SP Da Xo Xu Xx
010601	Convert HFP long to BFP long	SP Da Xx
010701	Convert HFP long to BFP extended	SP Da
010801	Convert HFP long to DFP short	SP Da Xx Xq
010901	Convert HFP long to DFP long	SP Da Xx Xq
010A01	Convert HFP long to DFP extended	SP Da Xx Xq
010502	Convert HFP extended to BFP short	SP Da Xo Xu Xx
010602	Convert HFP extended to BFP long	SP Da Xx
010702	Convert HFP extended to BFP extended	SP Da
010802	Convert HFP extended to DFP short	SP Da Xx Xq
010902	Convert HFP extended to DFP long	SP Da Xx Xq
010A02	Convert HFP extended to DFP extended	SP Da Xx Xq

Figure 9-28. Basic PFPO Functions (GR0 bits 33-55)

GR0 bits 33-55 (hex)	Function	Exceptions
010005	Convert BFP short to HFP short	SP Da Xi Xx
010105	Convert BFP short to HFP long	SP Da Xi
010205	Convert BFP short to HFP extended	SP Da Xi
010805	Convert BFP short to DFP short	SP Da Xi Xx Xq
010905	Convert BFP short to DFP long	SP Da Xi Xx Xq
010A05	Convert BFP short to DFP extended	SP Da Xi Xx Xq
010006	Convert BFP long to HFP short	SP Da Xi Xo Xu Xx
010106	Convert BFP long to HFP long	SP Da Xi Xo Xu Xx
010206	Convert BFP long to HFP extended	SP Da Xi Xo Xu Xx
010806	Convert BFP long to DFP short	SP Da Xi Xo Xu Xx Xq
010906	Convert BFP long to DFP long	SP Da Xi Xx Xq
010A06	Convert BFP long to DFP extended	SP Da Xi Xx Xq
010007	Convert BFP extended to HFP short	SP Da Xi Xo Xu Xx
010107	Convert BFP extended to HFP long	SP Da Xi Xo Xu Xx
010207	Convert BFP extended to HFP extended	SP Da Xi Xo Xu Xx
010807	Convert BFP extended to DFP short	SP Da Xi Xo Xu Xx Xq
010907	Convert BFP extended to DFP long	SP Da Xi Xo Xu Xx Xq
010A07	Convert BFP extended to DFP extended	SP Da Xi Xo Xu Xx Xq
010008	Convert DFP short to HFP short	SP Da Xi Xo Xu Xx
010108	Convert DFP short to HFP long	SP Da Xi Xo Xu Xx
010208	Convert DFP short to HFP extended	SP Da Xi Xo Xu Xx
010508	Convert DFP short to BFP short	SP Da Xi Xo Xu Xx
010608	Convert DFP short to BFP long	SP Da Xi Xx
010708	Convert DFP short to BFP extended	SP Da Xi Xx
010009	Convert DFP long to HFP short	SP Da Xi Xo Xu Xx
010109	Convert DFP long to HFP long	SP Da Xi Xo Xu Xx
010209	Convert DFP long to HFP extended	SP Da Xi Xo Xu Xx
010509	Convert DFP long to BFP short	SP Da Xi Xo Xu Xx
010609	Convert DFP long to BFP long	SP Da Xi Xo Xu Xx
010709	Convert DFP long to BFP extended	SP Da Xi Xx
01000A	Convert DFP extended to HFP short	SP Da Xi Xo Xu Xx
01010A	Convert DFP extended to HFP long	SP Da Xi Xo Xu Xx
01020A	Convert DFP extended to HFP extended	SP Da Xi Xo Xu Xx
01050A	Convert DFP extended to BFP short	SP Da Xi Xo Xu Xx
01060A	Convert DFP extended to BFP long	SP Da Xi Xo Xu Xx
01070A	Convert DFP extended to BFP extended	SP Da Xi Xo Xu Xx
Explanation:		
Da	AFP-register data exception.	
SP	Specification exception due to invalid PFPO rounding method; for BFP target, specification exception due to nonzero target-radix-dependent controls; for DFP target, specification exception due to nonzero DFP-quantum-permission control when the floating-point-extension facility is not installed.	
Xi	IEEE-invalid-operation exception.	
Xo	IEEE-overflow exception.	
Xq	Quantum exception, if the floating-point extension facility is installed.	
Xu	IEEE-underflow exception.	
Xx	IEEE-inexact exception.	

Figure 9-28. Basic PFPO Functions (GR0 bits 33-55)

In the detailed descriptions that follow there are many references to quantum exceptions. Those apply only when the floating-point extension facility is installed, and bit 58 of general register 0 is one.

Inexact-Suppression Control: Bit 56 of general register 0 is the inexact-suppression control. When the inexact-suppression control is zero, IEEE-inexact exceptions are recognized and reported in the normal manner. When the inexact-suppression control is one, IEEE-inexact exceptions are not recognized, and no trap or nontrap action for the exceptions

occurs. The inexact-suppression control has no effect on the DXC; that is, the DXC for IEEE-overflow or IEEE-underflow exceptions along with the detail for exact, inexact and truncated, or inexact and incremented, is reported according to the actual condition.

Alternate-Exception-Action Control: Bit 57 of general register 0 is the alternate-exception-action control. The setting of this control affects the action taken for IEEE-overflow and IEEE-underflow trap exceptions.

When the alternate-exception-action control is zero, IEEE-overflow and IEEE-underflow trap exceptions are reported in the normal manner. That is, the appropriate data exception code (DXC) is placed in byte 2 of the floating-point control register, the operation is completed, and a program interruption for a data exception occurs. (As part of the program interruption, the DXC is stored at location 147.) This is called an *IEEE trap exception with normal action*.

When the alternate-exception-action control is one, the DXC is placed in byte 2 of the floating-point control register, the operation is completed, condition code 2 is set, and program execution continues with the next sequential instruction. (There is no program interruption and the DXC is not stored at location 147.) This is called an *IEEE trap exception with alternate action*.

Target-Radix-Dependent Controls: Bits 58 and 59 comprise controls for a target (first) operand having either the HFP or DFP format, as described below. When the operand-format control for the first operand designates the BFP format, both bits 58 and 59 must contain zeros; otherwise, a specification exception is recognized (when the test bit is zero) or condition code 3 is set (when the test bit is one).

HFP-Overflow Control: Bit 58 of general register 0 is the HFP-overflow control. When the HFP-overflow control is zero, an HFP-overflow condition is reported as an IEEE-invalid-operation exception and is subject to the IEEE-invalid-operation mask. When the HFP-overflow control is one, an HFP-overflow condition is reported as an IEEE-overflow exception and is subject to the IEEE-overflow mask.

HFP-Underflow Control: For HFP targets, bit 59 of general register 0 is the HFP alternate underflow control. When the HFP-underflow control is zero, HFP underflow causes the result to be set to a true zero with the same sign as the source and underflow

is not reported. (The result in this case is inexact and subject to the inexact-suppression control.) When the HFP-underflow control is one, the condition is reported as an IEEE-underflow exception and is subject to the IEEE-underflow mask.

DFP Quantum-Permission Control (DQPC): When the floating-point extension facility is installed, for DFP targets, bit 58 of general register 0 is the DFP quantum-permission control (DQPC). If this control is zero, recognition of the quantum exception is suppressed so that no trap or nontrap action for the exception occurs; if the control is one, recognition of the quantum exception is not suppressed.

DFP Preferred Quantum Control (DPQC): For DFP targets, bit 59 of general register 0 is the DFP preferred quantum control (DPQC). For radix conversion with DFP targets, if the delivered value is inexact, the cohort member with the smallest quantum is selected; if the delivered value is exact, selection depends on the value of bit 59 of general register 0, the DFP preferred quantum control (DPQC). When the delivered value is exact and the DPQC bit is zero, the cohort member with the largest quantum is selected. When the delivered value is exact and the DPQC bit is one, the preferred quantum is one and the cohort member with the quantum closest to one is selected.

Return Code

Regardless of what condition code is set, and independent of whether the test bit is one, a 32-bit return code is placed in bits 32-63 of general register 1; bits 0-31 of general register 1 remain unchanged. A return code is also placed in general register 1 when a program interruption occurs for an IEEE trap exception that completes; general register 1 is not updated when a program interruption occurs for an IEEE trap exception that suppresses. Thus, general register 1 is updated on a program interruption for IEEE-overflow, IEEE-underflow, IEEE-inexact, and quantum-exception trap exceptions, but is not updated on a program interruption for an IEEE-invalid-operation trap exception.

Except where otherwise specified, the return code is a value of zero.

Sign Preservation

For PFPO convert floating-point radix, the sign of the result is the same as the sign of the source. The only exception to this is when the source is a NaN and the

target is HFP; in this case, the result is the largest representable number in the target HFP format (Hmax) with the sign set to plus.

Preferred Quantum

For radix conversion with DFP targets, the handling of the quantum is described in “DFP Preferred Quantum Control (DPQC)” on page 9-38.

NaN Conversion

When converting between DFP and BFP, the sign of the NaN is always preserved, and the value of the payload is preserved, when possible. If the value of the source payload exceeds the maximum value of the target payload, the target is set to the default QNaN, but with the same sign as the source.

When traps are disabled, an SNaN is converted to the corresponding QNaN, and the payload is preserved, when possible; that is, SNaN(x) is converted to QNaN(x), where x is the value of the payload. See the section “Propagation of NaNs” on page 9-3 for additional details.

For DFP, both QNaN(0) and SNaN(0) can be represented; but in BFP, there is a representation for QNaN(0), but not for SNaN(0).

Scaled Value and Signed Scaling Exponent (Ω) for PFPO

When, for the PFPO-convert-floating-point-radix operation, IEEE-overflow trap action or IEEE-underflow trap action occurs, the scaled value is computed using the following steps:

$$\Psi = b^{\Omega}$$

$$z = g \div \Psi$$

Where Ω is the signed scaling exponent, b is the target radix (2, 10, or 16), Ψ is the scale factor, g is the precision-rounded value, and z is the scaled value.

The signed scaling exponent (Ω) is selected to make the magnitude of the value of the scaled result (z) lie in the range:

$$1 \leq |z| < b.$$

The value of the signed scaling exponent (Ω), treated as a 32-bit signed binary integer, is placed in bits 32-63 of general register 1; bits 0-31 of general register 1 remain unchanged.

The scaled value is used as the delivered value and is placed in the result location. For DFP targets, the cohort member with the quantum nearest to the scaled preferred quantum is selected. (But it should be noted that for all currently supported conversions where scaling is required, the result is always inexact, so the cohort member with the smallest quantum is selected.) For BFP targets, there are no redundant representations, there is only one member in a cohort. For HFP targets, the result is normalized.

HFP Values

Unnormalized HFP values are accepted on input, but all HFP results are normalized. If an HFP result would be less than the smallest (in magnitude) representable normalized number, an HFP underflow condition exists.

HFP Zero Result

For PFPO-convert-BFP-to-HFP or PFPO-convert-DFP-to-HFP functions, if the source operand is zero, the result has the same sign as that of the source operand, and has all zeros in fraction and characteristic.

HFP Overflow and Underflow for PFPO

For an HFP target of a PFPO-convert-floating-point-radix operation, the handling of overflow and underflow conditions is controlled by the HFP-overflow control and the HFP-underflow control, respectively.

HFP Overflow: An HFP-overflow condition exists when an HFP target precision's largest number (Hmax) is exceeded in magnitude by the precision-rounded value. That is, when the characteristic of a normalized HFP result would exceed 127 and the fraction is not zero.

When the HFP-overflow control is zero, HFP-overflow is reported as an IEEE-invalid-operation exception and is subject to the IEEE-invalid-operation mask in the FPC register. This is called an *HFP-overflow-as-IEEE-invalid-operation condition*.

When the HFP-overflow control is one, HFP overflow is reported as an IEEE-overflow exception and is subject to the IEEE-overflow mask in the FPC register. This is called an *HFP-overflow-as-IEEE-overflow condition*.

HFP Underflow: An HFP-underflow condition exists when the precision-rounded value is nonzero and less in magnitude than the HFP target preci-

sion's smallest normalized number, Hmin. That is, when the characteristic of a normalized HFP result would be less than zero and the fraction is not zero. Reporting of the HFP-underflow condition is subject to the HFP-underflow control. The result in this case, however, is inexact and is subject to the controls for that condition.

When the HFP-underflow control is zero, the HFP-underflow condition is not reported. The result is set to a true zero with the same sign as the source.

When the HFP-underflow control is one, HFP underflow is reported as an IEEE-underflow exception and is subject to the IEEE-underflow mask (IMu) in the FPC register. This is called an *HFP-underflow-as-IEEE-underflow condition*. When IMu is zero, the result is set to a true zero with the same sign as the source, and the return code in general register 1 is zero; when IMu is one, the result is set to a scaled value, and the return code is nonzero.

IEEE Exceptions for PFPO

Except where otherwise stated, the following sections on IEEE exceptions apply to both BFP and DFP.

IEEE Invalid Operation: An IEEE-invalid-operation exception is recognized when any of the following occurs:

1. An SNaN is encountered in an IEEE source.
2. In an IEEE-to-HFP conversion, a NaN (QNaN or SNaN) or an infinity is encountered in the IEEE source.
3. An HFP-overflow-as-IEEE-invalid-operation condition exists.

IEEE-invalid-operation exceptions are recognized as either IEEE-invalid-operation nontrap exceptions or IEEE-invalid-operation trap exceptions.

IEEE-Invalid-Operation Nontrap Action: IEEE-invalid-operation nontrap action occurs when an IEEE-invalid-operation exception is recognized and the IEEE-invalid-operation mask bit in the FPC register is zero. The operation is completed, the IEEE-invalid-operation flag bit in the FPC register is set to one, and condition code 1 is set. The result is as follows:

- When the target is IEEE and the source is an IEEE SNaN, the result is the source NaN con-

verted to the corresponding canonical QNaN in the target format.

- When the target is HFP and the source is an IEEE NaN, the result is the largest representable number in the target HFP format (Hmax) with the sign set to plus.
- When the target is HFP and the source is an IEEE infinity, the result is Hmax with the same sign as the source.
- When an HFP-overflow-as-IEEE-invalid-operation condition exists, the result is Hmax with the same sign as the source.

IEEE-Invalid-Operation Trap Action: IEEE-invalid-operation trap action occurs when an IEEE-invalid-operation exception is recognized and the IEEE-invalid-operation mask bit in the FPC register is one. The operation is suppressed, and the exception is reported as a program interruption for a data exception with DXC 80 hex.

IEEE Overflow: For IEEE targets, an IEEE-overflow exception is recognized when the precision-rounded value is greater in magnitude than the largest finite number (Nmax) representable in the target format. For HFP targets, an IEEE-overflow exception is recognized when the HFP-overflow condition exists and the HFP-overflow control is one.

IEEE-Overflow Nontrap Action: IEEE-overflow nontrap action occurs when the IEEE-overflow exception is recognized and the IEEE-overflow mask bit in the FPC register is zero.

The operation is completed and the IEEE-overflow flag bit in the FPC register is set to one. For IEEE targets, the result of the operation depends on the sign of the precise intermediate value and on the effective rounding method:

1. For all round-to-nearest methods and round-away-from-0, the result is infinity with the sign of the precise intermediate value.
2. For round-toward-0 and round-to-prepare-for-shorter-precision, the result is the largest finite number of the format, with the sign of the precise intermediate value.
3. For round toward $+\infty$, the result is $+\infty$ if the sign is plus, or it is the negative finite number with the largest magnitude if the sign is minus.

4. For round toward $-\infty$, the result is the largest positive finite number if the sign is plus or $-\infty$ if the sign is minus.

For HFP targets, the result is set to the largest representable number in the target HFP format (Hmax) with the same sign as the source.

Additional action depends on whether there is also an IEEE-inexact exception or a quantum exception.

When IEEE-overflow nontrap action occurs, and neither IEEE-inexact exception nor quantum exception has been recognized, the IEEE-overflow flag bit in the FPC register is set to one and condition code 1 is set.

When an IEEE-overflow nontrap action occurs together with an IEEE-inexact nontrap action, or with a quantum-exception nontrap action, or with nontrap actions for both IEEE-inexact and quantum-exception, the IEEE flag bits in the FPC register for all the recognized exceptions are set to ones and condition code 1 is set.

When IEEE-overflow nontrap action and IEEE-inexact trap action occur, the condition code is not set, the IEEE-overflow flag bit in the FPC register is set to one, and the IEEE-inexact exception is reported as a program interruption for a data exception with DXC 08 or 0C hex, depending on whether the result is inexact and truncated (rounded toward zero) or inexact and incremented, respectively.

When IEEE-overflow nontrap action and quantum-exception trap action occur, the condition code is not set, the IEEE-overflow flag bit in the FPC register is set to one, and the quantum exception is reported as a program interruption for a data exception with DXC 04 hex. When in addition an IEEE-inexact nontrap action occurs, the IEEE-inexact flag bit in the FPC register is set to one.

IEEE-Overflow Trap Action: IEEE-overflow trap action occurs when the IEEE-overflow exception is recognized and the IEEE-overflow mask bit in the FPC register is one.

The operation is completed by setting the result to the scaled value; placing the value of the signed scaling exponent (Ω), treated as a 32-bit signed binary integer in bits 32-63 of general register 1; and setting DXC 20, 28, or 2C hex, depending on whether the

delivered value is exact, inexact and truncated (rounded toward zero), or inexact and incremented, respectively. When the precise intermediate result is rounded to an infinity, it is considered to be an incremented result.

For DFP targets, the delivered value is always inexact and the cohort member with the smallest quantum is selected.

Additional action depends on the value of the alternate-exception-action control.

When the alternate-exception-action control is zero, the condition code is not set and the exception is reported as a program interruption for a data exception.

When the alternate-exception-action control is one, condition code 2 is set and no program interruption occurs.

IEEE Underflow: For IEEE targets, an IEEE-underflow exception is recognized when the tininess condition exists and either: (1) the IEEE-underflow mask bit in the FPC register is zero and the result value is inexact, or (2) the IEEE-underflow mask bit in the FPC register is one.

The tininess condition exists when the precise intermediate value of an IEEE computational operation is nonzero and smaller in magnitude than the smallest normal number (Nmin) representable in the target format.

The result value is inexact if it is not equal to the precise intermediate value.

For HFP targets, an IEEE-underflow exception is recognized when the HFP-underflow condition exists and the HFP-underflow control is one.

IEEE-Underflow Nontrap Action: IEEE-underflow nontrap action occurs when the IEEE-underflow exception is recognized and the IEEE-underflow mask bit in the FPC register is zero.

The operation is completed and the IEEE-underflow flag bit in the FPC register is set to one.

For IEEE targets, the result is rounded to the denormalized value or Nmin. For DFP targets, the cohort member with the smallest quantum is selected.

For HFP targets, the result is set to a true zero with the same sign as the source.

Additional action depends on whether there is also an IEEE-inexact exception or a quantum exception.

When IEEE-underflow nontrap action occurs, and neither IEEE-inexact exception nor quantum exception has been recognized, the IEEE-underflow flag bit in the FPC register is set to one and condition code 1 is set.

When an IEEE-underflow nontrap action occurs together with an IEEE-inexact nontrap action, or with a quantum-exception nontrap action, or with nontrap actions for both IEEE-inexact and quantum-exception, the IEEE flag bits in the FPC register for all the recognized exceptions are set to ones and condition code 1 is set.

When IEEE-underflow nontrap action and IEEE-inexact trap action occur, the condition code is not set, the IEEE-underflow flag bit in the FPC register is set to one, and the IEEE-inexact trap exception is reported as a program interruption for a data exception with DXC 08 or 0C hex, depending on whether the result is inexact and truncated (rounded toward zero) or inexact and incremented, respectively.

When IEEE-underflow nontrap action and quantum-exception trap action occur, the condition code is not set, the IEEE-underflow flag bit in the FPC register is set to one, and the quantum exception is reported as a program interruption for a data exception with DXC 04 hex. When in addition an IEEE-inexact nontrap action occurs, the IEEE-inexact flag bit in the FPC register is set to one.

IEEE-Underflow Trap Action: IEEE-underflow trap action occurs when the IEEE-underflow exception is recognized and the IEEE-underflow mask bit in the FPC register is one.

The operation is completed by setting the result to the scaled value; placing the value of the signed scaling exponent (Ω), treated as a 32-bit signed binary integer in bits 32-63 of general register 1; and setting DXC 10, 18, or 1C hex, depending on whether the result is exact, inexact and truncated (rounded toward zero), or inexact and incremented, respectively.

For DFP targets, the delivered value is always inexact and the cohort member with the smallest quantum is selected.

Additional action depends on the value of the alternate-exception-action control.

When the alternate-exception-action control is zero, the condition code is not set and the exception is reported as a program interruption for a data exception.

When the alternate-exception-action control is one, condition code 2 is set and no program interruption occurs.

IEEE Inexact: An IEEE-inexact exception is recognized when, for a PFPO-convert-floating-point-radix operation, an inexact condition exists, recognition of the exception is not suppressed, and neither IEEE-overflow trap action nor IEEE-underflow trap action occurs.

In the absence of an IEEE-invalid-operation condition, an inexact condition exists when the rounded intermediate value differs from the precise intermediate value. The condition also exists when IEEE-overflow nontrap action occurs.

Even though an inexact condition exists, the IEEE-inexact exception is not recognized if the inexact-suppression control is one or if IEEE overflow or IEEE underflow trap action occurs. When an inexact condition exists and the conditions for an IEEE-overflow trap action or IEEE-underflow trap action also apply, the trap action takes precedence and the inexact condition is reported in the DXC.

IEEE-Inexact Nontrap Action: IEEE-inexact nontrap action occurs when the IEEE-inexact exception is recognized and the IEEE-inexact mask bit in the FPC register is zero.

In the absence of another IEEE nontrap action, the operation is completed using the rounded intermediate value, condition code 1 is set, and the IEEE-inexact flag bit in the FPC register is set to one. For DFP targets, the cohort member with the smallest quantum is selected.

When an IEEE-inexact nontrap action and an IEEE-overflow or IEEE-underflow nontrap action coincide, the operation is completed using the result specified for the other exception and the flag bits for both

exceptions are set to one, and condition code 1 is set. When in addition, a quantum-exception nontrap action occurs, the quantum-exception flag bit in the FPC register is also set to one.

IEEE-Inexact Trap Action: IEEE-inexact trap action occurs when the IEEE-inexact exception is recognized and the IEEE-inexact mask bit in the FPC register is one. The operation is completed, the condition code is not set, and the exception is reported as a program interruption for a data exception with DXC 08 or 0C hex, depending on whether the result is inexact and truncated (rounded toward zero) or inexact and incremented, respectively. When the precise intermediate result is rounded to an infinity, it is considered to be an incremented result.

In the absence of a coincident IEEE nontrap action, the delivered value is set to the rounded intermediate value. For DFP targets, the cohort member with the smallest quantum is selected.

When the IEEE-inexact trap action coincides with an IEEE nontrap action, the operation is completed using the result specified for the IEEE nontrap action, the flag bit for the nontrap exception is set to one, and the IEEE-inexact trap action takes place.

Quantum Exception: A quantum exception is recognized when the floating-point extension facility is installed, and when a quantum-exception condition exists, recognition of the exception is not suppressed (DQPC = 1), and none of IEEE-overflow trap action, IEEE-underflow trap action, and IEEE-inexact trap action occurs.

For a PFPO-convert-floating-point-radix operation with DFP result, a quantum-exception condition exists when the delivered DFP result is inexact, or when the delivered DFP result is exact and finite, but the delivered quantum exceeds the preferred quantum of 1. (See programming note 6.)

When the floating-point extension facility is not installed, no quantum exception is recognized.

Even though a quantum-exception condition exists, the quantum exception is not recognized if recognition of the exception is suppressed (DQPC = 0), or if IEEE-overflow, IEEE-underflow, or IEEE-inexact trap action occurs. When a quantum-exception condition exists, and the conditions for an IEEE-overflow, IEEE-underflow, or IEEE-inexact trap action also apply, the trap action takes precedence and the

quantum exception is not reported in status flag or DXC.

Quantum-Exception Nontrap Action: Quantum-exception nontrap action occurs when the quantum exception is recognized and the quantum-exception mask bit in the FPC register is zero.

In the absence of another IEEE nontrap action, the operation is completed using the rounded intermediate value, condition code 1 is set, and the quantum-exception flag bit in the FPC register is set to one.

When a quantum-exception nontrap action and another one or two IEEE nontrap actions coincide, the operation is completed using the result specified for the other exceptions and the flag bits for all two or three exceptions are set to one, and condition code 1 is set.

Quantum-Exception Trap Action: Quantum-exception trap action occurs when the quantum exception is recognized and the quantum-exception mask bit in the FPC register is one. The operation is completed, the condition code is not set, and the exception is reported as a program interruption for a data exception with DXC 04 hex.

In the absence of a coincident IEEE nontrap action, the delivered value is set to the rounded intermediate value.

When the quantum-exception trap action coincides with other IEEE nontrap actions, the operation is completed using the result specified for the other IEEE nontrap actions, the flag bits for the nontrap exceptions are set to one, and the quantum-exception trap action takes place.

Resulting Condition Code (when test bit is zero):

- 0 Normal result
- 1 Nontrap exception
- 2 Trap exception with alternate action
- 3 --

Resulting Condition Code (when test bit is one):

- 0 Function is valid
- 1 --
- 2 --
- 3 Function is invalid

IEEE Exceptions:

- Invalid operation
- Overflow
- Underflow
- Inexact
- Quantum (if the floating-point extension facility is installed)

Program Exceptions:

- Data with DXC 1, AFP register
- Data with DXC for IEEE exception
- Operation (if the PFPO facility is not installed)
- Specification
- Transaction constraint

Programming Notes:

1. The PFPO-convert-floating-point-radix operation performs “correct rounding”; that is, the result is accurately obtained from the precise intermediate value using the effective rounding method. This is in contrast to some radix conversion programs, which may produce results with larger rounding errors.
2. Note that a value of zero in the rounding-method field (GR0 bits 60-63) specifies rounding according to the current DFP rounding mode (FPC 3.1-3) regardless of whether the target is DFP, BFP, or HFP. Similarly, a value of one in the rounding-method field specifies rounding according to the current BFP rounding mode (FPC 3.5-7), regardless of the target format.
3. If the program does not supply a default QNaN (payload = zero) as a source, then its presence as a result indicates that the machine either created a new QNaN or the program attempted to convert a payload which was too large for this format.

If the program restricts payloads to values within the smallest payload capacity of any first-operand format, then payloads are preserved across radix conversions.

4. In the absence of suppression, bits 32-63 of general register 1 are always set to a return code, even though, in most cases, the return code is zero. Future extensions of PFPO may make more use of nonzero return codes. With the current definition, the only nonzero return codes are set for IEEE-overflow trap exceptions and IEEE-underflow trap exceptions. In this case, the value of the signed scaling exponent (Ω), is placed in

bits 32-63 of general register 1. For IEEE-inexact trap exceptions, the return code is set to zero, thus indicating that no scaling has occurred.

5. To display a value in scientific notation, many programming languages, calculators, and spread sheets use the letter e (or E) to separate the significand from the exponent. This is referred to as e-form notation. In this document, e-form notation, along with other forms of conventional numeric notation, is used to represent a value without regard to quantum. To indicate that both value and quantum are being represented, a variation of e-form notation, called q-form notation, is used. In q-form notation, the letter q replaces the letter e and the value shown after q is the right-units-view exponent, that is, the base 10 logarithm of the quantum. Thus, for example, the seven members of the cohort for the value 1e6 in the DFP short format are: 1q6, 10q5, 100q4, 1000q3, 10000q2, 100000q1, and 1000000q0.

As an example of the distinction between e-form and q-form notation, consider the representation of the members of the cohort of zero. The DFP short format, for example, can represent 198 exact powers of 10, ranging in value from 1e-101 to 1e96; but can represent only 192 values for a quantum, ranging from 1e-101 to 1e90. Thus, the 192 members of the cohort for zero range from 0q-101 to 0q90.

The effect of the DFP preferred quantum control is shown in Figure 9-29.

Rounded Intermediate Value	Result If Inexact	Result If Exact and DPQC = 0	Result If Exact and DPQC = 1
0	0q-101	0q90	0q0
0.125	1250000q-7	125q-3	125q-3
1	1000000q-6	1q0	1q0
10	1000000q-5	1q1	10q0
100	1000000q-4	1q2	100q0
1000	1000000q-3	1q3	1000q0
9999	9999000q-3	9999q0	9999q0
10000	1000000q-2	1q4	10000q0
10001	1000100q-2	10001q0	10001q0
1e5	1000000q-1	1q5	100000q0
1e6	1000000q0	1q6	1000000q0
1e10	1000000q4	1q10	1000000q4
1e15	1000000q9	1q15	1000000q9

Figure 9-29. Effect of DPQC on DFP Short Results

6. When the floating-point extension facility is installed, for a PFPO-convert-floating-point-radix operation with DFP result, if DPQC is zero and the DFP result is finite and exact, no quantum exception is recognized. This is because the operation always delivers the DFP result with the preferred quantum in this case.
7. The test bit (bit 32 of general register 0) provides a means of determining whether any future

extensions to the operation-type code, operand-format code, target-radix-dependent controls, rounding method, and various combinations thereof are supported by the CPU.

PFPO Actions

Figure 9-30 summarizes the actions performed by the PFPO-convert-floating-point-radix operation for various target formats.

Condition													Response							
Source	Rx	Rq	Csx	Caa	Cho	DQPC	Chu	IMi	IMo	IMu	IMx	IMq	Action	CC / PI	SFi	SFo	SFu	SFx	SFq	DXC (binary)
Actions for PFPO Binary-Floating-Point Targets																				
Normal	N												Complete	CC0						
Normal	Y		0							0			Complete	CC1				1		
Normal	Y		0							1			Complete	PI						00001y00
Normal	Y		1										Complete	CC0						
Xu	Y		1						0				Complete	CC1			1			
Xu	Y		0						0	0			Complete	CC1			1	1		
Xu	Y		0						0	1			Complete	PI			1			00001y00
Xu	N			0					1				Scaled	PI						00010000
Xu	Y			0					1				Scaled	PI						0001xy00
Xu	N			1					1				Scaled	CC2						00010000
Xu	Y			1					1				Scaled	CC2						0001xy00
Xo	Y'		1						0				Complete	CC1		1				
Xo	Y'		0						0	0			Complete	CC1		1		1		
Xo	Y'		0						0	1			Complete	PI		1				00001y00
Xo	N			0					1				Scaled	PI						00100000
Xo	Y			0					1				Scaled	PI						0010xy00
Xo	N			1					1				Scaled	CC2						00100000
Xo	Y			1					1				Scaled	CC2						0010xy00
Infinity	N'												Can.Inf	CC0						
QNaN	N'												QNaN	CC0						
SNaN	N'							0					QNaN	CC1	1					
SNaN	N'							1					Suppress	PI						10000000
Actions for PFPO Decimal-Floating-Point Targets																				
Normal	N	N											Complete	CC0						
Normal	N	Y				1						0	Complete	CC1					1	
Normal	N	Y				1						1	Complete	PI						00000100
Normal	N	Y				0							Complete	CC0						
Normal	Y	Y'	0			1				0	0		Complete	CC1				1	1	
Normal	Y	Y'	0			0				0			Complete	CC1				1		
Normal	Y	Y'	1			1						0	Complete	CC1					1	
Normal	Y	Y'	1			0							Complete	CC0						
Normal	Y	Y'	0			1				0	1		Complete	PI				1		00000100
Normal	Y	Y'	1			1						1	Complete	PI						00000100
Normal	Y	N'	0							1			Complete	PI						00001y00
Xu	Y	Y'	1			0			0				Complete	CC1			1			
Xu	Y	Y'	0			0			0	0			Complete	CC1			1	1		
Xu	Y	Y'	1			1			0	0			Complete	CC1			1		1	
Xu	Y	Y'	0			1			0	0	0		Complete	CC1			1	1	1	
Xu	Y	Y'	0			1			0	0	1		Complete	PI			1	1		00000100
Xu	Y	Y'	1			1			0		1		Complete	PI			1			00000100
Xu	Y	N'	0						0	1			Complete	PI			1			00001y00
Xu	N	N'		0					1				Scaled	PI						00010000
Xu	Y	N'		0					1				Scaled	PI						0001xy00
Xu	N	N'		1					1				Scaled	CC2						00010000
Xu	Y	N'		1					1				Scaled	CC2						0001xy00

Figure 9-30. Actions for Various PERFORM FLOATING POINT Conditions (Part 1 of 2)

Condition													Response								
Source	Rx	Rq	Csx	Caa	Cho	DQPC	Chu	IMi	IMo	IMu	IMx	IMq	Action	CC / PI	SFi	SFo	SFu	SFx	SFq	DXC (binary)	
Xo	Y'	Y'	1			0			0				Complete	CC1		1					
Xo	Y'	Y'	0			0			0	0			Complete	CC1		1		1			
Xo	Y'	Y'	1			1			0		0		Complete	CC1		1			1		
Xo	Y'	Y'	0			1			0	0	0		Complete	CC1		1		1	1		
Xo	Y'	Y'	0			1			0	0	1		Complete	PI		1		1			0000100
Xo	Y'	Y'	1			1			0		1		Complete	PI		1					0000100
Xo	Y'	N'	0						0	1			Complete	PI		1					00001y00
Xo	N	N'		0					1				Scaled	PI							00100000
Xo	Y	N'		0					1				Scaled	PI							0010xy00
Xo	N	N'		1					1				Scaled	CC2							00100000
Xo	Y	N'		1					1				Scaled	CC2							0010xy00
Infinity	N'												Can.Inf	CC0							
QNaN	N'												QNaN	CC0							
SNaN	N'							0					QNaN	CC1	1						
SNaN	N'							1					Suppress	PI							10000000
Actions for PFPO Hexadecimal-Floating-Point Targets																					
Normal	N												Complete	CC0							
Normal	Y		1										Complete	CC0							
Normal	Y		0							0			Complete	CC1				1			
Normal	Y		0							1			Complete	PI							00001y00
Ho					0			0					Hmax	CC1	1						
Ho					0			1					Supp.	PI							10000000
Ho	Y'		1		1			0					Hmax	CC1		1					
Ho	Y'		0		1			0	0				Hmax	CC1		1		1			
Ho	Y'		0		1			0	1				Hmax	PI		1					00001000
Ho				0	1				1				Scaled	PI							0010xy00
Ho				1	1				1				Scaled	CC2							0010xy00
Hu	Y'		1				0						TZ	CC0							
Hu	Y'		0				0			0			TZ	CC1				1			
Hu	Y'		0				0			1			TZ	PI							00001000
Hu	Y'		1				1		0				TZ	CC1			1				
Hu	Y'		0				1		0	0			TZ	CC1			1	1			
Hu	Y'		0				1		0	1			TZ	PI			1				00001000
Hu				0			1		1				Scaled	PI							0001xy00
Hu				1			1		1				Scaled	CC2							0001xy00
Infinity								0					Hmax	CC1	1						
Infinity								1					Supp.	PI							10000000
NaN								0					+Hmax	CC1	1						
NaN								1					Supp.	PI							10000000

Explanation:

Caa	Alternate-exception-action control (GR0.57)	N'	No (true by virtue of other conditions in this row)
Cho	HFP-overflow control (GR0.58 for HFP targets)	PI	Program interruption
Chu	HFP-underflow control (GR0.59 for HFP targets)	Rq	Quantum-exception condition
Csx	Inexact-suppression control (GR0.56)	Rx	Inexact-result condition
DQPC	DFP quantum-permission control (GR0.58 for DFP targets)	SFi	IEEE-invalid-operation flag (FPC.8)
DXC	Data-Exception Code (shown in binary)	SFo	IEEE-overflow flag (FPC.10)
Hmax	The largest (in magnitude) representable number in this HFP format with the same sign as the source.	SFq	Quantum-exception flag (FPC.13)
+Hmax	Hmax with a plus sign	SFu	IEEE-underflow flag (FPC.11)
Ho	HFP-overflow condition	SFx	IEEE-inexact flag (FPC.12)
Hu	HFP-underflow condition	Tz	True zero with the same sign as the source.
IMi	IEEE-invalid-operation mask (FPC.0)	x	Inexact result (bit 4 of the DXC)
IMo	IEEE-overflow mask (FPC.2)	Xi	IEEE-invalid-operation exception
IMq	Quantum-exception mask (FPC.5)	Xo	IEEE-overflow exception
IMu	IEEE-underflow mask (FPC.3)	Xu	IEEE-underflow exception
IMx	IEEE-inexact mask (FPC.4)	y	Inexact result was incremented in magnitude (bit 5 of the DXC)
N	No	Y	Yes
		Y'	Yes (true by virtue of other conditions in this row)

Figure 9-30. Actions for Various PERFORM FLOATING POINT Conditions (Part 2 of 2)

SET BFP ROUNDING MODE

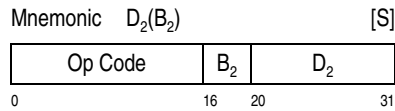

Mnemonic	Op Code	Operands
SRNM	'B299'	2-bit BFP rounding mode
SRNMB	'B2B8'	3-bit BFP rounding mode

The BFP rounding-mode bits in the FPC register are set from the second-operand address.

For SRNM, the second-operand address is not used to address data; instead, bits 30-31 of the FPC register are set to bits 62 and 63, respectively, of the address. Bits other than 62 and 63 of the second-operand address are ignored. When the floating-point extension facility is installed, bit 29 of the FPC register is set to zero.

For SRNMB, the second-operand address is not used to address data; instead, bits 29-31 of the FPC register are set to bits 61-63, respectively, of the address. Bits 0-55 of the second-operand address are ignored, bits 56-60 must be zero, and bits 61-63 must designate a valid rounding mode; otherwise, a specification exception is recognized.

Condition Code: The code remains unchanged.

IEEE Exceptions: None.

Program Exceptions:

- Data with DXC 2, BFP instruction
- Operation (SRNMB only if the floating-point extension facility is not installed)
- Specification (SRNMB only)
- Transaction constraint

Programming Note: SRNMB is a complete superset of the functionality of SRNM. It is recommended that newly developed software use the SRNMB instruction exclusively.

SET DFP ROUNDING MODE

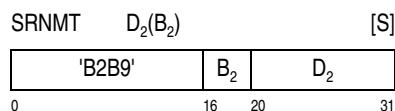

The DFP rounding-mode bits are set from the second-operand address.

The second-operand address is not used to address data; instead, the DFP rounding-mode bits in the FPC register are set with bits 61-63 of the address.

Bits other than 61-63 of the second-operand address are ignored.

Condition Code: The code remains unchanged.

IEEE Exceptions: None.

Program Exceptions:

- Data with DXC 3, DFP instruction
- Operation (if the decimal-floating-point-rounding facility is not installed)
- Transaction constraint

SET FPC

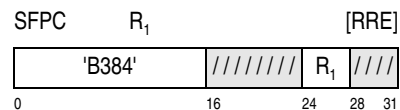

The contents of bit positions 32-63 of the general register designated by R_1 are placed in the FPC (floating-point-control) register.

All of bits 32-63 corresponding to unsupported bit positions in the FPC register must be zero; otherwise, a specification exception is recognized. For purposes of this checking, a bit position is considered to be unsupported only if it is either unassigned or assigned to a facility which is not installed in any architectural mode of the configuration. Bits 0-31 of the general register are ignored.

When the floating-point extension facility is installed, the bits corresponding to the BFP rounding mode must specify a valid rounding mode; otherwise, a specification exception is recognized.

Condition Code: The code remains unchanged.

IEEE Exceptions: None.

Program Exceptions:

- Data with DXC 2, BFP instruction

- Specification
- Transaction constraint

Programming Notes:

1. When the architectural mode of a CPU is changed without resetting the FPC register (by means of the set architecture signal-processor order, for example) the entire contents of the FPC register are preserved. This is true even when some of these bits are associated with a facility which is not available in both architectural modes. Checking for unsupported bit positions of the FPC register is performed independently of the current architectural mode of the CPU; thus, it is always safe to restore the FPC register from a value previously saved on this CPU, even after the architectural mode has changed.
2. See also the programming notes under LOAD FPC.

SET FPC AND SIGNAL

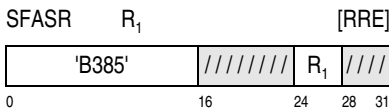

First, bits 0-4 of byte 1 of the floating-point-control (FPC) register at the beginning of the operation are preserved to be used as signaling flags. Next, the contents of the source operand are placed in the FPC register; then the flags in the FPC register are set to the logical OR of the signaling flags and the source flags. Finally, the conditions for simulated-IEEE-exception trap action are examined.

The source operand is in bits 32-63 of the general register designated by R₁; bits 0-31 of the general register are ignored.

If any signaling flag is one and the corresponding source mask is also one, simulated-IEEE-exception trap action occurs. The data-exception code (DXC) in the FPC register is updated to indicate the specific cause of the interruption and a data-exception program interruption occurs at completion of the instruction execution. The DXC for the interruption is shown in Figure 9-21 on page 9-33.

If no signaling flag is enabled, the DXC in the FPC register remains as loaded from the source and instruction execution completes with no trap action.

See Figure 9-22 on page 9-33 for a detailed description of the result of this instruction.

Bits in the source operand that correspond to unsupported bit positions in the FPC register must be zero; otherwise, a specification exception is recognized. For purposes of this checking, a bit position is considered to be unsupported only if it is either unassigned or assigned to a facility which is not installed in any architectural mode of the configuration.

When the floating-point extension facility is installed, the bits corresponding to the BFP rounding mode must specify a valid rounding mode; otherwise, a specification exception is recognized.

Condition Code: The code remains unchanged.

Program Exceptions:

- Data with DXC 3, DFP instruction
- Data with DXC for simulated IEEE exception
- Operation (if the IEEE-exception-simulation facility is not installed)
- Specification
- Transaction constraint

Programming Notes:

1. See also the programming notes under LOAD FPC AND SIGNAL.
2. Bits 0-31 of the general register designated by the R₁ field are reserved for future extension and should be set to zeros.

STORE

Mnemonic R₁,D₂(X₂,B₂) [RX-a]

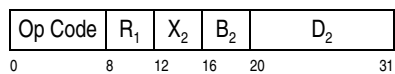

Mnemonic	Op Code	Operands
STE	'70'	Short
STD	'60'	Long

Mnemonic2 R₁,D₂(X₂,B₂) [RXY-a]

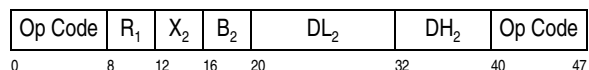

Mnemonic2	Op Code	Operands
STEY	'ED66'	Short
STDY	'ED67'	Long

The first operand is placed unchanged in storage at the second-operand location.

The displacement for STE and STD is treated as a 12-bit unsigned binary integer. The displacement for STEY and STDY is treated as a 20-bit signed binary integer.

Condition Code: The code remains unchanged.

Program Exceptions:

- Access (store, operand 2)
- Data with DXC 1, AFP register
- Operation (STEY and STDY, if the long-displacement facility is not installed)
- Transaction constraint

Programming Note: Data can be stored from the vector registers to the little endian format using the extended mnemonics STERV and STDRV for the VSTEBRF and VSTEBRG instructions (see page 21-22).

STORE FPC

STFPC D₂(B₂) [S]

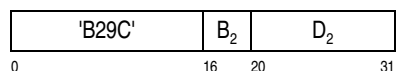

The contents of the FPC (floating-point-control) register are placed in storage at the second-operand location.

The operand is four bytes in length. All 32 bits of the FPC register are stored.

Condition Code: The code remains unchanged.

IEEE Exceptions: None.

Program Exceptions:

- Access (store, operand 2)

- Data with DXC 2, BFP instruction
- Transaction constraint

Summary of All Floating-Point Instructions

Figures 9-31 through 9-37 on the following pages show mnemonics for all floating-point instructions (except for PFPO) arranged in various categories of operand format and type of operation. Figure 9-31 shows those instructions which operate on the FPC register. Figure 9-32 on page 9-50 shows the floating-point instructions which have all operands in the same format (same radix and same length), including those FPS (floating-point support) instructions which operate on floating-point operands in a radix-independent manner. Figure 9-33 on page 9-51 and Figure 9-34 on page 9-51 show the floating-point instructions in which all operands are in the same radix but not all of the same length. Figure 9-35 on page 9-51 and Figure 9-36 on page 9-52 show the floating-point instructions in which the source or the result is in a general register. Figure 9-37 on page 9-52 shows the floating-point instructions other than PFPO which perform radix conversion.

Instruction Name	Mnemonic	Type
EXTRACT FPC	EFPC	BFP
LOAD FPC	LFPC	BFP
LOAD FPC AND SIGNAL	LFAS	DFP
SET BFP ROUNDING MODE	SRNM, SRNMB ¹	BFP
SET DFP ROUNDING MODE	SRNMT	DFP
SET FPC	SFPC	BFP
SET FPC AND SIGNAL	SFASR	DFP
STORE FPC	STFPC	BFP
Explanation:		
	Mnemonics in bold indicate a register-and-storage operation.	
¹	The instruction is only available if the floating-point extension facility is installed.	
BFP	The instruction is considered to be part of the BFP facility. An attempt to execute this instruction when the AFP-register-control bit is zero results in a BFP-instruction data exception, DXC 2.	
DFP	The instruction is considered to be part of the DFP facility. An attempt to execute this instruction when the AFP-register-control bit is zero results in a DFP-instruction data exception, DXC 3.	

Figure 9-31. Floating-Point-Control-Register Instructions

Instruction Name	FPS			HFP			BFP			DFP		
	Short	Long	Ext.	Short	Long	Ext.	Short	Long	Ext.	Short	Long	Ext.
ADD (NORMALIZED)				AER AE	ADR AD	AXR	AEBR AEB	ADBR ADB	AXBR		ADTR(A)	AXTR(A)
ADD UNNORMALIZED				AUR AU	AWR AW							
COMPARE				CER CE	CDR CD	CXR	CEBR CEB	CDBR CDB	CXBR		CDTR	CXTR
COMPARE AND SIGNAL							KEBR KEB	KDBR KDB	KXBR		KDTR	KXTR
COMPARE BIASED EXPONENT											CEDTR	CEXTR
COPY SIGN		CPSDR										
DIVIDE				DER DE	DDR DD	DXR	DEBR DEB	DDBR ddb	DXBR		DDTR(A)	DXTR(A)
DIVIDE TO INTEGER							DIEBR	DIDBR				
HALVE				HER	HDR							
LOAD	LER LE LEY	LDR LD LDY	LXR									
LOAD AND TEST				LTER	LTDR	LTXR	LTEBR	LTDBR	LTXBR		LTDR	LTXTR
LOAD COMPLEMENT		LCDFR		LCER	LCDR	LCXR	LCEBR	LCDBR	LCXBR			
LOAD FP INTEGER				FIER	FIDR	FIXR	FIEBR(A)	FIDBR(A)	FIXBR(A)		FIDTR	FIXTR
LOAD NEGATIVE		LNDFR		LNER	LNDR	LNXR	LNEBR	LNDBR	LNXBR			
LOAD POSITIVE		LPDFR		LPER	LPDR	LPXR	LPEBR	LPDBR	LPXBR			
LOAD ZERO	LZER	LZDR	LZXR									
MULTIPLY				MEER MEE	MDR MD	MXR	MEEBR MEEB	MDBR MDB	MXBR		MDTR(A)	MXTR(A)
MULTIPLY AND ADD				MAER MAE	MADR MAD		MAEBR MAEB	MADBR MADB				
MULTIPLY AND ADD UNNORMALIZED					MAYHR MAYH MAYLR MAYL							
MULTIPLY AND SUBTRACT				MSER MSE	MSDR MSD		MSEBR MSEB	MSDBR MSDB				
MULTIPLY UNNORMALIZED					MYHR MYH MYLR MYL							
QUANTIZE											QADTR	QAXTR
REROUND											RRDTR	RRXTR
SHIFT SIGNIFICAND LEFT											SLDT	SLXT
SHIFT SIGNIFICAND RIGHT											SRDT	SRXT
SQUARE ROOT				SQER SQE	SQDR SQD	SQXR	SQEBR SQEB	SQDBR SQDB	SQXBR			
STORE	STE STEY	STD STDY										
SUBTRACT (NORMALIZED)				SER SE	SDR SD	SXR	SEBR SEB	SDBR SDB	SXBR		SXTR(A)	SDTR(A)
SUBTRACT UNNORMALIZED				SUR SU	SWR SW							
TEST DATA CLASS							TCEB	TCDB	TCXB	TDCET	TDCDT	TDCXT
TEST DATA GROUP										TDGET	TDGDT	TDGXT

Explanation:

Mnemonics in **bold** indicate a register-and-storage operation.

When the last letter of mnemonic is A, the instruction is an alternate instruction, which uses additional modifier fields not available to the original instruction.

Figure 9-32. Floating-Point Instructions: All Operands Same Format

Instruction Name	HFP			BFP			DFP	
	Short to Long	Long to Ext.	Short to Ext.	Short to Long	Long to Ext.	Short to Ext.	Short to Long	Long to Ext.
LOAD LENGTHENED	LDER LDE	LXDR LXD	LXER LXE	LDEBR LDEB	LXDBR LXDB	LXEBR LXEB	LETR	LXDTR
MULTIPLY	MDER MDE	MXDR MXD		MDEBR MDEB	MXDBR MXDB			
MULTIPLY AND ADD UNNORMALIZED		MAYR MAY						
MULTIPLY UNNORMALIZED		MYR MY						
Explanation:								
Mnemonics in bold indicate a register-and-storage operation.								

Figure 9-33. Floating-Point Instructions: Result Longer than Source

Instruction Name	HFP			BFP			DFP	
	Long to Short	Ext. to Long	Ext. to Short	Long to Short	Ext. to Long	Ext. to Short	Long to Short	Ext. to Long
LOAD ROUNDED	LEDR	LDXR	LEXR	LEDBR(A)	LDXBR(A)	LEXBR(A)	LETR	LXDTR

Figure 9-34. Floating-Point Instructions: Result Shorter than Source

Instruction Name	Source GR Size (bits)	Result								
		FPS	HFP			BFP			DFP	
		Long	Short	Long	Ext.	Short	Long	Ext.	Long	Ext.
CONVERT FROM FIXED	32		CEFR	CDFR	CXFR	CEFBR(A)	CDFBR(A)	CXFBR(A)	CDFTR	CXFTR
CONVERT FROM FIXED	64		CEGR	CDGR	CXGR	CEGBR(A)	CDGBR(A)	CXGBR(A)	CDGTR(A)	CXGTR(A)
CONVERT FROM LOGICAL	32					CELFBR	CDLFBR	CXLFBR	CDLFTR	CXLFTR
CONVERT FROM LOGICAL	64					CELGBR	CDLGBR	CXLGBR	CDLGTR	CXLGTR
CONVERT FROM SIGNED PACKED	64								CDSTR	
CONVERT FROM SIGNED PACKED	128									CXSTR
CONVERT FROM UNSIGNED PACKED	64								CDUTR	
CONVERT FROM UNSIGNED PACKED	128									CXUTR
INSERT BIASED EXPONENT	64								IEDTR	IEXTR
LOAD FPR FROM GR	64	LDGR								

Figure 9-35. Floating-Point Instructions: General Register Source

Instruction Name	Result GR Size (bits)	Result								
		FPS	HFP			BFP			DFP	
		Long	Short	Long	Ext.	Short	Long	Ext.	Long	Ext.
CONVERT TO FIXED	32		CFER	CFDR	CFXR	CFEBR(A)	CFDBR(A)	CFXBR(A)	CFDTR	CFXTR
CONVERT TO FIXED	64		CGER	CGDR	CGXR	CGEBR(A)	CGDBR(A)	CGXBR(A)	CGDTR(A)	CGXTR(A)
CONVERT TO LOGICAL	32					CLFEBR	CLFDBR	CLFXBR	CLFDTR	CLFXTR
CONVERT TO LOGICAL	64					CLGEBR	CLGDBR	CLGXBR	CLGDTR	CLGXTR
CONVERT TO SIGNED PACKED	64								CSDTR	
CONVERT TO SIGNED PACKED	128									CSXTR
CONVERT TO UNSIGNED PACKED	64								CUDTR	
CONVERT TO UNSIGNED PACKED	128									CUXTR
EXTRACT BIASED EXPONENT	64								EEDTR	EEXTR
EXTRACT SIGNIFICANCE	64								ESDTR	ESXTR
LOAD GR FROM FPR	64	LGDR								

Figure 9-36. Floating-Point Instructions: General Register Result

Instruction Name	Source	Result		
		HFP	BFP	
		Long	Short	Long
CONVERT BFP TO HFP	BFP Short	THDER		
CONVERT BFP TO HFP	BFP Long	THDR		
CONVERT HFP TO BFP	HFP Long		TBEDR	TBDR

Figure 9-37. Floating-Point Instructions (other than PFPO): Radix Conversion

Instruction Name	Source	DFP Result	
		Long	Extended
CONVERT FROM ZONED	Zoned	CDZT	CXZT

Figure 9-38. Floating-Point Instructions: Zoned Conversion with Storage Source

Instruction Name	DFP Source		Result
	Long	Extended	
CONVERT TO ZONED	CZDT	CZXT	Zoned

Figure 9-39. Floating-Point Instructions: Zoned Conversion with Storage Result

Impacts on ESA/390 and ESA/390-Compatibility Mode

When the decimal-floating-point facility or the floating-point extension facility is installed in the z/Architectural mode, the behavior of some instructions in the ESA/390 mode and ESA/390-compatibility mode deviates from the definition in the ESA/390 architecture.

The following summarizes the different behavior of affected ESA/390 instructions caused by those two facilities in the z/Architecture architectural mode.

Impacts of the Decimal-Floating-Point Facility

When the decimal-floating-point facility is installed in the z/Architectural architecture mode, it causes the following deviations from the ESA/390 architecture.

- For LOAD FPC (LFPC) and SET FPC (SFPC), if bits 25-27 of the source operand contain a non-zero value, it is unpredictable whether a specification exception is recognized or the corresponding bits in the FPC register are set to this nonzero value.

Impacts of the Floating-Point Extension Facility

When the floating-point extension facility is installed in the z/Architectural architecture mode, it causes the following deviations from the ESA/390 architecture.

1. For LOAD FPC (LFPC) and SET FPC (SFPC), if either or both bit 5 and bit 13 of the source operand are one, it is unpredictable whether a specification exception is recognized or the corresponding bit in the FPC register is set to one; if bits 29-31 of the source operand contain all ones, it is unpredictable whether a specification exception is recognized or the corresponding bits in the FPC register are set to all ones.
2. For CONVERT HFP TO BFP (TBEDR, TBDR), if the M_3 field designates the value 3, it is unpredictable whether a specification exception is recognized or an undefined rounding method is performed.
3. For BFP CONVERT TO FIXED (CFEBR, CFDBR, CFXBR), if the M_3 field designates the value 3, it is unpredictable whether a specification exception is recognized or an undefined rounding method is performed. In addition, if bits 20-23 of the instruction contain a nonzero value, it is unpredictable whether recognition of IEEE-inexact exception is suppressed.
4. For BFP CONVERT FROM FIXED (CEFBR, CDFBR, CXFBR), if bits 16-19 of the instruction contain a nonzero value, it is unpredictable whether a specification exception is recognized or an undefined rounding method is performed. In addition, if bits 20-23 of the instruction contain a nonzero value, it is unpredictable whether recognition of IEEE-inexact exception is suppressed.
5. For BFP DIVIDE TO INTEGER (DIEBR, DIDBR), if the M_3 field designates the value 3, it is unpredictable whether a specification exception is recognized or an undefined rounding method is performed.
6. For BFP LOAD FP INTEGER (FIEBR, FIDBR, FIXBR), if the M_3 field designates the value 3, it is unpredictable whether a specification exception is recognized or an undefined rounding method is performed. In addition, if bits 20-23 of the instruction contain a nonzero value, it is unpredictable whether recognition of IEEE-inexact exception is suppressed.
7. For BFP LOAD ROUNDED (LEDBR, LDXBR, LEXBR), if bits 16-19 of the instruction contain a nonzero value, it is unpredictable whether a specification exception is recognized or an undefined rounding method is performed. In addition, if bits 20-23 of the instruction contain a nonzero value, it is unpredictable whether recognition of IEEE-inexact exception is suppressed.

whether a specification exception is recognized or an undefined rounding method is performed. In addition, if bits 20-23 of the instruction contain a nonzero value, it is unpredictable whether recognition of IEEE-inexact exception is suppressed.

Chapter 10. Control Instructions

BRANCH AND SET AUTHORITY	10-7	PERFORM TIMING FACILITY FUNCTION	10-83
BRANCH AND STACK	10-11	PERFORM TOPOLOGY FUNCTION	10-92
BRANCH IN SUBSPACE GROUP	10-13	PROGRAM CALL	10-93
COMPARE AND REPLACE DAT TABLE		PROGRAM RETURN	10-106
ENTRY	10-17	PROGRAM TRANSFER	10-110
COMPARE AND SWAP AND PURGE	10-21	PROGRAM TRANSFER WITH INSTANCE	10-110
DIAGNOSE	10-23	PURGE ALB	10-119
EXTRACT AND SET EXTENDED		PURGE TLB	10-119
AUTHORITY	10-24	RESET REFERENCE BIT EXTENDED	10-119
EXTRACT PRIMARY ASN	10-24	RESET REFERENCE BITS MULTIPLE	10-120
EXTRACT PRIMARY ASN AND INSTANCE	10-24	RESUME PROGRAM	10-120
EXTRACT SECONDARY ASN	10-24	SET ADDRESS SPACE CONTROL	10-123
EXTRACT SECONDARY ASN AND		SET ADDRESS SPACE CONTROL FAST	10-123
INSTANCE	10-25	SET CLOCK	10-124
EXTRACT STACKED REGISTERS	10-25	SET CLOCK COMPARATOR	10-125
EXTRACT STACKED STATE	10-26	SET CLOCK PROGRAMMABLE FIELD	10-126
INSERT ADDRESS SPACE CONTROL	10-29	SET CPU TIMER	10-126
INSERT PSW KEY	10-30	SET PREFIX	10-126
INSERT REFERENCE BITS MULTIPLE	10-30	SET PSW KEY FROM ADDRESS	10-127
INSERT STORAGE KEY EXTENDED	10-30	SET SECONDARY ASN	10-128
INSERT VIRTUAL STORAGE KEY	10-31	SET SECONDARY ASN WITH INSTANCE	10-128
INVALIDATE DAT TABLE ENTRY	10-32	SET STORAGE KEY EXTENDED	10-133
INVALIDATE PAGE TABLE ENTRY	10-37	SET SYSTEM MASK	10-136
LOAD ADDRESS SPACE PARAMETERS	10-41	SIGNAL PROCESSOR	10-136
LOAD CONTROL	10-50	STORE CLOCK COMPARATOR	10-138
LOAD PAGE TABLE ENTRY ADDRESS	10-50	STORE CONTROL	10-138
LOAD PSW	10-54	STORE CPU ADDRESS	10-139
LOAD PSW EXTENDED	10-55	STORE CPU ID	10-139
LOAD REAL ADDRESS	10-56	STORE CPU TIMER	10-141
LOAD USING REAL ADDRESS	10-60	STORE FACILITY LIST	10-141
MODIFY STACKED STATE	10-61	STORE PREFIX	10-142
MOVE PAGE	10-62	STORE REAL ADDRESS	10-142
MOVE TO PRIMARY	10-65	STORE SYSTEM INFORMATION	10-143
MOVE TO SECONDARY	10-65	STORE THEN AND SYSTEM MASK	10-167
MOVE WITH DESTINATION KEY	10-67	STORE THEN OR SYSTEM MASK	10-167
MOVE WITH KEY	10-67	STORE USING REAL ADDRESS	10-168
MOVE WITH OPTIONAL SPECIFICATIONS	10-69	TEST ACCESS	10-168
MOVE WITH SOURCE KEY	10-72	TEST BLOCK	10-170
PAGE IN	10-73	TEST PENDING EXTERNAL	
PAGE OUT	10-74	INTERRUPTION	10-172
PERFORM CRYPTOGRAPHIC KEY		TEST PROTECTION	10-173
MANAGEMENT OPERATION	10-75	TRACE	10-176
PERFORM FRAME MANAGEMENT		TRAP	10-177
FUNCTION	10-80		

This chapter includes all privileged and semiprivileged instructions described in this publication, except the input/output instructions, which are described in “I/O Instructions” on page 14-1.

Privileged instructions may be executed only when the CPU is in the supervisor state. An attempt to execute a privileged instruction in the problem state generates a privileged-operation exception.

The semiprivileged instructions are those instructions that can be executed in the problem state when certain authority requirements are met. An attempt to execute a semiprivileged instruction in the problem state when the authority requirements are not met generates a privileged-operation exception or some other program-interruption condition depending on the particular requirement which is violated. Those requirements which cause a privileged-operation exception to be generated in the problem state are not enforced when execution is attempted in the supervisor state.

The control instructions and their mnemonics, formats, and operation codes are listed in Figure 10-1 on page 10-3. The figure also indicates which instructions are new in z/Architecture as compared to ESA/390, when the condition code is set, the instruction fields that designate access registers, and the exceptional conditions in operand designations, data, or results that cause a program interruption.

The instructions that are new in z/Architecture are indicated in Figure 10-1 by “N.”

When the operands of an instruction are 32-bit operands, the mnemonic for the instruction does not include a letter indicating the operand length. If there is an instruction with the same name but with 64-bit operands, its mnemonic includes the letter “G.” In Figure 10-1, when there is an instruction with 32-bit operands and another instruction with the same name but with “G” added in its mnemonic, the first instruction has “(32)” after its name, and the other instruction has “(64)” after its name.

For those control instructions which have special rules regarding the handling of exceptional situations, a section called “Special Conditions” is included. This section indicates the type of ending (suppression, nullification, or completion) only for those exceptions for which the ending may vary.

Note: In the detailed descriptions of the individual instructions, the mnemonic and the symbolic operand designation for the assembler language are shown with each instruction. For LOAD PSW, for example, LPSW is the mnemonic and $D_2(B_2)$ the operand designation.

Programming Notes:

1. The following additional control instructions are available when the DAT-enhancement facility is installed:

- COMPARE AND SWAP AND PURGE (CSPG)
- INVALIDATE DAT TABLE ENTRY

CSPG operates on a doubleword in storage, in contrast to the previously existing instruction COMPARE AND SWAP AND PURGE (CSP), which operates on a word in storage.

2. The long-displacement facility uses new instruction formats, named RSY, RXY, and SIY, to provide 20-bit signed displacements. In connection with the long-displacement facility, all previously existing control instructions of the RSE or RXE format are changed to be of format RSY or RXY, respectively, where the new formats differ from the old by using a previously unused byte, now named DH, in the instructions. When the long-displacement facility is installed, the displacement for an instruction operand address is formed by appending DH on the left of the previous displacement field, now named DL, of the instruction. When the long-displacement facility is not installed, eight zero bits are appended on the left of DL, and DH is ignored.

The following additional control instruction is available when the long-displacement facility is installed:

- LOAD REAL ADDRESS (LRAY)

3. The following additional control instructions are available when the ASN-and-LX-reuse facility is installed:

- EXTRACT PRIMARY ASN AND INSTANCE
- EXTRACT SECONDARY ASN AND INSTANCE
- PROGRAM TRANSFER WITH INSTANCE
- SET SECONDARY ASN WITH INSTANCE

4. The LOAD PAGE TABLE ENTRY ADDRESS control instruction is available when the DAT-enhancement facility 2 is installed.

5. The PERFORM TIMING FACILITY FUNCTION control instruction is available when the TOD-clock-steering facility is installed.

6. The MOVE WITH OPTIONAL SPECIFICATIONS control instruction is available when the move-with-optional-specifications facility is installed.
7. The PERFORM TOPOLOGY FUNCTION control instruction is available when the configuration-topology facility is installed.
8. The PERFORM CRYPTOGRAPHIC KEY MANAGEMENT OPERATION control instruction is available when the message-security-assist extension 3 is installed.
9. The RESET REFERENCE BITS MULTIPLE control instruction is available when the reset-reference-bits-multiple facility is installed.
10. The COMPARE AND REPLACE DAT TABLE ENTRY instruction is available when the enhanced-DAT facility 2 is installed.
11. The INSERT REFERENCE BITS MULTIPLE control instruction is available when the insert-reference-bits-multiple facility is installed.
12. The TEST PENDING EXTERNAL INTERRUPTION control instruction is available when the test-pending-external-interruption facility is installed.

Name	Mnemonic	Characteristics							Op-code	Page	
BRANCH AND SET AUTHORITY	BSA	RRE		Q	A ¹ *	SO T		B		B25A	10-7
BRANCH AND STACK	BAKR	RRE		α ¹	A ¹ *	Z ⁵ T		B ST		B240	10-11
BRANCH IN SUBSPACE GROUP	BSG	RRE		α ¹	A ¹ *	SO T		B	R ₂	B258	10-13
COMPARE AND REPLACE DAT TABLE ENTRY	CRDTE	RRF-b	ED2	P	A ¹	SP	\$			B98F	10-17
COMPARE AND SWAP AND PURGE (32)	CSP	RRE	C	P	A ¹	SP	\$	ST	R ₂	B250	10-21
COMPARE AND SWAP AND PURGE (64)	CSPG	RRE	C DE	P	A ¹	SP	\$	ST	R ₂	B98A	10-21
DIAGNOSE	—		DM	P	DM				MD	83	10-23
EXTRACT AND SET EXTENDED AUTHORITY	ESEA	RRE	N	P						B99D	10-24
EXTRACT PRIMARY ASN	EPAR	RRE		Q		SO				B226	10-24
EXTRACT PRIMARY ASN AND INSTANCE	EPAIR	RRE	RA	Q		SO				B99A	10-24
EXTRACT SECONDARY ASN	ESAR	RRE		Q		SO				B227	10-24
EXTRACT SECONDARY ASN AND INSTANCE	ESAIR	RRE	RA	Q		SO				B99B	10-25
EXTRACT STACKED REGISTERS (32)	EREG	RRE		α ¹	A ¹ *	SE			U ₁ U ₂	B249	10-25
EXTRACT STACKED REGISTERS (64)	EREGG	RRE	N	α ¹	A ¹ *	SE			U ₁ U ₂	B90E	10-25
EXTRACT STACKED STATE	ESTA	RRE	C	α ¹	A ¹ *	SP	SE			B24A	10-26
INSERT ADDRESS SPACE CONTROL	IAC	RRE	C	Q		SO				B224	10-29
INSERT PSW KEY	IPK	S		Q			G2			B20B	10-30
INSERT REFERENCE BITS MULTIPLE	IRBM	RRE	IM	P	A ¹ *					B9AC	10-30
INSERT STORAGE KEY EXTENDED	ISKE	RRE		P	A ¹ *					B229	10-30
INSERT VIRTUAL STORAGE KEY	IVSK	RRE		Q	A ¹ *	SO			R ₂	B223	10-31
INVALIDATE DAT TABLE ENTRY	IDTE	RRF-b	U DE	P	A ¹	SP	\$			B98E	10-32
INVALIDATE PAGE TABLE ENTRY	IPTE	RRF-a		P	A ¹	SP	\$			B221	10-37
LOAD ADDRESS SPACE PARAMETERS	LASP	SSE	C	P	A ¹	SP	SO		B ₁	E500	10-41
LOAD CONTROL (32)	LCTL	RS-a		P	A	SP			B ₂	B7	10-50
LOAD CONTROL (64)	LCTLG	RSY-a	N	P	A	SP			B ₂	EB2F	10-50
LOAD PAGE TABLE ENTRY ADDRESS	LPTEA	RRF-b	C D2	P	A ¹ *	SP	SO		R ₂	B9AA	10-50
LOAD PSW	LPSW	SI	L	P	A	SP	¢		B ₂	82	10-54
LOAD PSW EXTENDED	LPSWE	S	L N	P	A	SP	¢		B ₂	B2B2	10-55
LOAD REAL ADDRESS (32)	LRA	RX-a	C	P	A ¹ *		SO		BP	B1	10-56
LOAD REAL ADDRESS (32)	LRAY	RXY-a	C LD	P	A ¹ *		SO		BP	E313	10-56
LOAD REAL ADDRESS (64)	LRAG	RXY-a	C N	P	A ¹ *				BP	E303	10-56
LOAD USING REAL ADDRESS (32)	LURA	RRE		P	A ¹	SP				B24B	10-60
LOAD USING REAL ADDRESS (64)	LURAG	RRE	N	P	A ¹	SP				B905	10-60
MODIFY STACKED STATE	MSTA	RRE		α ¹	A ¹ *	SP	SE	ST		B247	10-61
MOVE PAGE	MVPG	RRE	C	Q	A	SP	OP ¢ ⁴ G0	K ST	R ₁ R ₂	B254	10-62

Figure 10-1. Summary of Control Instructions (Part 1 of 5)

Name	Mnemonic	Characteristics							Op-code	Page
MOVE TO PRIMARY	MVCP	SS-d	C	Q	A	SO	ϕ	ST	DA	10-65
MOVE TO SECONDARY	MVCS	SS-d	C	Q	A	SO	ϕ	ST	DB	10-65
MOVE WITH DESTINATION KEY	MVCDK	SSE		Q	A		GM	ST	B ₁ B ₂	E50F 10-67
MOVE WITH KEY	MVCK	SS-d	C	Q	A			ST	B ₁ B ₂	D9 10-67
MOVE WITH OPTIONAL SPECIFICATIONS	MVCOS	SSF	C MO	Q	A	SO	G0	ST	B† B‡	C80 10-69
MOVE WITH SOURCE KEY	MVCSK	SSE		Q	A		GM	ST	B ₁ B ₂	E50E 10-72
PAGE IN	PGIN	RRE	C ES	P	A ¹		ϕ			B22E 10-73
PAGE OUT	PGOUT	RRE	C ES	P	A ¹		ϕ			B22F 10-74
PERFORM CRYPTO. KEY MGMT. OPERATION	PCKMO	RRE	M3	P	A SP		GM	ST		B928 10-75
PERFORM FRAME MANAGEMENT FUNCTION	PFMF	RRE	ED1	P	A ¹ SP	II	ϕ ³	K		B9AF 10-80
PERFORM TIMING FACILITY FUNCTION	PTFF	E	C TS	Q	A SP		GM	ST		0104 10-83
PERFORM TOPOLOGY FUNCTION	PTF	RRE	C CT	P	SP					B9A2 10-92
PROGRAM CALL	PC	S		Q	A ^{1*}	Z ¹ T	ϕ GM	B ST		B218 10-93
PROGRAM RETURN	PR	E	L	α ¹	A ^{1*} SP	Z ⁴ T	ϕ ²	B ST		0101 10-106
PROGRAM TRANSFER	PT	RRE		Q	A ^{1*} SP	Z ² T	ϕ	B		B228 10-110
PROGRAM TRANSFER WITH INSTANCE	PTI	RRE	RA	Q	A ^{1*} SP	Z ⁶ T	ϕ	B		B99E 10-110
PURGE ALB	PALB	RRE		P			\$			B248 10-119
PURGE TLB	PTLB	S		P			\$			B20D 10-119
RESET REFERENCE BIT EXTENDED	RRBE	RRE	C	P	A ^{1*}					B22A 10-119
RESET REFERENCE BITS MULTIPLE	RRBM	RRE	RB	P	A ^{1*}					B9AE 10-120
RESUME PROGRAM	RP	S	L	Q	A SP	WE T		B	B ₂	B277 10-120
SET ADDRESS SPACE CONTROL	SAC	S		Q	SP	SW	ϕ			B219 10-123
SET ADDRESS SPACE CONTROL FAST	SACF	S		Q	SP	SW				B279 10-123
SET CLOCK	SCK	S	C	P	A SP				B ₂	B204 10-124
SET CLOCK COMPARATOR	SCKC	S		P	A SP				B ₂	B206 10-125
SET CLOCK PROGRAMMABLE FIELD	SCKPF	E		P	SP		G0			0107 10-126
SET CPU TIMER	SPT	S		P	A SP				B ₂	B208 10-126
SET PREFIX	SPX	S		P	A SP		\$		B ₂	B210 10-126
SET PSW KEY FROM ADDRESS	SPKA	S		Q						B20A 10-127
SET SECONDARY ASN	SSAR	RRE		α ¹	A ^{1*}	Z ³ T	ϕ			B225 10-128
SET SECONDARY ASN WITH INSTANCE	SSAIR	RRE	RA	α ¹	A ^{1*}	Z ⁷ T	ϕ			B99F 10-128
SET STORAGE KEY EXTENDED	SSKE	RRF-c	C ¹	P	A ^{1*}	II	ϕ	K		B22B 10-133
SET SYSTEM MASK	SSM	SI		P	A SP	SO			B ₂	80 10-136
SIGNAL PROCESSOR	SIGP	RS-a	C	P			\$			AE 10-136
STORE CLOCK COMPARATOR	STCKC	S		P	A SP			ST	B ₂	B207 10-138
STORE CONTROL (32)	STCTL	RS-a		P	A SP			ST	B ₂	B6 10-138
STORE CONTROL (64)	STCTG	RSY-a	N	P	A SP			ST	B ₂	EB25 10-138
STORE CPU ADDRESS	STAP	S		P	A SP			ST	B ₂	B212 10-139
STORE CPU ID	STIDP	S		P	A SP			ST	B ₂	B202 10-139
STORE CPU TIMER	STPT	S		P	A SP			ST	B ₂	B209 10-141
STORE FACILITY LIST	STFL	S	N3	P						B2B1 10-141
STORE PREFIX	STPX	S		P	A SP			ST	B ₂	B211 10-142
STORE REAL ADDRESS (64)	STRAG	SSE	N	P	A ¹ SP			ST	B ₁ BP	E502 10-142
STORE SYSTEM INFORMATION	STSI	S	C	P	A SP		GM	ST	B ₂	B27D 10-143
STORE THEN AND SYSTEM MASK	STNSM	SI		P	A			ST	B ₁	AC 10-167
STORE THEN OR SYSTEM MASK	STOSM	SI		P	A SP			ST	B ₁	AD 10-167
STORE USING REAL ADDRESS (32)	STURA	RRE		P	A ¹ SP			SU		B246 10-168
STORE USING REAL ADDRESS (64)	STURG	RRE	N	P	A ¹ SP			SU		B925 10-168
TEST ACCESS	TAR	RRE	C	α ¹	A ^{1*}				U ₁	B24C 10-168
TEST BLOCK	TB	RRE	C	P	A ^{1*}	II	\$ G0	K		B22C 10-170

Figure 10-1. Summary of Control Instructions (Part 2 of 5)

Name	Mnemonic	Characteristics						Op-code	Page
TEST PENDING EXTERNAL INTERRUPTION	TPEI	RRE	C	TE	P			B9A1	10-172
TEST PROTECTION	TPROT	SSE	C		P	A ¹ *		B ₁	E501 10-173
TRACE (32)	TRACE	RS-a			P	A SP	T ϕ	B ₂	99 10-176
TRACE (64)	TRACG	RSY-a		N	P	A SP	T ϕ	B ₂	EB0F 10-176
TRAP	TRAP2	E			α^1	A*	SO T	B ST	01FF 10-177
TRAP	TRAP4	S			α^1	A*	SO T	B ST	B2FF 10-177

Explanation:

ϕ	Causes serialization and checkpoint synchronization.
ϕ^2	Causes serialization and checkpoint synchronization when the state entry to be unstacked is a program-call state entry.
ϕ^3	Causes serialization and checkpoint synchronization when the set-key control is one.
ϕ^4	Causes serialization and checkpoint synchronization when the KFC value is 4 or 5.
\$	Causes serialization.
α^1	Restricted from transactional execution.
*	PER zero-address-detection not recognized.
A	Access exceptions for logical addresses.
A ¹	Access exceptions; not all access exceptions may occur; see instruction description for details.
B	PER branch event.
B ₁	B ₁ field designates an access register in the access-register mode.
B ₂	B ₂ field designates an access register in the access-register mode.
BP	B ₂ field designates an access register when PSW bits 16 and 17 have the value 01 binary.
B†	B ₁ field designates an access register when bit 47 of GR0 is zero, and bits 16-17 of the current PSW are 01 binary; or when bit 47 of GR0 is one, and bits 40-41 of GR0 are 01 binary.
B‡	B ₂ field designates an access register when bit 63 of GR0 is zero, and bits 16-17 of the current PSW are 01 binary; or when bit 63 of GR0 is one, and bits 56-57 of GR0 are 01 binary.
C	Condition code is set.
C ¹	Condition code is set when the conditional-SSKE facility is installed, and either or both of the MR and MC bits are one.
CT	Configuration-topology facility.
DE	DAT-enhancement facility.
DM	Depending on the model, DIAGNOSE may generate various program exceptions and may change the condition code.
D2	DAT-enhancement facility 2.
E	E instruction format.
ED1	Enhanced-DAT facility 1.
ED2	Enhanced-DAT facility 2.
ES	Expanded-storage facility.
FC	Designation of access registers depends on the function code of the instruction.
G0	Instruction execution includes the implied use of general register 0.
G2	Instruction execution includes the implied use of general register 2.
GM	Instruction execution includes the implied use of multiple general registers: General registers 0 and 1 for MOVE WITH DESTINATION KEY, MOVE WITH SOURCE KEY, PERFORM CRYPTOGRAPHIC KEY MANAGEMENT OPERATION, PERFORM TIMING FACILITY FUNCTION, and STORE SYSTEM INFORMATION. General registers 3, 4, and 14, and, when the ASN-and-LX-reuse facility is installed, general register 15 for PROGRAM CALL.
II	Interruptible instruction (for SSKE, the instruction is interruptible when the multiple-block control is one).
IM	Insert-reference-bits--multiple facility.
K	PER storage-key-alteration event.
L	New condition code is loaded.

Figure 10-1. Summary of Control Instructions (Part 3 of 5)

	Name	Mnemonic	Characteristics	Op-code	Page
LD	Long-displacement facility.				
MD	Designation of access registers in the access-register mode is model-dependent.				
MO	Move-with-optional-specifications facility.				
M3	Message-security assist extension 3.				
N	Instruction is new in z/Architecture as compared to ESA/390.				
N3	Instruction is new in z/Architecture and has been added to ESA/390.				
OP	Operand exception				
P	Privileged-operation exception; also, restricted from transactional execution.				
Q	Privileged-operation exception for semiprivileged instructions also, restricted from transactional execution.				
R ₁	R ₁ field designates an access register in the access-register mode.				
R ₂	R ₂ field designates an access register in the access-register mode.				
RA	Reusable-ASN-and-LX facility.				
RB	Reset-reference-bits-multiple facility.				
RRE	RRE instruction format.				
RRF	RRF instruction format.				
RS	RS instruction format.				
RSY	RSY instruction format.				
RX	RX instruction format.				
RXY	RXY instruction format.				
S	S instruction format.				
SE	Special-operation, stack-empty, stack-specification, and stack-type exceptions.				
SF	Special-operation, stack-full, and stack-specification exceptions.				
SI	SI instruction format.				
SO	Special-operation exception.				
SP	Specification exception.				
SS	SS instruction format.				
SSE	SSE instruction format.				
SSF	SSF instruction format.				
ST	PER storage-alteration event.				
SU	PER store-using-real-address event.				
SW	Special-operation exception and space-switch event.				
T	Trace exceptions (which include trace table, addressing, and low-address protection).				
TE	Test-pending-external-interruption facility				
TS	TOD-clock-steering facility.				
U	Condition code is unpredictable.				
U ₁	R ₁ field designates an access register unconditionally.				
U ₂	R ₂ field designates an access register unconditionally.				
WE	Space-switch event.				
Z ¹	Additional exceptions and events for PROGRAM CALL (which include ASX-translation, EX-translation, LFX-translation, LSTE-sequence, LSX-translation, LX-translation, PC-translation-specification, special-operation, stack-full, stack-specification and subspace-replacement exceptions and space-switch event).				
Z ²	Additional exceptions and events for PROGRAM TRANSFER (which include AFX-translation, ASX-translation, primary-authority, special-operation, and subspace-replacement exceptions and space-switch event).				

Figure 10-1. Summary of Control Instructions (Part 4 of 5)

Name	Mnemonic	Characteristics	Op-code	Page
Z ³		Additional exceptions for SET SECONDARY ASN (which include AFX translation, ASX translation, secondary authority, special operation and subspace replacement).		
Z ⁴		Additional exceptions and events for PROGRAM RETURN (which include AFX-translation, ASTE-instance, ASX-translation, secondary-authority, special-operation, stack-empty, stack-operation, stack-specification, stack-type, and subspace-replacement exceptions and space-switch event).		
Z ⁵		Additional exceptions for BRANCH AND STACK (which include special operation, stack full, and stack specification)		
Z ⁶		Additional exceptions and events for PROGRAM TRANSFER WITH INSTANCE (which include AFX-translation, ASTE-instance, ASX-translation, primary-authority, special-operation, and subspace-replacement exceptions and space-switch event).		
Z ⁷		Additional exceptions for SET SECONDARY ASN WITH INSTANCE (which include AFX translation, ASTE instance, ASX translation, secondary authority, special operation, and subspace replacement).		

Figure 10-1. Summary of Control Instructions (Part 5 of 5)

BRANCH AND SET AUTHORITY

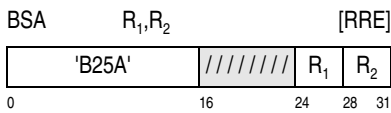

If the dispatchable unit is in the base-authority state and the 24-bit or 31-bit addressing mode: bits 32 and 97-127 of the current PSW, the basic-addressing-mode bit and bits 33-63 of the updated instruction address, are saved in the dispatchable-unit control table (DUCT); the PSW-key mask (PKM), PSW key, and problem-state bit also are saved in the DUCT; the PKM and PSW key are replaced using the contents of general register R₁; the problem-state bit is set to one; bits 32 and 97-127 of the PSW are replaced using the contents of general register R₂; and the dispatchable unit is placed in the reduced-authority state. In the 64-bit addressing mode, the action is the same except that bits 64-127 of the current PSW are saved in the DUCT and replaced from general register R₂, and bit 32 of the PSW is neither saved nor replaced.

If the dispatchable unit is in the reduced-authority state and the 24-bit or 31-bit addressing mode: bits 32 and 97-127 of the current PSW are saved in general register R₁ if R₁ is not zero; bits 32 and 97-127 of the PSW and the PKM, PSW key, and problem-state bit are replaced by values saved in the DUCT; and the dispatchable unit is placed in the base-authority state. In the 64-bit addressing mode, the action is the same except that bits 64-127 of the current PSW are saved in general register R₁ if R₁ is not zero, those bits in the PSW are replaced from the DUCT, and bit 32 of the PSW is neither saved nor replaced.

Words 5, 8, and 9 of the DUCT are used by this instruction. The contents of those words are as follows:



In the 24-Bit or 31-Bit Addressing Mode

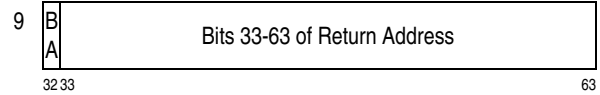
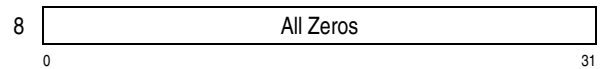

In the 64-Bit Addressing Mode

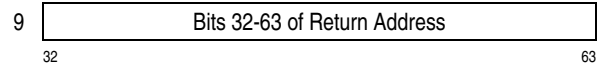
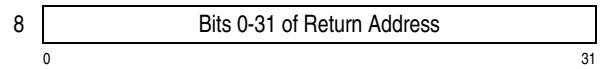

The fields in words 5, 8, and 9 of the DUCT are allocated as follows:

PSW-Key Mask: Bit positions 0-15 of word 5 contain the PSW-key mask (PKM), bits 32-47 of control register 3, saved by BRANCH AND SET AUTHORITY executed in the base-authority state. The PKM is restored to control register 3 by BRANCH AND SET AUTHORITY executed in the reduced-authority state.

PSW Key: Bit positions 24-27 of word 5 contain the PSW key, bits 8-11 of the PSW, saved by BRANCH AND SET AUTHORITY executed in the base-authority state. The PSW key is restored to the PSW by BRANCH AND SET AUTHORITY executed in the reduced-authority state.

Reduced Authority (RA): Bit 28 of word 5 indicates, when zero, that the dispatchable unit associated with the DUCT is in the base-authority state or, when one, that the dispatchable unit is in the reduced-authority state. Bit 28 is set to one by BRANCH AND SET AUTHORITY executed in the base-authority state, and it is set to zero by BRANCH AND SET AUTHORITY executed in the reduced-authority state.

Problem State (P): Bit position 31 of word 5 contains the problem-state bit, bit 15 of the PSW, saved by BRANCH AND SET AUTHORITY executed in the base-authority state. The problem-state bit is restored to the PSW by BRANCH AND SET AUTHORITY executed in the reduced-authority state.

Basic Addressing Mode (BA): In the 24-bit or 31-bit addressing mode, bit position 0 of word 9 contains the basic-addressing-mode bit, bit 32 of the PSW, saved by BRANCH AND SET AUTHORITY executed in the base-authority state. The basic-addressing-mode bit is restored to the PSW from the DUCT by BRANCH AND SET AUTHORITY executed in the reduced-authority state.

Return Address: In the 24-bit or 31-bit addressing mode, bit positions 1-31 of word 9 contain bits 33-63 of the updated instruction address, bits 97-127 of the PSW, saved by BRANCH AND SET AUTHORITY executed in the base-authority state. Bits 1-31 of word 9 of the DUCT are restored to bit positions 97-127 of the PSW by BRANCH AND SET AUTHORITY executed in the reduced-authority state. In the 64-bit addressing mode, words 8 and 9 contain the updated instruction address saved by BRANCH AND SET AUTHORITY executed in the base-authority state. The contents of words 8 and 9 are restored to bit positions 64-127 of the PSW by BRANCH AND SET AUTHORITY executed in the reduced-authority state.

In the 24-bit or 31-bit addressing mode, all zeros are stored in word 8 when saving occurs in the base-authority state. In any addressing mode, all zeros are stored in bit positions 16-23, 29, and 30 of word 5 when saving occurs in the base-authority state.

All other fields in words 5, 8, and 9 remain unchanged when bit 28 of word 5 is set to zero in the reduced-authority state.

The fetch, store, and update references to the DUCT are single-access references and appear to be word

concurrent as observed by other CPUs. The words of the DUCT are accessed in no particular order.

Base-Authority Operation

When BRANCH AND SET AUTHORITY is executed in the base-authority state, as indicated by the reduced-authority bit (RA) in the DUCT being zero, R_2 must be nonzero; otherwise, a special-operation exception is recognized. R_1 may be zero or nonzero.

The contents of bit positions 32-63 of general register R_1 and of general register R_2 when the execution of the instruction begins in the base-authority state are as follows:

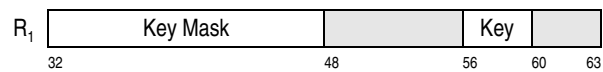

In the 24-Bit or 31-Bit Addressing Mode

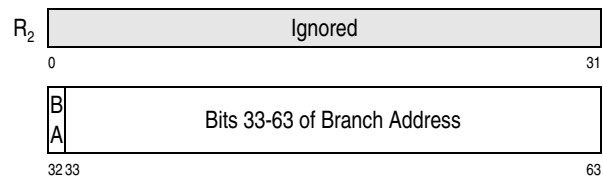

In the 64-Bit Addressing Mode

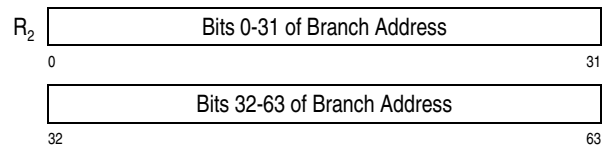

In any addressing mode, the contents of bit positions 0-31 of general register R_1 are ignored. In the 24-bit or 31-bit addressing mode, the contents of bit positions 0-31 of general register R_2 are ignored.

In the 24-bit or 31-bit addressing mode, PSW bits 32 and 97-127 are saved in word 9 of the DUCT, and zeros are stored in word 8. In the 64-bit addressing mode, PSW bits 64-127 are saved in words 8 and 9 of the DUCT. In any addressing mode, the PKM, the PSW key, and the problem-state bit are saved in word 5 of the DUCT, the RA bit in word 5 is set to one, and bits 16-23, 29, and 30 of word 5 are set to zeros.

Bits 56-59 of general register R_1 are placed in bit positions 8-11 of the PSW as the new PSW key. In the problem state, the new PSW key must be authorized by the PKM; otherwise, if the new PSW key is

not authorized, a privileged-operation exception is recognized.

After the new PSW key has been placed in the PSW, bits 32-47 of general register R_1 are ANDed with the PKM in control register 3, and the result replaces the PKM in control register 3.

The problem-state bit in the PSW is set to one.

In the 24-bit or 31-bit addressing mode, bit 32 of general register R_2 is placed in bit position 32 of the PSW as the new basic-addressing-mode bit. A branch address is generated from bits 33-63 of general register R_2 under the control of the new basic addressing mode, and the result is placed in bit positions 64-127 of the PSW as the new instruction address.

In the 64-bit addressing mode, a branch address is generated from bits 0-63 of general register R_2 and is placed in bit positions 64-127 of the PSW as the new instruction address. Bit 32 of the PSW remains unchanged.

Bits 48-55 and 60-63 of general register R_1 may be used for future extensions and should be zeros; otherwise, the program may not operate compatibly in the future.

Reduced-Authority Operation

When BRANCH AND SET AUTHORITY is executed in the reduced-authority state, as indicated by the reduced-authority (RA) bit in the DUCT being one, R_2 must be zero; otherwise, a special-operation exception is recognized. R_1 may be zero or nonzero. The initial contents of general registers R_1 and R_2 are ignored.

If R_1 is nonzero in the 24-bit or 31-bit addressing mode, bits 32 and 97-127 of the current PSW, the basic-addressing-mode bit and bits 33-63 of the updated instruction address, are placed in bit positions 32 and 33-63, respectively, of general register R_1 , and bits 0-31 of the register remain unchanged. If R_1 is nonzero in the 64-bit addressing mode, bits 64-127 of the current PSW are placed in bit positions 0-63 of general register R_1 . If R_1 is zero, general register 0 remains unchanged.

In the 24-bit or 31-bit addressing mode, bit 0 of word 9 of the DUCT is placed in PSW bit position 32, and bits 1-31 of word 9, with 33 leftmost zeros appended, are placed in PSW bit positions 64-127.

In the 64-bit addressing mode, the contents of words 8 and 9 of the DUCT are placed in PSW bit positions 64-127, and bit 32 of the PSW remains unchanged.

In any addressing mode, the PKM, the PSW key, and the problem-state bit are restored from the DUCT, and the RA bit is set to zero, as previously described. There is no test for whether the restored PSW key is authorized by the restored PKM.

Special Conditions

R_2 must be nonzero in the base-authority state and zero in the reduced-authority state. If either of these rules is violated, a special-operation exception is recognized, and the operation is suppressed.

In the problem state, the execution of the instruction in the base-authority state is subject to control by the PSW-key mask in control register 3. When the bit in the PSW-key mask corresponding to the PSW-key value to be set is one, the instruction is executed successfully. When the selected bit in the PSW-key mask is zero, a privileged-operation exception is recognized. In the supervisor state, any value for the PSW key is valid.

Key-controlled protection does not apply to any access made during the operation. Low-address protection does apply.

In the 24-bit or 31-bit addressing mode, the contents of word 9 of the DUCT are not checked for validity before they are loaded into the PSW. If the newly-loaded PSW contains a zero in bit position 32 and the contents of bit positions 97-103 are not zeros, then (a) the instruction is completed, (b) the resulting instruction-length code is 0, (c) a specification-exception is recognized, and (d) a program interruption occurs. The specification exception, which in this case is listed as a program exception in this instruction, is described in "Early Exception Recognition" on page 6-9.

In the ESA/390-compatibility mode, either (a) an operation exception is recognized, or (b) a special-operation exception is recognized when bit 47 of control register 0 is zero. It is unpredictable which exception is recognized.

The operation is suppressed on all addressing and protection exceptions.

Condition Code: The code remains unchanged.

Program Exceptions:

- Addressing (dispatchable-unit control table)
- Operation (in the ESA/390-compatibility mode)
- Privileged operation (selected PSW-key-mask bit is zero in the problem state, base-authority operation only)
- Protection (low-address; dispatchable-unit control table)
- Special operation
- Specification
- Trace
- Transaction constraint

The priority of recognition of program exceptions for the instruction is shown in Figure 10-2 on page 10-10.

1.-6.	Exceptions with the same priority as the priority of program-interruption conditions for the general case.
7.A	Access exceptions for second instruction halfword.
7.B	Transaction constraint.
7.C	Operation exception (ESA/390-compatibility mode only)
7.D	Special-operation exception due to bit 47 of control register 0 being zero (ESA/390-compatibility mode only)
8.A	Trace exceptions.
8.B	Protection exception (low-address protection) for access to dispatchable-unit control table.
8.C.1	Addressing exception for access to dispatchable-unit control table.
8.C.2	Special-operation exception due to R_2 being zero in the base-authority state or R_2 being nonzero in the reduced-authority state.
8.C.3	Privileged-operation exception due to selected PSW-key-mask bit being zero (base-authority operation only).
9.	Specification exception due to bit 32 of the newly loaded PSW being zero when bits 97-103 are not all zeros (reduced-authority operation only).

Figure 10-2. Priority of Execution: BRANCH AND SET AUTHORITY

Programming Notes:

1. BRANCH AND SET AUTHORITY can improve performance by replacing to-current-primary forms of PROGRAM TRANSFER (PT-cp) and basic (nonstacking) PROGRAM CALL (PC-cp) instructions. PT-cp and PC-cp are often used (within a single address space) to reduce the authority of the PSW-key mask (PKM) or change from supervisor state to problem state during a calling linkage made by PT-cp and then to restore the PKM authority or supervisor state during a return linkage made by PC-cp. Also, the PSW-key-setting operations of BRANCH AND SET AUTHORITY can be substituted for SET PSW KEY FROM ADDRESS instructions, and, since BRANCH AND SET AUTHORITY combines branching with PSW-key setting, it can be used to change the PSW key when branching from or to a fetch-protected program.
2. Only one base-authority state and one reduced-authority state are available to a dispatchable unit. Nested use of BRANCH AND SET AUTHORITY, that is, use within different subroutine levels, is not possible. The requirement that R_2 must be nonzero in the base-authority state and zero in the reduced-authority state provides detection of an attempt to use BRANCH AND SET AUTHORITY in the base-authority state when the dispatchable unit is already in the reduced-authority state because of a previous use of the instruction in the base-authority state.
3. BRANCH AND SET AUTHORITY in the base authority-state does not save an indication in the DUCT of whether the current addressing mode is the extended (64-bit) addressing mode or a basic (24-bit or 31-bit) addressing mode. The instruction, in either the base-authority state or the reduced-authority state, does not cause a switch between the extended addressing mode and a basic addressing mode. In the reduced-authority state, the contents of words 8 and 9 of the DUCT are interpreted based only on the current addressing mode. If saving occurs in the 31-bit addressing mode and then restoring occurs in the 64-bit addressing mode, bit 0 of word 9 of the DUCT will be used as an address bit instead of as the basic-addressing-mode bit. If saving occurs in the 64-bit addressing mode and then restoring occurs in the 24-bit addressing mode, an early specification exception may be recognized, after the instruction execution is com-

pleted, because bits 97-103 of the PSW may be nonzero when bit 32 is zero.

4. The instruction may be referred to as BSA-ba or BSA-ra depending on whether it is executed in the base-authority state or the reduced-authority state, respectively.

BRANCH AND STACK

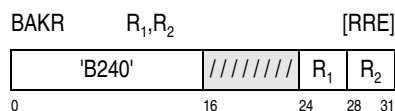

A linkage-stack branch state entry is formed, and the current PSW, except with an unpredictable PER mask and with the addressing-mode bits and instruction address replaced from the first operand, is placed in the state entry. Subsequently, the updated instruction address in the current PSW is replaced from the second operand. Indications of the current addressing-mode bits and the new instruction address are placed in the state entry, and the PSW-key mask, PASN, SASN, EAX, and contents of general registers 0-15 and access registers 0-15 also are placed in the state entry. When the ASN-and-LX-reuse facility is installed and the ASN-and-LX-reuse control in control register 0 is one, the PASTEIN and SASTEIN also are placed in the state entry. The action associated with an operand is not performed if the R field designating the operand is zero.

When the R_1 field is nonzero, the contents of general register R_1 specify an address referred to as the return address.

When R_1 is nonzero and bit 63 of general register R_1 is zero, the return address is generated from the contents of the register under the control of the basic addressing mode specified by bit 32 of the register: 24-bit mode if bit 32 is zero, or 31-bit mode if bit 32 is one. Bit 32 of the register and the return address are substituted for the basic-addressing-mode bit, bit 32, and the updated instruction address, respectively, in the current PSW when the contents of that PSW are placed in the state entry. The extended-addressing-mode bit, bit 31, is set to zero in the PSW that is placed in the state entry. The contents of the current PSW are not changed.

When R_1 is nonzero and bit 63 of general register R_1 is one, the return address is generated from the con-

tents of the register under the control of the 64-bit addressing mode. Bits 0-62 of the return address, with a zero appended on the right, are substituted for the updated instruction address in the current PSW when the contents of that PSW are placed in the state entry. Bits 31 and 32 are set to one in the PSW that is placed in the state entry. The contents of the current PSW are not changed.

When the R_1 field is zero, the current PSW is placed in the state entry without any change except for an unpredictable PER mask.

Subsequently, when the R_2 field is nonzero, the instruction address in the current PSW is replaced by the branch address. The branch address is generated from the contents of general register R_2 under the control of the current addressing mode. When the R_2 field is zero, the operation is performed without branching.

The branch state entry is formed and information is placed in it as described in "Stacking Process" on page 5-84.

In the 24-bit or 31-bit addressing mode, bits 33-63 of the branch address (or of the updated instruction address if the operation is performed without branching) are placed in bit positions 33-63 of bytes 144-151 in the state entry, bit 32 of the current PSW is placed in bit position 32 of those bytes, and zeros are placed in bit positions 0-31 of the bytes.

In the 64-bit addressing mode, bits 0-62 of the branch address (or of the updated instruction address if the operation is performed without branching) are placed in bit positions 0-62 of bytes 144-151 in the state entry, and a one is placed in bit position 63 of those bytes.

The entry-type code in the state entry is 0001100 binary.

Key-controlled protection does not apply to accesses to the linkage stack, but low-address and DAT protection do apply.

Special Conditions

The CPU must be in the primary-space mode or access-register mode; otherwise, a special-operation exception is recognized.

A stack-full or stack-specification exception may be recognized during the stacking process.

The operation is suppressed on all addressing and protection exceptions.

Condition Code: The code remains unchanged.

Program Exceptions:

- Access (fetch or store, except for key-controlled protection, linkage-stack entry)
- Special operation
- Stack full
- Stack specification
- Trace
- Transaction constraint

The priority of recognition of program exceptions for the instruction is shown in Figure 10-3 on page 10-12.

1.-6.	Exceptions with the same priority as the priority of program-interruption conditions for the general case.
7.A	Access exceptions for second instruction halfword.
7.B	Special-operation exception due to DAT being off or the CPU being in secondary-space mode or home-space mode.
7.C	Transaction constraint.
8.A	Trace exceptions (only if R_2 is nonzero).
8.B.1	Access exceptions (fetch) for entry descriptor of the current linkage-stack entry. Note: Exceptions 8.B.2-8.B.7 can occur only if there is not enough remaining free space in the current linkage-stack section.
8.B.2	Stack-specification exception due to remaining-free-space value in current linkage-stack entry not being a multiple of 8.
8.B.3	Access exceptions (fetch) for second word of the trailer entry of the current section. The entry is presumed to be a trailer entry; its entry-type field is not examined.
8.B.4	Stack-full exception due to forward-section validity bit in the trailer entry being zero.

Figure 10-3. Priority of Execution: BRANCH AND STACK (Part 1 of 2)

8.B.5	Access exceptions (fetch) for entry descriptor of the header entry of the next section. This entry is presumed to be a header entry; its entry-type field is not examined.
8.B.6	Stack-specification exception due to not enough remaining free space in the next section.
8.B.7	Access exceptions (store) for second word of the header entry of the next section. If there is no exception, the header is now called the current entry.
8.B.8	Access exceptions (store) for entry descriptor of the current entry and for the new state entry.

Figure 10-3. Priority of Execution: BRANCH AND STACK (Part 2 of 2)

Programming Notes:

1. Examples of the use of the BRANCH AND STACK instruction are given in Appendix A, “Number Representation and Instruction-Use Examples.”
2. In no case does BRANCH AND STACK change the current addressing mode.
3. The effect when the R_1 field is zero is that the return address, which would otherwise be specified by the R_1 general register, is the address of the next sequential instruction. In this case, BRANCH AND STACK provides a program-linkage function that is comparable to the function of BRANCH AND SAVE.
4. BRANCH AND STACK with a nonzero R_1 field is intended for use at or near the entry point of a called program. The program may be called by means of BRANCH AND LINK (BALR) or BRANCH AND SAVE (BAS or BASR) from a program being executed in the 24-bit or 31-bit addressing mode, by means of BRANCH AND SAVE AND SET MODE from a program being executed in any addressing mode, or by means of a BRANCH AND SET MODE instruction located in a “glue module” and being executed in any addressing mode. In all of these cases when the nonzero R_1 field of the calling instruction is the same as the R_1 field of BRANCH AND STACK, and even when the addressing mode was changed during the calling linkage, BRANCH AND STACK correctly saves the addressing mode and return address of the calling program so that the subsequent execution of

PROGRAM RETURN will return correctly to the calling program.

BRANCH IN SUBSPACE GROUP

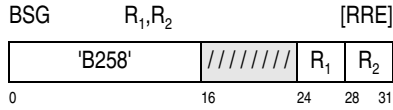

Provided that the current primary address space is in the subspace group, if any, associated with the current dispatchable unit, the access-list-entry token (ALET) in access register R₂ is translated by means of a special form of access-register translation (ART) to locate a destination ASN-second-table entry (DASTE). If the DASTE specifies the base space of the subspace group, the primary ASCE (PASCE) in control register 1 is replaced by the ASCE in the DASTE. If the DASTE specifies a subspace of the group, bits 0-55 and 58-63 of the PASCE are replaced by the same bits of the ASCE in the DASTE. In either case, the following actions also occur.

In the 24-bit or 31-bit addressing mode, bits 32 and 97-127 of the current PSW, the basic-addressing-mode bit and bits 33-63 of the updated instruction address, are saved in bit positions 32 and 33-63, respectively, of general register R₁, and bits 0-31 of the register remain unchanged. Subsequently, the basic-addressing-mode bit and bits 33-63 of the instruction address in the current PSW are replaced from bit positions 32-63 of general register R₂, and bits 0-31 of the register are ignored.

In the 64-bit addressing mode, bits 64-127 of the current PSW, the updated instruction address, are saved in bit positions 0-63 of general register R₁. Subsequently, the instruction address in the current PSW is replaced from bit positions 0-63 of general register R₂. Bit 32 of the PSW remains unchanged.

In any addressing mode, general register 0 remains unchanged if the R₁ field is zero.

The secondary ASCE (SASCE) in control register 7 is set equal to the new PASCE in control register 1. Also, the secondary ASN (SASN), bits 48-63 of control register 3, is set equal to the primary ASN (PASN), bits 48-63 of control register 4. If the ASN-and-LX-reuse facility is installed and is enabled by the ASN-and-LX-reuse control in control register 0,

the secondary ASTEIN (SASTEIN), bits 0-31 of control register 3, is set equal to the primary ASTEIN (PASTEIN), bits 0-31 of control register 4

The current primary address space is in the subspace group for the dispatchable unit if the current primary-ASTE origin (PASTE0), bits 33-57 of control register 5, designates the ASTE for the base space of the group. The PASTE0 designates the base-space ASTE if the PASTE0 is equal to the base-ASTE origin (BASTE0), bits 1-25 of word 0 of the dispatchable-unit control table (DUCT). For determining whether the PASTE0 equals the BASTE0, either the PASTE0 may be compared to the BASTE0 or the entire contents of bit positions 32-63 of control register 5 may be compared to the entire contents of word 0 of the DUCT.

Ordinary ART is described in "Access-Register-Translation Process" on page 5-59. The special ART performed by this instruction is contrasted to ordinary ART as follows:

1. The special ART is performed regardless of whether the CPU is in the access-register mode.
2. If the ALET being translated is 00000000 hex, called ALET 0, the DASTE is the ASTE for the base space. Bit 0 of the DASTE is ignored.
3. If the ALET is 00000001 hex, called ALET 1, the DASTE is the ASTE for the last subspace entered by the dispatchable unit by means of BRANCH IN SUBSPACE GROUP. That ASTE is designated by the subspace-ASTE origin (SSASTE0), bits 1-25 of word 1 of the DUCT. A special-operation exception is recognized if a subspace has not previously been entered, as indicated by an SSASTE0 of all zeros. An ASTE-validity exception is recognized if bit 0 of the DASTE is one. An ASTE-sequence exception is recognized if the ASTE sequence number (ASTESN) in the DASTE does not equal the subspace ASTESN (SSASTESN) in word 3 of the DUCT. The DASTE located because of ALET 1 is considered to specify a subspace even if, due to an error, the DASTE is the ASTE for the base space. That is, there is no comparison of the SSASTE0 to the BASTE0.
4. If the ALET is other than ALET 0 and ALET 1, an ASTE is located by obtaining its origin from an access-list entry (ALE) in a way similar to ordinary ART, and the DASTE is that located ASTE. In this case, as in ordinary ART:

- An ALET-specification exception is recognized if bits 0-6 of the ALET are not zeros.
- An ALEN-translation exception is recognized if the ALE is outside the effective access list or bit 0 of the ALE is one.
- An ASTE-validity exception is recognized if bit 0 of the DASTE is one.
- An ASTE-sequence exception is recognized if the ASTE sequence number (ASTESN) in the DASTE does not equal the ASTESN in the ALE.

The operation differs from ordinary ART in that the ALE sequence number (ALESN) in the ALE is not compared to the ALESN in the ALET, and the private bit in the ALE is treated as zero. Thus, ALE-sequence and extended-authority exceptions cannot occur.

The fetch-only bit in the ALE is ignored.

When the ALET is other than ALET 0 and ALET 1, the special ART may be performed by using the ART-lookaside buffer (ALB).

The DASTE located due to an ALET other than ALET 0 and ALET 1 may be the ASTE for the base space of the subspace group associated with the dispatchable unit. The DASTE is the base-space ASTE if the DASTE origin (DASTE0) obtained from an ALE by ART equals the BASTE0 in the DUCT. For determining whether the DASTE0 equals the BASTE0, either the DASTE0 may be compared to the BASTE0, or the DASTE0 with one leftmost and six rightmost zeros appended may be compared to the entire contents of word 0 of the DUCT. If the DASTE is not the base-space ASTE, the DASTE is treated as the ASTE for a subspace of the dispatchable unit's subspace group provided that (1) the subspace-group bit, bit 54, in the ASCE in the DASTE is one, and (2) the DASTE does not specify the base space of another subspace group. The DASTE specifies the base space of another subspace group if the base-space bit, bit 31 of word 0 of the DASTE, is one. A special-operation exception is recognized if either of those two provisions is not met.

If the DASTE specifies the base space of the subspace group, the PASCE in control register 1 is replaced by the ASCE in the DASTE. If the DASTE specifies a subspace, bits 0-55 and 58-63 of the PASCE are replaced by the same bits of the ASCE in

the DASTE, and bits 56 and 57 of the PASCE, the storage-alteration-event bit and space-switch-event-control bit, remain unchanged.

If R_1 is nonzero in the 24-bit or 31-bit addressing mode, bits 32 and 97-127 of the current PSW, the basic-addressing-mode bit and bits 33-63 of the updated instruction address, are placed in bit positions 32 and 33-63, respectively, of general register R_1 , and bits 0-31 of the register remain unchanged. If R_1 is nonzero in the 64-bit addressing mode, bits 64-127 of the current PSW, the updated instruction address, are placed in bit positions 0-63 of general register R_1 . If R_1 is zero, general register 0 remains unchanged.

Whether R_2 is nonzero or zero, in the 24-bit or 31-bit addressing mode, bits 32-63 of general register R_2 specify the new basic addressing mode and designate the branch address. Bit 32 of the register specifies the new basic addressing mode and replaces bit 32 of the current PSW, and the branch address is generated from the contents of bit positions 33-63 of the register under the control of the new basic addressing mode.

When R_2 is nonzero or zero in the 64-bit addressing mode, the contents of general register R_2 designate the branch address. The branch address is generated from the contents of the register under the control of the 64-bit addressing mode. Bit 32 of the PSW remains unchanged.

Regardless of the addressing mode, the new value for the PSW is computed before general register R_1 is changed.

The secondary ASCE (SASCE) in control register 7 is set equal to the new PASCE in control register 1. The secondary ASN (SASN), bits 48-63 of control register 3, is set equal to the primary ASN (PASN), bits 48-63 of control register 4. If the ASN-and-LX-reuse facility is installed and is enabled by a one value of the ASN-and-LX-reuse control, bit 44 of control register 0, the secondary ASTEIN (SASTEIN), bits 0-31 of control register 3, is set equal to the primary ASTEIN (PASTEIN), bits 0-31 of control register 4.

If the DASTE specifies the base space, the subspace-active bit, bit 0 of word 1 of the DUCT, is set to zero, and bits 1-31 of word 1 remain unchanged. If the DASTE specifies a subspace by means of ALET 1, then (1) the subspace-active bit is set to one,

(2) the SSASTEO in bit positions 1-25 of word 1 remains unchanged, and (3) bits 26-31 of word 1 either are set to zeros or remain unchanged. If the DASTE specifies a subspace by means of an ALET other than ALET 1, then (1) the subspace-active bit is set to one, (2) the DASTE is stored in bit positions 1-25 of word 1 as the SSASTEO, (3) zeros are stored in bit positions 26-31 of word 1, and (4) the ASTESN in the DASTE is stored in word 3 of the DUCT as the SSASTESN.

The fetch, store, and update references to the DUCT are single-access references and appear to be word concurrent as observed by other CPUs. The words of the DUCT are accessed in no particular order.

The operation, since it changes a translation parameter in control register 1, causes all copies of prefetched instructions to be discarded, except when in the home-space mode.

Special Conditions

DAT must be on; otherwise, a special-operation exception is recognized. A special-operation exception is also recognized if the current primary address space is not in a subspace group associated with the current dispatchable unit, if the ALET in access register R₂ is ALET 1 but a subspace has not previously been entered by the dispatchable unit by means of BRANCH IN SUBSPACE GROUP, or if the ALET used is other than ALET 0 and ALET 1 and the destination ASTE does not specify the base space or a subspace of the subspace group.

The primary space-switch-event-control bit, bit 57 of control register 1 either before or after the operation, does not cause a space-switch-event program interruption to occur.

Key-controlled protection does not apply to any access made during the operation. Low-address protection does apply.

The operation is suppressed on all addressing and protection exceptions.

Condition Code: The code remains unchanged.

Program Exceptions:

- Addressing (dispatchable-unit control table, effective access-list designation, access-list entry, destination ASN-second-table entry)

- ALET specification
- ALEN translation
- ASTE sequence
- ASTE validity
- Protection (low-address; dispatchable-unit control table)
- Special operation
- Trace
- Transaction constraint

The priority of recognition of program exceptions for the instruction is shown in the Figure 10-4.

1.-6.	Exceptions with the same priority as the priority of program-interruption conditions for the general case.
7.A	Access exceptions for second instruction halfword.
7.B	Special-operation exception due to DAT being off.
7.C	Transaction constraint.
8.A	Trace exceptions.
8.B	Protection exception (low-address protection) for access to dispatchable-unit control table.
8.C.1	Addressing exception for access to dispatchable-unit control table.
8.C.2	Special-operation exception due to current primary address space not being in a subspace group associated with the current dispatchable unit (primary-ASTE origin in control register 5 not equal to base-ASTE origin in dispatchable-unit control table). Note: Exception 8.C.3.A can occur only if the access-list-entry token (ALET) in access register R ₂ is ALET 0.
8.C.3.A	Addressing exception for access to base ASTE (ASTE designated by base-ASTE origin in dispatchable-unit control table). Note: Exceptions 8.C.3.B.1-8.C.3.B.4 can occur only if the access-list-entry token (ALET) in access register R ₂ is ALET 1.
8.C.3.B.1	Special-operation exception due to subspace-ASTE origin in dispatchable-unit control table being zero.
8.C.3.B.2	Addressing exception for access to subspace ASTE.

Figure 10-4. Priority of Execution: BRANCH IN SUBSPACE GROUP (Part 1 of 2)

8.C.3.B.3	ASTE-validity exception due to bit 0 in subspace ASTE being one.
8.C.3.B.4	ASTE-sequence exception due to ASTE sequence number in subspace ASTE not being equal to subspace-ASTE sequence number in dispatchable-unit control table. Note: Exceptions 8.C.3.C.1-8.C.3.C.9 can occur only if the access-list-entry token (ALET) in access register R_2 is other than ALET 0 and ALET 1.
8.C.3.C.1	ALET-specification exception due to bits 0-6 of ALET not being all zeros.
8.C.3.C.2	Addressing exception for access to effective access-list designation.
8.C.3.C.3	ALEN-translation exception due to access-list entry being outside the list.
8.C.3.C.4	Addressing exception for access to access-list entry.
8.C.3.C.5	ALEN-translation exception due to I bit in access-list entry being one.
8.C.3.C.6	Addressing exception for access to destination ASTE.
8.C.3.C.7	ASTE-validity exception due to bit 0 in destination ASTE being one.
8.C.3.C.8	ASTE-sequence exception due to ASTE sequence number (ASTESN) in access-list entry not being equal to ASTESN in destination ASTE.
8.C.3.C.9	Special-operation exception due to destination-ASTE origin not equal to base-ASTE origin in dispatchable-unit control table and (1) subspace-group bit, bit 54 in address-space-control element in destination ASTE being zero or (2) base-space bit 31, in destination ASTE being one.

Figure 10-4. Priority of Execution: BRANCH IN SUBSPACE GROUP (Part 2 of 2)

Programming Notes:

1. See the discussion of BRANCH IN SUBSPACE GROUP in “Subroutine Linkage without the Linkage Stack” on page 5-14. It is intended that there be a separate ASN-second-table entry (ASTE) for each of the base space and each subspace of a subspace group. The ASTEs for the subspaces can be “pseudo” ASTEs as described in the programming note in “Address-Space Number” on

page 3-23. A subspace can contain a subset of the storage in the base space by having the DAT tables for the subspace designate a subset of the pages that are designated by the DAT tables for the base space. A dispatchable unit has access to a subspace if an access-list entry designating the ASTE for the subspace is in the primary-space or dispatchable-unit access list of the dispatchable unit.

2. BRANCH IN SUBSPACE GROUP can be used to give control from the base space to a subspace, from a subspace to another subspace, and from a subspace to the base space. The instruction can also be used to give control from the base space to the base space or from a subspace to the same subspace.
3. Since BRANCH IN SUBSPACE GROUP sets the secondary address-space-control element (ASCE) in control register 7 equal to the new primary ASCE in control register 1 (along with setting the secondary ASN in control register 3 equal to the primary ASN in control register 4), the program in an address space given control by BRANCH IN SUBSPACE GROUP does not have access to the calling program’s address space by means of that address space being the secondary address space.
4. When a dispatchable unit has used BRANCH IN SUBSPACE GROUP to enter a subspace and has not subsequently used BRANCH IN SUBSPACE GROUP to return to the base space, the dispatchable unit is said to be “subspace active.” When LOAD ADDRESS SPACE PARAMETERS, PROGRAM CALL, PROGRAM RETURN, PROGRAM TRANSFER, PROGRAM TRANSFER WITH INSTANCE, SET SECONDARY ASN, or SET SECONDARY ASN WITH INSTANCE places an ASCE in control register 1 as the primary ASCE or in control register 7 as the secondary ASCE, and if (1) the ASCE has the subspace-group bit on in it, (2) the dispatchable unit is subspace active, and (3) the ASCE was obtained from the ASN-second-table entry (ASTE) for the base space of the current dispatchable unit, then the instruction (any of the seven named instructions) replaces bits 0-55 and 58-63 of the ASCE in the control register with the same bits of the ASCE in the ASTE for the subspace in which the dispatchable unit last had control. Further details about the effects of the subspace-group facility on the seven named instructions are given in “Subspace-Replace-

ment Operations” on page 5-70 and in the definitions of the instructions.

5. The use of BRANCH IN SUBSPACE GROUP (BSG) along with PROGRAM CALL (PC) and either PROGRAM TRANSFER (PT) (or PROGRAM TRANSFER WITH INSTANCE) or PROGRAM RETURN (PR) can produce results that may be unexpected. Consider the following sequence of operations:
 - a. Start in the base space
 - b. BSG to a subspace
 - c. PC (the first PC) to an address space that is not in the subspace group.
 - d. PC (the second PC) to the base space. Since the dispatchable unit is subspace active, control is given to the subspace.
 - e. BSG back to the base space.
 - f. PT or PR (paired with the second PC) back to the address space that is not in the subspace group.
 - g. PT or PR (paired with the first PC) back to the subspace group. Since the dispatchable unit is no longer subspace active, control is given to the base space even though the first PC was issued in the subspace.
6. BRANCH IN SUBSPACE GROUP does not perform the serialization or checkpoint-synchronization functions, but it does cause all copies of prefetched instructions to be discarded except when in the home-space mode.
7. Unlike the RR-format branch instructions, a value of zero in the R_2 field for BRANCH IN SUBSPACE GROUP designates general register 0, and branching occurs.
8. When the R_2 field designates access register 0, the access register is treated as containing ALET 0 regardless of the contents of the access register.

COMPARE AND REPLACE DAT TABLE ENTRY

CRDTE $R_1, R_3, R_2, [M_4]$ [RRF-b]

'B98F'	R_3	M_4	R_1	R_2
0	16	20	24	28 31

Note: The term “specified CPU or CPUs” has the following meaning for scope of TLBs affected by this instruction:

- When the local-clearing (LC) control in the M_4 field is zero, the term “specified CPU or CPUs” means all of the CPUs in the configuration.
- When the LC control in the M_4 field is one, the term “specified CPU or CPUs” means only the CPU executing the COMPARE AND REPLACE DAT TABLE ENTRY instruction (the local CPU). The TLBs in all other CPUs in the configuration may not be affected.

The first and second operands are compared. If they are equal, the contents of general register $R_1 + 1$ are stored at the second-operand location, and the specified CPU or CPUs in the configuration are cleared of (1) all TLB table entries of the designated type formed through the use of the replaced entry in storage, and (2) all lower-level TLB table entries formed through the use of the cleared higher-level TLB table entries. The TLB entries cleared may optionally be limited to entries formed to translate addresses in a specified address space.

If the first and second operands are unequal, the second operand is loaded at the first-operand location. However, on some models, the second operand may be fetched and subsequently stored back unchanged at the second-operand location. This update appears to be a block-concurrent interlocked-update reference as observed by other CPUs. The result of the comparison is indicated by the condition code.

The R_1 and R_2 fields each designate an even-odd pair of general registers and must designate an even-numbered register; otherwise, a specification exception is recognized.

The first operand is called the compare value and is contained in bit positions 0-63 of general register R_1 .

Bit positions 0-63 of general register $R_1 + 1$ are called the replacement value.

The second operand is a doubleword in storage designated by general registers R_2 and $R_2 + 1$. Bits 59-61 of general register R_2 are the designated-table type (DTT), specifying the bits in general register R_2 that form the origin of a table in storage; the DTT also specifies the bits in general register $R_2 + 1$ that are used as the effective index into the table to locate the second operand, as follows:

DTT (bits 59-61 of Reg. R_2)	Table Type	Table Origin Bits in Reg. R_2	Effective Index Bits in Reg. $R_2 + 1$
000	Page	0-52	44-51
001-011	—	—	—
100	Segment	0-51	33-43
101	Region third	0-51	22-32
110	Region second	0-51	11-21
111	Region first	0-51	0-10

When the DTT is 000 binary, the contents of bit positions 0-52 of general register R_2 , with eleven zeros appended on the right, form the table origin, and bits 53-58, 62, and 63 of the register are ignored. When the DTT is 100-111 binary, the contents of bit positions 0-51 of general register R_2 , with twelve zeros appended on the right, form the table origin, and bits

52-58, 62, and 63 of the register are ignored. DTT values of 001, 010, and 011 binary are invalid; a specification exception is recognized if the DTT is invalid.

Bits 0-51 of general register $R_2 + 1$ have the format of the region index, segment index, and page index of a virtual address. The part of bits 0-51 normally used by DAT to select an entry in the type of table designated by the DTT is called the effective index. The part of bits 0-51 of general register $R_2 + 1$ to the right of the effective index is ignored. Bit positions 52-53 are reserved for IBM use and must contain zeros; otherwise, results are unpredictable. Bit positions 54-63 of general register $R_2 + 1$ are reserved and must contain zeros; otherwise, a specification exception is recognized.

If R_3 is nonzero, the contents of general register R_3 have the format of an address-space-control element with only the table origin, bits 0-51, and designation-type control (DT), bits 60 and 61, used. These contents are used to select TLB entries to be cleared. Bits 52-59, 62, and 63 of general register R_3 are ignored. If R_3 is zero, the entire contents of general register 0 are ignored, and TLB entries are cleared regardless of the ASCE used to form them.

The contents of the general registers just described are shown in Figure 10-5.

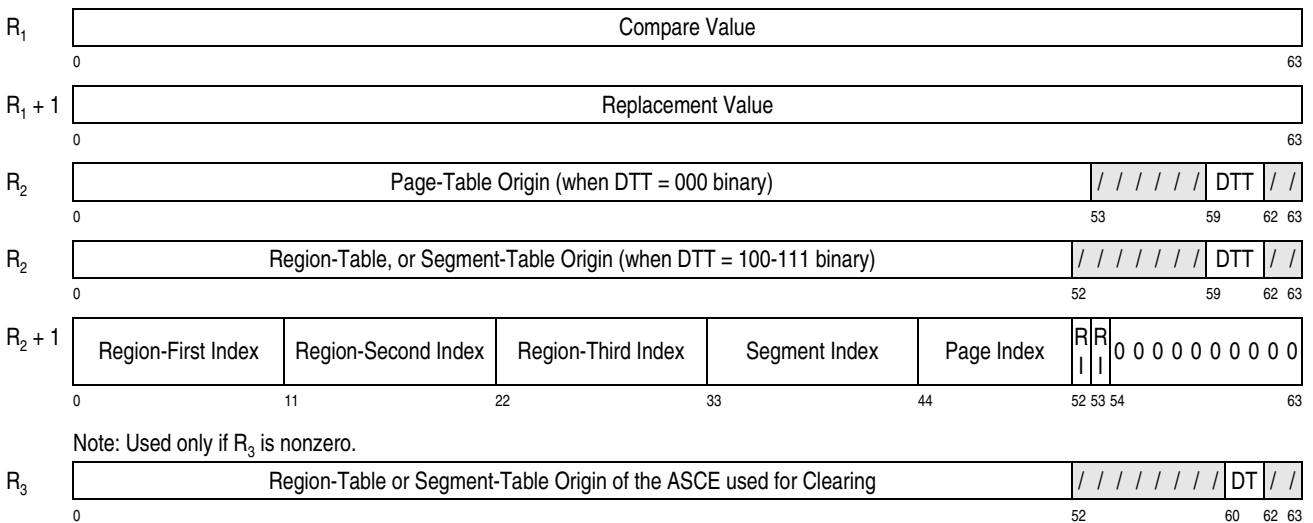

Figure 10-5. Register Contents for COMPARE AND REPLACE DAT TABLE ENTRY

The M_4 field has the following format:



The bits of the M_4 field are defined as follows:

- **Reserved:** Bits 0-2 are reserved. Reserved bit positions of the M_4 field are ignored but should contain zeros; otherwise, the program may not operate compatibly in the future.
- **Local-Clearing Control (LC):** The LC bit, bit 3 of the M_4 field controls whether only the TLB in the local CPU is cleared, or whether the TLBs in all CPUs of the configuration are cleared.

When the first and second operands are equal, the contents of general register $R_1 + 1$ are stored at the second-operand location, and the translation-lookaside buffers (TLBs) in the specified CPUs in the configuration are cleared of (1) all TLB table entries of the designated type formed through the use of the original contents of the second operand in storage (that is, the contents of the second operand before it is replaced with the replacement value), and (2) all lower-level TLB table entries formed through the use of the cleared higher-level TLB table entries. The TLB entries cleared may optionally be limited to entries formed to translate addresses in a specified address space.

Depending on the table type, the table origin in general register R_2 and effective index in general register $R_2 + 1$ designate a table entry in accordance with the rules in “Lookup in a Table Designated by an Address-Space-Control Element” on page 3-57, or “Page-Table Lookup” on page 3-61, except that a carry from bit position 0 of the resulting address is always ignored, and the index is not checked against a table-length field. The table origin is treated as a 64-bit address, and the addition is performed by using the rules for 64-bit address arithmetic, regardless of the current addressing mode specified by bits 31 and 32 of the current PSW. The address formed from these two components is a real or absolute address. The contents of the table entry are not examined for validity, and no exception conditions are recognized due to the contents of the table entry.

The fetch and store of the table entry are performed as a block-concurrent interlocked update. The fetch

access to the entry is subject to key-controlled protection, and the store access is subject to key-controlled protection and low-address protection.

A serialization function is performed before the operation begins and again after the operation is completed. As is the case for all serialization operations, this serialization applies only to this CPU; other CPUs are not necessarily serialized.

When the first and second operands are equal, this CPU clears selected entries from its TLB. In addition to the clearing of the local CPU, if the LC bit in the M_4 field is zero, all other CPUs in the configuration are signaled to clear selected entries from their TLBs. Each TLB is cleared of at least those entries for which all of the following conditions are met:

- The effective index in general register $R_2 + 1$ matches the corresponding index in the TLB table entry of type designated by the DTT field in bits 59-61 of general register R_2 . If the model implements a composite TLB entry that includes the index designated by the DTT field, bits to the left of the effective index in general register $R_2 + 1$ also match any corresponding bits provided in the designated TLB table entry.
- Either the R_3 field is zero, or the table-origin and designation-type fields in general register R_3 match the table-origin and designation-type fields in the address-space-control element (ASCE) used to form the TLB table entry.

If the R_3 field is zero, then the condition described in this step does not apply.

- If EDAT-1 applies and the entry replaced in storage is a segment-table entry, or if EDAT-2 applies and the entry replaced in storage is a region-third-table entry, the format control in the replaced entry matches that of the TLB entry.
- If the replaced entry in storage designates a lower-level translation table, the lower-level table origin in the entry matches the table-origin field in the TLB table entry.
- If EDAT-1 applies and the entry replaced in storage is a segment-table entry in which the format control is one, or if EDAT-2 applies and the entry replaced in storage is a region-third-table entry in which the format control is one, the segment-frame absolute address or region-frame absolute address, respectively, in the replaced entry matches that of the TLB entry.

Each affected TLB is also cleared of at least any lower-level TLB table entries for which all of the following conditions are met:

- The lower-level TLB table entry was formed through use of the replaced entry in storage or through use of a higher-level TLB table entry formed through use of either the replaced entry in storage or a TLB entry cleared in this process.
- Either the R_3 field is zero or the table-origin and designation-type fields in general register R_3 match the table-origin and designation-type fields in the address-space-control element (ASCE) used to form the lower-level TLB table entry. This ASCE may be one that attached a translation path containing a higher-level table entry that attached the lower-level table entry in storage from which the lower-level TLB table entry was formed, or it may be one that made usable a higher-level TLB table entry that attached the lower-level table entry in storage from which the lower-level TLB table entry was formed. See “Formation of TLB Entries” on page 3-63 for the meaning of the terminology used here.

If the R_3 field is zero, then the condition described in this step does not apply.

- If EDAT-1 applies and the entry replaced in storage is a segment-table entry, or if EDAT-2 applies and the entry replaced in storage is a region-third-table entry, the format control in the replaced entry matches that of the TLB entry.
- If the entry in storage designates a lower-level translation table, the lower-level table origin in the entry matches the table-origin field in the TLB table entry.

When the first and second operands are equal, the execution of COMPARE AND REPLACE DAT TABLE ENTRY is not completed on the CPU which executes it until the following occurs:

1. All entries meeting the criteria specified above have been cleared from the TLB of this CPU. When the LC control in the M_4 field is one, execution of COMPARE AND REPLACE DAT TABLE ENTRY is complete, and the following step is not performed.
2. When the LC control in the M_4 field is zero, all other CPUs in the configuration have completed

any storage accesses, including the updating of the change and reference bits.

The operation does not necessarily have any effect on TLB real-space entries.

Special Conditions

A specification exception is recognized, and the operation is suppressed if any of the following is true:

- Either the R_1 or R_2 field is odd.
- The DTT field, bit positions 59-61 of general register R_2 , contain 001, 010, or 011 binary.
- Bit positions 54-63 of general register $R_2 + 1$ contain nonzero values.

It is unpredictable whether a specification exception is recognized if bits 52-53 of general register $R_2 + 1$ contain non-zero values.

The operation is suppressed on all addressing and protection exceptions.

Resulting Condition Code:

- | | |
|---|--|
| 0 | First and second operands equal, second operand replaced by contents of general register $R_1 + 1$ |
| 1 | First and second operands unequal, first operand replaced by second operand |
| 2 | -- |
| 3 | -- |

Program Exceptions:

- Addressing
- Operation (if the enhanced-DAT facility 2 is not installed)
- Privileged operation
- Protection (fetch and store, region-, segment-, or page-table entry, key-controlled protection and low-address protection)
- Specification
- Transaction constraint

Programming Notes:

1. The selective clearing of TLB entries may be implemented in different ways, depending on the model, and, in general, more entries may be cleared than the minimum number required.

2. When clearing TLB entries associated with common segments, note that these entries may have been formed through use of address-space-control elements containing many different table origins.
3. The M_4 field of the instruction is considered to be optional, as indicated by the field being contained within brackets [] in the assembler syntax. When the M_4 field is not specified, the assembler places zeros in that field of the instruction.
4. The local-clearing control should be specified as one only when either of the following are true; otherwise, unpredictable results, including the presentation of a delayed-access-exception machine check, may occur.
 - The program is running in a uniprocessor configuration.
 - The program is assigned to run on a single CPU and the affinity between the program and that CPU is maintained.

On some models, use of COMPARE AND REPLACE DAT TABLE ENTRY specifying clearing of only the local TLB for the cases listed above may result in significant performance improvements.

COMPARE AND SWAP AND PURGE

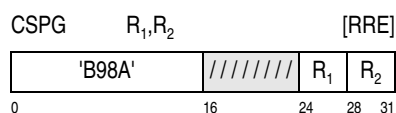
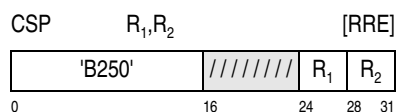

The first and second operands are compared. If they are equal, contents of general register $R_1 + 1$ are stored at the second-operand location, and a purging operation is performed. If they are unequal, the second operand is loaded at the first-operand location. The result of the comparison is indicated in the condition code.

The R_1 field designates an even-odd pair of general registers and must designate an even-numbered reg-

ister; otherwise, a specification exception is recognized.

For COMPARE AND SWAP AND PURGE (CSP), the first operand is the contents of bit positions 32-63 of general register R_1 . The second operand is a word in storage.

For COMPARE AND SWAP AND PURGE (CSPG), the first operand is the contents of bit positions 0-63 of general register R_1 . The second operand is a doubleword in storage.

For both CSP and CSPG, the location of the leftmost byte of the second operand is designated by contents of general register R_2 .

The purging operation applies to ART-lookaside buffers (ALBs) and translation-lookaside buffers (TLBs) in all CPUs in the configuration. Either ALBs or TLBs, or both ALBs and TLBs, may be selected for purging. All entries are cleared from the selected buffers.

The purging operation is specified by means of bits 62 and 63 of general register R_2 . When bit 62 is one, entries are cleared from ALBs. When bit 63 is one, entries are cleared from TLBs. When bits 62 and 63 both are ones, entries are cleared from ALBs and TLBs. When bits 62 and 63 both are zeros, no entries are cleared.

The handling of the address in general register R_2 is dependent on the addressing mode. For CSP in the 24-bit addressing mode, the contents of bit positions 40-61 of general register R_2 , with two zeros appended on the right, constitute the address, and the contents of bit positions 0-39 are ignored. In the 31-bit addressing mode, the contents of bit positions 33-61 of the register, with two zeros appended on the right, constitute the address, and the contents of bit positions 0-32 are ignored. In the 64-bit addressing mode, the contents of bit positions 0-61 of the register, with two zeros appended on the right, constitute the address.

For CSPG in the 24-bit addressing mode, the contents of bit positions 40-60 of general register R_2 , with three zeros appended on the right, constitute the address, and the contents of bit positions 0-39 and 61 are ignored. In the 31-bit addressing mode, the contents of bit positions 33-60 of the register, with three zeros appended on the right, constitute the address, and the contents of bit positions 0-32 and 61 are ignored. In the 64-bit addressing mode, the

contents of bit positions 0-60 of the register, with three zeros appended on the right, constitute the address, and the contents of bit position 61 are ignored.

The contents of the registers just described are shown in Figure 10-6 on page 10-22 and Figure 10-7 on page 10-22. When an equal comparison occurs,

the contents of bit positions 32-63 of general register R1 + 1 for CSP, or of bit positions 0-63 for CSPG, are stored at the second-operand location. The fetch of the second operand for purposes of comparison and the store into the second-operand location appear to be a block-concurrent interlocked-update reference as observed by other CPUs.

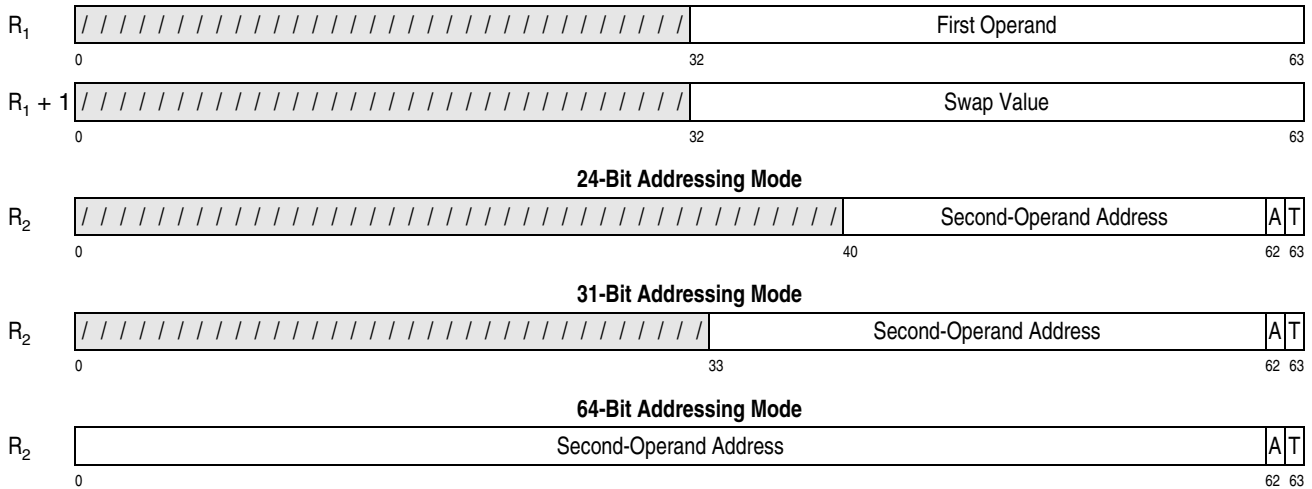

Figure 10-6. Register Contents for COMPARE AND SWAP AND PURGE (CSP)

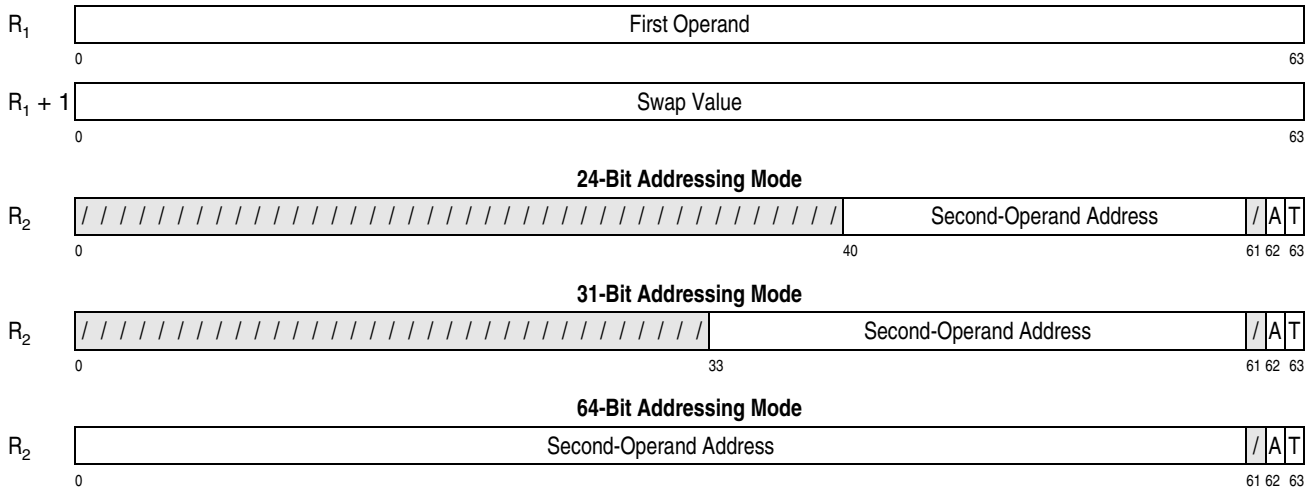

Figure 10-7. Register Contents for COMPARE AND SWAP AND PURGE (CSPG)

When the result of the comparison is unequal, the second-operand is loaded at the first-operand location, bits 0-31 of general register R₁ remain unchanged for CSP only, and the second-operand location remains unchanged. However, on some models, the second operand may be fetched and subsequently stored back unchanged at the second-

operand location. This update appears to be a block-concurrent interlocked-update reference as observed by other CPUs.

A serialization function is performed before the operand is fetched and again after the operation is completed.

When an equal comparison occurs, this CPU clears entries from its ALB and TLB, as specified by bits 62 and 63 of general register R_2 , and signals all CPUs in the configuration to clear the same specified entries from their ALBs and TLBs. The ALB entries that are cleared are all ALB access-list designations, access-list entries, ASN-second-table entries, and authority-table entries. The TLB entries that are cleared are all region-first-table entries, region-second-table entries, region-third-table entries, segment-table entries, page-table entries, and real-space entries.

Before the TLB purging operation, when bits 62 or 63 of general register R_2 are one, any active transactions on other CPUs in the configuration are aborted with abort code 255, condition code 2.

The execution of COMPARE AND SWAP AND PURGE is not completed on the CPU which executes it until (1) all specified entries have been cleared from the ALB and TLB of this CPU and (2) all other CPUs in the configuration have completed any storage accesses, including the updating of the change and reference bits, by using the specified ALB and TLB entries.

Special Conditions

The R_1 field must designate an even register; otherwise, a specification exception is recognized.

Resulting Condition Code:

- | | |
|---|--|
| 0 | First and second operands equal, second operand replaced by contents of general register $R_1 + 1$ |
| 1 | First and second operands unequal, first operand replaced by second operand |
| 2 | -- |
| 3 | -- |

Program Exceptions:

- Access (fetch and store, operand 2)
- Operation (if DAT-enhancement facility is not installed, CSPG only)
- Privileged operation
- Specification
- Transaction constraint

Programming Note: COMPARE AND SWAP AND PURGE provides a broadcast form of the PURGE ALB and PURGE TLB instructions, thus making it possible to avoid uses of SIGNAL PROCESSOR.

DIAGNOSE

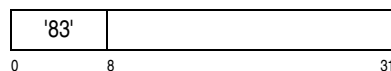

The CPU performs built-in diagnostic functions, or other model-dependent functions. The purpose of the diagnostic functions is to verify proper functioning of equipment and to locate faulty components. Other model-dependent functions may include disabling of failing buffers, reconfiguration of CPUs, storage, and channel paths, and modification of control storage.

Bits 8-31 may be used as in the SI or RS formats, or in some other way, to specify the particular diagnostic function. The use depends on the model.

The execution of the instruction may affect the state of the CPU and the contents of a register or storage location, as well as the progress of an I/O operation. Some diagnostic functions may cause the test indicator to be turned on.

Resulting Condition Code: The code is unpredictable.

Program Exceptions:

- Privileged operation
- Transaction constraint
- Depending on the model, other exceptions may be recognized.

Programming Notes:

1. Since the instruction is not intended for problem-state-program or control-program use, DIAGNOSE has no mnemonic.
2. DIAGNOSE, unlike other instructions, does not follow the rule that programming errors are distinguished from equipment errors. Improper use of DIAGNOSE may result in false machine-check indications or may cause actual machine malfunctions to be ignored. It may also alter other aspects of system operation, including instruction execution and channel-program operation, to an extent that the operation does not comply with that specified in this publication. As a result of the improper use of DIAGNOSE, the system may be left in such a condition that the power-on reset or initial-microprogram-loading (IML) function must be performed. Since the function performed

by DIAGNOSE may differ from model to model and between versions of a model, the program should avoid issuing DIAGNOSE unless the program recognizes the model number stored by STORE CPU ID.

EXTRACT AND SET EXTENDED AUTHORITY

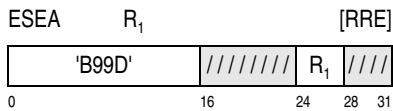

The extended authorization index (EAX), bits 32-47 of control register 8, is saved in bit positions 32-47 of the first operand, and then the EAX in control register 8 is replaced by the contents of bit positions 48-63 of the first operand. Bits 0-31 of the first operand are ignored, and bits 0-31 and 48-63 of the operand remain unchanged.

Condition Code: The code remains unchanged.

Program Exceptions:

- Privileged operation
- Transaction constraint

EXTRACT PRIMARY ASN

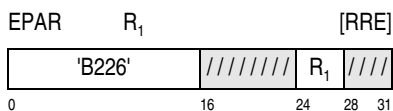

EXTRACT PRIMARY ASN AND INSTANCE

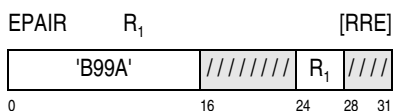

The 16-bit PASN, bits 48-63 of control register 4, is placed in bit positions 48-63 of general register R₁. Bits 32-47 of the general register are set to zeros.

In the EXTRACT PRIMARY ASN AND INSTANCE operation, the PASTEIN, bits 0-31 of control register 4, is placed in bit positions 0-31 of general register

R₁. In the EXTRACT PRIMARY ASN operation, bits 0-31 of general register R₁ remain unchanged.

Special Conditions

The instruction must be executed with DAT on; otherwise, a special-operation exception is recognized.

In the problem state, the extraction-authority control, bit 36 of control register 0, must be one; otherwise, a privileged-operation exception is recognized. In the supervisor state, the extraction-authority-control bit is not examined.

Condition Code: The code remains unchanged.

Program Exceptions:

- Operation (if the ASN-and-LX-reuse facility is not installed, EPAIR only)
- Privileged operation (extraction-authority control is zero in the problem state)
- Special operation
- Transaction constraint

The priority of recognition of program exceptions for the instruction is shown in Figure 10-8.

1.-6.	Exceptions with the same priority as the priority of program-interruption conditions for the general case.
7.A	Access exceptions for second instruction halfword.
7.B.1	Operation exception if the ASN-and-LX-reuse facility is not installed (EPAIR only).
7.B.2	Special-operation exception due to DAT being off.
7.C	Transaction constraint.
8.	Privileged-operation exception due to extraction-authority control, bit 36 of control register 0, being zero in problem state.

Figure 10-8. Priority of Execution: EXTRACT PRIMARY ASN (AND INSTANCE)

EXTRACT SECONDARY ASN

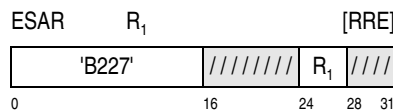

EXTRACT SECONDARY ASN AND INSTANCE

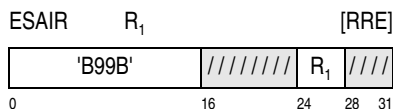

The 16-bit SASN, bits 48-63 of control register 3, is placed in bit positions 48-63 of general register R₁. Bits 32-47 of the general register are set to zeros.

In the EXTRACT SECONDARY ASN AND INSTANCE operation, the SASTEIN, bits 0-31 of control register 3, is placed in bit positions 0-31 of general register R₁. In the EXTRACT SECONDARY ASN operation, bits 0-31 of general register R₁ remain unchanged.

Special Conditions

The instruction must be executed with DAT on; otherwise, a special-operation exception is recognized.

In the problem state, the extraction-authority control, bit 36 of control register 0, must be one; otherwise, a privileged-operation exception is recognized. In the supervisor state, the extraction-authority-control bit is not examined.

Condition Code: The code remains unchanged.

Program Exceptions:

- Operation (if the ASN-and-LX-reuse facility is not installed, ESAIR only)
- Privileged operation (extraction-authority control is zero in the problem state)
- Special operation
- Transaction constraint

The priority of recognition of program exceptions for the instruction is shown in Figure 10-9.

1.-6.	Exceptions with the same priority as the priority of program-interruption conditions for the general case.
7.A	Access exceptions for second instruction halfword.

Figure 10-9. Priority of Execution: EXTRACT SECONDARY ASN (AND INSTANCE) (Part 1 of 2)

7.B.1	Operation exception if the ASN-and-LX-reuse facility is not installed (ESAIR only).
7.B.2	Special-operation exception due to DAT being off.
7.C	Transaction constraint.
8.	Privileged-operation exception due to extraction-authority control, bit 36 of control register 0, being zero in problem state.

Figure 10-9. Priority of Execution: EXTRACT SECONDARY ASN (AND INSTANCE) (Part 2 of 2)

EXTRACT STACKED REGISTERS

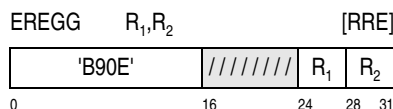
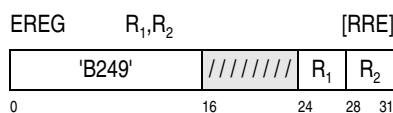

Contents of a set of general registers and a set of access registers that were saved in the last state entry in the linkage stack are restored to the registers. Each set of registers begins with register R₁ and ends with register R₂.

For EXTRACT STACKED REGISTERS (EREG), the contents of bit positions 32-63 of the general registers are restored, and the contents of bit positions 0-31 of the registers remain unchanged. For EXTRACT STACKED REGISTERS (EREGG), the contents of bit positions 0-63 of the general registers are restored. In either case, the contents of bit positions 0-31 of the access registers are restored.

For each of the general registers and the access registers, the registers are loaded in ascending order of their register numbers, starting with register R₁ and continuing up to and including register R₂, with register 0 following register 15. The bit positions of each register are loaded from the position in the state entry where the contents of the bit positions were saved when the state entry was created. The contents of the state entry remain unchanged.

The last state entry is located as described in “Unstacking Process” on page 5-86. The state entry

remains in the linkage stack, and the linkage-stack-entry address in control register 15 remains unchanged.

Key-controlled protection does not apply to references to the linkage stack.

Special Conditions

The CPU must be in the primary-space mode, access-register mode, or home-space mode; otherwise, a special-operation exception is recognized.

A stack-empty, stack-specification, or stack-type exception may be recognized during the unstacking process.

The operation is suppressed on all addressing exceptions.

Condition Code: The code remains unchanged.

Program Exceptions:

- Access (fetch, except for protection, linkage-stack entry)
- Special operation
- Stack empty
- Stack specification
- Stack type
- Transaction constraint

The priority of recognition of program exceptions for the instruction is shown in Figure 10-10.

1.-6.	Exceptions with the same priority as the priority of program-interruption conditions for the general case.
7.A	Access exceptions for second instruction halfword.
7.B	Special-operation exception due to DAT being off or the CPU being in secondary-space mode.
7.C	Transaction constraint.

Figure 10-10. Priority of Execution: EXTRACT STACKED REGISTERS (Part 1 of 2)

8.	Access exceptions (fetch) for entry descriptor of the current linkage-stack entry.
9.	Stack-type exception due to current entry not being a state entry or header entry. Note: Exceptions 10-14 can occur only if the current entry is a header entry.
10.	Access exceptions (fetch) for second word of the header entry.
11.	Stack-empty exception due to backward stack-entry validity bit in the header entry being zero.
12.	Access exceptions (fetch) for entry descriptor of preceding entry, which is the entry designated by the backward stack-entry address in the current (header) entry.
13.	Stack-specification exception due to preceding entry being a header entry.
14.	Stack-type exception due to preceding entry not being a state entry.
15.	Access exceptions (fetch) for the selected contents of the state entry.

Figure 10-10. Priority of Execution: EXTRACT STACKED REGISTERS (Part 2 of 2)

EXTRACT STACKED STATE

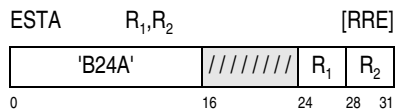

Sixty-four or 128 bits of status information in the last state entry in the linkage stack are placed in the pair of general registers designated by the R₁ field. The condition code is set to indicate whether the state entry is a branch state entry or a program-call state entry.

The R₁ field designates the even-numbered register of an even-odd pair of general registers.

Bits 56-63 of general register R₂ are an unsigned binary integer that is used as a code to select the state-entry byte positions, or byte and bit positions,

from which information is to be extracted, as shown in Figure 10-11.

Code (Bits 56-63 of GR R ₂)	State-Entry Content	State-Entry Byte, or Byte and Bit Positions, Selected
0	PKM, SASN, EAX, and PASN	128-135
1	PSW bits 0-32 and 97-127	136-139, 140.0, and 168-175.33-63 (see text)
2	Branch address or called space and PC number	144-151
3	Modifiable area	152-159
4	PSW bits 0-127	136-143 and 168-175
5	Secondary and primary ASTEIN	176-183

Figure 10-11. EXTRACT STACKED STATE Codes and Extracted State-Entry Fields

For a code of 0, 2, or 3 in bit positions 56-63 of general register R₂, the contents of the leftmost four bytes of the eight bytes of status information are placed in bit positions 32-63 of general register R₁, and the contents of the rightmost four bytes of the status information are placed in bit positions 32-63 of general register R₁ + 1. The contents of bit positions 0-31 of general registers R₁ and R₁ + 1 remain unchanged.

For a code of 1 in bit positions 56-63 of general register R₂, the contents of bytes 136-139 of the state entry, which are bits 0-31 of the PSW in the state entry, are placed in bit positions 32-63 of general register R₁; the contents of bit position 0 of byte 140 of the entry, which is bit 32 of that PSW, are placed in bit position 32 of general register R₁ + 1; and the contents of bit positions 33-63 of bytes 168-175 of the entry, which are bits 97-127 of the PSW, are placed in bit positions 33-63 of general register R₁ + 1. However, bit 44 of general register R₁, which corresponds to bit 12 of the PSW in the state entry, is set to one, indicating the extracted PSW is of the short-PSW format (as shown in Figure 4-3 on page 4-8). Also, if bits 0-32 of bytes 168-175 of the state entry are not all zeros, bit 63 of general register R₁ + 1 is set to one; otherwise, bit 63 remains with

the value loaded from bit position 63 of bytes 168-175 of the state entry. The contents of bit positions 0-31 of general registers R₁ and R₁ + 1 remain unchanged.

For a code of 4 in bit positions 56-63 of general register R₂, the contents of bytes 136-143 of the state entry, which are bits 0-63 of the PSW in the state entry, are placed in bit positions 0-63 of general register R₁, and the contents of bytes 168-175 of the state entry, which are bits 64-127 of that PSW, are placed in bit positions 0-63 of general register R₁ + 1.

Code 5 in bit positions 56-63 of general register R₂ is valid only if the ASN-and-LX-reuse facility is installed. For code 5, the contents of the leftmost four bytes of the eight bytes of status information are placed in bit positions 0-31 of general register R₁, and the contents of the rightmost four bytes of the status information are placed in bit positions 0-31 of general register R₁ + 1. The contents of bit positions 32-63 of general registers R₁ and R₁ + 1 remain unchanged.

The format of byte positions 128-183 of the state entry is as follows:

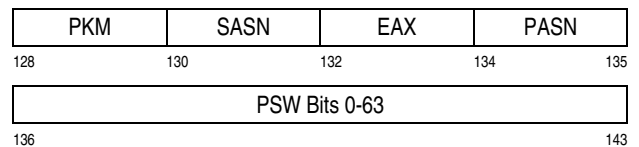

In a Branch State Entry Made in 24-Bit or 31-Bit Mode

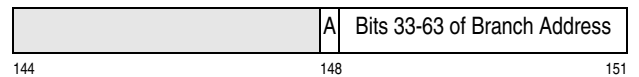

In a Branch State Entry Made in 64-Bit Mode

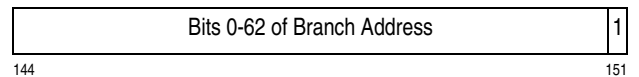

In a Program-Call State Entry Made When Resulting Mode Is 24 Bit or 31 Bit

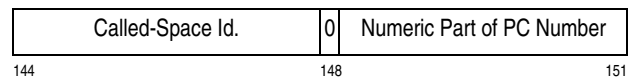

In a Program-Call State Entry Made When Resulting Mode Is 64 Bit

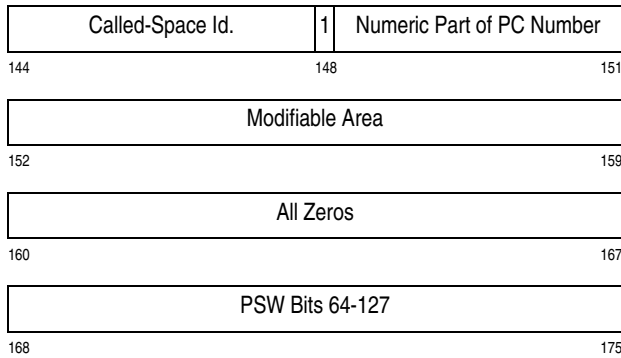

If ASN-and-LX Reuse Is Enabled; otherwise Unpredictable

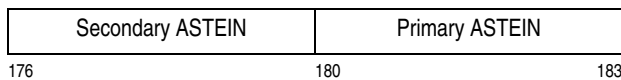

The contents of the state entry remain unchanged.

The last state entry is located as described in “Unstacking Process” on page 5-86. The state entry remains in the linkage stack, and the linkage-stack-entry address in control register 15 remains unchanged.

When the entry-type code in the entry descriptor of the state entry is 0001100 binary, indicating a branch state entry, the condition code is set to 0. When the entry-type code is 0001101 binary, indicating a program-call state entry, the condition code is set to 1.

Key-controlled protection does not apply to references to the linkage stack.

Bits 0-55 of general register R_2 are ignored.

Special Conditions

A specification exception is recognized when R_1 is odd or the code in bit positions 56-63 of general register R_2 is greater than 4 when the ASN-and-LX-reuse facility is not installed or is greater than 5 when the facility is installed.

The CPU must be in the primary-space mode, access-register mode, or home-space mode; otherwise, a special-operation exception is recognized.

A stack-empty, stack-specification, or stack-type exception may be recognized during the unstacking process.

The operation is suppressed on all addressing exceptions.

Resulting Condition Code:

- 0 Branch state entry
- 1 Program-call state entry
- 2 --
- 3 --

Program Exceptions:

- Access (fetch, except for protection, linkage-stack entry)
- Special operation
- Specification
- Stack empty
- Stack specification
- Stack type
- Transaction constraint

The priority of recognition of program exceptions for the instruction is shown in Figure 10-12.

1.-6.	Exceptions with the same priority as the priority of program-interruption conditions for the general case.
7.A	Access exceptions for second instruction halfword.
7.B	Special-operation exception due to DAT being off or the CPU being in secondary-space mode.
7.C	Transaction constraint.
8.A	Specification exception due to R_1 being odd or bits 56-63 of general register R_2 having a value greater than 4 when the ASN-and-LX-reuse facility is not installed or greater than 5 when the facility is installed.
8.B.1	Access exceptions (fetch) for entry descriptor of the current linkage-stack entry.
8.B.2	Stack-type exception due to current entry not being a state entry or header entry. Note: Exceptions 8.B.3-8.B.7 can occur only if the current entry is a header entry.
8.B.3	Access exceptions (fetch) for second word of the header entry.
8.B.4	Stack-empty exception due to backward stack-entry validity bit in the header entry being zero.

Figure 10-12. Priority of Execution: EXTRACT STACKED STATE (Part 1 of 2)

8.B.5	Access exceptions (fetch) for entry descriptor of preceding entry, which is the entry designated by the backward stack-entry address in the current (header) entry.
8.B.6	Stack-specification exception due to preceding entry being a header entry.
8.B.7	Stack-type exception due to preceding entry not being a state entry.
8.B.8	Access exceptions (fetch) for the selected contents of the state entry.

Figure 10-12. Priority of Execution: EXTRACT STACKED STATE (Part 2 of 2)

Programming Note: The results for a code of 1 in bit positions 56-63 of general register R_2 are intended to provide compatibility with ESA/390. However, the resulting values in bits 32-63 of general registers R_1 correspond to bits 0-31 of the short PSW (shown in Figure 4-3 on page 4-8); that is, the extracted values can indicate a stacked PSW with the extended-addressing control (bit 31) set to one, whereas an ESA/390-format PSW cannot. (It may be that only values of bits in bit positions 0-31 of the PSW are required.) Bit 63 of general register $R_1 + 1$ is set to one if the instruction address in the PSW in the state entry is larger than a 31-bit address.

INSERT ADDRESS SPACE CONTROL



The address-space-control bits, bits 16 and 17 of the current PSW, are placed in reversed order in bit positions 54 and 55 of general register R_1 ; that is, bit 16 is placed in bit position 55, and bit 17 is placed in bit position 54. Bits 48-53 of the register are set to zeros, and bits 0-47 and 56-63 of the register remain unchanged. The address-space-control bits are also used to set the condition code.

Special Conditions

The instruction must be executed with DAT on; otherwise, a special-operation exception is recognized.

In the problem state, the extraction-authority control, bit 36 of control register 0, must be one; otherwise, a

privileged-operation exception is recognized. In the supervisor state, the extraction-authority-control bit is not examined.

Resulting Condition Code:

- 0 PSW bits 16 and 17 zeros (indicating primary-space mode)
- 1 PSW bit 16 one and bit 17 zero (indicating secondary-space mode)
- 2 PSW bit 16 zero and bit 17 one (indicating access-register mode)
- 3 PSW bits 16 and 17 ones (indicating home-space mode)

Program Exceptions:

- Privileged operation (extraction-authority control is zero in the problem state)
- Special operation
- Transaction constraint

The priority of recognition of program exceptions for the instruction is shown in Figure 10-13.

1.-6.	Exceptions with the same priority as the priority of program-interruption conditions for the general case.
7.A	Access exceptions for second instruction halfword.
7.B	Special-operation exception due to DAT being off.
7.C	Transaction constraint.
8.	Privileged-operation exception due to extraction-authority control, bit 36 of control register 0, being zero in problem state.

Figure 10-13. Priority of Execution: INSERT ADDRESS SPACE CONTROL

Programming Notes:

1. Bits 48-53 of general register R_1 are reserved for expansion for use with possible future facilities. The program should not depend on these bits being set to zeros.
2. INSERT ADDRESS SPACE CONTROL and SET ADDRESS SPACE CONTROL are defined to operate on the seventh byte of a general register so that the address-space-control bits can be saved in the same general register as the PSW

key, which is placed in the eighth byte of general register 2 by INSERT PSW KEY.

INSERT PSW KEY

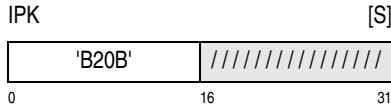

The four-bit PSW-key, bits 8-11 of the current PSW, is inserted in bit positions 56-59 of general register 2, and bits 60-63 of that register are set to zeros. Bits 0-55 of general register 2 remain unchanged.

Special Conditions

In the problem state, the extraction-authority control, bit 36 of control register 0, must be one; otherwise, a privileged-operation exception is recognized. In the supervisor state, the extraction-authority-control bit is not examined.

Condition Code: The code remains unchanged.

Program Exceptions:

- Privileged operation (extraction-authority control is zero in the problem state)
- Transaction constraint

INSERT REFERENCE BITS MULTIPLE

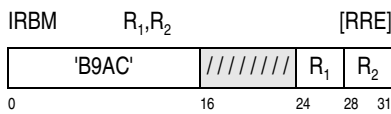

Beginning with the block designated by the address in general register R_2 , the reference bits in the storage keys of the 64 consecutive 4 K-byte blocks are inspected. For each of the 64 blocks, the reference bit is placed in an ascending bit position of general register R_1 , beginning with bit position 0 of the register.

General register R_2 designates the first of 64 blocks in absolute storage on a 64-block (256 K-byte) boundary. In the 24-bit addressing mode, bits 40-45 of the register, with six binary zeros appended on the

right, designate the first block, and bits 0-39 and 46-63 of the register are ignored. In the 31-bit addressing mode, bits 33-45 of the register, with six binary zeros appended on the right, designate the first block, and bits 0-32 and 46-63 of the register are ignored. In the 64-bit addressing mode, bits 0-45 of the register, with six binary zeros appended on the right, designate the first block, and bits 46-63 of the register are ignored.

Because it is an absolute address, the address designating the first storage block is not subject to dynamic address translation or prefixing. The references to the storage keys are not subject to protection exceptions.

Condition Code: The code remains unchanged.

Program Exceptions:

- Addressing (address specified by general register R_2)
- Operation (insert-reference-bits-multiple facility not installed)
- Privileged operation
- Transaction constraint

Programming Note: The reference bits provided by the INSERT REFERENCE BITS MULTIPLE instruction provide the control program with a substantially accurate census of the reference bits inspected by the instruction. However, depending on the model, the results returned by the instruction may differ from those provided by the RESET REFERENCE BITS MULTIPLE instruction for the same blocks of storage. Similarly, the results returned by INSERT REFERENCE BITS MULTIPLE may differ from those provided by a series of 64 INSERT STORAGE KEY EXTENDED or RESET REFERENCE BIT EXTENDED instructions for the same blocks of storage.

INSERT STORAGE KEY EXTENDED

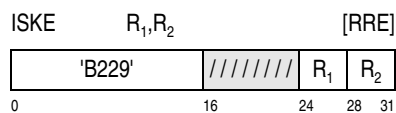

The storage key for the block that is addressed by the contents of general register R_2 is inserted in general register R_1 .

In the 24-bit addressing mode, bits 40-51 of general register R_2 designate a 4 K-byte block in real storage, and bits 0-39 and 52-63 of the register are ignored. In the 31-bit addressing mode, bits 33-51 of general register R_2 designate a 4 K-byte block in real storage, and bits 0-32 and 52-63 of the register are ignored. In the 64-bit addressing mode, bits 0-51 of general register R_2 designate a 4 K-byte block in real storage, and bits 52-63 of the register are ignored.

The address designating the storage block, being a real address, is not subject to dynamic address translation. The reference to the storage key is not subject to a protection exception.

The seven-bit storage key is inserted in bit positions 56-62 of general register R_1 , and bit 63 is set to zero. The contents of bit positions 0-55 of the register remain unchanged.

Condition Code: The code remains unchanged.

Program Exceptions:

- Addressing (address specified by general register R_2)
- Privileged operation
- Transaction constraint

Programming Note: See the programming note for INSERT REFERENCE BITS MULTIPLE on page 10-30 for a discussion of differing reference bits that may be returned by IRBM, ISKE, RRBE, and RRBM for the same block of storage.

INSERT VIRTUAL STORAGE KEY

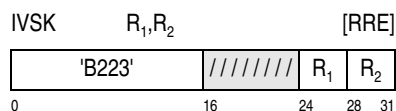

The storage key for the location designated by the virtual address in general register R_2 is inserted in general register R_1 .

Selected bits of general register R_2 are used as a virtual address. In the 24-bit addressing mode, the address is specified by bits 40-63 of the register, and

bits 0-39 are ignored. In the 31-bit addressing mode, the address is specified by bits 33-63, and bits 0-32 is ignored. In the 64-bit addressing mode, the address is specified by bits 0-63 of the register.

The address is a virtual address and is subject to the address-space-control bits, bits 16 and 17 of the current PSW. The address is treated as a primary virtual address in the primary-space mode, as a secondary virtual address in the secondary-space mode, as an AR-specified virtual address in the access-register mode, or as a home virtual address in the home-space mode. The reference to the storage key is not subject to a protection exception.

Bits 0-4 of the storage key, which are the access-control bits and the fetch-protection bit, are placed in bit positions 56-60 of general register R_1 , with bits 61-63 set to zeros. The contents of bit positions 0-55 of the register remain unchanged. The change and reference bits in the storage key are not inspected. The change bit is not affected by the operation. The reference bit, depending on the model, may or may not be set to one as a result of the operation.

The following diagram shows the storage key and the register positions just described.

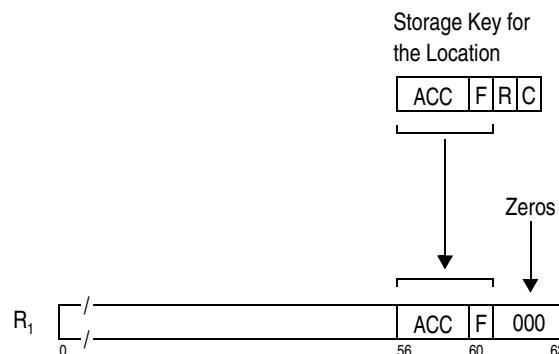

Special Conditions

The instruction must be executed with DAT on; otherwise, a special-operation exception is recognized.

In the problem state, the extraction-authority control, bit 36 of control register 0, must be one; otherwise, a privileged-operation exception is recognized. In the supervisor state, the extraction-authority-control bit is not examined.

Condition Code: The code remains unchanged.

Program Exceptions:

- Access (except for protection, address specified by general register R_2)
- Privileged operation (extraction-authority control is zero in the problem state)
- Special operation
- Transaction constraint

The priority of recognition of program exceptions for the instruction is shown in Figure 10-14.

1.-6.	Exceptions with the same priority as the priority of program-interruption conditions for the general case.
7.A	Access exceptions for second instruction halfword.
7.B	Special-operation exception due to DAT being off.
7.C	Transaction constraint.
8.	Privileged-operation exception due to extraction-authority control, bit 36 of control register 0, being zero.
9.	Access exceptions (except for protection) for address specified by general register R_2 .

Figure 10-14. Priority of Execution: INSERT VIRTUAL STORAGE KEY

Programming Notes:

1. Since all bytes in a 4 K-byte block are associated with the same page and the same storage key, bits 52-63 of general register R_2 essentially are ignored. Similarly, since all bytes in a 1 M-byte block are associated with the same segment, bits 44-63 of general register R_2 may be ignored when EDAT-1 applies and the STE-format and ACCF-validity controls are both one. Since all bytes in a 2 G-byte block are associated with the same region, bits 33-63 of general register R_2 may be ignored when EDAT-2 applies and the RTTE-format and ACCF-validity controls are both one.
2. In the access-register mode, access register 0 designates the primary address space regardless of the contents of access register 0.

INVALIDATE DAT TABLE ENTRY



Note: The term “specified CPU or CPUs” has the following meaning for scope of TLBs affected by this instruction:

- When the local-TLB-clearing facility is not installed, or when the facility is installed and the local-clearing-control (LC) bit in the M_4 field is zero, the term “specified CPU or CPUs” means all of the CPUs in the configuration.
- When the local-TLB-clearing facility is installed and the LC bit in the M_4 field is one, the term “specified CPU or CPUs” means only the CPU executing the IDTE instruction (the local CPU). The TLBs in all other CPUs in the configuration may not be affected.

When the clearing-by-ASCE-option bit, bit 52 of general register R_2 , is zero, an operation called the invalidation-and-clearing operation is performed, as follows. The designated region-table entry or segment-table entry in storage, or a range of entries beginning with the designated entry, is invalidated, and the translation-lookaside buffers (TLBs) in the specified CPU or CPUs in the configuration are cleared of (1) all TLB table entries of the designated type formed through the use of the invalidated entry or entries in storage, and (2) all lower-level TLB table entries formed through the use of the cleared higher-level TLB table entries. The TLB entries cleared may optionally be limited to entries formed to translate addresses in a specified address space.

When the clearing-by-ASCE-option bit is one, an operation called the clearing-by-ASCE operation is performed, as follows. The operation does not perform any invalidation of DAT-table entries in storage, but it does clear, from the TLBs in all CPUs in the configuration, all region-first-table entries, region-second-table entries, region-third-table entries, segment-table entries and page-table entries formed to translate addresses in a specified address space.

The two operations are described separately below, before the section “Common Operation.”

The M_4 field has the following format:



The bits of the M_4 field are defined as follows:

- **Reserved:** Bits 0-1 of the M_4 field are ignored but should contain zeros; otherwise, the program may not operate compatibly in the future.
- **Format-Control Summary (FS):** When EDAT-2 applies, bit 2 of the M_4 field is the format-control summary (FS) for the invalidation-and-clearing operation. Bit 2 of the M_4 field is ignored for the clearing-by-ASCE operation and when EDAT-2 does not apply.

The format-control summary applies when the designation type (DT), bits 60-61 of the general register R_1 , is 00 or 01 binary; when the DT in general register R_1 is 10 or 11 binary, the format-control summary is ignored. The meaning of the FS bit is as follows:

Value Meaning

- | | |
|---|--|
| 0 | The format control is not known to be one in all of the table entries designated by the effective invalidation index and additional-entry count. |
| 1 | The format control is one in all of the table entries designated by the effective invalidation index and additional-entry count. |

- **Local-Clearing Control (LC):** When the local-TLB-clearing facility is installed, the LC bit, bit 3 of the M_4 field, controls whether only the TLB in the local CPU is cleared or whether the TLBs in all CPUs of the configuration are cleared. When the local-TLB-clearing facility is not installed, bit 3 of the M_4 field is ignored.

Invalidation-and-Clearing Operation

When bit 52 of general register R_2 , the clearing-by-ASCE-option bit, is zero, the invalidation-and-clearing operation is specified.

The contents of general register R_1 have the format of an address-space-control element with only the table origin, bits 0-51, and designation-type control (DT), bits 60 and 61, used. The table origin designates the DAT table in which one or more entries are to be invalidated, and DT specifies the type of that table.

Bits 52-59, 62, and 63 of general register R_1 are ignored.

Bits 0-43 of general register R_2 have the format of the region index and segment index of a virtual address. The part of bits 0-43 normally used by DAT to select an entry in the type of table designated by general register R_1 is called the effective invalidation index.

Bits 60 and 61 of general register R_1 specify a table type and an effective invalidation index as follows:

Bits 60 and 61 of general register R_1 specify a table type and an effective invalidation index as follows:

Bits 60 and 61 of Reg. R_1	Table Type	Effective Invalidation Index in Reg. R_2
11	Region first table	Region first index (bits 0-10)
10	Region second table	Region second index (bits 11-21)
01	Region third table	Region third index (bits 22-32)
00	Segment table	Segment index (bits 33-43)

The part of bits 0-43 of general register R_2 to the left (if any) and to the right of the effective invalidation index is ignored.

The table origin in general register R_1 and the effective invalidation index designate a DAT-table entry to be invalidated. Bits 53-63 of general register R_2 are an unsigned binary integer specifying the number of additional table entries to be invalidated. Therefore, the number of entries to be invalidated is 1-2,048, corresponding to a value of bits 53-63.

Bits 44-49 of general register R_2 must be zeros; otherwise, a specification exception is recognized. It is unpredictable if a specification exception is recognized if bits 50 and 51 of general register R_2 contain non-zero values.

If R_3 is nonzero, the contents of general register R_3 have the format of an address-space-control element with only the table origin, bits 0-51, and designation-type control (DT), bits 60 and 61, used. These contents are used to select TLB entries to be cleared. Bits 52-59, 62, and 63 of general register R_3 are

ignored. If R_3 is zero, the entire contents of general register 0 are ignored, and TLB entries are cleared regardless of the ASCE used to form them.

The contents of the general registers just described are shown in Figure 10-15.

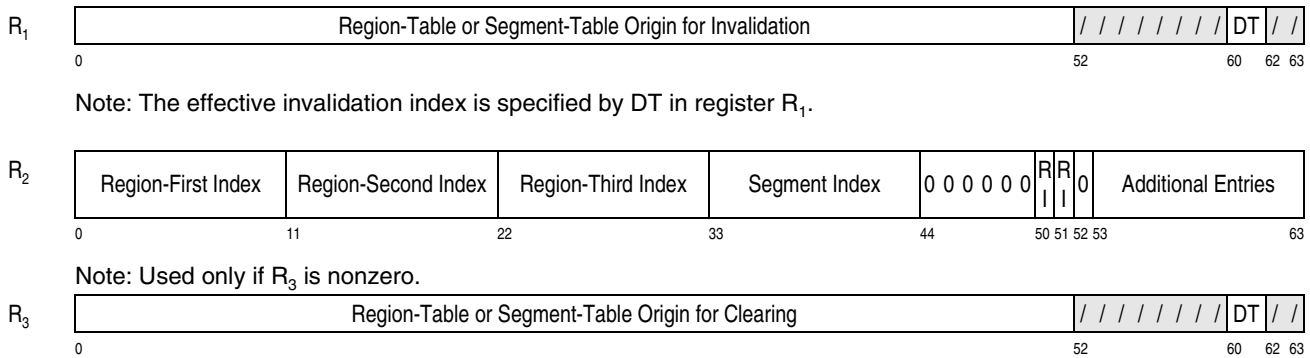

Figure 10-15. Register Contents for INVALIDATE DAT TABLE ENTRY Invalidation-and-Clearing Operation (Bit 52 of GR R_2 Is Zero)

The table origin in general register R_1 and effective invalidation index in general register R_2 designate a table entry in accordance with the rules in “Lookup in a Table Designated by an Address-Space-Control Element” on page 3-57, except that a carry from bit position 0 of the resulting address is always ignored, and the index is not checked against a table-length field. The table origin is treated as a 64-bit address, and the addition is performed by using the rules for 64-bit address arithmetic, regardless of the current addressing mode specified by bits 31 and 32 of the current PSW. The address formed from these two components is a real or absolute address. The invalid bit, bit 58, of this doubleword is set to one. During this procedure, the entry is not checked for a format error or for whether the origin, in the entry, of the next-lower-level table would cause an addressing exception. The table-type field in the entry is ignored. If the DT field in bits 60-61 of general register R_1 designates a segment-table entry, the common-segment bit in the entry is ignored. If EDAT-2 applies and the DT field designates a region-third-table entry, the common-region bit in the entry is ignored.

The entire table entry is fetched concurrently from storage. Subsequently, the byte containing the invalid bit is stored. The fetch access to the entry is subject to key-controlled protection, and the store access is subject to key-controlled protection and low-address protection.

If bits 53-63 of general register R_2 are not all zeros, the setting of the invalid bit to one in a region-table or segment-table entry is repeated by adding one to the previously used value of the effective invalidation

index, and this is done as many times as are specified by bits 53-63. A carry out of the leftmost bit position of the effective invalidation index is ignored, and wraparound in the table occurs in this case. The contents of general register R_2 remain unchanged.

A serialization function is performed before the operation begins and again after the operation is completed. As is the case for all serialization operations, this serialization applies only to this CPU; other CPUs are not necessarily serialized.

After it has set an invalid bit to one, this CPU clears selected entries from its TLB. Then if the local-TLB-clearing facility is not installed, or if the facility is installed and LC bit in the M_4 field is zero, this CPU signals all other CPUs in the configuration to clear selected entries from their TLBs. Each affected TLB is cleared of at least those entries for which all of the following conditions are met:

- The effective invalidation index in general register R_2 matches the corresponding index in the TLB table entry of type designated by the DT field in bits 60-61 of general register R_1 . If the model implements a composite TLB entry that includes the index designated by the DT field, bits to the left of the effective index in general register R_2 also match any corresponding bits provided in the designated TLB table entry. Note that when multiple table entries are invalidated due to bits 53-63 of general register R_2 , then the effective invalidation index is incremented, a carry out of the leftmost bit position of the index is lost, and TLB region- or segment-table entries

are cleared for each value of the index so obtained.

- Either the R_3 field is zero, or the table-origin and designation-type fields in general register R_3 match the table-origin and designation-type fields in the address-space-control element (ASCE) used to form the TLB table entry.

If the R_3 field is zero, then the condition described in this step does not apply.

- If the entry invalidated in storage designates a lower-level translation table, the lower-level table origin in the invalidated entry matches the table-origin field in the TLB table entry.

Each affected TLB is also cleared of at least any lower-level TLB table entries for which all of the following conditions are met:

- The lower-level TLB table entry was formed through use of an entry invalidated in storage or through use of a higher-level TLB table entry formed through use of either an entry invalidated in storage or a TLB entry cleared in this process.
- Either the R_3 field is zero or the table-origin and designation-type fields in general register R_3 match the table-origin and designation-type fields in the address-space-control element (ASCE) used to form the lower-level TLB table entry. This ASCE may be one that attached a translation path containing a higher-level table entry that attached the lower-level table entry in storage from which the lower-level TLB table entry was formed, or it may be one that made usable a higher-level TLB table entry that attached the lower-level table entry in storage from which the lower-level TLB table entry was formed. See “Formation of TLB Entries” on page 3-63 for the meaning of the terminology used here.

If the R_3 field is zero, then the condition described in this step does not apply.

- If the entry invalidated in storage designates a lower-level translation table, the lower-level table origin in the invalidated entry matches the table-origin field in the TLB table entry.

Programming Notes:

1. Setting the format-control summary to one may provide improved performance on certain models.
2. When the designation type (DT), bits 60-61 of general register R_1 , is 00 binary, the format-control summary applies to the segment-table entries being invalidated. When the DT in general register R_1 is 01 binary, the format-control summary applies to the region-third-table entries being invalidated.
3. The program should only set the format-control summary to one if it can ensure that format control (bit 53 of the table entry) is one in all of the table entries being invalidated. If the format-control summary is set to one, but the format control is not one in all of the table entries being invalidated, incomplete purging of the TLB may occur, resulting in unpredictable results from DAT.
4. The M_4 field of the instruction is considered to be optional, as indicated by the field being contained within brackets [] in the assembler syntax. When the M_4 field is not specified, the assembler places zeros in that field of the instruction.

Storing in the region- or segment-table entry and the clearing of TLB entries may or may not occur if the invalid bit is already one in the region- or segment-table entry.

When multiple entries are invalidated, clearing of TLB entries may be delayed until all entries have been invalidated.

Clearing-by-ASCE Operation

When bit 52 of general register R_2 , the clearing-by-ASCE-option bit, is one, the clearing-by-ASCE operation is specified.

The contents of general register R_3 have the format of an address-space-control element with only the table origin, bits 0-51, and designation-type control (DT), bits 60 and 61, used. These contents are used to select TLB entries to be cleared. Bits 52-59, 62, and 63 of general register R_3 are ignored. R_3 may be zero or nonzero, that is, any general register, including register 0, may be designated.

Bits 44-49 of general register R_2 must be zeros; otherwise, a specification exception is recognized. It is

unpredictable if a specification exception is recognized if bits 50 and 51 of general register R_2 do not contain zero values.

The contents of general register R_1 and of bit positions 0-43 and 53-63 of general register R_2 are ignored.

The contents of the general registers just described are shown in Figure 10-16.

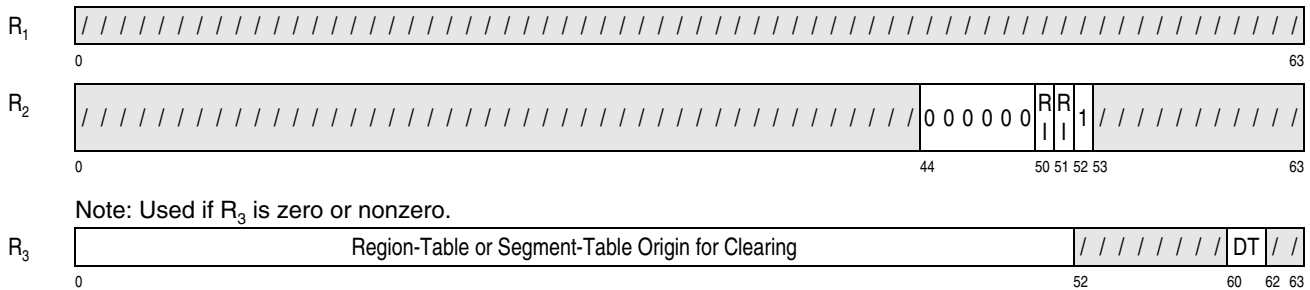

Figure 10-16. Register Contents for *INVALIDATE DAT TABLE ENTRY* Clearing-by-ASCE Operation (Bit 52 of GR R_2 Is One)

The TLBs of the specified CPU or CPUs in the configuration are cleared at all levels of at least those entries for which the table-origin and designation-type fields in general register R_3 match the table-origin and designation-type fields in the address-space-control element (ASCE) used to form the entry. This ASCE is the one used in the translation during which the entry was formed. See “Formation of TLB Entries” on page 3-63 for the meaning of the terminology used here.

When the clearing-by-ASCE-option bit (bit 52 of general register R_2) is one, the format-control summary bit (bit 2 of the M_4 field) is ignored.

Common Operation

The execution of *INVALIDATE DAT TABLE ENTRY* is not completed on the CPU which executes it until the following occur:

1. All entries meeting the criteria specified above have been cleared from the TLB of this CPU. When the local-TLB-clearing facility is installed and the LC bit in the M_4 field is one, execution of *INVALIDATE DAT TABLE ENTRY* is complete at this point and the following step is not performed.
2. When the local-TLB-clearing facility is not installed, or when the facility is installed and the LC bit in the M_4 field is zero, all other CPUs in the configuration have completed any storage accesses, including the updating of the change

and reference bits, by using TLB entries corresponding to the specified parameters.

Before the TLB purging operation, transactional execution by other CPUs in the configuration is aborted with abort code 255, condition code 2. The aborting of transactional execution affects at least those CPUs accessing the locations (transactionally or nontransactionally) for which TLB entries are being cleared. It is unpredictable whether some or all other CPUs are affected as well.

The operations do not necessarily have any effect on TLB real-space entries.

Special Conditions

Bits 44-49 of general register R_2 must be zeros; otherwise, a specification exception is recognized.

It is unpredictable whether a specification exception is recognized if bits 44-49 of general register R_2 contain non-zero values.

The operation is suppressed on all addressing and protection exceptions (invalidation-and-clearing operation only).

Resulting Condition Code: The code is unpredictable.

Program Exceptions:

- Addressing (invalidated region- or segment-table entry, invalidation-and-clearing operation only).
- Operation (if the DAT-enhancement facility is not installed)
- Privileged operation
- Protection (fetch and store, region- or segment-table entry, key-controlled protection and low-address protection; invalidation-and-clearing operation only).
- Specification
- Transaction constraint

Programming Notes:

1. The selective clearing of TLB entries may be implemented in different ways, depending on the model, and, in general, more entries may be cleared than the minimum number required. When the invalidation-and-clearing operation is performed, some models may clear all TLB entries when the effective invalidation index is not a segment index or may clear an entry regardless of the page-table origin in the entry. When that operation or the clearing-by-ASCE operation is performed, some models may clear a TLB entry regardless of the designation-type field in general register R_3 . When either operation is performed, other models may clear precisely the minimum number of entries required. Therefore, in order for a program to operate on all models, the program should not take advantage of any properties obtained by a less selective clearing on a particular model.
2. When using the clearing-by-ASCE operation to clear TLB entries associated with common segments, note that these entries may have been formed through use of address-space-control elements containing many different table origins.

The following notes apply when the invalidation-and-clearing operation is specified.

3. The clearing of TLB entries may make use of the page-table origin in a segment-table entry. Therefore, if the segment-table entry, when in the attached state, ever contained a page-table origin that is different from the current value, copies of entries containing the previous values may remain in the TLB.
4. INVALIDATE DAT TABLE ENTRY cannot be safely used to update a shared location in main storage if the possibility exists that another CPU

or a channel program may also be updating the location.

5. The address of the DAT-table entry for INVALIDATE DAT TABLE ENTRY is a 64-bit address, and the address arithmetic is performed by following the normal rules for 64-bit address arithmetic, with wraparound at $2^{64} - 1$. Also, offset and length fields are not used. Contrast this with implicit translation and the translations for LOAD REAL ADDRESS and STORE REAL ADDRESS, all of which may result either in wraparound or in an addressing exception when a carry occurs out of bit position 0 and which indicate an exception condition when the designated entry does not lie within its table. Accordingly, the DAT tables should not be specified to wrap from maximum storage locations to location 0, and the first designated entry and all additional entries specified by bits 53-63 of general register R_2 should lie within the designated table.
6. When the local-TLB-clearing facility is installed, the local-clearing control should be specified as one when the ASCE used to form the TLB entries being cleared has been attached only to the CPU on which the IDTE instruction is executed (for example, if the program is running on a uniprocessor). Otherwise, unpredictable results, including the presentation of a delayed-access-exception machine check, may occur.

On some models, use of INVALIDATE DAT TABLE ENTRY specifying clearing of only the local TLB for the cases listed above may result in significant performance improvements.

7. The M_4 field of the instruction is considered to be optional, as indicated by the field being contained within brackets [] in the assembler syntax. When the M_4 field is not specified, the assembler places zeros in that field of the instruction.

INVALIDATE PAGE TABLE ENTRY

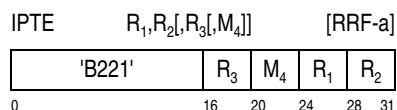

Note: The term “specified CPU or CPUs” has the following meaning for scope of TLBs affected by this instruction:

- When the local-TLB-clearing facility is not installed, or when the facility is installed and the local-clearing-control (LC) bit in the M_4 field is zero, the term “specified CPU or CPUs” means all of the CPUs in the configuration.
- When the local-TLB-clearing facility is installed and the LC bit in the M_4 field is one, the term “specified CPU or CPUs” means only the CPU executing the IPTE instruction (the local CPU). The TLBs in all other CPUs in the configuration may not be affected.

The designated page-table entries are invalidated, and the translation-lookaside buffers (TLBs) in the specified CPU or CPUs in the configuration are cleared of the associated entries.

The contents of general register R_1 have the format of a segment-table entry, with only the page-table origin used. The contents of general register R_2 have the format of a virtual address, with only the page index used. The contents of fields that are not part of the page-table origin or page index are ignored.

When the IPTE-range facility is not installed, or when the R_3 field is zero, the single page-table entry designated by the first and second operands is invalidated.

When the IPTE-range facility is installed and the R_3 field is nonzero, bits 56-63 of general register R_3 contain an unsigned binary integer specifying the count of additional page-table entries to be invalidated. Therefore, the number of page-table entries to be invalidated is 1-256, corresponding to a value of 0-255 in bits 56-63 of the register. Bits 0-55 of the register should be set to zero; otherwise, the program may not operate compatibly in the future.

When the IPTE-range facility is installed in the z/Architecture architectural mode, it is unpredictable whether it is installed in the ESA/390-compatibility mode.

The contents of the general registers just described are shown in Figure 10-17 .

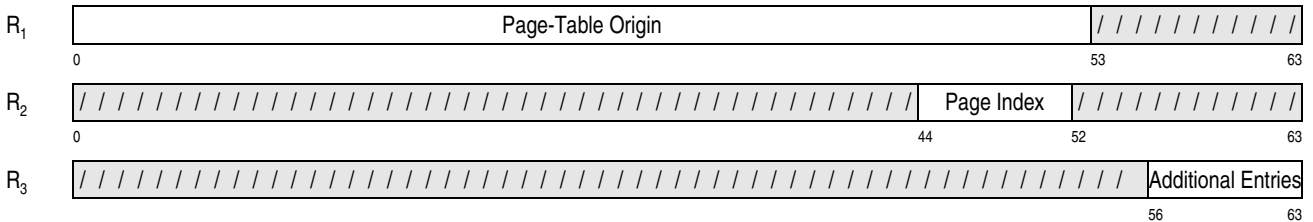

Figure 10-17. Register Contents for INVALIDATE PAGE TABLE ENTRY

When the IPTE-range facility is not installed, the R_3 field is ignored but should contain zeros; otherwise, the program may not operate compatibly in the future.

The M_4 field has the following format:



The bits of the M_4 field are defined as follows:

- **Reserved:** Bits 0-2 are reserved. Reserved bit positions of the M_4 field are ignored but should contain zeros; otherwise, the program may not operate compatibly in the future.

- **Local-Clearing Control (LC):** When the local-TLB-clearing facility is installed, the LC bit, bit 3 of the M_4 field, controls whether only the TLB in the local CPU is cleared or whether the TLBs in all CPUs of the configuration are cleared. When the local-TLB-clearing facility is not installed, bit 3 of the M_4 field is reserved.

The page-table origin and the page index designate a page-table entry, following the dynamic-address-translation rules for page-table lookup. In the z/Architecture architectural mode, the page-table origin is treated as a 64-bit address, and the addition is performed by using the rules for 64-bit address arithmetic, regardless of the current addressing mode, which is specified by bits 31 and 32 of the current PSW. A carry out of bit position 0 as a result of the addition of the page index and page-table origin cannot occur. In the ESA/390-compatibility mode, it is unpredictable

whether the page-table origin and page index are treated as in the z/Architecture architectural mode, or the page-table origin is treated as a 31-bit address and the page-table index is multiplied by four (as in the ESA/390 architectural mode). The address formed from these two components is a real or absolute address.

The page-invalid bit of this page-table entry is set to one. During this procedure, the page-table entry is not inspected for whether the page-invalid bit is already one or for format errors. Additionally, the page-frame real address contained in the entry is not checked for an addressing exception. In the z/Architecture architectural mode, the page-invalid bit is bit 53 of the doubleword PTE. In the ESA/390-compatibility mode, it is unpredictable whether the page invalid bit is bit 53 of the doubleword PTE or bit 21 of the word PTE.

When the IPTE-range facility is installed and the R_3 field is nonzero, the instruction is interruptible, and processing is as follows:

1. The invalidation process described above is repeated for each subsequent entry in the page table until either the number of additional entries specified in bits 56-63 of general register R_3 have been invalidated or an interruption occurs.
2. The page-index in bits 44-51 of general register R_2 is incremented by the number of page-table entries that were invalidated; a carry out of bit position 44 of general register R_2 is ignored.
3. The additional-entry count in bits 56-63 of general register R_3 is decremented by the number of page-table entries that were invalidated.

Therefore, when the IPTE-range facility is installed, the R_3 field is nonzero, and an interruption occurs (other than one that causes termination), general registers R_2 and R_3 have been updated, so that the instruction, when reexecuted, resumes at the point of interruption.

When the IPTE-range facility is not installed, or when the R_3 field is zero, the contents of registers R_2 , and R_3 remain unchanged.

For each page-table entry that is invalidated, the entire page-table entry appears to be fetched concurrently from storage as observed by other CPUs. Subsequently, the byte containing the page-invalid bit is

stored. The fetch access to each page-table entry is subject to key-controlled protection, and the store access is subject to key-controlled protection and low-address protection.

A serialization function is performed before the operation begins and again after the operation is completed. As is the case for all serialization operations, this serialization applies only to this CPU; other CPUs are not necessarily serialized.

If no exceptions are recognized, this CPU clears selected entries from its TLB. Then if the local-TLB-clearing facility is not installed, or if the facility is installed and LC bit in the M_4 field is zero, this CPU signals all CPUs in the configuration to clear selected entries from their TLBs. For each page-table entry invalidated, each affected TLB is cleared of at least those entries that have been formed using all of the following:

- The page-table origin specified by general register R_1
- The page index specified by general register R_2
- The page-frame real address contained in the designated page-table entry

When the local-TLB-clearing facility is installed in the z/Architecture architectural mode, it is unpredictable whether the facility is installed in the ESA/390-compatibility mode.

The execution of INVALIDATE PAGE TABLE ENTRY is not completed on the CPU which executes it until the following occur:

1. All page-table entries corresponding to the specified parameters have been invalidated.
2. All entries corresponding to the specified parameters have been cleared from the TLB of this CPU. When the local-TLB-clearing facility is installed and the LC bit in the M_4 field is one, the execution of INVALIDATE PAGE TABLE entry is complete at this point and the following step is not performed.
3. When the local-TLB-clearing facility is not installed, or when the facility is installed and LC bit in the M_4 field is zero, all other CPUs in the configuration have completed any storage accesses, including the updating of the change

and reference bits, by using TLB entries corresponding to the specified parameters.

Before the TLB purging operation, transactional execution by other CPUs in the configuration is aborted with abort code 255, condition code 2. The aborting of transactional execution affects at least those CPUs accessing the locations (transactionally or nontransactionally) for which TLB entries are being cleared. It is unpredictable whether some or all other CPUs are affected as well.

Special Conditions

When the IPTE-range facility is installed, the R_3 field is nonzero, and the page index in general register R_2 plus the additional-entry count in general register R_3 is greater than 255, a specification exception is recognized.

The unit of operation is suppressed on all addressing and protection exceptions.

Condition Code: The code remains unchanged.

Program Exceptions:

- Addressing (page-table entry)
- Privileged operation
- Protection (fetch and store, page-table entry, key-controlled protection, and low-address protection)
- Specification
- Transaction constraint

Programming Notes:

1. The selective clearing of entries may be implemented in different ways, depending on the model, and, in general, more entries may be cleared than the minimum number required. Some models may clear all entries which contain the page-frame real addresses obtained from the page-table entries in storage. Others may clear all entries which contain the designated page index (or indices), and some implementations may clear precisely the minimum number of entries required. Therefore, in order for a program to operate on all models, the program should not take advantage of any properties obtained by a less selective clearing on a particular model.
2. The clearing of TLB entries may make use of the page-frame real addresses in the page-table entries. Therefore, if the page-table entries, when in the attached state, ever contained page-frame real addresses that are different from the current values, copies of entries containing the previous values may remain in the TLB.
3. INVALIDATE PAGE TABLE ENTRY cannot be safely used to update a shared location in main storage if the possibility exists that another CPU or a channel program may also be updating the location.
4. When the IPTE-range facility is installed and the R_3 field is nonzero, the following applies:
 - a. All of the page-table entries to be invalidated must reside in the same page table. A specification exception is recognized if the page index in general register R_1 plus the additional-entry count in general register R_3 is greater than the maximum page index of 255.
 - b. The number of page-table entries that are invalidated by INVALIDATE PAGE TABLE ENTRY may vary from one execution to another.
 - c. The instruction cannot be used for situations where the program must rely on uninterrupted execution of the instruction. Similarly, the program should normally not use INVALIDATE PAGE TABLE ENTRY to invalidate a page-table entry, the page-frame-real address of which designates the 4 K-byte block containing the instruction or of an execute-type instruction that executes the IPTE.
 - d. Further programming notes concerning interruptible instructions are included in "Interruptible Instructions" on page 5-24.
5. When the local-TLB-clearing facility is installed, the local-clearing control should be specified as one when the ASCE used to form the TLB entries being cleared has been attached only to the CPU on which the IPTE instruction is executed (for example, if the program is running on a uniprocessor). Otherwise, unpredictable results, including the presentation of a delayed-access-exception machine check, may occur.

On some models, use of INVALIDATE PAGE TABLE ENTRY specifying clearing of only the local TLB for the cases listed above may result in significant performance improvements.

- The R_3 and M_4 fields of the instruction are considered to be optional, as indicated by the fields being contained within brackets [] in the assembler syntax. When either field is not specified, the assembler places zeros in the corresponding field of the instruction. When the M_4 field is coded but the R_3 field is not required, a zero should be coded to designate the place of the third operand.

LOAD ADDRESS SPACE PARAMETERS

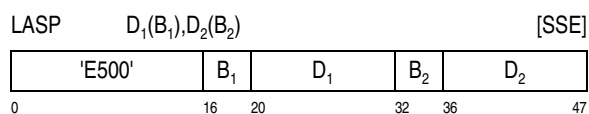

The first operand contains values to be loaded into control registers 3 and 4, including a secondary ASN (SASN) and a primary ASN (PASN), and, possibly, a secondary ASTE instance number (SASTEIN) and a primary ASTE instance number (PASTEIN). Execution of the instruction consists in performing four major steps: PASN translation, SASN translation, SASN authorization, and control-register loading. Each of these steps may or may not be performed, depending on the outcome of certain tests and on the setting of bits 61-63 of the second-operand address. The first three of these steps, when performed and successful, obtain additional values, that are loaded into control registers 1, 5, and 7. When the first three steps are not successful when performed, no control registers are changed, and the reason is indicated in the condition code.

When the ASN-and-LX-reuse facility is not installed, or is installed but is not enabled by a one value of the ASN-and-LX-reuse control, bit 44 of control register 0, the first operand is a doubleword containing a PSW-key mask (PKM), a SASN, an authorization index (AX), and a PASN. When the ASN-and-LX-reuse facility is installed and enabled, the first operand is two consecutive doublewords containing those four values and also a SASTEIN and a PASTEIN.

The primary ASN may be translated by means of the ASN-translation tables to obtain a primary-ASTE (PASTE) origin (PASTE0) and, from the PASTE, a primary ASCE (PASCE). The secondary ASN may be translated by means of the ASN-translation tables to obtain a secondary ASCE (SASCE). If the first operand is two doublewords and PASN or SASN translation occurs, the ASTEIN in the located ASTE is checked for being equal to the PASTEIN or SASTEIN, respectively, in the first operand. An authority check for ensuring that the new AX is authorized to establish the new SASN can be prevented when SASN translation occurs, or it can be required and cause SASN translation even when SASN translation would not otherwise occur. The new AX, which is placed in a control register and is used in SASN authorization if that occurs, is the old AX if PASN translation has not occurred or is the AX in the located PASTE otherwise. However, in either of these cases, the new AX may be the AX specified in the first operand.

A doubleword first operand has the following format:

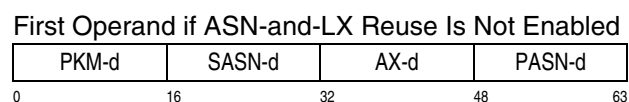

A two-doubleword first operand has the following format:

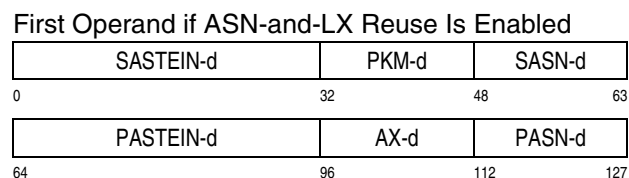

The “d” stands for designated value and is used to distinguish these fields from other fields with similar names which are referred to in the definition. The current contents of the corresponding fields in the control registers are referred to as SASTEIN-old, PKM-old, SASN-old, etc. The updated contents of the control registers are referred to as SASTEIN-new, PKM-new, SASN-new, etc.

The second-operand address is not used to address data; instead, the rightmost three bits are used to control portions of the operation. The remainder of

the second-operand address is ignored. Bits 61-63 of the second-operand address are used as follows:

Function Specified in Second-Operand Address		
Bit	When Bit Is Zero	When Bit Is One
61	ASN translation performed only when new ASN and old ASN are different.	ASN translation performed.*
62	AX associated with new PASN used.	AX in first operand used.
63	SASN authorization performed.*	SASN authorization not performed.
Explanation:		
* SASN translation and SASN authorization are performed only when SASN-d is not equal to PASN-d. When SASN-d is equal to PASN-d, the SASCE is set equal to the PASCE, the SASTEIN is set equal to the PASTEIN (if ASN-and-LX reuse is enabled), and no authorization is performed.		

The operation of LOAD ADDRESS SPACE PARAMETERS is depicted in Figure 10-21 on page 10-49.

Note: In the following sections, the actions involving the PASTEIN and SASTEIN occur only if the ASN-and-LX-reuse facility is installed and is enabled by the ASN-and-LX-reuse control in control register 0.

PASN Translation and Related Processing

In the PASN-translation process, the PASN-d is translated by means of the ASN first table and the ASN second table. The PASTEO resulting from PASN translation replaces the PASTEO in control register 5. The ASCE in the located ASTE replaces the PASCE in control register 1. When bit 62 of the second-operand address is zero, the AX in the ASTE replaces the AX in control register 4. When bit 62 is one, AX-d replaces the AX in the control register. When ASN-and-LX reuse is enabled, PASTEIN-d is compared to the ASTEIN in the ASTE, and, when equal, replaces the PASTEIN in control register 4.

When bit 61 of the second-operand address is one, PASN translation is always performed. When bit 61 is zero, PASN translation is performed only if PASN-d is not equal to PASN-old. When bit 61 is zero and PASN-d is equal to PASN-old, the PASCE-old, PASTEO-old, and PASTEIN-old are left unchanged in the control registers and become the PASCE-new, PAS-

TEO-new, and PASTEIN-new, respectively. In this case, if bit 62 is zero, then the AX-old is left unchanged in the control register and becomes the AX-new, or, if bit 62 is one, AX-new is set equal to AX-d.

The PASN translation follows the normal rules for ASN translation, except that the invalid bits, bit 0 in the ASN-first-table entry and bit 0 in the ASTE, when ones, do not result in an ASN-translation exception. When either of the invalid bits is one, condition code 1 is set. Condition code 1 is also set if PASN translation occurs, the ASN-and-LX-reuse facility is enabled, and PASTEIN-d is not equal to the ASTEIN in the ASTE. When a reason for setting condition code 1 does not exist and either the current primary space-switch-event-control bit in control register 1 is one or the space-switch-event-control bit in the ASTE is one, a space-switch event does not occur; instead, condition code 3 is set. When condition code 1 or 3 is set, the control registers remain unchanged.

The contents of the AX, ASCE, and ASTEIN fields in the ASTE which is accessed as a result of the PASN translation are referred to as AX-p, ASCE-p, and ASTEIN-p, respectively. The origin of the ASTE is referred to as PASTEO-p.

The description in this paragraph applies to use of the subspace-group facility. After ASCE-p has been obtained, if (1) the subspace-group-control bit, bit 54 in ASCE-p, is one, (2) the dispatchable unit is subspace active, and (3) PASTEO-p designates the ASTE for the base space of the dispatchable unit, then a copy of ASCE-p, called ASCE-rp, is made, and bits 0-55 and 58-63 of ASCE-rp are replaced by the same bits of the ASCE in the ASTE for the subspace in which the dispatchable unit last had control. Further details are in "Subspace-Replacement Operations" on page 5-70. If bit 0 in the subspace ASTE is one, or if the ASTE sequence number (ASTESN) in the subspace ASTE does not equal the subspace ASTESN in the dispatchable-unit control table, an exception is not recognized; instead, condition code 1 is set, and the control registers remain unchanged.

SASN Translation and Related Processing

In the SASN-translation process, the SASN-d is translated by means of the ASN first table and the ASN second table. The ASCE field obtained from the ASTE subsequently replaces the secondary ASCE (SASCE) in control register 7. When ASN-and-LX reuse is enabled, SASTEIN-d is compared to the

ASTEIN in the ASTE, and, when equal, replaces the SASTEIN in control register 3.

SASN translation is performed only when, but not necessarily when, SASN-d is not equal to PASN-d. When SASN-d is equal to PASN-d, SASCE-new and SASTEIN-new are set equal to PASCE-new and PASTEIN-new, respectively. In this case, there is not a test of whether SASTEIN-d is equal to PASTEIN-d; SASTEIN-d is ignored. When SASN-d is not equal to PASN-d and is equal to SASN-old, bit 61 (force ASN translation) is zero, and bit 63 (skip SASN authorization) is one, SASN translation is not performed, and SASCE-old and SASTEIN-old become SASCE-new and SASTEIN-new, respectively. In this case, there is not a test of whether SASTEIN-d is equal to SASTEIN-old; SASTEIN-d is ignored.

SASN translation is performed in each of the following cases:

- SASN-d is not equal to PASN-d or SASN-old.
- SASN-d is not equal to PASN-d but is equal to SASN-old, and either bit 61 (force ASN translation) of the second-operand address is one or bit 63 (skip secondary authority test) of that address is zero. (The translation must be performed when bit 63 is zero in order to obtain the ATO and ATL from the SASTE.)

The SASN translation follows the normal rules for ASN translation, except that the invalid bits, bit 0 in the ASN-first-table entry and bit 0 in the ASTE, when ones, do not result in an ASN-translation exception. When either of the invalid bits is one, condition code 2 is Condition code 2 is also set if SASN translation occurs, the ASN-and-LX-reuse facility is enabled, and SASTEIN-d is not equal to the ASTEIN in the ASTE. When condition code 2 is set, the control registers remain unchanged.

The contents of the ASCE, ATO, ATL and ASTEIN fields in the ASTE which is accessed as a result of the SASN translation are referred to as ASCE-s, ATO-s, ATL-s, and ASTEIN-s, respectively. The origin of the ASTE is referred to as SASTEO-s.

The description in this paragraph applies to use of the subspace-group facility. After ASCE-s has been obtained, if (1) the subspace-group-control bit, bit 54 in ASCE-s, is one, (2) the dispatchable unit is subspace active, and (3) SASTEO-s designates the ASTE for the base space of the dispatchable unit,

then a copy of ASCE-s, called ASCE-rs, is made, and bits 0-55 and 58-63 of ASCE-rs are replaced by the same bits of the ASCE in the ASTE for the subspace in which the dispatchable unit last had control. Further details are in “Subspace-Replacement Operations” on page 5-70. If bit 0 in the subspace ASTE is one, or if the ASTE sequence number (ASTESN) in the subspace ASTE does not equal the subspace ASTESN in the dispatchable-unit control table, an exception is not recognized; instead, condition code 2 is set, and the control registers remain unchanged.

SASN Authorization

SASN authorization is performed when bit 63 of the second-operand address is zero and SASN-d is not equal to PASN-d; it is performed in this case regardless of whether SASN-d is equal to SASN-old. When SASN-d is equal to PASN-d or when bit 63 of the second-operand address is one, SASN authorization is not performed.

SASN authorization is performed by using ATO-s, ATL-s, and the intended value for AX-new. When bit 62 of the second-operand address is zero and PASN translation was performed, the intended value for AX-new is AX-p. When bit 62 of that address is zero and PASN translation was not performed, the AX is not changed, and AX-new is the same as AX-old. When bit 62 of that address is one, the intended value for AX-new is AX-d. SASN authorization follows the rules for secondary authorization as described in “ASN-Authorization Process” on page 3-36. If the SASN is not authorized (that is, the authority-table length is exceeded, or the selected bit is zero), condition code 2 is set, and none of the control registers is updated.

Control-Register Loading

When the PASN-translation and SASN-translation functions and related functions, and the SASN-authorization functions and subspace-replacement operations, if called for in the instruction execution, are performed without encountering any exceptions or exception conditions, the execution is completed by replacing the contents of control registers 1, 3, 4, 5, and 7 with the new values, and condition code 0 is set. The control registers are loaded as follows.

The PSW-key-mask, bits 32-47, and SASN, bits 48-63, in control register 3 are replaced by the contents of the PKM-d and SASN-d fields of the first operand.

If ASN-and-LX reuse is enabled, the SASTEIN, bits 0-31, in control register 3 is replaced as follows:

- When SASN translation is performed, by SAS-TEIN-d.
- When SASN translation is not performed because SASN-d is equal to PASN-d, by PASTEIN-new.
- When SASN translation is not performed because (1) SASN-d is not equal to PASN-d but is equal to SASN-old, (2) bit 61 (force ASN translation) of the second-operand address is zero, and (3) bit 63 (skip secondary authority test) of the second-operand address is one, the SAS-TEIN remains unchanged.

When ASN-and-LX reuse is not enabled, bits 0-31 of control register 3 always remain unchanged.

The PASN, bits 48-63 of control register 4, is replaced by the PASN-d of the first operand. If ASN-and-LX reuse is enabled, the PASTEIN, bits 0-31 of control register 4, is replaced by the PASTEIN-d of the first operand; otherwise, bits 0-31 of the register remain unchanged.

The authorization index, bits 32-47 of control register 4, is replaced as follows:

- When bit 62 of the second-operand address is one, by AX-d.
- When bit 62 of the second-operand address is zero and PASN translation is performed, by AX-p.
- When bit 62 of the second-operand address is zero and PASN translation is not performed, the authorization index remains unchanged.

The primary address-space-control element (PASCE) in control register 1 and the primary-ASN-second-table-entry origin (PASTE0) in control register 5 are replaced as follows:

- When PASN translation is performed, the PASCE in control register 1 is replaced by the ASCE-p obtained as a result of PASN translation, except that it is replaced by ASCE-rp if a subspace-replacement operation was performed on ASCE-p. Also, the PASTE0 in control register 5 is replaced by PASTE0-p.

The PASTE0-p is placed in bit positions 33-57 of control register 5, and zeros are placed in bit positions 32 and 58-63. Bits 0-31 of the register remain unchanged.

- When PASN translation is not performed, the contents of control registers 1 and 5 remain unchanged.

The secondary address-space-control element (SASCE) in control register 7 is replaced as follows:

- When SASN-d equals PASN-d, by the new contents of control register 1, the PASCE. The new contents may be PASCE-old, ASCE-p, or ASCE-rp.
- When SASN translation is performed, by ASCE-s, or by ASCE-rs if a subspace-replacement operation was performed on ASCE-s.

When SASN-d does not equal PASN-d and SASN translation is not performed, the SASCE remains unchanged.

Other Condition-Code Settings

When PASN translation is called for and cannot be completed because bit 0 is one in either the ASN-first-table entry or the ASTE, or if it can be completed but (1) ASN-and-LX reuse is enabled and PASTEIN-d does not equal the ASTEIN in the ASTE or (2) a subspace-replacement-exception condition exists due to bit 0 or the ASTE sequence number in the subspace ASTE during a subspace-replacement operation on the ASCE-p, condition code 1 is set, and the control registers are not changed.

When PASN translation is called for and completed and any required PASTEIN-d comparison and subspace-replacement operations on the ASCE-p are also completed, and then either (1) the current primary space-switch-event-control bit, bit 57 of control register 1, is one or (2) the space-switch-event-control bit in the ASTE designated by PASTE0-p is one, condition code 3 is set, and the control registers are not changed.

When SASN translation is called for and the translation cannot be completed because bit 0 is one in either the ASN-first-table entry or the ASTE, or if it can be completed but (1) ASN-and-LX reuse is enabled and SASTEIN-d does not equal the ASTEIN in the ASTE, (2) a subspace-replacement-exception

condition exists due to bit 0 or the ASTE sequence number in the subspace ASTE during a subspace-replacement operation on the ASCE-s, or (3) SASN authorization is called for and the SASN is not authorized, or condition code 2 is set, and the control registers are not changed.

Special Conditions

The instruction can be executed only when the ASN-translation control, bit 44 of control register 14, is one. If the ASN-translation-control bit is zero, a special-operation exception is recognized.

The first operand must be designated on a doubleword boundary; otherwise, a specification exception is recognized.

In the ESA/390-compatibility mode, one of the following exceptions is recognized: (a) an operation exception, (b) a privileged-operation exception when the CPU is in the problem state, (c) a special-operation exception when bit 44 of control register 14 is zero, or (d) a specification exception when the first operand is not on a doubleword boundary. It is unpredictable which exception is recognized.

The operation is suppressed on all addressing and protection exceptions.

Figure 10-20 on page 10-48 and Figure 10-18 on page 10-45 summarize the functions of the instruction.

Resulting Condition Code:

- 0 Translation and authorization complete; parameters loaded
- 1 Primary ASN or subspace not available; parameters not loaded
- 2 Secondary ASN not available or not authorized, or secondary subspace not available; parameters not loaded
- 3 Space-switch event specified; parameters not loaded

Program Exceptions:

- Access (fetch, operand 1)
- Addressing (ASN-first-table entry, ASN-second-table entry, authority-table entry, dispatchable-unit control table)
- Operation (in the ESA/390-compatibility mode)
- Privileged operation
- Special operation
- Specification
- Transaction constraint

The priority of recognition of program exceptions for the instruction is shown in Figure 10-18.

1.-6.	Exceptions with the same priority as the priority of program-interruption conditions for the general case.
7.A	Access exceptions for second and third instruction halfwords.
7.B.1	Privileged-operation exception.
7.B.2	Special-operation exception due to the ASN-translation control, bit 44 of control register 14, being zero.
7.C	Transaction constraint.
7.D	Operation exception (in the ESA/390-compatibility mode)
8.	Specification exception.
9.	Access exceptions for the first operand.
10.	PASN translation and related processing (when performed).
10.1	Addressing exception for access to ASN-first-table entry.
10.2	Condition code 1 due to I bit (bit 0) in ASN-first-table entry being one.
10.3	Addressing exception for access to ASN-second-table entry.
10.4	Condition code 1 due to (1) I bit (bit 0) in ASN-second-table entry (ASTE) being one or (2) ASN-and-LX reuse enabled and primary ASTE instance number (PASTEIN) in first operand not being equal to ASTEIN in ASTE.
10.5	Addressing exception for access to dispatchable-unit control table.

Figure 10-18. Priority of Execution: LOAD ADDRESS SPACE PARAMETERS (Part 1 of 2)

10.6	Addressing exception for access to subspace ASN-second-table entry.
10.7	Condition code 1 due to I bit (bit 0) in subspace ASN-second-table entry being one.
10.8	Condition code 1 due to subspace ASN-second-table-entry sequence number (SSASTESN) in dispatchable-unit control table not being equal to ASTESN in subspace ASN-second-table entry.
10.9	Condition code 3 due to either the old or new space-switch-event-control bit being one.
11.	SASN translation and related processing (when performed).
11.1	Addressing exception for access to ASN-first-table entry.
11.2	Condition code 2 due to I bit (bit 0) in ASN-first-table entry being one.
11.3	Addressing exception for access to ASN-second-table entry.
11.4	Condition code 2 due to (1) I bit (bit 0) in ASN-second-table entry (ASTE) being one or (2) ASN-and-LX reuse enabled and secondary ASTE instance number (SASTEIN) in first operand not being equal to ASTEIN in ASTE.
12.A	Execution of secondary authorization (when performed).
12.A.1	Condition code 2 due to authority-table entry being outside table.
12.A.2	Addressing exception for access to authority-table entry.
12.A.3	Condition code 2 due to S bit in authority-table entry being zero.
12.B.1	Addressing exception for access to dispatchable-unit control table.
12.B.2	Addressing exception for access to subspace ASN-second-table entry.
12.B.3	Condition code 2 due to I bit (bit 0) in subspace ASN-second-table entry being one.
12.B.4	Condition code 2 due to subspace ASN-second-table-entry sequence number (SSASTESN) in dispatchable-unit control table not being equal to ASTESN in subspace ASN-second-table entry.

Figure 10-18. Priority of Execution: LOAD ADDRESS SPACE PARAMETERS (Part 2 of 2)

Programming Notes:

1. Bits 61 and 63 in the second-operand address are intended primarily to provide improved performance for those cases where the associated action is unnecessary.

When bit 61 is set to zero, the action of the instruction is based on the assumption that the current values for PASCE-old, PASTEO-old, and AX-old are consistent with PASN-old and that SASCE-old is consistent with SASN-old. When this is not the case, bit 61 should be set to one.

Bit 63, when one, eliminates the SASN-authorization test. The program may be able to determine in certain cases that the SASN is authorized, either because of prior use or because the AX being loaded is authorized to access all address spaces.

2. The SASN-translation and SASN-authorization steps are not performed when SASN-d is equal to PASN-d. This is consistent with the action in SET SECONDARY ASN to current primary (SSAR-cp), which does not perform the translation or ASN authorization.
3. The storage-operand references for LOAD ADDRESS SPACE PARAMETERS may be multiple-access references. (See "Storage-Operand Consistency" on page 5-125.)
4. See Figure 10-19 on page 10-46 for a listing of abbreviations used in this instruction description.

First-Operand Bit Positions when ASN-and-LX Reuse Not Enabled	Abbreviation
0-15	PKM-d
16-31	SASN-d
32-47	AX-d
48-63	PASN-d

Figure 10-19. Summary of Abbreviations for LOAD ADDRESS SPACE PARAMETERS (Part 1 of 2)

First-Operand Bit Positions when ASN-and-LX Reuse Enabled	Abbreviation
0-31	SASTEIN-d
32-47	PKM-d
48-63	SASN-d
64-95	PASTEIN-d
96-111	AX-d
112-127	PASN-d

Control-Register Number.Bit	Abbreviation for	
	Previous Contents	Subsequent Contents
1.0-63	PASCE-old	PASCE-new
3.0-31	SASTEIN-old	SASTEIN-new
3.32-47	PKM-old	PKM-new
3.48-63	SASN-old	SASN-new
4.0-31	PASTEIN-old	PASTEIN-new
4.32-47	AX-old	AX-new
4.48-63	PASN-old	PASN-new
5.33-57	PASTEO-old	PASTEO-new
7.0-63	SASCE-old	SASCE-new

Field in ASN-Second-Table Entry	Abbreviation Used for the Field When Accessed as Part of	
	PASN Translation	SASN Translation
1-29	-	ATO-s
32-47	AX-p	-
48-59	-	ATL-s
64-127	ASCE-p ¹	ASCE-s ¹
352-383	ASTEIN-p	ASTEIN-s

Explanation:

- The field is not used in this case.

¹ ASCE-rp is formed from ASCE-p, and ASCE-rs is formed from ASCE-s, by a subspace-replacement operation.

Figure 10-19. Summary of Abbreviations for LOAD ADDRESS SPACE PARAMETERS (Part 2 of 2)

PASN-d Equals PASN- old	Second- Operand- Address Bits ¹		PASN Translation Performed	Result Field						
	61	62		PASCE- new	AX- new	PASTE0- new	PKM- new	SASN- new	PASN- new	PASTEIN- new
Yes	0	0	No	PASCE-old	AX-old	PASTE0-old	PKM-d	SASN-d	PASN-d	PASTEIN-old
Yes	0	1	No	PASCE-old	AX-d	PASTE0-old	PKM-d	SASN-d	PASN-d	PASTEIN-old
Yes	1	0	Yes	ASCE-p ²	AX-p	PASTE0-p	PKM-d	SASN-d	PASN-d	PASTEIN-d
Yes	1	1	Yes	ASCE-p ²	AX-d	PASTE0-p	PKM-d	SASN-d	PASN-d	PASTEIN-d
No	-	0	Yes	ASCE-p ²	AX-p	PASTE0-p	PKM-d	SASN-d	PASN-d	PASTEIN-d
No	-	1	Yes	ASCE-p ²	AX-d	PASTE0-p	PKM-d	SASN-d	PASN-d	PASTEIN-d

Figure 10-20. Summary of Actions: LOAD ADDRESS
SPACE PARAMETERS (Part 1 of 2).

SASN-d Equals PASN-d	SASN-d Equals SASN-old	Second-Operand- Address Bits ¹		SASN Translation Performed	SASN Authorization Performed ³	Result Field	
		61	63			SASCE-new	SASTEIN- new
Yes	-	-	-	No	No	PASCE-new	PASTEIN-new
No	Yes	0	1	No	No	SASCE-old	SASTEIN-old
No	Yes	1	1	Yes	No	ASCE-s ⁴	SASTEIN-d
No	Yes	-	0	Yes	Yes	ASCE-s ⁴	SASTEIN-d
No	No	-	1	Yes	No	ASCE-s ⁴	SASTEIN-d
No	No	-	0	Yes	Yes	ASCE-s ⁴	SASTEIN-d

Explanation:

- Action in this case is the same regardless of the outcome of this comparison or of the setting of this bit.
- ¹ Second-operand-address bits:
61: Force ASN translation.
62: Use AX from first operand.
63: Skip secondary authority test.
- ² PASCE-new is ASCE-rp (a copy of ASCE-p except with bits 0-55 and 58-63 replaced from the ASCE in the subspace ASTE), if subspace replacement is performed.
- ³ SASN authorization is performed using ATO-s, ATL-s, and AX-new.
- ⁴ SASCE-new is ASCE-rs (a copy of ASCE-s except with bits 0-55 and 58-63 replaced from the ASCE in the subspace ASTE), if subspace replacement is performed.

Figure 10-20. Summary of Actions: LOAD ADDRESS
SPACE PARAMETERS (Part 2 of 2).

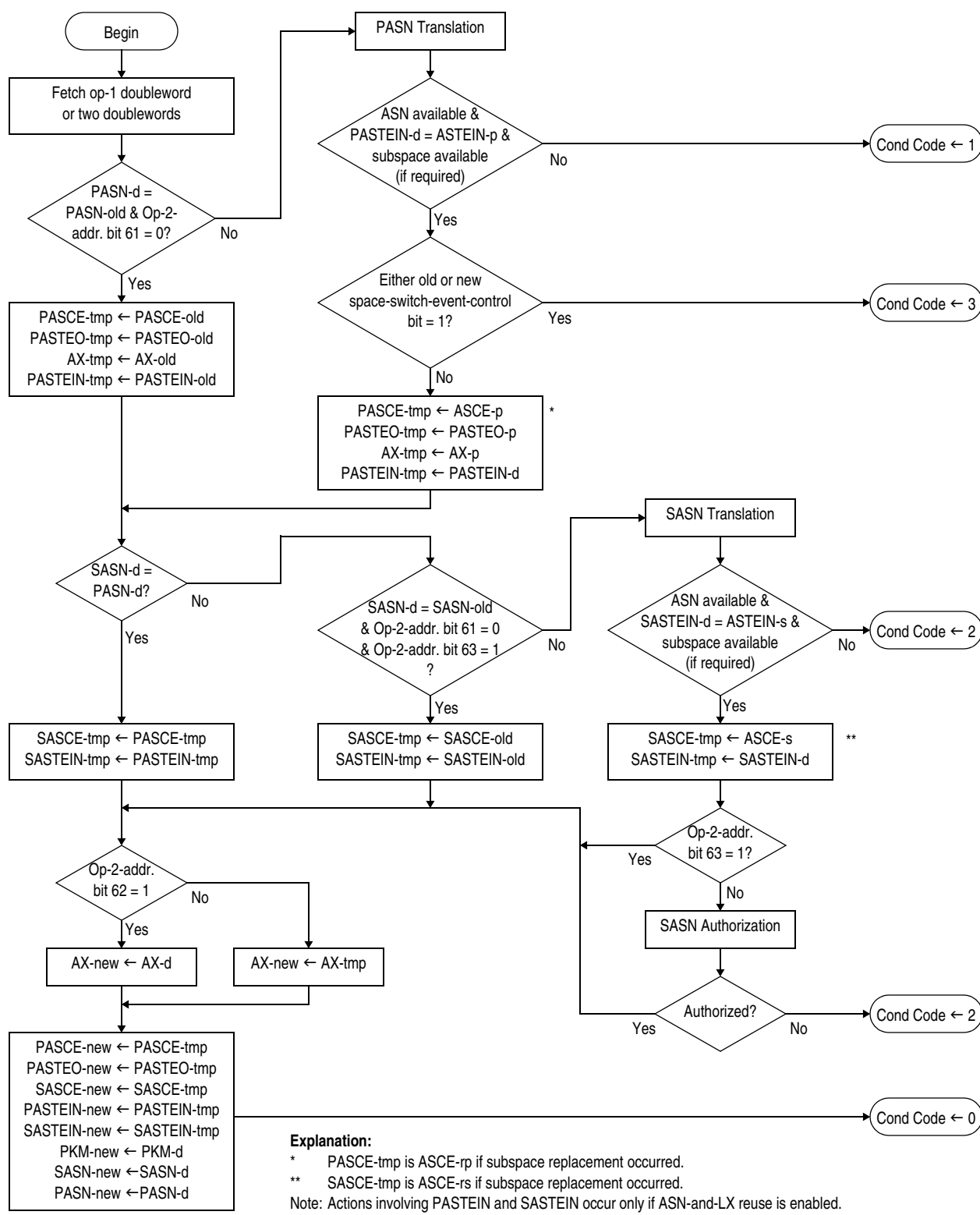
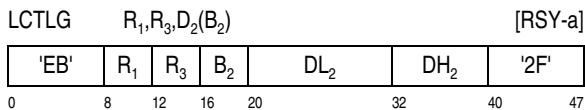
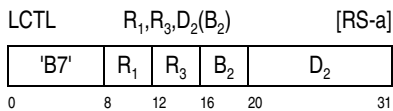

Figure 10-21. Execution of LOAD ADDRESS SPACE PARAMETERS

LOAD CONTROL



Bit positions of the set of control registers starting with control register R_1 and ending with control register R_3 are loaded from storage beginning at the location designated by the second-operand address and continuing through as many locations as needed.

For LOAD CONTROL (LCTL), bit positions 32-63 of the control registers are loaded from successive words beginning at the second-operand address, and bits 0-31 of the registers remain unchanged. For LOAD CONTROL (LCTLG), bit positions 0-63 of the control registers are loaded from successive doublewords beginning at the second-operand address. The control registers are loaded in ascending order of their register numbers, starting with control register R_1 and continuing up to and including control register R_3 , with control register 0 following control register 15.

The information loaded into the control registers becomes active when instruction execution has ended.

The displacement for LCTL is treated as a 12-bit unsigned binary integer. The displacement for LCTLG is treated as a 20-bit signed binary integer.

Special Conditions

The second operand must be designated on a word boundary for LCTL or on a doubleword boundary for LCTLG; otherwise, a specification exception is recognized.

Attempted execution of LCTLG in the ESA/390-compatibility mode results in an operation exception being recognized.

Condition Code: The code remains unchanged.

Program Exceptions:

- Access (fetch, operand 2)
- Operation (LCTLG, in the ESA/390-compatibility mode)
- Privileged operation
- Specification
- Transaction constraint

Programming Notes:

1. To ensure that existing programs operate correctly if and when new facilities using additional control-register positions are defined, only zeros should be loaded in unassigned control-register positions.
2. Loading of control registers on some models may require a significant amount of time. This is particularly true for changes in significant parameters.

For example, the TLB may be cleared of entries as a result of changing or enabling the program-event-recording parameters in control registers 9-11. Where possible, the program should avoid unnecessary loading of control registers. In loading control registers 9-11, most models attempt to optimize for the case when the bits of control register 9 are zeros.

LOAD PAGE TABLE ENTRY ADDRESS

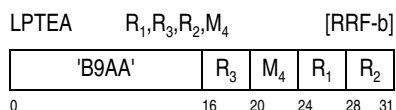

General register R_2 contains a virtual address that is processed by means of dynamic address translation to locate a page-table entry, the 64-bit real or absolute address of which is returned in general register R_1 . The M_4 field contains a value designating the effective address-space-control element (ASCE) that is used by DAT, as shown in the following table:

M_4 Field (binary)	Effective Address-Space-Control Element Used by DAT
0000	Contents of control register 1

M₄ Field (binary)	Effective Address-Space-Control Element Used by DAT
0001	The address-space-control element obtained by applying the access-register-translation (ART) process to the access register designated by the R ₂ field.
0010	Contents of control register 7
0011	Contents of control register 13
0100	The address-space-control element corresponding to the current address-space-control bits, bits 16 and 17 of the PSW.

When the M₄ field contains 0001 binary, or when the M₄ field contains 0100 binary and bits 16-17 of the PSW contain 01 binary, then access-register translation precedes, as is normal, the dynamic address translation.

The R₃ field is ignored but should be zero to permit possible future extensions.

The virtual address specified by the R₂ field is translated by means of dynamic-address translation, regardless of whether DAT is on or off. ART and DAT may be performed with the use of the ART-lookaside buffer (ALB) and translation-lookaside buffer (TLB), respectively. The DAT process completes upon locating the page-table entry. The contents of the page-table entry are not examined for format errors, the I bit is not examined to determine whether the page is invalid, and the page-frame real address is not fetched.

Virtual address computation is performed according to the addressing mode specified by bits 31 and 32 of the current PSW.

The addresses of the region-table entry or entries, if used, and of the segment-table entry and page-table entry are treated as 64-bit addresses, regardless of the current addressing mode. It is unpredictable whether the addresses of these entries are treated as real or absolute addresses.

If the DAT process successfully locates the page-table entry, the 64-bit real or absolute address of the entry is placed in general register R₁, and the condition code is set as follows:

- When EDAT-1 does not apply, the condition code is set based on the DAT-protection bit (P) of the

segment-table entry used in the translation. Condition code 0 is set when the P bit is zero; condition code 1 is set when the P bit is one.

- When EDAT-1 applies, the condition code is set based on all of the DAT-protection bits encountered in the translation. If the DAT-protection bit is zero in the segment-table entry and the DAT-protection bits are zero in any and all region-table entries used in the translation, condition code 0 is set. If the DAT-protection bit is one in any region- or segment-table entry used in the translation, condition code 1 is set.

When EDAT-1 applies and the DAT process successfully locates a valid segment-table entry in which the STE-format control is one, bits 0-60 of the segment-table entry address are placed in bit positions 0-60 of general register R₁, bit 61 of the register is set to the logical OR of the DAT-protection bit in the segment-table entry and any region-table entries used in the translation, bits 62-63 of the register are set to zeros, and the instruction completes by setting condition code 2.

When EDAT-2 applies and the DAT process successfully locates a valid region-third-table entry in which the RTTE-format control is one, bits 0-60 of the region-third-table entry address are placed in bit positions 0-60 of general register R₁, bit 61 of the register is set to the logical OR of the DAT-protection bit in the region-third-table entry and any higher-level region-table entries used in the translation, bits 62-63 of the register are set to zeros, and the instruction completes by setting condition code 2.

When a condition exists that would normally cause one of the exceptions shown in Figure 10-22, processing is as follows:

1. General register R₁ is updated as follows:
 - a. Bits 0-60 of the table-entry address are placed in bit positions 0-60 of the register.
 - b. When EDAT-1 does not apply, bit 61 of the register is set to zero. When enhanced DAT applies, bit 61 is set to the logical OR of the DAT-protection bits in all valid region-table entries used in the translation; if the DAT process does not require region-table entries, or if no valid region-table entries are encountered, bit 61 is set to zero.

- c. The expected table-type bits are placed in bit positions 62-63 of the register. When the region table or segment table containing the invalid entry is directly designated by the address-space-control element, then the expected table-type bits are those contained in the designation-type control (DT) in the ASCE. Otherwise, the expected table-type bits are one less than the value of those bits in the next-higher-level table.

2. The instruction is completed by setting condition code 2.

Exception Name	Cause	Code (hex)	Expected TT Bits
Region first translation	Invalid bit is one in the region-first-table entry selected by the RFX portion of the virtual address.	0039	11
Region second translation	Invalid bit is one in the region-second-table entry selected by the RSX portion of the virtual address.	003A	10
Region third translation	Invalid bit is one in the region-third-table entry selected by the RTX portion of the virtual address.	003B	01
Segment translation	Invalid bit is one in the segment-table entry selected by the SX portion of the virtual address.	0010	00

Figure 10-22. LPTEA Exception Conditions Causing CC2

When a condition exists that would normally cause one of the exceptions shown in Figure 10-23, (1) the interruption code assigned to the exception is placed in bit positions 48-63 of general register R₁, and bits

0-47 of the register are set to zeros; and (2) the instruction is completed by setting condition code 3.

Exception Name	Cause	Code (hex)
ALET specification	ALET bits 0-6 not all zeros.	0028
ALEN translation	ALE outside list or I bit is one.	0029
ALE sequence	ALESN in ALET not equal to ALESN in ALE.	002A
ASTE validity	ASTE I bit is one.	002B
ASTE sequence	ASTESN in ALE not equal to ASTESN in ASTE.	002C
Extended authority	ALE P bit not zero, ALEAX not equal to EAX, and secondary bit selected by EAX either outside authority table or zero.	002D
ASCE type	ASCE is a region-second-table designation, and bits 0-10 of virtual address not all zeros; ASCE is a region-third-table designation, and bits 0-21 of virtual address not all zeros; or ASCE is a segment-table designation, and bits 0-32 of virtual address not all zeros.	0038
Region first translation	Region-first-table entry selected by RFX portion of virtual address outside table.	0039
Region second translation	Region-second-table entry selected by RSX portion of virtual address outside table.	003A
Region third translation	Region-third-table entry selected by RTX portion of virtual address outside table.	003B
Segment translation	Segment-table entry selected by SX portion of virtual address outside table.	0010

Figure 10-23. LPTEA Exception Conditions Causing CC3

Special Conditions

If the M₄ field contains any value other than 0000-0100 binary, a specification exception is recognized.

The address-space-control element used in the translation must not be a real-space designation; otherwise, a special-operation exception is recognized. The exception due to the address-space-control element has priority 9 in Figure 6-8 on page 6-52.

An addressing exception is recognized when the address used by ART to fetch the effective access-list designation, the access-list entry, the address-space-second-table entry, or the authority-table entry designates a location which is not available in the configuration. An addressing exception is also recognized when the address used by DAT to fetch a region-table entry or the segment-table entry designates a location which is not available in the configuration.

A carry out of bit position 0 as a result of the addition done to compute the address of a region-table entry or the segment-table entry may be ignored or may result in an addressing exception.

A translation-specification exception is recognized if an accessed region-table entry or the segment-table entry has a zero I bit and a format error.

The operation is suppressed on all addressing exceptions.

In the ESA/390-compatibility mode, an operation exception is recognized.

Resulting Condition Code:

- 0 PTE address returned; P bit is 0 in all DAT-table entries examined
- 1 PTE address returned; P bit is 1 in any DAT-table entry examined
- 2 Invalid bit is one in the region- or segment-table entry; EDAT-1 applies, a valid STE was located, and STE FC is 1; or EDAT-2 applies, a valid RTTE was located, and RTTE FC is 1
- 3 Exception condition exists

Program Exceptions:

- Addressing (effective access-list designation, access-list entry, ASN-second-table entry, authority-table entry, region-table entry, or segment-table entry)
- Operation (DAT-enhancement facility 2 not installed or in the ESA/390-compatibility mode)
- Privileged operation
- Special operation
- Specification
- Transaction constraint
- Translation specification

Programming Notes:

1. An addressing exception is not recognized if the page-table-entry address returned in general register R_1 is not available in the configuration.
2. When EDAT-1 applies, the STE-format control is one, and no other exception conditions apply, the address of the segment-table entry is placed in general register R_1 , and condition code 2 is set. This effectively performs a *load-segment-table-entry-address* function, although no such instruction is defined.

However, because condition code 2 is also used to indicate an invalid region-table entry or segment-table entry, all of the following conditions must exist in order to assume that the located table entry is a valid STE:

- a. Bit positions 62-63 of general register R_1 must contain 00 binary.
- b. Bit position 58 of the table entry designated by bits 0-60 of general register R_1 must contain zero (indicating a valid table entry).
- c. The table-type field in bit positions 60-61 of the table entry designated by bits 0-60 of general register R_1 must contain 00 binary (designating a segment-table entry).

The following program fragment illustrates this determination when only EDAT-1 applies. If no branch is taken, then the address in general register 1 is that of a segment-table entry in which the STE-format control is one:

```

LPTEA 1,0,2,4
BRC 8,PTE_WITH_NEITHER_STE_NOR_RTE_PROT
BRC 4,PTE_WITH_PROTECTED_STE_OR_RTE
BRC 1,EXCEPTION_EXISTS
TMLL 1,X'0003'
JNZ EXCEPTION_EXISTS
NILL 1,X'FFF8'
LURAG 10,1
TMLL 10,X'0020'
JO EXCEPTION_EXISTS

```

3. When EDAT-2 applies, the RTTE-format control is one, and no other exception conditions apply, the address of the region-third-table entry is placed in general register R_1 , and condition code 2 is set. This effectively performs a *load-region-third-table-entry-address* function, although no such instruction is defined.

However, because condition code 2 is also used to indicate an invalid region-table entry, all of the following conditions must exist in order to assume that the located table entry is a valid RTTE:

- a. Bit positions 62-63 of general register R_1 must contain 00 binary.
- b. Bit position 58 of the table entry designated by bits 0-60 of general register R_1 must contain zero (indicating a valid table entry).
- c. The table-type field in bit positions 60-61 of the table entry designated by bits 0-60 of general register R_1 must contain 01 binary (designating a region-third-table entry).

The following program fragment continues the fragment in programming note 2, illustrating this determination when EDAT-2 applies. If no branch is taken, then the address in general register 1 is that of a region-third-table entry in which the RTTE-format control is one:

```
* Further check for EDAT-2
  TMLL 10,X'000C
  JZ    VALID_F1_STE
* Must be valid F1 RTTE
```

4. When condition code 2 is set as a result of locating a valid segment-table entry in which the STE-format control is one, bit 61 of general register R_1 indicates whether DAT protection applies to the segment. Similarly, when condition code 2 is set as a result of locating a valid region-third-table entry in which the RTTE-format control is one, bit 61 of general register R_1 indicates whether DAT protection applies to the region.
5. When EDAT-1 does not apply, only the STE is examined in determining whether condition code 0 or 1 is set. When EDAT applies, all DAT-table entries used in the translation may be examined in determining whether condition code 0 or 1 is to be set.

LOAD PSW

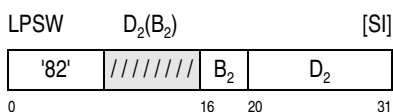

The current PSW is replaced by a 16-byte PSW formed from the contents of the doubleword at the location designated by the second-operand address. Figure 4-3 on page 4-8 illustrates the contents of the second operand.

Bits 8-15 of the instruction are reserved and should contain zeros; otherwise, the program may not operate compatibly in the future.

Bit 12 of the doubleword must be one; otherwise, depending on the model, a specification exception may be recognized and the operation suppressed.

Bits 0-11, 13-32, and 33-63 of the doubleword are placed in bit positions 0-11, 13-32, and 97-127 of the current PSW, respectively. Bits 33-96 of the current PSW are set to zeros.

Bit 12 of the doubleword is inverted and then placed in bit 12 of the current PSW. This applies in the z/Architecture architectural mode and in the ESA/390-compatibility mode.

A serialization and checkpoint-synchronization function is performed before or after the operand is fetched and again after the operation is completed.

Special Conditions

The operand must be designated on a doubleword boundary; otherwise, a specification exception is recognized. A specification exception may be recognized if bit 12 of the operand is zero, depending on the model.

The PSW fields which are to be loaded by the instruction are not checked for validity before they are loaded, except for the optional checking of bit 12. However, immediately after loading, a specification exception is recognized, and a program interruption occurs, when any of the following is true for the newly loaded PSW:

- Any of bits 0, 2-4, 12, or 25-30 is a one.
- In the ESA/390-compatibility mode, bit 5 of the PSW is one.
- Bit 24 is one (recognition of this condition is optional)
- Bits 31 and 32 are both zero, and bits 97-103 are not all zeros.

- Bits 31 and 32 are one and zero, respectively.
- In the ESA/390-compatibility mode, bit 31 is one (recognition of this condition is unpredictable).

In these cases, the operation is completed, and the resulting instruction-length code is 0.

The test for a specification exception after the PSW is loaded is described in “Early Exception Recognition” on page 6-9.

The operation is suppressed on all addressing and protection exceptions.

Resulting Condition Code: The code is set as specified in the new PSW loaded.

Program Exceptions:

- Access (fetch, operand 2)
- Privileged operation
- Specification
- Transaction constraint

Programming Note: The second operand of LOAD PSW has the short-PSW format (shown in Figure 4-3 on page 4-8), which is similar to that of an ESA/390-mode PSW (that is, bit 12 of the operand must be 1). When bit 12 of the second operand is zero, a specification exception is recognized, either during the execution of the instruction, or when the instruction completes and the new PSW becomes active.

However, unlike the ESA/390-format PSW in which bit 31 must be zero, bit 31 of the short PSW may be either zero or one in the z/Architecture architectural mode. In the ESA/390-compatibility mode, bit 5 must be zero and it is unpredictable whether bit 31 must be zero.

LOAD PSW EXTENDED

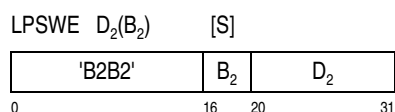

The current PSW is replaced by the contents of the 16-byte second operand. Figure 4-2 on page 4-5 illustrates the contents of the second operand.

Note: Bit 12 of the second operand is placed unchanged into bit 12 of the current PSW. This applies in the z/Architecture architecture mode and in the ESA/390-compatibility mode.

A serialization and checkpoint-synchronization function is performed before or after the operand is fetched and again after the operation is completed.

Special Conditions

The operand must be designated on a doubleword boundary; otherwise, a specification exception is recognized.

It is unpredictable whether LOAD PSW EXTENDED is supported in the ESA/390-compatibility mode. If the instruction is not supported, attempted execution results in an operation exception being recognized.

The value which is to be loaded by the instruction is not checked for validity before it is loaded. However, immediately after loading, a specification exception is recognized, and a program interruption occurs, when any of the following is true for the newly loaded PSW:

- Any of the unassigned bits (0, 2-4, 25-30, or 33-63) is a one.
- In the ESA/390-compatibility mode, bit 5 of the PSW is one.
- Bit 12 is a one.
- Bit 24 is one (recognition of this condition is optional)
- Bits 31 and 32 are zero and one, respectively, and bits 64-96 are not all zeros.
- Bits 31 and 32 are both zero, and bits 64-103 are not all zeros.
- Bits 31 and 32 are one and zero, respectively.
- In the ESA/390-compatibility mode, bit 31 is one (recognition of this condition is unpredictable).

In these cases, the operation is completed, and the resulting instruction-length code is zero.

The test for a specification exception after the PSW is loaded is described in “Early Exception Recognition” on page 6-9.

The operation is suppressed on all addressing and protection exceptions.

Resulting Condition Code: The code is set as specified in the new PSW loaded.

Program Exceptions:

- Access (fetch, operand 2)
- Privileged operation
- Specification
- Transaction constraint

LOAD REAL ADDRESS

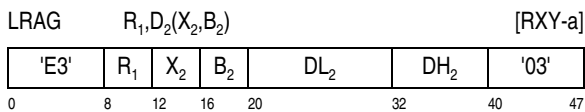
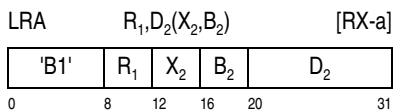

For LOAD REAL ADDRESS (LRA, LRAY) in the 24-bit or 31-bit addressing mode, if bits 0-32 of the 64-bit real or absolute address corresponding to the second-operand virtual address are all zeros, bits 32-63 of the real or absolute address are placed in bit positions 32-63 of general register R₁, and bits 0-31 of the register remain unchanged. If bits 0-32 of the real address or absolute are not all zeros, a special-operation exception is recognized.

For LRA or LRAY in the 64-bit addressing mode, and for LOAD REAL ADDRESS (LRAG) in any addressing mode, the 64-bit real or absolute address corresponding to the second-operand virtual address is placed in general register R₁.

When EDAT-1 does not apply, or when EDAT-1 applies but the second operand is translated by means of a segment-table entry in which the STE-format control is zero, the address placed in general register R₁ is real. When EDAT-1 applies and the second operand is translated by means of a segment-table entry in which the STE-format control is one, or when EDAT-2 applies and the second operand is

translated by means of a region-third-table entry in which the RTTE-format control is one, the address placed in general register R₁ is absolute.

The virtual address specified by the X₂, B₂, and D₂ fields is translated by means of the dynamic-address-translation facility, regardless of whether DAT is on or off.

The displacement for LRA is treated as a 12-bit unsigned binary integer. The displacement for LRAY and LRAg is treated as a 20-bit signed binary integer.

DAT is performed by using an address-space-control element that depends on the current value of the address-space-control bits, bits 16 and 17 of the PSW, as shown in Figure 10-24.

PSW Bits 16 and 17	Address-Space-Control Element Used by DAT
00	Contents of control register 1
01	The address-space-control element obtained by applying the access-register-translation (ART) process to the access register designated by the B ₂ field
10	Contents of control register 7
11	Contents of control register 13

Figure 10-24. Address-Space Control used by LOAD REAL ADDRESS

ART and DAT may be performed with the use of the ART-lookaside buffer (ALB) and translation-lookaside buffer (TLB), respectively.

The virtual-address computation is performed according to the current addressing mode, specified by bits 31 and 32 of the current PSW.

The addresses of the region-table entry or entries, if used, and of the segment-table entry and page-table entry, if used, are treated as 64-bit addresses regardless of the current addressing mode. It is unpredictable whether the addresses of these entries are treated as real or absolute addresses.

Condition code 0 is set when both ART, if applicable, and DAT can be completed and a special-operation exception is not recognized, that is, when an address-space-control element can be obtained, the entry in each DAT table lies within the table and has a zero I bit, and, for LRA or LRAY in the 24-bit or 31-bit addressing mode, bits 0-32 of the resulting real or absolute address are zeros. The translated address

is not inspected for boundary alignment or for addressing or protection exceptions.

When PSW bits 16 and 17 are 01 binary and an address-space-control element cannot be obtained because of a condition that would normally cause one of the exceptions shown in Figure 10-25, (1) the interruption code assigned to the exception is placed in bit positions 48-63 of general register R_1 , bit 32 of this register is set to one, bits 33-47 are set to zeros, and bits 0-31 remain unchanged, and (2) the instruction is completed by setting condition code 3.

Exception Name	Cause	Code (Hex)
ALET specification	Access-list-entry-token (ALET) bits 0-6 not all zeros	0028
ALEN translation	Access-list entry (ALE) outside list or invalid (bit 0 is one)	0029
ALE sequence	ALE sequence number (ALESN) in ALET not equal to ALESN in ALE	002A
ASTE validity	ASN-second-table entry (ASTE) invalid (bit 0 is one)	002B
ASTE sequence	ASTE sequence number (ASTESN) in ALE not equal to ASTESN in ALE	002C
Extended authority	ALE private bit not zero, ALE authorization index (ALEAX) not equal to extended authorization index (EAX), and secondary bit selected by EAX either outside authority table or zero	002D

Figure 10-25. Handling of ART-Related Exceptions for LOAD REAL ADDRESS

When ART is completed normally, the operation is continued through the performance of DAT.

When the segment-table entry is outside the table and bits 0-32 of the real or absolute address of the entry are all zeros, bits 32-63 of the entry address are placed in bit positions 32-63 of general register R_1 , bits 0-31 of the register remain unchanged, and the instruction completes by setting condition code 3. If bits 0-32 of the address are not all zeros, the result is as described in the section “DAT-Related Exceptions for LOAD REAL ADDRESS” on page 10-57.

When the I bit in the segment-table entry is one, the following applies:

- For LRA or LRAY in the 64-bit addressing mode or for LRA in any addressing mode, the 64-bit real or absolute address of the segment-table entry is placed in general register R_1 , and the

instruction is completed by setting condition code 1.

- For LRA or LRAY in the 24-bit or 31-bit addressing mode, the following applies:
 - If bits 0-32 of the address of the segment-table entry are all zeros, bits 32-63 of the real or absolute address of the segment-table entry are placed in bits 32-63 of general register R_1 , bits 0-31 of the register remain unchanged, and the instruction is completed by setting condition code 1.
 - If bits 0-32 of the address of the segment-table entry are not all zeros, the result is as described in the section “DAT-Related Exceptions for LOAD REAL ADDRESS”, below.

When the I bit in the page-table entry is one, the following applies:

- For LRA or LRAY in the 64-bit addressing mode or for LRA in any addressing mode, the 64-bit real or absolute address of the page-table entry is placed in general register R_1 , and the instruction is completed by setting condition code 2.
- For LRA or LRAY in the 24-bit or 31-bit addressing mode, the following applies:
 - If bits 0-32 of the address of the page-table entry are all zeros, bits 32-63 of the real or absolute address of the page-table entry are placed in bits 32-63 of general register R_1 , bits 0-31 of the register remain unchanged, and the instruction is completed by setting condition code 2.
 - If bits 0-32 of the address of the page-table entry are not all zeros, the result is as described in the section “DAT-Related Exceptions for LOAD REAL ADDRESS”, below.

A segment-table-entry or page-table-entry address placed in general register R_1 is real or absolute in accordance with the type of address that was used during the attempted translation.

DAT-Related Exceptions for LOAD REAL ADDRESS

If a condition exists that would normally cause one of the exceptions shown in the Figure 10-26, (1) the

interruption code assigned to the exception is placed in bit positions 48-63 of general register R₁, bit 32 of this register is set to one, bits 33-47 are set to zeros, and bits 0-31 remain unchanged, and (2) the instruction is completed by setting condition code 3.

Exception Name	Cause	Code (Hex)
ASCE type	Address-space-control element (ASCE) being used is a region-second-table designation, and bits 0-10 of virtual address not all zeros; ASCE is a region-third-table designation, and bits 0-21 of virtual address not all zeros; or ASCE is a segment-table designation, and bits 0-32 of virtual address not all zeros.	0038
Region first translation	Region-first-table entry selected by region-first-index portion of virtual address outside table or invalid.	0039
Region second translation	Region-second-table entry selected by region-second-index portion of virtual address outside table or invalid.	003A
Region third translation	Region-third-table entry selected by region-third-index portion of virtual address outside table or invalid.	003B
Segment translation	Segment-table entry selected by segment-index portion of virtual address outside table (for all instructions and all addressing modes, but only when bits 0-32 of entry address not all zeros); or segment-table entry invalid (LRA and LRAY only, and only in 24-bit or 31-bit addressing mode when bits 0-32 of entry address not all zeros).	0010
Page translation	Page-table entry selected by page-index portion of virtual address invalid (LRA and LRAY only, and only in 24-bit or 31-bit addressing mode when bits 0-32 of entry address not all zeros).	0011

Figure 10-26. Handling of DAT-Related Exceptions for LOAD REAL ADDRESS

Special Conditions

In the ESA/390-compatibility mode, an operation exception is recognized.

A special-operation exception is recognized when, for LRA or LRAY in the 24-bit or 31-bit addressing

mode, bits 0-32 of the resultant 64-bit real address are not all zeros.

An addressing exception is recognized when the address used by ART to fetch the effective access-list designation or the ALE, ASTE, or authority-table entry designates a location which is not available in the configuration or when the address used to fetch the region-table entry or entries, if any, segment-table entry, or page-table entry designates a location which is not available in the configuration.

A translation-specification exception is recognized when an accessed region-table entry or the segment-table entry or page-table entry has a zero I bit and a format error, that is, when any of the reasons 1-5 listed in "Translation-Specification Exception" on page 6-46 applies.

A carry out of bit position 0 as a result of the addition done to compute the address of a region-table entry or the segment-table entry may be ignored or may result in an addressing exception.

The operation is suppressed on all addressing exceptions.

Resulting Condition Code:

- 0 Translation available
- 1 Segment-table entry invalid (I bit one) for LRA, or for LRA and LRAY in 64-bit addressing mode, or for LRA and LRAY in 24-bit or 31-bit addressing mode and bits 0-32 of the entry address are all zeros
- 2 Page-table entry invalid (I bit one) for LRA, or for LRA and LRAY in 64-bit addressing mode, or for LRA and LRAY in 24-bit or 31-bit addressing mode and bits 0-32 of the entry address are all zeros
- 3 Address-space-control element not available, region-table entry outside table or invalid (I bit one), segment-table entry outside table, or, for LRA and LRAY only, and only in 24-bit or 31-bit addressing mode when bits 0-32 of entry address not all zeros, segment-table entry or page-table entry invalid (I bit one)

Program Exceptions:

- Addressing (effective access-list designation, access-list entry, ASN-second-table entry, authority-table entry, region-table entry, segment-table entry, or page-table entry)

- Operation (LRAY, if the long-displacement facility is not installed; LRA, LRAY, LRAg, in the ESA/390-compatibility mode)
- Privileged operation
- Special operation (LRA, LRAY only)
- Transaction constraint
- Translation specification

Programming Notes:

1. Caution must be exercised in the use of LOAD REAL ADDRESS in a multiprocessing configuration. Since INVALIDATE DAT TABLE ENTRY or INVALIDATE PAGE TABLE ENTRY may set I bits in storage to one before causing the corresponding entries in TLBs of other CPUs to be cleared, the simultaneous execution of LOAD REAL ADDRESS on this CPU and either INVALIDATE DAT TABLE ENTRY or INVALIDATE PAGE TABLE ENTRY on another CPU may produce inconsistent results. Because LOAD REAL ADDRESS may access the tables in storage, the

region-table entries, segment-table entry or page-table entry may appear to be invalid (condition codes 3, 1, or 2, respectively) even though the corresponding TLB entry has not yet been cleared, and the TLB entry may remain in the TLB until the completion of INVALIDATE DAT TABLE ENTRY or INVALIDATE PAGE TABLE ENTRY on the other CPU. There is no guaranteed limit to the number of instructions which may be executed between the completion of LOAD REAL ADDRESS and the TLB being cleared of the entry.

The above cautions for using LOAD REAL ADDRESS also apply when COMPARE AND SWAP AND PURGE or COMPARE AND REPLACE DAT TABLE ENTRY is used to explicitly set the invalid bit in a DAT-table entry.

2. Figure 10-27 on page 10-59 summarizes the resulting contents of general register R₁ and the condition code.

Exception/Cause/ Entry-Address Size or Resultant-Real- Address Size	General Register R ₁ Contents and Condition Code									
	LRA or LRAY in 24-Bit or 31-Bit Addressing Mode					LRA or LRAY in 64-Bit Addr. Mode or LRAg in Any Addressing Mode				
	0-31	32	33-47	48-63	CC	0-31	32	33-47	48-63	CC
ALET specification	U	1	0s	0028	3	U	1	0s	0028	3
ALEN translation	U	1	0s	0029	3	U	1	0s	0029	3
ALE sequence	U	1	0s	002A	3	U	1	0s	002A	3
ASTE validity	U	1	0s	002B	3	U	1	0s	002B	3
ASTE sequence	U	1	0s	002C	3	U	1	0s	002C	3
Extended authority	U	1	0s	002D	3	U	1	0s	002D	3
ASCE type	U	1	0s	0038	3	U	1	0s	0038	3
Region first trans.	U	1	0s	0039	3	U	1	0s	0039	3
Region second trans.	U	1	0s	003A	3	U	1	0s	003A	3
Region third trans.	U	1	0s	003B	3	U	1	0s	003B	3
Segment translation/ entry outside table/ entry address < 2GB	U	0	EA3	EA4	3	U	0	EA3	EA4	3
Segment translation/ entry outside table/ entry address >= 2GB	U	1	0s	0010	3	U	1	0s	0010	3
Segment translation/ I bit one/ entry address < 2GB	U	0	EA3	EA4	1	EA1	EA2	EA3	EA4	1
Segment translation/ I bit one/ entry address >= 2GB	U	1	0s	0010	3	EA1	EA2	EA3	EA4	1

Figure 10-27. Summary of Results: LOAD REAL ADDRESS

Exception/Cause/ Entry-Address Size or Resultant-Real- Address Size	General Register R ₁ Contents and Condition Code									
	LRA or LRAY in 24-Bit or 31-Bit Addressing Mode					LRA or LRAY in 64-Bit Addr. Mode or LRA in Any Addressing Mode				
	0-31	32	33-47	48-63	CC	0-31	32	33-47	48-63	CC
Page translation/ 1 bit one/ entry address < 2GB	U	0	EA3	EA4	2	EA1	EA2	EA3	EA4	2
Page translation/ 1 bit one/ entry address >= 2GB	U	1	0s	0011	3	EA1	EA2	EA3	EA4	2
Real Address < 2GB	U	0	RA3	RA4	0	RA1	RA2	RA3	RA4	0
Real Address >= 2GB	Special-Operation Exception					RA1	RA2	RA3	RA4	0

Explanation:

EA1 Bits 0-31 of the entry address.
EA2 Bit 32 of the entry address.
EA3 Bits 33-47 of the entry address.
EA4 Bits 48-63 of the entry address.
RA1 Bits 0-31 of the resultant real address.
RA2 Bit 32 of the resultant real address.
RA3 Bits 33-47 of the resultant real address.
RA4 Bits 48-63 of the resultant real address.
U Unchanged.

Figure 10-27. Summary of Results: LOAD REAL ADDRESS

3. When the instruction completes with condition code 3, the following applies:

- Only the rightmost 32 bits of general register R₁ are meaningful, regardless of the addressing mode or instruction executed. The program can determine whether the rightmost bits of general register R₁ contain the address of a DAT-table entry or a program-interruption code based on whether bit 32 of the register is zero or one, respectively.
- In order to correctly use a DAT-table-entry address returned in general register R₁ in the 64-bit addressing mode, the leftmost 32 bits of the register must be set to zeros.

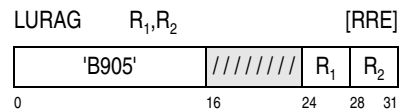

For LOAD USING REAL ADDRESS (LURA), the word at the real-storage location addressed by the contents of general register R₂ is placed in bit positions 32-63 of general register R₁, and the contents of bit positions 0-31 remain unchanged. For LOAD USING REAL ADDRESS (LURAG), the doubleword at that real-storage location is placed in bit positions 0-63 of general register R₁.

In the 24-bit addressing mode, bits 40-63 of general register R₂ designate the real-storage location, and bits 0-39 of the register are ignored. In the 31-bit addressing mode, bits 33-63 of general register R₂ designate the real-storage location, and bits 0-32 of the register are ignored. In the 64-bit addressing mode, bits 0-63 of general register R₂ designate the real-storage location.

Because it is a real address, the address designating the storage word or doubleword is not subject to dynamic address translation.

LOAD USING REAL ADDRESS

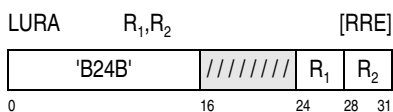

Special Conditions

The contents of general register R_2 must designate a location on a word boundary for LURA or on a doubleword boundary for LURAG; otherwise, a specification exception is recognized.

Condition Code: The code remains unchanged.

Program Exceptions:

- Addressing (address specified by general register R_2)
- Privileged operation
- Protection (fetch, operand 2, key-controlled protection)
- Specification
- Transaction constraint

MODIFY STACKED STATE

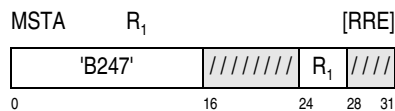

The contents of bit positions 32-63 of the pair of general registers designated by the R_1 field are placed in the modifiable area, byte positions 152-159, of the last state entry in the linkage stack.

The R_1 field designates the even-numbered register of an even-odd pair of general registers.

The last state entry is located as described in “Unstacking Process” on page 5-86. The state entry remains in the linkage stack, and the linkage-stack-entry address in control register 15 remains unchanged.

Key-controlled protection does not apply to the references to the linkage stack, but low-address and DAT protection do apply.

Special Conditions

A specification exception is recognized when R_1 is odd.

The CPU must be in the primary-space mode, access-register mode, or home-space mode; otherwise, a special-operation exception is recognized.

A stack-empty, stack-specification, or stack-type exception may be recognized during the unstacking process.

The operation is suppressed on all addressing and protection exceptions.

The priority of recognition of program exceptions for the instruction is shown in Figure 10-28 on page 10-61.

Condition Code: The code remains unchanged.

Program Exceptions:

- Access (fetch and store, except for key-controlled protection, linkage-stack entry)
- Special operation
- Specification
- Stack empty
- Stack specification
- Stack type
- Transaction constraint

1.-6.	Exceptions with the same priority as the priority of program-interruption conditions for the general case.
7.A	Access exceptions for second instruction halfword.
7.B	Special-operation exception due to DAT being off or the CPU being in secondary-space mode.
7.C	Transaction constraint.
8.A	Specification exception due to R_1 being odd.
8.B.1	Access exceptions (fetch) for entry descriptor of the current linkage-stack entry.
8.B.2	Stack-type exception due to current entry not being a state entry or header entry.
	Note: Exceptions 8.B.3-8.B.7 can occur only if the current entry is a header entry.
8.B.3	Access exceptions (fetch) for second word of the header entry.
8.B.4	Stack-empty exception due to backward stack-entry validity bit in the header entry being zero.

Figure 10-28. Priority of Execution: MODIFY STACKED STATE (Part 1 of 2)

8.B.5	Access exceptions (fetch) for entry descriptor of preceding entry, which is the entry designated by the backward stack-entry address in the current (header) entry.
8.B.6	Stack-specification exception due to preceding entry being a header entry.
8.B.7	Stack-type exception due to preceding entry not being a state entry.
8.B.8	Access exceptions (store) for the modifiable area of the state entry.

Figure 10-28. Priority of Execution: MODIFY STACKED STATE (Part 2 of 2)

Programming Note: The modifiable area can be obtained from the last linkage-stack state entry by means of EXTRACT STACKED STATE.

MOVE PAGE

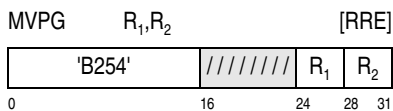

The first operand is replaced by the second operand and, optionally, the storage key associated with the 4K-byte block of storage designated by the first operand is set. The first and second operands both are 4K bytes on 4 K-byte boundaries. The results are indicated in the condition code. The accesses to the first-operand location or the second-operand location, but not to both locations, may be performed by using the key specified in general register 0; otherwise, the accesses to an operand location are performed by using the PSW key.

The location of the leftmost byte of the first operand and second operand is designated by the contents of general registers R_1 and R_2 , respectively.

The handling of the addresses in general registers R_1 and R_2 depends on the addressing mode. In the 24-bit addressing mode, the contents of bit positions 40-51 of a general register, with 12 rightmost zeros appended, are the address, and bits 0-39 and 52-63 in the register are ignored. In the 31-bit addressing mode, the contents of bit positions 33-51 of a general register, with 12 rightmost zeros appended, are the address, and bits 0-32 and 52-63 in the register are ignored. In the 64-bit addressing mode, the contents of bit positions 0-51 of a general register, with 12

rightmost zeros appended, are the address, and bits 52-63 in the register are ignored.

Bits 51-53 of general register 0 contain the key-function control (KFC) which is used to determine how the supplied storage key in bits 56-62 will be used or set.

KFC Meaning

- | | |
|-----|--|
| 0 | The PSW key is used for accessing both operands. The reference (R) and change (C) bits of the storage key associated with the 4K-byte block of storage designated by the first operand are set. |
| 1 | The PSW key is used for store accesses to the first operand and the supplied ACC key (bits 56-59 of general register 0) is used for fetch accesses to the second operand. The reference (R) and change (C) bits of the storage key associated with the 4K-byte block of storage designated by the first operand are set. |
| 2 | The supplied ACC key (bits 56-59 of general register 0) is used for store accesses to the first operand and the PSW key is used for fetch accesses to the second operand. The reference (R) and change (C) bits of the storage key associated with the 4K-byte block of storage designated by the first operand are set. |
| 3 | Reserved |
| 4 | Key-controlled protection does not apply to the first operand. The PSW key is used for fetch accesses to the second operand. The storage key associated with the 4K-byte block of storage designated by the first operand is set to the full key supplied in bits 56-62 of general register 0. |
| 5 | Key-controlled protection does not apply to the first operand. The PSW key is used for fetch accesses to the second operand. The storage key associated with the 4K-byte block of storage designated by the first operand is set as follows: the access-control bits (ACC) and fetch-protection bit (F) are copied from the storage key of the second operand and the reference bit (R) and change bit (C) use the value supplied in bits 61-62 of general register 0. |
| 6-7 | Reserved |

When the move-page-and-set-key facility is not installed, KFC values of 4 and 5 are also reserved. If a reserved value is specified, a specification exception is recognized.

Bit 54 of general register 0 is a destination-reference-intention bit, and bit 55 is a condition-code-option bit. Bits 48-50 of general register 0 must be zeros; other-

wise, a specification exception is recognized. Bits 0-47 and 63 of general register 0 are ignored. When the move-page-and-set-key facility is not installed, bits 60-62 are also ignored.

The contents of the registers just described are shown in Figure 10-29.

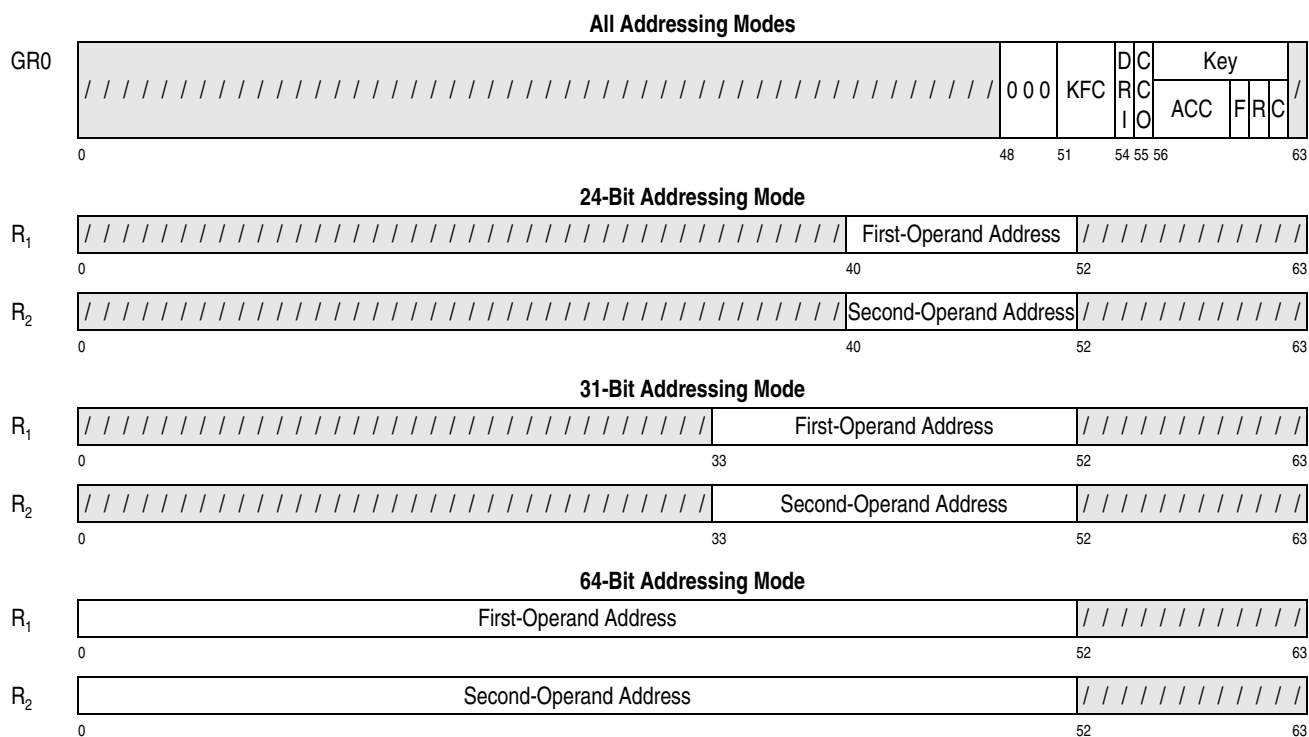

Explanation:

- CCO Condition-code-option bit.
- DRI Destination-reference-intention bit.
- Key Specified access key.
- KFC Key-function control.

Figure 10-29. Register Contents for MOVE PAGE

When 4K bytes have been moved, condition code 0 is set.

When a page-translation-exception condition exists, the exception is not recognized if the condition-code-option bit, bit 55 in general register 0, is one; instead, condition code 1 or 2 is set. Condition code 1 is set if a page-translation-exception condition exists for the first operand and not for the second operand. Condition code 2 is set if a page-translation-exception condition exists for the second operand, regardless of whether the condition exists for the first operand.

When the KFC value is 4 or 5 and the real or absolute addresses (possibly after DAT) of the first and second operands are the same, it is model dependent if an operand exception is recognized.

When an access exception can be recognized for both operands, it is unpredictable for which operand an exception is recognized. If one of the exceptions is a page-translation exception that would cause condition code 1 or 2 to be set, it is unpredictable whether the access exception for the other operand is recognized or condition code 1 or 2 is set.

When the instruction completes by setting condition codes 1 or 2, and a PER zero-address-detection condition also exists for either the first or second operand, it is unpredictable whether the zero-address-detection condition is recognized.

The references to main storage are not necessarily single-access references and are not necessarily

performed in a left-to-right direction, as observed by other CPUs and by channel programs.

When the storage key is set on the first operand block (KFC values of 4 or 5), a quiescing operation is not necessarily performed. See “Storage-Key Accesses” on page 5-120 for a discussion of the effects of quiescing on key-setting instructions, and see “Quiescing” on page 5-133 for details on the quiescing operation.

When the KFC value is 4 or 5, serialization and checkpoint-synchronization functions are performed before the operation begins and again after the operation is completed.

Special Conditions

In the problem state, when the KFC value is 1 or 2, the operation is performed only if the access key specified in general register 0 is valid, that is, if the corresponding PSW-key-mask bit in control register 3 is one. Otherwise, a privileged-operation exception is recognized. In the supervisor state, any value for the specified access key is valid.

When the KFC value is 0, the access key in general register 0 is not tested for validity and a privileged-operation exception is not recognized. In the problem state, when the move-page-and-set-key facility is installed and the KFC value is 4 or 5, a privileged-operation exception is recognized.

In the problem state, when the KFC value is 3 and the access key in general register 0 is not permitted by the PSW-key mask, it is unpredictable whether a specification exception or a privileged-operation exception is recognized.

KFC values of 6 or 7 always result in a specification exception.

In the ESA/390-compatibility mode, an operation exception is recognized when the configuration is not also operating in the ESA/extended-configuration (ESA/XC) mode. See Reference [12.] on page xxx for details on ESA/XC.

Resulting Condition Code:

- | | |
|---|--|
| 0 | Data moved and, optionally, key is set |
| 1 | Condition-code-option bit one, page-table entry for first operand invalid, and page-table entry for second operand valid |
| 2 | Condition-code-option bit one and page-table entry for second operand invalid |
| 3 | -- |

Program Exceptions:

- Access (fetch, operand 2; store, operand 1)
- Operand
- Operation (in the ESA/390 compatibility mode when not in ESA/XC mode)
- Privileged operation (access key specified, and selected PSW-key-mask bit is zero in the problem state; KFC values of 4 or 5 in the problem state)
- Specification
- Transaction constraint

Programming Notes:

1. MOVE PAGE, or a loop of MOVE PAGE instructions that moves multiple pages, may provide, on most models, better performance than a MOVE LONG instruction or a loop of MOVE (MVC) instructions that performs the same function. Whether MOVE PAGE provides better performance depends on control-program specifications and the method by which the control program handles page-translation exceptions.
2. The destination-reference-intention bit should be set to one when there is an intention to reference the first operand by means of an instruction other than MOVE PAGE. The bit may allow the control program to process a page-translation exception more efficiently.
3. On most models where the move-page-and-set-key facility is installed and it is desired to both move a page of data and copy or set its key, then using MVPG with KFC values of 4 or 5 will provide better performance compared to a separate move operation followed by a SET STORAGE KEY EXTENDED or PERFORM FRAME MANAGE FUNCTION.
4. When KFC values of 4 or 5 are used, another CPU might briefly observe the reference and

change bits being set to one for the first operand block, before being set to their final value by the key setting operation.

5. The condition code set by the instruction normally need not be examined if the condition-code-option bit is zero or if DAT is off.
6. See the definitions of real locations 162 and 168-175 under "Assigned Storage Locations" in Chapter 3, "Storage" for a description of information stored during a program interruption due to a DAT-related translation exception recognized by MOVE PAGE.

MOVE TO PRIMARY

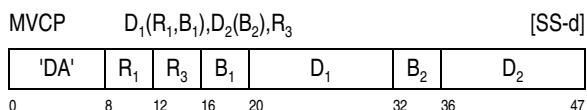

MOVE TO SECONDARY



The first operand is replaced by the second operand. One operand is in the primary address space, and the other is in the secondary address space. The accesses to the operand in the primary space are performed by using the PSW key; the accesses to the operand in the secondary space are performed by using the key specified by the third operand.

The addresses of the first and second operands are virtual, one operand address being translated by means of the primary address-space-control element and the other by means of the secondary address-space-control element. Operand-address translation is performed in the same way when the address-space-control bits in the current PSW specify either the primary-space mode or the secondary-space mode.

For MOVE TO PRIMARY, movement is to the primary space from the secondary space. The first-operand address is translated by using the primary address-space-control element, and the second-operand address is translated by using the secondary address-space-control element.

For MOVE TO SECONDARY, movement is to the secondary space from the primary space. The first-operand address is translated by using the secondary address-space-control element, and the second-operand address is translated by using the primary address-space-control element.

Bit positions 56-59 of general register R₃ are used as the secondary-space access key. Bit positions 0-55 and 60-63 of the register are ignored.

General register R₁ contains an unsigned binary integer called the true length. In the 24-bit or 31-bit addressing mode, the true length is in bit positions 32-63 of the register, and the contents of bit positions 0-31 of the register are ignored. In the 64-bit addressing mode, the true length is in bit positions 0-63 of the register.

The contents of the general registers just described are shown in Figure 10-30.

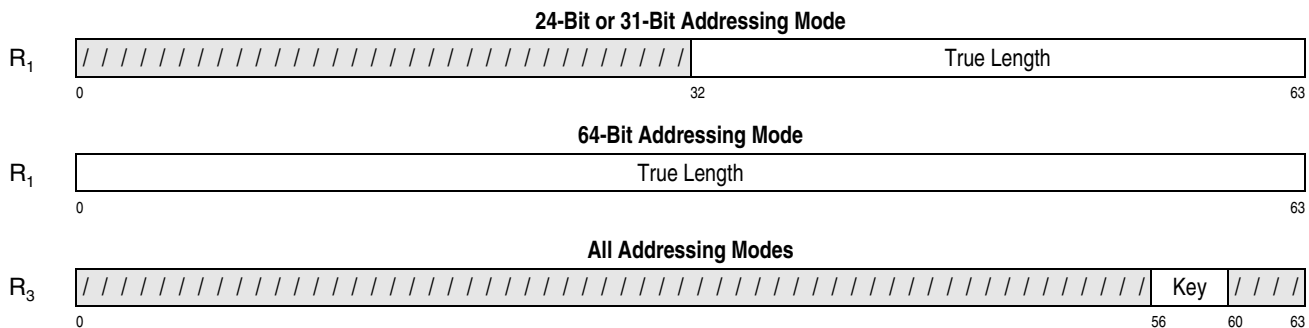

Figure 10-30. Register Contents of MOVE TO PRIMARY and MOVE TO SECONDARY

The first and second operands are the same length, called the effective length. The effective length is

equal to the true length or 256, whichever is less. Access exceptions for the first and second operands

are recognized only for that portion of the operand within the effective length. When the effective length is zero, no access exceptions are recognized for the first and second operands, and no movement takes place.

Each storage operand is processed left to right. The storage-operand-consistency rules are the same as for MOVE (MVC), except that when the operands overlap in real storage, the use of the common real-storage locations is not necessarily recognized.

As part of the execution of the instruction, the value of the true length is used to set the condition code. If the true length is 256 or less, including zero, the true length and effective length are equal, and condition code 0 is set. If the true length is greater than 256, the effective length is 256, and condition code 3 is set.

For both MOVE TO PRIMARY and MOVE TO SECONDARY, a serialization and checkpoint-synchronization function is performed before the operation begins and again after the operation is completed.

Special Conditions

Since the secondary space is accessed, the operation is performed only when the secondary-space control, bit 37 of control register 0, is one and DAT is on. When either the secondary-space control is zero or DAT is off, a special-operation exception is recognized. A special-operation exception is also recognized when the address-space-control bits in the current PSW specify the access-register or home-space mode.

In the problem state, the operation is performed only if the secondary-space access key is valid, that is, if the corresponding PSW-key-mask bit in control register 3 is one. Otherwise, a privileged-operation exception is recognized. In the supervisor state, any value for the secondary-space access key is valid.

Resulting Condition Code:

- 0 True length less than or equal to 256
- 1 --
- 2 --
- 3 True length greater than 256

Program Exceptions:

- Access (fetch, primary virtual address, operand 2, MVCS; fetch, secondary virtual address, operand 2, MVCP; store, secondary virtual address, operand 1, MVCS; store, primary virtual address, operand 1, MVCP)
- Privileged operation (selected PSW-key-mask bit is zero in the problem state)
- Special operation
- Transaction constraint

The priority of the recognition of exceptions and condition codes is shown in Figure 10-31.

1.-6.	Exceptions with the same priority as the priority of program-interruption conditions for the general case.
7.A	Access exceptions for second and third instruction halfwords.
7.B	Special-operation exception due to the secondary-space control, bit 37 of control register 0, being zero, to DAT being off, or to the CPU being in the access-register or home-space mode.
7.C	Transaction constraint.
8.	Privileged-operation exception due to selected PSW-key-mask bit being zero in the problem state.
9.	Completion due to length zero.
10.	Access exceptions for operands.

Figure 10-31. Priority of Execution: MOVE TO PRIMARY and MOVE TO SECONDARY

Programming Notes:

1. MOVE TO PRIMARY and MOVE TO SECONDARY can be used in a loop to move a variable number of bytes of any length. See the programming note under MOVE WITH KEY.
2. MOVE TO PRIMARY and MOVE TO SECONDARY should be used only when movement is between different address spaces. The performance of these instructions on most models may be significantly slower than that of MOVE WITH KEY, MOVE (MVC), or MOVE LONG. In addition, the definition of overlapping operands for MOVE TO PRIMARY and MOVE TO SECONDARY is not compatible with the more precise definitions for MOVE (MVC), MOVE WITH KEY, and MOVE LONG.

MOVE WITH DESTINATION KEY

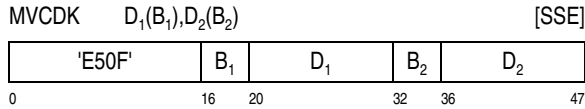

The first operand is replaced by the second operand. The accesses to the destination-operand location are performed by using the key specified in general register 1, and the accesses to the source-operand location are performed by using the PSW key.

The first and second operands are of the same length, which is specified by bits 56-63 of general register 0. Bits 0-55 of general register 0 are ignored.

Bits 56-59 of general register 1 are used as the specified access key. Bits 0-55 and 60-63 of general register 1 are ignored.

The contents of general registers 0 and 1 are shown in Figure 10-32.



Figure 10-32. Register Contents of MOVE WITH DESTINATION KEY

L specifies the number of bytes to the right of the first byte of each operand. Therefore, the length in bytes of each operand is 1-256, corresponding to a length code in L of 0-255.

The fetch accesses to the second-operand location are performed by using the PSW key, and the store accesses to the first-operand location are performed by using the key specified in general register 1.

Each of the operands is processed left to right. When the operands overlap destructively in real storage, the results in the first-operand location are unpredictable. Except for this unpredictability in the case of destructive overlap, the storage-operand-consistency rules are the same as for the MOVE (MVC) instruction.

Special Conditions

In the problem state, the operation is performed only if the access key specified in general register 1 is valid, that is, if the corresponding PSW-key-mask bit in control register 3 is one. Otherwise, a privileged-operation exception is recognized. In the supervisor state, any value for the specified access key is valid.

Condition Code: The code remains unchanged.

Program Exceptions:

- Access (fetch, operand 2; store, operand 1)

- Privileged operation (selected PSW-key-mask bit is zero in the problem state)
- Transaction constraint

Programming Note: See the programming notes for the MOVE WITH SOURCE KEY instruction.

MOVE WITH KEY

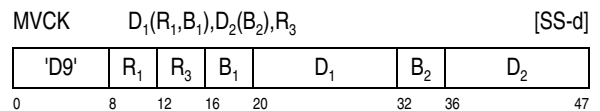

The first operand is replaced by the second operand. The fetch accesses to the second-operand location are performed by using the key specified in the third operand, and the store accesses to the first-operand location are performed by using the PSW key.

Bit positions 56-59 of general register R₃ are used as the source access key. Bit positions 0-55 and 60-63 of the register are ignored.

General register R₁ contains an unsigned binary integer called the true length. In the 24-bit or 31-bit addressing mode, the true length is in bit positions 32-63 of the register, and the contents of bit positions 0-31 of the register are ignored. In the 64-bit addressing mode, the true length is in bit positions 0-63 of the register.

The contents of the general registers just described are shown in Figure 10-33.

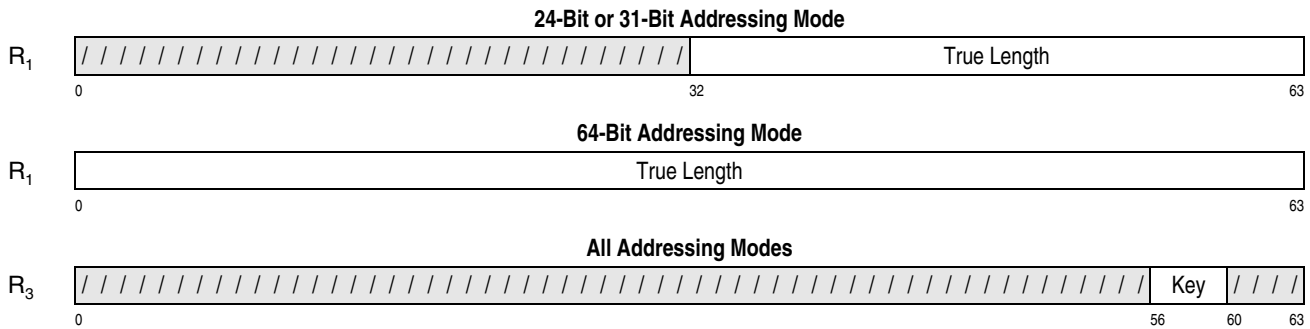

Figure 10-33. Register Contents of MOVE WITH KEY

The first and second operands are of the same length, called the effective length. The effective length is equal to the true length or 256, whichever is less. Access exceptions for the first and second operands are recognized only for that portion of the operand within the effective length. When the effective length is zero, no access exceptions are recognized for the first and second operands, and no movement takes place.

Each storage operand is processed left to right. When the storage operands overlap, the result is obtained as if the operands were processed one byte at a time and each result byte were stored immediately after the necessary operand byte was fetched. The storage-operand-consistency rules are the same as for the MOVE (MVC) instruction.

As part of the execution of the instruction, the value of the true length is used to set the condition code. If the true length is 256 or less, including zero, the true length and effective length are equal, and condition code 0 is set. If the true length is greater than 256, the effective length is 256, and condition code 3 is set.

Special Conditions

In the problem state, the operation is performed only if the source access key is valid, that is, if the corresponding PSW-key-mask bit in control register 3 is one. Otherwise, a privileged-operation exception is recognized. In the supervisor state, any value for the source access key is valid.

Resulting Condition Code:

- | | |
|---|---------------------------------------|
| 0 | True length less than or equal to 256 |
| 1 | -- |
| 2 | -- |
| 3 | True length greater than 256 |

Program Exceptions:

- Access (fetch, operand 2; store, operand 1)
- Privileged operation (selected PSW-key-mask bit is zero in the problem state)
- Transaction constraint

The priority of the recognition of exceptions and condition codes is shown in Figure 10-34.

1.-6.	Exceptions with the same priority as the priority of program-interruption conditions for the general case.
7.A	Access exceptions for second and third instruction halfwords.
7.B	Transaction constraint.
8.	Privileged-operation exception due to selected PSW-key-mask bit being zero in the problem state.
9.	Completion due to length zero.
10.	Access exceptions for operands.

Figure 10-34. Priority of Execution: MOVE WITH KEY

Programming Notes:

1. MOVE WITH KEY can be used in a loop to move a variable number of bytes of any length, as follows:

```

LOOP    MVCK  D1(R1,B1),D2(B2),R3
        BC   8,END
        AHI  B1,256
        AHI  B2,256
        AHI  R1,-256
        B    LOOP
END     [Any instruction]

```

The above program is for execution in the 24-bit or 31-bit addressing mode. In the 64-bit addressing mode, AGHI instructions should be substituted for the AHI instructions.

2. The performance of MOVE WITH KEY on most models may be significantly slower than that of the MOVE (MVC) and MOVE LONG instructions. Therefore, MOVE WITH KEY should not be used if the keys of the source and the target are the same.

MOVE WITH OPTIONAL SPECIFICATIONS

MVCOS $D_1(B_1), D_2(B_2), R_3$ [SSF]

'C8'	R_3	'0'	B_1	D_1	B_2	D_2
0	8	12	16	20	32	36
						47

The first operand is replaced by the second operand. Bits in general register 0 determine the address-space-control modes and protection keys that are used to access the first and second operands.

The addresses of the first and second operands are virtual.

Bits 32-47 of general register 0 contain the operand-access control for the first operand (OAC_1), and bits 48-63 of general register 0 contain the operand-

access control for the second operand (OAC_2). The operand-access control has the following format.

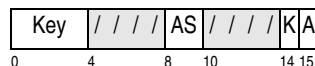

Specified-Access Key (Key): Bits positions 0-3 contain the specified-access key that is used to access the operand if the specified-access-key validity bit (K) is one; otherwise, the specified-access key is ignored.

Specified-Address-Space Control (AS): Bit positions 8-9 contain the address-space control that is used to access the operand when the specified-address-space-control validity bit (A) is one; otherwise, the specified-address-space control is ignored. The meaning of bits 8-9 is identical to that of the address-space control in bits 16-17 of the PSW.

Specified-Access-Key Validity Bit (K): Bit 14 controls whether the PSW key or the specified-access key is used to access the operand. When the K bit is zero, the PSW key is used. When the K bit is one, the specified-access key is used.

Specified-Address-Space-Control Validity Bit (A): Bit 15 controls whether the address-space control in the current PSW or the address-space control in the specified-ASC is used to access the operand. When the A bit is zero, the address-space control in the current PSW is used. When the A bit is one, the specified-address-space control is used.

Bits 0-31 of general register 0 are ignored. Bits 4-7 and 10-14 of both operand-access controls (that is, bits 36-39, 42-45, 52-55, and 58-61 of general register 0) are reserved and should contain zeros; otherwise, the program may not operate compatibly in the future.

General register R_3 contains an unsigned binary integer called the true length. In the 24-bit or 31-bit addressing mode, the true length is in bit positions 32-63 of the register, and the contents of bit positions 0-31 of the register are ignored. In the 64-bit addressing mode, the true length is in bit positions 0-63 of the register.

The contents of the general registers just described are shown in Figure 10-35.

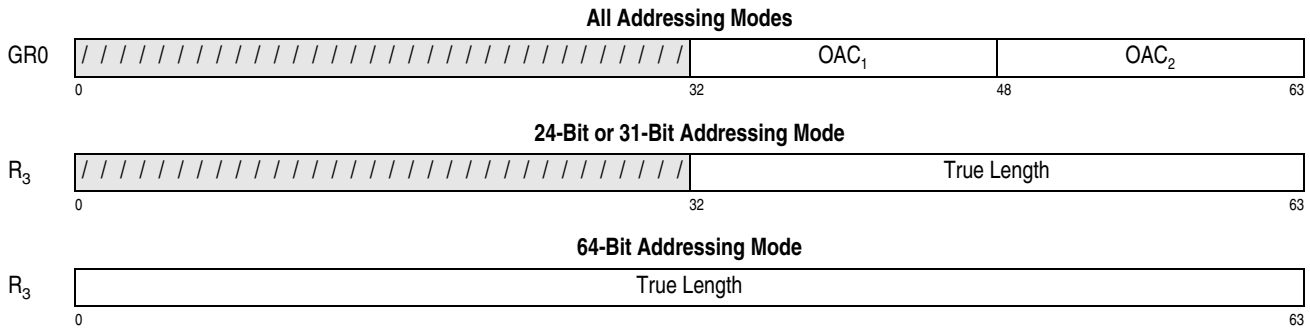

Figure 10-35. Register Contents for MOVE WITH OPTIONAL SPECIFICATIONS

The first and second operands are the same length, called the effective length. The effective length is equal to the true length or 4,096, whichever is less. Access exceptions for the first and second operands are recognized only for that portion of the operand within the effective length. When the effective length is zero, no access exceptions are recognized for the first and second operands, and no movement takes place.

As part of the execution of the instruction, the value of the true length is used to set the condition code. If the true length is 4,096 or less, including zero, then the true length and effective length are equal, and condition code 0 is set. If the true length is greater than 4,096, then the effective length is 4,096, and condition code 3 is set.

No test is made for destructive overlap, and the results in the first-operand location are unpredictable when destructive overlap exists. Operands are said to overlap destructively when the first-operand real location is used as a source after data has been moved into it.

Operands do not overlap destructively if the leftmost byte of the first operand does not coincide with any of the second-operand bytes participating in the operation other than the leftmost byte of the second operand. When an operand wraps around from location $2^{24} - 1$ (or $2^{31} - 1$ or $2^{64} - 1$) to location 0, operand bytes in locations up to and including $2^{24} - 1$ (or $2^{31} - 1$ or $2^{64} - 1$) are considered to be to the left of bytes in locations from 0 up.

In the 24-bit addressing mode, wraparound is from location $2^{24} - 1$ to location 0; in the 31-bit addressing

mode, wraparound is from location $2^{31} - 1$ to location 0; and, in the 64-bit addressing mode, wraparound is from location $2^{64} - 1$ to location 0.

Special Conditions

A special-operation exception is recognized for any of the following conditions:

- DAT is off.
- The address-space control in OAC_1 designates the home-space mode, the address-space-control validity bit in OAC_1 is one, and the current PSW is in the problem state (that is, bits 40-41 of general register 0 are 11 binary, bit 47 of the register is one, and bit 15 of the current PSW is one).
- The secondary-space control, bit 37 of control register 0, is zero, and either of the following is true:
 - The A bit of the OAC for either operand is zero, and bits 16-17 of the current PSW are 10 binary.
 - The A bit of the OAC for either operand is one, and the AS bits in the same OAC are 10 binary.

The secondary-space control is not examined for an operand that is accessed in the secondary-space mode as a result of access-register translation (that is, DAT is on, bits 16-17 of the current PSW are 01 binary, and the access register corresponding to the operand's base register contains an ALET of 00000001 hex).

When MOVE WITH OPTIONAL SPECIFICATIONS is executed in the problem state, and either the first or second operand's specified-access key (from GRO) or the implied-access key (from the PSW) is invalid, a privileged-operation exception is recognized. The validity of an access key is determined as follows:

- The specified-access key in OAC_1 is invalid if the specified-access-key control, bit 46 of general register 0, is one; and the specified-access key, bits 32-35 of the register, designates a PSW-key-mask (PKM) bit position in control register 3 that contains zero.
- The specified-access key in OAC_2 is invalid if the specified-access-key control, bit 62 of general register 0, is one; and the specified-access key, bits 48-51 of the register, designates a PKM bit position that contains zero.
- The implied-access key is invalid if both of the following conditions are true:
 - Either or both bits 46 and 62 of general register 0 are zero.
 - The PSW key, bits 8-11 of the PSW, designates a PKM bit position that contains zero.

In the supervisor state, any value for the implied- or specified-access key is valid.

Resulting Condition Code:

- | | |
|---|---|
| 0 | True length less than or equal to 4,096 |
| 1 | -- |
| 2 | -- |
| 3 | True length greater than 4,096 |

Program Exceptions:

- Access (fetch, second operand; store first operand)
- Operation (if the move-with-optional-specifications facility is not installed)
- Privileged operation (selected PSW-key-mask bit is zero in the problem state)
- Special operation
- Transaction constraint

The priority of the recognition of exceptions and condition codes is shown in Figure 10-36.

1.-7.B	Exceptions with the same priority as the priority of program-interruption conditions for the general case.
7.C.1	Operation exception.
7.C.2	Special-operation exception.
7.C.3	Privileged-operation exception.
7.D	Transaction constraint.
8.	Completion due to length zero.
9.	Access exceptions for operands.

Figure 10-36. Priority of Execution: MOVE WITH OPTIONAL SPECIFICATIONS

Programming Notes:

1. MOVE WITH OPTIONAL SPECIFICATIONS can be used in a loop to move a variable number of bytes of any length.
2. An example of moving 16 K-bytes to the home address space from the secondary address space is shown below. The first operand is accessed using the PSW key, and the second operand is accessed using key 5.

```

LA      3,OPERAND1
LA      5,OPERAND2
LHI     7,16384
LLILF   0,X'00C15083'
LOOP    MVCOS 0(3),0(5),7
AHI     3,4096
AHI     5,4096
AHI     7,-4096
BP      LOOP

```

In the 64-bit addressing mode, AGHI instructions should be substituted for the AHI instructions.

3. The performance of MOVE WITH OPTIONAL SPECIFICATIONS may be significantly slower than that of individual MOVE (MVC) instructions.
4. When bits 46-47 and 62-63 of general register 0 are all zero, MOVE WITH OPTIONAL SPECIFICATIONS uses the key and address-space control in the current PSW to access both the first and second operands.
5. In the MVCDK, MVCK, MVCP, MVCS, and MVCSK instructions, one operand is accessed using an implied key from the PSW, and the other operand is accessed using a specified key

in a register. In the problem state, only the specified key is checked for validity in the PSW-key mask (PKM).

When MVCOS is executed in the problem state, the access keys for the first and second operands are both checked for validity in the PKM, regardless of whether the keys are implied or specified.

MOVE WITH SOURCE KEY

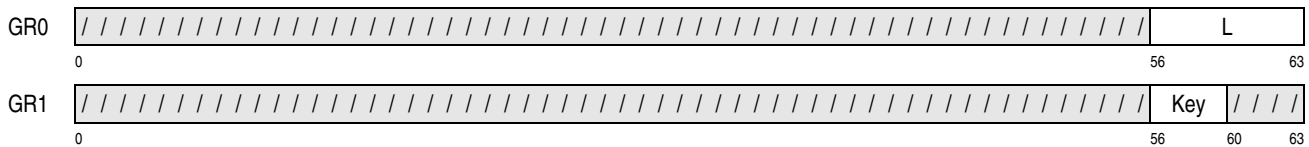
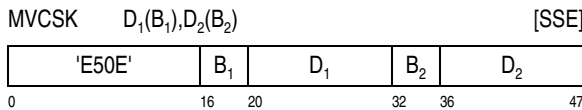

Figure 10-37. Register Contents of MOVE WITH SOURCE KEY

L specifies the number of bytes to the right of the first byte of each operand. Therefore, the length in bytes of each operand is 1-256, corresponding to a length code in L of 0-255.

The fetch accesses to the second-operand location are performed by using the key specified in general register 1, and the store accesses to the first-operand location are performed by using the PSW key.

Each of the operands is processed left to right. When the operands overlap destructively in real storage, the results in the first-operand location are unpredictable. Except for this unpredictability in the case of destructive overlap, the storage-operand-consistency rules are the same as for the MOVE (MVC) instruction.

Special Conditions

In the problem state, the operation is performed only if the access key specified in general register 1 is valid, that is, if the corresponding PSW-key-mask bit in control register 3 is one. Otherwise, a privileged-operation exception is recognized. In the supervisor state, any value for the specified access key is valid.

Condition Code: The code remains unchanged.

The first operand is replaced by the second operand. The accesses to the source-operand location are performed by using the key specified in general register 1, and the accesses to the destination-operand location are performed by using the PSW key.

The first and second operands are of the same length, which is specified by bits 56-63 of general register 0. Bits 0-55 of general register 0 are ignored.

Bits 56-59 of general register 1 are used as the specified access key. Bits 0-55 and 60-63 of general register 1 are ignored.

The contents of general registers 0 and 1 are shown in Figure 10-37.

Program Exceptions:

- Access (fetch, operand 2; store, operand 1)
- Privileged operation (selected PSW-key-mask bit is zero in the problem state)
- Transaction constraint

Programming Notes:

1. When data is to be moved alternately in both directions between two storage areas that are fetch protected by means of different keys, then MOVE WITH SOURCE KEY and MOVE WITH DESTINATION KEY can be used while leaving the PSW key unchanged; and this may be, on most models, significantly faster than using MOVE WITH KEY along with SET PSW KEY FROM ADDRESS to change the PSW key.
2. MOVE WITH SOURCE KEY and MOVE WITH DESTINATION KEY should be used only when movement is between storage areas having different keys. The performance of these instructions on most models may be significantly slower than that of the MOVE (MVC) instruction.
3. MOVE WITH SOURCE KEY or MOVE WITH DESTINATION KEY can be used in a loop to move a variable number of bytes as shown in the following example. In the example, the specified

access key, the first-operand address, the second-operand address, and the length of each operand are assumed to be in general registers 1-4, respectively, at the beginning of the example. The length of each operand is treated as a 32-bit signed value, and a negative value is treated as zero.

```

LTR  4,4
BC   12,END
AHI  4,-256
BC   12,LAST
LA   0,255
LOOP MVC SK 0(2),0(3)
LA   2,256(2)
LA   3,256(3)
AHI  4,-256
BC   2,LOOP
LAST LA   0,255(4)
MVC SK 0(2),0(3)
END  [Any instruction]

```

PAGE IN

PGIN R_1, R_2 [RRE]

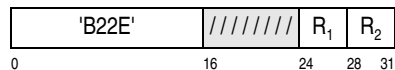

A page-in operation is performed which transfers a 4 K-byte block to the real-storage location designated by general register R_1 from the expanded-storage block designated by general register R_2 .

Bits 32-63 of general register R_2 are a 32-bit unsigned binary integer called the expanded-storage-block number. This number designates the 4 K-byte block of expanded storage which is to be transferred. If the expanded-storage-block number designates an inaccessible block in expanded storage, condition code 3 is set.

The contents of general register R_1 are a real address which designates a 4 K-byte block in main storage. In the 24-bit-addressing mode, bits 40-51 designate the block, and bits 0-39 are ignored. In the 31-bit-addressing mode, bits 33-51 designate the block, and bits 0-32 are ignored. In the 64-bit-addressing mode, bits 0-51 designate the block. In all modes, bits 52-63 of the address are ignored.

Because it is a real address, the address designating the main-storage block is not subject to dynamic address translation. PAGE IN is not subject to key-

controlled storage protection, but low-address protection does apply. PAGE IN is not subject to program-event recording for storage alteration.

A serialization and checkpoint-synchronization function is performed before the operation begins and again after the operation is completed.

If the page-in operation is completed with no errors, condition code 0 is set.

If the page-in operation encounters an expanded-storage data error, condition code 1 is set. For an expanded-storage data-error condition, the contents of the entire 4 K-byte block in real storage is unpredictable, but this condition does not result in the generation of invalid checking-block codes in real storage.

If the expanded-storage block is not available, that is, the block is not provided or is not currently in the configuration, then condition code 3 is set, and no other action is taken.

Operation of PAGE IN in a Multiple-CPU Configuration

The accesses to main storage and to expanded storage by PAGE IN are not necessarily single-access references and are not necessarily performed in a left-to-right direction, as observed by other CPUs and by channel programs.

See also the description under PAGE OUT.

Resulting Condition Code:

- 0 Page-in operation completed
- 1 Expanded-storage data error
- 2 --
- 3 Expanded-storage block not available

Program Exceptions:

- Addressing (block designated by general register R_1)
- Operation (if the expanded-storage facility is not installed)
- Privileged operation
- Protection (block designated by general register R_1 ; low-address protection)
- Transaction constraint

PAGE OUT

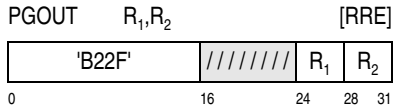

A page-out operation is performed which transfers a 4 K-byte block from the real-storage location designated by general register R₁ to the expanded-storage block designated by general register R₂.

Bits 32-63 of general register R₂ are a 32-bit unsigned binary integer called the expanded-storage-block number. This number designates the 4 K-byte block of expanded storage which is to be replaced. If the expanded-storage-block number designates an inaccessible block in expanded storage, condition code 3 is set.

The contents of general register R₁ are a real address which designates a 4 K-byte block in main storage. In the 24-bit-addressing mode, bits 40-51 designate the block, and bits 0-39 are ignored. In the 31-bit-addressing mode, bits 33-51 designate the block, and bits 0-32 is ignored. In the 64-bit-addressing mode, bits 0-51 designate the block. In all modes, bits 52-63 of the address are ignored.

Because it is a real address, the address designating the main-storage block is not subject to dynamic address translation. PAGE OUT is not subject to key-controlled protection.

A serialization and checkpoint-synchronization function is performed before the operation begins and again after the operation is completed.

Depending on the model, after the data has been written to the expanded-storage block, a read-back-check operation may be performed to determine whether the data was written correctly. If the read-back-check operation determines that the data has been written correctly, condition code 0 is set. If the read-back-check operation encounters an expanded-storage data error, condition code 1 is set.

Most models do not perform the read-back-check operation, and, after the page-out operation is completed, condition code 0 is set.

Regardless of whether condition code 0 or condition code 1 is set, the entire 4 K-byte block is written.

Errors, if any, in the block after the block is written are preserved. Thus, if a subsequent execution of PAGE IN addresses the same expanded-storage block, the expanded-storage data error will be detected and condition code 1 will be indicated.

If the expanded-storage block is not available, that is, the block is not provided or is not currently in the configuration, then condition code 3 is set, and no other action is taken.

Operation of PAGE OUT in a Multiple-CPU Configuration

The accesses to main storage and to expanded storage by PAGE OUT are not necessarily single-access references and are not necessarily performed in a left-to-right direction, as observed by other CPUs and by channel programs.

If two or more CPUs issue PAGE IN or PAGE OUT instructions at approximately the same instant in time, depending on the model, the operations may be performed one at a time, or the operations may be performed concurrently. Concurrent operation may occur even if the instructions address the same expanded-storage block.

When two or more PAGE OUT instructions addressing the same expanded-storage block are executed concurrently, the resulting values in the expanded-storage block for each group of bytes transferred may be from any of the instructions being executed simultaneously. The number of bytes transferred as a group depends on the model.

Similarly, for concurrent execution of a PAGE IN and a PAGE OUT instruction for the same expanded-storage block, the resulting values for each group of bytes transferred as a result of the execution of the PAGE IN instruction may be either the old or new values from the expanded-storage block.

Concurrent operation of paging instructions does not result in expanded-storage data errors.

Resulting Condition Code:

- 0 Page-out operation completed
- 1 Expanded-storage data error
- 2 --
- 3 Expanded-storage block not available

Program Exceptions:

- Addressing (block designated by general register R₁)
- Operation (if the expanded-storage facility is not installed)
- Privileged operation
- Transaction constraint

PERFORM CRYPTOGRAPHIC KEY MANAGEMENT OPERATION

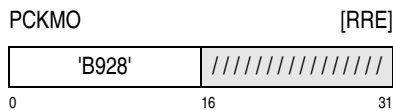

A function specified by the function code in general register 0 is performed.

Bits 16-31 of the instruction are ignored.

Bit positions 57-63 of general register 0 contain the function code. Figure 10-38 on page 10-75 shows the assigned function codes. All other function codes are unassigned. Bit 56 of general register 0 must be zero; otherwise, a specification exception is recognized. All other bits of general register 0 are ignored.

General register 1 contains the logical address of the leftmost byte of the parameter block in storage. In the 24-bit addressing mode, the contents of bit positions 40-63 of general register 1 constitute the address, and the contents of bit positions 0-39 are ignored. In the 31-bit addressing mode, the contents of bit positions 33-63 of general register 1 constitute the address, and the contents of bit positions 0-32 are ignored. In the 64-bit addressing mode, the contents of bit positions 0-63 of general register 1 constitute the address.

PCKMO-Query (Function Code 0)

The locations of the operands and addresses used by the instruction are as shown in Figure 10-39 on

The function codes for PERFORM CRYPTOGRAPHIC KEY MANAGEMENT OPERATION are as follows.

Code	Function	Parm. Block Size (bytes)	Data Block Size (bytes)
0	PCKMO-Query	16	—
1	PCKMO-Encrypt-DEA-Key	32	8
2	PCKMO-Encrypt-TDEA-128-Key	40	8
3	PCKMO-Encrypt-TDEA-192-Key	48	8
18	PCKMO-Encrypt-AES-128-Key	48	16
19	PCKMO-Encrypt-AES-192-Key	56	16
20	PCKMO-Encrypt-AES-256-Key	64	16
32	PCKMO-Encrypt-ECC-P256-Key	64	16
33	PCKMO-Encrypt-ECC-P384-Key	80	16
34	PCKMO-Encrypt-ECC-P521-Key	112	16
40	PCKMO-Encrypt-ECC-Ed25519-Key	64	16
41	PCKMO-Encrypt-ECC-Ed448-Key	96	16
Explanation:			
—		Not applicable	

Figure 10-38. Function Codes for PERFORM CRYPTOGRAPHIC KEY MANAGEMENT OPERATION

All other function codes are unassigned.

The query function provides the means of indicating the availability of the other functions.

Figure 10-39 shows the contents of general registers 0 and 1.

In the access-register mode, access register 1 specifies the address space containing the parameter block.

As observed by other CPUs and channel programs, reference to the parameter block may be multiple-access references, accesses to these storage locations are not necessarily block-concurrent, and the sequence of these accesses or references is undefined.

page 10-76.

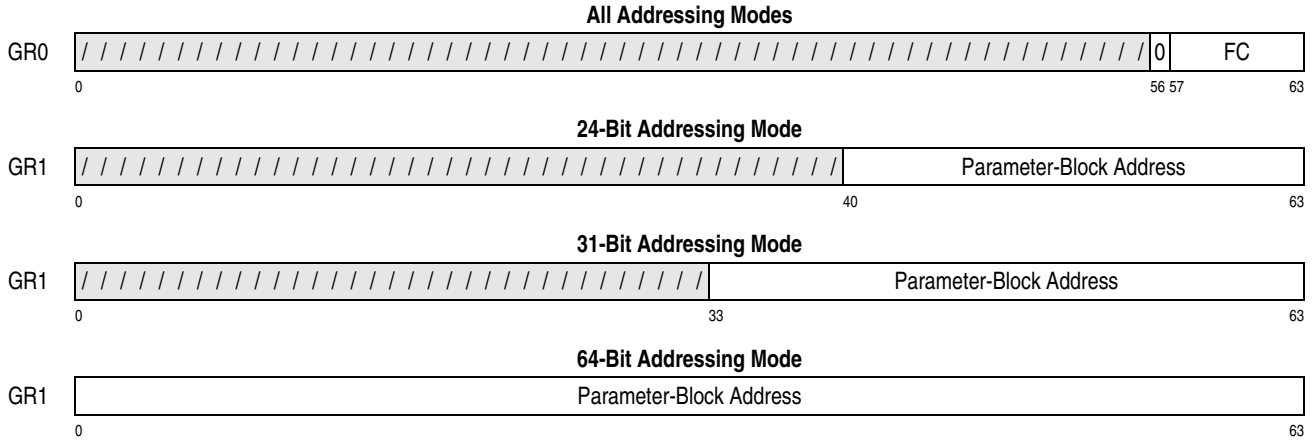

Figure 10-39. General Register Assignment for PCKMO

The parameter block used for the function has the following format:

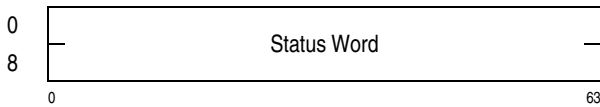

Figure 10-40. Parameter Block for PCKMO-Query

A 128-bit status word is stored in the parameter block. Bits 0-127 of this field correspond to function codes 0-127, respectively, of the PCKMO instruction. When a bit is one, the corresponding function is installed; otherwise, the function is not installed.

PCKMO-Encrypt-DEA-Key (Function Code 1)

The locations of the operands and addresses used by the instruction are as shown in Figure 10-39 on page 10-76.

The parameter block used for the function has the following format:

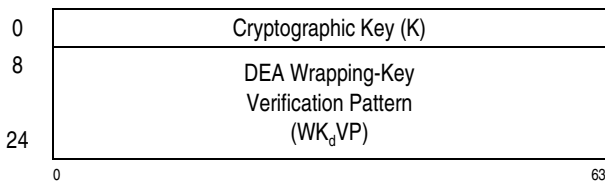

Figure 10-41. Parameter Block for PCKMO-Encrypt-DEA-Key

The 8-byte cryptographic key, K, in byte offsets 0-7 of the parameter block is encrypted using the DEA

wrapping key. (See the section “Protection of Cryptographic Keys” on page 7-431 for the encryption algorithm.) The result is placed back in byte offsets 0-7 of the parameter block. The contents of the DEA wrapping-key verification-pattern register are placed in byte offsets 8-31 of the parameter block.

PCKMO-Encrypt-TDEA-128-Key (Function Code 2)

The locations of the operands and addresses used by the instruction are as shown in Figure 10-39 on page 10-76.

The parameter block used for the function has the following format:

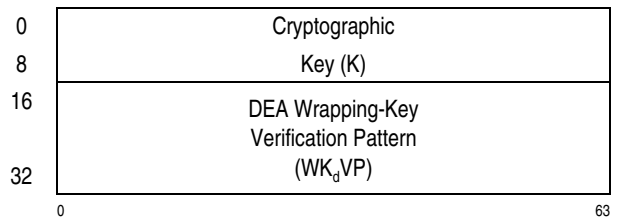

Figure 10-42. Parameter Block for PCKMO-Encrypt-TDEA-128-Key

The 16-byte cryptographic key, K, in byte offsets 0-15 of the parameter block is encrypted using the DEA wrapping key. (See the section “Protection of Cryptographic Keys” on page 7-431 for the encryption algorithm.) The result is placed back in byte offsets 0-15 of the parameter block. The contents of the DEA wrapping-key verification-pattern register are placed in byte offsets 16-31 of the parameter block.

PCKMO-Encrypt-TDEA-192-Key (Function Code 3)

The locations of the operands and addresses used by the instruction are as shown in Figure 10-39 on page 10-76.

The parameter block used for the function has the following format:

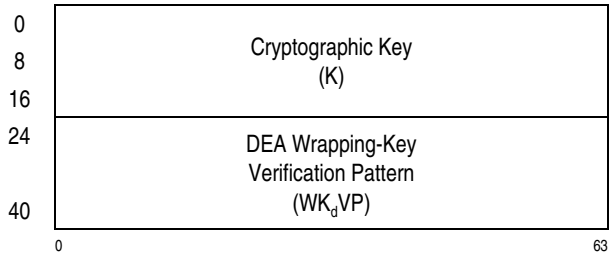

Figure 10-43. Parameter Block for PCKMO-Encrypt-TDEA-192-Key

The 24-byte cryptographic key, K, in byte offsets 0-23 of the parameter block is encrypted using the DEA wrapping key. (See the section “Protection of Cryptographic Keys” on page 7-431 for the encryption algorithm.) The result is placed back in byte offsets 0-23 of the parameter block. The contents of the DEA wrapping-key verification-pattern register are placed in byte offsets 24-47 of the parameter block.

PCKMO-Encrypt-AES-128-Key (Function Code 18)

The locations of the operands and addresses used by the instruction are as shown in Figure 10-39 on page 10-76.

The parameter block used for the function has the following format:

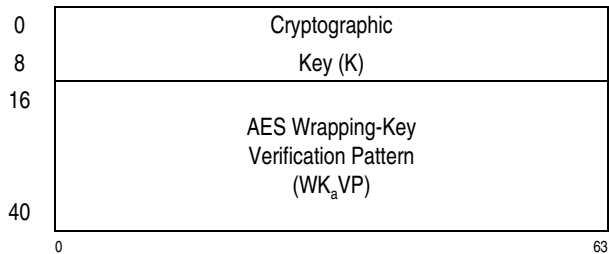

Figure 10-44. Parameter Block for PCKMO-Encrypt-AES-128-Key

The 16-byte cryptographic key, K, in byte offsets 0-15 of the parameter block is encrypted using the AES wrapping key. (See the section “Protection of Cryptographic Keys” on page 7-431 for the encryption algorithm.) The result is placed back in byte offsets 0-15 of the parameter block. The contents of the AES wrapping-key verification-pattern register are placed in byte offsets 16-47 of the parameter block.

PCKMO-Encrypt-AES-192-Key (Function Code 19)

The locations of the operands and addresses used by the instruction are as shown in Figure 10-39 on page 10-76.

The parameter block used for the function has the following format:

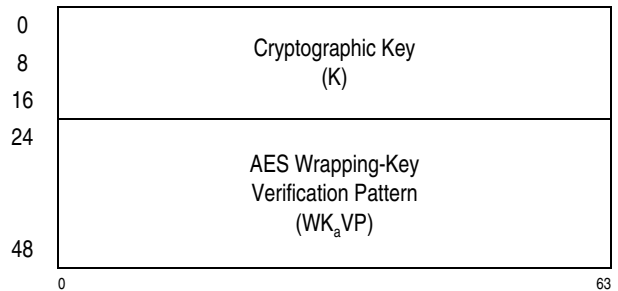

Figure 10-45. Parameter Block for PCKMO-Encrypt-AES-192-Key

The 24-byte cryptographic key, K, in byte offsets 0-23 of the parameter block is encrypted using the AES wrapping key. (See the section “Protection of Cryptographic Keys” on page 7-431 for the encryption algorithm.) The result is placed back in byte offsets 0-23 of the parameter block. The contents of the AES wrapping-key verification-pattern register are placed in byte offsets 24-55 of the parameter block.

PCKMO-Encrypt-AES-256-Key (Function Code 20)

The locations of the operands and addresses used by the instruction are as shown in Figure 10-39 on page 10-76.

The parameter block used for the function has the following format:

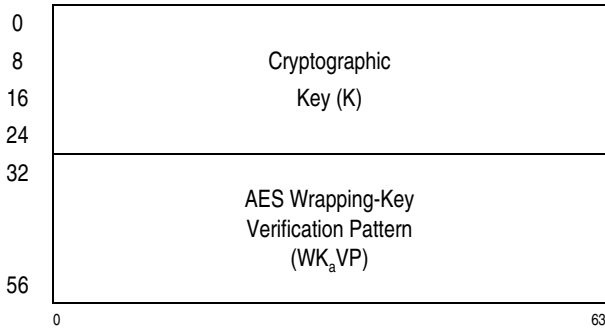

Figure 10-46. Parameter Block for PCKMO-Encrypt-AES-256-Key

The 32-byte cryptographic key, K, in byte offsets 0-31 of the parameter block is encrypted using the AES wrapping key. (See the section “Protection of Cryptographic Keys” on page 7-431 for the encryption algorithm.) The result is placed back in byte offsets 0-31 of the parameter block. The contents of the AES wrapping-key verification-pattern register are placed in byte offsets 32-63 of the parameter block.

PCKMO-Encrypt-ECC-P256-Key (Function Code 32)

This function is available only when message-security-assist extension 9 is installed. The locations of the operands and addresses used by the instruction are as shown in Figure 10-39 on page 10-76.

The parameter block used for the function has the following format:

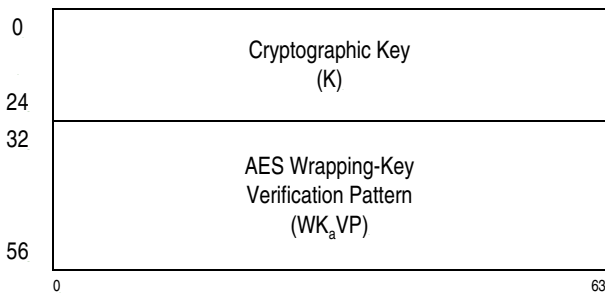

Figure 10-47. Parameter Block for PCKMO-Encrypt-ECC-P256-Key

The 32-byte cryptographic key, K, in byte offsets 0-31 of the parameter block is encrypted using the AES wrapping key. (See the section “Protection of Cryptographic Keys” on page 7-431 for the encryption algorithm.) The result is placed back in byte offsets 0-31 of the parameter block. The contents of the AES wrapping-key verification-pattern register are placed in byte offsets 32-63 of the parameter block.

PCKMO-Encrypt-ECC-P384-Key (Function Code 33)

This function is available only when message-security-assist extension 9 is installed. The locations of the operands and addresses used by the instruction are as shown in Figure 10-39 on page 10-76.

The parameter block used for the function has the following format:

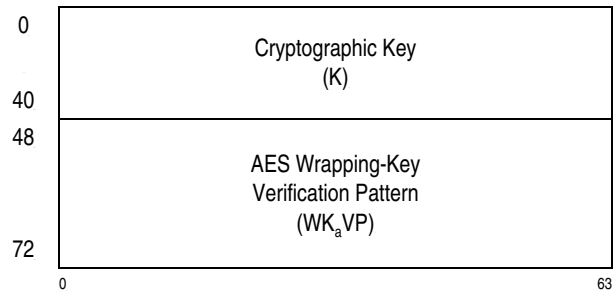

Figure 10-48. Parameter Block for PCKMO-Encrypt-ECC-P384-Key

The 48-byte cryptographic key, K, in byte offsets 0-47 of the parameter block is encrypted using the AES wrapping key. (See the section “Protection of Cryptographic Keys” on page 7-431 for the encryption algorithm.) The result is placed back in byte offsets 0-47 of the parameter block. The contents of the AES wrapping-key verification-pattern register are placed in byte offsets 48-79 of the parameter block.

PCKMO-Encrypt-ECC-P521-Key (Function Code 34)

This function is available only when message-security-assist extension 9 is installed. The locations of the operands and addresses used by the instruction are as shown in Figure 10-39 on page 10-76.

The parameter block used for the function has the following format:

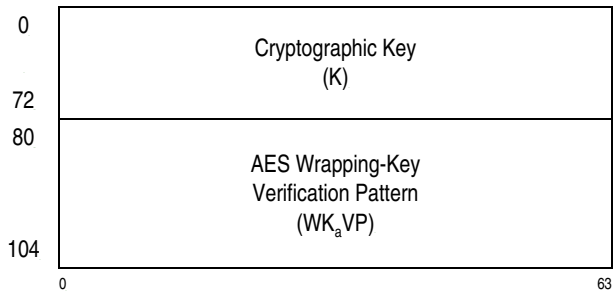

Figure 10-49. Parameter Block for PCKMO-Encrypt-ECC-P521-Key

The 521 bit cryptographic key, K, is right aligned in byte offsets 14-79 of the parameter block with padding in bytes 0 to 13 and part of byte 14. The programmer must pad with zeros in byte 14 or unpredictable results are possible when using this key. Bytes 0 to 79 are encrypted using the AES wrapping key. (See the section “Protection of Cryptographic Keys” on page 7-431 for the encryption algorithm.) The result is placed back in byte offsets 0-79 of the parameter block. The contents of the AES wrapping-key verification-pattern register are placed in byte offsets 80-111 of the parameter block.

PCKMO-Encrypt-ECC-Ed25519-Key (Function Code 40)

This function is available only when message-security-assist extension 9 is installed. The locations of the operands and addresses used by the instruction are as shown in Figure 10-39 on page 10-76.

The parameter block used for the function has the following format:

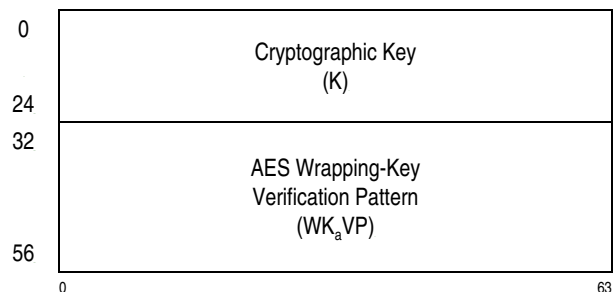

Figure 10-50. Parameter Block for PCKMO-Encrypt-ECC-Ed25519-Key

The 255 bit cryptographic key, K, is right aligned in byte offsets 0-31 of the parameter block and has a 1

bit zero pad. The programmer must use a zero for the padding or unpredictable results are possible when using this key. The whole 32 byte field is encrypted using the AES wrapping key. (See the section “Protection of Cryptographic Keys” on page 7-431 for the encryption algorithm.) The result is placed back in byte offsets 0-31 of the parameter block. The contents of the AES wrapping-key verification-pattern register are placed in byte offsets 32-63 of the parameter block.

PCKMO-Encrypt-ECC-Ed448-Key (Function Code 41)

This function is available only when message-security-assist extension 9 is installed. The locations of the operands and addresses used by the instruction are as shown in Figure 10-39 on page 10-76.

The parameter block used for the function has the following format:

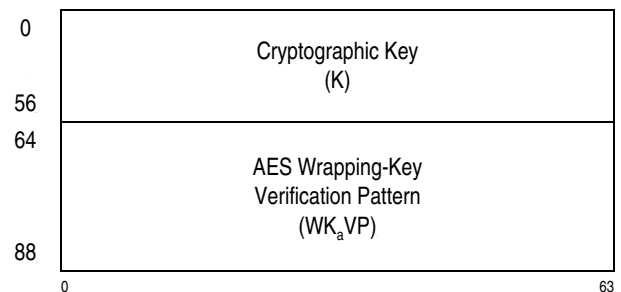

Figure 10-51. Parameter Block for PCKMO-Encrypt-ECC-Ed448-Key

Bytes 0 to 63 of the parameter block are encrypted using the AES wrapping key. (See the section “Protection of Cryptographic Keys” on page 7-431 for the encryption algorithm.) The 56-byte cryptographic key, K, is in byte offsets 8-63 of the parameter block and padding is in bytes 0-7. The result is placed back in byte offsets 0-63 of the parameter block. The contents of the AES wrapping-key verification-pattern register are placed in byte offsets 64-95 of the parameter block.

Special Conditions

A specification exception is recognized and no other action is taken if any of the following occurs:

1. Bit 56 of general register 0 is not zero.
2. Bits 57-63 of general register 0 specify an unassigned or uninstalled function code.

Condition Code: The code remains unchanged.

Program Exceptions:

- Access (fetch, parameter block; store, parameter block)
- Operation (if the message-security-assist extension 3 is not installed)
- Privileged operation
- Specification
- Transaction constraint

Programming Note: Each set of PCKMO-Encrypt-DEA-Key functions, PCKMO-Encrypt-AES-Key functions, and PCKMO-Encrypt-ECC-Key functions can be independently disabled by an external means. When a set is disabled, functions in the set appear as if they were not installed.

PERFORM FRAME MANAGEMENT FUNCTION

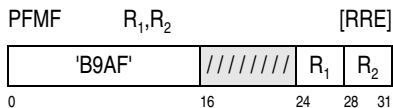

Subject to the controls in the first-operand register, a frame-management function is performed for the storage frame designated by the second-operand address.

The contents of general register R_1 are as follows:

Frame-management function indications: Bit positions 44-47 of general register R_1 contain the frame-management function indications (FMFI), as follows:

Reserved: Bits 44 and 45 are reserved and must contain zeros; otherwise, a specification exception is recognized.

Set-Key Control (SK): Bit 46 controls whether the storage key for each 4 K-byte block in the frame is set from bits 56-62 of general register R_1 . When the SK control is zero, the keys are not set; when the SK control is one, the keys are set.

Clear-Frame Control (CF): Bit 47 controls whether the frame is set to zeros. When the CF control is zero, no clearing operation is performed. When the CF control is one, the frame is cleared to zeros.

Usage Indication (UI): Bit position 48 of general register R_1 contains the usage indication (UI). When bit 48 is zero, it indicates that the program does not anticipate immediate usage of the frame. When bit 48 is one, it indicates that program anticipates usage of the frame in the near future.

Frame-Size Code (FSC): Bits 49-51 of general register R_1 contain the frame-size code (FSC), as follows:

FSC	Meaning
0	4 K-byte frame
1	1 M-byte frame
2	2 G-byte frame
3-7	Reserved

Reference-Bit Update Mask (MR): When the set-key control, bit 46 of general register R_1 , is one, bit 53 of general register R_1 controls whether updates to the reference bit in the storage key may be bypassed, as described below. When the set-key control is zero, bit 53 of general register R_1 is ignored.

Change-Bit Update Mask (MC): When the set-key control, bit 46 of general register R_1 , is one, bit 54 of general register R_1 controls whether updates to the change bit in the storage key may be bypassed. When the set-key control is zero, bit 54 of general register R_1 is ignored.

When the conditional-SSKE facility is installed, the handling of the MR and MC bits is identical to the handling of the corresponding bits of the M_3 field of the SET STORAGE KEY EXTENDED instruction (described on page 10-133), except that general register R_1 is not updated with the contents of the previous key, and the condition code is not changed. When the conditional-SSKE facility is not installed, the MR and MC bits are ignored.

Key: When the set-key control, bit 46 of general register R_1 , is one, bits 56-62 of the register contain the storage key to be set for each 4 K-byte block in the frame, with the access-protection bits, fetch-protection bit, reference bit, and change bit in bit positions 56-59, 60, 61, and 62, respectively. When the set-key control is zero, bits 56-62 of general register R_1 are ignored.

Bit positions 0-31 general register R_1 are ignored. Bit positions 32-45, 55, and 63 of general register R_1 are

reserved and must contain zeros. When the nonquiescing key-setting facility is not installed, bit position 52 of general register R_1 is also reserved and must contain zero. If any reserved bit position in general register R_1 does not contain zeros, a specification exception is recognized. When the nonquiescing key-setting facility is installed, bit position 52 of general register R_1 is ignored.

General register R_2 contains the real or absolute address of the storage frame upon which the frame-management function is to be performed. When the frame-size code designates a 4 K-byte block, the second-operand address is real; when the frame-size code designates a 1 M-byte or 2 G-byte block the second-operand address is absolute. The handling of

the address in general register R_2 depends on the addressing mode. In the 24-bit addressing mode, the contents of bit positions 40-51 of the register, with 12 rightmost zeros appended, are the address, and bits 0-39 and 52-63 in the register are ignored. In the 31-bit addressing mode, the contents of bit positions 33-51 of the register, with 12 rightmost zeros appended, are the address, and bits 0-32 and 52-63 in the register are ignored. In the 64-bit addressing mode, the contents of bit positions 0-51 of the register, with 12 rightmost zeros appended, are the address, and bits 52-63 in the register are ignored.

The contents of the registers just described are shown in Figure 10-52.

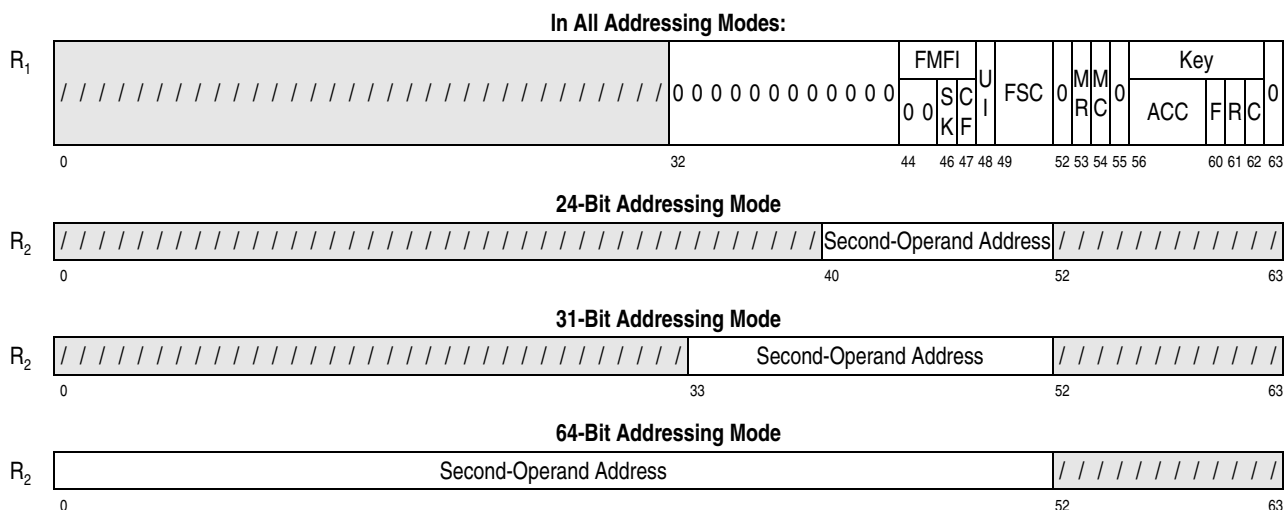

Explanation:

- ACC Access-protection bits of the storage key
- C Change bit of the storage key
- CF Clear-frame control
- F Fetch-protection bit of the storage key
- FMFI Frame-management function indication
- FSC Frame-size code
- MC Change-bit-update mask
- MR Reference-bit-update mask
- R Reference bit of the storage key
- SK Set-key control
- UI Usage indication

Figure 10-52. Register Contents for PERFORM FRAME-MANAGEMENT FUNCTION

When the frame-size code is 0, the specified frame-management functions are performed for the 4 K-byte frame specified by the second operand. General register R_2 is unmodified in this case.

When the frame-size code is 1, the specified frame-management functions are performed for one or more 4 K-byte blocks within the 1 M-byte frame, beginning with the block specified by the second-operand address, and continuing to the right with

each successive block up to the next 1 M-byte boundary.

When the enhanced-DAT facility 2 is installed and the frame-size code is 2, the specified frame-management functions are performed for one or more 4 K-byte blocks within the 2 G-byte frame, beginning with the block specified by the second-operand address, and continuing to the right with each successive block up to the next 2 G-byte boundary. When the enhanced-DAT facility 2 is not installed, a frame-size code of 2 is reserved.

PERFORM FRAME MANAGEMENT FUNCTION is interruptible. When the frame-size code is 1 or 2, an interruption may occur between the processing of successive 4 K-byte blocks. When both the clear-frame and set-key controls are one, an interruption may also occur between the clearing and key-setting operations for an individual 4 K-byte block.

When the frame-size code is 1 or 2, processing is as follows:

- When both the clear-frame and set-key functions are specified, both functions are completed for a 4 K-byte block before proceeding to the next block.
- When an interruption occurs (other than one that follows termination), the second-operand address in general register R_2 is updated by the number of 4 K-byte blocks completely processed, so the instruction, when reexecuted, resumes at the point of interruption.
- When the instruction completes without interruption, the second-operand address in general register R_2 is updated to the next 1 M-byte boundary (FSC=1) or 2 G-byte boundary (FSC=2).
- In any of the above cases, bit 52-63 of general register R_2 are unchanged.

When the CPU is in the 24-bit addressing mode and the frame-size code is 1, bits positions 32-39 of general register R_2 are set to zeros and bits 0-31 of the register are unchanged. When the CPU is in the 24-bit addressing mode and the frame-size code is 2, a specification exception is recognized.

When the CPU is in the 31-bit addressing mode, and the frame-size code is either 1 or 2, bit position 32 of general register R_2 is set to zero and bits 0-31 of general register R_2 are unchanged.

When the clear-frame control is one, references to main storage within the second operand may be multiple-access references and are not necessarily performed in a left-to-right direction as observed by other CPUs and by channel programs. The clear operation is not subject to key-controlled protection; however low-address protection applies regardless of whether the frame-size code designates a 4 K-byte, 1 M-byte, or 2 G-byte frame (that is, regardless of whether the second-operand address is real or absolute).

When the set-key control is one, the operation for each 4 K-byte block is similar to that described in "SET STORAGE KEY EXTENDED" on page 10-133, except that when the keys for multiple blocks are set, the condition code and the contents of general register R_1 are unchanged.

A serialization and checkpoint-synchronization function is performed before the operation begins and again after the operation is completed, except that when the seven bits of all storage keys to be set are the same as bits 56-62 of general register R_1 , or when the MR and MC bits allow all the storage keys to remain unchanged, it is unpredictable whether the serialization and checkpoint-synchronization functions are performed after the operation completes. See "SET STORAGE KEY EXTENDED" on page 10-133 for details on the cases where setting of the key may be bypassed.

When the set-key control is one, and the nonquiescing key-setting facility is not installed, a quiescing operation is performed. When the set-key control is one, and the nonquiescing key-setting facility is installed, a quiescing operation is not necessarily performed. See "Storage-Key Accesses" on page 5-120 for a discussion of the effects of quiescing on key-setting instructions, and see "Quiescing" on page 5-133 for details on the quiescing operation.

Provided that there is no other access to the storage by other CPUs or the channel subsystem, the final results of the instruction reflect the specified key value, including the specified R and C values when MR and MC are zero, respectively. Subject to this constraint, it is unpredictable whether the clear-frame or the set-key operation is performed first when both of the respective controls are one. When both the clear-frame and set-key controls are one, and either the MR or MC bit is also one, and the clear operation is performed first, the storage key that is compared with bits 56-62 of general register R_1 in the set-key

operation is the key following the clear operation (that is, both the R and C bits will have been set to one by the clear operation).

Before a quiescing key-setting operation is performed, transactional execution by other CPUs in the configuration is aborted with abort code 255, condition code 2. The aborting of transactional execution affects at least those CPUs accessing the locations (transactionally or nontransactionally) for which storage keys are being set. It is unpredictable whether some or all other CPUs are affected as well.

Special Conditions

A specification exception is recognized and the operation is suppressed for any of the following conditions:

- Bits 32-45, 55, or 63 of general register R₁ are not zero.
- When the nonquiescing key-setting facility is not installed, bit 52 of general register R₁ is not zero.
- The frame-size code specifies a reserved value.
- The CPU is in the 24-bit addressing mode and the frame-size code is 2.

Condition Code: The code remains unchanged.

Program Exceptions:

- Access (store, low-address-protection only, operand 2, when the clear-frame control is one)
- Addressing (operand 2)
- Operation (enhanced-DAT facility not installed)
- Privileged operation
- Specification
- Transaction constraint

Programming Notes:

1. When PFMF is issued with the set-key control set to one, the program must ensure that no other CPU or channel subsystem is simultaneously accessing the storage designated by general register R₂. Otherwise, unpredictable results may be observed by the other CPUs and channel subsystem, including the alteration of the block designated by general register R₂. See the programming note on page 5-122 for more information.

2. Access exceptions may be recognized for the second operand, even when the clear-frame and set-key controls are both zero.

3. When the move-page-and-set-key facility is installed, some models also implement a performance enhancement for simultaneously clearing a frame and setting its storage key. This is likely to be the fastest way to perform this combined operation. Even though these two functions are combined, another CPU may observe the reference and change bits being set to one, before being set to their final value by the key setting operation. The CPU can invoke this mode of operation for PERFORM FRAME MANAGEMENT FUNCTION when all of the following conditions are met:

- The set-key control (SK in R₁ bit 46) and the clear-frame control (CF in R₁ bit 47) are both one.
- The usage indication (UI) is zero. (R₁ bit 48).
- The reference-bit update mask (MR in R₁ bit 53) and the change-bit update mask (MC in R₁ bit 54) are both zero.

PERFORM TIMING FACILITY FUNCTION

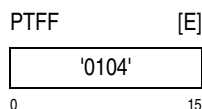

A timing facility function specified by the function code in general register 0 is performed. The condition code is set to indicate the outcome of the function. General register 1 contains the address of a parameter block in storage. PTFF query functions place information in the parameter block; PTFF control functions use information obtained from the parameter block.

As observed by other CPUs and channel programs, references to the parameter block may be multiple-access references, accesses to these storage locations are not necessarily block-concurrent, and the sequence of these accesses or references is undefined.

Bit positions 57-63 of general register 0 contain the function code. Figure 10-54 on page 10-84 shows

the assigned function codes. Bit 56 of general register 0 must be zero; otherwise, a specification exception is recognized. All other bits of general register 0 are ignored.

General register 1 contains the logical address of the leftmost byte of the parameter block in storage. In the 24-bit addressing mode, the contents of bit positions 40-63 of general register 1 constitute the address, and the contents of bit positions 0-39 are ignored. In

the 31-bit addressing mode, the contents of bit positions 33-63 of general register 1 constitute the address, and the contents of bit positions 0-32 are ignored. In the 64-bit addressing mode, the contents of bit positions 0-63 of general register 1 constitute the address.

Figure 10-53 shows the contents of the general registers just described.

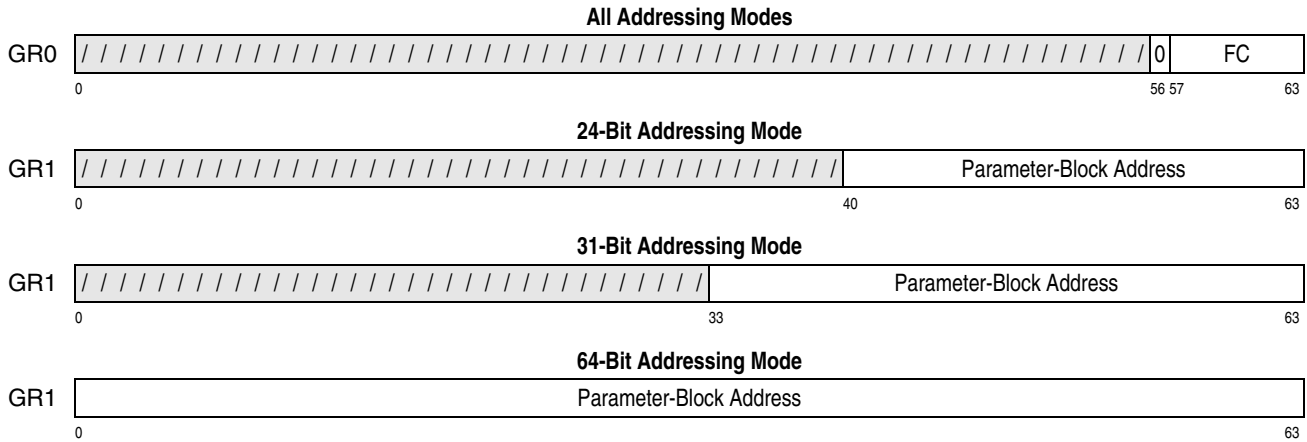

Figure 10-53. General Register Assignment for PERFORM TIMING FACILITY FUNCTION

In the access-register mode, access register 1 specifies the address space containing the parameter block.

The function codes for PERFORM TIMING FACILITY FUNCTION are as follows.

Code		Function	Parm. Block Size (bytes)	Availability
Hex	Dec			
00	0	PTFF-QAF	16	U
01	1	PTFF-QTO	32	U
02	2	PTFF-QSI	56	U
03	3	PTFF-QPT	8	U
04	4	PTFF-QUI	256	U
05	5	PTFF-QTOU	40	U
0A	10	PTFF-QSIE	96	U
0D	13	PTFF-QTOUE	80	U

Figure 10-54. Function Codes for PERFORM TIMING FACILITY FUNCTION

Code		Function	Parm. Block Size (bytes)	Availability
Hex	Dec			
41	65	PTFF-STO	8	P
45	69	PTFF-STOU	8	P
49	73	PTFF-STOE	16	P
4D	77	PTFF-STOUE	16	P
Explanation:				
P	Privileged: Available only in the supervisor state.			
U	Unprivileged: Available in both the problem state and the supervisor state			

Figure 10-54. Function Codes for PERFORM TIMING FACILITY FUNCTION

All other function codes are unassigned.

The PTFF-QAF (Query Available Functions) function provides the means of indicating the availability of the other functions.

Function 0: PTFQ-QAF (Query Available Functions)

The parameter block used for the function has the following format:

Hex	Dec		
00	0	Status Bits 0-31	pb.w1
04	4	Status Bits 32-63	pb.w2
08	8	Status Bits 64-95	pb.w3
0C	12	Status Bits 95-127	pb.w4
		0	31

Figure 10-55. Parameter Block for PTFQ-QAF (Query Available Functions)

A 128-bit field is stored in the parameter block. Bits 0-127 of this field correspond to function codes 0-127, respectively, of the PTFQ instruction. When a bit is one, the corresponding function is installed; otherwise, the function is not installed. The availability of an installed function is indicated by the condition code returned by the attempted execution of the function.

Function 1: PTFQ-QTO (Query TOD Offset)

The parameter block used for the function has the following format:

Hex	Dec		
00	0	Physical Clock (0:31)	pb.Tu
04	4	Physical Clock (32:63)	
08	8	TOD Offset (0:31)	pb.d
0C	12	TOD Offset (32:63)	
10	16	Logical TOD Offset (0:31)	pb.dl
14	20	Logical TOD Offset (32:63)	
18	24	TOD Epoch Difference (0:31)	pb.ed
1C	28	TOD Epoch Difference (32:63)	
		0	31

Figure 10-56. Parameter Block for PTFQ-QTO (Query TOD Offset)

When the STP-hardware-based-TOD-clock-steering facility is not installed, the 64-bit physical-clock value returned (pb.Tu) is the value of the physical clock at the most recent TOD-offset-update event. When the STP-hardware-based-TOD-clock-steering facility is installed, the 64-bit physical-clock value returned is the current physical clock.

The TOD offset returned is a 64-bit signed binary integer (pb.d) that indicates the value of the TOD-offset (d). This value indicates the amount of steering

that has been applied (actually in the case of offset-based TOD-clock steering, or conceptually in the case of hardware-based TOD-clock steering) to the physical clock to form the system TOD clock. The TOD epoch difference is not included in this value.

The 64-bit logical-TOD-offset value returned (pb.dl) indicates the current value of the difference between the TOD clock and the physical clock. The value includes the TOD epoch difference. Depending on the TOD clock resolution capability of the model, a model dependent number of the low order bits of bits 32:63 may be set to zero by the machine.

The 64-bit TOD epoch difference value returned (pb.ed) is the TOD epoch difference (includes both the user-specified epoch difference and the sync-check offset). Depending on the TOD clock resolution capability of the model, a model dependent number of the low order bits of bits 32:63 may be set to zero by the machine.

Function 2: PTFQ-QSI (Query Steering Information)

The parameter block used for the function has the following format:

Hex	Dec		
00	0	Physical Clock (0:31)	pb.Tu
04	4	Physical Clock (32:63)	
08	8	Old Episode Start Time (0:31)	pb.old.s
0C	12	Old Episode Start Time (32:63)	
10	16	Old Episode Base Offset (0:31)	pb.old.b
14	20	Old Episode Base Offset (32:63)	
18	24	Old Episode Fine-Steering Rate	pb.old.f
1C	28	Old Episode Gross-Steering Rate	pb.old.g
20	32	New Episode Start Time (0:31)	pb.new.s
24	36	New Episode Start Time (32:63)	
28	40	New Episode Base Offset (0:31)	pb.new.b
2C	44	New Episode Base Offset (32:63)	
30	48	New Episode Fine-Steering Rate	pb.new.f
34	52	New Episode Gross-Steering Rate	pb.new.g
		0	31

Figure 10-57. Parameter Block for PTFQ-QSI (Query Steering Information)

When the STP-hardware-based-TOD-clock-steering facility is not installed, the 64-bit physical-clock value returned (pb.Tu) is the value of the physical clock at the most recent TOD-offset-update event. When the STP-hardware-based-TOD-clock-steering facility is installed, the 64-bit physical-clock value returned is the current physical clock.

The remaining fields are the values of the old-episode and new-episode registers.

Function 3: PTFE-QPT (Query Physical Clock)

The parameter block used for the function has the following format:

Hex	Dec		
00	0	Physical Clock (0:31)	pb.Tr
04	4	Physical Clock (32:63)	

0 31

Figure 10-58. Parameter Block for PTFE-QPT (Query Physical Clock)

The 64-bit physical-clock value returned (pb.Tr) is the current value of the physical clock. Zeros are stored for the rightmost bit positions that are not provided by the physical clock. When the clock is running, two executions of PTFE-QPT, either on the same or different CPUs, do not necessarily return different values of the clock.

Function 4: PTFE-QUI (Query UTC Information)

The parameter block used for the function has the following format:

Hex	Dec	
00	0	UTC Information Block (UIB)
⋮	⋮	
FC	252	

0 31

Figure 10-59. Parameter Block for PTFE-QUI (Query UTC Information)

The UIB is described in “UTC Information Block (UIB)” on page 4-58.

Function 5: PTFE-QTOU (Query TOD Offset User)

The parameter block used for the function has the following format:

Hex	Dec		
00	0	Physical Clock (0:31)	pb.Tu
04	4	Physical Clock (32:63)	
08	8	TOD Offset (0:31)	pb.d
0C	12	TOD Offset (32:63)	
10	16	Logical TOD Offset (0:31)	pb.dl
14	20	Logical TOD Offset (32:63)	
18	24	TOD Epoch Difference (0:31)	pb.ed
1C	28	TOD Epoch Difference (32:63)	
20	32	TOD User Specified Epoch Difference (0:31)	pb.edu
24	36	TOD User Specified Epoch Difference (32:63)	

0 31

Figure 10-60. Parameter Block for PTFE-QTOU (Query TOD Offset User)

Bytes 0-31 are as defined for the PTFE query-TOD-offset function.

The 64-bit TOD user specified epoch difference value returned is the user-specified portion of the guest epoch difference for the current level of CPU execution. It does not include the sync-check offset portion of the guest epoch difference. When executed at the basic-machine or LPAR hypervisor level, this value is zero. When executed at the guest 1 level, this value is the guest epoch difference excluding the guest 1 sync-check offset portion of the guest 1 epoch difference. When executed at the guest 2 level, this value is the guest epoch difference excluding the guest 2 sync-check offset portion of the guest 2 epoch difference.

Function 10: PTFF-QSIE (Query Steering Information Extended)

The parameter block used for the function has the following format:

Hex	Dec		
00	0	Physical Clock (0:31)	pb.Tu
04	4	Physical Clock (32:63)	
08	8	Physical Clock (64:95)	
0C	12	Physical Clock (96:127)	
10	16	Old Episode Start Time (0:31)	pb.old.s
14	20	Old Episode Start Time (32:63)	
18	24	Old Episode Start Time (64:95)	
1C	28	Old Episode Start Time (96:127)	
20	32	Old Episode Base Offset (0:31)	pb.old.b
24	36	Old Episode Base Offset (32:63)	
28	40	Old Episode Base Offset (64:95)	
2C	44	Old Episode Base Offset (96:127)	
30	48	Old Episode Fine-Steering Rate	pb.old.f
34	52	Old Episode Gross-Steering Rate	pb.old.g
38	56	New Episode Fine-Steering Rate	pb.new.f
3C	60	New Episode Gross-Steering Rate	pb.new.g
40	64	New Episode Start Time (0:31)	pb.new.s
44	68	New Episode Start Time (32:63)	
48	72	New Episode Start Time (64:95)	
4C	76	New Episode Start Time (96:127)	
50	80	New Episode Base Offset (0:31)	pb.new.b
54	84	New Episode Base Offset (32:63)	
58	88	New Episode Base Offset (64:95)	
5C	92	New Episode Base Offset (96:127)	

Figure 10-61. Parameter Block for PTFF-QSIE (Query Steering Information Extended)

The PTFF-QSIE function is analogous to the PTFF-QSI function, except that the physical-clock, old-episode-start-time, old-episode-base-offset, new-episode-start-time, and new-episode-base-offset fields each contain 128 bits, rather than 64 bits.

The physical-clock, old-episode-start-time, and new-episode-start-time fields each contain a 72-bit unsigned binary integer in the rightmost bits and zeros in the leftmost 56 bits. The old-episode-base-offset and new-episode-base-offset fields each contain a 72-bit signed binary integer in the rightmost bits, and the sign bit in bit 56 is extended to the left 56 bits to form a 128-bit signed binary integer.

Programming Note: The PTFF-QSIE function is available when the multiple-epoch facility is installed in the configuration.

Function 13: PTFF-QTOUE (Query TOD Offset User Extended)

The parameter block used for the function has the following format:

Hex	Dec		
00	0	Physical Clock (0:31)	pb.Tu
04	4	Physical Clock (32:63)	
08	8	Physical Clock (64:96)	
0C	12	Physical Clock (96:127)	
10	16	TOD Offset (0:31)	pb.d
14	20	TOD Offset (32:63)	
18	24	TOD Offset (64:95)	
1C	28	TOD Offset (96:127)	
20	32	Logical TOD Offset (0:31)	pb.dl
24	36	Logical TOD Offset (32:63)	
28	40	Logical TOD Offset (64:95)	
2C	44	Logical TOD Offset (96:127)	
30	48	TOD Epoch Difference (0:31)	pb.ed
34	52	TOD Epoch Difference (32:63)	
38	56	TOD Epoch Difference (64:95)	
3C	60	TOD Epoch Difference (96:127)	
40	64	TOD User Specified Epoch Difference (0:31)	pb.edu
44	68	TOD User Specified Epoch Difference (32:63)	
48	72	TOD User Specified Epoch Difference (64:95)	
4C	76	TOD User Specified Epoch Difference (96:127)	

Figure 10-62. Parameter Block for PTFF-QTOUE (Query TOD Offset User Extended)

The PTFF-QTOUE function is analogous to the PTFF-QTOU function, except each field is 128 bits, rather than 64 bits.

The physical-clock field contains a 72-bit unsigned binary integer in the rightmost bits, and bits 0-55 are stored as zeros. The TOD-offset, logical-TOD-offset, TOD-epoch-difference, and TOD-user-specified-epoch-difference fields each contain a 72-bit signed binary integer in the rightmost bits. The sign bit in bit 56 is extended to the left 56 bits to form a 128-bit signed binary integer.

Programming Note: The PTFF-QTOUE function is available when the multiple-epoch facility is installed in the configuration.

Function 65: PTFE-STO (Set TOD Offset)

The parameter block used for the function has the following format:

Hex	Dec		
00	0	New TOD Epoch Difference (0:31)	pb.d
04	4	New TOD Epoch Difference (32:63)	
		0	31

Figure 10-63. Parameter Block for PTFE-STO (Set TOD Offset)

The function specifies a value that is to replace the TOD epoch difference; no new episode is scheduled and the change takes effect immediately. The function operates only on the TOD epoch difference (D), and the change takes place immediately. The function operates on the combined TOD-epoch difference ($D = SCO + Du$) and does not modify the sync-check offset. If the sync-check offset is nonzero, a subsequent sync-check-offset correction will modify the TOD epoch difference to reflect the amount of the correction. Depending on the TOD clock resolution capability of the model, a model dependent number of the contiguous rightmost bits of bits 32-63 may be ignored by the machine and treated as if they were zeros.

Programming Note: When the multiple-epoch facility is installed, the PTFE-STO function is deprecated, and the PTFE-STOE function should be used.

PTFE-STO provides no means by which an epoch index can be set. When the multiple-epoch facility is installed, the use of PTFE-STO may result in inconsistent values stored by SET CLOCK EXTENDED if the epoch index was previously set to a nonzero value.

At some future date, the PTFE-STO function may be removed from the architecture.

Function 69: PTFE-STOU (Set TOD Offset User)

The parameter block used for the function has the following format:

Hex	Dec		
00	0	New TOD User Specified Epoch Difference (0:31)	pb.du
04	4	New TOD User Specified Epoch Difference(32:63)	
		0	31

Figure 10-64. Parameter Block for PTFE-STOU (Set TOD Offset User)

The function specifies a value that is to replace the user-specified portion of the TOD epoch difference; no new episode is scheduled and the change takes effect immediately. Depending on the TOD clock resolution capability of the model, a model dependent number of the low order bits of bits 32:63 may be ignored by the machine and treated as if they were zeros.

When the multiple-epoch facility is installed, the PTFE-STOU function is deprecated, and the PTFE-STOUE function should be used.

Programming Note: At some future date, the PTFE-STOU function may be removed from the architecture.

Function 73: PTFE-STOE (Set TOD Offset Extended)

The parameter block used for the function has the following format:

Hex	Dec		
00	0	New TOD Epoch Difference (0:31)	pb.ed
04	4	New TOD Epoch Difference (32:63)	
08	8	New TOD Epoch Difference (64:95)	
0C	12	New TOD Epoch Difference (96:127)	
		0	31

Figure 10-65. Parameter Block for PTFE-STOE (Set TOD Offset Extended)

The PTFE-STOE function is analogous to the PTFE-STO function, except that the new-TOD-epoch-difference field is 128 bits for PTFE-STOE.

The new-TOD-epoch-difference field contains a 72-bit signed binary in the rightmost bits. Bits 0-56 of the field should contain either all zeros or all ones corre-

sponding to the sign of the new TOD epoch difference in bit 56, thus forming a 128-bit signed binary integer in the field. If a mixture of zeros and ones appear in bits 0-56, the results are unpredictable.

The function specifies a value that is to replace the TOD epoch difference; no new episode is scheduled and the change takes effect immediately. The function operates only on the TOD epoch difference (D); no new episode is scheduled, and the change takes place immediately. The function operates on the combined TOD-epoch difference ($D = SCO + Du$) and does not modify the sync-check offset. If the sync-check offset is nonzero, a subsequent sync-check-offset correction will modify the TOD epoch difference to reflect the amount of the correction.

Bit 127 of the new-TOD-epoch-difference field corresponds to a clock unit. Depending on the TOD-clock-resolution capability of the model, a model dependent number of the contiguous rightmost bits of bits 96-127 may be ignored by the machine and treated as if they were zeros.

Programming Note: The PTF-TOE function is available when the multiple-epoch facility is installed in the configuration.

Function 77: PTF-TOUE (Set TOD Offset User Extended)

The parameter block used for the function has the following format:

Hex	Dec		
00	0	New User-Specified TOD Epoch Diff. (0:31)	pb.ed
04	4	New User-Specified TOD Epoch Diff. (32:63)	
08	8	New User-Specified TOD Epoch Diff. (64:95)	
0C	12	New User-Specified TOD Epoch Diff. (96:127)	
		0	31

Figure 10-66. Parameter Block for PTF-TOUE (Set TOD Offset User Extended)

The PTF-TOUE function is analogous to the PTF-TOU function, except that the new-TOD-epoch-difference field is 128 bits for PTF-TOUE.

The new-user-specified-TOD-epoch-difference field contains a 72-bit signed binary in the rightmost bits. Bits 0-56 of the field should contain either all zeros or all ones corresponding to the sign of the new user-specified TOD epoch difference in bit 56, thus form-

ing a 128-bit signed binary integer in the field. If a mixture of zeros and ones appear in bits 0-56, the results are unpredictable.

The function specifies a value that is to replace the user-specified portion of the TOD epoch difference; no new episode is scheduled and the change takes effect immediately.

Bit 127 of the new-user-specified TOD-epoch-difference field corresponds to a clock unit. Depending on the TOD clock resolution capability of the model, a model dependent number of the contiguous rightmost bits of bits 96-127 may be ignored by the machine and treated as if they were zeros.

Programming Note: The PTF-TOUE function is available when the multiple-epoch facility is installed in the configuration.

Special Conditions

A privileged operation exception is recognized if a PTF control function is issued in the problem state.

A specification exception is recognized and no other action is taken if any of the following occurs:

1. Bit 56 of general register 0 is not zero.
2. Bits 57-63 of general register 0 specify an unassigned or uninstalled function code.

Resulting Condition Code:

0	Requested function performed
1	--
2	--
3	Requested function not available

Program Exceptions:

- Access (fetch, parameter block for control functions; store, parameter block for query functions)
- Operation (if the TOD-clock-steering facility instruction is not installed)
- Privileged operation (attempt to execute a PTF control function in the problem state)
- Specification
- Transaction constraint

The priority of execution for the PTFF instruction is shown in Figure 10-67.

1.-6.	Exceptions with the same priority as the priority of program-interruption conditions for the general case.
7.A	Operation exception.
7.B	Transaction constraint.
8.	Specification exception due to bit 56 of general register 0 being one or bits 57-63 of general register 0 specifying an unassigned or uninstalled function code.
9.	Privileged-operation exception due to attempt to issue PTFF control function in the problem state.
10.	Condition code 3 due to a control function not available in supervisor state.
11.	Access exceptions for an access to the parameter block.
12.	Condition code 0 indicating successful completion.

Figure 10-67. Priority of Execution: *PERFORM TIMING FACILITY FUNCTION (PTFF)*

Programming Notes:

- When the STP-hardware-based-TOD-clock-steering facility is not installed, the physical time (pb.Tu) returned in the parameter block for PTFF-QTO, PTFF-QTOU, and PTFF-QSI is the current value of the physical clock, but with zeros in positions to the right of the bit position incremented concurrently with each TOD-offset-update event. This value is not necessarily unique. The same value may be returned if the PTFF instruction is issued multiple times on the same CPU or issued at approximately the same time on different CPUs.
- When the STP-hardware-based-TOD-clock-steering facility is not installed, the 64-bit value of the physical clock at the most recent TOD-offset-update event (pb.Tu) returned by PTFF-QTO, PTFF-QTOU, and PTFF-QSI may be used by the program to ensure that all events during a short routine occurred with no intervening TOD-offset-update events. This can be accomplished by issuing one of these queries at the beginning of the routine and the other at the end and reiterating if the value of pb.Tu before and the value of pb.Tu after are different.
- When the STP-hardware-based-TOD-clock-steering facility is installed, there are no TOD-offset-update events, and pb.Tu reports the current value of the physical clock. Steering episode changes are reflected in the old and new episode start times.
- For Query Steering Information, pb.Tu can be used to determine whether the machine is operating in the old or new episode. When $pb.new.s \leq pb.Tu$, the machine is operating in the new episode, and none of the information returned by the query has changed since the most recent TOD-offset-update event. When $pb.new.s > pb.Tr$, the machine is operating in the old episode, a new episode has been scheduled and has not yet taken effect. The program should avoid any dependency on the new episode values returned in this case, as it is possible the values may change again before the new episode takes effect.
- Two or more executions of PTFF-QPT within a short period of time, either on the same or different CPUs, do not appear to step backwards, but are not necessarily unique. Thus, it is not always possible to use the values to determine the sequence of execution.
- The Network Time Protocol (NTP) is used extensively in the Internet. A description of NTP may be found in Request for Comments (RFC) 1305. Figure 10-69 on page 10-92 shows the value of the TOD clock and NTP timestamp for 00:00:00 (0 am), UTC time, for several dates: January 1, 1900, January 1, 1972, and for that instant in time just after each of the 27 leap seconds that will have occurred through January, 2017. Each of these leap seconds is inserted in the UTC time scale beginning at 23:59:60 UTC of the day previous to the one listed and ending at 00:00:00 UTC of the day listed. Also included are values for the beginning of each year since the most recent leap second. Figure 10-68 on page 10-91 shows the values of the TOD clock and NTP timestamp for those instants just after the left-most bit of one or the other has changed. For instants in the future, the number of leap sec-

onds must be applied and this value is not yet known.

YYYY	MM	DD	hh mm ss	TOD Clock (Hex)	NTP Timestamp (Hex)
1968	01	20	03:14:08.000000	7A12 0000 0000 0000	8000 0000 0000 0000
1971	05	11	11:56:53.685248	8000 0000 0000 0000	8637 BD05 AF6C 69B5*
2036	02	07	06:28:16.000000	F424 0000 0000 0000+	0000 0000 0000 0000
2042	09	17	23:53:47.370496-	0000 0000 0000 0000	0C6F 7A0B 5ED8 D36B*-

Explanation:

* Value is not exact.
 + Leap seconds must be added to this value.
 - Leap seconds must be subtracted from this value.

Figure 10-68. TOD Clock and NTP Timestamps When a Leftmost Bit Changes

Year	Month	Day	Leap Sec.	TOD Clock (Hex)	NTP Timestamp (Hex)
1900	1	1		0000 0000 0000 0000	0000 0000 0000 0000
1972	1	1		8126 D60E 4600 0000	876C E580 0000 0000
1972	7	1	1	820B A981 1E24 0000	885C D680 0000 0000
1973	1	1	2	82F3 00AE E248 0000	894F 6A80 0000 0000
1974	1	1	3	84BD E971 146C 0000	8B30 9E00 0000 0000
1975	1	1	4	8688 D233 4690 0000	8D11 D180 0000 0000
1976	1	1	5	8853 BAF5 78B4 0000	8EF3 0500 0000 0000
1977	1	1	6	8A1F E595 20D8 0000	90D5 8A00 0000 0000
1978	1	1	7	8BEA CE57 52FC 0000	92B6 BD80 0000 0000
1979	1	1	8	8DB5 B719 8520 0000	9497 F100 0000 0000
1980	1	1	9	8F80 9FDB B744 0000	9679 2480 0000 0000
1981	7	1	10	9230 5C0F CD68 0000	994A 4900 0000 0000
1982	7	1	11	93FB 44D1 FF8C 0000	9B2B 7C80 0000 0000
1983	7	1	12	95C6 2D94 31B0 0000	9D0C B000 0000 0000
1985	7	1	13	995D 40F5 17D4 0000	A0D0 6880 0000 0000
1988	1	1	14	9DDA 69A5 57F8 0000	A585 6380 0000 0000
1990	1	1	15	A171 7D06 3E1C 0000	A949 1C00 0000 0000
1991	1	1	16	A33C 65C8 7040 0000	AB2A 4F80 0000 0000
1992	7	1	17	A5EC 21FC 8664 0000	ADFB 7400 0000 0000
1993	7	1	18	A7B7 0ABE B888 0000	AFDC A780 0000 0000
1994	7	1	19	A981 F380 EAAC 0000	B1BD DB00 0000 0000
1996	1	1	20	AC34 336F ECD0 0000	B581 9380 0000 0000
1997	7	1	21	AEE3 EFA4 02F4 0000	B674 2780 0000 0000
1999	1	1	22	B196 2F93 0518 0000	BA36 8E80 0000 0000
2000	1	1	22	B361 1854 4318 0000	BC17 C200 0000 0000
2001	1	1	22	B52D 42F2 F718 0000	BDF A 4700 0000 0000
2002	1	1	22	B6F8 2BB4 3518 0000	BFDB 7A80 0000 0000
2003	1	1	22	B8C3 1475 7318 0000	C1BC AE00 0000 0000
2004	1	1	22	BA8D FD36 B118 0000	C39D E180 0000 0000
2005	1	1	22	BC5A 27D5 6518 0000	C580 6680 0000 0000
2006	1	1	23	BE25 1097 973C 0000	C761 9A00 0000 0000
2009	1	1	24	C387 0CB9 BB60 0000	CD06 8600 0000 0000
2012	7	1	25	C9CC 9A70 4D84 0000	D39A 1180 0000 0000
2015	7	1	26	CF2D 54B4 FBA8 0000	D93D AC00 0000 0000
2017	1	1	27	D1E0 D681 73CC 0000	DC12 C500 0000 0000

Figure 10-69. TOD Clock and NTP Timestamps

PERFORM TOPOLOGY FUNCTION

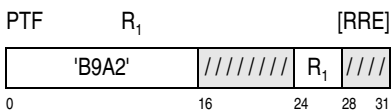

The contents of general register R₁ specify a function code in bit positions 56-63, as illustrated in Figure 10-70.

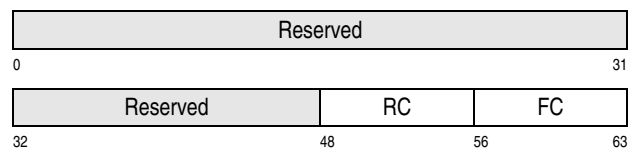

Figure 10-70. General-Register R₁ Format

The defined function codes are as follows:

FC Meaning

0	Request horizontal polarization.
1	Request vertical polarization.
2	Check topology-change status.

Undefined function codes in the range 0-255 are reserved for future extensions.

Upon completion, if condition code 2 is set, a reason code is stored in bit positions 48-55 of general register R₁.

Bits 16-23 and 28-31 of the instruction are ignored.

Operation of Function Codes 0 and 1

When no exceptional conditions are detected, a process is initiated to place all CPUs in the configuration into the polarization specified by the function code, and condition code 0 is set. Completion of the process is asynchronous with respect to execution of the instruction and may or may not be completed when execution of the instruction completes.

Execution completes with condition code 2, and the reason code is set, for any of the following reasons:

RC Reason

0	No reason specified.
1	The configuration is already polarized as specified by the function code.
2	A topology change is already in process

Operation of Function Code 2:

The topology-change-report-pending condition is checked. When a topology-change-report is not pending, condition code 0 is set. When a topology-change report is pending, condition code 1 is set.

A topology change is any alteration such that the contents of a SYSIB 15.1.2 would be different from the contents of the SYSIB 15.1.2 prior to the topology change.

A topology-change-report-pending condition is created when a topology-change process completes. A topology-change-report-pending condition is cleared for the configuration when any of the following is performed:

- Execution of PERFORM TOPOLOGY FUNCTION specifies function-code 2 that completes with condition code 1.
- Subsystem reset is performed.

Special Conditions

A specification exception is recognized for either of the following conditions:

- Bit positions 0-55 of general register R₁ are not zeros.
- An undefined function code is specified.

Resulting Condition Code: When the function code is 0 or 1, the condition code is set as follows:

0	Topology-change initiated
1	--
2	Request rejected
3	--

When the function code is 2, the condition code is set as follows:

0	Topology-change-report not pending
1	Topology-change report pending
2	--
3	--

Program Exceptions:

- Operation (configuration-topology facility is not installed)
- Privileged operation
- Specification
- Transaction constraint

Programming Note: Further information on configuration topology may be found in “SYSIB 15.1.2 - 15.1.6 (Configuration Topology)” on page 10-159.

PROGRAM CALL

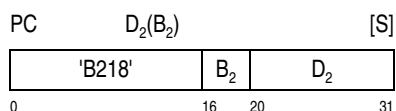

A program-call number specified by the second-operand address is used in a two-level or three-level lookup to locate an entry-table entry (ETE). The pro-

gram is authorized to use the ETE when the AND of the PSW-key mask in control register 3 and the authorization key mask in the ETE is nonzero or when the CPU is in the supervisor state.

When the PC-type bit, bit 128 of the ETE, is zero, an operation called basic PROGRAM CALL is performed. When the PC-type bit is one, an operation called stacking PROGRAM CALL is performed.

Basic PROGRAM CALL, in the 24-bit or 31-bit addressing mode, loads the basic-addressing-mode bit, bits 33-62 of the updated instruction address, and the problem-state bit from the PSW into bit positions 32-63 of general register 14, and it leaves bits 0-31 of this register unchanged. In the 64-bit addressing mode, bits 0-62 of the updated instruction address and the problem-state bit are placed in bit positions 0-63 of general register 14. In any addressing mode, the PSW-key mask and PASN are placed in bit positions 32-63 of general register 3, and bits 0-31 of this register remain unchanged.

Stacking PROGRAM CALL places the entire PSW contents, except with an unpredictable PER mask, and also the PSW-key mask, PASN, SASN, and EAX in a linkage-stack program-call state entry that it forms. A called-space identification, an indication of whether the resulting addressing mode is the 64-bit mode, the numeric part of the program-call number, and the contents of general registers 0-15 and access registers 0-15 also are placed in the state entry. If the ASN-and-LX-reuse facility is installed and enabled, the PASTEIN and SASTEIN also are placed in the state entry.

For basic PROGRAM CALL, the extended-addressing-mode bit, bit 31 of the PSW, must have the same value as the entry-extended-addressing-mode bit, bit 129 of the ETE; otherwise, a special-operation exception is recognized. Basic PROGRAM CALL does not change bit 31 of the PSW and, therefore, does not switch between a basic addressing mode (the 24-bit or 31-bit mode) and the extended addressing mode (the 64-bit mode). In the 24-bit or 31-bit addressing mode, basic PROGRAM CALL sets the basic-addressing-mode bit, bit 32 of the PSW, with the value of the entry-basic-addressing-mode bit, bit 32 of the ETE, and, thus, it may switch between the 24-bit and 31-bit addressing modes. In the 64-bit addressing mode, bit 32 of the PSW remains unchanged.

Stacking PROGRAM CALL, when bit 129 of the ETE is zero, sets bit 31 of the PSW to zero and sets bit 32 of the PSW with the value of bit 32 of the ETE. When bit 129 of the ETE is one, stacking PROGRAM CALL sets bits 31 and 32 of the PSW to one. Thus, stacking PROGRAM CALL can set the 24-bit, 31-bit, or 64-bit addressing mode.

When the resulting addressing mode is the 24-bit or 31-bit mode, both basic and stacking PROGRAM CALL place bits 33-62 of the entry instruction address in the ETE, which are bits 33-62 of the ETE, with 33 leftmost and one rightmost zeros appended, in bit positions 64-127 of the PSW as the new instruction address, and they place the entry-problem-state bit, bit 63 of the ETE, in bit position 15 of the PSW as the new problem-state bit. Bits 32-63 of the entry parameter in the ETE are placed in bit positions 32-63 of general register 4, and bits 0-31 of this register remain unchanged.

When the resulting addressing mode is the 64-bit mode, both basic and stacking PROGRAM CALL place bits 0-62 of the entry instruction address, bits 0-62 of the ETE, with one rightmost zero appended, in bit positions 64-127 of the PSW, and they place bit 63 of the ETE in bit position 15 of the PSW. Bits 0-63 of the entry parameter in the ETE are placed in general register 4.

Basic PROGRAM CALL ORs the entry key mask from the ETE into the PSW-key mask in control register 3. Stacking PROGRAM CALL does the same, or it replaces the PSW-key mask with the entry key mask, as determined by the PSW-key-mask control in the ETE.

Stacking PROGRAM CALL optionally replaces the PSW key in the PSW and the EAX in control register 8 from the ETE, and it sets the address-space-control bits in the PSW, as determined by control bits in the ETE.

The ETE causes a space-switching operation to occur if it contains a nonzero ASN. When the ETE contains a zero ASN, the operation is called PROGRAM CALL to current primary (PC-cp); when the ETE contains a nonzero ASN, the operation is called PROGRAM CALL with space switching (PC-ss). When space switching is specified, the new PASN is loaded into control register 4 from the ETE, and a new primary-ASTE origin (PASTE0) is loaded into control register 5, also from the ETE. From the PASTE, a new primary ASCE (PASCE) and AX are

loaded into control registers 1 and 4, respectively. If ASN-and-LX reuse is enabled, a new primary ASTE instance number (PASTEIN) is loaded into control register 4, also from the PASTE.

In both PC-cp and PC-ss, the SASN and secondary ASCE (SASCE) are set equal to the original PASN and PASCE, respectively, and, if ASN-and-LX reuse is enabled, the secondary ASTE instance number (SASTEIN) in control register 3 is set equal to the original PASTEIN. However, the space-switching stacking PROGRAM CALL operation may instead set the SASN and SASCE equal to the new PASN and PASCE, respectively, and, if ASN-and-LX reuse is enabled, set the SASTEIN equal to the new PASTEIN, as determined by a control bit in the ETE.

In a PC-ss to the base space of the dispatchable unit when the dispatchable unit is subspace active, bits 0-55 and 58-63 of the new PASCE are replaced by the same bits of the ASCE in the ASTE for the subspace in which the dispatchable unit last had control. This occurs before the possible setting of the SASCE equal to the PASCE.

PROGRAM CALL PC-Number Translation

The second-operand address is not used to address data; instead, the rightmost 20 or 32 bits of the address are used as a PC number divided into two fields: a linkage index (LX) and an entry index (EX). The entry index is always the rightmost eight bits of the PC number. When the ASN-and-LX-reuse is not installed or is not enabled by a one value of the ASN-and-LX-reuse control, bit 44 of control register 0, the PC number is 20 bits, and the leftmost 12 bits of the number are the linkage index. In this case, the second-operand address has the following format:

Second-Operand Address when ASN-and-LX Reuse Is Not Enabled

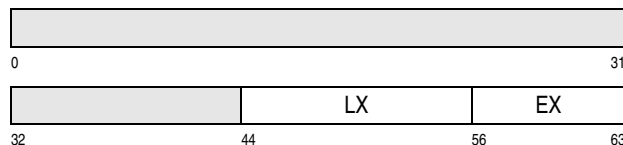

Bit 44 of the effective address has no special meaning and may be zero or one.

When the ASN-and-LX-reuse facility is installed and enabled, referred to simply by saying that ASN-and-LX reuse is enabled, the linkage index is further divided into a linkage first index (LFX) and a linkage

second index (LSX). The linkage second index is always the five bits immediately on the left of the entry index. The size and format of the linkage first index depend on whether the PC number is 20 bits or 32 bits, which in turn depends on whether bit 44 of the second-operand address is zero or one, respectively. In these cases, the second-operand address has the following formats:

Second-Operand Address when ASN-and-LX Reuse Is Enabled and Bit 44 Is Zero

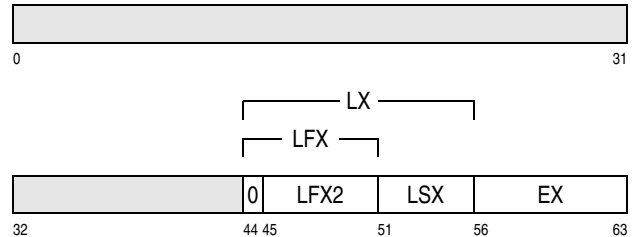

Second-Operand Address when ASN-and-LX Reuse Is Enabled and Bit 44 Is One

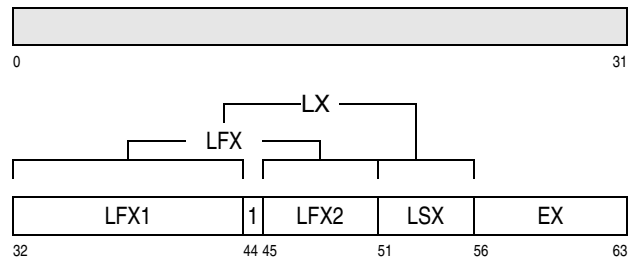

When ASN-and-LX reuse is enabled and bit 44 of the second-operand address is zero, the PC number is 20 bits, and the linkage first index is bits 44-50, or bits 45-50 (LFX2) with a zero appended on the left. Thus, the linkage first index is seven bits of which the leftmost bit is always zero. When bit 44 is one, the PC number is 32 bits, and the linkage first index is bits 45-50 (LFX2) with bits 32-43 (LFX1) appended on the left, or 18 bits, and bit 44 is not a numeric part of the PC number. However, a linkage first table can contain at most 16,384 entries, and, therefore, the leftmost four bits of the linkage first index, bits 32-35 of the second-operand address, must always be zeros; otherwise, an LFX-translation exception is recognized.

Linkage Index (LX): When ASN-and-LX reuse is not enabled, bits 44-55 of the second-operand address are the linkage index and are used to select an entry from the linkage table designated by the linkage-table designation in the primary ASTE.

Linkage First Index (LFX): When ASN-and-LX reuse is enabled and bit 44 of the second-operand address is zero, bits 44-50 of the second-operand address are the linkage first index. When ASN-and-LX reuse is enabled and bit 44 of the second-operand address is one, bits 45-50 with bits 32-43 appended on the left are the linkage first index. In either case, the linkage first index is used to select an entry from the linkage first table designated by the linkage-first-table designation in the primary ASTE.

Linkage Second Index (LSX): When ASN-and-LX reuse is enabled, bits 51-55 of the second-operand address are the linkage second index and are used to select an entry from the linkage second table designated by the linkage-first-table entry.

Entry Index (EX): Bits 56-63 of the second-operand address are the entry index and are used to select an entry from the entry table designated by the linkage-table entry or the linkage-second-table entry.

When the PC number is 20 bits, bits 32-43 of the second-operand address are ignored. Bits 0-31 of the second-operand address are always ignored.

When ASN-and-LX reuse is enabled, the second word of the linkage-second-table entry used contains a linkage-second-table-entry sequence number (LSTESN). When this LSTESN is nonzero, it must be equal to an LSTESN specified in bit positions 0-31 of general register 15; otherwise, an LSTE-sequence exception is recognized. When ASN-and-LX reuse is not enabled (including when it is not installed) or the LSTESN in the linkage-second-table entry is zero, bits 0-31 of general register 15 are ignored.

The 32-byte entry-table entry (ETE) has the following format:

When Resulting Addressing Mode Is the 24-Bit or 31-Bit Mode

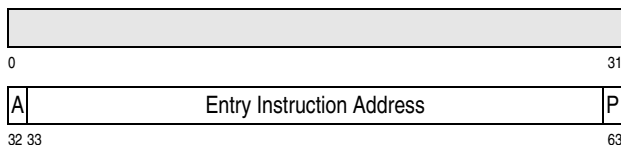

When Resulting Addressing Mode Is the 64-Bit Mode

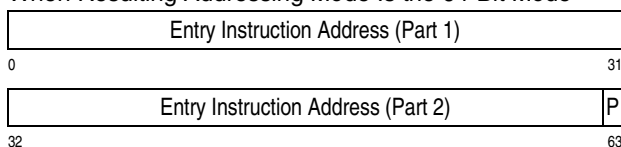

Remaining fields (independent of addressing mode)

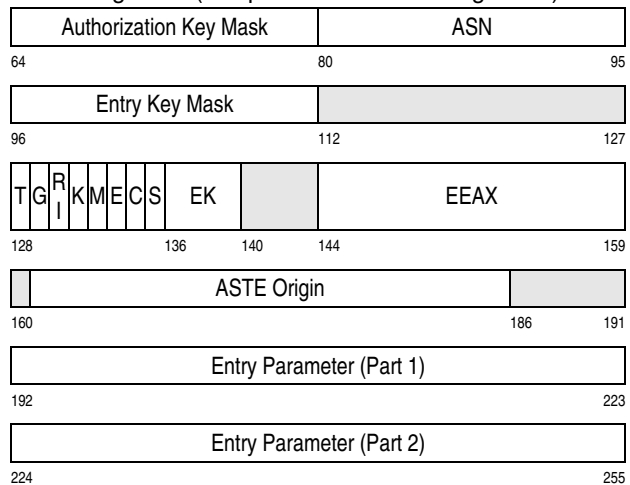

For basic PROGRAM CALL in the 24-bit or 31-bit addressing mode when bit 32 of the ETE (A) is zero (specifying the 24-bit mode), and for stacking PROGRAM CALL when bits 32 (A) and 129 (G) are zeros (specifying the 24-bit mode), bits 33-39 must be zeros; otherwise, a PC-translation-specification exception is recognized.

After the ETE has been fetched, if the current PSW specifies the problem state, the current PSW-key mask in control register 3 is tested against the AKM field in the ETE to determine whether the program is authorized to access this entry. The AKM and PSW-key mask are ANDed, and, if the result is zero, a privileged-operation exception is recognized. The PSW-key mask in control register 3 remains unchanged. When PROGRAM CALL is executed in the supervisor state, the AKM field is ignored.

If the result of the AND of the AKM and the PSW-key mask is not zero, or if the CPU is in the supervisor state, the execution of the instruction continues.

If bit 128 of the ETE (T) is zero, the basic PROGRAM CALL operation is specified. If bit 128 of the ETE is one, the stacking PROGRAM CALL operation is specified.

Basic PROGRAM CALL

The following operations are performed when basic PROGRAM CALL is specified.

Bit 31 of the current PSW (the extended-addressing-mode bit) must equal bit 129 (G) of the ETE; otherwise, a special-operation exception is recognized.

In the 24-bit or 31-bit addressing mode, bits 97-126 of the PSW (bits 33-62 of the updated instruction address) are placed in bit positions 33-62 of general register 14, bit 32 of the PSW (the basic-addressing-mode bit) is placed in bit position 32 of the register, and bit 15 of the PSW (the problem-state bit) is placed in bit position 63 of the register. Bits 0-31 of the register remain unchanged.

In the 64-bit addressing mode, bits 64-126 of the PSW (bits 0-62 of the updated instruction address) are placed in bit positions 0-62 of general register 14, and bit 15 of the PSW (the problem-state bit) is placed in bit position 63 of the register.

In the 24-bit or 31-bit addressing mode, bits 32 and 33-62 of the ETE (A and the EIA), with a zero appended on the right of bits 33-62, are placed in PSW bit positions 32 and 97-127, respectively (the basic-addressing-mode bit and bits 33-63 of the instruction address). In the 64-bit addressing mode, bits 0-62 of the ETE, with a zero appended on the right, are placed in PSW bit positions 64-127 (the instruction address), and PSW bit 32 remains unchanged. In any addressing mode, bit 63 of the ETE (P) is placed in PSW bit position 15 (the problem-state bit).

The PSW-key mask, bits 32-47 of control register 3, is placed in bit positions 32-47 of general register 3, and the current PASN, bits 48-63 of control register 4, is placed in bit positions 48-63 of general register 3. Bits 0-31 of general register 3 remain unchanged.

Bits 96-111 of the ETE (the EKM) are ORed with the PSW-key mask, bits 32-47 of control register 3, and the result replaces the PSW-key mask in control register 3.

In the 24-bit or 31-bit addressing mode, bits 224-255 of the ETE (bits 32-63 of the entry parameter) are loaded into bit positions 32-63 of general register 4, and bits 0-31 of the register remain unchanged. In the 64-bit addressing mode, bits 192-255 of the ETE (the entry parameter), are loaded into bit positions 0-63 of general register 4.

Stacking PROGRAM CALL

The following operations are performed when stacking PROGRAM CALL is specified.

The stacking process is performed to form a linkage-stack program-call state entry and place the following

information in the state entry: current PSW (with an unpredictable PER mask), PSW-key mask, PASN, SASN, EAX, called-space identification, an indication of whether the resulting addressing mode is the 64-bit mode, numeric part of the program-call number, contents of general registers 0-15, and contents of access registers 0-15, and, if ASN-and-LX reuse is enabled, PASTEIN and SASTEIN. This is described in "Stacking Process" on page 5-84. The entry-type code in the state entry is 0001101 binary.

When bit 129 of the ETE (G) is zero, bit 31 of the PSW (the extended-addressing-mode bit) is set to zero, and bit 32 of the ETE (A) is placed in bit position 32 of the PSW (the basic-addressing-mode bit). (The addressing mode is set to the 24-bit mode if bit 32 is zero or to the 31-bit mode if bit 32 is one.) When bit 129 of the ETE is one, bits 31 and 32 of the PSW are set to one. (The 64-bit addressing mode is set.)

When the resulting addressing mode is the 24-bit or 31-bit mode, bits 33-62 of the ETE (the EIA), with 33 leftmost and one rightmost zeros appended, are placed in PSW bit positions 64-127 (the instruction address). When the resulting addressing mode is the 64-bit mode, bits 0-62 of the ETE (the EIA), with one rightmost zero appended, are placed in PSW bit positions 64-127.

Bit 63 of the ETE (P) is placed in PSW bit position 15 (the problem-state bit).

When bit 131 of the ETE (K) is zero, bits 8-11 of the PSW (the PSW key) remain unchanged. When bit 131 of the ETE is one, bits 136-139 of the ETE (the EK) replace the PSW key in the PSW.

When bit 132 of the ETE (M) is zero, bits 96-111 of the ETE (the EKM) are ORed with the PSW-key mask, bits 32-47 of control register 3, and the result replaces the PSW-key mask in control register 3. When bit 132 of the ETE is one, bits 96-111 of the ETE replace the PSW-key mask in control register 3.

When bit 133 of the ETE (E) is zero, the EAX, bits 32-47 of control register 8, remains unchanged. When bit 133 of the ETE is one, bits 144-159 of the ETE (the EEAX) replace the EAX in control register 8.

When bit 134 of the ETE (C) is zero, bits 16 and 17 of the PSW (the address-space-control bits) are set to 00 binary (primary-space mode). When bit 134 of the ETE is one, the address-space-control bits in the PSW are set to 01 binary (access-register mode).

When the resulting addressing mode is the 24-bit or 31-bit mode, bits 224-255 of the ETE (bits 32-63 of the entry parameter) are loaded into bit positions 32-63 of general register 4, and bits 0-31 of this register remain unchanged. When the resulting addressing mode is the 64-bit mode, bits 192-255 of the ETE (the entry parameter), are loaded into bit positions 0-63 of general register 4.

Key-controlled protection does not apply to references to the linkage stack, but low-address and DAT protection do apply.

PROGRAM CALL to Current Primary (PC-cp)

If bits 80-95 of the ETE (the ASN), are zeros, PROGRAM CALL to current primary (PC-cp) is specified, and the execution of the instruction is completed after the operations described in “PROGRAM CALL PC-Number Translation” and either “Basic PROGRAM CALL” or “Stacking PROGRAM CALL” have been performed and the following operations have been performed.

The current PASN, bits 48-63 of control register 4, is placed in bit positions 48-63 of control register 3 to become the current SASN.

The current PASCE in control register 1 is placed in control register 7 to become the current SASCE.

If ASN-and-LX reuse is enabled, the current PASTEIN, bits 0-31 of control register 4, is placed in bit positions 0-31 of control register 3 to become the current SASTEIN.

The basic PC-cp operation is depicted in parts 1-3 of Figure 10-72 on page 10-102. The stacking PC-cp operation is depicted in parts 1, 4, and 5 of the figure.

PROGRAM CALL with Space Switching (PC-ss)

If the ASN in the ETE is nonzero, PROGRAM CALL with space switching (PC-ss) is specified, and the execution of the instruction is completed after the operations described in “PROGRAM CALL PC-Number Translation” and either “Basic PROGRAM CALL”

or “Stacking PROGRAM CALL” have been performed and the following operations have been performed.

Bits 80-95 of the ETE (the ASN) are placed in bit positions 48-63 of control register 4 as the new PASN.

Bits 161-185 of the ETE, with six zeros appended on the right, are used as the real address of the ASTE designated by the new PASN. An ASX-translation exception is recognized if bit 0 of the ASTE is one.

Bits 64-127 of the ASTE (the ASCE) are placed in control register 1 as the new PASCE.

Bits 32-47 of the ASTE (the AX) are placed in bit positions 32-47 of control register 4 as the new authorization index.

If ASN-and-LX reuse is enabled, bits 352-383 of the ASTE (the ASTEIN) are placed in bit positions 0-31 of control register 4 as the new PASTEIN.

Bits 33-57 of the ASTE address are placed in bit positions 33-57 of control register 5 as the new primary-ASTE origin, and zeros are placed in bit positions 32 and 58-63. Bits 0-31 of the register remain unchanged.

In basic PROGRAM CALL, or in stacking PROGRAM CALL when bit 135 of the ETE (S) is zero, the PASN existing before the PASN is replaced from the ETE is placed in bit positions 48-63 of control register 3 to become the current SASN, and the PASCE existing before the PASCE is replaced from the ASTE is placed in control register 7 to become the current SASCE. If ASN-and-LX reuse is enabled, the PASTEIN existing before the PASTEIN is replaced from the ASTE is placed in bit positions 0-31 of control register 3 to become the current SASTEIN. (The SASN and SASCE are set equal to the old PASN and PASCE, respectively, and, if ASN-and-LX reuse is enabled, the SASTEIN is set equal to the old PASTEIN.)

In stacking PROGRAM CALL when bit 135 of the ETE (S) is one, the SASN is replaced by the PASN after the PASN is replaced from the ETE, and the SASCE is replaced by the PASCE after the PASCE is replaced from the ASTE. If ASN-and-LX reuse is enabled, the SASTEIN is replaced by the PASTEIN after the PASTEIN is replaced from the ASTE. (The SASN and SASCE are set equal to the new PASN and PASCE, respectively, and, if ASN-and-LX reuse

is enabled, the SASTEIN is set equal to the new PASTEIN.)

The description in this paragraph applies to use of the subspace-group facility. After the new PASCE has been placed in control register 1 and the new primary-ASTE origin has been placed in control register 5, if (1) the subspace-group-control bit, bit 54, in the PASCE is one, (2) the dispatchable unit is subspace active, and (3) the primary-ASTE origin designates the ASTE for the base space of the dispatchable unit, then bits 0-55 and 58-63 of the PASCE are replaced by the same bits of the ASCE in the ASTE for the subspace in which the dispatchable unit last had control. This replacement occurs before a replacement of the SASCE in control register 7 by the PASCE. Further details are in “Subspace-Replacement Operations” on page 5-70.

The PC-ss operation is depicted in parts 1 and 4-6 of Figure 10-72 on page 10-102.

PROGRAM CALL Serialization

For both the PC-cp and PC-ss operations, a serialization and checkpoint-synchronization function is performed before the operation begins and again after the operation is completed. However, it is unpredictable whether or not a store into a trace-table entry or linkage-stack entry from which a subsequent instruction is fetched will be observed by the CPU that performed the store.

Special Conditions

The basic PROGRAM CALL operation can be performed successfully only when (1) the CPU is in the primary-space mode at the beginning of the operation, (2) the subsystem-linkage control, bit 0 of the linkage-table designation or linkage-first-table designation in the current primary ASN-second-table entry, is one, and (3) the extended-addressing-mode bit, bit 31 of the current PSW, equals the entry-extended-addressing-mode bit, bit 129 of the entry-table entry. Stacking PROGRAM CALL can be performed successfully only when the CPU is in the primary-space mode or access-register mode at the beginning of the operation and the subsystem-linkage control is one. In addition, PC-ss can be performed successfully only when the ASN-translation control, bit 44 of

control register 14, is one. If any of these rules is violated, a special-operation exception is recognized.

When ASN-and-LX reuse is enabled and the LSTESN in the linkage-second-table entry is non-zero, that LSTESN must be equal to the LSTESN specified in bit positions 0-31 of general register 15; otherwise, an LSTE-sequence exception is recognized.

A stack-full or stack-specification exception may be recognized during the stacking process.

When, for PC-ss, the primary space-switch-event-control bit, bit 57 of control register 1, is one either before or after the execution of the instruction, a space-switch-event program interruption occurs after the operation is completed. A space-switch-event program interruption also occurs after the completion of a PC-ss operation if a PER event is reported.

The operation is suppressed on all addressing and protection exceptions.

Condition Code: The code remains unchanged.

Program Exceptions:

- Access (fetch or store, except for key-controlled protection, linkage-stack entry)
- Addressing (linkage-table or linkage-first-table designation in primary ASN-second-table entry; linkage-table entry; linkage-first-table entry; linkage-second-table entry, entry-table entry; ASN-second-table entry, PC-ss only)
- ASX translation (PC-ss only)
- EX translation
- LFX translation
- LSTE sequence
- LSX translation
- LX translation
- PC-translation specification
- Privileged operation (AND of AKM and PSW-key mask is zero in the problem state)
- Space-switch event (PC-ss only)
- Special operation
- Stack full (stacking PC only)
- Stack specification (stacking PC only)
- Subspace replacement (PC-ss only)
- Trace
- Transaction constraint

The priority of recognition of program exceptions for the instruction is shown in Figure 10-71.

1.-6.	Exceptions with the same priority as the priority of program-interruption conditions for the general case.
7.A	Access exceptions for second instruction halfword.
7.B	Special-operation exception due to DAT being off or the CPU being in secondary-space mode or home-space mode.
7.C	Transaction constraint.
8.A	Trace exceptions.
8.B.1	Addressing exception for access to linkage-table designation or linkage-first-table designation in primary ASN-second-table entry.
8.B.2	Special-operation exception due to subsystem-linkage control in linkage-table designation or linkage-first-table designation being zero. Note: The LFX-translation, LSX-translation, and LSTE-sequence exceptions can be recognized only if ASN-and-LX reuse is enabled, and the LX-translation exception cannot be recognized in that case.
8.B.3	LX-translation or LFX-translation exception due to linkage-table or linkage-first-table entry, respectively, being outside table.
8.B.4	Addressing exception for access to linkage-table or linkage-first-table entry.
8.B.5	LX-translation or LFX-translation exception due to I bit (bit 0) in linkage-table or linkage-first-table entry, respectively, being one.
8.B.6	Addressing exception for access to linkage-second-table entry.
8.B.7	LSX-translation exception due to I bit (bit 0) in linkage-second-table entry being one.
8.B.8	LSTE-sequence exception due to LSTE sequence number in linkage-second-table entry being nonzero and not equal to bits 0-31 of general register 15.
8.B.9	EX-translation exception due to entry-table entry being outside table.
8.B.10	Addressing exception for access to entry-table entry.

Figure 10-71. Priority of Execution: PROGRAM CALL (Part 1 of 4)

8.B.11	Special-operation exception due to the CPU being in access-register mode or extended-addressing-mode bit, bit 31 of PSW, not being equal to entry-extended-addressing-mode bit, bit 129 of entry-table entry (basic PC only).
8.B.12	PC-translation-specification exception due to invalid combination (bits 33-39 not zeros when resulting addressing mode is 24 bit) in entry-table entry.
8.B.13	Privileged-operation exception due to zero result from ANDing PSW-key mask and AKM in the problem state.
8.B.14	Special-operation exception due to ASN-translation control, bit 44 of control register 14, being zero (PC-ss only).
8.B.15	Addressing exception for access to ASN-second-table entry (PC-ss only).
8.B.16	ASX-translation exception due to I bit (bit 0) in ASN-second-table entry being one (PC-ss only). Note: Subspace-replacement exceptions, which are not shown in detail in this figure, can occur with any priority after 8.B.16 and before 9.
8.B.17	Access exceptions (fetch) for entry descriptor of the current linkage-stack entry (stacking PC only). Note: Exceptions 8.B.18-8.B.23 can occur only if there is not enough remaining free space in the current linkage-stack section.
8.B.18	Stack-specification exception due to remaining-free-space value in current linkage-stack entry not being a multiple of 8.
8.B.19	Access exceptions (fetch) for second word of the trailer entry of the current section. The entry is presumed to be a trailer entry; its entry-type field is not examined (stacking PC only).
8.B.20	Stack-full exception due to forward-section validity bit in the trailer entry being zero (stacking PC only).
8.B.21	Access exceptions (fetch) for entry descriptor of the header entry of the next section (stacking PC only). This entry is presumed to be a header entry; its entry-type field is not examined.

Figure 10-71. Priority of Execution: PROGRAM CALL (Part 2 of 4)

8.B.22	Stack-specification exception due to not enough remaining free space in the next section (stacking PC only).
8.B.23	Access exceptions (store) for second word of the header entry of the next section. If there is no exception, the header is now called the current entry.
8.B.24	Access exceptions (store) for entry descriptor of the current entry and for the new state entry (stacking PC only).

Figure 10-71. Priority of Execution: PROGRAM CALL
(Part 3 of 4)

9.	Space-switch event (PC-ss only).
----	----------------------------------

Figure 10-71. Priority of Execution: PROGRAM CALL
(Part 4 of 4)

Programming Note: The effective address from which a PC number is derived is subject to the addressing mode in the current PSW. Therefore, bits 0-39 of the effective address in the 24-bit addressing mode, and bits 0-32 in the 31-bit addressing mode, are treated as containing zeros.

Basic PC-cp and PC-ss in 24-Bit or 31-Bit Addressing Mode

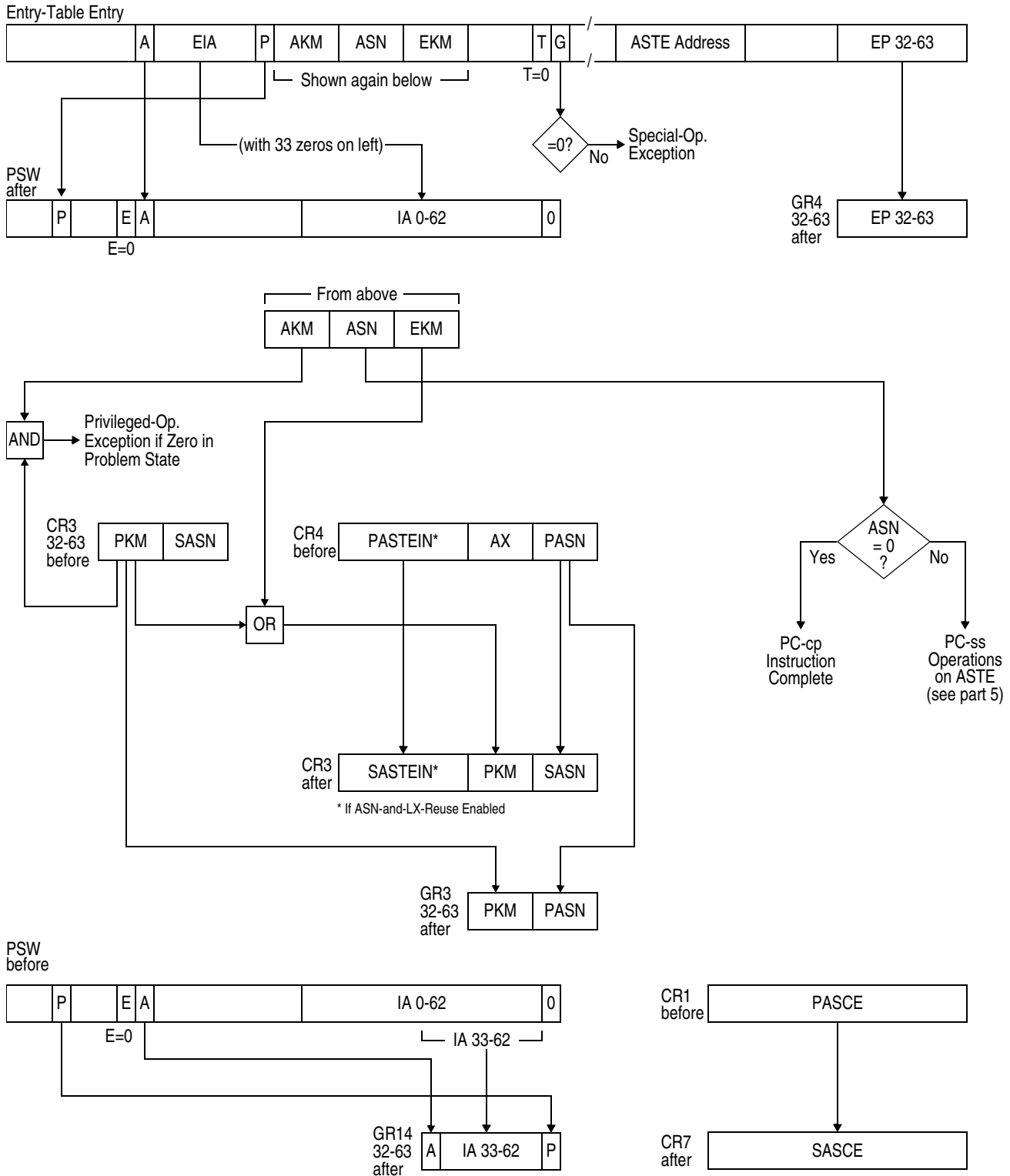

Figure 10-72. Execution of PROGRAM CALL (Part 1 of 5).

Basic PC-cp and PC-ss in 64-Bit Addressing Mode

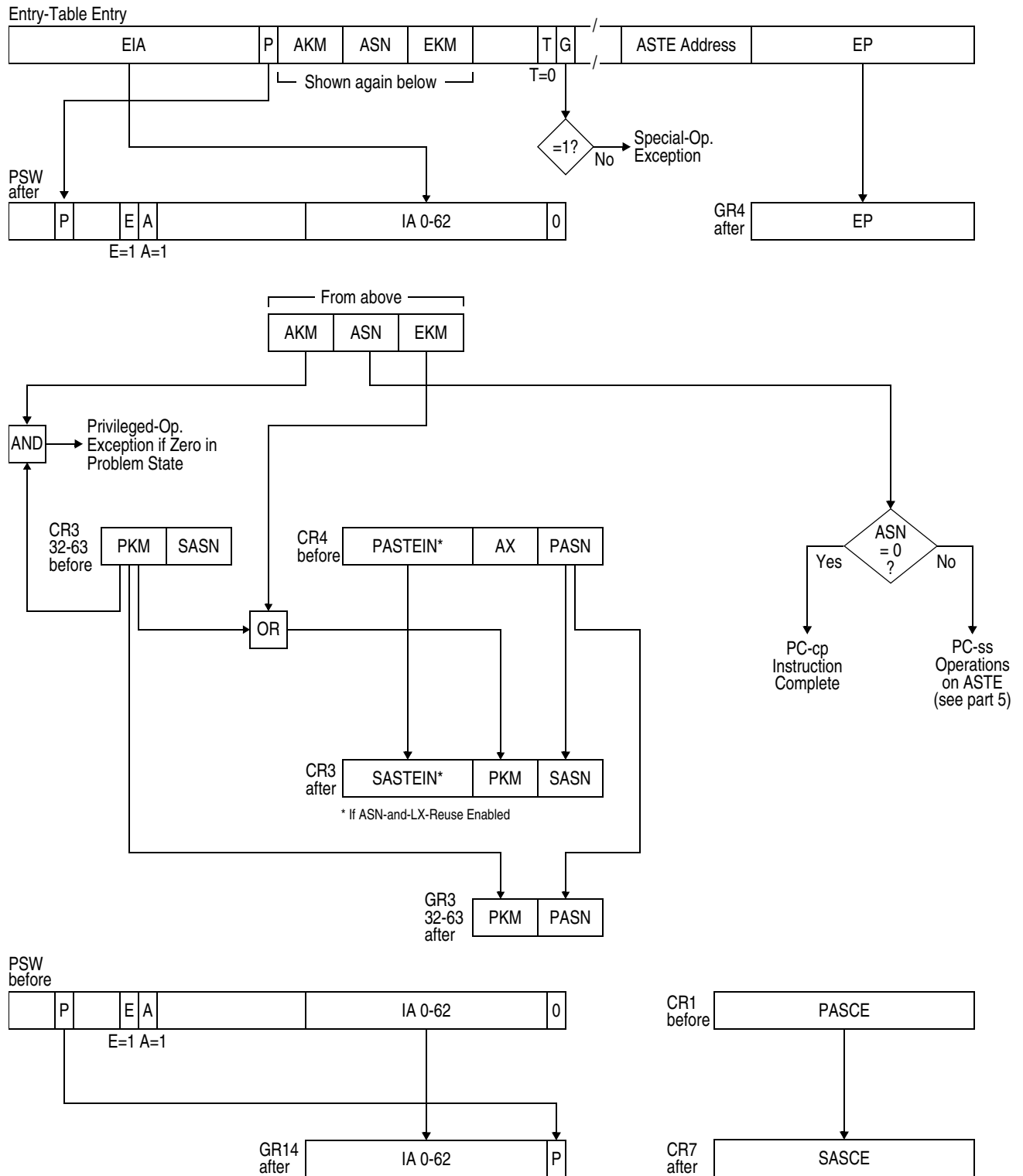

Figure 10-72. Execution of PROGRAM CALL (Part 2 of 5).

Stacking PC-cp and PC-ss from 24-Bit or 31-Bit Addressing Mode to 64-Bit Addressing Mode

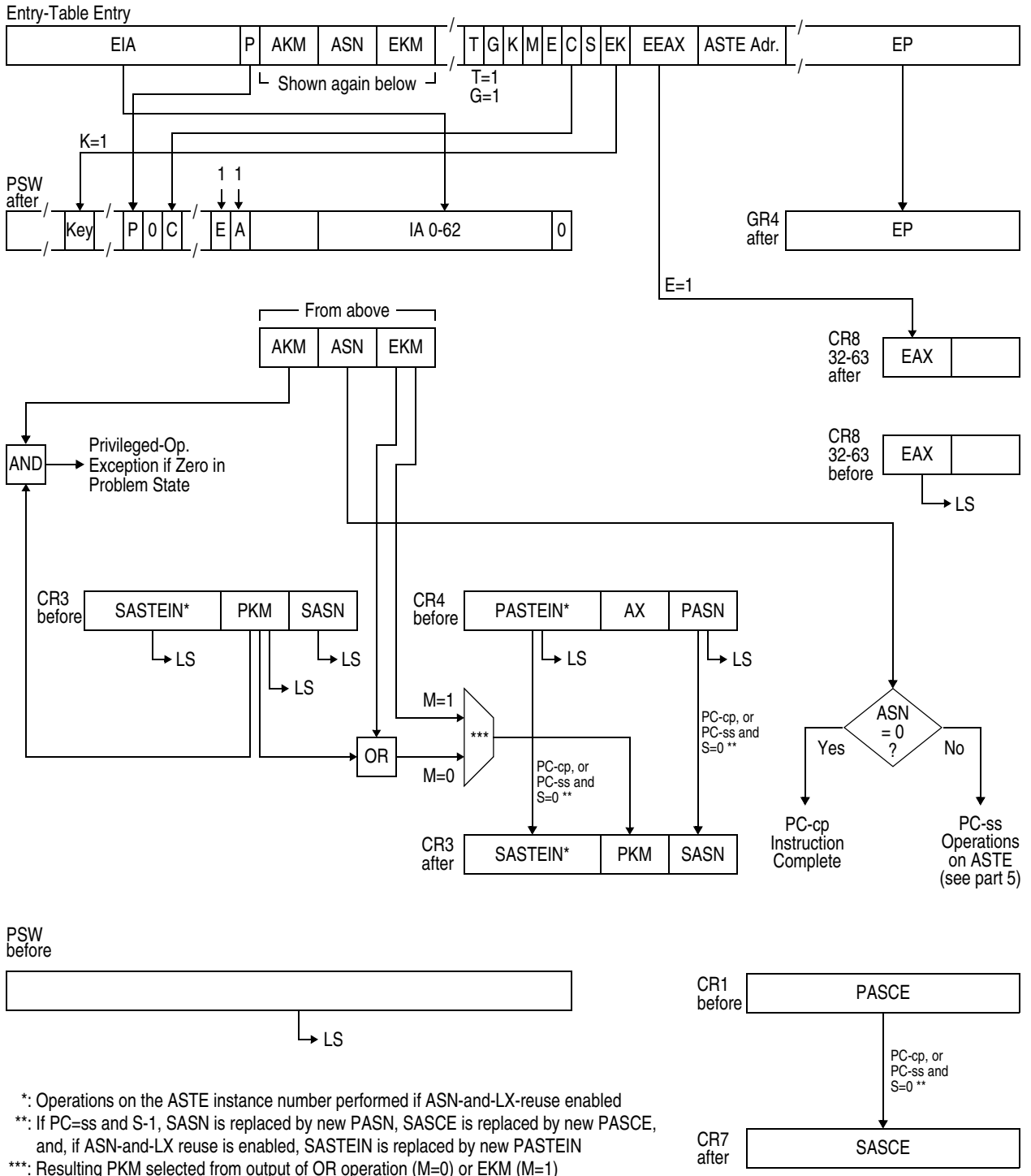

Figure 10-72. Execution of PROGRAM CALL (Part 3 of 5).

Stacking PC-cp and PC-ss from 64-Bit Addressing Mode to 24-Bit or 31-Bit Addressing Mode

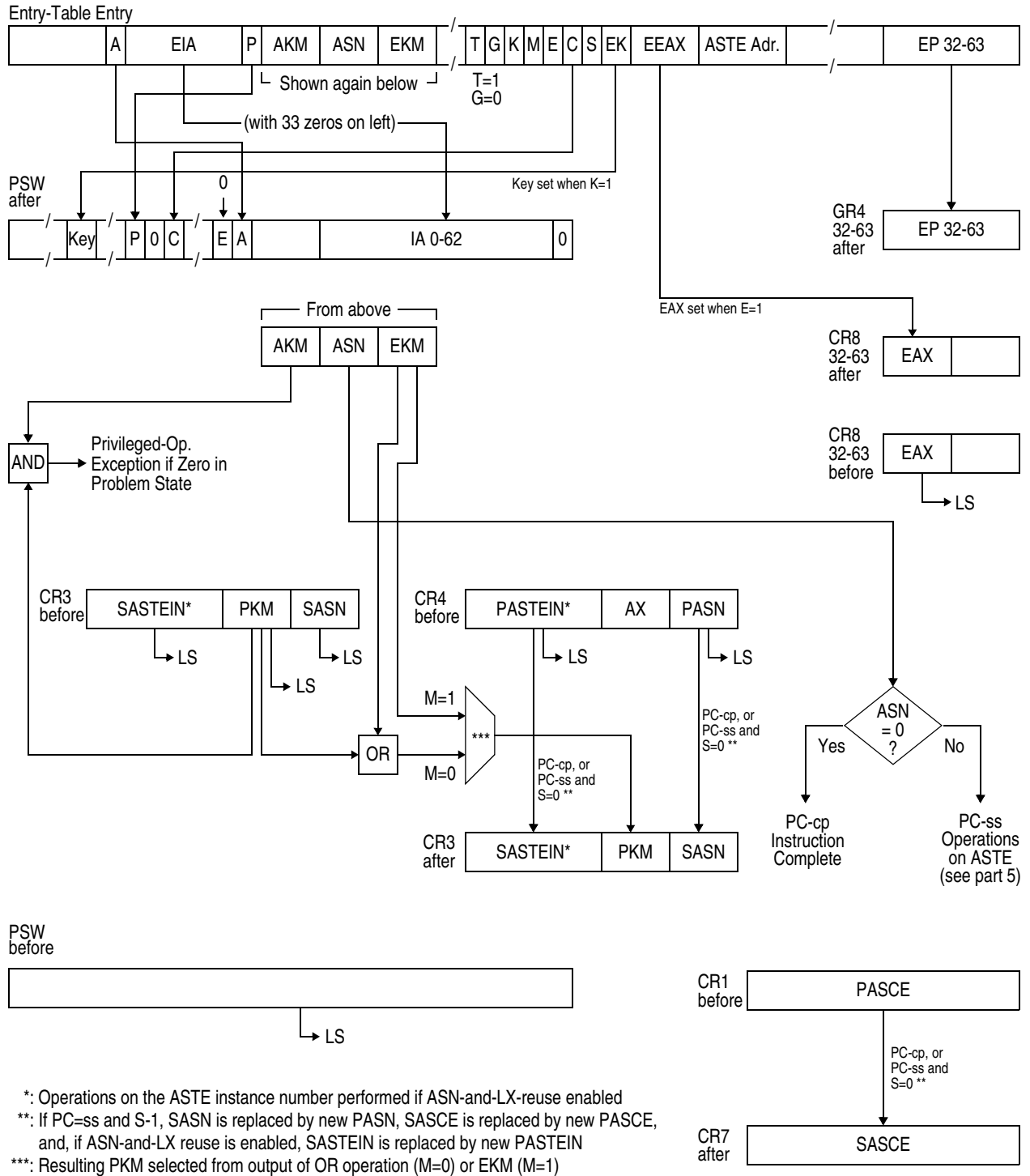
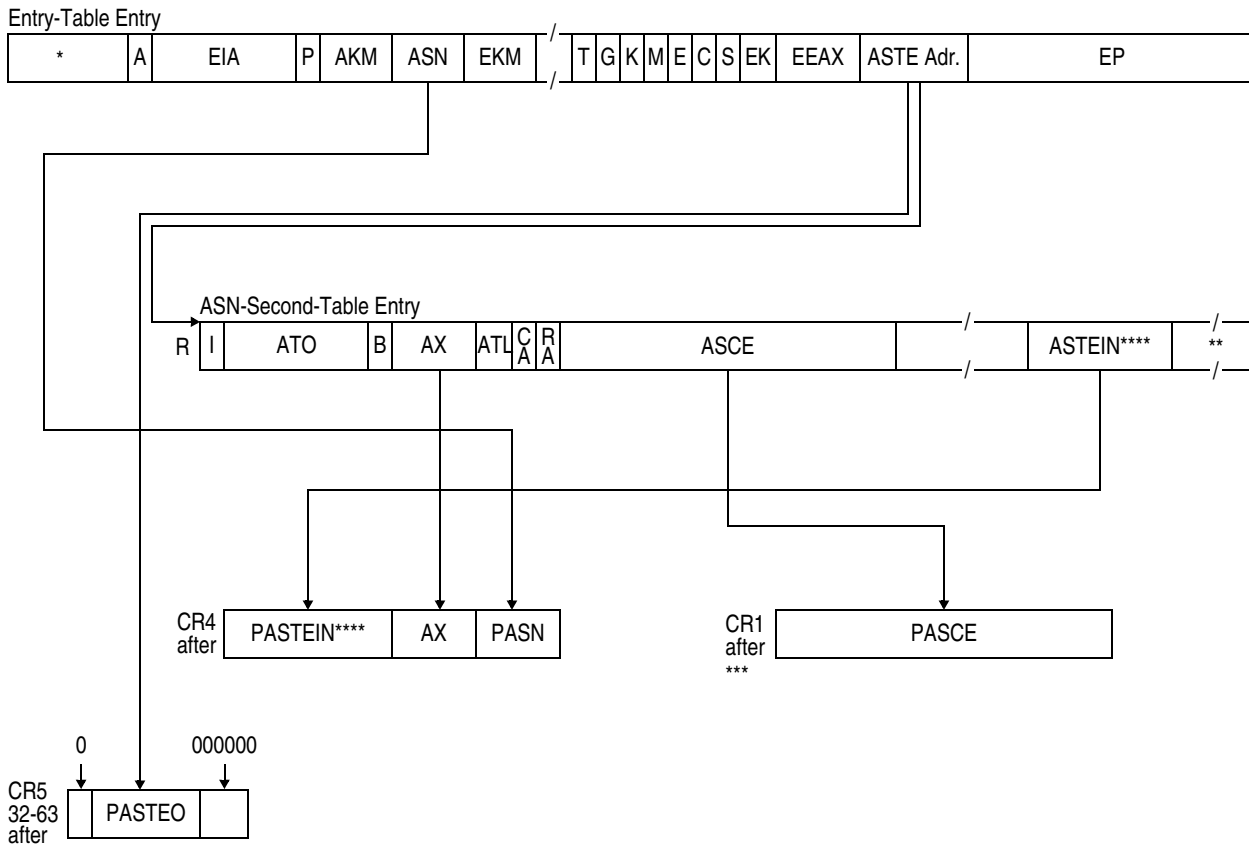

Figure 10-72. Execution of PROGRAM CALL (Part 4 of 5).

Operations on ASN-Second-Table-Entry for PC-ss



- R: Address is real
- *: First word and A of ETE are bits 0-32 of EIA if resulting addressing mode is the 64-bit mode.
- **: ASTE is 64 bytes; selected fields and the last 16 bytes are not shown.
- ***: Bits 0-55 and 58-63 of PASCE may be replaced from a subspace ASCE
- ****: Operations on the ASTE instance number performed if ASN-and-LX-reuse enabled

Figure 10-72. Execution of PROGRAM CALL (Part 5 of 5).

PROGRAM RETURN

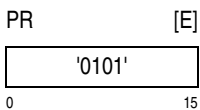

The PSW, except for the PER-mask bit, saved in the last linkage-stack state entry is restored as the current PSW. The PER mask in the current PSW remains unchanged. The contents of general registers 2-14 and access registers 2-14 also are restored from the state entry. When the entry-type code in the entry descriptor of the state entry is 0001101 binary, indicating a program-call state entry, (1) the primary ASN (PASN), secondary ASN (SASN), PSW-key

mask (PKM), and extended authorization index (EAX) in the control registers also are restored from the state entry and (2) if the ASN-and-LX-reuse facility is installed and is enabled by a one value of the ASN-and-LX-reuse control, bit 44 of control register 0, the primary ASTE instance number (PASTEIN) and secondary ASTE instance number (SASTEIN) in the control registers also are restored from the state entry. When the entry-type code is 0001100 binary, indicating a branch state entry, the current PASN, SASN, PKM, EAX, PASTEIN, and SASTEIN remain unchanged.

The last state entry is located, and information in it is restored, as described in “Unstacking Process” on page 5-86. The state entry is logically deleted from

the linkage stack, and the linkage-stack-entry address in control register 15 is replaced by the address of the next preceding state or header entry. This also is described in “Unstacking Process”.

When the state entry is a program-call state entry, it causes a space-switching operation to occur if it contains a PASN that is not equal to the current PASN. When the state entry contains a PASN that is equal to the current PASN, the operation is called PROGRAM RETURN to current primary (PR-cp); when the state entry contains a PASN that is not equal to the current PASN, the operation is called PROGRAM RETURN with space switching (PR-ss). PASN translation occurs in PR-ss. SASN translation and authorization may occur in either PR-cp or PR-ss. The terms PR-cp and PR-ss do not apply when the state entry is a branch state entry.

When the ASN-and-LX-reuse facility is installed and enabled and PASN or SASN translation occurs, the PASTEIN or SASTEIN, respectively, saved in the state entry is compared to the ASTEIN in the located ASTE.

Key-controlled protection does not apply to accesses to the linkage stack, but low-address and DAT protection do apply.

The sections “PASN Translation,” “SASN Translation,” “SASN Authorization,” and “PROGRAM RETURN Serialization” apply only when the unstacked state entry is a program-call state entry. The functions described in those sections are not performed when the state entry is a branch state entry.

The actions involving the PASTEIN and SASTEIN occur only when ASN-and-LX reuse is enabled by the ASN-and-LX reuse control in control register 0.

PASN Translation

If the new PASN is equal to the old PASN in bit positions 48-63 of control register 4, PASN translation is not performed, the PASTEIN in control register 4 remain as restored from the state entry, and the PASCE in control register 1 and primary-ASTE origin (PASTE0) in control register 5 are not changed. In this case, there is not a test of whether the new PASTEIN is equal to the old PASTEIN.

If the new PASN is not equal to the old PASN, the new PASN replaces the PASN in bit positions 48-63 of control register 4 and is translated to locate a

64-byte ASTE. The ASN table-lookup process is described in “ASN Translation” on page 3-30. The exceptions associated with ASN translation are collectively called ASN-translation exceptions. These exceptions and their priority are described in Chapter 6, “Interruptions.”

If ASN-and-LX reuse is enabled, the PASTEIN saved in bytes 180-183 of the state entry must equal the ASTEIN in bit positions 352-383 of the located ASTE; otherwise, an ASTE-instance exception is recognized.

Bits 64-127 of the ASTE are placed in control register 1 as the new PASCE.

Bits 32-47 of the ASTE are placed in bit positions 32-47 of control register 4 as the new AX. The PASN and PASTEIN in control register 4 remain as restored from the state entry.

Bits 33-57 of the ASTE address are placed in bit positions 33-57 of control register 5 as the new primary-ASTE origin, and zeros are placed in bit positions 32 and 58-63. Bits 0-31 of this register remain unchanged.

The description in this paragraph applies to use of the subspace-group facility when PASN translation has occurred. If (1) the subspace-group-control bit, bit 54, in the new PASCE is one, (2) the dispatchable unit is subspace active, and (3) the new primary-ASTE origin designates the ASTE for the base space of the dispatchable unit, then bits 0-55 and 58-63 of the new PASCE in control register 1 are replaced by the same bits of the ASCE in the ASTE for the subspace in which the dispatchable unit last had control. This replacement occurs, in the case when the new SASN is equal to the new PASN, before the SASCE is set equal to the PASCE. Further details are in “Subspace-Replacement Operations” on page 5-70.

SASN Translation

If the new SASN is equal to the new PASN, the SASCE in control register 7 is set equal to the new PASCE in control register 1. The SASTEIN, PKM, and SASN in control register 3 remain as restored from the state entry. In this case, there is not a test of whether the new SASTEIN is equal to the new PASTEIN.

If the new SASN is not equal to the new PASN, the new SASN is translated to locate a 64-byte ASTE.

If ASN-and-LX reuse is enabled, the SASTEIN saved in bytes 176-179 of the state entry must equal the ASTEIN in bit positions 352-383 of the located ASTE; otherwise, an ASTE-instance exception is recognized.

Bits 64-127 of the ASTE are placed in control register 7 as the new SASCE.

Control register 3 remains as restored from the state entry.

SASN Authorization

If the new SASN is not equal to the new PASN, the authority-table origin (ATO) from the ASTE for the new SASN is used as the base for a third table lookup. The new authorization index, bits 32-47 of control register 4, is used, after it has been checked against the authority-table length, as the index to locate the entry in the authority table. The authority-table lookup is described in “ASN Authorization” on page 3-35.

The description in this paragraph applies to use of the subspace-group facility when SASN translation and authorization have occurred. If (1) the subspace-group-control bit, bit 54, in the new SASCE is one, (2) the dispatchable unit is subspace active, and (3) the ASTE origin obtained by SASN translation designates the ASTE for the base space of the dispatchable unit, then bits 0-55 and 58-63 are replaced by the same bits of the ASCE of the ASCE in the ASTE for the subspace in which the dispatchable unit last had control. Further details are in “Subspace-Replacement Operations” on page 5-70.

PROGRAM RETURN Serialization

When the unstacked state entry is a program-call state entry, a serialization and checkpoint-synchronization function is performed before the operation begins and again after the operation is completed. However, it is unpredictable whether or not a store into a trace-table entry or linkage-stack entry from which a subsequent instruction is fetched will be observed by the CPU that performed the store.

Special Conditions

The instruction can be executed successfully only when the CPU is in the primary-space mode or access-register mode at the beginning of the opera-

tion. In addition, if ASN-translation is required for either the PASN or the SASN, it can only be performed when the ASN-translation control, bit 44 of control register 14, is one. If either of these rules is violated, a special-operation exception is recognized.

A stack-empty, stack-operation, stack-specification, or stack-type exception may be recognized during the unstacking process.

If ASN-and-LX reuse is enabled, the restored PASTEIN must equal the ASTEIN in the located ASTE if PASN translation is performed, and the restored SASTEIN must equal the ASTEIN in the located ASTE if SASN translation is performed; otherwise, an ASTE-instance exception is recognized.

When, for PR-ss, the primary space-switch-event control, bit 57 of control register 1, is one either before or after the execution of the instruction, a space-switch-event program interruption occurs after the operation is completed. A space-switch-event program interruption also occurs after the completion of a PR-ss operation if a PER event is reported.

The PSW which is to be loaded by the instruction is not checked for validity before it is loaded. However, after loading, a specification exception is recognized, and a program interruption occurs, if any of bits 0, 2-4, 12, 24-30, and 33-63 of the PSW is a one, if bits 31 and 32 are zero and one, respectively, and bits 64-96 are not all zeros, if bits 31 and 32 are both zero and bits 64-103 are not all zeros, or if bits 31 and 32 are one and zero, respectively. In these cases, the operation is completed, and the resulting instruction-length code is 0. The specification exception, which in this case is listed as a program exception in this instruction, is described in “Early Exception Recognition” on page 6-9.

If a space-switch event is indicated and the PSW that was loaded by the instruction is invalid because of a reason described in the preceding paragraph, it is unpredictable whether the resulting instruction-length code is 0 or 1, or 0 or 2 if EXECUTE was used, or 0 or 3 if EXECUTE RELATIVE LONG was used.

The operation is suppressed on all addressing and protection exceptions.

Resulting Condition Code: The code is set as specified in the new PSW loaded.

Program Exceptions:

- Access (fetch and store, except key-controlled protection, linkage-stack entry)
- Addressing (authority-table entry, if SASN translation occurs)
- ASN translation (if PASN or SASN translation occurs)
- ASTE instance (if ASN-and-LX reuse is enabled and PASN or SASN translation occurs)
- Secondary authority (if SASN translation occurs)
- Space-switch event
- Special operation
- Specification
- Stack empty
- Stack operation
- Stack specification
- Stack type
- Subspace replacement (if PASN or SASN translation occurs)
- Trace
- Transaction constraint

The priority of recognition of program exceptions for the instruction is shown in Figure 10-73.

1.-6.	Exceptions with the same priority as the priority of program-interruption conditions for the general case.
7.A	Special-operation exception due to DAT being off or the CPU being in secondary-space mode or home-space mode.
7.B	Transaction constraint.
8.A	Trace exceptions.
8.B.1	Access exceptions (fetch) for entry descriptor of the current linkage-stack entry.
8.B.2	Stack-type exception due to current entry not being a state entry or header entry. Note: Exceptions 8.B.3-8.B.7 can occur only if the current entry is a header entry.
8.B.3	Stack-operation exception due to unstack-suppression bit in the header entry being one.
8.B.4	Access exceptions (fetch) for second word of the header entry.

Figure 10-73. Priority of Execution: PROGRAM RETURN (Part 1 of 3)

8.B.5	Stack-empty exception due to backward stack-entry validity bit in the header entry being zero.
8.B.6	Access exceptions (fetch) for entry descriptor of preceding entry, which is the entry designated by the backward stack-entry address in the current (header) entry.
8.B.7	Stack-specification exception due to preceding entry being a header entry.
8.B.8	Stack-type exception due to preceding entry not being a state entry.
8.B.9	Stack-operation exception due to unstack-suppression bit being one in the state entry.
8.B.10	Access exceptions (fetch) for the state entry, and access exceptions (store) for entry descriptor of the entry preceding the state entry. Note: Exceptions 8.B.11-8.B.15 and the event 9 can occur only if the state entry is a program-call state entry.
8.B.11	Special-operation exception due to the ASN-translation control, bit 44 of control register 14, being zero (if PASN or SASN translation occurs).
8.B.12	ASN-translation exceptions (if PASN translation occurs).
8.B.13	ASTE-instance exception due to new PASTEIN not being equal to ASTEIN in ASN-second-table entry located by PASN translation (if ASN-and-LX reuse enabled). Note: Subspace-replacement exceptions for replacement of bits in the PASCE, which are not shown in detail in this figure, can occur with any priority after 8.B.13 and before 9.
8.B.14	ASN-translation exceptions (if SASN translation occurs).
8.B.15	ASTE-instance exception due to new SASTEIN not being equal to ASTEIN in ASN-second-table entry located by SASN translation (if ASN-and-LX reuse enabled). Note: Subspace-replacement exceptions for replacement of bits in the SASCE, which are not shown in detail in this figure, can occur with any priority after 8.B.15 and before 9.
8.B.16	Secondary-authority exception due to authority-table entry being outside table (if SASN translation occurs).

Figure 10-73. Priority of Execution: PROGRAM RETURN (Part 2 of 3)

8.B.17	Addressing exception for access to authority-table entry (if SASN translation occurs).
8.B.18	Secondary-authority exception due to S bit in authority-table entry being zero (if SASN translation occurs).
9.	Space-switch event (PR-ss only).
10.	Specification exception due to any PSW error of the type that causes an immediate interruption.

Figure 10-73. Priority of Execution: PROGRAM RETURN (Part 3 of 3)

Programming Note: Because PROGRAM CALL cannot be executed successfully in the secondary-space or home-space mode, PROGRAM RETURN is not intended to load a PSW specifying one of these translation modes. PROGRAM RETURN, unlike SET ADDRESS SPACE CONTROL and SET ADDRESS SPACE CONTROL FAST, does not recognize a space-switch event because of loading a PSW that specifies the home-space mode.

PROGRAM TRANSFER

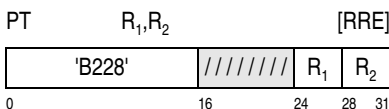

PROGRAM TRANSFER WITH INSTANCE

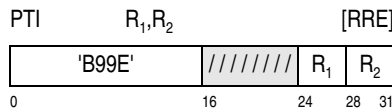

Note: In this instruction definition, the name “PROGRAM TRANSFER (WITH INSTANCE)” refers to the PROGRAM TRANSFER instruction and the PROGRAM TRANSFER WITH INSTANCE instruction.

Bits 32-47 of general register R₁ are used to update the PSW key mask, and bits 48-63 of the register are used as the new SASN and may be used as the new PASN. Bits 32-63 or 0-63 of general register R₂, depending on the current addressing mode, are used as the new values for the problem-state bit, basic-addressing-mode bit, and instruction address in the current PSW. In the PROGRAM TRANSFER WITH INSTANCE operation, bits 0-31 of general register R₁ are an ASTEIN and are compared against the new value of the PASTEIN if the PASN is changed. In the PROGRAM TRANSFER operation, bits 0-31 of general register R₁ are ignored.

The format of general registers R₁ and R₂ are shown in Figure 10-74.

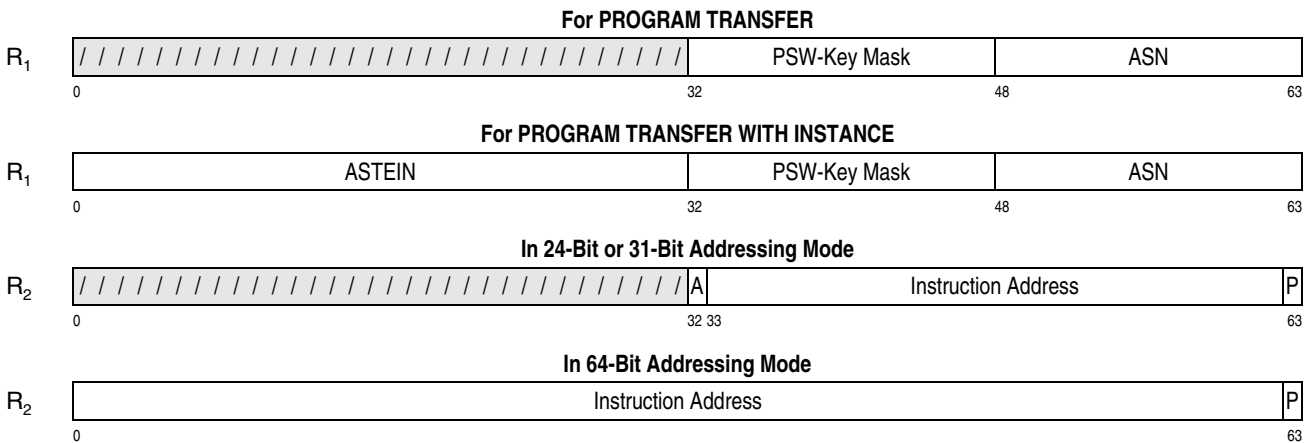

Figure 10-74. Register Contents for PROGRAM TRANSFER (WITH INSTANCE)

When the contents of bit positions 48-63 of general register R₁ are equal to the current PASN, the operation is called PROGRAM TRANSFER (WITH INSTANCE) to current primary (PT-cp or PTI-cp); when the fields are not equal, the operation is called

PROGRAM TRANSFER (WITH INSTANCE) with space switching (PT-ss or PTI-ss).

The contents of general register R₂ are used to update the problem-state bit and the instruction address in the current PSW and, in the 24-bit or

31-bit addressing mode, also the basic-addressing-mode bit in the current PSW. Bit 63 of general register R_2 is placed in the problem-state bit position, PSW bit position 15, unless the operation would cause PSW bit 15 to change from one to zero (problem state to supervisor state). If such a change would occur, a privileged-operation exception is recognized.

In the 24-bit or 31-bit addressing mode, bit 32 of general register R_2 replaces the basic-addressing-mode bit, bit 32 of the current PSW, and bits 33-62 of the register, with one rightmost zero appended, replace bits 33-63 of the instruction address in the PSW, bits 97-127 of the PSW. In the 64-bit addressing mode, bits 0-62 of general register R_2 , with one rightmost zero appended, replace the instruction address, and the basic-addressing-mode bit remains unchanged.

Bits 32-47 of general register R_1 are ANDed with the PSW-key mask, bits 32-47 of control register 3, and the result replaces the PSW-key mask.

In any of the PT-cp, PTI-cp, PT-ss, and PTI-ss operations, the ASN specified by bits 48-63 of general register R_1 replaces the SASN in control register 3, and the SASCE in control register 7 is replaced by the final contents of control register 1.

In the PROGRAM TRANSFER operation, if the ASN-and-LX-reuse facility is installed and is enabled by a one value of the ASN-and-LX-reuse control, bit 44 of control register 0, the SASTEIN in control register 3 is replaced by the final value of the PASTEIN in control register 4. This replacement occurs in the PROGRAM TRANSFER WITH INSTANCE operation regardless of the value of the ASN-and-LX-reuse control.

PROGRAM TRANSFER (WITH INSTANCE) to Current Primary (PT-cp or PTI-cp)

The PT-cp operation is depicted in part 1 of Figure 10-76 on page 10-115. The PTI-cp operation is depicted in part 1 of Figure 10-77 on page 10-117. The PT-cp or PTI-cp operation is completed when the common portion of the PROGRAM TRANSFER (WITH INSTANCE) operation, described above, is completed. The PASTEIN, authorization index, ASN, primary ASCE, and contents of control register 5 (primary-ASN-second-table-entry origin) are not changed by PT-cp or PTI-cp. In this case in the PTI-cp operation, there is not a test of whether the current PASTEIN equals the ASTEIN specified in bit

positions 0-31 of general register R_1 ; the ASTEIN is ignored.

PROGRAM TRANSFER (WITH INSTANCE) with Space Switching (PT-ss or PTI-ss)

If the ASN in bit positions 48-63 of general register R_1 is not equal to the current PASN, a PROGRAM TRANSFER (WITH INSTANCE) with space switching (PT-ss or PTI-ss) operation is specified, and the ASN is translated by means of a two-level table lookup.

The PT-ss operation is depicted in parts 1 and 2 of Figure 10-76 on page 10-115. The PTI-ss operation is depicted in parts 1 and 2 of Figure 10-77 on page 10-117. The PT-ss or PTI-ss operation is completed as follows.

In PT-ss or PTI-ss, the contents of bit positions 48-63 of general register R_1 are used as an ASN, which is translated by means of a two-level table lookup.

Bits 48-57 of general register R_1 are a 10-bit AFX that is used to select an entry from the ASN first table. Bits 58-63 are a six-bit ASX that is used to select an entry from the ASN second table. The ASN table-lookup process is described in "ASN Translation" on page 3-30. The exceptions associated with ASN translation are collectively called "ASN-translation exceptions." These exceptions and their priority are described in Chapter 6, "Interruptions."

In PT-ss if the ASN-and-LX-reuse facility is installed and is enabled by a one value of the ASN-and-LX-reuse control, bit 44 of control register 0, the reusable-ASN bit, bit 63, in the located ASN-second-table entry (ASTE) must be zero; otherwise, a special-operation exception is recognized. In PTI-ss, regardless of the ASN-and-LX-reuse control, the controlled-ASN bit, bit 62, in the ASTE must be zero if the CPU is in the problem state at the beginning of the operation; otherwise, a special-operation exception is recognized. Also in PTI-ss, and regardless of the ASN-and-LX-reuse control and the reusable-ASN bit, the ASTEIN in bit positions 0-31 of general register R_1 must equal the ASTEIN in bit positions 352-383 of the ASTE; otherwise, an ASTE-instance exception is recognized.

The authority-table origin from the ASN-second-table entry (ASTE) is used as the base for a third table lookup. The current authorization index, bits 32-47 of control register 4, is used, after it has been checked against the authority-table length, as the index to

locate the entry in the authority table. The authority-table lookup is described in “ASN Authorization” on page 3-35.

The PT-ss or PTI-ss operation is completed by placing bits 64-127 of the ASTE in control register 1 as the new PASCE and in control register 7 as the new SASCE. The contents of bit positions 32-47 of the ASTE replace the authorization index in bit positions 32-47 of control register 4. Bits 33-57 of the ASTE address are placed in bit positions 33-57 of control register 5 as the new primary-ASTE origin, and zeros are placed in bit positions 32 and 58-63. Bits 0-31 of this register remain unchanged. The ASN, bits 48-63 of general register R₁, replaces the SASN and PASN in bit positions 48-63 of control registers 3 and 4. In PT-ss if ASN-and-LX reuse is enabled, and in PTI-ss regardless of that enablement, the ASTEIN in the ASTE replaces the SASTEIN and PASTEIN in bit positions 0-31 of control registers 3 and 4.

The description in this paragraph applies to use of the subspace-group facility. After the new PASCE has been placed in control register 1 and the new primary-ASTE origin has been placed in control register 5, if (1) the subspace-group-control bit, bit 54, in the PASCE is one, (2) the dispatchable unit is subspace active, and (3) the primary-ASTE origin designates the ASTE for the base space of the dispatchable unit, then bits 0-55 and 58-63 of the PASCE in control register 1 are replaced by the same bits of the ASCE in the ASTE for the subspace in which the dispatchable unit last had control. This replacement occurs before a replacement of the SASCE in control register 7 by the PASCE. Further details are in “Subspace-Replacement Operations” on page 5-70.

PROGRAM TRANSFER (WITH INSTANCE) Serialization

For any of the PT-cp, PTI-cp, PT-ss, and PTI-ss operations, a serialization and checkpoint-synchronization function is performed before the operation begins and again after the operation is completed. However, it is unpredictable whether or not a store into a trace-table entry from which a subsequent instruction is fetched will be observed by the CPU that performed the store.

Special Conditions

The instruction can be executed only when the CPU is in the primary-space mode and the subsystem-linkage control, bit 0 of the linkage-table designation,

or linkage-first-table designation in the current primary ASN-second-table entry, is one. If the CPU is in the real mode, secondary-space mode, access-register mode, or home-space mode, or if the subsystem-linkage control is zero, a special-operation exception is recognized.

In PT-ss when ASN-and-LX reuse is enabled, the reusable-ASN bit in the ASN-second-table entry (ASTE) must be zero; otherwise, a special-operation exception is recognized. In PTI-ss, regardless of the ASN-and-LX-reuse control, a special-operation exception is recognized if the controlled-ASN bit in the ASTE is one and the CPU is in the problem state at the beginning of the operation, and an ASTE-instance exception is recognized if the ASTEIN in general register R₁ is not equal to the ASTEIN in the ASTE.

Bit 63 of general register R₂ is placed in the problem-state bit position, PSW bit position 15, unless the operation would cause PSW bit 15 to change from one to zero (problem state to supervisor state). If such a change would occur, a privileged-operation exception is recognized.

In the 24-bit or 31-bit addressing mode, the instruction is completed only if bits 32-39 of general register R₂ specify a valid combination of PSW bits 32 and 97-103. If bit 32 of general register R₂ is zero and bits 33-39 are not all zeros, a specification exception is recognized.

In addition to the above requirements, when a PT-ss or PTI-ss instruction is specified, the ASN-translation control, bit 44 of control register 14, must be one; otherwise, a special-operation exception is recognized.

When, for PT-ss or PTI-ss, the primary space-switch-event-control bit, bit 57 of register 1, is one either before or after the execution of the instruction, a space-switch-event program interruption occurs after the operation is completed. A space-switch-event program interruption also occurs after the completion of a PT-ss or PTI-ss operation if a PER event is reported.

The operation is suppressed on all addressing exceptions.

Condition Code: The code remains unchanged.

Program Exceptions:

- Addressing (linkage-table or linkage-first-table designation in primary ASN-second-table entry; authority-table entry, PT-ss and PTI-ss only)
- ASN translation (PT-ss and PTI-ss only)
- ASTE instance (PTI-ss only)
- Operation (if ASN-and-LX-reuse facility is not installed, PTI only)
- Primary authority (PT-ss and PTI-ss only)
- Privileged operation (attempt to set the supervisor state when in the problem state)
- Space-switch event (PT-ss and PTI-ss only)
- Special operation
- Specification
- Subspace replacement (PT-ss and PTI-ss only)
- Trace
- Transaction constraint

The priority of recognition of program exceptions for the instruction is shown in Figure 10-75.

1.-6.	Exceptions with the same priority as the priority of program-interruption conditions for the general case.
7.A	Access exceptions for second instruction halfword.
7.B.1	Operation exception (PTI only, if the ASN-and-LX-reuse facility is not installed).
7.B.2	Special-operation exception due to DAT being off or the CPU being in secondary-space mode, access-register mode, or home-space mode.
7.C	Transaction constraint.
8.A	Trace exceptions.
8.B.1	Addressing exception for access to linkage-table designation or linkage-first-table designation in primary ASN-second-table entry.
8.B.2	Special-operation exception due to subsystem-linkage control in linkage-table designation or linkage-first-table designation being zero.
8.B.3	Privileged-operation exception due to attempt to set the supervisor state when in the problem state.
8.B.4	Specification exception due to invalid combination (bit 32 is zero and bits 33-39 not zeros) in general register R_2 in 24-bit or 31-bit addressing mode.

Figure 10-75. Priority of Execution: PROGRAM TRANSFER (WITH INSTANCE) (Part 1 of 2)

8.B.5	Special-operation exception due to the ASN-translation control, bit 44 of control register 14, being zero (PT-ss or PTI-ss only).
8.B.6	ASN-translation exceptions (PT-ss and PTI-ss only).
8.B.7	Special-operation exception due to ASN-and-LX reuse enabled and reusable-ASN bit in ASN-second-table entry being one (PT-ss only).
8.B.8	Special-operation exception due to controlled-ASN bit in ASN-second-table entry being one and CPU being in problem state at the beginning of the operation (PTI-ss only).
8.B.9	ASTE-instance exception due to ASTEIN in general register R_1 not being equal to ASTEIN in ASN-second-table entry (PTI-ss only).
<p>Note: Subspace-replacement exceptions, which are not shown in detail in this figure, can occur with any priority after 8.B.9 and before 9.</p>	
8.B.10	Primary-authority exception due to authority-table entry being outside table (PT-ss and PTI-ss only).
8.B.11	Addressing exception for access to authority-table entry (PT-ss and PTI-ss only).
8.B.12	Primary-authority exception due to P bit in authority-table entry being zero (PT-ss and PTI-ss only).
9.	Space-switch event (PT-ss and PTI-ss only).

Figure 10-75. Priority of Execution: PROGRAM TRANSFER (WITH INSTANCE) (Part 2 of 2)

Programming Notes:

1. The operation of PROGRAM TRANSFER (PT) is such that it may be used to restore the CPU to the state saved by a previous basic PROGRAM CALL operation. This restoration is accomplished by issuing PT 3,14. Though general registers 3 and 14 are not restored to their original values, the PASN, PSW-key mask, problem-state bit, and instruction address are restored, and the authorization index, PASCE, and primary-ASN-second-table-entry origin are made consistent with the restored PASN. In the 24-bit or 31-bit addressing mode, the basic-addressing-mode bit also is restored. If ASN-and-LX reuse is enabled, the PASTEIN also is made consistent with the restored PASN. Note that the SASN is not saved by PROGRAM CALL or restored by PROGRAM TRANSFER; PROGRAM TRANSFER sets the

SASN equal to the restored PASN. PROGRAM TRANSFER WITH INSTANCE is the same as PROGRAM TRANSFER except that the PASTEIN is made consistent regardless of ASN-and-LX-reuse enablement.

2. With proper authority, and while being executed in a common area, PROGRAM TRANSFER (WITH INSTANCE) may be used to change the primary address space to any desired space. The secondary address space is also changed to be the same as the new primary address space.
3. Unlike the RR-format branch instructions, a value of zero in the R_2 field for PROGRAM TRANSFER (WITH INSTANCE) designates general register 0, and branching occurs.
4. A program given control by a basic PROGRAM CALL operation can use EXTRACT SECONDARY ASN AND INSTANCE to obtain the ASTEIN to be used by PROGRAM TRANSFER WITH INSTANCE to return to the calling program or by SET SECONDARY ASN WITH INSTANCE to restore its secondary address space after a change of that space. This EXTRACT SECONDARY ASN AND INSTANCE instruction should be executed while the original secondary space remains continuously the secondary space; otherwise, depending on actions by the control program, EXTRACT SECONDARY ASN AND INSTANCE may return an ASTEIN that allows return to or use of a conceptually incorrect secondary space for which the ASTEIN has been changed.

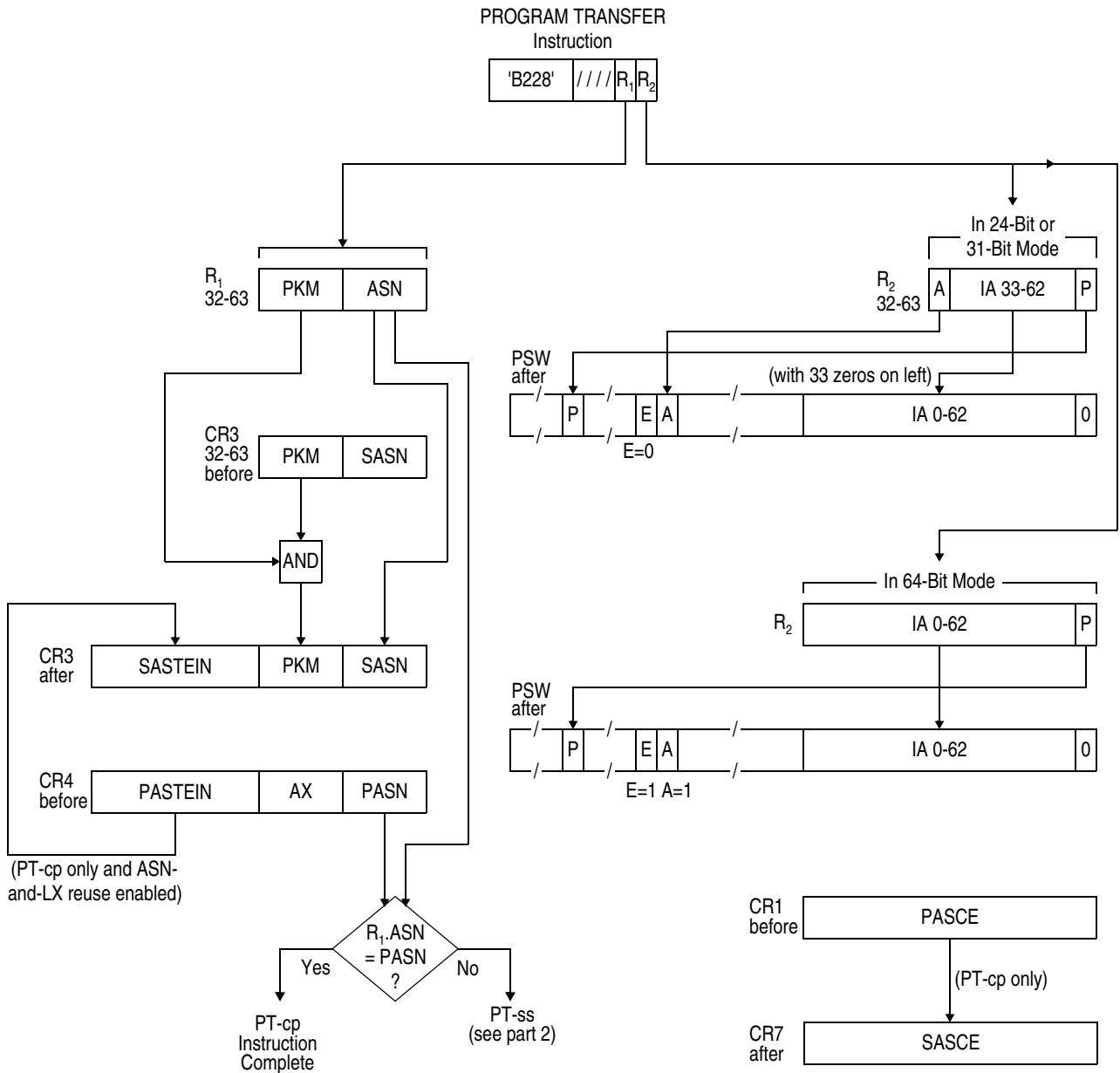
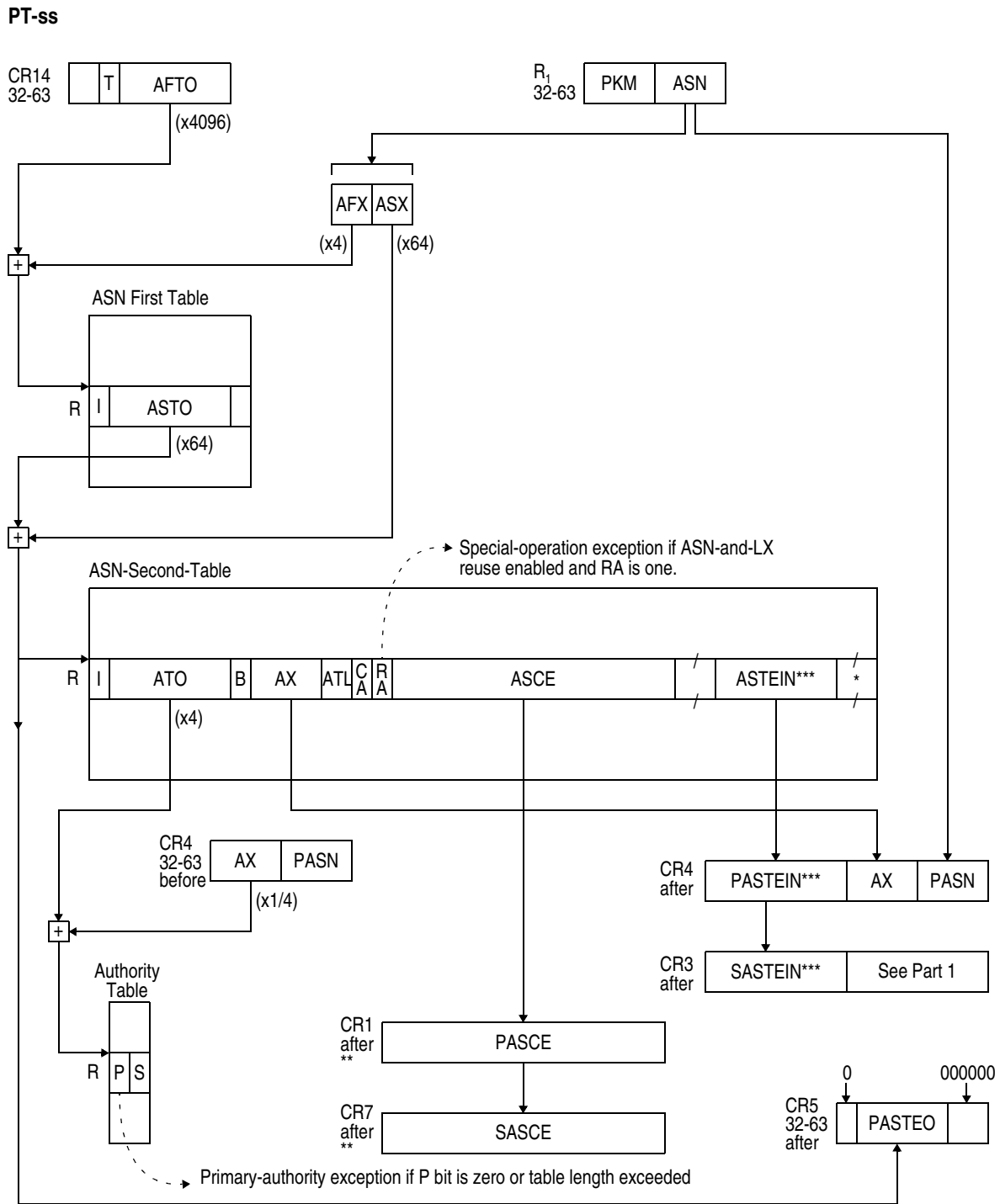

Figure 10-76. Execution of PROGRAM TRANSFER (Part 1 of 2).



R: Address is real

*: ASTE is 64 bytes; selected fields and the last 16 bytes are not shown.

** : Bits 0-55 and 58-63 of PASCE and SASCE may be replaced from a subspace ASCE

***: Operations on the ASTE instance number performed if ASN-and-LX-reuse enabled

Figure 10-76. Execution of PROGRAM TRANSFER (Part 2 of 2).

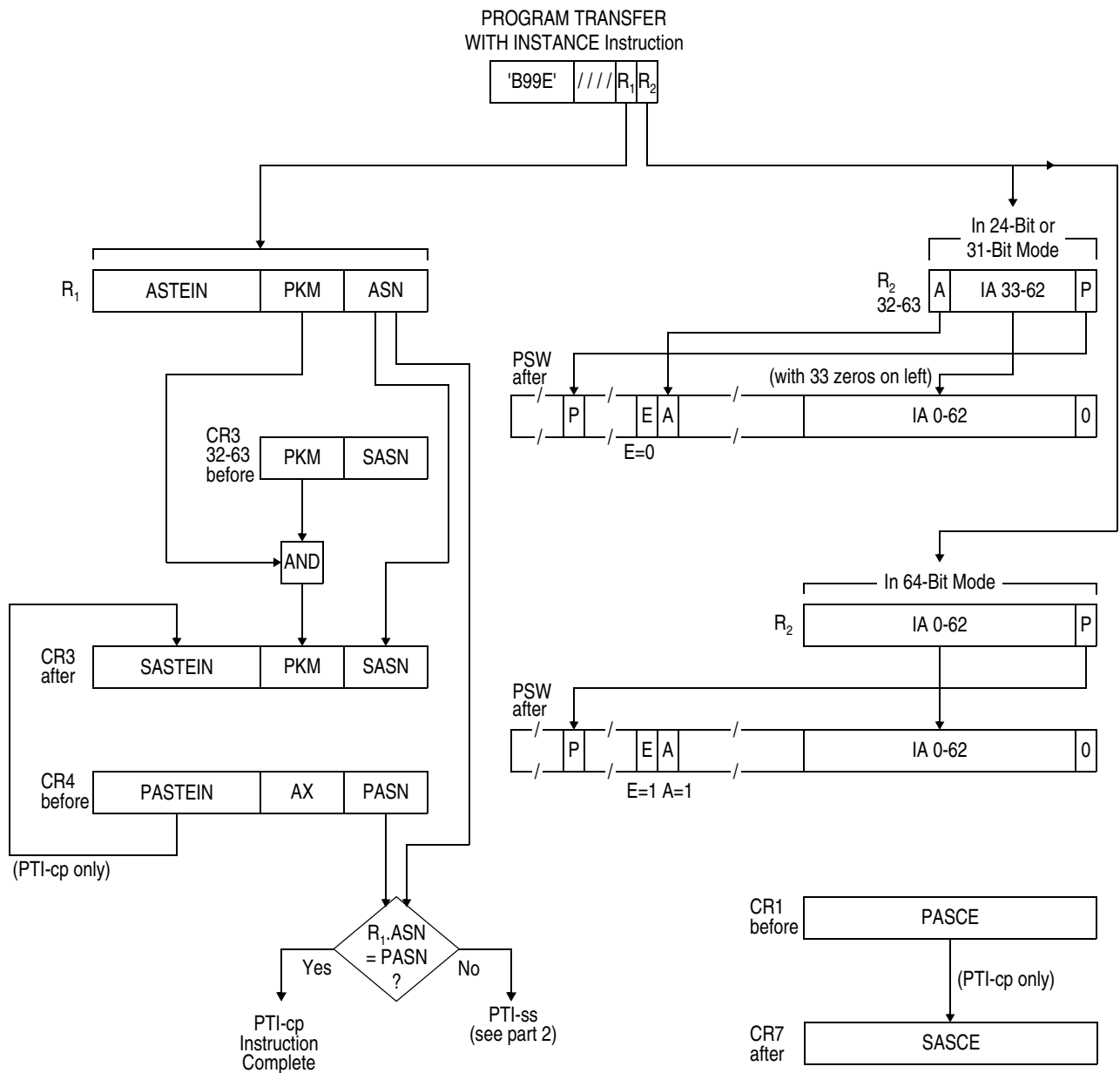
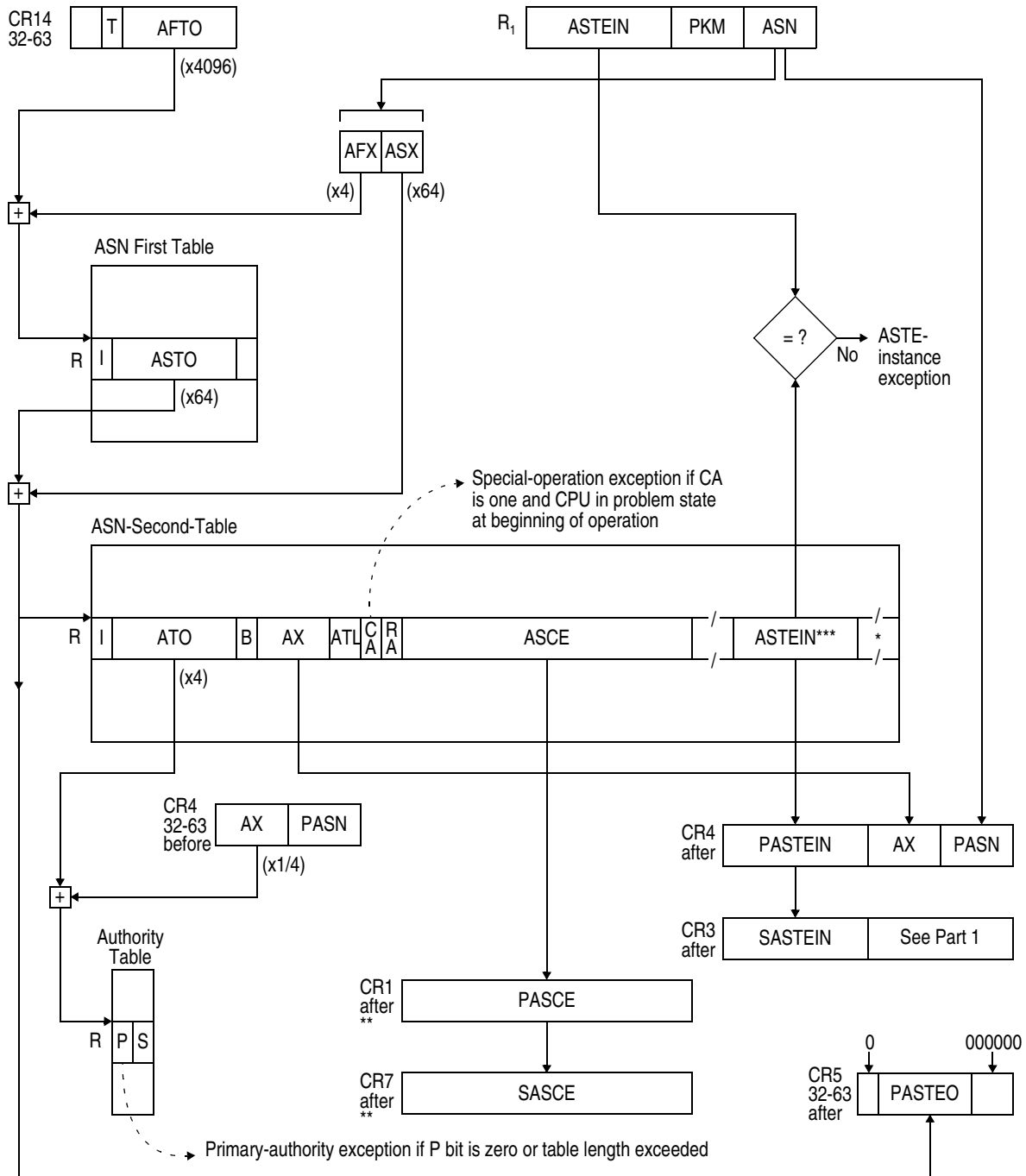

Figure 10-77. Execution of PROGRAM TRANSFER WITH INSTANCE (Part 1 of 2).

PTI-ss



R: Address is real

*: ASTE is 64 bytes; selected fields and the last 16 bytes are not shown.

** : Bits 0-55 and 58-63 of PASCE and SASCE may be replaced from a subspace ASCE

Figure 10-77. Execution of PROGRAM TRANSFER WITH INSTANCE (Part 2 of 2).

PURGE ALB

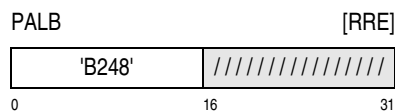

The ART-lookaside buffer (ALB) of this CPU is cleared of entries. No change is made to the contents of addressable storage or registers.

The ALB appears cleared of its original contents beginning with the execution of the next sequential instruction. The operation is not signaled to any other CPU.

A serialization function is performed.

Condition Code: The code remains unchanged.

Program Exceptions:

- Privileged operation
- Transaction constraint

PURGE TLB



The translation-lookaside buffer (TLB) of this CPU is cleared of entries. No change is made to the contents of addressable storage or registers.

The TLB appears cleared of its original contents beginning with the fetching of the next sequential instruction. The operation is not signaled to any other CPU.

A serialization function is performed.

Condition Code: The code remains unchanged.

Program Exceptions:

- Privileged operation
- Transaction constraint

RESET REFERENCE BIT EXTENDED

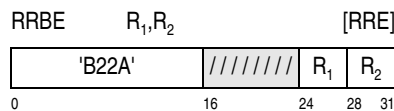

The reference bit in the storage key for the 4 K-byte block that is addressed by the contents of general register R₂ is set to zero. The contents of general register R₁ are ignored.

In the 24-bit addressing mode, bits 40-51 of general register R₂ designate a 4 K-byte block in real storage, and bits 0-39 and 52-63 of the register are ignored. In the 31-bit addressing mode, bits 33-51 of general register R₂ designate a 4 K-byte block in real storage, and bits 0-32 and 52-63 of the register are ignored. In the 64-bit addressing mode, bits 0-51 of general register R₂ designate a 4 K-byte block in real storage, and bits 52-63 of the register are ignored.

Because it is a real address, the address designating the storage block is not subject to dynamic address translation. The reference to the storage key is not subject to a protection exception.

The remaining bits of the storage key, including the change bit, are not affected.

The condition code is set to reflect the state of the reference and change bits before the reference bit is set to zero.

Resulting Condition Code:

- 0 Reference bit zero; change bit zero
- 1 Reference bit zero; change bit one
- 2 Reference bit one; change bit zero
- 3 Reference bit one; change bit one

Program Exceptions:

- Addressing (address specified by general register R₂)
- Privileged operation
- Transaction constraint

Programming Note: See the programming note for INSERT REFERENCE BITS MULTIPLE on page 10-30 for a discussion of differing reference bits

that may be returned by IRBM, ISKE, RRBE, and RRBM for the same block of storage.

RESET REFERENCE BITS MULTIPLE

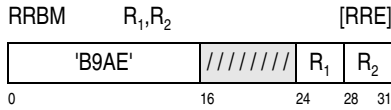

Beginning with the block designated by the address in general register R_2 , the reference bits in the storage keys of the 64 consecutive 4 K-byte blocks are inspected and reset. For each of the 64 blocks, the reference bit is placed in an ascending bit position of general register R_1 , beginning with bit position 0 of the register. Subsequent to the inspection of each reference bit, the reference bit in the storage key is reset to zero.

General register R_2 designates the first of 64 blocks in absolute storage on a 64-block (256 K-byte) boundary. In the 24-bit addressing mode, bits 40-45 of the register, with six binary zeros appended on the right, designate the first block, and bits 0-39 and 46-63 of the register are ignored. In the 31-bit addressing mode, bits 33-45 of the register, with six binary zeros appended on the right, designate the first block, and bits 0-32 and 46-63 of the register are ignored. In the 64-bit addressing mode, bits 0-45 of the register, with six binary zeros appended on the right, designate the first block, and bits 46-63 of the register are ignored.

Because it is an absolute address, the address designating the first storage block is not subject to dynamic address translation or prefixing. The references to the storage keys are not subject to protection exceptions.

The remaining bits of the storage keys are not affected.

Condition Code: The code remains unchanged.

Program Exceptions:

- Addressing (address specified by general register R_2)
- Operation (reset-reference-bits-multiple facility not installed)
- Privileged operation

- Transaction constraint

Programming Note: See the programming note for INSERT REFERENCE BITS MULTIPLE on page 10-30 for a discussion of differing reference bits that may be returned by IRBM, ISKE, RRBE, and RRBM for the same block of storage.

RESUME PROGRAM

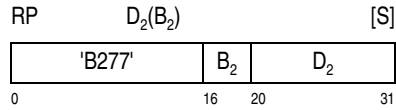

Certain contents of the current PSW and of access register and general register B_2 are replaced from three or four corresponding fields in the second operand. The size of the PSW field in the second operand, the size or number of general-register fields in the second operand, and the offsets of the fields in the second operand are specified in a parameter list that immediately follows the instruction in the instruction address space.

The instruction address space is the address space from which instructions are fetched. It is composed of real addresses if DAT is off.

The first 64 bits of the parameter list have the following format:

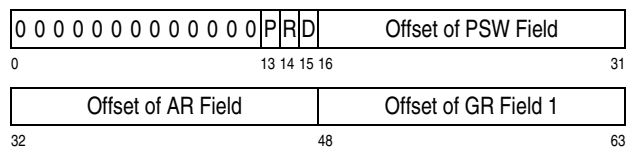

In the z/Architecture architectural mode, bits 13-15 of the parameter list further qualify the contents of the second operand, as described below. In the ESA/390-compatibility mode, if any of bits 13-15 of the parameter list is not zero, it is unpredictable whether a specification exception is recognized, or whether these bits operate as in the z/Architecture-architectural-mode definition.

When bits 14 (R) and 15 (D) of the parameter list are both one, the list is an additional 16 bits in length, as follows:

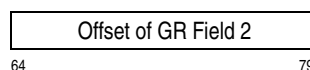

Bit 13 of the parameter list (P) specifies the size of the PSW field in the second operand. The field is eight bytes if bit 13 is zero or 16 bytes if bit 13 is one.

Bits 14 and 15 of the parameter list (R and D) provide specifications about one or two general-register fields in the second operand, as follows:

- When bit 14 is zero, then bit 15 is ignored, the general-register field 1 in the second operand is four bytes, from which bits 32-63 of general register B_2 will be replaced, there is not a general-register field 2 in the second operand, and bits 0-31 of general register B_2 will remain unchanged.
- When bit 14 is one and bit 15 is zero, then the general-register field 1 is eight bytes, from which bits 0-63 of general register B_2 will be replaced, and there is not a general-register field 2.
- When bits 14 and 15 are both one, then the general-register fields 1 and 2 are both four bytes, bits 32-63 of general register B_2 will be replaced from field 1, and bits 0-31 of the register will be replaced from field 2. (The letter “D” stands for disjoint.)

Bits 16-31 of the parameter list are an unsigned binary integer that is the offset in bytes from the beginning of the second operand to a field that has the format of an eight-byte or 16-byte PSW, depending on bit 13, and from which fields in the current PSW will be replaced. Bits 32-47 similarly are an offset to a four-byte field from which the contents of access register B_2 will be replaced. Bits 48-63 similarly are an offset to a four-byte or eight-byte field, depending on bits 14 and 15, from which bits 32-63 or 0-63, respectively, of general register B_2 will be replaced. If bits 64-79 of the parameter list exist, they similarly are an offset to a four-byte field from which bits 0-31 of general register B_2 will be replaced.

Bits 0-12 of the parameter list must be zeros; otherwise, a specification exception is recognized.

Fields in the current PSW are replaced from the corresponding fields in the PSW field in the second operand. The format of a short (eight-byte) PSW is shown in Figure 4-3 on page 4-8, and the format of a 16-byte PSW is shown in Figure 4-2 on page 4-5.

The PSW fields that are replaced are shown in Figure 10-78, below.

PSW Bits	Field Name
16 and 17	Address-space control (AS)
18 and 19	Condition code (CC)
20-23	Program mask
31	Extended addressing mode (EA)
32	Basic addressing mode (BA)
64-127	Instruction address

Figure 10-78. PSW Bits Replaceable by RESUME PROGRAM

There is no test for whether bit 31 is zero in an eight-byte PSW.

Fields in the current PSW are replaced from the corresponding fields in the PSW field in the second operand. The PSW fields that are replaced are as follows:

PSW Bits	Field Name
16 and 17	Address-space control (AS)
18 and 19	Condition code (CC)
20-23	Program mask
31	Extended addressing mode (EA)
32	Basic addressing mode (BA)
64-127	Instruction address

The remaining fields in the PSW field in the second operand are ignored. Specifically, there is no test for whether bit 12 is one in an eight-byte PSW or zero in a 16-byte PSW.

Unassigned fields in the PSW may be assigned in the future and may then be among those restored by RESUME PROGRAM. Therefore, these fields in the PSW field in the second operand should contain zeros; otherwise, the program may not operate compatibly in the future.

When PSW bits 64-127 are replaced from an eight-byte PSW field in the second operand, they are replaced with bits 33-63 of the field, with 33 zeros appended on the left.

The fields in the second operand are fetched before the contents of access register B_2 and general register B_2 are changed.

When RESUME PROGRAM is the target of an execute-type instruction, the parameter list immediately follows the RESUME PROGRAM instruction, not the execute-type instruction.

The references to the parameter list are storage-operand fetches, not instruction fetches.

Special Conditions

The instruction is completed only if the bits 31, 32, and 64-127 that are to be placed in the current PSW are valid for placement in the PSW. If bits 31 and 32 are both zero and bits 64-103 are not all zeros, if bits 31 and 32 are zero and one, respectively, and bits 64-96 are not all zeros, if bits 31 and 32 are one and zero, respectively, or if bit 127 is one, a specification exception is recognized. A specification exception may or may not result when bit 24 in the second operand is one.

In the ESA/390-compatibility mode, the following applies:

- It is unpredictable whether a specification exception is recognized when any of bits 13-15 of the parameter list is not zero.
- It is unpredictable whether a specification exception is recognized when bit 31 of the PSW in the second operand is one.

The CPU must be in the supervisor state when the operation is to set the home-space mode; otherwise, a privileged-operation exception is recognized. When DAT is off, the values of bits 16 and 17 of the PSW field in the second operand are not tested.

When the CPU is in the home-space mode either before or after the operation, but not both before and after the operation, a space-switch-event program interruption occurs after the operation is completed if any of the following is true: (1) the primary space-switch-event control, bit 57 of the primary address-space-control element (ASCE) in control register 1, is one; (2) the home space-switch-event control, bit 57 of the home ASCE in control register 13, is one; or (3) a PER event is to be indicated.

The operation is suppressed on all addressing and protection exceptions.

Resulting Condition Code: The code is set as specified by the new condition code loaded.

Program Exceptions:

- Access (fetch, parameter list and operand 2)
- Privileged operation (attempt to set the home-space mode when in the problem state)
- Space-switch event
- Specification
- Trace
- Transaction constraint

The priority of recognition of program exceptions for the instruction is shown in Figure 10-79.

1.-6.	Exceptions with the same priority as the priority of program-interruption conditions for the general case.
7.A	Access exceptions for second instruction halfword.
7.B	Transaction constraint.
8.A	Trace exceptions.
8.B.1	Access exceptions for bits 0-63 of parameter list.
8.B.2	Specification exception due to bits 0-12 of parameter list not being all zeros.
8.B.3	Access exceptions for bits 64-79 of parameter list, if these bits exist.
8.B.4	Access exceptions for second operand.
8.B.5	Privileged-operation exception due to attempt to set the home-space mode when in the problem state.
8.B.6.a	Specification exception due to invalid values in bit positions 31, 32, and 64-127 of PSW in second operand.
8.B.6.b	Specification exception may or may not occur due to a one in bit position 24 of PSW in second operand.
9.	Space-switch event.

Figure 10-79. Priority of Execution: RESUME PROGRAM

Programming Notes:

1. As described in "Instruction Fetching" on page 5-118, the bytes of an instruction may be fetched piecemeal, and the instruction may be fetched multiple times for a single execution.

Therefore, the results are unpredictable when instructions are fetched for execution from storage that is being changed by another CPU or a channel program. This warning is particularly applicable when RESUME PROGRAM is the target of an execute-type instruction since the execute-type instruction may be refetched in order to generate, from its second operand, the address of the parameter list used by RESUME PROGRAM. If the execute-type instruction is refetched, there is not necessarily a test for whether storage still contains either the execute-type instruction or the RESUME PROGRAM instruction.

- The storage-operand references for RESUME PROGRAM may be multiple-access references. (See "Storage-Operand Consistency" on page 5-125.)

SET ADDRESS SPACE CONTROL

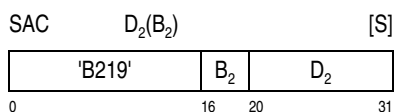

SET ADDRESS SPACE CONTROL FAST

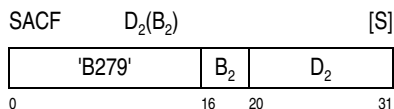

Bits 52-55 of the second-operand address are used as a code to set the address-space-control bits in the PSW. The second-operand address is not used to address data; instead, bits 52-55 form the code. Bits 0-51 and 56-63 of the second-operand address are ignored. Bits 52 and 53 of the second-operand address must be zeros; otherwise, a specification exception is recognized.

The following figure summarizes the operation of SET ADDRESS SPACE CONTROL and SET ADDRESS SPACE CONTROL FAST:

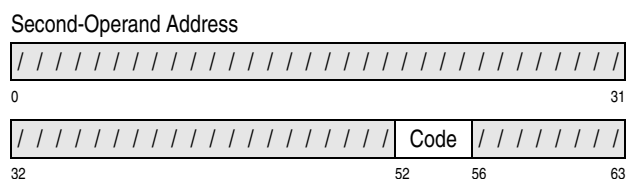

Code	Name of Mode	Result in PSW Bits 16 and 17
0000	Primary space	00
0001	Secondary space	10
0010	Access register	01
0011	Home space	11
All others	Invalid	

The CPU must be in the supervisor state when the operation is to set the home-space mode; otherwise, a privileged-operation exception is recognized.

For SET ADDRESS SPACE CONTROL, a serialization and checkpoint-synchronization function is performed before the operation begins and again after the operation is completed. This function is not performed for SET ADDRESS SPACE CONTROL FAST.

Special Conditions

For SET ADDRESS SPACE CONTROL, the operation is performed only when the secondary-space control, bit 37 of control register 0, is one and DAT is on. When either the secondary-space control is zero or DAT is off, a special-operation exception is recognized. The same rules apply also to SET ADDRESS SPACE CONTROL FAST, except that whether the secondary-space control is tested is unpredictable.

When the CPU is in the home-space mode either before or after the operation, but not both before and after the operation, a space-switch-event program interruption occurs after the operation is completed if any of the following is true: (1) the primary space-switch-event control, bit 57 of the primary address-space-control element (ASCE) in control register 1, is one; (2) the home space-switch-event control, bit 57 of the home ASCE in control register 13, is one; or (3) a PER event is to be indicated.

Condition Code: The code remains unchanged.

Program Exceptions:

- Privileged operation (attempt to set the home-space mode in the problem state)
- Space-switch event
- Special operation
- Specification
- Transaction constraint

The priority of recognition of program exceptions for the instructions is shown in Figure 10-80.

1.-6.	Exceptions with the same priority as the priority of program-interruption conditions for the general case.
7.A	Access exceptions for second instruction halfword.
7.B	Special-operation exception due to DAT being off.
7.C	Special-operation exception due to the secondary-space control, bit 37 of control register 0, being zero. May be omitted for SET ADDRESS SPACE CONTROL FAST.
7.D	Transaction constraint.
8.	Privileged-operation exception due to attempt to set home-space mode when in problem state.
9.	Specification exception due to nonzero value in bit positions 52 and 53 of second-operand address.
10.	Space-switch event.

Figure 10-80. Priority of Execution: SET ADDRESS SPACE CONTROL and SET ADDRESS SPACE CONTROL FAST

Programming Notes:

1. SET ADDRESS SPACE CONTROL and SET ADDRESS SPACE CONTROL FAST are defined in such a way that the mode to be set can be placed directly in the displacement field of the instruction or can be specified from the same bit positions of a general register as those in which the mode is saved by INSERT ADDRESS SPACE CONTROL.
2. SET ADDRESS SPACE CONTROL FAST may provide better performance than SET ADDRESS SPACE CONTROL, depending on the model.
3. Because SET ADDRESS SPACE CONTROL FAST does not perform the serialization function,

it does not cause copies of prefetched instructions to be discarded. To ensure predictable results after SET ADDRESS SPACE CONTROL FAST is used to switch to or from the home-space mode, the program must cause prefetched instructions to be discarded before an instruction is executed in a location that does not contain the same instruction in both the primary and home address spaces. The operations that cause prefetched instructions to be discarded are described in "Instruction Fetching" on page 5-118.

4. If a program stores into the instruction stream at a location following a subsequent SET ADDRESS SPACE CONTROL FAST instruction, and the SET ADDRESS SPACE CONTROL FAST instruction changes the translation mode either from or to either the access-register mode or the home-space mode, a copy of a prefetched instruction may be executed instead of the value that was stored. To avoid this situation, either SET ADDRESS SPACE CONTROL must be used instead of SET ADDRESS SPACE CONTROL FAST or some other means must be used to cause prefetched instructions to be discarded after the conceptual store occurs.

SET CLOCK

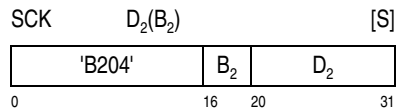

The current value of the TOD clock is replaced by the contents of the doubleword designated by the second-operand address, and the clock enters the stopped state.

The doubleword operand replaces the contents of the clock, as determined by the resolution of the clock. Only those bits of the operand are set in the clock that correspond to the bit positions which are updated by the clock; the contents of the remaining rightmost bit positions of the operand are ignored and are not preserved in the clock. In some models, starting at or to the right of bit position 52, the rightmost bits of the second operand are ignored, and the corresponding positions of the clock which are implemented are set to zeros. Zeros are also placed in positions to the right of bit position 63 of the clock.

After the clock value is set, the clock enters the stopped state. The clock leaves the stopped state to enter the set state and resume incrementing under control of the TOD-clock-sync control, bit 34 of control register 0, of the CPU which most recently caused the clock to enter the stopped state. When the bit is zero, the clock enters the set state at the completion of the instruction. When the bit is one, the clock remains in the stopped state until the bit is set to zero or until another CPU executes a SET CLOCK instruction affecting the clock. If an external time reference (ETR) is installed, a signal from the ETR may be used to set the set state from the stopped state. When the system is not in the interpretive-execution mode, and an external time reference (ETR) is not attached to the configuration, the TOD-clock-sync control is treated as being zero, regardless of its actual value; in this case, the clock enters the set state and resumes incrementing upon completion of the instruction.

The value of the clock is changed and the clock is placed in the stopped state only if the manual TOD-clock control of any CPU in the configuration is set to the enable-set position or the TOD-clock-control-override control, bit 42 of control register 14, is one. If the TOD-clock control of all CPUs is set to the secure position and the TOD-clock-control-override control is zero, the value and state of the clock are not changed. Whether the clock is set or remains unchanged is distinguished by condition codes 0 and 1, respectively.

When the clock is not operational, the value and state of the clock are not changed, regardless of the settings of the TOD-clock control and the TOD-clock-control-override control, and condition code 3 is set.

Special Conditions

The operand must be designated on a doubleword boundary; otherwise, a specification exception is recognized.

Resulting Condition Code:

- 0 Clock value set
- 1 Clock value secure
- 2 --
- 3 Clock in not-operational state

Program Exceptions:

- Access (fetch, operand 2)

- Privileged operation
- Specification
- Transaction constraint

Programming Notes:

1. When the TOD-clock-steering facility is installed, the use of the SET CLOCK instruction is deprecated. In this case, PTF control functions can be used to provide equivalent function to SET CLOCK.

The SET CLOCK instruction provides no means by which an epoch index can be set. When the multiple-epoch facility is installed, the use of SET CLOCK may result in inconsistent values stored by STORE CLOCK EXTENDED if the epoch index was previously set to a nonzero value. In this case, the PTF control function PTF-STOE (set TOD offset extended) should be used rather than SET CLOCK.

At some future date, the SET CLOCK instruction may be removed from the architecture.

2. SET CLOCK should be issued only while all other activity on all CPUs in the configuration has been suspended. This activity should not be resumed until after the TOD clock has entered the set state.

SET CLOCK COMPARATOR

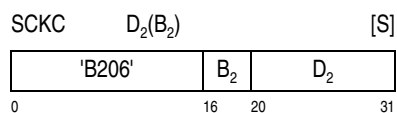

The current value of the clock comparator is replaced by the contents of the doubleword designated by the second-operand address.

Only those bits of the operand are set in the clock comparator that correspond to the bit positions to be compared with the TOD clock; the contents of the remaining rightmost bit positions of the operand are ignored and are not preserved in the clock comparator.

Special Conditions

The operand must be designated on a doubleword boundary; otherwise, a specification exception is recognized.

The operation is suppressed on all addressing and protection exceptions.

Condition Code: The code remains unchanged.

Program Exceptions:

- Access (fetch, operand 2)
- Privileged operation
- Specification
- Transaction constraint

SET CLOCK PROGRAMMABLE FIELD

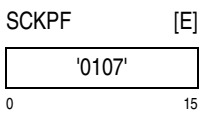

Bits 48-63 of general register 0 are placed in bit positions 16-31 of the TOD programmable register. Zeros are placed in bit positions 0-15 of the TOD programmable register.

Special Conditions

Bits 32-47 of general register 0 must be zeros; otherwise, a specification exception is recognized. Bits 0-31 of general register 0 are ignored.

Condition Code: The code remains unchanged.

Program Exceptions:

- Privileged operation
- Specification
- Transaction constraint

Programming Note: The values in the TOD programmable registers of a configuration should be the same and should be unique within a multiple-configuration system.

SET CPU TIMER

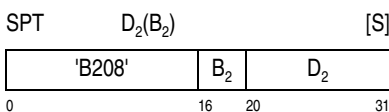

The current value of the CPU timer is replaced by the contents of the doubleword designated by the second-operand address.

Only those bits of the operand are set in the CPU timer that correspond to the bit positions to be updated; the contents of the remaining rightmost bit positions of the operand are ignored and are not preserved in the CPU timer.

Special Conditions

The operand must be designated on a doubleword boundary; otherwise, a specification exception is recognized.

The operation is suppressed on all addressing and protection exceptions.

Condition Code: The code remains unchanged.

Program Exceptions:

- Access (fetch, operand 2)
- Privileged operation
- Specification
- Transaction constraint

SET PREFIX

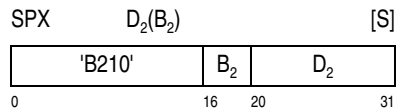

The word at the second-operand location is fetched, and selected bits of the operand are used to form the address of an area that is tested for accessibility. If accessible, the selected bits of the second operand replace contents of the prefix register, and the ART-lookaside buffer (ALB) and translation-lookaside buffer (TLB) of this CPU are cleared of entries.

Operation in the z/Architecture Architectural Mode

Bits 1-18 of the operand with 13 zeros appended on the right and 33 zeros appended on the left are used as an absolute address of the 8 K-byte new prefix area in storage. The contents of bit positions 0 and 19-31 of the second operand are ignored. The two 4 K-byte blocks within the new prefix area are accessed; if either is not available in the configuration, an addressing exception is recognized, and the

operation is suppressed. The accesses to the blocks are not subject to protection; however, the accesses may cause the reference bits for the blocks to be set to ones.

Assuming no access exception is recognized, the contents of bit positions 33-50 of the prefix register are replaced by the contents of bit positions 1-18 of the word at the location designated by the second-operand address.

Operation in the ESA/390-Compatibility Mode

Bits 1-19 of the operand with 12 zeros appended on the right and 33 zeros appended on the left are used as an absolute address of the 4 K-byte new prefix area in storage. The contents of bit positions 0 and 20-31 of the second operand are ignored. The 4 K-byte block within the new prefix area is accessed; if it is not available in the configuration, an addressing exception is recognized, and the operation is suppressed. The access to the block is not subject to protection; however, the access may cause the reference bit for the block to be set to one.

Assuming no access exception is recognized, the contents of bit positions 33-51 of the prefix register are replaced by the contents of bit positions 1-19 of the word at the location designated by the second-operand address.

Common Operation

The address of the prefix area is treated as a 64-bit address regardless of the addressing mode specified by the current PSW.

If the operation is completed, the new prefix is used for any interruptions following the execution of the instruction and for the execution of subsequent instructions.

The ART-lookaside buffer (ALB) and translation-lookaside buffer (TLB) are cleared of entries. The ALB and TLB appear cleared of their original contents, beginning with the fetching of the next sequential instruction.

A serialization function is performed before or after the second operand is fetched and again after the operation is completed.

Special Conditions

The second operand must be designated on a word boundary; otherwise, a specification exception is recognized.

The operation is suppressed on all addressing and protection exceptions.

Condition Code: The code remains unchanged.

Program Exceptions:

- Access (fetch, operand 2)
- Addressing (new prefix area)
- Privileged operation
- Specification
- Transaction constraint

SET PSW KEY FROM ADDRESS

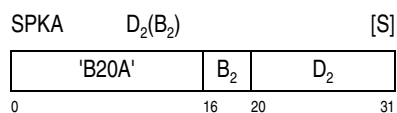

The four-bit PSW key, bits 8-11 of the current PSW, is replaced by bits 56-59 of the second-operand address.

The second-operand address is not used to address data; instead, bits 56-59 of the address form the new PSW key. Bits 0-55 and 60-63 of the second-operand address are ignored.

Special Conditions

In the problem state, the execution of the instruction is subject to control by the PSW-key mask in control register 3. When the bit in the PSW-key mask corresponding to the PSW-key value to be set is one, the instruction is executed successfully. When the selected bit in the PSW-key mask is zero, a privileged-operation exception is recognized. In the supervisor state, any value for the PSW key is valid.

Condition Code: The code remains unchanged.

Program Exceptions:

- Privileged operation (selected PSW-key-mask bit is zero in the problem state)
- Transaction constraint

Programming Notes:

1. The format of SET PSW KEY FROM ADDRESS permits the program to set the PSW key either from the general register designated by the B₂ field or from the D₂ field in the instruction itself.
2. When one program requests another program to access a location designated by the requesting program, SET PSW KEY FROM ADDRESS can be used by the called program to verify that the requesting program is authorized to make this access, provided the storage location of the called program is not protected against fetching. The called program can perform the verification by replacing the PSW key with the requesting-program PSW key before making the access and subsequently restoring the called-program PSW key to its original value. Caution must be exercised, however, in handling any resulting protection exceptions since such exceptions may cause the operation to be terminated. See TEST PROTECTION and the associated programming notes for an alternative approach to the testing of addresses passed by a calling program.

SET SECONDARY ASN

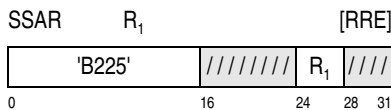

SET SECONDARY ASN WITH INSTANCE

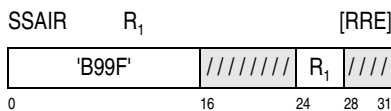

Note: In this instruction definition, the name “SET SECONDARY ASN (WITH INSTANCE)” refers to the SET SECONDARY ASN instruction and the SET SECONDARY ASN WITH INSTANCE instruction.

The ASN specified in bit positions 48-63 of general register R₁ replaces the secondary ASN in control register 3, and the address-space-control element corresponding to that ASN replaces the SASCE in control register 7.

The contents of bit positions 48-63 of general register R₁ are called the new ASN. For SET SECONDARY ASN WITH INSTANCE, bits 0-31 of the register are an STEIN and are compared against the new SAS-STEIN if the SASTEIN is not set equal to the PASTEIN, and bits 32-47 of the register are ignored. For SET SECONDARY ASN, bits 0-47 of the register are ignored.

When the new ASN is equal to the current PASN, the operation is called SET SECONDARY ASN (WITH INSTANCE) to current primary (SSAR-cp or SSAIR-cp); when the fields are not equal, the operation is called SET SECONDARY ASN (WITH INSTANCE) with space switching (SSAR-ss or SSAIR-ss). The SSAR-cp and SSAR-ss operations are depicted in Figure 10-82 on page 10-131. The SSAIR-cp and SSAIR-ss operations are depicted in Figure 10-83 on page 10-132.

SET SECONDARY ASN (WITH INSTANCE) to Current Primary (SSAR-cp or SSAIR-cp)

In the SSAR-cp or SSAIR-cp operation, the new ASN is equal to the PASN. The new ASN replaces the SASN, bits 48-63 of control register 3; the PASCE in control register 1 replaces the SASCE in control register 7.

In SSAR-cp, if the ASN-and-LX-reuse facility is installed and is enabled by a one value of the ASN-and-LX-reuse control, bit 44 of control register 0, the SASTEIN in bit positions 0-31 of control register 3 is replaced by the PASTEIN in bit positions 0-31 of control register 4. This replacement occurs in SSAIR-cp regardless of the value of the ASN-and-LX-reuse control. In SSAIR-cp, there is not a test of whether the current PASTEIN equals the ASTEIN in bit positions 0-31 of general register R₁; the ASTEIN is ignored. The operation is completed.

SET SECONDARY ASN (WITH INSTANCE) with Space Switching (SSAR-ss or SSAIR-ss)

In the SSAR-ss or SSAIR-ss operation, the new ASN is not equal to the PASN, and the new ASN is translated by means of a two-level table lookup. Bits 0-9 of the new ASN (bits 48-57 of the register) are a 10-bit AFX which is used to select an entry from the ASN first table. Bits 10-15 of the new ASN (bits 58-63 of the register) are a six-bit ASX which is used to select an entry from the ASN second table. The two-level lookup is described in “ASN Translation” on page 3-30. The exceptions associated with ASN

translation are collectively called “ASN-translation exceptions.” These exceptions and their priority are described in Chapter 6, “Interruptions.”

In SSAR-ss, if the ASN-and-LX-reuse facility is installed and is enabled by the ASN-and-LX-reuse control in control register 0, the reusable-ASN bit, bit 63, in the located ASN-second-table entry (ASTE) must be zero; otherwise, a special-operation exception is recognized. In SSAIR-ss, regardless of the ASN-and-LX-reuse control, the controlled-ASN bit, bit 62, in the ASTE must be zero in the problem state; otherwise, a special-operation exception is recognized. Also in SSAIR-ss, and regardless of the ASN-and-LX-reuse control and the reusable-ASN bit, the ASTEIN in bit positions 0-31 of general register R₁ must equal the ASTEIN in bit positions 352-383 of the ASTE; otherwise, an ASTE-instance exception is recognized.

The ASN-second-table entry (ASTE) obtained as a result of the second lookup contains the address-space-control element and the authority-table origin and length associated with the ASN.

The authority-table origin from the ASTE is used as a base for a third table lookup. The current authorization index, bits 32-47 of control register 4, is used, after it has been checked against the authority-table length, as the index to locate the entry in the authority table. The authority-table lookup is described in “ASN Authorization” on page 3-35.

The new ASN, bits 48-63 of general register R₁, replaces the SASN, bits 48-63 of control register 3. The address-space-control element in the ASTE replaces the SASCE in control register 7. In SSAR-ss if ASN-and-LX reuse is enabled, and in SSAIR-ss regardless of that enablement, the ASTEIN in the ASTE replaces the SASTEIN in bit positions 0-31 of control register 3.

The description in this paragraph applies to use of the subspace-group facility. After the new SASCE has been placed in control register 7, if (1) the subspace-group-control bit, bit 54, in the SASCE is one, (2) the dispatchable unit is subspace active, and (3) the ASTE obtained by ASN translation is the ASTE for the base space of the dispatchable unit, then bits 0-55 and 58-63 of the SASCE are replaced by the same bits of the ASCE in the ASTE for the subspace in which the dispatchable unit last had con-

trol. Further details are in “Subspace-Replacement Operations” on page 5-70.

SET SECONDARY ASN (WITH INSTANCE) Serialization

For any of the SSAR-cp, SSAIR-cp, SSAR-ss, and SSAIR-ss operations, a serialization and checkpoint-synchronization function is performed before the operation begins and again after the operation is completed. However, it is unpredictable whether or not a store into a trace-table entry from which a subsequent instruction is fetched will be observed by the CPU that performed the store.

Special Conditions

The operation is performed only when the ASN-translation control, bit 44 of control register 14, is one and DAT is on. When either the ASN-translation-control bit is zero or DAT is off, a special-operation exception is recognized.

In SSAR-ss when ASN-and-LX reuse is enabled, the reusable-ASN bit in the ASN-second-table entry (ASTE) must be zero; otherwise, a special-operation exception is recognized. In SSAIR-ss, regardless of the ASN-and-LX-reuse control, a special-operation exception is recognized if the controlled-ASN bit in the ASTE is one and the CPU is in the problem state, and an ASTE-instance exception is recognized if the ASTEIN in general register R₁ is not equal to the ASTEIN in the ASTE.

Condition Code: The code remains unchanged.

Program Exceptions:

- Addressing (authority-table entry, SSAR-ss and SSAIR-ss only)
- ASN translation (SSAR-ss and SSAIR-ss only)
- ASTE instance (SSAIR-ss only)
- Operation (if ASN-and-LX-reuse facility is not installed, SSAIR only)
- Secondary authority (SSAR-ss and SSAIR-ss only)
- Special operation
- Subspace replacement (SSAR-ss and SSAIR-ss only)
- Trace
- Transaction constraint

The priority of recognition of program exceptions for the instruction is shown in Figure 10-81 on page 10-130.

1.-6.	Exceptions with the same priority as the priority of program-interruption conditions for the general case.
7.A	Access exceptions for second instruction halfword.
7.B.1	Operation exception (SSAIR only, if the ASN-and-LX-reuse facility is not installed).
7.B.2	Special-operation exception due to DAT being off, or the ASN-translation control, bit 44 of control register 14, being zero.
7.C	Transaction constraint.
8.A	Trace exceptions.
8.B.1	ASN-translation exceptions (SSAR-ss and SSAIR-ss only).
8.B.2	Special-operation exception due to ASN-and-LX reuse enabled and reusable-ASN bit in ASN-second-table entry being one (SSAR-ss only).
8.B.3	Special-operation exception due to controlled-ASN bit in ASN-second-table entry being one in the problem state (SSAIR-ss only).
8.B.4	ASTE-instance exception due to ASTEIN in general register R_1 not being equal to ASTEIN in ASN-second-table entry (SSAIR-ss only).

Figure 10-81. Priority of Execution: SET SECONDARY ASN (WITH INSTANCE) (Part 1 of 2)

	Note: Subspace-replacement exceptions, which are not shown in detail in this figure, can occur with any priority after 8.B.4.
8.B.5	Secondary-authority exception due to authority-table entry being outside table (SSAR-ss and SSAIR-ss only).
8.B.6	Addressing exception for access to authority-table entry (SSAR-ss and SSAIR-ss only).
8.B.7	Secondary-authority exception due to S bit in authority-table entry being zero (SSAR-ss and SSAIR-ss only).

Figure 10-81. Priority of Execution: SET SECONDARY ASN (WITH INSTANCE) (Part 2 of 2)

Programming Note: A program given control by a basic PROGRAM CALL operation can use EXTRACT SECONDARY ASN AND INSTANCE to obtain the ASTEIN to be used by PROGRAM TRANSFER WITH INSTANCE to return to the calling program or by SET SECONDARY ASN WITH INSTANCE to restore its secondary address space after a change of that space. This EXTRACT SECONDARY ASN AND INSTANCE instruction should be executed while the original secondary space remains continuously the secondary space; otherwise, depending on actions by the control program, EXTRACT SECONDARY ASN AND INSTANCE may return an ASTEIN that allows return to or use of a conceptually incorrect secondary space for which the ASTEIN has been changed.

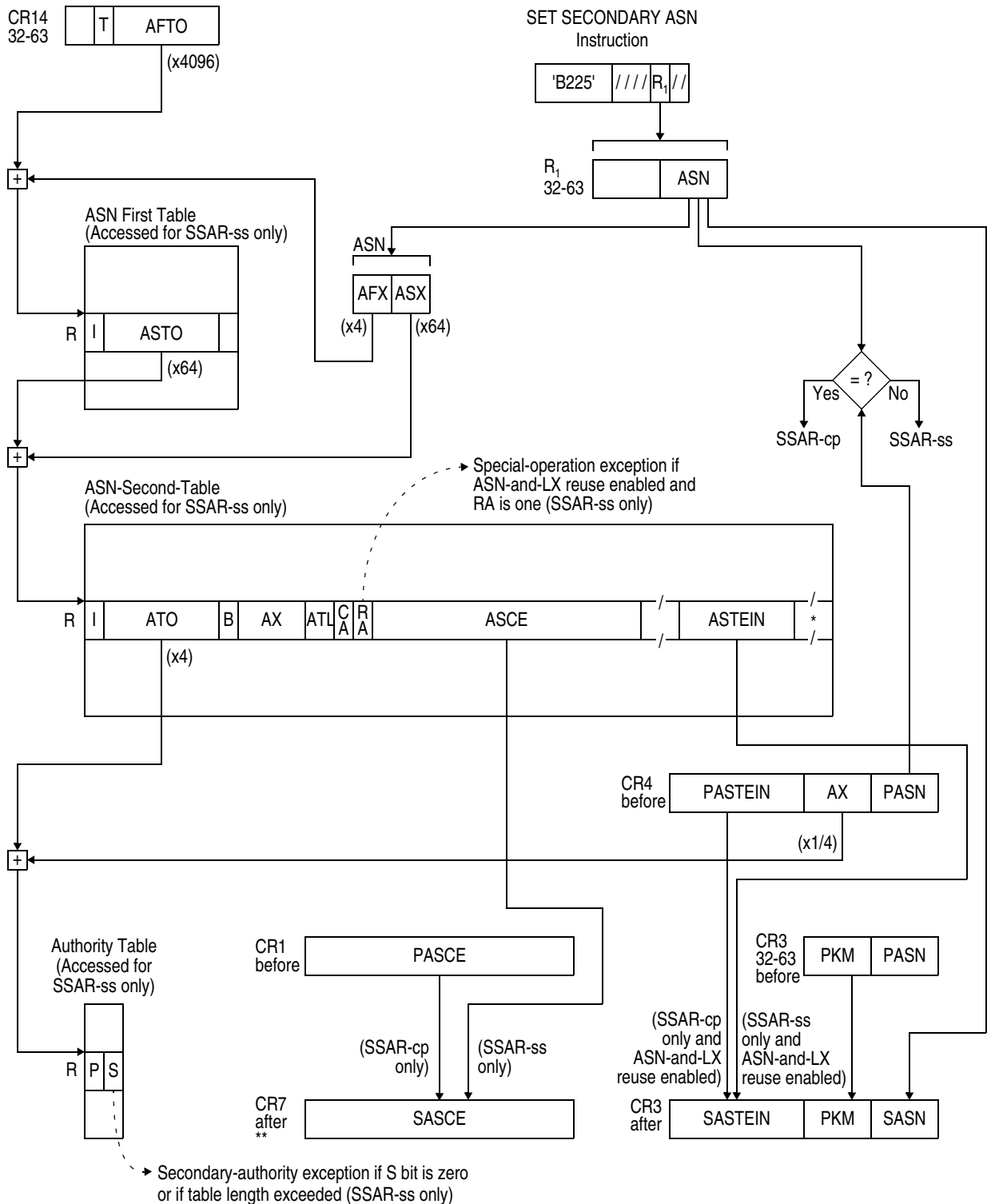

R: Address is real

*: ASTE is 64 bytes; selected fields and the last 16 bytes are not shown.

** : For SSAR-ss only, bits 0-55 and 58-63 of SASCE may be replaced from a subspace ASCE

Figure 10-82. Execution of SET SECONDARY ASN

SET SECONDARY ASN WITH INSTANCE

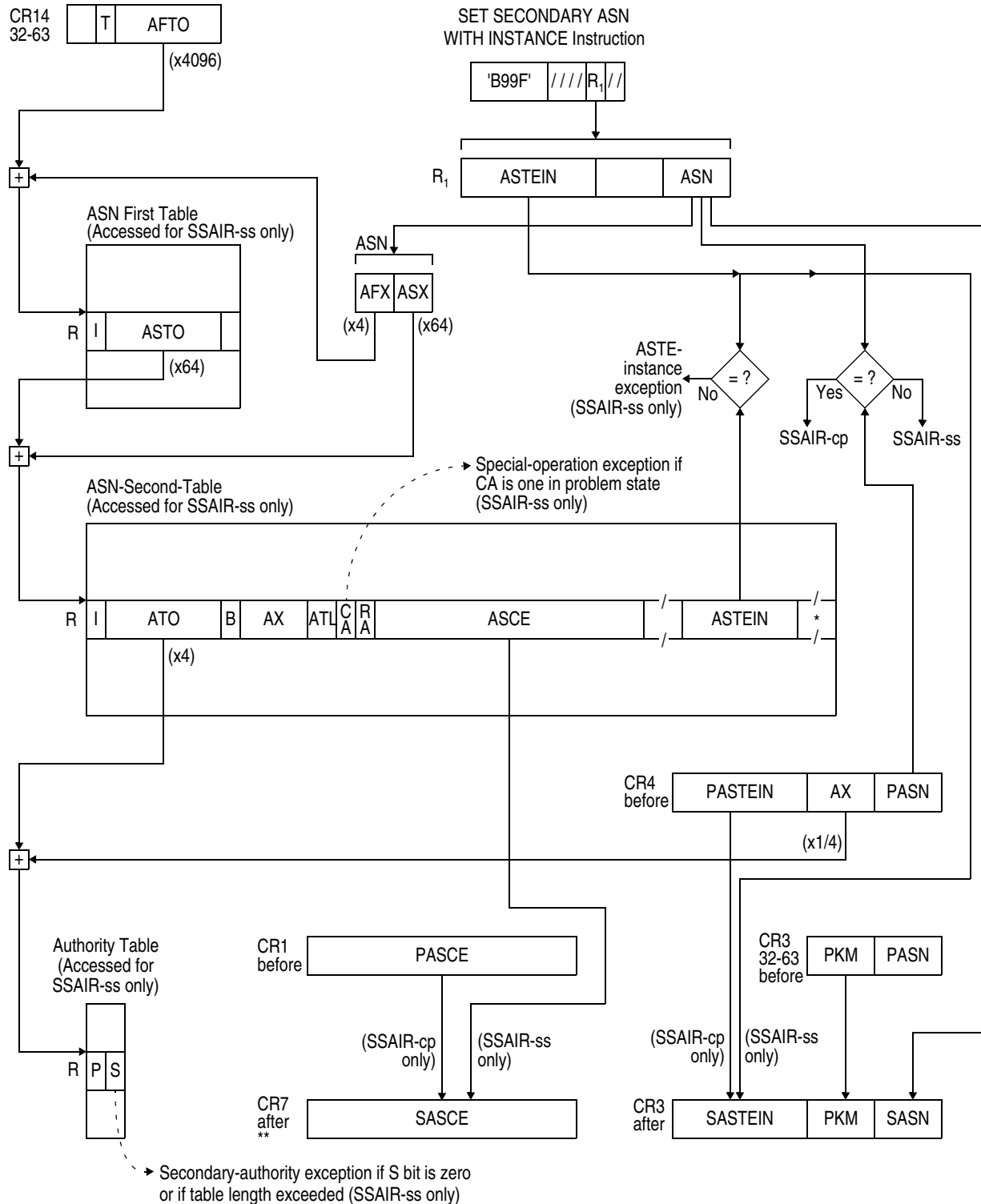

R: Address is real
 *: ASTE is 64 bytes; selected fields and the last 16 bytes are not shown.
 **: For SSAIR-ss only, bits 0-55 and 58-63 of SASCE may be replaced from a subspace ASCE

Figure 10-83. Execution of SET SECONDARY ASN WITH INSTANCE

SET STORAGE KEY EXTENDED

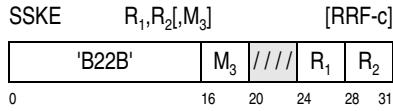

The storage key for one or more 4 K-byte blocks is replaced by the value in the first-operand register. When the conditional-SSKE facility is installed, certain functions of the key-setting operation may be bypassed.

When the conditional-SSKE facility is not installed, or when the conditional-SSKE facility is installed and both the MR and MC bits of the M_3 field are zero, the storage key for the 4 K-byte block that is addressed by the contents of general register R_2 is replaced by bits from general register R_1 . The instruction completes without changing the condition code.

When the conditional-SSKE facility is installed and either or both of the MR and MC bits are one, the access-control bits, fetch-protection bit, and, optionally, the reference bit and change bit of the storage key that is addressed by the contents of general register R_2 are compared with corresponding bits in general register R_1 . If the compared bits are equal, then no change is made to the key; otherwise, selected bits of the key are replaced by the corresponding bits in general register R_1 . The storage key prior to any modification is inserted in general register R_1 , and the result is indicated by the condition code.

When the enhanced-DAT facility 1 is installed, the above operations may be repeated for the storage keys of multiple 4 K-byte blocks within the same 1MB block, subject to the control of the multiple-block control, described below.

The M_3 field has the following format:



The bits of the M_3 field are defined as follows:

- **Nonquiescing Control (NQ):** The NQ bit, bit 0 of the M_3 field, controls whether a quiescing operation is performed, as described below.

- **Reference-Bit-Update Mask (MR):** The MR bit, bit 1 of the M_3 field, controls whether updates to the reference bit in the storage key may be bypassed, as described below.
- **Change-Bit-Update Mask (MC):** The MC bit, bit 2 of the M_3 field, controls whether updates to the change bit in the storage key may be bypassed, as described below.
- **Multiple-Block Control (MB):** The MB bit, bit 3 of the M_3 field, controls whether the storage keys for multiple 4 K-byte blocks of storage may be set, as described in “Setting Storage Keys in Multiple 4 K-byte Blocks” on page 10-135.

When the nonquiescing key-setting facility is not installed, bit 0 of the M_3 field is ignored. When the conditional-SSKE facility is not installed, bit positions 1 and 2 of the M_3 field are ignored. When the enhanced-DAT facility 1 is not installed, bit position 3 of the M_3 field is ignored.

When the conditional-SSKE facility is installed, processing is as follows:

1. When both the MR and MC bits, bits 1 and 2 of the M_3 field, are zero, the instruction completes as though the conditional-SSKE facility was not installed. The storage key for the 4 K-byte block that is addressed by the contents of general register R_2 is replaced by bits from general register R_1 , and the instruction completes without changing the condition code.
2. When either or both the MR and MC bits are one, processing is as follows:
 - a. Prior to any modification, the contents of the storage key for the 4 K-byte block that is addressed by general register R_2 are placed in bit positions 48-54 of general register R_1 , and bit 55 of general register R_1 is set to zero. Bits 0-47 and 56-63 of the register remain unchanged.

If an invalid checking-block code (CBC) is detected when fetching the storage key, then (a) the entire storage key for the 4 K-byte block is replaced by bits 56-62 of general register R_1 , (b) the contents of bit positions 48-55 of general register R_1 are unpredictable, and (c) the instruction completes by setting condition code 3.

- b. The access-control bits and fetch-protection bit of the storage key for the designated 4 K-byte block are compared with the corresponding fields in bits 56-60 of general register R_1 . If the respective fields are not equal, the entire storage key for the 4 K-byte block is replaced by bits from general register R_1 , and the instruction completes by setting condition code 1.

When the access-control and fetch-protection bits in the storage key are equal to the respective bits in general register R_1 , processing continues as described below.

- c. When both the MR and MC bits are one, the instruction completes by setting condition code 0. The storage key remains unchanged in this case.
- d. When the MR bit is zero and the MC bit is one, then the reference bit of the storage key for the designated 4 K-byte block is compared with bit 61 of general register R_1 . If the bits are equal, the instruction completes by setting condition code 0. The storage key remains unchanged in this case.

If the bits are not equal, then either (a) the entire storage key for the designated 4 K-byte block is replaced by the bits in general register R_1 , and the instruction completes by setting condition code 1; or (b) the reference bit for the storage key is replaced by bit 61 of general register R_1 , the change bit for the key is unpredictable, and the instruction completes by setting condition code 2. It is unpredictable whether condition code 1 or 2 is set.

- e. When the MC bit is zero and the MR bit is one, then the change bit of the storage key for the designated 4 K-byte block is compared with bit 62 of general register R_1 . If the bits are equal, the instruction completes by setting condition code 0. The storage key remains unchanged in this case, except that the reference bit is unpredictable.

If the bits are not equal, then either (a) the entire storage key for the designated 4 K-byte block is replaced by the bits in general register R_1 , and the instruction completes by setting condition code 1; or (b) the

change bit for the storage key is replaced by bit 62 of general register R_1 , the reference bit for the key is unpredictable, and the instruction completes by setting condition code 2. It is unpredictable whether condition code 1 or 2 is set.

When the enhanced-DAT facility 1 is not installed, or when the facility is installed but the multiple-block control is zero, general register R_2 contains a real address. When the enhanced-DAT facility 1 is installed and the multiple-block control is one, general register R_2 contains an absolute address.

In the 24-bit addressing mode, bits 40-51 of general register R_2 designate a 4 K-byte block in real or absolute storage, and bits 0-39 and 52-63 of the register are ignored. In the 31-bit addressing mode, bits 33-51 of general register R_2 designate a 4 K-byte block in real or absolute storage, and bits 0-32 and 52-63 of the register are ignored. In the 64-bit addressing mode, bits 0-51 of general register R_2 designate a 4 K-byte block in real or absolute storage, and bits 52-63 of the register are ignored.

Because it is a real or absolute address, the address designating the storage block is not subject to dynamic address translation. The reference to the storage key is not subject to a protection exception.

The new seven-bit storage-key value, or selected bits thereof, is obtained from bit positions 56-62 of general register R_1 . The contents of bit positions 0-55 and 63 of the register are ignored. When the conditional-SSKE facility is installed, and either or both the MR and MC bits are one, bit position 63 should contain a zero; otherwise, the program may not operate compatibly in the future.

A serialization and checkpoint-synchronization function is performed before the operation begins and again after the operation is completed, except that when the conditional-SSKE facility is installed and the resulting condition code is 0, it is unpredictable whether a serialization and checkpoint-synchronization function is performed after the operation completes.

When the nonquiescing key-setting facility is not installed, or when the facility is installed and the nonquiescing control (NQ) is zero, the following applies:

- A quiescing operation is performed.

- For any store access, by any CPU or channel program, completed to the designated 4 K-byte block either before or after the setting of the key by this instruction, the associated setting of the reference and change bits to one in the storage key for the block also is completed before or after, respectively, the execution of this instruction.
- Bits 52-63 of general register R_2 remain unchanged.
- When either or both the MR or MC bits are one, bits 48-55 of general register R_1 are unpredictable.

When the nonquiescing key-setting facility is installed and the NQ control is one, a quiescing operation is not necessarily performed. See “Storage-Key Accesses” on page 5-120 for a discussion the effects of quiescing on key-setting instructions, and see “Quiescing” on page 5-133 for details on the quiescing operation.

Setting Storage Keys in Multiple 4 K-byte Blocks

When the enhanced-DAT facility 1 is not installed, or when the facility is installed, but the multiple-block control is zero, the storage key for a single 4 K-byte block is set, as described above.

When the enhanced-DAT facility 1 is installed, and the multiple-block control is one, the storage keys for multiple 4 K-byte blocks within a 1 M-byte block may be set, beginning with the block specified by the second-operand address, and continuing to the right with each successive block up to the next 1 M-byte boundary. In this case, SET STORAGE KEY EXTENDED is interruptible, and processing is as follows:

- When an interruption occurs (other than one that follows termination), the leftmost bits of general register R_2 comprising the 4 K-byte block address have been updated so the instruction, when reexecuted, resumes at the point of interruption. If either or both the MR or MC bits are one, the condition code is unpredictable; otherwise, the condition code is unchanged.
- When the instruction completes without interruption, the leftmost bits of general register R_2 comprising the 4 K-byte block address have been updated to the next 1 M-byte boundary. If either or both the MR or MC bits are one, condition code 3 is set; otherwise, the condition code is unchanged.

In either of the above two cases, the following applies:

When multiple-block processing occurs and the R_1 and R_2 fields designate the same register, the second-operand address is placed in the register. When multiple-block processing occurs in the 24-bit or 31-bit addressing modes, the leftmost bits which are not part of the address in bit positions 32-63 of general register R_2 are set to zeros; bits 0-31 of the register are unchanged.

Before a quiescing key-setting operation is performed, transactional execution by other CPUs in the configuration is aborted with abort code 255, condition code 2. The aborting of transactional execution affects at least those CPUs accessing the locations (transactionally or nontransactionally) for which storage keys are being set. It is unpredictable whether some or all other CPUs are affected as well.

Resulting Condition Code:

When the conditional-SSKE facility is not installed, or when both the MR and MC bits of the M_3 field are zero, the condition code remains unchanged.

When the conditional-SSKE facility is installed, and either or both of the MR and MC bits are one, the condition code is set as follows:

- | | |
|---|---|
| 0 | Storage key not set |
| 1 | Entire storage key set |
| 2 | Partial storage key set |
| 3 | Entire storage key set; bits 48-55 of general register R_1 are unpredictable. |

Program Exceptions:

- Addressing (address specified by general register R_2)
- Privileged operation
- Transaction constraint

Programming Notes:

1. The M_3 field of the instruction is considered to be optional, as indicated by the field being contained within brackets [] in the assembler syntax.

When the M_3 field is not specified, the assembler places zeros in that field of the instruction.

- When setting multiple storage keys within the same 1 M-byte block to the same value, use of the multiple-block control (MB, bit 3 of the M_3 field) may yield better performance than executing separate SSKE instructions for each 4 K-byte block in the megabyte.
- If the program does not rely on the setting of the reference bit, it may set the MR bit of the M_3 field to one, regardless of whether or not the conditional-SSKE facility is installed. Similarly, if the program does not rely on the setting of the change bit, it may set the MC bit of the M_3 field to one, regardless of whether or not the conditional-SSKE facility is installed. In these cases, the program cannot rely on the condition code or the key value returned in general register R_1 . Conversely, if the program depends on accurate setting of the reference or change bit, then the MR and MC bits should be set to zero, such that reference and change bit recording are properly maintained when the conditional-SSKE facility is installed.
- When SSKE is issued, the program must ensure that no channel subsystem is simultaneously altering the storage designated by general register R_2 . The program also must ensure that no other CPU or channel subsystem is accessing the storage designated by general register R_2 when the nonquiescing (NQ) control is one. Otherwise, unpredictable results may be observed by the other CPUs and channel subsystem, including the alteration of the block designated by general register R_2 .
- Even when the enhanced-DAT facility 2 is installed, the multiple-block control is limited to setting keys in a 1 M-byte block; no provision is made for setting keys in a 2 G-byte block with SSKE. PERFORM FRAME MANAGEMENT FUNCTION with a set-key control of 1 and frame-size code of 2 may be used to set the keys of a 2 G-byte block. See "PERFORM FRAME MANAGEMENT FUNCTION" on page 10-80 for additional details.
- See the programming note on page 5-122 for restrictions on the use of the nonquiescing control.

SET SYSTEM MASK

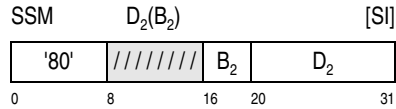

Bits 0-7 of the current PSW are replaced by the byte at the location designated by the second-operand address.

Bits 8-15 of the instruction are reserved and should contain zeros; otherwise, the program may not operate compatibly in the future.

Special Conditions

When the SSM-suppression-control bit, bit 33 of control register 0, is one and the CPU is in the supervisor state, a special-operation exception is recognized.

The value to be loaded into the PSW is not checked for validity before loading. However, immediately after loading, a specification exception is recognized, and a program interruption occurs, if either (a) the contents of bit positions 0 and 2-4 of the PSW are not all zeros, or (b) in the ESA/390-compatibility mode, bit position 5 of the PSW does not contain zero. In either of these cases, the instruction is completed, and the instruction-length code is set to 2 or 3. The specification exception, which is listed as a program exception for this instruction, is described in "Early Exception Recognition" on page 6-9.

The operation is suppressed on all addressing and protection exceptions.

Condition Code: The code remains unchanged.

Program Exceptions:

- Access (fetch, operand 2)
- Privileged operation
- Special operation
- Specification
- Transaction constraint

SIGNAL PROCESSOR

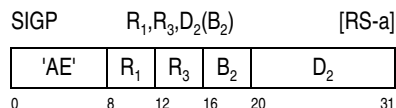

An eight-bit order code and, if called for, a 64-bit parameter are transmitted to the CPU designated by the CPU address contained in the third operand. The result is indicated by the condition code and may be detailed by status assembled in bit positions 32-63 of the first-operand location.

The second-operand address is not used to address data; instead, bits 56-63 of the address contain the eight-bit order code. Bits 0-55 of the second-operand address are ignored. The order code specifies the function to be performed by the addressed CPU. The assignment and definition of order codes appear in "CPU Signaling and Response" on page 4-85.

The 16-bit binary number contained in bit positions 48-63 of general register R_3 forms the CPU address. Bits 0-47 of the register are ignored. When the specified order is the set-architecture or set multithreading order, the CPU address is ignored; all CPUs in the configuration are considered to be addressed. See "CPU-Address Identification" on page 4-84 for details on the CPU address.

The general register containing the 64-bit parameter in bit positions 0-63 is R_1 or R_1+1 , whichever is the odd-numbered register. It depends on the order code whether a parameter is provided and for what purpose it is used.

The operands just described have the following formats:

General register designated by R_1 :

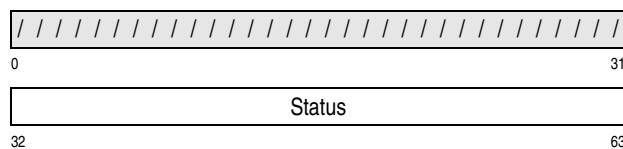

General register designated by R_1 or $R_1 + 1$, whichever is the odd-numbered register:

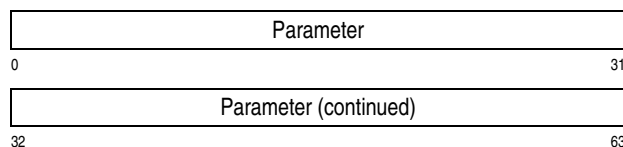

General register designated by R_3 :

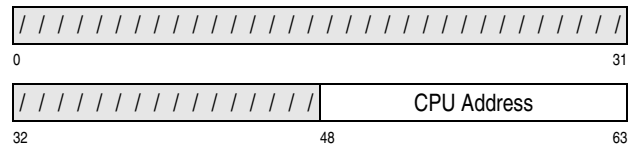

Second-operand address:

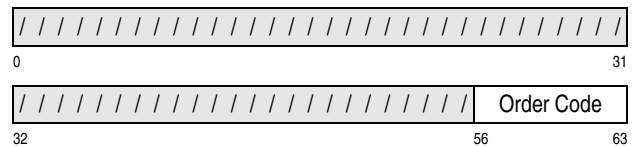

A serialization function is performed before the operation begins and again after the operation is completed.

When the order code is accepted and no nonzero status is returned, condition code 0 is set. When status information is generated by this CPU or returned by the addressed CPU, the status is placed in bit positions 32-63 of general register R_1 , bits 0-31 of the register remain unchanged, and condition code 1 is set.

When the access path to the addressed CPU is busy, or the addressed CPU is operational but in a state where it cannot respond to the order code, condition code 2 is set.

When the addressed CPU is not operational (that is, it is not provided in the installation, it is not in the configuration, it is in any of certain customer-engineer test modes, or its power is off), condition code 3 is set.

Resulting Condition Code:

- 0 Order code accepted
- 1 Status stored
- 2 Busy
- 3 Not operational

Program Exceptions:

- Privileged operation
- Transaction constraint

Programming Notes:

1. A more detailed discussion of the condition-code settings for SIGNAL PROCESSOR is contained in "CPU Signaling and Response" on page 4-85.
2. To ensure that presently written programs will be executed properly when new facilities using additional bits are installed, only zeros should appear in the unused bit positions of the second-operand address and in bit positions 32-47 of general register R_3 .
3. Certain SIGNAL PROCESSOR orders are provided with the expectation that they will be used primarily in special circumstances. Such orders may be implemented with the aid of an auxiliary maintenance or service processor, and, thus, the execution time may take several seconds. Unless all of the functions provided by the order are required, combinations of other orders, in conjunction with appropriate programming support, can be expected to provide a specific function more rapidly. The following orders are the only orders which are intended for frequent use:
 - Conditional emergency signal
 - Emergency-signal
 - External-call
 - Sense
 - Sense-running-status

The following orders are intended for infrequent use, and performance therefore may be much slower than for frequently used orders:

- CPU reset
- Initial CPU reset
- Restart
- Set architecture
- Set multithreading
- Set prefix
- Store additional status at address
- Store status at address
- Start
- Stop
- Stop and store status

An alternative to the set-prefix order, for faster performance when the receiving CPU is not already stopped, is the use of the emergency-signal or external-call order, followed by the execution of a SET PREFIX instruction on the addressed CPU. Clearing the TLB of entries is ordinarily accomplished more rapidly through the use of the emergency-signal or external-call

order, followed by execution of the PURGE TLB instruction on the addressed CPU, than by use of the set-prefix order.

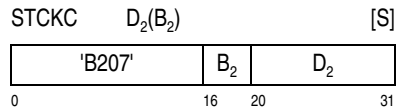
STORE CLOCK COMPARATOR

The current value of the clock comparator is stored at the doubleword location designated by the second-operand address.

Zeros are provided for the rightmost bit positions of the clock comparator that are not compared with the TOD clock.

Special Conditions

The operand must be designated on a doubleword boundary; otherwise, a specification exception is recognized.

Condition Code: The code remains unchanged.

Program Exceptions:

- Access (store, operand 2)
- Privileged operation
- Specification
- Transaction constraint

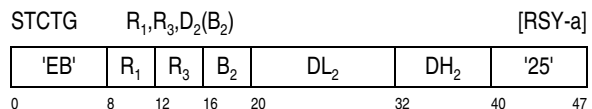
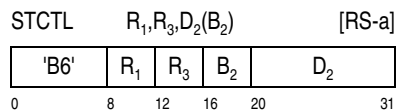
STORE CONTROL

Bits of the set of control registers starting with control register R_1 and ending with control register R_3 are stored at the locations designated by the second-operand address.

For STORE CONTROL (STCTL), bits 32-63 of the control registers are stored in successive words

beginning at the second-operand address, and bits 0-31 of the registers are ignored. For STORE CONTROL (STCTG), bits 0-63 of the control registers are stored in successive doublewords beginning at the second-operand address.

The storage area where the contents of the control registers are placed starts at the location designated by the second-operand address and continues through as many storage words, for STCTL, or doublewords, for STCTG, as the number of control registers specified. The contents of the control registers are stored in ascending order of their register numbers, starting with control register R_1 and continuing up to and including control register R_3 , with control register 0 following control register 15. The contents of the control registers remain unchanged.

The displacement for STCTL is treated as a 12-bit unsigned binary integer. The displacement for STCTG is treated as a 20-bit signed binary integer.

Special Conditions

The second operand must be designated on a word boundary for STCTL or on a doubleword boundary for STCTG; otherwise, a specification exception is recognized.

Condition Code: The code remains unchanged.

Program Exceptions:

- Access (store, operand 2)
- Privileged operation
- Specification
- Transaction constraint

STORE CPU ADDRESS

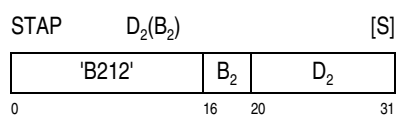

The CPU address by which this CPU is identified in a multiprocessing configuration is stored at the halfword location designated by the second-operand address.

Special Conditions

The operand must be designated on a halfword boundary; otherwise, a specification exception is recognized.

Condition Code: The code remains unchanged.

Program Exceptions:

- Access (store, operand 2)
- Privileged operation
- Specification
- Transaction constraint

STORE CPU ID

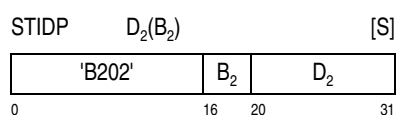

Information identifying (a) the execution environment, (b) the system serial number, (c) the machine type, and (d) the format of the response is stored at the doubleword location designated by the second-operand address. Depending on the format of the response, the CPU address, logical partition identification, or both may also be stored.

The information stored has the following format:

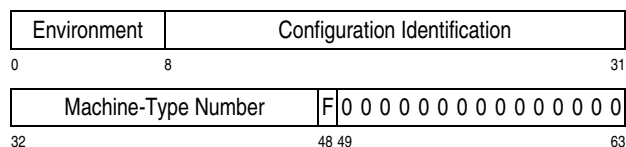

Environment: Bit positions 0-7 contain an indication of the environment in which the instruction was executed, as follows:

- For a program being executed by an IBM machine in a level-1 configuration (the basic machine), or for a program being executed by a level-2 configuration (in a logical partition), the environment field contains 00 hex.
- For a program being executed natively by the System z Personal-Development Tool (that is, when not executed in a virtual machine running on the zPDT), the environment field contains either C1 hex or D3 hex. (See programming note 6 on page 10-141).

- For a program being executed by a level-3 configuration (a virtual machine), the environment field contains FF hex.

Configuration Identification: Bit positions 8-31 contain six hexadecimal digits. Depending on the environment, the rightmost of these digits may be (a) selected from some or all of the machine's physical serial number, (b) derived from either the zPDT token or the zPDT unique-identification-manager (UIM) server, or (c) assigned by the virtual machine definition.

- When executed by a level-1 configuration, bits 8-31 are stored as follows:

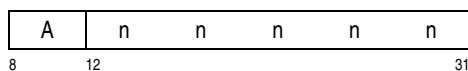

- When the format bit (bit 48 of the response) is zero, bit positions 8-11 (A) contain the rightmost hexadecimal digit of the physical CPU address. When the format bit is one, bit positions 8-11 contain zeros.
- Bit positions 12-31 (nnnnn) contain the rightmost five hexadecimal digits of the machine's physical serial number.
- When executed by a level-2 configuration, and the format bit is zero, bits 8-31 are stored as follows:

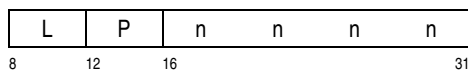

- Bit positions 8-11 (L) contain the rightmost hexadecimal digit of the logical CPU address.
- Bit positions 12-15 (P) contain a hexadecimal digit identifying the logical partition.
- Bit positions 16-31 (nnnn) contain the rightmost four hexadecimal digits of the machine's physical serial number.
- When executed by a level-2 configuration, and the format bit is one, bits 8-31 are stored as follows:

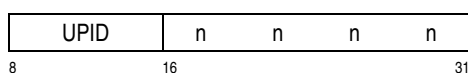

- Bit positions 8-15 contains a two hexadecimal digit user-partition identifier (UPID) which is bound to the logical partition.

- Bit positions 16-31 (nnnn) contains the rightmost four hexadecimal digits of the system's serial number.

- When executed by a zPDT configuration, the results are similar to those defined for a level-2 configuration when the format bit is one. See programming note 6 for further details.
- When executed by a level-3 configuration, the results are similar to those defined for a level-2 configuration. However, the hypervisor can supply alternate configuration identification.

Machine-Type Number: Bit positions 32-47 contain an unsigned packed-decimal number identifying the machine type of the CPU.

Format Indication (F): Bit position 48 specifies the format of the first two hexadecimal digits of the configuration-identification field, as described above.

Reserved: Bit positions 49-63 are reserved and stored as zeros.

Special Conditions

The operand must be designated on a doubleword boundary; otherwise, a specification exception is recognized.

Condition Code: The code remains unchanged.

Program Exceptions:

- Access (store, operand 2)
- Privileged operation
- Specification
- Transaction constraint

Programming Notes:

- The STORE SYSTEM INFORMATION (STSI) instruction provides more comprehensive and complete information identifying the machine, logical partition, and CPU on which the program is executing. In order to ensure world-wide unique identification of the configuration of the issuing CPU, the STSI instruction specifying SYSIB 1.1.1, 1.2.1, 2.2.1, or 3.2.2 should be used.

2. The program should allow for the possibility that the configuration-identification field may contain the hexadecimal digits A-F as well as the digits 0-9.
3. The format bit is stored as one beginning with the IBM eServer zSeries 990 and in newer models.
4. Except when executed in a level-3 configuration (that is, except when executed by a virtual machine), the value of the rightmost four or five hexadecimal digits of the configuration-identification field are equivalent to the value of the corresponding rightmost EBCDIC characters stored in the sequence-code field of the SYSIB 1.1.1 stored by STSI. When executed in a level-3 configuration, the hypervisor may provide a means by which an alternate configuration identification can be specified; however, the sequence code reported in the SYSIB 1.1.1 is that of the real machine, even when executed by a virtual machine.

Except when executed in a level-3 configuration, the content of the machine-type-number field stored by STIDP is equivalent to the EBCDIC type field of the SYSIB 1.1.1 stored by STSI. When executed in a level-3 configuration, hypervisor features such as live guest relocation may alter machine-type number stored by STIDP to reflect the machine type corresponding to a virtual architecture level. However, the type field reported in the SYSIB 1.1.1 is that of the real machine, even when executed by a virtual machine.

5. In previous versions of the architecture, bit positions 0-7 were called the version code. Prior to z/Architecture, a nonzero version code was usually indicative of the model number and number of CPUs contained in the model.

In previous versions of the architecture, bit positions 8-31 were called the CPU-identification number. This has been renamed the configuration-identification field to more accurately represent its z/Architecture content.

6. The following applies to execution of STIDP on the System z Personal-Development Tool (zPDT) or Rational Development and Test Environment for System z (RD&T; for brevity the term zPDT also applies to RD&T):
 - The user-partition identifier (UPID) is associated with the Linux zPDT instance number.

The zPDT instance-number field contains a value from 1-255, derived from either the zPDT token or from the unique-identification-manager (UIM) server.

- The rightmost four hex digits of the configuration-identification field (called the serial number in zPDT documentation) contain a 16-bit binary value from 1-65,535 that is derived from the UIM server.

STORE CPU TIMER

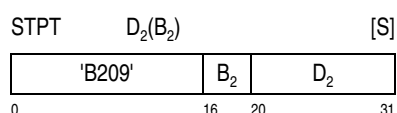

The current value of the CPU timer is stored at the doubleword location designated by the second-operand address.

Zeros are provided for the rightmost bit positions that are not updated by the CPU timer.

Special Conditions

The operand must be designated on a doubleword boundary; otherwise, a specification exception is recognized.

Condition Code: The code remains unchanged.

Program Exceptions:

- Access (store, operand 2)
- Privileged operation
- Specification
- Transaction constraint

STORE FACILITY LIST

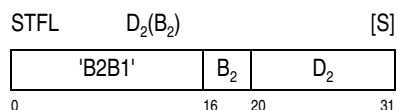

A list of bits providing information about facilities is stored in the word at real address 200. The meanings of the bits are identical to the first 32 bits stored by STORE FACILITY LIST EXTENDED. Figure 4-36,

“Assigned Facility Bits” on page 4-99 shows the meanings of the assigned facility bits.

The second-operand address is ignored but should be zero to permit possible future extensions.

Key-controlled and low-address protection do not apply.

Condition Code: The code remains unchanged.

Program Exceptions:

- Privileged operation
- Transaction constraint

Programming Note: STORE FACILITY LIST stores only a 32-bit indication of facilities. STORE FACILITY LIST EXTENDED may be used to store the entire list of installed facilities.

STORE PREFIX

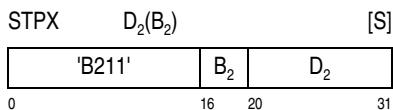

In the z/Architecture architectural mode, the contents of bit positions 33-50 of the prefix register are stored in bit positions 1-18 of the word location designated by the second-operand address, and zeros are stored in bit positions 0 and 19-31 of the word.

In the ESA/390-compatibility mode, the contents of bit positions 33-51 of the prefix register are stored in bit positions 1-19 of the word location designated by the second-operand address, and zeros are stored in bit positions 0 and 20-31 of the word.

Special Conditions

The operand must be designated on a word boundary; otherwise, a specification exception is recognized.

Condition Code: The code remains unchanged.

Program Exceptions:

- Access (store, operand 2)
- Privileged operation
- Specification

- Transaction constraint

STORE REAL ADDRESS

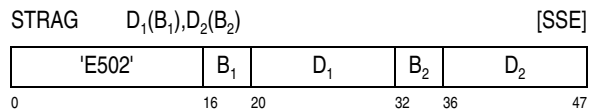

The 64-bit real address corresponding to the second-operand virtual address is stored in the doubleword at the location designated by the first-operand address.

The virtual address specified by the B_2 and D_2 fields is translated by means of the dynamic-address-translation facility, regardless of whether DAT is on or off.

DAT is performed by using an address-space-control element that depends on the current value of the address-space-control bits, bits 16 and 17 of the PSW, as shown in the following table:

PSW Bits 16 and 17	Address-Space-Control Element Used by DAT
00	Contents of control register 1
10	Contents of control register 7
01	The address-space-control element obtained by applying the access-register-translation (ART) process to the access register designated by the B_2 field
11	Contents of control register 13

ART and DAT may be performed with the use of the ART-lookaside buffer (ALB) and translation-lookaside buffer (TLB), respectively.

The resultant 64-bit real address is stored at the first-operand location.

The translated address is not inspected for boundary alignment or for addressing or protection exceptions.

The address computations for the operands are performed according to the current addressing mode, specified by bits 31 and 32 of the current PSW.

The addresses of the region-table entry or entries, if used, and of the segment-table entry and page-table entry are treated as 64-bit addresses regardless of the current addressing mode. It is unpredictable

whether the addresses of these entries are treated as real or absolute addresses.

Special Conditions

The first operand must be designated on a double-word boundary; otherwise, a specification exception is recognized.

In the ESA/390-compatibility mode, an operation exception is recognized.

The operation is suppressed on all addressing exceptions.

Condition Code: The code remains unchanged.

Program Exceptions:

- Access (fetch, operand 2, except for an addressing or protection exception for the designated location; store, operand 1)
- Operation (in the ESA/390-compatibility mode)
- Privileged operation
- Specification
- Transaction constraint

Programming Note: STORE REAL ADDRESS is contrasted to LOAD REAL ADDRESS as follows:

- In the 24-bit or 31-bit addressing mode, LOAD REAL ADDRESS (LRA) loads bits 33-63 of the real address if bits 0-32 of the address are all zeros or recognizes a special-operation exception if bits 0-32 are not all zeros. LRA in the 64-bit addressing mode, and LOAD REAL ADDRESS (LRAG) in any addressing mode, loads bits 0-63 of the real address. STORE REAL ADDRESS stores bits 0-63 of the real address in any addressing mode.
- LOAD REAL ADDRESS, for most access-exception conditions, does not recognize the conditions as exceptions but instead sets the condition code to indicate the occurrence of the conditions. STORE REAL ADDRESS recognizes all access-exception conditions as exceptions, resulting in a program interruption.

STORE SYSTEM INFORMATION

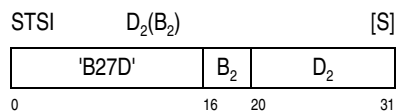

Depending on a function code in general register 0, either an identification of the level of the configuration executing the program is placed in general register 0 or information about a component or components of a configuration is stored in a system-information block (SYSIB). When information about a component or components is requested, the information is specified by further contents of general register 0 and by contents of general register 1. The SYSIB, if any, is designated by the second-operand address.

The machine is considered to provide one, two, or three levels of configuration. The levels are:

1. The basic machine, which is the machine as if it were operating in the basic mode.
2. A logical partition, which is provided if the machine is operating in the logically partitioned (LPAR) mode. A logical partition is provided by the LPAR hypervisor, which is a part of the machine. Basic-machine configuration information is provided even when the machine is operating in the LPAR mode.
3. A virtual machine, which is provided by a virtual-machine (VM) control program that is executed either by the basic machine or in a logical partition. A virtual machine may itself execute a VM control program that provides a higher-level (more removed from the basic machine) virtual machine, which also is considered a level-3 configuration.

The terms basic mode, LPAR mode, logical partition, hypervisor, and virtual machine, and any other terms related specifically to those terms, are not defined in this publication; they are defined in the machine manuals.

A program being executed by a level-1 configuration (the basic machine) can request information about that configuration. A program being executed by a level-2 configuration (in a logical partition) can request information about the logical partition and about the underlying basic machine. A program being executed by a level-3 configuration (a virtual

machine) can request information about the virtual machine and about the one or two underlying levels; a basic machine is always underlying, and a logical partition may or may not be between the basic machine and the virtual machine. When information about a virtual machine is requested, information is provided about the configuration executing the program and about any underlying level or levels of virtual machine.

The function code determining the operation is an unsigned binary integer in bit positions 32-35 of general register 0 and is as follows:

Function Code	Information Requested
0	Current-configuration-level number
1	Information about level 1 (the basic machine)
2	Information about level 2 (a logical partition)
3	Information about level 3 (a virtual machine)
4-14	None; codes are reserved
15	Current-configuration-level information

Invalid Function Code

The level of the configuration executing the program is called the current level. The configuration level specified by a nonzero function code (other than 15) is called the specified level. When the specified level is numbered higher than the current level, then the function code is called invalid, the condition code is set to 3, and no other action (including checking) is performed. Function code 15 is invalid when the configuration-topology facility is not installed.

Valid Function Code

When the function code is equal to or less than the number of the current level, or 15, it is called valid. In this case, bits 36-55 of general register 0 and bits 32-47 of general register 1 must be zero; otherwise, a specification exception is recognized. Bits 0-31 of general registers 0 and 1 always are ignored.

When the function code is 0, an unsigned binary integer identifying the current configuration level (1 for basic machine, 2 for logical partition, or 3 for virtual machine) is placed in bit positions 32-35 of general register 0, the condition code is set to 0, and no further action is performed.

When the function code is valid and nonzero, general registers 0 and 1 contain additional specifications about the information requested, as follows:

- Bit positions 56-63 of general register 0 contain an unsigned binary integer, called *selector 1*, that specifies a component or components of the specified configuration.
- Bit positions 48-63 of general register 1 contain an unsigned binary integer, called *selector 2*, that specifies the type of information requested.

The contents of general registers 0 and 1 are as follows:

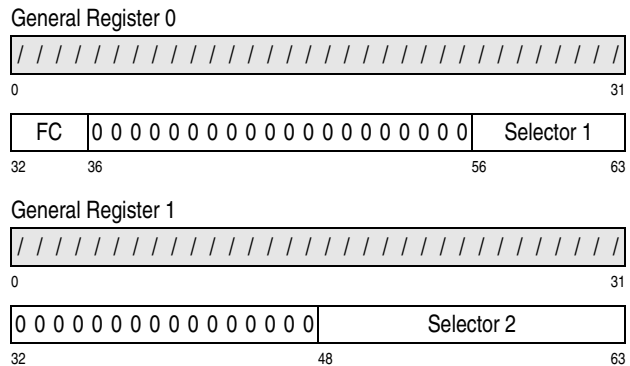

When the function code is valid and nonzero, information may be stored in a system-information block (SYSIB) beginning at the second-operand location. The SYSIB is 4K bytes and must begin at a 4 K-byte boundary; otherwise, a specification exception may be recognized, depending on selector 1 and selector 2 and on whether access exceptions are recognized due to references to the SYSIB (see “Special Conditions”).

Selector 1 can have values as follows:

Selector 1	Information Requested
0	None; selector is reserved
1	Information about the configuration level specified by the function code.
2	Information about one or more CPUs in the specified configuration level
3-255	None; selectors are reserved

When selector 1 is 1, selector 2 can have values as follows:

Selector 2 when Selector 1 Is 1	Information Requested
0	None; selector is reserved
1	Information about the specified configuration level

Selector 2

when

Selector 1**Is 1****Information Requested**

2-6	Topology information about the specified configuration level
7-65,535	None; selectors are reserved

When selector 1 is 2, selector 2 can have values as follows:

Selector 2

when

Selector 1 Is**2****Information Requested**

0	None; selector is reserved
1	Information about the CPU executing the program in the specified configuration level
2	Information about all CPUs in the specified configuration level
3-65,535	None; selectors are reserved

Only certain combinations of the function code, selector 1, and selector 2 are valid, as shown in Figure 10-84.

Function Code	Selector 1	Selector 2	Information Requested about
0	-	-	Current-configuration-level number
1	1	1	Basic-machine configuration
1	2	1	Basic-machine CPU
1	2	2	Basic-machine CPUs
2	2	1	Logical-partition CPU
2	2	2	Logical-partition CPUs
3	2	2	Virtual-machine CPUs
15	1	2-6	Topology information of current configuration
Explanation:			
- Ignored.			

Figure 10-84. Valid Function-Code, Selector-1, and Selector-2 Combinations for STORE SYSTEM INFORMATION

When the specified function-code, selector-1, and selector-2 combination is invalid (is other than as shown in Figure 10-84), or if it is valid but the requested information is not available because the specified level does not implement or does not fully implement the instruction or because a necessary

part of the level is uninstalled or not initialized, and provided that an exception is not recognized (see “Special Conditions”), the condition code is set to 3. When the function code is nonzero, the combination is valid, the requested information is available, and there is no exception, the requested information is stored in a system-information block (SYSIB) at the second-operand address.

Some or all of the SYSIB may be fetched before it is stored.

A SYSIB may be identified in references by means of “SYSIB fc.s1.s2,” where “fc,” “s1,” and “s2” are the values of a function code, selector 1, and selector 2, respectively.

Following sections describe the defined SYSIBs by means of figures and related text. In the figures, the offsets shown on the left are word values. “The configuration” refers to the configuration level specified by the function code (the configuration level about which information is requested).

Note: In the descriptions of the system-information block (SYSIB) stored by STSI, the term “CPU or core” (or briefly, “CPU/core”) indicates the applicability of the text. When the multithreading facility is not installed at the selected configuration level, certain STSI functions store information relevant to logical or physical CPU attributes. When the multithreading facility is installed at the selected configuration level, these STSI functions store information relevant to logical or physical core attributes.

SYSIB 1.1.1 (Basic-Machine Configuration)

SYSIB 1.1.1 is illustrated in Figure 10-85:

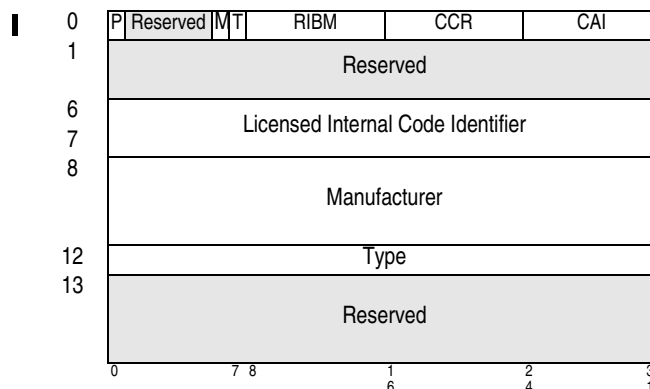

Figure 10-85. Format of the SYSIB 1.1.1 (Part 1 of 2)

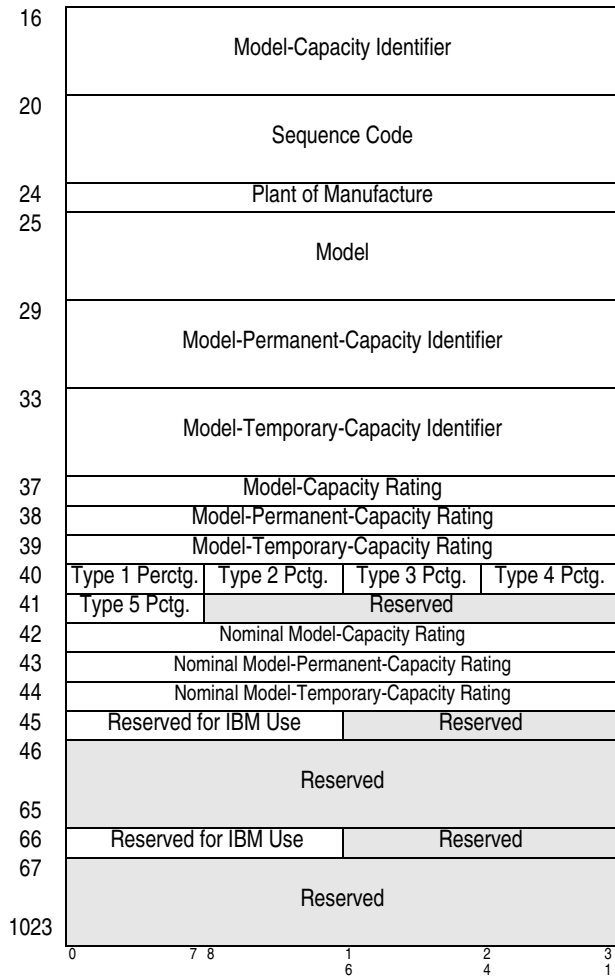

Figure 10-85. Format of the SYSIB 1.1.1 (Part 2 of 2)

Reserved: The contents of bits 1-5 of word 0, words 1-5, words 13-15, bits 8-31 of word 41, bits 16-31 of word 45, and words 46-63 are reserved and are stored as zeros. The contents of words 64-65, bits 16-31 of word 66, and words 67-1023 are reserved and may be stored as zeros or may remain unchanged.

Word 0, Byte 0: Byte 0 of word 0 contains the following bit definitions:

Bit Meaning

0 When bit 0 of byte 0 (P) is one, the type-percentage bytes, located in words 40-41, are valid. When P is zero, the bytes are stored as zeros, but have no meaning.

1-5 Bits 1-5 of byte 0 are reserved and stored as zeros.

- 6 When bit 6 of byte 0 (M) is zero, the multithreading facility is not installed in the basic machine configuration. When M is one, the multithreading facility is installed in the basic machine configuration.
- 7 Bit 7 of byte 0 (T), when one, indicates that the condition represented by the CCR and CAI fields is relatively transient.

Reserved for IBM Use (RIBM): Byte 1 of word 0, bytes 0-1 of word 45, and bytes 0-1 of word 66 are assigned to IBM internal use.

Capacity-Change Reason (CCR): When the CAI byte is nonzero, the content of byte 2 of word 0 is an 8-bit unsigned integer whose value indicates one of the following reasons which is associated with the present values contained in SYSIB 1.1.1.

CCR Capacity-Change Reason

- 0 Machine is running at nominal capacity.
- 1 The capacity change is due solely to the setting of a manual control, such as intentional power-save.
- 2 The capacity change is due to a machine-exception condition, such as detection of overheating.
- 3 The capacity change is due to a non-exception machine condition, such as concurrent service.
- 4 The capacity change is due to an exception condition external to the machine, such as detection of supplied power or cooling falling outside required tolerances.
- 5-255 Reserved.

When the CAI byte is zero, the CCR field is undefined, and stored as zero.

When multiple capacity-change reasons exist, CCR is set according to the following priority:

- 1a. Machine-exception condition, CCR=2.
- 1b. External-exception condition, CCR=4.
2. Non-exception machine condition, CCR=3.
3. Manual control, CCR=1.

Capacity-Adjustment Indication (CAI): Byte 3 of word 0, when nonzero, is an 8-bit unsigned integer whose value is in the range 1-100 and represents the aggregate position of model-dependent controls. Temporary capacity changes that affect machine performance are not included; such changes include those caused by capacity-backup (CBU), on/off-capacity-on-demand (OOCOD), and capacity-planned-event (CPE) features. When zero, the indication is not reported. When in the range 1-99, some amount of reduction is indicated. When 100, the machine is operating at its normal capacity.

Primary CPUs and all secondary-type CPUs are similarly affected.

The model-capacity rating is not affected. A change in the CAI may also reflect a change in CPU-capability fields of SYSIB 1.2.2.

Licensed Internal Code (LIC) Identifier: Words 6-7, when nonzero, indicate information about currently installed internal code. The definition of the information conveyed is model dependent. The internal code, to which the information applies, is model dependent.

Manufacturer: Words 8-11 contain the 16-character (0-9 or uppercase A-Z) EBCDIC name of the manufacturer of the configuration. The name is left justified with trailing blanks if necessary.

Type: Word 12 contains the four-character (0-9) EBCDIC type number of the configuration. (This is called the machine-type number in the definition of STORE CPU ID.)

Model-Capacity Identifier (C): Words 16-19 contain the 16-character (0-9 or uppercase A-Z) EBCDIC model-capacity identifier of the configuration. The model-capacity identifier is left justified with trailing blanks if necessary.

Sequence Code: Words 20-23 contain the 16-character (0-9 or uppercase A-Z) EBCDIC sequence code of the configuration. The sequence code is right justified with leading EBCDIC zeros if necessary.

Plant of Manufacture: Word 24 contains the four-character (0-9 or uppercase A-Z) EBCDIC code that identifies the plant of manufacture for the configuration. The code is left justified with trailing blanks if necessary.

Model: When word 25 is not binary zeros, words 25-28 contain the 16-character (0-9 or uppercase A-Z) EBCDIC model identification of the configuration. The model identification is left justified with trailing blanks if necessary. (This is called the model number in programming note 5 on page 10-141 of STORE CPU ID.) When word 25 is binary zeros, the contents of words 16-19 represent both the model-capacity identifier and the model.

Model-Permanent-Capacity Identifier (P): When nonzero, words 29-32 contain the 16-character (0-9 or uppercase A-Z) EBCDIC model-permanent-capacity identifier of the configuration. The identifier is left justified with trailing blanks if necessary.

Model-Temporary-Capacity Identifier (T): When nonzero, words 33-36 contain the 16-character (0-9 or uppercase A-Z) EBCDIC model-temporary-capacity identifier of the configuration. The identifier is left justified with trailing blanks if necessary.

Model-Capacity Rating (CR): When nonzero, word 37 contains a 32-bit unsigned integer whose value is associated with the model capacity as identified by the model-capacity identifier. There is no formal description of the algorithm used to generate this integer.

Model-Permanent-Capacity Rating (PR): When nonzero, word 38 contains a 32-bit unsigned integer whose value is associated with the model-permanent capacity as identified by the model-permanent-capacity identifier. There is no formal description of the algorithm used to generate this integer.

Model-Temporary-Capacity Rating (TR): When nonzero, word 39 contains a 32-bit unsigned integer whose value is associated with the model-temporary capacity as identified by the model-temporary-capacity identifier. There is no formal description of the algorithm used to generate this integer.

Type N Pctg. Each of the byte fields in words 40-41 that is designated as a type-N percentage contains an 8-bit unsigned binary integer whose value is in the range 0-100 and represents a percentage. When nonzero, the percentage may be used to affect the use and allowed utilization of the secondary-CPU's whose CPU type corresponds to the particular byte. When a byte in this range contains a value of zero, use rules of the corresponding secondary-CPU type are not overridden. The reserved bytes in word 41

are reserved for the potential addition of new secondary CPU types.

Nominal Model-Capacity Rating (NCR): When nonzero, word 42 contains a 32-bit unsigned integer whose value is associated with the nominal model capacity as identified by the model-capacity identifier. There is no formal description of the algorithm used to generate this integer. The NCR value equals the CR value when the CAI byte contains a value of 100. When the CAI byte is less than 100, the CR value is less than the NCR value.

Nominal Model-Permanent-Capacity Rating (NPR): When nonzero, word 43 contains a 32-bit unsigned integer whose value is associated with the nominal model-permanent capacity as identified by the model-permanent-capacity identifier. There is no formal description of the algorithm used to generate this integer. The NPR value equals the PR value when the CAI byte contains a value of 100. When the CAI byte is less than 100, the PR value is less than the NPR value.

Nominal Model-Temporary-Capacity Rating (NTR): When nonzero, word 44 contains a 32-bit unsigned integer whose value is associated with the nominal model-temporary capacity as identified by the model-temporary-capacity identifier. There is no formal description of the algorithm used to generate this integer. The NTR value equals the TR value when the CAI byte contains a value of 100. When the CAI byte is less than 100, the TR value is less than the NTR value.

Worldwide Unique Identification: Taken together, the machine type, manufacturer, plant of manufacture, and sequence code allow for worldwide unique identification of the system.

Programming Notes:

1. The fields of the SYSIB 1.1.1 are similar to those of the node descriptor described in the publication *Common I/O-Device Commands and Self Description*, SA22-7204. However, the contents of the SYSIB fields may not be identical to the contents of the corresponding node-descriptor fields because the SYSIB fields:
 - Allow more characters.
 - Are more flexible regarding the type of characters allowed.

- Provide information that is justified differently within the field.
 - May not use the same method to determine the contents of fields such as the sequence-code field.
2. The model field in a node descriptor corresponds to the content of the STSI model field and not the STSI model-capacity-identifier field.
 3. The model field specifies the model of the machine (i.e., the physical model); the model-capacity identifier field specifies a token that may be used to locate a statement of capacity or performance in the System Library publication for the model.
 4. Each of the three model-capacity-identifier fields specifies a token that may be used to locate a statement of capacity or performance in the System Library publication for the model.
 5. Each of the three model-capacity-rating fields, corresponding one-to-one with the three model-capacity-identifier fields, specifies a numeric value that may or may not represent the actual capacity of the machine
 6. The term *capacity backup* (CBU) represents a methodology by which spare capacity in a CPC can be used to replace capacity from another CPC within an enterprise, normally for a relatively limited period of time. Typically CBU is used when another CPC of the enterprise has failed, and the CPC operating under CBU rules is making up for the missing CPC's capacity. However, CBU can also indicate a capacity that reflects a net reduction such that the current capacity would be less than the permanent capacity.
 7. The term *On/Off Capacity on Demand* (On/Off CoD) represents a methodology by which spare capacity in a CPC can be made available to increase the total capacity within an enterprise, normally for a limited period of time. For example, On/Off CoD may be used to acquire additional capacity in order to handle a workload peak.
 8. The content of the model-capacity identifier (C) field corresponds to the current capacity at which the central-processing complex (CPC) is operating.

9. The content of the model-permanent-capacity identifier (P) corresponds to the capacity of the CPC exclusive of temporarily-available increased capacity and temporarily-available replacement capacity.
10. The content of the model-temporary-capacity identifier (T) corresponds to the total of permanent capacity and temporarily-available increased capacity but exclusive of any temporarily-available replacement capacity.
11. When the T bit in byte 0 is one, the current capacity values and indicators are in a relatively-short period of transition and should be permitted to stabilize, that is, a result where T is zero, before any resultant action proceeds.
12. There is no facility indication defined to distinguish whether a model stores zeros, or information pertaining to installed internal code, in the licensed internal code identifier field. A program may test the licensed internal code identifier field stored, for a nonzero value, to recognize whether or not a specific machine provides the information requested.

SYSIB 1.2.1 (Basic-Machine CPU/Core)

SYSIB 1.2.1 is illustrated in Figure 10-86:

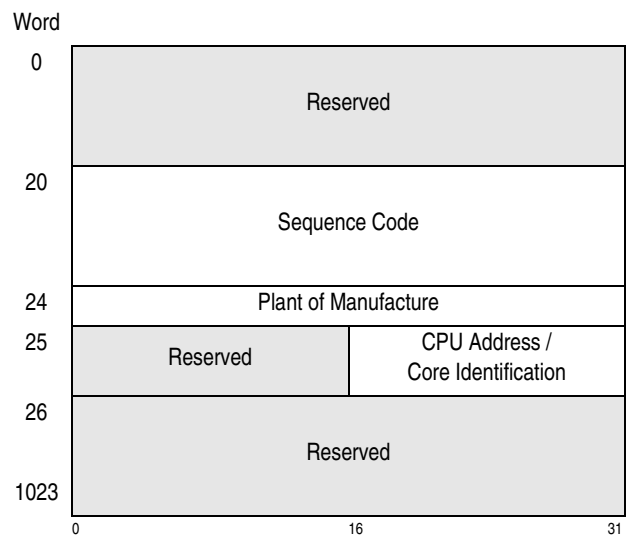

Figure 10-86. Format of the SYSIB 1.2.1

Reserved: The contents of words 0-19, bytes 0 and 1 of word 25, and words 26-63 are reserved and are stored as zeros. The contents of words 64-1023 are reserved and may be stored as zeros or may remain unchanged.

Sequence Code: Words 20-23 contain the 16-character (0-9 or uppercase A-Z) EBCDIC sequence code of the configuration. The code is right justified with leading EBCDIC zeros if necessary.

Plant of Manufacture: Word 24 contains the four-character (0-9 or uppercase A-Z) EBCDIC code that identifies the plant of manufacture for the configuration. The code is left justified with trailing blanks if necessary.

CPU Address: When the multithreading facility is not installed in the machine, bytes 2 and 3 of word 25 contain the CPU address by which this CPU is identified in a multiprocessing configuration. The CPU address is a 16-bit unsigned binary integer. The CPU address is the same as is stored by STORE CPU ADDRESS when the program is executed by a machine operating in the basic mode.

Core Identification: When multithreading is installed in the machine, bytes 2 and 3 of word 25 contain a 16-bit unsigned core identification, right justified in the field. The core ID field contains the core-ID portion of the value that would be stored by STORE CPU ADDRESS when executed by a machine operating in the basic mode; no thread ID is included.

Worldwide Unique Identification: Taken together, the machine type and manufacturer (from SYSIB 1.1.1) with the plant of manufacture and sequence code allow for worldwide unique identification of the system.

Programming Note: Multiple CPUs in the same configuration have the same sequence code, and it is necessary to use other information, such as the CPU address, to establish a unique CPU identity. The sequence code returned for a basic-machine CPU and a logical-partition CPU are identical and have the same value as the sequence code returned for the basic-machine configuration.

SYSIB 1.2.2 (Basic-Machine CPUs)

The general format of the SYSIB 1.2.2 is illustrated in Figure 10-87. Some fields may or may not be valid, as indicated by the contents of the format field in byte 0 of word zero.

When the multithreading facility is not installed (as indicated by bit 0 of word 1), fields labelled "CPU/Core" apply to a CPU. When the multithreading

facility is installed, fields labelled “CPU/Core” apply to a core.

Word			
0	Format	Reserved	ACC Offset (format-1 only)
1	MT Installed	MT General	Reserved
2	Reserved		
3	Reserved		
4	Primary CPU Speed		
5	Secondary CPU Speed		
6	Nominal CPU/Core Capability*		
7	Secondary CPU/Core Capability		
8	CPU/Core Capability		
9	Total CPU/Core Count*	Configured CPU/Core Count*	
10	Standby CPU/Core Count*	Reserved CPU/Core Count*	
11	Multiprocessing CPU/Core-Capability Adjustment Factors*		
N	Alternate CPU/Core Capability (format-1 only)		
N+1	Alternate Multiprocessing CPU/Core Capability Adjustment Factors (format-1 only)*		
⋮	Reserved		
1023	Reserved		
	0	8	31

Explanation:

* Field applies to general CPUs or to cores comprising general CPUs.

Figure 10-87. Format of the SYSIB 1.2.2

Reserved: The contents of byte 1 of word 0, bytes 2-3 of word 1, and words 2-3 are reserved and stored as zeros. When the format field contains a value of zero, bytes 2-3 of word 0 are reserved and stored as zeros.

When fewer than 64 words are needed to contain the information for all the CPUs or cores, the portion of the SYSIB following the adjustment-factor list in a format-0 SYSIB, or the alternate-adjustment-factor list in a format-1 SYSIB, up to and including word 63 are reserved and are stored as zeros. The contents of words 64-1023 are reserved and may be stored as zeros or may remain unchanged.

When 64 or more words are needed to contain the information for all the CPUs, the portion of the SYSIB following the adjustment-factor list in a format-0 SYSIB or the alternate-adjustment-factor list in a format-1 SYSIB, up to and including word 1023 are reserved and may be stored as zeros or may remain unchanged.

Format: Byte 0 of word 0 contains an 8-bit unsigned binary integer that specifies the format of SYSIB 1.2.2.

Alternate-CPU/Core-Capability Offset: When the format field has a value of one, bytes 2-3 of word 0 contain a 16-bit unsigned binary integer that specifies the offset in bytes of the alternate-CPU-capability field in the SYSIB. Zeros are stored in the rightmost two bits of the ACC offset field, thus the ACC offset is a multiple of four and designates word N in Figure 10-87.

MT Installed: When bit 0 of the MT-installed field (byte 0 of word 1) is zero, the remainder of the field and the MT-general field are not meaningful and stored as zeros. When bit 0 of the MT-installed field is one, the remainder of the field and the MT-general field are meaningful, as described below.

Bits Meaning

- | | |
|-----|---|
| 0 | When zero, the multithreading facility is not installed in the machine. When one, the multithreading facility is installed in the machine. |
| 1-2 | Reserved (stored as zeros). |
| 3-7 | A 5-bit unsigned integer whose value is the highest supported thread identification (TID) for a core in the machine. The value is in the range 1-31, indicating a minimum of two and a maximum of 32 CPUs per core. A specialty core may operate with this thread count . |

MT General: The contents of byte 1 of word 1 are meaningful only when bit 0 of word 1 is one.

Bit Meaning

- | | |
|-----|--|
| 0-2 | Reserved. |
| 3-7 | A 5-bit unsigned integer whose value is the highest supported thread identification for a core comprising general CPUs. The value is in the range 0-31, indicating a minimum of one and a maximum of 32 CPUs per core. |

The value is less than or equal to the value in bits 3-7 of the MT-installed field. A value of zero indicates that multithreading is not available for a general core. For a sub-capacity model, bits 3-7 of the MT-general field contain zeros.

Primary CPU/Core Speed: When not zero, word 4 contains a 32-bit unsigned binary integer whose value represents the dynamic speed of a primary CPU, encoded as the approximate number of CPU cycles per microsecond.

Secondary CPU/Core Speed: When not zero, word 5 contains a 32-bit unsigned binary integer whose value represents the dynamic speed of a secondary CPU, encoded as the approximate number of CPU cycles per microsecond.

Nominal CPU/Core Capability: Word 6, when not zero, is formatted and encoded the same as word 8, CPU capability, including that a lower value indicates a proportionally higher CPU capability.

When the CAI byte of SYSIB 1.1.1 is zero, the nominal CPU capability (word 6) is stored as zero. The nonzero value equals the word-8 value when the CAI byte of SYSIB 1.1.1 contains a value of 100. When the CAI byte of SYSIB 1.1.1 is nonzero and less than 100, the word-6 value indicates a CPU speed greater than the CPU speed indicated by the word-8 value.

Secondary CPU/Core Capability: Word 7, when not zero, is formatted and encoded the same as word 8, CPU capability, including that a lower value indicates a proportionally higher CPU capability, and specifies a secondary capability that may be applied to certain types of CPUs in the configuration.

There is no formal description of the algorithm used to generate this value, except that it is the same as the algorithm used to generate the CPU capability. The value is used as an indication of the capability of a CPU relative to the capability of other CPU models, and also relative to the capability of other CPU types within a model.

The capability value applies to each of the specialty CPUs/cores of one or more applicable CPU/core types in the configuration. That is, all CPUs in the configuration of an applicable type or types have the same capability. When the value is zero, all CPUs of any CPU type in the configuration have the same capability, as specified by the CPU capability.

The secondary CPU capability may or may not be the same value as the CPU-capability value.

The multiprocessing-CPU-capability-adjustment factors are also applicable to CPUs whose capability is specified by the secondary CPU capability.

CPU/Core Capability: Word 8 specifies the capability of one of the CPUs in the configuration.

If bits 0-8 of word 8 are zero, the word contains a 32-bit unsigned binary integer (I) in the range $1 \leq I < 2^{23}$. If bits 0-8 of word 8 are nonzero, the word contains a 32-bit binary floating point short-format number instead of an unsigned binary integer.

Regardless of encoding, the value represents the capability of one of the CPUs in the configuration, and a lower value indicates a proportionally higher CPU capability. Beyond that, there is no formal description of the algorithm used to generate this value. The value is used as an indication of the capability of the CPU relative to the capability of other CPU models.

The capability value applies to each of the general CPUs in the configuration. That is, all non-secondary CPUs in the configuration have the same capability.

Total CPU/Core Count: Bytes 0 and 1 of word 9 contain a 16-bit unsigned binary integer that specifies the total number of general CPUs or cores comprising general CPUs in the configuration. This number includes all general CPUs/cores in the configured state, the standby state, or the reserved state.

Configured CPU/Core Count: Bytes 2 and 3 of word 9 contain a 16-bit unsigned binary integer that specifies the number of general CPUs or cores comprising general CPUs that are in the configured state. A CPU/core is in the configured state when it is in the configuration and available to be used to execute programs.

Standby CPU/Core Count: Bytes 0 and 1 of word 10 contain a 16-bit unsigned binary integer that specifies the number of general CPUs or cores comprising general CPUs that are in the standby state. A CPU/core is in the standby state when it is in the configuration, is not available to be used to execute programs, and can be made available by issuing instructions to place it in the configured state.

Reserved CPU/Core Count: Bytes 2 and 3 of word 10 contain a 16-bit unsigned binary integer that specifies the number of general CPUs or cores comprising general CPUs that are in the reserved state. A CPU/core is in the reserved state when it is in the configuration, is not available to be used to execute programs, and cannot be made available by issuing instructions to place it in the configured state. (It may be possible to place a reserved CPU in the standby or configured state by means of manual actions.)

Multiprocessing CPU/Core-Capability Adjustment Factors: Beginning with bytes 0 and 1 of word 11, the SYSIB contains a series of contiguous two-byte fields, each containing a nonzero 16-bit unsigned binary integer used to form an adjustment factor (fraction) for the value contained in the CPU-capability field. Such a fraction is developed by using the value (V) of the first two-byte field according to one of the following methods:

- If V is in the range of 1 through 100, inclusive, a denominator of 100 is indicated which produces a fraction of $V/100$.
- If V is in the range of 101 through 255, inclusive, a denominator of 255 is indicated which produces a fraction of $V/255$.
- If V is in the range of 256 through 65,535, inclusive, a denominator of 65,535 is indicated which produces a fraction of $V/65,535$.

Thus, the fraction represented by each two-byte field is then developed by dividing the contents of a two-byte field by the indicated denominator.

The number of adjustment-factor fields is one less than the number of CPUs specified in the total-CPU-count field. The adjustment-factor fields correspond to configurations with increasing numbers of CPUs in the configured state. The first adjustment-factor field corresponds to a configuration with two CPUs in the configured state. Each successive adjustment-factor field corresponds to a configuration with a number of CPUs in the configured state that is one more than that for the preceding field.

Programming Note: The applicable MP adjustment factor is an approximation that is sensitive to the particular workload.

Alternate CPU/Core Capability: When the format field has a value of one, the location of word N is the

sum of the address of the SYSIB plus the byte-offset value in the alternate-CPU-capability-offset field. If bits 0-8 of word N are zero, the word contains a 32-bit unsigned binary integer (I) in the range $0 \leq I < 2^{23}$ that specifies the announced capability of one of the CPUs in the configuration. If bits 0-8 of word N are nonzero, the word contains a 32-bit binary floating point short-format number instead of a 32-bit unsigned binary integer.

Regardless of encoding, a lower value indicates a proportionally higher CPU capacity. Beyond that, there is no formal description of the algorithm used to generate this value. The value is used as an indication of the announced capability of the CPU relative to the announced capability of other CPU models.

The alternate-capability value applies to each of the general CPUs or cores comprising general CPUs in the configuration. That is, all general CPUs/cores in the configuration have the same alternate capability.

Alternate Multiprocessing CPU/Core-Capability Adjustment Factors: When the format field has a value of one, the location of word N + 1 is the sum of the address of the SYSIB plus the byte-offset value in the alternate-CPU-capability-offset field plus four. Beginning with bytes 0 and 1 of word N + 1, the SYSIB contains a series of contiguous two-byte fields, each containing a nonzero 16-bit unsigned binary integer used to form an adjustment factor (fraction) for the value contained in the alternate-CPU-capability field. Such a fraction is developed by using the value (V) of the first two-byte field according to one of the following methods:

- If V is in the range of 1 through 100, inclusive, a denominator of 100 is indicated which produces a fraction of $V/100$.
- If V is in the range of 101 through 255, inclusive, a denominator of 255 is indicated which produces a fraction of $V/255$.
- If V is in the range of 256 through 65,535, inclusive, a denominator of 65,535 is indicated which produces a fraction of $V/65,535$.

Thus, the fraction represented by each two-byte field is then developed by dividing the contents of a two-byte field by the indicated denominator.

The number of alternate-adjustment-factor fields is one less than the number of CPUs specified in the

total-CPU-count field. The alternate-adjustment-factor fields correspond to configurations with increasing numbers of CPUs in the configured state. The first alternate-adjustment-factor field corresponds to a configuration with two CPUs in the configured state. Each successive alternate-adjustment-factor field corresponds to a configuration with a number of CPUs in the configured state that is one more than that for the preceding field.

SYSIB 2.2.1 (Logical-Partition CPU/Core)

SYSIB 2.2.1 is illustrated in Figure 10-88.

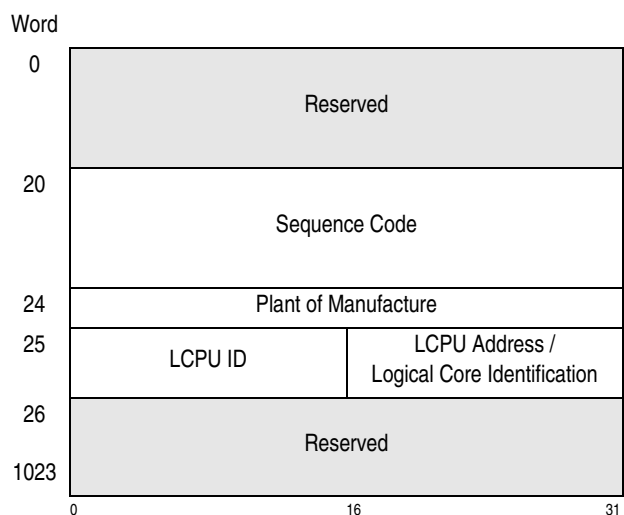

Figure 10-88. Format of the SYSIB 2.2.1

Reserved: The contents of words 0-19 and 26-63 are reserved and are stored as zeros. The contents of words 64-1023 are reserved and may be stored as zeros or may remain unchanged.

Sequence Code: Words 20-23 contain the 16-character (0-9 or uppercase A-Z) EBCDIC sequence code of the configuration. The code is right justified with leading EBCDIC zeros if necessary.

Plant of Manufacture: Word 24 contains the four-character (0-9 or uppercase A-Z) EBCDIC code that identifies the plant of manufacture for the configuration. The code is left justified with trailing blanks if necessary.

Logical-CPU ID: Bytes 0 and 1 of word 25 contain a 16-bit unsigned binary integer that can be used in conjunction with the logical-CPU address to distinguish the logical CPU from the other logical CPUs provided by the same LPAR hypervisor.

Logical-CPU Address: When the multithreading facility is not enabled in the level-2 configuration, bytes 2 and 3 of word 25 contain the logical-CPU address by which this logical CPU is identified within the level-2 configuration. The logical-CPU address is a 16-bit unsigned binary integer. The logical-CPU-address field contains the same information as is stored by STORE CPU ADDRESS when the machine is operating in the LPAR mode.

Logical-Core Identification: When the multithreading facility is enabled in the level-2 configuration, bytes 2 and 3 of word 25 contain a 16-bit unsigned core identification by which the core is identified within the configuration, right justified in the field.

Worldwide Unique Identification: Taken together, the machine type and manufacturer (from SYSIB 1.1.1) with the plant of manufacture and sequence code allow for worldwide unique identification of the system.

Programming Note: Multiple logical CPUs in the same level-2 configuration have the same logical-CPU sequence code, and it is necessary to use other information, such as the logical-CPU address, to establish a unique logical-CPU identity. The sequence code returned for a basic-machine CPU and a logical-partition CPU are identical and have the same value as the sequence code returned for the basic-machine configuration.

SYSIB 2.2.2 (Logical-Partition CPUs / Cores)

SYSIB 2.2.2 is illustrated in Figure 10-89.

When the multithreading facility is not enabled (as indicated by the PSMTID field), fields labeled with an asterisk (*) apply to a primary CPU. When the multithreading facility is enabled, fields labeled with an asterisk apply to a core comprising primary CPUs.

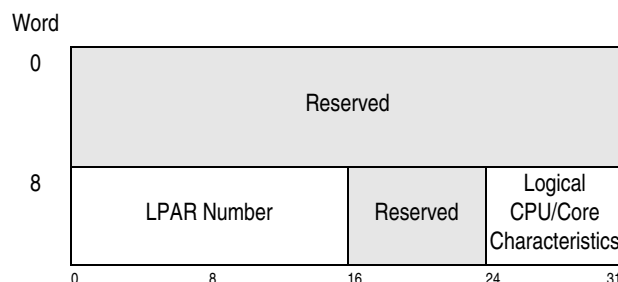

Figure 10-89. Format of the SYSIB 2.2.2 (Part 1 of 2)

Word					
9	Total Logical CPU/Core Count*		Configured Logical CPU/Core Count*		
10	Standby Logical CPU/Core Count*		Reserved Logical CPU/Core Count*		
11	Logical-Partition Name				
12					
13	Logical-Partition CAF				
14	Model-Dependent Data				
15					
16	MT Installed	MT General	PSMTID	Reserved	
17	Reserved				
18	Dedicated Logical CPU/Core Count*		Shared Logical CPU/Core Count*		
19	Reserved			VSNE	
20	Virtual-Server Identification				
21	⋮				
23					
24	Reserved				
25	⋮				
63					
64	Virtual-Server Name				
65	⋮				
127					
128	Reserved				
129	⋮				
1,023					
	0	8	16	24	31

Figure 10-89. Format of the SYSIB 2.2.2 (Part 2 of 2)

Reserved: The contents of words 0-7, byte 2 of word 8, byte 3 of word 16, word 17, bytes 0-2 of word 19, and words 24-63 are reserved and are stored as zeros. When virtual-server information is not provided, the contents of byte 3 of word 19 and words 20-23 are reserved and stored as zeros, and the contents of words 64-127 are reserved and may be stored as zeros or may remain unchanged. The contents of words 128-1023 are reserved and may be stored as zeros or may remain unchanged.

Logical-Partition Number: Bytes 0 and 1 of word 8 contain a 16-bit unsigned binary integer which is the number of the level-2 configuration. This number distinguishes the configuration from all other level-2 configurations provided by the same LPAR hypervisor.

Logical-CPU/Core Characteristics: The contents of byte 3 of word 8 describe the characteristics of the logical CPUs/cores that are provided for the level-2 configuration. The bits and their meanings are as follows:

Bit Meaning

- 0 Dedicated: When one, bit 0 indicates that one or more of the logical CPUs/cores for this level-2 configuration are provided using level-1 CPUs/cores that are dedicated to this level-2 configuration and are not used to provide logical CPUs/cores for any other level-2 configuration. The number of logical CPUs/cores that are provided using dedicated level-1 CPUs/cores is specified by the dedicated-LCPU-count value in bytes 0 and 1 of word 18.

When zero, bit 0 indicates that none of the logical CPUs/cores for this level-2 configuration are provided using level-1 CPUs/cores that are dedicated to this level-2 configuration.

- 1 Shared: When one, bit 1 indicates that one or more of the logical CPUs/cores for this level-2 configuration are provided using level-1 CPUs/cores that can be used to provide logical CPUs/cores for other level-2 configurations. The number of logical CPUs/cores that are provided using shared level-1 CPUs/cores is specified by the shared-LCPU-count value in bytes 2 and 3 of word 18.

When zero, bit 1 indicates that none of the logical CPUs/cores for this level-2 configuration are provided using shared level-1 CPUs/cores.

- 2 Utilization Limit: When one, bit 2 indicates that the amount of use of the level-1 CPUs/cores that are used to provide the logical CPUs/cores for this level-2 configuration is limited.

When zero, bit 2 indicates that the amount of use of the level-1 CPUs/cores that are used to provide the logical CPUs/cores for this level-2 configuration is unlimited.

3-7 Reserved.

Total Logical-CPU/Core Count: Bytes 0 and 1 of word 9 contain a 16-bit unsigned binary integer that specifies the total number of primary logical CPUs/cores that are provided for this level-2 configuration. This number includes all of the logical

CPUs/cores that are in the configured state, the standby state, or the reserved state.

Configured Logical-CPU/Core Count: Bytes 2 and 3 of word 9 contain a 16-bit unsigned binary integer that specifies the number of primary logical CPUs/cores for this level-2 configuration that are in the configured state.

A logical CPU/core is in the configured state when it is in the level-2 configuration and is available to be used to execute programs.

Standby Logical-CPU/Core Count: Bytes 0 and 1 of word 10 contain a 16-bit unsigned binary integer that specifies the number of primary logical CPUs/cores for this level-2 configuration that are in the standby state.

A logical CPU/core is in the standby state when it is in the level-2 configuration, is not available to be used to execute programs, and can be made available by issuing instructions to place it in the configured state.

Reserved Logical-CPU/Core Count: Bytes 2 and 3 of word 10 contain a 16-bit unsigned binary integer that specifies the number of primary logical CPUs/cores for this level-2 configuration that are in the reserved state.

A logical CPU/core is in the reserved state when it is in the level-2 configuration, is not available to be used to execute programs, and cannot be made available by issuing instructions to place it in the configured state. (It may be possible to place the reserved CPU/core in the standby or configured state through manual actions.)

Logical-Partition Name: Words 11-12 contain the 8-character EBCDIC name of this level-2 configuration. The name is left justified with trailing blanks if necessary.

Logical-Partition Capability Adjustment Factor (CAF): Word 13 contains a 32-bit unsigned binary integer, called an adjustment factor, with a value of 1000 or less. The adjustment factor specifies the amount of the underlying level-1-configuration capability that is allowed to be used for this level-2 configuration by the LPAR hypervisor. The fraction of level-1-configuration capability is determined by dividing the CAF value by 1000.

MT Installed: When bit 0 of the MT-installed field (byte 0 of word 16) is zero, the remainder of the field and the MT-general and PSMTID fields are not meaningful and stored as zeros. When bit 0 of the MT-installed field is one, the remainder of the field and the MT-general and PSMTID fields are meaningful, as described below.

Bits Meaning

0	When zero, the multithreading facility is not installed in the level-2 configuration. When one, the multithreading facility is installed in the level-2 configuration.
1-2	Reserved (stored as zeros).
3-7	A 5-bit unsigned integer whose value is the highest supported thread identification (TID) for a core of the level-2 configuration. The value is in the range 1-31, indicating a minimum of two and a maximum of 32 CPUs per core. A specialty core may operate with this thread count .

MT General: The contents of byte 1 of word 16 are meaningful only when bit 0 the MT-installed field is one.

Bit Meaning

0-2	Reserved.
3-7	A 5-bit unsigned integer whose value is the highest supported thread identification for a core comprising general CPUs. The value is in the range 0-31, indicating a minimum of one and a maximum of 32 CPUs per core. The value is less than or equal to the value in bits 3-7 of the MT-installed field. A value of zero indicates that multithreading is not available for a general core. For a sub-capacity model, bits 3-7 of the MT-general field contain zeros.

Program-Specified Maximum TID (PSMTID): The contents of byte 2 of word 16 are meaningful only when bit 0 of word 16 is one.

Bits Meaning

0-2	Reserved (stored as zeros).
3-7	When the multithreading facility is enabled in the level-2 configuration, bit positions 3-7 contain the program-specified maximum thread identification as set by the SIGNAL

PROCESSOR set-multithreading order; the value is copied from bit positions 59-63 of the SIGP parameter register. When the multithreading facility is not enabled in the level-2 configuration, bit positions 3-7 contain zeros.

Dedicated Logical-CPU Count/Core: Bytes 0 and 1 of word 18 contain a 16-bit unsigned binary integer that specifies the number of configured-state primary logical CPUs/cores for this level-2 configuration that are provided using dedicated level-1 CPUs/cores. (See the description of bit 0 of the logical-CPU-characteristics field.)

Shared Logical-CPU/Core Count: Bytes 2 and 3 of word 18 contain a 16-bit unsigned binary integer that specifies the number of configured-state primary logical CPUs/cores for this level-2 configuration that are provided using shared level-1 CPUs/cores. (See the description of bit 1 of the logical-CPU-characteristics field.)

Virtual-Server-Name Encoding (VSNE): Byte 3 of word 19 contains an 8-bit unsigned integer indicating whether virtual-server information is provided, and if so, the encoding of the virtual-server-name field in words 64-127, as follows:

Value Meaning

0	Virtual-server information is not provided.
1	EBCDIC
2	UTF-8
3-255	Reserved.

Virtual-Server Identification: When virtual-server information is provided, words 20-23 contain a 128-bit binary universally-unique identification (UUID, also known as a *handle*) of the virtual server for this configuration. When virtual-server information is not provided, words 20-23 are stored as zeros.

Virtual-Server Name: When virtual-server information is provided, words 64-127 contain a 256-byte name of the virtual server for this configuration. The virtual-server name is left justified in the field; if the name is less than 256 bytes, the field is padded on the right with zeros. The VSNE field, byte 3 of word 19, indicates the encoding of the virtual-server-name field.

When virtual-server information is not provided, words 64-127 are reserved and may be stored as zeros or may remain unchanged.

SYSIB 3.2.2 (Virtual-Machine CPUs / Cores)

SYSIB 3.2.2 is illustrated in Figure 10-90:

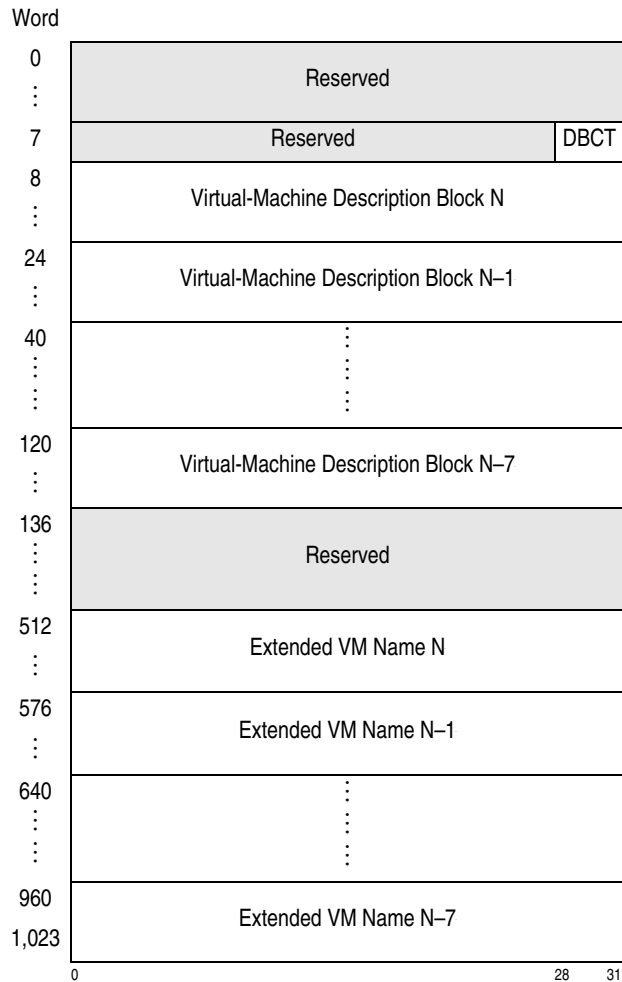

Figure 10-90. Format of the SYSIB 3.2.2

Reserved: The contents of words 0-6, bits 0-27 of word 7, and all portions of SYSIB words 8-1,023 that do not contain virtual-machine description blocks or extended virtual-machine-name blocks are reserved and are stored as zeros.

Description-Block Count (DBCT): Bits 28-31 of word 7 contain a four-bit unsigned binary integer that specifies the number (up to eight) of virtual-machine description blocks and extended-virtual-machine-name blocks that are stored in the SYSIB beginning at words 8 and 512, respectively.

Virtual-Machine Description Blocks: Depending on the number of nested level-3 configurations (if any) and their processing characteristics, from one to eight 64-byte virtual-machine description blocks are stored, beginning at word 8. The contents of the VMDB are described in the section “Virtual-Machine Description Block” on page 10-158.

When a level-3 configuration is provided by a virtual-machine control program and the control program is being executed by a level-3 configuration provided by another virtual-machine control program, the level-3 configurations are said to be “nested.” Level-3 configurations can be nested in this way for several levels.

The collection of nested level-3 configurations that is in the path between a program being executed by a level-3 configuration and the basic machine is called a “level-3-configuration stack.” The level-3 configurations in a stack are consecutively numbered. The level-3 configuration provided by a virtual-machine control program being executed by either a level-2 configuration or a level-1 configuration is the lowest-numbered (0) level-3 configuration in the stack. The level-3 configuration that is executing the program containing this instruction is the highest numbered (N) level-3 configuration in the stack.

If more than one virtual-machine description block is stored in words 8-135 of the SYSIB, the blocks are stored according to the following rules:

- The collection of level-3 configurations described is a contiguous subset of the total collection of level-3 configurations in the level-3-configuration stack. The subset always includes the highest-numbered level-3 configuration in the stack. One or more level-3 configurations at the bottom of the stack may not be described because the limit of eight description blocks would be exceeded.
- The highest-numbered level-3 configuration in the level-3-configuration stack is always described by the first description block in the SYSIB. The lowest-numbered level-3 configuration in the stack, of those that are included in the subset that is described, is described by the last description block in the SYSIB.

Extended VM Name(s): For each VMDB, there is a corresponding extended-VM-name field in the SYSIB 3.2.2, as shown below:

Nesting Level	SYSIB 3.2.2 Word Offset	
	VMDB	Extended VM Name
N	8	512
N-1	24	576
N-2	40	640
N-3	56	704
N-4	72	768
N-5	88	832
N-6	104	896
N-7	120	960

Figure 10-91. SYSIB 3.2.2 Offset of VMDB and Corresponding Extended-VM Name

The extended-VM-name-encoding (EVMNE) field of a VMDB indicates the encoding of the corresponding extended VM name. When the EVMNE field of a VMDB is zero, the corresponding extended-VM-name field is stored as zeros.

The extended VM name is left justified in the field; if the name is less than 256 bytes, the field is padded on the right with zeros. If the leftmost byte of the extended-VM-name field contains zeros, no extended VM name is provided for that nesting level, regardless of whether the corresponding EVMNE is nonzero.

Programming Note: The highest-numbered configuration in the level-3-configuration stack that does not provide an extended VM name effectively delimits the array of extended VM names.

For example, if VMDBs for nested levels 3, 2, 1, and 0 are stored in the SYSIB, but only levels 3, 2, and 0 provide extended VM names, then extended VM names will be stored only for levels 3 and 2 (beginning at words 512 and 576, respectively). Even though the EVMNE field of the VMDB at nesting level 0 may designate a valid nonzero encoding, the extended-VM-name field for nesting-level 0 (beginning at word 704) will contain zeros.

If the configuration is not capable of providing an extended VM name, then it is assumed that the configuration is also not capable of managing extended VM names for lower-numbered nesting levels.

Virtual-Machine Description Block

The virtual-machine description block is illustrated in Figure 10-92 .

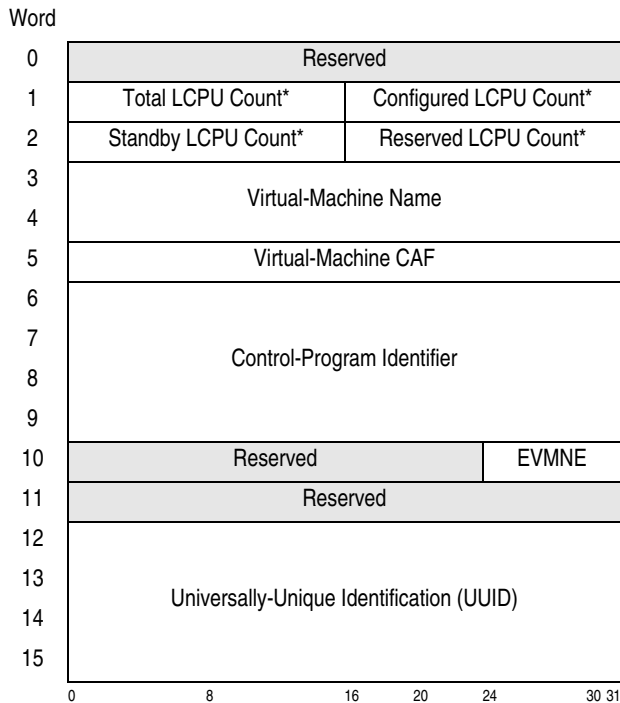

Explanation:

* Field applies to a primary CPU. The CPUs may either be general or specialty CPUs.

Figure 10-92. Virtual-Machine Descriptor Block

Reserved: The contents of word 0, bytes 0-2 of word 10, and word 11 are reserved and are stored as zeros.

Total Logical-CPU/Core Count: Bytes 0 and 1 of word 1 contain a 16-bit unsigned binary integer that specifies the total number of primary logical CPUs/cores that are provided for this level-3 configuration. This number includes all of the primary logical CPUs/cores that are in the configured state, the standby state, and the reserved state.

Configured Logical-CPU/Core Count: Bytes 2 and 3 of word 1 contain a 16-bit unsigned binary integer that specifies the number of primary logical CPUs/cores for this level-3 configuration that are in the configured state.

A logical CPU/core is in the configured state when it is in the level-3 configuration and is available to be used to execute programs.

Standby Logical-CPU/Core Count: Bytes 0 and 1 of word 2 contain a 16-bit unsigned binary integer that specifies the number of primary logical CPUs/cores for this level-3 configuration that are in the standby state.

A logical CPU/core is in the standby state when it is in the level-3 configuration, is not available to be used to execute programs, and can be made available by issuing instructions to place it in the configured state.

Reserved Logical-CPU/Core Count: Bytes 2 and 3 of word 2 contain a 16-bit unsigned binary integer that specifies the number of primary logical CPUs/cores for this level-3 configuration that are in the reserved state.

A logical CPU/core is in the reserved state when it is in the level-3 configuration, is not available to be used to execute programs, and cannot be made available by issuing instructions to place it in the configured state. (It may be possible to place the logical CPU/core in the standby or configured state through manual actions.)

Virtual-Machine Name: Words 3-4 contain the eight-character EBCDIC name of this level-3 configuration. The name is left justified with trailing blanks if necessary.

Virtual-Machine Capability Adjustment Factor (CAF): Word 5 contains a 32-bit unsigned binary integer, called an adjustment factor, with a value of 1000 or less. The adjustment factor specifies the amount of the underlying level-1-, level-2-, or level-3-configuration capability that is allowed to be used for this level-3 configuration by the virtual-machine control program. The fraction of the underlying capability is determined by dividing the CAF value by 1000.

Control-Program Identifier: Words 6-9 contain the 16-character EBCDIC identifier of the virtual-machine control program that provides this level-3 configuration. This identifier may include qualifiers such as version number and release level. The identifier is left justified with trailing blanks if necessary.

Extended VM-Name Encoding (EVMNE): Byte 3 of word 10 contains an 8-bit unsigned integer indicat-

ing whether a corresponding extended virtual-machine name is provided, and if so, the encoding of the extended-virtual-machine-name field, as follows:

Value Meaning

0	Extended virtual-machine name is not provided
1	EBCDIC
2	UTF-8
3-255	Reserved.

When byte 3 of word 10 is zero, an extended virtual-machine name is not provided for this configuration.

Programming Note: Even if the EVMNE field is nonzero, an extended-VM name is not provided when the leftmost byte of the corresponding extended-VM-name field is zero.

Universally-Unique Identification (UUID): When the 128-bit binary value formed by words 12-15 is nonzero, the value comprises a universally-unique identification (UUID, also known as a handle) of the configuration. When words 12-15 contain all zeros, no UUID is provided.

SYSIB 15.1.2 - 15.1.6 (Configuration Topology)

SYSIBs 15.1.2 through 15.1.6 are illustrated in each have the following format:

Word					
0	Reserved		Length		
1	Mag6	Mag5	Mag4	Mag3	
2	Mag2	Mag1	Reserved	MNest	
3	Reserved				
4	Topology List				
⋮					
N-1					
N	Reserved				
⋮					
1023					
	0	8	16	24	31

Figure 10-93. Format of the SYSIB 15.1.2 - 15.1.6

Selector 2 specifies the MNest value to which the response is limited. STSI completes with condition code 3 for the following cases:

1. If the maximum-MNest facility is installed and selector 2 exceeds the nonzero model-dependent maximum-selector-2 value.
2. If the maximum-MNest facility is not installed and selector 2 is not specified as two.

Reserved: The contents of bytes 0-1 of word 0, byte 2 of word 2, and word 3 are reserved and are stored as zeros. The contents of words N-1023 are reserved and may be stored as zeros or may remain unchanged.

Length: Bytes 2-3 of word 0 contain a 16-bit unsigned binary integer whose value is the count of bytes of the entire SYSIB 15.1.2. The length of just the topology list is determined by subtracting 16 from the length value in bytes 2-3 of word 0. N in Figure 10-94 is determined by evaluating the formula $N = \text{Length}/4$.

Mag1-6: Word 1 and bytes 0-1 of word 2 constitute six one-byte fields where the content of each byte indicates the maximum number of container-type topology-list entries (TLE) or CPU-type TLEs at the corresponding nesting level. CPU-type TLEs are always found only at the Mag1 level. Additionally, the Mag1 value also specifies the maximum number of CPUs that may be represented by a container-type TLE of the Mag2 level. When the value of the nesting level is greater than one, containing nesting levels above the Mag1 level are occupied only by container-type TLEs. A dynamic change to the topology may alter the number of TLEs and the number of CPUs at the Mag1 level, but the limits represented by the values of the Mag1-6 fields do not change within a model family of machines.

The topology is a structured list of entries where an entry defines one or more CPUs or else is involved with the nesting structure. The following illustrates the meaning of the magnitude fields:

- When all CPUs of the machine are peers and no containment organization exists, other than the entirety of the central-processing complex itself, the value of the nesting level is 1, Mag1 is the only nonzero magnitude field, and the number of CPU-type TLEs stored does not exceed the Mag1 value.
- When all CPUs of the machine are subdivided into peer groups such that one level of containment exists, the value of the nesting level is 2,

Mag1 and Mag2 are the only nonzero magnitude fields, the number of container-type TLEs stored does not exceed the Mag2 value, and the number of CPU-type TLEs stored within each container does not exceed the Mag1 value.

- The Mag3-6 bytes similarly become used (proceeding in a right-to-left direction) when the value of the nesting level falls in the range 3-6.

MNest: When the maximum-MNest facility is not installed, byte 3 of word 2 specifies the nesting level of the topology to which the configuration may be extended without requiring a re-IPL. The maximum MNest value is model dependent in the range 2-6; the minimum is one. If MNest is one, there is no actual TLE nesting structure, Mag1 is the only nonzero field in the Mag1-6 range, and only CPU-type TLEs are represented in the topology list. The MNest value indicates the number of nonzero magnitude values beginning with the magnitude field at byte 1 of word 2 (Mag1), proceeding left when MNest is greater than one, and with the remaining magnitude fields stored as zeros.

The value of MNest is the maximum possible nesting. No dynamic configuration change exceeds this limit.

When the maximum-MNest facility is installed, the maximum possible nesting is indicated by other means and the MNest value in byte 3 of word 2 reflects both the requested selector-2 value and the number of nonzero magnitude values beginning with the magnitude field at byte 1 of word 2 (Mag1).

Topology List: Words of Figure 10-94 in the range 4 through N-1 specify a list of one or more topology-list entries (TLE). Each TLE is an eight-byte or sixteen-byte field; thus N is an even number of words, and a corollary is that a TLE always starts on a doubleword boundary.

Topology-List Entries: The first TLE in the topology list begins at a nesting level equal to MNest-1. The entire topology list represents the configuration of the issuer of the STSI instruction specifying SYSIB 15.1.x; no outermost container TLE entry is used as it would be redundant with the entire list, and the entire configuration. Therefore, the highest nesting level may have more than a single peer container.

Figure 10-94 illustrates the container type of TLE, and Figure 10-95 illustrates the CPU type of TLC.

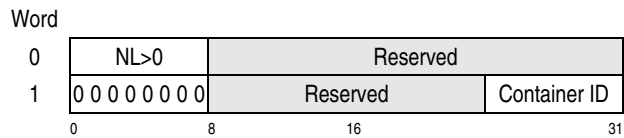

Figure 10-94. Container-Type Topology-List Entry

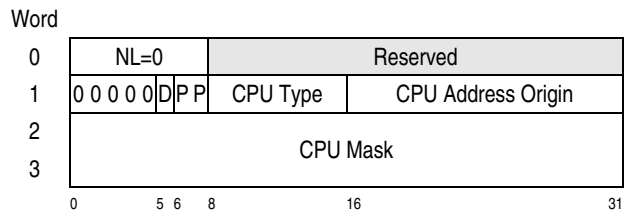

Figure 10-95. CPU-Type Topology-List Entry

Nesting Level (NL): Byte 0 of word 0 specifies the TLE nesting level.

NL Meaning

00 The TLE is a CPU-type TLE.

01-05 The TLE is a container-type TLE. The first container-type TLE stored in a topology list or a parent container has a container-ID in the range 1-255. If sibling containers exist within the same parent, they proceed in an ascending order of container IDs, that may or may not be consecutive, to a maximum value of 255.

06-FF Reserved

Sibling TLEs have the same value of nesting level which is equivalent to either the value of the nesting level minus one of the immediate parent TLE, or the value of MNest minus one, because the immediate parent is the topology list rather than a TLE.

Reserved, 0: For a container-type TLE, bytes 1-3 of word 0 and bytes 0-2 of word 1 are reserved and stored as zeros. For a CPU-type TLE, bytes 1-3 of word 0 and bits 0-4 of word 1 are reserved and stored as zeros.

Container ID: Byte 3 of word 1 of a container-type TLE specifies an 8-bit unsigned nonzero binary integer whose value is the identifier of the container. The container ID for a TLE is unique within the same parent container.

Fields Specific to a CPU-type TLE

The remaining fields described below are specific to a CPU-type TLE. When the multithreading facility is not installed, or when it the facility is installed but not enabled, these fields describe one or more CPUs in the configuration having common topology attributes. When the multithreading facility is installed and enabled, these fields describe one or more cores in the configuration having common topology attributes; each core comprises a set of CPUs that have the same topology attributes.

Dedicated (D): Bit 5 of word 1 of a CPU-type TLE, when one, indicates that the one or more CPUs represented by the TLE are dedicated. When D is zero, the one or more CPUs of the TLE are not dedicated.

Polarization (PP): Bits 6-7 of word 1 of a CPU-type TLE specify the polarization value and, when polarization is vertical, the degree of vertical polarization also called entitlement (high, medium, low) of the corresponding CPU(s) represented by the TLE. The following values are used:

PP Meaning

0	The one or more CPUs represented by the TLE are horizontally polarized.
1	The one or more CPUs represented by the TLE are vertically polarized. Entitlement is low.
2	The one or more CPUs represented by the TLE are vertically polarized. Entitlement is medium.
3	The one or more CPUs represented by the TLE are vertically polarized. Entitlement is high.

Polarization is only significant in a logical and virtual multiprocessing configuration that uses shared host processors and addresses how the resource assigned to a configuration is applied across the CPUs of the configuration. When horizontal polarization is in effect, each CPU of a configuration is guaranteed approximately the same amount of resource. When vertical polarization is in effect, CPUs of a configuration are classified into three levels of resource entitlement: high, medium, and low.

Both subsystem reset and successful execution of the SIGP set-architecture order specifying ESA/390 mode place a configuration and all of its CPUs into horizontal polarization. The CPUs immediately affected are those that are in the configured state. When a CPU in the standby state is configured, it acquires the current polarization of the configuration and causes a topology change of that configuration to be recognized.

A dedicated CPU is either horizontally or vertically polarized. When a dedicated CPU is vertically polarized, entitlement is always high. Thus, when D is one, PP is either 00 binary or 11 binary.

CPU Type: Byte 1 of word 1 of a CPU-type TLE specifies an 8-bit unsigned binary integer whose value is the CPU type of the one or more CPUs represented by the TLE. The CPU-type value specifies either a primary-CPU type or any one of the possible secondary-CPU types.

When the multithreading facility is installed and enabled, the TLE represents one or more cores, each CPU of which has the same CPU type.

CPU-Address Origin: When the multithreading facility is not installed, or when the facility is installed but not enabled, bytes 2-3 of word 1 of a CPU-type TLE specify a 16-bit unsigned binary integer whose value is the CPU address of the first CPU in the range of CPUs represented by the CPU mask, and whose presence is represented by the value of bit position 0 in the CPU mask. The value of a CPU-address origin is the same as that stored by the STORE CPU ADDRESS (STAP) instruction when executed on the CPU represented by bit position 0 in the CPU mask.

When the multithreading facility is installed and enabled, bytes 2-3 of word 1 specify a right-justified 16-bit unsigned binary integer whose value is the first core identification in the range of cores represented by the CPU mask, and whose presence is represented by the value of bit position 0 in the CPU mask.

The CPU-address origin is evenly divisible by 64.

CPU Mask: Words 2-3 of a CPU-type TLE specify a 64-bit mask where each bit position represents a CPU or core. When the multithreading facility is not installed, or when the facility is installed but not enabled, the following applies:

- The value of the CPU-address origin field plus a bit position in the CPU mask equals the CPU address for the corresponding CPU.
- When a CPU-mask bit is zero, the corresponding CPU is not represented by the TLE. Either the CPU is not in the configuration, or else it must be represented by another CPU-type TLE.

- When a CPU mask bit is one, the corresponding CPU has the modifier-attribute values specified by the TLE, is in the topology of the configuration, and is not present in any other TLE of the topology.

When the multithreading facility is installed and enabled, the following applies:

- The value of the CPU-address origin field plus a bit position in the CPU mask equals the core ID for the corresponding core.
- When a CPU-mask bit is zero, the corresponding core is not represented by the TLE. Either the core is not in the configuration or else must be represented by another CPU-type TLE.
- When a CPU-mask bit is one, the corresponding core and each of its CPUs has the modifier-attribute values specified by the TLE, is in the topology of the configuration, and is not present in any other TLE of the topology.

Programming Notes:

1. The following example applies when the multithreading facility is not installed, or when the facility is installed but disabled: If the CPU-address origin is a value of 64, and bit position 15 of the CPU mask is one, CPU 79 is in the configuration and has the CPU type, polarization, entitlement, and dedication as specified by the TLE.
2. The following examples apply when the multithreading facility is installed and enabled:

A CPU-address-origin value of 0000 hex represents a set of core IDs in the range 0 to 63, 0040 hex represents a set of core IDs in the range 64 to 127, as so forth.

If the CPU-address origin is a value of 64, and bit position 15 of the CPU mask is one, core ID 79 is in the configuration and has the CPU type, polarization, entitlement, and dedication as specified by the TLE.

In this example, if multithreading had been enabled with a program-specified maximum thread identification of three (that is, with four threads per core, thus a TID width of 2 bits), the CPU addresses of any CPU in the core can be determined by multiplying the core ID by four (that is, shifting it left TID-width bit positions), and

adding the thread ID. Thus, the CPU addresses for core 79 are 316 - 319 (013C-013F hex).

TLE Ordering: The modifier attributes that apply to a CPU-type TLE are CPU type, polarization, entitlement, and dedication. Polarization and entitlement (for vertical polarization) are taken as a single attribute, albeit with four possible values (horizontal, vertical-high, vertical-medium, and vertical-low).

A single CPU TLE is sufficient to represent as many as 64 CPUs or cores that all have the same modifier-attribute values.

When more than 64 CPUs or cores exist, or the entire range of CPU addresses are not covered by a single CPU-address origin, and the modifier attributes are constant, a separate sibling CPU TLE is stored for each CPU-address origin, as necessary, in ascending order of CPU-address origin. Each such TLE stored has at least one CPU or core represented. The collection of one or more such CPU TLEs is called a CPU-TLE set.

When multiple CPU types exist, a separate CPU-TLE set is stored for each, in ascending order of CPU type.

When multiple polarization-and-entitlement values exist, a separate CPU-TLE set is stored for each, in descending order of polarization value and degree (vertical high, medium, low, then horizontal). When present, all polarization CPU-TLE sets of a given CPU type are stored before the first CPU-TLE set of the next CPU type.

When both dedicated and not-dedicated CPUs exist, a separate CPU-TLE set is stored for each, dedicated appearing before not-dedicated.

All TLEs are ordered assuming a depth-first traversal where the sort order from major to minor is as follows:

1. CPU type
 - a. Lowest CPU-type value
 - b. Highest CPU-type value
2. Polarization-Entitlement
 - a. Vertical high
 - b. Vertical medium

- c. Vertical low
 - d. Horizontal
3. Dedication (when applicable)
 - a. Dedicated
 - b. Not dedicated

The ordering by CPU-address origin and modifier attributes of sibling CPU TLEs within a parent container is done according to the following list, which proceeds from highest to lowest.

1. CPU-TLE set of lowest CPU-type value, vertical high, dedicated
2. CPU-TLE set of lowest CPU-type value, vertical high, not-dedicated
3. CPU-TLE set of lowest CPU-type value, vertical medium, not-dedicated
4. CPU-TLE set of lowest CPU-type value, vertical low, not-dedicated
5. CPU-TLE set of lowest CPU-type value, horizontal, dedicated
6. CPU-TLE set of lowest CPU-type value, horizontal, not-dedicated
7. CPU-TLE set of highest CPU-type value, vertical high, dedicated
8. CPU-TLE set of highest CPU-type value, vertical high, not-dedicated
9. CPU-TLE set of highest CPU-type value, vertical medium, not-dedicated
10. CPU-TLE set of highest CPU-type value, vertical low, not-dedicated
11. CPU-TLE set of highest CPU-type value, horizontal, dedicated
12. CPU-TLE set of highest CPU-type value, horizontal, not-dedicated

Other TLE Rules :

1. A container-type TLE is located at nesting levels in the range 1-5.
2. A CPU-type TLE is located at nesting level 0.

3. The number of sibling container-type TLEs in a topology list or a given parent container does not exceed the value of the magnitude byte (Mag2-6) of the nesting level corresponding to the siblings.
4. The number of CPUs represented by the one or more CPU-type TLEs of the parent container does not exceed the value of the Mag1 magnitude byte.
5. The content of a TLE is defined as follows:
 - If a TLE is a container-type TLE, the content is a list that immediately follows the parent TLE, comprised of one or more child TLEs, and each child TLE has a nesting level of one less than the nesting level of the parent TLE or topology-list end.
 - If a TLE is a CPU-type TLE, the content is one or more CPUs, as identified by the other fields of a CPU TLE.
6. When the first TLE at a nesting level is a CPU entry, the maximum nesting level 0 has been reached.

CPU Topology Overview

With the advent of the IBM System z9 Enterprise Class and subsequent models, and even previously, machine organization into nodal structures has resulted in a non-uniform memory access (NUMA) behavior, sometimes also called “lumpiness”. The purpose of the SYSIB 15.1.2 and the PERFORM TOPOLOGY FUNCTION (PTF) instruction is to provide additional machine topology awareness to the program so that certain optimizations can be performed to improve cache-hit ratios and thereby improve overall performance.

The amount of host-CPU resource assigned to a multiprocessing (MP) guest configuration has generally been spread evenly across the number of configured guest CPUs. Such an even spread implies that no particular guest CPU or CPUs are entitled to any extra host-CPU provisioning than any other, arbitrarily-determined guest CPUs. This condition of the guest configuration, affecting all CPUs of the configuration, is called *horizontal polarization*.

Under horizontal polarization, assignment of a host CPU to a guest CPU is approximately the same amount of provisioning for each guest CPU. When the provisioning is not dedicated, the same host CPUs provisioning the guest CPUs also may be used

to provision guest CPUs of another guest, or even other guest CPUs of the same guest configuration. When the other guest configuration is a different logical partition, a host CPU, when active in each partition, typically must access main storage more because the cache-hit ratio is reduced by having to share the caches across multiple relocation zones. If host-CPU provisioning can alter the balance such that some host CPUs are mostly, or even exclusively, assigned to a given guest configuration, and that becomes the normal behavior, then cache-hit ratios improve, as does performance. Such an uneven spread implies that one or more guest CPUs are entitled to extra host-CPU provisioning versus other, arbitrarily-determined guest CPUs that are entitled to less host-CPU provisioning. This condition of the guest configuration, affecting all CPUs of the configuration, is called *vertical polarization*.

The architecture categorizes vertical polarization into three levels of entitlement of provisioning, high, medium, and low:

- High entitlement guarantees approximately 100% of a host CPU being assigned to a logical/virtual CPU, and the affinity is maintained as a strong correspondence between the two. With respect to provisioning of a logical partition, when vertical polarization is in effect, the entitlement of a dedicated CPU is defined to be high.
- Medium entitlement guarantees an unspecified amount of host CPU resource (one or more host CPUs) being assigned to a logical/virtual CPU, and any remaining capacity of the host CPU is considered to be slack that may be assigned elsewhere. The best case for the available slack would be to assign it as local slack if that is possible. A less-beneficial result occurs if that available slack is assigned as remote slack. (See “CPU Slack” on page 10-164 for descriptions of the two slack terms.) It is also the case that the resource percentage assigned to a logical CPU of medium entitlement is a much softer approximation as compared to the 100% approximation of a high-entitlement setting.
- Low entitlement guarantees approximately 0% of a host CPU being assigned to a logical/virtual CPU. However, if slack is available, such a logical/virtual CPU may still receive some CPU resource.

A model of nested containers using polarization is intended to provide a level of intelligence about the machine's nodal structure as it applies to the requesting configuration, so that, generally, clusters of host CPUs can be assigned to clusters of guest CPUs, thereby improving as much as possible the sharing of storage and the minimizing of different configurations essentially colliding on the same host CPUs.

Polarization and entitlement indicate the relationship of physical CPUs to logical CPUs or logical CPUs to virtual CPUs in a guest configuration, and how the capacity assigned to the guest configuration is apportioned across the CPUs that comprise the configuration. Historically, a guest configuration has been horizontally polarized. For however many guest CPUs were defined to the configuration, the host-CPU resource assigned was spread evenly across all of the guest CPUs in an equitable, non-entitled manner. It can be said that the weight of a single logical CPU in a logical partition when horizontal polarization is in effect is approximately equal to the total configuration weight divided by the number of CPUs. However, with the introduction of the 2097 and family models, it becomes imperative to be able to spread the host-CPU resource in a different manner, which is called vertical polarization of a configuration, and then the degree of provisioning of guest CPUs with host CPUs being indicated as high, medium, or low entitlement. High entitlement is in effect when a logical/virtual CPU of a vertically-polarized configuration is entirely backed by the same host CPU. Medium entitlement is in effect when a logical/virtual CPU of a vertically-polarized configuration is partially backed by a host CPU. Low entitlement is in effect when a logical/virtual CPU of a vertically-polarized configuration is not guaranteed any host-CPU resource, other than what might become available due to slack resource becoming available.

CPU Slack

Regarding slack CPU resource, there are two kinds:

- Local slack becomes available when a logical/virtual CPU of a configuration is not using all the resource to which it is entitled and such slack is then used within the configuration of that CPU. Local slack is preferred over remote slack as better hit ratios on caches are expected when the slack is used within the configuration.
- Remote slack becomes available when a logical/virtual CPU of a configuration is not using all

the resource to which it is entitled and such slack is then used outside the configuration of that CPU. Remote slack is expected to exhibit lower hit ratios on caches, but it is still better than not running a logical/virtual CPU at all.

The goal is to maximize the CPU cache hit ratios.

For a logical partition, the amount of physical-CPU resource is determined by the overall system weightings that determine the CPU resource assigned to each logical partition. For example, in a logical 3-way MP that is assigned physical-CPU resource equivalent to a single CPU, and is horizontally polarized, each logical CPU would be dispatched independently and thus receive approximately 33% physical-CPU resource. If the same configuration were to be vertically polarized, only a single logical CPU would be run and would receive approximately 100% of the assigned physical-CPU resource (high entitlement) while the remaining two logical CPUs would not normally be dispatched (low entitlement). Such resource assignment is normally an approximation. Even a low-entitlement CPU may receive some amount of resource if only to help ensure that a program does not get stuck on such a CPU.

By providing a means for a control program to indicate that it understands polarization, and to receive an indication for each CPU of its polarization and, if vertical polarization, the degree of entitlement, the control program can make more-intelligent use of data structures that are generally thought to be local to a CPU vs. available to all CPUs of a configuration. Also, such a control program can avoid directing work to any low-entitlement CPU.

The actual physical-CPU resource assigned might not constitute an integral number of CPUs, so there is also the possibility of one or more CPUs in an MP vertically-polarized configuration being entitled but not to a high degree, thereby resulting in such CPUs having either medium or low vertical entitlement.

It is possible for any remaining low-entitlement CPUs to receive some amount of host-CPU resource. For example, this may occur when such a CPU is targeted, such as via a SIGP order and slack host-CPU resource is available. Otherwise, such a logical/virtual CPU might remain in an undispached state, even if it is otherwise capable of being dispatched.

A 2-bit polarization field is defined for the CPU-type topology-list entry (TLE) of the STORE SYSTEM INFORMATION (STSI) instruction. The degree of vertical-polarization entitlement for each CPU is indicated as high, medium, or low. The assignment is not a precise percentage but rather is somewhat fuzzy and heuristic.

In addition to vertical polarization as a means of reassigning weighting to guest CPUs, another concept exists, which is the creation and management of slack capacity (also called “white space”). Slack capacity is created under the following circumstances:

- A high-vertical CPU contributes to slack when its average utilization (AU) falls below 100 percent (100-AU).
- A medium-vertical CPU that has an assigned provisioning of M percent of a host CPU contributes to slack when its average utilization (AU) falls below M percent ($M-AU > 0$).
- A low-vertical CPU does not contribute to slack.
- A high-vertical CPU is not a consumer of slack.
- A medium-vertical CPU may or may not be a consumer of slack.
- A low-vertical CPU is only a consumer of slack.

Depending upon its utilization and pattern of being dispatched, a horizontally-polarized CPU can be either a contributor to slack or a consumer of it.

Programming Note: A possible examination process of a topology list is described. Before an examination of a topology list is begun, the current-TLE pointer is initialized to reference the first or top TLE in the topology list, the prior-TLE pointer is initialized to null, and then TLEs are examined in a top-to-bottom order.

As a topology-list examination proceeds, the current-TLE pointer is advanced by incrementing the current-TLE pointer by the size of the current TLE to which it points. A container-type TLE is advanced by adding eight to the current-TLE pointer. A CPU-type TLE is advanced by adding sixteen to the current-TLE pointer. The process of advancing the current-TLE pointer includes saving its value as the prior-TLE pointer just before it is incremented. TLE examination is not performed if the topology list has no TLEs.

The examination process is outlined in the following steps:

1. If the current-TLE nesting level is zero, and the prior-TLE nesting level is null or one, the current TLE represents the first CPU-type TLE of a group of one or more CPU-type TLEs. The program should perform whatever action is appropriate for when a new group of one or more CPUs is first observed. Go to step 5.
2. If the current-TLE nesting level is zero, and the prior-TLE nesting level is zero, the current TLE represents a subsequent CPU-type TLE of a group of CPU-type TLEs that represent siblings of the CPUs previously observed in steps 1 or 2. The program should perform whatever action is appropriate for when the size of an existing sibling group of one or more CPUs is increased. Go to step 5.
3. If the current-TLE nesting level is not zero, and the prior-TLE nesting level is zero, the prior TLE represents a last or only CPU-type TLE of a group of one or more CPU-type TLEs. The program should perform whatever action is appropriate for when an existing group of one or more CPUs is completed. Go to step 5.
4. Go to step 5.

By elimination, this would be the case where the current-TLE nesting level is not zero, and the prior-TLE nesting level is not zero. If the current-TLE nesting level is less than the prior-TLE nesting level, the direction of topology-list traversal is toward a CPU-type TLE. If the current-TLE nesting level is greater than the prior-TLE nesting level, the direction of topology-list traversal is away from a CPU-type TLE. Container-type TLEs are being traversed leading to either (1) another group of CPU-type TLEs that are a separate group in the overall topology, or (2) the end of the topology list. In either case, no particular processing is required beyond advancing to the next TLE.

5. Advance to the next TLE position based upon the type of the current TLE. If the advanced current-TLE pointer is equivalent to the end of the topology list:
 - a. No more TLEs of any type exist.

- b. If the prior-TLE nesting level is zero, the program should perform whatever action is appropriate for when an existing group of one or more CPUs is completed.
- c. The examination is complete.

Otherwise go to step 1.

Special Conditions

The condition code is set to 3 if the function code in bit positions 32-35 of general register 0 is greater than the current-level number.

Bits 36-55 of general register 0 and 32-47 of general register 1 must be zero; otherwise, a specification exception is recognized.

When the function code is valid and nonzero, the following special conditions apply in an unpredictable order:

- The second operand must be designated on a 4 K-byte boundary; otherwise, a specification exception is recognized.
- If the function-code, selector-1, and selector-2 combination is invalid, or if it is valid but the requested information is not available, the condition code is set to 3.

Resulting Condition Code:

- | | |
|---|---|
| 0 | Requested configuration-level number placed in general register 0 or requested SYSIB information stored |
| 1 | -- |
| 2 | -- |
| 3 | Requested SYSIB information not available |

Program Exceptions:

- Access (store, operand 2, only if function code nonzero)
- Privileged operation
- Specification
- Transaction constraint

The priority of the recognition of exceptions and condition codes is shown in Figure 10-96.

1.-6.	Exceptions with the same priority as the priority of program-interruption conditions for the general case.
7.A	Access exceptions for second instruction halfword.
7.B	Privileged-operation exception for privileged instruction.
7.C	Transaction constraint.
8.	Condition code 3 due to function code greater than current-level number.
9.	Specification exception due to bits 36-55 of general register 0 or bits 32-47 of general register 1 not zero.
10.	Condition code 0 due to function code 0.
11.A	Specification exception due to second-operand address not designating a 4 K-byte boundary.
11.B	Condition code 3 due to invalid function-code, selector-1, and selector-2 combination or requested information not available.
12.	Access exceptions (store) for system-information block.
13.	Condition code 0 due to information stored in system-information block.

Figure 10-96. Priority of Execution: STORE SYSTEM INFORMATION

Programming Note: The storage-operand references for STORE SYSTEM INFORMATION may be multiple-access references. (See “Storage-Operand Consistency” on page 5-125.)

STORE THEN AND SYSTEM MASK

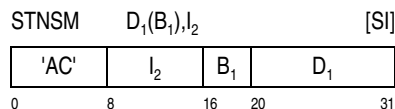

Bits 0-7 of the current PSW are stored at the first-operand location. Then the contents of bit positions 0-7 of the current PSW are replaced by the logical AND of their original contents and the second operand.

Special Conditions

The operation is suppressed on addressing and protection exceptions.

Condition Code: The code remains unchanged.

Program Exceptions:

- Access (store, operand 1)
- Privileged operation
- Transaction constraint

Programming Note: STORE THEN AND SYSTEM MASK permits the program to set selected bits in the system mask to zeros while retaining the original contents for later restoration. For example, it may be necessary that a program, which has no record of the present status, disable program-event recording for a few instructions.

STORE THEN OR SYSTEM MASK

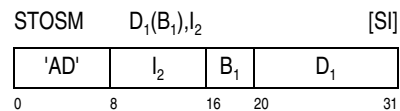

Bits 0-7 of the current PSW are stored at the first-operand location. Then the contents of bit positions 0-7 of the current PSW are replaced by the logical OR of their original contents and the second operand.

Special Conditions

The value to be loaded into the PSW is not checked for validity before loading. However, immediately after loading, a specification exception is recognized, and a program interruption occurs, if either (a) the contents of bit positions 0 and 2-4 of the PSW are not all zeros, or (b) in the ESA/390-compatibility mode, bit position 5 of the PSW does not contain zero. In either of these cases, the instruction is completed, and the instruction-length code is set to 2 or 3. The specification exception, which is listed as a program exception for this instruction, is described in “Early Exception Recognition” on page 6-9.

The operation is suppressed on addressing and protection exceptions.

Condition Code: The code remains unchanged.

Program Exceptions:

- Access (store, operand 1)
- Privileged operation
- Specification
- Transaction constraint

Programming Note: STORE THEN OR SYSTEM MASK permits the program to set selected bits in the system mask to ones while retaining the original contents for later restoration. For example, the program may enable the CPU for I/O interruptions without having available the current status of the external-mask bit.

STORE USING REAL ADDRESS

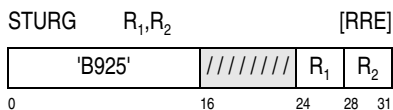
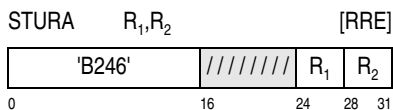

For STORE USING REAL ADDRESS (STURA), bits 32-63 of general register R_1 are stored in the word at the real-storage location addressed by the contents of general register R_2 . For STORE USING REAL ADDRESS (STURG), bits 0-63 of general register R_1 are stored in the doubleword at that real-storage location.

In the 24-bit addressing mode, bits 40-63 of general register R_2 designate the real-storage location, and bits 0-39 of the register are ignored. In the 31-bit addressing mode, bits 33-63 of general register R_2 designate the real-storage location, and bits 0-32 of the register are ignored. In the 64-bit addressing mode, bits 0-63 of general register R_2 designate the real-storage location.

Because it is a real address, the address designating the storage word or doubleword is not subject to dynamic address translation.

Special Conditions

The contents of general register R_2 must designate a location on a word boundary for STURA or on a dou-

bleword boundary for STURG; otherwise, a specification exception is recognized.

Condition Code: The code remains unchanged.

Program Exceptions:

- Addressing (address specified by general register R_2)
- Privileged operation
- Protection (store, operand 2, key-controlled protection and low-address protection)
- Specification
- Transaction constraint

TEST ACCESS

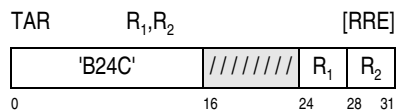

Note: In the ESA/390-compatibility mode when ESA extended-configuration (ESA/XC) applies, the behavior of TEST ACCESS is described in Reference [12.] on page xxx, except that it is unpredictable whether a special-operation exception is recognized when bit position 47 of control register 0 contains zero.

The access-list-entry token (ALET) in access register R_1 is tested for exceptions recognized during access-register translation (ART). The extended authorization index (EAX) used is bits 32-47 of general register R_2 . The ALET is also tested for whether it designates the dispatchable-unit access list or the primary-space access list and for whether it is 00000000 or 00000001 hex.

When R_1 is 0, the actual contents of access register 0 are used in ART, instead of the 00000000 hex that is usually used.

Bits 0-31 and 48-63 of general register R_2 are ignored.

The operation does not depend on the translation mode — bits 5, 16, and 17 of the PSW are ignored.

When the ALET specified by means of the R_1 field is other than 00000000 or 00000001 hex, the ART process is applied to the ALET. The EAX specified by means of the R_2 field is called the effective EAX, and it is the EAX which is used by ART. When a condition

exists that would normally cause one of the exceptions shown in the following table, the instruction is completed by setting condition code 3.

Exception Name	Cause
ALET specification	ALET bits 0-6 not all zeros
ALEN translation	Access-list entry (ALE) outside list or invalid (bit 0 is one)
ALE sequence	ALE sequence number (ALESN) in ALET not equal to ALESN in ALE
ASTE validity	ASN-second-table entry (ASTE) invalid (bit 0 is one)
ASTE sequence	ASTE sequence number (ASTESN) in ALE not equal to ASTESN in ASTE
Extended authority	ALE private bit not zero, ALE authorization index (ALEAX) not equal to effective EAX, and secondary bit selected by effective EAX either outside authority table or zero

When ART is completed without one of the above conditions being present, the instruction is completed by setting condition code 1 or 2, depending on whether the effective access list is the dispatchable-unit access list or the primary-space access list, respectively. The effective access list is the dispatchable-unit access list if bit 7 of the ALET is zero, or it is the primary-space access list if bit 7 is one. ART, including the obtaining of the effective access-list designation, is described in "Access-Register-Translation Process" on page 5-59.

When the ALET is 00000000 hex, the instruction is completed by setting condition code 0. When the ALET is 00000001 hex, the instruction is completed by setting condition code 3.

Special Conditions

An addressing exception is recognized when the address used by ART to fetch the effective access-list designation or the ALE, ASTE, or authority-table entry designates a location which is not available in the configuration.

In the ESA/390-compatibility mode, it is unpredictable whether a special-operation exception is recognized when bit position 47 of control register 0 contains zero.

The operation is suppressed on all addressing exceptions.

Resulting Condition Code:

- 0 Access-list-entry token (ALET) is 00000000 hex
- 1 ALET designates the dispatchable-unit access list and does not cause exceptions in access-register translation (ART)
- 2 ALET designates the primary-space access list and does not cause exceptions in ART
- 3 ALET is 00000001 hex or causes exceptions in ART

Program Exceptions:

- Addressing (effective access-list designation, access-list entry, ASN-second-table entry, or authority-table entry)
- Special operation (in the ESA/390-compatibility mode)
- Transaction constraint

The priority of recognition of program exceptions for the instruction is shown in Figure 10-97.

1.-6.	Exceptions with the same priority as the priority of program-interruption conditions for the general case.
7.A	Access exceptions for second instruction halfword.
7.B	Transaction constraint.
8.	Condition code 0 due to access-list-entry-token (ALET) being 00000000 hex.
9.	Condition code 3 due to ALET being 00000001 hex or ALET bits 0-6 not being all zeros.
10.	Addressing exception for access to effective access-list designation.
11.	Condition code 3 due to access-list entry (ALE) being outside the list.
12.	Addressing exception for access to ALE.
13.	Condition code 3 due to ALE being invalid (bit 0 is 1) or access-list-entry sequence number (ALESN) in the ALET not being equal to the ALESN in the ALE.
14.	Addressing exception for access to ASN-second-table entry (ASTE).

Figure 10-97. Priority of Execution: TEST ACCESS (Part 1 of 2)

15.	Condition code 3 due to ASTE being invalid (bit 0 is one) or ASTE sequence number (ASTESN) in the ALE not being equal to the ASTESN in the ASTE.
16.	Condition code 3 due to authority-table entry being outside table.
17.	Addressing exception for access to authority-table entry.
18.	Condition code 3 due to ALE private bit not being zero, ALE authorization index (ALEAX) not being equal to effective extended authorization index (EAX), and secondary bit selected by effective EAX being zero.
19.	Condition code 1 if ALET bit 7 is zero; otherwise, condition code 2.

Figure 10-97. Priority of Execution: TEST ACCESS (Part 2 of 2)

Programming Notes:

1. TEST ACCESS permits a called program to check whether an ALET passed from the calling program is authorized for use by means of the calling program's EAX. The calling program's EAX can be obtained from the last linkage-stack state entry by means of EXTRACT STACKED STATE. The called program can thus avoid performing an operation for the calling program, through the use of the called program's EAX, which the calling program is not authorized to perform by means of its own EAX.
2. When an ALET equal to 00000000 hex is passed during a program linkage performed by PROGRAM CALL with space switching (PC-ss), and the ALET conceptually designates the calling program's primary address space and the called program's secondary address space, the ALET must be changed to 00000001 hex before it is used by the called program. Condition code 0 of TEST ACCESS indicates a 00000000 hex ALET so that the ALET can be changed to 00000001 hex by the called program.
3. PROGRAM CALL to current primary (PC-cp) sets the secondary address space equal to the primary address space. PC-ss sets the secondary address space equal to the calling program's primary address space, except that stacking PC-ss sets it equal to the called program's primary address space when the secondary-ASN control in the entry-table entry used is one. In all these

cases, a passed 00000001 hex ALET that conceptually designates the calling program's secondary address space is not usable by the called program, even after any transformation (unless the operation was PC-cp and the calling program's PASN and SASN are equal). This is why TEST ACCESS sets condition code 3 when the tested ALET is 00000001 hex.

4. After a PC-ss, a passed ALET that conceptually designates an entry in the primary-space access list of the calling program is not usable by the called program. This is why TEST ACCESS sets condition code 2, instead of condition code 1, when the tested ALET designates the primary-space access list.
5. The control program may manage the ASN-second-table entry in a way that causes a correctable ASTE-validity or ASTE-sequence exception situation to exist; that is, a situation which, if it were to cause a program interruption during access-register translation, would be corrected by the control program so that access-register translation could be completed successfully. In this case, the program should not use TEST ACCESS directly but should instead use a control-program service that uses TEST ACCESS and that corrects the situation, if possible, when condition code 3 is set. MVS/ESA provides the TESTART macro instruction for use instead of the direct use of TEST ACCESS.

TEST BLOCK

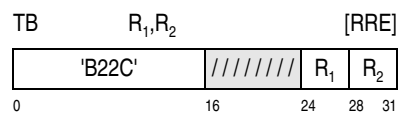

The storage locations and storage key of a 4 K-byte block are tested for usability, and the result of the test is indicated in the condition code. The test for usability is based on the susceptibility of the block to the occurrence of invalid checking-block code.

The block tested is addressed by the contents of general register R_2 . The contents of general register R_1 are ignored.

A complete testing operation is necessarily performed only when the initial contents of bit positions 32-63 of general register 0 are zero in the 24-bit or 31-bit addressing mode, or the initial contents of bit

positions 0-63 of that register are zero in the 64-bit addressing mode. In the 24-bit or 31-bit addressing mode, the contents of bit positions 32-63 of general register 0 are set to zero at the completion of the operation, and bits 0-31 of the register always are ignored and remain unchanged. In the 64-bit addressing mode, the contents of bit positions 0-63 of the register are set to zero at the completion of the operation.

If the block is found to be usable, the 4K bytes of the block are cleared to zeros, the contents of the storage key are unpredictable, and condition code 0 is set. If the block is found to be unusable, the data and the storage key are set, as far as is possible by the model, to a value such that subsequent fetches to the area do not cause a machine-check condition, and condition code 1 is set.

In the 24-bit addressing mode, bits 40-51 of general register R_2 designate a 4 K-byte block in real storage, and bits 0-39 and 52-63 of the register are ignored. In the 31-bit addressing mode, bits 33-51 of the register designate the block, and bits 0-32 and 52-63 are ignored. In the 64-bit addressing mode, bits 0-51 of the register designate the block, and bits 52-63 are ignored.

The address of the block is a real address, and the accesses to the block designated by the second-operand address are not subject to access-list-controlled, DAT, instruction-execution, or key-controlled protection. Low-address protection does apply. The operation is terminated on addressing and protection exceptions. If termination occurs, the condition code and the contents of bit positions 32-63 of general register 0 are unpredictable in the 24-bit or 31-bit addressing mode, or the condition code and bits 0-63 of the register are unpredictable in the 64-bit addressing mode. The contents of the storage block and its associated storage key are not changed when these exceptions occur.

Depending on the model, the test for usability may be performed (1) by alternately storing and reading out test patterns to the data and storage key in the block or (2) by reference to an internal record of the usability of the blocks which are available in the configuration, or (3) by using a combination of both mechanisms.

In models in which an internal record is used, the block is indicated as unusable if a solid failure has

been previously detected, or if intermittent failures in the block have exceeded the threshold implemented by the model. In such models, depending on the criteria, attempts to store may or may not occur. Thus, if block 0 is not usable, and no store occurs, low-address protection may or may not be indicated.

In models in which test patterns are used, TEST BLOCK may be interruptible. When an interruption occurs after a unit of operation, other than the last one, the condition code is unpredictable, and the contents of bit positions 32-63 of general register 0 may contain a record of the state of intermediate steps in the 24-bit or 31-bit addressing mode, or the contents of bit positions 0-63 may contain that record in the 64-bit addressing mode. When execution is resumed after an interruption, the condition code is ignored, but the record in general register 0 may be used to determine the resumption point.

If (1) TEST BLOCK is executed with an initial value other than zero in bit positions 32-63 of general register 0 in the 24-bit or 31-bit addressing mode or bit positions 0-63 in the 64-bit addressing mode, or (2) the interrupted instruction is resumed after an interruption with a value in bit positions 32-63 or 0-63 (depending on the addressing mode) of general register 0 or a value in the storage block or its associated storage key other than the corresponding value which was present at the time of the interruption, or (3) the block or its associated storage key is accessed by another CPU or by the channel subsystem during the execution of the instruction, then the contents of the storage block, its associated storage key, and bit positions 32-63 or 0-63 of general register 0 are unpredictable, along with the resultant condition-code setting.

Invalid checking-block-code errors initially found in the block or encountered during the test do not normally result in machine-check conditions. The test-block function is implemented in such a way that the frequency of machine-check interruptions due to the instruction execution is not significant. However, if, during the execution of TEST BLOCK for an unusable block, that block is accessed by another CPU (or by the channel subsystem), error conditions may be reported both to this CPU and to the other CPU (or to the channel subsystem).

A serialization function is performed before the block is accessed and again after the operation is completed (or partially completed).

Resulting Condition Code:

- 0 Block usable
- 1 Block not usable
- 2 --
- 3 --

Program Exceptions:

- Addressing (fetch and store, operand 2)
- Privileged operation
- Protection (store, operand 2, low-address protection only)
- Transaction constraint

The priority of the recognition of exceptions and condition codes is shown in Figure 10-98.

1.-6.	Exceptions with the same priority as the priority of program-interruption conditions for the general case.
7.A	Access exceptions for second instruction halfword.
7.B	Privileged-operation exception.
7.C	Transaction constraint.
8.	Addressing exception due to block not being available in the configuration.*
9.A	Condition code 1, block not usable.
9.B	Protection exception due to low-address protection.*
10.	Condition code 0, block usable and set to zeros.
Explanation:	
*	The operation is terminated on addressing and protection exceptions, and the condition code may be unpredictable.

Figure 10-98. Priority of Execution: TEST BLOCK

Programming Notes:

1. The execution of TEST BLOCK on most models is significantly slower than that of the MOVE LONG instruction with padding; therefore, the instruction should not be used for the normal case of clearing storage.
2. The program should use TEST BLOCK at initial program loading and as part of the vary-storage-

online procedure to determine if blocks of storage exist which should not be used.

3. The program should use TEST BLOCK when an uncorrected error is reported in either the data or storage key of a block. This is because in the execution of TEST BLOCK the attempt is made, as far as is possible on the model, to leave the contents of a block in a state such that subsequent prefetches or unintended references to the block do not cause machine-check conditions. The program may use the resulting condition code in this case to determine if the block can be reused. (The block could be indicated as usable if, for example, the error were an externally generated error or an indirect storage error.) This procedure should be followed regardless of whether the indirect-storage-error indication is reported.
4. The model may or may not be successful in removing the errors from a block when TEST BLOCK is executed. The program therefore should take every reasonable precaution to avoid referencing an unusable block. For example, the program should not place the page-frame real address of an unusable block in an attached and valid page-table entry.
5. On some models, machine checks may be reported for a block even though the block is not referenced by the program. When a machine check is reported for a storage-key error in a block which has been marked as unusable by the program, it is possible that SET STORAGE KEY EXTENDED may be more effective than TEST BLOCK in validating the storage key.
6. The storage-operand references for TEST BLOCK may be multiple-access references. (See "Storage-Operand Consistency" on page 5-125.)

TEST PENDING EXTERNAL INTERRUPTION

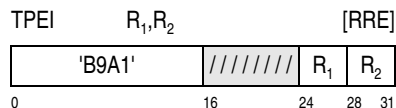

General register R₂ contains a mask representing one or more external-interruption subclasses to be tested for pending interruptions. The bit positions representing tested subclasses are shown in Figure 10-99. All other bits in general register R₂ are

reserved and should contain zeros; otherwise, the program may not operate compatibly in the future.

Bit	External Interruption Subclass
30	Warning track
48	Malfunction alert
49	Emergency signal
50	External call

Figure 10-99. External-Interruption Subclasses and Corresponding Bit Positions in General Registers R₁ and R₂.

For the purposes of this instruction, an interruption is considered to be pending for a subclass regardless of whether the subclass is enabled in control register 0 and regardless of PSW bit 7. If an external interruption is pending for a designated subclass, the corresponding bit in general register R₁ is set to one; otherwise, the corresponding bit in general register R₁ is set to zero. All other bit positions in general register R₁ are set to zeros.

When any resulting bit position in general register R₁ contains a one, the instruction completes by setting condition code 1; otherwise, the instruction completes by setting condition code 0.

Resulting Condition Code:

- 0 None of the tested subclasses of external interruptions are pending, or no subclasses were tested.
- 1 One or more of the tested subclasses of external interruptions are pending
- 2 --
- 3 --

Program Exceptions:

- Operation (test-pending-external-interruption facility not installed)
- Privileged operation
- Transaction constraint

Programming Note: Unlike the TEST PENDING INTERRUPTION (TPI) instruction which is subject to the I/O-interruption subclass-mask bits in control register 6, TEST PENDING EXTERNAL INTERRUPTION does not take subclass enablement into consideration.

TEST PROTECTION

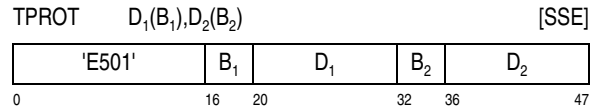

The location designated by the first-operand address is tested for protection exceptions by using the access key specified by bits 56-59 of the second-operand address.

The second-operand address is not used to address data; instead, bits 56-59 of the address form the access key to be used in testing. Bits 0-55 and 60-63 of the second-operand address are ignored.

The first-operand address is a logical address. When the CPU is in the access-register mode (when DAT is on and PSW bits 16 and 17 are 01 binary), the first-operand address is subject to translation by means of both the access-register-translation (ART) and the dynamic-address-translation (DAT) processes. ART applies to the access register designated by the B₁ field, and it obtains the address-space-control element to be used by DAT. When DAT is on but the CPU is not in the access-register mode, the first-operand address is subject to translation by DAT. In this case, DAT uses the address-space-control element contained in control register 1, 7, or 13 when the CPU is in the primary-space, secondary-space, or home-space mode, respectively. When DAT is off, the first-operand address is a real address not subject to translation by either ART or DAT.

When the CPU is in the access-register mode and an address-space-control element cannot be obtained by ART because of a condition that would normally cause one of the exceptions shown in the following

table, the instruction is completed by setting condition code 3.

Exception Name	Cause
ALET specification	Access-list-entry-token (ALET) bits 0-6 not all zeros
ALEN translation	Access-list entry (ALE) outside list or invalid (bit 0 is one)
ALE sequence	ALE sequence number (ALESN) in ALET not equal to ALESN in ALE
ASTE validity	ASN-second-table entry (ASTE) invalid (bit 0 is one)
ASTE sequence	ASTE sequence number (ASTESN) in ALE not equal to ASTESN in ASTE
Extended authority	ALE private bit not zero, ALE authorization index (ALEAX) not equal to extended authorization index (EAX), and secondary bit selected by EAX either outside authority table or zero

When the access register contains 00000000 hex or 00000001 hex, ART obtains the address-space-control element from control register 1 or 7, respectively, without accessing the access list. When the B₁ field designates access register 0, ART treats the access register as containing 00000000 hex and does not examine the actual contents of the access register.

When ART is completed successfully, the operation is continued through the performance of DAT.

When DAT is on and the first-operand address cannot be translated because of a condition that would normally cause one of the exceptions shown in the

following table, the instruction is completed by setting condition code 3.

Exception Name	Cause
ASCE type	Address-space-control element (ASCE) being used is a region-second-table designation, and bits 0-10 of first-operand address not all zeros; ASCE is a region-third-table designation, and bits 0-21 of first-operand address not all zeros; or ASCE is a segment-table designation, and bits 0-32 of first-operand address not all zeros.
Region first translation	Region-first-table entry outside table or invalid.
Region second translation	Region-second-table entry outside table or invalid.
Region third translation	Region-third-table entry outside table or invalid.
Segment translation	Segment-table entry outside table or invalid
Page translation	Page-table entry invalid

When translation of the first-operand address can be completed, or when DAT is off, the storage key for the block designated by the first-operand address is tested against the access key specified in bit positions 56-59 of the second-operand address, and the condition code is set to indicate whether store and fetch accesses are permitted, taking into consideration all applicable protection mechanisms except for instruction-execution protection. Thus, for example, if low-address protection is active and the first-operand effective address is in the range 0-511 or 4096-4607, then a store access is not permitted. Access-list-controlled protection, DAT protection, storage-protection override, and fetch-protection override also are taken into account; instruction-execution protection is not considered.

When EDAT-1 does not apply, when EDAT-1 applies but the STE-format control is zero, or when EDAT-2 applies but the RTTE-format control is zero, bits 0-4 of the storage key for the 4 K-byte block corresponding to the virtual address in the first operand are examined to determine the condition code. When EDAT-1 applies and both the STE-format and AV controls in the STE are one, it is unpredictable whether bits 0-4 of the storage key or bits 48-52 of the segment-table entry used in the translation of the

first operand are examined to determine the condition code. When EDAT-2 applies and both the RTTE-format and AV controls in the RTTE are one, it is unpredictable whether bits 0-4 of the storage key or bits 48-52 of the region-third-table entry used in the translation of the first operand are examined to determine the condition code.

The contents of storage, including the change bit, are not affected. Depending on the model, the reference bit for the first-operand address may be set to one, even for the case in which the location is protected against fetching.

Special Conditions

When the CPU is in the access-register mode, an addressing exception is recognized when the address used by ART to fetch the effective access-list designation or the ALE, ASTE, or authority-table entry designates a location which is not available in the configuration.

When DAT is on, an addressing exception is recognized when the address of the region-table entry or entries, segment-table entry, or page-table entry or the operand real address after translation designates a location which is not available in the configuration. Also, a translation-specification exception is recognized when a region-table entry or the segment-table entry or page-table entry has a format error, that is, when any of the reasons 1-5 listed in "Translation-Specification Exception" on page 6-46 applies. When DAT is off, only the addressing exception due to the operand real address applies.

For all of the above cases, the operation is suppressed.

Resulting Condition Code:

- 0 Fetching permitted; storing permitted
- 1 Fetching permitted; storing not permitted
- 2 Fetching not permitted; storing not permitted
- 3 Translation not available

Program Exceptions:

- Addressing (effective access-list designation, access-list entry, ASN-second-table entry, authority-table entry, region-table entry, segment-table entry, page-table entry, or operand 1)
- Privileged operation
- Translation specification

- Transaction constraint

Programming Notes:

1. TEST PROTECTION permits a program to determine the protection attributes of an address passed from a calling program without incurring program exceptions. The instruction sets a condition code to indicate whether fetching or storing is permitted at the location designated by the first-operand address of the instruction. The instruction takes into consideration all of the protection mechanisms in the machine: access-list controlled, DAT, key-controlled, and low-address protection, storage-protection override, and fetch-protection override. Additionally, since ASCE-type, region-translation, segment-translation, and page-translation-exception conditions may be a program substitute for a protection violation, these conditions are used to set the condition code rather than cause a program exception.

When the CPU is in the access-register mode, TEST PROTECTION additionally permits the program to check the usability of an access-list-entry token (ALET) in an access register without incurring program exceptions. The ALET is checked for validity (absence of an ALET-specification, ALEN-translation, and ALE-sequence-exception condition) and for being authorized for use by the program (absence of an ASTE-validity, ASTE-sequence, and extended-authority-exception condition).

2. See the programming notes under SET PSW KEY FROM ADDRESS for more details and for an alternative approach to testing the key-controlled protection attributes of addresses passed by a calling program. The approach using TEST PROTECTION has the advantage of a test which does not result in interruptions; however, the test and use are separated in time and may not be accurate if the possibility exists that the storage key of the location in question can change between the time it is tested and the time it is used.
3. In the handling of dynamic address translation, TEST PROTECTION is similar to LOAD REAL ADDRESS in that the instructions do not cause ASCE-type, region-translation, segment-translation, and page-translation exceptions. Instead, these exception conditions are indicated by means of a condition-code setting. Similarly, access-register translation sets a condition code

for certain exception conditions when performed during either of the two instructions. Conditions which result in condition codes 1, 2, and 3 for LOAD REAL ADDRESS result in condition code 3 for TEST PROTECTION. The instructions also differ in several other respects. The first-operand address of TEST PROTECTION is a logical address and thus is not subject to dynamic address translation when DAT is off. The second-operand address of LOAD REAL ADDRESS is a virtual address which is always translated.

Access-register translation applies to TEST PROTECTION only when the CPU is in the access-register mode (DAT is on), whereas it applies to LOAD REAL ADDRESS when PSW bits 16 and 17 are 01 binary regardless of whether DAT is on or off. When condition code 3 is set because of an exception condition in access-register translation, LOAD REAL ADDRESS, but not TEST PROTECTION, returns in a general register the program-interruption code assigned to the exception.

- Condition code 3 does not necessarily indicate that the first-operand location will always be inaccessible to the program; rather it merely indicates that the current conditions prevent the instruction from determining the protection attributes of the operand. For example, in a virtual storage environment, condition code 3 may be set if the storage location has been paged out by the operating system. If the program attempts to access the location, the operating system may resolve the page-translation exception and subsequently make the location accessible to the program.

Similarly, condition code 1 does not necessarily indicate that the address cannot ever be stored into. In an operating system that implements a Posix fork function, DAT protection is used to alert the operating system of a copy-on-write event (as described in Programming Note 1 on page 3-19). Following the operating-system resolution of the copy-on-write event, the program may be given store access to the location.

TRACE

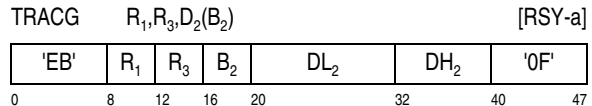
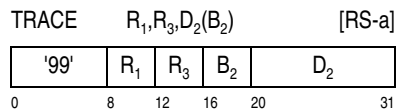

When explicit tracing is on (bit 63 of control register 12 is one), the second operand, which is a 32-bit word in storage, is fetched, and bit 0 of the word is examined. If bit 0 of the second operand is zero, a trace entry is formed at the real-storage location designated by control register 12.

If explicit tracing is off (bit 63 of control register 12 is zero), or if bit 0 of the second operand is one, no trace entry is formed, and no trace exceptions are recognized.

The displacement for TRACE is treated as a 12-bit unsigned binary integer. The displacement for TRACG is treated as a 20-bit signed binary integer.

The trace entry is composed of an entry-type identifier, a count of the number of general registers whose partial or entire contents are placed in the entry, a field whose contents indicate whether the entry was formed by TRACE (TRACE) or TRACE (TRACG), selected bits of the TOD clock, the second operand, and the partial or entire contents of a range of general registers. For TRACE (TRACE), bits 16-63 of the TOD clock and bits 32-63 of the general registers are placed in the trace entry. For TRACE (TRACG), bits 1-7 of the epoch index, bits 0-79 of the clock, and bits 0-63 of the registers are placed in the entry. See "Trace Entries" on page 4-15 for further details.

The general registers are stored in ascending order of their register numbers, starting with general register R_1 and continuing up to and including general register R_3 , with general register 0 following general register 15. The trace table and the trace-entry formats are described in "Tracing" on page 4-12.

When a trace entry is made, a serialization and checkpoint-synchronization function is performed before the operation begins and again after the operation is completed. However, it is unpredictable whether or not a store into a trace-table entry from which a subsequent instruction is fetched will be observed by the CPU that performed the store. Additionally, when the store-clock-fast facility is installed and the TRACE TOD-clock control in bit 32 of control register 0 is one, it is unpredictable whether explicit tracing causes serialization to be performed.

Special Conditions

A privileged-operation exception is recognized in the problem state, even when explicit tracing is off or bit 0 of the second operand is one.

The second operand must be designated on a word boundary; otherwise, a specification exception is recognized. It is unpredictable whether the specification exception is recognized when explicit tracing is off.

It is unpredictable whether access exceptions or PER zero-address-detection events are recognized for the second operand when explicit tracing is off.

Condition Code: The code remains unchanged.

Program Exceptions:

- Access (fetch, operand 2)
- Privileged operation
- Specification
- Trace
- Transaction constraint

Programming Notes:

1. Bits 1-15 of the second operand are reserved for model-dependent functions and should therefore be set to zeros.
2. When the store-clock-fast facility is not installed, or when the TOD-clock-control in bit 32 of control register 0 is zero, the entire 32-bit TRACE operand is stored in bits 64-95 of the trace entry for TRACE (TRACE) and in bits 96-127 of the trace entry for TRACE (TRACG).
3. When the store-clock-fast facility is installed and the TRACE TOD-clock control in bit 32 of control register 0 is one, the following conditions apply:

- Two executions of the instruction do not necessarily store different values in the TOD-clock bits of the trace entry.
- The value of the TOD clock bits stored in the trace entry does not necessarily indicate the order of operations among multiple CPUs.
- The contents of bit positions 16-31 of the TRACE operand are stored in bits 80-95 of the trace entry for TRACE (TRACE) and in bits 112-127 of the trace entry for TRACE (TRACG).
- Bits 64-79 of the trace entry for TRACE (TRACE) and bits 96-111 of the trace entry for TRACE (TRACG) are set to a model-dependent value.

TRAP

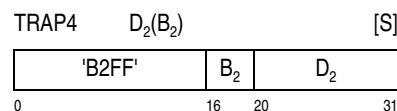
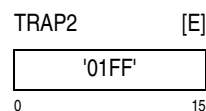

A trap operation is performed if the CPU is in the primary-space or access-register mode and the TRAP-enabled bit in byte 47 of the dispatchable-unit control table (DUCT) is one. Otherwise, a special-operation exception is recognized.

The trap operation obtains a trap-control-block address from the DUCT and then a trap-save-area address and a trap-program address from the trap control block. State information is stored in the trap save area. Then the trap-control-block address is loaded into general register 15. Finally, the current PSW is updated by setting the basic-addressing-mode bit to one (which will leave the addressing mode as either the 31-bit mode or the 64-bit mode or will change the addressing mode from the 24-bit mode to the 31-bit mode) and the address-space-control bits to zeros (primary-space mode) and by replacing the instruction address with the trap-program address. Compatibility with the ESA/390 operation of TRAP optionally is provided.

For TRAP4, the second-operand address is not used to address data; instead, bits 33-63 of the address are stored in the trap save area.

Dispatchable-Unit Control Table

Bytes 44-47 (word 10) of the dispatchable-unit-control table (DUCT) are used by this instruction. The contents of those bytes are as follows:

DUCT Bytes 44-47

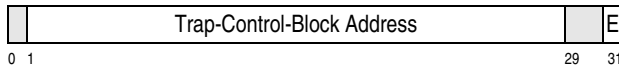

The fields in bytes 44-47 of the DUCT are allocated as follows:

Trap-Control-Block Address: Bits 1-28, with three zeros appended on the right, form the 31-bit home virtual address of the trap control block. This address is treated as a 31-bit home virtual address regardless of the current addressing mode and regardless of the current value of the address-space-control bits. This address, with a zero appended on the left, is placed in bit positions 32-63 of general register 15 after the contents of that register have been saved in the trap save area. If the current addressing mode is the 64-bit mode, bits 0-31 of general register 15 are set to zeros.

TRAP-Enabled Bit (E): Bit 31 specifies, when one, that the trap operation is to be performed. TRAP recognizes a special-operation exception if bit 31 is zero.

Bits 0, 29, and 30 of bytes 44-47 are ignored, but they should be zeros to permit possible future extensions.

Trap Control Block

The trap control block is 64 bytes aligned on a doubleword boundary. The format of the trap control block is:

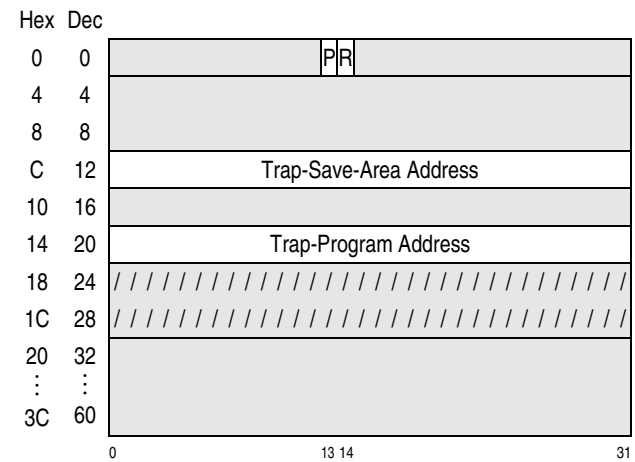

The fields in the trap control block are allocated as follows:

PSW Control (P): Bit 13 of bytes 0-3 controls the allowed value of bit 31 of the current PSW and how bits 12 and 33-127 of the current PSW are stored in the PSW-values field in the trap save area. When bit 13 is zero:

- Bit 31 of the current PSW, the extended-addressing-mode bit, must be zero; otherwise, a special-operation exception is recognized.
- A one is stored in bit position 12 of the PSW-values field even though bit 12 of the current PSW is zero.
- Bits 97-127 of the current PSW are stored in bit positions 33-63 of the PSW-values field, bits 33-96 of the current PSW are not stored, and zeros are stored in bit positions 64-127 of the PSW-values field.

When bit 13 is one:

- Bit 31 of the current PSW may be zero or one.
- Bit 12 of the current PSW is stored in bit position 12 of the PSW-values field.
- Bits 64-127 of the current PSW are stored in bit positions 64-127 of the PSW-values field.

General-Registers Control (R): Bit 14 of bytes 0-3 controls how the contents of the general registers are

stored in the general-registers 0-15 field in the trap save area. When R is zero, bits 32-63 of the general registers are stored in consecutive four-byte locations beginning at the beginning of the general-registers 0-15 field, bits 0-31 of the registers are not stored, and the last 64 bytes of the general-registers 0-15 field remain unchanged. When R is one, bits 0-63 of the general registers are stored in consecutive eight-byte locations in the general-registers 0-15 field.

Trap-Save-Area Address: Bits 1-28 of bytes 12-15, with three zeros appended on the right, form the 31-bit home virtual address of the trap save area. This address is treated as a 31-bit home virtual address regardless of the current addressing mode and regardless of the current value of the address-space-control bits. Bits 0 and 29-31 of bytes 12-15 are ignored.

Trap-Program Address: Bits 1-31 of bytes 20-23 form the 31-bit primary virtual address of the trap program. This address is treated as a 31-bit primary virtual address regardless of the current addressing mode.

Bit positions 0-12 and 15-31 of bytes 0-3 and bytes 4-11, 16-19, and 32-63 of the trap control block are reserved and should contain zeros. Bytes 24-31 are available for use by programming.

Trap Save Area

The trap save area is 256 bytes aligned on a double-word boundary.

The trap operation stores information into the trap save area as follows:

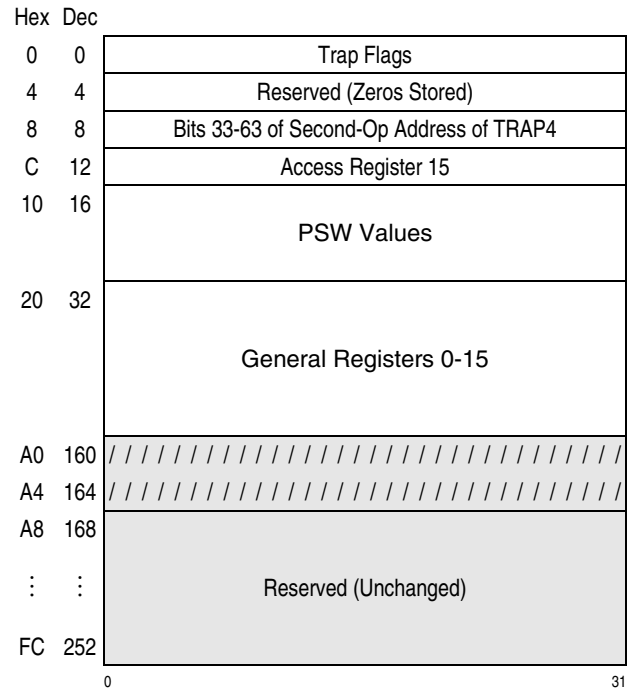

The fields in the trap save area are allocated as follows:

Trap Flags: Information identifying the instruction(s) causing the trap operation is stored in byte positions 0-3. The detailed format of bytes 0-3 is as follows:

Flag Bits	Meaning
0	TRAP was target of an execute-type instruction
1	TRAP is TRAP4 (not TRAP2)
2-12	Reserved, zeros stored
13-14	Instruction-length code (ILC)
15-31	Reserved, zeros stored

Bit 0 of bytes 0-3 is set to one if TRAP was the target of an execute-type instruction (EXECUTE or EXECUTE RELATIVE LONG).

Bit 1 of bytes 0-3 is set to one if TRAP is TRAP4 (not TRAP2).

Bits 13 and 14 are the instruction-length code (ILC) that specifies the length of the TRAP instruction, or the length of the execute-type instruction if TRAP was the target of an execute-type instruction.

Bits 2-12 and 15-31 are reserved and are stored as zeros.

Bits 33-63 of Second-Operand Address of TRAP4: For TRAP4, bits 33-63 of the second-operand address, generated under the control of the current addressing mode and with a zero appended on the left, are stored in byte positions 8-11. Only bits 33-63 of the second-operand address are stored even when the current addressing mode is the 64-bit mode. For TRAP2, all zeros are stored in byte positions 8-11.

Access Register 15: The contents of access register 15 are stored in byte positions 12-15.

PSW Values: The following description applies when the PSW control, bit 13 of bytes 0-3 of the trap control block, is one.

Certain information from the current PSW is stored in byte positions 16-31. The PSW has the following format:

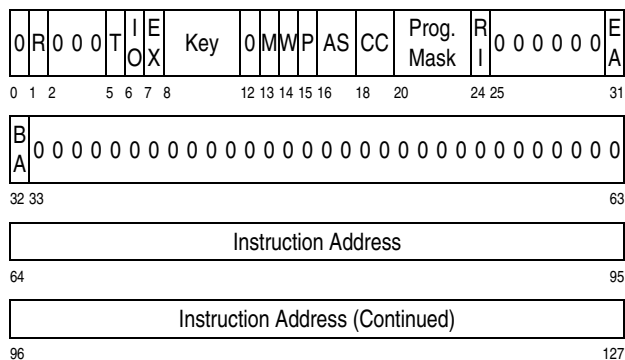

Bits 0-127 of bytes 16-31 correspond one-to-one with bits 0-127 of the PSW. For some bit positions of bytes 16-31, the corresponding PSW bits are stored. For the other bit positions of bytes 16-31, unpredictable values are stored. Information is stored in bytes 16-31 as follows:

Bits	Value
0	Zero
1	Unpredictable
2-4	Zero
5-11	Unpredictable
12	Zero
13	Unpredictable
14	Wait state (W)
15	Problem state (P)

Bits	Value
16-17	Address-space control (AS)
18-19	Condition code (CC)
20-23	Program mask
25-30	Zero
31	Extended addressing mode (EA)
32	Basic addressing mode (BA)
33-63	Zero
64-127	Instruction address

In summary, bits 0, 2-4, 12, 24-30, and 33-63 are zero, bits 1, 5-11, and 13 are unpredictable, and the other bits are set with variable information from the PSW.

The wait-state, problem-state, address-space-control, condition-code, program-mask, extended-addressing-mode, and basic-addressing-mode values specify the state of the CPU before the TRAP instruction was executed. The instruction-address value is the updated instruction address, which is the address of the instruction following TRAP, or the address of the instruction following the execute-type instruction if TRAP was the target of an execute-type instruction.

When the PSW control in the trap control block is zero, the operation is as described above except as follows:

- Bit 31 of the current PSW must be zero; otherwise, a special-operation exception is recognized.
- A one is stored in bit position 12 of bytes 16-31.
- Bits 97-127 of the current PSW are stored in bit positions 33-63 of bytes 16-31, bits 33-96 of the current PSW are not stored, and zeros are stored in bit positions 64-127 of bytes 16-31 (bytes 24-31).

In this case, bytes 16-23 have the format of an ESA/390 PSW, which is as follows:

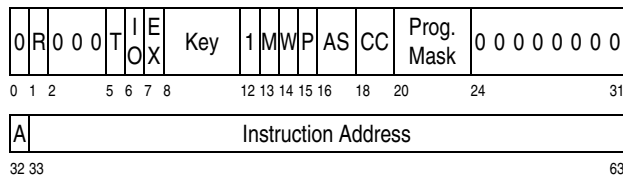

General Registers 0-15: Contents of general registers 0-15 are stored in byte positions 32-159 as

described in “General-Registers Control (R)” on page 10-178. When bits 32-63 or 0-63 of the general registers are stored, they are stored in ascending order of register numbers, starting with register 0 and continuing up to and including register 15.

Bytes 160-255 always remain unchanged. Bytes 168-255 are reserved. Bytes 160-167 are available for use by programming.

Special Conditions

The CPU must be in the primary-space mode or access-register mode, and bit 31 in bytes 44-47 of the dispatchable-unit control table must be one; otherwise, a special-operation exception is recognized. A special-operation exception is also recognized if the PSW control, bit 13 of bytes 0-3 of the trap control block is zero and bit 31 of the current PSW, the extended-addressing-mode bit, is one.

All protection mechanisms apply in the usual way to the accesses to the trap control block and trap save area. Access exceptions may or may not be recognized for sections of the trap control block and trap save area that are not referenced by the TRAP instruction.

The trap-program address in the trap control block is not tested before it replaces the instruction address in the PSW. An odd address will cause a specification exception to be recognized as part of the execution of the next instruction.

The operation is suppressed on all addressing and protection exceptions.

Condition Code: The code remains unchanged.

Program Exceptions:

- Access (fetch, trap control block; store, trap save area)
- Addressing (dispatchable-unit control table)
- Special operation
- Trace
- Transaction constraint

The priority of recognition of program exceptions for the instruction is shown in Figure 10-100.

1.-6.	Exceptions with the same priority as the priority of program-interruption conditions for the general case.
7.A	Access exceptions for second instruction halfword (TRAP4 only).
7.B	Special-operation exception due to the CPU not being in the primary-space mode or access-register mode.
7.C.1	Addressing exception for access to dispatchable-unit control table.
7.C.2	Special-operation exception due to bit 31 in bytes 44-47 of dispatchable-unit control table being zero.
7.D	Transaction constraint.
8.A	Trace exceptions.
8.B.1	Access exceptions (fetch) for trap control block.
8.B.2	Special-operation exception due to PSW control in trap control block being zero and PSW bit 31 being one.
8.B.3	Access exceptions (store) for trap save area.

Figure 10-100. Priority of Execution: TRAP

Programming Notes:

1. It is intended that TRAP instructions will overlay instructions in an application program in order to give control to a trap program, which might be a program for performing fix-ups of data used by the application program, such as dates that may be a “Year-2000” problem. TRAP2 can overlay a two-byte instruction, and TRAP4 can overlay a four-byte instructions or the first four bytes of a six-byte instruction. The trap program is to simulate the overlaid instruction and perform fix-ups as appropriate, and it is then to return control to the application program.
2. The trap program can use the RESUME PROGRAM instruction to return control to the application program. For example, the trap program can restore the contents of all registers except access and general registers 15, and then, using those registers (or at least the general register) to address the trap save area, can restore the contents of those registers and also PSW fields from the trap save area. RESUME PROGRAM

has control bits in its parameter list that allow it to restore PSW fields from a field having either the short format (as shown in Figure 4-3 on page 4-8) or the 16-byte format (as shown in Figure 4-2 on page 4-5) and to restore either bits 32-63 or 0-63 of a general register.

3. The trap control block and trap save area are in the home address space, and the trap program is in the primary address space. The trap-control-block address placed in general register 15 by TRAP can be useful to the trap program if (1) the primary address space and home address space are the same address space, (2) the trap control block and trap save area are at the same locations in the primary address space as in the home address space, or (3) the trap program can use access registers to access the home address space.
4. The storage-operand references for TRAP may be multiple-access references. (See “Storage-Operand Consistency” on page 5-125.)

Chapter 11. Machine-Check Handling

Machine-Check Detection	11-2	Storage Errors	11-19
Correction of Machine Malfunctions	11-2	Storage Error Uncorrected	11-20
Error Checking and Correction	11-3	Storage Error Corrected	11-20
CPU Retry	11-3	Storage-Key Error Uncorrected	11-20
Effects of CPU Retry	11-3	Storage Degradation	11-20
Checkpoint Synchronization	11-4	Indirect Storage Error	11-20
Handling of Machine Checks during		Machine-Check Interruption-Code Validity	
Checkpoint Synchronization	11-4	Bits	11-21
Checkpoint-Synchronization Operations	11-4	PSW-MWP Validity	11-21
Checkpoint-Synchronization Action	11-5	PSW Mask and Key Validity	11-21
Channel-Subsystem Recovery	11-5	PSW Program-Mask and Condition-Code	
Unit Deletion	11-5	Validity	11-21
Handling of Machine Checks	11-5	PSW-Instruction-Address Validity	11-21
Validation	11-6	Failing-Storage-Address Validity	11-21
Invalid CBC in Storage	11-7	Vector Register Validity	11-21
Programmed Validation of Storage	11-7	External-Damage-Code Validity	11-21
Invalid CBC in Storage Keys	11-8	Floating-Point-Register Validity	11-22
Invalid CBC in Registers	11-9	General-Register Validity	11-22
Check-Stop State	11-10	Control-Register Validity	11-22
System Check Stop	11-10	Storage Logical Validity	11-22
Machine-Check Interruption	11-10	Access-Register Validity	11-22
Exigent Conditions	11-11	Guarded-Storage-Registers Validity	11-22
Repressible Conditions	11-11	TOD-Programmable-Register Validity	11-22
Interruption Action	11-12	Floating-Point-Control-Register Validity	11-22
Interruption Action in the z/Architecture		CPU-Timer Validity	11-23
Architectural Mode	11-12	Clock-Comparator Validity	11-23
Interruption Action in the ESA/390-		Machine-Check Extended Interruption	
Compatibility Mode	11-12	Information	11-23
Interruption Action: Common Actions	11-13	Register-Save Areas	11-23
Point of Interruption	11-14	External-Damage Code	11-24
Machine-Check-Interruption Code	11-15	Failing-Storage Address	11-25
Subclass	11-16	Machine-Check Extended Save Area	
System Damage	11-16	(MCESA)	11-25
Instruction-Processing Damage	11-16	Machine-Check Extended Save Area in the	
System Recovery	11-16	z/Architecture Architectural Mode	11-25
Timing-Facility Damage	11-16	Machine-Check Extended Save Area in the	
External Damage	11-17	ESA/390 Compatibility Mode	11-25
Degradation	11-17	Handling of Machine-Check Conditions	11-26
Warning	11-17	Floating Interruption Conditions	11-26
Channel Report Pending	11-17	Floating Machine-Check-Interruption	
Service-Processor Damage	11-18	Conditions	11-26
Channel-Subsystem Damage	11-18	Floating I/O Interruptions	11-26
Subclass Modifiers	11-18	Machine-Check Masking	11-27
Backed Up	11-18	Channel-Report-Pending Subclass Mask	11-27
Delayed Access Exception	11-18	Recovery Subclass Mask	11-27
Ancillary Report	11-18	Degradation Subclass Mask	11-27
Synchronous Machine-Check-Interruption		External-Damage Subclass Mask	11-27
Conditions	11-18	Warning Subclass Mask	11-27
Processing Backup	11-19	Machine-Check Logout	11-27
Processing Damage	11-19		

The machine-check-handling mechanism provides extensive equipment-malfunction detection to ensure the integrity of system operation and to permit automatic recovery from some malfunctions. Equipment malfunctions and certain external disturbances are reported by means of a machine-check interruption to assist in program-damage assessment and recovery. The interruption supplies the program with information about the extent of the damage and the location and nature of the cause. Equipment malfunctions, errors, and other situations which can cause machine-check interruptions are referred to as machine checks.

Machine-Check Detection

Machine-check-detection mechanisms may take many forms, especially in control functions for arithmetic and logical processing, addressing, sequencing, and execution. For program-addressable information, detection is normally accomplished by encoding redundancy into the information in such a manner that most failures in the retention or transmission of the information result in an invalid code. The encoding normally takes the form of one or more redundant bits, called check bits, appended to a group of data bits. Such a group of data bits and the associated check bits are called a checking block. The size of the checking block depends on the model.

The inclusion of a single check bit in the checking block allows the detection of any single-bit failure within the checking block. In this arrangement, the check bit is sometimes referred to as a "parity bit." In other arrangements, a group of check bits is included to permit detection of multiple errors, to permit error correction, or both.

For checking purposes, the contents of the entire checking block, including the redundancy, are called the checking-block code (CBC). When a CBC completely meets the checking requirements (that is, no failure is detected), it is said to be valid. When both detection and correction are provided and a CBC is not valid but satisfies the checking requirements for correction (the failure is correctable), it is said to be near-valid. When a CBC does not satisfy the check-

ing requirements (the failure is uncorrectable), it is said to be invalid.

Correction of Machine Malfunctions

Four mechanisms may be used to provide recovery from machine-detected malfunctions: error checking and correction, CPU retry, channel-subsystem recovery, and unit deletion.

Machine failures which are corrected successfully may or may not be reported as machine-check interruptions. If reported, they are system-recovery conditions, which permit the program to note the cause of CPU delay and to keep a log of such incidents.

Error Checking and Correction

When sufficient redundancy is included in circuitry or in a checking block, failures can be corrected. For example, circuitry can be triplicated, with a voting circuit to determine the correct value by selecting two matching results out of three, thus correcting a single failure. An arrangement for correction of failures of one order and for detection of failures of a higher order is called error checking and correction (ECC). Commonly, ECC allows correction of single-bit failures and detection of double-bit failures.

Depending on the model and the portion of the machine in which ECC is applied, correction may be reported as system recovery, or no report may be given.

Uncorrected errors in storage and in the storage key may be reported, along with a failing-storage address, to indicate where the error occurred. Depending on the situation, these errors may be reported along with system recovery or with the damage or backup condition resulting from the error.

CPU Retry

In some models, information about some portion of the state of the machine is saved periodically. The

point in the processing at which this information is saved is called a checkpoint. The information saved is referred to as the checkpoint information. The action of saving the information is referred to as establishing a checkpoint. The action of discarding previously saved information is called invalidation of the checkpoint information. The length of the interval between establishing checkpoints is model-dependent. Checkpoints may be established at the beginning of each instruction or several times within a single instruction, or checkpoints may be established less frequently.

Subsequently, this saved information may be used to restore the machine to the state that existed at the time when the checkpoint was established. After restoring the appropriate portion of the machine state, processing continues from the checkpoint. The process of restoring to a checkpoint and then continuing is called CPU retry.

CPU retry may be used for machine-check recovery, to effect nullification and suppression of instruction execution when certain program interruptions occur, and in other model-dependent situations.

Effects of CPU Retry

CPU retry is, in general, performed so that there is no effect on the program. However, change bits which have been changed from zeros to ones are not necessarily set back to zeros. As a result, change bits may appear to be set to ones for blocks which would have been accessed if restoring to the checkpoint had not occurred. If the path taken by the program is dependent on information that may be changed by another CPU or by a channel program or if an interruption occurs, then the final path taken by the program may be different from the earlier path; therefore, change bits may be ones because of stores along a path apparently never taken.

During the execution of the following instructions, CPU retry may result in condition code 3 being set with possibly incorrect data having been stored in the first operand location at or to the right of the location designated by the final address in general register R_1 .

- COMPRESSION CALL
- CONVERT UTF-16 TO UTF-32
- CONVERT UTF-16 TO UTF-8
- CONVERT UTF-32 TO UTF-16
- CONVERT UTF-32 TO UTF-8

- CONVERT UTF-8 TO UTF-16
- CONVERT UTF-8 TO UTF-32
- CIPHER MESSAGE
- CIPHER MESSAGE WITH AUTHENTICATION
- CIPHER MESSAGE WITH CHAINING
- CIPHER MESSAGE WITH COUNTER
- CIPHER MESSAGE WITH CIPHER FEEDBACK
- CIPHER MESSAGE WITH OUTPUT FEEDBACK
- DEFLATE CONVERSION CALL (see below for additional information)
- TRANSLATE ONE TO ONE
- TRANSLATE ONE TO TWO
- TRANSLATE TWO TO ONE
- TRANSLATE TWO TO TWO

During the execution of the PERFORM RANDOM NUMBER OPERATION instruction's generate operation, CPU retry may result in condition code 3 being set with possibly incorrect data having been stored in the first operand location at or to the left of the rightmost byte of the first operand (that is, to the left of the location designated by the combination of general registers R_1 and $R_1 + 1$).

During the execution of DEFLATE CONVERSION CALL when the specified function is DFLTCC-CMPR or DFLTCC-XPND and the history-buffer type is circular, CPU retry may result with possibly incorrect data stored to the third-operand location.

The amount of data stored depends on the operation and the point in time at which CPU retry occurred. The amount of incorrect data stored will not exceed the minimum of (a) the length of the first operand, (b) the length of the second operand (for instructions having a second operand), and (c) the data processed in a single unit of operation of the instruction. In all cases, the storing will occur again, with correct data stored, if the instruction is executed again to continue processing the same operands.

Checkpoint Synchronization

Checkpoint synchronization consists in the following steps.

1. The CPU operation is delayed until all conceptually previous accesses by this CPU to storage have been completed, both for purposes of machine-check detection and as observed by other CPUs and by channel programs.
2. All previous checkpoints, if any, are invalidated.

3. Optionally, a new checkpoint is established.

The CPU operation is delayed until all of these actions appear to be completed, as observed by other CPUs and by channel programs.

Handling of Machine Checks during Checkpoint Synchronization

When, in the process of completing all previous stores as part of the checkpoint-synchronization action, the machine is unable to complete all stores successfully but can successfully restore the machine to a previous checkpoint, processing backup is reported.

When, in the process of completing all stores as part of the checkpoint-synchronization action, the machine is unable to complete all stores successfully and cannot successfully restore the machine to a previous checkpoint, the type of machine-check-interruption condition reported depends on the origin of the store. Failure to successfully complete stores associated with instruction execution may be reported as instruction-processing damage, or some less critical machine-check-interruption condition may be reported with the storage-logical-validity bit set to zero. A failure to successfully complete stores associated with the execution of an interruption, other than program or supervisor call, is reported as system damage.

When the machine check occurs as part of a checkpoint-synchronization action before the execution of an instruction, the execution of the instruction is nullified. When it occurs before the execution of an interruption, the interruption condition, if the interruption is external, I/O, or restart, is held pending. If the checkpoint-synchronization operation was a machine-check interruption, then along with the originating condition, either the storage-logical-validity bit is set to zero or instruction-processing damage is also reported. Program interruptions, if any, are lost.

Checkpoint-Synchronization Operations

All interruptions and the execution of certain instructions cause a checkpoint-synchronization action to be performed. The operations which cause a checkpoint-synchronization action are called checkpoint-synchronization operations and include:

- CPU reset
- All interruptions: external, I/O, machine check, program, restart, and supervisor call

- The BRANCH ON CONDITION (BCR) instruction with the M_1 and R_2 fields containing all ones and all zeros, respectively
- The instructions LOAD PSW, LOAD PSW EXTENDED, SET STORAGE KEY EXTENDED, and SUPERVISOR CALL
- All I/O instructions
- The instructions MOVE TO PRIMARY, MOVE TO SECONDARY, PROGRAM CALL, PROGRAM TRANSFER, SET ADDRESS SPACE CONTROL, and SET SECONDARY ASN, and PROGRAM RETURN when the state entry to be unstacked is a program-call state entry
- The four trace functions: branch tracing, ASN tracing, mode tracing, and explicit tracing, except that when the store-clock-fast facility is installed and the TRACE TOD-clock control in bit 32 of control register 0 is one, then it is unpredictable whether explicit tracing causes a checkpoint-synchronization action.
- PAGE IN and PAGE OUT

Programming Note: The instructions which are defined to cause the checkpoint-synchronization action invalidate checkpoint information but do not necessarily establish a new checkpoint. Additionally, the CPU may establish a checkpoint between any two instructions or units of operation, or within a single unit of operation. Thus, the point of interruption for the machine check is not necessarily at an instruction defined to cause a checkpoint-synchronization action.

Checkpoint-Synchronization Action

For all interruptions except I/O interruptions, a checkpoint-synchronization action is performed at the completion of the interruption. For I/O interruptions, a checkpoint-synchronization action may or may not be performed at the completion of the interruption. For all interruptions except program, supervisor-call, and exigent machine-check interruptions, a checkpoint-synchronization action is also performed before the interruption. The fetch access to the new PSW may be performed either before or after the first checkpoint-synchronization action. The store accesses and the changing of the current PSW associated with the interruption are performed after the first checkpoint-synchronization action and before the second.

For all checkpoint-synchronization instructions except BRANCH ON CONDITION (BCR), I/O instructions, and SUPERVISOR CALL, checkpoint-synchronization actions are performed before and

after the execution of the instruction. For BCR, only one checkpoint-synchronization action is necessarily performed, and it may be performed either before or after the instruction address is updated. For SUPERVISOR CALL, a checkpoint-synchronization action is performed before the instruction is executed, including the updating of the instruction address in the PSW. The checkpoint-synchronization action taken after the supervisor-call interruption is considered to be part of the interruption action and not part of the instruction execution. For I/O instructions, a checkpoint-synchronization action is always performed before the instruction is executed and may or may not be performed after the instruction is executed.

The four trace functions — branch tracing, ASN tracing, mode tracing, and explicit tracing — cause checkpoint-synchronization actions to be performed before the trace action and after completion of the trace action, except that when the store-clock-fast facility is installed and the TRACE TOD-clock control in bit 32 of control register 0 is one, then it is unpredictable whether checkpoint-synchronization actions are performed for explicit tracing.

Channel-Subsystem Recovery

When errors are detected in the channel subsystem, the channel subsystem attempts to analyze and recover the internal state associated with the various channel-subsystem functions and the state of the channel subsystem and various subchannels. This process, which is called channel-subsystem recovery, may result in a complete recovery or may result in the termination of one or more I/O operations and the clearing of the affected subchannels. Special channel-report-pending machine-check-interruption conditions may be generated to indicate to the program the status of the channel-subsystem recovery.

Malfunctions associated with the I/O operations, depending on the severity of the malfunction, may be reported by means of the I/O-interruption mechanism or by means of the channel-report-pending and channel-subsystem-damage machine-check-interruption conditions.

Unit Deletion

In some models, malfunctions in certain units of the system can be circumvented by discontinuing the use of the unit. Examples of cases where unit dele-

tion may occur include the disabling of all or a portion of a cache or of a translation-lookaside buffer (TLB). Unit deletion may be reported as a degradation machine-check-interruption condition.

Handling of Machine Checks

A machine check is caused by a machine malfunction and not by data or instructions. This is ensured during the power-on sequence by initializing the machine controls to a valid state and by placing valid CBC in the CPU registers, in the storage keys, and in main storage.

Designation of an unavailable component, such as a storage location, subchannel, or I/O device, does not cause a machine-check indication. Instead, such a condition is indicated by the appropriate program or I/O interruption or condition-code setting. In particular, an attempt to access a storage location which is not in the configuration, or which has power off at the storage unit, results in an addressing exception when detected by the CPU and does not generate a machine-check condition, even though the storage location or its associated storage key has invalid CBC. Similarly, if the channel subsystem attempts to access such a location, an I/O-interruption condition indicating program check is generated rather than a machine-check condition.

A machine check is indicated whenever the result of an operation could be affected by information with invalid CBC or when any other malfunction makes it impossible to establish reliably that an operation can be, or has been, performed correctly. When information with invalid CBC is fetched but not used, the condition may or may not be indicated, and the invalid CBC is preserved.

When a machine malfunction is detected, the action taken depends on the model, the nature of the malfunction, and the situation in which the malfunction occurs. Malfunctions affecting operator-facility actions may result in machine checks or may be indicated to the operator. Malfunctions affecting certain other operations such as SIGNAL PROCESSOR may be indicated by means of a condition code or may result in a machine-check-interruption condition.

A malfunction detected as part of an I/O operation may cause a machine-check-interruption condition, an I/O-error condition, or both. I/O-error conditions

are indicated by an I/O interruption or by the appropriate condition-code setting during the execution of an I/O instruction. When the machine reports a failing-storage location detected during an I/O operation, both I/O-error and machine-check conditions may be indicated. The I/O-error condition is the primary indication to the program. The machine-check condition is a secondary indication, which is presented as system recovery together with a failing-storage address.

Certain malfunctions detected as part of I/O instructions and I/O operations are reported by means of special machine-check conditions called I/O machine-check conditions. Thus, malfunctions detected as part of an operation which is I/O related may be reported, depending on the error, in any of three ways: I/O-error condition, I/O machine-check condition, or non-I/O machine-check condition. In some cases, the definition requires the error to be reported by only one of these mechanisms; in other cases, any one, or in some cases, more than one, may be indicated.

Programming Note: Although the definition for machine-check conditions is that they are caused by machine malfunctions and not by data and instructions, there are certain unusual situations in which machine-check conditions are caused by events which are not machine malfunctions. Two examples follow:

1. In some cases, the channel-report-pending machine-check-interruption condition indicates a non-error situation. For example, this condition is generated at the completion of the function specified by RESET CHANNEL PATH.
2. Improper use of DIAGNOSE may result in machine-check conditions.

Validation

Machine errors can be generally classified as solid or intermittent, according to the persistence of the malfunction. A persistent machine error is said to be solid, and one that is not persistent is said to be intermittent. In the case of a register or storage location, a third type of error must be considered, called externally generated. An externally generated error is one where no failure exists in the register or storage location but invalid CBC has been introduced into the location by actions external to the location. For exam-

ple, the value could be affected by a power transient, or an incorrect value may have been introduced when the information was placed at the location.

Invalid CBC is preserved as invalid when information with invalid CBC is fetched or when an attempt is made to update only a portion of the checking block. When an attempt is made to replace the contents of the entire checking block and the block contains invalid CBC, it depends on the operation and the model whether the block remains with invalid CBC or is replaced. An operation which replaces the contents of a checking block with valid CBC, while ignoring the current contents, is called a validation operation. Validation is used to place a valid CBC in a register or at a location which has an intermittent or externally generated error.

Validating a checking block does not ensure that a valid CBC will be observed the next time the checking block is accessed. If the failure is solid, validation is effective only if the information placed in the checking block is such that the failing bits are set to the value to which they fail. If an attempt is made to set the bits to the state opposite to that in which they fail, then the validation will not be effective. Thus, for a solid failure, validation is only useful to eliminate the error condition, even though the underlying failure remains, thereby reducing the exposure to additional reports. The locations, however, cannot be used, since invalid CBC will result from attempts to store other values at the location. For an intermittent failure, however, validation is useful to restore a valid CBC such that a subsequent partial store into the checking block will be permitted. (A partial store is a store into a checking block without replacing the entire checking block.)

When a checking block consists of multiple bytes in storage, or multiple bits in CPU registers, the invalid CBC can be made valid only when all of the bytes or bits are replaced simultaneously.

A register is automatically validated as part of the machine-check-interruption sequence after the original contents of the register are placed in the appropriate save area.

When an error occurs in a checking block, the original information contained in the checking block should be considered lost even after validation. Automatic register validation leaves the contents unpredictable.

Invalid CBC in Storage

The size of the checking block in storage depends on the model but is never more than 4K bytes.

When invalid CBC is detected in storage, a machine-check condition may occur; depending on the circumstances, the machine-check condition may be system damage, instruction-processing damage, or system recovery. If the invalid CBC is detected as part of the execution of a channel program, the error is reported as an I/O-error condition. When a CCW, indirect-data-address word, modified-indirect-data-address word, or data is prefetched from storage, is found to have invalid CBC, but is not used in the channel program, the condition is normally not reported as an I/O-error condition. The condition may or may not be reported as a machine-check-interruption condition. Invalid CBC detected during accesses to storage for other than CPU-related accesses may be reported as system recovery with storage error uncorrected indicated, since the primary error indication is reported by some other means.

When the storage checking block consists of multiple bytes and contains invalid CBC, special storage-validation procedures are generally necessary to restore or place new information in the checking block. Validation of storage is provided with the manual load-clear and system-reset-clear operations and is also provided as a program function. Programmed storage validation is done a block at a time, by executing the privileged instruction TEST BLOCK. Manual storage validation by clear reset validates all blocks which are available in the configuration.

A checking block with invalid CBC is never validated unless the entire contents of the checking block are replaced. An attempt to store into a checking block having invalid CBC, without replacing the entire checking block, leaves the data in the checking block (including the check bits) unchanged. Even when an instruction or a channel-program-input operation specifies that the entire contents of a checking block are to be replaced, validation may or may not occur, depending on the operation and the model.

Programming Note: Machine-check conditions may be reported for prefetched and unused data. Depending on the model, such situations may or may not be successfully retried. For example, a BRANCH AND LINK (BALR) instruction which specifies an R_2

field of zero will never branch, but on some models a prefetch of the location designated by register 0 may occur. Access exceptions associated with this prefetch will not be reported. However, if an invalid checking-block code is detected, CPU retry may be attempted. Depending on the model, the prefetch may recur as part of the retry, and thus the retry will not be successful. Even when the CPU retry is successful, the performance degradation of such a retry is significant, and system recovery may be presented, normally with a failing-storage address. To avoid continued degradation, the program should initiate proceedings to eliminate use of the location and to validate the location.

Programmed Validation of Storage

Provided that an invalid CBC does not exist in the storage key associated with a 4 K-byte block, the instruction TEST BLOCK causes the entire 4 K-byte block to be set to zeros with a valid CBC, regardless of the current contents of the storage. TEST BLOCK thus removes an invalid CBC from a location in storage which has an intermittent, or one-time, failure. However, if a permanent failure exists in a portion of the storage, a subsequent fetch may find an invalid CBC.

Invalid CBC in Storage Keys

Depending on the model, each storage key may be contained in a single checking block, or the access-control and fetch-protection bits and the reference and change bits may be in separate checking blocks.

Figure 11-1 on page 11-8 describes the action taken when the storage key has invalid CBC. The figure indicates the action taken for the case when the access-control and fetch-protection bits are in one checking block and the reference and change bits are in a separate checking block. In machines where both fields are included in a single checking block, the action taken is the combination of the actions for each field in error, except that completion is permitted only if an error in all affected fields permits completion. References to main storage to which key-controlled protection does not apply are treated as if an access key of zero is used for the reference. This includes such references as channel-program references during initial program loading and implicit references, such as interruption action and DAT-table accesses.

Type of Reference	Action Taken on Invalid CBC	
	For Access-Control and Fetch-Protection Bits	For Reference and Change Bits
SET STORAGE KEY EXTENDED	Complete; validate.	Complete; validate.
INSERT STORAGE KEY EXTENDED	PD; preserve.	PD; preserve.
RESET REFERENCE BIT EXTENDED	PD or complete; preserve.	PD; preserve.
INSERT VIRTUAL STORAGE KEY or TEST PROTECTION	PD; preserve.	CPF; preserve.
CPU prefetch (information not used)	CPF; preserve.	CPF; preserve.
Channel-program prefetch (information not used)	IPF; preserve.	IPF; preserve.
Fetch, nonzero access key	MC; preserve.	MC or complete; preserve.
Store ¹ , nonzero access key	MC ² ; preserve.	MC and preserve; or complete ³ and correct.
Fetch, zero access key ⁴	MC or complete; preserve.	MC or complete; preserve.
Store ¹ , zero access key ²	MC or complete; preserve.	MC and preserve; or complete ³ and correct.

Explanation:

¹ CPU virtual- and logical-address store accesses are subject to DAT protection. When the DAT-protection bit is one, the location will not be changed; however, the machine may indicate a machine-check condition if the storage key or the data itself has invalid CBC.

² The contents of the main-storage location are not changed.

³ The contents of the reference and change bits are set to ones if the “complete” action is taken.

⁴ The action shown for an access key of zero is also applicable to references to which key-controlled protection does not apply.

Complete The condition does not cause termination of the execution of the instruction, and, unless an unrelated condition prohibits it, the execution of the instruction is completed, ignoring the error condition. No machine-check-damage conditions are reported, but system recovery may be reported.

Correct The reference and change bits are set to ones with valid CBC.

Preserve The contents of the entire checking block having invalid CBC are left unchanged.

Validate The entire key is set to the new value with valid CBC. When the conditional-SSKE facility is installed and either or both the MR and MC bits of the M₃ field are one, condition code 3 is set when the instruction completes.

CPF Invalid CBC in the storage key for a CPU prefetch which is unused, or for instructions which do not examine the reference and change bits, may result in any of the following situations:

- The operation is completed; no machine-check condition is reported.
- The operation is completed; system recovery, with storage-key error uncorrected, is reported.
- Instruction-processing damage, with or without backup and with storage-key error uncorrected, is reported.

IPF Invalid CBC in the storage key for a channel-program prefetch which is unused may result in any of the following:

- The I/O operation is completed; no machine-check condition is reported.
- The I/O operation is completed; system recovery, with storage-key error uncorrected, is reported.

MC Same as PD for CPU references, but a channel-subsystem reference may result in the following combinations of I/O-error conditions and machine-check conditions:

- An I/O-error condition is reported; no machine-check condition is reported.
- An I/O-error condition is reported; system recovery, with or without storage-key error uncorrected, is reported.

PD Instruction-processing damage, with or without backup and with or without storage-key error uncorrected, is reported.

Note: When storage-key error uncorrected is reported, a failing storage address may or may not also be reported.

Figure 11-1. Invalid CBC in Storage Keys

Invalid CBC in Registers

When invalid CBC is detected in a CPU register, a machine-check condition may be recognized. CPU registers include the general, floating-point, floating-point-control, access, control, vector, and TOD programmable registers, the current PSW, the prefix register, the TOD clock, the CPU timer, and the clock comparator.

When a machine-check interruption occurs, whether or not it is due to invalid CBC in a CPU register, the following actions affecting the CPU registers, other than the prefix register and the TOD clock, are taken as part of the interruption.

1. The contents of the registers are saved in assigned storage locations. Any register which is in error is identified by a corresponding validity bit of zero in the machine-check-interruption code. Malfunctions detected during register saving do not result in additional machine-check-interruption conditions; instead, the correctness of all the information stored is indicated by the appropriate setting of the validity bits.
2. Registers with invalid CBC are then changed to have valid CBC, their actual contents being unpredictable, except that in the ESA/390-compatibility mode, bits 0-31 of all control registers are predictably set to zeros.

The prefix register and the TOD clock are not stored during a machine-check interruption, have no corresponding validity bit, and are not validated. Invalid CBC associated with the prefix register cannot safely be reported by the machine-check interruption, since the interruption itself requires that the prefix value be applied to convert real addresses to the corresponding absolute addresses. Invalid CBC in the prefix register causes the CPU to enter the check-stop state immediately.

Programming Note: Prior to the advent of z/Architecture, certain older models did not perform validation of registers during a machine-check interruption. On such models, programmed validation of the registers during machine-check interruption handling was necessary.

All z/Architecture-capable processors automatically validate registers prior to presenting a machine-check interruption to the program. Therefore, any

programmed validation of registers during machine-check interruption handling is superfluous.

However, regardless of the automatic register validation that occurs as a result of a machine-check interruption, the contents of the access registers, clock-comparator register, control registers, CPU-timer register, floating-point registers, floating-point-control register, general registers, guarded-storage-control registers, TOD-programmable register, and vector registers are unpredictable following a machine-check interruption. Prior to using any of these registers or features that they control following a machine-check interruption, the program should load the register with predictable contents.

Check-Stop State

In certain situations, it is impossible or undesirable to continue operation when a machine error occurs. In these cases, the CPU may enter the check-stop state, which is indicated by the check-stop indicator.

In general, the CPU may enter the check-stop state whenever an uncorrectable error or other malfunction occurs and the machine is unable to recognize a specific machine-check-interruption condition.

The CPU always enters the check-stop state if any of the following conditions exists:

- PSW bit 13 is zero, and an exigent machine-check condition is generated.
- During the execution of an interruption due to one exigent machine-check condition, another exigent machine-check condition is detected.
- During a machine-check interruption, the machine-check-interruption code cannot be stored successfully, or the new PSW cannot be fetched successfully.
- Invalid CBC is detected in the prefix register.
- A malfunction in the receiving CPU, which is detected after accepting the order, prevents the successful completion of a SIGNAL PROCESSOR order and the order was a reset, or the receiving CPU cannot determine what the order was. The receiving CPU enters the check-stop state.

There may be many other conditions for particular models when an error may cause check stop.

When the CPU is in the check-stop state, instructions and interruptions are not executed. The TOD clock is normally not affected by the check-stop state. The CPU timer may or may not run in the check-stop state, depending on the error and the model. The start key and stop key are not effective in this state.

The CPU may be removed from the check-stop state by CPU reset.

In a multiprocessing configuration, a CPU entering the check-stop state generates a request for a malfunction-alert external interruption to all CPUs in the configuration. Except for the reception of a malfunction alert, other CPUs and the I/O system are normally unaffected by the check-stop state in a CPU. However, depending on the nature of the condition causing the check stop, other CPUs may also be delayed or stopped, and channel subsystem and I/O activity may be affected.

System Check Stop

In a multiprocessing configuration, some errors, malfunctions, and damage conditions are of such severity that the condition causes all CPUs in the configuration to enter the check-stop state. This condition is called a system check stop. The state of the channel subsystem and I/O activity is unpredictable.

Machine-Check Interruption

A request for a machine-check interruption, which is made pending as the result of a machine check, is called a machine-check-interruption condition. There are two types of machine-check-interruption conditions: exigent conditions and repressible conditions.

Exigent Conditions

Exigent machine-check-interruption conditions are those in which damage has or would have occurred such that execution of the current instruction or interruption sequence cannot safely continue. Exigent conditions include two subclasses: instruction-processing damage and system damage. In addition to indicating specific exigent conditions, system dam-

age is used to report any malfunction or error which cannot be isolated to a less severe report.

Exigent conditions for instruction sequences can be either nullifying exigent conditions or terminating exigent conditions, according to whether the instructions affected are nullified or terminated. Exigent conditions for interruption sequences are terminating exigent conditions. The terms “nullification” and “termination” have the same meanings as those used in Chapter 5, “Program Execution”, except that more than one instruction may be involved. Thus, a nullifying exigent condition indicates that the CPU has returned to the beginning of a unit of operation prior to the error. A terminating exigent condition means that the results of one or more instructions may have unpredictable values.

Repressible Conditions

Repressible machine-check-interruption conditions are those in which the results of the instruction-processing sequence have not been affected. Repressible conditions can be delayed, until the completion of the current instruction or even longer, without affecting the integrity of CPU operation. Repressible conditions are of three groups: recovery, alert, and repressible damage. Each group includes one or more subclasses.

A malfunction in the CPU, storage, or operator facilities which has been successfully corrected or circumvented internally without logical damage is called a recovery condition. Depending on the model and the type of malfunction, some or all recovery conditions may be discarded and not reported. Recovery conditions that are reported are grouped in one subclass, system recovery.

A machine-check-interruption condition not directly related to a machine malfunction is called an alert condition. The alert conditions are grouped in two subclasses: degradation and warning.

A malfunction resulting in an incorrect state of a portion of the system not directly affecting sequential CPU operation is called a repressible-damage condition. Repressible-damage conditions are grouped in five subclasses, according to the function affected: timing-facility damage, external damage, channel report pending, channel-subsystem damage, and service-processor damage.

Programming Notes:

1. Even though repressible conditions are usually reported only at normal points of interruption, they may also be reported with exigent machine-check conditions. Thus, if an exigent machine-check condition causes an instruction to be abnormally terminated and a machine-check interruption occurs to report the exigent condition, any pending repressible conditions may also be reported. The meaningfulness of the validity bits depends on what exigent condition is reported.
2. Classification of damage as either exigent or repressible does not imply the severity of the damage. The distinction is whether action must be taken as soon as the damage is detected (exigent) or whether the CPU can continue processing (repressible). For a repressible condition, the current instruction can be completed before taking the machine-check interruption if the CPU is enabled for machine checks; if the CPU is disabled for machine checks, the condition can safely be kept pending until the CPU is again enabled for machine checks.

For example, the CPU may be disabled for machine-check interruptions because it is handling an earlier instruction-processing-damage interruption. If, during that time, an I/O operation encounters a storage error, that condition can be kept pending because it is not expected to interfere with the current machine-check processing. If, however, the CPU also makes a reference to the area of storage containing the error before re-enabling machine-check interruptions, another instruction-processing-damage condition is created, which is treated as an exigent condition and causes the CPU to enter the check-stop state.

3. A repressible condition may be a floating condition. A floating repressible condition is eligible to cause an interruption on any CPU in the configuration. At the point when a CPU performs an interruption for a floating repressible condition, the condition is no longer eligible to cause an interruption on the remaining CPUs in the configuration.

Interruption Action

A machine-check interruption causes the following actions to be taken, depending on the architectural mode of the configuration.

Interruption Action in the z/Architecture Architectural Mode

An architectural-mode identification with the value 01 hex is stored at real location 163. The PSW reflecting the point of interruption is stored as the machine-check old PSW in the quadword at real location 352. The contents of other registers are stored in register-save areas at real locations 4608-4863, 4892-4895, 4900-4911, 4913-4919, 4928-5119, and in a machine-check extended save area designated by the contents of real locations 4528-4535. After the contents of the registers are stored in register-save areas and extended save area, depending on the model, the registers may be validated with the contents being unpredictable. A machine-check-interruption code (MCIC) of eight bytes is stored at real locations 232-239. An external-damage code may be stored at real locations 244-247, and a failing-storage address may be stored at real locations 248-255. The new PSW is fetched from real locations 480-495. In addition, a machine-check logout may have occurred.

The machine-generated addresses used to access the old and new PSW, the MCIC, extended interruption information, and the fixed-logout area are all real addresses.

The fields in assigned storage locations that are accessed during the machine-check interruption are summarized in Figure 11-2.

Information Stored (Fetched)	Starting Location*	Length in Bytes
Architectural-mode identification	163	1
Old PSW	352	16
New PSW (fetched)	480	16
Machine-check-interruption code	232	8
Register-save areas		
Floating-point registers 0-15	4608	128
General registers 0-15	4736	128
Floating-point control register	4892	4
TOD programmable register	4900	4
CPU timer	4904	8

Figure 11-2. Machine-Check-Interruption Locations in the z/Architecture Architectural Mode

Information Stored (Fetched)	Starting Location*	Length in Bytes
Clock comparator	4913	7
Access registers 0-15	4928	64
Control registers 0-15	4992	128
Extended interruption information		
External-damage code	244	4
Failing-storage address	248	8
Fixed-logout area	4864	16
Explanation:		
* All locations are in real storage.		

Figure 11-2. Machine-Check-Interruption Locations in the z/Architecture Architectural Mode

When certain facilities are installed, and the machine-check-extended-save-area origin (beginning at real location 4528) is nonzero, the contents of the respective facilities' registers may be stored in the machine-check extended save area. See "Machine-Check-Extended-Save-Area Designation (MCESAD): During a machine check interruption, additional information may be stored at the absolute storage location designated by the doubleword at locations 4528-4535. The leftmost bits of the doubleword, called the machine-check-extended-save-area origin (MCESAO), appended on the right with binary zeros, forms the address of the area." on page 3-81 for a description of the contents of real locations 4528-4535.

The section "Machine-Check Extended Save Area (MCESA)" on page 11-24 provides a description of the contents of the area. Depending on the facilities installed and the length of the extended save area, the following additional registers may be stored:

- Vector registers
- Guarded-storage registers

Interruption Action in the ESA/390-Compatibility Mode

An architectural-mode identification with an all zeros value is stored at real location 163. The PSW reflecting the point of interruption is stored as the short-format machine-check old PSW at real locations 48-55. The contents of other registers are stored in register save areas at real locations 216-231 and 288-511, and in a machine-check extended save area designated by the contents of real locations 212-215. After the contents of the registers are stored in register save areas and the extended save area, depending

on the model, the registers may be validated with the contents being unpredictable. A failing-storage address may be stored at real locations 248-251, and an external-damage code may be stored at real locations 244-247. A machine-check-interruption code (MCIC) of eight bytes is stored at real locations 232-239. The new short-format PSW is fetched from real locations 112-119. In addition, a machine-check logout may have occurred.

The machine-generated addresses used to access the old and new PSW, the MCIC, extended interruption information, the locations containing the extended-save-area address, and the fixed-logout area are all real addresses. The extended-save-area address is an absolute address.

The fields in assigned storage locations that are accessed during the machine-check interruption are summarized in Figure 11-3.

Information Stored (Fetched)	Starting Location*	Length in Bytes
Old PSW	48	8
Architectural-mode identification	163	1
New PSW (fetched)	112	8
Extended-save-area address (fetched)	212	4
Machine-check-interruption code	232	8
Register-save areas		
CPU timer	216	8
Clock comparator	224	8
Access registers 0-15	288	64
Floating-point registers 0, 2, 4, and 6	352	32
General registers 0-15 (bits 32-63)	384	64
Control registers 0-15 (bits 32-63)	448	64
Extended interruption information		
External-damage code	244	4
Failing-storage address	248	8
Fixed-logout area	256	16
Explanation:		
* All locations are in real storage.		

Figure 11-3. Machine-Check-Interruption Locations in the ESA/390-compatibility Mode

When the extended-save-area control, bit 34 of control register 14, is one, and bits 1-19 of the word at real locations 212-215 are not all zeros, then other fields are stored in the machine-check extended save area. Figure 11-4 lists the fields that are stored, their

offsets within the area, and their lengths. Bytes 144-4095 of the extended save area remain unchanged.

Field	Byte Offset	Length in Bytes
Floating-point registers 0-15	0	128
Floating-point control register	128	4
Reserved (zeros stored)	132	12

Figure 11-4. Machine-Check Extended-Save-Area Locations in the ESA/390-compatibility Mode

The address of the machine-check extended save area is formed by appending 33 zeros to the left and 12 zeros to the right of bits 1-19 of the word at real locations 212-215. This address is treated as a 64-bit absolute address. If the 4096-byte block of storage at the address is not available in the configuration, storing into the extended save area is not performed.

Interruption Action: Common Actions

If the machine-check-interruption code cannot be stored successfully or the new PSW cannot be fetched successfully, the CPU enters the check-stop state.

A repressible machine-check condition can initiate a machine-check interruption only if both PSW bit 13 is one and the associated subclass mask bit, if any, in control register 14 is also one. When it occurs, the interruption does not terminate the execution of the current instruction; the interruption is taken at a normal point of interruption, and no program or supervisor-call interruptions are eliminated. If the machine check occurs during the execution of a machine function, such as a CPU-timer update, the machine-check interruption takes place after the machine function has been completed.

When the CPU is disabled for a particular repressible machine-check condition, the condition remains pending. Depending on the model and the condition, multiple repressible conditions may be held pending for a particular subclass, or only one condition may be held pending for a particular subclass, regardless of the number of conditions that may have been detected for that subclass.

When a repressible machine-check interruption occurs because the interruption condition is in a subclass for which the CPU is enabled, pending conditions in other subclasses may also be indicated by the same interruption code, even though the CPU is

disabled for those subclasses. All indicated conditions are then cleared.

If a machine check which is to be reported as a system-recovery condition is detected during the execution of the interruption procedure due to a previous machine-check condition, the system-recovery condition may be combined with the other conditions, discarded, or held pending.

An exigent machine-check condition can cause a machine-check interruption only when PSW bit 13 is one. When a nullifying exigent condition causes a machine-check interruption, the interruption is taken at a normal point of interruption. When a terminating exigent condition causes a machine-check interruption, the interruption terminates the execution of the current instruction and may eliminate the program and supervisor-call interruptions, if any, that would have occurred if execution had continued. Proper execution of the interruption sequence, including the storing of the old PSW and other information, depends on the nature of the malfunction. When an exigent machine-check condition occurs during the execution of a machine function, such as a CPU-timer update, the sequence is not necessarily completed.

If, during the execution of an interruption due to one exigent machine-check condition, another exigent machine check is detected, the CPU enters the check-stop state. If an exigent machine check is detected during an interruption due to a repressible machine-check condition, system damage is reported.

When PSW bit 13 is zero, an exigent machine-check condition causes the CPU to enter the check-stop state.

Machine-check-interruption conditions are handled in the same manner regardless of whether the wait-state bit in the PSW is one or zero: a machine-check condition causes an interruption if the CPU is enabled for that condition.

Machine checks which occur while the rate control is set to the instruction-step position are handled in the same manner as when the control is set to the process position; that is, recovery mechanisms are active, and machine-check interruptions occur when allowed. Machine checks occurring during a manual operation may be indicated to the operator, may generate a system-recovery condition, may result in sys-

tem damage, or may cause a check stop, depending on the model.

Every reasonable attempt is made to limit the side effects of any machine check and the associated interruption. Normally, interruptions, as well as the progress of I/O operations, remain unaffected. The malfunction, however, may affect these activities, and, if the currently active PSW has bit 13 set to one, the machine-check interruption will indicate the total extent of the damage caused, and not just the damage which originated the condition.

Architecture Notes:

Point of Interruption

The point in the processing which is indicated by the interruption and used as a reference point by the machine to determine and indicate the validity of the status stored is referred to as the point of interruption.

Because of the checkpoint capability in models with CPU retry, the interruption resulting from an exigent machine-check-interruption condition may indicate a point in the CPU processing sequence which is logically prior to the error. Additionally, the model may have some choice as to which point in the CPU processing sequence the interruption is indicated, and, in some cases, the status which can be indicated as valid depends on the point chosen.

Only certain points in the processing may be used as a point of interruption. For repressible machine-check interruptions, the point of interruption must be after one unit of operation is completed and any associated program or supervisor-call interruption is taken, and before the next unit of operation is begun.

Exigent machine-check conditions for instruction sequences are those in which damage has or would have occurred to the instruction stream. Thus, the damage can normally be associated with a point part way through an instruction, and this point is called the point of damage. In some cases, there may be one or more instructions separating the point of damage and the point of interruption, and the processing associated with one or more instructions may be damaged. When the point of interruption is a point prior to the point of damage due to a nullifiable exigent machine-check condition, the point of interrup-

tion can be only at the same points as for repressible machine-check conditions.

In addition to the point of interruption permitted for repressible machine-check conditions, the point of interruption for a terminating exigent machine-check condition may also be after the unit of operation is completed but before any associated program or supervisor-call interruption occurs. In this case, a valid PSW instruction address is defined as that which would have been stored in the old PSW for the program or supervisor-call interruption. Since the operation has been terminated, the values in the result fields, other than the instruction address, are unpredictable. Thus, the validity bits associated with fields which are due to be changed by the instruction stream are meaningless when a terminating exigent machine-check condition is reported.

When the point of interruption and the point of damage due to an exigent machine-check condition are separated by a checkpoint-synchronization function, the damage has not been isolated to a particular program, and system damage is indicated.

When an exigent machine-check-interruption condition occurs, the point of interruption which is chosen affects the amount of damage which must be indicated. An attempt is made, when possible, to choose a point of interruption which permits the minimum indication of damage. In general, the preference is the interruption point immediately preceding the error.

When all the status information stored as a result of an exigent machine-check-interruption condition does not reflect the same point, an attempt is made, when possible, to choose the point of interruption so that the instruction address which is stored in the machine-check old PSW is valid.

Machine-Check-Interruption Code

On all machine-check interruptions, a machine-check-interruption code (MCIC) is stored in the doubleword starting at real location 232. The code has the format shown in Figure 11-5.

Bits in the MCIC which are not assigned or not implemented by a particular model are stored as zeros.

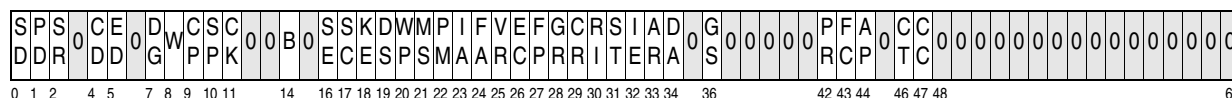

Bit	Name
0	System damage (SD)
1	Instruction-processing damage (PD)
2	System recovery (SR)
4	Timing-facility damage (CD)
5	External damage (ED)
7	Degradation (DG)
8	Warning (W)
9	Channel report pending (CP)
10	Service-processor damage (SP)
11	Channel-subsystem damage (CK)
14	Backed up (B)
16	Storage error uncorrected (SE)
17	Storage error corrected (SC)
18	Storage-key error uncorrected (KE)
19	Storage degradation (DS)
20	PSW-MWP validity (WP)
21	PSW mask and key validity (MS)
22	PSW program-mask and condition-code validity (PM)
23	PSW-instruction-address validity (IA)
24	Failing-storage-address validity (FA)
25	Vector-register validity (VR)
26	External-damage-code validity (EC)
27	Floating-point-register validity (FP)
28	General-register validity (GR)
29	Control-register validity (CR)
30	Reserved for IBM use
31	Storage logical validity (ST)
32	Indirect storage error (IE)
33	Access-register validity (AR)
34	Delayed-access exception (DA)
36	Guarded-storage-registers validity (GS)
42	TOD-programmable-register validity (PR)
43	Floating-point-control-register validity (FC)
44	Ancillary report (AP)
46	CPU-timer validity (CT)
47	Clock-comparator validity (CC)

Note: All other bits of the MCIC are unassigned and stored as zeros.

Figure 11-5. Machine-Check Interruption-Code Format

Subclass

Bits 0-2 and 4-11 are the subclass bits which identify the type of machine-check condition causing the interruption. At least one of the subclass bits is

stored as a one. When multiple errors have occurred, several subclass bits may be set to ones.

System Damage

Bit 0 (SD), when one, indicates that damage has occurred which cannot be isolated to one or more of the less severe machine-check subclasses. When system damage is indicated, the ancillary-report bit, bit 44, is meaningful, the remaining bits in the machine-check-interruption code are not meaningful, and information stored in the register-save areas and machine-check extended-interruption fields is not meaningful.

System damage is a terminating exigent condition and has no subclass-mask bit.

Instruction-Processing Damage

Bit 1 (PD), when one, indicates that damage has occurred to the instruction processing of the CPU.

The exact meaning of bit 1 depends on the setting of the backed-up bit, bit 14. When the backed-up bit is one, the condition is called processing backup. When the backed-up bit is zero, the condition is called processing damage. These two conditions are described in "Synchronous Machine-Check-Interruption Conditions" on page 11-18.

Instruction-processing damage can be a nullifying or a terminating exigent condition and has no subclass-mask bit.

System Recovery

Bit 2 (SR), when one, indicates that malfunctions were detected but did not result in damage or have been successfully corrected. Some malfunctions detected as part of an I/O operation may result in a system-recovery condition in addition to an I/O-error condition. The presence and extent of the system-recovery capability depend on the model.

System recovery is a repressible condition. It is masked by the recovery subclass-mask bit, which is in bit position 36 of control register 14.

Programming Notes:

1. System recovery may be used to report a failing-storage address detected by a CPU prefetch or by an I/O operation.
2. Unless the corresponding validity bits are ones, the indication of system recovery does not imply storage logical validity or that the fields stored as a result of the machine-check interruption are valid.

Timing-Facility Damage

Bit 4 (CD), when one, indicates that damage has occurred to the TOD clock, CPU timer, clock comparator, or TOD programmable register, or to the CPU-timer or clock-comparator external-interruption conditions. The timing-facility-damage machine-check condition is set whenever any of the following occurs:

1. The TOD clock enters the error or not-operational state.
2. The CPU timer is damaged, and the CPU is enabled for CPU-timer external interruptions. On some models, this condition may be recognized even when the CPU is not enabled for CPU-timer interruptions. Depending on the model, the machine-check condition may be generated only as the CPU timer enters an error state. Or, the machine-check condition may be continuously generated whenever the CPU is enabled for CPU-timer interruptions, until the CPU timer is validated.
3. The clock comparator is damaged, and the CPU is enabled for clock-comparator external interruptions. On some models, this condition may be recognized even when the CPU is not enabled for clock-comparator interruptions.

Timing-facility damage may also be set along with instruction-processing damage when an instruction which accesses the TOD clock, CPU timer, or clock comparator produces incorrect results. Depending on the model, the TOD programmable register, CPU timer, or clock comparator may be validated by the interruption which reports the TOD programmable register, CPU timer, or clock comparator as invalid.

Timing-facility damage is a repressible condition. It is masked by the external-damage subclass-mask bit, which is in bit position 38 of control register 14.

Timing-facility-damage conditions for the CPU timer and the clock comparator are not recognized on most models when these facilities are not in use. The facilities are considered not in use when the CPU is disabled for the corresponding external interruptions (PSW bit 7, or the subclass-mask bits, bits 52 and 53 of control register 0, are zeros), and when the corresponding set and store instructions are not executed. Timing-facility-damage conditions that are already pending remain pending, however, when the CPU is disabled for the corresponding external interruption.

Timing-facility-damage conditions due to damage to the TOD clock are always recognized.

With TOD-clock steering, damage to the TOD clock is considered to be of such severity that it is undesirable to continue operation. When the TOD-clock-steering facility is installed, and damage has occurred to the TOD-clock-steering registers or the TOD clock and the damage is limited to a single CPU, then that CPU enters the check-stop state. If the TOD clock is in the not-operational state or error state, or when damage has occurred to the TOD-clock-steering registers or the TOD clock, and the damage affects all CPUs, then a system check stop occurs.

External Damage

Bit 5 (ED), when one, indicates that damage has occurred during operations not directly associated with processing the current instruction.

When bit 5, external damage, is one and bit 26, external-damage-code validity, is also one, the external-damage code has been stored to indicate, in more detail, the cause of the external-damage machine-check interruption. When the external damage cannot be isolated to one or more of the conditions as defined in the external-damage code, or when the detailed indication for the condition is not implemented by the model, external damage is indicated with bit 26 set to zero. The presence and extent of reporting external damage depend on the model.

External damage is a repressible condition. It is masked by the external-damage subclass-mask bit, which is in bit position 38 of control register 14.

Degradation

Bit 7 (DG), when one, indicates that continuous degradation of system performance, more serious than

that indicated by system recovery, has occurred. Degradation may be reported when system-recovery conditions exceed a machine-preestablished threshold or when unit deletion has occurred. The presence and extent of the degradation-report capability depend on the model.

Degradation is a repressible condition. It is masked by the degradation subclass-mask bit, which is in bit position 37 of control register 14.

Warning

Bit 8 (W), when one, indicates that damage is imminent in some part of the system (for example, that power is about to fail, or that a loss of cooling is occurring). Whether warning conditions are recognized depends on the model.

If the condition responsible for the imminent damage is removed before the interruption request is honored (for example, if power is restored), the request does not remain pending, and no interruption occurs. Conversely, the request is not cleared by the interruption, and, if the condition persists, more than one interruption may result from the same condition.

Warning is a repressible condition. It is masked by the warning subclass-mask bit, which is in bit position 39 of control register 14.

Channel Report Pending

Bit 9 (CP), when one, indicates that a channel report, consisting of one or more channel-report words, has been made pending, and the contents of the channel-report words describe, in further detail, the effect of the malfunction and the results of analysis or the action performed. A channel report becomes pending when one of the following conditions has occurred:

1. Channel-subsystem recovery has been completed. The channel-subsystem recovery may have been initiated with no prior notice to the program or may have been a result of a condition previously reported to the program.
2. The function specified by RESET CHANNEL PATH has been completed.

A channel report may also become pending under other conditions.

The channel-report words which make up the channel report may be cleared, one at a time, by execu-

tion of the instruction STORE CHANNEL REPORT WORD, which is described in “I/O Instructions” on page 14-1.

Bit 9 is meaningless when channel-subsystem damage is reported.

Channel report pending is a floating repressible condition. It is masked by the channel-report-pending subclass-mask bit, which is in bit position 35 of control register 14.

Service-Processor Damage

Bit 10 (SP), when one, indicates that damage has occurred to the service processor. Service-processor damage may be made pending at all CPUs in the configuration, or it may be detected independently by each CPU. The presence and extent of reporting service-processor damage depend on the model.

Service-processor damage is a repressible condition and has no subclass-mask bit.

Channel-Subsystem Damage

Bit 11 (CK), when one, indicates that an error or malfunction has occurred in the channel subsystem, or that the channel subsystem is in the check-stop state. The channel subsystem enters the check-stop state when a malfunction occurs which is so severe that the channel subsystem cannot continue, or if power is lost in the channel subsystem.

Channel-subsystem damage is a floating repressible condition and has no subclass-mask bit.

Subclass Modifiers

Bits 14 (B), 34 (DA), and 44 (AP) of the machine-check-interruption code act as modifiers to the subclass bits.

Backed Up

Bit 14 (B), when one, indicates that the point of interruption is at a checkpoint before the point of error. This bit is meaningful only when the instruction-processing-damage bit, bit 1, is also set to one. The presence and extent of the capability to indicate a backed-up condition depend on the model.

Delayed Access Exception

Bit 34 (DA), when one, indicates that an access exception was detected during a storage access

using DAT when no such exception was detected by an earlier test for access exceptions.

Bit 34 is a modifier to instruction-processing damage (bit 1) and is meaningful only when bit 1 of the machine-check-interruption code is one. When bit 1 is zero, bit 34 has no meaning. The presence and extent of reporting delayed access exception depend on the model.

Programming Note: The occurrence of a delayed access exception normally indicates that the program is using an improper procedure to update the DAT tables.

Ancillary Report

Bit 44 (AP), when one, indicates that a malfunction of a system component has occurred which has been recognized previously or which has affected the activities of multiple system elements such as CPUs and subchannels. When the malfunction affects the activities of multiple elements, an ancillary-report condition is recognized for all of the affected elements except one. This bit, when zero, indicates that this malfunction of a system component has not been recognized previously. This bit is meaningful for all conditions indicated by either the machine-check-interruption code or the external-damage code.

Depending on the model, recognition of an ancillary-report condition may not be provided, or it may not be provided for all system malfunctions. When ancillary-report recognition is not provided, bit 44 is set to zero.

Synchronous Machine-Check-Interruption Conditions

The instruction-processing damage and backed-up bits, bits 1 and 14 of the machine-check-interruption code, identify, in combination, two conditions.

Bit 1	Bit 14	Name of Condition
1	0	Processing damage
1	1	Processing backup

Processing Backup

The processing-backup condition indicates that the point of interruption is prior to the point, or points, of error. This is a nullifying exigent condition. When all of the other CPU-related-damage subclasses and

modifiers of the machine-check-interruption code are zero, and certain validity bits associated with CPU status are indicated as valid, then the machine has successfully returned to a checkpoint prior to the malfunction, and no damage has yet occurred to the CPU.

The subclass bits which must be zero for no damage to have occurred are as follows:

MCIC

Bit	Name
0	System damage
4	Timing-facility damage

The delayed-access-exception subclass-modifier bit, MCIC bit 34, must be zero for no damage to have occurred.

The validity bits in the machine-check-interruption code which must be one for no damage to have occurred are as follows:

MCIC

Bit	Name
20	PSW MWP bits
21	PSW mask and key
22	PSW program mask and condition code
23	PSW instruction address
25	Vector registers
27	Floating-point registers
28	General registers
29	Control registers
31	Storage logical validity (result fields within current checkpoint interval)
33	Access registers
42	TOD programmable register
43	Floating-point-control register
46	CPU timer
47	Clock comparator

Programming Note: The processing-backup condition is reported rather than system recovery to indicate that a malfunction or failure stands in the way of continued operation of the CPU. The malfunction has not been circumvented, and damage would have occurred if instruction processing had continued.

Processing Damage

The processing-damage condition indicates that damage has occurred to the instruction processing of the CPU. The point of interruption is a point beyond some or all of the points of damage. Processing damage is a terminating exigent condition; therefore, the contents of result fields may be unpredictable and still indicated as valid.

Processing damage may include malfunctions in program-event recording, monitor call, tracing, access-register translation, and dynamic address translation. Processing damage causes any supervisor-call-interruption condition and program-interruption condition to be discarded. However, the contents of the old PSW and interruption-code locations for these interruptions may be set to unpredictable values.

Storage Errors

Bits 16-18 of the machine-check-interruption code are used to indicate an invalid CBC or a near-valid CBC detected in main storage or an invalid CBC in a storage key. Bit 19, storage degradation, may be indicated concurrently with bit 17. The failing-storage-address field, when indicated as valid, identifies a location within the storage checking block containing the error, or, for storage-key error uncorrected, within the block associated with the storage key. Bit 32, indirect storage error, may be set to one to indicate that the location designated by the failing-storage address is not the original source of the error.

The storage-error-uncorrected and storage-key-error-uncorrected bits do not in themselves indicate the occurrence of damage because the error detected may not have affected a result. The portion of the configuration affected by an invalid CBC is indicated in the subclass field of the machine-check-interruption code.

Storage errors detected for a channel program, when indicated as I/O-error conditions, may also be reported as system recovery. CBC errors that occur in storage or in the storage key and that are detected on prefetched or unused data for a CPU program may or may not be reported, depending on the model.

Storage Error Uncorrected

Bit 16 (SE), when one, indicates that a checking block in main storage contained invalid CBC and that

the information could not be corrected. The contents of the checking block in main storage have not been changed. The location reported may have been accessed or prefetched for this CPU or another CPU or a channel program, or it may have been accessed as the result of a model-dependent storage access.

Storage Error Corrected

Bit 17 (SC), when one, indicates that a checking block in main storage contained near-valid CBC and that the information has been corrected before being used. Depending on the model, the contents of the checking block in main storage may or may not have been restored to valid CBC. The location reported may have been accessed or prefetched for this CPU or for another CPU or for a channel program, or it may have been accessed as the result of a model-dependent storage access. The presence and extent of the storage-error-correction capability depend on the model. This indication may or may not be accompanied by an indication of storage degradation, bit 19 (DS).

Storage-Key Error Uncorrected

Bit 18 (KE), when one, indicates that a storage key contained invalid CBC and that the information could not be corrected. The contents of the checking block in the storage key have not been changed. The storage key may have been accessed or prefetched for this CPU or for another CPU or for a channel program, or it may have been accessed as the result of a model-dependent storage access.

Storage Degradation

Bit 19 (DS), when one, indicates that degradation of the recovery characteristics has occurred for the 4 K-byte block reported by the failing-storage address.

Storage degradation indicates that although the associated storage error has been corrected, there are solid failures associated with the storage block (or with its associated key) that cause the correction process to take a substantial amount of time, and that if an additional error occurs in the block, the error may not be correctable or may go undetected. Thus, this bit indicates that use of the indicated block of storage should be avoided, if possible.

The indication of storage degradation has meaning only when failing-storage-address validity, MCIC bit 24, is also one. The presence and extent of reporting storage degradation depend on the model.

Because storage degradation is normally reported with system recovery, the recovery subclass mask, bit 36 of control register 14, should be set to one in order for storage degradation to be indicated.

Indirect Storage Error

Bit 32 (IE), when one, indicates that the physical main-storage location identified by the failing-storage address is not the original source of the error. Instead, the error originated in another level of the storage hierarchy and has been propagated to the current physical-storage portion of the storage hierarchy. Bit 32 is meaningful only when bit 16 or 18 (storage error uncorrected or storage-key error uncorrected) of the machine-check-interruption code is one. When bits 16 and 18 are both zeros, bit 32 has no meaning.

For errors originating outside the storage hierarchy, the attempt to store is rejected, and the appropriate error indication is presented. When an error is detected during implicit movement of information inside the storage hierarchy, the action is not rejected and reported in this manner because the movement may be asynchronous and may be initiated as the result of an attempt to access completely unrelated information. Instead, errors in the contents of the source during implicit moving of information from one portion of the storage hierarchy to another may be preserved in the target area by placing a special invalid CBC in the checking block associated with the target location. These propagated errors, when detected later, are reported as indirect storage errors. The original source of such an error may have been in a cache associated with an I/O processor or a CPU, or the error may have been the result of a data-path failure in transmitting data from one portion of the storage hierarchy to another. Additionally, a propagated error may be generated during the movement of data from one physical portion of storage to another as the result of a storage-reconfiguration action.

The presence and extent of reporting indirect storage error depend on the model.

Programming Note: See the programming notes under TEST BLOCK in Chapter 10, “Control Instructions” for the action which should be taken after storage errors are reported.

Machine-Check Interruption-Code Validity Bits

Bits 20-29, 31 33, 42, 43, 46, and 47 of the machine-check-interruption code are validity bits. Each bit indicates the validity of a particular field in storage. With the exception of the storage-logical-validity bit (bit 31), each bit is associated with a field stored during the machine-check interruption. When a validity bit is one, it indicates that the saved value placed in the corresponding storage field is valid with respect to the indicated point of interruption and that no error was detected when the data was stored.

When a validity bit is zero, one or more of the following conditions may have occurred: the original information was incorrect, the original information had invalid CBC, additional malfunctions were detected while storing the information, or none or only part of the information was stored. Even though the information is unpredictable, the machine attempts, when possible, to place valid CBC in the storage field and thus reduce the possibility of additional machine checks being caused.

The validity bits for the floating-point registers, general registers, control registers, access registers, vector registers, TOD programmable register, floating-point control register, CPU timer, and clock comparator indicate the validity of the saved value placed in the corresponding save area. The information in these registers after the machine-check interruption is not necessarily correct even when the correct value has been placed in the save area and the validity bit set to one. The use of the registers and the operation of the facility associated with the control registers, floating-point control register, TOD programmable register, CPU timer, and clock comparator are unpredictable until these registers are validated. (See “Invalid CBC in Registers” on page 9.)

PSW-MWP Validity

Bit 20 (WP), when one, indicates that bits 12-15 of the machine-check old PSW are correct.

PSW Mask and Key Validity

Bit 21 (MS), when one, indicates that the system mask, PSW key, and miscellaneous bits of the machine-check old PSW are correct. specifically, this bit covers bits 0-11, 16, 17, 24-30, and 33-63 of the PSW.

PSW Program-Mask and Condition-Code Validity

Bit 22 (PM), when one, indicates that the program mask and condition code of the machine-check old PSW are correct.

PSW-Instruction-Address Validity

Bit 23 (IA), when one, indicates that the addressing-mode and instruction-address bits, bits 31, 32, and 64-127, of the machine-check old PSW are correct.

Failing-Storage-Address Validity

Bit 24 (FA), when one, indicates that a correct failing-storage address has been stored at real location 248-255 (in the z/Architecture architectural mode) or real location 248-251 (in the ESA/390-compatibility mode) after a storage-error-uncorrected, storage-key-error-uncorrected, or storage-error-corrected condition has occurred. The presence and extent of the capability to identify the failing-storage location depend on the model. When no such errors are reported, that is, bits 16-18 of the machine-check-interruption code are zeros, the failing-storage address is meaningless, even though it may be indicated as valid.

Vector Register Validity

Bit 25 (VR), when one, indicates that the contents of locations 0-1023 of the machine-check extended save area reflect the correct state of the vector registers 0-31 at the point of the interruption.

Bit 25 is zero when the vector facility for z/Architecture is not installed or the machine-check extended save area address formed from the contents of real locations 4528-4535 is either invalid or all zeros.

External-Damage-Code Validity

Bit 26 (EC), when one, and provided that bit 5, external damage, is also one, indicates that a valid external-damage code has been stored in the word at real location 244. When bit 5 is zero, bit 26 has no meaning.

Floating-Point-Register Validity

In the z/Architecture architectural mode, bit 27 (FP), when one, indicates that the contents of the floating-point-register save area at real locations 4608-4735 reflect the correct state of the floating-point registers at the point of interruption. In the ESA/390-compatibility mode, bit 27 (FP), when one, indicates that the contents of the floating-point-register save area at

real locations 352-383 reflect the correct state of floating-point registers 0, 2, 4, and 6 at the point of interruption.

General-Register Validity

In the z/Architecture architectural mode, bit 28 (GR), when one, indicates that the contents of the general-register save area at real locations 4736-4863 reflect the correct state of the general registers at the point of interruption. In the ESA/390-compatibility mode, bit 28 (GR), when one, indicates that the contents of the general-register save area at real locations 384-447 reflect the correct state of bits 32-63 of the general registers at the point of interruption.

Control-Register Validity

In the z/Architecture architectural mode, bit 29 (CR), when one, indicates that the contents of the control-register save area at real locations 4992-5119 reflect the correct state of the control registers at the point of interruption. In the ESA/390-compatibility mode, bit 29 (CR), when one, indicates that the contents of the control-register save area at real locations 448-511 reflect the correct state of bits 32-63 of the control registers at the point of interruption.

Storage Logical Validity

Bit 31 (ST), when one, indicates that the storage locations, the contents of which are modified by the instructions being executed, contain the correct information relative to the point of interruption. That is, all stores before the point of interruption are completed, and all stores, if any, after the point of interruption are suppressed. When a store before the point of interruption is suppressed because of an invalid CBC, the storage-logical-validity bit may be indicated as one, provided that the invalid CBC has been preserved as invalid.

When instruction-processing damage is indicated but processing backup is not indicated, the storage-logical-validity bit has no meaning.

Storage logical validity reflects only the instruction-processing activity and does not reflect errors in the state of storage as the result of either I/O operations or the storing of the old PSW and other interruption information.

Access-Register Validity

In the z/Architecture architectural mode, bit 33 (AR), when one, indicates that the contents of the access-

register save area at real locations 4928-4991 reflect the correct state of the access registers at the point of interruption. In the ESA/390-compatibility mode, bit 33 (AR), when one, indicates that the contents of the access-register save area at real locations 288-351 reflect the correct state of the access registers at the point of interruption.

Guarded-Storage-Registers Validity

Bit 36 (GS), when one, indicates that the contents of locations 1024-1055 of the machine-check extended save area reflect the correct state of the guarded-storage registers at the point of the interruption. The guarded-storage registers are stored in the same format as that of the guarded-storage control block as shown in Figure 4-19 on page 4-67.

Bit 36 is zero when any of the following is true:

- The guarded-storage facility is not installed.
- The machine-check extended save area address formed from the contents of real locations 4528-4535 is either invalid or all zeros.
- The length characteristic (LC) in bits 60-63 of real locations 4528-4535 specifies a reserved value or a value less than 11.

TOD-Programmable-Register Validity

Bit 42 (PR), when one, indicates that the contents of the TOD-programmable-register save area at real locations 4900-4903 reflect the correct state of the TOD programmable register at the point of interruption.

Floating-Point-Control-Register Validity

In the z/Architecture architectural mode, bit 43 (FC), when one, indicates that the contents of the floating-point-control-register save area at real locations 4892-4895 reflect the correct state of the floating-point-control register at the point of interruption.

In the ESA/390-compatibility mode, bit 43 (XF), when one, indicates that the contents of locations 0-143 of the machine-check extended save area reflect the correct state of floating-point registers 0-15 and the floating-point-control register at the point of interruption. Bit 43 is zero when the extended-save-area control, bit 34 of control register 14, is zero, or the machine-check extended-save-area address formed from the contents of real locations 212-215 is either invalid or all zeros.

CPU-Timer Validity

In the z/Architecture architectural mode, bit 46 (CT), when one, indicates that the CPU timer is not in error and that the contents of the CPU-timer save area at real locations 4904-4911 reflect the correct state of the CPU timer at the time the interruption occurred. In the ESA/390-compatibility mode, bit 46 (CT), when one, indicates that the CPU timer is not in error and that the contents of the CPU-timer save area at real location 216-223 reflect the correct state of the CPU timer at the time the interruption occurred.

Clock-Comparator Validity

In the z/Architecture architectural mode, bit 47 (CC), when one, indicates that the clock comparator is not in error, that the contents of the clock-comparator save area at real locations 4913-4919 reflect the correct state of the clock comparator at the time the interruption occurred, and that zeros have been stored at real location 4912. In the ESA/390-compatibility mode, bit 47 (CC), when one, indicates that the clock comparator is not in error and that the contents of the clock-comparator save area at real locations 224-231 reflect the correct state of the clock comparator at the time the interruption occurred.

Programming Note: The validity bits must be used in conjunction with the subclass bits and the backed-up bit in order to determine the extent of the damage caused by a machine-check condition. No damage has occurred to the system when all of the following are true:

- The four PSW-validity bits, the seven register-validity bits, the two timing-facility-validity bits, and the storage-logical-validity bit are all ones.
- Subclass bits 0, 4, 5, 10, and 11 are zeros.
- The instruction-processing-damage bit is zero or, if one, the backed-up bit is also one.
- The delayed-access-exception bit is zero.

Machine-Check Extended Interruption Information

As part of the machine-check interruption, in some cases, extended interruption information is placed in fixed areas assigned in storage. The contents of registers associated with the CPU are placed in register-save areas. For external damage, additional informa-

tion is provided for some models by storing an external-damage code. When storage error uncorrected, storage error corrected, or storage-key error uncorrected is indicated, the failing-storage address is saved.

Each of these fields has associated with it a validity bit in the machine-check-interruption code. If, for any reason, the machine cannot store the proper information in the field, the associated validity bit is set to zero.

Register-Save Areas

As part of the machine-check interruption, the current contents of the CPU registers, except for the prefix register and the TOD clock, are stored in register-save areas assigned in storage. Each of these areas has associated with it a validity bit in the machine-check-interruption code. If, for any reason, the machine cannot store the proper information in the field, the associated validity bit is set to zero.

Figure 11-6 lists the eight sets of registers and the real locations in storage where their contents are saved during a machine-check interruption in the z/Architecture architectural mode.

Locations	Registers
4608-4735	Floating-point registers 0-15
4736-4863	General registers 0-15
4892-4895	Floating-point-control register
4900-4903	TOD programmable register
4904-4911	CPU timer
4913-4919	Clock comparator
4928-4991	Access registers 0-15
4992-5119	Control registers 0-15

Figure 11-6. Register Save Areas in the z/Architecture Architectural Mode.

Figure 11-7 lists the six sets of registers and the real locations in storage where their contents are saved during a machine-check interruption in the ESA/390-compatibility mode.

Locations	Registers
216-223	CPU timer
224-231	Clock comparator
288-351	Access registers 0-15
352-383	Floating-point registers 0, 2, 4, and 6

Figure 11-7. Register Save Areas in the ESA/390-compatibility Mode.

Locations	Registers
384-447	General registers 0-15 (bits 32-63)
448-511	Control registers 0-15 (bits 32-63)

Figure 11-7. Register Save Areas in the ESA/390-compatibility Mode.

External-Damage Code

The word at real location 244 is the external-damage code. This field, when implemented and indicated as valid, describes the cause of external damage. The field is valid only when the external-damage bit and the external-damage-code-validity bit (bits 5 and 26 in the machine-check-interruption code) are both ones. The presence and extent of reporting an external-damage code depend on the model.

The external-damage code has the following format:

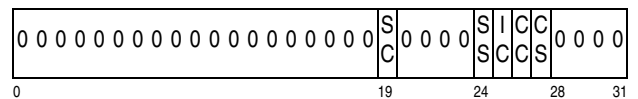

ETR Sync Check (SC): Bit 19, when one, indicates that bits 32 through the rightmost incremented bit of a running clock are not in synchronism with the same bits of the ETR.

If the condition happens more than once before the interruption occurs, the condition is generated only once. The condition is generated for all CPUs in the configuration, and the condition for a CPU is cleared by the interruption taken by the CPU.

STP Sync Check (SS): Bit 24, when one, indicates that an STP-sync-check has occurred. The STP-sync-check condition is generated when the configuration is in the STP-timing mode and the timing state changes from the synchronized state to the unsynchronized or stopped state.

The machine-check condition is generated for all CPUs in the configuration, and the condition for a CPU is cleared by the interruption taken by the CPU.

Island Condition (IC): Bit 25, when one, indicates that an island condition has been detected. The island condition is generated when an attached server attempts to communicate over an STP link and both of the following conditions are detected:

- The servers have matching CTN IDs, and

- Both servers have valid stratum-1-configurations and the configurations do not match.

The island condition indicates that two separate CTNs may be operating with the same CTN ID.

The machine-check condition is generated for all CPUs in the configuration, and the condition for a CPU is cleared by the interruption taken by the CPU.

CTN Configuration Change (CC): Bit 26, when one, indicates that a CTN-configuration-change has occurred in the CTN. The conditions that cause the CTN-configuration-change condition to be generated include the following:

- A new node with a matching CTN ID has attached to this node.
- An attached node that had a matching CTN ID is no longer attached to this node
- The CTN ID for this node has changed.
- The stratum level of this node has changed, or a change in the stratum-1 or alternate-stratum-1 for the network has changed.
- STP active or maximum version number has changed.

The machine-check condition is generated for all CPUs in the configuration, and the condition for a CPU is cleared by the interruption taken by the CPU.

STP Clock Source Error (CS): Bit 27, when one, indicates that an STP-clock-source error has occurred. The STP-clock-source condition is generated when the configuration is in the STP-timing mode and the STP-clock-source state changes from the usable state to the not-usable state.

The machine-check condition is generated for all CPUs in the configuration, and the condition for a CPU is cleared by the interruption taken by the CPU.

Reserved: Bits 0-7, 10-16, 21-23, and 28-31 are reserved for future expansion and are always set to zero.

Failing-Storage Address

When storage error uncorrected, storage error corrected, or storage-key error uncorrected is indicated

in the machine-check-interruption code, the associated address, called the failing-storage address, is stored at real locations 248-255 (in the z/Architecture architectural mode) or 248-251 (in the ESA/390-compatibility mode). The field is valid only if the failing-storage-address validity bit, bit 24 of the machine-check-interruption code, is one.

In the case of storage errors, the failing-storage address may designate any byte within the checking block. For storage-key error uncorrected, the failing-storage address may designate any address within the block of storage associated with the storage key that is in error. When an error is detected in more than one location before the interruption, the failing-storage address may designate any of the failing locations. The address stored is an absolute address; that is, the value stored is the address that is used to reference storage after dynamic address translation and prefixing have been applied.

Machine-Check Extended Save Area (MCESA)

Machine-Check Extended Save Area in the z/Architecture Architectural Mode

In the z/Architecture architectural mode, the machine-check-extended-save-area designation (MCESAD) at real locations 4528-4535 specifies the location and size of the machine-check extended save area (MCESA). See “Machine-Check-Extended-Save-Area Designation (MCESAD): During a machine check interruption, additional information may be stored at the absolute storage location designated by the doubleword at locations 4528-4535. The leftmost bits of the doubleword, called the machine-check-extended-save-area origin (MCE-SAO), appended on the right with binary zeros, forms the address of the area.” on page 3-81 for a description of the contents of the MCESAD field. When the machine-check-extended-save-area origin (MCE-SAO) is nonzero, the designated area is accessible, and the length characteristic (LC) provides sufficient length, the contents of various facilities’ registers are stored in the save area. A facility’s registers are only stored in the MCESA when the facility is installed. The facilities accommodated by the MCESA include the following:

- Vector facility for z/Architecture
- Guarded-storage facility

When the guarded-storage facility is not installed, the length and alignment of the MCESA is 1024 bytes. When the guarded-storage facility is installed, the length characteristic (LC) in bits 60-63 of the MCESAD specifies the length and alignment of the MCESA as a power of two; an LC value of zero is treated as 10. Figure 11-8 shows the contents of the MCESA; reserved fields remain unmodified.

Offset		Content	Minimum LC
Hex	Dec		
000-1FF	0-511	Vector Registers 0-31	10
200-3FF	512-1023	Reserved	
400-407	1024-1031	Zeros	11
408-40F	1032-1039	GSD Register	
410-417	1040-1047	GSSM Register	
418-41F	1048-1055	GSEPLA Register	
420-7FF	1056-2047	Reserved	
800-FFF	2048-4095	Reserved	12

Figure 11-8. Contents of the Machine-Check Extended Save Area, Associated MCIC-Validity Bit, and Minimum Length Characteristic Required

If the minimum length required to store a facility's registers is not specified in the length code, then those registers are not stored in the MCESA.

The parameter register and additional-status-area used by the SIGNAL PROCESSOR store-additional-status-at-address order have formats identical to those of the MCESAD and MCESA, respectively. See "Store Additional Status at Address" on page 4-93 for further details.

Machine-Check Extended Save Area in the ESA/390 Compatibility Mode

In the ESA/390-compatibility mode, when the extended-save-area control, bit 34 of control register 14, is one, and bits 1-19 of real locations 212-215 are not all zeros, then, as part of a machine-check interruption, the current contents of floating-point registers 0-15 and the floating-point-control register are stored in a machine-check extended save area. The absolute address of the extended save area is obtained by appending 33 bits of zeros to the left and 12 bits of zeros to the right of bits 1-19 of real locations 212-215. Storing does not occur if the address is invalid.

The extended save area has associated with it a validity bit, bit 43, in the machine-check-interruption code. If, for any reason, the machine cannot store the

proper information in the area, the associated validity bit is set to zero.

Figure 11-9 lists the fields that are stored, their offsets within the area, and their lengths. Bytes 144-4095 of the extended save area remain unchanged.

Field	Byte Offset	Length in Bytes
Floating-point registers 0-15	0	128
Floating-point control register	128	4
Reserved (zeros stored)	132	12

Figure 11-9. Machine-Check Extended-Save-Area Locations in the ESA/390-compatibility Mode

Handling of Machine-Check Conditions

Floating Interruption Conditions

An interruption condition which is made available to any CPU in a multiprocessing configuration is called a floating interruption condition. The first CPU that accepts the interruption clears the interruption condition, and it is no longer available to any other CPU in the configuration.

Floating interruption conditions include service-signal external-interruption and I/O-interruption conditions. Two machine-check-interruption conditions, channel report pending and channel-subsystem damage, are floating interruption conditions. Additionally, floating interruption conditions include STP external-damage machine-check conditions (STP Sync Check, STP Island Condition, STP CTN Configuration Error, and STP Clock Source Error) when STP machine-check floating interruptions are enabled.

Depending on the model, some machine-check-interruption conditions associated with system recovery and warning may also be floating interruption conditions.

A floating interruption is presented to the first CPU in the configuration which is enabled for the interruption condition and can accept the interruption. A CPU cannot accept the interruption when the CPU is in the check-stop state, has an invalid prefix, is performing an unending string of interruptions due to a PSW-format error of the type that is recognized early, or is in

the stopped state. However, a CPU with the rate control set to instruction step can accept the interruption when the start key is activated.

Programming Note: When a CPU enters the check-stop state in a multiprocessing configuration, the program on another CPU can determine whether a floating interruption may have been reported to the failing CPU and then lost. This can be accomplished if the interruption program places zeros in the real storage locations containing old PSWs and interruption codes after the interruption has been handled (or has been moved into another area for later processing). After a CPU enters the check-stop state, the program on another CPU can inspect the old-PSW and interruption-code locations of the failing CPU. A nonzero value in an old PSW or interruption code indicates that the CPU has been interrupted but the program did not complete the handling of the interruption.

Floating Machine-Check-Interruption Conditions

Floating machine-check-interruption conditions are reset only by the manually initiated resets through the operator facilities. When a machine check occurs which prohibits completion of a floating machine-check interruption, the interruption condition is no longer considered a floating interruption condition, and system damage is indicated.

Floating I/O Interruptions

The detection of a machine malfunction by the channel subsystem, while in the process of presenting an I/O-interruption request for a floating I/O interruption, may be reported as channel report pending or as channel-subsystem damage. Detection of a machine malfunction by a CPU, while in the process of accepting a floating I/O interruption, is reported as system damage.

Machine-Check Masking

All machine-check interruptions are under control of the machine-check mask, PSW bit 13. In addition, some machine-check conditions are controlled by subclass masks in control register 14.

The exigent machine-check conditions (system damage and instruction-processing damage) are controlled only by the machine-check mask, PSW bit 13. When PSW bit 13 is one, an exigent condition

causes a machine-check interruption. When PSW bit 13 is zero, the occurrence of an exigent machine-check condition causes the CPU to enter the check-stop state.

The repressible machine-check conditions, except channel-subsystem damage and service-processor damage, are controlled both by the machine-check mask, PSW bit 13, and by five subclass-mask bits in control register 14. If PSW bit 13 is one and one of the subclass-mask bits is one, the associated condition initiates a machine-check interruption. If a subclass-mask bit is zero, the associated condition does not initiate an interruption but is held pending. However, when a machine-check interruption is initiated because of a condition for which the CPU is enabled, those conditions for which the CPU is not enabled may be presented along with the condition which initiates the interruption. All conditions presented are then cleared.

Control register 14 contains mask bits that specify whether certain conditions can cause machine-check interruptions. It has the following format:

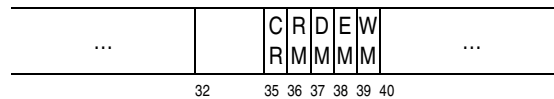

Bits 35-39 of control register 14 are the subclass masks for repressible machine-check conditions. In addition, bit 32 of control register 14 is initialized to one but is otherwise ignored by the machine.

Programming Note: The program should avoid, whenever possible, operating with PSW bit 13, the machine-check mask, set to zero, since any exigent machine-check condition which is recognized during this situation will cause the CPU to enter the check-stop state. In particular, the program should avoid executing I/O instructions or allowing I/O interruptions with PSW bit 13 zero.

Channel-Report-Pending Subclass Mask

Bit 35 (CM) of control register 14 controls channel-report-pending interruption conditions. This bit is initialized to zero.

Recovery Subclass Mask

Bit 36 (RM) of control register 14 controls system-recovery interruption conditions. This bit is initialized to zero.

Degradation Subclass Mask

Bit 37 (DM) of control register 14 controls degradation interruption conditions. This bit is initialized to zero.

External-Damage Subclass Mask

Bit 38 (EM) of control register 14 controls timing-facility-damage and external-damage interruption conditions. This bit is initialized to one.

Warning Subclass Mask

Bit 39 (WM) of control register 14 controls warning interruption conditions. This bit is initialized to zero.

Machine-Check Logout

As part of the machine-check interruption, some models may place model-dependent information in the fixed-logout area. In the z/Architecture architectural mode, this area is 16 bytes in length and starts at real location 4864. In the ESA/390-compatibility mode, this area is 16 bytes in length and starts at real location 256.

Summary of Machine-Check Masking

A summary of machine-check masking is given in Figure 11-10 and Figure 11-11.

Machine-Check Condition		Sub-Class Mask	Action when CPU Disabled for Subclass
MCIC Bit	Subclass		
0	System damage	-	Check stop
1	Instruction-processing damage	-	Check stop
2	System recovery	RM	Y
4	Timing-facility damage	EM	P
5	External damage	EM	P
7	Degradation	DM	P
8	Warning	WM	P
9	Channel report pending	CM	P
10	Service-processor damage	-	P
11	Channel-subsystem damage	-	P

Explanation:

- The condition does not have a subclass mask.
- P Indication is held pending.
- Y Indication may be held pending or may be discarded.
- CM Channel-report-pending subclass mask (bit 35 of CR14).
- DM Degradation subclass mask (bit 37 of CR14).
- EM External-damage subclass mask (bit 38 of CR14).
- RM Recovery subclass mask (bit 36 of CR14).
- WM Warning subclass mask (bit 39 of CR14).

Figure 11-10. Machine-Check-Condition Masking

Bit Description	Control Register 14 Bit Position	State of Bit on Initial CPU Reset
Channel-report-pending subclass mask	35	0
Recovery subclass mask	36	0
Degradation subclass mask	37	0

Figure 11-11. Machine-Check Control-Register Bits

External-damage subclass mask	38	1
Warning subclass mask	39	0

Figure 11-11. Machine-Check Control-Register Bits

Chapter 12. Operator Facilities

Manual Operation	12-1	Load-Unit-Address Controls	12-4
Basic Operator Facilities	12-1	Manual Indicator	12-4
Address-Compare Controls	12-1	Power Controls	12-4
Alter-and-Display Controls	12-2	Rate Control	12-5
Architectural-Mode Indicator	12-2	Restart Key	12-5
Architectural-Mode-Selection Controls	12-3	Start Key	12-5
Check-Stop Indicator	12-3	Stop Key	12-5
CPUs-per-Core Indicator	12-3	Store-Status Key	12-5
IML Controls	12-3	System-Reset-Clear Key	12-6
Interrupt Key	12-3	System-Reset-Normal Key	12-6
Load Indicator	12-3	Test Indicator	12-6
Load-Clear Key	12-4	TOD-Clock Control	12-6
Load-Clear-List-Directed Key	12-4	Wait Indicator	12-6
Load-Normal Key	12-4	Multiprocessing Configurations	12-7
Load-with-Dump Key	12-4	Multithreading Considerations	12-7

Manual Operation

The operator facilities provide functions for the manual operation and control of the machine. The functions include operator-to-machine communication, indication of machine status, control over the setting of the TOD clock, initial program loading, resets, and other manual controls for operator intervention in normal machine operation. A model may not implement all of the operator facilities described in this chapter.

A model may provide additional operator facilities which are not described in this chapter. Examples are the means to indicate specific error conditions in the equipment, to change equipment configurations, and to facilitate maintenance. Furthermore, controls covered in this chapter may have additional settings which are not described here. Such additional facilities and settings may be described in the appropriate System Library publication.

Most models provide, in association with the operator facilities, a console device which may be used as an I/O device for operator communication with the program; this console device may also be used to implement some or all of the facilities described in this chapter.

The operator facilities may be implemented on different models in various technologies and configurations. On some models, more than one set of

physical representations of some keys, controls, and indicators may be provided, such as on multiple local or remote operating stations, which may be effective concurrently.

A machine malfunction that prevents a manual operation from being performed correctly, as defined for that operation, may cause the CPU to enter the check-stop state or give some other indication to the operator that the operation has failed. Alternatively, a machine malfunction may cause a machine-check-interruption condition to be recognized

Basic Operator Facilities

Address-Compare Controls

The address-compare controls provide a way to stop the CPU when a preset address matches the address used in a specified type of main-storage reference.

One of the address-compare controls is used to set up the address to be compared with the storage address.

Another control provides at least two positions to specify the action, if any, to be taken when the address match occurs:

1. The normal position disables the address-compare operation.
2. The stop position causes the CPU to enter the stopped state on an address match. When the control is in this setting, the test indicator is on. Depending on the model and the type of reference, pending I/O, external, and machine-check interruptions may or may not be taken before entering the stopped state.

A third control may specify the type of storage reference for which the address comparison is to be made. A model may provide one or more of the following positions, as well as others:

1. The any position causes the address comparison to be performed on all storage references.
2. The data-store position causes address comparison to be performed when storage is addressed to store data.
3. The I/O position causes address comparison to be performed when storage is addressed by the channel subsystem to transfer data or to fetch a channel-command or indirect-data-address word. Whether references to the measurement block, interruption-response block, channel-path-status word, channel-report word, subchannel-status word, subchannel-information block, and operation-request block cause a match to be indicated depends on the model.
4. The instruction-address position causes address comparison to be performed when storage is addressed to fetch an instruction. The rightmost bit of the address setting may or may not be ignored. The match is indicated only when the first byte of the instruction is fetched from the selected location (which includes fetching the target instruction of an execute-type instruction).

Depending on the model and the type of reference, address comparison may be performed on virtual, real, or absolute addresses, and it may be possible to specify the type of address.

In a multiprocessing configuration, it depends on the model whether the address setting applies to one or all CPUs in the configuration and whether an address match causes one or all CPUs in the configuration to stop.

Depending on the model, the availability of address-compare controls may be limited by the use of program-event-recording (PER) controls; PER controls include bit 1 of the PSW and all bits of control registers 9, 10, and 11. The address-compare-control limitations are as follows:

- The setting of address-compare controls may be inhibited when any PER control is nonzero. In a multi-processing configuration, the setting of address-compare controls may be inhibited on all CPUs in the configuration when any PER control is nonzero on any CPU in the configuration.
- If address-compare controls have been set on a CPU, and any PER control is set to a nonzero value, the address-compare controls may be disabled; the address-compare controls may remain disabled even if the respective PER controls are all subsequently reset to zero. In a multi-processing configuration, the address-compare controls may be disabled on all CPUs in the configuration if any PER control is set to a nonzero value in any CPU in the configuration.

Alter-and-Display Controls

The operator facilities provide controls and procedures to permit the operator to alter and display the contents of locations in storage, the storage keys, the general, floating-point, floating-point-control, vector, access, and control registers, the prefix, and the PSW.

Before alter-and-display operations may be performed, the CPU must first be placed in the stopped state. During alter-and-display operations, the manual indicator may be turned off temporarily, and the start and restart keys may be inoperative.

Addresses used to select storage locations for alter-and-display operations are real addresses. The capability of specifying logical, virtual, or absolute addresses may also be provided.

Architectural-Mode Indicator

Depending on the model, the configuration may be activated in the ESA/390 architectural mode, the ESA/390 compatibility mode, or the z/Architecture architectural mode.

The architectural-mode indicator shows the architectural mode of operation (the ESA/390 mode, ESA/390 compatibility mode, z/Architecture mode, or some other mode) selected by the last architectural-mode-selection operation and by the last SIGNAL PROCESSOR set-architecture order or the last reset that determined the mode.

When the configuration-z/Architecture-architectural-mode (CZAM) facility is installed, the z/Architecture architectural mode is indicated.

Architectural-Mode-Selection Controls

The architectural-mode-selection controls provide for the selection of the ESA/390 architectural mode of operation, the ESA/390 compatibility mode of operation, the z/Architecture architectural mode of operation, or, possibly, some other architectural mode of operation. (When a configuration is activated in either the ESA/390 or ESA/390-compatibility mode, the z/Architecture mode is selected from the ESA/390 mode by the SIGNAL PROCESSOR set-architecture order.) Depending on the model, the architectural-mode selection may be provided as part of the IML operation or may be a separate operation.

As part of the architectural-mode-selection process, all CPUs and the associated channel-subsystem components in a particular configuration are placed in the same architectural mode.

Check-Stop Indicator

The check-stop indicator is on when the CPU is in the check-stop state. Reset operations normally cause the CPU to leave the check-stop state and thus turn off the indicator. The manual indicator may also be on in the check-stop state.

CPUs-per-Core Indicator

When the multithreading facility is installed, the CPUs-per-core indicator is provided. When the multithreading facility is not enabled, the value of this indicator is one. When the multithreading facility is enabled, the value of this indicator is one more than value of the program-specified maximum thread identification last set by the SIGNAL PROCESSOR set-multithreading order.

Operation Note: Certain operator functions are addressed to a specific CPU, designated by a CPU address. When multithreading is enabled, the CPU address includes a core identification and a thread identification as described in “CPU-Address Identification” on page 4-84. The CPUs-per-core indicator can be used to determine which format of CPU address is needed when selecting a CPU to which operator functions are addressed.

IML Controls

The IML controls provided with some models perform initial machine loading (IML), which is the loading of licensed internal code into the machine.

When the IML operation is completed, the state of the affected CPUs, channel subsystem, main storage, and operator facilities is the same as if a power-on reset had been performed, except that the value and state of the TOD clock are not changed. The contents of expanded storage may have been cleared to zeros with valid checking-block code or may have remained unchanged, depending on the model.

The IML controls are effective while the power is on.

Interrupt Key

When the interrupt key is activated, an external-interruption condition indicating the interrupt key is generated. (See “Interrupt Key” on page 6-13.)

The interrupt key is effective when the CPU is in the operating or stopped state. It depends on the model whether the interrupt key is effective when the CPU is in the load state.

Load Indicator

The load indicator is on during CCW-type initial program loading, indicating that the CPU is in the load state. The indicator goes on for a particular CPU when the load-clear, load-clear-list-directed, load-normal or load-with-dump key is activated for that CPU and the corresponding operation is started. It goes off after the new PSW is loaded successfully. For details, see “Initial Program Loading” on page 4-81 and “Initial Program Loading” on page 17-16.

Load-Clear Key

Activating the load-clear key causes a reset operation to be performed and CCW-type initial program loading to be started by using the I/O device designated by the load-unit-address controls. Clear reset is performed on the configuration. For details, see “Resets” on page 4-74 and “Initial Program Loading” on page 4-81.

The load-clear key is effective when the CPU is in the operating, stopped, load, or check-stop state.

Load-Clear-List-Directed Key

Activating the load-clear-list-directed key causes a reset operation to be performed and list-directed initial program loading to be started using the I/O device designated by the list-directed IPL parameters. Clear reset is performed on the configuration. For details, see “Resets” on page 4-74 and “List-Directed IPL” on page 17-19.

The load-clear-list-directed key is effective when the CPU is in the operating, stopped, load, or check-stop state.

Load-Normal Key

Activating the load-normal key causes a reset operation to be performed and CCW-type initial program loading to be started by using the I/O device designated by the load-unit-address controls. Initial CPU reset is performed on the CPU for which the load-normal key was activated, CPU reset is propagated to all other CPUs in the configuration, and a subsystem reset is performed on the remainder of the configuration. For details, see “Resets” on page 4-74 and “Initial Program Loading” on page 4-81.

The load-normal key is effective when the CPU is in the operating, stopped, load, or check-stop state.

Load-with-Dump Key

Activating the load-with-dump key causes a reset operation to be performed and list-directed initial program loading to be started by using the I/O devices designated by the list-directed IPL parameters. A store-status operation followed by an initial CPU reset is performed on the CPU for which the load-

with-dump key was activated, CPU reset is propagated to all other CPUs in the configuration, and a subsystem reset is performed on the remainder of the configuration. For details, see “Resets” on page 4-74 and “List-Directed IPL” on page 17-19.

The load-with-dump key is effective when the CPU is in the operating, stopped, load, or check-stop state.

Load-Unit-Address Controls

The load-unit-address controls specify four hexadecimal digits that provide the device number used for CCW-type initial program loading. When the alternate-subchannel-set-IPL-device facility is installed the load-unit-address controls may specify an additional hexadecimal digit that provides the subchannel-set ID for CCW-type initial program loading. For details, see “Initial Program Loading” on page 4-81.

Manual Indicator

The manual indicator is on when the CPU is in the stopped state. Some functions and several manual controls are effective only when the CPU is in the stopped state.

Power Controls

The power controls are used to turn the power on and off.

The CPUs, storage, channel subsystem, operator facilities, and I/O devices may all have their power turned on and off by common controls, or they may have separate power controls. When a particular unit has its power turned on, that unit is reset. The sequence is performed so that no instructions or I/O operations are performed until explicitly specified. The controls may also permit power to be turned on in stages, but the machine does not become operational until power on is complete.

When the power is completely turned on, an IML operation is performed on models which have an IML function. A power-on reset is then initiated (see “Resets” on page 4-74). It depends on the model whether the architectural mode of operation can be selected when the power is turned on, or whether the mode-selection controls have to be used to change the mode after the power is on.

Rate Control

A model may provide the rate control, the setting of which determines the effect of the start function and the manner in which instructions are executed.

When the rate control is provided, it has at least two positions. The normal position is the process position. Another position is the instruction-step position. When the rate control is set to the process position and the start function is performed, the CPU starts operating at normal speed. When the rate control is set to the instruction-step position and the wait-state bit is zero, one instruction or, for interruptible instructions, one unit of operation is executed, and all pending allowed interruptions are taken before the CPU returns to the stopped state. When the rate control is set to the instruction-step position and the wait-state bit is one, no instruction is executed, but all pending allowed interruptions are taken before the CPU returns to the stopped state. For details, see "CPU States" on page 4-2.

The test indicator is on while the rate control is not set to the process position.

If the setting of the rate control is changed while the CPU is in the operating or load state, the results are unpredictable.

When the rate control is not provided, the CPU operates as though the rate control was in the process position, and instruction stepping is not available.

Restart Key

Activating the restart key initiates a restart interruption. (See "Restart Interruption" on page 6-56.)

The restart key is effective when the CPU is in the operating or stopped state. The key is not effective when the CPU is in the check-stop state. It depends on the model whether the restart key is effective when any CPU in the configuration is in the load state.

The effect is unpredictable when the restart key is activated while any CPU in the configuration is in the load state. In particular, if the CPU performs a restart interruption and enters the operating state while another CPU is in the load state, operations such as I/O instructions, the SIGNAL PROCESSOR instruc-

tion, and the INVALIDATE PAGE TABLE ENTRY instruction may not operate according to the definitions given in this publication

Start Key

Activating the start key causes the CPU to perform the start function. (See "CPU States" on page 4-2.)

The start key is effective only when the CPU is in the stopped state. The effect is unpredictable when the stopped state has been entered by a reset.

Stop Key

Activating the stop key causes the CPU to perform the stop function. (See "CPU States" on page 4-2.)

The stop key is effective only when the CPU is in the operating state.

Operation Note: Activating the stop key has no effect when:

- An unending string of certain program or external interruptions occurs.
- The prefix register contains an invalid address.
- The CPU is in the load or check-stop state.

Store-Status Key

Activating the store-status key initiates a store-status operation. (See "Store Status" on page 4-82.)

The store-status key is effective only when the CPU is in the stopped state.

Operation Note: The store-status operation may be used in conjunction with a standalone dump program for the analysis of major program malfunctions. For such an operation, the following sequence would be called for:

1. Activation of the stop or system-reset-normal key
2. Activation of the store-status key (this step is unnecessary if the standalone dump program is loaded by activating the load-with-dump key)
3. Activation of the load-normal key to enter a stand-alone dump program

The system-reset-normal key must be activated in step 1 when (1) the stop key is not effective because a continuous string of interruptions is occurring, (2) the prefix register contains an invalid address, or (3) the CPU is in the check-stop state.

System-Reset-Clear Key

Activating the system-reset-clear key causes a clear-reset operation to be performed on the configuration. For details, see “Resets” on page 4-74.

The system-reset-clear key is effective when the CPU is in the operating, stopped, load, or check-stop state.

System-Reset-Normal Key

Activating the system-reset-normal key causes a CPU-reset operation and a subsystem-reset operation to be performed. In a multiprocessing configuration, a CPU reset is propagated to all CPUs in the configuration. For details, see “Resets” on page 4-74.

The system-reset-normal key is effective when the CPU is in the operating, stopped, load, or check-stop state.

Test Indicator

The test indicator is on when a manual control for operation or maintenance is in an abnormal position that can affect the normal operation of a program.

Setting the address-compare controls to the stop position or setting the rate control to the instruction-step position turns on the test indicator.

The test indicator may be on when one or more diagnostic functions under the control of DIAGNOSE are activated, or when other abnormal conditions occur.

The abnormal setting of a manual control causes the test indicator of the affected CPU to be turned on; however, in a multiprocessing configuration, the operation of other CPUs may be affected even though their test indicators are not turned on.

Depending on the model, if address-compare controls have been disabled due to bit position 1 of the PSW being set to one or any or all of control registers

9, 10, and 11 containing nonzero values, the test indicator may remain on even though the address-compare controls have been disabled.

Operation Note: If a manual control is left in a setting intended for maintenance purposes, such an abnormal setting may, among other things, result in false machine-check indications or cause actual machine malfunctions to be ignored. It may also alter other aspects of machine operation, including instruction execution, channel-subsystem operation, and the functioning of operator controls and indicators, to the extent that operation of the machine does not comply with that described in this publication.

TOD-Clock Control

When the TOD-clock control is not activated, that is, the control is set to the secure position, the state and value of the TOD clock are protected against unauthorized or inadvertent change by not permitting the instructions SET CLOCK or DIAGNOSE to change the state or value.

When the TOD-clock control is activated, that is, the control is set to the enable-set position, alteration of the clock state or value by means of SET CLOCK or DIAGNOSE is permitted. This setting is momentary, and the control automatically returns to the secure position.

If there is more than one physical representation of the TOD-clock control, the TOD clock is secure only if all TOD-clock controls in the configuration are set to the secure position.

Wait Indicator

The wait indicator is on when the wait-state bit in the current PSW is one. Instead of a wait indicator, a model may have a means of indicating a time-averaged value of the wait-state bit.

Multiprocessing Configurations

In a multiprocessing configuration, one of each of the following keys and controls is provided for each CPU:

- Alter and display
- Interrupt

- Restart
- Start
- Stop
- Store status.

On some models, a rate control may also be provided.

On some models, the load-clear, load-clear-list-directed, load-normal, load-with-dump, and load-unit-address keys are provided for each primary CPU in the configuration. On other models, a single load-clear, load-clear-list-directed, load-normal, and load-with-dump key are provided for the entire configuration and apply to the lowest-numbered primary online CPU that is not in the check-stop state.

There need not be more than one of each of the following keys and controls in a multiprocessing configuration: address compare, IML, power, system reset clear, system reset normal, and TOD clock.

One check-stop, manual, test, and wait indicator may be provided for each CPU. A load indicator is provided only on a primary CPU. Alternatively, a single set of indicators may be switched to more than one CPU.

There need not be more than one architectural-mode and CPUs-per-core indicator in a multiprocessing configuration.

In a system capable of reconfiguration, there must be a separate set of keys, controls, and indicators in each configuration.

Multithreading Considerations

A CPU address is used to identify the CPU to which CPU-specific operator functions are directed. These CPU-specific operator functions are enumerated in the section “Multiprocessing Configurations”, above. When multithreading is enabled (that is, when the CPUs-per-core indicator is greater than one), the CPU address comprises a core identification and a thread identification, as described in “CPU-Address Identification” on page 4-84.

Some models provide a control to select the primary CPU to be started following a load operation. On such a model, when the multithreading facility is enabled prior to the load operation, the operator designates an expanded-format CPU address as described in “CPU-Address Identification” on page 4-84. However, only the core-identification portion of the designated CPU address is meaningful; the operation is always targeted to the CPU having thread identification zero of the designated core.

On models that do not provide a control to select the primary CPU to be started following a load operation, the operation is targeted to the CPU having thread identification zero in the lowest-numbered operational core.

In either case, the targeted CPU is (a) the one upon which the initial-CPU reset is performed, and (b) the CPU that is started after the load operation is completed

Chapter 13. I/O Overview

Input/Output (I/O)	13-1	Transport Command Word (TCW)	13-7
The Channel Subsystem	13-1	Channel Program Organization	13-7
Subchannel Sets	13-2	CCW Channel Program	13-7
Subchannels	13-2	TCW Channel Program	13-8
Attachment of Input/Output Devices	13-3	Execution of I/O Operations	13-8
Channel Paths	13-3	Start-Function Initiation	13-8
Control Units	13-4	Subchannel Operation Modes	13-9
I/O Devices	13-5	Path Management	13-9
I/O Addressing	13-5	Channel-Program Execution	13-9
Subchannel-Set Identifier	13-5	Conclusion of I/O Operations	13-10
Channel-Path Identifier	13-5	Chaining When Using a CCW Channel	
Subchannel Number	13-5	Program	13-11
Device Number	13-6	Chaining When Using a TCW Channel	
Device Identifier	13-6	Program	13-12
Fibre-Channel Extensions	13-6	Premature Conclusion of I/O Operations	13-12
I/O-Command Words	13-7	I/O Interruptions	13-12

Input/Output (I/O)

The terms “input” and “output” are used to describe the transfer of data between I/O devices and main storage. An operation involving this kind of transfer is referred to as an I/O operation. The facilities used to control I/O operations are collectively called the channel subsystem. (I/O devices and their control units attach to the channel subsystem.) This chapter provides a brief description of the basic components and operation of the channel subsystem.

The Channel Subsystem

The channel subsystem directs the flow of information between I/O devices and main storage. It relieves CPUs of the task of communicating directly with I/O devices and permits data processing to proceed concurrently with I/O processing. The channel subsystem uses one or more channel paths as the communication link in managing the flow of information to or from I/O devices. As part of I/O processing, the channel subsystem also performs a path-management operation by testing for channel-path availability, chooses an available channel path, and initiates the performance of the I/O operation by the device.

Within the channel subsystem are subchannels. One subchannel is provided for and dedicated to each I/O device accessible to the program through the channel subsystem.

The multiple-subchannel-set facility is an optional facility. When it is installed, subchannels are partitioned into multiple subchannel sets, and each subchannel set may provide one dedicated subchannel to an I/O device. Depending on the model and the interface used, some I/O devices may only be allowed to be accessed via certain subchannel sets.

Each subchannel provides information concerning the associated I/O device and its attachment to the channel subsystem. The subchannel also provides information concerning I/O operations and other functions involving the associated I/O device. The subchannel is the means by which the channel subsystem provides information about associated I/O devices to CPUs, which obtain this information by executing I/O instructions. The actual number of subchannels provided depends on the model and the configuration; the maximum addressability is 0-65,535 in each subchannel set.

I/O devices are attached through control units to the channel subsystem by means of channel paths. Control units may be attached to the channel subsystem by more than one channel path, and an I/O device may be attached to more than one control unit. In all,

an individual I/O device may be accessible to the channel subsystem by as many as eight different channel paths via a subchannel, depending on the model and the configuration. The total number of channel paths provided by a channel subsystem depends on the model and the configuration; the maximum addressability is 0-255.

The performance of a channel subsystem depends on its use and on the system model in which it is implemented. Channel paths are provided with different data-transfer capabilities, and an I/O device designed to transfer data only at a specific rate (a magnetic-tape unit or a disk storage, for example) can operate only on a channel path that can accommodate at least this data rate.

The channel subsystem contains common facilities for the control of I/O operations. When these facilities are provided in the form of separate, autonomous equipment designed specifically to control I/O devices, I/O operations are completely overlapped with the activity in CPUs. The only main-storage cycles required by the channel subsystem during I/O operations are those needed to transfer data and control information to or from the final locations in main storage, along with those cycles that may be required for the channel subsystem to access the subchannels when they are implemented as part of non-addressable main storage. These cycles do not delay CPU programs, except when both the CPU and the channel subsystem concurrently attempt to reference the same main-storage area.

Subchannel Sets

When the multiple-subchannel-set facility is installed, subchannels are partitioned into multiple subchannel sets. There may be up to four subchannel sets, each identified by a subchannel-set identifier (SSID). When the multiple-subchannel-set facility is not installed, there is only one subchannel set with an SSID of zero. When the multiple-subchannel-set facility is not enabled, only subchannel set zero is visible to the program. See “Multiple-Subchannel-Set Facility” on page 17-33 for more information on the multiple-subchannel-set facility.

Subchannels

A subchannel provides the logical appearance of a device to the program and contains the information

required for sustaining a single I/O operation. The subchannel consists of internal storage that contains information in the form of a channel-program designation, channel-path identifier, device number, count, status indications, and I/O-interruption-subclass code, as well as information on path availability and functions pending or being performed. I/O operations are initiated with a device by the execution of I/O instructions that designate the subchannel associated with the device.

Each device is accessible by means of one subchannel in each channel subsystem to which it is assigned during configuration at installation time. The device may be a physically identifiable unit or may be housed internal to a control unit. For example, in certain disk-storage devices, each actuator used in retrieving data is considered to be a device. In all cases, a device, from the point of view of the channel subsystem, is an entity that is uniquely associated with one subchannel and that responds to selection by the channel subsystem by using the communication protocols defined for the type of channel path by which it is accessible.

On some models, subchannels are provided in blocks. On these models, more subchannels may be provided than there are attached devices. Subchannels that are provided but do not have devices assigned to them are not used by the channel subsystem to perform any function and are indicated by storing the associated device-number-valid bit as zero in the subchannel-information block of the subchannel.

The number of subchannels provided by the channel subsystem is independent of the number of channel paths to the associated devices. For example, a device accessible through alternate channel paths still is represented by a single subchannel. Each subchannel is addressed by using the following:

- a 16-bit binary subchannel number
- a two-bit SSID when the subchannel-set facility is installed

After I/O processing at the subchannel has been requested by the execution of START SUBCHANNEL, the CPU is released for other work, and the channel subsystem assembles or disassembles data and synchronizes the transfer of data bytes between the I/O device and main storage. To accomplish this, the channel subsystem maintains and updates an address and a count that describe the destination or

source of data in main storage. Similarly, when an I/O device provides signals that should be brought to the attention of the program, the channel subsystem transforms the signals into status information and stores the information in the subchannel, where it can be retrieved by the program.

Attachment of Input/Output Devices

Channel Paths

The channel subsystem communicates with I/O devices by means of channel paths between the channel subsystem and control units. A control unit may be accessible by the channel subsystem by more than one channel path. Similarly, an I/O device may be accessible by the channel subsystem through more than one control unit, each having one or more channel paths to the channel subsystem.

Devices that are attached to the channel subsystem by multiple channel paths configured to a subchannel, may be accessed by the channel subsystem using any of the available channel paths. Similarly, a device having the dynamic-reconnection feature and operating in the multipath mode can be initialized to operate such that the device may choose any of the available channel paths configured to the subchannel, when logically reconnecting to the channel subsystem to continue a chain of I/O operations.

The channel subsystem may contain more than one type of channel path. Examples of channel-path types used by the channel subsystem are the ESCON I/O interface, FICON I/O interface, FICON-converted I/O interface, and IBM System/360 and System/370 I/O interface. The term “serial-I/O interface” is used to refer the ESCON I/O interface, the FICON I/O interface, and the FICON-converted I/O interface. The term “parallel-I/O interface” is used to refer to the IBM System/360 and System/370 I/O interface.

The ESCON I/O interface is described in the System Library publication *IBM Enterprise Systems Architecture/390 ESCON I/O Interface*, SA22-7202.

The FICON I/O interface is described in the ANSI standards document *Fibre Channel - Single-Byte Command Code Sets-2 (FC-SB-2)*

The IBM System/360 and System/370 I/O interface is described in the System Library publication *IBM System/360 and System/370 I/O Interface Channel to Control Unit OEMI*, GA22-6974.

Depending on the type of channel path, the facilities provided by the channel path, and the I/O device, an I/O operation may occur in one of three modes, frame-multiplex mode, burst mode, or byte-multiplex mode.

In the frame-multiplex mode, the I/O device may stay logically connected to the channel path for the duration of the execution of a channel program. The facilities of a channel path capable of operating in the frame-multiplex mode may be shared by a number of concurrently operating I/O devices. In this mode the information required to complete an I/O operation is divided into frames that may be interleaved with frames from I/O operations for other I/O devices. During this period, multiple I/O devices are considered to be logically connected to the channel path.

In the burst mode, the I/O device monopolizes a channel path and stays logically connected to the channel path for the transfer of a burst of information. No other device can communicate over the channel path during the time a burst is transferred. The burst can consist of a few bytes, a whole block of data, a sequence of blocks with associated control and status information (the block lengths may be zero), or status information that monopolizes the channel path. The facilities of the channel path capable of operating in the burst mode may be shared by a number of concurrently operating I/O devices.

Some channel paths can tolerate an absence of data transfer for about a half minute during a burst-mode operation, such as occurs when a long gap on magnetic tape is read. An equipment malfunction may be indicated when an absence of data transfer exceeds the prescribed limit.

In the byte-multiplex mode, the I/O device stays logically connected to the channel path only for a short interval of time. The facilities of a channel path capable of operating in the byte-multiplex mode may be shared by a number of concurrently operating I/O devices. In this mode, all I/O operations are split into short intervals of time during which only a segment of information is transferred over the channel path. During such an interval, only one device and its associated subchannel are logically connected to the channel path. The intervals associated with the con-

current operation of multiple I/O devices are sequenced in response to demands from the devices. The channel-subsystem facility associated with a subchannel exercises its controls for any one operation only for the time required to transfer a segment of information. The segment can consist of a single byte of data, a few bytes of data, a status report from the device, or a control sequence used for the initiation of a new operation.

Ordinarily, devices with high data-transfer-rate requirements operate with the channel path in the frame-multiplex mode, slower devices operate in the burst mode, and the slowest devices operate in the byte-multiplex mode. Some control units have a manual switch for setting the desired mode of operation.

An I/O operation that occurs on a parallel-I/O-interface type of channel path may occur in either the burst mode or the byte-multiplex mode depending on the facilities provided by the channel path and the I/O device. For improved performance, some channel paths and control units are provided with facilities for high-speed transfer and data streaming. See the *System Library publication IBM System/360 and System/370 I/O Interface Channel to Control Unit OEMI, GA22-6974*, for a description of those two facilities.

An I/O operation that occurs on a serial-I/O-interface type of channel path may occur in either the frame-multiplex mode or the burst mode. For improved performance, some control units attaching to the serial-I/O interface provide the capability to provide sense data to the program concurrent with the presentation of unit-check status, if permitted to do so by the program. (See "Concurrent Sense" on page 17-27.)

Depending on the control unit or channel subsystem, access to a device through a subchannel may be restricted to a single channel-path type.

The modes and features described above affect only the protocol used to transfer information over the channel path and the speed of transmission. No effects are observable by CPU or channel programs with respect to the way these programs are executed.

Control Units

A control unit provides the logical capabilities necessary to operate and control an I/O device and adapts

the characteristics of each device so that it can respond to the standard form of control provided by the channel subsystem.

Communication between the control unit and the channel subsystem takes place over a channel path. The control unit accepts control signals from the channel subsystem, controls the timing of data transfer over the channel path, and provides indications concerning the status of the device.

The I/O device attached to the control unit may be designed to perform only certain limited operations, or it may perform many different operations. A typical operation is moving a recording medium and recording data. To accomplish its operations, the device needs detailed signal sequences peculiar to its type of device. The control unit decodes the commands received from the channel subsystem, interprets them for the particular type of device, and provides the signal sequence required for the performance of the operation.

A control unit may be housed separately, or it may be physically and logically integrated with the I/O device, the channel subsystem, or a CPU. In the case of most electromechanical devices, a well-defined interface exists between the device and the control unit because of the difference in the type of equipment the control unit and the device require. These electromechanical devices often are of a type where only one device of a group attached to a control unit is required to transfer data at a time (magnetic-tape units or disk-access mechanisms, for example), and the control unit is shared among a number of I/O devices. On the other hand, in some electronic I/O devices, such as the channel-to-channel adapter, the control unit does not have an identity of its own.

From the programmer's point of view, most functions performed by the control unit can be merged with those performed by the I/O device. Therefore, this publication normally makes no specific mention of the control-unit function; the performance of I/O operations is described as if the I/O devices communicated directly with the channel subsystem. Reference is made to the control unit only when emphasizing a function performed by it or when describing how the sharing of the control unit among a number of devices affects the performance of I/O operations.

I/O Devices

An input/output (I/O) device provides external storage, a means of communication between data-processing systems, or a means of communication between a system and its environment. I/O devices include such equipment as magnetic-tape units, direct-access-storage devices (for example, disks), display units, typewriter-keyboard devices, printers, teleprocessing devices, and sensor-based equipment. An I/O device may be physically distinct equipment, or it may share equipment with other I/O devices.

Most types of I/O devices, such as printers, or tape devices, use external media, and these devices are physically distinguishable and identifiable. Other types are solely electronic and do not directly handle physical recording media. The channel-to-channel adapter, for example, provides for data transfer between two channel paths, and the data never reaches a physical recording medium outside main storage. Similarly, communication controllers may handle the transmission of information between the data-processing system and a remote station, and its input and output are signals on a transmission line.

In the simplest case, an I/O device is attached to one control unit and is accessible from one channel path. Switching equipment is available to make some devices accessible from two or more channel paths by switching devices among control units and by switching control units among channel paths. Such switching equipment provides multiple paths by which an I/O device may be accessed. Multiple channel paths to an I/O device are provided to improve performance or I/O availability, or both, within the system. The management of multiple channel paths to devices is under the control of the channel subsystem and the device, but the channel paths may indirectly be controlled by the program.

I/O Addressing

Four different types of I/O addressing are provided by the channel subsystem for the necessary addressing of the various components: channel-path identifiers, subchannel numbers, device numbers, and, though not visible to programs, addresses dependent on the channel-path type. When the multiple-subchannel-

set facility is installed, the subchannel-set identifier (SSID) is also used in I/O addressing.

Subchannel-Set Identifier

The subchannel-set identifier (SSID) is a two-bit value assigned to each provided subchannel set.

Channel-Path Identifier

The channel-path identifier (CHPID) is a system-unique eight-bit value assigned to each installed channel path of the system. A CHPID is used to address a channel path. A CHPID is specified by the second-operand address of RESET CHANNEL PATH and used to designate the channel path that is to be reset. The channel paths by which a device is accessible are identified in the subchannel-information block (SCHIB), each by its associated CHPID, when STORE SUBCHANNEL is executed. The CHPID can also be used in operator messages when it is necessary to identify a particular channel path. A system model may provide as many as 256 channel paths. The maximum number of channel paths and the assignment of CHPIDs to channel paths depends on the system model.

Subchannel Number

A subchannel number is a 16-bit value used to address a subchannel. This value is unique within a subchannel set of a channel subsystem. The subchannel is addressed by eight I/O instructions: CANCEL SUBCHANNEL, CLEAR SUBCHANNEL, HALT SUBCHANNEL, MODIFY SUBCHANNEL, RESUME SUBCHANNEL, START SUBCHANNEL, STORE SUBCHANNEL, and TEST SUBCHANNEL. All I/O functions relative to a specific I/O device are specified by the program by designating a subchannel assigned to the I/O device. Subchannels in each subchannel set are always assigned subchannel numbers within a single range of contiguous numbers. The lowest-numbered subchannel is subchannel 0. The highest-numbered subchannel of the channel subsystem has a subchannel number equal to one less than the number of subchannels provided. A maximum of 65,536 subchannels can be provided in each subchannel set. Normally, subchannel numbers are only used in communication between the CPU program and the channel subsystem.

Device Number

Each subchannel that has an I/O device assigned to it also contains a parameter called the device number. The device number is a 16-bit value that is assigned as one of the parameters of the subchannel at the time the device is assigned to the subchannel. The device number identifies a device to the program and is unique within a subchannel set of a channel subsystem.

The device number provides a means to identify a device, independent of any limitations imposed by the system model, the configuration, or channel-path protocols. The device number is used in communications concerning the device that take place between the system and the system operator. For example, the device number is entered by the system operator to designate the input device to be used for initial program loading.

Programming Note: The device number is assigned at device-installation time and may have any value. However, the user must observe any restrictions on device-number assignment that may be required by the control program, support programs, or the particular control unit or I/O device.

Device Identifier

A device identifier is an address, not apparent to the program, that is used by the channel subsystem to communicate with I/O devices. The type of device identifier used depends on the specific channel-path type and the protocols provided. Each subchannel contains one or more device identifiers.

For a channel path of the parallel-I/O-interface type, the device identifier is called a device address and consists of an eight-bit value. For the ESCON I/O interface, the device identifier consists of a four-bit control-unit address and an eight-bit device address. For the FICON I/O interface, the device identifier consists of an eight-bit control-unit-image ID and an eight-bit device address. For the FICON-converted I/O interface, the device identifier consists of a four-bit control-unit address and an eight-bit device address.

The device address identifies the particular I/O device (and, on the parallel-I/O interface, the control unit) associated with a subchannel. The device

address may identify, for example, a particular magnetic-tape drive, disk-access mechanism, or transmission line. Any number in the range 0-255 can be assigned as a device address.

For further information about the device identifier used with a particular channel-path type, see the appropriate publication for the channel-path type.

Fibre-Channel Extensions

The fibre-channel-extensions (FCX) facility is an optional facility that provides for the formation of a channel program that is composed of a transport-control word (TCW) that designates a transport-command-control block (TCCB) and a transport-status block (TSB). The TCCB includes a transport-command area (TCA) which contains a list of up to 30 I/O commands that are in the form of device-command words (DCWs).

The FCX-bidirectional-data-transfer facility is an additional and optional facility that provides support for TCW channel programs that specify both read and write operations. Whether a device recognizes bidirectional data transfers is determined by device-dependent means.

When a device does not recognize bidirectional data transfers, a TCW and its TCCB may specify either read or a write data transfers. When a device recognizes bidirectional data transfers, a TCW and its TCCB may, depending on the device, specify both read and write data transfers. For interruptions, the TSB contains the completion status and other information related to the TCW channel program in addition to the information in the IRB.

For some devices, the list of DCWs may be extended past what will fit in the TCA. For such devices, the TCA extension (TCAX) is specified and transferred as output data. Whether a device supports TCA extensions is determined by device-dependent means.

In addition to the IRB, the TSB contains the completion status and other information related to the TCW channel program.

The FCX facility provides the ability to directly or indirectly designate any or all of the TCCB, the input data storage area, and the output data storage area.

When a storage area is designated directly, the TCW specifies the location of a single, contiguous block of storage. When a storage area is designated indirectly, the TCW designates the location of a list of one or more transport-indirect-data-address words (TIDAWs). TIDAW lists and the storage area designated by each TIDAW in a list are restricted from crossing 4 K-byte boundaries

The FCX facility also provides an interrogate operation that may be initiated by the CANCEL SUBCHANNEL instruction to determine the state of an I/O operation.

I/O-Command Words

An I/O-command word specifies a command and contains information associated with the command. When the FCX facility is installed, there are two elemental forms of I/O command words which are the channel-command word (CCW) and the device-command word (DCW).

A CCW is 8-bytes in length and specifies the command to be executed. For commands that initiate certain operations the CCW also designates the storage area associated with the operation, the count of data bytes, the action to be taken when the command completes, and other options. All I/O devices recognize CCWs.

A DCW is 8-bytes in length and specifies the command to be executed, the count of data bytes, and other options. I/O devices that support FCX recognize DCWs.

Transport Command Word (TCW)

A TCW designates a transport-command-control block (TCCB) which contains a list of commands to be transported to and executed by an I/O device. The TCW also designates the storage areas for the commands in the TCCB as well as a transport-status block (TSB) to contain the status of the I/O operation.

Channel Program Organization

When the FCX facility is not installed, there is a single form of channel program which is the CCW channel program. When the FCX facility is installed, there

is an additional form of channel program which is the TCW channel program. Both forms of channel programs are described below.

CCW Channel Program

A channel program that is composed of one or more CCWs is called a CCW channel program (CCP). Such a channel program contains one or more CCWs that are logically linked and arranged for sequential execution by the channel subsystem.

Figure 13-1 shows a conceptual example of a simple CCW channel program in program storage. This channel program contains 4 CCWs and specifies the transfer of data to or from contiguous areas of storage. The first CCW designates a control command and the remaining CCWs designate the transfer of data.

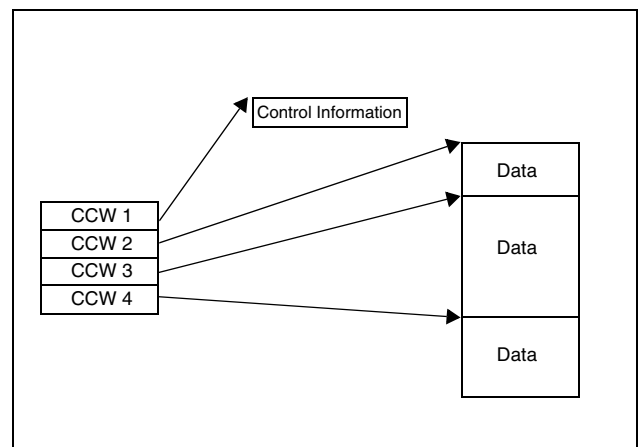

Figure 13-1. CCW Channel Program Example

TCW Channel Program

A channel program that is composed of a single TCW is called a TCW channel program. A TCW designates a transport-command-control block (TCCB) that contains from 1 to 30 DCWs.

When DCWs within the TCCB are logically linked and arranged for sequential execution. For DCWs that specify control information, the TCCB also contains the control information for those commands. The TCW also designates the storage area or areas for the DCWs that specify the transfer of data from or to the device and the location of a transport-status block (TSB) for completion status. The TCCB and the storage areas for the transfer of data may be specified as either contiguous or noncontiguous storage.

Figure 13-2 shows a conceptual example of a TCW channel program storage. This channel program is similar to the CCW channel program in Figure 13-1. This channel program is composed of a TCW that designates a TCCB containing 4 DCWs, all of which specify the transfer of data either to or from contiguous areas of storage. The first DCW designates a control command and the remaining DCWs designate the transfer of data. The TCW also designates a TSB for completion status.

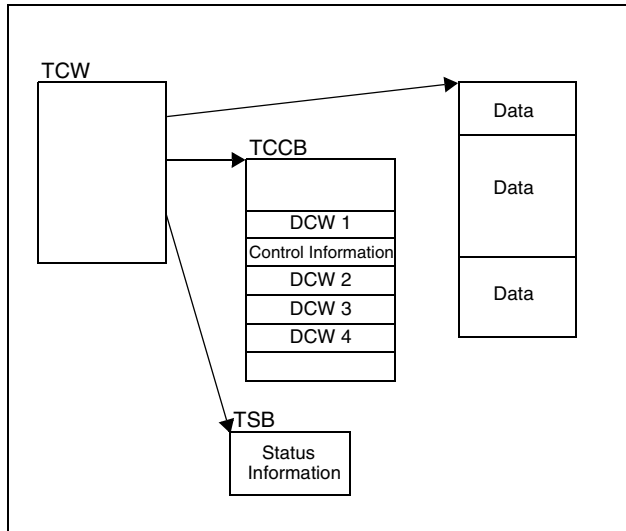

Figure 13-2. Example of TCW Channel Program Example Designating I/O

Execution of I/O Operations

I/O operations are initiated and controlled by information with four types of formats: the instruction START SUBCHANNEL, transport-command words, I/O-command words, and orders. The START SUBCHANNEL instruction is executed by a CPU and is part of the CPU program that supervises the flow of requests for I/O operations from other programs that manage or process the I/O data.

When START SUBCHANNEL is executed, parameters are passed to the target subchannel requesting that the channel subsystem perform a start function with the I/O device associated with the subchannel. The channel subsystem performs the start function by using information at the subchannel, including the information passed during the execution of the START SUBCHANNEL instruction, to find an accessible channel path to the device. Once the device has been selected, the execution of an I/O operation is

accomplished by the decoding and execution of a CCW by the channel subsystem and the I/O device, for CCW channel programs, or for TCW channel programs, by transporting the TCCB to the I/O device by the channel subsystem and the decoding and execution of a DCW by the device. I/O-command words, and transport-command words, are fetched from main storage, although the modifier bits in the command code of a CCW DCW may specify device-dependent conditions for the execution of an operation at the device.

Operations peculiar to a device, such as rewinding tape or positioning the access mechanism on a disk drive, are specified by orders that are decoded and executed by I/O devices. Orders may be transferred to the device as modifier bits in the command code of a control command, may be transferred to the device as data during a control or write operation, or may be made available to the device by other means.

Start-Function Initiation

CPU programs initiate I/O operations with the instruction START SUBCHANNEL. This instruction passes the contents of an operation-request block (ORB) to the subchannel.

If the ORB specifies a CCW channel program, the contents of the ORB include the subchannel key, the address of the first CCW to be executed, and a specification of the format of the CCWs. The CCW specifies the command to be executed and the storage area, if any, to be used. If the ORB specifies a TCW channel program, the contents of the ORB include the subchannel key and the address of the TCW to be executed. The TCW designates the TCCB which contains the commands to be transported to the device for execution, the storage area or areas, if any, to be used for data transfer, and the TSB to contain the status of the I/O operation.

When the ORB contents have been passed to the subchannel, the execution of START SUBCHANNEL is complete. The results of the execution of the instruction are indicated by the condition code set in the program-status word.

When facilities become available and the ORB specifies a CCW channel program, the channel subsystem fetches the first CCW and decodes it according to the format bit specified in the ORB. If the format bit is zero, format-0 CCWs are specified. If the format bit is

one, format-1 CCWs are specified. Format-0 and format-1 CCWs contain the same information, but the fields are arranged differently in the format-1 CCW so that 31-bit addresses can be specified directly in the CCW. When facilities become available and the ORB specifies a TCW channel program, the channel subsystem fetches the designated TCW and transports the designated TCCB to the device. Storage areas designated by the TCW for the transfer of data to or from the device are 64-bit addresses.

Subchannel Operation Modes

There are two modes of subchannel operation. A subchannel enters transport mode when the FCX facility is installed and the start function is set at the subchannel as the result of the execution of a START SUBCHANNEL instruction that specifies a TCW channel program. The subchannel remains in transport mode until the start function is reset at the subchannel. At all other times, the subchannel is in command mode.

Path Management

If ORB specifies a CCW channel program and the first CCW passes certain validity tests and does not have the suspend flag specified as one or if the ORB specifies a TCW channel program and the designated TCW passes certain validity tests, the channel subsystem attempts device selection by choosing a channel path from the group of channel paths that are available for selection. A control unit that recognizes the device identifier connects itself logically to the channel path and responds to its selection.

If the ORB specifies a CCW channel program, the channel subsystem sends the command-code part of the CCW over the channel path, and the device responds with a status byte indicating whether the command can be executed. The control unit may logically disconnect from the channel path at this time, or it may remain connected to initiate data transfer.

If the ORB specifies a TCW channel program, the channel subsystem uses information in the designated TCW to transfer the TCCB to the control unit. The contents of the TCCB are ignored by the channel subsystem and only have meaning to the control unit and I/O device.

If the attempted selection does not occur as a result of either a busy indication or a path-not-operational condition, the channel subsystem attempts to select

the device by an alternate channel path if one is available. When selection has been attempted on all paths available for selection and the busy condition persists, the operation remains pending until a path becomes free. If a path-not-operational condition is detected on one or more of the channel paths on which device selection was attempted, the program is alerted by a subsequent I/O interruption. The I/O interruption occurs either upon execution of the channel program (assuming the device was selected on an alternate channel path) or as a result of the execution being abandoned because path-not-operational conditions were detected on all of the channel paths on which device selection was attempted.

Channel-Program Execution

If the command is initiated at the device and command execution does not require any data to be transferred to or from the device, the device may signal the end of the operation immediately on receipt of the command code. In operations that involve the transfer of data, the subchannel is set up so that the channel subsystem will respond to service requests from the device and assume further control of the operation.

An I/O operation may involve the transfer of data to or from one storage area, designated by a single CCW or TCW or to or from a number of noncontiguous storage areas. In the latter case, generally a list of CCWs is used for the execution of the I/O operation, with each CCW designating a contiguous storage area and the CCWs are coupled by data chaining. Data chaining is specified by a flag in the CCW and causes the channel subsystem to fetch another CCW upon the exhaustion or filling of the storage area designated by the current CCW. The storage area designated by a CCW fetched on data chaining pertains to the I/O operation already in progress at the I/O device, and the I/O device is not notified when a new CCW is fetched.

Provision is made in the CCW format for the programmer to specify that, when the CCW is decoded, the channel subsystem request an I/O interruption as soon as possible, thereby notifying a CPU program that chaining has progressed at least as far as that CCW in the channel program.

To complement dynamic address translation in CPUs, CCW indirect data addressing and modified CCW indirect data addressing are provided.

When the ORB specifies a CCW channel program and CCW-indirect-data addressing is used, a flag in the CCW specifies that an indirect-data-address list is to be used to designate the storage areas for that CCW. Each time the boundary of a block of storage is reached, the list is referenced to determine the next block of storage to be used. The ORB specifies whether the size of each block of storage is 2K bytes or 4K bytes.

When the ORB specifies a CCW channel program and modified-CCW-indirect-data addressing is used, a flag in the ORB and a flag in the CCW specify that a modified-indirect-data-address list is to be used to designate the storage areas for that CCW. Each time the count of bytes specified for a block of storage is reached, the list is referenced to determine the next block of storage to be used. Unlike when indirect data addressing is used, the block may be specified on any boundary and length up to 4K, provided a data transfer across a 4 K-byte boundary is not specified.

When the ORB specifies a TCW channel program and transport-indirect-data addressing is used, flags in the TCW specify whether a transport-indirect-data-address list is to be used to designate the storage areas containing the TCCB and whether a transport-indirect-data-address list is used to designate the data storage areas associated with the DCWs in the TCCB. Each time the count of bytes specified for a block of storage is reached, the corresponding transport-indirect-data-address list is referenced to determine the next storage block to be used.

CCW indirect data addressing and modified CCW indirect data addressing permit essentially the same CCW sequences to be used for a program running with dynamic address translation active in the CPU as would be used if the CPU were operating with equivalent contiguous real storage. CCW indirect data addressing permits the program to designate data blocks having absolute storage addresses up to $2^{64}-1$ independent of whether format-0 or format-1 CCWs have been specified in the ORB. Modified CCW indirect data addressing permits the program to designate data blocks having absolute storage addresses up to $2^{64}-1$, independent of whether format-0 or format-1 CCWs have been specified in the ORB.

In general, the execution of an I/O operation or chain of operations involves as many as three levels of participation:

1. Except for effects due to the integration of CPU and channel-subsystem equipment, a CPU is busy for the duration of the execution of START SUBCHANNEL, which lasts until the addressed subchannel has been passed the ORB contents.
2. The subchannel is busy for a new START SUBCHANNEL from the receipt of the ORB contents until the primary interruption condition is cleared at the subchannel.
3. The I/O device is busy from the initiation of the first operation at the device until either the subchannel becomes suspended or the secondary interruption condition is placed at the subchannel. In the case of a suspended subchannel, the device again becomes busy when the execution of the suspended channel program is resumed.

Conclusion of I/O Operations

The conclusion of an I/O operation normally is indicated by two status conditions: channel end and device end. The channel-end condition indicates that the I/O device has received or provided all data associated with the operation and no longer needs channel-subsystem facilities. This condition is called the primary interruption condition, and the channel end in this case is the primary status. Generally, the primary interruption condition is any interruption condition that relates to an I/O operation and that signals the conclusion at the subchannel of the I/O operation or chain of I/O operations.

The device-end signal indicates that the I/O device has concluded execution and is ready to perform another operation. This condition is called the secondary interruption condition, and the device end in this case is the secondary status. Generally, the secondary interruption condition is any interruption condition that relates to an I/O operation and that signals the conclusion at the device of the I/O operation or chain of operations. The secondary interruption condition can occur concurrently with, or later than, the primary interruption condition.

Concurrent with the primary or secondary interruption conditions, both the channel subsystem and the I/O device can provide indications of unusual situations.

The conditions signaling the conclusion of an I/O operation can be brought to the attention of the program by I/O interruptions or, when the CPUs are dis-

abled for I/O interruptions, by programmed interrogation of the channel subsystem. In the former case, these conditions cause storing of the I/O-interruption code, which contains information concerning the interrupting source. In the latter case, the interruption code is stored as a result of the execution of TEST PENDING INTERRUPTION.

When the primary interruption condition is recognized, the channel subsystem attempts to notify the program, by means of an interruption request, that a subchannel contains information describing the conclusion of an I/O operation at the subchannel. For command-mode interruptions, the information identifies the last CCW used and may provide its residual byte count, thus describing the extent of main storage used. For transport-mode interruptions, the information identifies the current TCW and the TSB associated with the channel program that contains additional status about the I/O operation, such as residual byte count. In addition to information about the channel program, both the channel subsystem and the I/O device may provide additional indications of unusual conditions as part of either the primary or the secondary interruption condition. The information contained at the subchannel may be stored by the execution of TEST SUBCHANNEL or the execution of STORE SUBCHANNEL. This information, when stored, is called a subchannel-status word (SCSW).

Chaining When Using a CCW Channel Program

When the ORB specifies a CCW channel program, facilities are provided for the program to initiate the execution of a chain of I/O operations with a single START SUBCHANNEL instruction. When the current CCW specifies command chaining and no unusual conditions have been detected during the operation, the receipt of the device-end signal causes the channel subsystem to fetch a new CCW. If the CCW passes certain validity tests and the suspend flag is not specified as a one in the new CCW, execution of a new command is initiated at the device. If the CCW fails to pass the validity tests, the new command is not initiated, command chaining is suppressed, and the status associated with the new CCW causes an interruption condition to be generated. If the suspend flag is specified as a one and this value is valid because of a one value in the suspend control, bit 4 of word 1 of the associated ORB, execution of the new command is not initiated, and command chaining is concluded.

Execution of the new command is initiated by the channel subsystem in the same way as in the previous operation. The ending signals occurring at the conclusion of an operation caused by a CCW specifying command chaining are not made available to the program. When another I/O operation is initiated by command chaining, the channel subsystem continues execution of the channel program. If, however, an unusual condition has been detected, command chaining is suppressed, the channel program is terminated, an interruption condition is generated, and the ending signals causing the termination are made available to the program.

The suspend-and-resume function provides the program with control over the execution of a channel program. The initiation of the suspend function is controlled by the setting of the suspend-control bit in the ORB. The suspend function is signaled to the channel subsystem during channel-program execution when the suspend-control bit in the ORB is one and the suspend flag in the first CCW or in a CCW fetched during command chaining is one.

Suspension occurs when the channel subsystem fetches a CCW with the suspend flag validly (because of a one value of the suspend-control bit in the ORB) specified as one. The command in this CCW is not sent to the I/O device, and the device is signaled that the chain of commands is concluded. A subsequent RESUME SUBCHANNEL instruction informs the channel subsystem that the CCW that caused suspension may have been modified and that the channel subsystem must refetch the CCW and examine the current setting of the suspend flag. If the suspend flag is found to be zero in the CCW, the channel subsystem resumes execution of the chain of commands with the I/O device.

Chaining When Using a TCW Channel Program

When the ORB specifies a TCW channel program, facilities are also provided for the program to initiate the execution of a chain of device operations with a single START SUBCHANNEL instruction. Command chaining may be specified for those DCWs designated by a single TCW. When the current DCW specifies command chaining and no unusual conditions have been detected during the operation, recognition of the successful execution of the DCW causes the next DCW in the current TCCB to be processed.

If the next DCW passes certain validity tests, execution of a new command is initiated at the device and the DCW becomes the current DCW. If the DCW fails to pass the validity tests, the new command is not initiated, command chaining is suppressed, the channel program is terminated, and the status associated with the new DCW causes an interruption condition to be generated.

Execution of the new command is initiated in the same way as in the previous operation. The ending signals occurring at the conclusion of an operation caused by a DCW that is not the last specified DCW are not made available to the program. When another I/O operation is initiated by command chaining, execution of the channel program continues. If, however, an unusual condition has been detected, command chaining is suppressed, the channel program is terminated, an interruption condition is generated, and status is made available to the program that identifies the unusual condition.

Premature Conclusion of I/O Operations

Channel-program execution may be terminated prematurely by CANCEL SUBCHANNEL, HALT SUBCHANNEL or CLEAR SUBCHANNEL. The execution of CANCEL SUBCHANNEL causes the channel subsystem to terminate the start function at the subchannel if the channel program has not been initiated at the device. When the start function is terminated by the execution of CANCEL SUBCHANNEL, the channel subsystem sets condition code 0 in response to the CANCEL SUBCHANNEL instruction. The execution of HALT SUBCHANNEL causes the channel subsystem to issue the halt signal to the I/O device and terminate channel-program execution at the subchannel. When channel-program execution is terminated by the execution of HALT SUBCHANNEL, the program is notified of the termination by means of an I/O-interruption request. When the subchannel is in command mode, the interruption request is generated when the device presents status for the terminated operation. When the subchannel is in transport mode, the interruption request is generated immediately. If, however, the halt signal was issued to the device during command chaining after the receipt of device end but before the next command was transferred to the device, the interruption request is generated after the device has been signaled. In the latter case, the device-status field of the SCSW will contain zeros. The execution of CLEAR SUBCHANNEL clears the subchannel of indications of the channel program in execution, causes the channel subsystem

to issue the clear signal to the I/O device, and causes the channel subsystem to generate an I/O-interruption request to notify the program of the completion of the clear function.

I/O Interruptions

Conditions causing I/O-interruption requests are asynchronous to activity in CPUs, and more than one condition can occur at the same time. For I/O interruptions associated with subchannels, the conditions are preserved at the subchannels until cleared by TEST SUBCHANNEL or CLEAR SUBCHANNEL, or reset by an I/O-system reset.

When an I/O-interruption condition has been recognized by the channel subsystem and indicated at the subchannel, an I/O-interruption request is made pending for the I/O-interruption subclass specified at the subchannel. The I/O-interruption subclass for which the interruption is made pending is under programmed control through the use of MODIFY SUBCHANNEL. A pending I/O interruption may be accepted by any CPU that is enabled for interruptions from its I/O-interruption subclass. Each CPU has eight mask bits, in control register 6, that control the enablement of that CPU for each of the eight I/O-interruption subclasses, with the I/O mask, bit 6 in the PSW, being the master I/O-interruption mask for the CPU.

When an I/O interruption occurs at a CPU, the I/O-interruption code is stored in real locations 184-195, and the I/O-interruption request is cleared. For I/O interruptions associated with subchannels, the I/O-interruption code identifies the subchannel for which the interruption was pending. The conditions causing the generation of the interruption request associated with the subchannel may then be retrieved from the subchannel explicitly by TEST SUBCHANNEL or by STORE SUBCHANNEL.

A pending I/O-interruption request may also be cleared by TEST PENDING INTERRUPTION when the corresponding I/O-interruption subclass is enabled but the PSW has I/O interruptions disabled. For I/O interruptions associated with subchannels, a pending I/O interruption may also be cleared by TEST SUBCHANNEL when the CPU is disabled for I/O interruptions from the corresponding I/O-interruption subclass. A pending I/O-interruption request associated with a subchannel may also be cleared by CLEAR SUBCHANNEL. Both CLEAR SUBCHAN-

NEL and TEST SUBCHANNEL clear the preserved interruption condition at the subchannel as well.

TEST SUBCHANNEL to obtain subchannel information concerning the execution of the operation.

Normally, unless the interruption request is cleared by CLEAR SUBCHANNEL, the program issues

Chapter 14. I/O Instructions

I/O-Instruction Formats	14-2	RESET CHANNEL PATH	14-10
I/O-Instruction Execution	14-2	RESUME SUBCHANNEL	14-11
Serialization	14-2	SET ADDRESS LIMIT	14-13
Operand Access	14-3	SET CHANNEL MONITOR	14-13
Condition Code	14-3	START SUBCHANNEL	14-16
Program Exceptions	14-3	STORE CHANNEL PATH STATUS	14-17
Instructions	14-3	STORE CHANNEL REPORT WORD	14-18
CANCEL SUBCHANNEL	14-4	STORE SUBCHANNEL	14-19
CLEAR SUBCHANNEL	14-6	TEST PENDING INTERRUPTION	14-20
HALT SUBCHANNEL	14-7	I/O-Interrupt Code	14-20
MODIFY SUBCHANNEL	14-8	TEST SUBCHANNEL	14-21

All the I/O instructions described here are provided for the control of channel-subsystem operations. The I/O instructions are listed in Figure 14-1 on page 14-3. All of the I/O instructions are privileged instructions.

Several I/O instructions result in the channel subsystem being signaled to perform functions asynchronous to the execution of the instructions. The description of each instruction of this type contains a section, “Associated Functions,” that summarizes the asynchronous functions.

and. For these I/O instructions, general register 1 contains the subsystem-identification word (SID).

When the multiple-subchannel set (MSS) facility is installed, the format of the subsystem-identification word is as follows:

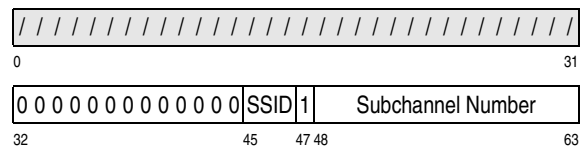

Bit positions 0-31 are ignored. Bit positions 32-44 must contain zeros and bit 47 must contain 1. (Exception conditions are listed later in the section.)

Bit positions 45-46 of general register 1 contain the subchannel-set identifier (SSID) uniquely identifying a subchannel set (SS). When the multiple-subchannel-set facility is not installed, the SSID must be equal to zero. Bit positions 48-63 of general register 1 contain the binary number of the subchannel within the specified subchannel set to be used for the function specified by the instruction.

(See “Multiple-Subchannel-Set Facility” on page 17-33 for more information on SSID.)

The format of the subsystem-identification word when the MSS facility is not installed is as follows:

I/O-Instruction Formats

I/O instructions use the S format:

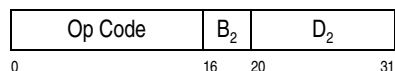

The use of the second-operand address and general registers 1 and 2 (as implied operands) depends on the I/O instruction. Figure 14-1 on page 14-3 defines which operands are used to execute each I/O instruction. In addition, detailed information regarding operand usage appears in the description of each I/O instruction.

All I/O instructions that reference a subchannel use the contents of general register 1 as an implied oper-

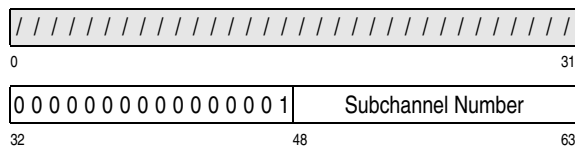

Bit positions 48-63 of general register 1 contain the binary number of the subchannel to be used for the function specified by the instruction. Bit positions 0-31 of general register 1 are ignored and bits 32-47 specify the binary number one.

I/O-Instruction Execution

Serialization

The execution of any I/O instruction causes a serialization and checkpoint synchronization function to occur. For a definition of the serialization of CPU operations, see “CPU Serialization” on page 5-130 and “Channel-Program Serialization” on page 5-133.

Operand Access

During the execution of an I/O instruction, the order in which fields of the operand and fields of the subchannel, if applicable, are accessed is unpredictable. It is also unpredictable whether fetch accesses are made to fields of an operand or the subchannel, as applicable, when those fields are not needed to complete the execution of the I/O instruction. (See “Relation between Operand Accesses” on page 5-129.)

Condition Code

During the execution of some I/O instructions, the results of certain tests are used to set one of four condition codes in the PSW. The I/O instructions for which execution can result in the setting of the condition code are listed in Figure 14-1 on page 14-3. The condition code indicates the result of the execution of the I/O instruction. The general meaning of the condition code for I/O instructions is given below; the meaning of the condition code for a specific instruction appears in the description of that instruction.

Condition Code 0: Instruction execution produced the expected or most probable result. (See “Deferred

Condition Code (CC)” on page 16-9 for a description of conditions that can be encountered subsequent to the presentation of condition code 0 that result in a nonzero deferred condition code.)

Condition Code 1: Instruction execution produced the alternate or second-most-probable result, or status conditions were present that may or may not have prevented the expected result.

Condition Code 2: Instruction execution was ineffective because the designated subchannel or channel-subsystem facility was busy with a previously initiated function.

Condition Code 3: Instruction execution was ineffective because the designated element was not operational or because some condition precluded initiation of the normal function.

In situations where conditions exist that could cause more than one nonzero condition code to be set, the priority of the condition codes is as follows:

Condition code 3 has precedence over condition codes 1 and 2.

Condition code 1 has precedence over condition code 2.

Program Exceptions

The program exceptions that the I/O instructions can encounter are access, operand, privileged-operation, and specification exceptions. Figure 14-1 on page 14-3 shows the exceptions that are applicable to each of the I/O instructions. The execution of the instruction is suppressed for privileged-operation, operand, and specification exceptions. Except as indicated otherwise in the section “Special Conditions” for each instruction, the instruction ending for access exceptions is as described in “Recognition of Access Exceptions” on page 6-47).

Instructions

The mnemonics, format, and operation codes of the I/O instructions are given in Figure 14-1 on page 14-3. The figure also indicates the conditions that can cause a program interruption and whether the condition code is set.

In the detailed descriptions of the individual instructions, the mnemonic and the symbolic operand designation for the assembler language are shown with each instruction. For START SUBCHANNEL, for

example, SSCH is the mnemonic and $D_2(B_2)$ the operand designation.

Name	Mnemonic	Characteristics						Op-code	Page		
CANCEL SUBCHANNEL	XSCH	S	C	P	OP	¢	GS	B276	14-3		
CLEAR SUBCHANNEL	CSCH	S	C	P	OP	¢	GS	B230	14-5		
HALT SUBCHANNEL	HSCH	S	C	P	OP	¢	GS	B231	14-6		
MODIFY SUBCHANNEL	MSCH	S	C	P A SP	OP	¢	GS	B ₂	B232	14-7	
RESET CHANNEL PATH	RCHP	S	C	P				B23B	14-9		
RESUME SUBCHANNEL	RSCH	S	C	P	OP	¢	GS		B238	14-10	
SET ADDRESS LIMIT	SAL	S		P	OP	¢	G1		B237	14-12	
SET CHANNEL MONITOR	SCHM	S		P	OP	¢	GM		B23C	14-13	
START SUBCHANNEL	SSCH	S	C	P A SP	OP	¢	GS	B ₂	B233	14-15	
STORE CHANNEL PATH STATUS	STCPS	S		P A SP				ST	B ₂	B23A	14-16
STORE CHANNEL REPORT WORD	STCRW	S	C	P A SP				ST	B ₂	B239	14-17
STORE SUBCHANNEL	STSCH	S	C	P A SP	OP	¢	GS	ST	B ₂	B234	14-18
TEST PENDING INTERRUPTION	TPI	S	C	P A ¹ SP				ST	B ₂	B236	14-19
TEST SUBCHANNEL	TSCH	S	C	P A SP	OP	¢	GS	ST	B ₂	B235	14-21

Explanation:

* PER zero-address-detection not recognized
 ¢ Causes a serialization and checkpoint synchronization function.
 A Access exceptions for logical addresses.
 A¹ When the effective address is zero, it is not used to access storage, and no access exceptions can occur, except that access exceptions may occur during access-register translation.
 B₂ B₂ field designates an access register in the access-register mode.
 C Condition code is set.
 G1 Instruction execution includes implied use of general register 1 as a parameter.
 GM Instruction execution includes the implied use of multiple general registers:
 • General registers 0 and 1 for SET CHANNEL MONITOR.
 GS Instruction execution includes the implied use of general register 1 as the subsystem-identification word.
 OP Operand exception.
 P Privileged-operation exception; also, restricted from transactional execution.
 S S instruction format.
 SP Specification exception.
 ST PER storage-alteration event.

Figure 14-1. Summary of I/O Instructions

CANCEL SUBCHANNEL

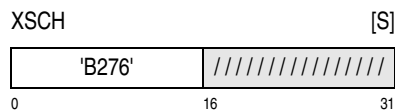

The current start function, if any, is terminated at the designated subchannel if CANCEL SUBCHANNEL is applicable.

General register 1 contains a subsystem-identification word that designates the subchannel for which the current START FUNCTION, if any, is to be terminated.

If the subchannel (1) is not subchannel active, (2) is start pending, resume pending, or suspended, and (3) is performing only the start function, then the start function at the subchannel is terminated, and the subchannel is made no longer start pending, resume pending, or suspended, as appropriate. In addition, internal indications of busy are reset for the subchannel.

Condition code 0 is set to indicate that the actions described above have been taken.

If an invalid ORB field or a no-path-available condition is present for a previously initiated start function and the condition was not reported during the execu-

tion of START SUBCHANNEL, condition code 0 may be indicated for CANCEL SUBCHANNEL provided that the subchannel is not yet status pending to report the error condition; if condition code 0 is presented, no subsequent status is generated to indicate the error condition.

During the execution of CANCEL SUBCHANNEL for a transport-mode operation, the channel subsystem may be signaled to asynchronously perform the interrogate function.

Special Conditions

Condition code 1 is set, and no other action is taken, when the subchannel is status pending with any status.

Condition code 2 is set, and no other action is taken, when CANCEL SUBCHANNEL is not applicable and the subchannel is not status pending, or when conditions exist that prevent immediate determination of internal conditions for the subchannel and the CPU has determined to end the instruction. CANCEL SUBCHANNEL is not applicable when the subchannel (1) has no function specified, (2) has a function other than the start function alone specified, (3) is not resume pending, is not start pending, and is not suspended, or (4) is subchannel active.

When the subchannel is operating in transport mode and condition code 2 is set, the CPU may signal the channel subsystem to asynchronously perform the interrogate function, and end the instruction.

Condition code 3 is set, and no other action is taken, when the subchannel is not operational for CANCEL SUBCHANNEL. A subchannel is not operational for CANCEL SUBCHANNEL when the subchannel is not provided by the channel subsystem, has no valid device number assigned to it, or is not enabled.

CANCEL SUBCHANNEL can encounter the program exceptions described or listed below.

When the multiple-subchannel-set facility is not installed, bits 32-47 of general register 1 must contain 0001 hex; otherwise, an operand exception is recognized.

When the multiple-subchannel-set facility is installed, bits 32-44 of general register 1 must contain zeros, bits 45-46 must contain a valid value, and bit 47 must

contain the value one; otherwise, an operand exception is recognized.

Resulting Condition Code:

- 0 Start function canceled
- 1 Status pending
- 2 CANCEL SUBCHANNEL not applicable
- 3 Not operational

Program Exceptions:

- Operand
- Privileged operation
- Transaction constraint

Programming Notes:

1. The actions taken by CANCEL SUBCHANNEL are completed during the execution of the instruction.

If condition code 0 is presented, there is no subsequent I/O interruption resulting from the terminated I/O operation. However, the device may have signaled a busy condition while the canceled operation was start pending. In this case, the device owes a no-longer-busy signal to the channel subsystem. This may result in unsolicited device-end status before the next operation is initiated at the device.

Condition code 2 may be presented to indicate that the CPU has determined to end the instruction because the internal conditions of the specified subchannel cannot be immediately determined. Subsequent execution of STORE SUBCHANNEL may store an SCSW indicating that CANCEL SUBCHANNEL is applicable (i.e., the subchannel is performing the start function alone, is start pending, resume pending, or suspended, and is not subchannel-active). In such a case, the program can either recognize that the I/O operation has not been terminated and allow the operation to start or the program can retry CANCEL SUBCHANNEL in an attempt to terminate the start function. However, retrying CANCEL SUBCHANNEL does not guarantee that the instruction will end with condition code 0.

In transport mode, condition code 2 may be presented to indicate that the CPU has determined to asynchronously signal the channel subsystem to perform the interrogate function, and end the

instruction. The LPUM must contain a nonzero value for the interrogate to be initiated.

2. Upon the completion of CANCEL SUBCHANNEL with condition code 0, the subchannel is ready to accept a new start function initiated by START SUBCHANNEL.

CLEAR SUBCHANNEL



The designated subchannel is cleared, the current start or halt function, if any, is terminated at the designated subchannel, and the channel subsystem is signaled to asynchronously perform the clear function at the designated subchannel and at the associated device.

General register 1 contains a subsystem-identification word (SID) that designates the subchannel to be cleared.

If a start or halt function is in progress, it is terminated at the subchannel.

The subchannel is made no longer status pending. All activity, as indicated in the activity-control field of the SCSW, is cleared at the subchannel, except that the subchannel is made clear pending. Any functions in progress, as indicated in the function-control field of the SCSW, are cleared at the subchannel, except for the clear function that is to be performed because of the execution of this instruction.

The channel subsystem is signaled to asynchronously perform the clear function. The clear function is summarized below in the section “Associated Functions” and is described in detail in “Clear Function” on page 15-14.

Condition code 0 is set to indicate that the actions described above have been taken.

Associated Functions

Subsequent to the execution of CLEAR SUBCHANNEL, the channel subsystem asynchronously per-

forms the clear function. If conditions allow, the channel subsystem chooses a channel path and attempts to issue the clear signal to the device to terminate the I/O operation, if any. The subchannel then becomes status pending. Conditions encountered by the channel subsystem that preclude issuing the clear signal to the device do not prevent the subchannel from becoming status pending (see “Clear Function” on page 15-14).

When the subchannel becomes status pending as a result of performing the clear function, data transfer, if any, with the associated device has been terminated. The SCSW stored when the resulting status is cleared by TEST SUBCHANNEL has the clear-function bit stored as one. If the channel subsystem can determine that the clear signal was issued to the device, the clear-pending bit is stored as zero in the SCSW. Otherwise, the clear-pending bit is stored as one, and other indications are provided that describe in greater detail the condition that was encountered. (See “Interruption-Response Block” on page 16-6.)

Measurement data is not accumulated, and device-connect time is not stored in the extended-status word for the subchannel, for a start function that is terminated by CLEAR SUBCHANNEL.

Special Conditions

Condition code 3 is set, and no other action is taken, when the subchannel is not operational for CLEAR SUBCHANNEL. A subchannel is not operational for CLEAR SUBCHANNEL when the subchannel is not provided in the channel subsystem, has no valid device number assigned to it, or is not enabled.

CLEAR SUBCHANNEL can encounter the program exceptions described or listed below.

When the multiple-subchannel-set facility is not installed, bits 32-47 of general register 1 must contain 0001 hex; otherwise, an operand exception is recognized.

When the multiple-subchannel-set facility is installed, bits 32-44 of general register 1 must contain zeros, bits 45-46 must contain a valid value, and bit 47 must contain the value one; otherwise, an operand exception is recognized.

Resulting Condition Code:

- 0 Function initiated
- 1 —
- 2 —
- 3 Not operational

Program Exceptions:

- Operand
- Privileged operation
- Transaction constraint

HALT SUBCHANNEL

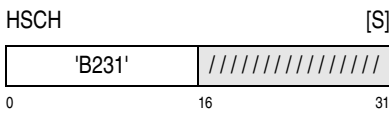

The current start function, if any, is terminated at the designated subchannel, and the channel subsystem is signaled to asynchronously perform the halt function at the designated subchannel and at the associated device.

General register 1 contains a subsystem-identification word that designates the subchannel to be halted.

If a start function is in progress, it is terminated at the subchannel.

The subchannel is made halt pending, and the halt function is indicated at the subchannel.

When HALT SUBCHANNEL is executed and the designated subchannel is subchannel-and-device active and status pending with intermediate status, the status-pending indication is eliminated (see the discussion of bits 24, 25, and 28 in “Activity Control (AC)” on page 16-14). The status-pending condition is reestablished as part of the halt function (see the section “Associated Functions” below).

The channel subsystem is signaled to asynchronously perform the halt function. The halt function is summarized below in the section “Associated Functions” and is described in detail in “Halt Function” on page 15-16.

Condition code 0 is set to indicate that the actions described above have been taken.

Associated Functions

Subsequent to the execution of HALT SUBCHANNEL, the channel subsystem asynchronously performs the halt function. If conditions allow, the channel subsystem chooses a channel path and attempts to issue the halt signal to the device to terminate the I/O operation, if any. The subchannel then becomes status pending.

When the subchannel becomes status pending as a result of performing the halt function, data transfer, if any, with the associated device has been terminated. The SCSW stored when the resulting status is cleared by TEST SUBCHANNEL has the halt-function bit stored as one. If the halt signal was issued to the device, the halt-pending bit is stored as zero. Otherwise, the halt-pending bit is stored as one, and other indications are provided that describe in greater detail the condition that was encountered. (See “Interruption-Response Block” on page 16-6. and “Halt Function” on page 15-16.)

On some models, path availability is tested as part of the halt function instead of as part of the execution of the instruction. In these models, when no channel path is available for selection, the halt signal is not issued, and the subchannel is made status pending. When the status-pending condition is subsequently cleared by TEST SUBCHANNEL, the halt-pending bit is stored as one in the SCSW.

If a status-pending condition is eliminated during the execution of HALT SUBCHANNEL, then this condition is reestablished along with the other status conditions when the completion of the halt function is indicated to the program.

The halt-pending condition may not be recognized by the channel subsystem if a status-pending condition has been generated. This situation could occur, for example, when alert status is presented or generated while the subchannel is already start pending or resume pending, or when primary status is presented during the attempt to initiate the I/O operation for the first command as specified by the start function or implied by the resume function. If recognition of the status-pending condition by the channel subsystem has occurred logically prior to recognition of the halt-pending condition, the SCSW, when cleared by TEST SUBCHANNEL, has the halt-pending bit stored as one.

If measurement data is being accumulated when a start function is terminated by HALT SUBCHANNEL, the measurement data continues to be accumulated for the subchannel and reflects the extent of subchannel and device usage required, if any, while performing the currently terminated start function. The measurement data, if any, is accumulated in the measurement block for the subchannel or placed in the extended-status word, as appropriate, when the subchannel becomes status-pending with primary or secondary status. (See “Channel-Subsystem Monitoring” on page 17-1.)

Special Conditions

Condition code 1 is set, and no other action is taken, when the subchannel is status pending alone or is status pending with any combination of alert, primary, or secondary status.

Condition code 2 is set, and no other action is taken, when the subchannel is busy for HALT SUBCHANNEL. The subchannel is busy for HALT SUBCHANNEL when a halt function or clear function is already in progress at the subchannel.

Condition code 3 is set, and no other action is taken, when the subchannel is not operational for HALT SUBCHANNEL. A subchannel is not operational for HALT SUBCHANNEL when the subchannel is not provided in the channel subsystem, has no valid device number assigned to it, or is not enabled. On some models, a subchannel is also not operational for HALT SUBCHANNEL when no channel path is available for selection by the device. (See “Channel-Path Availability” on page 15-13 for a description of channel paths that are available for selection.)

HALT SUBCHANNEL can encounter the program exceptions described or listed below.

When the multiple-subchannel-set facility is not installed, bits 32-47 of general register 1 must contain 0001 hex; otherwise, an operand exception is recognized.

When the multiple-subchannel-set facility is installed, bits 32-44 of general register 1 must contain zeros, bits 45-46 must contain a valid value, and bit 47 must contain the value one; otherwise, an operand exception is recognized.

Resulting Condition Code:

- 0 Function initiated
- 1 Status pending with other than intermediate status
- 2 Busy
- 3 Not operational

Program Exceptions:

- Operand
- Privileged operation
- Transaction constraint

Programming Note: After the execution of HALT SUBCHANNEL, the status-pending condition indicating the completion of the halt function may be delayed for an extended period of time, for example, when the device is a magnetic-tape unit executing a rewind command.

MODIFY SUBCHANNEL

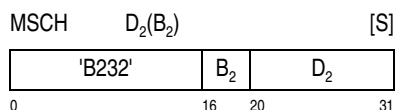

The information contained in the subchannel-information block (SCHIB) is placed in the program-modifiable fields at the subchannel. As a result, the program influences, for that subchannel, certain aspects of I/O processing relative to the clear, halt, resume, and start functions and certain I/O support functions.

General register 1 contains a subsystem-identification word (SID) that designates the subchannel that is to be modified as specified by certain fields of the SCHIB. The second-operand address is the logical address of the SCHIB and must be designated on a word boundary; otherwise, a specification exception is recognized.

The channel-subsystem operations that may be influenced due to placement of SCHIB information in the subchannel are:

- I/O processing (E field)
- Interruption processing (interruption parameter and ISC field)
- Path management (D, LPM, and POM fields)

- Monitoring and address-limit checking (measurement-block index, LM, and MM fields)
- Measurement-block-format control (F field)
- Extended-measurement-word-mode enable (X field)
- Concurrent-sense facility (S field)
- Measurement-block address (MBA)

Bits 0, 1, 6, and 7 of word 1, and bits 0-28 of word 6 of the SCHIB operand must be zeros, and bits 9 and 10 of word 1 must not both be ones. When the extended-I/O-measurement-block facility is installed and a format-1 measurement block is specified, bits 26-31 of word 11 must be specified as zeros. When the extended-I/O-measurement-block facility is not installed, bit 29 of word 6 must be specified as zero; otherwise, an operand exception is recognized. When the extended-I/O-measurement-word facility is not installed, or is installed but not enabled, bit 30 of word 6 must be specified as zero; otherwise, an operand exception is recognized. The remaining fields of the SCHIB are ignored and do not affect the processing of MODIFY SUBCHANNEL. (For further details, see “Subchannel-Information Block” on page 15-2.)

Condition code 0 is set to indicate that the information from the SCHIB has been placed in the program-modifiable fields at the subchannel, except that, when the device-number-valid bit (V) at the designated subchannel is zero, then condition code 0 is set, and the information from the SCHIB is not placed in the program-modifiable fields.

Special Conditions

Condition code 1 is set, and no other action is taken, when the subchannel is status pending. (See “Status Control (SC)” on page 16-17.)

Condition code 2 is set, and no other action is taken, when a clear, halt, or start function is in progress at the subchannel. (See “Function Control (FC)” on page 16-13.)

Condition code 3 is set, and no other action is taken, when the subchannel is not operational for MODIFY SUBCHANNEL. A subchannel is not operational for MODIFY SUBCHANNEL when the subchannel is not provided in the channel subsystem.

MODIFY SUBCHANNEL can encounter the program exceptions described or listed below.

In word 1 of the SCHIB, bits 0, 1, 6, and 7 must be zeros and, when the address-limit-checking facility is installed, bits 9 and 10 must not both be ones. In word 6 of the SCHIB, bits 0-28 must be zeros. Otherwise an operand exception is recognized.

When the extended-I/O-measurement-block facility is installed and a format-1 measurement block is specified, bits 26-31 of word 11 must be specified as zeros; otherwise, an operand exception is recognized. When the extended-I/O-measurement-block facility is not installed, bit 29 of word 6 must be specified as zero; otherwise, an operand exception is recognized. When the extended-I/O-measurement-word facility is not installed, or is installed but not enabled, bit 30 of word 6 must be specified as zero; otherwise, an operand exception is recognized.

When the multiple-subchannel-set facility is not installed, bits 32-47 of general register 1 must contain 0001 hex; otherwise, an operand exception is recognized.

When the multiple-subchannel-set facility is installed, bits 32-44 of general register 1 must contain zeros, bits 45-46 must contain a valid value, and bit 47 must contain the value one; otherwise, an operand exception is recognized.

The second operand must be designated on a word boundary; otherwise, a specification exception is recognized.

The execution of MODIFY SUBCHANNEL is suppressed on all addressing and protection exceptions.

Resulting Condition Code:

- 0 Function completed
- 1 Status pending
- 2 Busy
- 3 Not operational

Program Exceptions:

- Access (fetch, operand 2)
- Operand
- Privileged operation
- Specification
- Transaction constraint

Programming Notes:

1. If a device signals I/O-error alert while the associated subchannel is disabled, the channel subsystem issues the clear signal to the device and discards the I/O-error-alert indication without generating an I/O-interruption condition.
2. If a device presents unsolicited status while the associated subchannel is disabled, that status is discarded by the channel subsystem without generating an I/O-interruption condition. However, if the status presented contains unit check, the channel subsystem issues the clear signal for the associated subchannel and does not generate an I/O-interruption condition. This should be taken into account when the program uses MODIFY SUBCHANNEL to enable a subchannel. For example, the medium on the associated device that was present when the subchannel became disabled may have been replaced, and, therefore, the program should verify the integrity of that medium.
3. It is recommended that the program inspect the contents of the subchannel by subsequently issuing STORE SUBCHANNEL when MODIFY SUBCHANNEL sets condition code 0. Use of STORE SUBCHANNEL is a method for determining if the designated subchannel was changed or not. Failure to inspect the subchannel following the setting of condition code 0 by MODIFY SUBCHANNEL may result in conditions that the program does not expect to occur.

RESET CHANNEL PATH

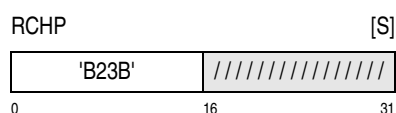

The channel-path-reset facility is signaled to perform the channel-path-reset function on the channel path designated by the contents of general register 1.

The format of general register 1 is as follows:

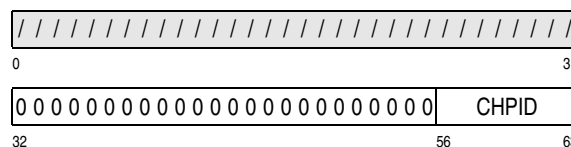

Channel-Path Identifier (CHPID): Bit positions 56-63 of general register 1 contain an unsigned binary integer that designates the channel path on which the channel-path-reset function is to be performed.

Bit positions in general register 1 that are shown as zeros, are reserved and must contain zeros; otherwise, an operand exception is recognized. Bit positions 0-31 of general register 1 are ignored.

If conditions allow, the channel-path-reset facility is signaled to asynchronously perform the channel-path-reset function on the designated channel path. The channel-path-reset function is summarized below in the section “Associated Functions” and is described in detail in “Channel-Path Reset” on page 17-13.

Condition code 0 is set to indicate that the channel-path-reset facility has been signaled.

Associated Functions

Subsequent to the execution of RESET CHANNEL PATH, the channel-path-reset facility asynchronously performs the channel-path-reset function. Certain indications are reset at all subchannels that have access to the designated channel path, and the reset signal is issued on that channel path. Any I/O functions in progress at the devices are reset, but only for the channel path on which the reset signal is received. An I/O operation or chain of I/O operations taking place in the multipath mode may be able to continue to be executed on other channel paths in the multipath group, if any. (See “Channel-Path-Reset Function” on page 15-80.)

The result of performing the channel-path-reset function on the designated channel path is communicated to the program by means of a channel report (see “Channel Report” on page 17-28).

Special Conditions

Condition code 2 is set, and no other action is taken, when, on some models, the channel-path-reset facility is busy performing the channel-path-reset function for a previous execution of the RESET CHANNEL PATH instruction.

Condition code 3 is set, and no other action is taken, when, on some models, the designated channel path is not operational for the execution of RESET CHANNEL PATH. On these models, the channel path is not operational for the execution of RESET CHANNEL PATH when the designated channel path is not physically available.

If the channel-path-reset facility is busy and the designated channel path is not physically available, it depends on the model whether condition code 2 or 3 is set.

RESET CHANNEL PATH can encounter the program exceptions described or listed below.

Bit positions 32-55 of general register 1 must contain zeros; otherwise, an operand exception is recognized. Bit positions 0-31 of general register 1 are ignored.

Resulting Condition Code:

- 0 Function initiated
- 1 —
- 2 Busy
- 3 Not operational

Program Exceptions:

- Operand
- Privileged operation
- Transaction constraint

Programming Notes:

1. To eliminate the possibility of a data-integrity exposure for devices that have the capability of generating unsolicited device-end status, I/O operations in progress with such devices on the channel path for which RESET CHANNEL PATH is to be executed must be terminated by the execution of either HALT SUBCHANNEL or CLEAR SUBCHANNEL. Otherwise, subsequent to receiving the reset signal, the device may present an unsolicited device end that may be inter-

preted by the channel subsystem as a solicited device end and cause command chaining to occur.

2. If the status-verification facility is being used and RESET CHANNEL PATH is executed without first stopping all ongoing operations associated with the channel path being reset, erroneous device-status-check conditions may be detected

RESUME SUBCHANNEL

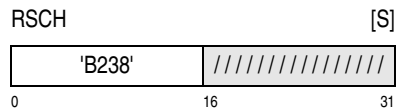

The channel subsystem is signaled to perform the resume function at the designated subchannel.

General register 1 contains a subsystem-identification word that designates the subchannel at which the resume function is to be performed.

The subchannel is made resume pending.

Logically prior to the setting of condition code 0 and only if the subchannel is currently in the suspended state, path-not-operational conditions at the subchannel, if any, are cleared.

The channel subsystem is signaled to asynchronously perform the resume function. The resume function is summarized below in the section “Associated Functions” and is described in detail in “Start Function and Resume Function” on page 15-20

Condition code 0 is set to indicate that the actions described above have been taken.

Associated Functions

Subsequent to the execution of RESUME SUBCHANNEL, the channel subsystem asynchronously performs the resume function. Except when the subchannel is subchannel active, if the execution of RESUME SUBCHANNEL results in the setting of condition code 0, performance of the resume function causes execution of a currently suspended channel program to be resumed with the associated device, provided that the suspend flag for the current CCW has been set to zero by the program. If the suspend flag remains one, execution of the channel pro-

gram remains suspended. But, if the subchannel is subchannel active at the time the execution of RESUME SUBCHANNEL results in the setting of condition code 0, then it is unpredictable whether execution of the current program is resumed or whether it is found by the resume function that the subchannel has become suspended in the interim. The subchannel is found to be suspended by the resume function only if the subchannel is status pending with intermediate status when the resume-pending condition is recognized by the channel subsystem. (See “Start Function and Resume Function” on page 15-20.)

Special Conditions

Condition code 1 is set, and no other action is taken, when the subchannel is status pending.

Condition code 2 is set, and no other action is taken, when the resume function is not applicable. The resume function is not applicable when the subchannel (1) has any function other than the start function alone specified, (2) has no function specified, (3) is resume pending, or (4) does not have suspend control specified for the start function in progress.

Condition code 3 is set, and no other action is taken, when the subchannel is not operational for the resume function. A subchannel is not operational for the resume function if the subchannel is not provided in the channel subsystem, has no valid device number assigned to it, or is not enabled.

RESUME SUBCHANNEL can encounter the program exceptions described or listed below.

When the multiple-subchannel-set facility is not installed, bits 32-47 of general register 1 must contain 0001 hex; otherwise, an operand exception is recognized.

When the multiple-subchannel-set facility is installed, bits 32-44 of general register 1 must contain zeros, bits 45-46 must contain a valid value, and bit 47 must contain the value one; otherwise, an operand exception is recognized.

Resulting Condition Code:

- 0 Function initiated
- 1 Status pending
- 2 Function not applicable
- 3 Not operational

Program Exceptions:

- Operand
- Privileged operation
- Transaction constraint

Programming Notes:

1. When channel-program execution is resumed from the suspended state, the device views the resumption as the beginning of a new chain of commands. When the suspension of channel-program execution occurs and the device requires that certain commands be first or appear only once in a chain of commands (for example, direct-access-storage devices), the program must ensure that the appropriate commands in the proper sequence are fetched by the channel subsystem after channel-program execution is resumed. One way the program can ensure proper sequencing of commands at the device is by allowing the I/O interruption to occur for an intermediate interruption condition due to suspension.

It is not reliable to notify the program that the subchannel is suspended by using the PCI flag in the CCW that contains the S flag because the PCI I/O interruption may occur before the subchannel is suspended. The SCSW would indicate that an I/O operation is in progress at the subchannel and device in this case.

The suspend flag of the target CCW should be set to zero before RESUME SUBCHANNEL is executed; otherwise, it is possible that the resume-pending condition may be recognized and the CCW refetched while the suspend flag is still one, in which case the resume-pending condition would be reset, and the execution of the channel program would be suspended. If the suspend flag of the target CCW is set to zero before the execution of RESUME SUBCHANNEL, the channel program is not suspended, provided that the subchannel is not subchannel active at the time the execution of RESUME SUBCHANNEL results in the setting of condition

code 0. If condition code 0 is set while the subchannel is still subchannel active, it is unpredictable whether the resume-pending condition is recognized by the channel subsystem or whether it is found by the resume function that the subchannel has become suspended in the interim. The subchannel is found to be suspended by the resume function only if the subchannel is status pending with intermediate status at the time the resume-pending condition is recognized. When the subchannel is suspended, the execution of TEST SUBCHANNEL, which clears the intermediate interruption condition, also clears the indication of resume pending.

2. Some models recognize a resume-pending condition only after a CCW having an S flag validly set to one is fetched. Therefore, if a subchannel is resume pending and, during the execution of the channel program, no CCW is fetched having an S flag validly set to one, the subchannel remains resume pending until the primary interruption condition is cleared by TEST SUBCHANNEL.
3. Path availability is not tested during the execution of RESUME SUBCHANNEL. Instead, path availability is tested when the channel subsystem begins performance of the resume function.
4. The contents of the CCW fetched during performance of the resume function may be different from the contents of the same CCW when it was previously fetched and contained an S flag validly set to one.

SET ADDRESS LIMIT

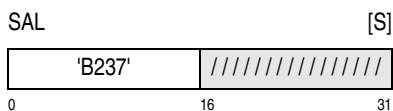

The address-limit-checking facility is signaled to use the specified address as the address-limit value, and the specified address is passed to the facility. Depending on the model, this instruction may not be provided. When this instruction is not provided, it is checked for operand exception and privileged-operation exception, and then is suppressed.

When the address-limit-checking facility is installed, the SET ADDRESS LIMIT instruction is available for use. When the address-limit-checking facility is not

installed, or the FCX facility is installed, the SET ADDRESS LIMIT instruction is not provided.

General register 1 contains the absolute address to be used as the address-limit value. The specified address must be on a 64 K-byte boundary and may designate a maximum absolute storage address of 2,147,418,112 (7FFF0000 hex) regardless of whether the CPU is operating in the 24-bit, 31-bit, or 64-bit addressing mode. Bits 0-31 of general register 1 are ignored, and bit 32 must be zero.

General register 1 has the following format:

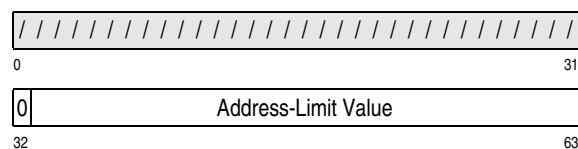

Associated Functions

The value that is used by the address-limit-checking facility when determining whether to permit or prohibit a data access is called the address-limit value. The initial address-limit value is zero. The initial address-limit value is used by the address-limit-checking facility until the facility recognizes a signal, caused by the execution of SET ADDRESS LIMIT, to use a specified address. The recognition of this specified address as the new address-limit value occurs asynchronously with respect to the execution of SET ADDRESS LIMIT.

If address-limit checking is specified for a subchannel, then whether the specified address is used by the address-limit-checking facility, when determining whether to permit or prohibit a data access, depends on whether SET ADDRESS LIMIT was executed before, during, or after the execution of START SUBCHANNEL for that subchannel. If SET ADDRESS LIMIT is executed before START SUBCHANNEL, the specified address is used by the address-limit-checking facility. If SET ADDRESS LIMIT is executed during or after the execution of START SUBCHANNEL, it is unpredictable whether the specified address is used by the address-limit-checking facility for that particular start function. For a description of the manner in which address-limit checking is performed, see "Address-Limit Checking" on page 17-26.

Special Conditions

SET ADDRESS LIMIT can encounter the program exceptions described or listed below.

The address in general register 1 must be designated on a 64K byte boundary, and bit 32 of general register 1 must be zero; otherwise, an operand exception is recognized.

Condition Code: The code remains unchanged.

Program Exceptions:

- Operand
- Privileged operation
- Transaction constraint

SET CHANNEL MONITOR

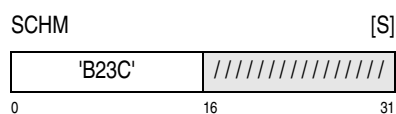

Each of the measurement-block-update mode and device-connect-time-measurement mode of the channel subsystem is made either active or inactive, depending on the values of the measurement-mode-control bits in general register 1. If the measurement-mode-control bit for measurement-block update is one, the measurement-block origin and measurement-block key are passed to the channel subsystem.

General register 1 has the following format:

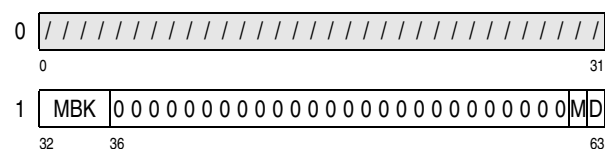

Ignored: Bit positions 0-31 of general register 1 are ignored.

Measurement-Block Key (MBK): Bit positions 32-35 of general register 1 contain the measurement-block key. When bit 62 is one, MBK specifies

the access key that is to be used by the channel subsystem when it accesses the measurement-block area and, when the extended-I/O-measurement-block facility is installed, to access format-1 measurement blocks. Otherwise, MBK is ignored.

Measurement-Block-Update Control (M): Bit 62 of general register 1 is the measurement-mode-control bit that controls the measurement-block-update mode. When bit 62 of general register 1 is one and conditions allow, the measurement-block-update facility is signaled to asynchronously make the measurement-block-update mode active. In addition, the measurement-block-origin (MBO) address in general register 2 and the measurement-block key (MBK) in general register 1 are passed to the measurement-block-update facility.

The measurement-block origin is used to determine the location of format-0 measurement blocks; the address of format-1 measurement blocks is stored at the subchannel using MODIFY SUBCHANNEL. The measurement-block key is used to access both format-0 and format-1 measurement blocks. The asynchronous functions that are performed by the measurement-block-update facility are summarized below in the section “Associated Functions” and are described in detail in “Channel-Subsystem Monitoring” on page 17-1.

When bit 62 of general register 1 is zero and conditions allow, the measurement-block-update mode is made inactive if it is active or remains inactive if it is inactive. The contents of bit positions 32-35 (MBK) of general register 1 and the contents of general register 2 are ignored.

Device-Connect-Time-Measurement Control (D): Bit 63 of general register 1 is the measurement-mode-control bit (D). When bit 63 is one and conditions allow, the device-connect-time-measurement mode is made active if it is inactive or remains active if it is active. When bit 63 is zero and conditions allow, the device-connect-time-measurement mode is made inactive if it is active or remains inactive if it is inactive.

Bit positions 36-61 of general register 1 are reserved and must contain zeros; otherwise, an operand exception is recognized.

General register 2 has the following format:

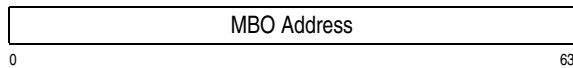

Measurement-Block-Origin (MBO) Address:

When bit 62 (M) of general register 1 is one, bit positions 0-63 of general register 2 contain the absolute address of the measurement-block origin (MBO), which is the beginning of the measurement-block area. The MBO address is used by the channel subsystem to locate format-0 measurement blocks. The origin of the measurement-block area must be designated on a 32-byte boundary otherwise, an operand exception is recognized. When bit 62 of general register 1 is zero, the contents of general register 2 are ignored.

If the channel-subsystem timer that is used by the channel-subsystem-monitoring facilities is in the error state, the state is reset. This happens independent of the setting of the two measurement-mode-control bits. (See “Channel-Subsystem Timing” on page 17-2 for a description of the timing facilities.)

Associated Functions

When the measurement-block-update facility is signaled (by means of SET CHANNEL MONITOR) to make the measurement-block-update mode active, the functions that are performed by the facility depend on whether or not the mode is already active when the signal is generated.

If the measurement-block-update mode is inactive when the signal is generated, the mode remains inactive until the measurement-block-update facility recognizes the signal. When the measurement-block-update facility recognizes the signal, the measurement-block-update mode is made active, and the MBK that was passed when the signal was generated is used to access all measurement blocks, and the MBO that was passed when the signal was generated is used to determine the address of format-0 measurement blocks.

If the measurement-block-update mode is active when the signal is generated, the mode remains active, and the MBK and MBO associated with the execution of a previous SET CHANNEL MONITOR instruction continue to be used to control the storing of measurement data until the measurement-block-update facility recognizes the signal. When the mea-

surement-block-update facility recognizes the signal, the MBK and MBO associated with that signal are used instead of the MBK and MBO associated with the execution of a previous SET CHANNEL MONITOR instruction. The SET CHANNEL MONITOR instruction does not affect the measurement-block address used for format-1 measurement blocks, but the MBK associated with the signal becomes the key used to access the measurement block.

In all above cases, the measurement-block-update facility recognizes the signal during, or subsequent to, the execution of the SET CHANNEL MONITOR instruction that caused the signal to be generated and logically prior to the performance of any start function that is initiated by the subsequent execution of START SUBCHANNEL for a subchannel that is enabled for measurement by this facility. If a subchannel that is enabled for measurement by this facility already has a start function in progress when the signal is generated, it is unpredictable when measurement data for that subchannel is stored by using the MBK and MBO associated with that signal.

While the measurement-block-update mode is active, performance measurements are accumulated for subchannels that are enabled for measurement-block update. Measurements for a subchannel are either accumulated in a single 32-byte format-0 measurement block within the measurement-block area, or a 64-byte format-1 measurement block pointed to by the measurement-block address at the subchannel. A subchannel is enabled for the measurement-block-update mode by setting the measurement-block-update-enable bit to one in the SCHIB and then executing the MODIFY SUBCHANNEL instruction for that subchannel. The measurement-block-format-control bit (F) at the subchannel specifies whether a format-0 or format-1 measurement block is stored for a subchannel when the measurement-block-update mode is active and the subchannel is enabled for measurement-block updates. When the F bit is zero, the MBO and MBI are used to determine the address of the measurement block for the subchannel, and a format-0 measurement block is stored. When the F bit is one, the measurement-block-address field at the subchannel contains the address of the measurement block for the subchannel, and a format-1 measurement block is stored. The F bit and measurement-block-address field are modified using the MODIFY SUBCHANNEL instruction.

When the device-connect-time-measurement mode is active, measurements of the length of time that the

device is actively communicating with the channel subsystem during the execution of a channel program are accumulated for subchannels that are enabled for device-connect-time measurement. Measurements for a subchannel are provided in the extended-status word ESW of the IRB. A subchannel is enabled for device-connect-time-measurement mode by setting the device-connect-time-measurement-enable bit to one in the SCHIB and then executing MODIFY SUBCHANNEL for that subchannel.

For a more detailed description of the measurement-block-update mode, the format and contents of the measurement block, and the device-connect-time-measurement mode, see “Channel-Subsystem Monitoring” on page 17-1.

Special Conditions

SET CHANNEL MONITOR can encounter the program exceptions described or listed below.

Bits 36-61 of general register 1 must be zeros. When bit 62 (M) of general register 1 is one, the MBO address in general register 2 must be designated on a 32-byte boundary. Otherwise, an operand exception is recognized.

Condition Code: The code remains unchanged.

Program Exceptions:

- Operand
- Privileged operation
- Transaction constraint

Programming Note: When the channel subsystem is initialized, the measurement-block-update and device-connect-time-measurement modes are made inactive.

START SUBCHANNEL

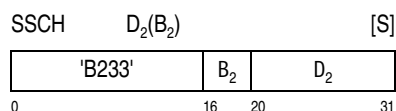

The channel subsystem is signaled to asynchronously perform the start function for the associated device, and the execution parameters that are contained in the designated ORB are placed at the des-

ignated subchannel. (See “Operation-Request Block” on page 15-24.)

General register 1 contains a subsystem-identification word that designates the subchannel to be started. The second-operand address is the logical address of the ORB and must be designated on a word boundary; otherwise, a specification exception is recognized.

The execution parameters contained in the ORB are placed at the subchannel.

When START SUBCHANNEL is executed, the subchannel is status pending with only secondary status, and the extended-status-word-format bit (L) is zero, the status-pending condition is discarded at the subchannel.

The subchannel is made start pending, and the start function is indicated at the subchannel. If the second operand designates a command-mode ORB, the subchannel remains in command mode. If the second operand designates a transport-mode ORB, the subchannel enters transport mode. When the subchannel enters transport mode, the LPUM is set to zero if no previous dedicated allegiance exists; otherwise the LPUM is not changed.

Logically prior to the setting of condition code 0, path-not-operational conditions at the subchannel, if any, are cleared.

The channel subsystem is signaled to asynchronously perform the start function. The start function is summarized below in the section “Associated Functions” and is described in detail in “Start Function and Resume Function” on page 15-20.

Condition code 0 is set to indicate that the actions described above have been taken.

Associated Functions

Subsequent to the execution of START SUBCHANNEL, the channel subsystem asynchronously performs the start function.

The contents of the ORB, other than the fields that must contain all zeros, are checked for validity. On some models, the fields of the ORB that must contain zeros are checked asynchronously, instead of during the execution of the instruction. When invalid fields are detected asynchronously, the subchannel

becomes status pending with primary, secondary, and alert status and with deferred condition code 1 and program check indicated. (See “Program Check” on page 16-25.) In this situation, the I/O operation or chain of I/O operations is not initiated at the device, and the condition is indicated by the start-pending bit being stored as one when the SCSW is cleared by the execution of TEST SUBCHANNEL. (See “Subchannel-Status Word” on page 16-7).

On some models, path availability is tested asynchronously, instead of during the execution of the instruction. When no channel path is available for selection, the subchannel becomes status pending with primary and secondary status and with deferred condition code 3 indicated. The I/O operation or chain of I/O operations is not initiated at the device, and this condition is indicated by the start-pending bit being stored as one when the SCSW is cleared by the execution of TEST SUBCHANNEL.

If conditions allow, a channel path is chosen, and execution of the channel program that is designated in the ORB is initiated. (See “Start Function and Resume Function” on page 15-20.)

Special Conditions

Condition code 1 is set, and no other action is taken, when the subchannel is status pending when START SUBCHANNEL is executed. On some models, condition code 1 is not set when the subchannel is status pending with only secondary status; instead, the status-pending condition is discarded.

Condition code 2 is set, and no other action is taken, when a start, halt, or clear function is currently in progress at the subchannel (see “Function Control (FC)” on page 16-13).

Condition code 3 is set, and no other action is taken, when the subchannel is not operational for START SUBCHANNEL. A subchannel is not operational for START SUBCHANNEL if the subchannel is not provided in the channel subsystem, has no valid device number associated with it, or is not enabled.

A subchannel is also not operational for START SUBCHANNEL, on some models, when no channel path is available for selection. On these models, the lack of an available channel path is detected as part of the START SUBCHANNEL execution. On other models, channel-path availability is only tested as part of the asynchronous start function.

START SUBCHANNEL can encounter the program exceptions described or listed below.

In word 1 of the command-mode ORB, bits 26-30 must be zeros, and, in word 2 of the command-mode ORB, bit 0 must be zero. Otherwise, on some models, an operand exception is recognized. On other models, an I/O-interruption condition is generated, indicating program check, as part of the asynchronous start function.

START SUBCHANNEL can also encounter the program exceptions listed below.

When the multiple-subchannel-set facility is not installed, bits 32-47 of general register 1 must contain 0001 hex; otherwise, an operand exception is recognized.

When the multiple-subchannel-set facility is installed, bits 32-44 of general register 1 must contain zeros, bits 45-46 must contain a valid value, and bit 47 must contain the value one; otherwise, an operand exception is recognized.

The second operand must be designated on a word boundary; otherwise, a specification exception is recognized.

The execution of START SUBCHANNEL is suppressed on all addressing and protection exceptions.

Resulting Condition Code:

- 0 Function initiated
- 1 Status pending
- 2 Busy
- 3 Not operational

Program Exceptions:

- Access (fetch, operand 2)
- Operand
- Privileged operation
- Specification
- Transaction constraint

STORE CHANNEL PATH STATUS

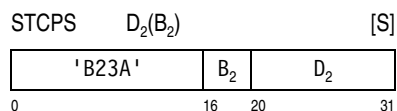

Depending on the model, this instruction may not be provided. When this instruction is not provided, it is checked for privileged operation exception and the instruction is suppressed by the machine

A channel-path-status word of up to 256 bits is stored at the designated location.

The second-operand address is the logical address of the location where the channel-path-status word is to be stored and must be designated on a 32-byte boundary; otherwise, a specification exception is recognized.

The channel-path-status word indicates which channel paths are actively communicating with a device at the time STORE CHANNEL PATH STATUS is executed. Bit positions 0-255 correspond, respectively, to the channel paths having the channel-path identifiers 0-255. Each of the 256 bits at the designated location is set to one, set to zero, or left unchanged, as follows:

- For all channel paths in the configuration that are actively communicating with devices at the time STORE CHANNEL PATH STATUS is executed, the corresponding bits are stored as ones.
- For all channel paths that are (1) provided in the system (PIM bit in the PMCW is one) and (2) in the configuration but not currently being used by the channel subsystem in actively communicating with devices, the corresponding bits are stored as zeros.
- For all channel paths that are not provided in the system (PIM bit in the PMCW is zero), the corresponding bits either are not stored or are stored as zeros.
- For all channel paths in the configuration that are in the channel-path-terminal state or are not physically available (the corresponding PAM bit in the PMCW is zero), the corresponding bits are stored as zeros.

Special Conditions

STORE CHANNEL PATH STATUS can encounter the program exceptions described or listed below.

The second operand must be designated on a 32-byte boundary; otherwise, a specification exception is recognized.

The execution of STORE CHANNEL PATH STATUS is suppressed on all addressing and protection exceptions.

Condition Code: The code remains unchanged.

Program Exceptions:

- Access (store, operand 2)
- Privileged operation
- Specification
- Transaction constraint

Programming Notes:

1. To ensure a consistent interpretation of channel-path-status-word bits, the program should, prior to the initial use of the area, store zeros at the location where the channel-path-status word is to be stored.

STORE CHANNEL REPORT WORD

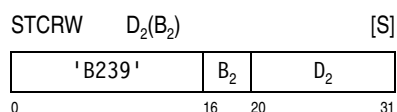

A CRW containing information affecting the channel subsystem is stored at the designated location.

The second-operand address is the logical address of the location where the CRW is to be stored and must be designated on a word boundary; otherwise, a specification exception is recognized.

When a malfunction or other condition affecting channel-subsystem operation is recognized, a channel report (consisting of one or more CRWs) describing the condition is made pending for retrieval and analysis by the program. The channel report contains information concerning the identity and state of a facility following the detection of the malfunction or other condition. For a description of the channel report, the CRW, and program-recovery actions related to the channel subsystem, see "Channel-Subsystem Recovery" on page 17-27.

When one or more channel reports are pending, the instruction causes a CRW to be stored at the designated location and condition code 0 to be set. A pending CRW can only be stored by the execution of STORE CHANNEL REPORT WORD and, once

stored, is no longer pending. Thus, each pending CRW is presented only once to the program.

When no channel reports are pending in the channel subsystem execution of STORE CHANNEL REPORT WORD causes zeros to be stored at the designated location and condition code 1 to be set.

Special Conditions

STORE CHANNEL REPORT WORD can encounter the program exceptions described or listed below.

The second operand must be designated on a word boundary; otherwise, a specification exception is recognized.

The execution of STORE CHANNEL REPORT WORD is suppressed on all addressing and protection exceptions.

Resulting Condition Code:

- | | |
|---|--------------|
| 0 | CRW stored |
| 1 | Zeros stored |
| 2 | — |
| 3 | — |

Program Exceptions:

- Access (store, operand 2)
- Privileged operation
- Specification
- Transaction constraint

Programming Notes:

1. CRW overflow conditions may occur if STORE CHANNEL REPORT WORD is not executed to clear pending channel reports. If the overflow condition is encountered, one or more channel-report words have been lost. (See “Channel-Subsystem Recovery” on page 17-27 for details.)
2. A pending CRW can be cleared by any CPU in the configuration executing STORE CHANNEL REPORT WORD, regardless of whether a machine-check interruption has occurred in any CPU.

STORE SUBCHANNEL

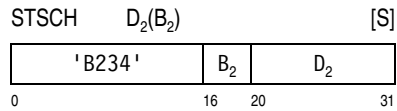

Control and status information for the designated subchannel is stored in the designated SCHIB.

General register 1 contains a subsystem-identification word that designates the subchannel for which the information is to be stored. The second-operand address is the logical address of the SCHIB and must be designated on a word boundary; otherwise, a specification exception is recognized.

When the extended-I/O-measurement-block facility is not installed, the information that is stored in the SCHIB consists of a path-management-control word, a SCSW, and three words of model-dependent information. When the extended-I/O-measurement-block facility is installed, the information that is stored in the SCHIB consists of a path-management-control word, a SCSW, the measurement-block-address field, and one word of model-dependent information. (See “Subchannel-Information Block” on page 15-2.)

The execution of STORE SUBCHANNEL does not change any information at the subchannel.

Condition code 0 is set to indicate that control and status information for the designated subchannel has been stored in the SCHIB. When the execution of STORE SUBCHANNEL results in the setting of condition code 0, the information in the SCHIB indicates a consistent state of the subchannel.

Special Conditions

Condition code 3 is set, and no other action is taken, when the designated subchannel is not operational for STORE SUBCHANNEL. A subchannel is not operational for STORE SUBCHANNEL if the subchannel is not provided in the channel subsystem.

STORE SUBCHANNEL can encounter the program exceptions described or listed below.

When the multiple-subchannel-set facility is not installed, bits 32-47 of general register 1 must contain 0001 hex; otherwise, an operand exception is recognized.

When the multiple-subchannel-set facility is installed, bits 32-44 of general register 1 must contain zeros, bits 45-46 must contain a valid value, and bit 47 must contain the value one; otherwise, an operand exception is recognized.

The second operand must be designated on a word boundary; otherwise, a specification exception is recognized.

Resulting Condition Code:

- 0 SCHIB stored
- 1 —
- 2 —
- 3 Not operational

Program Exceptions:

- Access (store, operand 2)
- Operand
- Privileged operation
- Specification
- Transaction constraint

Programming Notes:

1. Device status that is stored in the SCSW may include device-busy, control-unit-busy, or control-unit-end indications.
2. The information that is stored in the SCHIB is obtained from the subchannel. The STORE SUBCHANNEL instruction does not cause the channel subsystem to interrogate the addressed device.
3. STORE SUBCHANNEL may be executed at any time to sample conditions existing at the subchannel, without causing any pending status conditions to be cleared.
4. Repeated execution of STORE SUBCHANNEL without an intervening delay (for example, to determine when a subchannel changes state) should be avoided because repeated accesses of the subchannel by the CPU may delay or prohibit access of the subchannel by a channel subsystem to update the subchannel.

TEST PENDING INTERRUPTION

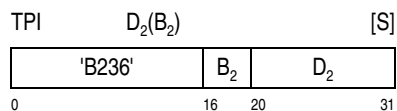

The I/O-interruption code for a pending I/O interruption at a subchannel is stored at the location designated by the second-operand address, and the pending I/O-interruption request is cleared.

The second-operand address, when nonzero, is the logical address of the location where the two-word I/O-interruption code, consisting of words 0 and 1, is to be stored. The second-operand address must be designated on a word boundary; otherwise, a specification exception is recognized.

If the second-operand address is zero, the three-word I/O-interruption code, consisting of words 0-2, is stored at real locations 184-195. In this case, low-address protection and key-controlled protection do not apply.

In the access-register mode when the second-operand address is zero, it is unpredictable whether access-register translation occurs for access register B_2 . If the translation occurs, the resulting address-space-control element is not used; that is, the interruption code still is stored at real locations 184-195.

Pending I/O-interruption requests are accepted only for those I/O-interruption subclasses allowed by the I/O-interruption-subclass mask in control register 6 of the CPU executing the instruction. If no I/O-interruption requests exist that are allowed by control register 6, the I/O-interruption code is not stored, the second-operand location is not modified, and condition code 0 is set.

If a pending I/O-interruption request is accepted, the I/O-interruption code is stored, the pending I/O-interruption request is cleared, and condition code 1 is set. The I/O-interruption code that is stored is the same as would be stored if an I/O interruption had occurred. However, PSWs are not swapped as when an I/O-interruption occurs.

I/O-Interruption Code

The I/O-interruption code that is stored during the execution of the instruction is defined as follows:

Word	
0	Subsystem-Identification Word
1	Interruption Parameter
2	Interruption-Identification Word

0 31

Subsystem-Identification Word (SID):

Bits 32-63 of the SID are placed in word 0.

See “I/O-Instruction Formats” in Chapter 14.

Interruption Parameter: Word 1 contains a four-byte parameter that was specified by the program and passed to the subchannel in word 0 of the ORB or the PMCW. When a device presents alert status and the interruption parameter was not previously passed to the subchannel by an execution of START SUBCHANNEL or MODIFY SUBCHANNEL, this field contains zeros.

Interruption-Identification Word: Word 2, when stored, contains the interruption-identification word, which further identifies the source of the I/O-interruption. Word 2 is stored only when the second-operand address is zero.

The interruption-identification word is defined as follows:

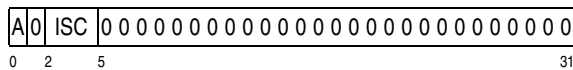

A bit (A) Bit 0 of the interruption-identification word specifies the type of pending I/O-interruption request that was cleared. When bit 0 is zero, the I/O-interruption request was associated with a subchannel.

I/O-Interruption Subclass (ISC): Bit positions 2-4 of the interruption-identification word contain an unsigned binary integer, in the range 0-7, that specifies the I/O-interruption subclass associated with the subchannel for which the pending I/O-interruption request was cleared.

The remaining bit positions are reserved and stored as zeros.

Special Conditions 15-31

TEST PENDING INTERRUPTION can encounter the program exceptions described or listed below.

The second operand must be designated on a word boundary; otherwise, a specification exception is recognized.

The execution of TEST PENDING INTERRUPTION is suppressed on all addressing and protection exceptions.

Resulting Condition Code:

- 0 Interruption code not stored
- 1 Interruption code stored
- 2 —
- 3 —

Program Exceptions:

- Access (store, operand 2, second-operand address nonzero only)
- Privileged operation
- Specification
- Transaction constraint

Programming Notes:

1. TEST PENDING INTERRUPTION should only be executed with a second-operand address of zero when I/O interruptions are masked off. Otherwise, an I/O-interruption code stored by the instruction may be lost if an I/O interruption occurs. The I/O-interruption code that identifies the source of an I/O interruption taken subsequent to TEST PENDING INTERRUPTION is also stored at real locations 184-195, replacing an I/O-interruption code that was stored by the instruction.
2. In the access-register mode when the second-operand address is zero, an access exception is recognized if access-register translation occurs and the access register is in error. This exception can be prevented by making the B₂ field zero or by placing 00000000 hex, 00000001 hex, or any other valid contents in the access register.

TEST SUBCHANNEL

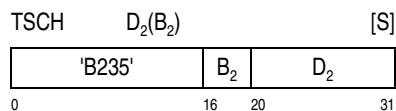

Control and status information for the subchannel is stored in the designated IRB.

General register 1 contains a subsystem-identification word that designates the subchannel for which the information is to be stored. The second-operand address is the logical address of the IRB and must be designated on a word boundary; otherwise, a specification exception is recognized.

The information that is stored in the IRB consists of a SCSW, an extended-status word, and an extended-control word. (See "Interruption-Response Block" on page 16-6.)

If the subchannel is status pending, the status-pending bit of the status-control field is stored as one. Whether or not the subchannel is status pending has an effect on the functions that are performed when TEST SUBCHANNEL is executed.

When the subchannel is status pending and TEST SUBCHANNEL is executed, information, as described above, is stored in the IRB, followed by the clearing of certain conditions and indications that exist at the subchannel as described in Figure 14-2 on page 14-21. If the subchannel is in transport mode, the clearing of these conditions, specifically the start function, places the subchannel in command mode. (See Figure 14-2 on page 14-21. If an I/O-interruption request is pending for the subchannel, the request is cleared. Condition code 0 is set to indicate that these actions have been taken.

When the subchannel is not status pending and TEST SUBCHANNEL is executed, information (as described above) is stored in the IRB, and no conditions or indications are cleared. Condition code 1 is set to indicate that these actions have been taken.

Figure 14-2 on page 14-21 describes which conditions and indications are cleared by TEST SUBCHANNEL when the subchannel is status pending. All other conditions and indications at the subchannel remain unchanged.

Field	Subchannel Conditions*									
	Alert Status Pending		Int Status Pending		Pri Status Pending		Sec. Status Pending		Status Pending Alone	
	CM	TM	CM	TM	CM	TM	CM	TM	CM	TM
Function Control	C	C	Nc	Nm	C	C	C	C	C	C
Activity Control	Cp	Cp	Nr	Nm	Cp	Cp	Cp	Cp	Cp	Cp
Status Control	Cs	Cs	Cs	C	Cs	Cs	Cs	Cs	Cs	Cs
N Condition	C	C	Nr	Nm	C	C	C	C	C	C
Q Condition	-	C	-	C	-	C	-	C	-	C
Explanation:										
-	N/A.									
CM	Command-Mode Operation									
TM	Transport-Mode Operation									
*	Note that the rightmost column applies to status pending when it is alone. The other four status-pending conditions result in the clearing actions given. These actions apply both when a single status-pending condition occurs and when a combination of the four status-pending conditions occurs. In the combination case, all the clearing actions of the individual cases apply.									
C	Cleared.									
Nm	Not reset or modified by TEST SUBCHANNEL.									
Cp	The resume-, start-, halt-, clear pending, and suspended conditions are cleared.									
Cs	The status-pending condition is cleared.									
Nc	Not changed unless function control indicates the halt function and activity control indicates suspended. If both the halt function and suspended are indicated, conditions are cleared as for status pending alone.									
Nr	Not changed unless activity control indicates suspended and function control indicates the start function with or without the halt function. If the halt function is indicated, the conditions are cleared as for status pending alone. If only the start function is indicated, the resume-pending condition and the N condition are cleared.									
Note: The clearing of certain subchannel conditions, places the subchannel in command mode. A subchannel in the idle state, or with the function control bits zero is considered to be in command-mode.										

Figure 14-2. Conditions and Indications Cleared at the Subchannel by TEST SUBCHANNEL

Special Conditions

Condition code 3 is set, and no other action is taken, when the subchannel is not operational for TEST SUBCHANNEL. A subchannel is not operational for TEST SUBCHANNEL if the subchannel is not provided, has no valid device number associated with it, or is not enabled.

TEST SUBCHANNEL can encounter the program exceptions described or listed below.

When the multiple-subchannel-set facility is not installed, bits 32-47 of general register 1 must contain 0001 hex; otherwise, an operand exception is recognized.

When the multiple-subchannel-set facility is installed, bits 32-44 of general register 1 must contain zeros, bits 45-46 must contain a valid value, and bit 47 must contain the value one; otherwise, an operand exception is recognized.

The second operand must be designated on a word boundary; otherwise, a specification exception is recognized.

When the execution of TEST SUBCHANNEL is terminated on addressing and protection exceptions, the state of the subchannel is not changed.

Resulting Condition Code:

- 0 IRB stored; subchannel status pending
- 1 IRB stored; subchannel not status pending
- 2 —
- 3 Not operational

Program Exceptions:

- Access (store, operand 2)
- Operand
- Privileged operation
- Specification

The priority of recognition of program exceptions for the instruction is shown in Figure 14-3.

1.-7	Exceptions with the same priority as the priority of program-interruption conditions for the general case.
8.A	Specification exception due to the address specified by the second operand not being on a word boundary.
8.B	Access exceptions for an access to the subchannel-status-word, extended-status-word, and extended-control-word sections of the IRB designated by the second operand.

Figure 14-3. Priority of Execution: TEST SUBCHANNEL (Part 1 of 2)

8.C	Operand exception due to an invalid field in the subsystem-identification word specified in register 1.
8.D	Access exceptions for an access to the extended-measurement-word section of the IRB designated by the second operand when the extended-I/O-measurement-word mode is enabled at the designated subchannel.

Figure 14-3. Priority of Execution: TEST SUBCHANNEL (Part 2 of 2)

Programming Notes:

1. Device status that is stored in the SCSW may include device-busy, control-unit-busy, or control-unit-end indications.
2. The information that is stored in the IRB is obtained from the subchannel. The TEST SUBCHANNEL instruction does not cause the channel subsystem to interrogate the addressed device.
3. When an I/O interruption occurs, it is the result of a status-pending condition at the subchannel, and typically TEST SUBCHANNEL is executed to clear the status. TEST SUBCHANNEL may also be executed at any other time to sample conditions existing at the subchannel.
4. Repeated execution of TEST SUBCHANNEL to determine when a start function has been completed should be avoided because there are conditions under which the completion of the start function may or may not be indicated. For example, if the channel subsystem is holding an interface-control-check (IFCC) condition in abeyance (for any subchannel) because another subchannel is already status pending, and if the start function being tested by TEST SUBCHANNEL has as the only path available for selection the channel path with the IFCC condition, then the start function may not be initiated until the status-pending condition in the other subchannel is cleared, allowing the IFCC condition to be indicated at the subchannel to which it applies.
5. Repeated execution of TEST SUBCHANNEL without an intervening delay, for example, to determine when a subchannel changes state, should be avoided because repeated accesses of the subchannel by the CPU may delay or prohibit accessing of the subchannel by the channel subsystem. Execution of TEST SUBCHANNEL

by multiple CPUs for the same subchannel at approximately the same time may have the same effect and also should be avoided.

6. The priority of I/O-interruption handling by a CPU can be modified by the execution of TEST SUBCHANNEL. When TEST SUBCHANNEL is executed and the designated subchannel has an I/O-interruption request pending, that I/O-interruption request is cleared, and the SCSW is

stored, without regard to any previously established priority. The relative priority of the remaining I/O-interruption requests is unchanged.

- Bit position 52 of the IOTA contains zero.

Chapter 15. Basic I/O Functions

Control of Basic I/O Functions	15-3	Transport-Command-Area Trailer	15-41
Subchannel-Information Block	15-3	Transport-Command DCW	15-43
Path-Management-Control Word	15-3	Transfer-CBC-Offset-Block DCW	15-44
Subchannel-Status Word	15-10	CBC-Offset Block	15-45
Model-Dependent Area/Measurement		Transfer-TCA-Extension DCW	15-45
Block Address	15-10	Transport-Command-Area Extension	15-46
Summary of Modifiable Fields	15-11	Interrogate TCCB	15-47
Channel-Path Allegiance	15-13	Interrogate DCW	15-47
Working Allegiance	15-13	Interrogate Data	15-47
Working Allegiance for Subchannels		Transport Status Block	15-49
Operating in Command Mode	15-13	Transport-Status Header (TSH)	15-49
Working Allegiance for Subchannels		I/O-Status TSA	15-50
Operating in Transport Mode	15-13	Device-Detected-Program-Check TSA	15-51
Active Allegiance	15-14	Interrogate TSA	15-57
Dedicated Allegiance	15-14	Command Code	15-58
Channel-Path Availability	15-14	Designation of Storage Area	15-59
Control-Unit Type	15-15	CCW Channel Program Chaining	15-61
Clear Function	15-15	Data Chaining	15-62
Clear-Function Path Management	15-15	Command Chaining	15-64
Clear-Function Subchannel Modification	15-16	TCW Channel Program Chaining	15-64
Clear-Function Signaling and Completion	15-16	Skipping	15-65
Halt Function	15-17	Program-Controlled Interruption	15-65
Halt-Function Path Management	15-17	Indirect-Storage Designator (ISD)	15-67
Halt-Function Signaling and Completion	15-18	CCW Indirect Data Addressing	15-67
Start Function and Resume Function	15-21	Modified CCW Indirect Data Addressing	15-69
Start-Function and Resume-Function Path		Transport Indirect Data Addressing	15-71
Management	15-21	Suspension of CCW Channel-Program	
Interrogate Function	15-23	Execution	15-74
Interrogate-Function Path Management	15-23	Commands and Flags for CCWs	15-76
Interrogate TCCB Transportation and		Branching in CCW Channel Programs	15-77
Completion	15-23	Transfer in Channel	15-78
Execution of I/O Operations	15-24	Command Retry	15-78
Blocking of Data	15-25	Concluding I/O Operations before Initiation	15-78
Operation-Request Block	15-25	Concluding I/O Operations during Initiation	15-79
Command-Mode ORB	15-26	Immediate Conclusion of Command-Mode I/O	
Transport-Mode ORB	15-31	Operations	15-79
Channel-Command Word	15-32	Concluding I/O Operations During Data	
Transport Control Word	15-34	Transfer	15-80
Transport-Command-Control Block	15-37	Channel-Path-Reset Function	15-81
Transport-Command-Area Header	15-38	Channel-Path-Reset-Function Signaling	15-82
Transport-Command Area	15-38	Channel-Path-Reset-Function-Completion	
Device-Command Word	15-39	Signaling	15-82

Some I/O instructions specify to the channel subsystem that a function is to be performed. Collectively, these functions are referred to as the basic I/O functions. The basic I/O functions are the clear, halt, start, resume, and channel-path-reset functions.

Control of Basic I/O Functions

Information that is present at the subchannel controls how the clear, halt, resume, and start functions are

performed. This information is communicated to the program in the subchannel-information block during the execution of STORE SUBCHANNEL.

Subchannel-Information Block

The subchannel-information block (SCHIB) is the operand of the MODIFY SUBCHANNEL and STORE SUBCHANNEL instructions. The two rightmost bits of the SCHIB address are zeros, designating the SCHIB on a word boundary. The SCHIB contains three major fields: the path-management-control word (PMCW), the subchannel-status word (SCSW), and a model-dependent area. When the extended-I/O-measurement-block facility is installed the SCHIB also contains the measurement-block-address field. (Figure 15-1 on page 15-2. shows the format of the PMCW, and Figure 16-3 on page 16-8 shows the format of the command-mode SCSW and Figure 16-8 on page 16-34 shows the format of the transport-mode SCSW.)

STORE SUBCHANNEL is used to store the current PMCW, the SCSW, model-dependent data, and, when the extended-I/O-measurement-block facility is installed, the measurement-block-address field, for the designated subchannel. MODIFY SUBCHANNEL alters certain PMCW fields and, when the extended-I/O-measurement-block facility is installed, the measurement-block address in the subchannel. When the program needs to change the contents of one or more of the PMCW fields, the normal procedure is to (1) issue STORE SUBCHANNEL to obtain the current contents, (2) perform the required modifications to the PMCW field or the measurement-block-address field in main storage, and (3) issue MODIFY

SUBCHANNEL to pass the new information to the subchannel. The SCHIB has the following format:

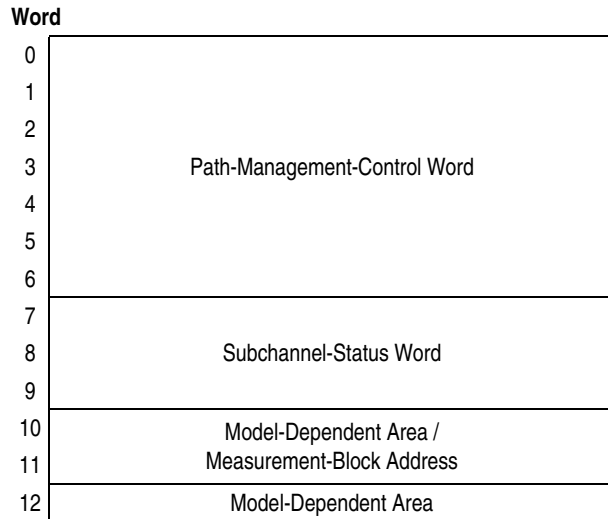

Path-Management-Control Word

Words 0-6 of the SCHIB contain the path-management-control word (PMCW). The PMCW has the format shown in Figure 15-1 on page 15-2 when the subchannel is valid (see “Device Number Valid (V)” on page 15-4).

The format of the PMCW is as follows:

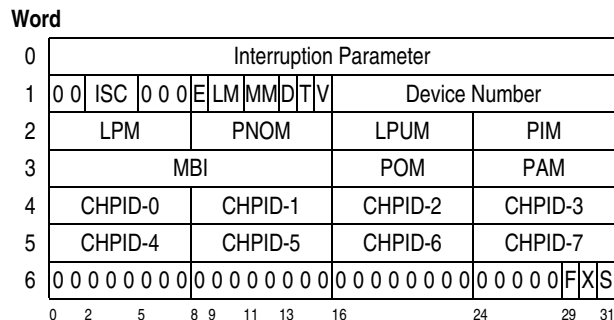

Figure 15-1. PMCW Format

Interruption Parameter: Bit positions 0-31 of word 0 contain the interruption parameter that is stored as word 1 of the interruption code. The interruption parameter can be set to any value by START SUBCHANNEL and MODIFY SUBCHANNEL. The initial value of the interruption parameter is zero.

I/O-Interruption-Subclass Code (ISC): Bits 2-4 of word 1 are an unsigned binary integer, in the range 0-7, that corresponds to the bit position of the I/O-

interruption subclass-mask bit in control register 6 of each CPU in the configuration. The setting of that mask bit in control register 6 of a CPU controls the recognition of interruption requests relating to this subchannel by that CPU (see “Priority of Interruptions” on page 16-5). The ISC can be set to any value by MODIFY SUBCHANNEL. The initial value of the ISC is zero.

Reserved: Bits 0, 1, and 5-7 of word 1 are reserved and stored as zeros by STORE SUBCHANNEL. Bits 0, 1, 6, and 7 must be zeros when MODIFY SUBCHANNEL is executed; otherwise, an operand exception is recognized. Bit 5 of word 1 is ignored when MODIFY SUBCHANNEL is executed.

Enabled (E): Bit 8 of word 1, when one, indicates that the subchannel is enabled for all I/O functions. When the E bit is zero, status presented by the device is not made available to the program, and I/O instructions other than MODIFY SUBCHANNEL and STORE SUBCHANNEL that are executed for the designated subchannel cause condition code 3 to be set. The E bit can be either zero or one when MODIFY SUBCHANNEL is executed; initially, all subchannels are not enabled; IPL causes the IPL I/O device to become enabled.

Limit Mode (LM): When the address-limit-checking facility is installed, bits 9 and 10 of word 1 define the limit mode (LM) of the subchannel. The limit mode is used by the channel subsystem when address-limit checking is invoked for an I/O operation. (See “Address-Limit Checking” on page 17-26.) Address-limit checking is under the control of the address-limit-checking-control bit that is passed to the subchannel in the operation-request block (ORB) during the execution of START SUBCHANNEL. (See “Address-Limit-Checking Control (A)” on

page 15-27.) The definitions of the LM bits, whose values are used during data transfer, are as follows:

Bit 9	Bit 10	Function
0	0	Initialized value. No limit checking is performed for this subchannel.
0	1	Data address must be equal to or greater than the current address limit.
1	0	Data address must be less than the current address limit.
1	1	Reserved.

Bit positions 9 and 10 can contain any of the first three bit combinations shown above when MODIFY SUBCHANNEL is executed. Specification of the reserved bit combination in the operand causes an operand exception to be recognized when MODIFY SUBCHANNEL is executed.

When the address-limit-checking facility is not installed, bits 9-10 of word 1 may be set as described above; however, they are ignored and are not set at the specified subchannel. When bits 9-10 are not specified as described above and MODIFY SUBCHANNEL is executed, an operand exception is recognized.

Measurement-Mode Enable (MM): Bits 11 and 12 of word 1 enable the measurement-block-update mode and the device-connect-time-measurement mode, respectively, of the subchannel. These bits can have any value when MODIFY SUBCHANNEL is executed; initially, neither measurement mode is

enabled. The definition of each of these bits is as follows:

- Bit 11 Measurement-Block-Update Enable:**
- 0 Initialized value. The subchannel is not enabled for measurement-block update. Storing of measurement-block data does not occur.
 - 1 The subchannel is enabled for measurement-block update. If the measurement-block-update mode is active, measurement data is accumulated in the measurement block at the time channel-program execution is completed or suspended at the subchannel or completed at the device, as appropriate, provided no error conditions described by subchannel logout have been detected. (See “Measurement-Block Update” on page 17-2.) If the measurement-block-update mode is inactive, no measurement-block data is stored.

- Bit 12 Device-Connect-Time-Measurement Enable:**
- 0 Initialized value. The subchannel is not enabled for device-connect-time measurement. Storing of the device-connect-time interval (DCTI) in the extended-status word (ESW) does not occur.
 - 1 The subchannel is enabled for device-connect-time measurement. If the device-connect-time-measurement mode is active and timing facilities are provided for the subchannel, the value of the DCTI is stored in the ESW when TEST SUBCHANNEL is executed after channel-program execution is completed or suspended at the subchannel, provided no error conditions described by subchannel logout have been detected. If the device-connect-time-measurement mode is inactive, no measurement values are stored in the ESW.

The meaning of the measurement-mode-enable bits (MM), described above, applies when the timing-facility bit for the subchannel is one. When the timing-facility bit is zero, the effect of the MM bits is changed, as described below under “Timing Facility (T)” on page 15-4. (For more discussion on measurement modes, see “Measurement-Block Update” on

page 17-2 and “Device-Connect-Time Measurement” on page 17-10.)

Multipath Mode (D): Bit 13 of word 1, when one, indicates that the subchannel operates in the multipath mode when performing an I/O operation or chain of I/O operations. For proper operation in the multipath mode when more than one channel path is available for selection, the associated device must have the dynamic-reconnection feature installed and must be set up for multipath-mode operation. During performance of a start function in the multipath mode, a device is allowed to request service from the channel subsystem over any of the channel paths indicated at the subchannel as being available for selection (see “Logical-Path Mask (LPM)” on page 15-5 and “Path-Available Mask (PAM)” on page 15-7). Bit 13, when zero, indicates that the subchannel operates in single-path mode when performing an I/O operation or chain of I/O operations. In the single-path mode, the entire start function is performed by using the channel path on which the first command of the I/O operation or chain of I/O operations was accepted by the device. The D bit can be either zero or one when MODIFY SUBCHANNEL is executed; initially, the subchannel is in the single-path mode.

Timing Facility (T): Bit 14 of word 1, when one, indicates that the channel-subsystem-timing facility is available for the subchannel and is under the control of the two measurement-mode-enable bits (MM) and SET CHANNEL MONITOR. Bit 14, when zero, indicates that the channel-subsystem-timing facility is not available for the subchannel. When bit 14 is zero, the START SUBCHANNEL count is the only measurement data that can be accumulated in the measurement block for the subchannel. Storing of the START SUBCHANNEL count is under the control of bit 11 and SET CHANNEL MONITOR, as described above under “Measurement-Mode Enable (MM)” on page 15-3. Similarly, if the T bit is zero, no device-connect-time-interval (DCTI) values can be measured for the subchannel. (See “Measurement-Block Update” on page 17-2 and “Device-Connect-Time Measurement” on page 17-10.)

Device Number Valid (V): Bit 15 of word 1, when one, indicates that the device-number field (see below) contains a valid device number and that a device associated with this subchannel may be physically installed. Bit 15, when zero, indicates that the subchannel is not valid, there is no I/O device currently associated with the subchannel, and the con-

tents of all other defined fields of the SCHIB are unpredictable.

Device Number: Bit positions 16-31 of word 1 contain the binary representation of the four-digit hexadecimal device number of the device that is associated with this subchannel. The device number is a system-unique parameter that is assigned to the subchannel and the associated device when the device is installed.

Logical-Path Mask (LPM): Bits 0-7 of word 2 indicate the logical availability of channel paths to the associated device. Each bit of the LPM corresponds one-for-one, by relative bit position, with a CHPID located in an associated byte of words 4 and 5 of the SCHIB. A bit set to one means that the corresponding channel path is logically available; a zero means the corresponding channel path is logically not available. When a channel path is logically not available, the channel subsystem does not use that channel path to initiate performance of any clear, halt, resume, or start function, except when a dedicated allegiance exists for that channel path. When a dedicated allegiance exists at the subchannel for a channel path, the logical availability of the channel path is ignored whenever a clear, halt, resume, or start function is performed. (See “Channel-Path Allegiance” on page 15-12). If the subchannel is idle, the logical availability of the channel path is ignored whenever the control unit initiates a request to present alert status to the channel subsystem. The logical availability of a channel path associated with the subchannel can be changed by setting the corresponding LPM bit in the SCHIB and then issuing MODIFY SUBCHANNEL, or by setting the corresponding LPM bit in the ORB and then issuing START SUBCHANNEL. Initially, each installed channel path is logically available.

Path-Not-Operational Mask (PNOM): Any of bits 8-15 of word 2, when one, indicates that a path-not-operational condition has been recognized on the corresponding channel path. Each bit of the PNOM corresponds one-for-one, by relative bit position, with a CHPID located in an associated byte of words 4 and 5 of the SCHIB. The channel subsystem recognizes a path-not-operational condition when, during an attempted device selection in order to perform a clear, halt, resume, or start function, the device associated with the subchannel appears not operational on a channel path that is operational for the subchannel. When a path-not-operational condition is recognized, the state of the channel path changes from

operational for the subchannel to not operational for the subchannel. A channel path is operational for the subchannel if the associated device appeared operational on that channel path the last time the channel subsystem attempted device selection in order to perform a clear, halt, resume, or start function. A device appears to be operational on a channel path when the device responds to an attempted device selection. A channel path is not operational for the subchannel if the associated device appeared not operational on that channel path the last time the channel subsystem attempted device selection in order to perform a clear, halt, resume, or start function. Any of bits 8-15 of word 2, when zero, indicates that a path-not-operational condition has not been recognized on the corresponding channel path.

Initially, each of the eight possible channel paths associated with each subchannel is considered to be operational, regardless of whether the respective channel paths are installed or available; therefore, unless a path-not-operational condition is recognized during initial program loading, the PMCW, if stored, contains a PNOM of all zeros if stored prior to the execution of a CLEAR SUBCHANNEL, HALT SUBCHANNEL, RESUME SUBCHANNEL, or START SUBCHANNEL instruction.

Programming Note: The PNOM indicates those channel paths for which a path-not-operational condition has been recognized during the performance of the most recent clear, halt, resume, or start function. That is, the PNOM indicates which of the channel paths associated with the subchannel have made a transition from the operational to the not-operational state for the subchannel during the performance of the most recent clear, halt, resume, or start function. However, the transition of a channel path from the not-operational to the operational state for the subchannel is indicated in the POM. Therefore, the POM must be examined in order to determine whether any of the channel paths that are associated with a designated subchannel are operational for the subchannel.

Furthermore, while performing either a start function or a resume function, the transition of a channel path from the not-operational to the operational state for the subchannel is recognized by the channel subsystem only during the initiation sequence for the first command specified by the start function or implied by the resume function. Therefore, a channel path that is currently not operational for the subchannel can be used by the device associated with the subchannel

when reconnecting to the channel subsystem in order to continue command chaining; however, the channel subsystem does not indicate a transition of that channel path from the not-operational to the operational state for the subchannel in the POM.

POM Value and Device State before Selection Attempt		Value of Specified Bit Subsequent to Selection Attempt		
Device State ¹	POM	POM	PNOM ²	SCSW N Bit
OP	0	1	0	0
NOP	0	0	0	0
OP	1	1	0	0
NOP	1	0	1	1 ³

Explanation:

¹ Device state as it appears on the corresponding channel path.

² Prior to the attempted device selection during the performance of either a start function or a resume function while the subchannel is suspended, the channel subsystem clears all existing path-not-operational conditions, if any, at the designated subchannel.

³ The N bit (bit 15 of word 0 of the SCSW) is indicated to the program and the N condition is cleared at the subchannel when TEST SUBCHANNEL is executed the next time the subchannel is status pending for other than intermediate status alone provided that it is not also suspended.

NOP The device is not operational on the corresponding channel path.

OP The device is operational on the corresponding channel path.

Figure 15-2. Resulting POM, PNOM, and N-Bit Values Subsequent to Selection Attempt

Last-Path-Used Mask (LPUM): Bits 16-23 of word 2 indicate the channel path that was last used for communicating or transferring information between the channel subsystem and the device. Each bit of the LPUM corresponds one-for-one, by relative bit position, with a CHPID located in an associated byte of words 4 and 5 of the SCHIB.

For a subchannel operating in command mode, each bit of the LPUM is stored as zero, except for the bit that corresponds to the channel path last used, whenever one of the following occurs:

1. The first command of a start or resume function is accepted by the device (see “Activity Control (AC)” on page 16-14).

2. The device and channel subsystem are actively communicating when the suspend function is performed for the channel program in execution.
3. Status has been accepted from the device and is recognized as an interruption condition, or a condition has been recognized that suppresses command chaining (see “Interruption Conditions” on page 16-2).
4. An interface-control-check condition has been recognized (see “Interface-Control Check” on page 16-29), and no subchannel-logout information is currently present in the subchannel.

For a subchannel operating in transport mode, each bit of the LPUM is stored as zero, except for the bit that corresponds to the channel path last used, whenever one of the following occurs:

1. The path has been selected for transporting the TCCB for the operation.
2. Status has been accepted from the device and is recognized as an interruption condition. If the accepted status is an interrogate response, the LPUM may be different than that stored with primary or secondary status or both.
3. An interface-control-check has been recognized and no subchannel-logout information is currently present in the subchannel.

The LPUM field of the PMCW contains the most recent setting. For transport-mode operations the LPUM in the subchannel is set to zeros when the start function is set and no dedicated-allegiance condition exists for the subchannel.

Path-Installed Mask (PIM): Bits 24-31 of word 2 indicate which of the channel paths 0-7 to the I/O device are physically installed. The PIM indicates the validity of the channel-path identifiers (see below) for those channel paths that are physically installed. Each bit of the PIM corresponds one-for-one, by relative bit position, with a CHPID located in an associated byte of words 4 and 5 of the SCHIB. A PIM bit stored as one indicates that the corresponding channel path is installed. A PIM bit stored as zero indicates that the corresponding channel path is not installed. The PIM always reflects the full complement of installed paths to the device, regardless of how the system is configured. Therefore, some of the channel paths indicated in the PIM may not be physically available in that configuration, as indicated by

the bit settings in the path-available mask (see below). The initial value of the PIM indicates all the physically installed channel paths to the device.

Measurement-Block Index (MBI): Bits 0-15 of word 3 form an index value used by the measurement-block-update facility when the measurement-block-update mode is active (see “SET CHANNEL MONITOR” on page 14-13.) and the subchannel is enabled for the mode (see “Measurement-Mode Enable (MM)” on page 15-3).

When the measurement-block index is used, five zero bits are appended on the right, and the result is added to the measurement-block-origin address designated by SET CHANNEL MONITOR. The calculated address, called the measurement-block address, designates the beginning of a 32-byte storage area where measurement data is stored. (See “Measurement Block” on page 17-3.) The MBI can contain any value when MODIFY SUBCHANNEL is executed; the initial value is zero.

Programming Note: The measurement-block-origin address specified by SET CHANNEL MONITOR is used as the origin address for the measurement blocks for subchannels in all subchannel sets available to the program. However, the two-byte measurement-block-index field is capable of supporting a maximum of 65,536 unique MBI values. It is the responsibility of the program to coordinate use of the measurement-block index among subchannels and subchannel sets.

Path-Operational Mask (POM): Bits 16-23 of word 3 indicate the last known operational state of the device on the corresponding channel paths. Each bit of the POM corresponds one-for-one, by relative bit position, with a CHPID located in an associated byte of words 4 and 5 of the SCHIB. If the associated device appeared operational on a channel path the last time the channel subsystem attempted device selection in order to perform a clear, halt, resume, or start function, then the channel path is operational for the subchannel, and the bit corresponding to the channel path in the POM is one. A device appears to be operational on a channel path when the device responds to an attempted device selection. A channel path is also operational for the subchannel if MODIFY SUBCHANNEL is executed and the bit corresponding to that channel path in the POM is specified as one.

If the associated device appeared not operational on a channel path the last time the channel subsystem attempted device selection in order to perform a clear, halt, resume, or start function, then the channel path is not operational for the subchannel, and the bit corresponding to the channel path in the POM is zero. A channel path is also not operational for the subchannel if MODIFY SUBCHANNEL is executed and the bit corresponding to that channel path in the POM is specified as zero.

If the device associated with the subchannel appears not operational on a channel path that is operational for the subchannel during an attempted device selection in order to perform a clear, halt, resume, or start function, then the channel subsystem recognizes a path-not-operational condition. If an SCSW is subsequently stored, then bit 15 of word 0 is one, indicating the path-not-operational condition. When a path-not-operational condition is recognized, the state of the channel path changes from operational for the subchannel to not operational for the subchannel.

When the channel path is not operational for the subchannel, a path-not-operational condition cannot be recognized. Moreover, a channel path that is not operational for the subchannel may be available for selection; if the channel subsystem chooses that channel path while performing a path-management operation, and if, during the attempted device selection, the device appears to be operational again on that channel path, then the state of the channel path changes from not operational for the subchannel to operational for the subchannel.

The POM can contain any value when MODIFY SUBCHANNEL is executed. Initially, each of the eight possible channel paths associated with each subchannel is considered to be operational, regardless of whether the respective channel paths are installed or available; therefore, unless a path-not-operational condition is recognized during initial program loading, the PMCW, if stored, contains a POM of all ones if stored prior to the execution of a CLEAR SUBCHANNEL, HALT SUBCHANNEL, RESUME SUBCHANNEL, or START SUBCHANNEL instruction.

Path-Available Mask (PAM): Bits 24-31 of word 3 indicate the physical availability of installed channel paths. Each bit of the PAM corresponds one-for-one, by relative bit position, with a CHPID located in an associated byte of words 4 and 5 of the SCHIB. A PAM bit of one indicates that the corresponding channel path is physically available for use in access-

ing the device. A PAM bit of zero indicates the channel path is not physically available for use in accessing the device. When a channel path is not physically available, it may, depending on the model and the extent of failure, be used during performance of the reset-channel-path function. A channel path that is physically available may become not physically available as a result of reconfiguring the system, or this may occur as a result of the performance of the channel-path-reset function. The initial value of the PAM reflects the set of channel paths by which the I/O device is physically accessible at the time of initialization.

Note: The change in the availability of a channel path affects all subchannels having access to that channel path. Whenever the setting of a PAM bit is referred to in conjunction with the availability status of a channel path, for brevity, reference is made in this chapter to a single PAM bit instead of to the respective PAM bits in all of the affected subchannels.

Channel-Path Identifiers (CHPIDs): Words 4 and 5 contain eight one-byte channel-path identifiers corresponding to channel paths 0-7 of the PIM. A CHPID is valid if the corresponding PIM bit is one. Each valid CHPID contains the identifier of a physical channel path to a control unit by which the associated I/O device may be accessed. A unique CHPID is assigned to each physical channel path in the system.

Different devices that are accessible by the same physical channel path have, in their respective subchannels, the same CHPID value. The CHPID value may, however, appear in each subchannel in different locations in the CHPID fields 0-7.

Subchannels that share an identical set of channel paths have the same corresponding PIM bits set to ones. The channel-path identifiers (CHPIDs) for these channel paths are the same and occupy the same respective locations in each SCHIB.

Reserved: Bits 0-28 of word 6 are reserved and are stored as zeros by STORE SUBCHANNEL. They must be zeros when MODIFY SUBCHANNEL is executed; otherwise, an operand exception may be recognized.

Measurement Block Format Control (F): When the extended-I/O-measurement-block facility is installed, bit 29 of word 6 specifies the format of the measurement block to be stored when the subchan-

nel is enabled for the measurement-block-update mode, and measurement-block-update mode is active. The bit can contain any value when MODIFY SUBCHANNEL is executed. The initial value is zero. The definition of the bit is as follows:

Bit	
29	Measurement-Block-Format Control:
0	Format-0 measurement block. Specifies that a format-0 measurement block is used when performing a measurement-block update for the subchannel. The address of the 32-byte measurement block is obtained using the MBI provided by MSCH in conjunction with the MBO provided by SCHM.
1	Format-1 measurement block. Specifies that a format-1 measurement block is used when performing a measurement-block update for the subchannel. The address of the 64-byte format-1 measurement block is provided by MSCH.

If the extended-measurement-block facility is not installed, bit 29 of word 6 of the SCHIB operand must be zero when MODIFY SUBCHANNEL is executed; otherwise, an operand exception is recognized.

Extended Measurement Word Mode Enable (X): When the extended-measurement-word facility is installed and enabled, bit 30 of word 6 enables the extended-measurement-word mode for the subchannel. Initially, the extended-measurement-word mode is not enabled. The definition of the bit is as follows:

Bit	
30	Measurement-Block-Word-Mode Enable:
0	Initialized value. The subchannel is not enabled for extended-measurement-word mode. Storing of the extended-measurement word does not occur.
1	The subchannel is enabled for extended-measurement-word mode. Measurement data is stored in the extended-measurement word at the time channel-program execution is completed or suspended at the subchannel or completed at the device, as appropriate, provided no error conditions described by subchannel logout have been detected.

If the extended-measurement-word facility is not installed, or is installed but is not enabled, bit 30 of word 6 of the SCHIB operand must be zero when MODIFY SUBCHANNEL is executed; otherwise, an operand exception is recognized.

Concurrent Sense (S): Bit 31 of word 6, when one, indicates that the subchannel is in the concurrent-sense mode. When the subchannel is in command mode and concurrent-sense mode, whenever the subchannel becomes status pending with alert status, and the status byte accepted from the device contains the unit-check indication, then the channel subsystem may attempt to retrieve sense information from the associated device and place that sense information in the extended-control word.

When the subchannel is operating in transport mode, any available sense information is provided in the TSB regardless of the setting of bit 31 of word 6.

If the concurrent-sense facility is not installed, bit 31 of word 6 of the SCHIB operand must be zero when MODIFY SUBCHANNEL is executed; otherwise, an operand exception is recognized.

Subchannel-Status Word

Words 7-9 of the SCHIB contain a copy of the SCSW. The format of the SCSW is described in "Subchannel-Status Word" on page 16-7. The SCSW is stored

by the execution of either STORE SUBCHANNEL or TEST SUBCHANNEL (see "STORE SUBCHANNEL" on page 14-18 and "TEST SUBCHANNEL" on page 14-21).

Model-Dependent Area/Measurement Block Address

When the extended-I/O-measurement-block facility is not installed, words 10-12 of the SCHIB contain model-dependent information.

When the extended-I/O-measurement-block facility is installed, words 10-11 are defined as the measurement-block-address field. Word 12 contains model-dependent information.

When (1) the measurement-block-update mode is active (see "SET CHANNEL MONITOR" on page 14-13), (2) the subchannel is enabled for the mode (see "Measurement-Mode Enable (MM)" on page 15-3), and (3) the format-1-measurement block is specified (see "Measurement Block Format Control (F)" on page 15-8) at the subchannel, the measurement-block-address field contains the absolute storage address of the measurement block used by the measurement-block-update facility. The measurement-block address designates the beginning of a 64-byte storage area and must be designated on 64-byte boundary. The initial value of the measurement block address is zero.

Summary of Modifiable Fields

*Figure 15-3 on page 15-10 lists the initial settings for fields in a subchannel whose device-number-valid bit is one and indicates what modifies the fields.

All of the PMCW fields contain meaningful information when STORE SUBCHANNEL is executed and the designated subchannel is idle. Subchannel fields

that the channel subsystem does not modify contain valid information whenever STORE SUBCHANNEL is executed, provided that the device-number-valid bit is one. The validity of the subchannel fields that are modifiable by the channel subsystem depends on the state of the subchannel at the time STORE SUBCHANNEL is executed.

Subchannel Field	Initial Value ¹	Program Modifies by Executing	Modified by Channel Subsystem ²
Interruption parameter	Zeros	MSCH,SSCH	No
I/O-interruption-subclass code	Zeros	MSCH	No
Enabled (E)	Zero	MSCH	No
Limit mode (LM)	Zeros	MSCH ⁷	No
Measurement mode (MM)	Zeros	MSCH	Yes ³
Multipath mode (D)	Zero	MSCH	No
Timing facility (T)	Installed value ⁴	None	No
Device number valid (V)	Installed value ⁴	None	No
Device number	Installed value ⁴	None	No
Logical-path mask (LPM)	Path-installed-mask value	MSCH,SSCH	No
Path-not-operational mask (PNOM)	Zeros	CSCH,SSCH,RSCH ⁵	Yes
Last-path-used mask (LPUM)	Zeros	CSCH	Yes
Path-installed mask (PIM)	Installed value ⁴	None	No
Measurement-block index (MBI)	Zeros	MSCH	No
Path-operational mask (POM)	Ones	CSCH,MSCH,RSCH ⁵	Yes
Path-available mask (PAM)	Installed values ^{4,6}	None	Yes ⁶
Channel-path ID 0-7	Installed value ₄	None	No
Concurrent sense (S)	ZERO	MSCH	No
Subchannel-status word (SCSW)	Zero	TSCH	Yes
Model-dependent area	*	None	*
Measurement-block-format control (F)	Zero	MSCH	No
Extended-measurement-word enable (X)	Zero	MSCH	No
Measurement-block address	Zeros	MSCH	No

Figure 15-3. Modification of Subchannel Fields (Part 1 of 2)

Explanation:

- * Model dependent.
- 1 These fields are not meaningful if the subchannel is not valid. Initialization of a subchannel is performed when I/O-system reset occurs. (See the section "I/O-System Reset" in Chapter 17, "I/O Support Functions.") One or more of the installed-value parameters that are unmodifiable by the program may be set when the subchannel is idle. In this case, all the program-modifiable fields are set to their initialized values, and the program is notified of such a change by a channel report. (See the section "Channel-Report Word" in Chapter 17, "I/O Support Functions.")
- 2 Subchannel fields that are not normally modifiable by the channel subsystem may be modified as a result of dynamic configuration changes or as a result of external actions. When this occurs, the program is notified of the change by a channel report that is made pending at the time of the change.
- 3 When any of the following error conditions associated with the measurement-block-update mode is detected, the measurement-block-update mode is disabled by the channel subsystem (bit 11 of word 1 of the SCHIB is zero) in the affected subchannel. The device-connect-time-measurement-enable bit (bit 12 of word 1 of the SCHIB) is never modified by the channel subsystem.
 - Measurement program check
 - Measurement protection check
 - Measurement data check
 - Measurement key check
- 4 This information is entered when the channel-subsystem configuration is established
- 5 The mask is modified by the resume function only when the subchannel is in the suspended state at the time RESUME SUBCHANNEL is executed.
- 6 The channel subsystem may modify the PAM to reflect changes in the system configuration caused by partitioning or unpartitioning channel paths because of reconfiguration or permanent failure of part of the I/O system.

Figure 15-3. Modification of Subchannel Fields (Part 2 of 2)

Programming Notes:

1. System performance may be degraded if the LPM is not used to make channel paths for which a path-not-operational condition has been indicated in the PNOM logically not available.
2. If, during the performance of a start function, a channel path becomes not physically available because a channel-path failure has been recognized, continued performance of the start function may be precluded. That is, the program may or may not be notified, and the subchannel may remain in the subchannel-and-device-active state until cleared by the performance of the clear function.
3. If the same MBI is placed in more than one subchannel by the program, the channel-subsystem-monitoring facility updates the same locations with measurement data relating to more than one subchannel. In this case, the values stored in the measurement data are unpredictable. (See "Measurement-Block Update" on page 17-2.)
4. Modification of the I/O configuration (reconfiguration) may be accomplished in various ways depending on the model. If the reconfiguration

procedure affects the physical availability of a channel path, then any change in availability can be detected by executing STORE SUBCHANNEL for a subchannel that has access to the channel path and by subsequently examining the PAM bits of the SCHIB.

5. The definitions of the PNOM, POM, and N bit are such that a path-not-operational condition is reported to the program only the first time the condition is detected by the channel subsystem after the corresponding POM bit is set to one.

For example, if the POM bit for every channel path available for selection is one and the device appears not operational on all corresponding channel paths while the channel subsystem is attempting to initiate a start function at the device, the channel subsystem makes the subchannel status pending, with deferred condition code 3 and with the N bit stored as one. The PNOM in the SCHIB indicates the channel path or channel paths that appeared not operational, for which the corresponding POM bits have been set to zeros. The next START SUBCHANNEL causes the channel subsystem to again attempt device selection by choosing a channel path from among all of the channel paths that are available

for selection. If device selection is not successful and all channel paths available for selection have again been chosen, deferred condition code 3 is set, but the N bit in the SCSW is zero. The POM contains zeros in at least those bit positions that correspond to the channel paths that are available for selection. (See “Channel-Path Availability” on page 15-13 for a description of the term “available for selection.”) When the N bit in the SCSW is zero, the PNOM is also zero.

6. If the program is to detect path-not-operational conditions, the PNOM should be inspected following the execution of TEST SUBCHANNEL (which results in the setting of condition code zero and the valid storing of the N bit as one) and preceding the performance of another start, resume, halt, or clear function at the subchannel.

Channel-Path Allegiance

The channel subsystem establishes allegiance conditions between subchannels and channel paths. The kind of allegiance established at a subchannel for a channel path or set of channel paths depends upon the state of the subchannel, the device, and the information, if any, transferred between the channel subsystem and device. The way in which path management is handled during the performance of a clear, halt, resume, or start function is determined by the kind of allegiance, if any, currently recognized between a subchannel and a channel path.

Performing the clear function at a subchannel clears any currently existing allegiance condition in the subchannel for all channel paths.

Performing the reset-channel-path function clears all currently existing allegiances for that channel path in all subchannels.

When a channel path becomes not physically available, all internal indications of prior allegiance conditions are cleared in all subchannels having access to the designated channel path.

Note that allegiance rules do not apply for interrogate operations. An interrogate operation may be initiated and successfully complete while a subchannel is in transport mode. Furthermore, interrogate operations do not alter any allegiance conditions that may exist.

Working Allegiance

Working Allegiance for Subchannels Operating in Command Mode

A subchannel has a working allegiance for a channel path when the subchannel is operating in command mode and becomes device active on that channel path. Once a working allegiance is established, the channel subsystem maintains the working allegiance at the subchannel for the channel path until either the subchannel is no longer device active or a dedicated allegiance is recognized, whichever occurs earlier. Unless a dedicated allegiance is recognized, a working allegiance for a channel path is extended to the set of channel paths that are available for selection if the device is specified to be operating in the multipath mode (that is, the multipath-mode bit is stored as one in the SCHIB). Otherwise, the working allegiance remains only for that channel path over which the start function was initiated.

Once a working allegiance is established for a channel path or set of channel paths, the working allegiance is not changed until the subchannel is no longer device active or until a dedicated allegiance is established. If the subchannel is operating in the single-path mode, a working allegiance is maintained only for a single path.

While a working allegiance exists at a subchannel, an active allegiance can occur only for a channel path for which the working allegiance is being maintained, unless the device is specified as operating in the multipath mode. When the device is specified as operating in the multipath mode, an active allegiance may also occur for a channel path that is not available for selection if the presentation of status by the device on that channel path causes an alert interruption condition to be recognized.

A working allegiance is cleared in any subchannel having access to a channel path if the channel path becomes not physically available.

Working Allegiance for Subchannels Operating in Transport Mode

A subchannel has a working allegiance for a channel path when the subchannel is operating in transport mode, becomes start pending, and the designated TCCB is transported over that channel path to the I/O device. Once a working allegiance is established, the channel subsystem maintains the working allegiance

at the subchannel for the channel path until a busy condition is encountered or the subchannel is made status pending with primary status. The working allegiance remains only for that channel path over which the start function was initiated.

While a working allegiance exists at a subchannel that is operating in transport mode, an active allegiance can occur only for the channel path for which the working allegiance is being maintained.

A working allegiance is cleared in any subchannel having access to a channel path if the channel path becomes not physically available.

Active Allegiance

A subchannel has an active allegiance established for a channel path no later than when active communication has been initiated on that channel path with an I/O device. The subchannel can have an active allegiance to only one channel path at a time. While the subchannel has an active allegiance for a channel path, the channel subsystem does not actively communicate with that device on any other channel path. When the channel subsystem accepts a no-longer-busy indication from the device that does not cause an interruption condition, this status does not constitute the initiation of active communication. An active allegiance at a subchannel for a channel path is terminated when the channel subsystem is no longer actively communicating with the I/O device on that channel path.

A working allegiance can become an active allegiance.

Dedicated Allegiance

If a channel path is physically available (that is, if the corresponding PAM bit is one), a dedicated allegiance may be recognized for that channel path. If a channel path is not physically available, a dedicated allegiance cannot be recognized for the corresponding channel path. The channel subsystem establishes a dedicated allegiance at the subchannel for a channel path when (1) the subchannel is operating in command mode, the subchannel becomes status pending with alert status, and device status containing the unit-check indication is present but (2) concurrent-sense information is not present at the

subchannel. A dedicated allegiance is maintained until the subchannel is no longer start pending (unless it becomes suspended) or resume pending following performance of the next start function, clear function, or channel-path-reset function or the next resume function if applicable. If the subchannel becomes suspended, the dedicated allegiance remains until the resume function is initiated and the subchannel is no longer resume pending. Unless a clear or channel-path-reset function is performed, the subchannel establishes a working allegiance when the dedicated allegiance ends. This occurs when the subchannel becomes device active. While a dedicated allegiance exists at a subchannel for a channel path, only that channel path is available for selection until the dedicated-allegiance condition is cleared.

Dedicated allegiance does not apply to subchannels operating in transport mode. When a subchannel operating in transport mode becomes status pending with unit check indicated, the sense information has already been transferred from the I/O device into the TSB for the I/O operation.

A dedicated allegiance can become an active allegiance. While a dedicated allegiance exists, an active allegiance can only occur for the same channel path.

A currently existing dedicated allegiance is cleared at any subchannel having access to a channel path when the channel path becomes not physically available or whenever the device appears not operational on the channel path for which the dedicated allegiance exists.

Channel-Path Availability

When a channel path is not physically available, the channel subsystem does not use the channel path to perform any of the basic I/O functions except, in some cases, the channel-path-reset function and does not respond to any control-unit-initiated requests on that same channel path. If a channel path is not physically available, the condition is indicated by the corresponding path-available-mask PAM bit being zero when STORE SUBCHANNEL is executed (see "Path-Available Mask (PAM)" on page 15-7). Furthermore, if the channel path is not physically available for the subchannel designated by STORE SUBCHANNEL, then it is not physically available for any subchannel that has a device which is accessible by that channel path.

Unless a dedicated allegiance exists at a subchannel for the channel path, a channel path becomes available for selection if it is logically available and physically available, as indicated by the bits in the LPM and PAM corresponding to the channel path being stored as ones when STORE SUBCHANNEL is executed. If a dedicated allegiance exists at a subchannel for the channel path, only that channel path is available for selection, and the setting of the corresponding LPM bit is ignored. If the channel path is currently being used and a dedicated allegiance exists at the subchannel for the channel path, selection of the device is delayed until the channel path is no longer being used.

The availability status of the eight logical paths to the associated device described in Figure 15-4 on page 15-14 is determined by the hierarchical arrangement of the corresponding bit values contained in the PIM, PAM, and LPM and by existing conditions, if any, recognized by the channel subsystem.

Value of Bit 'n'			Channel-Path Condition1	Channel-Path State
PIM	PAM	LPM		
0	0 ²	-	X	Not installed
1	0	-	X	Not physically available
1	1	0 ³	X	Not logically available
1	1	1 ³	Active	Available for selection ⁴
1	1	1	Inactive	Available for selection
Explanation:				
-	Bit value is not meaningful.			
1	If the channel path is recognized as being used in active communication with a device, the channel-path condition is described as active. Otherwise, its condition is described as inactive.			
2	A PAM bit cannot have the value one when the corresponding PIM bit has the value zero.			
3	If a dedicated allegiance exists to the channel path at the subchannel, the state of the bit is ignored, and the channel path is considered to be available for selection.			
4	The channel path may appear to be active when a channel-path-terminal condition has been recognized.			
X	Condition is not meaningful			

Figure 15-4. Path condition and Path-Availability Status for PIM, PAM, and LPM Values

Control-Unit Type

In "Clear Function" on page 15-14, "Halt Function" on page 15-16, and "Start Function and Resume Function" on page 15-20, reference is made to type-1, type-2, and type-3 control units. For a description of these control-unit types, see the System Library publication *IBM System/360 and System/370 I/O Interface Channel to Control Unit OEMI, GA22-6974*. For the purposes of this definition, all control units attaching to a serial-I/O interface are considered type-2 control units.

Clear Function

Subsequent to the execution of CLEAR SUBCHANNEL, the channel subsystem performs the clear function. Performance of the clear function consists in (1) performing a path-management operation, (2) modifying fields at the subchannel, (3) issuing the clear signal to the associated device, and (4) causing the subchannel to be made status pending, indicating the completion of the clear function.

Clear-Function Path Management

A path-management operation is performed as part of the clear function in order to examine channel-path conditions for the associated subchannel and to attempt to choose an available channel path on which the clear signal can be issued to the associated device.

Channel-path conditions are examined in the following order:

1. If the channel subsystem is actively communicating or attempting to establish active communication with the device to be signaled, the channel path that is in use is chosen.
2. If the channel subsystem is in the process of accepting a no-longer-busy indication (which will not cause an interruption condition to be recognized) from the device to be signaled, and the associated subchannel has no allegiance to any channel path, the channel path that is in use is chosen.

3. If the associated subchannel has a dedicated allegiance for a channel path, that channel path is chosen.
4. If the associated subchannel has a working allegiance for one or more channel paths, one of those channel paths is chosen.
5. If the associated subchannel has no allegiance for any channel path, if a last-used channel path is indicated, and if that channel path is available for selection, that channel path is chosen. If that channel path is not available for selection, either no channel path is chosen or a channel path is chosen from the set of channel paths, if any, that are available for selection (as though no last-used channel path were indicated).
6. If the associated subchannel has no allegiance for any channel path, if no last-used channel path is indicated, and if there exist one or more channel paths that are available for selection, one of those channel paths is chosen.

If none of the channel-path conditions listed above apply, no channel path is chosen.

For item 4, for item 5 under the specified conditions, and for item 6, the channel subsystem chooses a channel path from a set of channel paths. In these cases, the channel subsystem may attempt to choose a channel path, provided that the following conditions *do not* apply:

1. A channel-path-terminal condition exists for the channel path.
2. For a parallel or ESCON channel path: Another subchannel has an active allegiance for the channel path.

For a FICON channel path: The channel path is currently being used to actively communicate with the maximum number of subchannels that can have concurrent active communications.

3. The device to be signaled is attached to a type-1 control unit, and the subchannel for another device attached to the same control unit has an allegiance to the same channel path, unless the allegiance is a working allegiance and primary status has been accepted by that subchannel.
4. The device to be signaled is attached to a type-3 control unit, and the subchannel for another

device attached to the same control unit has a dedicated allegiance to the same channel path.

Clear-Function Subchannel Modification

Path-management-control indications at the subchannel are modified during performance of the clear function. Effectively, this modification occurs after the attempt to choose a channel path, but prior to the attempt to select the device to issue the clear signal. The path-management-control indications that are modified are as follows:

1. The state of all eight possible channel paths at the subchannel is set to operational for the subchannel.
2. The last-path-used indication is reset to indicate no last-used channel path.
3. Path-not-operational conditions, if any, are reset.

Clear-Function Signaling and Completion

Subsequent to the attempt to choose a channel path and the modification of the path-management-control fields, the channel subsystem, if conditions allow, attempts to select the device to issue the clear signal. (See "Clear Signal" on page 17-12.) Conditions associated with the subchannel and the chosen channel path, if any, affect (1) whether an attempt is made to issue the clear signal, and (2) whether the attempt to issue the clear signal is successful. Independent of these conditions, the subchannel is subsequently set status pending, and the performance of the clear function is complete. These conditions and their effect on the clear function are described as follows:

No Attempt Is Made to Issue the Clear Signal:

The channel subsystem does not attempt to issue the clear signal to the device if any of the following conditions exist:

1. No channel path was chosen. (See "Clear-Function Path Management" on page 15-14.)
2. The chosen channel path is no longer available for selection.
3. A channel-path-terminal condition exists for the chosen channel path.

4. For parallel and ESCON channel paths: The chosen channel path is currently being used to actively communicate with a different device.

For FICON channel paths: The chosen channel path is currently being used to actively communicate with the maximum number of devices that can have concurrent active communications.

5. The device to be signaled is attached to a type-1 control unit, and the subchannel for another device attached to the same control unit has an allegiance to the same channel path, unless the allegiance is a working allegiance and primary status has been accepted by that subchannel.
6. The device to be signaled is attached to a type-3 control unit, and the subchannel for another device attached to the same control unit has a dedicated allegiance to the same channel path.

If any of the conditions above exist, the subchannel remains clear pending and is set status pending, and the performance of the clear function is complete.

The Attempt to Issue the Clear Signal Is Not Successful: When the channel subsystem attempts to issue the clear signal to the device, the attempt may not be successful because of the following conditions:

1. The control unit or device signals a busy condition when the channel subsystem attempts to select the device to issue the clear signal.
2. A path-not-operational condition is recognized when the channel subsystem attempts to select the device to issue the clear signal.
3. An error condition is encountered when the channel subsystem attempts to issue the clear signal.

If any of the conditions above exists and the channel subsystem either determines that the attempt to issue the clear signal was not successful or cannot determine whether the attempt was successful, the subchannel remains clear pending and is set status pending, and the performance of the clear function is complete.

The Attempt to Issue the Clear Signal Is Successful: When the channel subsystem determines that the attempt to issue the clear signal was successful, the subchannel is no longer clear pending and is set

status pending, and the performance of the clear function is complete. When the subchannel becomes status pending, the I/O operation, if any, with the associated device has been terminated.

Programming Note: Subsequent to the performance of the clear function, any nonzero status, except control unit end alone, that is presented to the channel subsystem by the device is passed to the program as unsolicited alert status. Unsolicited status consisting of control unit end alone or zero status is not presented to the program.

Halt Function

Subsequent to the execution of HALT SUBCHANNEL, the channel subsystem performs the halt function. Performance of the halt function consists of (1) performing a path-management operation, (2) issuing the halt signal to the associated device, and (3) causing the subchannel to be made status pending, indicating the completion of the halt function.

Halt-Function Path Management

A path-management operation is performed as part of the halt function to examine channel-path conditions for the associated subchannel and to attempt to choose a channel path on which the halt signal can be issued to the associated device.

Channel-path conditions are examined in the following order:

1. If the channel subsystem is actively communicating or attempting to establish active communication with the device to be signaled, the channel path that is in use is chosen.
2. If the channel subsystem is in the process of accepting a no-longer-busy indication (which will not cause an interruption condition to be recognized) from the device to be signaled, and the associated subchannel has no allegiance to any channel path, the channel path that is in use is chosen.
3. If the associated subchannel has a dedicated allegiance for a channel path, that channel path is chosen.

4. If the associated subchannel has a working allegiance for one or more channel paths, one of those channel paths is chosen.
5. If the associated subchannel has no allegiance for any channel path, if a last-used channel path is indicated, and if that channel path is available for selection, that channel path is chosen. If that channel path is not available for selection, either no channel path is chosen or a channel path is chosen from the set of channel paths, if any, that are available for selection (as though no last-used channel path were indicated).
6. If the associated subchannel has no allegiance for any channel path, if no last-used channel path is indicated, and if there exist one or more channel paths that are available for selection, one of those channel paths is chosen.

If none of the channel-path conditions listed above apply, no channel path is chosen.

For item 4, for item 5 under the specified conditions, and for item 6, the channel subsystem chooses a channel path from a set of channel paths. In these cases, the channel subsystem may attempt to choose a channel path for which the following conditions *do not* apply:

1. A channel-path-terminal condition exists for the channel path.
2. For a parallel or ESCON channel path: Another subchannel has an active allegiance for the channel path.

For a FICON channel path: The channel path is currently being used to actively communicate with the maximum number of subchannels that can have concurrent active communications.

3. The device to be signaled is attached to a type-1 control unit, and the subchannel for another device attached to the same control unit has an allegiance to the same channel path, unless the allegiance is a working allegiance and primary status has been accepted by that subchannel.
4. The device to be signaled is attached to a type-3 control unit, and the subchannel for another device attached to the same control unit has a dedicated allegiance to the same channel path.

Halt-Function Signaling and Completion

Subsequent to the attempt to choose a channel path, the channel subsystem, if conditions allow, attempts to select the device to issue the halt signal. (See “Halt Signal” on page 17-12.)

Conditions associated with the subchannel and the chosen channel path, if any, affect (1) whether an attempt is made to issue the halt signal, (2) whether the attempt to issue the halt signal is successful, and (3) whether the subchannel is made status pending to complete the halt function. These conditions and their effect on the halt function are described as follows:

No Attempt Is Made to Issue the Halt Signal:

The channel subsystem does not attempt to issue the halt signal to the device if any of the following conditions exist:

1. No channel path was chosen. (See “Halt-Function Path Management” on page 15-16.)
2. The chosen channel path is no longer available for selection.
3. A channel-path-terminal condition exists for the chosen channel path.
4. The associated subchannel is status pending with other than intermediate status alone.
5. The device to be signaled is attached to a type-1 control unit, and the subchannel for another device attached to the same control unit has an allegiance to the same channel path, unless the allegiance is a working allegiance and primary status has been accepted by that subchannel.
6. The device to be signaled is attached to a type-3 control unit, and the subchannel for another device attached to the same control unit has a dedicated allegiance to the same channel path.

If the conditions described in items 3, 5, or 6 exist, the associated subchannel remains halt pending until those conditions no longer exist. When the conditions no longer exist (for the channel-path-terminal condition, when the condition no longer exists as a result of executing RESET CHANNEL PATH), the channel subsystem attempts to issue the halt signal to the device.

If any of the remaining conditions above exist, the subchannel remains halt pending and is set status pending, and the halt function is complete.

The Attempt to Issue the Halt Signal Is Not Successful: When the channel subsystem attempts to issue the halt signal to the device, the attempt may not be successful because of the following conditions:

1. The control unit or device signals a busy condition when the channel subsystem attempts to select the device to issue the halt signal.
2. A path-not-operational condition is recognized when the channel subsystem attempts to select the device to issue the halt signal.
3. An error condition is encountered when the channel subsystem attempts to issue the halt signal.

If the control unit or device signals a busy condition (item 1), the subchannel remains halt pending until the internal indication of busy is reset. When this event occurs, the channel subsystem again attempts to issue the halt signal to the device.

If any of the remaining conditions above exists and the channel subsystem either determines that the attempt to issue the halt signal was not successful or cannot determine whether the attempt was successful, then the subchannel remains halt pending and is set status pending, and the halt function is complete.

The Attempt to Issue the Halt Signal Is Successful: When the channel subsystem determines that the attempt to issue the halt signal was successful and ending status, if appropriate, has been received at the subchannel, the subchannel is no longer halt pending and is set status pending, and the halt function is complete. When the subchannel becomes status pending, the I/O operation, if any, with the associated device has been terminated. The conditions that affect the receipt of ending status at the subchannel, and the effect of the halt signal at the device are described in the following discussion.

When the subchannel is subchannel-and-device active or only device active during the performance of the halt function, the state continues until the subchannel is made status pending because (1) the device has provided ending status or (2) the channel

subsystem has determined that ending status is unavailable.

When the subchannel is operating in command mode and is idle, start pending, start pending and resume pending, suspended, or suspended and resume pending, or when the halt signal is issued during command chaining after the receipt of device end but before the next command is transferred to the device, no operation is in progress at the device, and therefore no status is generated by the device as a result of receiving the halt signal. When the subchannel is neither subchannel active, nor status pending with intermediate status, and no errors are detected during the attempt to issue the halt signal to the device, an interruption condition indicating status pending alone is generated after the halt signal is issued.

When the subchannel is operating in transport mode and is start pending, an operation may or may not be in progress at the device. Regardless of whether an operation is in progress, device status is not generated.

The effect of the halt signal at the device depends partially on the subchannel operation mode, type of device, and its state. The effect of the halt signal on a device that is not active or that is performing a mechanical operation in which data is not transferred across the channel path, such as rewinding tape or positioning a disk-access mechanism, depends upon the control-unit or device model. If the device is performing a type of operation that is unpredictable in duration or in which data is transferred across the channel path, the control unit interprets the signal as one to terminate the operation. Pending status conditions at the device are not reset. When the control unit recognizes the halt signal, it immediately ceases all communication with the channel subsystem until it has reached the normal ending point. The control unit then requests selection by the channel subsystem to present any generated status.

If the subchannel is involved in the data-transfer portion of an I/O operation, data transfer is terminated during the performance of the halt function, and the device is logically disconnected from the channel path. If the halt function is addressed to a subchannel operating in command mode, performing a chain of I/O operations, and the device has already provided channel end for the current I/O operation, the channel subsystem causes the device to be discon-

nected and command chaining or command retry to be suppressed.

If the subchannel is operating in command mode, performing a chain of I/O operations with the device, and the halt signal is issued during command chaining at a point after the receipt of device end for the previous I/O operation but before the next command is transferred to the device, the subchannel is made status pending with primary and secondary status immediately after the halt signal is issued. The device-status field of the SCSW contains zeros in this case. If the halt function is addressed to a subchannel that is operating in command mode, start pending, and the halt-pending condition is recognized before initiation of the start function, initiation of the start function is not attempted, and the subchannel becomes status pending after the device has been signaled.

If the halt function is addressed to a subchannel operating in transport mode that is start pending, the halt signal is issued as follows

- If the TCCB has been transported to the I/O device for execution, the halt signal is issued and the subchannel becomes status pending.
- If the TCCB has not been transported to the I/O device, the TCCB is not transported and the subchannel becomes status pending.

When the subchannel is not performing an I/O operation with the associated device, the device is selected, and an attempt is made to issue the halt signal as the device responds. If the subchannel is in the device-active state, the subchannel does not become status pending until it receives the device-end status from the halted device. If the subchannel is neither subchannel-and-device active nor device active, the subchannel becomes status pending immediately after selecting the device and issuing the halt signal. The SCSW for the latter case has the status-pending bit set to one (see “Status-Pending (Bit 31)” on page 16-19).

The termination of an I/O operation by performing the halt function may result in two distinct interruption conditions.

The first interruption condition occurs when the device generates the channel-end condition. The channel subsystem handles this condition as it would any other interruption condition from the device,

except that the command address in the associated SCSW designates the point at which the I/O operation is terminated as follows:

- When a command-mode IRB is stored, the SCSW contains the address of the last-executed CCW, plus 8, and the subchannel-status bits may reflect unusual conditions that were detected.
- When a transport-mode IRB is stored, the SCSW contains the address of the current TCW, and the subchannel-status, subchannel-extended-status, and FCX bits may reflect unusual conditions that were detected.

If the halt signal was issued before all data designated for the operation had been transferred, incorrect length is indicated, subject to the control of the SLI flag in the current CCW when the subchannel is operating in command mode. The value in the count field of the associated SCSW is unpredictable. If the halt signal was issued before all data designated for the operation had been transferred, incorrect length is not indicated, when the subchannel is operating in transport mode.

The second interruption condition occurs if device-end status was not presented with the channel-end interruption condition. In this situation, the subchannel-key, command-address, and count fields of the associated SCSW are not meaningful.

When HALT SUBCHANNEL terminates an I/O operation, the method of termination differs from that used upon exhaustion of count or upon detection of programming errors to the extent that termination by HALT SUBCHANNEL is not contingent on the receipt of a service request from the associated device.

Programming Notes:

1. When, after an operation is terminated by HALT SUBCHANNEL, the subchannel is status pending with primary, primary and secondary, or secondary status, the extent of data transferred as described by the count field is unpredictable.
2. When the path that is chosen by the path-management operation has a channel-path-terminal condition associated with it, the halt function remains pending until the condition no longer exists. Until the condition is cleared, the associated subchannel cannot be used to perform I/O operations, even if other channel paths become

available for selection. CLEAR SUBCHANNEL can be executed to terminate the halt-pending condition and make the subchannel usable.

Start Function and Resume Function

The start and resume functions initiate I/O operations as described below. The start function applies to subchannels operating in either command mode or transport mode. The resume function applies only to subchannels operating in command mode.

Subsequent to the execution of START SUBCHANNEL and RESUME SUBCHANNEL, the channel subsystem performs the start and resume functions, respectively, to initiate an I/O operation with the associated device. Performance of a start or resume function consists of: (1) performing a path-management operation, (2) performing an I/O operation or chain of I/O operations with the associated device, and (3) causing the subchannel to be made status pending, indicating the completion of the start function. (Completion of a start function is described in “I/O Interruptions” on page 16-1.) The start function initiates the execution of a channel program that is designated in the ORB, which in turn is designated as the operand of START SUBCHANNEL, in contrast to the resume function that initiates the execution of a suspended channel program, if any, beginning at the CCW that caused suspension; otherwise, the resume function is performed as if it were a start function (see “Resume-Pending (Bit 20)” on page 16-14).

Start-Function and Resume-Function Path Management

A path-management operation is performed by the channel subsystem during the performance of either a start or a resume function to choose an available channel path that can be used for device selection to initiate an I/O operation with that device. The actions taken are as follows:

1. If the subchannel is currently start pending and device active, the start function remains pending at the subchannel until the secondary status for the previous start function has been accepted from the associated device and the subchannel is made start pending alone. When the status is

accepted and does not describe an alert interruption condition, the subchannel is not made status pending, and the performance of the pending start function is subsequently initiated. If the status describes an alert interruption condition, the subchannel becomes status pending with secondary and alert status, the pending start function is not initiated, deferred condition code 1 is set, and the start-pending bit remains one. If the subchannel is currently start pending alone, the performance of the start function is initiated as described below.

2. If a dedicated allegiance exists at the subchannel for a channel path, the channel subsystem chooses that path for device selection. If a busy condition is encountered while attempting to select the device and a dedicated allegiance exists at the subchannel, the start function remains pending until the internal indication of busy is reset for that channel path. When the internal indication of busy is reset, the performance of the pending start function is initiated on that channel path.
3. If no channel path is available for selection and no dedicated allegiance exists in the subchannel for a channel path, a channel path is not chosen.
4. If all channel paths that are available for selection have been tried and one or more of them are being used to actively communicate with other devices, or, alternatively, if the channel subsystem has encountered either a control-unit-busy or a device-busy condition on one or more of those channel paths, or a combination of those conditions on one or more of those channel paths, the start function remains pending at the subchannel until a channel path, control unit, or device, as appropriate, becomes available.
5. If (1) the start function is to be initiated on a channel path with a device attached to a type-1 control unit and (2) no other device is attached to the same control unit whose subchannel has either a dedicated allegiance to the same channel path or a working allegiance to the same channel path where primary status has not been received for that subchannel, then that channel path is chosen if it is available for selection; otherwise, that channel path is not chosen. If, however, another channel path to the device is available for selection and no allegiances exist as described above, that channel path is chosen. If no other channel path is available for selection,

the start or resume function, as appropriate, remains pending until a channel path becomes available.

6. If the device is attached to a type-3 control unit, and if at least one other device is attached to the same control unit whose subchannel has a dedicated allegiance to the same channel path, another channel path that is available for selection may be chosen, or the start function remains pending until the dedicated allegiance for the other device is cleared.
7. If a channel path has been chosen and a busy indication is received during device selection to initiate the execution of the first command of a pending CCW channel program or to transport the TCCB of a pending TCW channel program, the channel path over which the busy indication is received is not used again for that device or control unit (depending on the device-busy or control-unit-busy indication received) until the internal indication of busy is reset.
8. If, during an attempt to select the device in order to initiate the execution of the first command specified for the start or implied for the resume function for a CCW channel program, or to initiate the transportation of the TCCB for the start function for a TCW channel program, (as described in action 7 above), the channel subsystem receives a busy indication, it performs one of the following actions:
 - a. If the device is specified to be operating in the multipath mode and the busy indication received is device busy, then the start or resume function remains pending until the internal indication of busy is reset. (See "Multipath Mode (D)" on page 15-4.)
 - b. If the device is specified to be operating in the multipath mode and the busy indication received is control unit busy, or if the device is specified to be operating in the single-path mode, the channel subsystem attempts selection of the device by choosing an alternate channel path that is available for selection and continues the path-management operation until either the start or the resume function is initiated or selection of the device has been attempted on all channel paths that are available for selection. If the start or resume function has not been initiated by the channel subsystem after all channel paths available for selection have been chosen, the start or resume function remains pending until the internal indication of busy is reset.
 - c. If the subchannel has a dedicated allegiance, then action 2 on page 20 applies.
9. When, during the selection attempt to transfer the first command for a CCW channel program, or to transport the TCCB for a TCW channel program, the device appears not operational and the corresponding channel path is operational for the subchannel, a path-not-operational condition is recognized, and the state of the channel path changes at the subchannel from operational for the subchannel to not operational for the subchannel (see "Path-Not-Operational Mask (PNOM)" on page 15-5). The path-not-operational conditions at the subchannel, if any, are preserved until the subchannel next becomes clear pending, start pending, or resume pending (if the subchannel was suspended), at which time the path-not-operational conditions are cleared. If, however, the corresponding channel path is not operational for the subchannel, a path-not-operational condition is not recognized. When the device appears not operational during the selection attempt to transfer the first command or TCCB on a channel path that is available for selection, one of the following actions occurs:
 - a. If a dedicated allegiance exists for that channel path, then it is the only channel path that is available for selection; therefore, further attempts to initiate the start or resume function are abandoned, and an interruption condition is recognized.
 - b. If no dedicated allegiance exists and there are alternate channel paths available for selection that have not been tried, one of those channel paths is chosen to attempt device selection and transfer the first command for a CCW channel program, or the TCCB for a TCW channel program.
 - c. If no dedicated allegiance exists, no alternate channel paths are available for selection that have not been tried, and the device has appeared operational on at least one of the channel paths that were tried, the start or resume function remains pending at the subchannel until a channel path, a control unit,

or the device, as appropriate, becomes available.

- d. If no dedicated allegiance exists, no alternate channel paths are available for selection that have not been tried, and the device has appeared not operational on all channel paths that were tried, further attempts to initiate the start or resume function are abandoned, and an interruption condition is recognized.

10. When the subchannel is active and an I/O operation is to be initiated with a device, all device selections occur according to the LPUM indication if the multipath mode is not specified at the subchannel. For example, if command chaining is specified for a CCW channel program, the channel subsystem transfers the first and all subsequent commands describing a chain of I/O operations over the same channel path.

Interrogate Function

Subsequent to the execution of CANCEL SUBCHANNEL for a subchannel operating in transport mode, the channel subsystem performs the interrogate function. Performance of the interrogate function consists of (1) transporting the designated interrogate TCCB to the I/O device, (2) storing the interrogate TSB, and (3) causing the subchannel to become intermediate status pending with interrogate-complete status indicated.

All storage accesses used to perform the interrogate operation are made as if a storage-access key of zero is used.

Interrogate-Function Path Management

The same channel path that was used to transport the TCCB for the I/O operation being interrogated is used for the interrogate function.

Interrogate TCCB Transportation and Completion

Subsequent to determining the channel path, the channel subsystem, if conditions allow, attempts to transport the interrogate TCCB. Conditions associ-

ated with the subchannel, the interrogate TCCB, and the chosen channel path, if any, affect (1) whether an attempt is made to transport the interrogate TCCB, (2) whether the attempt to transport the interrogate TCCB is successful, and (3) whether the interrogate TSB is stored. These conditions and their effect on the interrogate function are described as follows:

No Attempt Is Made to Transport the Interrogate TCCB: The channel subsystem does not transport the interrogate TCCB if any of the following conditions exists:

- The subchannel is status pending with primary status indicated.
- The subchannel is idle or device active only.
- The TCCB for the I/O operation being interrogated has not been transported to the device.
- Another interrogate function is already in progress on the channel path for the I/O device.
- The interrogate-TCW-address field of the TCW for the I/O operation being interrogated contains zeros.
- The channel subsystem doesn't have the resources to process the interrogate.

The Attempt to Transport the Interrogate TCCB or Store the Interrogate TSB is Unsuccessful:

When the channel subsystem attempts to transport the interrogate TCCB, the attempt may not be successful if any of the following conditions exists:

- The interrogate-TCW address designated by the TCW of the I/O operation being interrogated designates an unavailable storage location or does not designate the interrogate TCW on a 64-byte boundary.
- The TCCB-TIDA flag is one in the flags field of the interrogate TCW and the TCCB-address field in the interrogate TCW does not designate the first TIDAW on a quadword boundary.
- The interrogate-TSB address designated by the TCW of the I/O operation being interrogated designates an unavailable storage location or does not designate the interrogate TSB on a doubleword boundary.

If any of the above conditions is true, the subchannel is made status pending with program check and

interrogate-failed status indicated in the subchannel-extended-status field of the IRB.

The attempt to transport the interrogate TCCB is also not successful when a device-detected program check is recognized. In this case, interrogate-failed status is also indicated in the subchannel-extended-status field of the IRB.

If the interrogate TCCB has been sent and the corresponding interrogate response is not received within a model-dependent amount of time, an interface-control check is recognized with interrogate-failed status indicated in the subchannel-extended-status field of the IRB.

The Attempt to Transport the Interrogate TCCB is Successful: When the channel subsystem determines that the attempt to transport the interrogate TCCB was successful and the interrogate data has been received at the subchannel before the completion of the I/O operation being interrogated, the interrogate data is stored into the interrogate TSB, and the subchannel is made status pending with intermediate status and interrogate-complete status indicated. The status related to the operation being interrogated remains unchanged.

When the channel subsystem determines that the operation being interrogated has completed before the interrogate data has been received at the subchannel, the channel subsystem waits until the interrogate data is received. When received, the interrogate data is stored into the interrogate TSB, and the subchannel is made status pending with primary status indicated. The status related to the operation being interrogated is unchanged.

Execution of I/O Operations

After a channel path is chosen, the channel subsystem, if conditions allow, initiates the execution of an I/O operation with the associated device. Execution of additional I/O operations may follow the initiation and execution of the first I/O operation.

For subchannels operating in command mode, the channel subsystem can execute seven types of commands: write, read, read backward, control, sense, sense ID, and transfer in channel. Each command, except transfer in channel, initiates a corresponding I/O operation. Except for periods when channel-pro-

gram execution is suspended at the subchannel (see “Suspension of CCW Channel-Program Execution” on page 15-73), the subchannel is active from the acceptance of the first command until the primary interruption condition is recognized at the subchannel. If the primary interruption condition is recognized before the acceptance of the first command, the subchannel does not become active. Normally, the primary interruption condition is caused by the channel-end signal or, in the case of command chaining, the channel-end signal for the last CCW of the chain. (See “Primary Interruption Condition” on page 16-4.) The device is active until the secondary interruption condition is recognized at the subchannel. Normally, the secondary interruption condition is caused by the device-end signal or, in the case of command chaining, the device-end signal for the last CCW of the chain. (See “Secondary Interruption Condition” on page 16-5.)

For subchannels operating in transport mode, the channel subsystem can transport six types of commands for execution: write, read, control, sense, sense ID, and interrogate. Each command initiates a corresponding device operation. When one or more commands are transported to the I/O device in a TCCB, the subchannel remains start pending until primary status is presented.

Programming Notes:

In the single-path mode, all transfers of commands, data, and status for the I/O operation or chain of I/O operations occur on the channel path over which the first command was transferred to the device.

When the device has the dynamic-reconnection feature installed, an I/O operation or chain of I/O operations may be performed in the multipath mode. To operate in the multipath mode, MODIFY SUBCHANNEL must have been previously executed for the subchannel with bit 13 of word 1 of the SCHIB specified as one. (See “Multipath Mode (D)” on page 15-4.) In addition, the device must be set up for the multipath mode by the execution of certain model-dependent commands appropriate to that type of device. The general procedures for handling multipath-mode operations are as follows:

1. Setup
 - a. A set-multipath-mode type of command must be successfully executed by the device on each channel path that is to be a member of

the multipath group being set up; otherwise, the multipath mode of operation may give unpredictable results at the subchannel. If, for any reason, one or more physically available channel paths to the device are not included in the multipath group, these channel paths must not be available for selection while the subchannel is operating in the multipath mode. A channel path can be made not available for selection by having the corresponding LPM bit set to zero either in the SCHIB prior to the execution of MODIFY SUBCHANNEL or in the ORB prior to the execution of START SUBCHANNEL.

- b. When a set-multipath-mode type of command is transferred to a device, only a single channel path must be logically available in order to avoid alternate channel-path selection for the execution of that start function; otherwise, device-busy conditions may be detected by the channel subsystem on more than one channel path, which may cause unpredictable results for subsequent multipath-mode operations. This type of setup procedure should be used whenever the membership of a multipath group is changed.

2. Leaving the Multipath Mode

To leave the multipath mode and continue processing in the single-path mode, either of the following two procedures may be used:

- a. A disband-multipath-mode type of command may be executed for any channel path of the multipath group. This command must be followed by either (1) the execution of MODIFY SUBCHANNEL with bit 13 of word 1 of the SCHIB specified as zero, or (2) the specification of only a single channel path as logically available in the LPM. A start function must not be performed at a subchannel operating in the multipath mode with multiple channel paths available for selection while the device is operating in single-path mode; otherwise, unpredictable results may occur at the subchannel for that function or subsequent start functions.
- b. A resign-multipath-mode type of command is executed on each channel path of the multipath group (the reverse of the setup described in item 1 on page 23). This com-

mand must be followed by either (1) the execution of MODIFY SUBCHANNEL with bit 13 of word 1 of the SCHIB specified as zero, or (2) the specification of only a single channel path as logically available in the LPM. No start function may be performed at a subchannel operating in the multipath mode with multiple channel paths available for selection while the device is operating in single-path mode; otherwise, unpredictable results may occur at the subchannel for that or subsequent start functions.

Blocking of Data

Data recorded by an I/O device is divided into blocks. The length of a block depends on the device; for example, a block can be a card, a line of printing, or the information recorded between two consecutive gaps on magnetic tape.

The maximum amount of information that can be transferred in one I/O operation is one block. An I/O operation is terminated when the associated main-storage area is exhausted or the end of the block is reached, whichever occurs first. For some operations, such as writing on a magnetic-tape unit or at an inquiry station, blocks are not defined, and the amount of information transferred is controlled only by the program.

Operation-Request Block

The operation-request block (ORB) is the operand of START SUBCHANNEL. The ORB specifies the parameters to be used in controlling that particular start function. These parameters include the interruption parameter, the subchannel key, the address of first CCW or the TCW, operation-control bits, priority-control numbers, and a specification of the logical availability of channel paths to the designated device.

The contents of the ORB are placed at the designated subchannel during the execution of START SUBCHANNEL, prior to the setting of condition code 0. If the execution will result in a nonzero condition code, the contents of the ORB are not placed at the designated subchannel.

The two rightmost bits of the ORB address must be zeros, placing the ORB on a word boundary; otherwise, a specification exception is recognized.

When the fibre-channel-extensions (FCX) facility is installed, the channel-program-type control (B) (word 1, bit 13) of the ORB specifies the type of channel program that is designated by the ORB. When B is zero, the ORB designates a CCW channel program. When the B is one, the ORB designates a TCW channel program. Only I/O-devices that support FCX recognize TCW channel programs.

If the contents of an ORB that designates a CCW channel program are placed at the designated subchannel during the execution of START SUBCHANNEL, the subchannel remains in command mode. Thus, such an ORB is also known as a command-mode ORB. If the contents of an ORB that designates a TCW channel program are placed at the designated subchannel during execution of START SUBCHANNEL, the subchannel enters transport mode. Thus, such an ORB is also known as a transport-mode ORB.

Command-Mode ORB

This section describes the command-mode ORB. The term operation-request block (ORB), in this section, means an ORB in which bit 13 of word 1 (the channel-program-type control (B)) is zero.

The format of the command-mode ORB is as follows when the ORB-format facility is not installed:

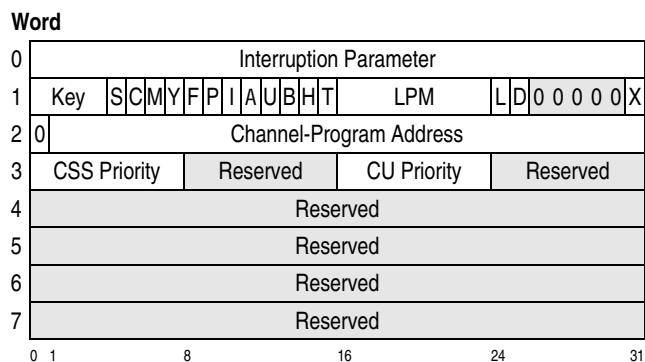

Figure 15-5. Command-Mode Operation-Request Block

The fields in the command-mode ORB are defined as follows:

Interruption Parameter: Bits 0-31 of word 0 are preserved unmodified in the subchannel until replaced by a subsequent START SUBCHANNEL or MODIFY SUBCHANNEL instruction. These bits are placed in word 1 of the interruption code when an I/O interruption occurs and when an interruption request

is cleared by the execution of TEST PENDING INTERRUPTION.

Subchannel Key: Bits 0-3 of word 1 form the subchannel key for all fetching of CCWs, IDAWs, MIDAWs, and output data and for the storing of input data associated with the start function initiated by START SUBCHANNEL. This key is matched with a storage key during these storage references. For details, see the section “Key-Controlled Protection” on page 3-11.

Suspend Control (S): Bit 4 of word 1 controls the performance of the suspend function for the channel program designated in the ORB. The setting of the S bit applies to all CCWs of the channel program designated by the ORB (see “Commands and Flags for CCWs” on page 15-75).

When bit 4 is one, suspend control is specified, and channel-program suspension occurs when a suspend flag set to one is detected in a CCW. When bit 4 is zero, suspend control is not specified, and the presence of a suspend flag set to one in any CCW of the channel program causes a program-check condition to be recognized.

Streaming-Mode Control (C): Bit 5 of word 1 controls streaming-mode enablement for subchannels configured to FICON-converted-I/O-interface channel paths during performance of the specified start function. When bit 5 is zero, the streaming mode is enabled at the subchannel. When bit 5 is one, the streaming mode is disabled at the subchannel. Bit 5 is meaningful only for subchannels configured to FICON-converted-I/O-interface channel paths and is ignored for subchannels configured to other channel-path types.

When the streaming mode is enabled, the channel path considers the first command of the designated channel program to be in progress at the associated device when the channel path receives the indication that the command has been accepted at the device. In addition, the channel path's acceptance of status, under certain conditions, is recognized by the channel path without receiving acknowledgement of status acceptance from the device.

When the streaming mode is not enabled, the channel path does not consider the first command of the designated channel program to be in progress at the associated device until the appropriate channel-path response, indicating that the device-command

response or status has been accepted at the channel path, is sent to the device. In addition, when the device sends status to the channel path, the channel path's acceptance of that status is not recognized at the channel path until the channel path's confirmation of acceptance is received and acknowledged by the device.

Modification Control (M): Bit 6 of word 1 specifies whether modification control is required for the channel program. When bit 6 is zero, modification control is specified. When bit 6 is one, modification control is not specified.

When modification control is specified, the channel subsystem forces command synchronization with the addressed I/O device each time a command is executed and the previously executed command has the PCI and chain-command flags set to one and the chain-data and suspend flags set to zero. When this condition is recognized, the channel subsystem signals a synchronization request to the I/O device for the current command. The channel subsystem temporarily suspends command chaining and does not fetch (or refetch) the next command-chained CCW until after normal ending status is received for the synchronizing command.

When modification control is not specified, then command synchronization is not required, and the channel subsystem may transfer commands to the I/O device without waiting for status.

The M bit is meaningful only for subchannels configured to FICON-I/O-interface or FICON-converted-I/O-interface channel paths and is ignored for other subchannels configured to other channel-path types.

Programming Notes:

1. For FICON-I/O-interface and FICON-converted-I/O-interface channel paths, modification control provides the capability to optimize dynamically modified channel programs that use the PCI flag in the CCW to initiate channel-program modification. Specifically, it allows the program to delay the channel-subsystem fetching and transferring of commands until after status is received for the command following the command with the PCI bit set. This increases the likelihood that a program-controlled interruption will be accepted by a CPU and acted upon by the program that dynamically modifies one or more command-chained CCWs that follow the synchronizing command.

In order to increase the probability that any dynamically modified CCWs are fetched after their modification and not prior to their modification, the modifying program should be executed as soon as possible following the CPU's acceptance of the program-controlled interruption. Additionally, the program should minimize the periods during which the configured CPUs are disabled for I/O interruptions.

For channel paths other than FICON-I/O-interface or FICON-converted-I/O-interface channel paths, command synchronization is implicit in the signaling protocol between the channel subsystem and the I/O device; therefore no explicit programming action is required to force command synchronization. Regardless, the program should still attempt to accept and process program-controlled interruptions for these channel-path types in as timely a manner as possible for the same reason as stated above.

2. In order to allow the channel subsystem to optimize the execution of channel programs for FICON-I/O-interface or FICON-converted-I/O-interface channel paths, use of the modification-control facility is discouraged except for channel programs that require dynamic modification.

Synchronization Control (Y): Bit 7 of word 1 specifies whether synchronization control is required for the channel program. When bit 7 is zero and the prefetch-control bit, bit 9 of word 1, is one, synchronization control is specified. When bit 7 is one and bit 9 is one, synchronization control is not specified.

When synchronization control is specified, the channel subsystem forces command synchronization with the addressed I/O device whenever the current command in execution describes an input operation and the next CCW to be fetched describes an output operation. When this condition is recognized, the channel subsystem signals a synchronization request to the I/O device when the input command is transferred. The transfer of the output command is held pending at the subchannel until normal ending status, signaling the completion of the performance of the input operation by the I/O device, is received. Upon receipt of the ending status, the channel subsystem fetches (or refetches) the data associated with the output command and transfers it to the I/O device.

When synchronization control is not specified, the channel subsystem may transfer commands of the channel program without awaiting status that would signal the completion of the I/O operation for each command.

The Y bit is meaningful only when the subchannel is configured to FICON-I/O-interface or FICON-converted-I/O-interface channel paths and the prefetch-control bit, bit 9 of word 1, is one. The Y bit is ignored for subchannels configured to other channel-path types and when the prefetch-control bit is zero.

CCW-Format Control (F): Bit 8 of word 1 specifies the format of the channel-command words (CCWs) that make up the channel program designated by the channel-program-address field. When bit 8 of word 1 is zero, format-0 CCWs are specified. When bit 8 is one, format-1 CCWs are specified. (See “Channel-Command Word” on page 15-31 for the definition of the CCW formats.)

Prefetch Control (P): Bit 9 of word 1 specifies whether or not unlimited prefetching of CCWs is allowed for the channel program. When bit 9 is one, unlimited prefetching of CCWs is allowed. (Unlimited prefetching of data, IDAWs, and MIDAWs, associated with the current and prefetched CCWs is always allowed.) It is model dependent whether prefetching is actually performed.

When bit 9 of word 1 is zero, no prefetching is allowed, except in the case of data chaining on output, where the prefetching of one CCW describing a data area is allowed. When bit 9 of word 1 is zero, the synchronization-control bit, bit 7 of word 1, is ignored.

Additional controls may limit the scope of prefetching.

Initial-Status-Interruption Control (I): Bit 10 of word 1 specifies whether or not the channel subsystem must verify to the program that the device has accepted the first command associated with a start or resume function. When the I bit is specified as one in the ORB, then, when the subchannel becomes active, indicating that the first command has been accepted for this start or resume function, the Z bit (see “Zero Condition Code (Z)” on page 16-12) is set to one at this subchannel, and the subchannel becomes status pending with intermediate status.

If the subchannel does not become active — for example, when the device signals channel end immediately upon receiving the first command, com-

mand chaining is not specified in the CCW, and command retry is not signaled — the command-accepted condition (Z bit set to one) is not generated; instead, the subchannel becomes status pending with primary status. Intermediate status may also be indicated in this case when the command is accepted if the first CCW contained the PCI flag set to one.

Address-Limit-Checking Control (A): When the address-limit-checking facility is installed, bit 11 of word 1 specifies whether or not address-limit checking is specified for the channel program. When this bit is zero, no address-limit checking is performed for the execution of the channel program, independent of the setting of the limit-mode bits in the subchannel (see “Limit Mode (LM)” on page 15-3). When this bit is one, address-limit checking is allowed for the channel program, subject to the setting of the limit-mode bits in the subchannel.

When the address-limit-checking facility is not installed, the address-limit-checking-control bit (A) must be zero in the ORB when START SUBCHANNEL is executed; otherwise, an operand exception is recognized.

Suppress-Suspended-Interruption Control (U): Bit 12 of word 1, when one, specifies that the channel subsystem is to suppress the generation of an intermediate interruption condition due to suspension if the subchannel becomes suspended. When bit 12 is zero, the channel subsystem generates an intermediate interruption condition whenever the subchannel becomes suspended during the execution of the channel program.

Channel-Program Type Control (B): Bit 13 of word 1 specifies the type of channel program that is designated by the channel-program-address field. When bit 13 is zero, the channel-program-address field designates a CCW channel program. When bit 13 is one, the channel-program-address field designates a TCW channel program. If the FCX facility is not installed and this bit is one, an operand exception or program-check exception is recognized.

Bit 13 also designates the layout of the ORB. When bit 13 is zero, a command-mode ORB is specified. When bit 13 is one, a transport-mode ORB is specified.

Format-2-IDAW Control (H):

Bit 14 of word 1 specifies the format of IDAWs for CCWs that specify indirect data addressing. When

bit 14 of word 1 is one, format-2 (64-bit data address) IDAWs are provided for all CCWs that have the IDAW flag set to one in the CCW. When bit 14 of word 1 is zero, format-1 (31-bit data address) IDAWs are provided for all CCWs that have the IDAW flag set to one in the CCW.

Programming Note: Format-2 IDAWs and MIDAWs provide the only means by which data can be transferred directly between an I/O device and storage locations with addresses greater than 2G bytes.

2K-IDAW Control (T): Bit 15 of word 1 specifies the main-storage block size for format-2-IDAW data areas. Bit 15 is meaningful only when bit 14 (format-2 IDAW control) is one and is ignored when bit 14 is zero. When bit 15 of word 1 is one, all format-2 IDAWs designate 2 K-byte storage blocks. When bit 15 of word 1 is zero, all format-2 IDAWs designate 4 K-byte storage blocks.

Logical-Path Mask (LPM): Bits 16-23 of word 1 are preserved unmodified in the subchannel and specify to the channel subsystem which of the logical paths 0-7 are to be considered logically available, as viewed by the program. A bit setting of one means that the corresponding channel path is logically available; a zero specifies that the corresponding channel path is logically not available. If a channel path is specified by the program as being logically not available, the channel subsystem does not use that channel path to perform clear, halt, resume, or start functions when requested by the program, except when a dedicated-allegiance condition exists for that channel path. If a dedicated-allegiance condition exists, the setting of the LPM is ignored, and a resume, start, halt, or clear function is performed by using the channel path having the dedicated allegiance.

Incorrect-Length-Suppression Mode (L): When bit 8 of word 1 is one, then bit 24 of word 1, when one, specifies the incorrect-length-suppression mode. When the subchannel is in this mode when an immediate operation occurs (that is, when a device signals the channel-end condition during initiation of the command) and the current CCW contains a non-zero value in bit positions 16-31, indication of an incorrect-length condition is suppressed.

When bit 8 of word 1 is one, then bit 24 of word 1, when zero, specifies the incorrect-length-indication mode. When the subchannel is in this mode when an immediate operation occurs (that is, when a device

signals the channel-end condition during initiation of the command) and the current CCW contains a non-zero value in bit positions 16-31, indication of an incorrect-length condition is recognized. Command chaining is suppressed unless the SLI flag in the CCW is one and the chain-data flag is zero.

When bit 8 of word 1 is zero, the value of bit 24 is ignored by the channel subsystem, and the subchannel is in the incorrect-length-suppression mode.

Modified-CCW-Indirect-Data-Addressing Control (D): When the modified-CCW-indirect-data-addressing facility is installed, bit 25 of word 1 specifies whether the channel program may include CCWs that specify modified-CCW-indirect-data-address lists. When bit 25 of word 1 is one, the channel program may include CCWs that specify lists of quadwords each called a modified-CCW-indirect-data-address word (MIDAW). When bit 25 of word 1 is zero, the channel program may not include CCWs that specify modified-CCW-indirect-data-address lists.

When the modified-CCW-indirect-data-addressing facility is not installed, the modified-CCW-indirect-data-addressing control must be zero in the ORB when START SUBCHANNEL is executed; otherwise, an operand exception is recognized.

ORB-Extension Control (X): Bit 31 of word 1 specifies whether the ORB is extended. When bit 31 of word 1 is zero, the ORB consists of words 0-2, and words 3-7 are ignored. When bit 31 of word 1 is one, the ORB consists of words 0-7. Words 0 and 1 are described above. Words 2-7 are described below.

Reserved: Bits 26-30 of word 1 are reserved for future use and must be set to zeros. Bit 31 of word 1 must be zero if the ORB-extension facility is not installed. Otherwise, an operand exception or program-check condition is recognized.

Channel-Program Address: Bits 1-31 of word 2 specify the absolute address of the first CCW in main storage. Bit 0 of word 2 must be zero; otherwise, either an operand exception or a program-check condition is recognized. If format-0 CCWs are specified by bit 8 of word 1, then bits 1-7 of word 2 also must be zeros; otherwise, a program-check condition is recognized.

The three rightmost bits of the channel-program address must be zeros, designating the CCW on a

doubleword boundary; otherwise, a program-check condition is recognized.

If the channel-program address designates a location protected against fetching or designates a location outside the storage of the particular configuration, the start function is not initiated at the device. In this situation, the subchannel becomes status pending with primary, secondary, and alert status.

Channel-Subsystem (CSS) Priority: When bit 31 (X) of word 1 of the ORB is one, byte 0 of word 3 contains an unsigned binary integer, called the channel-subsystem-priority number, that is assigned to the designated subchannel and used to order the selection of subchannels when either a start function or a resume function is to be initiated for one or more subchannels that are start pending or resume pending.

The specified channel-subsystem-priority number can be any number in the range of 0 to 255. The numbers 0 and 255 designate the lowest and highest priorities, respectively.

Depending on the model and the configuration:

1. Fewer than 256 priority levels may be provided. For such models, the ORB-specified priority number may be ignored, and an alternative priority number may be implicitly assigned to the subchannel when the subchannel becomes start pending.
2. When bit 31 (X) of word 1 of the ORB is zero, an implicit priority number is assigned to the subchannel.

See "Channel-Subsystem-I/O-Priority Facility" on page 17-32 for details about how the priority number is assigned for both of these cases.

Control-Unit (CU) Priority: When bit 31 (X) of word 1 of the ORB is one, byte 2 of word 3 contains an unsigned binary integer, called the control-unit-priority number, that specifies, for an associated control unit attached by a FICON channel path, the priority level that is applied at the associated control unit for all I/O operations associated with the start function.

The specified control-unit-priority number can be any integer in the range of 1 to 255. The numbers 1 and 255 designate the lowest and highest priorities,

respectively. The number 0 designates that no priority is assigned to the I/O operations associated with the start function. The handling of I/O operations when the priority number is 0 depends on the control-unit model.

Also depending on the control-unit model, fewer than 255 priority levels may be supported by the control unit. See the control-unit's System Library publication for additional information regarding the range of priority numbers supported and how this priority number is used.

The specified control-unit-priority number is ignored if any of the following conditions exists:

1. Bit 31 (X) of word 1 is zero. In this case, a control-unit-priority number of 0 is transmitted in the associated outbound frames.
2. The designated subchannel is not associated with a control unit configured to a FICON channel path.
3. The associated control unit does not provide prioritized performance of I/O operations. In this case, the control-unit-priority number in the associated outbound frames is ignored at the control unit.
4. The channel-subsystem model does not provide for the transmission of the control-unit-priority number.
5. The channel-subsystem-I/O-priority facility is not operational due to an operator action.

Reserved: All fields in the ORB that are defined as either "0" or "Reserved" must contain zeros when START SUBCHANNEL is executed; otherwise, either an operand exception or a program-check condition is recognized.

Programming Notes:

1. Bit positions of the ORB that presently are specified to contain zeros may in the future be assigned for the control of new functions.
2. The interruption parameter may contain any information, but ordinarily the information is of significance to the program handling the I/O interruption.

Transport-Mode ORB

This section describes the transport-mode ORB. The term operation-request block (ORB), in this section, means an ORB in which bit 13 of word 1 (the channel-program-type control (B)) is one.

The format of the transport-mode ORB is as follows:

Word	0			
0	Interruption Parameter			
1	Key	0 0 0 0 0 0 0 0	B	0 0
			LPM	0 0 0 0 0 0 0 X
2	0	Channel-Program Address		
3	CSS Priority	Reserved	Rsv. for Pgm.	Reserved
4	Reserved			
5	Reserved			
6	Reserved			
7	Reserved			
	0 1	8	16	24 31

Figure 15-6. Transport-Mode Operation-Request Block

The fields in the transport-mode ORB are defined as follows:

Interruption Parameter: This field has the same meaning as in the ORB that designates a CCW channel program. See “Interruption Parameter” on page 15-2.

Subchannel Key: Bits 0-3 of word 1 form the subchannel key for all fetching of TCWs, TCCBs, TIDAWS, and output data and for the storing of input data associated with the start function initiated by START SUBCHANNEL. This key is matched with a storage key during these storage references. For details, see the section “Key-Controlled Protection” on page 3-11.

All storage accesses to the TSB are made as if the subchannel key is zero.

Reserved: All fields in the ORB that are defined as either “0” or “Reserved” must contain zeros when START SUBCHANNEL is executed; otherwise, either an operand exception or a program-check condition is recognized.

Channel-Program Type Control (B): This bit has the same meaning as in the ORB that designates a CCW channel program. For the transport-mode ORB, the value of this bit is one. See “Channel-Program Type Control (B)” on page 15-27.

Logical-Path Mask (LPM): Bits 16-23 of word 1 are preserved unmodified in the subchannel and specify to the channel subsystem which of the logical paths 0-7 are to be considered logically available, as viewed by the program. A bit setting of one means that the corresponding channel path is logically available; a zero specifies that the corresponding channel path is logically not available. If a channel path is specified by the program as being logically not available, the channel subsystem does not use that channel path to perform clear, halt, or start functions when requested by the program.

If the LPM specifies a channel path that does not support FCX, either an operand-exception or a program check may be recognized.

ORB-Extension Control (X): This field has the same meaning as in the ORB that designates a CCW channel program. See “ORB-Extension Control (X)” on page 15-28.

Channel-Program Address: Bits 1-31 of word 2 specify the absolute address of the TCW in main storage. Bit 0 of word 2 must be zero; otherwise, either an operand exception or a program-check condition is recognized.

The six rightmost bits of the channel-program address must be zeros, designating the TCW on a 64-byte boundary; otherwise, a program-check condition is recognized.

If the channel-program address designates a location protected against fetching or designates a location outside the storage of the particular configuration, the start function is not initiated at the device. In this situation, the subchannel becomes status pending with primary, secondary, and alert status.

Channel-Subsystem (CSS) Priority: This field has the same meaning as in the ORB that designates a CCW channel program. See “Channel-Subsystem (CSS) Priority” on page 15-29

Reserved for Program Use (Rsv. for Pgm.): Byte 2 of word 3 is reserved for program use and is not checked or used by the channel subsystem.

Programming Note: See the programming notes on page 29.

Channel-Command Word

The channel-command word (CCW) specifies the command to be executed and, for commands initiating certain I/O operations, it designates the storage area associated with the operation, the action to be taken whenever transfer to or from the area is completed, and other options.

A channel program consists of one or more CCWs that are logically linked such that they are fetched and executed by the channel subsystem in either a sequential or a nonsequential order. Sequential (contiguous) CCWs are linked by the use of the chain-data and chain-command flags, and nonsequential (noncontiguous) CCWs are linked by a CCW specifying the transfer-in-channel command.

As each CCW is executed, it is recognized as the current CCW. A CCW becomes current (1) when it is the first CCW of a channel program and has been fetched, (2) when, during command chaining, the new CCW is logically fetched, or (3) when, during data chaining, the new CCW takes over control of the I/O operation (see "Data Chaining" on page 15-61). When chaining is not specified, a CCW is no longer current after TEST SUBCHANNEL clears the start-function bit in the subchannel.

The location of the first CCW of the channel program is designated in the ORB that is the operand of START SUBCHANNEL. The first CCW is fetched subsequent to the execution of the instruction. The format of the CCWs fetched by the channel subsystem is specified by bit 8 of word 1 of the ORB. Each additional CCW in the channel program is obtained when the CCW is needed. Fetching of the CCWs by the channel subsystem does not affect those locations in main storage.

CCWs have either of two different formats, format 0 or format 1. The two formats do not differ in the information contained in the CCW, but they do differ in the size of the address and the arrangement of fields within the CCW.

The formats are defined as follows:

Format-0 CCW



Format-1 CCW

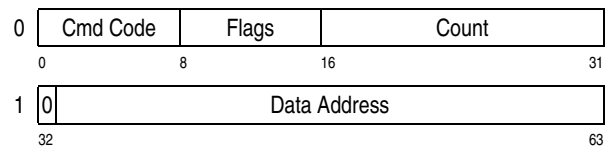

Flags

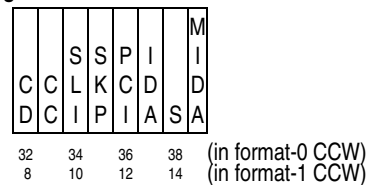

Format-0 CCWs can be located anywhere in the first 2^{24} (16M) bytes of absolute storage, and format-1 CCWs can be located anywhere in the first 2^{31} (2G) bytes of absolute storage.

If indirect data addressing is specified and the format-2-IDAW-control bit is zero in the ORB associated with the CCW, then:

1. Bits 30 and 31 (format 0) or 62 and 63 (format 1) of the CCW must be zeros, designating a word boundary,
2. Bit 0 of the first entry of the indirect-data-address list must be zero.
3. The MIDA flag must be zero.

If indirect data addressing is specified and the format-2-IDAW-control bit is one in the ORB associated with the CCW, bits 29-31 (format 0) or bits 61-63 (format 1) of the CCW must be zeros, designating a doubleword boundary.

If modified indirect data addressing is specified, then:

1. The modified-CCW-indirect-data-addressing-control bit in the ORB must be one.

2. Bits 28-31 (format 0) or bits 60-63 (format 1) of the CCW must be zeros, designating a quadword boundary.
3. The CCW SKP and IDA flags must be zero.
4. The MIDAW count field must be greater than zero.
5. The combination of the MIDAW count and data-address fields must not specify the transfer of data across a 4 K-byte boundary, unless skipping is in effect for the MIDAW.
6. Reserved bits in the first entry of the modified-CCW-indirect-data-address list must be zero.

When any of these requirements is not met, a program-check condition may be recognized (see “CCW Indirect Data Addressing” on page 15-66 and “Modified CCW Indirect Data Addressing” on page 15-68). Detection of this condition during data chaining causes the I/O device to be signaled to conclude the operation. When a failure to meet these requirements is detected during command chaining or subsequent to the execution of START SUBCHANNEL, the new operation is not initiated, and an interruption condition is generated.

The contents of bit positions 40-47 of a format-0 CCW are ignored.

The fields in the CCWs are defined as follows:

Command Code: Bits 0-7 (both formats) specify the operation to be performed.

Data Address: Bits 8-31 (format 0) or bits 33-63 (format 1) designate a location in absolute storage. The designated location is the first location referred to in the area designated by the CCW. Bit 32 of a format-1 CCW must be zero; otherwise, a program-check condition is recognized. If a byte count of zero is specified, this field is not checked.

When the MIDA flag is one, the data-address field must designate an absolute storage location that is on a quadword boundary; otherwise, a program-check condition is recognized.

See “CCW Indirect Data Addressing” on page 15-66 and “Modified CCW Indirect Data Addressing” on page 15-68 for information about the specification of data addresses greater than 2G bytes.

Chain-Data (CD) Flag: Bit 32 (format 0) or bit 8 (format 1), when one, specifies chaining of data. The bit causes the storage area designated by the next CCW to be used with the current I/O operation. When the CD flag is one in a CCW, the chain-command and suppress-length-indication flags (see below) are ignored.

Chain-Command (CC) Flag: Bit 33 (format 0) or bit 9 (format 1), when one, and when the CD flag and S flag are both zeros, specifies chaining of commands. The bit causes the operation specified by the command code in the next CCW to be initiated upon the normal completion of the current operation.

Suppress-Length-Indication (SLI) Flag: Bit 34 (format 0) or bit 10 (format 1) controls whether an incorrect-length condition is to be indicated to the program. When this bit is one and the CD flag is zero, the incorrect-length indication is suppressed. When both the CC and SLI flags are ones and the CD flag is zero, command chaining takes place, regardless of the presence of an incorrect-length condition. This bit should be specified in *all* CCWs where suppression of the incorrect-length indication is desired.

Skip (SKP) Flag: Bit 35 (format 0) or bit 11 (format 1), when one, specifies the suppression of transfer of information to storage during a read, read-backward, sense ID, or sense operation. This bit must be zero when the MIDA flag is one; otherwise, a program-check condition is recognized.

Program-Controlled-Interruption (PCI) Flag: Bit 36 (format 0) or bit 12 (format 1), when one, causes the channel subsystem to generate an intermediate interruption condition when the CCW containing the bit takes control of the I/O operation. When the PCI flag bit is zero, normal operation takes place.

Indirect-Data-Address (IDA) Flag: Bit 37 (format 0) or bit 13 (format 1), when one, specifies indirect data addressing. This bit must be zero when the MIDA flag is one; otherwise, a program-check condition is recognized.

Suspend (S) Flag: Bit 38 (format 0) or bit 14 (format 1), when one, specifies suspension of channel-program execution. When valid, it causes channel-program execution to be suspended prior to the execution of the CCW containing the S flag. A one value of the S flag is valid when bit 4 of word 1 of the associated ORB is one.

Modified-Indirect-Data-Address (MIDA) Flag: Bit 39 (format 0) or bit 15 (format 1), when one, specifies modified indirect data addressing. This bit must be zero when the modified-CCW-indirect-data-addressing-control bit in the ORB is zero, the CCW IDA flag is one, the CCW SKP flag is one, or the channel paths associated with the subchannel do not support modified CCW indirect data addressing; otherwise, a program-check condition is recognized.

Count: Bits 48-63 (format 0) or bits 16-31 (format 1) specify the number of bytes in the storage area designated by the CCW.

Transport Control Word

The transport-control word (TCW) specifies a transport-command-control block (TCCB) whose contents are to be transported to the I/O device for processing. The TCCB contains one or more device-command words (DCWs) and associated options. For a DCW that specifies a command which initiates the transfer of data (with the exception of control data contained within the TCCB), the TCW designates one or more storage areas where the data is located.

When a TCW specifies bidirectional data transfer and the designated DCWs specify write data transfers for storage areas that overlap with the storage areas for read data transfers, the results are unpredictable.

When START SUBCHANNEL is issued specifying a transport-mode ORB, the TCW designated by the ORB becomes the current TCW, the subchannel becomes start pending, and the TCCB designated by the TCW is transported to the I/O device for execution. The TCW remains the current TCW until TEST SUBCHANNEL clears the start-function indication in the subchannel.

The TCW is a 64-byte control block that is designated on a 64-byte boundary. For all operations, except for the interrogate operation, accesses to the TCW by the channel subsystem are made using the subchannel storage-access key specified in the ORB. For interrogate operations, fetch accesses to the interrogate TCW by the channel subsystem are made as if a subchannel storage-access key of zero is used. The channel subsystem does not make any store accesses to a TCW

The format of the TCW is as follows:

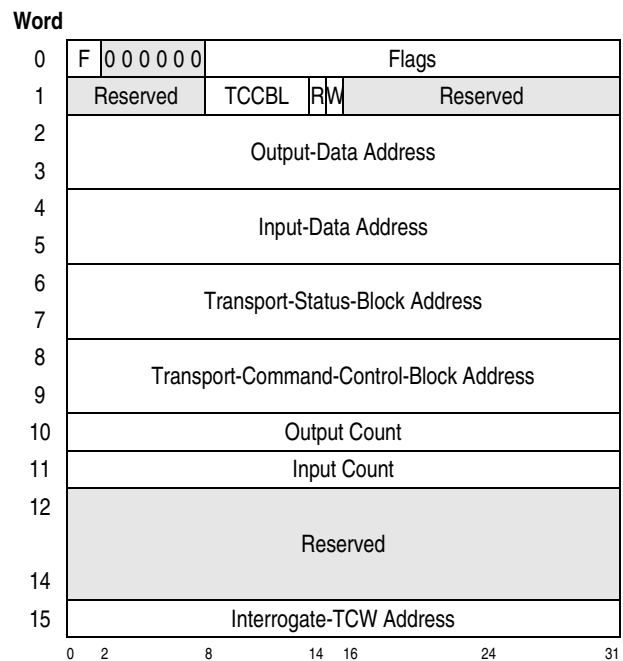

Figure 15-7. Transport-Control Word (TCW)

Format (F): Bits 0-1 of word 0 form the TCW-format that contains a 2-bit unsigned integer value that defines the layout of the TCW. The value of this field must be zero, otherwise a program-check condition is recognized.

Reserved: Bits 2-7 of word 0 are reserved and must be zeros, otherwise a program-check condition is recognized.

Bytes 0 and 2-3 of word 1 and words 12-14 are reserved and not checked. These fields are reserved for future extensions. Programs which place nonzero values in these fields may not operate compatibly on future models.

Flags: Bytes 1-3 of word 0 contain information about the TCW. The meaning of each flag bit is as follows:

Bit	Meaning
0-4	Reserved. Bits 0-4 are reserved and must be zero, otherwise a program-check condition is recognized.
5	Input transport-indirect-data addressing (TIDA): When bit 5 is zero and bit 14 of word 1 (the R-bit) is one, the input-data-

address field designates the absolute address of the input location. When bit 5 is one and the R-bit is one, the input-data-address field designates the absolute address of a transport-indirect-data-address word (TIDAW) or the first TIDAW in a list of TIDAWS that designate the input storage location or locations, respectively.

When the R-bit is zero, bit 5 has no meaning.

6 Transport-command-control-block TIDA: When bit 6 is zero, the transport-command-control-block-address field designates the absolute address of the transport-command-control block for the TCW. When bit 6 is one, the transport-command-control-block-address field designates the absolute address of a TIDAW or list of TIDAWs that designate the location or locations, respectively, of the transport-command-control block for the TCW.

7 Output TIDA: When bit 7 is zero and bit 15 of word 1 (the W-bit) is one, the output-data-address field designates an output location in absolute storage. When bit 7 is one and the W-bit is one, the output-data-address field designates the absolute address of a TIDAW or list of TIDAWs that designates the output storage location or locations, respectively.

When the W-bit is zero, bit 7 has no meaning.

8-9 TIDAW format: Bits 8-9 form a 2-bit encoded field that specifies the format of TIDAWs designated by the TCW. This field must contain zeros, otherwise a program-check condition is recognized.

10-23 Reserved. Bits 10-23 are reserved and must be zero, otherwise a program-check condition is recognized.

Transport-Command-Control-Block Length (TCCBL): Bits 8-13 of word 1, with two zeros appended on the right, specify the unsigned integer whose value, when added to 20 for unidirectional data transfers or when added to 24 for bidirectional data transfers, specifies the length of the TCCB in

bytes. This field, before having 20 added to it for unidirectional data transfers or before having 24 added to it for bidirectional data transfers, must specify a length that is between 12 and 244 inclusive, otherwise a program-check condition is recognized.

Note: The TCCBL is based on the FCP additional command length and does not include the TCA header (16 bytes), and the transport-count (4 bytes) in the TCA trailer for unidirectional data transfers, nor does it include the write count (4 bytes) and read count (4 bytes) in the TCA trailer for bidirectional data transfers.

Read Operations (R): When bit 14 of word 1 is one, the input count (word 11) is valid and contains a nonzero value, indicating the number of bytes to be transferred into main storage.

Write Operations (W): When bit 15 of word 1 is one, the output count (word 10) is valid and contains a nonzero value, indicating the number of bytes to be transferred from main storage.

If the R-bit and W-bit are both one and the device does not support bidirectional data transfer, and flags bit 10 is zero, a program-check condition is recognized.

If the W-bit is one and the TCW is an interrogate TCW, a program-check condition is recognized.

Output-Data Address: When bit 15 of word 1 (the W-bit) is one and bit 7 of the flags field (the output-TIDA flag) is zero, words 2-3 designate the 64-bit output location in absolute storage. When the W-bit is one and the output-TIDA flag is one, words 2-3 designate the 64-bit location in absolute storage of a TIDAW or list of TIDAWs that designate the output storage location or locations.

When the W-bit is one and the output-TIDA flag is one, words 2-3 must designate a storage location that is on a quadword boundary, otherwise a program-check condition is recognized.

When the W-bit is zero, words 2-3 have no meaning and are ignored.

Input-Data Address: When the bit 14 of word 1 (the R-bit) is one and bit 5 of the flags field (the input-TIDA flag) is zero, words 4-5 designate the 64-bit input location in absolute storage. When the R-bit is one and the input-TIDA flag is one, words 4-5 design

nate the location in absolute storage of a TIDAW or list of TIDAWs that designate the input storage location(s).

When the R-bit is one and the input-TIDA flag is one words 4-5 must designate a storage location that is on a quadword boundary, otherwise a program-check condition is recognized.

When the R-bit is zero, words 4-5 have no meaning and are ignored.

Transport-Status-Block Address: Words 6-7 designate the 64-bit location in absolute storage of the transport-status block for the TCW.

Words 6-7 must designate a storage location on an doubleword boundary, otherwise a program-check condition is recognized.

Transport-Command-Control-Block Address: If the transport-command-control-block-TIDA bit (bit 6 of the flags field) is zero, words 8-9 designate 64-bit location in absolute storage of the transport-command-control block. When the transport-command-control-block-TIDA bit is zero, the transport-command-control block is specified to reside in a contiguous area of storage. If the transport-command-control-block-TIDA bit is one, words 8-9 designate the 64-bit location in absolute storage of a TIDAW or list of TIDAWs that designate the location in absolute storage of the transport-command-control block. When the transport-command-control-block-TIDA bit is one, the transport-command-control block may be specified to reside in noncontiguous areas of storage.

When the transport-command-control-block-TIDA flag is zero, words 8-9 should designate a storage location on a doubleword boundary, otherwise, degradation of performance is possible.

When the transport-command-control-block-TIDA flag is one:

- Words 8-9 must designate a storage location on a quadword boundary, otherwise a program-check condition is recognized.
- The transport-command-control-block-address and transport-command-control-block-length fields must not specify a list of TIDAWs that cross a 4 K-byte boundary, otherwise a program-check condition is recognized.

- The TIDAW-transfer-in-channel (TTIC) bit should be zero in all specified TIDAWs, otherwise degradation of performance is possible.
- The first TIDAW should designate the TCCB on a doubleword boundary; otherwise, degradation of performance is possible.

Output Count: When bit 15 of word 1 (the W-bit) is one, word 10 contains the unsigned integer total count of output bytes for the TCW.

When the W-bit is one and word 10 contains zeros, a program-check condition is recognized.

When the W-bit is one:

- The output-count value, rounded upwards to the nearest multiple of 4, plus 4, should equal the value in the transport-count field in the associated TCCB for unidirectional data transfers or the value in the write-count field in the associated TCCB for bidirectional transfer, otherwise this may lead to a device-detected-program-check condition being recognized.
- The output-count value should equal the sum of the following, otherwise this may lead to a device-detected-program-check condition being recognized.
 - The sum of count field values in all of the DCWs that specify a write command.
 - The sum of the count field values in all of the transport-command DCWs that specify the transfer of transport-command-meta information (TCMI) plus the size of the reserved fields in the TCMI. (Note that the size of a TCMI reserved field may be zero. See “Transport-Command DCW” on page 15-42.)
 - The count of any inserted padding and CBC bytes when flags bit 7 (the output-TIDA bit) is one as follows:
 - Four bytes for the CBC information for every TIDAW designated by the output-address field for which the insert-CBC flag bit is one.
 - The count of padding bytes added for every TIDAW designated by the output-address field for which the insert-CBC

flag bit is one. (See “Transport Indirect Data Addressing” on page 15-70.)

When the R-bit is one and word 11 contains zeros, a program-check condition is recognized.

When the W-bit is zero, word 10 is ignored.

Input Count: When bit 14 of word 1 (the R-bit) is one, word 11 contains the unsigned integer total count of input bytes for the TCW.

When the R-bit is one and word 11 contains zeros, a program-check condition is recognized.

When the R-bit is one:

- The input-count value, rounded upwards to the nearest multiple of 4, plus 4, should equal the value in the transport-count field in the associated TCCB for unidirectional transfer or the value in the read-count field in the associated TCCB for bidirectional transfer, otherwise this may lead to a device-detected-program-check condition being recognized.
- The input-count value should equal the sum of count fields in all of the DCWs that specify a read-type command in the associated TCCB and any such DCWs specified in a TCA extension, otherwise this may lead to a device-detected-program-check condition being recognized.

When the R-bit is zero, word 11 is ignored.

Interrogate-TCW Address: When a START SUBCHANNEL designates a TCW, word 15 of the TCW is not checked. When a CANCEL SUBCHANNEL designates a subchannel that is start pending for a TCW channel program and is not status pending, bits 1-31 of word 15 of the TCW designated by START SUBCHANNEL specify the 31-bit location in absolute storage of the interrogate-TCW that is used to initiate

an interrogate operation for the subchannel. If word 15 contains zeros when CANCEL SUBCHANNEL is issued, an interrogate operation is not initiated.

When CANCEL SUBCHANNEL is issued, bit 0 of word 15 must be zero, otherwise a program-check condition is recognized with interrogate-failed status indicated. When CANCEL SUBCHANNEL is issued and bits 1-31 of word 15 do not contain zeros, bits 1-31 of word 15 must designate a storage location on a 64-byte boundary, otherwise a program-check condition is recognized with interrogate-failed status indicated.

Transport-Command-Control Block

The transport-command-control block (TCCB) is variable in length, contains header and trailer information, and from 1 to 30 device-command words (DCWs) that are logically linked such that they are executed by the control unit in a sequential manner.

A TCCB may reside as a single block of contiguous storage or it may reside as multiple blocks of noncontiguous storage. The TCCB-TIDA flag specifies whether the TCCB resides in contiguous storage. When the flag is zero, the TCW designates a contiguous TCCB. When the flag is one, the TCW designates one or more TIDAWs that designate the location of the TCCB in noncontiguous storage.

The transport-command-control block is designated on an doubleword boundary and has a maximum length of 264 bytes. For non-interrogate operations, fetch accesses to the TCCB by the channel subsystem are made using the subchannel storage-access key specified in the ORB. For interrogate operations, fetch accesses to the interrogate TCCB by the channel subsystem are made as if a storage-access key of zero is used. The channel subsystem does not make any store accesses to a TCCB nor does it examine its contents.

The format of the TCCB is as follows:

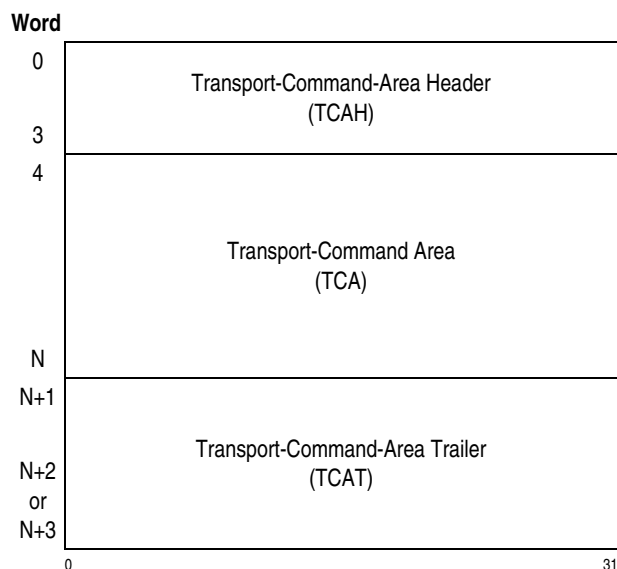

Explanation:

The offset of the last word of the TCCB is N+2 for unidirectional data transfers and N+3 for bidirectional data transfers.

Figure 15-8. Transport-Command-Control Block (TCCB)

Transport-Command-Area Header

The transport-command-area header (TCAH) is a 16-byte control block that contains information about the transport-command area and the operations described therein. The TCAH has the following format:

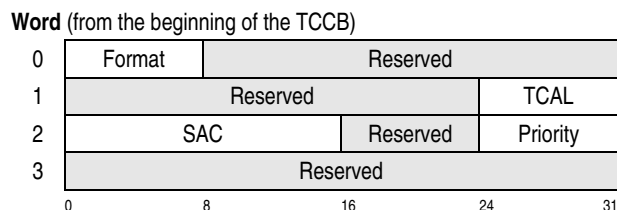

Figure 15-9. Transport-Command-Area Header (TCAH)

Format Control: Byte 0 of word 0 is the TCCB format control. The value of this field must be 7F hex, otherwise a device-detected-program-check is recognized.

Reserved: Byte 1 of word 0 is reserved and must contain zeros, otherwise a device-detected-program-check condition may be recognized. Bytes 2-3 of word 0, bytes 0-2 of word 1, byte 2 of word 2, and bytes 0-3 of word 3 are reserved and should contain

zeros, otherwise the channel program may not operate compatibly in the future.

Transport-Command-Area Length (TCAL): Byte 3 of word 1 specifies an 8-bit unsigned integer whose value, when reduced by 12, specifies the length of the TCA in bytes. The specified value must be a non-zero multiple of 4 that is between 20 and 252, inclusive, otherwise a device-detected-program-check condition may be recognized.

Service-Action Code (SAC): Bytes 0-1 of word 2 contain an unsigned integer value that must be either 1FFE hex or 1FFF hex. The meanings of these values is device dependent.

Priority: Byte 3 of word 2 contains the 8-bit unsigned binary integer priority value for the TCCB. A value of zero indicates that no priority has been assigned. Valid priority values range from 1, the lowest priority, to 255, the highest priority.

Transport-Command Area

The transport-command area (TCA) is a variable-length area that contains from 1 to 30 device-command words (DCWs). The length of the TCA is an integral number of words.

For DCWs that specify control data, the TCA also contains the control data associated with the commands. Each DCW that specifies control data, reduces the maximum-DCW capacity by one or more DCWs, depending on the size of the command-associated data.

For DCWs that specify input or output data, the TCW specifying the TCCB designates the associated storage area or areas (see “Input-Data Address” on page 15-34 and “Output-Data Address” on page 15-34) and the DCW designates the count of bytes to transfer.

For some devices, the list of DCWs may be extended past what will fit in the TCA. For such devices, the TCA extension (TCAX) is specified and transferred as if it were output data; however, the TCAX is treated as a logical continuation of the TCA instead of transfer data. (See “Transport-Command-Area Extension” on page 15-45.) A TCAX is specified by the transfer-TCA-extension DCW. (See “Transfer-TCA-Extension DCW” on page 15-44.)

Whether a device supports TCA extensions is determined by device-dependent means.

The maximum size of the TCA is 240 bytes. The TCA has the following format:

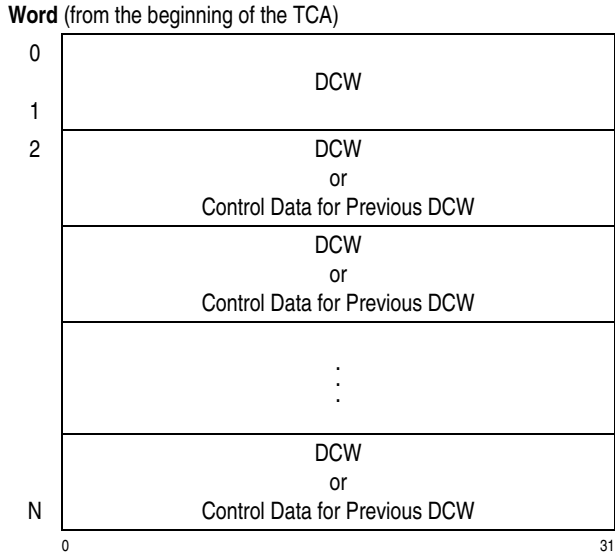

Figure 15-10. Transport-Command Area (TCA)

Device-Command Word

A device-command word (DCW) specifies a command to be executed. For commands initiating certain I/O operations, it designates the count of bytes on which the operation is performed, the action to be taken whenever transfer to or from storage is completed, and other options. The storage area or areas associated with a DCW data-transfer operation are designated, depending on the operation specified by the command, by the input-data-address field or the output-data-address field of the TCW that designates the transport-control-block containing the DCW. Whether the input-data-address field or the output-data-address field of the TCW designates the storage directly or indirectly, by use of a TIDAW list, is specified by the input-TIDA and output-TIDA flags in the TCW, respectively.

For commands initiating control operations, the associated data immediately follows the command. If this data is not a multiple of 4 bytes, the field immediately following the data begins on the next word boundary that immediately follows the last byte of specified data. In the TCA, this field will be either the next DCW, if additional DCWs are specified, or the transport-command-area trailer, if additional DCWs are not specified. When the DCW is in a transport-com-

mand-area extension (TCAX), this field will be one of the following:

- The next DCW when additional DCWs are specified.
- The TCAX reserved area when present, and additional DCWs are not specified.
- The end of the TCAX when the TCAX reserved area is not present and additional DCWs are not specified.

As each DCW is executed and while it is executing it is recognized as the current DCW. A DCW becomes current when it is the first DCW of a channel program and has been selected by the I/O device for execution or when, during command chaining, the subsequent DCW takes over control of the I/O operation.

The first DCW to be executed is at offset zero of the TCA in the TCCB. Each additional DCW in the channel program is also in the TCA and is used when the DCW is needed by the I/O device.

The DCW is an 8-byte control block that is designated on an word boundary. The format of the DCW is as follows:

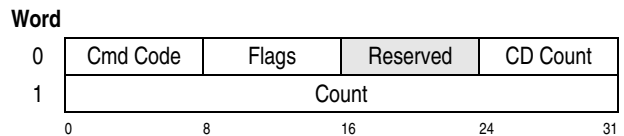

Flags:

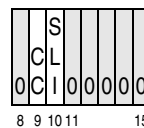

Figure 15-11. Device-Command Word (DCW)

Command Code : Bits 0-7 of word 0 specify the operation to be performed.

Whether a command is valid is device dependent and dependent on the value of the service-action-code field in the TCAH.

Reserved: Bits 8, 11-15, and 16-23 of word 0 are reserved and should contain zeros, otherwise the channel program may not operate compatibly in the future. When the FCX-incorrect-length-indication facility is not installed or the device does not support

incorrect-length indication, bit 10 of word 0 is reserved and should contain zero, otherwise the channel program may not operate compatibly in the future.

Chain-Command (CC) Flag: Bit 9 of word 0, when one, specifies the chaining of commands. When one, the bit causes the operation specified by the next DCW to be initiated upon normal completion of the current DCW. When the control-data count is zero, the next DCW immediately follows the DCW in the TCA or TCAX. When the control-data count is not zero, the next DCW immediately follows the control-data, rounded to a word boundary, specified for the DCW.

If bit 9 of word 0 is one in a DCW whose offset, plus 8, plus its control-data-count value leaves less than 8 bytes in the TCA and a TCAX is not specified, a device-detected-program-check condition may be recognized.

If bit 9 of word 0 is one in a DCW whose offset, plus 8, plus its control-data-count value leaves less than 8 bytes in the TCAX, a device-detected-program-check condition may be recognized.

If bit 9 of word 0 is zero in a DCW whose offset, plus 8, plus its control-data-count value leaves greater than 3 bytes remaining in the TCA, a device-detected-program-check condition may be recognized.

Note: When the chain-command flag is one, the next DCW location in the TCA or TCAX is determined by adding eight and the value in the CD-count field to the location of the current DCW and rounding upwards to the nearest word boundary. If the chain-command flag is one in a DCW in a TCA, the next DCW location is past the end of the TCA, and a TCAX is specified, the next DCW is at the beginning of the TCAX.

Suppress-Length-Indication (SLI) Flag: When the FCX-incorrect-length-indication facility is installed and the device supports incorrect-length indication, bit 10 of word 0 controls whether an incorrect-length condition is to be indicated to the program when the condition is recognized for the DCW in control as follows:

- When the SLI flag is one, incorrect-length indication is suppressed. When both the CC and SLI

flags are ones, command chaining takes place, regardless of the presence of an incorrect-length condition. This bit should be specified as one in *all* DCWs where suppression of the incorrect-length indication is desired.

- When the SLI flag is not one, processing of the TCA is terminated (command-chaining is terminated) and the subchannel is made status pending with incorrect length indicated in the subchannel status.

When an incorrect-length condition exists for a DCW and the SLI flag in the DCW is set to zero, data transfer occurs as follows for read operations:

- If the DCW count is greater than the amount of data available at the device for the command, the data available at the device is transferred.
- If the DCW count is less than the amount of data available at the device for the command, only an amount of data equal to the DCW count is transferred

When an incorrect-length condition exists for a DCW and the SLI flag in the DCW is set one, data transfer occurs as follows for read operations:

- If the DCW count is greater than the amount of data available at the device for the command and the DCW chain-command (CC) flag is one, the following occurs in order:
 - 1) The data available at the device is transferred.
 - 2) Pad bytes of zeros are transferred until the total amount transferred is equal to the DCW count.
- If the DCW count is greater than the amount of data available at the device for the command and the DCW chain-command (CC) flag is zero, the following occurs in order:
 - 1) The data available at the device is transferred
 - 2) Depending on the device, either data transfer is terminated or pad bytes of zeros are transferred until the total amount transferred is equal to the DCW count.

- If the DCW count is less than the amount of data available at the device for the command, only an amount of data equal to the DCW count is transferred

When an incorrect-length condition exists for a DCW, data transfer occurs as follows for write operations regardless of the setting of the SLI flag:

- If the DCW count is greater than the amount of data required by the device for the command and the DCW chain-command (CC) flag is one, the following occurs in order:
 - 1) The data required by the device is transferred.
 - 2) Data continues to be transferred until the total amount transferred is equal to the DCW count. Data not required by the device is discarded.
- If the DCW count is greater than the amount of data required by the device for the command and the DCW chain-command (CC) flag is zero, the following occurs in order:
 - 1) The data required by the devices is transferred.
 - 2) Data continues to be transferred until the next intermediate CBC is specified to be inserted or until the total amount transferred is equal to the DCW count. Data not required by the device is discarded.
- For write operations, if the DCW count is less than the amount of data required by the device for the command, only the amount of data specified by the DCW count is transferred.

Whether a device supports the suppression of incorrect-length indication is determined by device-dependent means.

Control-Data (CD) Count: When the command-code field specifies a command that requires control data, the data for the command immediately follows the DCW and byte 3 of word 0 specifies the length of the data, in bytes. If the command code specifies a command that requires control data and byte 3 of word 0 specifies a control-data count that is less than required for the command a unit-check condition is recognized. If the command code specifies a command that requires control data and byte 3 of word 0

contains zero or contains a value that specifies data past the end of the TCA or past the end of the specified TCAX, a device-detected-program-check condition is recognized.

Count: Word 1 specifies the 32-bit unsigned integer count of bytes in the storage area designated by the TCW for this DCW.

Transport-Command-Area Trailer

The transport-command-area trailer (TCAT) contains additional information about the TCCB. When uni-directional data transfer is specified (either the R-bit or the W-bit is set to one) or no data transfer is specified (both the R-bit and W-bit in the TCW are set to zero), the TCAT is two words in length. When bidirectional data transfer is specified (both the R-bit and the W-bit in the TCW are set to one), the TCAT is three words in length. The TCAT has the following format:

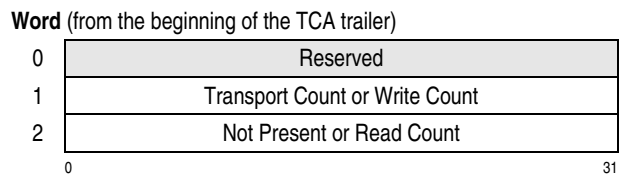

Figure 15-12. Transport-Command-Area Trailer (TCAT)

Reserved: Word 0 is reserved and not checked.

Transport Count: When uni-directional data transfer is specified, word 1 is the transport count and specifies the 32-bit unsigned integer count of total data to be transferred.

When a read operation is specified (the TCW R-bit is one), the value in the transport-count field in the TCAT is determined as follows, otherwise a device-detected-program-check condition may be recognized:

- The count field values in the DCWs that each specify a read-type command are summed.
- The sum is rounded upwards to the nearest multiple of 4.
- The rounded sum is increased by 4 giving the transport-count value.

When a read operation is specified, the transport-count value should be equal to the value in the TCW input-count field, rounded upwards to the next multi-

ple of 4, plus 4, otherwise a device-detected-program-check condition may be recognized.

When a write operation is specified (the W-bit in the TCW is one), the value in the transport-count field in the TCAT is determined as follows, otherwise a device-detected-program-check condition may be recognized:

- The count field values in the DCWs that each specify a write command are summed.
- The count field values in all of the transport-command DCWs that specify the transfer of transport-command-meta information (TCMI) plus the size of the reserved fields in the TCMI are added to the sum. (Note that the size of a TCMI reserved field may be zero. See “Transport-Command DCW” on page 15-42.)
- The total of the counts of any TIDAW-specified CBC bytes and padding bytes (see “Transport Indirect Data Addressing” on page 15-70) is added to the sum.
- The sum is rounded upwards to the nearest multiple of 4.
- The rounded sum is increased by 4 giving the transport-count value.

When a write operation is specified, the transport-count value should be equal to the value in TCW output-count field, rounded upwards to the next multiple of 4, plus 4, otherwise a device-detected-program-check condition may be recognized.

When neither a read nor a write operation is specified (both the W-bit and R-bit in the TCW are zero), the transport count value should be zero, otherwise this may lead to a device-detected-program-check condition being recognized.

Write Count: When bidirectional data transfer is specified, word 1 is the write count and specifies the 32-bit unsigned integer count of total output data to be transferred. The value in the write-count field in the TCAT is determined as follows, otherwise a device-detected-program-check condition may be recognized:

- The count field values in the DCWs that each specify a write command are summed.
- The count field values in all of the transport-command DCWs that specify the transfer of transport-command-meta information (TCMI) plus the size of the reserved fields in the TCMI are added to the sum. (Note that the size of a TCMI reserved field may be zero. See “Transport-Command DCW” on page 15-42.)
- The total of the counts of any TIDAW-specified CBC bytes and padding bytes (see “Transport Indirect Data Addressing” on page 15-70) is added to the sum.
- The sum is rounded upwards to the nearest multiple of 4.
- The rounded sum is increased by 4 giving the transport-count value.

The write-count value should be equal to the value in TCW output-count field, rounded upwards to the next multiple of 4, plus 4, otherwise a device-detected-program-check condition may be recognized.

Read Count: When uni-directional data transfer is specified the read count field is not present. When a bidirectional data transfer is specified, word 2 is the read count and specifies the 32-bit unsigned integer count of total input data to be transferred. The value in the read-count field in the TCAT is determined as follows, otherwise a device-detected-program-check condition may be recognized:

- The count field values in the DCWs that each specify a read-type command are summed.
- The sum is rounded upwards to the nearest multiple of 4.
- The rounded sum is increased by 4 giving the transport-count value.

The read-count value should be equal to the value in the TCW input-count field, rounded upwards to the next multiple of 4, plus 4, otherwise a device-detected-program-check condition may be recognized.

Programming Note: The following table summarizes the determination of the TCW input-count, output-

count, and the TCCB transport count values for unidirectional data transfers:

Operation	TCW Input Count	TCW Output Count	TCAT Transport Count
Input operation (TCW R-bit is 1)	Sum of DCW count values in the TCA.	n/a	Sum of DCW count values in TCA, rounded to four, ² plus four ²
Output operation (TCW W-bit is 1), TIDAWS not used (TCW output-TIDA flag is 0)	n/a	Sum of DCW count values in TCA.	Sum of DCW count values in TCA, rounded to four, ² plus four ²
Output operation (TCW W-bit is 1), TIDAWS used (TCW output-TIDA flag is 1)	n/a	Sum of DCW count values in TCA and TCAX plus the size of the reserved areas in any specified TCMI ³ , plus total of TIDAW-specified CBC and padding bytes ¹	Sum of DCW count values in TCA and TCAX, plus the size of the reserved areas in any specified TCMI ³ , plus total of TIDAW-specified CBC and padding bytes, ¹ rounded to four, ² plus four ²
Explanation:			
¹ See the description of the insert-CBC control in "Flags" on page 15-70.			
² The channel subsystem adds a CBC word to the end of the last data transported. Up to 3 padding bytes are added after the last data transported to ensure the added CBC word is on a word boundary.			
³ Because of alignment requirements, the size of the reserved area in a TCMI is either 0 or 4.			

Figure 15-13. Determination of the TCAT Transport Count, TCW Input Count, and TCW Output Count for Uni-Directional Data Transfers

The following table summarizes the determination of read and write count values for bidirectional data transfers: the TCW input-count, output-count, and the TCCB transfers:

Operation	TCW Input Count	TCW Output Count	TCAT Read Count	TCAT Write Count
Input operation (TCW R-bit is 1) and output operation (TCW W-bit is 1), TIDAWS not used (TCW output-TIDA flag is 0)	Sum of read DCW count values in the TCA and TCAX.	Sum of write DCW count values in the TCA, plus count values in DCWs that specify the transfer of TCMI	Sum of read DCW count values in the TCA and TCAX, rounded to four, ² plus four ²	Sum of write DCW count values in the TCA, plus count values in DCWs that specify the transfer of TCMI, rounded to four, ² plus four ²
Input operation (TCW R-bit is 1) and output operation (TCW W-bit is 1), TIDAWS used (TCW output-TIDA flag is 1)	Sum of read DCW count values in the TCA and TCAX.	Sum of write DCW count values in the TCA and TCAX, plus count values in DCWs that specify the transfer of TCMI, plus the size of the reserved areas in any specified TCMI ³ , plus total of TIDAW-specified CBC and padding bytes. ¹	Sum of read DCW count values in the TCA and TCAX, rounded to four, ² plus four ²	Sum of write DCW count values in the TCA and TCAX, plus count values in DCWs that specify the transfer of TCMI, plus the size of the reserved areas in any specified TCMI ³ , plus total of TIDAW-specified CBC and padding bytes, ¹ rounded to four, ² plus four ²
Explanation:				
¹ See the description of the insert-CBC control in "Flags" on page 15-70.				
² The channel subsystem adds a CBC word to the end of the last data transported. Up to 3 padding bytes are added after the last data transported to ensure the added CBC word is on a word boundary.				
³ Because of alignment requirements, the size of the reserved area in a TCMI is either 0 or 4.				

Figure 15-14. Determination of the TCAT Transport Count, TCW Input Count, TCAT Read Count, and TCAT Write Count for Bidirectional Data Transfers

Transport-Command DCW

A transport-command DCW specifies a transport command that performs a device-support function associated with transport-mode operations. (See "Command Code" on page 15-57.) A transport-command DCW may specify control data and may also

specify the transfer of transport-command-meta information (TCMI).

When a transport-command DCW specifies the transfer of TCMI to a device, the TCMI is transferred as output data. The size of the TCMI is command-

dependent and is a multiple of 4. Furthermore, the TCMI may be extended by 4 reserved bytes when all of the following are true:

- The size of the TCMI is an even multiple of 4.
- TIDAWs are used to specify the output storage areas.
- The insert-CBC flag is one in the last TIDAW used to specify the storage containing the TCMI.
- The chain-command bit is one in the transport-command DCW that specifies the TCMI.
- A subsequent DCW specifies the transfer of a TCMI or output data.

Note that when a transport command specifies the transfer of a TCMI to a device and the TCMI is extended by 4 reserved bytes because all of the preceding conditions are met, the 4 reserved bytes are not included in the data-count value in the transport-command DCW but are included in the following:

- The count value in the last TIDAW used to specify the storage containing the TCMI.
- The output-count value in the TCW.
- The transport-count value in the associated TCCB for unidirectional data transfers or the write-count value in the associated TCCB for bidirectional transfer.

The following summarizes the transport-command DCWs and identifies the specific TCMI that may be transferred to the device:

Transport-Command DCW	Transport-Command-Meta Information (TCMI)	Page
Transfer-CBC-Offset Block TCOB_	CBC-Offset Block (COB)	15-43
Transfer-TCA Extension (TTE)	TCA Extension (TCAX)	15-44
Interrogate	(none)	15-46
Explanation: (none) - The transport-command DCW does not transfer TCMI.		

Figure 15-15. Summary of Transport-Command DCWs

Transfer-CBC-Offset-Block DCW

For write operations, the transfer-CBC-offset-block (TCOB) DCW specifies that a CBC-offset block (COB) is transported to the device. The content of the TCOB DCW is as follows:

- The command code contains the transfer-CBC-offset-block command which is a value of 60 hex.
- The chain-command flag is one.
- When the CD-count is not zero, the COB immediately follows the TCOB DCW in the TCA and the CD-count specifies the number of CBC offsets in the COB multiplied by 4.
- When the CD-count is zero, the COB is specified as TCMI in the output data, the location of the COB is specified by the output-data-address field in the TCW, and the count field specifies the number of CBC offsets in the COB multiplied by 4.

The incorrect-length condition is not recognized for the transfer-CBC-offset-block command regardless of whether the FCX-incorrect-length-indication facility is installed and supported by the device.

When a TCOB DCW is used, a device-detected program check is recognized when any of the following conditions exist:

- A TCOB DCW is specified and a write operation is not specified (that is, the W-bit in the TCW is zero).
- A TCOB DCW is the only DCW in the TCA. (That is the chain-command flag in the TCOB DCW is zero.)
- A TCOB DCW is not the first DCW in the TCA.
- More than one TCOB DCW is specified
- The control-data-count field and the count field in the TCOB DCW both contain the value zero or both contain a value that is nonzero.
- The control-data-count field contains the value zero, the count field contains a value that is nonzero, but the value in the count field is not a multiple of 4.
- The count field contains the value zero, the control-data-count field contains a value that is nonzero, but the value in the control-data-count field is not a multiple of 4.

When a TCOB is used that specifies the COB in the output data, the following must be true; otherwise, a device-detected program check may be recognized:

- The output-TIDA flag (flags bit 7) in the TCW must be one.
- The insert-CBC control must be set to one in the last or only TIDAW that is used to transfer the COB when the transfer of a TCAX or output data or both is also specified.
- When there is an odd number of CBC offsets in the COB, the total of the count fields in the TIDAWs used to transfer the COB must specify the number of CBC offsets in the COB multiplied by 4. When there is an even number of CBC offsets in the COB, the total of the count fields in the TIDAWs used to transfer the COB must specify the number of CBC offsets in the COB multiplied by 4, plus 4.

Whether a device recognizes the TCOB command is determined by device-dependent means.

CBC-Offset Block

The CBC-offset block (COB) is a variable-length control block that contains a list of 4-byte entries, each of which identifies the offset of a CBC specified by a TIDAW to be inserted in the output data. When the COB is specified in the output data, the offset of the CBC inserted by the TIDAW that specifies the transfer of the COB is not included in the COB.

Accesses to a CBC-offset block by the channel subsystem are treated as if a storage-access key of zero is used.

The COB has the following format:

4-Byte Entry

0	CBC Offset 0
1	CBC Offset 1
2	.
⋮	⋮
N	CBC Offset N

Figure 15-16. CBC-Offset Block (COB)

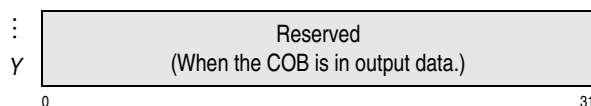

Explanation:

- The size of the COB is $4(N+1)$ when the COB is specified in the TCA. (There is no reserved field for this case.)
- The size of the COB is $4(Y+1)$ when the COB is specified in the output data, where Y is an even number that is equal to either N or $N+1$.

Figure 15-16. CBC-Offset Block (COB) (Continued)

CBC Offsets: Entries 0 through N contain CBC offsets. Each CBC offset is a 4-byte field containing a 32-bit unsigned integer value that specifies the relative offset, from the beginning of the output-data area, to a CBC that is specified to be inserted by a TIDAW. When a COB is in the TCA, the beginning of the output-data area is specified by the output-data-address field of the TCW. When a COB is in the output-data, the output-data area begins immediately after the COB.

Reserved: When a COB is specified in the TCA, or a COB is specified in the output data and there is an odd number of CBC offsets in the COB, there are no reserved bytes.

When a COB is specified in the output data and there is an even number of CBC offsets in the COB, the 4 bytes immediately following the last CBC offset are reserved and should contain zeros, otherwise unpredictable results may result.

See “Transport-Command DCW” on page 15-42 for the handling of reserved bytes when calculating the DCW count, TIDAW count, TCCB write-count (for bidirectional transfers) and TCCB transport count (for unidirectional data transfers).

Programming Note: When a device indicates that it supports the TCOB command and TIDAWs are used that specify insert-CBC, a TCOB and COB should be used; otherwise, unpredictable results or errors may result.

Transfer-TCA-Extension DCW

The transfer-TCA-extension (TTE) DCW specifies that the TCA is logically extended in the output data and that the TCA extension (TCAX) is transported to the device. The content of the TTE DCW is as follows:

- The command code contains the transfer-TCA-extension command which is the value of 50 hex.
- The chain-command flag is set to one.
- The CD-count is zero.
- The count specifies the length of the TCAX as a multiple of 4.

The incorrect-length condition is not recognized for the transfer-TCA-extension command regardless of whether the FCX-incorrect-length-indication facility is installed and supported by the device.

When a TTE DCW is used, a device-detected program check is recognized when any of the following conditions exist:

- When a TCOB DCW is not specified, the TTE DCW is not the first DCW in the TCA. When a TCOB DCW is specified, the TTE DCW is not the second DCW in the TCA.
- The TTE DCW is specified and a write operation is not specified (that is, the W-bit in the TCW is zero).
- The chain-command flag in the TTE DCW is zero.
- More than one TTE DCW is specified
- The control-data-count field in the TTE DCW does not contain zero.
- The count field contains less than 8 or a value that is not a multiple of 4.
- Any of the following are true for the TCA:
 - The TCA does not contain at least one DCW that is not a transport-command DCW.
 - The TCA contains one or more DCWs that are not transport-command DCWs and the chain-command flag in the last DCW of the TCA is zero.

Whether a device recognizes the TTE command is determined by device-dependent means.

Programming-System Note: When a TTE DCW is used and additional TCMI and/or output data follows the TCAX, the following should be true; otherwise, a device-detected program check may be recognized:

- The output-TIDA flag (flags bit 7) in the TCW must be one.
- When TIDAWs are used for the transfer of a TCAX and for the transfer of data, the insert-CBC control must be set to one in the last or only TIDAW that is used to transfer the TCAX. When TIDAWs are used for the transfer of only the TCAX, it is not necessary to set the insert-CBC control in the last or only TIDAW.

Transport-Command-Area Extension

The transport-command-area extension (TCAX) is a variable-length area that is the logical continuation of the TCA. At a minimum, the TCAX contains one DCW. The length of the TCAX is an integral multiple of 4 and is specified by the TTE DCW.

For DCWs that specify control data, the TCAX also contains the control data associated with the commands.

For DCWs that specify input or output data, the associated TCW designates the associated storage area or areas (see “Input-Data Address” on page 15-34 and “Output-Data Address” on page 15-34) and the DCW designates the count of bytes to transfer.

The maximum size of the TCAX is device dependent. The TCAX has the following format:

4-Byte Entry

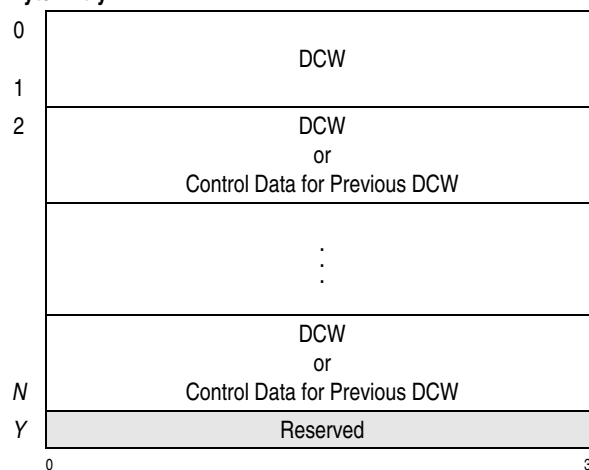

Explanation:

The size of the TCAX is $4(Y+1)$, where Y is an even number that is equal to either N or N+1.

Figure 15-17. Transport-Command Area Extension (TCAX)

Device-Command Word (DCW) or Control Data for Previous DCW: For information about DCWs and control data, see “Device-Command Word” on page 15-38.

Reserved: When the last information in the TCAX is a DCW, the end of the DCW defines the end of the meaningful information in the TCAX. When the last information in the TCAX is control data and the control data ends on a 4-byte boundary, the end of the control data defines the end of the meaningful information in the TCAX. When the last information in the TCAX is control data and the control data does not end on a 4-byte boundary, padding bytes are appended to the control data to reach a 4-byte boundary and the end of the padding bytes define the end of the meaningful information in the TCAX.

When the size of the meaningful information in the TCAX divided by four is an odd number, there are no reserved bytes; otherwise, the four bytes immediately following the meaningful information in the TCAX are reserved and should contain zeros, otherwise unpredictable results may result.

See “Transport-Command DCW” on page 15-42 for the handling of reserved bytes when calculating the DCW count, TIDAW count, TCAT write-count (for bidirectional transfers) and TCAT transport count (for unidirectional data transfers).

Interrogate TCCB

The interrogate TCCB is a TCCB that specifies a service-action code value of 1FFF hex, contains a TCA that is at least 8 bytes in length that specifies an interrogate DCW, and may specify a read operation.

Any data that immediately follows the interrogate DCW and is specified by a nonzero CD-count in the interrogate DCW is transported to the device and may be written to a device-dependent log. Any input data that is specified by the interrogate TCW is device-dependent data and is transferred from the I/O device.

Accesses to the interrogate TCCB by the channel subsystem are treated as if a storage-access key of zero is used.

The format of the interrogate TCA is as follows:

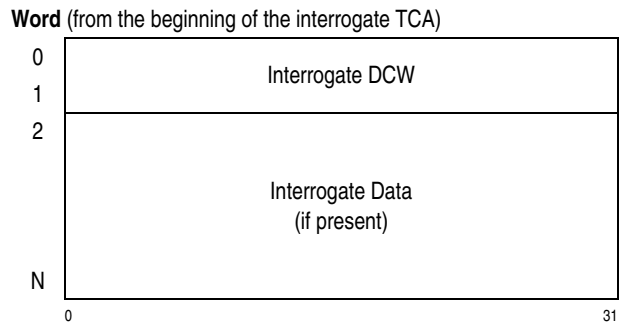

Figure 15-18. Interrogate Transport-Command Area (TCA)

Interrogate DCW

Words 0 and 1 of the interrogate TCA contain a DCW that specifies an interrogate operation. The content of the interrogate DCW is as follows:

- The command code contains the interrogate command which is a value of 40 hex.
- The CD-count field must contain a value that is not greater than 232, otherwise a device-detected-program-check condition is recognized with interrogate-failed status indicated in the subchannel-extended-status field of the IRB.
- With the exceptions of the command code, SLI flag, count and CD-count fields, all other fields in the DCW must contain zeros, otherwise a device-detected-program-check condition is recognized with interrogate-failed status indicated in the subchannel-extended-status field of the IRB.

The incorrect-length condition is not recognized for the interrogate command regardless of whether the FCX-incorrect-length-indication facility is installed and supported by the device.

Interrogate Data

If the CD-count of the interrogate DCW is greater than zero, interrogate data is specified. Since interrogate data is for device-dependent logging purposes only, interrogate data that is incorrectly specified

does not cause any exception condition to be recognized. The interrogate data has the following format:

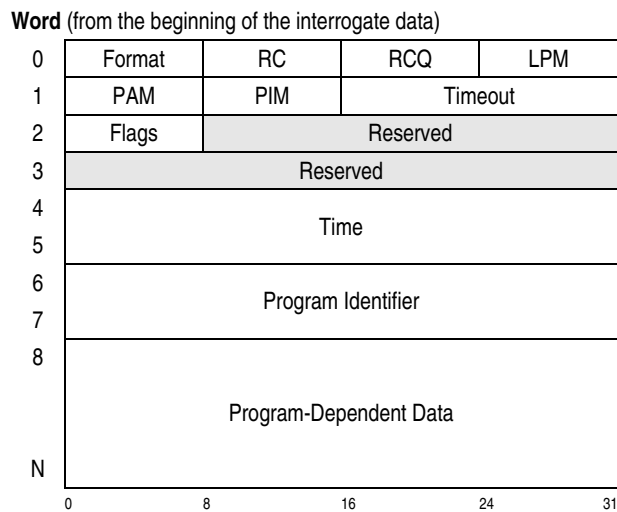

Figure 15-19. Interrogate Data

Format: Byte 0 of word 0 contains the unsigned integer value that defines the layout of the interrogate data. The value of this field should be zero, otherwise the I/O device may not recognize the layout of the interrogate data

Reason Code (RC): Byte 1 of word 0 contains the unsigned integer value that indicates the reason the interrogate operation was initiated. The following values may be specified. The meaning of RC values is as follows:

Value	Meaning
0	Interrogate reason not specified.
1	Timeout: Program-detected timeout for the operation being interrogated.
2-255	Reserved.

Reason-Code Qualifier (RCQ): Byte 2 of word 0 contains the unsigned integer value that indicates additional information about the reason the interrogate operation was initiated.

When the reason-code field contains the value one, the meaning of RCQ values are as follows:

Value	Meaning
0	Interrogate reason qualifier not specified.

- 1 Primary: The timeout was specified by the primary program.
- 2 Secondary: The timeout was specified by a secondary program.
- 3-255 Reserved.

When the reason-code field does not contain the value one, the reason-code-qualifier field has no meaning.

Logical-Path Mask (LPM): Byte 3 of word 0 contains the LPM that was used when the operation being interrogated was initiated by START SUB-CHANNEL.

Path-Available Mask (PAM): Byte 0 of word 1 contains the value of the PAM at the time the interrogate operation is initiated.

Path-Installed Mask (PIM): Byte 1 of word 1 contains the value of the PAM at the time the interrogate operation is initiated.

Timeout: When the RC field contains the value one or two, bytes 2-3 of word 1 contain the timeout interval used by the designated program, in unsigned integer seconds.

Flags: Byte 0 of word 2 contains information about the interrogate. The meaning of each flag bit is as follows:

Bit	Meaning
0	Multipath mode: This bit has the same setting as the multipath-mode bit (D) at the time the interrogate operation is initiated.
1	Program path recovery: The interrogate is issued during path recovery by the program.
2	Critical: The device is a critical device for the program.
3-7	Reserved.

Reserved: Bytes 1-3 of word 2 and word 3 are reserved.

Time: Words 4-5 contain the time the interrogate operation was initiated.

Program Identifier: Words 6-7 identify the program initiating the interrogate operation. The content of this field is program dependent.

Program-Dependent Data: Words 8-N contain program-dependent information.

Programming Notes:

1. It is assumed that the program will specify the value in the time field as UTC in the same form as the TOD clock.
2. If the interrogate operation does not complete within a model-dependent amount of time, an interface-control check condition is recognized, terminating the I/O operation being interrogated.
3. If a timeout value is specified and the timeout value is less than a device-dependent minimum, the I/O device may not write the interrogate data into its log.

Transport Status Block

When the TSB-valid bit in the IRB is one, the transport-status block (TSB) for the I/O operation may contain additional information about the completion of the associated TCW channel program. When the interrogate-complete (Q) bit in the IRB is one, the interrogate TSB may contain interrogate data.

The TSB is 64 bytes in length and is allocated on a doubleword boundary. Accesses to the TSB by the channel subsystem are treated as if a storage-access key of zero is used.

The format of the TSB is as follows:

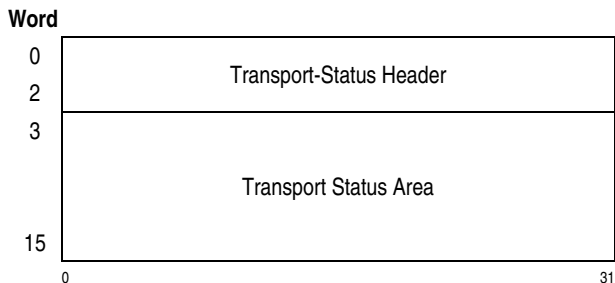

Figure 15-20. Transport-Status Block

Transport-Status Header (TSH)

The transport-status header is a 12-byte control block that contains information about the transport status. The format of the TSH is as follows:

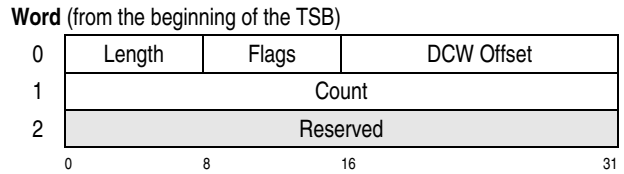

Figure 15-21. Transport-Status Header (TSH)

Length: Byte 0 of word 0 contains the unsigned binary integer length, in bytes, of the status information stored in the TSB. This length includes the TSH and the transport-status area (TSA), if present. If this value is less than 64, the difference between the length value and 64 specifies the number of bytes, at the end of the TSB, that are not used, have no meaning, and may or may not be stored.

Flags: Byte 1 of word 0 contains information about the TSB. The meaning of each flag bit is as follows.:

Bit	Meaning
0	DCW-offset field valid. When bit 0 is one, the DCW-offset field contains a DCW-offset value. When bit 0 is zero, the DCW-offset field has no meaning.
1	Count field valid. When bit 1 is one, the count field contains a count value. When bit 1 is zero, the count field has no meaning.
2	Cache miss. When flag bits 4-7 specify an I/O-status TSB and bit 2 is one, one or more I/O-device cache misses occurred during the I/O operation. When flag bits 4-7 specify an I/O-status TSB and bit 2 is zero, no cache misses occurred. When flag bits 4-7 do not specify an I/O-status TSB, bit 2 is reserved.
3	Time fields valid. When flag bits 4-7 specify an I/O-status TSB and bit 3 is one, the device-time, defer-time, queue-time, device-busy-time, and device-active-only time fields in the I/O-status TSA contain time information. When flag bits 4-7 specify an I/O-status TSB and bit

3 is zero, the contents of the device-time, defer-time, queue-time, device-busy-time, and device-active-only time fields in the I/O-status TSA have no meaning.

When flag bits 4-7 do not specify an I/O-status TSB, bit 3 is reserved.

- 4 Reserved.
- 5-7 TSA format. Bits 5-7 form a 3-bit unsigned integer that indicates the layout of the TSA as follows:

Value Meaning

- 0 TSA contents have no meaning: The other fields of the TSA do not contain meaningful data.
- 1 I/O Status TSA: The TSA contains ending status in addition to ending status in the IRB for the I/O operation.
- 2 Device-detected-program-check TSA: The TSA contains information describing the reason for the device-detected program check
- 3 Interrogate TSA: The TSA contains interrogate response information
- 4-7 Reserved.

DCW Offset: When bit 0 of the flags field (the DCW-offset-field-valid bit) is one and the DCW-offset value is less than the size of the TCA, bytes 2-3 of word 0 contain the byte offset, from the beginning of the TCA to the DCW either partially or completely executed when the TSB is stored. When bit 0 of the flags field is one and the DCW-offset value is greater than or equal than the size of the TCA, the value in bytes 2-3 of word 0 minus the size of the TCA is the offset, from the beginning of the TCAX to the DCW either partially or completely executed when the TSB is stored.

If the channel program cannot be completed, this offset identifies the DCW for which processing could not be completed. Additional information in the IRB and TSB may be used for recovery purposes. When bit 0 of the flags field is zero, bytes 2-3 of word 0 have no meaning.

Count: When bit 1 of the flags field (the count-field-valid bit) is one, word 1 contains the residual count for the DCW designated by the DCW-offset field.

Reserved: Word 2 is reserved and contains zeros.

Programming Note: If the program sets the length and flags fields to zeros before initiating an operation, the program can determine whether the TSB contains meaningful information after the operation completes by checking that both the length and flags field contain nonzero values.

I/O-Status TSA

When the TSB-format field in the TSH contains one, the TSA has the following format:

Word (from the beginning of the TSA)

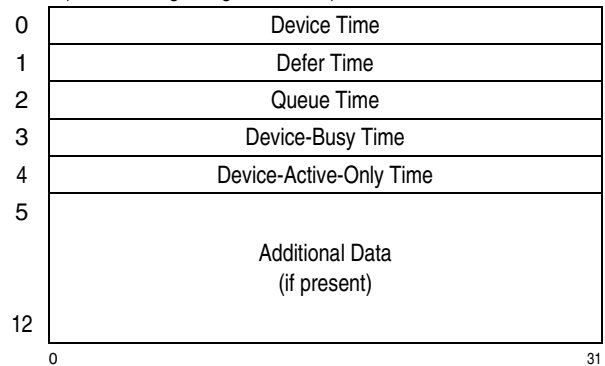

Figure 15-22. I/O-Status Transport-Status Area (TSA)

Device Time: When bit 3 of the flags field in the TSH (the time-fields-valid flag) is one, word 0 contains the 32-bit unsigned integer total count of time intervals between when the I/O device received the information in the TCCB until the I/O device returned the information in the TSB. The resolution of the device time is such that bit 31 corresponds to one microsecond.

When bit 3 of the flags field in the TSH (the time-fields-valid flag) is zero, the contents of word 0 have no meaning.

Defer Time: When bit 3 of the flags field in the TSH (the time-fields-valid flag) is one, word 1 contains the 32-bit unsigned integer total count of time intervals that the I/O operation was temporarily delayed by the I/O device to perform device-dependent operations or other operations not associated with the current channel program. The resolution of the defer time is such that bit 31 corresponds to one microsecond.

When bit 3 of the flags field in the TSH (the time-fields-valid flag) is zero, the contents of word 1 have no meaning.

Queue Time: When bit 3 of the flags field in the TSH (the time-fields-valid flag) is one, word 2 contains the 32-bit unsigned integer total count of timer intervals that the I/O operation or portions of the operation were queued at the control unit while waiting for operations not associated with the current operation to complete. The resolution of the queue time is such that bit 31 corresponds to one microsecond.

When bit 3 of the flags field in the TSH (the time-fields-valid flag) is zero, the contents of word 2 have no meaning.

Device-Busy Time: When bit 3 of the flags field in the TSH (the time-fields-valid flag) is one, word 3 contains the 32-bit unsigned integer total count of time intervals that the I/O device was busy attempting to initiate a command. The resolution of the device-busy time is such that bit 31 corresponds to one microsecond.

When bit 3 of the flags field in the TSH (the time-fields-valid flag) is zero, the contents of word 3 have no meaning.

Device-Active-Only Time: When bit 3 of the flags field in the TSH (the time-fields-valid flag) is one, word 4 contains the 32-bit unsigned integer total count of time between the time that the channel-end condition existed and the time that the channel-end and device-end conditions were recognized by the device. The resolution of the device-active time is such that bit 31 corresponds to one microsecond.

When bit 3 of the flags field in the TSH (the time-fields-valid flag) is zero, the contents of word 4 have no meaning.

Additional Data: When the length field in the TSH contains a value greater than 32, additional data has been provided by the I/O device. The count of meaningful additional-data bytes in this field is determined by subtracting 32 from the value in the length field.

When unit check is included in the device status, any additional data provided is sense data. When unit check is not included in the device status, any additional data provided is device dependent.

Device-Detected-Program-Check TSA

When the TSB-format field in the TSH contains two, the TSA has the following format:

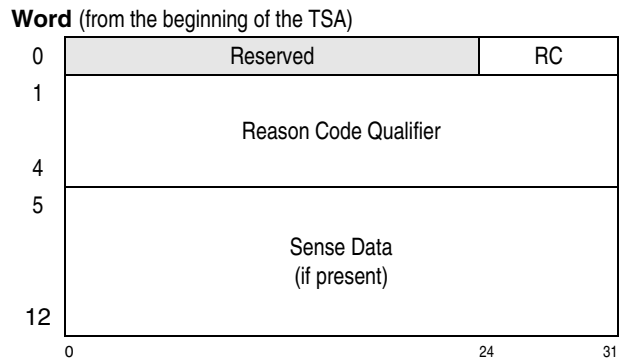

Figure 15-23. Device-Detected-Program-Check Transport-Status Area (TSA)

Reserved: Bytes 0-2 of word 0 are reserved and have no meaning.

Reason Code (RC): Byte 3 of word 0 contains an 8-bit unsigned integer code that indicates the primary reason for the device-detected program check. The meaning of each reason code value is as follows:

Value Meaning

- 0 No information: Byte 3 has no meaning.
- 1 TCCB transport failure: An invalid CBC was detected by the I/O device while transporting the TCCB. The reason-code-qualifier (RCQ) field contains additional information.
- 2 Invalid CBC detected on output data: An invalid CBC was detected while transferring output data. The RCQ field contains additional information.
- 3 Incorrect TCCB length specification: The RCQ field contains additional information.
- 4 TCAH specification error: The RCQ field contains additional information.

When a TCAH specification error is recognized, pre-existing allegiance conditions are not cleared.
- 5 DCW specification error: There is an error with the DCW designated by the

- DCW-offset field in the TSH. The RCQ field contains additional information.
- 6 Transfer-direction specification error: The command specified by the DCW designated by the DCW-offset field in the TSH specifies a direction of data transfer that disagrees with the transfer direction specified in the TCW, or both the read-operation (R) and write-operation (W) bits in the TCW are set to one and the device does not support bidirectional data transfers. The RCQ field contains additional information.
- 7 Transport-count specification error: The RCQ field contains additional information.
- 8 Two I/O operations active: While an I/O operation is active at the device a second non-interrogate TCCB has been transported to the device for execution. The RCQ field has no meaning.
- 9 CBC-offset specification error: One or more CBC offsets in the CBC-offset block indicate that a CBC is at a location that is not recognized by the device or is not recognized for the designated DCW. The RCQ field contains additional information.
- 10-255 Reserved.

For a summary of the meanings of reason-code values and their associated reason-code-qualifier values see Figure 15-24 on page 15-54.

Reason Code Qualifier (RCQ): Words 1-4 may contain additional information about the reason for the device-detected program check as follows.

When the RC field contains the value one, only byte 0 of the RCQ field has meaning. For this case, byte 0 of the RCQ field contains an 8-bit unsigned integer code that further describes the condition indicated by the RC field and the meaning of each RCQ value is as follows:

Value	Meaning
0	No additional information.
1	TCCB transport size error: The value of the TCCBL field of the TCW that was

sent to the I/O device is not equivalent to the count of bytes actually transported for the TCCB.

- 2 TCCB CBC error: An invalid CBC was detected while transferring the TCCB.
- 3-255 Reserved.

When the RC field contains the value two, only words 0-1 of the RCQ field have meaning as follows:

Value	Meaning
0	Word 0 contains the 32-bit unsigned integer offset of the first output-data byte for which the invalid CBC was detected.
1	Word 1 contains the 32-bit unsigned integer offset of the last byte of the last output-data word for which the invalid CBC was detected.

When the RC field contains the value three, only byte 0 of the RCQ field has meaning. For this case, byte 0 of the RCQ field contains an 8-bit unsigned integer code that further describes the condition indicated by the RC field and the meaning of each RCQ value is as follows:

Value	Meaning
0	No additional information.
1	The value specified by the TCAL field is not 8 greater than the value specified by the TCCBL field in the TCW for the operation.
2	The value specified by the TCAL field is less than 20 or greater than 252.
3-255	Reserved.

When the RC field contains the value four, only byte 0 of the RCQ field has meaning. For this case, byte 0 of the RCQ field contains an 8-bit unsigned integer code that further describes the condition indicated by the RC field and the meaning of each RCQ value is as follows:

Value	Meaning
0	No additional information.
1	Format-field specification error: The format field contains an unrecognized

- value. See “Format Control” on page 15-37.
- 2 Reserved-field specification error: A reserved field in the TCAH does not contain zeros.
 - 3 Service-action-code-field specification error: The service-action-code field in the TCAH contains an unrecognized value or a value that is incorrect for command specified by the DCW designated by the DCW-offset field in the TSH. See “Service-Action Code (SAC)” on page 15-37.
- 4-255 Reserved.

When the RC field contains the value five, only byte 0 of the RCQ field has meaning. For this case, byte 0 of the RCQ field contains an 8-bit unsigned integer code that further describes the condition indicated by the RC field and the meaning of each RCQ value is as follows:

Value Meaning

- 0 No additional information.
- 1 Reserved-field specification error: A reserved field in the DCW does not contain zeros.
- 2 Flags-field command-chaining specification error: Either of the following is true:
 - The chain-command flag is one and the offset of the next DCW is such that all or part of the next DCW extends past the end of the TCA or TCAX.
 - The chain-command flag is zero and more than 3 unused bytes remain in the TCA or TCAX (excluding the TCAX reserved field).
 - The DCW is the last DCW in the TCA, a TCAX is not specified, and the chain-command flag is one.
 - The DCW is the last DCW in the TCAX and the chain-command flag is one.

See “Chain-Command (CC) Flag” on page 15-39.

- 3 Control-data-count-field specification error: The CD-count field specifies control data past the end of the TCA or TCAX.
See “Control-Data (CD) Count” on page 15-40.
- 4 TCOB location error: The TCOB DCW is not the first DCW in the TCA
- 5 TCOB duplication error: More than one TCOB DCW is specified.
- 6 TCOB multiple-count error: The control-data-count field and the count field in the TCOB DCW both specify the value zero or both specify a nonzero value.
- 7 TCOB direction error: A TCOB DCW is specified and the write-operation (W) in the TCW is zero.
- 8 TCOB chaining error: The chain-command bit in the TCOB DCW is zero.
- 9 TCOB count-specification error: Either of the following is true:
 - The count field in the TCOB is zero, the control-data-count field in the TCOB DCW is nonzero, and the control-data-count field in the TCOB specifies a value that is not an even multiple of four
 - The control-data-count field in the TCOB is zero, the count field in the TCOB DCW is nonzero, and the count field in the TCOB specifies a value that is not an even multiple of four,
- 10 TTE location error: Either of the following is true:
 - A TCOB DCW is not specified and the TTE DCW is not the first DCW in the TCA.
 - A TCOB DCW is specified and the TTE DCW specified is not the second DCW in the TCA.
- 11 TTE duplication error: More than one TTE DCW is specified.

- 12 TTE CD-count specification error: The control-data-count field in the TTE DCW specifies a value that is not zero.
- 13 TTE count specification error: The count field in the TTE DCW specifies a value that is less than 8 or a value that is not a multiple of 4.
- 14 TTE direction error: A TTE DCW is specified and the write-operation (W) in the TCW is zero.
- 15 TTE chaining error: The chain-command bit in the TTE DCW is zero.
- 16 TCAX specification error: A TTE DCW is specified and any of the following is true:
 - The TCA does not contain at least one DCW that specifies the transfer of data (that is, at least one DCW that is not a transport-command DCW).
 - The TCA contains one or more DCWs that specify the transfer of data and the chain-command flag in the last DCW of the TCA is zero.

17-255 Reserved.

When the RC field contains the value six, only byte 0 of the RCQ field has meaning. For this case, byte 0 of the RCQ field contains an 8-bit unsigned integer code that further describes the condition indicated by the RC field and the meaning of each RCQ value is as follows:

Value	Meaning
0	No additional information.
1	Read-direction specification error: The DCW specifies an input operation, but the R-bit in the TCW used to transport the TCCB is zero.
2	Write-direction specification error: The DCW specifies an output operation, a TCOB operation, or a TTE operation, but the W-bit in the TCW used to transport the TCCB is zero.
3	Read-write-conflict specification error: Both the R-bit and the W-bit are one in the TCW used to transport the TCCB

and the device does not support bidirectional data transfers.

4-255 Reserved.

When the RC field contains the value seven, only byte 0 of the RCQ field has meaning. For this case, byte 0 of the RCQ field contains an 8-bit unsigned integer code that further describes the condition indicated by the RC field and the meaning of each RCQ value is as follows:

Value	Meaning
0	No additional information.
1	Read-count specification error: The specified read-count value is incorrect for any of the following reason: <ul style="list-style-type: none"> • For unidirectional data transfers, the TCAT transport-count specifies a value that is not equivalent to the TCW input-count value. See “Transport Count” on page 15-40. • For bidirectional data transfers, the TCAT read-count is not equivalent to the TCW input-count value. See “Read Count” on page 15-41. • For unidirectional data transfers, the TCAT transport-count is not equivalent to the total count of bytes specified by the DCWs in the TCA and TCAX (when specified) that specify read operations. • For bidirectional data transfers, the TCAT read-count is not equivalent to the total count of bytes specified by the DCWs in the TCA and in the TCAX (when specified), that specify read operations.
2	Write-count specification error: The specified write-count value is incorrect for any of the following reason: <ul style="list-style-type: none"> • For unidirectional data transfers, the TCAT transport-count specifies a value that is not equivalent to the TCW output-count value. See “Transport Count” on page 15-40. • For bidirectional data transfers, the TCAT write-count is not equivalent to

the TCW output-count value. See “Write Count” on page 15-41.

- For unidirectional data transfers, the TCAT transport-count is not equivalent to the total count of bytes specified by the DCWs in the TCA and TCAX (when specified) that specify write operations.
- For bidirectional data transfers, the TCAT write-count is not equivalent to the total count of bytes specified by the DCWs in the TCA and TCAX that specify write operations, the transfer of a COB, and the transfer of a TCAX.

3-255 Reserved.

When the RC field contains the value nine, only words 1 of the RCQ field has meaning as follows:

Value Meaning

- 0 Word 0 contains the 32-bit unsigned integer byte offset of the first CBC-offset entry in the COB that specifies a CBC offset that is not at a location that is recognized by the device or is not recognized for the DCW

Sense Data: When the length field in the TSH contains a value greater than 32, sense data has been provided by the I/O device. The count of meaningful sense-data bytes in this field is determined by subtracting 32 from the value in the length field.

Summary of Reason Codes and Associated Reason-Code Qualifiers

Figure 15-24 on page 15-54 provides a summary of the device-detected-program-check RC values and the meanings of their associated RCQ values.

Reason Code Value	Meaning	
0	No information.	
1	TCCB Transport Failure.	
	Reason-Code Qualifier Byte 0 Value	Meaning
	0	No additional information.
	1	TCCB transport size error
2	TCCB CBC error.	
2	Invalid CBC detected on output data.	
	Reason-Code Qualifier	Meaning
	Word 0 Value:	Offset of first output-data byte for which the invalid CBC was detected.
	Word 1 Value:	Offset of last output-data byte for which the invalid CBC was detected.
3	Incorrect TCCB length specification.	
	Reason-Code Qualifier Byte 0 Value	Meaning
	0	No additional information.
	1	TCCB TCAL field value not 8 greater than TCW TCCBL field value.
2	TCCB TCAL field value is less than 20 or greater than 252.	
4	TCAH specification error.	
	Reason-Code Qualifier Byte 0 Value	Meaning
	0	No additional information.
	1	TCCB format field specification error.
	2	TCCB reserved field specification error.
3	TCCB service-action-code field specification error.	

Figure 15-24. Summary of Reason-Code (RC) and Reason-Code-Qualifier (RCQ) Values in the Device-Detected-Program-Check TSA (Part 1 of 2)

Reason Code Value	Meaning	
5	DCW specification error.	
	Reason-Code Qualifier Byte 0 Value	Meaning
	0	No additional information.
	1	DCW reserved field specification error.
	2	DCW flags field command-chaining specification error.
	3	DCW control-data-count field specification error.
	4	TCOB location error
	5	TCOB duplication error
	6	TCOB multiple-count error
	7	TCOB direction error
	8	TCOB chaining error
	9	TCOB count-specification error
	10	TTE location error.
	11	TTE duplication error.
	12	TTE CD-count specification error.
	13	TTE count specification error.
	14	TTE direction error.
15	TTE chaining error.	
16	TCAX specification error.	
6	Transfer-direction specification error.	
	Reason-Code Qualifier Byte 0 Value	Meaning
	0	No additional information.
	1	Read-direction specification error.
	2	Write-direction specification error.
	3	Read-write conflict error.
7	Transport-count specification error.	
	Reason-Code Qualifier Byte 0 Value	Meaning
	0	No additional information.
	1	Read-count specification error.
	2	Write-count specification error.
8	Two I/O operations active.	
	Reason-Code Qualifier	No additional information.
9	CBC-offset-specification error.	
	Reason-Code Qualifier	No additional information.
	Word 0 Value:	Offset of first CBC-offset entry that specifies a CBC offset that is not at a location that is recognized.
Explanation: <ul style="list-style-type: none"> Reason-code values and reason-code-qualifier values that have no meaning do not appear in this summary. Portions of the reason-code-qualifier field that have no meaning for a specific reason code do not appear in this summary. 		

Figure 15-24. Summary of Reason-Code (RC) and Reason-Code-Qualifier (RCQ) Values in the Device-Detected-Program-Check TSA (Part 2 of 2)

Interrogate TSA

When the TSB-format field in the TSH contains three, the TSA has the following format:

Word (from the beginning of the TSA)

0	Format	Flags	CS	DS	
1	OS	Reserved			
2	State-Dependent Information				
4	State-Dependent Information				
5	Device-Level Identifier				
6	Device-Dependent Data				
12	Device-Dependent Data				
	0	8	16	24	31

Figure 15-25. Interrogate Transport-Status Area (TSA)

Format: Byte of word 0 contains the unsigned integer value that defines the layout of the interrogate TSA. If the value of this field is not one, the contents of the interrogate TSA are meaningless.

Flags: Byte 1 of word 0 contains information about the interrogate TSA. The meaning of each flag bit is as follows.:

Bit Meaning

- | | |
|-----|---|
| 0 | Control-unit-state valid: When bit 0 is one, the control-unit-state field contains meaningful information. When bit 0 is zero, the control-unit-state field has no meaning. |
| 1 | Device-state valid: When bit 1 is one, the device-state field contains meaningful information. When bit 1 is zero, the device-state field has no meaning. |
| 2 | Operation-state valid: When bit 2 is one, the operation-state field contains meaningful information. When bit 2 is zero, the operation-state field has no meaning. |
| 3-7 | Reserved. |

Control-Unit State (CS): Byte 2 of word 0 contains an 8-bit unsigned integer that indicates a current state of the control unit for the I/O device. The meaning of each value is as follows:

Value Meaning

- | | |
|---------|--|
| 0 | Busy: The control unit is busy and the device-dependent-data field may contain additional information about the busy state. |
| 1 | Recovery: The control unit is performing a recovery process and the device-dependent-data field may contain additional information about the recovery state. |
| 2 | Interrogate maximum: The control unit is executing the maximum number of interrogate operations that it supports. |
| 3-127 | Reserved. |
| 128-255 | Device-dependent meanings. |

Device State (DS): Byte 3 of word 0 contains an 8-bit unsigned integer that indicates a current state of the I/O device. The meaning of this byte is

Value Meaning

- | | |
|---------|--|
| 0 | Path-group identification: The state-dependent-information field contains information identifying a path group. |
| 1 | Long busy: The device is in a long-busy state. The meaning of long busy is device dependent and the device-dependent field may contain additional information about the long-busy state. |
| 2 | Recovery: The device is performing a recovery process and the device-dependent-data field may contain additional information about the recovery state. |
| 3-127 | Reserved. |
| 128-255 | Device-dependent meanings. |

Operation State (OS): Byte 0 of word 1 contains an 8-bit unsigned integer that indicates whether an I/O operation is present at the device and, when present, the state of the operation. The meaning of this byte is as follows:

Value Meaning

- | | |
|---|------------------------------|
| 0 | No I/O operation is present. |
|---|------------------------------|

- 1 An I/O operation is present and executing.
- 2 An I/O operation is present and waiting for completion of an I/O operation that was initiated by another configuration.
- 3 An I/O operation is present and waiting for completion of an I/O operation that was initiated for the same device extent.
- 4 An I/O operation is present and waiting to perform a device-dependent operation.
- 5-127 Reserved.
- 128-255 Device-dependent meanings.

State-Dependent Information: Words 2-4 may contain state-dependent information. Whether this field has meaning is designated by the CS, DS, and OS fields.

The contents of this field are device dependent. When the device places one or more bytes in this field, they are left justified.

Device-Level Identifier: Word 5 contains a device-dependent token that identifies the implementation level of the device.

Device-Dependent Data: Words 6-12 contain device dependent information. Whether this field has meaning is designated by the CS, DS, and OS fields.

When the device places one or more bytes in this field, they are left justified.

Note:

- 1. An interrogate TSA is stored only in a TSB designated by an interrogate TCW.
- 2. If a program-check condition is recognized for an interrogate TCCB, a device-detect-program-check TSA is stored in the TSB designated by the interrogate TCW.

Command Code

For CCW channel programs, the command code, bit positions 0-7 of the CCW, specifies to the channel subsystem and the I/O device the operation to be performed. For TCW channel programs, the command code, bit positions 0-7 of the DCW, specifies to the I/O device the operation to be performed.

With the exception of transport commands, the two rightmost bits or, when these bits are zeros, the four rightmost bits of the command code identify the operation to the channel subsystem. The channel subsystem distinguishes among the following operations:

- Control
- Output forward (write)
- Input forward (read, sense, sense ID)
- Input backward (read backward)
- Branching (transfer in channel)
- Interrogate
- Transport

For CCW channel programs, the channel subsystem ignores the leftmost four bits of the command code in a format-0 CCW that specifies transfer-in-channel. In a format-1 CCW that specifies transfer in channel, all bits of the command code are decoded by the channel subsystem.

For CCW channel programs, commands that initiate I/O operations (write, read, read backward, control, sense, and sense ID) cause all eight bits of the command code to be transferred to the control unit.

In command codes that initiate I/O operations, the leftmost bit positions contain modifier bits. The modifier bits specify to the device how the command is to be executed. They may, for example, cause the device to compare data received during a write operation with data previously recorded, and they may specify such attributes as recording density and parity. For the control command, the modifier bits may contain the order code specifying the control function to be performed. The meaning of the modifier bits depends on the type of I/O device and is specified in the System Library publication for the device.

The command-code assignment is listed in Figure 15-26 on page 15-58. The symbol x indicates

that the bit position is ignored; the symbol m identifies a modifier bit.

Code		Command
x x x x	0 0 0 0	Invalid
m m m m	m m 0 1	Write ¹
m m m m	m m 1 0	Read ¹
m m m m	1 1 0 0	Read Backward ²
m m m m	m m 1 1	Control
m m m m	0 1 0 0	Sense
1 1 1 0	0 1 0 0	Sense ID
x x x x	1 0 0 0	Transfer in channel ³
0 0 0 0	1 0 0 0	Transfer in channel ⁴
m m m m	1 0 0 0	Invalid ⁵
0 1 m m	0 0 0 0	Transport ⁶
Explanation:		
m	Modifier bit	
x	Ignored	
1	May designate control data in DCWs.	
2	CCW only	
3	Format-0 CCW	
4	Format-1 CCW	
5	Format-1 CCW with any of bits 0-3 nonzero	
6	DCW only	

Figure 15-26. Command-Code Assignment

Whenever the channel subsystem detects an invalid command code during the initiation of command execution for a CCW channel program, the program-check-interruption condition is generated, and channel-program execution is terminated. The command code is ignored during data chaining, unless it specifies transfer in channel.

Whenever an I/O device detects an invalid command code while executing the commands in a TCCB, a device-detected-program-check condition is recognized and channel-program execution is terminated.

Designation of Storage Area

For CCW channel programs, the main-storage area associated with an I/O operation is defined by one or more CCWs. A CCW defines an area by specifying the address of the first byte to be transferred and the number of consecutive bytes contained in the area. The address of the first byte of data to be transferred is specified either directly in the data-address field of the CCW or indirectly in an indirect-data-address word (IDAW) or modified-indirect-data-address word

(MIDAW) designated by the data-address field of the CCW. The number of bytes contained in the storage area is specified in the count field.

For TCW channel programs the main-storage area associated with an I/O operation is designated by a TCW. A TCW designates an area by specifying the address of the first byte to be transferred and the number of consecutive bytes contained in the area. The address of the first byte of data to be transferred for input operations is specified either directly in the input-data-address field of the TCW or indirectly by a transport-indirect-data-address word (TIDAW) designated by the input-data-address field of the TCW. The number of bytes contained in the storage area for input operations is specified in the input-count field. The address of the first byte of data to be transferred for output operations is specified either directly in the output-data-address field of the TCW or indirectly by a TIDAW designated by the output-data-address field of the TCW. The number of bytes contained in the storage area for output operations is specified in the output-count field. In this case, the actual number of bytes in the storage area is determined by subtracting the number of any inserted padding or CBC bytes from the output-count field value. The address of the first byte of data to be transferred into the TSB is specified in the TSB-address field of the TCW. The number of bytes contained in the storage area for the TSB is dependent on the status being returned and is a maximum of 64.

In general, for write, read, control, and sense operations, storage locations are used in ascending order of addresses. As information is transferred to or from main storage, the address from the appropriate address field is incremented, and the count from the associated count field is decremented. For command-mode operations, the read-backward operation places data in storage in a descending order of addresses, and both the count and the address are decremented. When the associated count reaches zero, the storage area defined by the CCW is exhausted.

When a subchannel is operating in transport mode, the channel subsystem may take advantage of performance optimizations and access storage locations in a non-sequential order within the storage area or areas designated by the current TCW. When a transport-mode operation is concluded, the transfer of specified data, as indicated by information in the I/O-status TSB, is complete.

Any main-storage location available to the start function can be used in the transfer of data to or from an I/O device, provided that the location is not protected against that type of reference. Format-0 CCWs can be located in any available part of the first 2^{24} (16M) bytes of absolute storage, and format-1 CCWs and TCWs can be located in any available part of the first 2^{31} (2G) bytes of absolute storage, provided that, in both cases, the location is not protected against a fetch-type reference. When the channel subsystem attempts to refer to a protected location, the protection-check condition is generated, and the device is signaled to terminate the operation.

A main-storage location is available if it is available in the configuration and access to the location is not prevented by the address-limit-checking facility. CCWs, TCWs, ISDs, TSBs, and the data they address reside in main-storage locations. If a main-storage location is not available, it is said to have an invalid address

If the channel subsystem refers to a location that is not available, the program-check condition is generated. When the first CCW or TCW designated by the channel-program address is at an unavailable location, the start function is not initiated at the device, the status portion of the SCSW is updated with the program-check indication, the subchannel becomes status pending with primary, secondary, and alert status, and deferred condition code 1 is indicated. An invalid data address, as well as any invalid CCW address detected on chaining or subsequent to the execution of START SUBCHANNEL, causes the channel subsystem to signal the device to conclude the operation, if and when the device requests or offers a byte of data or status at the invalid address. In this situation, the subchannel is made status pending with program check indicated in the subchannel status, and the device status is a function of the status received from the device. The program-check condition causes command chaining and command retry to be suppressed.

During an output operation, the channel subsystem may fetch data from main storage before the time the I/O device requests the data. Any number of bytes specified by the current CCW or TCW may be prefetched and buffered.

When data chaining during an output operation for a CCW channel program, the channel subsystem may fetch one CCW describing a data area at any time during the execution of the current CCW. If unlimited

prefetching is allowed by the setting of the prefetch-control bit in the ORB CCW channel program, any number of CCWs, IDAWs, and MIDAWs and the associated data may be prefetched by the channel subsystem. When the I/O operation uses data or CCWs from locations near the end of the available storage, such prefetching may cause the channel subsystem to refer to locations that do not exist. Invalid addresses detected during prefetching do not affect the performance of the I/O operation and do not cause error indications until the operation actually attempts to use the information. If the operation is concluded by the I/O device or by the execution of HALT SUBCHANNEL or CLEAR SUBCHANNEL before the invalid information is needed, the condition is not brought to the attention of the program.

The count field in the CCW can specify any number of bytes up to 65,535. In format-0 CCWs, the count field is always nonzero unless the command code specifies transfer in channel, in which case the count field is ignored. In format-1 CCWs, the count field may contain the value zero unless data chaining is specified or the CCW is fetched while data chaining. Whenever (1) the count field in a format-1 CCW is zero, (2) data chaining is either not specified or not in effect, and (3) data transfer is requested by the device, the device is signaled to stop, and the I/O operation is terminated. The channel subsystem sets the incorrect-length condition if the SLI flag is not one in the CCW. No data is transferred. If the device does not request data transfer, the operation proceeds to the normal ending point.

If a zero byte count is contained in a format-0 CCW that does not specify transfer in channel, or if a zero byte count is contained in a format-1 CCW that specifies data chaining or was fetched while data chaining, a program-check condition is recognized, and the subchannel is made status pending with combinations of primary, secondary, and alert status as a function of the state of the subchannel and the status received from the device.

The input-count and output-count fields in the TCW can specify any number of bytes up to $2^{32} - 8$. For input operations, the input-count field is always nonzero; otherwise, a program-check condition is recognized. For output operations, the output-count field is always nonzero; otherwise, a program-check condition is recognized.

Note: For a description of the storage area associated with a CCW when indirect data addressing is

used, see “CCW Indirect Data Addressing” on page 15-66. For a description of the storage area associated with a TCW when indirect data addressing is used, see “Transport Indirect Data Addressing” on page 15-70.

Programming Notes:

1. Since a format-1 CCW with a count of zero is valid, the program can use the CCW count field to specify that no data be transferred to the I/O device. If the device requests a data transfer, the device is signaled to terminate data transfer. If the SLI and chain-command flags are also specified as ones, and no unusual conditions are encountered subsequent to signaling the device to terminate data transfer, the new operation is initiated upon receipt of device end from the device.
2. If the subchannel is in the incorrect-length-suppression mode, the chain-data flag in the current CCW is zero, and the operation is performed as an immediate operation, then incorrect length is not indicated, regardless of the setting of the SLI flag.

If the subchannel is in the incorrect-length-indication mode, if the chain-data flag in the current CCW is zero, and if the operation is performed as an immediate operation, then incorrect length is indicated if the count field of the current CCW specifies a nonzero value, unless suppressed by the SLI flag of the CCW; incorrect length is not indicated, however, if the count field of the CCW specifies a value of zero.

If a new CCW that has a count field of zero is fetched during data chaining or if a CCW is fetched with the chain-data flag set to one and a count field of zero, a program-check condition is recognized by the channel subsystem.

3. Since the channel-subsystem may access storage in a non-sequential manner while a subchannel is operating in transport mode, the results may be unpredictable if the program accesses the input storage area or areas desig-

nated by a TCW before primary status is indicated.

CCW Channel Program Chaining

When the channel subsystem has completed the transfer of information specified by a CCW, it can continue performing the start function by fetching a new CCW. Such fetching of a new CCW is a form of chaining, and the CCWs belonging to such a sequence are said to be chained.

Chaining takes place between CCWs located in successive doubleword locations in storage. It proceeds in an ascending order of addresses; that is, the address of the new CCW is obtained by adding 8 to the address of the current CCW. Two chains of CCWs located in noncontiguous storage areas can be coupled for chaining purposes by a transfer-in-channel command. All CCWs in a chain apply to the I/O device that is associated with the subchannel designated by the original START SUBCHANNEL instruction.

Two types of chaining are provided for CCWs: Chaining is controlled by the chain-data (CD) and chain-command (CC) flags in conjunction with the suppress-length-indication (SLI) flag in the CCW. These flags specify the action to be taken by the channel subsystem upon the exhaustion of the current CCW and upon receipt of ending status from the device, as shown in Figure 15-27 on page 15-61.

The specification of chaining is effectively propagated through a transfer-in-channel command. When, in the process of chaining, a transfer-in-channel command is fetched, the CCW designated by the transfer-in-channel command is used for the type of chaining specified in the CCW preceding the transfer-in-channel command.

The CD and CC flags are ignored in a format-0 CCW specifying the transfer-in-channel command. In a format-1 CCW specifying the transfer-in-channel com-

mand, the CD and CC flags must be zeros; otherwise, a program-check condition is recognized.

Flags in Current CCW			Action at the Subchannel upon Exhaustion of Count or Receipt of Channel End						
			Immediate Operation				Non-immediate Operation		
			Incorrect-Length-Suppression Mode ¹		Incorrect-Length-Indication Mode		Count Exhausted		Count Not Exhausted and CE Received
CD	CC	SLI	CCW Count≠0	CCW Count=0	CCW Count≠0	CCW Count=0	CE Not Received	CE Received	
0	0	0	End, NIL	End, NIL	End, IL	End, NIL	Stop, IL	End, NIL	End, IL
0	0	1	End, NIL	End, NIL	End, NIL	End, NIL	Stop, NIL	End NIL,	End, NIL
0	1	0	CC	CC	End, IL	CC	Stop, IL	CC	End, IL
0	1	1	CC	CC	CC	CC	Stop, CC	CC	CC
1	-	-	End, NIL	PC	End, IL	PC	CD	*	End IL

Explanation:

- The selected bit is ignored and may be either zero or one.
- * These situations cannot validly occur. When data chaining is specified, the new CCW takes control of the operation after transferring the last byte of data designated by the current CCW, but before the next request for data or status transfer from the device. The new CCW (which cannot contain a count of zero unless a program-check condition is also recognized) is in control of the operation
- ¹ The count field must contain a nonzero value when format-0 CCWs are specified; otherwise, the operation is terminated with a program-check condition.
- CC Command chaining is performed by the channel subsystem upon receipt of device end.
- CD The chain-data flag causes the channel subsystem to immediately fetch a new CCW for the same operation. The operation continues unless the CCW thus fetched has a count field of zero, in which case the operation is terminated with a program-check condition.
- CE Channel end from the device that indicates end of block.
- End Operation is terminated.
- IL Incorrect length is indicated with the subsequent interruption condition generated at the subchannel.
- NIL Incorrect length is not indicated with the subsequent interruption condition generated at the subchannel.
- PC These situations cannot validly occur. The channel subsystem recognizes a program-check condition when a CCW is fetched that has the chain-data flag set to one and a count field of zero.
- STOP Device is signaled to terminate data transfer, but subchannel remains subchannel active until channel end is received.

Figure 15-27. Subchannel Chaining Action

Programming Note: When bit 9 of word 1 of the ORB is one, unlimited prefetching of chained CCWs (including CCWs linked by a transfer-in-channel command) by the channel subsystem is permitted. When prefetching is allowed by the ORB, no modification of the channel program should be performed after START SUBCHANNEL is executed and before the primary interruption condition for the operation has been received unless the subchannel is currently suspended and is not resume pending.

Data Chaining

During data chaining, the new CCW fetched by the channel subsystem defines a new storage area for the original I/O operation. If the channel path is of the parallel-I/O-interface type, the performance of the operation at the I/O device is not affected. If the channel path is of the serial-I/O-interface type, then

the performance of the operation at the I/O device either is not affected or, depending on the device model, may be terminated with unit-check status. When the operation at the I/O device is not affected and all data designated by the current CCW has been transferred to main storage or to the device, data chaining causes the operation to continue, using the storage area designated by the new CCW. The contents of the command-code field of the new CCW are ignored, unless they specify transfer in channel.

Data chaining is considered to occur immediately after the last byte of data designated by the current CCW has been transferred to main storage or to the device. When the last byte of the data transfer has been placed in main storage or accepted by the device, the new CCW takes over the control of the operation. If the device sends channel end after

exhausting the count of the current CCW but before transferring any data to or from the storage area designated by the new CCW, the SCSW associated with the concluded operation pertains to the new CCW.

If programming errors are detected in the new CCW or during its fetching, the error indication is generated, and the device is signaled to conclude the operation when it attempts to transfer data designated by the new CCW. If the device signals the channel-end condition before transferring any data designated by the new CCW, program check or protection check is indicated in the SCSW associated with the termination. The contents of the SCSW pertain to the new CCW unless the address of the new CCW is invalid, the location is protected against fetching, or programming errors are detected in an intervening transfer-in-channel command. A data address referring to a nonexistent or protected area causes an error indication only after the I/O device has attempted to transfer data to or from the invalid location.

Data chaining during an input operation causes the new CCW to be fetched when all data designated by the current CCW has been placed in main storage. On an output operation, the channel subsystem may fetch the new CCW from main storage before data chaining occurs. Any programming errors in the prefetched CCW, however, do not affect the performance of the operation until all data designated by the current CCW has been transferred to the I/O device. If the device concludes the operation before all data designated by the current CCW has been transferred, the conditions associated with the prefetched CCW are not indicated to the program. Unlimited prefetching is allowed under the control of the prefetch bit specified in the ORB. (See "Prefetch Control (P)" on page 15-27.) When unlimited prefetching is not allowed and an output operation is specified, only one CCW describing a data area may be prefetched. If a prefetched CCW specifies transfer in channel, only one more CCW may be fetched before the exhaustion of the current CCW.

Programming Notes:

1. If the ORB does not specify unlimited prefetching, no prefetching of CCWs is performed, except in the case of data chaining on an output operation where one CCW describing a data area may be prefetched at a time.

If the ORB for the I/O operation specifies that prefetching is allowed, any number of CCWs,

IDAWs, and MIDAWs and the associated data areas may be prefetched and buffered in the channel subsystem.

The same actions for signaling errors and terminating operations take place when unlimited prefetching is allowed by the ORB as when it is not allowed. However, when unlimited prefetching is specified and an error condition is detected, both the channel subsystem and the program must recognize that the points of termination at the channel subsystem and at the I/O device may be different in terms of the channel command in execution at the point of error. The channel subsystem indicates the point of termination at the channel subsystem by storing the appropriate CCW address in word 1 of the sub-channel-status word and the point of termination at the device by storing the secondary-CCW address in word 4 of the format-0 extended-status word.

When prefetching has been specified in the ORB, the result of modifications to CCWs after START SUBCHANNEL has been executed or after self-describing channel programs have been used is unpredictable. (See note 2 for the definition of self-describing channel programs.)

2. Data chaining may be used to rearrange information as it is transferred between main storage and an I/O device. Data chaining permits blocks of information to be transferred to or from non-contiguous areas of storage, and, when used in conjunction with the skipping function, data chaining allows the program to place in main storage specified portions of a block of data.

When, during an input operation, the program specifies data chaining to a location in which data has been placed under the control of the current CCW, the channel subsystem, in fetching the next CCW, fetches the new contents of the location. This is true even if the location contains the last byte transferred under the control of the current CCW. When a channel program data-chains to a CCW placed in storage by the CCW specifying data chaining, the input block is said to be self-describing. A self-describing block contains one or more CCWs that designate storage locations and counts for subsequent data in the same input block.

The use of self-describing blocks is equivalent to the use of unchecked data. An I/O data-transfer

malfunction that affects validity of a block of information is signaled only at the completion of data transfer. The error condition normally does not prematurely terminate or otherwise affect the performance of the operation. Thus, there is no assurance that a CCW read as data is valid until the operation is completed. If the CCW thus read is in error, use of the CCW in the current operation may cause subsequent data to be placed at wrong locations in main storage with resultant destruction of its contents, subject only to the control of the protection key and the address-limit-checking facility, if used.

3. When, during data chaining, a device transfers data by using the data-streaming feature, an overrun or chaining-check condition may be recognized when a small byte-count value is specified in the CCW. The minimum acceptable number of bytes that can be specified varies as a function of the system model and system activity.

Command Chaining

During command chaining, the new CCW fetched by the channel subsystem specifies a new I/O operation. The channel subsystem fetches the new CCW upon the receipt of the device-end signal for the current operation. If the new CCW does not have its S flag set to one and no unusual conditions are detected, the channel subsystem initiates the new operation. The presence of the S flag set to one or unusual conditions causes command chaining to be suppressed. When command chaining takes place, the completion of the current operation does not cause an I/O interruption, and the count indicating the amount of data transferred during the current operation is not made available to the program. For operations involving data transfer, the new command always applies to the next block of data at the device.

Command chaining takes place and the new operation is initiated only if no unusual conditions have been detected in the current operation. In particular, the channel subsystem initiates a new I/O operation by command chaining upon receipt of a status byte containing only the following bit combinations: (1) device end, (2) device end and status modifier, (3) device end and channel end, and (4) device end, channel end, and status modifier. In the first two cases, channel end is signaled before device end, with all other status bits zeros. If a condition such as attention, unit check, unit exception, incorrect length, program check, or protection check has occurred, the sequence of operations is concluded, and the status

associated with the current operation causes an interruption condition to be generated. The new CCW in this case is not fetched. The incorrect-length condition does not suppress command chaining if the current CCW has the SLI flag set to one.

An exception to sequential chaining of CCWs occurs when the I/O device presents the status-modifier condition with the device-end signal or channel-end and device-end signals. When command chaining is specified and no unusual conditions have been detected, or when command retry has been previously signaled and an immediate retry could not be performed, the combination of status-modifier and device-end bits causes the channel subsystem to alter the sequential execution of CCWs. If command chaining was specified, status modifier and device end cause the channel subsystem to fetch and chain to the CCW whose main-storage address is 16 higher than that of the CCW that specified chaining. If command retry was previously signaled and immediate retry could not be performed, the status causes the channel subsystem to command chain to the CCW whose storage address is 8 higher than that of the CCW for which retry was initially signaled.

When both command and data chaining are specified, the first CCW associated with the operation specifies the operation to be performed, and the last CCW specifies whether another operation follows.

Programming Note: Command chaining makes it possible for the program to initiate transfer of multiple blocks of data by issuing a single START SUBCHANNEL instruction. It also permits a subchannel to be set for execution of other commands, such as positioning the disk-access mechanism, and for data-transfer operations without interference by the program at the end of each operation. Command chaining, in conjunction with the status-modifier condition, permits the channel subsystem to modify the normal sequence of operations in response to signals provided by the I/O device.

TCW Channel Program Chaining

When the I/O device has completed a control operation or the transfer of information specified by a DCW, the device can continue by executing the next DCW that is specified. Such execution of a new DCW is a form of command chaining, and the DCWs belonging to such a sequence are said to be chained.

Command chaining is controlled by the DCW chain-command (CC) flag in the DCW. This flag specifies the action to be taken upon the exhaustion of the current DCW. Chaining takes place between successive DCWs within the TCA. When a TCAX is specified, chaining also takes place between the last DCW in the TCA and the first DCW in the TCAX, and between successive DCWs within the TCAX.

When a TCCB is transported to an I/O device and selected by the device for processing, the first DCW in the TCA becomes the current DCW and is executed by the device. When the current DCW specifies command chaining and no unusual conditions have been detected during the operation, the completion of the current DCW causes the next DCW to become the current DCW and be executed by the device. The TCA offset of the next DCW is determined by adding 8, plus the value of the control-data (CD) count field of the DCW, to the TCA offset of the current DCW and rounding upwards to the next word boundary. If a TCAX is specified and the offset of the next DCW is past the end of the TCA, chaining continues with the first DCW of the TCAX whose TCAX offset is determined by subtracting the TCA length from the calculated offset. Thus, command chaining proceeds in ascending order of TCA offsets and then TCAX offsets when a TCAX is specified.

During command chaining, the new DCW executed by the device specifies a new I/O command. When command chaining takes place, the completion of the execution of the current command does not cause an I/O interruption, and the count indicating the amount of data transferred during the current operation is not made available to the program. For operations involving data transfer, the new command always applies to the next block of data at the device.

Command chaining takes place and the new command is initiated only if no unusual conditions have been detected in the execution of the current command. In particular, the I/O device initiates a new I/O operation by command chaining upon successful completion of the current command. If a condition such as attention, unit check, unit exception, or incorrect length has occurred, the sequence of operations is concluded, and the status associated with the current operation causes an interruption condition to be generated. The new DCW in this case is not executed.

Command chaining makes it possible for the program to initiate transfer of multiple blocks of data by issuing

a single START SUBCHANNEL instruction. It also permits a subchannel to be set for execution of other commands, such as positioning the disk-access mechanism, and for data-transfer operations without interference by the program at the end of each operation. For command-mode operations, command chaining, in conjunction with the status-modifier condition, permits the channel subsystem to modify the normal sequence of operations in response to signals provided by the I/O device

Skipping

Skipping causes the suppression of main-storage references during an I/O operation. It is defined only for read, read-backward, sense-ID, and sense operations. Skipping is controlled by the skip flag, which can be specified individually for each CCW, MIDAW, or TIDAW. When the skip flag is one, skipping occurs; when it is zero, normal operation takes place. The setting of the skip flag is ignored in all other operations.

Skipping affects only the handling of information by the channel subsystem. The operation at the I/O device proceeds normally, and information is transferred. The channel subsystem keeps updating the count but does not place the information in main storage. Chaining is not precluded by skipping. In the case of CCW data chaining, normal operation is resumed if the skip flag in the new CCW is zero.

No checking for invalid or protected data addresses takes place during skipping.

Programming Note: Skipping, when combined with CCW data chaining, MIDAWs, and TIDAWs, permits the program to place in main storage specified portions of a block of information from an I/O device.

Program-Controlled Interruption

The program-controlled-interruption (PCI) function permits the program to cause an I/O interruption during the performance of an I/O operation. The function is controlled by the PCI flag of the CCW. Neither the value of the PCI flag nor the associated interruption request affects the performance of the current operation.

The value of the PCI flag can be one either in the first CCW designated for the current start or resume func-

tion or in a CCW fetched during chaining. If the PCI flag is one in a CCW that has become current, the subchannel becomes status pending with intermediate status, and an I/O-interruption request is generated. The point at which the subchannel becomes status pending depends on the progress of the current start or resume function as follows:

1. If the PCI flag is one in the first CCW associated with a start function or a resume function, the subchannel becomes status pending with intermediate status only after the command has been accepted.
2. If the PCI flag is one in a CCW that has become current while data chaining, the subchannel becomes status pending with intermediate status after all data designated by the preceding CCW has been transferred.
3. If the PCI flag is one in a CCW that has become current while command chaining, the subchannel becomes status pending with intermediate status as that CCW becomes current.

In all cases, if the subchannel is enabled for I/O interruptions, the point of interruption depends on the current activity in the system and may be delayed. No predictable relationship exists between the point at which the interruption request is generated because of the PCI flag and the extent to which data transfer has been completed to or from the area designated by the CCW. However, all the fields within the SCSW pertain to the same instant.

An intermediate interruption condition that is made pending because of a PCI flag remains pending during chaining if not cleared by TEST SUBCHANNEL or CLEAR SUBCHANNEL. If another CCW containing a PCI flag that is one becomes current prior to the clearing of the intermediate interruption condition, only one interruption condition is preserved.

An intermediate interruption may occur while the subchannel is subchannel-and-device active with the operation specified by the CCW causing the intermediate interruption condition or with the operation specified by a CCW that has subsequently become current. If the intermediate interruption condition is not cleared prior to the conclusion of the operation or chain of operations, the condition is indicated together with the primary interruption condition at the conclusion of the operation or chain of operations. The intermediate interruption condition may be

cleared by TEST SUBCHANNEL while the subchannel is subchannel active.

If the SCSW stored by TEST SUBCHANNEL indicates that the subchannel is status pending with intermediate status and the operation or chain of operations has not been concluded (that is, the activity-control field indicates subchannel-and-device active or suspended), then the CCW-address field contains an address that is 8 higher than the address of the most recent CCW to become current and have a PCI flag that is one, or the CCW-address field contains an address that is 8 higher than the address of a CCW that has subsequently become current. Unless the SCSW also contains the primary-status bit set to one, the device-status field contains zeros, and the count is unpredictable.

Subchannel-status conditions other than PCI may be indicated when the SCSW is stored. If the subchannel is not also status pending with primary status, these conditions may or may not be indicated again. If the subchannel-status condition is detected while prefetching and the operation or chain of operations is concluded before the condition affects an operation, the condition is reset and is not indicated when the subchannel subsequently becomes status pending with primary status. If the subchannel-status condition affects an operation, the condition is indicated when the subchannel becomes status pending with primary status.

If the program-controlled-interruption condition remains pending until the operation or chain of operations is concluded at the subchannel, a single interruption request exists. When TEST SUBCHANNEL is subsequently executed, the status-control field of the SCSW stored indicates both the primary interruption condition and the intermediate interruption condition, and the PCI bit of the subchannel-status field is one.

The value of the PCI flag is inspected in every CCW except for those CCWs that specify the transfer-in-channel command. The PCI flag is ignored during initial program loading.

Programming Notes:

1. The program-controlled interruption provides a means of alerting the program to the progress of chaining during an I/O operation. It permits programmed dynamic main-storage allocation.

2. A CCW with a PCI flag set to one may, if retried because of command retry, cause multiple PCI interruptions to occur. (See “Command Retry” on page 15-77.)

Indirect Storage Addressing

Indirect-storage addressing (ISA) allows for storage areas designated by a channel program to be specified in noncontiguous storage. Depending on the model, more than one form of ISA facility may be installed as follows:

- CCW-indirect-data (see “CCW Indirect Data Addressing” on page 15-66) addressing is installed in all models.
- Modified-CCW-indirect-data (see “Modified CCW Indirect Data Addressing” on page 15-68) addressing may also be installed in a model.
- TCW-indirect-data-addressing (see “Transport Indirect Data Addressing” on page 15-70) may also be installed in a model.

Indirect-Storage Designator (ISD)

Each ISA facility description includes the definition of a facility-unique indirect-storage designator (ISD) that is used to specify a block of storage to the channel subsystem. Thus, a list of ISDs may be used to designate noncontiguous storage blocks. How the location and size of a storage block are specified and whether the specification of the storage block has boundary restrictions, size restrictions, or both is dependent on the method of ISA used. The following ISDs may be used as follows:

- Format-1 and format-2 indirect-data-address word (IDAW). See “CCW Indirect Data Addressing” on page 15-66.
- Modified-indirect-data-address word (MIDAW), when the modified-CCW-indirect-data-addressing facility is installed. See “Modified CCW Indirect Data Addressing” on page 15-68.
- Transport-indirect-data-address word (TIDAW), when the fibre-channel-extensions (FCX) facility is installed. See “Transport Indirect Data Addressing” on page 15-70.

CCW Indirect Data Addressing

CCW indirect data addressing permits a single channel-command word to control the transfer of data that spans noncontiguous 2 K-byte or 4 K-byte blocks in main storage. The use of CCW indirect data addressing also allows the program to designate data addresses above 16M bytes when using format-0 CCWs or above 2G bytes when using format-1 CCWs. CCW indirect data addressing is specified by a flag in the CCW which, when one, indicates that the data address is not used to directly address data. Instead, the address points to a list of words or doublewords, called indirect-data-address words (IDAWs), each of which contains an absolute address designating a data area in main storage.

IDAWs have either of two formats, called format 1 and format 2, as determined by the format-2-IDAW control, bit 14 of word 1 of the ORB associated with the channel program being executed. When the format-2-IDAW control is zero, the IDAW is format 1 and is a word containing a 31-bit address. When the control is one, the IDAW is format 2 and is a doubleword containing a 64-bit address. The IDAW formats are as follows:

Format-1 IDAW

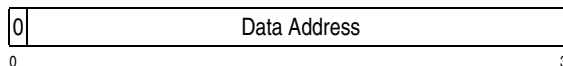

Format-2 IDAW

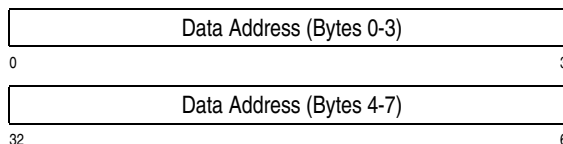

Bit 0 (format 1) is reserved for future use and must be zero; otherwise, a program-check condition may be recognized, as described below.

A format-1 IDAW designates a data area within a 2 K-byte block of main storage and is capable of addressing storage in the range of 0 to $2^{31} - 1$.

A format-2 IDAW designates a data area within a 2 K-byte or 4 K-byte block of main storage, as determined by the 2K-IDAW control, bit 15 of word 1 of the ORB associated with the channel program being executed, and is capable of addressing storage in the range of 0 to $2^{64} - 1$. When the 2K-IDAW-control bit is zero, each format-2 IDAW of the designated channel

program designates a 4 K-byte block of main storage. When the 2K-IDAW-control bit is one, each format-2 IDAW designates a 2 K-byte data-area block. All IDAWs associated with the designated channel program must have the same IDAW format, and all of those IDAWs specify the same size of storage block.

When the indirect-data-addressing bit in the CCW is one, the data-address field of the CCW designates the location of the first IDAW to be used for data transfer for the command. Additional IDAWs, if needed for completing the data transfer for the CCW, are in successive locations in storage. The number of IDAWs required for a CCW is determined by the IDAW format as specified in the ORB, by the count field of the CCW, and by the data address in the initial IDAW. When, for example, (1) the ORB specifies format-2 IDAWs with 4 K-byte blocks, (2) the CCW count field specifies 8K bytes, and (3) the first IDAW designates a location in the middle of a 4 K-byte block, then three IDAWs are required.

The IDAW designated by the CCW can designate any location. Data is then transferred, for read, write, control, sense ID, and sense commands, to or from successively higher storage locations or, for a read-backward command, to successively lower storage locations, until a 2 K-byte block boundary (format-1 or format-2 IDAW) or a 4 K-byte block boundary (format-2 IDAW) is reached. The control of data transfer is then passed to the next IDAW. The second and any subsequent IDAWs must designate, depending on the command, the first byte, or the last byte for read backward, of a 2 K-byte block (format-1 or format-2 IDAW) or a 4 K-byte block (format-2 IDAW). Thus, for read, write, control, sense ID, and sense commands, such format-1 IDAWs must have zeros in bit positions 21-31, and such format-2 IDAWs must have zeros in bit positions 53-63 (2 K-byte blocks) or 52-63 (4 K-byte blocks). For a read-backward command, such format-1 IDAWs must have ones in bit positions 21-31, and such format-2 IDAWs must have ones in bit positions 53-63 (2 K-byte blocks) or 52-63 (4 K-byte blocks). If any of these rules is violated, a program-check condition is recognized.

Except for the unique restrictions on the designation of the data address by the IDAW, all other actions taken for the data address, such as for protected storage and invalid addresses, and the actions taken for data prefetching are the same as when indirect data addressing is not used.

IDAWs pertaining to the current CCW or a prefetched CCW may be prefetched. The number of IDAWs that can be prefetched cannot exceed that required to satisfy the count in the CCW that points to the IDAWs. An IDAW takes control of data transfer when the last byte has been transferred for the previous IDAW. The same actions take place as with data chaining regarding when an IDAW takes control of data transfer during an I/O operation. That is, when the count for the CCW has not reached zero, a new IDAW takes control of the data transfer when the last byte has been transferred for the previous IDAW for that CCW, even in situations where (1) channel end, (2) channel end and device end, or (3) channel end, device end, and status modifier are received prior to the transfer of any data bytes pertaining to the new IDAW.

A prefetched IDAW does not take control of an I/O operation if the count in the CCW has reached zero with the transfer of the last byte of data for the previous IDAW for that CCW. Program or access errors detected in prefetched IDAWs are not indicated to the program until the IDAW takes control of data transfer. However, when the channel subsystem detects an invalid CBC on the contents of a prefetched IDAW or its associated key, the condition may be indicated to the program, when detected, before the IDAW takes control of data transfer. For a description of the indications provided when an invalid CBC is detected on the contents of an IDAW or its associated key, see "Channel-Control Check" on page 16-29.

Bits 1-31 (format 1) or bits 0-63 (format 2) designate the absolute storage location of the first byte to be used in the data transfer. When format-1 IDAWs are specified, the channel subsystem forms a 64-bit absolute main-storage address by appending 33 zero bits on the left of bit 1.

When the IDAW flag of the CCW is set to one and any of the following conditions occurs:

1. Format-1 IDAWs are specified in the ORB, and the address in the CCW does not designate the first IDAW on a word boundary,
2. Format-2 IDAWs are specified in the ORB, and the address in the CCW does not designate the first IDAW on a doubleword boundary,
3. The address in the CCW designates a storage location that is not physically available,

4. Access to the storage location specified by the address in the CCW is prohibited by protection, or
5. Bit 0 (format 1 only) of the first IDAW is not zero,

then, depending on the model, one of the following two actions is taken independent of the setting of the skip flag (if condition 5 above is true, action 2 must be taken).

1. The above conditions are checked before initiating the operation at the device. If any of these conditions is recognized, initiation of the I/O operation does not occur, and the subchannel is made status pending with primary, secondary, and alert status.
2. The operation is initiated at the device prior to checking for these conditions. If the device attempts to transfer data, the device is signaled to terminate the I/O operation, and the subchannel is made status pending with primary, secondary, and alert status as a function of the subchannel state and the status presented by the device.

Modified CCW Indirect Data Addressing

Modified CCW indirect data addressing (MIDA) permits a single channel-command word to control the transfer of up to 65,535 bytes of data that spans non-contiguous blocks in main storage. Each block of main storage to be transferred may be specified on any boundary and length up to 4K bytes, provided the specified block does not cross a 4 K-byte boundary. The use of modified CCW indirect data addressing requires that the program designate 64-bit data addresses.

Modified CCW indirect data addressing is controlled by a flag in the ORB and specified by a flag in the CCW which, when both are one, indicates that the CCW data address is not used to directly address data. Instead, the address points to a contiguous list of up to 256 quadwords called modified-indirect-data-address words (MIDAWs), each of which contains flags, a byte count, and a 64-bit address designating a data area in absolute storage.

Use of modified CCW indirect data addressing may be restricted to certain channel-path types. If the

MIDA flag in the CCW is one, specifying the use of modified CCW indirect data addressing, and the subchannel is associated with channel paths that do not support modified CCW indirect data addressing, a program check is recognized.

The MIDAW begins on a quadword boundary and has the following format:

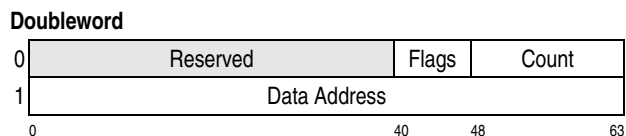

Figure 15-28. Modified-Indirect-Data-Address Word (MIDAW)

Reserved : Bits 0-39 of the MIDAW are reserved for future use and must be zero; otherwise, a program-check condition may be recognized.

Flags : Bits 40-47 of the MIDAW contain an 8-bit flag field. The meaning of each flag bit is as follows. Bits not shown are reserved.

Bit Meaning

40 Last MIDAW: Bit 40, when one, specifies that the MIDAW is the last in the contiguous list of MIDAWs.

41 Skip: Bit 41, when one, specifies the suppression of transfer of information to main storage during a read, read-backward, sense ID, or sense operation, thus specifying that skipping is in effect. When the operation is not read, read-backward, sense ID, or sense, bit 41 is ignored and skipping is not in effect

When skipping is in effect, no checking for invalid or protected data addresses takes place.

42 Data-transfer-interruption control: Bit 42, when one, specifies that a program-check be recognized when the device attempts to transfer data.

Count : Bits 48-63 of the MIDAW specify the number of bytes in the storage area designated by the data-address field. The count value must not be zero; otherwise a program-check condition is recognized. When skipping is in effect, the count value may be in the range of 1 - 65,535. When skipping is not in effect, the count value, in conjunction with the data address, must not specify the transfer of data that crosses a 4K-block boundary; otherwise, a program-

check condition is recognized. When the count value causes the total data transfer count to exceed that specified in the CCW count field, a program-check condition is recognized.

Data Address : Bits 64-127 of the MIDAW designate the 64-bit address of a location in absolute storage which is the first byte of information to be transferred. If the count field specifies zero, this field is not checked.

When modified CCW indirect data addressing is specified, the data-address field of the CCW designates the location of the first MIDAW to be used for data transfer for the CCW command. Additional MIDAWs, if needed for completing the data transfer for the CCW, are fetched from successive locations in storage. The number of MIDAWs required for a CCW is determined by the count field of the CCW in relation to the count fields in the list of MIDAWs designated by the CCW. The list must not cross a 4 K-byte boundary.

If a list of two or more MIDAWs is designated for a read operation, it is unpredictable in which order the MIDAW data addresses are used to transfer information into main storage. Thus, if two or more MIDAWs in a MIDAW list designate overlapping storage areas, the results are unpredictable.

MIDAWs that specify the transfer of data (MIDAWs for which skipping is not in effect) may specify a transfer count in the range of 1 - 4096 bytes, provided the MIDAW does not specify a data transfer that crosses a 4 K-byte boundary; MIDAWs that specify the suppression of the transfer of data (MIDAWs for which skipping is in effect) may specify a skip count in the range of 1 - 65,535 bytes. The total number of bytes that can be transferred or skipped or both by a single MIDAW list is limited by the CCW count field, which is a maximum of 65,535 bytes. The sum of the count fields in all of the MIDAWs in the list designated by the CCW should equal the value in the count field of the CCW; otherwise, a program-check condition may be recognized.

The MIDAW designated by the CCW can designate any location. When the MIDAW skip flag is zero and the CCW specifies the read, write, control, sense ID, or sense command, data is then transferred to or from successively higher storage locations until the number of bytes specified by the MIDAW count field have been transferred. When the MIDAW skip flag is zero and the CCW specifies the read backwards

command, data is then transferred to successively lower storage locations until the number of bytes specified by the MIDAW count field have been transferred. When the MIDAW skip flag is one and the CCW specifies the read, sense ID, or sense command, skipping occurs to successively higher storage locations until the number of bytes specified by the MIDAW count field have been skipped. When the MIDAW skip flag is one and the CCW specifies the read backwards command, skipping occurs to successively lower storage locations until the number of bytes specified by the MIDAW count field have been skipped.

When the specified number of bytes have been transferred or skipped and the CCW specifies a subsequent MIDAW, the control of data transfer is then passed to the next MIDAW in the list. Like the MIDAW designated by the CCW, subsequent MIDAWs may designate any location and any length, provided the MIDAW does not specify a data transfer that crosses a 4 K-byte boundary; otherwise, a program-check condition is recognized.

Except for the unique restriction on designating a valid combination of data address and count by a MIDAW and the resulting behavior when the data-transfer-interruption control is one, all other actions taken for data addresses specified by a MIDAW, such as for protected storage and invalid addresses, and the actions taken for data prefetching, are the same as when modified CCW indirect data addressing is not used.

MIDAWs pertaining to the current CCW or a prefetched CCW may be prefetched. The number of MIDAWs that can be prefetched cannot exceed that required to satisfy the count in the CCW that designates the MIDAWs. Any MIDAWs that are prefetched for a CCW and are not used are discarded.

Similar to when CCW data chaining occurs, the action of transferring control from one MIDAW to the next is transparent to any attached device. A MIDAW takes control of data transfer when the last byte specified by the previous MIDAW has been transferred, even in situations where (1) channel end, (2) channel end and device end, or (3) channel end, device end, and status modifier are received prior to the transfer of any data bytes pertaining to the new MIDAW.

A prefetched MIDAW does not take control of an I/O operation if the count in the CCW has reached zero with the transfer of the last byte of data for the previ-

ous MIDAW. Program or access errors detected in prefetched MIDAWs are not indicated to the program until the MIDAW takes control of data transfer, even if an attempt had been made to prefetch that data. However, when the channel subsystem detects an invalid CBC on the contents of a prefetched MIDAW or its associated key, the condition may be indicated to the program, when detected, before the MIDAW takes control of data transfer. For a description of the indications provided when an invalid CBC is detected on the contents of a MIDAW or its associated key, see “Channel-Control Check” on page 16-29.

When a CCW specifies a MIDAW list and either the address in the CCW designates a storage location that is not physically available or the address designates a storage location to which access is prohibited by protection, then, depending on the model, one of the following two actions is taken:

- The above conditions are checked before initiating the operation at the device. If any of these conditions is recognized, initiation of the I/O operation does not occur, and the subchannel is made status pending with primary, secondary, and alert status.
- The operation is initiated at the device prior to checking for these conditions. If the device attempts to transfer data, the device is signaled to terminate the I/O operation, and the subchannel is made status pending with primary, secondary, and alert status as a function of the subchannel state and the status presented by the device.

Transport Indirect Data Addressing

When a designated subchannel is operating in transport mode, transport indirect data addressing (TIDA) may be used. TIDA permits a TCW to specify the transfer of data from noncontiguous blocks in main storage or to specify the transfer-command-control block (TCCB) in noncontiguous blocks of storage or both.

The use of transport indirect data addressing is controlled by flags in the TCW as follows:

When the input-TIDA flag is one in the TCW, the TCW input-data address is not used to directly address data. Instead, the TCW input-data address points to a list of quadwords called

transport-indirect-data-address words (TIDAWs), each of which contains flags, a byte count, and a 64-bit address designating a data area in absolute storage.

When the output-TIDA flag is one in the TCW, the TCW output-data address is not used to directly address data. Instead, the TCW output-data address points to a list of TIDAWs, each of which designates a data area in absolute storage.

When the transport-command-control-block-TIDA flag is one in the TCW, the TCW transport-command-control-block address is not used to directly address a TCCB. Instead, the TCW transport-command-control-block address points to a list of TIDAWs, each of which designates a portion of the TCCB in absolute storage.

A list of one or more TIDAWs is called a transport-indirect-data-addressing list (TIDAL).

Unless otherwise specified, TIDAWs may designate a block of main storage on any boundary and length up to 4K bytes, provided the specified block does not cross a 4 K-byte boundary.

A TIDAW begins on a quadword boundary and has the following format:

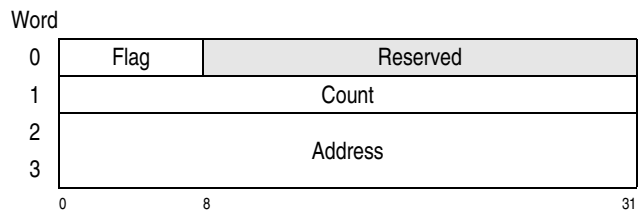

Figure 15-29. Transport-Indirect-Data-Address Word (TIDAW)

Flags : Bits 0-7 of word 0 contain an 8-bit flag field. The meaning of each flag bit is as follows. Bits not described below are reserved.

Bit	Meaning
0	Last TIDAW: Bit 0, when one, specifies that the TIDAW is the last in the contiguous list of TIDAWs.
1	Skip: Bit 1, when one, specifies the suppression of transfer of information to main storage during an input operation, thus specifying that skipping is in effect.

When the operation is an output operation, bit 1 is ignored and skipping is not in effect. When the TIDAW is being used to transport a TCCB, bit 1 is ignored and assumed to be zero.

When skipping is in effect, no checking for invalid or protected data addresses takes place.

- 2 Data-transfer-interruption control: Bit 2, when one, specifies that a program-check be recognized when the TIDAW is the current TIDAW.
- 3 TIDAW-transfer-in-channel (TTIC): Bit 3, when one, specifies that the TIDAW is not used to transfer data or TCCB storage. Instead, the address field designates the address of the next TIDAW to be used for the transfer of data. If bit 3 is one and the address field designates a TIDAW in which bit 3 is one, a program-check condition is recognized. If bit 3 is one and any other TIDAW flag bits are one, a program-check condition is recognized.
- 4 Insert-CBC control: Bit 4, when one, specifies that the following occurs when an output operation is specified and all of the data specified by the TIDAW has been transferred:
 - If the count of data bytes transferred is not a multiple of 4, up to 3 padding bytes are transferred to make the total count of data bytes, plus the count of padding bytes, a multiple of 4.
 - A word of CBC information is generated and transferred to the device.

Bit 4 has no meaning for the following cases:

- When the TIDAW is being used for an input data transfer.
- When the TIDAW is being used for an output data transfer and the last-TIDAW flag, bit 0, is one.
- When the TIDAW is in a TIDAW list designated by the TCCB-address field of the TCW.

5-7 Reserved: Bits 5-7 are reserved and must be zero, otherwise a program-check condition is recognized.

Reserved: Bits 8-31 are reserved for future use and must be zero; otherwise, a program-check condition may be recognized.

Count : Bits 32-63 specify the number of bytes to be transferred. When skipping is in effect, the count value may be in the range of 1 through $2^{32}-8$ for a TIDAW. When skipping is not in effect and the TTIC flag, bit 3, is zero, the count value, in conjunction with the data address, must not specify the transfer of data that crosses a 4 K-byte block boundary; otherwise, a program-check condition is recognized.

When a TIDAW is in the TIDAW list designated by the input-address field in the TCW, the count value specified in the TIDAW in which the last-TIDAW flag is one and the input-count value specified in the TCW must both decrement to zero for the same byte transferred, otherwise a program-check condition is recognized.

When a TIDAW is in the TIDAW list designated by the output-address field in the TCW, the count value specified in the TIDAW in which the last-TIDAW flag is one and the output-count value specified in the TCW must both decrement to zero for the same byte transferred, otherwise a program-check condition is recognized.

When a TIDAW is in the TIDAW list designated by the TCCB-address field in the TCW, the following are true:

- The count value specified in the TIDAW in which the last-TIDAW flag is one and the count of bytes specified by the TCCB-length field in the TCW must both decrement to zero for the same byte transferred, otherwise a program-check condition is recognized.
- If the TIDAW specifies the TCCB to cross a 4 K-byte boundary, a program-check condition is recognized.
- If the specified count value is zero or is not evenly divisible by four, a program-check condition is recognized.

When the TTIC flag is zero, the count field must not be zero, otherwise a program-check condition is recognized. When the TTIC flag is one, the count field

must be zero, otherwise a program-check condition is recognized.

Address : Bits 64-127 of the TIDAW designate the 64-bit address of a location in absolute storage. When the TTIC flag is zero, this is the location of the first byte of information to be transferred. When the TTIC flag is one, this is the location of the next TIDAW to be used and must specify an address on a quadword boundary, otherwise a program-check condition is recognized.

Input TIDAL: When transport indirect data addressing is specified for input (the input-TIDA flag in the TCW is one), the input-address field of the TCW designates the location of the first TIDAW to be used for data transfer for the first DCW in the associated TCCB that specifies a data transfer command. Additional TIDAWs, if needed for completing the data transfer for the DCW or subsequent DCWs, are fetched from successive locations in storage. The number of TIDAWs required for an input TIDAL is variable and is a function of the following factors:

- The total number of bytes being transferred as specified by the input-count field in the TCW.
- The number of noncontiguous fragments that compose the data being transferred.
- The number of 4 K-byte boundaries within those fragments.

The input TIDAL must not cross a 4 K-byte boundary, otherwise a program-check condition is recognized.

If a list of two or more TIDAWs is designated for an input operation, it is unpredictable in which order the TIDAW data addresses are used to transfer information into main storage. Thus, if two or more TIDAWs in a TIDAW list designate overlapping storage areas, the results are unpredictable.

Output TIDAL: When transport indirect data addressing is specified for output (the output-TIDA flag in the TCW is one), the output-address field of the TCW designates the location of the first TIDAW to be used for data transfer for the first DCW in the associated TCCB that specifies a data transfer command. Additional TIDAWs, if needed for completing the data transfer for the DCW or subsequent DCWs, are fetched from successive locations in storage. The number of TIDAWs required for a TCW is determined by the output-count field of the TCW. The number of

TIDAWs required for an output TIDAL is variable and is a function of the following factors:

- The total number of bytes being transferred as specified by the output-count field in the TCW.
- The number of noncontiguous fragments that compose the data being transferred.
- The number of 4 K-byte boundaries within those fragments.

The output TIDAL must not cross a 4 K-byte boundary, otherwise a program-check condition is recognized.

TCCB TIDAL: When transport indirect data addressing is specified for the TCCB (the transport-command-control-block-TIDA flag in the TCW is one), the transport-command-control-block-address field of the TCW designates the location of the first TIDAW to be used to designate the storage location of the TCCB. Additional TIDAWs, if needed for completing the TCCB, are fetched from successive locations in storage. The number of TIDAWs required for a TCCB TIDAL is variable and is a function of the following factors:

- The total number of bytes being transferred as specified by the TCCB-length field in the TCW.
- The number of noncontiguous fragments that compose the data being transferred.
- The number of 4 K-byte boundaries within those fragments.

The TCCB TIDAL must not cross a 4 K-byte boundary, otherwise a program-check condition is recognized.

Additional Information

TIDAWs that specify the transfer of data (TIDAWs for which skipping is not in effect) may specify a transfer count in the range of 1 through 4096 bytes, provided the TIDAW does not specify a data transfer that crosses a 4 K-byte boundary.

TIDAWs that specify the suppression of the transfer of data may specify a skip count in the range of 1 through $2^{32}-8$.

The total number of bytes that can be transferred or skipped or both by a single TIDAL is limited by the

TCW count field that applies to the TIDAL, which may be a maximum of $2^{32}-8$ bytes. If a TIDAL does not specify the same number of data bytes to be transferred as the count in the TCW for the TIDAL, or does not specify the same number of data bytes to be transferred as that specified by the associated TCCB, a program-check condition may be recognized.

A TIDAW can designate any location. When the TIDAW skip flag is zero and a DCW specifies the read, write, control, sense ID, or sense command, data is then transferred to or from successively higher storage locations until the number of bytes specified by the TIDAW count field have been transferred. When the TIDAW skip flag is one and a DCW specifies the read, sense ID, or sense command, skipping occurs to successively higher storage locations until the number of bytes specified by the TIDAW count field have been skipped.

When the specified number of bytes have been transferred or skipped and the TCW and DCW specify a subsequent TIDAW, the control of data transfer is then passed to the next TIDAW in the list. Like the TIDAW designated by the TCW, subsequent TIDAWs may designate any location and any length, provided the TIDA does not specify a data transfer that crosses a 4 K-byte boundary; otherwise, a program-check condition is recognized.

Except for the unique restriction on designating a valid combination of data address and count by a TIDAW, and the resulting behavior when the data-transfer-interruption control is one, all other actions taken for data addresses specified by a TIDAW, such as for protected storage and invalid addresses, and the actions taken for data prefetching, are the same as when transport indirect data addressing is not used.

TIDAWs pertaining to the current TCW may be prefetched. The number of TIDAWs that can be prefetched cannot exceed that required to satisfy the associated count in the TCW that designates the TIDAWs. Any TIDAWs that are prefetched for a TCW and are not used are discarded.

The action of transferring control from one TIDAW to the next is transparent to any attached device. A TIDAW takes control of data transfer when the last byte specified by the previous TIDAW has been transferred, this may occur even in situations where (1) channel end, (2) channel end and device end, or (3) channel end, device end, and status modifier are

received prior to the transfer of any data bytes pertaining to the new TIDAW.

Program or access errors when fetching or prefetching TIDAWs are indicated to the program when detected. For output operations, this may preclude transporting the TCCB to the I/O device.

When the channel subsystem detects an invalid CBC on the contents of a prefetched TIDAW or its associated key, the condition may be indicated to the program, when detected, before the TIDAW takes control of data transfer. For a description of the indications provided when an invalid CBC is detected on the contents of a TIDAW or its associated key, see "Channel-Control Check" on page 16-29.

When a TCW specifies a TIDAL and either the address in the TCW designates a storage location that is not physically available or the address designates a storage location to which access is prohibited by protection, then, depending on the model, one of the following two actions is taken:

- The above conditions are checked before initiating the operation at the device. If any of these conditions is recognized, initiation of the I/O operation does not occur, and the subchannel is made status pending with primary, secondary, and alert status.
- The operation is initiated at the device prior to checking for these conditions. If the device attempts to transfer data, the device is signaled to terminate the I/O operation, and the subchannel is made status pending with primary, secondary, and alert status as a function of the subchannel state and any status presented by the device.

Suspension of CCW Channel-Program Execution

The suspend function, when used in conjunction with RESUME SUBCHANNEL, provides the program with a means to stop and restart the execution of a channel program. The initiation of the suspend function is controlled by the setting of the suspend control, bit 4 of word 1 of the command-mode ORB. The suspend function is signaled when suspend control has been specified for the subchannel in the ORB and a CCW containing an S flag set to one becomes the current CCW. The flag can be indicated either in the first

CCW of the channel program or in a CCW fetched while command chaining. The S flag is not valid and causes a program-check condition to be recognized if (1) the ORB contains the suspend-control bit set to zero, or (2) the CCW is fetched while data chaining (see “Data Chaining” on page 15-61, concerning the handling of programming errors detected during data chaining).

Upon recognition of the suspend function, suspension of channel-program execution occurs when the CCW becomes current (see “Channel-Command Word” on page 15-31, for a definition of when a CCW becomes current). If suspension occurs during command chaining, the device is signaled that command chaining is no longer in effect.

RESUME SUBCHANNEL signals that the CCW that caused channel-program suspension may have been modified, that the CCW must be refetched, and that the contents of the CCW must be examined to determine the settings of the flags. If the S flag is one, execution of that CCW does not occur. If the CCW is valid and the S flag in the CCW is zero, execution is initiated (see “RESUME SUBCHANNEL” on page 14-10 and “Start Function and Resume Function” on page 15-20).

When a valid CCW that contains an S flag validly set to one becomes the current CCW during command chaining and the resume-pending condition is not recognized, the suspend function is performed and causes the following actions to occur in the order given:

1. The device is signaled that the chain of operations has been concluded.
2. Channel-program execution is suspended at the subchannel; all prefetched IDAWs, MIDAWs, CCWs, and data are discarded; and the subchannel is set up such that the resume function can be performed when the subchannel is next recognized to be resume pending.
3. If the measurement-block-update mode is active and the subchannel is enabled for the mode, the accrued values of the measurement data, including the start-subchannel and sample count, are added to the accumulated values in the measurement block for the subchannel. The start-subchannel count is the only measurement data that is updated in the measurement block if the channel-subsystem-timing facility is not available

for the subchannel. (See “Channel-Subsystem Monitoring” on page 17-1 for more information.)

If a measurement-check condition is detected during the measurement-block update, the channel program is terminated at the subchannel. The subchannel is made status pending with primary, secondary, and alert status, the device-status and subchannel-status fields are set to zero, and one of the measurement-check conditions is indicated in the extended-status flags of the format-0 ESW. The subchannel is not placed in the suspended state. (See “Subchannel-Control Field” on page 16-12.)

4. The subchannel is placed in the suspended state.
5. If the subchannel is not resume pending at this point, the intermediate interruption condition due to suspension is recognized if the suppress-suspended-interruption bit of the ORB is zero; otherwise, the resume function is performed.

When a valid CCW that contains an S flag validly set to one becomes the current CCW during command chaining and the resume-pending condition is recognized, the resume function is performed instead of the suspend function.

When the first CCW of a channel program contains an S flag validly set to one and the resume-pending condition is not recognized, the suspend function is performed and causes the following actions to occur in the order given:

1. Channel-program execution is suspended prior to the selection of the device.
2. The subchannel is set up such that the resume function can be performed when the subchannel is next recognized to be resume pending.
3. If the measurement-block-update mode is active and the subchannel is enabled for the mode, the SSCH+RSCH count is incremented, and the accrued function-pending time (a function of the setting of the timing-facility bit) is added to the accumulated value in the measurement block for the subchannel.

If a measurement-check condition is detected during the measurement-block update, the channel program is not started at the subchannel. The subchannel is made status pending with primary, secondary, and alert status. Deferred condition

code one is set, and the start-pending bit remains set to one. The device-status and sub-channel-status fields are set to zero, and one of the measurement-check conditions is indicated in the extended-status flags of the format-0 ESW. The subchannel is not placed in the suspended state. (See “Subchannel-Control Field” on page 16-12.)

4. The subchannel is placed in the suspended state.
5. If the subchannel is not resume pending at this point, the subchannel is made status pending with intermediate status due to suspension if the suppress-suspended-interruption-control bit of the ORB is zero; otherwise, the resume function is performed.

When the first CCW of a channel program contains an S flag validly set to one and the resume-pending condition is recognized, the resume function is performed instead of the suspend function.

Programming Notes:

1. The execution of MODIFY SUBCHANNEL and START SUBCHANNEL completes with condition code 2 set if the designated subchannel is suspended. The start function is indicated at the subchannel while the subchannel is in the suspended state.
2. In certain situations, normal resumption of the execution of a channel program that has been suspended may not be desired. Normal termination of the suspended channel-program execution may be accomplished by:
 - a. Executing HALT SUBCHANNEL and designating the subchannel.
 - b. Modifying the CCWs in storage such that, when channel-program execution is resumed, the command transferred to the device is a control command with all modifier bits specified as zeros (no-operation) and with the chain-command flag specified as zero; and then executing RESUME SUBCHANNEL.
 - c. When an IRB indicates measurement check along with zero device status, zero subchannel status, and status pending with primary, secondary, and alert status, it may indicate that the measurement check was detected

during an attempt to place the subchannel into the suspended state.

3. If the suspended interruption is suppressed, the N condition and DCTI values applicable to the preceding subchannel-active period are not made available to the program. The execution of RESUME SUBCHANNEL when the subchannel is in the suspended state causes path-not-operational conditions and the N condition to be reset to zeros. Path-not-operational conditions and the N condition are not reset when RESUME SUBCHANNEL is executed and the designated subchannel is not in the suspended state.

Commands and Flags for CCWs

Figure 15-30 on page 15-75 lists the command codes for the seven CCW commands and indicates which flags are defined for each command. Except for a format-1 CCW specifying transfer in channel, the flags are ignored for all commands for which they are not defined. The flags are reserved in a format-1 CCW specifying transfer in channel and must be zeros.

Name	Code	Flags
Write	M M M M M M 0 1	CD CC SLI PCI IDA MIDA
Read	M M M M M M 1 0	CD CC SLI SK PCI IDA MIDA
Read backward	M M M M 1 1 0 0	CD CC SLI SK PCI IDA MIDA
Control	M M M M M M 1 1	CD CC SLI PCI IDA MIDA
Sense	M M M M 0 1 0 0	CD CC SLI SK PCI IDA MIDA
Sense ID	1 1 1 0 0 1 0 0	CD CC SLI SK PCI IDA MIDA
Transfer in Channel	X X X X 1 0 0 0	(See note below)
Explanation:		
CC	Chain command	
CD	Chain data	
IDA	Indirect data addressing	
M	Modifier bit	
MIDA	Modified indirect data addressing	
PCI	Program-controlled interruption	
S	Suspend	
SK	Skip	
SLI	Suppress-length indication	
X	Ignored in a format-0 CCW; must be zero in a format-1 CCW	
Note:	Flags are ignored in a format-0 transfer-in-channel CCW and must be zeros in a format-1 transfer-in-channel CCW.	

Figure 15-30. Command Codes and Flags for CCWs

All flags have individual significance, except for the following cases:

- The CC and SLI flags are ignored when the CD flag is set to one, and, for output forward operations the SK flag is ignored.
- The presence of the SLI flag is ignored for immediate operations involving format-0 CCWs, in which case the incorrect-length indication is suppressed regardless of the setting of the flag.
- The incorrect-length indication may be suppressed for immediate operations when executing a format-1 CCW, depending on the incorrect-length-suppression mode.
- The PCI flag is ignored during initial program loading. All flags, except the PCI flag, are ignored when the S flag is one.
- The MIDA flag is mutually exclusive from both the IDA and SKP flags. If the IDA or SKP flag is specified and the MIDA flag is specified, a program-check condition is recognized.

Programming Notes:

1. A malfunction that affects the validity of data transferred in an I/O operation is signaled at the end of the operation by means of unit check or channel-data check, depending on whether the device (control unit) or the channel subsystem detected the error. In order to make use of the checking facilities provided in the system, data read in an input operation should not be used until the end of the operation has been reached and the validity of the data has been checked. Similarly, on writing, the copy of data in main storage should not be destroyed until the program has verified that no malfunction affecting the transfer and recording of data was detected.
2. An error condition may be recognized and the I/O operation terminated when 256 or more chained commands are executed with a device and none of the executed commands result in the transfer of any data. When this condition is recognized, program check is indicated.

3. All CCWs that require suppression of incorrect-length indications must use the SLI flag.

Commands and Flags for DCWs

Figure 15-31 on page 15-76 lists the command codes for the eight DCW commands and indicates which flags are defined for each command.

Name	Code	DCW Flags
Write	m m m m m m 0 1	CC SLI
Read	m m m m m m 1 0	CC SLI
Control	m m m m m m 1 1	CC SLI
Sense	m m m m 0 1 0 0	CC SLI
Sense ID	1 1 1 0 0 1 0 0	CC SLI
Interrogate	0 1 0 0 0 0 0 0	
Transport COB	0 1 1 0 0 0 0 0	CC SLI ¹
Transfer TCAX	0 1 0 1 0 0 0 0	CC SLI ¹
Explanation:		
CC	Chain command	
m	Modifier bit.	
SLI	Suppress-length indication	
¹	Incorrect-length condition not recognized for this command; the SLI flag is ignored	

Figure 15-31. Command Codes and Flags for DCWs

Branching in CCW Channel Programs

The channel subsystem provides two methods to modify the normal sequential execution of the CCWs in a channel program. One is the transfer-in-channel (TIC) command (described in "Transfer in Channel" on page 15-77), which can be used to loop back to a previously executed CCW, or to connect discontinuous segments of the channel program. The other method, which uses the status-modifier device-status bit (described in the publication *ESA/390 Common I/O-Device Commands, SA22-7204*), allows conditions at the device to cause the channel to bypass the next CCW in the channel program.

Transfer in Channel

Format-0 TIC CCW

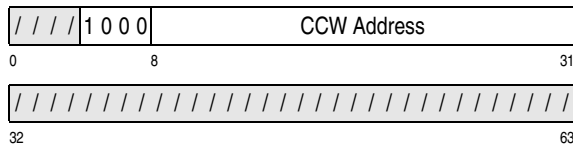

Format-1 TIC CCW

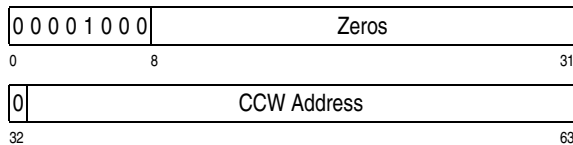

The next CCW is fetched from the location in absolute main storage designated by the data-address field of the CCW specifying transfer in channel. The transfer-in-channel command does not initiate any I/O operation, and the I/O device is not signaled of the execution of the command. The purpose of the transfer-in-channel command is to provide chaining between CCWs not located in adjacent doubleword locations in an ascending order of addresses. The command can occur in both data and command chaining.

Bits 29-31 (format 0) or bits 61-63 (format 1) of a CCW that specifies the transfer-in-channel command must be zeros, designating a CCW on a doubleword boundary. Furthermore, a CCW specifying transfer in channel may not be fetched from a location designated by an immediately preceding transfer in channel. When either of these errors is detected or when an invalid address is designated in the transfer-in-channel command, the program-check condition is generated. When a CCW that specifies the transfer-in-channel command designates a CCW at a location protected against fetching, the protection-check condition is generated. Detection of these errors during data chaining causes the operation at the I/O device to be terminated and an interruption condition to be generated, while during command chaining it causes only an interruption condition to be generated.

The contents of the second half of the format-0 CCW, bit positions 32-63, are ignored. Similarly, the contents of bit positions 0-3 of the format-0 CCW are ignored.

Bit positions 0-3 and 8-32 of the format-1 CCW must contain zeros; otherwise, a program-check condition is generated.

Command Retry

The channel subsystem has the capability to perform command retry, a procedure that causes a command to be retried without requiring an I/O interruption. This retry is initiated by the control unit presenting either of two status-bit combinations by means of a special sequence. When immediate retry can be performed, it presents a channel-end, unit-check, and status-modifier status-bit combination, together with device end. When immediate retry cannot be performed, the presentation of device end is delayed until the control unit is prepared. When device end is presented alone, the previous command is transferred again. If device end is accompanied by status modifier, command retry is not performed, and the channel subsystem command-chains to the CCW following the one for which command retry was signaled (for information on status modifier, see the publication *ESA/390 Common I/O-Device Commands*, SA22-7204). When the channel subsystem is not capable of performing command retry due to an error condition, or when any status bit other than device end or device end and status modifier accompanies the requested command-retry initiation, the retry is suppressed, and the subchannel becomes status pending. The SCSW stored by TEST SUBCHANNEL contains the status provided by the I/O device.

Programming Note: The following possible results of a command retry must be anticipated by the program:

1. A CCW containing a PCI may, if retried because of command retry, cause multiple PCI interruptions to occur.
2. If a CCW used in an operation is changed before that operation has been successfully completed, the results are unpredictable.

Concluding I/O Operations before Initiation

Subsequent to the execution of START SUBCHANNEL or RESUME SUBCHANNEL for a command-mode operation and before the first command is accepted, the start function can be ended at the subchannel by CANCEL SUBCHANNEL, CLEAR SUBCHANNEL, or HALT SUBCHANNEL.

Subsequent to the execution of START SUBCHANNEL for a transport-mode operation, the start function may be ended at the subchannel by CANCEL SUBCHANNEL, CLEAR SUBCHANNEL, or HALT SUBCHANNEL before the TCCB is transported.

For both command-mode and transport-mode operations, if the I/O operation is ended by CANCEL SUBCHANNEL, there is no subsequent interruption condition from the I/O operation, and the subchannel is available for the initiation of another start function. However, the device may have signaled a busy condition while the canceled operation was start pending. In this case, the device owes a no-longer-busy signal to the channel subsystem. This may result in unsolicited device-end status before the next operation is initiated at the device. (See also “Clear Function” on page 15-14 and “Halt Function” on page 15-16.)

Concluding I/O Operations during Initiation

After the designated subchannel has been determined to be in a state such that START SUBCHANNEL can be executed, certain tests are performed on the validity of the information specified by the program and on the logical availability of the associated device. This testing occurs during or subsequent to the execution of START SUBCHANNEL and during command chaining and command retry.

A data-transfer operation is initiated at the subchannel and device only when no programming or equipment errors are detected by the channel subsystem and when the device responds with zero status during the initiation sequence. When the channel subsystem detects or the device signals any unusual condition during the initiation of a command-mode I/O operation, the command is said to be not accepted. When the channel subsystem detects or the device signals any unusual condition during the initiation of a transport-mode I/O operation, the I/O-operation initiation is said to be not accepted. For these cases, the subchannel becomes status pending with primary, secondary, and alert status. Deferred condition code 1 is set, and the start-pending bit remains set to one.

Conditions that preclude the initiation of an I/O operation are detailed in the SCSW stored by TEST SUB-

CHANNEL. In this situation, the device is not started, no interruption conditions are generated subsequent to TEST SUBCHANNEL, and the subchannel is idle. The device is immediately available for the initiation of another operation, provided the command was not rejected because of the busy or not-operational condition.

When an unusual condition causes a command to be not accepted during the initiation of a command-mode I/O operation by command chaining or command retry, an interruption condition is generated, and the subchannel becomes status pending with combinations of primary, secondary, and alert status as a function of the status signaled by the device. The status describing the condition remains at the subchannel until cleared by TEST SUBCHANNEL. The conditions are indicated to the program by means of the corresponding status bits in the SCSW. A path-not-operational condition recognized during command chaining is signaled to the program by means of an interface-control-check indication. The new I/O operation at the device is not started.

START SUBCHANNEL is executed independent of its associated device. Tests on most program-specified information, on device availability and unit status, and on most error conditions are performed subsequent to the execution of START SUBCHANNEL. When any conditions are detected that preclude the performance of the start function, an interruption condition is generated by the channel subsystem and placed at the subchannel, causing it to become status pending.

Immediate Conclusion of Command-Mode I/O Operations

During the initiation of an I/O operation, the device can accept the command and signal the channel-end condition immediately upon receipt of the command code. An I/O operation causing the channel-end condition to be signaled during the initiation sequence is called an *immediate operation*. Status generated by the device for the immediate command, when command chaining is not specified and command retry is not signaled, causes the subchannel to become status pending with combinations of primary, secondary, intermediate, and alert status as a result of information specified in the ORB and CCW and status presented by the device. If the immediate operation is

the first operation of the channel program, deferred condition code 1 is set and accompanies the status indications. If intermediate status is indicated, the indication can occur only as a result of the CCW having the PCI flag set to one (see "Program-Controlled Interruption" on page 15-64).

Whenever command chaining is specified after an immediate operation and no unusual conditions have been detected during the operation, or when command retry occurs for an immediate operation, an interruption condition is not generated. The subsequent commands in the chain are handled normally, and, usually, the channel-end condition for the last CCW generates a primary interruption condition. If device end is signaled with channel end, a secondary interruption condition is also generated.

Whenever immediate completion of an I/O operation is signaled, no data has been transferred to or from the device, and the data address in the CCW is not checked for validity. If the subchannel is in the incorrect-length-suppression mode, incorrect length is not indicated to the program, and command chaining is performed when specified. If the subchannel is in the incorrect-length-indication mode, incorrect length and command chaining are under control of the SLI and chain-command flags. The conditions that cause the incorrect-length indication to be suppressed are summarized in Figure 15-27 on page 15-61.

Programming Note: I/O operations for which the entire operation is specified in the command code may be performed as immediate operations. Whether the command is executed as an immediate operation depends on the operation and type of device.

Concluding I/O Operations During Data Transfer

When the subchannel has been passed the contents of an ORB, the subchannel is said to be start pending. When a command-mode I/O operation has been initiated and the command has been accepted, the subchannel becomes subchannel-and-device active. When a transport-mode I/O operation has been initiated, the subchannel remains start pending while the TCCB is transported and executed. The subchannel remains in the respective state unless (1) the channel subsystem detects an equipment malfunction, (2) the operation is concluded by the execution of

CLEAR SUBCHANNEL or HALT SUBCHANNEL, or (3) status that causes a primary interruption condition to be recognized (usually channel end) is accepted from the device.

When CCW command chaining and command retry are not specified or when chaining is suppressed because of unusual conditions, the status that is recognized as primary status causes the operation at the subchannel to be concluded and an interruption condition to be generated. The status bits in the associated SCSW indicate primary status and the unusual conditions, if any. The device can present status that is recognized as primary status at any time after the initiation of the I/O operation, and the presentation of status may occur before any data has been transferred.

For operations not involving data transfer, the device normally controls the timing of the channel-end condition. The duration of data-transfer operations may be variable and may be controlled by the device or the channel subsystem.

Excluding equipment errors and the execution of the CLEAR SUBCHANNEL, HALT SUBCHANNEL, and RESET CHANNEL PATH instructions, the channel subsystem signals the device to conclude the performance of an I/O operation during data transfer whenever any of the following conditions occurs:

- The storage areas designated for the operation are exhausted or filled.
- A program-check condition is detected.
- A protection-check condition is detected.
- A CCW chaining-check condition is detected.
- A channel-control-check condition is detected that does not affect the control of the I/O operation.

The first of these conditions occurs when the channel subsystem has decremented the count to zero in the last CCW or current TCW associated with the operation. A count of zero indicates that the channel subsystem has transferred all information specified by the I/O operation. The other four conditions are due to errors and cause premature conclusion of data transfer. In either case, the conclusion is signaled in response to a service request from the device and causes data transfer to cease. If the device has no blocks defined for the operation (such as writing on

magnetic tape), it concludes the operation and presents channel-end status.

For command-mode operations, the device can control the duration of an operation and the timing of channel end by blocking of data. On certain operations for which blocks are defined (such as reading on magnetic tape), the device does not present channel-end status until the end of the block is reached, regardless of whether the device has been previously signaled to conclude data transfer.

Checking for the validity of the CCW data address is performed only as data is transferred to or from main storage. When the initial data address in the CCW is invalid, no data is transferred during the operation, and the device is signaled to conclude the operation in response to the first service request. On writing, devices such as magnetic-tape units request the first byte of data before any mechanical motion is started, and, if the initial data address is invalid, the operation is terminated by the channel subsystem before the recording medium has been advanced. However, since the operation has been initiated at the device, the device presents channel-end status, causing the channel subsystem to recognize a primary interruption condition. Subsequently, the device also presents device-end status, causing the channel subsystem to recognize a secondary interruption condition. Whether a block at the device is advanced when no data is transferred depends on the type of device.

Checking for the validity of main-storage addresses of the TCCB is performed before attempting to transport the TCCB to the I/O device. When an applicable address is invalid, a program check condition is recognized and no data is transferred during the operation nor is there any communication with the I/O device. After the TCCB has been transported to the device, the operation is considered initiated at the device and subsequent checks for the validity of main-storage addresses are performed either as information is transferred to or from main storage or as information is prefetched, as specified by the applicable TCW reference to storage (directly or indirectly by a TIDAW). If a main-storage address is found to be invalid after the operation has been initiated at the device, the device presents channel-end status, causing the channel subsystem to recognize a primary interruption condition. Subsequently, the device may also present device-end status, causing the channel subsystem to recognize a secondary interruption condition. Whether a block at the device

is advanced when no data is transferred depends on the type of device.

When CCW command chaining takes place, the subchannel is in the subchannel-and-device-active state from the time the first I/O operation is initiated at the device until the device presents channel-end status for the last I/O operation of the chain. The subchannel remains in the device-active state until the device presents the device-end status for the last I/O operation of the chain.

Any unusual conditions cause CCW command chaining to be suppressed and a primary interruption condition to be generated. The unusual conditions can be detected by either the channel subsystem or the device, and the device can provide the indications with channel end, control unit end, or device end. When the channel subsystem is aware of the unusual condition by the time the channel-end status for the operation is accepted, the chain is ended as if the operation during which the condition occurred were the last operation of the chain. The device-end status is recognized as a secondary interruption condition whether presented together with the channel-end status or separately. If the device presents unit check or unit exception together with either control unit end or device end as status that causes the channel subsystem to recognize the primary interruption condition, then the subchannel-and-device-active state of the subchannel is terminated, and the subchannel is made status pending with primary, secondary, and alert status. Intermediate status may also be indicated if an intermediate interruption condition previously existed at the subchannel for the initial-status-interruption condition or the PCI condition and that condition still remains pending at the subchannel. The channel-end status that was presented to the channel subsystem previously when command chaining was signaled is not made available to the program.

Channel-Path-Reset Function

Subsequent to the execution of RESET CHANNEL PATH, the channel-path-reset function is performed. The performance of the function consists of: (1) issuing the reset signal on the designated channel path and (2) causing a channel report to be made pending, indicating the completion of the channel-path-reset function.

Channel-Path-Reset-Function Signaling

The channel subsystem issues the reset signal on the designated channel path. As part of this operation, the following actions are taken:

1. All internal indications associated with control-unit-busy, device-busy, and allegiance conditions for the designated channel path are reset. These indications are reset at all subchannels that have access to the designated channel path. The reset function has no other effect on subchannels, including those having I/O operations in progress.
2. If the channel path fails to respond properly to the reset signal (see “I/O-System Reset” on page 17-13 for a detailed description) or, because of a malfunction, the reset signal could not be issued, the channel path is made physically not available at each applicable subchannel.
3. If an I/O operation is in progress at the device and the device is actively communicating on the channel path in the performance of that I/O operation when the reset signal is received on that channel path, the I/O operation is reset, and the control unit and device immediately terminate current communication with the channel subsystem. (To avoid possible misinterpretation of unsolicited device-end status, programming measures can be taken as described in programming note 2 on page 82.)
4. If an I/O operation is in progress in the multipath mode at the device and the device is not currently communicating over the channel path in the performance of that I/O operation when the reset signal is received, then the I/O operation may or may not be reset depending on whether another channel path is available for selection in the same multipath group for the device. If there is at least one other channel path in the multipath group for the device that is available for selection, the I/O operation is not reset. However, the channel path on which the system reset is received is removed from the current set of channel paths that form the multipath group. If the channel path on which the reset signal is received is the only channel path of a multipath group, or if the device is operating in the single-path mode, the I/O operation is reset.

5. The channel-path-reset function causes I/O operations to be terminated at the device as described above; however, I/O operations are *never* terminated at the subchannel by the channel-path-reset function.

If an I/O operation is in progress at the subchannel and the channel path designated for the performance of the channel-path-reset function is being used for that I/O operation, the subchannel may or may not accurately reflect the progress of the I/O operation up to that instant. The subchannel remains in the state that exists at the time the channel-path-reset function is performed until the state is changed because of some action taken by the program or by the device.

Channel-Path-Reset-Function-Completion Signaling

After the reset signal has been issued and an attempt has been made to issue the reset signal, or after it has been determined that the reset signal cannot be issued, the channel-path-reset function is completed. (See “Reset Signal” on page 17-12.)

As a result of the channel-path-reset function being performed, a channel report is made pending (see “Channel-Subsystem Recovery” on page 17-27)

to report the results. If the channel path responds properly to the system-reset signal, the channel report indicates that the channel path has been initialized and is physically available for use. If the reset signal was issued but either the channel path failed to respond properly or the channel path was already not physically available at each subchannel having access to the channel path, the channel report indicates that the channel path has been initialized but is not physically available for use. If, because of a malfunction or because the designated channel path is not in the configuration, the reset signal could not be issued, the channel report indicates that the channel path has not been initialized and is not physically available for use.

Programming Notes:

1. If an I/O operation is in progress in the multipath mode when the channel-path-reset function is performed on a channel path of the multipath group, it is possible for the I/O operation to be

continued on a remaining channel path of the group.

2. When the performance of the channel-path-reset function causes the I/O operation at the device to be reset, unsolicited device-end status presented by the device, if any, may be erroneously interpreted by the channel subsystem to be chaining status and thus cause the channel subsystem to continue the chain of commands. If this situation occurs, then the device-end status is not made available to the program, and the device is selected again by the channel subsystem; however, the device may interpret the initiation sequence as the beginning of a new channel program instead of as command chaining. This possibility can be avoided by issuing CLEAR SUBCHANNEL or HALT SUBCHANNEL, designating the affected subchannels, prior to issuing RESET CHANNEL PATH.

3. The performance of the channel-path-reset function may, on some models, cause overruns to occur on other channel paths.

Even though reset is signaled on the designated channel path, by one or more devices may not have been reset because of a malfunction at a control unit or a malfunction at the physical channel path to the control unit.

Chapter 16. I/O Interruptions

Interruption Conditions	16-2	Transport-Mode SCSW	16-34
Intermediate Interruption Condition	16-4	Subchannel Key	16-35
Primary Interruption Condition	16-4	Reserved	16-35
Secondary Interruption Condition	16-5	Extended-Status-Word Format (L)	16-35
Alert Interruption Condition	16-5	Deferred Condition Code (CC)	16-35
Priority of Interruptions	16-5	Format (FMT)	16-35
Interruption Action	16-6	IRB-Format Control (X)	16-35
Interruption-Response Block	16-6	Interrogate Complete (Q)	16-35
IRB Format	16-6	Subchannel-Control Field	16-35
Subchannel-Status Word	16-7	Extended Control (E)	16-35
Command-Mode SCSW	16-8	Path Not Operational (N)	16-35
Subchannel Key	16-9	Function Control (FC)	16-35
Suspend Control (S)	16-9	Activity Control (AC)	16-36
Extended-Status-Word Format (L)	16-9	Status Control (SC)	16-36
Deferred Condition Code (CC)	16-9	TCW Address Field	16-36
CCW Format (F)	16-11	Device-Status Field	16-39
Prefetch (P)	16-11	Subchannel-Status Field	16-39
Initial-Status-Interruption Control (I)	16-12	Incorrect Length	16-39
Address-Limit-Checking Control (A)	16-12	Program Check	16-40
IRB-Format Control (X)	16-12	Protection Check	16-42
Suppress-Suspended Interruption (U)	16-12	Channel-Data Check	16-42
Subchannel-Control Field	16-12	Channel-Control Check	16-43
Zero Condition Code (Z)	16-12	Interface-Control Check	16-43
Extended Control (E)	16-12	Channel-Subsystem Retry Failed	16-44
Path Not Operational (N)	16-13	FCX-Status Field	16-44
Function Control (FC)	16-13	Subchannel-Extended-Status Field	16-44
Activity Control (AC)	16-14	Extended-Status Word	16-47
Status Control (SC)	16-17	Extended-Status Format 0	16-47
CCW-Address Field	16-19	Subchannel Logout	16-47
Device-Status Field	16-24	Extended-Report Word	16-51
Subchannel-Status Field	16-24	Failing-Storage Address	16-53
Program-Controlled Interruption	16-24	Extended-Subchannel-Logout Descriptor (ESLD)	16-53
Incorrect Length	16-24	Secondary-CCW Address	16-53
Program Check	16-25	Extended-Status Format 1	16-53
Protection Check	16-28	Extended-Status Format 2	16-54
Channel-Data Check	16-28	Extended-Status Format 3	16-55
Channel-Control Check	16-29	Extended-Control Word	16-56
Interface-Control Check	16-29	Extended-Measurement Word	16-56
Chaining Check	16-30		
Count Field	16-31		

When an I/O operation or sequence of I/O operations initiated by the execution of START SUBCHANNEL is ended, the channel subsystem and the device generate status conditions. The generation of these conditions can be brought to the attention of the program by means of an I/O interruption or by means of the execution of the TEST PENDING INTERRUPTION instruction. (During certain abnormal situations,

these conditions can be brought to the attention of the program by means of a machine-check interruption. See “Channel-Subsystem Recovery” on page 17-27 for details.)

The status conditions, as well as an address and a count indicating the extent of the operation sequence, are presented to the program in the form

of a subchannel-status word (SCSW). The SCSW is stored in an interruption-response block (IRB) during the execution of TEST SUBCHANNEL. When a transport-mode IRB is stored, additional information describing the status of the operation is also stored in the transport-status block.

Normally an I/O operation is being performed until the device signals primary interruption status. Primary interruption status can be signaled during initiation of an I/O operation, or later. An I/O operation can be terminated by the channel subsystem performing a clear or halt function when it detects an equipment malfunction, a program check, a chaining check, a protection check, or an incorrect-length condition, or by performing a clear, halt, or channel-path-reset function as a result of the execution of CLEAR SUBCHANNEL, HALT SUBCHANNEL, or RESET CHANNEL PATH, respectively.

I/O interruptions provide a means for the CPU to change its state in response to conditions that occur at I/O devices or subchannels. These conditions can be caused by the program, by the channel subsystem, or by an external event at the device.

Interruption Conditions

The conditions causing requests for I/O interruptions to be initiated are called I/O-interruption conditions. When an interruption condition is recognized by the channel subsystem, it is indicated at the appropriate subchannel. The subchannel is then said to be status pending. The subchannel becoming status pending causes the channel subsystem to generate an I/O-interruption request. An I/O-interruption request can be brought to the attention of the program only once.

An I/O-interruption request remains pending until it is accepted by a CPU in the configuration, is withdrawn by the channel subsystem, or is cleared by means of the execution of TEST PENDING INTERRUPTION, TEST SUBCHANNEL, or CLEAR SUBCHANNEL, or by means of subsystem reset. When a CPU accepts an interruption request and stores the associated interruption code, the interruption request is cleared. When the pending interruption is cleared by the execution of TEST PENDING INTERRUPTION, the subchannel remains status pending until the associated interruption condition is cleared when TEST SUB-

CHANNEL or CLEAR SUBCHANNEL is executed or when the subchannel is reset.

An I/O-interruption condition is normally cleared by means of the execution of TEST SUBCHANNEL. If TEST SUBCHANNEL is executed, designating a subchannel that has an I/O-interruption request pending, both the interruption request and the interruption condition at the subchannel are cleared. The interruption request and the interruption condition can also be cleared by CLEAR SUBCHANNEL.

A device-end status condition generated by the I/O device and presented following the conclusion of the last I/O operation of a start function is reset at the subchannel by the channel subsystem without generating an I/O-interruption condition or I/O-interruption request if the subchannel is currently start pending and if the status contains device end either alone or accompanied by control unit end. If any other status bits accompany the device-end status bit, then the channel subsystem generates an I/O-interruption request with deferred condition code 1 indicated.

When an I/O operation is terminated because of an unusual condition detected by the channel subsystem during the command-initiation sequence, status describing the interruption condition is placed at the subchannel, causing it to become status pending. If the unusual condition is detected by the device, the device-status field of the associated SCSW identifies the condition.

When command chaining takes place, the generation of status by the device does not cause an interruption, and the status is not made available to the program.

When the channel subsystem detects any of the following interruption conditions, it initiates a request for an I/O interruption without necessarily communicating with, or having received the status byte from, the device:

- A programming error associated with the contents of the ORB passed to the subchannel by the previous execution of START SUBCHANNEL
- A suspend flag set to one in the first CCW fetched that initiates a CCW channel program execution for either START SUBCHANNEL or RESUME SUBCHANNEL, and suppress suspended interruption not specified in the command-mode ORB.

- A programming error associated with the first CCW, TCW, TIDAW, TCCB fetch, data fetch, IDAW, or MIDAW.

These interruption conditions from the subchannel, except for the suspended condition, can be accompanied by other subchannel-status indications, but the device-status indications are all stored as zeros.

The channel subsystem issues the clear signal to the device when status containing unit check is presented to a subchannel that is disabled or when the device is not associated with any subchannel. However, if the presented status does not contain unit check, the status is accepted by the channel subsystem and discarded without causing the subchannel to become status pending.

An interruption condition caused by the device may be accompanied by multiple device-status conditions. Furthermore, more than one interruption condition associated with the same device can be accepted by the channel subsystem without an intervening I/O interruption. As an example, when the channel-end condition is not cleared at the device by the time device end is generated, both conditions may be cleared at the device concurrently and indicated in the SCSW together. Alternatively, channel-end status may have been previously accepted at the subchannel, and an I/O interruption may have occurred; however, the associated status-pending condition may not have been cleared by TEST SUBCHANNEL by the time device-end status was accepted at the subchannel. In this situation, the device-end status may be merged with the channel-end status without causing an additional I/O interruption. Whether an interruption condition may be merged at the subchannel with other existing interruption conditions depends

upon whether the interruption condition is unsolicited or solicited.

Unsolicited Interruption Condition: An unsolicited interruption condition is any interruption condition that is unrelated to the performance of a clear, halt, resume, interrogate, or start function. An unsolicited interruption condition is identified at the subchannel as alert status. An unsolicited interruption condition can be generated only when the subchannel is not device active.

The subchannel and device status associated with an unsolicited interruption condition is never merged with that of any currently existing interruption condition. If the subchannel is currently status pending, the unsolicited interruption condition is held in abeyance in either the channel subsystem or the device, as appropriate, until the status-pending condition has been cleared. Whenever the subchannel is idle and zero status is presented by the device, the status is discarded.

Solicited Interruption Condition: A solicited interruption condition is any interruption condition generated as a direct consequence of performing or attempting to perform a clear, halt, resume, interrogate, or start function. Solicited interruption conditions include any interruption condition generated while the subchannel is either subchannel-and-device active or device active. When the subchannel is operating in transport mode, solicited interruption conditions can be generated when the subchannel is start pending. The subchannel and device status associated with a solicited interruption condition may be merged at the subchannel with that of another currently existing solicited interruption condition. Figure 16-1 on page 16-4 describes the interruption

condition that results from any combination of bits in the status-control field of the SCSW.

Status-Control Field	Status-Control-Bit Combinations														
Alert	1	1	1	1	1	1	1	1	0	0	0	0	0	0	0
Primary	0	1	1	1	1	0	0	0	1	1	1	1	0	0	0
Secondary	0	0	1	1	0	1	1	0	0	1	1	0	1	1	0
Intermediate	0	0	0	1	1	0	1	1	0	0	1	1	0	1	0
Status pending	1	1	1	1	1	1	1	1	1	1	1	1	1	1	1
Resulting interruption condition	E	S	S	S	S	S	-	S	S	S	S	S	S	-	S
Explanation:															
-	Combination does not occur.														
E	Unsolicited or solicited interruption condition.														
S	Solicited interruption condition.														
0	Indicates the bit stored as zero.														
1	Indicates the bit stored as one.														

Figure 16-1. Interruption Condition for Status-Control-Bit Combinations

Intermediate Interruption Condition

An intermediate interruption condition is a solicited interruption condition that indicates that an event has occurred for which the program had previously requested notification. An intermediate interruption condition is described by any of, or any combination of the following:

- solicited subchannel status
- the Z bit
- the subchannel-suspended condition
- the Q bit

An intermediate interruption condition can occur only after it has been requested by the program through the use of flags in the ORB, CCW, or a CANCEL SUBCHANNEL for a subchannel operating in transport mode that requests an interrogate operation. Depending on the state of the subchannel, the performance or suspension of the I/O operation continues, unaffected by the setting of the intermediate-status bit.

An intermediate interruption condition can be indicated only together with one of the following indications:

1. Subchannel active
2. Status pending with primary status alone

3. Status pending with primary status together with alert status or secondary status or both
4. Suspended
5. Interrogate-complete (Q-bit)

If only the intermediate-status bit and the status-pending bit of the status-control field are ones during the execution of TEST SUBCHANNEL, the device-status field is zero.

Primary Interruption Condition

A primary interruption condition is a solicited interruption condition that indicates the performance of the start function is completed at the subchannel. A primary interruption condition is described by the SCSW stored as a result of the execution of TEST SUBCHANNEL while the subchannel is status pending with primary status. Once the primary interruption condition is indicated at the subchannel, the channel subsystem is no longer actively participating in the I/O operation by transferring commands or data. When a subchannel is status pending with a primary interruption condition, the execution of any of the following instructions results in the setting of a nonzero condition code: HALT SUBCHANNEL, MODIFY SUBCHANNEL, RESUME SUBCHANNEL, and START SUBCHANNEL. Once the primary interruption condition is cleared by the execution of TEST SUBCHANNEL, the subchannel accepts the START

SUBCHANNEL instruction. (See “START SUBCHANNEL” on page 14-15)

Secondary Interruption Condition

A secondary interruption condition is a solicited interruption condition that normally indicates the completion of an I/O operation at the device. A secondary interruption condition is also generated by the channel subsystem if the start function is terminated because a solicited alert interruption condition is recognized prior to initiating the first I/O operation at the device. A secondary interruption condition is described by the SCSW stored as a result of the execution of TEST SUBCHANNEL while the subchannel is status pending with secondary status. Once the channel subsystem has accepted status from the device that causes a secondary interruption condition to be recognized, the start function is completed at the device.

Alert Interruption Condition

An alert interruption condition is either a solicited interruption condition that indicates the occurrence of an unusual condition in a halt, resume, or start function or an unsolicited interruption condition that describes a condition unrelated to the performance of a halt, resume, or start function. An alert interruption condition is described by the SCSW stored as a result of the execution of TEST SUBCHANNEL while the subchannel is status pending with alert status. An alert interruption condition may be generated by either the channel subsystem or the device. Nonzero alert status is always brought to the attention of the program.

Priority of Interruptions

All requests for an I/O interruption are asynchronous to any activity in any CPU, and interruption requests associated with more than one subchannel can exist at the same time. The priority of interruptions is controlled by two types of mechanisms — one establishes within the channel subsystem the priority among interruption requests from subchannels associated with the same I/O-interruption subclass, and another establishes within a given CPU the priority among requests from subchannels of different I/O-interruption subclasses. The channel subsystem

requests an I/O interruption only after it has established priority among requests from its subchannels. The conditions responsible for the I/O-interruption requests associated with subchannels are preserved at the subchannels until cleared by a CPU's execution of TEST SUBCHANNEL or CLEAR SUBCHANNEL or I/O-system reset is performed.

The assignment of priority among requests for interruption from subchannels of the same I/O-interruption subclass is in the order that the need for interruption is recognized by the channel subsystem. The order of recognition by the channel subsystem is a function of the type of interruption condition and the type of channel path. For the parallel-I/O-interface type of channel path, the order depends on the electrical position of the device on the channel path to which it is attached. (A device's electrical position on the parallel-I/O interface is not related to its device address.)

The assignment of priority among requests for interruption from subchannels of different I/O-interruption subclasses is made by the CPU according to the numerical value of the I/O-interruption subclass codes (with zero having highest priority), in conjunction with the I/O-interruption-subclass mask in control register 6. The numerical value of the I/O-interruption-subclass code directly corresponds to the bit position in the I/O-interruption-subclass mask in control register 6 of a CPU. If, in any CPU, an I/O-interruption-subclass-mask bit is zero, then all subchannels having an I/O-interruption-subclass code numerically equal to the associated position in the mask register are said to be masked off in the respective CPU. Therefore, a CPU accepts the highest-priority I/O-interruption request from a subchannel that has the lowest-numbered I/O-interruption subclass code that is not masked off by a corresponding bit in control register 6 of that CPU. When the highest-priority interruption request is accepted by a CPU, it is cleared so that the interruption request is not accepted by any other CPU in the configuration.

The priority of interruption handling can be modified by the execution of either TEST SUBCHANNEL or CLEAR SUBCHANNEL. When either of these instructions is executed and the designated subchannel has an interruption request pending, that interruption request is cleared, without regard to any previous established priority. The relative priority of the remaining interruption requests is unchanged.

Programming Notes:

1. The I/O-interruption subclass mask is in control register 6, which has the following format:

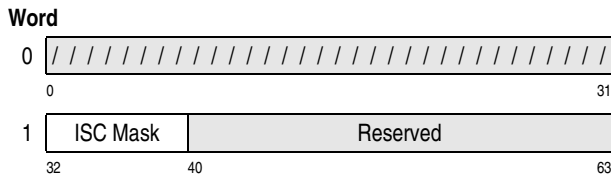

2. Control register 6 is set to all zeros during initial CPU reset.

Interruption Action

An I/O interruption can occur only when the I/O-interruption-subclass-mask bit associated with the subchannel is one and the CPU is enabled for I/O interruptions.

The interruption occurs at the completion of a unit of operation (see “Point of Interruption” on page 5-24). If the channel subsystem establishes the priority among requests for interruption from subchannels while the CPU is disabled for I/O interruptions, the interruption occurs immediately after the completion of the instruction enabling the CPU and before the next instruction is executed, provided that the I/O-interruption subclass-mask bit associated with the subchannel is one. Alternatively, if the channel subsystem establishes the priority among requests for interruption from subchannels while the I/O-interruption-subclass-mask bit is zero for each subchannel that is status pending, the interruption occurs immediately after the completion of the instruction that sets at least one of the I/O-interruption-subclass-mask bits to one, provided that the CPU is also enabled for I/O interruptions. This interruption is associated with the highest-priority I/O-interruption request, as established by the CPU.

If the channel subsystem has not established the priority among requests for interruption from the subchannels by the time the interruption is allowed, the interruption does not necessarily occur immediately after the completion of the instruction enabling the CPU. A delay can occur regardless of how long the interruption condition has existed at the subchannel.

The interruption causes the current PSW to be stored as the input/output old PSW at real locations 368-383 and causes the I/O-interruption code associated with the interruption to be stored at real locations 184-195 of the CPU allowing the interruption. Subsequently, a new input/output PSW is loaded from real locations 496-511 and processing resumes in the CPU state indicated by that PSW. The subchannel causing the interruption is identified by the interruption code.

The I/O-interruption code has the following format when it is stored. The code is described in “TEST PENDING INTERRUPTION” on page 14-19.

Hex.

B8	184	Subsystem-Identification Word
BC	188	I/O-Interruption Parameter
C0	192	I/O-Interruption-Identification Word

Programming Note: The I/O-interruption subclass code for all subchannels is set to zero by I/O-system reset. It may be set to any of the values 0-7 by the execution of MODIFY SUBCHANNEL. (The operation of the instruction is described in “MODIFY SUBCHANNEL” on page 14-7.)

Interruption-Response Block

The interruption-response block (IRB) is the operand of TEST SUBCHANNEL. The two rightmost bits of the IRB address are zeros, designating the IRB on a word boundary. The IRB contains three major fields: the subchannel-status word, the extended-status word, and the extended-control word. When the extended-I/O-measurement-word mode is enabled at the subchannel, the IRB contains a fourth major field, the extended-measurement word.

IRB Format

The format of the IRB stored depends upon the subchannel status. The status present at the subchannel when a TEST SUBCHANNEL instruction is executed determines whether a command-mode IRB or transport-mode IRB is stored. Bit 11 of word 0 of the IRB

is the IRB-format control bit (X). When an IRB is stored with X set to zero, a command-mode IRB is stored. (See “Command-Mode SCSW” on page 16-8.) When an IRB is stored with X set to one, a 3-bit format field is defined. (See “Format (FMT)” on page 16-35.) The format of the IRB is specified according to the table below:

Subchannel Mode	Subchannel Status	Bit (X)	FMT	IRB Mode Stored
Command mode	Any subchannel status or combination of status	0	N	Command mode
Transport mode	Status-pending alone with halt function	1	Y-0	Transport mode
	Status-pending alone with clear function	0	N	Command mode
	Primary status with or without any other status combination	1	Y-0	Transport mode
	Secondary status alone	0	N	Command mode
	Intermediate status	1	Y-0	Transport mode
	Alert status with secondary, without primary or intermediate status	0	N	Command mode
Explanation:				
N: Format field is not defined.				
Y-0: Format field is defined and its value is 0.				

Figure 16-2. Summary of IRB Format as Function of Subchannel Status

The general layout of the IRB is as follows:

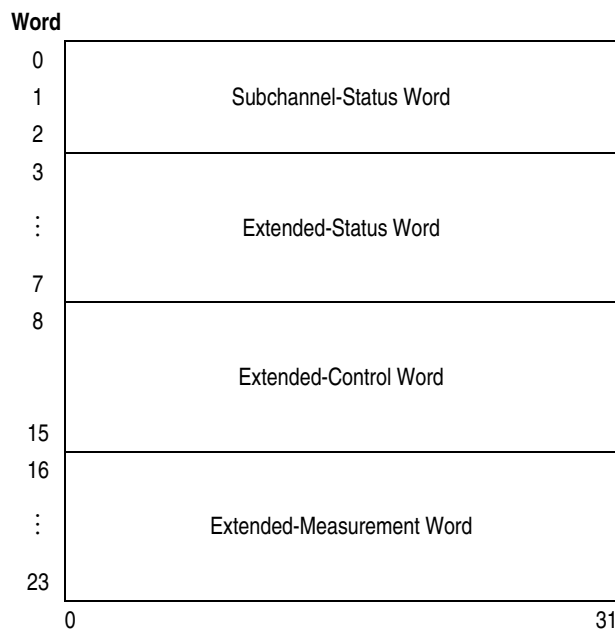

The length of the subchannel-status and extended-status words is 12 bytes and 20 bytes, respectively. The length of the extended-control word is 32 bytes. When the extended-control bit, bit 14 of word 0 of the SCSW, is zero, words 8-15 of the interruption-response block may or may not be stored. The length of the extended-measurement word is 32 bytes. When the conditions for storing the extended-measurement word are not met (see “Extended-Measurement Word” on page 16-56), words 16-23 of the interruption-response block may or may not be stored.

Subchannel-Status Word

The subchannel-status word (SCSW) provides to the program indications describing the status of a subchannel and its associated device. When a transport-mode IRB is stored, additional information describing the status of the operation and the associated device may also be stored in the transport-status block associated with the operation. If performance of a halt, resume, or start function has occurred, the SCSW may describe the conditions under which the operation was concluded.

The SCSW is stored when TEST SUBCHANNEL is executed and the designated subchannel is operational. The SCSW is placed in words 0-2 of the IRB that is designated as the TEST SUBCHANNEL operand. When STORE SUBCHANNEL is executed, the SCSW is stored in words 7-9 of the subchannel-information block (described in “Subchannel-Information Block” on page 15-2).

Figure 16-3 on page 16-8 shows the summary and contents of the command-mode SCSW.

Command-Mode SCSW

The format of a command-mode SCSW is as follows:

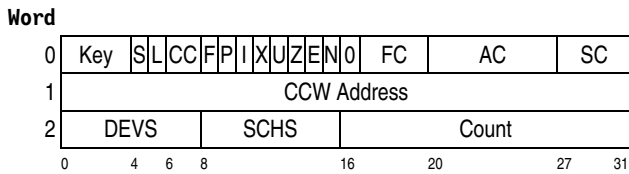

Figure 16-3. Command-Mode SCSW Format

Bits Name

Word 0

- 0-3 Subchannel Key
- 4 Suspend control (S)
- 5 ESW format (L)
- 6-7 Deferred condition code (CC)
- 8 CCW Format (F)
- 9 Prefetch (P)
- 10 Initial-status interruption control (I)
- 11 IRB-format control (X)
- 12 Suppressed-suspended interruption (U)
- 13 Zero condition (Z)
- 14 Extended control (E)
- 15 Path not operational (N)
- 16 Reserved

17-19 Function Control (FC)

- 17 Start function
- 18 Halt function
- 19 Clear function

20-26 Activity Control (AC)

- 20 Resume pending
- 21 Start pending
- 22 Halt pending
- 23 Clear pending
- 24 Subchannel active
- 25 Device active
- 26 Suspended

27-31 Status Control (SC)

- 27 Alert status
- 28 Intermediate status
- 29 Primary status
- 30 Secondary status
- 31 Status pending

Word 1

- 0-31 **CCW Address**

Word 2

0-7 Device Status (DEVS)

- 0 Attention
- 1 Status modifier
- 2 Control-unit end
- 3 Busy
- 4 Channel end
- 5 Device end
- 6 Unit check
- 7 Unit exception

8-15 Subchannel Status (SCHS)

- 8 Program-controlled interruption
- 9 Incorrect length
- 10 Program check
- 11 Protection check
- 12 Channel-data check
- 13 Channel-control check
- 14 Interface-control check
- 15 Chaining check

16-31 Count

Figure 16-4. Command-Mode SCSW

The contents of the subchannel-status word (SCSW) depend on the state of the subchannel when the SCSW is stored. Depending on the state of the subchannel and the device, the specific fields of the SCSW may contain (1) information pertaining to the last operation, (2) information unrelated to the performance of an operation, (3) zeros, or (4) meaningless values. The following descriptions indicate when an SCSW field contains meaningful information for a command-mode IRB.

Subchannel Key

When the start-function bit, bit 17 of word 0, is one, bit positions 0-3 of word 0 contain the access key used during performance of the associated start function. These bits are identical with the key specified in bit positions 0-3 of word 1 of the ORB. The subchannel key is meaningful only when the start-function bit, bit 17 of word 0, is one.

Suspend Control (S)

When the start-function bit, bit 17 of word 0, is one, bit 4 of word 0, when one, indicates that the suspend function can be initiated at the subchannel. Bit 4 is meaningful only when bit 17 is one. If bit 17 is one and bit 4 is one, channel-program execution can be suspended if the channel subsystem recognizes an S flag set to one in a CCW. If bit 4 is zero, channel-program execution cannot be suspended, and, if an S flag set to one in a CCW is encountered, a program-check condition is recognized.

Extended-Status-Word Format (L)

When the status-pending bit, bit 31 of word 0, is one, bit 5 of word 0, when one, indicates that a format-0 ESW has been stored. A format-0 ESW is stored when an interruption condition containing any of the following indications is cleared by TEST SUBCHANNEL:

- Channel-data check
- Channel-control check
- Interface-control check
- Measurement-block-program check
- Measurement-block-data check
- Measurement-block-protection check
- Path verification required
- Authorization check
- Extended subchannel logout pending

The extended-status-word-format bit is meaningful whenever the subchannel is status pending. The

extended-status information that is used to form a format-0 ESW is cleared at the subchannel by TEST SUBCHANNEL or CLEAR SUBCHANNEL.

Deferred Condition Code (CC)

When the start-function bit, bit 17 of word 0, is one and the status-pending bit, bit 31 of word 0, is also one, bits 6 and 7 of word 0 indicate the general reason that the subchannel was status pending when TEST SUBCHANNEL or STORE SUBCHANNEL was executed. The deferred condition code is meaningful when the subchannel is status pending with any combination of status and only when the start-function bit of the function-control field in the SCSW is one. The meaning of the deferred condition code for each value when the subchannel is status pending is given in Figure 16-5 on page 16-11.

The deferred condition code, if not zero, is used to indicate whether conditions have been encountered that preclude the subchannel becoming subchannel-and-device active while the subchannel is either start pending or suspended.

Deferred Condition Code 0: A normal I/O interruption has taken place.

Deferred Condition Code 1: Status is present in the SCSW that was presented by the associated device or generated by the channel subsystem subsequent to the setting of condition code 0 for START SUBCHANNEL or RESUME SUBCHANNEL. If only the alert-status bit and the status-pending bit of the status-control field of the SCSW are ones, the status present is not related to the execution of a channel program. If the intermediate-status bit, the primary-status bit, or both are ones, then the status is related to the execution of the channel program specified by the most recently executed START SUBCHANNEL instruction or implied by the most recently executed RESUME SUBCHANNEL instruction. (See "Immediate Conclusion of Command-Mode I/O Operations" on page 15-78.) If the secondary-status bit is one and the primary-status bit is zero, the status present is related to the channel program specified by the START SUBCHANNEL instruction or implied by the RESUME SUBCHANNEL instruction that preceded the most recently executed START SUBCHANNEL instruction.

Deferred Condition Code 2: This code does not occur and is reserved for future use.

Deferred Condition Code 3: An attempted device selection has occurred, and the device appeared not operational on all of the channel paths that were available for selection of the device.

A device appears not operational when it does not respond to a selection attempt by the channel subsystem. This occurs when the control unit is not provided in the system, when power is off in the control unit, or when the control unit has been logically switched off the channel path. The not-operational state is also indicated when the control unit is provided and is capable of attaching the device, but the device has not been installed and the control unit is not designed to recognize the device being selected as one of its attached devices. (See also "I/O Addressing" on page 13-5.)

A deferred condition code 3 also can be set by the channel subsystem if no channel paths to the device are available for selection. (See Figure 16-5 on page 16-11.)

Programming Notes:

1. If, during performance of a start function, the I/O device being selected is not installed or has been logically removed from the control unit, but the associated control unit is operational and the control unit recognizes the I/O device being selected as one of its I/O devices, the control

unit, depending upon the model, either fails to recognize the address of the I/O device or considers the I/O device to be not ready. In the former case, a path-not-operational condition is recognized, subject to the setting of the path-operational mask. (See "Path-Operational Mask (POM)" on page 15-7.) In the latter case, the not-ready condition is indicated when the control unit responds to the selection and indicates unit check whenever the not-ready state precludes successful initiation of the operation at the I/O device. In this case, unit-check status is indicated in the SCSW, the subchannel becomes status pending with primary, secondary, and alert status, and with deferred condition code 1 indicated. (See the publication *ESA/390 Common I/O-Device Commands*, SA22-7204, for a description of unit-check status.) Refer to the System Library publication for the control unit to determine how the condition is indicated.

2. The deferred condition code is 1, and the status-control field contains the status-pending and intermediate-status bits or the status-pending, intermediate-status, and alert-status bits as ones when HALT SUBCHANNEL has been executed and the designated subchannel is suspended and status pending with intermediate status. If the alert-status bit is one, then subchannel-logout information was generated as a result of attempting to issue the halt signal to the device.

Bit 6	Bit 7	Status Control ¹	Meaning
0	0	A I P S X A I P - X A - P S X A - P - X - I P S X - I P - X - I - - X - - P S X - - P - X	Normal I/O Interruption
0	1	A I P S X A I P - X A I - - X ² A - P S X A - P - X A - - S X A - - - X - I P S X - I P - X - I - - X ² - - P S X - - P - X - - - S X ³ - - - - X ^{3 2}	Either an immediate operation, with chaining not specified, has ended normally, or the setting of some status condition precluded the initiation or resumption of a requested I/O operation at the device.
1	0	Reserved	Reserved
1	1	- - P S X - I P S X	The device is not operational on any available path or, if a dedicate-allegiance condition exists, the device is not operational on the path to which the dedicated-allegiance is owed.
Explanation: - Bit is zero. ¹ The allowed combinations of status-control-bit settings when the start-function bit is one in the function-control field. ² The condition is encountered after the execution of HALT SUBCHANNEL when the subchannel is currently suspended ³ The condition is encountered after the execution of HALT SUBCHANNEL when the subchannel is currently start pending. A Alert status. I Intermediate status. P Primary status. S Secondary status. X Status pending.			

Figure 16-5. Deferred-Condition-Code Meaning for Status-Pending Subchannel

CCW Format (F)

When the start-function bit, bit 17 of word 0, is one, bit 8 of word 0 indicates the format of the CCWs associated with an I/O operation. The format bit is meaningful only when bit 17 is one. If bit 8 of word 0 is zero, format-0 CCWs are indicated. If it is one, format-1 CCWs are indicated. (See “Channel-Com-

mand Word” on page 15-31 for the description of the two CCW formats.)

Prefetch (P)

When the start-function bit, bit 17 of word 0, is one, bit 9 of word 0 indicates whether or not unlimited prefetching of CCWs, IDAWs, MIDAWS, and associ-

ated data is allowed. The prefetch bit is meaningful only when bit 17 is one. If bit 9 is zero, prefetching of one CCW describing a data area is allowed during output-data-chaining operations and is not allowed during any other operations. If bit 9 is one, unlimited prefetching of CCWs, IDAWs, MIDAWS, and associated data is allowed. It is model dependent whether prefetching is actually performed for any or all of the CCWs, IDAWs, MIDAWS, and associated data that comprise the CCW channel program.

Initial-Status-Interrupt Control (I)

When the start-function bit, bit 17 of word 0, is one, bit 10 of word 0, when one, indicates that the channel subsystem is to generate an intermediate interruption condition if the subchannel becomes subchannel active (see “Initial-Status-Interrupt Control (I)” on page 15-27). Bit 10 of word 0, when zero, indicates that the subchannel becoming subchannel active is not to cause an intermediate interruption condition to be generated.

The program requests the intermediate interruption condition by means of the command-mode ORB. An I/O interruption that results from that request may be due to the channel subsystem performing either a start function or a resume function. (See “Zero Condition Code (Z)” on page 16-12 for details of the indication given by the channel subsystem when the intermediate interruption condition is cleared by TEST SUBCHANNEL.)

Address-Limit-Checking Control (A)

When the address-limit-checking facility is installed and the start-function bit, bit 17 of word 0, is one, bit 11 of word 0, when one, indicates that the channel subsystem has been requested by the program to perform address-limit checking, subject to the setting of the limit mode at the subchannel (see “Address-Limit-Checking Control (A)” on page 15-27). The address-limit-checking-control bit is meaningful only when bit 17 is one.

IRB-Format Control (X)

Bit 11 of word 0 is the IRB-format control bit (X). The value of this bit is zero for the command-mode IRB. See Figure 16-2 on page 16-7.

Suppress-Suspended Interruption (U)

When the start-function bit, bit 17 of word 0, is one, bit 12 of word 0, when one, indicates that the channel subsystem has been requested by the program to

suppress the generation of a subchannel-suspended interruption condition when the subchannel is suspended (see “Suppress-Suspended-Interruption Control (U)” on page 15-27). When bit 12 is zero, the channel subsystem generates an intermediate interruption condition whenever the subchannel is suspended during the execution of the associated channel program. The suppress-suspended-interruption bit is meaningful only when bit 17 is one.

Subchannel-Control Field

The following subchannel-control-information descriptions apply to the subchannel-control field, bits 13-31 of word 0 of the SCSW.

Zero Condition Code (Z)

Bit 13 of word 0, when one, indicates that the subchannel has become subchannel active and the channel subsystem has recognized an initial-status-interruption condition at the subchannel. The Z bit is meaningful only when the intermediate-status bit, bit 28 of word 0, and the start-function bit, bit 17 of word 0, are both ones.

If the initial-status-interruption-control bit, bit 10 of word 1 of the command-mode ORB, is one when START SUBCHANNEL is executed, then the subchannel becoming subchannel active causes the subchannel to be made status pending with intermediate status indicating the initial-status-interruption condition. The initial-status-interruption condition remains at the subchannel until the intermediate interruption condition is cleared by the execution of TEST SUBCHANNEL or CLEAR SUBCHANNEL. If the initial-status-interruption-control bit of the command-mode ORB is zero when START SUBCHANNEL is executed, then the subchannel becoming subchannel active does not cause an intermediate interruption condition to be generated, and the initial-status-interruption condition is not recognized.

Extended Control (E)

Bit 14 of word 0, when one, indicates that model-dependent information or concurrent-sense information is stored in the extended-control word (ECW). When bit 14 is zero, the contents of words 0-7 of the ECW, if stored, are unpredictable. The E bit is meaningful whenever the subchannel is status pending with alert status either alone or together with primary status, secondary status, or both.

Programming Note: During the execution of TEST SUBCHANNEL, the storing of words 0-7 of the ECW is a model-dependent function subject to the setting of bit 14 as described above. Therefore, the program should always provide sufficient storage to accommodate the storing of at least a 64-byte IRB or, when the extended-I/O-measurement-word mode is enabled at the subchannel, a 96-byte IRB.

Path Not Operational (N)

Bit 15 of word 0, when one, indicates that the N condition has been recognized by the channel subsystem. The N condition, in turn, indicates that one or more path-not-operational conditions have been recognized. The channel subsystem recognizes a path-not-operational condition when, during an attempted device selection in order to perform a clear, halt, resume, or start function, the device associated with the subchannel appears not operational on a channel path that is operational for the subchannel. A channel path is operational for the subchannel if the associated device appeared operational on that channel path the last time the channel subsystem attempted device selection in order to perform a clear, halt, resume, or start function. A channel path is not operational for the subchannel if the associated device appeared not operational on that channel path the last time the channel subsystem attempted device selection in order to perform a clear, halt, resume, or start function. A device appears to be operational on a channel path when the device responds to an attempted device selection.

The N bit is meaningful whenever the status-control field contains any of the indications listed below and at least one basic I/O function is also indicated at the subchannel:

- Status pending with any combination of primary, secondary, or alert status
- Status pending alone
- Status pending with intermediate status when the subchannel is also suspended

The N condition is reset whenever the execution of TEST SUBCHANNEL results in the setting of condition code 0 and the N bit is meaningful as described above.

Notes:

1. A path-not-operational condition does not imply a malfunctioning channel path. A malfunctioning channel path causes the generation of an error indication, such as interface-control check.
2. When a path-not-operational condition has been recognized and the subchannel subsequently becomes status pending with only intermediate status, the path-not-operational condition (a) continues to be recognized until the subchannel becomes status pending with primary status or becomes suspended and (b) is indicated by storing the path-not-operational bit as a one during the execution of TEST SUBCHANNEL. When a path-not-operational condition has been recognized and the channel-program execution subsequently becomes suspended, the path-not-operational condition does not remain pending if channel-program execution is subsequently resumed. Instead, the old indication is lost, and the path-not-operational indication, if any, pertains to the attempt by the channel subsystem to resume channel-program execution.

Function Control (FC)

The function-control field indicates the basic I/O functions that are indicated at the subchannel. This field may indicate the acceptance of as many as two functions. The function-control field is contained in bit positions 17-19 of the first word of the SCSW. The function-control field is meaningful at an installed subchannel whenever the subchannel is valid (see "Device Number Valid (V)" on page 15-4). The function-control field contains all zeros whenever both the activity- and status-control fields contain all zeros. The meaning of the individual bits is as follows:

Start Function (Bit 17): When one, bit 17 indicates that a start function has been requested and is either pending or in progress at the subchannel. A start function is requested by the execution of START SUBCHANNEL. A start function is indicated at the subchannel when condition code 0 is set during the execution of START SUBCHANNEL. The start-function indication is cleared at the subchannel when TEST SUBCHANNEL is executed and the subchannel is either status pending alone or status pending with any combination of alert, primary, or secondary status. The start-function indication is also cleared at the subchannel during the execution of CLEAR SUBCHANNEL.

Halt Function (Bit 18): When one, bit 18 indicates that a halt function has been requested and is either pending or in progress at the subchannel. A halt function is requested by the execution of HALT SUBCHANNEL. A halt function is indicated at the subchannel when condition code 0 is set for HALT SUBCHANNEL. The halt-function indication is cleared at the subchannel when the next status-pending condition that occurs is cleared by the execution of TEST SUBCHANNEL. The next status-pending condition depends on the state of the subchannel when HALT SUBCHANNEL is executed. If the subchannel is subchannel active when HALT SUBCHANNEL is executed, then the next status-pending condition is status pending with at least primary status indicated. If the subchannel is device active when HALT SUBCHANNEL is executed, then the next status-pending condition is status pending with at least secondary status indicated. If the subchannel is suspended and status pending with intermediate status when HALT SUBCHANNEL is executed, then the next status-pending condition is status pending with intermediate status. If the subchannel is idle when HALT SUBCHANNEL is executed, then the next status-pending condition is status pending alone. The halt-function indication is also cleared at the subchannel during the execution of CLEAR SUBCHANNEL. In normal operations, this function is indicated together with bit 17; that is, there is a start function either pending or in progress that is to be halted.

Clear Function (Bit 19): When one, bit 19 indicates that a clear function has been requested and is either pending or in progress at the subchannel. A clear function is requested by the execution of CLEAR SUBCHANNEL. A clear function is indicated at the subchannel when condition code 0 is set for CLEAR SUBCHANNEL (see “CLEAR SUBCHANNEL” on page 14-5). The clear-function indication is cleared at the subchannel when the resulting status-pending condition is cleared by TEST SUBCHANNEL.

Activity Control (AC)

The activity-control field is contained in bit positions 20-26 of the first word of the SCSW. This field indicates the current progress of a basic I/O function previously accepted at the subchannel. By using the contents of this field, the program can determine the degree of completion of the basic I/O function. The activity-control field is meaningful at an installed subchannel whenever the subchannel is valid (see

“Device Number Valid (V)” on page 15-4). However, if an IFCC or CCC condition is detected during the performance of a basic I/O function and that function is indicated as pending, I/O operations may or may not have been performed at the device. The activity-control bits are defined as follows:

Bit	Meaning
20	Resume pending
21	Start pending
22	Halt pending
23	Clear pending
24	Subchannel active
25	Device active
26	Suspended

When an SCSW is stored that has the status-pending bit of the status-control field zero and all zeros in the activity-control field, the subchannel is said to be idle or in the idle state.

Note: All conditions that are represented by the bits in the function-control field and by the resume-pending, start-pending, halt-pending, clear-pending, subchannel-active, and suspended bits in the activity-control field are reset at the subchannel when TEST SUBCHANNEL is executed and the subchannel is (1) status pending alone, (2) status pending with primary status, (3) status pending with alert status, or (4) status pending with intermediate status and is also suspended.

Resume-Pending (Bit 20): When one, bit 20 indicates that the subchannel is resume pending. The channel subsystem may or may not be in the process of performing the start function. The subchannel becomes resume pending when condition code 0 is set for RESUME SUBCHANNEL. The point at which the subchannel is no longer resume pending is a function of the subchannel state existing when the resume-pending condition is recognized and the state of the device if channel-program execution is resumed.

If the subchannel is in the suspended state when the resume-pending condition is recognized, the CCW that caused the suspension is refetched, the setting of the suspend flag is examined, and one of the following actions is taken by the channel subsystem:

1. If the CCW suspend flag is one, the device is not selected, the subchannel is no longer resume pending, and the channel-program execution remains suspended.

2. If the CCW suspend flag is zero, the channel subsystem attempts to resume channel-program execution by performing a modified start function. The resumption of channel-program execution appears to the device as the initiation of a new channel-program execution. The resume function causes the channel subsystem to perform the path-management operation as if a new start function were being initiated, using the ORB parameters previously passed to the subchannel by START SUBCHANNEL with the exception that the channel-program address is the address of the CCW that caused the suspension of the channel-program execution.

The subchannel remains resume pending when, during the performance of the start function, the channel subsystem (1) determines that it is not possible to attempt to initiate the I/O operation for the first command, (2) determines that an attempt to initiate the I/O operation for the first command does not result in the command being accepted, or (3) detects an IFCC or CCC condition and is unable to determine whether the first command has been accepted. (See “Start Function and Resume Function” on page 15-20.)

The subchannel is no longer resume pending when any of the following events occurs:

- a. While performing the start function, the subchannel becomes subchannel-and-device active or device active only, or the first command is accepted with channel-end and device-end initial status and the CCW does not specify command chaining.
- b. CLEAR SUBCHANNEL is executed.
- c. TEST SUBCHANNEL clears any combination of primary, secondary, and alert status or clears the status-pending condition alone.
- d. TEST SUBCHANNEL clears intermediate status while the subchannel is suspended.
- e. CANCEL SUBCHANNEL is executed with a resulting condition code 0.

If the subchannel is not in the suspended state when the resume-pending condition is recognized, the CCW suspend flag of the most recently fetched CCW, if any, is examined, and one of the following actions is taken by the channel subsystem:

1. If a CCW has not been fetched or the suspend flag of the most recently fetched CCW is zero, the subchannel is no longer resume pending, and the resume function is not performed.
2. If the suspend flag of the most recently fetched CCW is one, the subchannel is no longer resume pending, and the CCW is refetched. The subchannel proceeds with channel-program execution if the suspend flag of the refetched CCW is zero. The subchannel suspends channel-program execution if the suspend flag of the refetched CCW is one.

Some models recognize a resume-pending condition only after a CCW having an S flag validly set to one is fetched. Therefore, if a subchannel is resume pending and, during the execution of the channel program, no CCW is fetched that has an S flag validly set to one, the subchannel remains resume pending until the primary interruption condition is cleared by TEST SUBCHANNEL.

Start-Pending (Bit 21): When one, bit 21 indicates that the subchannel is start pending. The channel subsystem may or may not be in the process of performing the start function. The subchannel becomes start pending when condition code 0 is set for START SUBCHANNEL. The subchannel remains start pending when, during the performance of the start function, the channel subsystem (1) determines that it is not possible to attempt to initiate the I/O operation for the first command, (2) determines that an attempt to initiate the I/O operation for the first command does not result in the command being accepted, or (3) detects an IFCC or CCC condition and is unable to determine whether the first command has been accepted. (See “Start Function and Resume Function” on page 15-20.)

The subchannel becomes no longer start pending when any of the following occurs:

1. While performing the start function, the subchannel becomes subchannel-and-device active or device active only, or the first command is accepted with channel-end and device-end initial status and the CCW does not specify command chaining.
2. The subchannel becomes suspended because of a suspend flag validly set to one in the first CCW.
3. CLEAR SUBCHANNEL is executed.

4. TEST SUBCHANNEL clears any combination of primary, secondary, and alert status or clears the status-pending condition alone.
5. CANCEL SUBCHANNEL is executed with a resulting condition code 0.

Halt-Pending (Bit 22): When one, bit 22 indicates that the subchannel is halt pending. The channel subsystem may or may not be in the process of performing the halt function. The subchannel becomes halt pending when condition code 0 is set for HALT SUBCHANNEL. The subchannel remains halt pending when, during the performance of the halt function, the channel subsystem (1) determines that it is not possible to attempt to issue the halt signal to the device, (2) determines that the attempt to issue the halt signal to the device is not successful, or (3) detects an IFCC or CCC condition and is unable to determine whether the halt signal is issued to the device. (See “Halt Function” on page 15-16.)

The subchannel is no longer halt pending when any of the following occurs:

1. While performing the halt function, the channel subsystem determines that the halt signal has been issued to the device.
2. CLEAR SUBCHANNEL is executed.
3. TEST SUBCHANNEL clears any combination of primary, secondary, and alert status or clears the status-pending condition alone.
4. TEST SUBCHANNEL clears intermediate status while the subchannel is suspended.

Clear-Pending (Bit 23): When one, bit 23 indicates that the subchannel is clear pending. The channel subsystem may or may not be in the process of performing the clear function. The subchannel becomes clear pending when condition code 0 is set for CLEAR SUBCHANNEL. The subchannel remains clear pending when, during performance of the clear function, the channel subsystem (1) determines that it is not possible to attempt to issue the clear signal to the device, (2) determines that the attempt to issue the clear signal to the device is not successful, or (3) detects an IFCC or CCC condition and is unable to determine whether the clear signal is issued to the device. (See “Clear Function” on page 15-14.)

The subchannel is no longer clear pending when either of the following occurs:

1. While performing the clear function, the channel subsystem determines that the clear signal has been issued to the device.
2. TEST SUBCHANNEL clears the status-pending condition alone.

Subchannel Active (Bit 24): When one, bit 24 indicates that the subchannel is subchannel active. A subchannel is said to be subchannel active when an I/O operation is currently being performed at the subchannel. The subchannel becomes subchannel active when the first command is accepted and the start function or resume function is not immediately concluded at the subchannel. (See “Immediate Conclusion of Command-Mode I/O Operations” on page 15-78.)

The subchannel is no longer subchannel active when any of the following occurs:

1. The subchannel becomes suspended.
2. The subchannel becomes status pending with primary status.
3. CLEAR SUBCHANNEL is executed.
4. The device appears not operational during performance of a halt function.

The subchannel does not become subchannel active during performance of the function specified by either a HALT SUBCHANNEL or a CLEAR SUBCHANNEL instruction.

Device Active (Bit 25): When one, bit 25 indicates that the subchannel is device active. A subchannel is said to be device active when an I/O operation is currently in progress at the associated device. The subchannel becomes device active when the first command is accepted.

The subchannel is no longer device active when any of the following occurs:

1. The subchannel becomes suspended.
2. The subchannel becomes status pending with secondary status.
3. CLEAR SUBCHANNEL is executed.
4. The device appears not operational during performance of a halt function.

If the subchannel is not start pending or if the status accepted from the device also describes an alert condition, the subchannel becomes status pending with secondary status. After the status has been accepted from the device, the device is capable of accepting a command for performing a new I/O operation. If the subchannel is start pending and the status is device end or device end with control unit end, then the channel subsystem discards the status and performs the start function for the new channel program. (See “Start Function and Resume Function” on page 15-20) In this situation, the subchannel does not become status pending with the secondary interruption condition, and the status is not made available to the program.

The subchannel does not become device active during performance of the functions specified by either a HALT SUBCHANNEL or a CLEAR SUBCHANNEL instruction.

Suspended (Bit 26): When one, bit 26 indicates that the subchannel is suspended. A subchannel is said to be suspended when channel-program execution is currently suspended. The subchannel becomes suspended as part of the suspend function. (See “Suspension of CCW Channel-Program Execution” on page 15-73.)

The subchannel is no longer suspended when any of the following occurs:

1. As part of the resume function following the execution of RESUME SUBCHANNEL when the subchannel becomes subchannel-and-device active or device active only, or the first command is accepted for channel-end and device-end initial status, with or without status modifier, and the CCW does not specify command chaining.
2. CLEAR SUBCHANNEL is executed.
3. TEST SUBCHANNEL clears any combination of primary, secondary, and alert status or clears the status-pending condition alone.
4. TEST SUBCHANNEL clears intermediate status while the halt function is specified.
5. CANCEL SUBCHANNEL is executed with a resulting condition code 0.

Programming Note: When an SCSW is stored by STORE SUBCHANNEL or TEST SUBCHANNEL following CLEAR SUBCHANNEL but prior to the sub-

channel becoming status pending, and the subchannel-active bit, bit 24 of word 0, is stored as zero, this does not mean that data transfer has stopped for the device. The program cannot determine whether data transfer has stopped until the subchannel becomes status pending as a result of performing the clear function.

Status Control (SC)

The status-control field is contained in bit positions 27-31 of the first word of the SCSW. This field provides the program with a summary-level indication of the interruption condition described by either subchannel or device status, the Z bit, or, in the case of the subchannel-suspended interruption, the suspended bit, bit 26. More than one summary indication may be signaled as a result of existing conditions at the subchannel. Whenever the subchannel is enabled (see “Enabled (E)” on page 15-3) and at least bit 31 is one, the subchannel is said to be status pending. Whenever the subchannel is disabled, the subchannel is not made status pending. Bit 31 of SCSW word 0 is meaningful at an installed subchannel whenever the subchannel is valid (see “Device Number Valid (V)” on page 15-4); bits 27-30 are meaningful when bit 31 is one. The status-control bits are defined as follows:

Alert Status (Bit 27): When one (and when the status-pending bit is also one), bit 27 indicates an alert interruption condition exists. In such a case, the subchannel is said to be status pending with alert status. An alert interruption condition is recognized when alert status is present at the subchannel. Alert status may be subchannel status or device status. Alert status is status generated by either the channel subsystem or the device under any of the following conditions:

- The subchannel is idle (activity-control bits 20-26 and status-control bit 31 are zeros).
- The subchannel is start pending, and the status condition precludes initiation of the I/O operation.
- The subchannel is subchannel-and-device active, and the status condition has suppressed command chaining or would have suppressed command chaining if chaining had been specified (see “CCW Channel Program Chaining” on page 15-60).
- The subchannel is subchannel-and-device active, command chaining is not specified, the

execution of the channel program has just been concluded, and the status presented by the device is attempting to alter the sequential execution of commands (see the publication *ESA/390 Common I/O-Device Commands*, SA22-7204, for more information on the use of status modifier to alter the sequential execution of commands).

- The subchannel is device active only, and the status presented by the device is other than device end, control unit end, or device end and control unit end.
- The subchannel is suspended (bit 26 is one).

If the subchannel is start pending when an alert interruption condition is recognized, the subchannel becomes status pending with alert status, deferred condition code 1 is set, the start-pending bit remains one, and the performance of the pending I/O operation is not initiated.

When TEST SUBCHANNEL is executed and stores an SCSW with the alert-status bit and the status-pending bit as ones in the IRB, the alert interruption condition is cleared at the subchannel. The alert interruption condition is also cleared during the execution of CLEAR SUBCHANNEL.

Whenever alert status is present at the subchannel, it is brought to the attention of the program. Examples of alert status include attention, device end (which signals a transition from the not-ready to the ready state), incorrect length, program check, and unit check.

Intermediate Status (Bit 28): When one (and when the status-pending bit is also one), bit 28 indicates an intermediate interruption condition exists. In such a case, the subchannel is said to be status pending with intermediate status. Intermediate status can be indicated when the Z bit (of the subchannel-control field), the suspended bit (of the activity-control field), or the PCI bit (of the subchannel-status field) is one.

When the initial-status-interruption-control bit is one in the command-mode ORB, the subchannel becomes status pending with intermediate status (the Z bit indicated) only after the subchannel is subchannel active. If the subchannel does not become subchannel active, the Z condition is not generated.

When suspend control is specified and the generation of an intermediate interruption condition due to suspension is not suppressed in the command-mode ORB, then the subchannel can become status pending with intermediate status due to suspension if a CCW becomes current that contains the suspend flag set to one. When the suspend flag is specified in the first CCW of a channel program, channel-program execution is suspended, and the subchannel becomes status pending with intermediate status (the suspended bit indicated) before the command in the first CCW is transferred to the device. When the suspend flag is specified in a CCW fetched during command chaining, then channel-program execution is suspended, and the subchannel becomes status pending with intermediate status (the suspended bit indicated), only after the execution of the preceding CCW is complete.

When the PCI flag is specified in a CCW, the generation of an intermediate interruption condition due to PCI depends on whether the CCW is the first CCW of the channel program. When the PCI flag is specified in the first CCW of a channel program, the subchannel becomes status pending with intermediate status (the PCI bit indicated) only after initial status is received for the first CCW of the channel program indicating the command has been accepted. When the PCI flag is specified in a CCW fetched while chaining, the subchannel becomes status pending with intermediate status (the PCI bit indicated) only after the execution of the preceding CCW is complete. If chaining occurs before an interruption condition containing PCI is cleared by TEST SUBCHANNEL, the condition is carried over to the next CCW. This carry-over occurs during both data and command chaining, and, in either case, the condition is propagated through the transfer-in-channel command.

If the subchannel is status pending with intermediate status when HALT SUBCHANNEL is executed, the intermediate interruption condition remains at the subchannel, but the interruption request, if any, is withdrawn, and the subchannel becomes no longer status-pending. The subchannel remains no longer status pending until performance of the halt function has ended. The subchannel then becomes status pending with intermediate status indicated (possibly together with any combination of primary, secondary, and alert status).

When TEST SUBCHANNEL is executed and stores an SCSW with the intermediate-status bit and the

status-pending bit as ones in the IRB, the intermediate interruption condition is cleared at the subchannel. The intermediate interruption condition is also cleared at the subchannel during the execution of CLEAR SUBCHANNEL.

Primary Status (Bit 29): When one (and when the status-pending bit is also one), bit 29 indicates a primary interruption condition exists. In such a case, the subchannel is said to be status pending with primary status. A primary interruption condition is a solicited interruption condition that indicates the completion of the start function at the subchannel. The primary interruption condition is described by the SCSW stored. When an I/O operation is terminated by HALT SUBCHANNEL but the halt signal is not issued to the device because the device appeared not operational, the subchannel is made status pending with primary status (and secondary status) with both the subchannel-status field and the device-status field set to zero.

When TEST SUBCHANNEL is executed and stores an SCSW with the primary-status bit and the status-pending bit as ones in the IRB, the primary interruption condition is cleared at the subchannel. The primary interruption condition is also cleared at the subchannel during the execution of CLEAR SUBCHANNEL.

Secondary Status (Bit 30): When one (and when the status-pending bit is also one), bit 30 indicates a secondary interruption condition exists. In such a case, the subchannel is said to be status pending with secondary status. A secondary interruption condition is a solicited interruption condition that normally indicates the completion of the I/O operation at the device. The secondary interruption condition is described by the SCSW stored.

When an I/O operation is terminated by HALT SUBCHANNEL but the halt signal is not issued to the device because the device appeared not operational, the subchannel is made status pending with secondary status (and primary status if the subchannel is also subchannel active) with zeros for subchannel and device status.

When TEST SUBCHANNEL is executed and stores an SCSW with the secondary-status bit as one in the IRB, the secondary interruption condition is cleared at the subchannel. The secondary interruption condition is also cleared at the subchannel during the execution of CLEAR SUBCHANNEL.

Status-Pending (Bit 31): When one, bit 31 indicates that the subchannel is status pending and that information describing the cause of the interruption condition is available to the program. The subchannel becomes status pending whenever intermediate, primary, secondary, or alert status is generated. When HALT SUBCHANNEL is executed, designating a subchannel that is idle, the subchannel becomes status pending subsequent to performance of the halt function to notify the program that the halt function has been completed. When TEST SUBCHANNEL is executed, thus storing an SCSW with the status-pending bit as one in the IRB, the status-pending condition is cleared at the subchannel. The status-pending condition is also cleared at the subchannel during the execution of CLEAR SUBCHANNEL. When CLEAR SUBCHANNEL is executed and the designated subchannel is operational, the subchannel becomes status pending subsequent to performance of the clear function to notify the program that the clear function has been completed.

Note: The status-pending bit, in conjunction with the remaining bits of the status-control field, indicates the type of status condition. For example, if bits 29 and 31 are ones, the subchannel is status pending with primary status. Alternatively, if only bit 31 is one, then the subchannel is said to be status pending or status pending alone. If only bit 31 is one in the status-control field, the settings of all bits in the subchannel-status and device-status fields are unpredictable. If bit 31 is not one, then the remaining bits of the status-control field are not meaningful.

CCW-Address Field

Bits 1-31 of word 1 form an absolute address. The address indicated is a function of the subchannel state when the SCSW is stored, as indicated in Figure 16-6 on page 16-20. When the subchannel-status field indicates channel-control check, channel-data check, or interface-control check, the CCW-address field is usable for recovery purposes if the CCW-address field-validity flag in the ESW is one.

Programming Note: When a CCW address, either detected in the channel-program address (see “Channel-Program Address” on page 15-28) or generated during chaining, would cause the channel subsystem to fetch a CCW from a location greater than $2^{24} - 1$ while format-0 CCWs are specified for the operation, the invalid address is stored in the CCW-address field of the SCSW without truncation.

If the invalid address causes the channel subsystem, while chaining, to fetch a CCW from a location greater than $2^{31} - 1$ while format-1 CCWs are speci-

fied for the operation, the rightmost 31 bits of the invalid address are stored in the CCW-address field.

Subchannel State ¹	CCW Address ²
Start pending (UUUU0/AIPSX) ³	Unpredictable
Start pending and device active (UUUU0/AIPSX) ³	Unpredictable
Subchannel-and-device active (UUUU0/AIPSX) ³	Unpredictable
Device active only (UUUU0/AIPSX)	Unpredictable
Suspended (YYYYY/AIPSX) ³	See note 1
Status pending (10001/AIPSX) because of unsolicited alert status from the device while the subchannel was start pending ³	Channel-program address + 8
Status pending (0Y111/AIPSX) because the device appeared not operational on all paths ³	Channel-program address + 8
Status pending (10011/AIPSX) because of solicited alert status from the device while the subchannel was start pending and device active ³	Channel-program address + 8
Status pending (10111/AIPSX) because of solicited alert status generated by the channel subsystem while the subchannel was start pending ³ or start pending and device active ³	See note 2
Status pending (01001/AIPSX) for the program-controlled-interruption condition while the subchannel was subchannel-and-device active ³	CCW + 8 of the CCW that contained the last recognized PCI, or 8 higher than a CCW that has subsequently become current
Status pending (01001/AIPSX) for the initial-status-interruption condition while the subchannel was subchannel-and-device active ³	CCW + 8 of the CCW causing the intermediate interruption condition, or a CCW that has subsequently become current
Status pending (1Y1Y1/AIPSX); termination occurred because of program check caused by one of the following conditions: ³	
Bit 24 of word 1 of the ORB set to one; incorrect-length-indication-suppression facility not installed	Channel-program address + 8
Unused bits in ORB not set to zeros	Channel-program address + 8
Invalid CCW-address specification in transfer in channel (TIC)	Address of TIC + 8
Invalid CCW-address specification in the channel-program address in the ORB	Channel-program address + 8 ⁴

Figure 16-6. (Part 1 of 4) CCW Address as Function of Subchannel State

Subchannel State ¹	CCW Address ²
Invalid CCW address in TIC	Address of TIC + 8
Invalid CCW address in the channel-program address in the ORB	Channel-program address + 8 ⁴
Invalid CCW address while chaining	Invalid CCW address + 8
Invalid command code	Address of invalid CCW + 8 ⁵
Invalid count	Address of invalid CCW + 8 ⁵
Invalid IDAW-address or MIDAW-address specification	Address of invalid CCW + 8 ⁵
Invalid IDAW or MIDAW address in CCW	Address of invalid CCW + 8 ⁵
Invalid IDAW address while sequentially fetching IDAWs or invalid MIDAW address while sequentially fetching MIDAWs	Address of current CCW + 8
Invalid data-address specification, format 1	Address of invalid CCW + 8 ⁵
Invalid data address in a CCW	Address of invalid CCW + 8 ⁵
Invalid data address while sequentially accessing storage	Address of current CCW + 8
Invalid data address in IDAW or MIDAW	Address of current CCW + 8
Invalid IDAW or MIDAW specification	Address of current CCW + 8
Invalid CCW, format 0 or 1, for a CCW other than a TIC	Address of invalid CCW + 8 ⁵
Invalid suspend flag – CCW fetched during data chaining has suspend flag set to one	Address of invalid CCW + 8
Invalid suspend flag – CCW has suspend flag set to one, but suspend control was not specified in the ORB	Address of invalid CCW + 8
Invalid MIDA flag – CCW has MIDA flag set to one, but modified-CCW-indirect-data addressing was not specified in the ORB	Address of invalid CCW + 8
Invalid MIDA flag – CCW has MIDA flag set to one and either the skip flag or the IDA flag or both are set to one	Address of invalid CCW + 8
Invalid CCW, format 1, for a TIC	Address of TIC + 8
Invalid sequence – two TICs	Address of second TIC + 8
Invalid sequence – 256 or more CCWs without data transfer	Address of 256th CCW + 8
Status pending (1Y1Y1/AIP SX); termination occurred because of protection check detected as follows: ³	
On a CCW access	Address of protected CCW + 8 ⁵
On data or an IDAW or a MIDAW access	Address of current CCW + 8

Figure 16-6. (Part 2 of 4) CCW Address as Function of Subchannel State

Subchannel State ¹	CCW Address ²
Status pending (1Y1Y1/AIP SX); termination occurred because of chaining check ³	Address of current CCW + 8
Status pending (YY1Y1/AIP SX); termination occurred under count control ³	Address of current CCW + 8 ⁶
Status pending (1Y1Y1/AIP SX); operation prematurely terminated by the device because of alert status ³	Address of current CCW + 8 ⁶
Status pending (YYYY1/AIP SX) after termination by HALT SUB-CHANNEL and the activity-control-field bits indicated below set to ones:	
Status pending alone	Unpredictable
Start pending ³	Unpredictable
Device active and start pending ³	Unpredictable
Device active	Unpredictable
Subchannel active and device active ³	CCW + 8 of the last-executed CCW
Suspended	CCW + 8 of CCW causing suspension
Suspended and resume pending	Unpredictable
Status pending (00001/AIP SX) after termination by CLEAR SUB-CHANNEL	Unpredictable
Status pending (YY1Y1/AIP SX); operation completed normally at the subchannel ³	CCW + 8 of the last-executed CCW ⁶
Status pending (00011/AIP SX)	Unpredictable
Status pending (10001/AIP SX)	Unpredictable
Status pending (00001/AIP SX)	Unpredictable
Status pending (1Y111/AIP SX); command chaining suppressed because of alert status other than channel-control check or interface-control check ³	Address of current CCW + 8 ⁶
Status pending (1YYY1/AIP SX) because of alert status for channel-control check or interface-control check ³	See note 3 ⁶
Status pending (1Y1Y1/AIP SX) because of channel-data check ³	See note 3 ⁶

Figure 16-6. (Part 3 of 4) CCW Address as Function of Subchannel State

Explanation:

- 1 The meaning of the notation used in this column is as follows:
- A Alert status
 - I Intermediate status
 - P Primary status
 - S Secondary status
 - X Status Pending
- The possible combination of status-control-bit settings is shown to the left of the "/" symbol by the use of these symbols:
- 0 Corresponding condition is not indicated
 - 1 Corresponding condition is indicated
 - U Unpredictable. The corresponding condition is not meaningful when the subchannel is not status pending.
 - Y The corresponding condition is not significant and is indicated as a function of the subchannel state.
- 2 A CCW becomes current when (1) it is the first CCW of a channel program and has been fetched, (2) while command chaining, the previous CCW is no longer current and the new CCW has been fetched, or (3) in the case of data chaining, the new CCW takes over control of the I/O operation (see the section "Data Chaining" in Chapter 15, "Basic I/O Functions"). If chaining is not specified or is suppressed, a CCW is no longer current and becomes the last-executed CCW when secondary status has been accepted by the channel subsystem. During command chaining, a CCW is no longer current when device-end status has been accepted or, in the case of data chaining, when the last byte of data for that CCW has been accepted.
- 3 The subchannel may also be resume pending.
- 4 The stored address is the channel-program address (in the ORB) + 8 even though it is either invalid or protected.
- 5 The stored address is the address of the current CCW + 8 even though it is either invalid or protected.
- 6 Incorrect length is indicated as a function of the setting of the suppress-length-indication flag in the current CCW (see the section "Channel-Command Word" in Chapter 15, "Basic I/O Functions").

Notes:

1. Unless the subchannel is also resume pending, the address stored is the address of the CCW that caused suspension, plus 8. Otherwise, the address stored is unpredictable.
2. The address of the CCW is given as a function of the alert status indicated. For example, if a program-check or protection-check condition is recognized, the CCW address stored is the same as for the entry for program check or protection check, respectively, in this table. Alternatively, if alert status for interface-control check or channel-control check is indicated, the CCW address stored is either the channel-program address (in the ORB) + 8 or invalid as specified by the field-validity flags in the subchannel logout. If alert status for path-verification required is indicated, the CCW address stored is the channel-program address (in the ORB) + 8.
3. Bit 21 of the subchannel-logout information, when stored as one, indicates that the address is CCW + 8 of the last-fetched CCW if the command for the CCW has not been accepted by the device. If the command has been accepted by the device at the time the error condition is recognized, then the address stored is the address of the CCW + 8 of the last-executed CCW.

Figure 16-6. (Part 4 of 4) CCW Address as Function of Subchannel State

Device-Status Field

Device-status conditions are generated by the I/O device and are presented to the channel subsystem over the channel path. The timing and causes of these conditions for each type of device are specified in the System Library publication for the device. The device-status field is meaningful whenever the subchannel is status pending with any combination of primary, secondary, intermediate, or alert status. Whenever the subchannel is status pending with intermediate status alone, the device-status field is zero. When the subchannel-status field indicates channel-control check, channel-data check, or interface-control check, the device-status field is usable for recovery purposes if the device-status field-validity flag in the ESW is one. When the subchannel is status pending with deferred condition code 3 indicated, the contents of the device-status field are not meaningful.

If, within a system, the I/O device is accessible from more than one channel path, status related to channel-subsystem-initiated operations in the single-path mode (solicited status) is signaled over the initiating channel path. Devices operating in the multipath mode may signal solicited status over any channel path that belongs to the same path group as the initiating channel path. The handling of conditions not associated with I/O operations (unsolicited alert status), such as attention, unit exception, and device end due to transition from the not-ready to the ready state, depends on the type of device and condition and is specified in the System Library publication for the device.

The channel subsystem does not modify the status bits received from the I/O device. These bits appear in the SCSW as received over the channel path. For more information on the status bits received from the I/O device, see the publication *ESA/390 Common I/O-Device Commands*, SA22-7204.

Subchannel-Status Field

Subchannel-status conditions are detected and indicated in the SCSW by the channel subsystem. Except for the conditions caused by equipment malfunctioning, they can occur only while the channel subsystem is involved with the performance of a halt, resume, or start function. The subchannel-status field is meaningful whenever the subchannel is status

pending with any combination of primary, secondary, intermediate, or alert status. Individual bits contained in the subchannel-status field may be unpredictable even when the subchannel-status field is meaningful. When the subchannel is status pending with deferred condition code 3 indicated, the contents of the subchannel-status field are not meaningful.

Program-Controlled Interruption

An intermediate interruption condition is generated after a CCW with the program-controlled-interruption (PCI) flag set to one becomes the current CCW. The I/O interruption due to the PCI flag may be delayed an unpredictable amount of time because of masking of the interruption request or other activity in the system. (See “Program-Controlled Interruption” on page 15-64.) When the channel subsystem recognizes an alert interruption condition due to either a channel-control-check condition or an interface-control-check condition, then any previously existing intermediate interruption condition caused by a PCI flag in a CCW may or may not be recognized by the channel subsystem.

Detection of the PCI condition does not affect the progress of the I/O operation.

Incorrect Length

Incorrect length occurs when the number of bytes contained in the storage areas assigned for the I/O operation is not equal to the number of bytes requested or offered by the I/O device. Incorrect length is indicated for one of the following reasons:

Long Block on Input: During a read, read-backward, or sense operation, the device attempted to transfer one or more bytes to main storage after the assigned main-storage areas were filled, or the device indicated that more data could have been transferred if the count had been larger. The extra bytes have not been placed in main storage. The count in the SCSW is zero.

Long Block on Output: During a write or control operation, the device requested one or more bytes from the channel subsystem after the assigned main-storage areas were exhausted, or the device indicated that more data could have been transferred if the count had been larger. The count in the SCSW is zero.

Short Block on Input: The number of bytes transferred during a read, read-backward, or sense opera-

tion is insufficient to fill the main-storage areas assigned to the operation. The count in the SCSW is not zero.

Short Block on Output: The device terminated a write or control operation before all information contained in the assigned main-storage areas was transferred to the device. The count in the SCSW is not zero.

The incorrect-length indication is suppressed when the current CCW has the SLI flag set to one and the CD flag set to zero. The indication does not occur for operations rejected during the initiation sequence. The indication also does not occur for immediate operations when the count field is nonzero and the subchannel is in the incorrect-length-suppression mode. The incorrect-length indication is not meaningful when the count field of the SCSW is not meaningful.

Presence of the incorrect-length condition suppresses command chaining unless the SLI flag in the CCW is one or unless the condition occurs in an immediate operation when the subchannel is in the incorrect-length-suppression mode.

Program Check

Program check occurs when programming errors are detected by the channel subsystem. The condition can be due to the following causes:

Invalid CCW-Address Specification: The channel-program address (CPA) or the transfer-in-channel command does not designate the CCW on a doubleword boundary, or bit 0 of the CPA or bit 32 of a format-1 CCW specifying the transfer-in-channel command is not zero.

Invalid CCW Address: The channel subsystem has attempted to fetch a CCW from a main-storage location that is not available. An invalid CCW address can occur because the program has designated an invalid address in the channel-program-address field of the command-mode ORB or in the transfer-in-channel command or because, on chaining, the channel subsystem attempts to fetch a CCW from an unavailable location. A main-storage location is unavailable when any of the following conditions is detected:

1. The absolute CCW address does not correspond to a physical location.

2. Format-0 CCWs are specified in the ORB, and the absolute CCW address is greater than $2^{24} - 1$.
3. Format-1 CCWs are specified in the ORB, and the absolute CCW address is greater than $2^{31} - 1$.

Invalid Command Code: There are zeros in the four rightmost bit positions of the command code in the CCW designated by the CPA or in a CCW fetched on command chaining. The command code is not tested for validity during data chaining.

Invalid Count, Format 0: A CCW, which is other than a CCW specifying transfer in channel, contains zeros in bit positions 48-63.

Invalid Count, Format 1: A CCW that specifies data chaining or a CCW fetched while data chaining contains zeros in bit positions 16-31.

Invalid IDAW-Address or MIDAW-Address Specification: Indirect data addressing or modified indirect data addressing is specified, and any of the following conditions is detected:

1. The ORB specifies format-1 IDAWs, the CCW specifies indirect data addressing, and the contents of the data-address field in the CCW do not designate the first IDAW on a word boundary; that is, bits 30 and 31 (format-0 CCW) or 62 and 63 (format-1 CCW) are not zeros.
2. The ORB specifies format-2 IDAWs, the CCW specifies indirect data addressing, and the contents of the data-address field in the CCW do not designate the first IDAW on a doubleword boundary; that is, bits 29-31 (format-0 CCW) or 61-63 (format-1 CCW) are not zeros.
3. The ORB specifies modified-CCW-indirect-data addressing, the CCW specifies modified-indirect-data addressing, and the contents of the data-address field in the CCW do not designate the first MIDAW on a quadword boundary.

Invalid IDAW or MIDAW Address: The channel subsystem has attempted to fetch an IDAW or MIDAW from a main-storage location that is not available. An invalid IDAW or MIDAW address can occur because the program has designated an invalid address in a CCW that specifies indirect data addressing or modified indirect data addressing, or because the channel subsystem, on sequentially fetching IDAWs or MIDAWs, attempts to fetch from

an unavailable location. A main-storage location is unavailable when any of the following conditions is detected:

1. The absolute IDAW or MIDAW address does not correspond to a physical location.
2. Format-0 CCWs are specified in the ORB, and the absolute IDAW or MIDAW address is greater than $2^{24} - 1$.
3. Format-1 CCWs are specified in the ORB, and the absolute IDAW or MIDAW address is greater than $2^{31} - 1$.

Invalid Data-Address Specification: Bit 32 of a format-1 CCW is not zero.

Invalid Data Address: When any of the following conditions is detected, an invalid data address is recognized by the channel subsystem.

1. Use of the data address has caused the channel subsystem to attempt to wrap from the maximum storage address to zero.
2. Use of the data address has caused the channel subsystem to attempt to wrap from zero to the maximum storage address during a read-backward operation.
3. The channel subsystem has attempted to transfer data to a storage location that is unavailable.

An invalid data address can occur because the program has designated an unavailable location in a CCW or in an IDAW or MIDAW, or because the channel subsystem, on sequentially accessing storage, attempted to access an unavailable location. A main-storage location is unavailable when any of the following conditions is detected:

1. The absolute address of the location does not correspond to a physical location.
2. Format-0 CCWs are specified in the ORB, indirect data addressing is not specified in the CCW, and the absolute address is greater than $2^{24} - 1$.
3. Format-1 CCWs are specified in the ORB, indirect data addressing is not specified in the CCW, and the absolute address is greater than $2^{31} - 1$.
4. Format-1 IDAWs are specified in the ORB, indirect data addressing is specified in the CCW, and the absolute address is greater than $2^{31} - 1$.

5. When the address-limit-checking facility is installed, the absolute address is outside the addressing range specified by SET ADDRESS LIMIT, and the limit mode at the subchannel is active.

Note: The maximum storage address is determined as a function of the CCW and IDAW formats used or MIDAWs used. When neither an IDAW nor a MIDAW is used, the maximum storage address is a function of the CCW format specified, as follows:

1. When 24-bit (format 0) CCWs are specified, the maximum storage address recognized by the channel subsystem is $2^{24} - 1$.
2. When 31-bit (format 1) CCWs are specified, the maximum storage address recognized by the channel subsystem is $2^{31} - 1$.

When an IDAW is used, the maximum storage address is a function of the IDAW format specified, as follows:

1. When 31-bit (format 1) IDAWs are specified, the maximum storage address recognized by the channel subsystem is $2^{31} - 1$.
2. When 64-bit (format 2) IDAWs are specified, the maximum storage address recognized by the channel subsystem is $2^{64} - 1$.

When a MIDAW is used, the maximum storage address recognized by the channel subsystem is $2^{64} - 1$.

Invalid IDAW or MIDAW Specification: When any of the following conditions is detected, an invalid IDAW specification is recognized by the channel subsystem:

1. Bit 0 of a format-1 IDAW is not zero.
2. A second or subsequent format-1 IDAW does not designate the location of the beginning byte of a 2 K-byte block or, for read-backward operations, the location of the ending byte of a 2 K-byte block.
3. A second or subsequent format-2 IDAW does not designate the location of the beginning byte of a 2 K-byte or 4 K-byte block, as required by the 2K-IDAW control in the ORB, or, for read-backward operations, the location of the ending byte of a 2 K-byte or 4 K-byte block.

When bit 0 of a format-1 IDAW is not zero, the sub-channel is made status pending with program-check indicated only after the I/O device attempts to transfer data, just as when an invalid data address that refers to a nonexistent data area is detected. If the device ends the operation prior to the transfer of data, no error condition is reported. See “CCW Indirect Data Addressing” in Chapter 15 for additional information about the reporting of program-check conditions.

When any of the following conditions is detected, an invalid MIDAW specification is recognized by the channel subsystem:

1. One or more bits defined as reserved in the MIDAW are not zero.
2. The MIDAW count field contains zeros.
3. The combination of the MIDAW data-address and count fields specify data addresses that cross a 4 K-byte block boundary, unless skipping is in effect for the MIDAW.
4. The MIDAW in control has its last-MIDAW flag set to zero and the sum of the count values of the previous MIDAWs in the MIDAL and the MIDAW in control is greater than or equal to the count value in the CCW.
5. The MIDAW in control has its last-MIDAW flag set to one and the sum of the count values in the previous MIDAWs in the MIDAL and the MIDAW in control do not equal the count value in the CCW.
6. The MIDAW in control is a second or subsequent MIDAW whose address is on a 4 K-byte boundary.

Invalid CCW, Format 0: A CCW other than a CCW specifying transfer in channel does not contain a zero in bit position 39.

Invalid CCW, Format 1: A CCW other than a CCW specifying transfer in channel does not contain a zero in bit position 15, or a CCW specifying transfer in channel does not contain zeros in bit positions 0-3 and 8-31.

Invalid Suspend Flag: A format-0 or format-1 CCW fetched during data chaining, other than a CCW specifying transfer in channel, does not contain a zero in bit position 38 or 14, respectively. A CCW

other than a CCW specifying transfer in channel does not contain a zero in bit position 38 for a format-0 CCW or bit position 14 for a format-1 CCW, and suspend control was not specified by bit 4 of word 1 of the ORB.

Invalid MIDA Flag: When either of the following conditions is detected, an invalid MIDA flag condition is recognized by the channel subsystem.

1. Bit 39 (format 0) or bit 15 (format 1) of the CCW is one, specifying modified CCW indirect data addressing; however, modified CCW indirect data addressing was not specified by bit 25 of word 1 of the ORB.
2. Bit 39 (format 0) or bit 15 (format 1) of the CCW is one, specifying modified CCW indirect data addressing, and bit 35 (format 0) or bit 11 (format 1) of the CCW is one, specifying skip.
3. Bit 39 (format 0) or bit 15 (format 1) of the CCW is one, specifying modified CCW indirect data addressing, and bit 37 (format 0) or bit 13 (format 1) of the CCW is one, specifying indirect data addressing.
4. Bit 39 (format 0) or bit 15 (format 1) of the CCW is one, specifying modified CCW indirect data addressing, and the designated subchannel is not associated with channel paths that support modified CCW indirect data addressing.

Invalid ORB Format: One or more reserved bit positions in the operation-request block (ORB) is not zero. (See “Operation-Request Block” on page 15-24 for more information.) If the incorrect-length-indication-suppression facility is not installed, then bit 24 of word 1 of the command-mode ORB must also be zero.

Invalid Sequence: The channel subsystem has fetched two successive CCWs both of which specify transfer in channel, or, depending on the model, a sequence of 256 or more CCWs with command chaining specified was executed by the channel subsystem and did not result in the transfer of any data to or from an I/O device.

Detection of the program-check condition during the initiation of an operation at the device causes the operation to be suppressed and the subchannel to be made status pending with primary, secondary, and alert status. When the condition is detected after the

I/O operation has been initiated at the device, the device is signaled to conclude the operation the next time the device requests or offers a byte of data or status. In this situation, the subchannel is made status pending as a function of the status received from the device. The program-check condition causes command chaining and command retry to be suppressed.

Protection Check

Protection check occurs when the channel subsystem attempts a storage access that is prohibited by the protection mechanism. Protection applies to the fetching of CCWs, IDAWs, MIDAWs, and output data and to the storing of input data. The subchannel key provided in the ORB is used as the access key for storage accesses associated with an I/O operation.

Detection of the protection-check condition during the fetching of the first CCW, IDAW, or MIDAW causes the operation to be suppressed and the subchannel to be made status pending with primary, secondary, and alert status. When protection check is detected after the I/O operation has been initiated at the device, the device is signaled to conclude the operation after the available data logically prior to the protection check has been transferred. However, if an access violation occurs when the channel subsystem is in the process of fetching either a new IDAW, MIDAW, or a new CCW while data chaining, and if the device signals the channel-end condition before transferring any data designated by the new CCW, IDAW or MIDAW, then the status is accepted, and the subchannel becomes status pending with primary and alert status and with protection check indicated. Other indications may accompany the protection-check indication as a function of the operation specified by the CCW, the status received from the device, and the current state of the subchannel. The protection-check condition causes command chaining and command retry to be suppressed.

Channel-Data Check

Channel-data check indicates that an uncorrected storage error has been detected in regard to data, contained in main storage, that is currently used in the performance of an I/O operation. The condition may be indicated when detected, even if the data is not used when prefetched. Channel-data check is indicated when data or the associated key has an invalid checking-block code (CBC) in main storage when that data is referenced by the channel subsystem.

On an input operation, when the channel subsystem attempts to store less than a complete checking block, and invalid CBC is detected on the checking block in storage, the contents of the location remain unchanged and with invalid CBC. On an output operation, whenever channel-data check is indicated, no bytes from the checking block with invalid CBC are transferred to the device.

During a storage access, the maximum number of bytes that can be transferred is model dependent. If a channel-data-check condition is recognized during that storage access, the number of bytes transferred to or from storage may not be detectable by the channel subsystem. Consequently, the number of bytes transferred to or from storage may not be correctly reflected by the residual count. However, the residual count that is stored in the SCSW, when used in conjunction with the storage-access code and the CCW address, designates a byte location within the block of main storage in which the channel-data-check condition was recognized.

A condition indicated as channel-data check causes the current operation, if any, to be terminated. The subchannel becomes status pending with primary and alert status, or with primary, secondary, and alert status, as a function of the status received from the device. The count and address fields of the SCSW stored by TEST SUBCHANNEL pertain to the operation terminated. The extended-status-word-format bit is one, and subchannel-logout information is stored in the ESW, when TEST SUBCHANNEL is executed.

Whenever the channel-data-check condition pertains to prefetched data, the failing-storage-address-validity flag, bit 6 of the ERW, is one. An address of a location within the checking block for which the channel-data-check condition is generated is stored in the ESW failing-storage-address field.

Uncorrectable storage or key errors detected on prefetched data while the subchannel is start pending cause the operation to be canceled before initiation at the device. In this case, the subchannel is made status pending with primary, secondary, and alert status, with channel-data check indicated, and with the ESW failing-storage address stored.

Whenever channel-data check is indicated, no measurement data for the subchannel is stored.

Channel-Control Check

Channel-control check is caused by any machine malfunction affecting channel-subsystem controls. The condition includes invalid CBC on a CCW, an IDAW, a MIDAW, or the respective associated key. The condition may be indicated when an invalid CBC is detected on a prefetched CCW, IDAW, MIDAW, or the respective associated key, even if that CCW, IDAW, or MIDAW is not used.

Channel-control check may also indicate that an error has been detected in the information transferred to or from main storage during an I/O operation. However, when this condition is detected, the error has occurred inboard of the channel path: in the channel subsystem or in the path between the channel subsystem and main storage.

Detection of the channel-control-check condition causes the current operation, if any, to be terminated immediately. The subchannel is made status pending with primary and alert status or with primary, secondary, and alert status as a function of the type of termination, the current subchannel state, and the device status presented, if any. When the channel subsystem recognizes a channel-control-check condition, any previously existing intermediate interruption condition caused by a PCI flag in a CCW may or may not be recognized by the channel subsystem. The count and data-address fields of the SCSW stored by TEST SUBCHANNEL pertain to the operation terminated. The extended-status-word-format bit is one, and subchannel-logout information is stored in the ESW, when TEST SUBCHANNEL is executed.

Whenever the channel-control-check condition pertains to an invalid CBC detected on a prefetched CCW, a prefetched IDAW, a prefetched MIDAW, or the key associated with the prefetched CCW, the prefetched IDAW, or the prefetched MIDAW, an extended-report word with bit 6 set to one, and the failing-storage address, are stored in the ESW when TEST SUBCHANNEL is executed.

Channel-control-check conditions encountered while prefetching when the subchannel is start pending cause the operation to be canceled before initiation at the device. In this case, the subchannel is made status pending with primary, secondary, and alert status, with channel-control check indicated, and with a failing-storage address that will be stored in the ESW.

If a subchannel is halt pending and the channel subsystem encounters a channel-control-check condition while performing the halt function for that subchannel, the subchannel remains halt pending unless the channel subsystem can determine that the halt signal was issued. The subchannel remains halt pending even if the channel subsystem was attempting to issue the halt signal and is unable to determine if the halt signal was issued.

If a subchannel is start pending or resume pending and the channel subsystem encounters a channel-control-check condition while performing the start function for that subchannel, the subchannel remains start pending or resume pending unless the channel subsystem can determine that the first command was accepted. The subchannel remains start pending or resume pending even if the channel subsystem was attempting to initiate the I/O operation for the first command and is unable to determine if the command was accepted. If the channel subsystem is unable to determine whether the first command was accepted, the subchannel is made status pending with at least alert and primary status.

In some situations in which a channel-subsystem malfunction exists, the channel-control-check condition may be reported as a machine-check condition.

Whenever channel-control check is indicated, no measurement data for the subchannel is stored.

Programming Note: If the status-control field of the SCSW indicates that the subchannel is status pending with alert status but the field-validity flags of the SCSW indicate that the device-status field is not usable for error-recovery purposes, the program should (1) assume that the channel-control-check condition occurred while the channel subsystem was accepting alert status from the device and (2) take the appropriate action for alert status, even though the status itself has been lost.

Interface-Control Check

Interface-control check indicates that an invalid signal has occurred on the channel path. The condition is detected by the channel subsystem and usually indicates malfunctioning of an I/O device. Interface-control check can occur for any of the following reasons:

1. A data or status byte received from a device while the subchannel is subchannel-and-device

active or device active has an invalid checking-block code.

2. The status byte received from a device while the subchannel is idle, start pending, suspended, or halt pending has an invalid checking-block code.
3. A device responded with an address other than the address designated by the channel subsystem during initiation of an operation.
4. During command chaining, the device appeared not operational.
5. A signal from an I/O device either did not occur or occurred at an invalid time or had an invalid duration.
6. The channel subsystem recognized the I/O-error-alert condition (see “I/O-Error Alert (A)” on page 16-50).
7. ESW bit 26, indicating device-status check, is set to one.

Detection of an interface-control check during a CCW-type IPL I/O operation on a machine that retries IPL I/O operations on an alternate channel path causes the channel subsystem to terminate operations on the current channel path and to retry the IPL I/O operation on another logically-available channel path to the designated device, if one is available, without causing the subchannel to become status-pending. (See “CCW-type IPL” on page 17-17 for additional information.) In all other cases and when an interface-control check has been detected for a CCW-type IPL operation on all logically-available channel paths to the designated device, detection of the interface-control-check condition causes the current operation, if any, to be terminated immediately, and the subchannel is made status pending with alert status, primary and alert status, secondary and alert status, or primary, secondary, and alert status as a function of the type of termination, the current subchannel state, and the device status presented, if any. When the channel subsystem recognizes an interface-control-check condition, any previously existing intermediate interruption condition caused by a PCI flag in a CCW may or may not be recognized by the channel subsystem. The extended-status-word-format bit is one, and subchannel-logout information is stored in the ESW, when TEST SUBCHANNEL is executed.

If a subchannel is halt pending and the channel subsystem encounters an interface-control-check condition while performing the halt function for that subchannel, the subchannel remains halt pending unless the channel subsystem can determine that the halt signal was issued. The subchannel remains halt pending even if the channel subsystem was attempting to issue the halt signal and is unable to determine if the halt signal was issued.

If a subchannel is start pending or resume pending and the channel subsystem encounters an interface-control-check condition while performing the start function for that subchannel, the subchannel remains start pending or resume pending unless the channel subsystem can determine that the first command was accepted. The subchannel remains start pending or resume pending even if the channel subsystem was attempting to initiate the I/O operation for the first command and is unable to determine if the command was accepted. If the channel subsystem is unable to determine whether the first command was accepted, the subchannel is made status pending with at least alert and primary status.

If, while initiating a signaling sequence with the channel subsystem for the purpose of presenting status or transferring data, the device presents an address with invalid parity, the error condition is not made available to the program since the identity of the device and associated subchannel are unknown.

Whenever interface-control check is indicated, no measurement data for the subchannel is stored.

Programming Note: If the status-control field of the SCSW indicates that the subchannel is status pending with alert status but the field-validity flags of the SCSW indicate that the device-status field is not usable for error-recovery purposes, the program should (1) assume that the interface-control-check condition occurred while the channel subsystem was accepting alert status from the device and (2) take the appropriate action for alert status, even though the status itself has been lost.

Chaining Check

Chaining check is caused by channel-subsystem overrun during data chaining on input operations. The condition occurs when the I/O-data rate is too high for the particular resolution of data addresses. Chaining check cannot occur on output operations.

Detection of the chaining-check condition causes the I/O device to be signaled to conclude the operation. It causes command chaining to be suppressed.

Count Field

Bit positions 16-31 of word 2 contain the residual count. The count is to be used in conjunction with the original count specified in the last CCW and, depending upon existing conditions (see Figure 16-7 on page 16-32), indicates the number of bytes trans-

ferred to or from the area designated by the CCW. The count field is meaningful whenever the subchannel is status pending with primary status that consists of either (1) device status only or (2) device status together with subchannel status of incorrect length only, PCI only, or both.

In Figure 16-7 on page 16-32, the contents of the count field are listed for all cases where the subchannel is start pending, subchannel-and-device active, device active, suspended, or status pending.

Subchannel State ¹	Count ²
Start pending (UUUU0/AIP SX) ²	Not meaningful ³
Start pending and status pending (10YY1/AIP SX) ²	Not meaningful ³
Start pending and status pending (00111/AIP SX) because the device appeared not operational on all paths ²	Not meaningful ³
Start pending and device active (UUUU0/AIP SX) ²	Not meaningful ³
Suspended (YYYYY/AIP SX) ²	Not meaningful ³
Subchannel-and-device active (UUUU0/AIP SX) ²	Not meaningful ³
Device active (UUUU0/AIP SX)	Not meaningful ³
Status pending (01001/AIP SX) because of program-controlled-interruption condition or initial-status interruption	Not meaningful ³
Status pending (1Y1Y1/AIP SX); termination occurred because of: ²	
Program check	Not meaningful ³
Protection check	Not meaningful ³
Chaining check	Not meaningful ³
channel-control check	See note 1
Interface-control check	Not meaningful ³
Channel-data check	See note 2
Status pending (YY1Y1/AIP SX); termination occurred under count control ²	Correct
Status pending (Y0011/AIP SX) ²	Not meaningful ³
Status pending (1Y1Y1/AIP SX) ²	Correct; residual count of last used CCW
Status pending (1Y111/AIP SX); command chaining suppressed because of alert status ²	Correct; residual count of last used CCW
Status pending (YYYY1/AIP SX); after termination by HALT SUB-CHANNEL ²	Unpredictable
Status pending (00001/AIP SX); after termination by CLEAR SUB-CHANNEL	Not meaningful ³
Status pending (YY1Y1/AIP SX); operation completed normally at the subchannel ²	Correct; indicates the residual count
Status pending (1Y111/AIP SX); command chaining terminated because of alert status ²	Correct; original count of CCW specifying the new I/O operation
Status pending (10001/AIP SX) because of alert status	Not meaningful ³

Figure 16-7. (Part 1 of 2) Contents of Count Field in SCSW

Explanation:

¹ In situations where more than a single condition exists because of, for example, alert status that is described by program check and unit check, the entry appearing first in the table takes precedence.

The meaning of the notation used in this column is as follows:

- A Alert status
- I Intermediate status
- P Primary status
- S Secondary status
- X Status Pending

The allowed combinations of status-control-bit settings is shown to the left of the "/" symbol by the use of these symbols:

- 0 Corresponding condition is not indicated
- 1 Corresponding condition is indicated
- U Unpredictable. The corresponding condition is not meaningful when the subchannel is not status pending.
- Y The corresponding condition is not significant and is indicated as a function of the subchannel state.

² The subchannel may also be resume pending.

³ The contents of the count field are not meaningful because the count field is not valid when the SCSW is stored and the subchannel is in the given state.

Notes:

1. The count is unpredictable unless IDAW/MIDAW check is indicated, in which case the count may not correctly reflect the number of bytes transferred to or from main storage but will (when used in conjunction with the CCW address) designate a byte location within the page in which the channel-control-check condition was recognized.
2. During a storage access, the maximum number of bytes that can be stored by a channel subsystem is model dependent. If a channel-data-check condition is recognized during that access, the number of bytes transferred to or from storage may not be detectable by the channel subsystem. Consequently, the number of bytes transferred to or from storage may not be correctly reflected by the residual count. However, the residual count that is stored when used in conjunction with the storage-access code and the CCW address designates a byte location within the page in which the channel-data-check condition was recognized.

Figure 16-7. (Part 2 of 2) Contents of Count Field in SCSW

Transport-Mode SCSW

The format of a transport-mode SCSW is as follows:

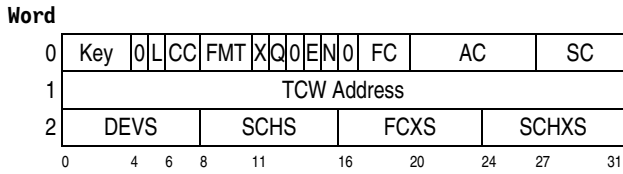

Figure 16-8. Transport-Mode SCSW Format

Figure 16-9 on page 16-34 shows the summary and contents of the transport-mode SCSW:

Bits	Name
Word 0	
0-3	Subchannel Key
4	Reserved
5	ESW format (L)
6-7	Deferred condition code (CC)
8-10	Format (FMT)
11	IRB-Format control (X)
12	Interrogate-complete (Q)
13	Reserved
14	Extended control (E)
15	Path not operational (N)
16	Reserved
17-19	Function Control (FC)
17	Start function
18	Halt function
19	Clear function
20-26	Activity Control (AC)
20	Reserved
21	Start pending
22	Halt pending
23	Clear pending
24	Reserved
25	Device active
26	Reserved
27-31	Status Control (SC)
27	Alert status
28	Intermediate status
29	Primary status
30	Secondary status
31	Status pending
Word 1	
0-31	TCW Address
Word 2	
0-7	Device Status (DEVS)
0	Attention
1	Status modifier
2	Control-unit end
3	Busy
4	Channel end
5	Device end
6	Unit check
7	Unit exception
8-15	Subchannel Status (SCHS)
8	Reserved
9	Incorrect length
10	Program check
11	Protection check
12	Channel-data check
13	Channel-control check
14	Interface-control check
15	Channel-subsystem retry failed
16-23	FCX Status (FCXS)
16	Reserved
17	Reserved
18	Reserved
19	Reserved
20	Reserved
21	Reserved
22	Reserved
23	TSB Valid
24-31	Subchannel-Extended Status (SCHXS)
24	Interrogate-Failed (F)
25-31	Subchannel-Extended-Status Qualifier (SESQ)

Figure 16-9. Transport-Mode SCSW (Continued)

Figure 16-9. Transport-Mode SCSW

The following descriptions indicate when an SCSW field contains meaningful information for a transport-mode IRB.

Subchannel Key

This bit has the same meaning as in the command mode SCSW. (See “Subchannel Key” on page 16-9).

Reserved

SCSW bits 4, 13, 16, 20, 24, and 26 of word 0, bits 0 of word 1, and bits 1, 8, 15, and 16-22 of word 2 are reserved and stored as zeros.

Extended-Status-Word Format (L)

This bit has the same meaning as in the command-mode SCSW. (See “Extended-Status-Word Format (L)” on page 16-9).

Deferred Condition Code (CC)

This field has the same meaning as in the command-mode SCSW. (See “Deferred Condition Code (CC)” on page 16-9).

Format (FMT)

Bits 8-10 of word 0 are the IRB-format field that contains a 3-bit, unsigned integer whose value specifies the layout of the IRB, when the IRB-format control bit (X), is set to one.

FMT	Description
0	Transport-Mode IRB
1-7	Reserved

IRB-Format Control (X)

Bit 11 of word 0 is the IRB-format control bit. The value of this bit is one for the transport-mode IRB. (See Figure 16-2 on page 16-7).

Interrogate Complete (Q)

Bit 12 of word 0 is the interrogate-complete bit (Q). When one, Q indicates that the interrogate operation has completed successfully, and the subchannel is made status-pending with intermediate interruption status. If the pending intermediate interruption condition has not been cleared by TEST SUBCHANNEL by the time the primary interruption condition for the original interrogated operation is presented at the subchannel, both conditions may be merged and indicated together in the SCSW.

Subchannel-Control Field

The subchannel-control information is contained in bit positions 13-31 of the first word of the SCSW.

Extended Control (E)

Bit 14 of word 0, when one, indicates that model-dependent information is stored in the extended-control word (ECW). When bit 14 is zero, the contents of words 0-7 of the ECW are unpredictable. The E bit is meaningful whenever the subchannel is status pending with alert status either alone or together with primary status, secondary status, or both. The concurrent sense information has no meaning when a transport-mode IRB is stored.

Path Not Operational (N)

This bit has the same meaning as in the command-mode SCSW. See “Path Not Operational (N)” on page 16-13.

Function Control (FC)

The function-control field indicates the basic I/O functions that are indicated at the subchannel. This field may indicate the acceptance of as many as two functions. The function-control field is contained in bit positions 17-19 of the first word of the SCSW. The function-control field is meaningful at an installed subchannel whenever the subchannel is valid (see “Function Control (FC)” on page 16-13). The function-control field contains all zeros whenever both the activity- and status-control fields contain all zeros. The meaning of the individual bits is as follows:

Start Function (Bit 17): This bit has the same meaning as in the command-mode SCSW. (See “Start Function (Bit 17)” on page 16-13).

Halt Function (Bit 18): When one, bit 18 indicates that a halt function has been requested and is either pending or in progress at the subchannel. A halt function is requested by the execution of HALT SUBCHANNEL. A halt function is indicated at the subchannel when condition code 0 is set for HALT SUBCHANNEL. The halt-function indication is cleared at the subchannel when the next status-pending condition that occurs is cleared by the execution of TEST SUBCHANNEL. The next status-pending condition depends on the state of the subchannel when HALT SUBCHANNEL is executed. If the subchannel is start pending or device active when HALT SUBCHANNEL is executed, then the

next status-pending condition is status pending with at least primary status indicated. The halt-function indication is also cleared at the subchannel during the execution of CLEAR SUBCHANNEL.

Clear Function (Bit 19): This bit has the same meaning as in the command-mode SCSW. (See “Clear Function (Bit 19)” on page 16-14).

Activity Control (AC)

The activity-control field is contained in bit positions 20-26 of word 0 of the SCSW. The activity-control field is meaningful at an installed subchannel whenever the subchannel is valid (see “Device Number Valid (V)” on page 15-4). However, if an IFCC or CCC condition is detected during the performance of a basic I/O function and that function is indicated as pending, I/O operations may or may not have been performed at the device. The activity-control bits are defined as follows:

Bit	Meaning
20	Reserved
21	Start pending
22	Halt pending
23	Clear pending
24	Reserved
25	Device active
26	Reserved

Start Pending (Bit 21): This bit has the same meaning as in the command-mode SCSW with the exception that the subchannel remains start pending until a primary interruption condition is generated. (See “Start-Pending (Bit 21)” on page 16-15).

Halt Pending (Bit 22): This bit has the same meaning as in the command-mode SCSW. (See “Halt-Pending (Bit 22)” on page 16-16).

Clear Pending (Bit 23): This bit has the same meaning as in the command-mode SCSW. (See “Clear-Pending (Bit 23)” on page 16-16).

Device Active (Bit 25): When one, bit 25 indicates that the subchannel is device active. A subchannel is said to be device active when an I/O operation is currently in progress at the associated device. The subchannel becomes device active, only when primary status is presented without secondary.

Status Control (SC)

The status-control field is contained in bit positions 27-31 of word 0 of the SCSW. This field provides the program with a summary-level indication of the interruption condition described by either subchannel or device status or the Q bit. More than one summary indication may be signaled as a result of existing conditions at the subchannel. Whenever the subchannel is enabled (see “Enabled (E)” on page 15-3) and at least bit 31 is one, the subchannel is said to be status pending. Whenever the subchannel is disabled, the subchannel is not made status pending. Bit 31 of SCSW word 0 is meaningful at an installed subchannel whenever the subchannel is valid (see “Device Number Valid (V)” on page 15-4); bits 27-30 are meaningful when bit 31 is one. The status-control bits are defined as follows:

Alert Status (Bit 27): This bit has the same meaning as in the command-mode SCSW with the exception that a command-mode IRB is stored when alert status is presented with secondary status. (See “Alert Status (Bit 27)” on page 16-17).

Intermediate Status (Bit 28): Intermediate status can be indicated when the interrogate operation associated with the TCW is completed, and the Q-bit (interrogate-complete) is one.

Primary Status (Bit 29): This bit has the same meaning as in the command-mode SCSW. (See “Primary Status (Bit 29)” on page 16-19).

Secondary Status (Bit 30): This bit has the same meaning as in the command-mode SCSW. (See “Secondary Status (Bit 30)” on page 16-19).

Status Pending (Bit 31): This bit has the same meaning as in the command-mode SCSW. (See “Status-Pending (Bit 31)” on page 16-19).

TCW Address Field

Bits 1-31 of word 1 form an absolute address of a TCW. The TCW address indicated is the address of the current TCW when the subchannel becomes pending with primary interruption. When the subchannel-status field indicates channel-control check, channel-data check, program check or interface-control check, the TCW-address field is usable for recovery.

ery purposes if the TCW-address field-validity flag in the ESW is one.

Subchannel State	TCW Address
Start pending (UUUU0/AIP SX)	Unpredictable
Start pending and device active (UUUU0/AIP SX)	Unpredictable
Subchannel-and-device active (UUUU0/AIP SX)	N/A
Device active only (UUUU0/AIP SX)	Unpredictable
Suspended (YYYYY/AIP SX)	N/A
Status pending (10001/AIP SX) because of unsolicited alert status from the device while the subchannel was start pending	Address of current TCW ³
Status pending (0Y111/AIP SX) because the device appeared not operational on all paths	Address of current TCW ³
Status pending (10011/AIP SX) because of solicited alert status from the device while the subchannel was start pending and device active	Address of current TCW ³
Status pending (10111/AIP SX) because of solicited alert status generated by the channel subsystem while the subchannel was start pending or start pending and device active	See note 2
Status pending (01001/AIP SX) for the program-controlled-interruption condition while the subchannel was subchannel-and-device active	N/A
Status pending (01001/AIP SX) for the initial-status-interruption condition while the subchannel was subchannel-and-device active	N/A
Status pending (01001/AIP SX) for the intermediate/interrogate	Address of current TCW ²
Status pending (1Y1Y1/AIP SX); termination occurred because of program check caused by one of the following conditions:	
Bit 24 of word 1 of the ORB set to one; incorrect-length-indication-suppression facility not installed	N/A
Unused bits in ORB not set to zeros	Address of current TCW ²
Invalid TCW-address specification in the channel-program address in the ORB	Address of invalid TCW
Invalid TCW address in the channel-program address in the ORB	Address of invalid TCW
Invalid TCW address while DCW data chaining	N/A
Invalid TCW count or TIDAW count	Address of invalid TCW ⁴
Invalid TIDAW-address specification	Address of invalid TCW ⁴
Invalid TIDAW address in TCW	Address of invalid TCW ⁴
Invalid TIDAW address while sequentially fetching TIDAWs	N/A
Invalid data-address specification	Address of invalid TCW ⁴
Invalid data address in a TCW	Address of invalid TCW ⁴
Invalid data address while sequentially accessing storage	Address of current TCW
Invalid data address in TIDAW	Address of current TCW
Invalid TIDAW	Address of current TCW

Figure 16-10. (Part 1 of 3) TCW Address as Function of Subchannel State

Subchannel State	TCW Address
Invalid TSB-address specification	Address of current TCW
Invalid TSB address	Address of current TCW
Invalid TCCB address specification	Address of current TCW
Invalid TCCB address	Address of current TCW
Device-detected program checks	Address of current TCW
Status pending (1Y1Y1/AIP SX); termination occurred because of protection check detected as follows:	
On a TCW access	Address of protected TCW ⁴
On data or an TIDAW access	Address of current TCW
Status pending (1Y1Y1/AIP SX); termination occurred because of chaining check	N/A
Status pending (YY1Y1/AIP SX); termination occurred under count control	Address of current TCW
Status pending (1Y1Y1/AIP SX); operation prematurely terminated by the device because of alert status	Address of current TCW ³
Status pending (YYYY1/AIP SX) after termination by HALT SUBCHANNEL and the activity-control-field bits indicated below set to ones:	
Status pending alone	Unpredictable
Start pending	Unpredictable
Device active and start pending	Unpredictable
Device active	Unpredictable
Status pending (00001/AIP SX) after termination by CLEAR SUBCHANNEL	Unpredictable
Status pending (YY1Y1/AIP SX); operation completed normally at the subchannel	Address of current TCW
Status pending (00011/AIP SX)	Unpredictable
Status pending (10001/AIP SX)	Unpredictable
Status pending (00001/AIP SX)	Unpredictable
Status pending (1Y111/AIP SX); command chaining suppressed because of alert status other than channel-control check or interface-control check	N/A
Status pending (1YYY1/AIP SX) because of alert status for channel-control check or interface-control check	See note 3
Status pending (1Y1Y1/AIP SX) because of channel-data check	Address of current TCW
Status pending (1Y1Y1/AIP SX) because of channel-subsystem retry failed	Address of current TCW
Explanation:	
¹ The meaning of the notation used in this column is as follows:	
A Alert status	
I Intermediate status	
P Primary status	
S Secondary status	
X Status Pending	

Figure 16-10. (Part 2 of 3) TCW Address as Function of Subchannel State (Continued)

Subchannel State	TCW Address
The possible combination of status-control-bit settings is shown to the left of the “/” symbol by the use of these symbols:	
0	Corresponding condition is not indicated
1	Corresponding condition is indicated
U	Unpredictable. The corresponding condition is not meaningful when the subchannel is not status pending.
Y	The corresponding condition is not significant and is indicated as a function of the subchannel state.
2	A TCW becomes current when start subchannel is issued, specifying a transport-mode ORB, and the instruction completes with condition code 0.
3	Command-mode IRB may be stored depending on the current subchannel status
4	The stored address is the address of the current TCW even though it is either invalid or protected.
5	Not applicable
Notes:	
1.	The address stored is unpredictable.
2.	The address of the TCW is given as a function of the alert status indicated.
3.	Bit 21 of the subchannel-logout information, when stored as one, indicates that the address is the address of the current TCW.

Figure 16-10. (Part 3 of 3) TCW Address as Function of Subchannel State (Continued)

Device-Status Field

The device-status field is contained in bit positions 0-7 of word 2 of the SCSW. Each bit of the device-status field has the same meaning as in the command-mode SCSW. See “Device-Status Field” on page 16-24 for details.

Subchannel-Status Field

The subchannel-status field is contained in bit positions 8-15 of word 2 of the SCSW. Subchannel-status conditions are detected and indicated in the SCSW by the channel subsystem. Except for the conditions caused by equipment malfunctioning, they can occur only while the channel subsystem is involved with the performance of a halt or start function. The subchannel-status field is meaningful whenever the subchannel is status pending with any combination of primary, secondary, intermediate, or alert status. When the subchannel is status pending with deferred condition code 3 indicated, the contents of the subchannel-status field are not meaningful. The following subchannel-status conditions are described:

Incorrect Length

Incorrect length occurs when the number of bytes contained in the storage areas assigned for the I/O

operation is not equal to the number of bytes requested or offered by the I/O device.

When the FCX-incorrect-length-indication facility is not installed and an incorrect-length condition is detected, the processing of the transport-mode channel program is terminated with program-check status.

When the FCX-incorrect-length-indication facility is installed, the device supports incorrect-length indication, incorrect-length-indication is not being suppressed, and an incorrect-length condition is detected, incorrect length is indicated for one of the following reasons:

Long Block on Input: During a read or sense operation, the device attempted to transfer one or more bytes to main storage after the assigned main-storage areas were filled, or the device indicated that more data could have been transferred if the count had been larger. The extra bytes have not been placed in main storage. The count in the TSB header (TSH) is zero.

Long Block on Output: During a write operation, the device requested one or more bytes from the channel subsystem after the assigned main-storage areas were exhausted, or the device indicated that more data could have been transferred if the count had been larger. The count in the TSH is zero.

Short Block on Input: The number of bytes transferred during a read or sense operation is insufficient to fill the main-storage areas assigned to the operation. The count in the TSH is not zero.

Short Block on Output: The device terminated a write before all of the information contained in the assigned main-storage areas was transferred to the device. The count in the TSH is not zero.

The incorrect-length indication is suppressed when the current DCW has the SLI flag set to one. The incorrect-length indication is not meaningful when the count field of the TSH is not meaningful.

Presence of the incorrect-length condition suppresses command chaining unless the SLI flag in the DCW is one.

Program Check

Program check occurs when programming errors are detected by the channel subsystem. For a transport-mode operation, programming errors may also be detected by the I/O device and are reported as program checks. When a program check condition is recognized, additional information may be available in the “Subchannel-Extended-Status Qualifier (SESQ)” section of the subchannel-extended-status field when a program check is indicated.

Whenever the program-check condition pertains to the fetching of data, the failing-storage-address validity flag, bit 6 of the ERW, is one. An address of a location within the checking block for which the program-check condition is generated is stored in the ESW failing-storage-address field.

A program check condition can be due to any of the following reasons:

Invalid TCW Specification: When any of the following conditions is detected, an invalid TCW specification is recognized:

1. A reserved field that is checked for zeros in the TCW does not contain zeros.
2. A nonzero value is specified in the TCW format field.
3. The read and write bits in the TCW are both one, bit 10 of the TCW flags field is zero, and either or both of the following are true.

- The FCX-bidirectional-data-transfer facility is not installed.
- The specified device does not support bidirectional data transfers.

4. The TCCB-length field in a TCW specifies a length that is less than 12 or greater than 244.

Invalid TCW-Address Specification: An invalid TCW address specification can occur because the TCW address is not designated on a 64-byte boundary.

Invalid TCW Address: The channel-subsystem has attempted to fetch a TCW from a main-storage location that is not available. An invalid TCW address can occur because the program has designated an invalid address in the channel-program-address field of the transport-mode ORB, when the B-bit (channel-program-type control), is one. A main-storage location is unavailable when the absolute TCW address does not correspond to a physical location.

Invalid TCW Counts: When any of the following conditions is detected by the channel subsystem, an invalid TCW byte count is recognized:

1. The write-bit is one in the TCW and the value in the TCW output-count field is zero.
2. The read-bit is one in the TCW and the value in the TCW input-count field is zero.

Invalid TSB-Address Specification: An invalid transport-status-block address specification can occur if the content of the transport-status-block-address field specified in the TCW does not designate a storage location on a doubleword boundary.

Invalid TSB Address: The channel-subsystem has attempted to store a TSB to a main-storage location that is not available. An invalid transport-status-block address can occur because the program has designated an unavailable location in a TCW, or the channel-subsystem has attempted to store the transport status to a main-storage location that is not available. A main-storage location is unavailable when the absolute address of the location does not correspond to a physical location.

Invalid TCCB Address: The channel-subsystem has attempted to fetch a TCCB from a main-storage location that is not available. An invalid transport-command-control-block address can occur because

the program has designated an unavailable location in a TCW, or has specified a transport-command-control-block address and a length which caused a list of TIDAW to cross a 4 K-byte when the transport-command-control-block-TIDA flag in the TCW is one. A main-storage location is unavailable when the absolute address of the location does not correspond to a physical location. **Invalid TIDAW-Address Specification:** Transport-indirect data addressing is specified, and any of the following conditions is detected:

1. A write operation is requested, the output-TIDA flag in a TCW is one, and the contents of the output-data-address field in the TCW do not designate a storage location on a quadword boundary.
2. A read operation is requested, the input-TIDA flag in a TCW is one, and the contents of the input-data-address field in the TCW do not designate a storage location on a quadword boundary.
3. The transport-command-control-block-TIDA flag in the TCW is one, and the contents of the transport-command-control-block-address do not designate a storage location on a quadword boundary.

Invalid Data Address: An invalid data address can occur because the program has designated an unavailable location specified by a TCW or a TIDAW. When any of the following conditions is detected, an invalid data address is recognized by the channel subsystem.

1. The channel-subsystem has attempted to access a main-storage location that is not available. A main-storage location is unavailable when the absolute address of the location does not correspond to a physical location.
2. The channel subsystem, on sequentially accessing storage for a data fetch or data store, attempted to access an unavailable location.
3. Use of the data address has caused the channel subsystem to attempt to wrap from the maximum storage address to zero.

Invalid TIDAW Specification: When the use of TIDAW is specified, an invalid TIDAW specification is recognized when any of the following conditions is detected by the channel subsystem:

1. Any of the bits defined as reserved in the TIDAW are not zero.
2. The TIDAW-transfer-in-channel flag (TTIC) in a TIDAW is one, and one or more other flag bits are also one.
3. The TTIC points to a TIDAW in which the TTIC flag is one.
4. The TIDAW count field contains zeros when the TTIC flag is zero.
5. The combination of a TIDAW data-address and count fields specify data that crosses a 4 K-byte block boundary, when skipping is not in effect.
6. The count value specified in the TIDAW in which the last-TIDAW flag is one and the value for either input-count or output-count specified in a TCW did not both decrement to zero for the same byte of data transferred.
7. For a read operation only, the TIDAW in control has its data-transfer-interruption control flag set to one when data transfer was attempted by the device.
8. The TIDAW is in the TIDAW list designated by the TCCB-address field in the TCW and the count field of the TIDAW contains either a value that is zero or a value that is not evenly divisible by four.

Invalid TIDAW Address: The channel-subsystem has attempted to fetch a TIDAW from a main-storage location that is not available. An invalid TIDAW address can occur because the program has designated an invalid address in a TCW that specifies TIDAW addressing, or because the channel subsystem, on sequentially fetching TIDAWs, attempts to fetch from an unavailable location. A main-storage location is unavailable when the absolute address of the location does not correspond to a physical location. **Storage-Requests Limit Exceeded:** The use of TIDAWs is specified, and the model-dependent maximum number of storage requests required to satisfy the transfer of a block of data has been reached.

Max Data-Count Exceeded: The model-dependent maximum count of data for a single transport-control area (TCA) has been reached or exceeded for the current operation.

Device-Detected Program Check: Device-detected program checks are errors detected during a transport-mode operation by the I/O device and the channel-subsystem is requested to present a program-check condition. When a device-detected-program-check condition is recognized, additional information is available in the subchannel-extended status field, and the TSB is stored with a transport-status-area format of two. (See device-detected-program check in chapter 15.)

Protection Check

Protection check occurs when the channel subsystem attempts a storage access that is prohibited by the protection mechanism. A protection check condition is indicated as a result of a storage operation that detects any of the following errors:

1. Protection applies to the fetching of TCW.
2. Protection applies to the fetching of TCCB.
3. Protection applies to the fetching of TIDAWs.
4. Protection applies to the fetching of output data.
5. Protection applies to the storing of input data.

The subchannel key provided in the transport-mode ORB is used as the access key for storage accesses associated with an I/O operation except for the TSB store.

Detection of the protection-check condition during the fetching of a TCW, TCCB, or a TIDAW would cause the operation to be suppressed and the subchannel to be made status pending with primary, secondary, and alert status. When protection check is detected after the I/O operation has been initiated at the device, the device may be signaled to conclude the operation. Other indications may accompany the protection-check indication as a function of the operation specified by the TCW, the status received from the device, on a read operation, and the current state of the subchannel. The protection-check condition may or may not cause the execution of subsequent DCWs in a TCCB to be suppressed.

Whenever the protection-check condition pertains to the fetching of data, the failing-storage-address validity flag, bit 6 of the ERW, is one. An address of a location within the checking block for which the protection-check condition is generated is stored in the ESW failing-storage-address field.

Additional information may be available in the “Subchannel-Extended-Status Qualifier (SESQ)” section of the subchannel-extended-status field when a protection check condition check is indicated.

Channel-Data Check

Channel-data check indicates that an uncorrected storage error has been detected in regard to data, contained in main storage, that is currently used in the performance of an I/O operation. Channel-data check is indicated when data has an invalid checking-block code (CBC) in main storage when that data is referenced by the channel subsystem.

On an input operation, when the channel subsystem attempts to store less than a complete checking block, and invalid CBC is detected on the checking block in storage, the contents of the location remain unchanged and with invalid CBC. On an output operation, whenever channel-data check is indicated, no bytes from the checking block with invalid CBC are transferred to the device.

During a storage access, the maximum number of bytes that can be transferred is model dependent. If a channel-data-check condition is recognized during that storage access, the number of bytes transferred to or from storage may not be detectable by the channel subsystem. Consequently, the number of bytes transferred to or from storage may not be correctly reflected by the residual count. When a channel-data-check condition is recognized during a storage access, the channel subsystem stores the address where the storage exception is encountered.

A condition indicated as channel-data check causes the current operation, if any, to be terminated. The subchannel becomes status pending with primary, secondary and alert status, as a function of the status received from the device. The TCW address field of the SCSW stored by TEST SUBCHANNEL pertains to the operation terminated. The extended-status-word-format bit is one, and subchannel-logout information is stored in the ESW, when TEST SUBCHANNEL is executed.

Whenever the channel-data-check condition pertains to the fetching of data, the failing-storage-address validity flag, bit 6 of the ERW, is one. An address of a location within the checking block for which the channel-data-check condition is generated is stored in the ESW failing-storage-address field.

Uncorrectable storage or key errors detected during data access causes the operation to be terminated. In this case the subchannel is made status pending with primary, secondary, and alert status, with channel-data check indicated, and with the ESW failing-storage address stored.

Whenever channel-data check is indicated, no measurement data for the subchannel is stored. The transport-status block may or may not be stored. Additional information may be available in the “Subchannel-Extended-Status Qualifier (SESQ)” section of the subchannel-extended-status field.

Channel-Control Check

Channel-control check is caused by any machine malfunction affecting channel-subsystem controls. The condition may be indicated when an invalid CBC is detected on a TCW, TIDAW, TCCB, TSB, or the respective associated key.

Channel-control check may also indicate that an error has been detected in the information transferred to or from main storage during an I/O operation. However, when this condition is detected, the error has occurred inboard of the channel path: in the channel subsystem or in the path between the channel subsystem and main storage.

Detection of the channel-control-check condition causes the current operation, if any, to be terminated immediately. The subchannel is made status pending with primary and alert status or with primary, secondary, and alert status as a function of the type of termination, the current subchannel state, and the device status presented, if any. When the channel subsystem recognizes a channel-control-check condition, any previously existing intermediate interruption condition may or may not be recognized by the channel subsystem.

Whenever the channel-control-check condition pertains to an invalid CBC detected on fetching a TCW or a TCCB, or a TIDAW or storing a TSB, an extended-report word with bit 6 set to one, and the failing-storage address, are stored in the ESW when TEST SUBCHANNEL is executed.

Channel-control-check conditions encountered while fetching when the subchannel is start pending cause the operation to be terminated. In this case, the subchannel is made status pending with primary, secondary, and alert status, with channel-control check

indicated, and with a failing-storage address that is stored in the ESW.

If a subchannel is halt pending and the channel subsystem encounters a channel-control-check condition while performing the halt function for that subchannel, the subchannel remains halt pending unless the channel subsystem can determine that the halt signal was issued. The subchannel remains halt pending even if the channel subsystem was attempting to issue the halt signal and is unable to determine if the halt signal was issued.

If a subchannel is start pending and the channel subsystem encounters a channel-control-check condition while performing the start function for that subchannel, the subchannel is made status pending with at least alert and primary status.

In some situations in which a channel-subsystem malfunction exists, the channel-control-check condition may be reported as a machine-check condition.

Whenever channel-control check is indicated, no measurement data for the subchannel is stored. The transport-status block may or may not be stored. Additional information may be available in the “Subchannel-Extended-Status Qualifier (SESQ)” section of the subchannel-extended-status field.

Interface-Control Check

Interface-control check indicates that an invalid signal has occurred on the channel path. The condition is detected by the channel subsystem and usually indicates malfunctioning of an I/O device. Interface-control check can occur for any of the following reasons:

1. A data or status byte received from a device has an invalid checking-block code.
2. A signal from an I/O device either did not occur or occurred at an invalid time.
3. ESW bit 26, indicating device-status check, is set to one.
4. A failed interrogate function or a recovery operation.
5. The TCW residual count did not match the residual count in the response from the device.

When the channel subsystem recognizes an interface-control-check condition, any previously existing

intermediate interruption condition may or may not be recognized by the channel subsystem. The extended-status-word-format bit is one, and subchannel-logout information is stored in the ESW, when TEST SUBCHANNEL is executed.

If a subchannel is halt pending and the channel subsystem encounters an interface-control-check condition while performing the halt function for that subchannel, the subchannel remains halt pending unless the channel subsystem can determine that the halt signal was issued. The subchannel remains halt pending even if the channel subsystem was attempting to issue the halt signal and is unable to determine if the halt signal was issued.

If a subchannel is start pending and the channel subsystem encounters an interface-control-check condition while performing the start function for that subchannel, the subchannel is made status pending with at least alert and primary status.

Whenever interface-control check is indicated, no measurement data for the subchannel is stored. The transport-status block may or may not be stored. Additional information may also be available in the "Subchannel-Extended-Status Qualifier (SESQ)" section of the subchannel-extended-status field.

Channel-Subsystem Retry Failed

Channel-subsystem retry failed indicates that internal channel-subsystem conditions exist that prevent the fetching of the TCCB, a TIDAW, or data. The channel subsystem retried the fetch and the retry failed.

FCX-Status Field

The FCX-status field is contained in bit positions 16-23 of word 2 of the SCSW. This field contains chan-

nel specific status information returned by the I/O device.

TSB Valid (Bit 23): Bit 23, when set to one, indicates that additional status information for the I/O operation designated by the subchannel is available in the transport-status block. When zero, the contents of the transport-status block do not contain any additional status information for the completed I/O operation.

Subchannel-Extended-Status Field

The subchannel-extended-status field is contained in bit positions 24-31 of word 2 of the SCSW. This field may contain information used to further qualify the reason for any the following conditions, when indicated in the subchannel-status: interface-control check, channel-control check, channel-data check, program check, and protection check. If none of these bits are active in the subchannel-status byte, the fields of the subchannel-extended-status contain no meaningful information. When more than one condition is indicated, the interface-control check takes priority over the other conditions.

Interrogate Failed (F): Bit 24 is the interrogate-failed operation bit. When set to one, the F bit indicates that an interrogate operation failed because of a program check, channel-control check, or interface-control check.

Subchannel-Extended-Status Qualifier (SESQ): Bits 25-31 are the subchannel-extended-status qualifier and contain an unsigned integer value. When the subchannel-status field indicates program check, interface-control check, protection check, data check, or channel-control check, bits 25-31 may contain additional information as follows:

Value	Description	IFCC	CCC	CDC	PGC	PTC	
0	No status available for the exception condition indicated.	X	X	X	X	X	
1	Storage-request limit exceeded, a model-dependent number of storage requests has been exceeded for the requested block of data.	-	-	-	X	-	

Figure 16-11. Subchannel-Extended Status Qualifiers

Value	Description	IFCC	CCC	CDC	PGC	PTC	
2	Program check when all of the following conditions are met: (1) The TCW read or write data count did not go to zero and either the incorrect-length indication facility is not installed or incorrect-length indication is not supported by the device. (2) CE only or CE and DE only status was received, or unit-check with CE or CE and DE status was received. (3) The operation is not an interrogate, transfer-COB, or transfer-TCAX operation.	-	-	-	X	-	
3	Transport mode not supported by the I/O device.	-	-	-	X	-	
4	Transport mode not supported on the selected channel path.	-	-	-	X	-	
5	Reserved						
6	Program check on the TCW: An invalid TCW was detected.	-	-	-	X	-	
7	A device-detected program check condition exists due to indeterminate cause.	-	-	-	X	-	
8	A device-detected program check condition exists.	-	-	-	X	-	
9 ^a	Program check on a TIDAW: An invalid TIDAW was detected.	-	-	-	X	-	-
10-31	Reserved.	-	-	-	-	-	
32 ^b	TCW access exception: An exception was detected on while fetching a TCW.	-	X	-	X	X	
33 ^c	TSB access exception: An exception was detecting while storing a TSB.	-	X	-	X	-	
34 ^d	TCCB access exception: An exception was detected while fetching a TCCB.	-	X	-	X	X	
35 ^e	TIDAW access exception: An exception was detected while fetching a TIDAW.	-	X	-	X	X	
36 ^f	Data access exception: An exception was detected while storing or fetching data.	-	-	X	X	X	
37-63	Reserved.	-	-	-	-	-	
64	An invalid CBC error on read data	X	-	-	-	-	
65	Reserved	-	-	-	-	-	
66	A link protocol error condition has occurred.	X	-	-	-	-	
67	A failed device-level recovery operation.	X	-	-	-	-	
68	IFCC occurred because a device-level recovery operation failed. A program, protection or data check may also be set to one in the Subchannel status.	X	-	-	-	-	
69	The residual count between the TCW and the response from the device are not the same.	X	-	-	-	-	
70	An Invalid CBC was detected on the status portion of the transport response from the device.	X	-	-	-	-	
71	An Invalid CBC was detected on the TSB transported from the device.	X	-	-	-	-	
72-127	Reserved.	-	-	-	-	-	

Figure 16-11. Subchannel-Extended Status Qualifiers (Continued)

Value	Description	IFCC	CCC	CDC	PGC	PTC	
Explanation:							
X	Applicable						
-	Not applicable						
IFCC	Interface-control check						
CCC	Channel-control check						
CDC	Channel-data check						
PGC	Program check						
PTC	Protection check						
Footnotes:							
a	The failing-storage-address (FSA) field in the ESW is valid and contains the address of the TIDAW which was determined to be invalid.						
b	The FSA field is valid and contains the address of the current TCW.						
c	The FSA field is valid and contains the address of the TSB designated by the current TCW.						
d	The FSA field is valid and contains the address of the TCCB designated (directly or indirectly) by the TCW.						
e	The FSA field is valid and contains the address of the TIDAW for which the exception was detected.						
f	The FSA field is valid and contains the address of the input or output data designated (directly or indirectly) by the TCW.						
Note:	If the FSA field is valid for any SESQ value other than those identified by footnotes a-f, the FSA field contains the address of the current TCW.						

Figure 16-11. Subchannel-Extended Status Qualifiers (Continued)

Extended-Status Word

The extended-status word (ESW) provides additional information to the program about the subchannel and its associated device. The ESW is placed in words 3-7 of the IRB designated by the second operand of TEST SUBCHANNEL when TEST SUBCHANNEL is executed and the subchannel designated is operational. If the subchannel is status pending or status pending with any combination of primary, secondary, intermediate, or alert status (except as noted in the next paragraph) when TEST SUBCHANNEL is executed, the ESW may have any of the following types of extended-status format:

Format 0 Subchannel logout in word 0, an ERW in word 1, a failing-storage address or zeros in words 2 and 3, and a secondary-CCW address or zeros in word 4.

Format 1 Zeros in bytes 0, 2, and 3 of word 0, the LPUM in byte 1 of word 0, an ERW in word 1, and zeros in words 2-4.

Format 2 Zeros in byte 0, the LPUM in byte 1, and the device-connect time in bytes 2 and 3 of word 0; an ERW in word 1; zeros in words 2-4.

Format 3 Zeros in byte 0, the LPUM in byte 1, and unpredictable values in bytes 2 and 3 of word 0; an ERW in word 1; zeros in words 2-4.

Words 0-4 of the ESW contain unpredictable values if any of the following conditions is met:

1. The subchannel is not status pending.
2. The subchannel is status pending alone, and the extended-status-word-format bit is zero.
3. The subchannel is status pending with intermediate status alone for other than the intermediate interruption condition due to suspension.

The type of extended-status format stored depends upon conditions existing at the subchannel at the time TEST SUBCHANNEL is executed. The conditions under which each of the types of formats is stored are described in the remainder of this section.

Extended-Status Format 0

The ESW stored by TEST SUBCHANNEL is a format-0 ESW when the extended-status-word-format bit, bit 5 of word 0 of the SCSW, is one and the subchannel is status pending with any combination of status as defined in Figure 16-12 on page 16-51. In this case, subchannel-logout information and an ERW are stored in the extended-status word. Subchannel logout provides detailed model-independent information relating to a subchannel and describing equipment errors detected by the channel subsystem. The information is provided to aid the recovery of an I/O operation, a device, or both. Whenever subchannel logout is provided, the error conditions relate only to the subchannel reporting the error. If I/O operations involving other subchannels have been affected by the error condition, those subchannels also provide similar subchannel-logout information. An extended-report word provides additional information relating to the cause of the malfunction.

A format-0 ESW has the following format:

Word	Content
0	Subchannel Logout
1	Extended-Report Word
2	Failing-Storage Address or ESLD
3	
4	Secondary-CCW Address or Zeros

0 31

Subchannel Logout

The subchannel logout has the following format:

0	ESF	LPUM	R	FVF	SA	TC	DE	EA	SC			
0	1	8		16	17	22	24	26	27	28	29	31

Extended-Status Flags (ESF): Any of bits 1-7, when one, specifies that an error-check condition has been detected by the channel subsystem. The following indications are provided in the ESF field:

Key Check. Bit 1, when one, indicates that the channel subsystem, when accessing data, when attempting to update the measurement block, or when attempting to fetch either a CCW, an IDAW, MIDAW, TCW, TCCB, TIDAW, or when accessing a TSB, has detected an invalid checking-block code (CBC) on the associated storage key. The channel-data-check bit, bit 12 of word 2 of the

SCSW, the measurement-block data-check bit, bit 3 of word 0 of the ESW, the CCW-check bit, bit 5 of word 0 of the ESW, or the IDAW/MIDAW-check bit, bit 6 of word 0 of the ESW, identifies the source of the key error.

Note: This condition may be indicated to the program when an invalid checking-block code on a key is detected but the data, CCW, IDAW, TIDAW, or MIDAW then is not used after being prefetched. In this case, the failing-storage-address-validity bit, bit 6 of the ERW, is one, indicating that the address of a location within the storage block having the key is stored in words 2 and 3 of the ESW.

Measurement-Block Program Check. Bit 2, when one, indicates that the channel subsystem, in attempting to update the measurement block, has either detected an invalid absolute address when combining the measurement-block origin with the measurement-block index for this subchannel or has detected an invalid measurement-block address at the subchannel.

Measurement-Block Data Check. Bit 3, when one, indicates that a malfunction has been detected involving the data of the measurement block in main storage. (See “Measurement Block” on page 17-3.) Measurement-block data check is indicated when the measurement block is updated and an invalid checking-block code (CBC) is detected on the storage used to contain the measurement data or on the associated key. When invalid CBC on the associated key is detected, the key-check bit, bit 1 of the ESF field, is also stored as one.

Measurement-Block Protection Check. Bit 4, when one, indicates that the channel subsystem, when attempting to update the measurement block, has been prohibited from accessing the measurement block because the storage key does not match the measurement-block key (see “Measurement Block” on page 17-3.) The key provided by SET CHANNEL MONITOR is used for the access of storage associated with measurement-block-update operations (see “SET CHANNEL MONITOR” on page 14-13.).

Note: Whenever any of the measurement-check conditions is indicated by bits 2-4, the channel subsystem sets the subchannel measurement-block-update-enable bit to zero, disabling the storing of measurement data for the subchannel

(see “Measurement-Mode Enable (MM)” on page 15-3).

CCW Check. When a command-mode IRB is stored, bit 5, when one, indicates that an invalid CBC on the contents of the CCW or its associated key has been detected. When either of these conditions is detected, the I/O operation is terminated, the subchannel becomes status pending with primary and alert status, the extended-status-word-format bit in the SCSW is stored as one, and channel-control check is indicated in the subchannel-status field. The subchannel also becomes status pending with secondary status as a function of the type of termination or status received from the device. When invalid CBC on the associated key is detected, the key-check bit, bit 1 of the ESF field, is also stored as one.

When a transport-mode IRB is stored, bit 5 is reserved and set to zero.

Note: This condition may be indicated to the program when an invalid checking-block code on a prefetched CCW is detected but the CCW is not used. In this case, the failing-storage-address-validity bit, bit 6 of the ERW, is one, indicating that the address of a location having the invalid CBC is stored in words 2 and 3 of the ESW.

IDAW/MIDAW Check. When a command-mode IRB is stored, bit 6, when one, indicates that an invalid CBC on the contents of an IDAW or MIDAW or its associated key has been detected. When either of these conditions is detected, the I/O operation is terminated with the device, the subchannel becomes status pending with primary and alert status, the extended-status-word-format bit in the SCSW is one, and channel-control check is indicated in the subchannel-status field. The subchannel also becomes status pending with secondary status as a function of the type of termination or status received from the device. When invalid CBC on the associated key is detected, the key-check bit, bit 1 of the ESF field, is also one.

When a transport-mode IRB is stored, bit 6 is reserved and set to zero.

Note: This condition may be indicated to the program when an invalid checking-block code on the contents of a prefetched IDAW or MIDAW is detected but the IDAW or MIDAW is not used. In this case, the failing-storage-address-validity bit,

bit 6 of the ERW, is one, indicating that the address of a location having the invalid CBC is stored in words 2 and 3 of the ESW. Detection of a channel-data-check condition does not cause the CCW-check and IDAW/MIDAW-check bits to be stored as ones.

Reserved. Bit 7 is stored as zero.

Last-Path-Used Mask (LPUM): Bits 8-15 indicate the channel path that was last used for communicating or transferring information between the channel subsystem and the device. When a command-mode IRB is stored, the bit corresponding to the channel path in use is set whenever any of the following occurs:

1. The first command of a start-subchannel function is accepted by the device (see “Activity Control (AC)” on page 16-14).
2. The device and channel subsystem are actively communicating when the channel subsystem performs the suspend function for the channel program in execution.
3. The channel subsystem accepts status from the device that is recognized as an interruption condition, or a condition has been recognized that suppresses command chaining (see “Interruption Conditions” on page 16-2).
4. The channel subsystem recognizes an interface-control-check condition (see “Interface-Control Check” on page 16-29), and no subchannel-logout information is currently present at the subchannel.

When a transport-mode IRB is stored, each bit of the LPUM is stored as zero, except for the bit that corresponds to the channel path last used, whenever one of the following occurs:

1. The path has been selected for transporting the TCCB for the operation.
2. The channel subsystem accepts status from the device that is recognized as an interruption condition. If the accepted status is an interrogate response, the LPUM may be different than that stored with primary or secondary status, or both.
3. The channel subsystem recognizes an interface-control-check condition (see “Interface-Control Check” on page 16-29), and no subchannel-

logout information is currently present at the subchannel.

The LPUM field contains the most recent setting and is valid whenever the ESW contains information in one of the formats 0-3 (see “Extended-Status Word” on page 16-47) and the SCSW is stored. When subchannel-logout information is present in the ESW, a zero LPUM-field-validity flag indicates that the LPUM setting is not consistent with the other subchannel-logout indications.

Ancillary Report (R): Bit 16, when one, indicates that a malfunction of a system component has occurred that has been recognized previously or that has affected the activities of multiple subchannels. When the malfunction affects the activities of multiple subchannels, an ancillary-report condition is recognized for all of the affected subchannels except one. This bit, when zero, indicates that this malfunction of a system component has not been recognized previously. This bit is meaningful only when a channel-control check, channel-data check, or an interface-control check is indicated in bit positions 12-14 of word 2 of the SCSW.

Depending on the model, recognition of an ancillary-report condition may not be provided or it may not be provided for all system malfunctions that effect subchannel activity. When ancillary-report recognition is not provided, bit 16 is set to zero

Field-Validity Flags (FVF): Bits 17-21 indicate the validity of the information stored in the corresponding fields of either the SCSW or the extended-status word. When the validity bit is one, the corresponding field has been stored and is usable for recovery purposes. When the validity bit is zero, the corresponding field is not usable.

This bit-significant field has meaning when channel-data check, channel-control check, or interface-control check is indicated in the SCSW. When these checks are not indicated, this field, as well as the termination-code and sequence-code fields, has no meaning. Furthermore, when these checks are not indicated, the last-path-used-mask, device-status, and the TCW address or the CCW-address fields are all valid. The fields are defined as follows:

- 17 Last-path-used mask
- 18 Termination code
- 19 Sequence code
- 20 Device status

21 CCW address or TCW address

Storage-Access Code (SA): Bits 22-23 indicate the type of storage access that was being performed by the channel subsystem at the time of error. The SA field pertains only to the access of storage for the purpose of fetching or storing data during the performance of an I/O operation. This encoded field has meaning only when channel-data check, channel-control check, or interface-control check is indicated in the subchannel status. The access-code assignments are as follows:

- 00 Access type unknown
- 01 Read
- 10 Write
- 11 Read backward for a command-mode operation.

Termination Code (TC): Bits 24 and 25 indicate the type of termination that has occurred. This encoded field has meaning only when channel-data check, channel-control check, or interface-control check is indicated in the SCSW. The types of termination are as follows:

- 00 Halt signal issued
- 01 Stop, stack, or normal termination
- 10 Clear signal issued
- 11 Reserved

When at least one channel check is indicated in the SCSW but the termination-code-field-validity flag is zero, it is unpredictable which, if any, termination has been signaled to the device. If more than one channel-check condition is indicated in the SCSW, the device may have been signaled one or more termination codes that are the same or different. In this situation, if the termination-code-field-validity flag is one, the termination code indicates the most severe of the terminations signaled to the device. The termination codes, in order of increasing severity, are: stop, stack, or normal termination (01); halt signal issued (00); and clear signal issued (10)

Device-Status Check (D): When the status-verification facility is installed, bit 26, when one, indicates that the subchannel logout in the ESW resulted from the channel subsystem detecting device status that had valid CBC but that contained a combination of bits that was inappropriate when the status byte was presented to the channel subsystem. When the device-status-check bit is one, the interface-control-check status bit is set to one. If, additionally, bit 20 of the subchannel-logout field has been stored as one,

then the status byte in error has been stored in the device-status field of the SCSW. If the status-verification facility is not installed, bit 26 is stored as zero.

Secondary Error (E): Bit 27, when one, indicates that a malfunction of a system component that may or may not have been directly related to any activity involving subchannels or I/O devices has occurred. Subsequent to this occurrence, the activity related to this subchannel and the associated I/O device was affected and caused the subchannel to be set status pending with either channel-control check or interface-control check.

I/O-Error Alert (A): Bit 28, when one, indicates that subchannel logout in the ESW resulted from the signaling of I/O-error alert. The I/O-error-alert signal indicates that the control unit or device has detected a malfunction that must be reported to the channel subsystem. The channel subsystem, in response, issues a clear signal and, except as described in the next paragraph, causes interface-control check to be set and extended-status-format-0 (logout) information to be stored in the ESW.

When I/O-error alert is signaled and the subchannel has previously been set disabled or no subchannel is associated with the device, the clear signal is issued to the device, and the I/O-error-alert indication is ignored by the channel subsystem.

Sequence Code (SC): When a command-mode IRB is stored, bits 29-31 identify the I/O sequence in progress at the time of error. The sequence code pertains only to I/O operations initiated by the execution of START SUBCHANNEL or RESUME SUBCHANNEL. This encoded field has meaning only when channel-data check, channel-control check, or interface-control check is indicated in the SCSW.

When a transport-mode IRB is stored, and the validity bit corresponding to the sequence-code field is one, bits 29-31 are stored as zeros.

The sequence-code assignments are:

- 000 Reserved
- 001 A nonzero command byte has been sent by the channel subsystem, but a response has not yet been analyzed by the channel subsystem. This code is set during the initiation sequence.

- 010 The command has been accepted by the device, but no data has been transferred.
- 011 At least one byte of data has been transferred between the channel subsystem and the device. This code may be used when the channel path is in an idle or polling state.
- 100 The command in the current CCW (1) has not yet been sent to the device, (2) was sent but not accepted by the device, or (3) was sent and accepted but command-retry status was presented. This code is set when any of the following conditions occurs:
1. The command address is updated during command chaining or during the initiation of a start function or resume function at the device.
 2. During the initiation sequence, the status includes attention, control unit end, unit check, unit exception, busy, status modifier (without channel end and device end), or device end (without channel end).
 3. Command retry is signaled.
 4. The channel subsystem interrogates the device in the process of clearing an interruption condition.
 5. The channel subsystem signals the conclusion of the chain of operations to the device during command chaining while performing the suspend function.
- 101 The command in the current CCW has been accepted, but data transfer is unpredictable. This code applies from the time a device is logically connected to a channel path until the time it is determined that a new sequence code applies. This code may also be used when the channel subsystem places a channel path in the polling or idle state and it is impossible to determine that code 010 or 011 applies. It may also be used at other times when a channel path cannot distinguish between code 010 or 011.
- 110 Reserved.
- 111 Reserved.

Figure 16-12 on page 16-51 defines the relationship between indications provided as subchannel-logout data and the appropriate SCSW bits.

Subchannel-Logout Condition Indicated	Logout Condition for SCSW Indication of ¹		
	CDC	CCC	IFCC
Key check	V	V	-
Measurement-block-program check ²	-	-	-
Measurement-block-data check ²	-	-	-
Measurement-block-protection check ²	-	-	-
CCW check	-	V	-
IDAW/MIDAW check	-	V	-
Last-path-used mask ³	V	V	V
Field-validity flags	V	V	V
Termination code ³	V	V	V
Device-status check	-	-	V
Secondary error	-	V	V
I/O-error alert	-	-	V
Sequence code ³	V	V	V

Explanation:

- No relationship.

¹ When more than one SCSW indication is signaled, the subchannel-logout conditions that are valid are the logical OR for each of the respective SCSW indications.

² Only one measurement-block check may be indicated in a specific subchannel logout.

³ This field has a field-validity flag.

CCC Channel-control check.
 CDC Channel-data check.
 IFCC Interface-control check.
 V Bit setting valid.

Figure 16-12. Relationship Between Subchannel-Logout Data and SCSW Bits

Extended-Report Word

The extended-report word (ERW) provides information to the program describing specific conditions that may exist at the device, subchannel, or channel subsystem. The ERW is stored whenever the extended-status word is stored. When the extended-status-word-format bit, bit 5 of word 0 of the SCSW, and the extended-control bit, bit 14 of word 0 of the SCSW, are both zeros, the ERW contains all zeros. When the extended-status-word-format bit or the extended-control bit or both are ones, the ERW has the following format:

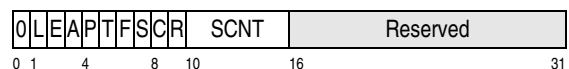

Request Logging Only (L): Bit 1, when one, requests that the program only record information about the condition that caused the extended-status word to be stored.

Extended-Subchannel-Logout Pending (E): Bit 2, when one, and when the extended-status-word-format bit, bit 5 of word 0 of the SCSW, is also one, indicates that an extended-subchannel logout is pending and that words 2-3 of the ESW contain the extended-subchannel-logout descriptor.

Bit 2 is set to zero when bit 6 is set to one.

When an ERW is stored with bits 2 and 6 both set to zero, zeros are stored in words 2 and 3 of the ESW.

Authorization Check (A): Bit 3, when one, indicates that the start or resume function was terminated because the channel subsystem has been placed in the isolated state in which pending I/O operations are not initiated and I/O operations currently being performed either are in the process of being terminated or have been terminated.

Path Verification Required (P): Bit 4, when one, indicates that the program must verify the identity of the device. The LPUM, when valid, indicates the channel path for which device verification is to be performed. When a valid LPUM is not available, the identity of the device must be verified for each available channel path.

Channel-Path Timeout (T): Bit 5, when one, indicates that, during a signaling sequence, an appropriate signal from the device did not occur within a predetermined time interval. Bit 5 is meaningful when the extended-status-word-format bit, bit 5 of word 0 of the SCSW, and the interface-control-check bit, bit 14 of word 2 of the SCSW, are both ones.

Failing-Storage-Address Validity (F): Bit 6, when one, and when the extended-status-word-format bit, bit 5 of word 0 of the SCSW, is also one, indicates that the channel subsystem has detected an invalid CBC on a CCW, a data location, an IDAW, a MIDAW, a TCW, TCCB, a TIDAW, a TSB or on the respective associated key and has stored, in words 2 and 3 of the ESW, the absolute address of a location associated with the invalid CBC.

Bit 6 is set to zero when bit 2 is set to one.

When an ERW is stored with bits 2 and 6 both set to zero, zeros are stored in words 2 and 3 of the ESW.

Concurrent Sense (S): When a command-mode IRB is stored, bit 7, when one, indicates that the concurrent-sense facility has placed sense information accepted from the device in the extended-control word and has stored a value, in bit positions 10-15 of the ERW, that specifies the number of sense bytes that have been stored in the extended-control word. When bit 7 is one, bit 14 of word 0 of the SCSW is also one.

When a transport-mode IRB is stored, bit 7 is reserved and set to zero.

Concurrent-Sense Count (SCNT): When bit 7 is one, bit positions 10-15 contain a value, in the range 1-32, that specifies the number of sense bytes stored into the extended-control word by the concurrent-sense facility. When bit 7 is zero, bit positions 10-15 contain zeros.

Secondary-CCW-Address Validity (C): When a command-mode IRB is stored, bit 8, when one, and when the extended-status-word-format bit, bit 5 of word 0 of the SCSW, is also one, indicates that the channel subsystem has detected an error condition that precludes the continued performance of an I/O operation. When prefetching applies (bit 9 of word 1 of the ORB is one) and certain error conditions identified by channel-control check, channel-data check, or interface-control check are recognized by the channel subsystem, situations may exist where the termination point of execution of the channel program differs between the channel subsystem and the I/O device. To properly identify the termination points, bit 8 is set to one, and a second CCW address (secondary-CCW address) is provided in the ESW and designates the last CCW executed at the device. When the validity bit is zero for the previously mentioned errors, the channel subsystem was unable to determine the termination point of the control-unit execution, and the secondary-CCW-address field contains zeros.

Bit 8 is not set to one unless the program has permitted prefetching by setting the prefetch-control bit, bit 9 of word 1 of the ORB, to one for the channel program in execution.

When a transport-mode IRB is stored, bit 8 is reserved and set to zero.

Failing-Storage-Address Format (R): Bit 9 indicates the format of the failing-storage address when the failing-storage-address validity bit, bit 6 of the ERW, is one. When bit 6 is zero, bit 9 is not meaningful and is stored as zero. When bit 6 is one and bit 9 is zero, a format-1 failing-storage address is stored in words 2 and 3 of the ESW. When bit 6 is one and bit 9 is one, a format-2 failing-storage address is stored in words 2 and 3. See “Failing-Storage Address” below for a description of format-1 and format-2 addresses.

Failing-Storage Address

Words 2 and 3 of the extended-status contain a 24-, 31-, or 64-bit absolute address. When the failing-storage-address-validity flag, bit 6 of the ERW, is one, words 2 and 3 contain either a format-1 failing-storage address or a format-2 failing-storage address. When bit 6 is one, the failing-storage-address field designates a byte location within the invalid checking block associated with an invalid CBC for a CCW, data location, IDAW, MIDAW, TCW, TCCB, TIDAW, TSB, or their respective associated key.

When a transport-mode IRB is stored, and the failing-storage-address validity flag, bit 6 of the ERW, is one, the failing-storage address contains the absolute address associated with the reported failing condition.

When an error condition is detected and a command-mode IRB is stored, the form of the address stored in words 2 and 3 depends on the format-2-IDAW control, bit 14 of word 1 of the ORB, and on the MIDA control, bit 25 of word 1 of the ORB, as follows:

1. When the format-2-IDAW control is zero, specifying that fullword IDAWs containing 31-bit addresses are used, and the modified-CCW-indirect-data-addressing-control is zero, a format-1 address is stored, and the failing-storage-address-format bit, bit 9 of the ERW, is stored as zero.
2. When either the format-2-IDAW control is one, specifying that doubleword IDAWs containing 64-bit addresses are used, or the modified-CCW-indirect-data-addressing-control is one, or both are one, a format-2 address is stored, and the failing-storage-address-format bit is stored as one.

When an error condition is detected and a transport-mode IRB is stored, a format-2 failing-storage address is stored. A format-2 failing-storage address is stored for a transport-mode IRB when a program-check, protection check, channel-data check or channel-control check condition is indicated by the subchannel status.

When a format-1 address is stored, bits 1-31 of word 2 form the address associated with the reported error condition, and bit 0 of word 2 and all of word 3 are stored as zeros. When a format-2 address is stored, bits 0-31 of word 2 followed by bits 0-31 of word 3 form the 64-bit address associated with the reported error condition.

Extended-Subchannel-Logout Descriptor (ESLD)

When the extended-status-word-format (L) bit, bit 5 of SCSW word 0, is one and the extended-subchannel-logout pending (E) flag, bit 2 of the ERW, is one, an extended-subchannel-logout descriptor is provided in words 2-3 of the ESW. The ESLD identifies the logout and the channel path for which the extended-subchannel logout is pending.

Secondary-CCW Address

When the subchannel-status field indicates channel-control check, channel-data check, or interface-control check and the secondary-CCW-address-validity flag, bit 8 of word 1, is one, bits 1-31 of word 4 form an absolute address of the last CCW executed by the I/O device at the point the reported check condition caused channel-program termination. When provided, the secondary-CCW address may be used for recovery purposes. When the secondary-CCW-address-validity flag is zero, this field contains zeros.

When a transport-mode IRB is stored and the subchannel-status field indicates channel-control check, channel-data check, or interface-control check, word 4 is reserved and contains zeros.

Extended-Status Format 1

The ESW stored by TEST SUBCHANNEL is a format-1 ESW when all of the following conditions are met:

1. The extended-status-word-format bit, bit 5 of word 0 of the SCSW, is zero.

2. The subchannel status-control field has the status-pending bit, bit 31 of word 0 of the SCSW, set to one, together with:
 - a. The primary-status bit, bit 29 of word 0 of the SCSW, alone,
 - b. The primary-status bit and other status-control bits, or
 - c. The intermediate-status bit, bit 28 of word 0 of the SCSW, and the suspended bit, bit 26 of word 0 of the SCSW.
3. At least one of the following conditions is indicated:
 - a. The device-connect-time-measurement mode is inactive.
 - b. The channel-subsystem-timing facility is not available for the subchannel.
 - c. The subchannel is not enabled for the device-connect-time-measurement mode.

Zeros are stored in bytes 0, 2, and 3 of word 0, and the LPUM is stored in byte 1 of word 0; an ERW is stored in word 1; zeros are stored in words 2-4.

The device-connect-time-measurement mode is made inactive when SET CHANNEL MONITOR is executed and bit 31 of general register 1 is zero.

A format-1 ESW has the following format:

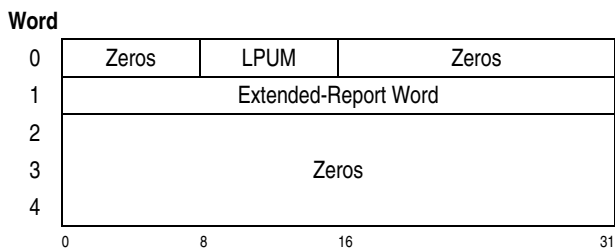

Last-Path-Used Mask (LPUM): For a definition of the LPUM, see “Last-Path-Used Mask (LPUM)” on page 16-49.

Extended-Report Word (ERW): For a definition of the ERW, see “Extended-Report Word” on page 16-51.

Extended-Status Format 2

The ESW stored by TEST SUBCHANNEL is a format-2 ESW when all of the following conditions are met:

1. The extended-status-word-format bit, bit 5 of word 0 of the SCSW, is zero.
2. The channel-subsystem-timing facility is available for the subchannel.
3. The subchannel is enabled for the device-connect-time-measurement mode.
4. The device-connect-time-measurement mode is active.
5. The subchannel status-control field has the status-pending bit, bit 31 of word 0 of the SCSW, set to one, together with:
 - a. The primary-status bit, bit 29 of word 0 of the SCSW, alone,
 - b. The primary-status bit and other status-control bits, or
 - c. The intermediate-status bit, bit 28 of word 0 of the SCSW, and the suspended bit, bit 26 of word 0 of the SCSW.

Zeros are stored in byte 0 of word 0, the LPUM is stored in byte 1 of word 0, and the device-connect time is stored in bytes 2 and 3 of word 0; an ERW is stored in word 1; zeros are stored in words 2-4.

A format-2 ESW has the following format:

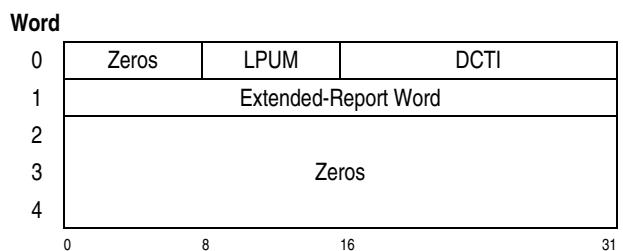

Last-Path-Used Mask (LPUM): For a definition of the LPUM, see “Last-Path-Used Mask (LPUM)” on page 16-49.

Device-Connect-Time Interval (DCTI): Bit positions 16-31 contain the binary count of time increments accumulated by the channel subsystem during

the time that the channel subsystem and the device were actively communicating and the subchannel was subchannel active for a command-mode operation, or start pending for a transport-mode operation. The time increment of the DCTI is 128 microseconds.

If the above conditions for the storing of the DCTI value in the ESW are met but the device-connect-time-measurement mode was made active by SET CHANNEL MONITOR subsequent to the execution of START SUBCHANNEL for this subchannel, the DCTI value stored is greater than or equal to zero and less than or equal to the correct DCTI value.

Note: The DCTI value stored in the ESW is the same as that used to update the corresponding measurement-block data for the subchannel if the measurement-block-update mode is in use for the subchannel. If the measurement-block-update mode for the channel subsystem is active and the subchannel is enabled for the device-connect-time-measurement mode but no DCTI value is stored in the ESW (because of the presence of subchannel-logout information), or if the DCTI is zero, then nothing is added to the corresponding measurement-block data.

Extended-Report Word (ERW): For a definition of the ERW, see “Extended-Report Word” on page 16-51.

Extended-Status Format 3

The ESW stored by TEST SUBCHANNEL is a format-3 ESW when the extended-status-word-format

bit, bit 5 of word 0 of the SCSW, is zero and the subchannel is status pending with (1) secondary status, alert status, or both when primary status is not also present, or (2) intermediate status when the subchannel is not suspended. Zeros are stored in byte 0 of word 0, and the LPUM is stored in byte 1 of word 0. Bytes 2 and 3 of word 0 contain unpredictable values; an ERW is stored in word 1; zeros are stored in words 2-4.

A format-3 ESW has the following format:

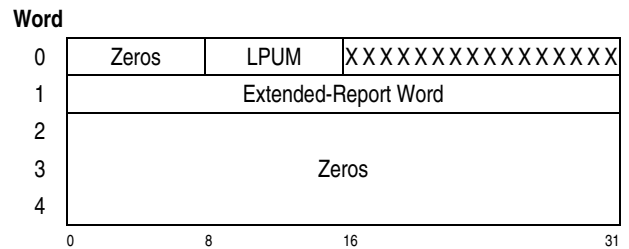

Last-Path-Used Mask (LPUM): For a definition of the LPUM, see “Last-Path-Used Mask (LPUM)” on page 16-49.

An “X” in the format indicates the bit may be zero or one.

Extended-Report Word (ERW): For a definition of the ERW, see “Extended-Report Word” on page 16-51.

Figure 16-13 on page 16-56 summarizes the conditions at the subchannel under which each type of information is stored in the ESW.

Subchannel Conditions When IRB is stored						Extended-Status Word (ESW), Word 0	
Subchannel-Status Word			Path-Management-Control Word			Format	Contents Bytes 0,1,2,3
Status-Control Field	L Bit	Suspended Bit	Device Connect-Time-Msrmt Mode	Timing-Facility Bit	Device-Connect-Time-Msrmt-Mode-Enable Bit		
----0	///	///	///	///	///		
00001	0	///	///	///	///	U	****
01001	0	0	///	///	///	1	ZMZZ
		1	Inactive	///	0		
			Active	///	1	0	
**1*1	0	///	///	///	///	1	ZMZZ
		///	Inactive	///	0		
			Active	///	1	0	
**011	0	///	///	///	///	2	ZMDD
1*001	0	///	///	///	///	3	ZM**
****1	1	///	///	///	///	0	RRRR

Explanation:

- Defined to be not meaningful when X is zero.
- * Bits may be zeros or ones.
- / Information not relevant in this situation.
- A Alert status.
- D Accumulated device-connect-time-interval (DCTI) value stored in bytes 2 and 3.
- I Intermediate status.
- L Extended-status-word format.
- M Last-path-used mask (LPUM) stored in byte 1.
- P Primary status.
- R Subchannel-logout information stored in word 0.
- S Secondary status.
- U No format defined.
- X Status pending.
- Z Bits are stored as zeros.

Figure 16-13. Information Stored in ESW

Extended-Control Word

The extended-control word, which is words 8-15 of an interruption-response block (see "Interruption-Response Block" on page 16-6), provides additional information to the program describing conditions that may exist at the channel subsystem, subchannel, or device. The extended-control (E) bit, bit 14 of word 0

of the SCSW, when one, indicates that model-dependent information or concurrent-sense information has been stored in the extended-control word.

The information provided in the extended-control word is as follows:

SCSW Bits 5 14	ERW Bit 7	ERW Bits 10-15	ECW Words 0-7
0 0	0	Zeros	Unpredictable ¹
0 1	0	(⁵)	(⁵)
0 1	1	(³)	Concurrent-sense information ⁴
1 0	0	Zeros	Unpredictable ¹
1 1	0	Zeros	Model-dependent information ²
1 1	1	(³)	Concurrent-sense information ⁴

Explanation:

- ¹ If stored, the value of these words is unpredictable.
- ² Unused bits in the model-dependent information are stored as zeros.
- ³ Bit positions 10-15 contain a value equal to the number of sense bytes returned.
- ⁴ Unused bytes in the concurrent-sense information are stored as zeros.
- ⁵ The combination of SCSW bit 5 as 0, SCSW bit 14 as one, and ERW bit 7 as zero does not occur.

Extended-Measurement Word

The extended-measurement word (EMW) provides I/O measurement information to the program for the most recent start or resume operation performed at the subchannel. When the extended-I/O-measurement-word facility is installed and enabled, the EMW is conditionally stored in words 16-23 of the IRB designated by the second operand of TEST SUBCHANNEL when TEST SUBCHANNEL is executed. The EMW is stored by TEST SUBCHANNEL when all of the following conditions are met:

1. The extended-status-word-format (L) bit (bit 5, word 0 of the SCSW) is zero.
2. The channel-subsystem-timing facility is available for the subchannel, as indicated by the timing facility bit (T) at the subchannel.
3. The extended-I/O-measurement-word-mode enable bit (X) at the subchannel is one.

4. The subchannel status-control field has the status-pending bit (bit 31, word 0 of the SCSW) set to one, together with:
 - a. The primary-status bit (bit 29, word 0 of the SCSW) alone, or
 - b. The primary-status bit and other status-control bits, or
 - c. The secondary-status bit (bit 29, word 0 of the SCSW) alone, or
 - d. The intermediate-status bit (bit 28, word 0 of the SCSW) and the suspended bit (bit 26, word 0 of the SCSW).

Words 16-23 of the IRB contain unpredictable values when the extended-I/O-measurement-word facility is installed and enabled but the conditions listed above are not met.

When the extended-I/O-measurement-word facility is not installed, or the facility is installed but not enabled, words 16-23 of the IRB are not accessed by the channel subsystem.

The format of the extended-measurement word is shown below:

Word	
0	Device-Connect Time
1	Function-Pending Time
2	Device-Disconnect Time
3	Control-Unit-Queuing Time
4	Device-Active-Only Time
5	Device-Busy Time
6	Initial Command Response Time
7	Reserved

Each field in the EMW, when valid, contains a 32 bit binary count in which each increment of the count represents a value of 0.5 microseconds. A value of 00000000 hex represents a time period of zero seconds; the maximum value of FFFFFFFF hex represents approximately 35.79 minutes.

The accuracy of each of the measurement fields stored by the measurement facility is undefined and may vary depending on the resolution of timers implemented at the channel subsystem, the types of channels used to perform the operation, the capabilities

of control units accessed during the operation, and the overall length of the I/O operation that was performed. The maximum value of FFFFFFFF hex is stored if a counter overflows; the program is not alerted when an overflow occurs.

Device-Connect Time: Bit positions 0-31 of word 0 contain the measured device-connect time for the operation. The device-connect time is the sum of the time intervals measured whenever the device is logically connected to a channel path while the subchannel is subchannel active for a command-mode operation, or start-pending for a transport-mode operation, and the device is actively communicating with the channel path, as defined in the section "Device-Connect Time" on page 17-4.

Function-Pending Time: Bit positions 0-31 of word 1 contain the SSCH- or RSCH-function-pending time for the operation. Function-pending time is the time interval between acceptance of the start function (or resume function if the subchannel is in the suspended state) at the subchannel and acceptance of the first command associated with the initiation or resumption of channel-program execution at the device, as defined in the section "Function-Pending Time" on page 17-5.

Device-Disconnect Time: Bit positions 0-31 of word 2 contain the device-disconnect time for the operation. Device-disconnect time is the sum of the time intervals measured whenever the device is logically disconnected from the channel subsystem while the subchannel is subchannel-active for a command-mode operation, or start-pending for a transport-mode operation, as defined in the section "Device-Disconnect Time" on page 17-5.

Control-Unit-Queuing Time : Bit positions 0-31 of word 3 contain the control-unit-queuing time for the operation. Control-unit-queuing time is the sum of the time intervals measured by the control unit whenever the device is logically disconnected from the channel subsystem during an I/O operation while the device is busy with an operation initiated from a different system, as defined in the section "Control-Unit-Queuing Time" on page 17-5.

Device-active-only time: Bit positions 0-31 of word 4 contain the device-active-only time for the operation. For a command-mode operation, device-active-only time is the sum of the time intervals when the subchannel is device-active but not subchannel-active at the end of an I/O operation or chain of I/O

operations initiated by a start function or resume function, as defined in section “Device-Active-Only Time” on page 17-6. When a transport-mode IRB is stored, device-active-only time is the sum of the times that the I/O device was active executing device command and the time interval between when channel-end and device-end status were presented.

Device-busy time: Bit positions 0-31 of word 5 contain the device-busy time for the operation. When a command-mode IRB is stored, the device-busy time is the sum of the time intervals when the device is found to be device busy during an attempt to initiate a start function or resume function at the sub-channel, as defined in the section “Device-Busy Time” on page 17-6. When a transport-mode IRB is stored, device-busy time is the sum of the times that the I/O device was busy attempting to initiate a command and the device busy time accumulated by the channel subsystem.

Initial Command Response Time: Bit positions 0-31 of word 6 contain the initial-command-response time for the operation. When a command-mode IRB is stored, initial-command-response time for an operation is the time interval beginning from when the first command of the channel program is sent to the device until the device indicates it has accepted the command. When a transport-mode IRB is stored, the initial-command-response time, is the time interval difference between when a TCCB is sent to the I/O device until the response is received from the I/O device, minus the time from when the control unit receives the TCCB until the channel subsystem receives the response from the control unit.

Chapter 17. I/O Support Functions

Channel-Subsystem Monitoring	17-3	Clear Signal	17-14
Channel-Subsystem Timing	17-3	Reset Signal	17-14
Channel-Subsystem Timer	17-4	Resets	17-14
Measurement-Block Update	17-4	Channel-Path Reset	17-15
Measurement Block	17-5	I/O-System Reset	17-15
Measurement-Block Format	17-9	Externally Initiated Functions	17-18
Measurement-Block Origin	17-9	Initial Program Loading	17-18
Measurement-Block Address	17-9	CCW-type IPL	17-19
Measurement-Block Key	17-9	List-Directed IPL	17-21
Measurement-Block Index	17-9	IPL Information Report Block	17-23
Measurement-Block-Update Mode	17-10	IPL Signature Certificate List	17-24
Measurement-Block-Format Control	17-10	IPL Signature Certificate Entry	17-24
Measurement-Block-Update Enable	17-10	Reconfiguration of the I/O System	17-27
Control-Unit-Queuing Measurement	17-11	Status Verification	17-28
Control-Unit-Defer Time	17-11	Address-Limit Checking	17-28
Device-Active-Only Measurement	17-11	Configuration Alert	17-29
Initial-Command-Response Measurement	17-11	Incorrect-Length-Indication Suppression	17-29
Time-Interval-Measurement Accuracy	17-11	Concurrent Sense	17-29
Device-Connect-Time Measurement	17-12	Channel-Subsystem Recovery	17-29
Device-Connect-Time-Measurement		Channel Report	17-30
Mode	17-12	Channel-Report Word	17-31
Device-Connect-Time-Measurement		Restore-Subchannel Facility	17-33
Enable	17-12	Extended-Subchannel-Logout Facility	17-34
Extended Measurement Word	17-12	Channel-Subsystem-I/O-Priority Facility	17-34
Extended-Measurement-Word Enable	17-13	Number of Channel-Subsystem-Priority	
Signals and Resets	17-13	Levels	17-35
Signals	17-13	Multiple-Subchannel-Set Facility	17-35
Halt Signal	17-13		

The I/O support functions are those functions of the channel subsystem that are not directly related to the initiation or control of I/O operations. The following I/O support functions are described in this chapter:

- Channel-subsystem monitoring
- Signals and resets
- Externally initiated functions
- Status verification
- Address-limit checking
- Configuration alert
- Incorrect-length-indication suppression
- Concurrent sense
- Channel-subsystem recovery
- I/O-priority facility
- Restore-subchannel facility
- Multiple-subchannel-set facility

Channel-Subsystem Monitoring

Monitoring facilities are provided in the channel subsystem so that the program can retrieve measured values on performance for a designated subchannel. The use of these facilities is under program control by means of the execution of the SET CHANNEL MONITOR instruction and the MODIFY SUBCHANNEL instruction.

The principal components of the channel-subsystem-monitoring facilities are the channel-subsystem-timing facility, measurement-block-update facility, and device-connect-time-measurement facility. The measurement-block-update facility and device-connect-time-measurement facility both use the channel-subsystem-timing facility but otherwise are logically distinct and operate independent of one another.

Other components of the channel-subsystem-monitoring facilities are the control-unit-queuing-measurement facility, the control-unit-defer-time facility, the device-active-only-measurement facility, the initial-command-response-measurement facility, the extended-I/O-measurement-block facility, and the extended-I/O-measurement-word facility. These enhance the measurements of the measurement-block-update facility if they are available as described in later sections, where each of the facilities that constitute the channel-subsystem-monitoring facilities is described in this chapter.

Channel-Subsystem Timing

The channel-subsystem-timing facility provides the channel subsystem with the capability of measuring the elapsed time required for performing several different phases of the processing of a start function initiated by START SUBCHANNEL. These elapsed-time measurements are used by both the measurement-block-update facility and the device-connect-time-measurement facility to provide subchannel performance information to the program.

While every channel subsystem has a channel-subsystem-timing facility, it may or may not be provided for use with all subchannels. Subchannels for which the facility is provided have the timing-facility bit, bit 14 of word 1, stored as one in the associated subchannel-information block. (See “Timing Facility (T)” on page 15-4.) If the channel-subsystem-timing facility is not provided for the subchannel, the subchannel's timing-facility bit is stored as zero.

Subchannels that do not have the channel-subsystem-timing facility provided are those for which the characteristics of the associated device, the manner in which it is attached to the channel subsystem, or the channel-subsystem resources required to support the device are such that use of the channel-subsystem-timing facility is precluded.

The channel-subsystem-timing facility consists of at least one channel-subsystem timer and the associated logic and storage required for computing and recording the elapsed-time intervals for use by the two measurement facilities. The aspects of the channel-subsystem-timing facility that are of importance to the program are described below.

Channel-Subsystem Timer

Each channel-subsystem timer is a binary counter that is not accessible to the program. The channel-subsystem timer provides a minimum timer resolution of 128 microseconds. A timer resolution of 1.0 microseconds is provided when FICON-I/O-interface channel paths are supported. When incrementing the channel-subsystem timer causes a carry out of the leftmost bit position, the carry is ignored, and counting continues from zero. No indications are generated as a result of the overflow.

Just as every CPU has access to a TOD clock, every channel subsystem has access to at least one channel-subsystem timer. When multiple channel-subsystem timers are provided, synchronization among these timers is also provided, creating the effect that all the timing facilities of the channel subsystem share a single timer. Synchronization among these timers may be supplied either through some TOD clock or independently by the channel subsystem.

If the TOD clocks are not synchronized, the elapsed times measured by the channel-subsystem-timing facility may have unpredictable values for some or all of the subchannels, depending on the model and on the particular channel-subsystem timer and the way the associated devices are physically attached to the system. The values are unpredictable for those devices attached to the system by separately configurable channel paths whose associated CPU TOD clocks are not synchronized.

Synchronization: If either the measurement-block-update mode or the device-connect-time-measurement mode is active and any of the channel-subsystem timers is found to be out of synchronization, a channel-subsystem-timer-sync check is recognized, and a channel report is generated to alert the program (see “Channel-Subsystem Recovery” on page 17-27). If neither of these modes is active, the lack of synchronization is not recognized.

Measurement-Block Update

The measurement-block-update facility provides the program with the capability of accumulating performance information for subchannels that are enabled for the measurement-block-update mode when the measurement-block-update mode is active. A subchannel is enabled for the measurement-block-update mode by setting bit 11 of word 1 of the SCHIB operand to one and then issuing MODIFY SUB-

CHANNEL. The measurement-block-update mode is made active by the execution of SET CHANNEL MONITOR when bit 62 of general register 1 is one.

When the measurement-block-update mode is active and the subchannel is enabled for the measurement-block-update mode, information is accumulated in a measurement block associated with the subchannel. A measurement block is either a 32-byte area (format-0 measurement block) or a 64-byte area (format-1 measurement block) in main storage that is associated with a subchannel for the purpose of accumulating measurement data.

For format-0 measurement blocks, the program specifies a contiguous area of absolute storage, referred to as the measurement-block area, and subdivides this area into 32-byte blocks, one block for each subchannel for which measurement data is to be accumulated. The measurement-block-update facility uses the measurement-block index contained at the subchannel in conjunction with the measurement-block origin established by the execution of SET CHANNEL MONITOR to compute the absolute address of the measurement block associated with a subchannel.

For format-1 measurement blocks, the program provides a 64-byte contiguous area of absolute storage for the subchannel. The measurement-block-update facility uses the measurement-block address provided by the MSCH instruction to access the measurement block.

Measurement data is stored in the measurement block associated with the subchannel each time an I/O operation or chain of I/O operations initiated by a START SUBCHANNEL instruction or RESUME SUBCHANNEL instruction is suspended or is completed at the device. The completion of an I/O operation or chain of I/O operations at the device is normally determined when secondary status is accepted from the device.

The measurement data accumulated in the format-0 and format-1 measurement blocks by the measurement-block-update facility is described in the following section, "Measurement Block".

Measurement Block

A measurement block is either a 32-byte area (format-0 measurement block) at a location designated by the program by its use of a measurement-block-

origin address in conjunction with the measurement-block index, or a 64-byte area (format-1 measurement block) at a location designated by the measurement-block address provided in the SCHIB during the execution of the MODIFY SUBCHANNEL instruction.

The measurement block contains the accumulated values of the measurement data described below. When the measurement-block-update mode is active and the subchannel is enabled for measurement-block update, the measurement-block-update facility accumulates the values for the measurement data that accrue during the performance of an I/O operation or chain of I/O operations initiated by START SUBCHANNEL.

When the I/O operation or chain of I/O operations is suspended or completed and no error condition is encountered, the accrued values are added to the accumulated values in the measurement block for that subchannel. If an error condition is detected and subchannel-logout information is stored in the extended-status word (ESW), the accrued values are not added to the accumulated values in the measurement block for the subchannel, and the two count fields in the measurement block are not incremented.

If (1) any of the accrued time values is detected to exceed the internal storage provided for containing these values, (2) the control unit cannot provide an accurate queuing time or defer time for the current operation, or (3) the channel subsystem successfully recovers from certain error conditions, none of the accrued values is added to the measurement block for the subchannel, and the sample count in the measurement block is not incremented, but the SSCH+RSCH count in the block is incremented.

References to the measurement block by the measurement-block-update facility, in order to accumulate measurement data at the suspension or completion of an I/O function, are single-access references and appear to be word concurrent as observed by CPUs.

The measurement-block-update facility updates all fields in the measurement block that are required to be updated for a suspended I/O operation prior to putting the subchannel into the suspended state. The measurement-block-update facility updates all fields in the measurement block that are required to be updated for a completed I/O operation prior to making the subchannel status pending with secondary status or, if the subchannel is start pending for a sub-

sequent operation, prior to initiating the start function.

A format-0 measurement block is stored when the measurement-block-format-control bit at the subchannel is zero; a format-1 measurement block is stored when the measurement-block-format-control bit at the subchannel is one.

The format-0 measurement block has the following format:

Word	Field
0	SSCH+RSCH Count (bits 0-15) Sample Count (bits 16-31)
1	Device-Connect Time
2	Function-Pending Time
3	Device-Disconnect Time
4	Control-Unit-Queuing Time
5	Device-Active-Only Time
6	Device-Busy Time
7	Initial Command Response Time

The format-1 measurement block has the following format:

0	SSCH+RSCH Count
1	Sample Count
2	Device-Connect Time
3	Function-Pending Time
4	Device-Disconnect Time
5	Control-Unit-Queuing Time
6	Device-Active-Only Time
7	Device-Busy Time
8	Initial Command Response Time
9	Interrupt Delay Time
10	I/O Priority Delay Time
11	Reserved
12	
13	
14	
15	

SSCH+RSCH Count: Bits 0-15 of word 0 in the format-0 measurement block and bits 0-31 of word 0 in the format-1 measurement block are used as a binary counter. During the performance of a start

function for which measurement-block update is active, when (1) the secondary status condition is recognized or (2) the suspend function is performed, the counter is incremented by one, and the measurement data is stored. The counter wraps around from the maximum value to 0. The program is not alerted when counter overflow occurs.

If the measurement-block-update mode is active and the subchannel is enabled for measuring, the SSCH+RSCH count is incremented even when the lack of measured values for an individual start function precludes the updating of the remaining fields of the measurement block or when the timing-facility bit for the subchannel is zero. The SSCH+RSCH count is not incremented if the measurement-block-update mode is inactive, if the subchannel is not enabled for the measurement-block update, or if subchannel-logout information has been generated for the start function.

Sample Count: Bits 16-31 of word 0 in the format-0 measurement block and bits 0-31 of word 1 in the format-1 measurement block are used as a binary counter. When the time-accumulation fields following word 0 of the format-0 measurement block or following word 1 of the format-1 measurement block are updated, the counter is incremented by one. On some models, certain conditions may prevent the measurement-block-update facility from obtaining the accrued values of the measurement data for an individual start function, even when the measurement-block-update mode is active and the subchannel is enabled for that mode. The control unit may also signal that it was not able to accumulate an accurate queuing time. In these situations, the sample-count field is not incremented.

The counter wraps around from the maximum value to 0. The program is not alerted when counter overflow occurs. This field is not updated if the channel-subsystem-timing facility is not provided for the subchannel.

The System Library publication for the system model specifies the conditions, if any, that preclude the updating of the sample count and time-accumulation fields of the measurement block.

Device-Connect Time: Bit positions 0-31 of word 1 in the format-0 measurement block and bit positions 0-31 of word 2 in the format-1 measurement block contain the accumulation of measured device-connect-time intervals. The device-connect-time

interval (DCTI) is the sum of the time intervals measured whenever the device is logically connected to a channel path while the subchannel is subchannel active and the device is actively communicating with the channel path. The device-connect time does not include the intervals when a device is logically connected to a channel path but is not actively communicating with the channel. The device reports the accumulation of time intervals when the device is logically connected but not actively communicating with the channel path as control-unit-defer time. The control-unit-defer time is not included in the device-connect-time measurement but, instead, is added to the accrued device-disconnect-time measurement for the operation.

The time intervals are stored using a resolution of 128 microseconds. The accumulated value is modulo approximately 152.71 hours, and the program is not alerted when an overflow occurs. This field is not updated if (1) the channel-subsystem-timing facility is not provided for the subchannel, (2) the measurement-block-update mode is inactive, or (3) any of the time values accrued for the current start function has been detected to exceed the internal storage in which it was accrued.

Accumulation of device-connect-time intervals for a subchannel and storing this data in the ESW are not affected by whether the measurement-block-update mode is active. (See "Device-Connect-Time Measurement" on page 17-10.)

Function-Pending Time: Bit positions 0-31 of word 2 in the format-0 measurement block and bit positions 0-31 of word 3 in the format-1 measurement block contain the accumulated SSCH- and RSCH-function-pending time. Function-pending time is the time interval between acceptance of the start function (or resume function if the subchannel is in the suspended state) at the subchannel and acceptance of the first command associated with the initiation or resumption of channel-program execution at the device.

When channel-program execution is suspended because of a suspend flag in the first CCW of a channel program, the suspension occurs prior to transferring the first command to the device. In this case, the function-pending time accumulated up to that point is added to the value in the function-pending-time field of the measurement block. Function-pending time is not accrued while the subchannel is suspended. Function-pending time begins to be accrued again, in

this case, when RESUME SUBCHANNEL is subsequently executed while the designated subchannel is in the suspended state.

The function-pending-time interval is stored using a resolution of 128 microseconds. The accumulated value is modulo approximately 152.71 hours, and the program is not alerted when an overflow occurs. This field is not updated if the channel-subsystem-timing facility is not provided for the subchannel.

Device-Disconnect Time: Bit positions 0-31 of word 3 in the format-0 measurement block and bit positions 0-31 of word 4 in the format-1 measurement block contain the accumulated device-disconnect time. Device-disconnect time is the sum of the time intervals measured whenever the device is logically disconnected from the channel subsystem while the subchannel is subchannel active. The device-disconnect time also includes the sum of control-unit-defer-time intervals reported by the device during the I/O operation.

Device-disconnect time is not accrued while the subchannel is in the suspended state. Device-disconnect time begins to be accrued again, in this case, on the first device disconnection after channel-program execution has been resumed at the device (the subchannel is again subchannel active).

The device-disconnect-time interval is stored using a resolution of 128 microseconds. The accumulated value is modulo approximately 152.71 hours; the program is not alerted when an overflow occurs. This field is not updated if the channel-subsystem-timing facility is not provided for the subchannel.

The device-disconnect time does not include the interval between the primary status condition and the secondary status condition at the end of an I/O operation when the subchannel is no longer subchannel active but the I/O device is active. If the channel subsystem provides the device-active-only measurement facility, this time is accumulated in the device-active-only-time field of the measurement block.

Control-Unit-Queuing Time: Bit positions 0-31 of word 4 in the format-0 measurement block and bit positions 0-31 of word 5 in the format-1 measurement block contain the accumulated control-unit-queuing time. Control-unit-queuing time is the sum of the time intervals measured by the control unit whenever the device is logically disconnected from the channel subsystem during an I/O operation while the

device is busy with an operation initiated from a different system.

Control-unit-queuing time is not accrued while the subchannel is in the suspended state. Control-unit-queuing time may be accrued for the channel program after the subchannel becomes subchannel active following a successful resumption.

The control-unit-queuing-time field is updated such that bit 31 represents 128 microseconds. The accumulated value is modulo approximately 152.71 hours; the program is not alerted when an overflow occurs. This field is not updated if the channel-subsystem-timing facility is not provided for the subchannel or if the control unit does not provide a queuing time.

Device-Active-Only Time: Bit positions 0-31 of word 5 in the format-0 measurement block and bit positions 0-31 of word 6 in the format-1 measurement block contain the accumulated device-active-only time. Device-active-only time is the sum of the time intervals when the subchannel is device active but not subchannel active at the end of an I/O operation or chain of I/O operations initiated by a start function or resume function.

Device-active-only time is not accumulated when the subchannel is device active during periods when the subchannel is active; such time is accumulated as device-connect time or device-disconnect time, as appropriate.

The device-active-only-time field is updated such that bit 31 represents 128 microseconds. The accumulated value is modulo approximately 152.71 hours; the program is not alerted when an overflow occurs. This field is not updated if the channel-subsystem-timing facility is not provided for the subchannel.

Device-Busy Time: When the extended-I/O-measurement-block facility is installed, bit positions 0-31 of word 6 in the format-0 measurement block, and bit positions 0-31 of word 7 in the format-1 measurement block contain the accumulated device-busy time. Device-busy time is the sum of the time intervals when the subchannel is device busy during an attempt to initiate a start function or resume function at the subchannel.

The device-busy-time field is updated such that bit 31 represents 128 microseconds. The accumulated value is modulo approximately 152.71 hours; the pro-

gram is not alerted when an overflow occurs. This field is not updated if the channel-subsystem-timing facility is not provided for the subchannel.

Initial-Command-Response Time: Bit positions 0-31 of word 7 in the format-0 measurement block, and bit positions 0-31 of word 8 in the format-1 measurement block contain the accumulated initial-command-response time for the subchannel.

The initial-command-response time for a start or resume function is the time interval beginning from when the first command of the channel program is sent to the device until the device indicates it has accepted the command.

The initial-command-response time is stored at a resolution of 128 microseconds. The accumulated value is modulo approximately 152.71 hours; the program is not alerted when an overflow occurs.

This field is not updated if the channel-subsystem-timing facility is not provided for the subchannel or if the initial-command-response-measurement facility is not installed.

Control-Unit-Defer Time: Control-unit-defer time is the sum of the time intervals measured by the control unit whenever the device is logically connected to the channel subsystem during an I/O operation but is not actively communicating with the channel because of device-dependent delays in channel-program execution. The control-unit-defer time is not stored in the measurement block as a separate measurement field but is used in the calculation of device-connect-time measurement and device-disconnect-time measurement for an operation.

Control-unit-defer time, if provided by a control unit, is accrued while the device is logically connected to the channel. The time is reported to the channel when channel-end status is presented that causes a device disconnection or terminates the I/O operation. Control-unit-defer time is subtracted from the device-connect-time measurement and is added to the device-disconnect-time measurement reported for the operation.

Interrupt-Delay Time: When the interrupt-delay-measurement facility is installed, bit positions 0-31 of word 9 in the format-1 measurement block contain the accumulated interrupt-delay time for the subchannel. Interrupt-delay time is the time interval from when a subchannel is made status pending with pri-

mary status to when the status is cleared by TSCH. When the interrupt-delay-measurement facility is not installed, bit positions 0-31 of word 9 in the format-1 measurement block are not updated and contain zeros.

The interrupt-delay time is accumulated in the measurement block when a measurement-block update is performed on a subsequent SSCH since the interrupt-delay time is not known when the measurement block is updated for the current SSCH. Consequently, the interrupt-delay time contains the accumulated interrupt-delay time for SSCH operations completed prior to the last completed SSCH operation.

The interrupt-delay time is stored using a resolution of 128 microseconds. The accumulated value is modulo approximately 152.71 hours and the program is not alerted when an overflow occurs. This field is not updated if the channel-subsystem-timing facility is not provided for the subchannel.

I/O-Priority-Delay Time: Bit positions 0-31 of word 10 in the format-1 measurement block contain the accumulated I/O-priority-delay time for the subchannel. The I/O-priority-delay time is that portion of the queue time that can be attributed to delay due to I/O-priority management performed by the control unit. The measurement applies only to TCW I/O operations and is reported in the additional data area of the TSB according to device-dependent definition. If the control unit does not support I/O-priority management or if there is no I/O-priority delay, bit positions 0-31 of word 10 in the format-1 measurement block are not updated.

The I/O-priority-delay time is stored using a resolution of 128 microseconds. The accumulated value is modulo approximately 152.71 hours, and the program is not alerted when an overflow occurs. This field is not updated if the channel-subsystem-timing facility is not provided for the subchannel.

Programming Note: This time is a direct measurement of the effect of the software setting I/O priorities for the I/O executed at the control unit for all I/O devices. Times will vary depending if priorities are kept low for some work. Software uses the time to validate the correctness of the algorithms used for I/O priority management.

Reserved: The remaining words of the measurement block, along with any words associated with facilities that are not provided by the channel subsys-

tem or the subchannel, are reserved for future use. They are not updated by the measurement-block-update facility.

Programming Note: It is possible for the program to fetch a portion of a measurement block immediately prior to, or during, a measurement block update by the measurement-block-update facility. To ensure that a consistent measurement block is fetched, the program should not fetch measurement data for a subchannel during the time from when a start or resume function is initiated at the subchannel until the operation is suspended or completes with secondary status.

Measurement-Block Format

The measurement block is stored as either a format-0 measurement block or a format-1 measurement block. The format-0 measurement block is a 32-byte area (format-0 measurement block) at a location designated by the program using the measurement-block origin in conjunction with the measurement-block index. The format-1 measurement block is a 64-byte area (format-1 measurement block) at a location designated by the measurement-block address provided in the SCHIB during the execution of the MODIFY SUBCHANNEL instruction. The measurement-block-format-control bit at the subchannel indicates whether a format-0 or format-1 measurement block is stored when measurement-block-update mode is active and enabled at the subchannel.

Measurement-Block Origin

The measurement-block origin is the beginning of the measurement-block area in main storage, used to store format-0 measurement blocks. The absolute address of the measurement-block origin, specified on a 32-byte boundary, is passed in general register 2 to the measurement-block-update facility when SET CHANNEL MONITOR is executed with bit 62 of general register 1 set to one.

Measurement-Block Address

The measurement-block address is set at the subchannel through the execution of MODIFY SUBCHANNEL. The measurement block address specifies the absolute address of the beginning of the 64-byte area to be used for accumulating format-1 measurement-block parameters for that subchannel.

Programming Note: The initial value of the measurement-block address is zero. The program is

responsible for setting the measurement-block address to the proper value prior to enabling the subchannel for the measurement-block-update mode for format-1 measurement blocks and making the mode active.

Measurement-Block Key

Bits 32-35 of general register 1 form the four-bit access key to be used for subsequent measurement-block updates when SET CHANNEL MONITOR causes the measurement-block-update mode to be made active. The measurement-block key is passed to the measurement-block-update facility whenever the measurement-block-update mode is made active. The key is used for format-0 and format-1 measurement block updates.

Measurement-Block Index

The measurement-block index is set in the subchannel through the execution of MODIFY SUBCHANNEL. The measurement-block index specifies which 32-byte measurement block, relative to the measurement-block origin, is to be used for accumulating the format-0 measurement-block parameters for that subchannel. The location of the format-0 measurement block of a subchannel is computed by the measurement-block-update facility by appending five rightmost zeros to the measurement-block index of the subchannel and adding the result to the measurement-block origin. The result is the absolute address of the 32-byte format-0 measurement block for that subchannel. When the computed measurement-block address exceeds 2^{31} , a measurement-block program-check condition is recognized, and measurement-block updating does not occur for the preceding subchannel-active period.

Programming Note: The initial value of the measurement-block index is zero. The program is responsible for setting the measurement-block index to the proper value prior to enabling the subchannel for the measurement-block-update mode and making the mode active. To ensure predictable results for the measured parameters in the measurement block, each subchannel for which measured parameters are to be accumulated must have a different value for its measurement-block index.

Measurement-Block-Update Mode

The measurement-block-update mode is made active by the execution of SET CHANNEL MONITOR with bit 62 of general register 1 set to one. If bit 62 of general register 1 is zero when SET CHANNEL

MONITOR is executed, the mode is made inactive. When the measurement-block-update mode is inactive, no measurement values are accumulated in main storage. When the measurement-block-update mode is made active, the contents of general register 2 are passed to the measurement-block-update facility as the absolute address of the measurement-block origin and is used to calculate the address of format-0 measurement blocks. The measurement-block origin is not used for format-1 measurement blocks. The MBK is also passed to the measurement-block-update facility as the access key to be used when updating either format-0 or format-1 measurement blocks for each subchannel. When the measurement-block-update mode is active, the measurement-block-update facility accumulates measurements in individual measurement blocks for subchannels whose measurement-block-update-enable bit is one. (See the section "Measurement Block" on page 17-3 for a description of the measured parameters.)

If the measurement-block-update mode is already active when SET CHANNEL MONITOR is executed, the values for the measurement-block origin and measurement-block key that are used for a subchannel enabled for measuring by the measurement-block-update facility are dependent upon whether SET CHANNEL MONITOR is executed prior to, during, or subsequent to the execution of START SUBCHANNEL for that subchannel. If SET CHANNEL MONITOR is executed prior to START SUBCHANNEL, the current measurement-block origin and measurement-block key are in control. If SET CHANNEL MONITOR is executed during or subsequent to execution of START SUBCHANNEL, it is unpredictable whether the measurement-block origin and measurement-block key that are in control are old or current.

Measurement-Block-Format Control

Bit 29, word 6, of the SCHIB is the measurement-block-format-control bit. This bit provides the capability of specifying whether a format-0 or format-1 measurement block is stored on a subchannel basis. The initial value of the bit is zero. When MODIFY SUBCHANNEL is executed with the measurement-block-format-control bit in the SCHIB operand set to one, the format-1 measurement block is specified for the subchannel. If the measurement-block-update mode is active and enabled at the subchannel, the measurement-block-update facility stores a format-1 measurement-block for the subchannel, starting with

the next START SUBCHANNEL issued to that subchannel. Similarly, if MODIFY SUBCHANNEL is executed with measurement-block-format-control bit of the SCHIB operand set to zero by the program, the measurement-block-update facility stores a format-0 measurement-block for the subchannel, starting with the next START SUBCHANNEL issued to that subchannel.

Measurement-Block-Update Enable

Bit 11 of word 1 of the SCHIB is the measurement-block-update-enable bit. This bit provides the capability of controlling the accumulation of measurement-block parameters on a subchannel basis. The initial value of the enable bit is zero. When MODIFY SUBCHANNEL is executed with the enable bit set to one in the SCHIB, the subchannel is enabled for the measurement-block-update mode. If the measurement-block-update mode is active, the measurement-block-update facility accumulates measurement-block parameters for the subchannel, starting with the next START SUBCHANNEL issued to that subchannel. Conversely, if MODIFY SUBCHANNEL is executed with bit 11 of word 1 of the SCHIB operand set to zero by the program, the subchannel is disabled for the measurement-block-update mode, and no additional measurement-block parameters are accumulated for that subchannel.

Control-Unit-Queuing Measurement

The control-unit-queuing-measurement facility allows the channel subsystem to accept queuing times from control units and, in conjunction with the measurement-block-update facility, to accumulate those times in the measurement block.

The System Library publication for the control-unit model specifies its ability to supply queuing time. If a control-unit model is capable of supplying queuing time, the publication specifies the conditions that prevent the control unit from accumulating an accurate control-unit-queuing time.

Control-Unit-Defer Time

The control-unit-defer-time facility allows the channel subsystem to accept defer times from control units and, in conjunction with the measurement-block-update facility, to modify the device-connect and device-disconnect times reported in the measurement block to reflect the defer time. The control-unit-defer time is subtracted from the device-connect-time

measurement and is added to the device-disconnect-time measurement reported for an I/O operation.

The System Library publication for the control-unit model specifies its ability to supply defer time. If a control-unit model is capable of supplying defer time, the publication specifies the conditions that prevent the control unit from accumulating an accurate control-unit-defer time.

Device-Active-Only Measurement

The device-active-only-measurement facility permits the channel subsystem to report the times that the device is disconnected between primary status and secondary status at the end of an I/O operation or chain of I/O operations.

The measurement-block updates are performed at the time that secondary status is accepted from the I/O device, in order that the device-active time between primary status and secondary status can be reported.

If the subchannel is start pending when secondary status is accepted from the I/O device and the measurement-block update is to be performed, the measurement-block update is performed prior to performing the start function. If measurement-block errors occur, they are reported to the program along with the secondary status instead of performing the start function.

Initial-Command-Response Measurement

The initial-command-response-measurement facility allows the channel subsystem to calculate initial-command-response time for I/O operations and, in conjunction with the measurement-block-update facility, to accumulate those times in the measurement block. The initial-command-response time is accumulated in word 7 of the measurement block.

Time-Interval-Measurement Accuracy

On some models, when time intervals are to be measured and condition code 0 is set for START SUBCHANNEL (or RESUME SUBCHANNEL in the case of a suspended subchannel), a period of latency may occur prior to the initiation of the function-pending time measurement. The System Library publication for the system model specifies the mean latency value and variance for each of the measured time intervals.

Programming Notes:

1. Excessive delays may be encountered by the channel subsystem when attempting to update measurement data if the program is concurrently accessing the same measurement-block area. A programming convention should ensure that the storage block designated by SET CHANNEL MONITOR is made read-only while the measurement-block-update mode is active.
2. To ensure that programs written to support measurement functions are executed properly, the program should initialize all the measurement blocks to zeros prior to making the measurement-block-update mode active. Only zeros should appear in the reserved and unused words of the measurement blocks.
3. When the incrementing of an accumulated value causes a carry to be propagated out of bit position 0, the carry is ignored, and accumulating continues from zero on.

Device-Connect-Time Measurement

The device-connect-time-measurement facility provides the program with the capability of retrieving the length of time that a device is actively communicating with the channel subsystem while executing a channel program. The measured length of time that the device spends actively communicating on a channel path during the execution of a channel program is called the device-connect-time interval (DCTI). Control-unit-defer time is not included in the DCTI.

If timing facilities are provided for the subchannel, the DCTI value is passed to the program in the extended-status word (ESW) at the completion of the operation when the primary-status condition is cleared by TEST SUBCHANNEL and when TEST SUBCHANNEL clears an intermediate-status condition alone while the subchannel is suspended. The DCTI value passed in the ESW pertains to the previous subchannel-active period. The passing of the DCTI in the ESW is under program control by the SET CHANNEL MONITOR device-connect-time-measurement mode-control bit and the corresponding enable bit in the subchannel. However, the DCTI value is not stored in the ESW if the I/O function initiated by START SUBCHANNEL is terminated because of an error condition that is described by subchannel logout. See the

section “Extended-Status Format 0” on page 16-47. In this case, the extended-status bit (L) of the SCSW is stored as one, indicating that the ESW contains logout information describing the error condition. See the section “Extended-Status Word” on page 16-47 for the description of the logout information. If the accrued DCTI value exceeded 8.388608 seconds during the previous subchannel-active period, then the maximum value (FFFF hex) is passed in the ESW.

Device-Connect-Time-Measurement Mode

The device-connect-time-measurement mode is made active by the execution of SET CHANNEL MONITOR when bit 63 of general register 1 is one. If bit 63 of general register 1 is zero when SET CHANNEL MONITOR is executed, the mode is made inactive, and DCTIs are not passed to the program. When timing facilities are provided for the subchannel, the device-connect-time-measurement mode is active, and the subchannel is enabled for the mode, the DCTI value is passed to the program in the ESW stored when TEST SUBCHANNEL (1) clears the primary-interruption condition with no logout information indicated in the SCSW (extended-status-word-format bit is zero) or (2) clears the intermediate-status condition alone while the subchannel is suspended.

If a start function is currently being executed with a subchannel enabled for the device-connect-time-measurement mode when SET CHANNEL MONITOR makes this mode active for the channel subsystem, the value of the DCTI stored under the appropriate conditions may be zero, a partial result, or the full and correct value, depending on the model and the progress of the start function at the time the mode was activated.

Provision of the DCTI value in the measurement-block area is not affected by whether the device-connect-time-measurement mode is active.

Device-Connect-Time-Measurement Enable

Bit 12 of word 1 of the SCHIB is the device-connect-time measurement-mode-enable bit. This bit provides the program with the capability of selectively controlling the storing of DCTI values for a subchannel when the device-connect-time-measurement mode is active. The initial value of the enable bit is zero. When this enable bit is one in the SCHIB and MODIFY SUBCHANNEL is executed, the subchan-

nel is enabled for the device-connect-time-measurement mode. If the device-connect-time-measurement mode is active, the device-connect-time-measurement facility begins providing DCTI values for the subchannel, starting with the next START SUBCHANNEL issued to the subchannel. In this situation, the DCTI values are provided in the ESW (see the section “Extended-Status Format 2” on page 16-54). Similarly, if MODIFY SUBCHANNEL is executed with bit 12 of word 1 of the SCHIB operand set to zero by the program, the subchannel is disabled for the device-connect-time-measurement mode, and no further DCTI values are passed to the program for that subchannel.

Extended Measurement Word

The extended-I/O-measurement-word facility provides the program with the capability of retrieving measurement information for a channel program. The measurement information is stored into the extended-measurement word (EMW) in the Interruption Response Block when the extended-measurement-word enable bit is one at the subchannel. See the section “Extended-Measurement Word” on page 16-56 in Chapter 16, “I/O Interruptions,” for the description of the extended-measurement word.

When the extended-measurement-word is enabled for the subchannel, measurement values are passed to program in the EMW when TEST SUBCHANNEL clears a primary-status condition, secondary-status condition alone, or an intermediate-status condition alone while the subchannel is suspended. The measurement values stored in the EMW pertain to the previous subchannel-active and device-active period. Measurement values are not stored in the EMW if the I/O function initiated by START SUBCHANNEL is terminated because of an error condition that is described by subchannel logout (see the section “Extended-Status Format 0” on page 16-47). In this case, the extended-status bit (L) of the SCSW is stored as one, indicating that the ESW contains logout information describing the error condition. See the section “Extended-Status Word” on page 16-47 for the description of the logout information. If any of the accrued measurement values exceeded the maximum value capable of being measured during the previous subchannel-active and device-active period, then the maximum value is stored for that value in the EMW.

Extended-Measurement-Word Enable

Bit 30 of word 6 of the SCHIB is the extended-measurement-word enable bit. This bit provides the program with the capability of selectively controlling the storing of measurement values for a subchannel. The initial value of the enable bit is zero. When this enable bit is one in the SCHIB and MODIFY SUBCHANNEL is executed, the subchannel is enabled for the extended-measurement-word and the extended-measurement-word facility begins providing measurement values for the subchannel starting with the next START SUBCHANNEL issued to the subchannel. Similarly, if MODIFY SUBCHANNEL is executed with bit 30, word 6, of the SCHIB operand set to zero by the program, the subchannel is disabled for the extended-measurement-word and no further measurement values are passed to the program for that subchannel.

Signals and Resets

During system operation, it may become necessary to terminate an I/O operation or to reset either the I/O system or a portion of the I/O system. (The I/O system consists of the channel subsystem plus all of the attached control units and devices.) Various signals and resets are provided for this purpose. Three signals are provided for the channel subsystem to notify an I/O device to terminate an operation or perform a reset function or both. Two resets are provided to cause the channel subsystem to reinitialize certain information contained either at the I/O device or at the channel subsystem.

Signals

The request that the channel subsystem initiate a signaling sequence is made by one of the following:

1. The program's issuance of the CLEAR SUBCHANNEL, HALT SUBCHANNEL, or RESET CHANNEL PATH instruction
2. The I/O device's signaling of I/O-error alert
3. The channel subsystem itself, upon detecting certain error conditions or equipment malfunctions

The three signals are the halt signal, the clear signal, and the reset signal.

Halt Signal

The halt signal is provided so the channel subsystem can terminate an I/O operation. The halt signal is issued by the channel subsystem as part of the halt function performed subsequent to the execution of HALT SUBCHANNEL. The halt signal is also issued by the channel subsystem when certain error conditions are encountered.

For the parallel-I/O-interface type of channel path, the halt signal results in the channel subsystem using the interface-disconnect sequence control defined in the System Library publication *IBM System/360 and System/370 I/O Interface Channel to Control Unit OEMI, GA22-6974*.

For the ESCON-I/O-interface type of channel path, the halt signal results in the channel subsystem using the cancel function defined in the System Library publication *IBM Enterprise Systems Architecture/390 ESCON I/O Interface, SA22-7202*.

For the FICON-I/O-interface type of channel path and the subchannel is operating in command-mode, the halt signal results in the channel subsystem using the cancel function defined in the ANSI standards document *Fibre Channel - Single-Byte Command Code Sets-2 (FC-SB-2)*.

For the FICON-I/O-interface type of channel path with the subchannel is operating in transport mode, the halt signal results in the channel subsystem using the transport-mode abort-sequence function.

Clear Signal

The clear signal is provided so the channel subsystem can terminate an I/O operation and reset status and control information contained at the device. The clear signal is issued as part of the clear function performed subsequent to the execution of CLEAR SUBCHANNEL. The clear signal is also issued by the channel subsystem when certain error conditions or equipment malfunctions are detected by the I/O device or the channel subsystem.

For the parallel-I/O-interface type of channel path, the clear signal results in the channel subsystem using the selective-reset sequence control defined in the System Library publication *IBM System/360 and System/370 I/O Interface Channel to Control Unit OEMI, GA22-6974*.

For the ESCON-I/O-interface type of channel path, the clear signal results in the channel subsystem using the selective-reset function defined in the System Library publication *IBM Enterprise Systems Architecture/390 ESCON I/O Interface, SA22-7202*.

For the FICON-I/O-interface type of channel path and the subchannel is operating in command-mode, the clear signal results in the channel subsystem using the selective-reset function defined in the ANSI standards document *Fibre Channel - Single-Byte Command Code Sets-2 (FC-SB-2)*.

For the FICON-I/O-interface type of channel path with the subchannel is operating in transport mode, the clear signal results in the channel subsystem using the selective-reset function.

When the subchannel is operating in command mode, if an I/O operation is in progress at the device and the device is actively communicating over a channel path in the performance of that I/O operation when a clear signal is received on that channel path, the device disconnects from that channel path upon receiving the clear signal. Data transfer and any operation using the facilities of the control unit are immediately concluded, and the I/O device is not necessarily positioned at the beginning of a block. Mechanical motion not involving the use of the control unit, such as rewinding magnetic tape or positioning a disk-access mechanism, proceeds to the normal stopping point, if possible. The device may appear busy until termination of the mechanical motion or the inherent cycle of operation, if any, whereupon it becomes available. Status information in the device and control unit is reset, but an interruption condition may be generated upon the completion of any mechanical operation.

Reset Signal

The reset signal is provided so the channel subsystem can reset all I/O devices on a channel path. The reset signal is issued by the channel subsystem as part of the channel-path-reset function performed subsequent to the execution of RESET CHANNEL PATH. The reset signal is also issued by the channel subsystem as part of the I/O-system-reset function.

For the parallel-I/O-interface type of channel path, the reset signal results in the channel subsystem using the system-reset sequence control defined in the System Library publication *IBM System/360 and*

System/370 I/O Interface Channel to Control Unit OEMI, GA22-6974.

For the ESCON-I/O-interface type of channel path, the reset signal results in the channel subsystem using the system-reset function defined in the System Library publication *IBM Enterprise Systems Architecture/390 ESCON I/O Interface, SA22-7202.*

For the FICON-I/O-interface type of channel path, the reset signal results in the channel subsystem using the system-reset function defined in the ANSI standards document *Fibre Channel - Single-Byte Command Code Sets-2 (FC-SB-2).*

Resets

Two resets are provided so the channel subsystem can reinitialize certain information contained at either the I/O device or the channel subsystem. The request that the channel subsystem initiate one of the reset functions is made by one of the following:

1. The program's issuance of the RESET CHANNEL PATH instruction
2. The operator's activation of a system-reset-clear or system-reset-normal key or a load-clear or load-normal key
3. The channel subsystem itself upon detecting certain error conditions or equipment malfunctions

The resets are channel-path reset and I/O-system reset.

Channel-Path Reset

The channel-path-reset facility provides a mechanism to reset certain indications that pertain to a designated channel path at all associated subchannels. Channel-path reset occurs when the channel subsystem performs the channel-path-reset function initiated by RESET CHANNEL PATH. (See "RESET CHANNEL PATH" on page 14-9.) All internal indications of dedicated allegiance, control unit busy, and device busy that pertain to the designated channel path are cleared in all subchannels, and reset is signaled on that channel path.

The receipt of the reset signal by control units attached to that channel path causes all operations in progress and all status, mode settings, and allegiance, pertaining to that channel path, of the control

unit and its attached devices to be reset. (See also the description of the system-reset-signal actions in "I/O-System Reset" on page 17-13.)

The results of the channel-path-reset function on the designated channel path are communicated to the program by means of a subsequent machine-check-interruption condition generated by the channel subsystem (see "Channel-Subsystem Recovery" on page 17-27).

I/O-System Reset

The I/O-system-reset function is performed when the channel subsystem is powered on, when initial program loading is initiated manually (see "Initial Program Loading" on page 17-16), and when the system-reset-clear or system-reset-normal key is activated. The I/O-system-reset function cannot be initiated under program control; it must be initiated manually. I/O-system reset may fail to complete due to malfunctions detected at the channel subsystem or on a channel path. I/O-system reset is performed as part of subsystem reset, which also resets all floating interruption requests, including pending I/O interruptions. (See "Subsystem Reset" on page 4-80.) Detailed descriptions of the effects of I/O-system reset on the various components of the I/O system appear later in this chapter.

I/O-system reset provides a means for placing the channel subsystem and its attached I/O devices in the initialized state. I/O-system reset affects only the channel-subsystem configuration in which it is performed, including all channel-subsystem components configured to that channel subsystem. I/O-system reset has no effect on any system components that are not part of the channel-subsystem configuration that is being reset. The effects of I/O-system reset on the configured components of the channel subsystem are described in the following sections.

Channel-Subsystem State: I/O-system reset causes the channel subsystem to be placed in the initialized state, with all the channel-subsystem components in the states described in the following sections. All operations in progress are terminated and reset, and all indications of prior conditions are reset. These indications include status information, interruption conditions (but not pending interruptions), dedicated-allegiance conditions, pending channel reports, and all internal information regarding prior conditions and operations. In the initialized state, the channel subsystem has no activity in progress and is

ready to perform the initial-program-loading (IPL) function or respond to I/O instructions, as described in “I/O Instructions” on page 14-1.

Control Units and Devices: I/O-system reset causes a reset signal to be sent on all configured channel paths, including those which are not physically available (as indicated by the PAM bit being zero) because of a permanent error condition detected earlier. When the reset signal is received by a control unit, control-unit functions in progress, control-unit status, control-unit allegiance, and control-unit modes for the resetting channel path are reset. Device operations in progress, device status, device allegiance, and the device mode for the resetting channel path are also reset. Control-unit and device mode, allegiance, status, and I/O functions in progress for other channel paths are not affected.

For devices that are operating in the single-path mode, an operation can be in progress for, at most, one channel path. Therefore, if the reset signal is received on that channel path, the operation in progress is reset. Devices that have the dynamic-reconnection feature and are operating in the multipath mode, however, have the capability to establish an allegiance to a group of channel paths during an I/O operation, where all the channel paths of the path group are configured to the same channel subsystem. If an operation is in progress for a device that is operating in the multipath mode and the reset signal is received on one of the channel paths of that path group, then the operation in progress is reset for the resetting channel path only. Although the operation in progress cannot continue on the resetting channel path, it can continue on the other channel paths of the path group, subject to the following restrictions:

1. If the device is actively communicating with the channel subsystem on a channel path when it receives the reset signal on that channel path, then the operation is reset unconditionally, regardless of path groups.
2. If the operation is in progress in the multipath mode but the path group consists only of the resetting path, then the operation is reset.
3. Except as noted in item 2, if the operation in progress is currently in a disconnected state (device not actively communicating with the channel subsystem) or is active on another channel path of a path group, system reset has no

effect upon the continued performance of the operation.

A control unit is completely reset after the reset signal has been received on all its channel paths, provided no new activity is initiated at the control unit between the receipt of the first and last reset signal. “Completely reset” means that the current operation, if any, at the control unit is terminated and that control-unit allegiance, control-unit status, and the control-unit mode, if any, are reset.

An I/O device is completely reset after the reset signal has been received on all channel paths of all control units by which the device is accessible, provided no new activity is initiated at the device between the receipt of the first and last reset signal. “Completely reset” means that the current operation, if any, at the device is terminated and that device allegiance, device status, and the device mode are reset.

In summary, system reset always causes an operation in progress to be reset for the channel path on which the reset signal is received. If the resetting channel path is the only channel path for which the operation is in progress, then the operation is completely reset. If a device is actively communicating on a channel path over which the reset signal is received, then the operation in progress is unconditionally and completely reset.

The reset signal is not received by control units and devices on channel paths from which the control unit has been partitioned. A control unit is partitioned from a channel path by means of an enable/disable switch on the control unit for each channel path by which it is accessible. Multi-tagged, unsolicited status, if any, remains pending at the control unit for such a channel path in this case. However, from the point of view of the program, the control unit and device appear to be completely reset if the reset signal is received by the control unit on all the channel paths by which it is currently accessible.

The resultant reset state of individual control units and devices is described in the System Library publication for the control unit.

Channel Paths: I/O-system reset causes a reset signal to be sent on all configured channel paths and causes the channel subsystem to be placed in the reset and initialized state, as described in the previous sections. As a result of these actions, all communication between the channel subsystem and its

attached control units and devices is terminated and the components reset, and all configured channel paths are made quiescent or are deconfigured.

Subchannels: I/O-system reset causes all operations on all subchannels to be concluded. Status information, all interruption conditions (but not pending interruptions), dedicated-allegiance conditions, and internal indications regarding prior conditions and operations in all subchannels are reset, and all valid subchannels are placed in the initialized state.

In the initialized state, the subchannel parameters of all valid subchannels are set to their initial values. The initial values of the following subchannel parameters are zeros:

- Interruption parameter
- I/O-interruption-subclass code (ISC)
- Enabled
- Limit mode when the address-limit-checking facility is installed
- Measurement mode
- Multipath mode
- Path-not-operational mask
- Last-path-used mask
- Measurement-block index
- Concurrent sense

The initial values of the following subchannel parameters are assigned as part of the installation procedure for the device associated with each valid subchannel:

- Timing facility
- Device number
- Logical-path mask (same value as path-installed mask)
- Path-installed mask
- Path-available mask
- Channel-path ID 0-7

The values assigned may depend upon the particular system model and the configuration; dependencies, if any, are described in the System Library publication for the system model. Programming considerations may further constrain the values assigned.

The initial value of the path-operational mask is all ones.

The device-number-valid bit is one for all subchannels having an assigned I/O device.

The initial value of the model-dependent area of the subchannel-information block is described in the System Library publication for the system model.

The initial value of the subchannel-status word and extended-status word is all zeros.

The initialized state of the subchannel is the state specified by the initial values for the subchannel parameters described above. The description of the subchannel parameters can be found in “Subchannel-Information Block” on page 15-2, “Subchannel-Status Word” on page 16-7, and “Extended-Status Word” on page 16-47.

Channel-Path-Reset Facility: I/O-system reset causes the channel-path-reset facility to be reset. A channel-path-reset function initiated by RESET CHANNEL PATH, either pending or in progress, is overridden by I/O-system reset. The machine-check-interruption condition, which normally signals the completion of a channel-path-reset function, is not generated for a channel-path-reset function that is pending or in progress at the time I/O-system reset occurs.

Address-Limit-Checking Facility: When the address-limit-checking facility is installed, I/O-system reset causes the address-limit-checking facility to be reset. The address-limit value is initialized to all zeros and validated.

Channel-Subsystem-Monitoring Facilities: I/O-system reset causes the channel-subsystem-monitoring facilities to be reset. The measurement-block-update mode and the device-connect-time-measurement mode, if active, are made inactive. The measurement-block origin and the measurement-block key are both initialized to zeros and validated.

Pending Channel Reports: I/O-system reset causes pending channel reports to be reset.

Channel-Subsystem Timer: I/O-system reset does not necessarily affect the contents of the channel-subsystem timer. In models that provide channel-subsystem-timer checking, I/O-system reset may cause the channel-subsystem timer to be validated.

Pending I/O Interruptions: I/O-system reset does not affect pending I/O interruptions. However, during subsystem reset, I/O interruptions are cleared concurrently with the performance of I/O-system reset. (See “Subsystem Reset” on page 4-80.)

Area Affected	Effect on I/O-System Reset ¹
Channel-subsystem state	Reset and initialized
Control units and devices	Reset
Channel paths	Quiescent
Subchannels	Reset and initialized
Interruption parameter	Zeros ²
I/O-interruption-subclass code (ISC)	Zeros ²
Enabled bit	Zero ²
Address-limit-mode bits ⁴	Zeros ²
Timing-facility bit	Installed value ²
Multipath-mode bit	Zero ²
Measurement-mode bits	Zeros ²
Device-number-valid bit	Installed value ²
Device number	Installed value ²
Logical-path mask	Equal to path-installed mask value ²
Path-not-operational mask	Zeros ²
Last-path-used mask	Zeros ²
Path-installed mask	Installed value ²
Measurement-block index	Zeros ²
Path-operational mask	Ones ²
Path-available mask	Installed value ^{2 3}
Channel-path ID 0-7	Installed value ²
Concurrent-sense bit	Zero ²
Subchannel-status word	Zeros ²
Extended-status word	Zeros ²
Model-dependent area	Model dependent ²
Channel-path-reset facility	Reset
Address-limit-checking facility ⁴	Reset and initialized
Address-limit value	Zeros ²
Channel-subsystem-monitoring facility	Reset and initialized
Measurement-block-update mode	Inactive ²
Device-connect-time-measurement mode	Inactive ²
Measurement-block origin	Zeros ²
Measurement-block key	Zeros ²
Pending channel-report words	Cleared
Channel-subsystem timer	Unchanged/validated
Explanation:	
¹	For a detailed description of the effect of I/O-system reset on each area, see the text.
²	Initialized value.
³	Also subject to model-dependent configuration controls, if any.
⁴	When the FCX facility is not installed.

Figure 17-1. Summary of I/O-System-Reset Actions

Externally Initiated Functions

I/O-system reset, which is an externally initiated function, is described in “I/O-System Reset” on page 17-13.

Initial Program Loading

Initial program loading (IPL) provides a manual means for causing a program to be read from a designated device and for initiating the execution of that program.

Some models may provide additional controls and indications relating to IPL; this additional information is specified in the System Library publication for the model.

There are two types of IPL: CCW-type IPL and list-directed IPL. CCW-type IPL is provided by all machine configurations. List-directed IPL may be provided, depending on the model.

CCW-type IPL

CCW-type IPL is initiated manually by setting the load-unit-address controls to a four-digit number to designate an input device and by subsequently activating the load-clear or load-normal key.

When the configuration-z/Architecture-architectural-mode (CZAM) facility is not installed, activating the load-clear or load-normal key sets the architectural mode to the ESA/390 mode (or ESA/390 compatibility mode). When the CZAM facility is installed, activating the load-clear or load-normal key leaves the architectural mode unchanged (that is, it remains in the z/Architecture architectural mode).

Activating the load-clear key causes a clear reset to be performed on the configuration.

Activating the load-normal key causes an initial CPU reset to be performed on this CPU, CPU reset to be propagated to all other CPUs in the configuration, and a subsystem reset to be performed on the remainder of the configuration.

In the loading part of the operation, after the resets have been performed, this CPU enters the load state. This CPU does not necessarily enter the stopped state during performance of the reset. The load indicator is on while the CPU is in the load state.

Subsequently, if conditions allow, a read operation is initiated from the designated input device and associated subchannel. The read operation is performed as if a START SUBCHANNEL instruction were executed that designated (1) the subchannel corresponding to the device number specified by the load-unit-address controls and (2) a command-mode ORB containing all zeros, except for a byte of all ones in the logical-path-mask field.

Figure 17-2 illustrates the ORB parameters used by the channel subsystem for a CCW-type IPL.

ORB		Field	Value
Word	Bit(s)		
0	0-31	Interruption parameter	Zeros
1	0-3	Key: Subchannel key	Zeros
1	4	S: Suspend control	0
1	5	C: Streaming-mode control	0
1	6	M: Modification control	0
1	7	Y: Synchronization control	0
1	8	F: CCW-format control	0
1	9	P: Prefetch control	0
1	10	I: Initial-status-interruption control	0
1	11	A: Address-limit-checking control	0
1	12	U: Suppress-suspended-interruption control	0
1	13	B: Channel-program-type control	0
1	14	H: IDAW control	0
1	15	T: 2K-IDAW control	0
1	16-23	LPM: Logical Path Mask	Ones
1	24	L: Incorrect-length-suppression-mode control	0
1	25	D: Modified-CCW-IDA control	0
1	31	X: ORB-extension control	0
2	1-31	CCW Address (absolute address)	Zeros

Figure 17-2. ORB Parameters Used in a CCW-Type IPL

The first CCW to be executed is not fetched from storage. Instead, the effect is as if an implied format-0 CCW, beginning in absolute location 0 and having the following detailed format, were executed:

Loc.	0	8	16	31
	00000010	00000000	00000000	00000000
	01100000	/ / / / / / / /	00000000	000011000

In the illustration above, the CCW specifies a read command with the modifier bits zeros, a data address of 0, a byte count of 24, the chain-command flag one, the suppress-incorrect-length-indication flag one, the chain-data flag zero, the skip flag zero, the program-controlled-interruption (PCI) flag zero, the indirect-data-address (IDA) flag zero, and the suspend flag zero. The CCW fetched, as a result of command chaining, from location 8 or 16, as well as any subsequent CCW in the IPL sequence, is interpreted the same as a CCW in any I/O operation, except that any PCI flags that are specified in the IPL channel program are ignored.

At the time the subchannel is made start pending for the IPL read, it is also enabled, which ensures proper handling of subsequent status from the device by the channel subsystem and facilitates subsequent I/O operations using the IPL device. (Except for the sub-

channel used by the IPL I/O operation, each subchannel must first be made enabled by MODIFY SUBCHANNEL before it can accept a start function or any status from the device.)

When the IPL subchannel becomes status pending for the last operation of the IPL channel program, no I/O-interruption condition is generated. Instead, the subsystem ID is stored in absolute locations 184-187, zeros are stored in absolute locations 188-191, and the subchannel is cleared of the pending status as if TEST SUBCHANNEL had been executed but without storing information usually stored in an IRB. If the subchannel-status field that would normally have been stored is all zeros and the device-status field that would normally have been stored contains only the channel-end indication, with or without the device-end indication, the IPL I/O operation is considered to be completed successfully. If the device-end status for the IPL I/O operation is provided separately after channel-end status, it causes an I/O-interruption condition to be generated.

If an interface-control check is detected during execution of the IPL channel program, some models may re-initiate the same channel program on another channel path. The other path chosen is any logically-available channel path to the designated device on which the IPL channel program has not previously been initiated during the current IPL operation. (See programming note 6 on page 17-19 for additional information.)

When the IPL I/O operation is completed successfully, a new PSW is loaded from absolute locations 0-7. When the configuration-z/Architecture-architectural-mode (CZAM) facility is not installed, the CPU is in the ESA/390 architectural mode (or ESA/390 compatibility mode), and absolute locations 0-7 have the format of an ESA/390 PSW (in which case, bit 31 of the new PSW must be zero). When the CZAM facility is installed, the CPU is in the z/Architecture architectural mode, and absolute locations 0-7 have the short-PSW format shown in Figure 4-3 on page 4-8 (in which case, bit 31 of the new PSW is the extended-addressing bit).

If the PSW loading is successful and no malfunctions are recognized that preclude the completion of IPL, then the CPU leaves the load state, and the load indicator is turned off. If the rate control is set to the process position, the CPU enters the operating state, and CPU operation proceeds under control of the new PSW. If the rate control is set to the instruction-

step position, the CPU enters the stopped state, with the manual indicator on, after the new PSW has been loaded.

If the IPL I/O operation or the PSW loading is not completed successfully, the CPU remains in the load state, and the load indicator remains on.

IPL does not complete when any of the following occurs

- No subchannel contains a valid device number equal to the IPL device number specified by the load-unit-address controls.
- A malfunction is detected in the CPU, main storage, or channel subsystem that precludes the completion of IPL.
- Unsolicited alert status is presented by the device subsequent to the subchannel becoming start pending for the IPL read and before the IPL subchannel becomes subchannel active. The IPL read operation is not initiated in this case.
- There were no available channel paths to the IPL device.
- On every available channel path to the IPL device, either the IPL device appeared not operational or an interface-control check was detected.
- The IPL device presented a status byte containing indications other than channel end, device end, status modifier, control unit end, control unit busy, device busy, or retry status during the IPL I/O operation. Whenever control unit end, control unit busy, or device busy is presented in the status byte, normal path-management actions are taken.
- A subchannel-status indication other than PCI was generated during the IPL I/O operation, except that on some models, detection of an interface-control check may cause the I/O operation to be retried on another available channel path to the IPL device.
- The PSW loaded from absolute locations 0-7 has a PSW-format error of the type that is recognized early.

Except in the cases of no corresponding subchannel for the device number entered or a machine malfunction, the subsystem ID of the IPL device is stored in

absolute locations 184-187; otherwise, the contents of these locations are unpredictable. In all cases of unsuccessful IPL, the contents of absolute locations 0-7 are unpredictable.

Subsequent to a successful IPL, the subchannel parameters contain the normal values as if an actual START SUBCHANNEL had been executed, designating the ORB as described above.

Programming Notes:

1. The information read and placed at absolute locations 8-15 and 16-23 may be used as CCWs for reading additional information during the IPL I/O operation: the CCW at location 8 may specify reading additional CCWs elsewhere in storage, and the CCW at location 16 may specify the transfer-in-channel command, causing transfer to these CCWs.
2. The status-modifier bit has its normal effect during the IPL I/O operation, causing the channel subsystem to fetch and chain to the CCW whose address is 16 higher than that of the current CCW. This applies also to the initial chaining that occurs after completion of the read operation specified by the implicit CCW.
3. The PSW that is loaded at the completion of the IPL operation may be provided by the first eight bytes of the IPL I/O operation or may be placed at absolute locations 0-7 by a subsequent CCW.
4. Activating the load-normal key implicitly specifies the use of the first 24 bytes of main storage and the eight bytes at absolute locations 184-191. Since the remainder of the IPL program may be placed in any part of storage below the 2 G-byte boundary, it is possible to preserve such areas of storage as may be helpful in debugging or recovery. The IPL program should not be placed in the low 512 bytes of storage since that area is reserved as described in a programming note under "Compatibility between z/Architecture and ESA/390" on page 1-37. When the load-clear key is activated, the IPL program starts with a cleared machine in a known state, except that information on external storage remains unchanged.
5. When the PSW at absolute location 0 has bit 14 set to one, the CPU is placed in the wait state after the IPL operation is completed. At that

point, the load and manual indicators are off, and the wait indicator is on.

6. When the program receives control after the machine leaves the load state during IPL, the last-path-used mask (LPUM) in the subchannel-information block (SCHIB) for the IPL device should be saved. The program should use this saved LPUM as the logical-path mask (LPM) in the ORB until the program reaches the point in its initialization where it has the ability to process and recover from interface-control checks, and verify that all of the channel paths associated with the subchannel are connected to the same device.

When multiple paths are associated with the subchannel of the IPL device, it is possible that mis-cabling of one or more of the paths can cause the program initialization to proceed on different devices. This affects the integrity of the IPL process. The program should ensure that all paths are connected to the same device, but this typically is not possible before program initialization completes. Thus the use of the saved LPUM ensures that all I/O operations to the IPL device during program initialization are executed on the same device, allowing postponement of the checking of the paths.

Using the saved LPUM also helps to ensure that the channel subsystem will not select a path on which errors would prevent completion of the program initialization, since the path indicated in the LPUM has demonstrated its functionality. On some models, using the saved LPUM also ensures that the path selection will not re-select a path on which an interface-control check was detected while the machine was in the load state.

7. Because the CCW-format control (bit 8 of word 1 in the implied ORB) used during the IPL I/O operation is zero, the CCWs are limited to format-0 CCWs with 24-bit addresses. However, the IPL process may read in additional CCWs that specify indirect addressing using IDAWs. Because the IDAW control (bit 14 of word 1 in the implied ORB) is zero, the IDAWs are limited to format-1 IDAWs with 31-bit addresses. Therefore, the IPL process can read into (or write from) any location below the 2 G-byte boundary.

List-Directed IPL

List-directed IPL supports the use of I/O devices which are not accessed by CCWs. List-directed IPL

may be provided for a logical partition or virtual machine, depending on the model and the amount of memory available to the logical partition or virtual machine. The terms logical partition and virtual machine are not defined in this publication. The term logical partition is defined in the System Library publications. The term virtual machine is defined in the virtual-machine product manuals.

List-directed IPL is initiated by activating the load-clear-list-directed or load-with-dump key. Prior to activating either of these keys, the list-directed-IPL parameters are entered using a model-dependent console. List-directed-IPL parameters include the following information:

- Information which identifies the I/O device from which a program is to be loaded. This I/O device is referred to as the load device.
- Information which identifies a location on a load device from which a program will be loaded.
- Information to be used by the program which will be loaded from the load device.

The list-directed-IPL parameters required by a specific machine and the means by which they are entered are specified in the System Library publications.

After the list-directed-IPL parameters have been entered, the load-clear-list-directed or load-with-dump key for a particular CPU is activated. In the description which follows, the term “this CPU” refers to the CPU in the configuration for which the load-clear-list-directed key was activated.

Activating the load-clear-list-directed key causes a clear reset to be performed on all of the CPUs in the configuration.

Activating the load-with-dump key causes a store-status operation to be performed on this CPU. After the store-status operation, an initial-CPU-reset operation is performed on this CPU, CPU reset is propagated to all other CPUs in the configuration, and a

subsystem reset is performed on the remainder of the configuration.

In the loading part of the operation, after the resets have been performed, the operations listed below are performed.

- If the rate control is not in the process position, it is forced into the process position.
- If the list-directed IPL operation was initiated by activating the load-with-dump key, the contents of a model-dependent number of contiguous logical-partition or virtual-machine storage locations starting with absolute location 0 are stored in a model-dependent holding area. The data stored includes the contents of all storage locations into which the program will be loaded from the load device. See Programming Note 4 for additional information.
- The program to be loaded from the load device is loaded into logical-partition or virtual-machine storage at the locations specified on the load device.
- A system IPL-parameter block used by the machine during list-directed IPL is placed in storage in the format shown in Figure 17-3 on page 17-21. The absolute address of the first word of the system IPL-parameter block is stored in absolute address locations 20-23. When the secure-IPL facility is installed in the z/Architecture architectural mode, an XML document is not present; otherwise, the presence of an XML document is model dependent. If an XML document is present, it contains the system IPL parameters and it immediately follows the last byte of the system IPL-parameter block. (See Reference [22.] on page xxx for information regarding XML.) When the IPL-Information-Report (IPLIR), bit 2 of word 2 of the system IPL-parameter block, is one, an IPL-information-report block (IIRB) containing the IPL information report immediately follows the last byte of the system IPL-parameter block (instead of an XML document) and is aligned on a doubleword boundary; otherwise, an IIRB containing the system IPL information report is not present.

The system IPL-parameter block has the following format:

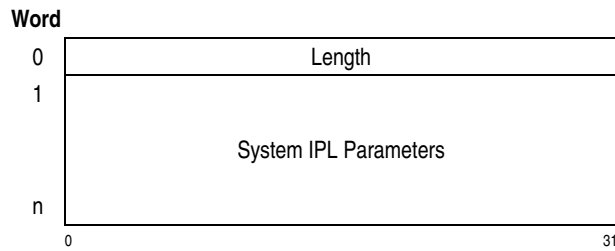

Figure 17-3. System IPL-Parameter Block

Bits 0-31 of word 0 of the system IPL-parameter block contains a length field. The length field contains a 32-bit binary number representing the number of bytes occupied by the system IPL-parameter block. When the secure-IPL facility is installed in the z/Architecture architectural mode, the system IPL-parameter block length field must contain a value that is multiple of 8-bytes to ensure the IPL-information-report block (IIRB) immediately follows the last byte of the system IPL-parameter block and is aligned on a doubleword boundary. Words 1 through n contain the system IPL parameters.

IPL Information Report Block

The IPL-information-report block (IIRB) contains information used to locate various IPL records and to report the results of signature verification of one or more secure components of the load device. IIRB is generated by the machine loader after DIAGNOSE x'0308' functions are used to update the system IPL-parameter block. The generated IIRB is stored immediately following the system IPL-parameter block by the machine loader and is aligned on a doubleword boundary.

The IPL-information-report block has the following format:

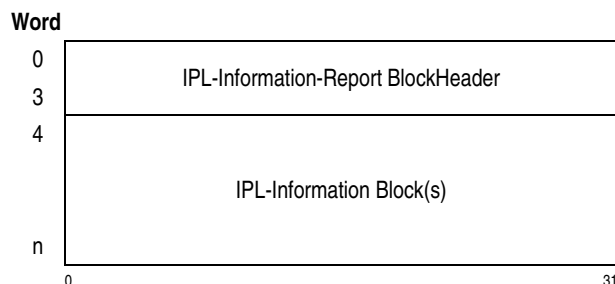

Figure 17-4. IPL-Information-Report Block

The IPL-information-report block contains an IPL-information-report block header, followed by one or more IPL-information blocks.

The IPL-information-report block header has the following format:

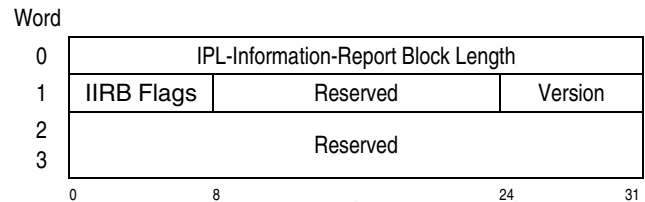

Figure 17-5. IPL-Information-Report BlockHeader

The IPL-information-report block header contains the following fields:

IPL-Information-Report Block Length: Word 0 contains a 32-bit unsigned binary integer specifying the number of bytes in the IIRB. Byte 0 of word 0 must be zero to indicate XML file is not present following the system IPL-parameter block and to limit the length to a maximum of 16-Megabytes; otherwise, an error is reported.

IIRB Flags: Byte 0 of word 1 contains a flag field defined as follows:

Bit	Meaning
0-7	Reserved.

Version: Bits 24-31 of word 1 contain an 8-bit unsigned binary integer specifying the version number of the IPL-information-report block. This field is set to zero.

IPL Information Blocks

One or two IPL-information blocks follow the IPL-information-report block header. The first type of IPL-information block identifies an IPL-signature-certificate list. A second type of IPL-information block identifies an IPL-device-component list.

Each IPL-information block contains a common header followed by one or more specific types of IPL-information block entries.

The IPL-information block header has the following format:

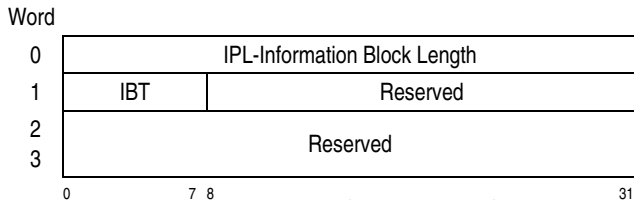

Figure 17-6. IPL-Information Block Header

The IPL-information block header contains the following fields:

IPL-Information Block Length: Word 0 contains a 32-bit unsigned binary integer specifying the number of bytes in the IPL-information block.

IPL-Information Block Type (IBT): Byte 0 of word 1 contains a value that specifies the format of the specific IPL-information block type. The IBT field values are defined as follows:

Value Meaning

- 0 Reserved.
- 1 The IPL-information block specifies an IPL-signature-certificate list.
- 2 The IPL-information block specifies an IPL-device-component list.
- 3-255 Reserved.

IPL Signature Certificate List

The IPL-information block identifying an IPL-signature-certificate list has the following format:

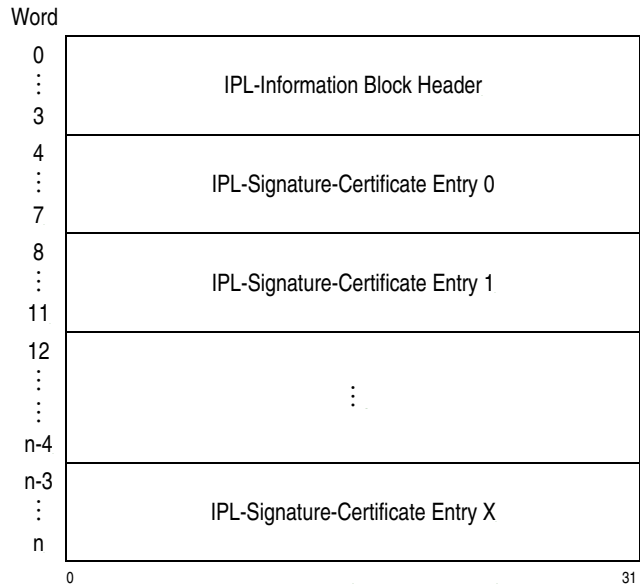

Figure 17-7. IPL-Information Block for IPL-Signature-Certificate List

IPL Signature Certificate Entry

The IPL-signature-certificate entry has the following format:

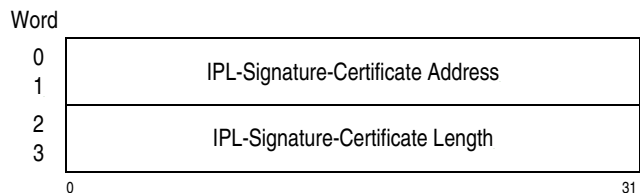

Figure 17-8. IPL-Signature-Certificate Entry

The IPL-signature-certificate entry contains the following fields:

IPL-Signature-Certificate Address: Words 0-1 contain a 64-bit absolute storage location of an X.509 certificate.

IPL-Signature-Certificate Length: Words 2-3 contain a 64-bit unsigned binary integer specifying the number of bytes in an X.509 certificate.

IPL Device Component List

The IPL-information block identifying an IPL-device-component list has the following format:

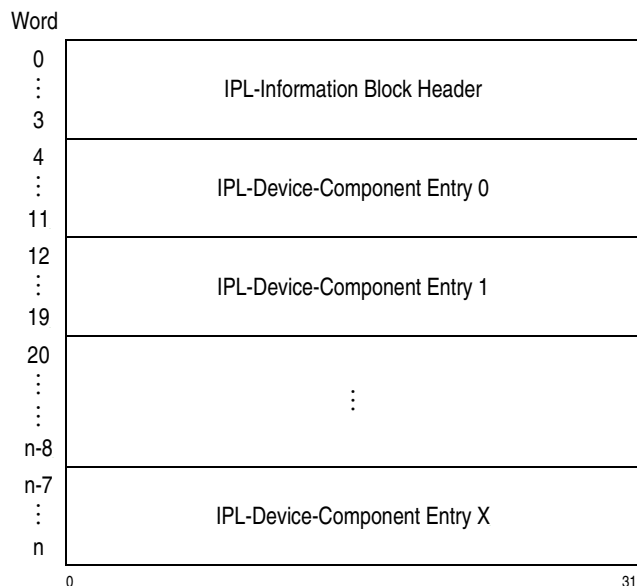

Figure 17-9. IPL-Information Block for IPL-Device-Component List

IPL Device Component Entry

The IPL-device-component entry has the following format:

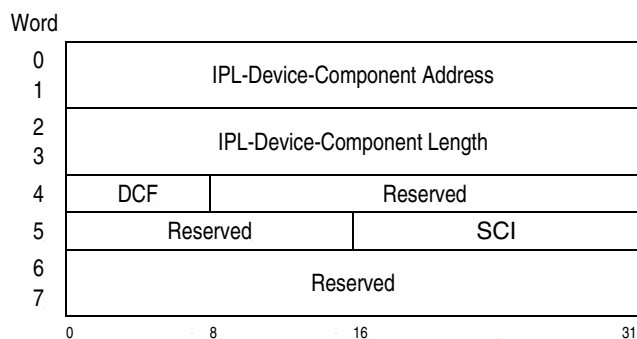

Figure 17-10. IPL-Device-Component Entry

The IPL-device-component entry contains the following fields:

IPL-Device-Component Address: Words 0-1 contain a 64-bit absolute storage location of the binary code of a component.

IPL-Device-Component Length: Words 2-3 contain a 64-bit unsigned binary integer specifying the number of bytes in the binary code of a component.

IPL-Device-Component Flags (DCF): Byte 0 of word 4 contains a flag field defined as follows:

Bit	Meaning
0	Signed Component (SC). When bit 0 is one, the binary code of the component is signed. When bit 0 is zero, the binary code of the component is not signed.
1	Component-Signature-Verified (CSV). When bit 1 is one, the component signature verification is successful. When bit 1 is zero, the component signature verification is not successful.
	CSV bit is meaningful only when SC bit is set to one. When SC bit is set to zero, CSV bit should also be set to zero.
2-7	Reserved.

IPL-Signature-Certificate Index (SCI): Bytes 2-3 of word 5 contain a 16-bit unsigned binary integer specifying the index of the IPL-signature-certificate entry containing the X.509 certificate that was used to verify this signed component.

The IPL-signature-certificate index (SCI) field is meaningful only when the signed Component (SC) bit is set to one, indicating that the binary code of the component is signed.

If no errors occur during the operations listed above, then if a subchannel is associated with the IPL-device, the subsystem-identification word is stored in absolute locations 184-187; otherwise zeros are stored in absolute locations 184-187. Additionally, zeros are stored in absolute locations 188-191, and a new PSW is loaded from absolute locations 0-7.

When the configuration-z/Architecture-architectural-mode (CZAM) facility is not installed, the CPU is in the ESA/390 architectural mode (or ESA/390 compatibility mode), and absolute locations 0-7 have the format of an ESA/390 PSW (in which case, bit 31 of the new PSW must be zero). When the CZAM facility is installed, the CPU is in the z/Architecture architectural mode, and absolute locations 0-7 have the short-PSW format shown in Figure 4-3 on page 4-8 (in which case, bit 31 of the new PSW is the extended-addressing bit).

If the PSW loading is successful and if no malfunctions are recognized which preclude execution of the

program which was loaded from the load device, then operation proceeds under control of the new PSW.

If errors occur during the operations listed above, or if the PSW loading is not successful, then this CPU remains in the operating state. See the appropriate System Library publications for additional information.

When list-directed IPL was initiated by activating the load-clear-list-directed key, the state of the machine resources at the time when the loaded program is initiated is the same as it was immediately after the clear reset was performed except as indicated below. For a description of the state of the machine resources immediately after the clear reset was performed, see “Resets” on page 4-74.

- This CPU is in the operating state. The contents of the ALB and TLB for this CPU are unpredictable.
- The PSW for this CPU is set from the contents of absolute storage locations 0-7. When the CZAM facility is not installed, the CPU is in the ESA/390 architectural mode (or ESA/390 compatibility mode), and absolute locations 0-7 have the format of an ESA/390 PSW (in which case, bit 31 of the new PSW must be zero). When the CZAM facility is installed, the CPU is in the z/Architecture architectural mode, and absolute locations 0-7 have the short-PSW format shown in Figure 4-3 on page 4-8 (in which case, bit 31 of the new PSW is the extended-addressing bit).
- Main storage locations into which the program was loaded from the load device contain the program which was loaded, except for absolute storage locations 20-23 and 184-191. Absolute storage locations 20-23 contain the absolute address of the system IPL-parameter block; storage locations starting with this absolute address contain the system IPL-parameter block, immediately followed by an XML document containing the same system IPL parameters or IIRB containing the IPL information report (if present). If a subchannel is associated with the IPL device, then absolute storage locations 184-187 contain the subsystem-identification word for the IPL-device and absolute storage locations 188-191 contain zeros; otherwise, absolute storage locations 184-191 contain zeros. The contents of all other storage locations are unpredictable.

- The ACC and F bits of the storage keys associated with all main storage locations are set to zero. The R and C bits of the storage keys associated with the first 4 K-byte block of storage, the blocks of storage containing the XML document or IIRB (if present), and IPL-parameter list, and the blocks of storage containing the loaded program are set to one. The R and C bits of the storage keys associated with all other blocks of storage are unpredictable.
- The TOD clock is unaffected by initial-program loading.

When list-directed IPL was initiated by activating the load-with-dump key, the state of the machine resources when control is passed to the loaded program is as follows:

- The I/O system has been reset.
- The state of all CPUs in the configuration except for this CPU is the same as it was immediately after the CPUs were reset.
- This CPU is in the operating state. The contents of all registers, the ALB, and the TLB for this CPU are unpredictable.
- The PSW for this CPU is set from the contents of absolute storage locations 0-7. When the CZAM facility is not installed, the CPU is in the ESA/390 architectural mode (or ESA/390 compatibility mode), and absolute locations 0-7 have the format of an ESA/390 PSW (in which case, bit 31 of the new PSW must be zero). When the CZAM facility is installed, the CPU is in the z/Architecture architectural mode, and absolute locations 0-7 have the short-PSW format shown in Figure 4-3 on page 4-8 (in which case, bit 31 of the new PSW is the extended-addressing bit).
- The contents of all main storage locations which were not stored in the model-dependent holding area are unchanged from the time when the load-with-dump key was activated.
- The contents of all main storage locations which were stored in the model-dependent holding area are unpredictable except as follows:
 - Main storage locations into which the program was loaded from the load device contain the program which was loaded, except for absolute storage locations 20-23.

- Absolute storage locations 20-23 contain the absolute address of the system IPL-parameter block; storage locations starting with the absolute address indicated by the contents of absolute addresses 20-23 contain the system IPL-parameter block, which is immediately followed by an XML document containing the system IPL parameters or IIRB containing the IPL information report (if present).
- If a subchannel is associated with the IPL device, then absolute storage locations 184-187 contain the subsystem-identification word for the IPL-device and absolute storage locations 188-191 contain zeros; otherwise, absolute storage locations 184-191 contain zeros.
- The storage keys associated with the blocks of main storage which were stored in the model-dependent holding area are unpredictable. The storage keys associated with all other blocks of main storage are in the same state as they were immediately after the CPUs were reset.
- The TOD clock is unaffected by initial-program loading.

List-directed IPL does not complete if any of the following occurs:

- A malfunction is detected in the CPU, channel subsystem, or main storage which precludes the completion of IPL.
- The list-directed IPL parameters did not contain sufficient information to identify the load device or the program on the load device.
- An I/O device designated by the list-directed-IPL parameters is not in the machine configuration.
- The I/O device designated by the list-directed-IPL parameters is a CCW-type device and is not supported by list-directed IPL.
- The I/O device appeared not operational.
- The amount of storage in the logical partition or virtual machine is insufficient to allow list-directed IPL to complete.
- The PSW to be loaded from locations 0-7 has a PSW-format error of the type that is recognized early.

Programming Notes:

1. The executable portion of the program loaded during list-directed IPL should be located in absolute storage starting at absolute storage locations 8192 and higher. This is necessary in order to avoid use of the architecturally assigned storage locations. See “Assigned Storage Locations” on page 3-73.
2. When the address indicated by storage locations 20-23 is above 16 MB, it is necessary for the machine to be in 31-bit addressing mode in order to access the IPL-parameter list and XML document or IIRB (if present).
3. When list-directed IPL is initiated by activation of the load-clear-list-directed key, the program loaded from the load device is typically an operating-system loader. In this case, the load device may also contain the operating system to be loaded by the operating-system loader. See the applicable operating-system manuals for additional information.
4. When list-directed IPL is initiated by activation of the load-with-dump key, the contents of storage which are affected by the IPL operation are stored in a model-dependent holding area so that they can be retrieved by the program which was loaded from the load device. The program loaded from the load device is typically an O/S-specific system dump program which stores the retrieved data onto a dump device. This process ensures that the contents of storage affected by the IPL operation are preserved for analysis during subsequent debug operations. See the applicable operating system manuals for additional information.

Reconfiguration of the I/O System

Reconfiguration of the I/O system is handled in a model-dependent manner. For example, changes may be made under program control, by using the model-dependent DIAGNOSE instruction; or manually, by using system-operator configuration controls; or by using a combination of DIAGNOSE and manual controls. The method used depends on the system model. The System Library publication for the system model specifies how the changes are made. The partitioning of channel paths because of reconfiguration is indicated by the setting of the PAM bits in the SCHIB stored when STORE SUBCHANNEL is exe-

cuted (see “Path-Available Mask (PAM)” on page 15-7).

Status Verification

The status-verification facility provides the channel subsystem with a means of indicating that a device has presented a device-status byte that has valid CBC but that contained a combination of bits that was inappropriate when the status byte was presented to the channel subsystem. The indication provided to the program in the ESW by the channel subsystem is called device-status check. When the channel subsystem recognizes a device-status-check condition, an interface-control-check condition is also recognized. For a summary of the status combinations considered to be appropriate or inappropriate, see the System Library publications *IBM Enterprise Systems Architecture/390 ESCON I/O Interface, SA22-7202*, and *IBM System/360 and System/370 I/O Interface Channel to Control Unit OEMI, GA22-6974*, and the ANSI standards document *Fibre Channel - Single-Byte Command Code Sets-2 (FC-SB-2)*.

Address-Limit Checking

The address-limit-checking facility may be installed on a model and when installed provides a storage-protection mechanism for I/O data accesses to storage that augments key-controlled protection. The address-limit-checking facility is not installed when the FCX facility is installed. When address-limit checking is used, absolute storage is divided into two parts by a program-controlled address-limit value. I/O data accesses can then be optionally restricted to only one of the two parts of absolute storage by the limit mode at each subchannel. The address-limit constraint applies at a higher priority than key-controlled protection, that is, I/O data accesses to the part of main storage that is protected by address-limit checking are prevented even when the subchannel key is zero or matches the key in storage. Address-limit checking does not apply to the fetching of CCWs, IDAWs and MIDAWs.

The address-limit-checking facility consists of the following elements:

- The I/O instruction SET ADDRESS LIMIT.

- The limit mode at each subchannel.
- The address-limit-checking-control bit in the ORB.

The execution of SET ADDRESS LIMIT passes the contents of general register 1 to the address-limit-checking facility to be used as the address-limit value. Bits 32 and 48-63 of general register 1 must be zeros to designate a valid absolute address on a 64 K-byte boundary; otherwise, an operand exception is recognized, and the execution of the instruction is suppressed.

The limit mode at each subchannel indicates the manner in which address-limit checking is to be performed. The limit mode is set by placing the desired value in bit positions 9 and 10 of word 1 in the SCHIB and executing MODIFY SUBCHANNEL. The settings of these bits in the SCHIB have the following meanings:

- | | |
|----|--|
| 00 | No limit checking (initialized value). |
| 01 | Data address must be equal to or greater than the current address limit. |
| 10 | Data address must be less than the current address limit. |
| 11 | Reserved. This combination of limit-mode bits causes an operand exception to be recognized when MODIFY SUBCHANNEL is executed. |

The address-limit-checking-control bit, bit 11 of word 1 of the ORB, specifies whether address-limit checking is to be used for the start function that is accepted when the execution of START SUBCHANNEL causes the contents of the ORB to be passed to the subchannel. If the address-limit-checking-control bit is zero when the contents of the ORB are passed, address-limit checking is not specified for that start function. If the bit is one, address-limit checking is specified and is under the control of the current address limit and the current setting of the limit mode at the subchannel.

During the performance of the start function, an attempt to access an absolute storage location for data that is protected by an address limit (either high or low) is recognized as an address-limit violation, and the access is not allowed. A program-check condition is recognized, and channel-program execution

is terminated, just as when an attempt is made to access an invalid address.

Configuration Alert

The configuration-alert facility provides a detection mechanism for devices that are not associated with a subchannel in the configuration. The configuration-alert facility notifies the program, by means of a channel report, that a device which is not associated with a subchannel has attempted to communicate with the program.

Each device must be assigned to a subchannel during an installation procedure; otherwise, the channel subsystem is unable to generate an I/O-interruption condition for the device. This is because the I/O-interruption code contains the subchannel number that identifies the particular device causing the I/O-interruption condition. When a device that is not associated with a subchannel attempts to communicate with the channel subsystem, the configuration-alert facility generates a channel report in which the unassociated device is identified. For a description of the means by which the program is notified of a pending channel report and how the information in the channel report is retrieved, see “Channel Report” on page 17-28.

Incorrect-Length-Indication Suppression

The incorrect-length-indication-suppression facility allows the indication of incorrect length for immediate operations to be suppressed in the same manner when using format-1 CCWs as when using format-0 CCWs. When the incorrect-length-indication-suppression facility is installed, bit 24 of word 1 of the ORB specifies whether the channel subsystem is to suppress the indication of incorrect length for an immediate operation when format-1 CCWs are used or whether this indication will remain under the control of the SLI flag of the current CCW (as is the case for CCWs not executed as immediate operations). This bit provides the capability for a channel program to operate in the same manner regarding the indication of incorrect length regardless of whether format-0 or format-1 CCWs are used.

Concurrent Sense

The concurrent-sense facility provides a mechanism whereby sense information that is provided by the device can be presented by the channel subsystem to the program in the same command-mode IRB that contains the unit-check indication when the subchannel is in the concurrent-sense mode. The concurrent-sense mode is made active at a subchannel for which the concurrent-sense facility is applicable when MODIFY SUBCHANNEL is executed and bit 31 of word 6 of the SCHIB operand is set to one. The concurrent-sense facility is applicable to subchannels that are operating in command-mode and are associated with channel paths by which the channel subsystem can attempt to retrieve sense information from the device without requiring program intervention.

The concurrent-sense facility is not applicable when a subchannel is operating in transport mode. When a transport-mode IRB is presented that contains the unit-check indication, the associated sense information is found in the TSB for the associated TCW channel program. Therefore, the concurrent sense facility is not necessary with FCX.

Channel-Subsystem Recovery

The channel subsystem provides various methods for extensive detection of malfunctions and other conditions to ensure the integrity of channel-subsystem operation and to achieve automatic recovery of some malfunctions.

The method used to report a particular malfunction or other condition is dependent upon the severity of the malfunction or other condition and the degree to which the malfunction or other condition can be isolated. A malfunction or other condition in the channel subsystem may be indicated to the program by information being stored by one of the following methods:

1. Information is provided in the IRB describing a condition that has been recognized by either the channel subsystem or device that must be brought to the attention of the program. Generally, this information is made available to the program by the execution of TEST SUBCHANNEL, which is usually executed in response to the

occurrence of an I/O interruption. (See “Interruption Action” on page 16-6, for a definition of the information stored, as well as “Interruptions” on page 6-1.)

2. Information is provided in a channel report describing a machine malfunction affecting the identified facility associated with the channel-subsystem. This information is made available to the program by the execution of STORE CHANNEL REPORT WORD, which is usually executed in response to the occurrence of a machine-check interruption. (See “Machine-Check Handling” on page 11-1 for a description of the machine-check-interruption mechanism and the contents of the machine-check-interruption code.)
3. Information is provided in a channel report describing a malfunction or other condition affecting a collection of channel-subsystem facilities. This information is made available to the program as indicated in item 2.
4. Information is provided in the machine-check-interruption code (MCIC) describing a malfunction affecting the continued operational integrity of the channel subsystem. (See “Channel-Subsystem Damage” on page 11-17.)
5. Information is provided in the MCIC describing a malfunction affecting the continued operational integrity of a process or of the system. (See “Instruction-Processing Damage” on page 11-15 and “System Damage” on page 11-15.)

Channel reports are used to report malfunctions or other conditions only when the use of the I/O-interruption facility is not appropriate and in preference to reporting channel-subsystem damage, instruction-processing damage, or system damage.

Channel Report

When a malfunction or other condition affecting elements of the channel subsystem has been recognized, a channel report is generated. The performance of recovery actions by the program or by external means may be required to gain recovery from the error condition. The channel report indicates the source of the channel report and the recovery state to the extent necessary for determining the proper recovery action. A channel report consists of one or more channel-report words (CRWs) that have

been generated from an analysis of the malfunction or other condition. The inclusion of two or more CRWs within a channel report is indicated by the chaining flag being stored as one in all of the CRWs of the channel report except the last one in the chain.

When a channel report is made pending by the channel subsystem for retrieval and analysis by the program (by means of the execution of STORE CHANNEL REPORT WORD), a malfunction or other condition that affects the normal operation of one or more of the channel-subsystem facilities has been recognized. If the channel report that is made pending is an initial channel report, a machine-check-interruption condition is generated that indicates one or more CRWs are pending at the channel subsystem. A channel report is initial either if it is the first channel report to be generated after the most recent I/O-system reset or if no previously generated reports are pending and the last STORE CHANNEL REPORT WORD instruction that was executed resulted in the setting of condition code 1, indicating that no channel report was pending. When the machine-check interruption occurs and bit 9 of the machine-check-interruption code (channel report pending) is one, a channel report is pending. If the program clears the first CRW of a channel report before the associated machine-check interruption has occurred, some models may reset the machine-check-interruption condition, and the associated machine-check interruption does not occur. A machine-check interruption indicating that a channel report is pending occurs only if the machine-check mask (PSW bit 13) and the channel-report-pending subclass mask, bit 3 of control register 14, are both ones.

If the channel report that is made pending is not an initial channel report, a machine-check-interruption condition is not generated. The CRW that is presented to the program in response to the first STORE CHANNEL REPORT WORD instruction that is executed after a machine-check interruption may or may not be part of the initial channel report that caused the machine-check condition to be generated. A pending channel-report word is cleared by any CPU executing STORE CHANNEL REPORT WORD, regardless of whether a machine-check interruption has occurred in any CPU. If a CRW is not pending and STORE CHANNEL REPORT WORD is executed, condition code 1 is set, and zeros are stored at the location designated by the second-operand address. During the execution of STORE CHANNEL REPORT WORD as a result of receiving a machine-

check interruption, condition code 1 may be set, and zeros may be stored because (1) the related channel report has been cleared by another CPU or (2) a malfunction occurred during the generation of a channel report. In the latter case, if, during a subsequent attempt, a valid channel report can be made pending, an additional machine-check-interruption condition is generated.

When a channel report consists of multiple chained CRWs, they are presented to the program in the same order that they are placed in the chain by the channel subsystem as a result of consecutive executions of STORE CHANNEL REPORT WORD. If, for example, the first CRW of a chain is presented to the program as a result of executing STORE CHANNEL REPORT WORD, the CRW that is presented as a result of the next execution of STORE CHANNEL REPORT WORD is the second CRW of the same chain and not a CRW that is part of another channel report.

Channel reports are not presented to the program in any special order, except for channel reports whose first or only CRW indicates the same reporting-source code and the same reporting-source ID. These channel reports are presented to the program in the same order that they are generated by the channel subsystem, but they are not necessarily presented consecutively. For example, suppose the channel subsystem generates channel reports A, B, and C, in that order. The first CRW of channel reports B and C indicates the same reporting-source code and the same reporting-source ID. Channel report B is presented to the program before channel report C is presented, but channel report A may be presented after channel report B and before channel report C.

Programming Notes:

1. The information that is provided in a single CRW may be made obsolete by another CRW that is subsequently generated for the same channel-subsystem facility. Therefore, the information that is provided in one channel report should be interpreted in light of the information provided by all of the channel reports that are pending at a given instant.
2. A machine-check-interruption condition is not always generated when a channel report is made pending. The conditions that result in a machine-check-interruption condition being generated are described earlier in this section.

3. After a machine-check interruption has occurred with bit 9 of the machine-check-interruption code set to one, STORE CHANNEL REPORT WORD should be issued repeatedly until all of the pending channel reports have been cleared and condition code 1 has been set.
4. A CRW-overflow condition can occur if the program does not issue successive STORE CHANNEL REPORT WORD instructions in a timely manner after the machine-check interruption occurs.
5. The number of CRWs that can be pending at the same time is model dependent. During the existence of an overflow condition, CRWs that would have otherwise been made pending are lost and are never presented to the program.

Channel-Report Word

The channel-report word (CRW) provides information to the program that can be used to facilitate the recovery of an I/O operation, a device, or some element of the channel subsystem, such as a channel path or subchannel.

The format of the CRW is as follows:

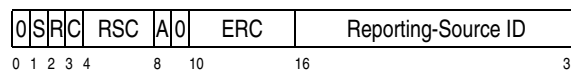

Solicited CRW (S): Bit 1, when one, indicates a solicited CRW. A CRW is considered by the channel subsystem to be solicited if it is made pending as the direct result of some action that is taken by the program. When bit 1 is zero, the CRW is unsolicited and has been made pending as the result of an action taken by the channel subsystem that is independent of the program.

Overflow (R): Bit 2, when one, indicates that a CRW-overflow condition has been recognized since this CRW became pending and that one or more CRWs have been lost. This bit is one in the CRW that has most recently been set pending when the overflow condition is recognized. When bit 2 is zero, a CRW-overflow condition has not been recognized.

A CRW that is part of a channel report is not made pending, even though the overflow condition does not exist, if an overflow condition prevented a previous CRW of that report from being made pending.

Chaining (C): Bit 3, when one, and when the overflow flag is zero, indicates chaining of associated CRWs. Chaining of CRWs is indicated whenever a malfunction or other condition is described by more than a single CRW. The chaining flag is zero if the channel report is described by a single CRW or if the CRW is the last CRW of a channel report.

The chaining flag is not meaningful if the overflow bit, bit 2, is one.

Reporting-Source Code (RSC): Bits 4-7 identify the channel-subsystem facility that is associated with the channel report. Some facilities are further identified in the reporting-source-identification field (see below). The following combinations of bits identify the facilities:

Bits				Facility
4	5	6	7	
0	0	1	0	Monitoring facility
0	0	1	1	Subchannel
0	1	0	0	Channel Path
1	0	0	1	Configuration-alert facility
1	0	1	1	Channel subsystem

All other bit combinations in the reporting-source-code field are reserved.

Ancillary Report (A): Bit 8, when one, indicates that a malfunction of a system component has occurred that was recognized previously or which has affected the activity of multiple channel-subsystem facilities. When the malfunction affects the activity of multiple channel-subsystem facilities, an ancillary-report condition is recognized for all of the affected facilities except one. This bit, when zero, indicates that this malfunction of a system component was not recognized previously. This bit is meaningful for all channel reports.

Depending on the model, recognition of an ancillary-report condition may not be provided, or it may not be provided for all system malfunctions that affect channel-subsystem facilities. When ancillary-report recognition is not provided, bit 8 is set to zero.

Error-Recovery Code (ERC): Bits 10-15, when zero, indicate that the channel subsystem has error information regarding the channel-subsystem facility identified in the reporting-source code, and that the program can now request that information. Other-

wise, bit positions 10-15 contain the error-recovery code that defines the recovery state of the channel-subsystem facility identified in the reporting-source code. This field, when used in conjunction with the reporting-source code, can be used by the program to determine whether the identified facility has already been recovered and is available for use or whether recovery actions are still required. The following error-recovery codes are defined:

Bits						State
10	11	12	13	14	15	
0	0	0	0	0	0	Event-information pending
0	0	0	0	0	1	Available
0	0	0	0	1	0	Initialized
0	0	0	0	1	1	Temporary error
0	0	0	1	0	0	Installed parameters initialized
0	0	0	1	0	1	Terminal
0	0	0	1	1	0	Permanent error with facility not initialized
0	0	0	1	1	1	Permanent error with facility initialized
0	0	1	0	0	0	Installed parameters modified
0	0	1	0	1	0	Installed parameters restored ¹

Explanation:

¹ Installed-parameters restored is presented only if reporting of the installed-parameters-restored CRW is enabled in the restore-subchannel facility.

All other bit combinations in the error-recovery-code field are reserved.

The specific meaning of each error-recovery code depends on the particular reporting-source code that accompanies it in a CRW. The error-recovery codes are defined as follows:

Event-Information Pending: Event information for the identified facility is available for retrieval by the program. This CRW does not indicate the state of the identified facility.

Available: The identified facility is in the same state that the program would expect if the CRW had not been generated.

Initialized: The identified facility is in the same state that existed immediately following the I/O-system reset that was part of the most recent system IPL.

Temporary Error: The identified facility is not operating in a normal manner or has recognized the occurrence of an abnormal event. It is expected that subsequent actions either will restore the facility to

normal operation or will record the appropriate information describing the abnormal event.

Installed Parameters Initialized: This state is the same as the initialized state, except that one or more parameters that are associated with the facility and that are not modifiable by the program may have been changed.

On some models that do not implement the restore-subchannel facility, or in the absence of enablement by the program of reporting of the installed-parameters-restored CRW by the restore-subchannel facility, the installed-parameters-initialized CRW may be reported as a result of the channel subsystem's recovery of the facility designated by the reporting-source ID.

Terminal: The identified facility is in a state such that an operation that was in progress can neither be completed nor terminated in the normal manner.

Permanent Error with Facility Not Initialized: The identified facility is in a state of malfunction, and the channel subsystem has not caused a reset function to be performed for that facility.

Permanent Error with Facility Initialized: The identified facility is in a state of malfunction, and the channel subsystem has caused or may have caused a reset function to be performed for that facility.

Installed Parameters Modified: One or more parameters of the specified facility have been changed.

Installed Parameters Restored: This state is the same as the initialized state, except that one or more parameters that are associated with the facility and that are not modifiable by the program may have been changed from their most recent values back to their initialized values as a result of the channel subsystem's recovery of the facility.

Reporting-Source ID (RSID): Bit positions 16-31 contain the reporting-source ID, which may, depending upon the condition that caused the channel report and the reporting-source code, either further identify the affected channel-subsystem facility or provide additional information describing the condition that caused the channel report. The RSID field has the

following format as a function of the bit settings of the reporting-source code.

Reporting-Source Code				Reporting-Source ID Bits 16-31			
4	5	6	7				
0	0	1	0	0000	0000	0000	0000
0	0	1	1	xxxx	xxxx	xxxx	xxxx
0	0	1	1	0000	0000	00ss	0000
0	1	0	0	0000	0000	yyyy	yyyy
1	0	0	1	0000	0000	yyyy	yyyy
1	0	1	1	0000	0000	0000	0000

Note:

xxxx xxxx xxxx xxxx Subchannel Number

ss Subchannel-set ID when the MSS facility is installed and the CRW is chained immediately following a CRW for a subchannel.

yyyy yyyy Channel-path ID (CHPID)

When the MSS facility is installed an additional CRW is chained to every channel report for subchannels. The content of this chained CRW is identical to the original CRW except for the RSID field. In this chained CRW, bit positions 10-11 of the RSID field contain the SSID identifying the subchannel set.

Restore-Subchannel Facility

The restore-subchannel facility may be available on a model implementing z/Architecture. This facility provides the means for the channel subsystem to recover a damaged subchannel and report the recovery to the program by means of a CRW. When the facility is installed and reporting of the installed-parameters-restored CRW is enabled in the restore-subchannel facility, the channel subsystem may recover the damaged subchannel and make a CRW pending that indicates installed-parameters restored. When the facility is installed and reporting of the installed-parameters-restored CRW is not enabled, the channel subsystem may recover the damaged subchannel and make a CRW pending that indicates installed-parameters initialized.

In some models that do not implement the restore-subchannel facility, the channel subsystem may nevertheless recover a damaged subchannel, and make a CRW pending that indicates installed-parameters initialized.

Extended-Subchannel-Logout Facility

When the extended-subchannel-logout facility is installed and enabled, all fibre-channel (FC) channel paths can create extended-subchannel logouts, under applicable error conditions, and generate I/O interruptions that indicate such a logout is pending retrieval. The extended-subchannel logouts are stored in and retrieved from a model-dependent number of extended-subchannel-logout buffers associated with each channel path supported by the facility.

When TEST SUBCHANNEL for a subchannel that specifies an FC channel path stores an interruption-response block (IRB) containing a format-0 ESW in which the extended-subchannel-logout-pending (E) bit is 1, an extended-subchannel logout is pending for the specified subchannel. Words 2-3 of the format-0 ESW contain the extended-subchannel-logout descriptor (ESLD) that identifies the logout and the channel path for which the logout is pending.

If all of the buffers for a given channel contain pending extended-subchannel logouts, the logouts will remain pending for a model-dependent time interval. If, during that time interval, a subsequent condition occurs that warrants a new extended-subchannel logout, that logout is not made and is lost. If the time interval has been exceeded and the program has not used the ESLD to retrieve a pending logout, the logout may be removed from the buffer or the buffer may be reused to contain a subsequent logout. When a logout is removed from a buffer and the buffer is not reused, the ESLD is no longer recognized as a valid logout identifier. When a buffer is reused, the ESLD may be recognized as a valid logout identifier albeit for a logout different from the logout for which the original I/O interruption was generated.

Channel-Subsystem-I/O-Priority Facility

The channel-subsystem-I/O-priority facility provides a means by which the program can establish a priority relationship, at the channel subsystem, among the subchannels that are placed into the start-pending

state when START SUBCHANNEL is executed and condition code 0 is indicated. For I/O-subchannels that are configured to fibre-channel channel paths (FICON and FICON-converted channel paths), it also provides a means by which the program can establish a priority relationship for I/O operations at the fibre-channel-attached control units.

The program assigns the desired channel-subsystem priority and control-unit priority by specifying the desired priority numbers in the ORB extension when START SUBCHANNEL is executed.

The channel-subsystem-priority number specified in the ORB is used by the channel subsystem to determine the order in which start-pending and resume-pending subchannels are selected when the channel subsystem attempts to initiate a start function or a resume function. See the section “Start Function and Resume Function” on page 15-20 for details about these functions. In general, I/O subchannels that are in the start-pending or resume-pending state and have a higher priority number are selected for start-function or resume-function initiation by the channel subsystem before start-pending or resume-pending subchannels that have a lower priority number. The specific priority selection algorithm used by the channel subsystem for this purpose depends on the model. Additionally, the channel subsystem also applies a fairness selection algorithm in conjunction with the priority selection algorithm when selecting I/O subchannels. The specific fairness selection algorithm also depends on the model. For all models, the channel-subsystem priority and fairness selection algorithms are always applied to I/O subchannels that are either start pending or resume pending. Some models may also apply both algorithms to subchannels that are either clear pending or halt pending. See a model's System-Library publication for a description of the priority and fairness selection algorithms that the model provides and whether these algorithms are also applied to clear-pending or halt-pending subchannels.

The control-unit-priority number specified in the ORB is used by control units attached to fibre-channel channel paths in order to determine the priority of the execution of CCWs at the control unit. See “Control-Unit (CU) Priority:” on page 15-29 for additional information.

Number of Channel-Subsystem-Priority Levels

Depending on the model, fewer than 256 channel-subsystem-priority levels may be provided by the channel subsystem. Each priority level that the model provides is designated by an eight-bit unsigned binary integer. The lowest provided channel-subsystem-priority level is designated by the integer 0, and each succeeding higher priority level is designated by the next-higher sequential integer. For example, if the model provides 16 priority levels, they are numbered 0-15, respectively, from the lowest priority level to the highest priority level.

Multiple-Subchannel-Set Facility

The multiple-subchannel-set (MSS) facility increases the maximum number of subchannels that can be configured to a program. When the MSS facility is not provided, a single set of subchannels, in the range 0-65,535 may be provided for a program. When the

MSS facility is provided, a maximum of four sets of subchannels may be provided for a program. Each subchannel set provides from one to 64K subchannels in the range 0 to-65,535. A two-bit unsigned binary integer, in the range of 0-3, called the subchannel-set identifier (SSID) is used to specify each provided subchannel set. The default subchannel set for a program is SSID 0. The initialized state of the MSS facility is disabled, in this state the MSS facility functions are not provided to programs executing in logical partitions.

When the MSS facility is provided, a subchannel is specified by a unique address formed by the concatenation of:

1. The subchannel-set identifier (SSID) of the subchannel-image set to which the designated subchannel-image is configured,
2. The subchannel number of the subchannel-image being accessed.

Chapter 18. Hexadecimal-Floating-Point Instructions

HFP Arithmetic	18-1	LOAD AND TEST	18-13
HFP Number Representation	18-1	LOAD COMPLEMENT	18-14
Normalization	18-2	LOAD FP INTEGER	18-15
HFP Data Formats	18-2	LOAD LENGTHENED	18-15
HFP Short Format	18-4	LOAD NEGATIVE	18-16
HFP Long Format	18-4	LOAD POSITIVE	18-16
HFP Extended Format	18-4	LOAD ROUNDED	18-17
Instructions	18-5	MULTIPLY	18-17
ADD NORMALIZED	18-8	MULTIPLY AND ADD	18-19
ADD UNNORMALIZED	18-9	MULTIPLY AND SUBTRACT	18-19
COMPARE	18-10	MULTIPLY AND ADD UNNORMALIZED	18-20
CONVERT FROM FIXED	18-11	MULTIPLY UNNORMALIZED	18-22
CONVERT TO FIXED	18-11	SQUARE ROOT	18-23
DIVIDE	18-12	SUBTRACT NORMALIZED	18-24
HALVE	18-13	SUBTRACT UNNORMALIZED	18-25

HFP Arithmetic

HFP Number Representation

A hexadecimal-floating-point (HFP) number consists of a sign bit, a hexadecimal fraction, and an unsigned seven-bit binary integer called the characteristic. The characteristic represents a signed exponent and is obtained by adding 64 to the exponent value (excess-64 notation). The range of the characteristic is 0 to 127, which corresponds to an exponent range of -64 to +63. The magnitude of an HFP number is the product of its fraction and the number 16 raised to the power of the exponent that is represented by its characteristic. The number is positive or negative depending on whether the sign bit is zero or one, respectively.

The fraction of an HFP number is treated as a hexadecimal number because it is considered to be multiplied by a number which is a power of 16. The name, fraction, indicates that the radix point is assumed to be immediately to the left of the leftmost fraction digit.

When an HFP operation would cause the result exponent to exceed 63, the characteristic wraps around from 127 to 0, and an HFP-exponent-overflow condition exists. The result characteristic is then too small by 128. When an operation would cause the exponent to be less than -64, the characteristic

wraps around from 0 to 127, and an HFP-exponent-underflow condition exists. The result characteristic is then too large by 128, except that a zero characteristic is produced when a true zero is forced.

A true zero is an HFP number with a zero characteristic and zero fraction. A true zero may arise as the normal result of an arithmetic operation because of the particular magnitude of the operands. For HFP operations, the result is forced to be a positive true zero when:

1. An HFP exponent underflow occurs and the HFP-exponent-underflow mask bit in the PSW is zero.
2. The result fraction of a normalized or unnormalized addition or subtraction operation is zero and the HFP-significance mask bit in the PSW is zero.
3. The operand of the CONVERT FROM FIXED instruction is zero.
4. The dividend in the DIVIDE instruction has a zero fraction.
5. The operand of the HALVE, LOAD FP INTEGER, or SQUARE ROOT instruction has a zero fraction.
6. One or both operands of a multiplication operation has a zero fraction.

When a program interruption for HFP exponent underflow occurs, a true zero is not forced; instead, the fraction and sign remain correct, and the characteristic is too large by 128. When a program interruption for HFP significance occurs, the fraction remains zero, the sign is positive, and the characteristic remains correct.

The sign of a sum, difference, product, quotient, square root, the result of CONVERT FROM FIXED, or the result of LOAD FP INTEGER with a zero fraction is positive. The sign for a zero fraction resulting from other HFP operations is established from the operand sign, the same as for nonzero fractions.

Normalization

A quantity can be represented with the greatest precision by an HFP number of a given fraction length when that number is normalized. A normalized HFP number has a nonzero leftmost hexadecimal fraction digit. If one or more leftmost fraction digits are zeros, the number is said to be unnormalized.

Unnormalized numbers are normalized by shifting the fraction left, one digit at a time, until the leftmost hexadecimal digit is nonzero and reducing the characteristic by the number of hexadecimal digits shifted. A number with a zero fraction cannot be normalized; either its characteristic remains unchanged or its characteristic is made zero when the result is forced to be a true zero.

Addition and subtraction with extended operands, as well as the MULTIPLY, DIVIDE, CONVERT FROM FIXED, HALVE, LOAD FP INTEGER, and SQUARE ROOT operations, are performed only with normalization. Addition and subtraction with short or long operands may be specified as either normalized or unnormalized. For all other operations, the result is produced without normalization.

With unnormalized operations, leftmost zeros in the result fraction are not eliminated. The result may or

may not be in normalized form, depending upon the original operands.

In both normalized and unnormalized operations, the initial operands need not be in normalized form. The operands for multiply, divide, and square-root operations are normalized before the arithmetic process. For other normalized operations, normalization takes place when the intermediate arithmetic result is changed to the final result.

When the intermediate result of addition, subtraction, or rounding causes the fraction to overflow, the fraction is shifted right by one hexadecimal-digit position, and the value one is supplied to the vacated leftmost digit position. The fraction is then truncated to the final result length, while the characteristic is increased by one. This adjustment is made for both normalized and unnormalized operations.

Figure 18-1 on page 18-3 summarizes, for all instructions producing HFP results, the handling of zero results and whether normalization occurs for nonzero results.

Programming Note: Up to three leftmost bits of the fraction of a normalized number may be zeros, since the nonzero test applies to the entire leftmost hexadecimal digit.

HFP Data Formats

HFP numbers have a 32-bit (short) format, a 64-bit (long) format, or a 128-bit (extended) format. Numbers in the short and long formats may be designated as operands both in storage and in the floating-point registers, whereas operands having the extended format can be designated only in the floating-point registers.

In all formats, the first bit (bit 0) is the sign bit (S). The next seven bits are the characteristic. In the short and long formats, the remaining bits constitute the fraction, which consists of six or 14 hexadecimal digits, respectively.

Instruction	Nonzero Result Normalized	Zero Result Forced to True Zero		Zero Result Made Positive	
		Short and Long	Extended	Short and Long	Extended
ADD NORMALIZED	Yes	Y/N	Y/N	Yes	Yes
ADD UNNORMALIZED	No	Y/N	–	Yes	–
CONVERT BFP TO HFP ¹	Yes	Yes	–	No	–
CONVERT FROM FIXED	Yes	Yes	Yes	Yes	Yes
DIVIDE	Yes	Yes	Yes	Yes	Yes
HALVE	Yes	Yes	–	Yes	–
LOAD ¹	No	No	No	No	No
LOAD AND TEST	No	No	Yes	No	No
LOAD COMPLEMENT	No	No	Yes	No	No
LOAD FP INTEGER	Yes	Yes	Yes	Yes	Yes
LOAD LENGTHENED	No	No	Yes	No	No
LOAD NEGATIVE	No	No	Yes	No	No
LOAD POSITIVE	No	No	Yes	Yes	Yes
LOAD ROUNDED	No	No	–	No	–
LOAD ZERO ¹	–	Yes	Yes	Yes	Yes
MULTIPLY	Yes	Yes	Yes	Yes	Yes
MULTIPLY AND ADD	Yes	Yes	–	Yes	–
MULTIPLY AND ADD UNNORMALIZED	No	–	No	–	No
MULTIPLY AND SUBTRACT	Yes	Yes	–	Yes	–
MULTIPLY UNNORMALIZED	No	–	No	–	No
PERFORM FLOATING-POINT OPERATION ¹	Yes	Yes	Yes	No	No
SQUARE ROOT	Yes	Yes	Yes	Yes	Yes
STORE ¹	No	No	–	No	–
SUBTRACT NORMALIZED	Yes	Y/N	Y/N	Yes	Yes
SUBTRACT UNNORMALIZED	No	Y/N	–	Yes	–
Explanation:					
-	Not applicable.				
¹	Floating-point-support instruction.				
Y/N	When the HFP-significance mask bit (PSW bit 23) is zero, a true zero is forced. When the HFP-significance mask bit is one, the characteristic remains unchanged, and a program interruption for HFP significance occurs.				

Figure 18-1. Normalization and Zero Handling for Instructions with HFP Results

HFP Short Format

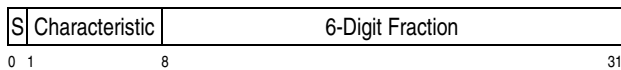

HFP Long Format

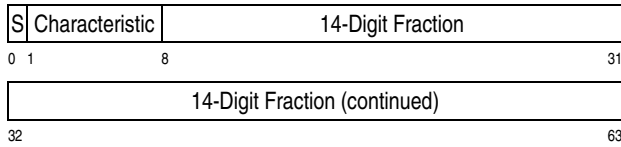

HFP Extended Format

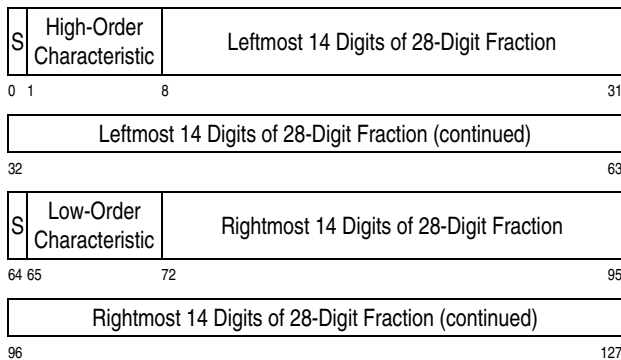

An extended HFP number has a 28-digit fraction and consists of two long HFP numbers that are called the high-order and low-order parts. The high-order part may be any long HFP number. The fraction of the high-order part contains the leftmost 14 hexadecimal digits of the 28-digit fraction. The characteristic and sign of the high-order part are the characteristic and sign of the extended HFP number. If the high-order part is normalized, the extended number is considered normalized. The fraction of the low-order part contains the rightmost 14 digits of the 28-digit fraction. The sign and characteristic of the low-order part of an extended operand are ignored.

When a result is generated in the extended format and placed in a register pair, the sign of the low-order part is made the same as that of the high-order part, and, unless the result is a true zero, the low-order characteristic is made 14 less than the high-order characteristic. When the subtraction of 14 would cause the low-order characteristic to become less than zero, the characteristic is made 128 greater than its correct value. (Thus, the subtraction is performed modulo 128.) HFP exponent underflow is indicated only when the high-order characteristic underflows.

When an extended result is made a true zero, both the high-order and low-order parts are made a true zero.

The range covered by the magnitude (M) of a normalized HFP number depends on the format.

In the short format:

$$16^{-65} \leq M \leq (1 - 16^{-6}) \times 16^{63}$$

In the long format:

$$16^{-65} \leq M \leq (1 - 16^{-14}) \times 16^{63}$$

In the extended format:

$$16^{-65} \leq M \leq (1 - 16^{-28}) \times 16^{63}$$

In all formats, approximately:

$$5.4 \times 10^{-79} \leq M \leq 7.2 \times 10^{75}$$

Although the final result of an HFP operation has six hexadecimal fraction digits in the short format, 14 fraction digits in the long format, and 28 fraction digits in the extended format, intermediate results have one additional hexadecimal digit on the right. This digit is called the guard digit. The guard digit may increase the precision of the final result because it participates in addition, subtraction, and comparison operations and in the left shift that occurs during normalization.

The entire set of HFP operations with normalized results is available for short, long, and extended operands in register-register versions; and for short and long operands in register-storage versions. Most instructions generate a result that has the same format as the source operands, except that there are multiplication operations which can generate a long product from short operands or an extended product from long operands. Other exceptions are instructions which convert operands from one floating-point format to another or between floating-point and fixed-point (binary-integer) formats.

Programming Notes:

1. In the absence of an HFP exponent overflow or HFP exponent underflow, the long HFP number constituting the low-order part of an extended result correctly expresses the value of the low-order part of the extended result when the characteristic of the high-order part is 14 or higher. This applies also when the result is a true zero. When the high-order characteristic is less than 14 but the number is not a true zero, the low-

order part, when considered as a long HFP number, does not express the correct characteristic value.

- The entire fraction of an extended result participates in normalization. The low-order part alone may or may not appear to be a normalized long HFP number, depending on whether the 15th digit of the normalized 28-digit fraction is nonzero or zero.

- F Thirty-two-bit fixed point
- G Sixty-four-bit fixed point
- D Long normalized
- E Short normalized
- U Short unnormalized
- W Long unnormalized
- X Extended normalized

Note: In the detailed descriptions of the individual instructions, the mnemonic and the symbolic operand designation for the assembler language are shown with each instruction. For a register-to-register operation using COMPARE (short), for example, CER is the mnemonic and R₁,R₂ the operand designation.

Instructions

The HFP instructions and their mnemonics and operation codes are listed in Figure 18-2 on page 18-5. The figure indicates, in the column labeled “Characteristics”, the instruction format, when the condition code is set, the instruction fields that designate access registers, and the exceptional conditions in operand designations, data, or results that cause a program interruption.

All HFP instructions are subject to the AFP-register-control bit, bit 45 of control register 0. The AFP-register-control bit must be one when an AFP register is specified as an operand location; otherwise, an AFP-register data exception, DXC 1, is recognized.

Mnemonics for the HFP instructions have an R as the last letter when the instruction is in the RR, RRE, or RRF format. Certain letters are used for HFP instructions to represent operand-format length and normalization, as follows:

Programming Notes:

- The following additional HFP instructions are available when the HFP-multiply-and-add/subtract facility is installed:
 - MULTIPLY AND ADD (MAD, MADR, MAE, MAER)
 - MULTIPLY AND SUBTRACT (MSD, MSDR, MSE, MSER)
- The following additional HFP instructions are available when the HFP-unnormalized-extensions facility is installed:
 - MULTIPLY AND ADD UNNORMALIZED (MAY, MAYH, MAYHR, MAYL, MAYLR, MAYR)
 - MULTIPLY UNNORMALIZED (MY, MYH, MYHR, MYL, MYLR, MYR)

Name	Mnemonic	Characteristics										Op Code	Page
ADD NORMALIZED (extended HFP)	AXR	RR	C	a ^{7,9}	SP	Da	EU	EO	LS			36	18-8
ADD NORMALIZED (long HFP)	AD	RX-a	C	a ^{7,9}	A	Da	EU	EO	LS		B ₂	6A	18-8
ADD NORMALIZED (long HFP)	ADR	RR	C	a ^{7,9}		Da	EU	EO	LS			2A	18-8
ADD NORMALIZED (short HFP)	AE	RX-a	C	a ^{7,9}	A	Da	EU	EO	LS		B ₂	7A	18-8
ADD NORMALIZED (short HFP)	AER	RR	C	a ^{7,9}		Da	EU	EO	LS			3A	18-8
ADD UNNORMALIZED (long HFP)	AW	RX-a	C	a ^{7,9}	A	Da		EO	LS		B ₂	6E	18-9
ADD UNNORMALIZED (long HFP)	AWR	RR	C	a ^{7,9}		Da		EO	LS			2E	18-9
ADD UNNORMALIZED (short HFP)	AU	RX-a	C	a ^{7,9}	A	Da		EO	LS		B ₂	7E	18-9
ADD UNNORMALIZED (short HFP)	AUR	RR	C	a ^{7,9}		Da		EO	LS			3E	18-9
COMPARE (extended HFP)	CXR	RRE	C	a ^{7,9}	SP	Da						B369	18-10
COMPARE (long HFP)	CD	RX-a	C	a ^{7,9}	A	Da					B ₂	69	18-10
COMPARE (long HFP)	CDR	RR	C	a ^{7,9}		Da						29	18-10
COMPARE (short HFP)	CE	RX-a	C	a ^{7,9}	A	Da					B ₂	79	18-10
COMPARE (short HFP)	CER	RR	C	a ^{7,9}		Da						39	18-10
CONVERT FROM FIXED (32 to extended HFP)	CXFR	RRE		a ^{7,9}	SP	Da						B3B6	18-11

Figure 18-2. Summary of HFP Instructions (Part 1 of 4)

Name	Mnemonic	Characteristics						Op Code	Page
CONVERT FROM FIXED (32 to long HFP)	CDFR	RRE		$\alpha^{7,9}$		Da	B3B5	18-11	
CONVERT FROM FIXED (32 to short HFP)	CEFR	RRE		$\alpha^{7,9}$		Da	B3B4	18-11	
CONVERT FROM FIXED (64 to extended HFP)	CXGR	RRE	N	$\alpha^{7,9}$	SP	Da	B3C6	18-11	
CONVERT FROM FIXED (64 to long HFP)	CDGR	RRE	N	$\alpha^{7,9}$		Da	B3C5	18-11	
CONVERT FROM FIXED (64 to short HFP)	CEGR	RRE	N	$\alpha^{7,9}$		Da	B3C4	18-11	
CONVERT TO FIXED (extended HFP to 32)	CFXR	RRF-e	C	$\alpha^{7,9}$	SP	Da	B3BA	18-11	
CONVERT TO FIXED (extended HFP to 64)	CGXR	RRF-e	C N	$\alpha^{7,9}$	SP	Da	B3CA	18-11	
CONVERT TO FIXED (long HFP to 32)	CFDR	RRF-e	C	$\alpha^{7,9}$	SP	Da	B3B9	18-11	
CONVERT TO FIXED (long HFP to 64)	CGDR	RRF-e	C N	$\alpha^{7,9}$	SP	Da	B3C9	18-11	
CONVERT TO FIXED (short HFP to 32)	CFER	RRF-e	C	$\alpha^{7,9}$	SP	Da	B3B8	18-11	
CONVERT TO FIXED (short HFP to 64)	CGER	RRF-e	C N	$\alpha^{7,9}$	SP	Da	B3C8	18-11	
DIVIDE (extended HFP)	DXR	RRE		$\alpha^{7,9}$	SP	Da EU EO FK	B ₂ B22D	18-12	
DIVIDE (long HFP)	DD	RX-a		$\alpha^{7,9}$	A	Da EU EO FK	B ₂ 6D	18-12	
DIVIDE (long HFP)	DDR	RR		$\alpha^{7,9}$		Da EU EO FK	2D	18-12	
DIVIDE (short HFP)	DE	RX-a		$\alpha^{7,9}$	A	Da EU EO FK	B ₂ 7D	18-12	
DIVIDE (short HFP)	DER	RR		$\alpha^{7,9}$		Da EU EO FK	3D	18-12	
HALVE (long HFP)	HDR	RR		$\alpha^{7,9}$		Da EU	24	18-13	
HALVE (short HFP)	HER	RR		$\alpha^{7,9}$		Da EU	34	18-13	
LOAD AND TEST (extended HFP)	LTXR	RRE	C	$\alpha^{7,9}$	SP	Da	B362	18-14	
LOAD AND TEST (long HFP)	LTDR	RR	C	$\alpha^{7,9}$		Da	22	18-13	
LOAD AND TEST (short HFP)	LTER	RR	C	$\alpha^{7,9}$		Da	32	18-13	
LOAD COMPLEMENT (extended HFP)	LCXR	RRE	C	$\alpha^{7,9}$	SP	Da	B363	18-14	
LOAD COMPLEMENT (long HFP)	LCDR	RR	C	$\alpha^{7,9}$		Da	23	18-14	
LOAD COMPLEMENT (short HFP)	LCER	RR	C	$\alpha^{7,9}$		Da	33	18-14	
LOAD FP INTEGER (extended HFP)	FIXR	RRE		$\alpha^{7,9}$	SP	Da	B367	18-15	
LOAD FP INTEGER (long HFP)	FIDR	RRE		$\alpha^{7,9}$		Da	B37F	18-15	
LOAD FP INTEGER (short HFP)	FIER	RRE		$\alpha^{7,9}$		Da	B377	18-15	
LOAD LENGTHENED (long to extended HFP)	LXD	RXE		$\alpha^{7,9}$	A SP	Da	B ₂ ED25	18-15	
LOAD LENGTHENED (long to extended HFP)	LXDR	RRE		$\alpha^{7,9}$	SP	Da	B325	18-15	
LOAD LENGTHENED (short to extended HFP)	LXE	RXE		$\alpha^{7,9}$	A SP	Da	B ₂ ED26	18-15	
LOAD LENGTHENED (short to extended HFP)	LXER	RRE		$\alpha^{7,9}$	SP	Da	B326	18-15	
LOAD LENGTHENED (short to long HFP)	LDE	RXE		$\alpha^{7,9}$	A	Da	B ₂ ED24	18-15	
LOAD LENGTHENED (short to long HFP)	LDER	RRE		$\alpha^{7,9}$		Da	B324	18-15	
LOAD NEGATIVE (extended HFP)	LNXR	RRE	C	$\alpha^{7,9}$	SP	Da	B361	18-16	
LOAD NEGATIVE (long HFP)	LNDR	RR	C	$\alpha^{7,9}$		Da	21	18-16	
LOAD NEGATIVE (short HFP)	LNER	RR	C	$\alpha^{7,9}$		Da	31	18-16	
LOAD POSITIVE (extended HFP)	LPXR	RRE	C	$\alpha^{7,9}$	SP	Da	B360	18-16	
LOAD POSITIVE (long HFP)	LPDR	RR	C	$\alpha^{7,9}$		Da	20	18-16	
LOAD POSITIVE (short HFP)	LPER	RR	C	$\alpha^{7,9}$		Da	30	18-16	
LOAD ROUNDED (extended to long HFP)	LDXR	RR		$\alpha^{7,9}$	SP	Da EO	25	18-17	
LOAD ROUNDED (extended to long HFP)	LRDR	RR		$\alpha^{7,9}$	SP	Da EO	25	18-17	
LOAD ROUNDED (extended to short HFP)	LEXR	RRE		$\alpha^{7,9}$	SP	Da EO	B366	18-17	
LOAD ROUNDED (long to short HFP)	LEDR	RR		$\alpha^{7,9}$		Da EO	35	18-17	
LOAD ROUNDED (long to short HFP)	LRER	RR		$\alpha^{7,9}$		Da EO	35	18-17	
MULTIPLY (extended HFP)	MXR	RR		$\alpha^{7,9}$	SP	Da EU EO	26	18-17	
MULTIPLY (long HFP)	MD	RX-a		$\alpha^{7,9}$	A	Da EU EO	B ₂ 6C	18-18	
MULTIPLY (long HFP)	MDR	RR		$\alpha^{7,9}$		Da EU EO	2C	18-17	
MULTIPLY (long to extended HFP)	MXD	RX-a		$\alpha^{7,9}$	A SP	Da EU EO	B ₂ 67	18-18	
MULTIPLY (long to extended HFP)	MXDR	RR		$\alpha^{7,9}$	SP	Da EU EO	27	18-17	
MULTIPLY (short HFP)	MEE	RXE		$\alpha^{7,9}$	A	Da EU EO	B ₂ ED37	18-18	

Figure 18-2. Summary of HFP Instructions (Part 2 of 4)

Name	Mnemonic	Characteristics						Op Code	Page
MULTIPLY (short HFP)	MEER	RRE		$\alpha^{7,9}$		Da EU EO		B337	18-17
MULTIPLY (short to long HFP)	MDE	RX-a		$\alpha^{7,9}$ A		Da EU EO	B ₂	7C	18-18
MULTIPLY (short to long HFP)	MDER	RR		$\alpha^{7,9}$		Da EU EO		3C	18-17
MULTIPLY (short to long HFP)	ME	RX-a		$\alpha^{7,9}$ A		Da EU EO	B ₂	7C	18-18
MULTIPLY (short to long HFP)	MER	RR		$\alpha^{7,9}$		Da EU EO		3C	18-18
MULTIPLY AND ADD (long HFP)	MAD	RXF	HM	$\alpha^{7,9}$ A		Da EU EO	B ₂	ED3E	18-19
MULTIPLY AND ADD (long HFP)	MADR	RRD	HM	$\alpha^{7,9}$		Da EU EO		B33E	18-19
MULTIPLY AND ADD (short HFP)	MAE	RXF	HM	$\alpha^{7,9}$ A		Da EU EO	B ₂	ED2E	18-19
MULTIPLY AND ADD (short HFP)	MAER	RRD	HM	$\alpha^{7,9}$		Da EU EO		B32E	18-19
MULTIPLY AND ADD UNNORM. (long to ext. HFP)	MAY	RXF	UE	$\alpha^{7,9}$ A		Da	B ₂	ED3A	18-20
MULTIPLY AND ADD UNNORM. (long to ext. HFP)	MAYR	RRD	UE	$\alpha^{7,9}$		Da		B33A	18-20
MULTIPLY AND ADD UNNRM. (long to ext. high HFP)	MAYH	RXF	UE	$\alpha^{7,9}$ A		Da	B ₂	ED3C	18-20
MULTIPLY AND ADD UNNRM. (long to ext. high HFP)	MAYHR	RRD	UE	$\alpha^{7,9}$		Da		B33C	18-20
MULTIPLY AND ADD UNNRM. (long to ext. low HFP)	MAYL	RXF	UE	$\alpha^{7,9}$ A		Da	B ₂	ED38	18-20
MULTIPLY AND ADD UNNRM. (long to ext. low HFP)	MAYLR	RRD	UE	$\alpha^{7,9}$		Da		B338	18-20
MULTIPLY AND SUBTRACT (long HFP)	MSD	RXF	HM	$\alpha^{7,9}$ A		Da EU EO	B ₂	ED3F	18-19
MULTIPLY AND SUBTRACT (long HFP)	MSDR	RRD	HM	$\alpha^{7,9}$		Da EU EO		B33F	18-19
MULTIPLY AND SUBTRACT (short HFP)	MSE	RXF	HM	$\alpha^{7,9}$ A		Da EU EO	B ₂	ED2F	18-19
MULTIPLY AND SUBTRACT (short HFP)	MSER	RRD	HM	$\alpha^{7,9}$		Da EU EO		B32F	18-19
MULTIPLY UNNORM. (long to ext. high HFP)	MYH	RXF	UE	$\alpha^{7,9}$ A		Da	B ₂	ED3D	18-22
MULTIPLY UNNORM. (long to ext. high HFP)	MYHR	RRD	UE	$\alpha^{7,9}$		Da		B33D	18-22
MULTIPLY UNNORM. (long to ext. low HFP)	MYL	RXF	UE	$\alpha^{7,9}$ A		Da	B ₂	ED39	18-22
MULTIPLY UNNORM. (long to ext. low HFP)	MYLR	RRD	UE	$\alpha^{7,9}$		Da		B339	18-22
MULTIPLY UNNORMALIZED (long to ext. HFP)	MY	RXF	UE	$\alpha^{7,9}$ A	SP	Da	B ₂	ED3B	18-22
MULTIPLY UNNORMALIZED (long to ext. HFP)	MYR	RRD	UE	$\alpha^{7,9}$	SP	Da		B33B	18-22
SQUARE ROOT (extended HFP)	SQXR	RRE		$\alpha^{7,9}$ SP		Da SQ		B336	18-23
SQUARE ROOT (long HFP)	SQD	RXE		$\alpha^{7,9}$ A		Da SQ	B ₂	ED35	18-23
SQUARE ROOT (long HFP)	SQDR	RRE		$\alpha^{7,9}$		Da SQ		B244	18-23
SQUARE ROOT (short HFP)	SQE	RXE		$\alpha^{7,9}$ A		Da SQ	B ₂	ED34	18-23
SQUARE ROOT (short HFP)	SQER	RRE		$\alpha^{7,9}$		Da SQ		B245	18-23
SUBTRACT NORMALIZED (extended HFP)	SXR	RR	C	$\alpha^{7,9}$ SP		Da EU EO LS		37	18-24
SUBTRACT NORMALIZED (long HFP)	SD	RX-a	C	$\alpha^{7,9}$ A		Da EU EO LS	B ₂	6B	18-24
SUBTRACT NORMALIZED (long HFP)	SDR	RR	C	$\alpha^{7,9}$		Da EU EO LS		2B	18-24
SUBTRACT NORMALIZED (short HFP)	SE	RX-a	C	$\alpha^{7,9}$ A		Da EU EO LS	B ₂	7B	18-24
SUBTRACT NORMALIZED (short HFP)	SER	RR	C	$\alpha^{7,9}$		Da EU EO LS		3B	18-24
SUBTRACT UNNORMALIZED (long HFP)	SW	RX-a	C	$\alpha^{7,9}$ A		Da EO LS	B ₂	6F	18-25
SUBTRACT UNNORMALIZED (long HFP)	SWR	RR	C	$\alpha^{7,9}$		Da EO LS		2F	18-25
SUBTRACT UNNORMALIZED (short HFP)	SU	RX-a	C	$\alpha^{7,9}$ A		Da EO LS	B ₂	7F	18-25
SUBTRACT UNNORMALIZED (short HFP)	SUR	RR	C	$\alpha^{7,9}$		Da EO LS		3F	18-25

Explanation:

- α^7 Restricted from transactional execution when the effective allow-floating-point-operation control is zero.
- α^9 Restricted in the constrained transactional-execution mode; a transaction-constraint program exception may be recognized.
- A Access exceptions for logical addresses.
- B₂ B₂ field designates an access register in the access-register mode.
- C Condition code is set.

Figure 18-2. Summary of HFP Instructions (Part 3 of 4)

Name	Mnemonic	Characteristics	Op Code	Page
Da		AFP-register data exception.		
EO		HFP-exponent-overflow exception.		
EU		HFP-exponent-underflow exception.		
FK		HFP-divide exception.		
HM		HFP-multiply-add/subtract facility.		
LS		HFP-significance exception.		
N		Instruction is new in z/Architecture as compared to ESA/390.		
RR		RR instruction format.		
RRD		RRD instruction format.		
RRE		RRE instruction format.		
RRF		RRF instruction format.		
RX		RX instruction format.		
RXE		RXE instruction format.		
SP		Specification exception.		
SQ		HFP-square-root exception.		
UE		HFP unnormalized-extensions facility.		

Figure 18-2. Summary of HFP Instructions (Part 4 of 4)

ADD NORMALIZED

Mnemonic1 R₁,R₂ [RR]

Op Code	R ₁	R ₂
0	8	12 15

Mnemonic1	Op Code	Operands
AER	'3A'	Short HFP
ADR	'2A'	Long HFP
AXR	'36'	Extended HFP

Mnemonic2 R₁,D₂(X₂,B₂) [RX-a]

Op Code	R ₁	X ₂	B ₂	D ₂
0	8	12 16	20	31

Mnemonic2	Op Code	Operands
AE	'7A'	Short HFP
AD	'6A'	Long HFP

The second operand is added to the first operand, and the normalized sum is placed at the first-operand location.

Addition of two HFP numbers consists in characteristic comparison, fraction alignment, and signed fraction addition. The characteristics of the two operands are compared, and the fraction accompanying the smaller characteristic is aligned with the other fraction by a right shift, with its characteristic increased

by one for each hexadecimal digit of shift until the two characteristics agree.

When a fraction is shifted right during alignment, the leftmost hexadecimal digit shifted out is retained as a guard digit. The fraction that is not shifted is considered to be extended with a zero in the guard-digit position. When no alignment shift occurs, both operands are considered to be extended with zeros in the guard-digit position. The fractions with signs are then added algebraically to form a signed intermediate sum.

The intermediate-sum fraction consists of seven (short format), 15 (long format), or 29 (extended format) hexadecimal digits, including the guard digit, and a possible carry. If a carry is present, the sum is shifted right one digit position so that the carry becomes the leftmost digit of the fraction, and the characteristic is increased by one.

If the addition produces no carry, the intermediate-sum fraction is shifted left as necessary to eliminate any leading hexadecimal zero digits resulting from the addition, provided the fraction is not zero. Zeros are supplied to the vacated rightmost digits, and the characteristic is reduced by the number of hexadecimal digits of shift. The fraction thus normalized is then truncated on the right to six (short format), 14 (long format), or 28 (extended format) hexadecimal

digits. In the extended format, a characteristic is generated for the low-order part, which is 14 less than the high-order characteristic.

The sign of the sum is determined by the rules of algebra, unless all digits of the intermediate-sum fraction are zero, in which case the sign is made plus.

An HFP-exponent-overflow exception exists when a carry from the leftmost position of the intermediate-sum fraction would cause the characteristic of the normalized sum to exceed 127. The operation is completed by making the result characteristic 128 less than the correct value, and a program interruption for HFP exponent overflow occurs. The result is normalized, and the sign and fraction remain correct. For extended results, the characteristic of the low-order part remains correct.

An HFP-exponent-underflow exception exists when the characteristic of the normalized sum would be less than zero and the fraction is not zero. If the HFP-exponent-underflow mask bit in the PSW is one, the operation is completed by making the result characteristic 128 greater than the correct value, and a program interruption for HFP exponent underflow occurs. The result is normalized, and the sign and fraction remain correct. If the HFP-exponent-underflow mask bit in the PSW is zero, a program interruption does not occur; instead, the operation is completed by making the result a positive true zero. For extended results, HFP exponent underflow is not recognized when the low-order characteristic is less than zero but the high-order characteristic is equal to or greater than zero.

The result fraction is zero when the intermediate-sum fraction, including the guard digit, is zero. With a zero result fraction, the action depends on the setting of the HFP-significance mask bit in the PSW. If the HFP-significance mask bit in the PSW is one, no normalization occurs, the intermediate and final result characteristics are the same, and a program interruption for HFP significance occurs. If the HFP-significance mask bit in the PSW is zero, the program interruption does not occur; instead, the result is made a positive true zero.

For AXR, the R fields must designate valid floating-point-register pairs; otherwise, a specification exception is recognized.

Resulting Condition Code:

- 0 Result is zero
- 1 Result is less than zero
- 2 Result is greater than zero
- 3 --

Program Exceptions:

- Access (fetch, operand 2 of AE and AD only)
- Data with DXC 1, AFP register
- HFP exponent overflow
- HFP exponent underflow
- HFP significance
- Specification (AXR only)
- Transaction constraint

Programming Notes:

1. An example of the use of the ADD NORMALIZED instruction (AE) is given in Appendix A.
2. Interchanging the two operands in an HFP addition does not affect the value of the sum.
3. The ADD NORMALIZED instruction normalizes the sum but not the operands. Thus, if one or both operands are unnormalized, precision may be lost during fraction alignment.

ADD UNNORMALIZED

Mnemonic1 R₁,R₂ [RR]

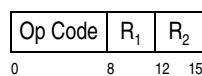

Mnemonic1	Op Code	Operands
AUR	'3E'	Short HFP
AWR	'2E'	Long HFP

Mnemonic2 R₁,D₂(X₂,B₂) [RX-a]

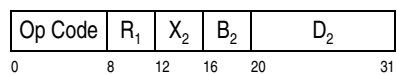

Mnemonic2	Op Code	Operands
AU	'7E'	Short HFP
AW	'6E'	Long HFP

The second operand is added to the first operand, and the unnormalized sum is placed at the first-operand location.

The execution of ADD UNNORMALIZED is identical to that of ADD NORMALIZED, except that:

1. When no carry is present after the addition, the intermediate-sum fraction is truncated to the proper result-fraction length without a left shift to eliminate leading hexadecimal zeros and without the corresponding reduction of the characteristic.
2. HFP exponent underflow cannot occur.
3. The guard digit does not participate in the recognition of a zero result fraction. A zero result fraction is recognized when the fraction (that is, the intermediate-sum fraction, excluding the guard digit) is zero.

Resulting Condition Code:

- 0 Result fraction zero
- 1 Result less than zero
- 2 Result greater than zero
- 3 --

Program Exceptions:

- Access (fetch, operand 2 of AU and AW only)
- Data with DXC 1, AFP register
- HFP exponent overflow
- HFP significance
- Transaction constraint

Programming Notes:

1. An example of the use of the ADD UNNORMALIZED instruction (AU) is given in Appendix A.
2. Except when the result is made a true zero, the characteristic of the result of ADD UNNORMALIZED is equal to the greater of the two operand characteristics, increased by one if the fraction addition produced a carry, or set to zero if HFP exponent overflow occurred.

COMPARE

Mnemonic1 R₁,R₂ [RR]

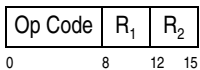

Mnemonic1	Op Code	Operands
CER	'39'	Short HFP
CDR	'29'	Long HFP

Mnemonic2 R₁,R₂ [RRE]

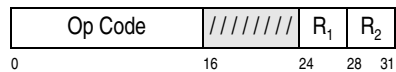

Mnemonic2	Op Code	Operands
CXR	'B369'	Extended HFP

Mnemonic3 R₁,D₂(X₂,B₂) [RX-a]

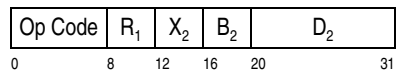

Mnemonic3	Op Code	Operands
CE	'79'	Short HFP
CD	'69'	Long HFP

The first operand is compared with the second operand, and the condition code is set to indicate the result.

The comparison is algebraic and follows the procedure for normalized subtraction, except that the difference is discarded after setting the condition code and both operands remain unchanged. When the difference, including the guard digit, is zero, the operands are equal. When a nonzero difference is positive or negative, the first operand is high or low, respectively.

An HFP-exponent-overflow, HFP-exponent-underflow, or HFP-significance exception cannot occur.

For CXR, the R fields must designate valid floating-point-register pairs; otherwise, a specification exception is recognized.

Resulting Condition Code:

- 0 Operands equal
- 1 First operand low
- 2 First operand high
- 3 --

Program Exceptions:

- Access (fetch, operand 2 of CE and CD only)
- Data with DXC 1, AFP register
- Specification (CXR only)
- Transaction constraint

Programming Notes:

1. Examples of the use of the COMPARE instruction (CDR) are given in Appendix A.

- An exponent inequality alone is not sufficient to determine the inequality of two operands with the same sign, because the fractions may have different numbers of leading hexadecimal zeros.
- Numbers with zero fractions compare equal even when they differ in sign or characteristic.

CONVERT FROM FIXED

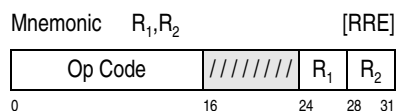

Mnemonic	Op Code	Operands
CEFR	'B3B4'	32-bit binary-integer operand, short HFP result
CDFR	'B3B5'	32-bit binary-integer operand, long HFP result
CXFR	'B3B6'	32-bit binary-integer operand, extended HFP result
CEGR	'B3C4'	64-bit binary-integer operand, short HFP result
CDGR	'B3C5'	64-bit binary-integer operand, long HFP result
CXGR	'B3C6'	64-bit binary-integer operand, extended HFP result

The fixed-point second operand is converted to the HFP format, and the normalized result is placed at the first-operand location.

A nonzero result is normalized. A zero result is made a positive true zero.

The second operand is a signed binary integer that is located in the general register designated by R_2 . A 32-bit operand is in bit positions 32-63 of the register.

The result is normalized and rounded toward zero (truncated) before it is placed at the first-operand location.

For CXFR and CXGR, the R_1 field must designate a valid floating-point-register pair; otherwise, a specification exception is recognized.

Condition Code: The code remains unchanged.

Program Exceptions:

- Data with DXC 1, AFP register
- Specification (CXFR and CXGR)
- Transaction constraint

CONVERT TO FIXED

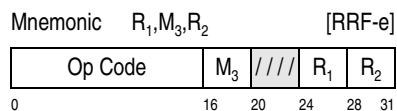

Mnemonic	Op Code	Operands
CFER	'B3B8'	Short HFP operand, 32-bit binary-integer result
CFDR	'B3B9'	Long HFP operand, 32-bit binary-integer result
CFXR	'B3BA'	Extended HFP operand, 32-bit binary-integer result
CGER	'B3C8'	Short HFP operand, 64-bit binary-integer result
CGDR	'B3C9'	Long HFP operand, 64-bit binary-integer result
CGXR	'B3CA'	Extended HFP operand, 64-bit binary-integer result

The HFP second operand is rounded to an integer value and then converted to the fixed-point format. The result is placed at the first-operand location.

The result is a signed binary integer that is placed in the general register designated by R_1 . For instructions that produce a 32-bit result, the result replaces bits 32-63 of the register, and bits 0-31 of the register remain unchanged.

The second operand is rounded to an integer value by rounding as specified by the modifier in the M_3 field:

M₃ Effective Rounding Method

- 0 Round toward 0
- 1 Round to nearest with ties away from 0
- 4 Round to nearest with ties to even
- 5 Round toward 0
- 6 Round toward $+\infty$
- 7 Round toward $-\infty$

For details on rounding see the section "Rounding Methods" on page 9-14.

A modifier other than 0, 1, or 4-7 is invalid.

The sign of the result is the sign of the second operand, except that a zero result has a plus sign.

If the rounded result would have a value exceeding the range that can be represented in the result format, the largest (in magnitude) representable num-

ber of the same sign as the source is placed at the target location, and condition code 3 is set.

HFP exponent underflow is not recognized because small values are rounded to one (with the appropriate sign) or to zero, depending on the rounding mode.

The M_3 field must designate a valid modifier; otherwise, a specification exception is recognized. For CFXR and CGXR, the R_2 field must designate a valid floating-point-register pair; otherwise, a specification exception is recognized.

Resulting Condition Code:

- 0 Source was zero
- 1 Source was less than zero
- 2 Source was greater than zero
- 3 Special case

Program Exceptions:

- Data with DXC 1, AFP register
- Specification
- Transaction constraint

DIVIDE

Mnemonic1 R_1, R_2 [RR]

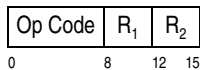

Mnemonic1	Op Code	Operands
DER	'3D'	Short HFP
DDR	'2D'	Long HFP

Mnemonic2 R_1, R_2 [RRE]

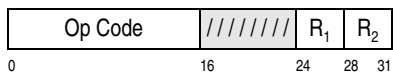

Mnemonic2	Op Code	Operands
DXR	'B22D'	Extended HFP

Mnemonic3 $R_1, D_2(X_2, B_2)$ [RX-a]

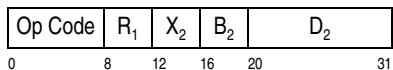

Mnemonic3	Op Code	Operands
DE	'7D'	Short HFP
DD	'6D'	Long HFP

The first operand (the dividend) is divided by the second operand (the divisor), and the normalized quo-

tient is placed at the first-operand location. No remainder is preserved.

HFP division consists in characteristic subtraction and fraction division. The operands are first normalized to eliminate leading hexadecimal zeros. The difference between the dividend and divisor characteristics of the normalized operands, plus 64, is used as the characteristic of an intermediate quotient.

All dividend and divisor fraction digits participate in forming the fraction of the intermediate quotient. The intermediate-quotient fraction can have no leading hexadecimal zeros, but a right shift of one digit position may be necessary, with this causing an increase of the characteristic by one. The fraction is then truncated to the proper result-fraction length.

An HFP-exponent-overflow exception exists when the characteristic of the final quotient would exceed 127 and the fraction is not zero. The operation is completed by making the result characteristic 128 less than the correct value, and a program interruption for HFP exponent overflow occurs. The result is normalized, and the sign and fraction remain correct. If, for extended results, the low-order characteristic would also exceed 127, it too is decreased by 128.

An HFP-exponent-underflow exception exists when the characteristic of the final quotient would be less than zero and the fraction is not zero. If the HFP-exponent-underflow mask bit in the PSW is one, the operation is completed by making the result characteristic 128 greater than the correct value, and a program interruption for HFP exponent underflow occurs. The result is normalized, and the sign and fraction remain correct. If the HFP-exponent-underflow mask bit in the PSW is zero, a program interruption does not occur; instead, the operation is completed by making the result a positive true zero. For extended results, HFP exponent underflow is not recognized when the low-order characteristic is less than zero but the high-order characteristic is equal to or greater than zero.

HFP exponent underflow does not occur when the characteristic of an operand becomes less than zero during normalization of the operands or when the intermediate-quotient characteristic is less than zero, as long as the final quotient can be represented with the correct characteristic.

When the divisor fraction is zero, an HFP-divide exception is recognized. This includes the case of division of zero by zero.

When the dividend fraction is zero but the divisor fraction is nonzero, the quotient is made a positive true zero. No HFP exponent overflow or HFP exponent underflow occurs.

The sign of the quotient is the exclusive or of the operand signs, except that the sign is always plus when the quotient is made a positive true zero.

For DXR, the R fields must designate valid floating-point-register pairs; otherwise, a specification exception is recognized.

Condition Code: The code remains unchanged.

Program Exceptions:

- Access (fetch, operand 2 of DE and DD only)
- Data with DXC 1, AFP register
- HFP divide
- HFP exponent overflow
- HFP exponent underflow
- Specification (DXR only)
- Transaction constraint

Programming Note: Examples of the use of the DIVIDE instruction (DER) are given in Appendix A.

HALVE

Mnemonic R₁,R₂ [RR]

Op Code	R ₁	R ₂
0	8	12 15

Mnemonic	Op Code	Operands
HER	'34'	Short HFP
HDR	'24'	Long HFP

The second operand is divided by 2, and the normalized quotient is placed at the first-operand location.

The fraction of the second operand is shifted right one bit position, placing the contents of the rightmost bit position in the leftmost bit position of the guard digit, and a zero is supplied to the leftmost bit position of the fraction. The intermediate result, including the guard digit, is then normalized, and the final result is truncated to the proper length.

An HFP-exponent-underflow exception exists when the characteristic of the final result would be less than zero and the fraction is not zero. If the HFP-exponent-underflow mask bit in the PSW is one, the operation is completed by making the result characteristic 128 greater than the correct value, and a program interruption for HFP exponent underflow occurs. The result is normalized, and the sign and fraction remain correct. If the HFP-exponent-underflow mask bit in the PSW is zero, a program interruption does not occur; instead, the operation is completed by making the result a positive true zero.

When the fraction of the second operand is zero, the result is made a positive true zero, and no HFP exponent underflow occurs.

The sign of the result is the same as that of the second operand, except that the sign is always plus when the quotient is made a positive true zero.

Condition Code: The code remains unchanged.

Program Exceptions:

- Data with DXC 1, AFP register
- HFP exponent underflow
- Transaction constraint

Programming Notes:

1. An example of the use of the HALVE instruction (HDR) is given in Appendix A.
2. With short and long operands, the halve operation is identical to a divide operation with the number 2 as divisor. Similarly, the result of HDR is identical to that of MD or MDR with one-half as a multiplier, and the result of HER is identical to that of MEE or MEER with one-half as a multiplier.

LOAD AND TEST

Mnemonic1 R₁,R₂ [RR]

Op Code	R ₁	R ₂
0	8	12 15

Mnemonic1	Op Code	Operands
LTER	'32'	Short HFP
LTDR	'22'	Long HFP

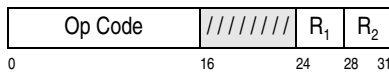
Mnemonic2 R₁,R₂ [RRE]

Mnemonic2	Op Code	Operands
LTXR	'B362'	Extended HFP

The second operand is placed at the first-operand location, and its sign and magnitude are tested to determine the setting of the condition code. The condition code is set the same as for a comparison of the second operand with zero.

For short and long operands, the second operand is placed unchanged in the first-operand location.

For extended operands, the high-order sign and the entire fraction of the source are placed unchanged in the result, and the low-order sign is set equal to the high-order sign. If the extended-operand fraction is nonzero, the high-order characteristic is placed unchanged in the result high-order characteristic, and the low-order characteristic is set to 14 less than the high-order characteristic, modulo 128. If the extended-operand fraction is zero, the result is made a true zero with the same sign as the source (the high-order and low-order sign bits of the result are the same as the high-order sign bit of the source).

For LTXR, the R fields must designate valid floating-point-register pairs; otherwise, a specification exception is recognized.

Resulting Condition Code:

- 0 Result is zero
- 1 Result is less than zero
- 2 Result is greater than zero
- 3 --

Program Exceptions:

- Data with DXC 1, AFP register
- Specification (LTXR only)
- Transaction constraint

Programming Note: When, for LTER and LTDR, the same register is designated as the first-operand and second-operand location, the operation is equivalent to a test without data movement.

LOAD COMPLEMENT

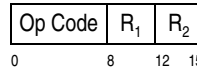
Mnemonic1 R₁,R₂ [RR]

Mnemonic1	Op Code	Operands
LCER	'33'	Short HFP
LCDR	'23'	Long HFP

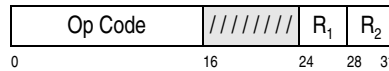
Mnemonic2 R₁,R₂ [RRE]

Mnemonic2	Op Code	Operands
LCXR	'B363'	Extended HFP

The second operand is placed at the first-operand location with the sign bit inverted.

The sign bit is inverted even if the operand is zero. For all operand lengths, the source fraction is placed unchanged in the result.

For short and long operands, the source characteristic is placed unchanged in the result.

For extended operands, the low-order sign is set equal to the high-order sign. If the extended-operand fraction is nonzero, the high-order characteristic is placed unchanged in the result high-order characteristic, and the low-order characteristic is set to 14 less than the high-order characteristic, modulo 128. If the extended-operand fraction is zero, the result is made a true zero with the sign inverted from the source (the high-order and low-order sign bits of the result are inverted from the high-order sign bit of the source).

For LCXR, the R fields must designate valid floating-point-register pairs; otherwise, a specification exception is recognized.

Resulting Condition Code:

- 0 Result is zero
- 1 Result is less than zero
- 2 Result is greater than zero
- 3 --

Program Exceptions:

- Data with DXC 1, AFP register
- Specification (LCXR only)
- Transaction constraint

LOAD FP INTEGER

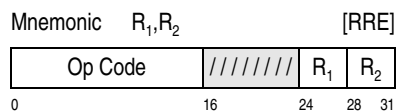

Mnemonic	Op Code	Operands
FIER	'B377'	Short HFP
FIDR	'B37F'	Long HFP
FIXR	'B367'	Extended HFP

The second operand is truncated (rounded toward zero) to an integer value in the same floating-point format, and the normalized result is placed at the first-operand location.

A nonzero result is normalized. A zero result is made a positive true zero.

For FIXR, the R fields must designate valid floating-point-register pairs; otherwise, a specification exception is recognized.

Condition Code: The code remains unchanged.

Program Exceptions:

- Data with DXC 1, AFP register
- Specification (FIXR only)
- Transaction constraint

Programming Notes:

1. LOAD FP INTEGER truncates (rounds toward zero) an HFP number to an integer value. These integers, which remain in the HFP format, should not be confused with binary integers, which use a fixed-point format.
2. If the HFP operand has a large enough exponent so that it is already an integer, the result value remains the same, except that an unnormalized operand is normalized, and an operand with a zero fraction is changed to a positive true zero.

LOAD LENGTHENED

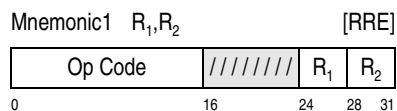

Mnemonic1	Op Code	Operands
LDER	'B324'	Short HFP operand 2, long HFP operand 1
LXDR	'B325'	Long HFP operand 2, extended HFP operand 1
LXER	'B326'	Short HFP operand 2, extended HFP operand 1

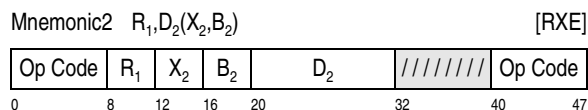

Mnemonic2	Op Code	Operands
LDE	'ED24'	Short HFP operand 2, long HFP operand 1
LXD	'ED25'	Long HFP operand 2, extended HFP operand 1
LXE	'ED26'	Short HFP operand 2, extended HFP operand 1

The second operand is extended to a longer format, and the result is placed at the first-operand location.

For all operand lengths, the source fraction is extended with zeros and placed in the result. The sign bit of the result is set the same as the sign of the source even when the result is made a true zero.

For long results, the source characteristic is placed unchanged in the result.

For extended results, the low-order sign is set equal to the high-order sign. If the fraction is nonzero, the source characteristic is placed unchanged in the result high-order characteristic, and the low-order characteristic is set to 14 less than the high-order characteristic, modulo 128. If the fraction is zero, the result is made a true zero with the same sign as the source (the high-order and low-order sign bits of the result are the same as the sign bit of the source).

For LXD, LXDR, LXE, and LXER, the R_1 field must designate a valid floating-point-register pair; otherwise, a specification exception is recognized.

Condition Code: The code remains unchanged.

Program Exceptions:

- Access (fetch, operand 2 of LDE, LXE, and LXD only)
- Data with DXC 1, AFP register
- Specification (LXE, LXER, LXD, LXDR)
- Transaction constraint

LOAD NEGATIVE

Mnemonic1 R₁,R₂ [RR]

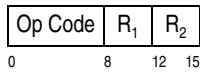

Mnemonic1	Op Code	Operands
LNER	'31'	Short HFP
LNDR	'21'	Long HFP

Mnemonic2 R₁,R₂ [RRE]

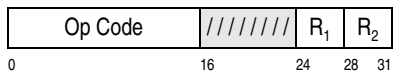

Mnemonic2	Op Code	Operands
LNXR	'B361'	Extended HFP

The second operand is placed at the first-operand location with the sign bit made one.

The sign bit is made one even if the operand is zero. For all operand lengths, the source fraction is placed unchanged in the result.

For short and long operands, the source characteristic is placed unchanged in the result.

For extended operands, the low-order sign is set equal to the high-order sign. If the extended-operand fraction is nonzero, the high-order characteristic is placed unchanged in the result high-order characteristic, and the low-order characteristic is set to 14 less than the high-order characteristic, modulo 128. If the extended-operand fraction is zero, the result is made a negative true zero (the high-order and low-order sign bits of the result are set to one).

For LNXR, the R fields must designate valid floating-point-register pairs; otherwise, a specification exception is recognized.

Resulting Condition Code:

- 0 Result is zero
- 1 Result is less than zero
- 2 --
- 3 --

Program Exceptions:

- Data with DXC 1, AFP register
- Specification (LNXR only)
- Transaction constraint

LOAD POSITIVE

Mnemonic1 R₁,R₂ [RR]

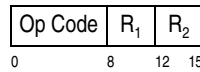

Mnemonic1	Op Code	Operands
LPER	'30'	Short HFP
LPDR	'20'	Long HFP

Mnemonic2 R₁,R₂ [RRE]

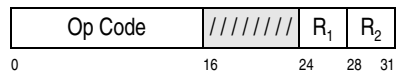

Mnemonic2	Op Code	Operands
LPXR	'B360'	Extended HFP

The second operand is placed at the first-operand location with the sign bit made zero.

For all operand lengths, the sign bit is made zero, and the source fraction is placed unchanged in the result.

For short and long operands, the source characteristic is placed unchanged in the result.

For extended operands, the low-order sign is set equal to the high-order sign. If the extended-operand fraction is nonzero, the high-order characteristic is placed unchanged in the result high-order characteristic, and the low-order characteristic is set to 14 less than the high-order characteristic, modulo 128. If the extended-operand fraction is zero, the result is made a positive true zero (the high-order and low-order sign bits of the result are set to zero).

For LPXR, the R fields must designate valid floating-point-register pairs; otherwise, a specification exception is recognized.

Resulting Condition Code:

- 0 Result is zero
- 1 --
- 2 Result is greater than zero
- 3 --

Program Exceptions:

- Data with DXC 1, AFP register
- Specification (LPXR only)
- Transaction constraint

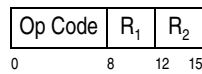
LOAD ROUNDEDMnemonic1 R₁,R₂ [RR]

Mnemonic1	Op Code	Operands
LEDR	'35'	Long HFP operand 2, short HFP operand 1
LDXR	'25'	Extended HFP operand 2, long HFP operand 1

The above mnemonics are alternatives to the following older mnemonics that are less descriptive of operand lengths:

Mnemonic2	Op Code	Operands
LRER	'35'	Long HFP operand 2, short HFP operand 1
LRDR	'25'	Extended HFP operand 2, long HFP operand 1

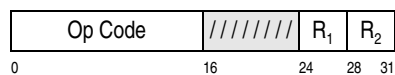
Mnemonic2 R₁,R₂ [RRE]

Mnemonic2	Op Code	Operands
LEXR	'B366'	Extended HFP operand 2, short HFP operand 1

The second operand is rounded to a shorter format, and the result is placed at the first-operand location.

Rounding consists in adding a one to the leftmost bit position of the second operand that is to be dropped and propagating any carry through the fraction. The sign of the second operand is ignored, and addition is performed as if the fraction were positive.

If rounding causes a carry out of the leftmost hexadecimal digit position of the fraction, the fraction is shifted right one digit position so that the carry becomes the leftmost digit of the fraction, and the characteristic is increased by one.

The intermediate fraction is then truncated to the proper result-fraction length. For LEDR and LEXR, the result replaces the leftmost 32 bits of the target register, and the rightmost 32 bit positions of the target register remain unchanged. For LDXR, the 64-bit result is placed in a floating-point register, not a floating-point register pair.

The sign of the result is the same as the sign of the second operand. There is no normalization to eliminate leading zeros.

An HFP-exponent-overflow exception exists when shifting the fraction right would cause the characteristic to exceed 127. The operation is completed by making the result characteristic 128 less than the correct value, and a program interruption for HFP exponent overflow occurs. The result is normalized, and the sign and fraction remain correct.

HFP-exponent-underflow and HFP-significance exceptions cannot occur.

For LDXR (or LRDR) and LEXR, the R₂ field must designate a valid floating-point-register pair; otherwise, a specification exception is recognized.

Condition Code: The code remains unchanged.

Program Exceptions:

- Data with DXC 1, AFP register
- HFP exponent overflow
- Specification (LDXR, LEXR, LRDR)
- Transaction constraint

Programming Note: The sign of the rounded result is the same as the sign of the operand, even when the result is zero.

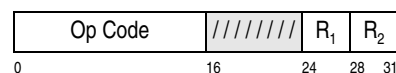
MULTIPLYMnemonic1 R₁,R₂ [RRE]

Mnemonic1	Op Code	Operands
MEER	'B337'	Short HFP

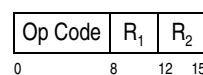
Mnemonic2 R₁,R₂ [RR]

Mnemonic2	Op Code	Operands
MDR	'2C'	Long HFP
MXR	'26'	Extended HFP
MDER	'3C'	Short HFP multiplier and multiplicand, long HFP product
MXDR	'27'	Long HFP multiplier and multiplicand, extended HFP product

The above mnemonic MDER is an alternative to the following older mnemonic that is less descriptive of operand lengths:

MER '3C' Short HFP multiplier and multiplicand, long HFP product

Mnemonic3 $R_1, D_2(X_2, B_2)$ [RXE]

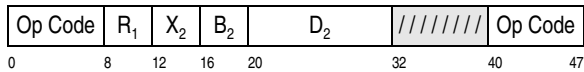

Mnemonic3 Op Code Operands
MEE 'ED37' Short HFP

Mnemonic4 $R_1, D_2(X_2, B_2)$ [RX-a]

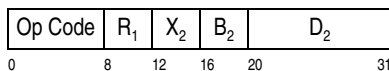

Mnemonic4 Op Code Operands
MD '6C' Long HFP
MDE '7C' Short HFP multiplier and multiplicand, long HFP product
MXD '67' Long HFP multiplier and multiplicand, extended HFP product

The above mnemonic MDE is an alternative to the following older mnemonic that is less descriptive of operand lengths:

ME '7C' Short HFP multiplier and multiplicand, long HFP product

The normalized product of the second operand (the multiplier) and the first operand (the multiplicand) is placed at the first-operand location.

Multiplication of two HFP numbers consists in exponent addition and fraction multiplication. The operands are first normalized to eliminate leading hexadecimal zeros. The sum of the characteristics of the normalized operands, less 64, is used as the characteristic of the intermediate product.

The fraction of the intermediate product is the exact product of the normalized operand fractions. If the intermediate-product fraction has one leading hexadecimal zero digit, the fraction is shifted left one digit position, bringing the contents of the guard-digit position into the rightmost position of the result fraction, and the intermediate-product characteristic is reduced by one. The fraction is then truncated to the proper result-fraction length.

For MDE and MDER, the multiplier and multiplicand fractions have six hexadecimal digits; the product fraction has the full 14 digits of the long format, with the two rightmost fraction digits always zeros. For MEE and MEER, the multiplier and multiplicand fractions have six digits, and the final product fraction is

truncated to six digits; the result, as for all short-format results, replaces the leftmost 32 bits of the target register, and the rightmost 32 bit positions of the target register remain unchanged.

For MD and MDR, the multiplier and multiplicand fractions have 14 digits, and the final product fraction is truncated to 14 digits. For MXD and MXDR, the multiplier and multiplicand fractions have 14 digits, with the multiplicand occupying the high-order part of the first operand; the final product fraction contains 28 digits and is an exact product of the operand fractions. For MXR, the multiplier and multiplicand fractions have 28 digits, and the final product fraction is truncated to 28 digits.

An HFP-exponent-overflow exception exists when the characteristic of the final product would exceed 127 and the fraction is not zero. The operation is completed by making the result characteristic 128 less than the correct value, and a program interruption for HFP exponent overflow occurs. The result is normalized, and the sign and fraction remain correct. If, for extended results, the low-order characteristic would also exceed 127, it too is decreased by 128.

HFP exponent overflow is not recognized when the intermediate-product characteristic is initially 128 but is brought back within range by normalization.

An HFP-exponent-underflow exception exists when the characteristic of the final product would be less than zero and the fraction is not zero. If the HFP-exponent-underflow mask bit in the PSW is one, the operation is completed by making the result characteristic 128 greater than the correct value, and a program interruption for HFP exponent underflow occurs. The result is normalized, and the sign and fraction remain correct. If the HFP-exponent-underflow mask bit in the PSW is zero, a program interruption does not occur; instead, the operation is completed by making the result a positive true zero. For extended results, HFP exponent underflow is not recognized when the low-order characteristic is less than zero but the high-order characteristic is equal to or greater than zero.

HFP exponent underflow does not occur when the characteristic of an operand becomes less than zero during normalization of the operands, as long as the final product can be represented with the correct characteristic.

If either or both operand fractions are zero, the result is made a positive true zero, and no HFP exponent overflow or HFP exponent underflow occurs.

The sign of the product is the exclusive or of the operand signs, except that the sign is always plus when the result is made a true zero.

The R_1 field for MXD, MXDR, and MXR, and the R_2 field for MXR must designate valid floating-point-register pairs. Otherwise, a specification exception is recognized.

Condition Code: The code remains unchanged.

Program Exceptions:

- Access (fetch, operand 2 of MDE, MEE, MD, and MXD only)
- Data with DXC 1, AFP register
- HFP exponent overflow
- HFP exponent underflow
- Specification (MXD, MXDR, MXR)
- Transaction constraint

Programming Notes:

1. An example of the use of the MULTIPLY instruction (MDR) is given in Appendix A.
2. Interchanging the two operands in an HFP multiplication does not affect the value of the product.

MULTIPLY AND ADD

Mnemonic1 R_1, R_3, R_2 [RRD]

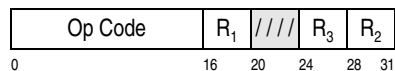

Mnemonic1	Op Code	Operands
MAER	'B32E'	Short HFP
MADR	'B33E'	Long HFP

Mnemonic2 $R_1, R_3, D_2(X_2, B_2)$ [RXF]

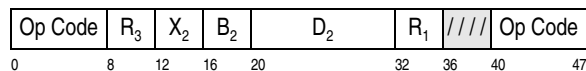

Mnemonic2	Op Code	Operands
MAE	'ED2E'	Short HFP
MAD	'ED3E'	Long HFP

MULTIPLY AND SUBTRACT

Mnemonic1 R_1, R_3, R_2 [RRD]

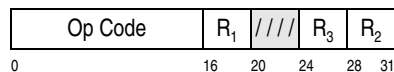

Mnemonic1	Op Code	Operands
MSER	'B32F'	Short HFP
MSDR	'B33F'	Long HFP

Mnemonic2 $R_1, R_3, D_2(X_2, B_2)$ [RXF]

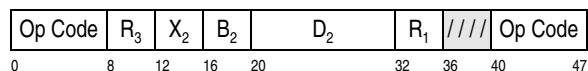

Mnemonic2	Op Code	Operands
MSE	'ED2F'	Short HFP
MSD	'ED3F'	Long HFP

The third operand is multiplied by the second operand, and then the first operand is added to or subtracted from the product. The sum or difference is placed at the first-operand location. The MULTIPLY AND ADD and MULTIPLY AND SUBTRACT operations may be summarized as:

$$op_1 = op_3 \cdot op_2 \pm op_1$$

The third and second HFP operands are multiplied, forming an intermediate product, and the first operand is then added (or subtracted) algebraically to (or from) the intermediate product, forming an intermediate result. The exponent and fraction of the intermediate product and intermediate result are maintained exactly. The intermediate result, if nonzero, is normalized and truncated to the operand format and then placed at the first-operand location.

The sign of the result is determined by the rules of algebra, unless the intermediate-result fraction is zero, in which case the result is made a positive true zero.

An HFP-exponent-overflow exception exists when the characteristic of the normalized result would exceed 127 and the fraction is not zero. The operation is completed by making the result characteristic 128 less than the correct value, and a program interruption for HFP exponent overflow occurs. The result is normalized, and the sign and fraction remain correct.

HFP exponent overflow is not recognized on intermediate values, provided the normalized result can be represented with the correct characteristic.

An HFP-exponent-underflow exception exists when the characteristic of the normalized result would be less than zero and the fraction is not zero. If the HFP-exponent-underflow mask bit in the PSW is one, the operation is completed by making the result characteristic 128 greater than the correct value, and a program interruption for HFP exponent underflow occurs. The result is normalized, and the sign and fraction remain correct. If the HFP-exponent-underflow mask bit in the PSW is zero, a program interruption does not occur; instead, the operation is completed by making the result a positive true zero.

HFP exponent underflow is not recognized on input operands and intermediate values, provided the normalized result can be represented with the correct characteristic.

Condition Code: The code remains unchanged.

Program Exceptions:

- Access (fetch, operand 2 of MAE, MAD, MSE, MSD)
- Data with DXC 1, AFP register
- HFP exponent overflow
- HFP exponent underflow
- Operation (if the HFP multiply-add/subtract facility is not installed)
- Transaction constraint

Programming Note: MULTIPLY AND ADD (SUBTRACT) differs from MULTIPLY followed by ADD (SUBTRACT) NORMALIZED in the following ways:

1. The product is maintained to full precision, and overflow and underflow are not recognized on the product.
2. The HFP-significance exception is not recognized for MULTIPLY AND ADD (SUBTRACT).
3. ADD (SUBTRACT) NORMALIZED maintains only a single guard digit and does not prenormalize input operands; thus, in some cases, an unnormalized input operand may cause loss of precision in the result. MULTIPLY AND ADD (SUBTRACT) maintains the entire intermediate sum (difference), which is normalized before the truncation operation is performed; thus, unnormalized operands do not cause any additional loss of precision.
4. On most models, the execution time of MULTIPLY AND ADD (SUBTRACT) is less than the

combined execution time of MULTIPLY followed by ADD (SUBTRACT) NORMALIZED. The performance of MULTIPLY AND ADD (SUBTRACT) may be severely degraded in the case of unnormalized input operands.

MULTIPLY AND ADD UNNORMALIZED

Mnemonic1 R₁,R₃,R₂ [RRD]

Op Code	R ₁	////	R ₃	R ₂
0	16	20	24	28 31

Mnemonic1	Op Code	Operands
MAYR	'B33A'	Long HFP sources, extended HFP result
MAYHR	'B33C'	Long HFP sources, high-order part of extended HFP result
MAYLR	'B338'	Long HFP sources, low-order part of extended HFP result

Mnemonic2 R₁,R₃,D₂(X₂,B₂) [RXF]

Op Code	R ₃	X ₂	B ₂	D ₂	R ₁	////	Op Code
0	8	12	16	20	32	36	40 47

Mnemonic2	Op Code	Operands
MAY	'ED3A'	Long HFP sources, extended HFP result
MAYH	'ED3C'	Long HFP sources, high-order part of extended HFP result
MAYL	'ED38'	Long HFP sources, low-order part of extended HFP result

The second and third HFP operands are multiplied, forming an intermediate product; the first operand (addend) is then added algebraically to the intermediate product to form an intermediate sum; the intermediate-sum fraction is truncated on the left or on the right, if need be, to form an intermediate extended result. All (or a part) of the intermediate extended result is placed in the floating-point-register pair (or floating-point register) designated by the R₁ field. The operands, intermediate values, and results are not normalized to eliminate leading hexadecimal zeros.

The MULTIPLY AND ADD UNNORMALIZED operations may be summarized as:

$$t_1 \leftarrow op_3 \cdot op_2 + op_1$$

Multiplication of two HFP numbers consists in exponent addition and fraction multiplication. The sum of the characteristics of the second and third operands, less 64, is used as the characteristic of the high-

order part of the intermediate product; this value is independent of whether the result fraction is zero. The characteristic of the intermediate product is maintained correctly and does not wrap.

In all cases, the second- and third-operand fractions have 14 digits; the intermediate-product fraction contains 28 digits and is an exact product of the operand fractions. The intermediate-product fraction is not inspected for leading hexadecimal zero digits and is used without shifting in the subsequent addition.

In all cases, the first operand is located in the floating-point register designated by the R_1 field and the first-operand fraction has 14 digits.

Addition of two HFP numbers consists in characteristic comparison, fraction alignment, and signed fraction addition. The characteristics of the intermediate product and the addend are compared. If the characteristics are equal, no alignment is required. If the characteristic of the addend is smaller than the characteristic of the product, the fraction of the addend is aligned with the product fraction by a right shift, with its characteristic increased by one for each hexadecimal digit of shift. If the characteristic of the addend is larger than the characteristic of the product, the fraction of the addend is aligned with the product fraction by a left shift, with its characteristic decreased by one for each hexadecimal digit of shift. Shifting continues until the two characteristics agree. All hexadecimal digits shifted out are preserved and participate in the subsequent addition.

After alignment, the fractions with signs are then added algebraically to form a signed intermediate sum. The fraction of the intermediate sum is maintained exactly. The intermediate-sum fraction is not inspected for leading hexadecimal zero digits and is not shifted. Only those 28 hexadecimal digits of the intermediate-sum fraction which are aligned with the 28 hexadecimal digits of the intermediate-product fraction are used as the fraction of the intermediate extended-result.

The high-order characteristic of the intermediate extended result is set to the characteristic of the intermediate product, modulo 128. The low-order characteristic of the intermediate extended result is set to 14 less than the high-order characteristic, modulo 128. Wrap-around of the characteristic is independent of whether the result fraction is zero.

The sign of the result is determined by the rules of algebra, unless the entire intermediate-sum fraction is zero, in which case the sign of the result is made positive.

For MAY and MAYR, the entire intermediate extended result is placed in the floating-point register-pair designated by the R_1 field; the R_1 field may designate either the lower-numbered or higher-numbered register of a floating-point-register pair. For MAYH and MAYHR, the high-order part of the intermediate extended result is placed in the floating-point register designated by the R_1 field and the low-order part is discarded. For MAYL and MAYLR, the low-order part of the intermediate extended result is placed in the floating-point register designated by the R_1 field and the high-order part is discarded.

HFP-exponent-overflow and HFP-exponent-underflow exceptions are not recognized. Characteristics of the intermediate extended result wrap-around modulo 128 and no exception is reported.

Condition Code: The code remains unchanged.

Program Exceptions:

- Access (fetch, operand 2 of MAYH, MAY, and MAYL only)
- Data with DXC 1, AFP register
- Operation (if the HFP-unnormalized-extensions facility is not installed)
- Transaction constraint

Programming Notes:

1. While performance of MULTIPLY AND ADD may be severely degraded for the case of unnormalized input operands, this is not the case for MULTIPLY AND ADD UNNORMALIZED.
2. MULTIPLY AND ADD UNNORMALIZED can be used to efficiently perform multiple precision arithmetic on numbers of any arbitrary size. This is accomplished by organizing the numbers into big digits of 52 bits each, with each big digit maintained as an integer in the HFP long format. Using a radix of 2^{52} and big digits which can hold up to 56 bits provides a redundant representation. This redundant representation permits multiplication and addition using a “carry save” technique and permits maximum utilization of the floating-point pipeline.

- By setting the multiplier to an integer value of 1 with the proper characteristic, the multiplicand can be scaled by any power of 16 and then added to the addend. This permits, for example, adding the “carry” from one stage of a multiplication to the “sum” of the next stage to the left. In the same manner, the “sum” of one stage can be scaled to be added to the “carry” of the stage to the right.
- In the first round of a multiply and accumulate, the step of clearing the accumulated value to zero, may be avoided by using the MULTIPLY UNNORMALIZED instead of MULTIPLY AND ADD UNNORMALIZED.
- For additional notes concerning the unnormalized operations see the programming notes under the MULTIPLY UNNORMALIZED instruction.

MULTIPLY UNNORMALIZED

Mnemonic1 R_1, R_3, R_2 [RRD]

Op Code	R_1	////	R_3	R_2
0	16	20	24	28 31

Mnemonic1	Op Code	Operands
MYR	'B33B'	Long HFP multiplier and multiplicand, extended HFP product
MYHR	'B33D'	Long HFP multiplier and multiplicand, high-order part of extended HFP product
MYLR	'B339'	Long HFP multiplier and multiplicand, low-order part of extended HFP product

Mnemonic2 $R_1, R_3, D_2(X_2, B_2)$ [RXF]

Op Code	R_3	X_2	B_2	D_2	R_1	////	Op Code
0	8	12	16	20	32	36	40 47

Mnemonic2	Op Code	Operands
MY	'ED3B'	Long HFP multiplier and multiplicand, extended HFP product
MYH	'ED3D'	Long HFP multiplier and multiplicand, high-order part of extended HFP product
MYL	'ED39'	Long HFP multiplier and multiplicand, low-order part of extended HFP product

The second and third HFP operands are multiplied, forming an intermediate product, which, in turn, is used to form an intermediate extended result. All (or a part) of the intermediate extended result is placed in the floating-point-register pair (or floating-point register) designated by the R_1 field. The operands,

intermediate values, and results are not normalized to eliminate leading hexadecimal zeros.

Multiplication of two HFP numbers consists in exponent addition and fraction multiplication. The sum of the characteristics of the second and third operands, less 64, is used as the characteristic of the high-order part of the intermediate product; this value is independent of whether the result fraction is zero. The characteristic of the intermediate product is maintained correctly and does not wrap.

The high-order characteristic of the intermediate extended result is set to the characteristic of the intermediate product, modulo 128. The low-order characteristic of the intermediate extended result is set to 14 less than the high-order characteristic, modulo 128. Wrap-around of the characteristic is independent of whether the result fraction is zero.

In all cases, the second- and third-operand fractions have 14 digits; the intermediate-product fraction contains 28 digits and is an exact product of the operand fractions. The intermediate-product fraction is not inspected for leading hexadecimal zero digits and is used without shifting as the fraction of the intermediate extended result.

The sign of the result is the exclusive or of the operand signs, including the case when the result fraction is zero.

For MY and MYR, the entire intermediate extended result is placed in the floating-point-register pair designated by the R_1 field. For MYH and MYHR, the high-order part of the intermediate extended result is placed in the floating-point register designated by the R_1 field and the low-order part is discarded. For MYL and MYLR, the low-order part of the intermediate extended result is placed in the floating-point register designated by the R_1 field and the high-order part is discarded.

HFP-exponent-overflow and HFP-exponent-underflow exceptions are not recognized. Characteristics of the intermediate extended result wrap-around modulo 128 and no exception is reported.

The R_1 field for MY and MYR must designate a valid floating-point-register pair. Otherwise, a specification exception is recognized.

Condition Code: The code remains unchanged.

Program Exceptions:

- Access (fetch, operand 2 of MYH, MY, and MYL only)
- Data with DXC 1, AFP register
- Operation (if the HFP-unnormalized-extensions facility is not installed)
- Specification (MY and MYR)
- Transaction constraint

Programming Notes:

1. The formal definition of Long HFP numbers is in terms of a 14-digit fraction and a signed exponent in “excess-64 notation”. But, without change in function, these numbers can also be described as having a 14-digit integer and a signed exponent in “excess-78 notation”. When using the unnormalized instructions, the programmer may find it more convenient to consider these values in the later terms rather than the former. Thus, in these terms, MULTIPLY UNNORMALIZED multiplies two 14-digit integers to produce a 28-digit integer result. The characteristic of the low-order part is the sum of the operand characteristics less 78 and the high-order characteristic is set 14 larger than the low-order part. When considered as described above, MULTIPLY UNNORMALIZED provides the exact 28-digit integer product of two 14-digit integers.
2. Rather than using MY (or MYR) to provide the entire 28-digits in a floating-point-register pair, the programmer may find it more convenient to issue two separate instructions, MYH and MYL (or MYHR and MYLR), to place the high-order part and low-order part in any floating-point register. It is expected that on most machines, the performance of these two approaches is essentially the same.
3. The MULTIPLY UNNORMALIZED instruction format designates three operand locations and can be used to produce a product without overlaying the source operands. In many cases this saves an extra load.

SQUARE ROOT

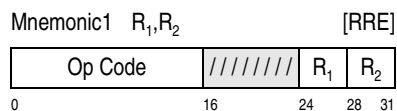

Mnemonic1	Op Code	Operands
SQER	'B245'	Short HFP
SQDR	'B244'	Long HFP
SQXR	'B336'	Extended HFP

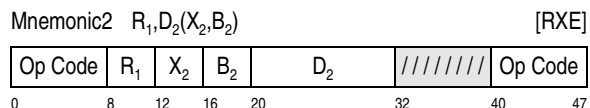

Mnemonic2	Op Code	Operands
SQE	'ED34'	Short HFP
SQD	'ED35'	Long HFP

The normalized and rounded square root of the second operand is placed at the first-operand location.

When the fraction of the second operand is zero, the sign and characteristic of the second operand are ignored, and the operation is completed by placing a positive true zero at the first-operand location.

If the second operand is less than zero, an HFP-square-root exception is recognized.

If the second operand is normalized and greater than zero, the characteristic, fraction, and sign of the result are produced as follows:

- The result characteristic is one-half of the sum of the operand characteristic and either 64, if the operand characteristic is even, or 65, if it is odd.
- If the operand characteristic is odd, the operand fraction is shifted right one digit position, the rightmost digit entering the guard-digit position.
- An intermediate-result fraction is produced by computing without rounding the square root of the operand fraction, after any right shift as described. The intermediate-result fraction consists of the 29 most significant hexadecimal digits of the square-root result in the extended format, 15 in the long format, or seven in the short format, where all three formats include a guard digit on the right.
- A one is added to the leftmost bit of the guard digit of the intermediate result, any carry is prop-

agated to the left, and the guard digit is dropped to produce the result fraction.

- The result sign is made plus.

If the second operand is unnormalized and greater than zero, the operand is first normalized. The operation then proceeds as for normalized operands.

For SQXR, the R fields must designate valid floating-point-register pairs; otherwise, a specification exception is recognized.

Condition Code: The code remains unchanged.

Program Exceptions:

- Access (fetch, operand 2 of SQE and SQD only)
- Data with DXC 1, AFP register
- HFP square root
- Specification (SQXR only)
- Transaction constraint

Programming Notes:

1. The use of the SQUARE ROOT instruction with short operands (SQER) is illustrated by the examples in the following table:

Operand (hex)	Decimal Value	Result (hex)	Decimal Value
42 190000	25.0	41 500000	5.0
40 400000	0.250	40 800000	0.50
40 800000	0.50	40 B504F3	0.7071...
41 800000	8.0	41 2D413D	2.8284...

2. The result fraction is correctly normalized without any further left or right shifts of the intermediate-result fraction and without any further exponent adjustment. Rounding cannot cause a carry out of the leftmost digit.
3. Although a characteristic greater than 127 or less than zero may temporarily be generated during the operation, the result characteristic is always within the representable range, and no HFP exponent overflow or underflow occurs.

Specifically, the smallest nonzero operand in the long format consists of a one bit, preceded on the left by 63 zeros. This operand is an unnormalized number with a value of 16^{-78} , and its square root is 16^{-39} . The normalized representation of this result has a characteristic of 26 (decimal). Similarly, the square root of the largest

representable operand has a characteristic of 96 (decimal). The instruction, therefore, cannot produce a nonzero result with a characteristic outside the range of 26 to 96.

SUBTRACT NORMALIZED

Mnemonic1 R₁,R₂ [RR]

Op Code	R ₁	R ₂
0	8	12 15

Mnemonic1	Op Code	Operands
SER	'3B'	Short HFP
SDR	'2B'	Long HFP
SXR	'37'	Extended HFP

Mnemonic2 R₁,D₂(X₂,B₂) [RX-a]

Op Code	R ₁	X ₂	B ₂	D ₂
0	8	12	16 20	31

Mnemonic2	Op Code	Operands
SE	'7B'	Short HFP
SD	'6B'	Long HFP

The second operand is subtracted from the first operand, and the normalized difference is placed at the first-operand location.

The execution of SUBTRACT NORMALIZED is identical to that of ADD NORMALIZED, except that the second operand participates in the operation with its sign bit inverted.

For SXR, the R fields must designate valid floating-point-register pairs; otherwise, a specification exception is recognized.

Resulting Condition Code:

- 0 Result is zero
- 1 Result is less than zero
- 2 Result is greater than zero
- 3 --

Program Exceptions:

- Access (fetch, operand 2 of SE and SD only)
- Data with DXC 1, AFP register
- HFP exponent overflow
- HFP exponent underflow
- HFP significance
- Specification (SXR only)
- Transaction constraint

SUBTRACT UNNORMALIZED

Mnemonic1 R₁,R₂ [RR]

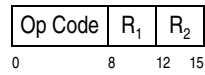

Mnemonic1	Op Code	Operands
SUR	'3F'	Short HFP
SWR	'2F'	Long HFP

Mnemonic2 R₁,D₂(X₂,B₂) [RX-a]

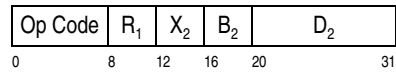

Mnemonic2	Op Code	Operands
SU	'7F'	Short HFP
SW	'6F'	Long HFP

The second operand is subtracted from the first operand, and the unnormalized difference is placed at the first-operand location.

The execution of SUBTRACT UNNORMALIZED is identical to that of ADD UNNORMALIZED, except that the second operand participates in the operation with its sign bit inverted.

Resulting Condition Code:

- 0 Result fraction zero
- 1 Result less than zero
- 2 Result greater than zero
- 3 --

Program Exceptions:

- Access (fetch, operand 2 of SU and SW only)
- Data with DXC 1, AFP register
- HFP exponent overflow
- HFP significance
- Transaction constraint

SUBTRACT UNNORMALIZED

Chapter 19. Binary-Floating-Point Instructions

Binary-Floating-Point Facility	19-1	Instructions	19-11
Floating-Point-Control (FPC) Register	19-2	ADD	19-15
BFP Arithmetic	19-2	COMPARE	19-17
BFP Data Formats	19-2	COMPARE AND SIGNAL	19-18
BFP Short Format	19-2	CONVERT FROM FIXED	19-19
BFP Long Format	19-2	CONVERT FROM LOGICAL	19-21
BFP Extended Format	19-2	CONVERT TO FIXED	19-22
Biased Exponent	19-2	CONVERT TO LOGICAL	19-25
Significand	19-3	DIVIDE	19-27
Values of Nonzero Numbers	19-3	DIVIDE TO INTEGER	19-28
Classes of BFP Data	19-4	LOAD AND TEST	19-31
Zeros	19-4	LOAD COMPLEMENT	19-31
Subnormal Numbers	19-4	LOAD FP INTEGER	19-32
Normal Numbers	19-4	LOAD LENGTHENED	19-33
Infinities	19-4	LOAD NEGATIVE	19-34
Signaling and Quiet NaNs	19-4	LOAD POSITIVE	19-35
BFP-Format Conversion	19-5	LOAD ROUNDED	19-35
BFP Rounding	19-5	MULTIPLY	19-37
BFP Comparison	19-5	MULTIPLY AND ADD	19-38
Remainder	19-5	MULTIPLY AND SUBTRACT	19-38
IEEE Exceptions	19-7	SQUARE ROOT	19-40
Summary of Rounding And Range Actions	19-8	SUBTRACT	19-40
Result Figures	19-9	TEST DATA CLASS	19-41
Data-Exception Codes (DXC) and Abbreviations	19-10		

Binary-Floating-Point Facility

The binary-floating-point (BFP) facility provides instructions to operate on binary (radix-2) floating-point data.

BFP provides a number of important advantages over hexadecimal floating point (HFP):

- Greater precision and exponent range (except for numbers in the short format where HFP has the greater range).
- Automatic rounding to the nearest value for all arithmetic operations. There are directed-rounding options that may be used instead.
- Special entities of “infinity” and “Not-a-Number” (NaN), which are accepted and handled by arithmetic operations in a reasonable fashion. They provide better defaults for exponent overflow and invalid operations (such as division of zero by

zero). This allows most programs to continue running without hiding such errors and without using specialized exception handlers.

- Exponent underflow gives “subnormal” numbers as the default, which provides more consistent results than the abrupt result of zero produced by the HFP instructions.
- The greater exponent range makes exponent overflow and underflow in correctly written programs very unlikely, so that programmers may often be able to ignore these conditions.
- Both mask and flag bits are provided for all IEEE exceptions. The mask bits enable or disable interruptions. When interruptions are disabled, the flag bits keep track of exceptions during execution so that warning messages may be issued.
- Programs can be migrated from and to workstations and other systems using different architectures and still give consistent results, provided that floating-point operations on the other sys-

tems also conform to ANSI/IEEE Standard 754-2008 (see Reference [20.] on page xxx). This does not mean, however, that bit-wise compatible results can be guaranteed, because the standard allows implementation flexibility, especially in the presence of exceptions.

Programming Note: The bit representation of the BFP data formats in storage is defined to be left-to-right in a manner that is uniform for all numeric operands in the z/Architecture architecture. Although the format diagrams in ANSI/IEEE Standard 754-2008 appear to use the same left-to-right bit sequence, the standard only defines the meaning of the bits without specifying how they appear in storage; the storage arrangement is left to the implementation. Several implementations in fact use other sequences; this may affect programs which are dependent on the bit representation of floating-point data in storage.

Floating-Point-Control (FPC) Register

The floating-point-control (FPC) register is a 32-bit register that contains mask bits, flag bits, a data-exception code, and two rounding-mode fields. The FPC register is described in the section “Floating-Point-Control (FPC) Register” on page 9-9. An overview of the FPC register is shown in Figure 9-5 on page 9-9. Details are shown in Figure 9-6 on page 9-9, Figure 9-7 on page 9-10, and in Figure 9-8 on page 9-10. (In Figure 9-6 on page 9-9, the abbreviations “IM” and “SF” are based on the terms “interruption mask” and “status flag,” respectively.)

The bits of the FPC register are often referred to as, for example, FPC 1.0, meaning bit 0 of byte 1 of the register.

BFP Arithmetic

BFP Data Formats

Binary-floating-point data may be represented in any of three formats: short, long, or extended.

BFP Short Format

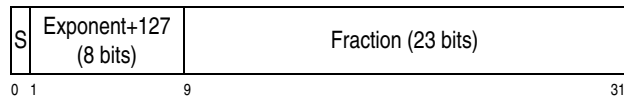

Figure 19-1. BFP Short Format (4 bytes)

When an operand in the BFP short format is loaded into a floating-point register, it occupies the left half of the register, and the right half remains unchanged.

BFP Long Format

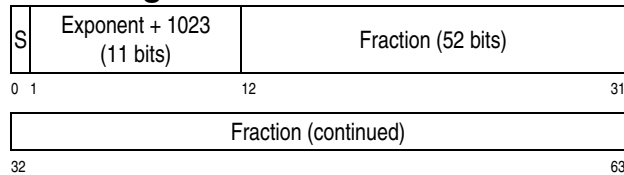

Figure 19-2. BFP Long Format (8 bytes)

When an operand in the BFP long format is loaded into a floating-point register, it occupies the entire register.

BFP Extended Format

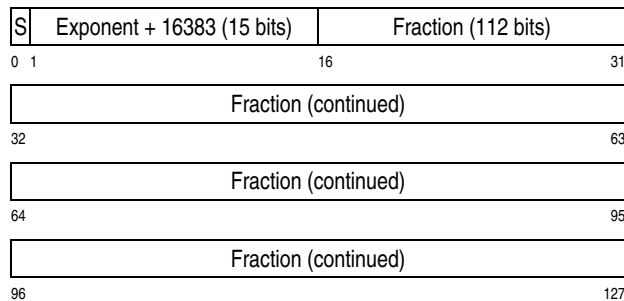

Figure 19-3. BFP Extended Format (16 bytes)

An operand in the BFP extended format occupies a register pair. The sign and biased exponent are in the leftmost 16 bits of the lower-numbered register of the pair and are followed by the leftmost 48 bits of the fraction. The rightmost 64 bits of the fraction are in the higher-numbered register of the pair.

The properties of the three formats are tabulated in Figure 19-4 on page 19-3.

Biased Exponent

For each format, the bias that is used to allow all exponents to be expressed as unsigned numbers is shown in the Figure 19-4 on page 19-3. Biased exponents are similar to the characteristics of the HFP format, except that special meanings are attached to

Property	Format		
	Short	Long	Extended
Format length (bits)	32	64	128
Biased-exponent length (bits)	8	11	15
Fraction length (bits)	23	52	112
Precision (p)	24	53	113
Maximum left-units-view (LUV) exponent (Emax)	127	1023	16383
Minimum left-units-view (LUV) exponent (Emin)	-126	-1022	-16382
Left-units-view (LUV) bias	127	1023	16383
Nmax	$(1-2^{-24})x2^{128}$ $\approx 3.4x10^{38}$	$(1-2^{-53})x2^{1024}$ $\approx 1.8x10^{308}$	$(1-2^{-113})x2^{16384}$ $\approx 1.2x10^{4932}$
Nmin	$1.0x2^{-126}$ $\approx 1.2x10^{-38}$	$1.0x2^{-1022}$ $\approx 2.2x10^{-308}$	$1.0x2^{-16382}$ $\approx 3.4x10^{-4932}$
Dmin	$1.0x2^{-149}$ $\approx 1.4x10^{-45}$	$1.0x2^{-1074}$ $\approx 4.9x10^{-324}$	$1.0x2^{-16494}$ $\approx 6.5x10^{-4966}$
Explanation:			
<p>≈ Value is approximate.</p> <p>Dmin Smallest (in magnitude) representable subnormal number.</p> <p>Nmax Largest (in magnitude) representable finite number.</p> <p>Nmin Smallest (in magnitude) representable normal number.</p>			

Figure 19-4. Summary of BFP Data Formats

biased exponents of all zeros and all ones, which are discussed in the section “Classes of BFP Data” on page 19-4.

Significand

In each format, the binary point of a BFP number is considered to be to the left of the leftmost fraction bit. To the left of the binary point there is an implied unit bit, which is considered to be one for normal numbers and zero for zeros and subnormal numbers. The fraction with the implied unit bit appended on the left is the *significand* of the number.

The value of a normal BFP number is the significand multiplied by the radix 2 raised to the power of the unbiased exponent. The value of a subnormal BFP number is the significand multiplied by the radix 2 raised to the power of the minimum exponent.

A value of one in the rightmost bit position of the significand in each format is sometimes referred to as one ulp (unit in the last place).

Values of Nonzero Numbers

The values of nonzero numbers in the various formats are shown in Figure 19-5.

Number Class	Format	Value
Normal	Short	$\pm 2^{e-127}x(1.f)$
	Long	$\pm 2^{e-1023}x(1.f)$
	Extended	$\pm 2^{e-16383}x(1.f)$
Subnormal	Short	$\pm 2^{-126}x(0.f)$
	Long	$\pm 2^{-1022}x(0.f)$
	Extended	$\pm 2^{-16382}x(0.f)$
Explanation:		
e	Biased exponent (shown in decimal).	
f	Fraction (in binary).	

Figure 19-5. Values of Nonzero Numbers

Programming Note: ANSI/IEEE Standard 754-2008 specifies minimum requirements for the extended format but does not include details. The BFP extended format meets these requirements, far exceeding them in the area of precision.

Classes of BFP Data

There are six classes of BFP data, which include numeric and related nonnumeric entities. Each data item consists of a sign, an exponent, and a significand. The exponent is biased such that all biased exponents are nonnegative unsigned numbers and the minimum biased exponent is zero. The significand consists of an explicit fraction and an implicit unit bit to the left of the binary point. The sign bit is zero for plus and one for minus.

All nonzero finite numbers permitted by a given format have a unique BFP representation. There are no unnormalized numbers, which numbers might allow multiple representations for the same values, and there are no unnormalized arithmetic operations. Tiny numbers of a magnitude below the minimum normal number in a given format are represented as *subnormal* numbers, but those values are also represented uniquely. The implied unit bit of a normal number is one, and that of a subnormal number or a zero is zero.

The six classes of BFP data are summarized in Figure 19-6 on page 19-4.

Data Class	Sign	Biased Exponent	Unit Bit*	Fraction
Zero	±	0	0	0
Subnormal numbers	±	0**	0	Not 0
Normal numbers	±	Not 0, not all ones	1	Any
Infinity	±	All ones	—	0
Quiet NaN	±	All ones	—	F0=1, Fr=any
Signaling NaN	±	All ones	—	F0=0, Fr≠0

Explanation:

— Does not apply.
 * The unit bit is implied.
 ** The biased exponent is treated arithmetically as if it had the value one.
 F0 Leftmost bit of fraction.
 Fr Remaining bits of fraction.
 NaN Not-a-number.

Figure 19-6. Classes of BFP Data

The instruction TEST DATA CLASS may be used to determine the class of a BFP operand.

Zeros

Zeros have a biased exponent of zero and a zero fraction. The implied unit bit is zero. A +0 is distinct from -0, except that comparison treats them as equal.

Subnormal Numbers

Subnormal numbers are numbers which are smaller than the smallest normal number and greater than zero in magnitude. They have a biased exponent of zero and a nonzero fraction. The biased exponent is treated arithmetically as if it were one, which causes the exponent to be the minimum exponent. The implied unit bit is zero. (In ANSI/IEEE Standard 754-1985, subnormal numbers were called “denormalized numbers”.)

Normal Numbers

Normal numbers have a biased exponent greater than zero but less than all ones. The implied unit bit is one, and the fraction may have any value. (In some early documentation, normal numbers were called “normalized numbers”.)

Infinities

An infinity is represented by a biased exponent of all ones and a zero fraction. Infinities can participate in most arithmetic operations and give a consistent result, usually infinity. In comparisons, $+\infty$ compares greater than any finite number, and $-\infty$ compares less than any finite number.

Signaling and Quiet NaNs

A NaN (not-a-number) entity is represented by a biased exponent of all ones and a nonzero fraction. NaNs are produced in place of a numeric result after an invalid operation when there is no interruption. NaNs may also be used by the program to flag special operands, such as the contents of an uninitialized storage area.

There are two types of NaNs, signaling and quiet. A signaling NaN (SNaN) is distinguished from the corresponding quiet NaN (QNaN) by the leftmost fraction bit: zero for the SNaN and one for the QNaN. A special QNaN is supplied as the default result for an IEEE-invalid-operation exception; it has a plus sign and a leftmost fraction bit of one, with the remaining fraction bits being set to zeros.

Normally, QNaNs are just propagated during computations so that they will remain visible at the end. An

SNaN operand causes an IEEE-invalid-operation exception. If the IEEE-invalid-operation mask (FPC 0.0) is zero, the result is the corresponding QNaN, which is produced by setting the leftmost fraction bit to one, and the IEEE-invalid-operation flag (FPC 1.0) is set to one. If the IEEE-invalid-operation mask (FPC 0.0) is one, the operation is suppressed, and a data exception for IEEE-invalid operation occurs.

Where applicable, the propagation of NaNs is illustrated in the action figure for an instruction.

Programming Notes:

1. The program can generate and assign meanings to any nonzero fraction values of a NaN. The CPU propagates those values unchanged, except that an SNaN is changed to the corresponding QNaN if the IEEE-invalid-operation mask bit is zero, and conversion to a narrower format may truncate significant bits on the right.
2. ANSI/IEEE Standard 754-2008 requires SNaNs to signal the invalid-operation exception for the arithmetic, comparison, and conversion operations that are part of the standard, but it makes it an implementation option whether copying an SNaN without a change of format signals the exception. In the appendix, the standard also makes it an implementation option whether SNaNs should signal the invalid-operation exception for the recommended functions of copying the sign, taking the absolute value, reversing the sign, and testing the data class of a datum.

The above functions generally correspond to the instructions LOAD, LOAD COMPLEMENT, LOAD NEGATIVE, LOAD POSITIVE, and TEST DATA CLASS. These instructions do not signal the invalid-operation exception but, instead, treat SNaNs like any other data; giving an exception would be disruptive when the intention is to include SNaNs. TEST DATA CLASS does not give an exception since it is the instruction with which to test for the presence of SNaNs.
3. LOAD AND TEST signals the invalid-operation exception when the operand is an SNaN. This instruction, in conjunction with the above instructions, gives the program the choice of either option permitted by ANSI/IEEE Standard 754-2008.

4. Load-type instructions which change the precision signal the invalid-operation exception when the operand is an SNaN, as this is required by ANSI/IEEE Standard 754-2008.

BFP-Format Conversion

BFP format conversion is described in the section “IEEE Same-Radix Format Conversion” on page 9-23.

BFP Rounding

BFP rounding is described in the section “IEEE Rounding” on page 9-13.

BFP Comparison

BFP comparison is described in the section “IEEE Comparison” on page 9-24.

Remainder

The instruction DIVIDE TO INTEGER produces two floating-point results, an exact integer quotient and the corresponding remainder. The remainder is defined as follows:

Let

a = Dividend
b = Divisor
q = Exact quotient (a÷b)
r = Remainder

in the selected floating-point format. Then

$$r = a - b \cdot n$$

where n is an integer. If q is an integer, then n equals q. Otherwise, n is obtained by rounding q according to a final-quotient-rounding method.

When the final-quotient-rounding method is round to nearest with ties to even or round toward zero, the remainder is exact for any finite dividend and any nonzero divisor. The remainder cannot overflow.

If the integer quotient has a value that lies outside the range of the operand format, a scaled result is provided.

In certain cases where the number of bits in the integer quotient exceeds or may exceed the maximum number of bits provided in the precision of the operand format, partial results are produced, and more than one execution of the instruction is required to obtain the final result; this may be done with a simple instruction loop.

Partial results are produced when the precise quotient is not an integer and the two integers closest to this precise quotient cannot both be represented exactly in the precision of the quotient. This situation exists when the precise quotient is greater than 2^P , where P is the precision of the operand format, and the remainder is not zero. When the remainder is zero, then the quotient is an integer, and the number of bits required to represent the quotient is never more than the precision of the target.

Programming Note: The remainder result of DIVIDE TO INTEGER with a final-quotient-rounding method of round to nearest with ties to even corresponds to the *Remainder* function in ANSI/IEEE Standard 754-

2008. This function is similar to the *MOD* function found in some languages and to the mathematical *modulo* function, but they are not the same. They differ in the definition of n:

Remainder	n is q rounded to nearest with ties to even.
modulo	n is q rounded toward $-\infty$.
MOD	n is q rounded toward 0.

Another important difference is that implementations of modulo and MOD may put range restrictions on the result because they may simply use the DIVIDE instruction and accept its range restrictions.

The MOD definition provides an exact result, as does Remainder, but the modulo definition may result in rounding errors.

The differences between the various methods may be illustrated by the simple example of computing a divided by b to obtain an integer quotient n, where a is a series of integers, and b is +4 or -4. Figure 19-7 shows the results for the three definitions.

		a																	
		-8	-7	-6	-5	-4	-3	-2	-1	-0	+0	+1	+2	+3	+4	+5	+6	+7	+8
		Remainder																	
b=+4:	n	-2	-2	-2	-1	-1	-1	-0	-0	-0	+0	+0	+0	+1	+1	+1	+2	+2	+2
	r	-0	+1	+2	-1	-0	1	-2	-1	-0	+0	+1	+2	-1	+0	+1	-2	-1	+0
b=-4:	n	+2	+2	+2	+1	+1	+1	+0	+0	+0	-0	-0	-0	-1	-1	-1	-2	-2	-2
	r	-0	+1	+2	-1	-0	+1	-2	-1	-0	+0	+1	+2	-1	+0	+1	-2	-1	+0
		MOD																	
b=+4:	n	-2	-1	-1	-1	-1	0	0	0	0	0	0	0	+1	+1	+1	+1	+1	+2
	r	0	-3	-2	-1	0	-3	-2	-1	0	+1	+2	+3	0	+1	+2	+3	0	
b=-4:	n	+2	+1	+1	+1	+1	0	0	0	0	0	0	0	-1	-1	-1	-1	-1	-2
	r	0	-3	-2	-1	0	-3	-2	-1	0	+1	+2	+3	0	+1	+2	+3	0	
		modulo																	
b=+4:	n	-2	-2	-2	-2	-1	-1	-1	-1	0	0	0	0	+1	+1	+1	+1	+1	+2
	r	0	+1	+2	+3	0	+1	+2	+3	0	+1	+2	+3	0	+1	+2	+3	0	
b=-4:	n	+2	+1	+1	+1	+1	0	0	0	0	-1	-1	-1	-1	-2	-2	-2	-2	
	r	0	-3	-2	-1	0	-3	-2	-1	0	-3	-2	-1	0	-3	-2	-1	0	
Explanation:																			
a	Dividend.																		
b	Divisor.																		
n	Integer quotient.																		
r	Result (Remainder, MOD, or modulo).																		

Figure 19-7. Comparison of Remainder with MOD and Modulo

The result of Remainder lies in the range of zero to one-half the divisor, inclusive, in magnitude. A zero result is defined to have the sign of the dividend. A zero divisor is invalid.

The modulo and MOD results can both be computed from the Remainder result; the reverse may not be true, because of rounding errors and, depending on the implementation, range restrictions.

An extreme example of the rounding error that can occur with the modulo definition is the following, where the result is restricted to two significant decimal digits:

$\text{modulo}(0.01, -95) = -94.99$, which rounds to -95

$\text{Remainder}(0.01, -95) = 0.01$

The properly rounded modulo result is completely wrong since it is equal to the divisor instead of being smaller in magnitude. The Remainder result is exact and can be used to compute the theoretical result of modulo.

Remainder is included as an arithmetic operation because of its usefulness in argument reduction when computing elementary transcendental functions. Thus, $\text{SIN}(X)$ can be computed to full precision for any value of X in degrees by first reducing the argument to $\text{Remainder}(X, 360)$.

IEEE Exceptions

The IEEE exceptions for the BFP instructions are described in the section “IEEE Exceptions” on page 9-18.

Summary of Rounding And Range Actions

Figure 19-8 summarizes the BFP rounding and range actions.

Range of v	Case	Nontrap Result (r) when Effective Rounding Method Is				
		To Nearest with ties to even	Toward 0	Toward +∞	Toward -∞	Prepare for shorter precision
$v < -N_{max}, g < -N_{max}$	Overflow	$-\infty^1$	-Nmax	-Nmax	$-\infty^1$	-Nmax
$v < -N_{max}, g = -N_{max}$	Normal	-Nmax	-Nmax	-Nmax	–	-Nmax
$-N_{max} \leq v \leq -N_{min}$	Normal	g	g	g	g	g
$-N_{min} < v \leq -D_{min}$	Tiny	d*	d	d	d*	d
$-D_{min} < v < -D_{min}/2$	Tiny	-Dmin	-0	-0	-Dmin	-Dmin
$-D_{min}/2 \leq v < 0$	Tiny	-0	-0	-0	-Dmin	-Dmin
$v = 0$	Exact zero difference ²	+0	+0	+0	-0	+0
$0 < v \leq +D_{min}/2$	Tiny	+0	+0	+Dmin	+0	+Dmin
$+D_{min}/2 < v < +D_{min}$	Tiny	+Dmin	+0	+Dmin	+0	+Dmin
$+D_{min} \leq v < +N_{min}$	Tiny	d*	d	d*	d	d
$+N_{min} \leq v \leq +N_{max}$	Normal	g	g	g	g	g
$+N_{max} < v, g = +N_{max}$	Normal	+Nmax	+Nmax	–	+Nmax	+Nmax
$+N_{max} < v, +N_{max} < g$	Overflow	$+\infty^1$	+Nmax	$+\infty^1$	+Nmax	+Nmax

Explanation:

- This situation cannot occur.
- * The rounded value, in the extreme case, may be Nmin. In this case, the exceptions are underflow, inexact and incremented.
- ¹ The nontrap result r is considered to have been incremented.
- ² The exact-zero-difference case applies only to ADD, SUBTRACT, MULTIPLY AND ADD, and MULTIPLY AND SUBTRACT. For all other BFP operations, a zero result is detected by inspection of the source operands without use of the R(v) function.
- d The denormalized value. The value derived when the precise intermediate value (v) is rounded to the format of the target, including both precision and bounded exponent range. Except as explained in note *, this is a subnormal number.
- g The precision-rounded value. The value derived when the precise intermediate value (v) is rounded to the precision of the target, but assuming an unbounded exponent range.
- v Precise intermediate value. This is the value, before rounding, assuming unbounded precision and an unbounded exponent range. For LOAD ROUNDED, v is the source value (a).
- Dmin Smallest (in magnitude) representable subnormal number in the target format.
- Nmax Largest (in magnitude) representable finite number in the target format.
- Nmin Smallest (in magnitude) representable normal number in the target format.

Figure 19-8. Action for R(v): Rounding and Range Function (Part 1 of 2)

Case	Is r Inexact (r≠v)	Overflow Mask (FPC 0.2)	Underflow Mask (FPC 0.3)	IEEE Inexact Exception Control (XxC) ²	Inexact Mask (FPC 0.4)	Is r Incremented (r > v)	Is g Inexact (g≠v)	Is g Incremented (g > v)	Results
Overflow	Yes ¹	0	–	1	–	–	–	–	T(r), SFo←1
Overflow	Yes ¹	0	–	0	0	–	–	–	T(r), SFo←1, SFx←1
Overflow	Yes ¹	0	–	0	1	No	–	–	T(r), SFo←1, PIDx(08)
Overflow	Yes ¹	0	–	0	1	Yes	–	–	T(r), SFo←1, PIDy(0C)
Overflow	Yes ¹	1	–	–	–	–	No	No ¹	Tw(g÷Ψ), PIDo(20)
Overflow	Yes ¹	1	–	–	–	–	Yes	No	Tw(g÷Ψ), PIDox(28)
Overflow	Yes ¹	1	–	–	–	–	Yes	Yes	Tw(g÷Ψ), PIDoy(2C)
Normal	No	–	–	–	–	–	–	–	T(r)
Normal	Yes	–	–	1	–	–	–	–	T(r)
Normal	Yes	–	–	0	0	–	–	–	T(r), SFx←1
Normal	Yes	–	–	0	1	No	–	–	T(r), PIDx(08)
Normal	Yes	–	–	0	1	Yes	–	–	T(r), PIDy(0C)
Tiny	No	–	0	–	–	–	–	–	T(r)
Tiny	No	–	1	–	–	–	No ¹	No ¹	Tw(g÷Ψ), PIDu(10)
Tiny	Yes	–	0	1	–	–	–	–	T(r), SFu←1
Tiny	Yes	–	0	0	0	–	–	–	T(r), SFu←1, SFx←1
Tiny	Yes	–	0	0	1	No	–	–	T(r), SFu←1, PIDx(08)
Tiny	Yes	–	0	0	1	Yes	–	–	T(r), SFu←1, PIDy(0C)
Tiny	Yes	–	1	–	–	–	No	No ¹	Tw(g÷Ψ), PIDu(10)
Tiny	Yes	–	1	–	–	–	Yes	No	Tw(g÷Ψ), PIDux(18)
Tiny	Yes	–	1	–	–	–	Yes	Yes	Tw(g÷Ψ), PIDuy(1C)

Explanation:

– The results do not depend on this condition or mask bit.

¹ This condition is true by virtue of the state of some condition to the left of this column.

² The IEEE-inexact-exception control (XxC) is defined only if the floating-point extension facility is installed.

Ψ Scale factor. For overflow, $\Psi = 2^{+\alpha}$. For underflow, $\Psi = 2^{-\alpha}$. The unsigned scaling exponent (α) depends on the type of operation and operand format. For all BFP operations except LOAD ROUNDED, α depends on the target format and is 192 for short, 1536 for long, and 24576 for extended. For LOAD ROUNDED, α depends on the source format, and is 512 for long and 8192 for extended.

g The precision-rounded value. The value derived when the precise intermediate value (v) is rounded to the precision of the target, but assuming an unbounded exponent range.

r Nontrap result as defined in Part 1 of this figure.

v Precise intermediate value. This is the value, before rounding, assuming unbounded precision and unbounded exponent range.

PIDc(h) Program interruption for data exception, condition c, with DXC of h in hex. See Figure 19-10 on page 19-11.

SFo IEEE overflow flag, FPC 1.2.

SFu IEEE underflow flag, FPC 1.3.

SFx IEEE inexact flag, FPC 1.4.

T(x) The value x is placed at the target operand location.

Tw(x) The scaled result x is placed at the target operand location. For all operations except BFP LOAD ROUNDED, the scaled result is in the format and length of the target and rounded to the precision of the target. For LOAD ROUNDED, the scaled result is in the format and length of the source, but rounded to the precision of the target.

Figure 19-8. Action for R(v): Rounding and Range Function (Part 2 of 2)

Result Figures

Concise descriptions of the results produced by many of the BFP instructions are made by means of figures which contain columns and rows representing all possible combinations of BFP data class for the source operands of an instruction. The information shown at the intersection of a row and a column is one or more symbols representing the result or results produced for that particular combination of

source-operand data classes. Explanations of the symbols used are contained in each figure. In many cases, the explanation of a particular result is in the form of a cross reference to another figure. In many cases, the information shown at the intersection consists of several symbols separated by commas. All such results are produced unless one of the results is a program interruption. In the case of a program interruption, the operation is suppressed or completed as shown in Figure 19-10 on page 19-11.

Data-Exception Codes (DXC) and Abbreviations

Figure 19-9 shows IEEE exceptions and flag abbreviations that are used in the result figures, and it explains the symbols “Xi:” and “Xz:” that are used in the figures. Bits 0-4 (i, z, o, u, and x) of the eight-bit data-exception code (DXC) in byte 2 of the FPC register are trap flags and correspond to the same bits in bytes 0 and 1 of the register (IEEE masks and IEEE flags). The trap flag for an exception, instead of the IEEE flag, is set to one when an interruption for the exception is enabled by the corresponding IEEE mask bit. Bit 5 of byte 2 (y) is used in conjunction with bit 4, inexact (x), to indicate that the result has been incremented in magnitude.

Exception		FPC IEEE Mask Bit	IEEE Flag	
Name	Abbr.		FPC Bit	Abbr.
IEEE invalid operation	Xi ¹	0.0	1.0	SFi
IEEE division by zero	Xz ²	0.1	1.1	SFz
IEEE overflow	Xo	0.2	1.2	SFo
IEEE underflow	Xu	0.3	1.3	SFu
IEEE inexact	Xx	0.4	1.4	SFx

Explanation:

¹ The symbol “Xi:” followed by a list of results in a figure indicates that, when FPC 0.0 is zero, then instruction execution is completed by setting SFi (FPC 1.0) to one and producing the indicated results; and when FPC 0.0 is one, then instruction execution is suppressed, the data exception code (DXC) is set to 80 hex, and a program interruption for a data exception occurs.

² The symbol “Xz:” followed by a list of results in a figure indicates that, when FPC 0.1 is zero, then instruction execution is completed by setting SFz (FPC 1.1) to one and producing the indicated results; and when FPC 0.1 is one, then instruction execution is suppressed, the data exception code (DXC) is set to 40 hex, and a program interruption for a data exception occurs.

Figure 19-9. IEEE Exception and Flag Abbreviations

Figure 19-10 on page 19-11 shows the various DXCs that can be indicated, the associated instruction endings, and abbreviations that are used for the DXCs in the result figures. (The abbreviation “PID” stands for “program interruption for a data exception.”)

Abbr.	DXC (Hex)	Data-Exception-Code Name	Instruction Ending
PIDx	08	IEEE inexact and truncated	Complete
PIDy	0C	IEEE inexact and incremented	Complete
PIDu	10	IEEE underflow, exact	Complete, scale exponent
PIDux	18	IEEE underflow, inexact and truncated	Complete, scale exponent
PIDuy	1C	IEEE underflow, inexact and incremented	Complete, scale exponent
PIDo	20	IEEE overflow, exact	Complete, scale exponent
PIDox	28	IEEE overflow, inexact and truncated	Complete, scale exponent
PIDoy	2C	IEEE overflow, inexact and incremented	Complete, scale exponent
PIDz	40	IEEE division by zero	Suppress
PIDi	80	IEEE invalid operation	Suppress

Figure 19-10. IEEE Data-Exception Codes (DXC) and Abbreviations

Instructions

The BFP instructions and their mnemonics and operation codes are listed in Figure 19-11 on page 19-12.

The figure indicates, in the column labeled “Characteristics”, the instruction format, when the condition code is set, the instruction fields that designate access registers, and the exceptional conditions in operand designations, data, or results that cause a program interruption.

All BFP instructions are subject to the AFP-register-control bit, bit 45 of control register 0. For the BFP instructions to be executed successfully, the AFP-register-control bit must be one; otherwise, a BFP-instruction data exception, DXC 2, is recognized.

Mnemonics for the BFP instructions are distinguished from the corresponding HFP instructions by a B in the mnemonic. Mnemonics for the BFP instructions have an R as the last letter or the letter next to the last letter when the instruction is in the RRE or RRF format. Mnemonics for the BFP instructions have an A as the last letter when the instruction is an alternate instruction, which uses additional modifier fields not available to the original instruction. Certain letters are used for BFP instructions to represent operand-format length, as follows:

- F Thirty-two-bit signed fixed point
- G Sixty-four-bit signed fixed point
- LF Thirty-two-bit unsigned fixed point
- LG Sixty-four-bit unsigned fixed point
- D Long
- E Short
- X Extended

Note: In the detailed descriptions of the individual instructions, the mnemonic and the symbolic operand designation for the assembler language are shown with each instruction. For a register-to-register operation using COMPARE (short), for example, CEBR is the mnemonic and R_1, R_2 the operand designation.

Programming Note: The floating-point extension facility includes the following BFP features:

- The following new BFP instructions are added:
 - CONVERT FROM LOGICAL (CXLFBFR, CDLFBFR, CELFBFR, CXLGBR, CDLGBR, and CELGBR).
 - CONVERT TO LOGICAL (CLFXBR, CLFDBR, CLFEFR, CLGXBR, CLGDBR, and CLGEFR)
- One new value of the effective rounding method field is assigned to support the round to prepare for shorter precision rounding method for CONVERT TO FIXED, DIVIDE TO INTEGER, and LOAD FP INTEGER
- An IEEE-inexact-exception control (XxC) is added to CONVERT TO FIXED and LOAD FP INTEGER.

- An effective rounding method field and an IEEE-inexact-exception control (XxC) are added to CONVERT FROM FIXED and LOAD ROUNDED.

Name	Mnemonic	Characteristics							Op Code	Page			
ADD (extended BFP)	AXBR	RRE	C	$\alpha^{7,9}$	SP	Db	Xi	Xo	Xu	Xx	B ₂	B34A	19-15
ADD (long BFP)	ADB	RXE	C	$\alpha^{7,9}$	A	Db	Xi	Xo	Xu	Xx	B ₂	ED1A	19-15
ADD (long BFP)	ADBR	RRE	C	$\alpha^{7,9}$		Db	Xi	Xo	Xu	Xx	B ₂	B31A	19-15
ADD (short BFP)	AEB	RXE	C	$\alpha^{7,9}$	A	Db	Xi	Xo	Xu	Xx	B ₂	ED0A	19-15
ADD (short BFP)	AEBR	RRE	C	$\alpha^{7,9}$		Db	Xi	Xo	Xu	Xx		B30A	19-15
COMPARE (extended BFP)	CXBR	RRE	C	$\alpha^{7,9}$	SP	Db	Xi				B ₂	B349	19-17
COMPARE (long BFP)	CDB	RXE	C	$\alpha^{7,9}$	A	Db	Xi				B ₂	ED19	19-17
COMPARE (long BFP)	CDBR	RRE	C	$\alpha^{7,9}$		Db	Xi				B ₂	B319	19-17
COMPARE (short BFP)	CEB	RXE	C	$\alpha^{7,9}$	A	Db	Xi				B ₂	ED09	19-17
COMPARE (short BFP)	CEBR	RRE	C	$\alpha^{7,9}$		Db	Xi					B309	19-17
COMPARE AND SIGNAL (extended BFP)	KXBR	RRE	C	$\alpha^{7,9}$	SP	Db	Xi				B ₂	B348	19-18
COMPARE AND SIGNAL (long BFP)	KDB	RXE	C	$\alpha^{7,9}$	A	Db	Xi				B ₂	ED18	19-18
COMPARE AND SIGNAL (long BFP)	KDBR	RRE	C	$\alpha^{7,9}$		Db	Xi				B ₂	B318	19-18
COMPARE AND SIGNAL (short BFP)	KEB	RXE	C	$\alpha^{7,9}$	A	Db	Xi				B ₂	ED08	19-18
COMPARE AND SIGNAL (short BFP)	KEBR	RRE	C	$\alpha^{7,9}$		Db	Xi					B308	19-18
CONVERT FROM FIXED (32 to extended BFP)	CXFBR	RRE		$\alpha^{7,9}$	SP	Db						B396	19-19
CONVERT FROM FIXED (32 to extended BFP)	CXFBRA	RRF-e	F	$\alpha^{7,9}$	SP	Db						B396	19-19
CONVERT FROM FIXED (32 to long BFP)	CDFBR	RRE		$\alpha^{7,9}$		Db						B395	19-19
CONVERT FROM FIXED (32 to long BFP)	CDFBRA	RRF-e	F	$\alpha^{7,9}$	SP	Db						B395	19-19
CONVERT FROM FIXED (32 to short BFP)	CEFBR	RRE		$\alpha^{7,9}$		Db			Xx			B394	19-19
CONVERT FROM FIXED (32 to short BFP)	CEFBRA	RRF-e	F	$\alpha^{7,9}$	SP	Db			Xx			B394	19-19
CONVERT FROM FIXED (64 to extended BFP)	CXGBR	RRE	N	$\alpha^{7,9}$	SP	Db						B3A6	19-19
CONVERT FROM FIXED (64 to extended BFP)	CXGBRA	RRF-e	F	$\alpha^{7,9}$	SP	Db						B3A6	19-19
CONVERT FROM FIXED (64 to long BFP)	CDGBR	RRE	N	$\alpha^{7,9}$		Db			Xx			B3A5	19-19
CONVERT FROM FIXED (64 to long BFP)	CDGBRA	RRF-e	F	$\alpha^{7,9}$	SP	Db			Xx			B3A5	19-19
CONVERT FROM FIXED (64 to short BFP)	CEGBR	RRE	N	$\alpha^{7,9}$		Db			Xx			B3A4	19-19
CONVERT FROM FIXED (64 to short BFP)	CEGBRA	RRF-e	F	$\alpha^{7,9}$	SP	Db			Xx			B3A4	19-19
CONVERT FROM LOGICAL (32 to extended BFP)	CXLFBR	RRF-e	F	$\alpha^{7,9}$	SP	Db						B392	19-21
CONVERT FROM LOGICAL (32 to long BFP)	CDLFBR	RRF-e	F	$\alpha^{7,9}$	SP	Db						B391	19-21
CONVERT FROM LOGICAL (32 to short BFP)	CELFBR	RRF-e	F	$\alpha^{7,9}$	SP	Db			Xx			B390	19-21
CONVERT FROM LOGICAL (64 to extended BFP)	CXLGBR	RRF-e	F	$\alpha^{7,9}$	SP	Db						B3A2	19-21
CONVERT FROM LOGICAL (64 to long BFP)	CDLGBR	RRF-e	F	$\alpha^{7,9}$	SP	Db			Xx			B3A1	19-21
CONVERT FROM LOGICAL (64 to short BFP)	CELGBR	RRF-e	F	$\alpha^{7,9}$	SP	Db			Xx			B3A0	19-21
CONVERT TO FIXED (extended BFP to 32)	CFXBR	RRF-e	C	$\alpha^{7,9}$	SP	Db	Xi		Xx			B39A	19-22
CONVERT TO FIXED (extended BFP to 32)	CFXBRA	RRF-e	C	$\alpha^{7,9}$	SP	Db	Xi		Xx			B39A	19-22
CONVERT TO FIXED (extended BFP to 64)	CGXBR	RRF-e	C	$\alpha^{7,9}$	SP	Db	Xi		Xx			B3AA	19-22
CONVERT TO FIXED (extended BFP to 64)	CGXBRA	RRF-e	C	$\alpha^{7,9}$	SP	Db	Xi		Xx			B3AA	19-22
CONVERT TO FIXED (long BFP to 32)	CFDBR	RRF-e	C	$\alpha^{7,9}$	SP	Db	Xi		Xx			B399	19-22
CONVERT TO FIXED (long BFP to 32)	CFDBRA	RRF-e	C	$\alpha^{7,9}$	SP	Db	Xi		Xx			B399	19-22
CONVERT TO FIXED (long BFP to 64)	CGDBR	RRF-e	C	$\alpha^{7,9}$	SP	Db	Xi		Xx			B3A9	19-22
CONVERT TO FIXED (long BFP to 64)	CGDBRA	RRF-e	C	$\alpha^{7,9}$	SP	Db	Xi		Xx			B3A9	19-22
CONVERT TO FIXED (short BFP to 32)	CFEBR	RRF-e	C	$\alpha^{7,9}$	SP	Db	Xi		Xx			B398	19-22
CONVERT TO FIXED (short BFP to 32)	CFEBRA	RRF-e	C	$\alpha^{7,9}$	SP	Db	Xi		Xx			B398	19-22
CONVERT TO FIXED (short BFP to 64)	CGEBR	RRF-e	C	$\alpha^{7,9}$	SP	Db	Xi		Xx			B3A8	19-22
CONVERT TO FIXED (short BFP to 64)	CGEBRA	RRF-e	C	$\alpha^{7,9}$	SP	Db	Xi		Xx			B3A8	19-22
CONVERT TO LOGICAL (extended BFP to 32)	CLFXBR	RRF-e	C	$\alpha^{7,9}$	SP	Db	Xi		Xx			B39E	19-25
CONVERT TO LOGICAL (extended BFP to 64)	CLGXBR	RRF-e	C	$\alpha^{7,9}$	SP	Db	Xi		Xx			B3AE	19-25

Figure 19-11. Summary of BFP Instructions (Part 1 of 3)

Name	Mnemonic	Characteristics						Op Code	Page
CONVERT TO LOGICAL (long BFP to 32)	CLFDBR	RRF-e	C	F	$\alpha^{7,9}$	SP	Db Xi Xx	B39D	19-25
CONVERT TO LOGICAL (long BFP to 64)	CLGDBR	RRF-e	C	F	$\alpha^{7,9}$	SP	Db Xi Xx	B3AD	19-25
CONVERT TO LOGICAL (short BFP to 32)	CLFEBR	RRF-e	C	F	$\alpha^{7,9}$	SP	Db Xi Xx	B39C	19-25
CONVERT TO LOGICAL (short BFP to 64)	CLGEBR	RRF-e	C	F	$\alpha^{7,9}$	SP	Db Xi Xx	B3AC	19-25
DIVIDE (extended BFP)	DXBR	RRE			$\alpha^{7,9}$	SP	Db Xi Xz Xo Xu Xx	B34D	19-27
DIVIDE (long BFP)	DDB	RXE			$\alpha^{7,9}$	A	Db Xi Xz Xo Xu Xx	B ₂ ED1D	19-27
DIVIDE (long BFP)	DDBR	RRE			$\alpha^{7,9}$		Db Xi Xz Xo Xu Xx	B31D	19-27
DIVIDE (short BFP)	DEB	RXE			$\alpha^{7,9}$	A	Db Xi Xz Xo Xu Xx	B ₂ ED0D	19-27
DIVIDE (short BFP)	DEBR	RRE			$\alpha^{7,9}$		Db Xi Xz Xo Xu Xx	B30D	19-27
DIVIDE TO INTEGER (long BFP)	DIDBR	RRF-b	C		$\alpha^{7,9}$	SP	Db Xi Xu Xx	B35B	19-28
DIVIDE TO INTEGER (short BFP)	DIEBR	RRF-b	C		$\alpha^{7,9}$	SP	Db Xi Xu Xx	B353	19-28
LOAD AND TEST (extended BFP)	LTXBR	RRE	C		$\alpha^{7,9}$	SP	Db Xi	B342	19-31
LOAD AND TEST (long BFP)	LTDBR	RRE	C		$\alpha^{7,9}$		Db Xi	B312	19-31
LOAD AND TEST (short BFP)	LTEBR	RRE	C		$\alpha^{7,9}$		Db Xi	B302	19-31
LOAD COMPLEMENT (extended BFP)	LCXBR	RRE	C		$\alpha^{7,9}$	SP	Db	B343	19-31
LOAD COMPLEMENT (long BFP)	LCDBR	RRE	C		$\alpha^{7,9}$		Db	B313	19-31
LOAD COMPLEMENT (short BFP)	LCEBR	RRE	C		$\alpha^{7,9}$		Db	B303	19-31
LOAD FP INTEGER (extended BFP)	FIXBR	RRF-e			$\alpha^{7,9}$	SP	Db Xi Xx	B347	19-32
LOAD FP INTEGER (extended BFP)	FIXBRA	RRF-e		F	$\alpha^{7,9}$	SP	Db Xi Xx	B347	19-32
LOAD FP INTEGER (long BFP)	FIDBR	RRF-e			$\alpha^{7,9}$	SP	Db Xi Xx	B35F	19-32
LOAD FP INTEGER (long BFP)	FIDBRA	RRF-e		F	$\alpha^{7,9}$	SP	Db Xi Xx	B35F	19-32
LOAD FP INTEGER (short BFP)	FIEBR	RRF-e			$\alpha^{7,9}$	SP	Db Xi Xx	B357	19-32
LOAD FP INTEGER (short BFP)	FIEBRA	RRF-e		F	$\alpha^{7,9}$	SP	Db Xi Xx	B357	19-32
LOAD LENGTHENED (long to extended BFP)	LXDB	RXE			$\alpha^{7,9}$	A SP	Db Xi	B ₂ ED05	19-34
LOAD LENGTHENED (long to extended BFP)	LXDDBR	RRE			$\alpha^{7,9}$	SP	Db Xi	B305	19-33
LOAD LENGTHENED (short to extended BFP)	LXEB	RXE			$\alpha^{7,9}$	A SP	Db Xi	B ₂ ED06	19-34
LOAD LENGTHENED (short to extended BFP)	LXEBR	RRE			$\alpha^{7,9}$	SP	Db Xi	B306	19-33
LOAD LENGTHENED (short to long BFP)	LDEB	RXE			$\alpha^{7,9}$	A	Db Xi	B ₂ ED04	19-34
LOAD LENGTHENED (short to long BFP)	LDEBR	RRE			$\alpha^{7,9}$		Db Xi	B304	19-33
LOAD NEGATIVE (extended BFP)	LNDBR	RRE	C		$\alpha^{7,9}$	SP	Db	B341	19-34
LOAD NEGATIVE (long BFP)	LNDDBR	RRE	C		$\alpha^{7,9}$		Db	B311	19-34
LOAD NEGATIVE (short BFP)	LNEBR	RRE	C		$\alpha^{7,9}$		Db	B301	19-34
LOAD POSITIVE (extended BFP)	LPXBR	RRE	C		$\alpha^{7,9}$	SP	Db	B340	19-35
LOAD POSITIVE (long BFP)	LPDBR	RRE	C		$\alpha^{7,9}$		Db	B310	19-35
LOAD POSITIVE (short BFP)	LPEBR	RRE	C		$\alpha^{7,9}$		Db	B300	19-35
LOAD ROUNDED (extended to long BFP)	LDXBR	RRE			$\alpha^{7,9}$	SP	Db Xi Xo Xu Xx	B345	19-35
LOAD ROUNDED (extended to long BFP)	LDXBRA	RRF-e		F	$\alpha^{7,9}$	SP	Db Xi Xo Xu Xx	B345	19-35
LOAD ROUNDED (extended to short BFP)	LEXBR	RRE			$\alpha^{7,9}$	SP	Db Xi Xo Xu Xx	B346	19-35
LOAD ROUNDED (extended to short BFP)	LEXBRA	RRF-e		F	$\alpha^{7,9}$	SP	Db Xi Xo Xu Xx	B346	19-35
LOAD ROUNDED (long to short BFP)	LEDBR	RRE			$\alpha^{7,9}$		Db Xi Xo Xu Xx	B344	19-35
LOAD ROUNDED (long to short BFP)	LEDBRA	RRF-e		F	$\alpha^{7,9}$	SP	Db Xi Xo Xu Xx	B344	19-35
MULTIPLY (extended BFP)	MXBR	RRE			$\alpha^{7,9}$	SP	Db Xi Xo Xu Xx	B34C	19-37
MULTIPLY (long BFP)	MDB	RXE			$\alpha^{7,9}$	A	Db Xi Xo Xu Xx	B ₂ ED1C	19-37
MULTIPLY (long BFP)	MDBR	RRE			$\alpha^{7,9}$		Db Xi Xo Xu Xx	B31C	19-37
MULTIPLY (long to extended BFP)	MXDB	RXE			$\alpha^{7,9}$	A SP	Db Xi	B ₂ ED07	19-37
MULTIPLY (long to extended BFP)	MXDBR	RRE			$\alpha^{7,9}$	SP	Db Xi	B307	19-37
MULTIPLY (short BFP)	MEEB	RXE			$\alpha^{7,9}$	A	Db Xi Xo Xu Xx	B ₂ ED17	19-37
MULTIPLY (short BFP)	MEEBR	RRE			$\alpha^{7,9}$		Db Xi Xo Xu Xx	B317	19-37
MULTIPLY (short to long BFP)	MDEB	RXE			$\alpha^{7,9}$	A	Db Xi	B ₂ ED0C	19-37
MULTIPLY (short to long BFP)	MDEBR	RRE			$\alpha^{7,9}$		Db Xi	B30C	19-37

Figure 19-11. Summary of BFP Instructions (Part 2 of 3)

Name	Mnemonic	Characteristics						Op Code	Page		
MULTIPLY AND ADD (long BFP)	MADB	RXF	$\alpha^{7,9}$ A	Db	Xi	Xo	Xu	Xx	B ₂	ED1E	19-38
MULTIPLY AND ADD (long BFP)	MADBR	RRD	$\alpha^{7,9}$	Db	Xi	Xo	Xu	Xx		B31E	19-38
MULTIPLY AND ADD (short BFP)	MAEB	RXF	$\alpha^{7,9}$ A	Db	Xi	Xo	Xu	Xx	B ₂	ED0E	19-38
MULTIPLY AND ADD (short BFP)	MAEBR	RRD	$\alpha^{7,9}$	Db	Xi	Xo	Xu	Xx		B30E	19-38
MULTIPLY AND SUBTRACT (long BFP)	MSDB	RXF	$\alpha^{7,9}$ A	Db	Xi	Xo	Xu	Xx	B ₂	ED1F	19-38
MULTIPLY AND SUBTRACT (long BFP)	MSDBR	RRD	$\alpha^{7,9}$	Db	Xi	Xo	Xu	Xx		B31F	19-38
MULTIPLY AND SUBTRACT (short BFP)	MSEB	RXF	$\alpha^{7,9}$ A	Db	Xi	Xo	Xu	Xx	B ₂	ED0F	19-38
MULTIPLY AND SUBTRACT (short BFP)	MSEBR	RRD	$\alpha^{7,9}$	Db	Xi	Xo	Xu	Xx		B30F	19-38
SQUARE ROOT (extended BFP)	SQXBR	RRE	$\alpha^{7,9}$ SP	Db	Xi			Xx		B316	19-40
SQUARE ROOT (long BFP)	SQDB	RXE	$\alpha^{7,9}$ A	Db	Xi			Xx	B ₂	ED15	19-40
SQUARE ROOT (long BFP)	SQDBR	RRE	$\alpha^{7,9}$	Db	Xi			Xx		B315	19-40
SQUARE ROOT (short BFP)	SQEB	RXE	$\alpha^{7,9}$ A	Db	Xi			Xx	B ₂	ED14	19-40
SQUARE ROOT (short BFP)	SQEBR	RRE	$\alpha^{7,9}$	Db	Xi			Xx		B314	19-40
SUBTRACT (extended BFP)	SXBR	RRE C	$\alpha^{7,9}$ SP	Db	Xi	Xo	Xu	Xx		B34B	19-40
SUBTRACT (long BFP)	SDB	RXE C	$\alpha^{7,9}$ A	Db	Xi	Xo	Xu	Xx	B ₂	ED1B	19-40
SUBTRACT (long BFP)	SDBR	RRE C	$\alpha^{7,9}$	Db	Xi	Xo	Xu	Xx		B31B	19-40
SUBTRACT (short BFP)	SEB	RXE C	$\alpha^{7,9}$ A	Db	Xi	Xo	Xu	Xx	B ₂	ED0B	19-40
SUBTRACT (short BFP)	SEBR	RRE C	$\alpha^{7,9}$	Db	Xi	Xo	Xu	Xx		B30B	19-40
TEST DATA CLASS (extended BFP)	TCXB	RXE C	$\alpha^{7,9}$ SP	Db						ED12	19-41
TEST DATA CLASS (long BFP)	TCDB	RXE C	$\alpha^{7,9}$	Db						ED11	19-41
TEST DATA CLASS (short BFP)	TCEB	RXE C	$\alpha^{7,9}$	Db						ED10	19-41

Explanation:

- α^7 Restricted from transactional execution when the effective allow-floating-point-operation control is zero.
- α^9 Restricted in the constrained transactional-execution mode; a transaction-constraint program exception may be recognized.
- A Access exceptions for logical addresses.
- B₂ B₂ field designates an access register in the access-register mode.
- C Condition code is set.
- Db BFP-instruction data exception.
- F Floating-point extension facility
- N Instruction is new in z/Architecture as compared to ESA/390.
- RRD RRE instruction format.
- RRE RRE instruction format.
- RRF RRF instruction format.
- RXE RXE instruction format.
- RXF RXF instruction format.
- SP Specification exception.
- Xi IEEE invalid-operation data exception.
- Xo IEEE overflow data exception.
- Xu IEEE underflow data exception.
- Xx IEEE inexact data exception.
- Xz IEEE division-by-zero data exception.

Figure 19-11. Summary of BFP Instructions (Part 3 of 3)

ADD

Mnemonic1 R₁,R₂ [RRE]

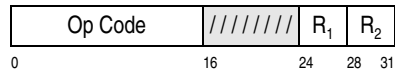

Mnemonic1	Op Code	Operands
AEBR	'B30A'	Short BFP
ADBR	'B31A'	Long BFP
AXBR	'B34A'	Extended BFP

Mnemonic2 R₁,D₂(X₂,B₂) [RXE]

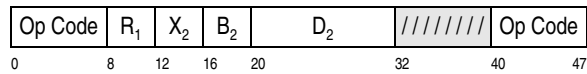

Mnemonic2	Op Code	Operands
AEB	'ED0A'	Short BFP
ADB	'ED1A'	Long BFP

The second operand is added to the first operand, and the sum is placed at the first-operand location.

If both operands are finite numbers, they are added algebraically, forming an intermediate sum. The intermediate sum, if nonzero, is rounded to the operand format according to the current BFP rounding mode. The sum is then placed at the result location.

The sign of the sum is determined by the rules of algebra. This also applies to a result of zero:

- If the result of rounding a nonzero intermediate sum is zero, the sign of the zero result is the sign of the intermediate sum.
- If the sum of two operands with opposite signs is exactly zero, the sign of the result is plus in all rounding methods except round toward $-\infty$, in which method the sign is minus.
- The sign of the sum x plus x is the sign of x , even when x is zero.

If one operand is an infinity and the other is a finite number, the result is that infinity. If both operands are infinities of the same sign, the result is the same infinity. If the two operands are infinities of opposite signs, an IEEE-invalid-operation exception is recognized.

See Figure 19-13 on page 19-16 for a detailed description of the results of this instruction. (Figure 19-12 is referred to by Figure 19-13.)

For AXBR, the R fields must designate valid floating-point-register pairs; otherwise, a specification exception is recognized.

Resulting Condition Code:

- 0 Result is zero
- 1 Result is less than zero
- 2 Result is greater than zero
- 3 Result is a NaN

IEEE Exceptions:

- Invalid operation
- Overflow
- Underflow
- Inexact

Program Exceptions:

- Access (fetch, operand 2 of AEB and ADB only)
- Data with DXC 2, BFP instruction
- Data with DXC for IEEE exception
- Specification (AXBR only)
- Transaction constraint

Programming Note: Interchanging the two operands in a BFP addition does not affect the value of the sum when the result is numeric. This is not true, however, when both operands are QNaNs, in which case the result is the first operand; or when both operands are SNaNs and the IEEE-invalid-operation mask bit in the FPC register is zero, in which case the result is the QNaN derived from the first operand.

Value of Result (r)	Condition Code
$r=0$	0
$r<0$	1
$r>0$	2

Figure 19-12. Condition Code for Resultant Sum

First Operand (a) Is	Results for ADD (a+b) when Second Operand (b) Is									
	$-\infty$	-Nn	-Dn	-0	+0	+Dn	+Nn	$+\infty$	QNaN	SNaN
$-\infty$	T($-\infty$), cc1	T($-\infty$), cc1	T($-\infty$), cc1	T($-\infty$), cc1	T($-\infty$), cc1	T($-\infty$), cc1	T($-\infty$), cc1	Xi: T(dNaN), cc3	T(b), cc3	Xi: T(b*), cc3
-Nn	T($-\infty$), cc1	R(a+b), cc1	R(a+b), cc1	T(a), cc1	T(a), cc1	R(a+b), cc1	R(a+b), ccrs	T($+\infty$), cc2	T(b), cc3	Xi: T(b*), cc3
-Dn	T($-\infty$), cc1	R(a+b), cc1	R(a+b), cc1	R(a), cc1	R(a), cc1	R(a+b), ccrs	R(a+b), cc2	T($+\infty$), cc2	T(b), cc3	Xi: T(b*), cc3
-0	T($-\infty$), cc1	T(b), cc1	R(b), cc1	T(-0), cc0	Rezd, cc0	R(b), cc2	T(b), cc2	T($+\infty$), cc2	T(b), cc3	Xi: T(b*), cc3
+0	T($-\infty$), cc1	T(b), cc1	R(b), cc1	Rezd, cc0	T(+0), cc0	R(b), cc2	T(b), cc2	T($+\infty$), cc2	T(b), cc3	Xi: T(b*), cc3
+Dn	T($-\infty$), cc1	R(a+b), cc1	R(a+b), ccrs	R(a), cc2	R(a), cc2	R(a+b), cc2	R(a+b), cc2	T($+\infty$), cc2	T(b), cc3	Xi: T(b*), cc3
+Nn	T($-\infty$), cc1	R(a+b), ccrs	R(a+b), cc2	T(a), cc2	T(a), cc2	R(a+b), cc2	R(a+b), cc2	T($+\infty$), cc2	T(b), cc3	Xi: T(b*), cc3
$+\infty$	Xi: T(dNaN), cc3	T($+\infty$), cc2	T($+\infty$), cc2	T($+\infty$), cc2	T($+\infty$), cc2	T($+\infty$), cc2	T($+\infty$), cc2	T($+\infty$), cc2	T(b), cc3	Xi: T(b*), cc3
QNaN	T(a), cc3	T(a), cc3	T(a), cc3	T(a), cc3	T(a), cc3	T(a), cc3	T(a), cc3	T(a), cc3	T(a), cc3	Xi: T(b*), cc3
SNaN	Xi: T(a*), cc3	Xi: T(a*), cc3	Xi: T(a*), cc3	Xi: T(a*), cc3	Xi: T(a*), cc3	Xi: T(a*), cc3	Xi: T(a*), cc3	Xi: T(a*), cc3	Xi: T(a*), cc3	Xi: T(a*), cc3

Explanation:

* The SNaN is converted to the corresponding QNaN before it is placed at the target operand location.

ccn Condition code is set to n.

ccrs Condition code is set according to the resultant sum. See Figure 19-12 on page 19-15.

dNaN Default NaN.

Dn Subnormal number.

Nn Normal number.

R(v) Rounding and range action is performed on the value v. See Figure 19-8 on page 19-8.

Rezd Exact zero-difference result. See Figure 19-8 on page 19-8.

T(x) The value x is placed at the target operand location.

Xi: IEEE invalid-operation exception. The results shown are produced only when FPC 0.0 is zero.

Figure 19-13. Results: ADD

COMPARE

Mnemonic1 R₁,R₂ [RRE]

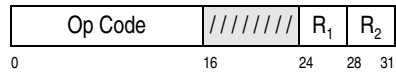

Mnemonic1	Op Code	Operands
CEBR	'B309'	Short BFP
CDBR	'B319'	Long BFP
CXBR	'B349'	Extended BFP

Mnemonic2 R₁,D₂(X₂,B₂) [RXE]

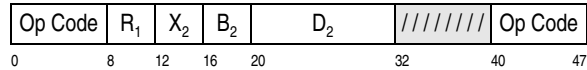

Mnemonic2	Op Code	Operands
CEB	'ED09'	Short BFP
CDB	'ED19'	Long BFP

The first operand is compared with the second operand, and the condition code is set to indicate the result.

If both operands are finite numbers, the comparison is algebraic and follows the procedure for BFP subtraction, except that the difference is discarded after setting the condition code, and both operands remain unchanged. If the difference is exactly zero with either sign, the operands are equal; this includes zero operands (so +0 equals -0). If a nonzero difference is positive or negative, the first operand is high or low, respectively.

+∞ compares greater than any finite number, and all finite numbers compare greater than -∞. Two infinity operands of like sign compare equal.

Numeric comparison is exact, and the condition code is determined for finite operands as if range and precision were unlimited. No overflow or underflow exception can occur.

If either or both operands are QNaNs and neither operand is an SNaN, the comparison result is unordered, and condition code 3 is set.

If either or both operands are SNaNs, an IEEE-invalid-operation exception is recognized. If the IEEE-invalid-operation mask bit is one, a program interrup-

tion for a data exception with DXC 80 hex (IEEE invalid operation) occurs. If the IEEE-invalid-operation mask bit is zero, the IEEE-invalid-operation flag bit is set to one, and instruction execution is completed by setting condition code 3.

See Figure 19-14 on page 19-18 for a detailed description of the results of this instruction.

For CXBR, the R fields must designate valid floating-point-register pairs; otherwise, a specification exception is recognized.

Resulting Condition Code:

- 0 Operands equal
- 1 First operand low
- 2 First operand high
- 3 Operands unordered

IEEE Exceptions:

- Invalid operation

Program Exceptions:

- Access (fetch, operand 2 of CEB and CDB only)
- Data with DXC 2, BFP instruction
- Data with DXC for IEEE exception
- Specification (CXBR only)
- Transaction constraint

Programming Notes:

1. COMPARE may be used to implement those comparisons which are required by ANSI/IEEE Standard 754-2008 to not recognize an exception when the result is unordered due to a QNaN.
2. ANSI/IEEE Standard 754-2008 requires that it be possible to compare BFP operands in different formats. To accomplish this, LOAD LENGTHENED may be used before COMPARE to convert the shorter operand to the same format as the longer.

First Operand (a) Is	Results for COMPARE (a:b) when Second Operand (b) Is							
	$-\infty$	-Fn	-0	+0	+Fn	$+\infty$	QNaN	SNaN
$-\infty$	cc0	cc1	cc1	cc1	cc1	cc1	cc3	Xi: cc3
-Fn	cc2	C(a:b)	cc1	cc1	cc1	cc1	cc3	Xi: cc3
-0	cc2	cc2	cc0	cc0	cc1	cc1	cc3	Xi: cc3
+0	cc2	cc2	cc0	cc0	cc1	cc1	cc3	Xi: cc3
+Fn	cc2	cc2	cc2	cc2	C(a:b)	cc1	cc3	Xi: cc3
$+\infty$	cc2	cc2	cc2	cc2	cc2	cc0	cc3	Xi: cc3
QNaN	cc3	cc3	cc3	cc3	cc3	cc3	cc3	Xi: cc3
SNaN	Xi: cc3	Xi: cc3	Xi: cc3	Xi: cc3	Xi: cc3	Xi: cc3	Xi: cc3	Xi: cc3

Explanation:

ccn Condition code is set to n.
 C(a:b) Basic compare results. See Figure 19-15.
 Fn Finite nonzero number (includes both subnormal and normal).
 Xi: IEEE invalid-operation exception. The results shown are produced only when FPC 0.0 is zero.

Figure 19-14. Results: COMPARE

Relation of Value (a) to Value (b)	Condition Code for C(a:b)
a=b	0
a<b	1
a>b	2

Figure 19-15. Basic Compare Results

COMPARE AND SIGNAL

Mnemonic1 R₁,R₂ [RRE]

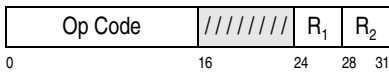

Mnemonic1	Op Code	Operands
KEBR	'B308'	Short BFP
KDBR	'B318'	Long BFP
KXBR	'B348'	Extended BFP

Mnemonic2 R₁,D₂(X₂,B₂) [RXE]

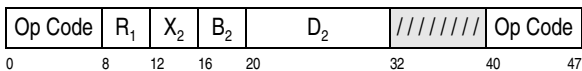

Mnemonic2	Op Code	Operands
KEB	'ED08'	Short BFP
KDB	'ED18'	Long BFP

The first operand is compared with the second operand, and the condition code is set to indicate the result. The operation is the same as for COMPARE except that QNaN operands cause an IEEE-invalid-operation exception to be recognized. Thus, QNaN operands are treated as if they were SNaNs.

See Figure 19-16 on page 19-19 for a detailed description of the results of this instruction.

For KXBR, the R fields must designate valid floating-point-register pairs; otherwise, a specification exception is recognized.

Resulting Condition Code:

- 0 Operands equal
- 1 First operand low
- 2 First operand high
- 3 Operands unordered

IEEE Exceptions:

- Invalid operation

Program Exceptions:

- Access (fetch, operand 2 of KEB and KDB only)
- Data with DXC 2, BFP instruction
- Data with DXC for IEEE exception
- Specification (KXBR only)
- Transaction constraint

Programming Notes:

1. COMPARE AND SIGNAL may be used to implement those comparisons which are required by ANSI/IEEE Standard 754-2008 to recognize an exception when the result is unordered due to a QNaN.

2. ANSI/IEEE Standard 754-2008 requires that it be possible to compare BFP operands in different formats. To accomplish this, LOAD LENGTH-

ENED may be used before COMPARE AND SIGNAL to convert the shorter operand to the same format as the longer.

First Operand (a) Is	Results for COMPARE AND SIGNAL (a:b) when Second Operand (b) Is						
	$-\infty$	-Fn	-0	+0	+Fn	$+\infty$	NaN
$-\infty$	cc0	cc1	cc1	cc1	cc1	cc1	Xi: cc3
-Fn	cc2	C(a:b)	cc1	cc1	cc1	cc1	Xi: cc3
-0	cc2	cc2	cc0	cc0	cc1	cc1	Xi: cc3
+0	cc2	cc2	cc0	cc0	cc1	cc1	Xi: cc3
+Fn	cc2	cc2	cc2	cc2	C(a:b)	cc1	Xi: cc3
$+\infty$	cc2	cc2	cc2	cc2	cc2	cc0	Xi: cc3
NaN	Xi: cc3	Xi: cc3	Xi: cc3	Xi: cc3	Xi: cc3	Xi: cc3	Xi: cc3

Explanation:

ccn Condition code is set to n.
C(a:b) Basic compare results. See Figure 19-15 on page 19-18
Fn Finite nonzero number (includes both subnormal and normal).
Xi: IEEE invalid-operation exception. The results shown are produced only when FPC 0.0 is zero.

Figure 19-16. Results: COMPARE AND SIGNAL

CONVERT FROM FIXED

Mnemonic1 R₁,R₂ [RRE]

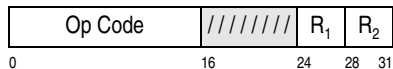

Mnemonic1	Op Code	Operands
CEFBR	'B394'	32-bit binary-integer operand, short BFP result
CDFBR	'B395'	32-bit binary-integer operand, long BFP result
CXFBR	'B396'	32-bit binary-integer operand, extended BFP result
CEGBR	'B3A4'	64-bit binary-integer operand, short BFP result
CDGBR	'B3A5'	64-bit binary-integer operand, long BFP result
CXGBR	'B3A6'	64-bit binary-integer operand, extended BFP result

Mnemonic2 R₁,M₃,R₂,M₄ [RRF-e]

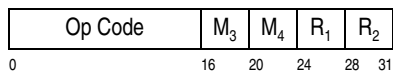

Mnemonic2	Op Code	Operands
CEFBRA	'B394'	32-bit binary-integer operand, short BFP result
CDFBRA	'B395'	32-bit binary-integer operand, long BFP result
CXFBRA	'B396'	32-bit binary-integer operand, extended BFP result
CEGBRA	'B3A4'	64-bit binary-integer operand, short BFP result
CDGBRA	'B3A5'	64-bit binary-integer operand, long BFP result
CXGBRA	'B3A6'	64-bit binary-integer operand, extended BFP result

The fixed-point second operand is converted to the BFP format, and the result is placed at the first-operand location.

The second operand is a signed binary integer that is located in the general register designated by R₂. A 32-bit operand is in bit positions 32-63 of the register.

When the floating-point extension facility is installed, the converted result is rounded by rounding as specified by the modifier in the M₃ field:

M₃ Effective Rounding Method

- 0 According to current BFP rounding mode
- 1 Round to nearest with ties away from 0
- 3 Round to prepare for shorter precision
- 4 Round to nearest with ties to even
- 5 Round toward 0

- 6 Round toward $+\infty$
- 7 Round toward $-\infty$

An M_3 modifier other than 0, 1, or 3-7 is invalid. The M_3 field must designate a valid modifier; otherwise, a specification exception is recognized.

When the M_3 modifier field is zero, rounding is controlled by the current BFP rounding mode specified in the FPC register. When the field is not zero, rounding is performed as specified by the modifier, regardless of the current BFP rounding mode.

When the floating-point extension facility is not installed and bits 16-19 of the instruction contain a value of zero, the converted result is rounded according to the current BFP rounding mode. When the floating-point extension facility is not installed and bits 16-19 of the instruction contain a nonzero value, it is undefined whether a specification exception is recognized or an unpredictable rounding method is performed.

When the floating-point extension facility is installed, bit 1 of the M_4 field is the IEEE-inexact-exception control (XxC). Bits 0, 2, and 3 are ignored. If XxC is zero, recognition of IEEE-inexact exception is not suppressed; if XxC is one, recognition of IEEE-inexact exception is suppressed.

When the floating-point extension facility is not installed and if bits 20-23 of the instruction are zeros,

recognition of IEEE-inexact exception is not suppressed; when the floating-point extension facility is not installed and if bits 20-23 of the instruction contain a nonzero value, then it is unpredictable whether recognition of IEEE-inexact exception is suppressed.

See Figure 19-17 on page 19-21 for a detailed description of the results of this instruction.

For CXFBR, CXFBRA, CXGBR, and CXGBRA, the R_1 field must designate a valid floating-point-register pair; otherwise, a specification exception is recognized.

Condition Code: The code remains unchanged.

IEEE Exceptions:

- Inexact (CEFBR, CEFBRA, CDGBR, CDGBRA, CEGBR, CEGBRA)

Program Exceptions:

- Data with DXC 2, BFP instruction
- Data with DXC for IEEE exception
- Specification
- Transaction constraint

Programming Note: Unassigned bits in the M_4 field are reserved for future extensions and should be set to zeros; otherwise the program may not operate compatibly in the future.

Instruction	Results for Instructions with a Single Operand (a) when Operand (a) Is							
	$-\infty$	-Fn	-0	+0	+Fn	$+\infty$	QNaN	SNaN
CONVERT FROM FIXED	–	Rf(a)	–	T(+0)	Rf(a)	–	–	–
LOAD AND TEST	T($-\infty$)	T(a)	T(-0)	T(+0)	T(a)	T($+\infty$)	T(a)	Xi: T(a*)
LOAD LENGTHENED	T($-\infty$)	T(a) ¹	T(-0)	T(+0)	T(a) ¹	T($+\infty$)	T(a) ¹	Xi: T(a*) ¹
LOAD ROUNDED	T($-\infty$)	R(a)	T(-0)	T(+0)	R(a)	T($+\infty$)	T(a) ²	Xi: T(a*) ²
SQUARE ROOT	Xi: T(dNaN)	Xi: T(dNaN)	T(-0)	T(+0)	R(\sqrt{a})	T($+\infty$)	T(a)	Xi: T(a*)

Explanation:

– This situation cannot occur.

* The SNaN is converted to the corresponding QNaN before it is placed at the target operand location.

¹ The operand is extended to the longer format by appending zeros on the right before it is placed at the target operand location.

² The NaN is shortened to the target format by truncating the rightmost bits.

dNaN Default NaN.

Fn Finite nonzero number (includes both subnormal and normal).

R(v) Rounding and range action is performed on the value v. See Figure 19-8 on page 19-9.

Rf(a) The value a is converted to the precise intermediate value floating-point number v, and then action R(v) is performed.

T(x) The value x is placed in the target operand location.

Xi: IEEE invalid-operation exception. The results shown are produced only when FPC 0.0 is zero.

Figure 19-17. Results: Single-Operand Instructions

CONVERT FROM LOGICAL

Mnemonic R₁,M₃,R₂,M₄ [RRF-e]

Op Code	M ₃	M ₄	R ₁	R ₂
0	16	20	24	28 31

Mnemonic	Op Code	Operands
CELFBR	'B390'	32-bit binary-integer operand, short BFP result
CDLFBR	'B391'	32-bit binary-integer operand, long BFP result
CXLFBR	'B392'	32-bit binary-integer operand, extended BFP result
CELGBR	'B3A0'	64-bit binary-integer operand, short BFP result
CDLGBR	'B3A1'	64-bit binary-integer operand, long BFP result
CXLGBR	'B3A2'	64-bit binary-integer operand, extended BFP result

The fixed-point second operand is converted to the BFP format, and the result is placed at the first-operand location.

The second operand is an unsigned binary integer that is located in the general register designated by R₂. A 32-bit operand is in bit positions 32-63 of the register.

The converted result is rounded by rounding as specified by the modifier in the M₃ field:

M₃ Effective Rounding Method

- 0 According to current BFP rounding mode
- 1 Round to nearest with ties away from 0
- 3 Round to prepare for shorter precision
- 4 Round to nearest with ties to even
- 5 Round toward 0
- 6 Round toward $+\infty$
- 7 Round toward $-\infty$

An M₃ modifier other than 0, 1, or 3-7 is invalid.

When the M₃ modifier field is zero, rounding is controlled by the current BFP rounding mode specified in the FPC register. When the field is not zero, rounding is performed as specified by the modifier, regardless of the current BFP rounding mode.

The M₃ field must designate a valid modifier; otherwise, a specification exception is recognized. For CXLFBR and CXLGBR, the R₁ field must designate a valid floating-point-register pair; otherwise, a specification exception is recognized.

Bit 1 of the M₄ field is the IEEE-inexact-exception control (XxC). Bits 0, 2, and 3 are ignored. If XxC is

zero, recognition of IEEE-inexact exception is not suppressed; if XxC is one, recognition of IEEE-inexact exception is suppressed.

The result always has a plus sign.

See Figure 19-17 on page 19-21 for a detailed description of the results of this instruction.

Condition Code: The code remains unchanged.

IEEE Exceptions:

- Inexact (CELFBR, CDLGBR, CELGBR)

Program Exceptions:

- Data with DXC 2, BFP instruction
- Data with DXC for IEEE exception
- Operation (if the floating-point extension facility is not installed)
- Specification
- Transaction constraint

Programming Notes:

1. Unassigned bits in the M_4 field are reserved for future extensions and should be set to zeros; otherwise the program may not operate compatibly in the future
2. Using either the round toward 0 or the round toward $-\infty$ rounding method produces the same result.

CONVERT TO FIXED

Mnemonic1 R_1, M_3, R_2 [RRF-e]

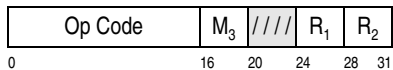

Mnemonic1	Op Code	Operands
CFEBR	'B398'	Short BFP operand, 32-bit binary-integer result
CFDBR	'B399'	Long BFP operand, 32-bit binary-integer result
CFXBR	'B39A'	Extended BFP operand, 32-bit binary-integer result
CGEBR	'B3A8'	Short BFP operand, 64-bit binary-integer result
CGDBR	'B3A9'	Long BFP operand, 64-bit binary-integer result
CGXBR	'B3AA'	Extended BFP operand, 64-bit binary-integer result

Mnemonic2 R_1, M_3, R_2, M_4 [RRF-e]

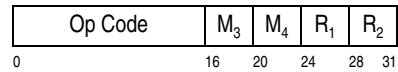

Mnemonic2	Op Code	Operands
CFEBRA	'B398'	Short BFP operand, 32-bit binary-integer result
CFDBRA	'B399'	Long BFP operand, 32-bit binary-integer result
CFXBRA	'B39A'	Extended BFP operand, 32-bit binary-integer result
CGEBRA	'B3A8'	Short BFP operand, 64-bit binary-integer result
CGDBRA	'B3A9'	Long BFP operand, 64-bit binary-integer result
CGXBRA	'B3AA'	Extended BFP operand, 64-bit binary-integer result

The BFP second operand is rounded to an integer value and then converted to the fixed-point format. The result is placed at the first-operand location.

The result is a signed binary integer that is placed in the general register designated by R_1 . For instructions that produce a 32-bit result, the result replaces bits 32-63 of the register, and bits 0-31 of the register remain unchanged.

If the second operand is a finite number, it is rounded to an integer value by rounding as specified by the modifier in the M_3 field:

M₃ Effective Rounding Method

- 0 According to current BFP rounding mode
- 1 Round to nearest with ties away from 0
- 3 Round to prepare for shorter precision
- 4 Round to nearest with ties to even
- 5 Round toward 0
- 6 Round toward $+\infty$
- 7 Round toward $-\infty$

An M_3 modifier other than 0, 1, or 3-7 is invalid. If the floating-point extension facility is not installed, an M_3 modifier of 3 is also invalid.

When the M_3 modifier field is zero, rounding is controlled by the current BFP rounding mode specified in the FPC register. When the field is not zero, rounding is performed as specified by the modifier, regardless of the current BFP rounding mode.

The sign of the result is the sign of the second operand, except that a zero result has a plus sign.

When the floating-point extension facility is installed, bit 1 of the M_4 field is the IEEE-inexact-exception control (XxC). Bits 0, 2, and 3 are ignored. If XxC is zero, recognition of IEEE-inexact exception is not suppressed; if XxC is one, recognition of IEEE-inexact exception is suppressed.

recognition of IEEE-inexact exception is not suppressed; when the floating-point extension facility is not installed and if bits 20-23 of the instruction contain a nonzero value, it is unpredictable whether recognition of IEEE-inexact exception is suppressed.

When the floating-point extension facility is not installed and if bits 20-23 of the instruction are zeros,

See Figure 19-18 for a detailed description of the results of this instruction.

Operand (a)	Is n Inexact (n≠a)	Inv.-Op. Mask (FPC 0.0)	IEEE Inexact Exception Control (XxC)	Inexact Mask (FPC 0.4)	Is n Incremented (n > a)	Results
$-\infty \leq a < MN, n < MN$	–	0	1^3	–	–	T(MN), SFi←1, cc3
$-\infty \leq a < MN, n < MN$	–	0	0^4	0	–	T(MN), SFi←1, SFx←1, cc3 †
$-\infty \leq a < MN, n < MN$	–	0	0^4	1	–	T(MN), SFi←1, cc3, PIDx(08) †
$-\infty \leq a < MN, n < MN$	–	1	–	–	–	PIDi(80)
$-\infty < a < MN, n = MN$	–	–	1^3	–	–	T(MN), cc1
$-\infty < a < MN, n = MN$	–	–	0^4	0	–	T(MN), SFx←1, cc1
$-\infty < a < MN, n = MN$	–	–	0^4	1	–	T(MN), cc1, PIDx(08)
$MN \leq a < 0$	No	–	–	–	–	T(f), cc1
$MN \leq a < 0$	Yes	–	1^3	–	–	T(f), cc1
$MN \leq a < 0$	Yes	–	0^4	0	–	T(f), SFx←1, cc1
$MN \leq a < 0$	Yes	–	0^4	1	No	T(f), cc1, PIDx(08)
$MN \leq a < 0$	Yes	–	0^4	1	Yes	T(f), cc1, PIDy(0C)
-0	No ¹	–	–	–	–	T(0), cc0
+0	No ¹	–	–	–	–	T(0), cc0
$0 < a \leq MP$	No	–	–	–	–	T(f), cc2
$0 < a \leq MP$	Yes	–	1^3	–	–	T(f), cc2
$0 < a \leq MP$	Yes	–	0^4	0	–	T(f), SFx←1, cc2
$0 < a \leq MP$	Yes	–	0^4	1	No	T(f), cc2, PIDx(08)
$0 < a \leq MP$	Yes	–	0^4	1	Yes	T(f), cc2, PIDy(0C)
$MP < a < +\infty, n = MP^2$	–	–	1^3	–	–	T(MP), cc2
$MP < a < +\infty, n = MP^2$	–	–	0^4	0	–	T(MP), SFx←1, cc2
$MP < a < +\infty, n = MP^2$	–	–	0^4	1	–	T(MP), cc2, PIDx(08)
$MP < a \leq +\infty, n > MP$	–	0	1^3	–	–	T(MP), SFi←1, cc3
$MP < a \leq +\infty, n > MP$	–	0	0^4	0	–	T(MP), SFi←1, SFx←1, cc3 †
$MP < a \leq +\infty, n > MP$	–	0	0^4	1	–	T(MP), SFi←1, cc3, PIDx(08) †
$MP < a \leq +\infty, n > MP$	–	1	–	–	–	PIDi(80)
NaN	–	0	1^3	–	–	T(MN), SFi←1, cc3
NaN	–	0	0^4	0	–	T(MN), SFi←1, SFx←1, cc3 †
NaN	–	0	0^4	1	–	T(MN), SFi←1, cc3, PIDx(08) †

Figure 19-18. Results: CONVERT TO FIXED

Operand (a)	Is n Inexact (n≠a)	Inv.-Op. Mask (FPC 0.0)	IEEE Inexact Exception Control (XxC)	Inexact Mask (FPC 0.4)	Is n Incremented (n > a)	Results
NaN	–	1	–	–	–	PIDi(80)
Explanation:						
–	The results do not depend on this condition or mask bit.					
1	This condition is true by virtue of the state of some condition to the left of this column.					
2	The n=MP condition only applies to CFDBR, CFDBRA, CFXBR, CFXBRA, CGXBR, and CGXBRA.					
3	Floating-point extension facility is installed and XxC bit in the M ₄ field is 1.					
4	Bit 21 of the instruction is 0, regardless of whether the floating-point extension facility is installed.					
†	Result differs from DFP CONVERT TO FIXED. The DFP instruction combines two cases as it does not recognize inexact for this case and does not test the inexact mask.					
ccn	Condition code is set to n.					
f	The value n converted to a fixed-point result.					
n	The value derived when the source value (a) is rounded to a floating-point integer using the effective rounding method.					
MN	Maximum negative number representable in the target fixed-point format.					
MP	Maximum positive number representable in the target fixed-point format.					
PIDc(h)	Program interruption for data exception, condition c, with DXC of h in hex. Figure 19-10 on page 19-11.					
SFi	IEEE invalid-operation flag, FPC 1.0.					
SFx	IEEE inexact flag, FPC 1.4.					
T(x)	The value x is placed at the target operand location.					

Figure 19-18. Results: CONVERT TO FIXED

If the M₃ field designates any of the following invalid modifier values: 2 and 8-15, then a specification exception is recognized. When the floating-point extension facility is not installed, if the M₃ field designates the invalid value 3, it is undefined whether a specification exception is recognized or an unpredictable rounding method is performed.

For CFXBR, CFXBRA, CGXBR and CGXBRA, the R₂ field must designate a valid floating-point-register pair; otherwise, a specification exception is recognized.

Resulting Condition Code:

- 0 Source was zero
- 1 Source was less than zero
- 2 Source was greater than zero
- 3 Special case

IEEE Exceptions:

- Invalid operation
- Inexact

Program Exceptions:

- Data with DXC 2, BFP instruction
- Data with DXC for IEEE exception
- Specification
- Transaction constraint

Programming Note: Unassigned bits in the M₄ field are reserved for future extensions and should be set to zeros; otherwise the program may not operate compatibly in the future.

CONVERT TO LOGICAL

Mnemonic R_1, M_3, R_2, M_4 [RRF-e]

Op Code	M_3	M_4	R_1	R_2
0	16	20	24	28 31

Mnemonic	Op Code	Operands
CLFEBR	'B39C'	Short BFP operand, 32-bit binary-integer result
CLFDBR	'B39D'	Long BFP operand, 32-bit binary-integer result
CLFXBR	'B39E'	Extended BFP operand, 32-bit binary-integer result
CLGEBR	'B3AC'	Short BFP operand, 64-bit binary-integer result
CLGDBR	'B3AD'	Long BFP operand, 64-bit binary-integer result
CLGXBR	'B3AE'	Extended BFP operand, 64-bit binary-integer result

The BFP second operand is rounded to an integer value and then converted to the fixed-point format. The result is placed at the first-operand location.

The result is an unsigned binary integer that is placed in the general register designated by R_1 . For instructions that produce a 32-bit result, the result replaces bits 32-63 of the register, and bits 0-31 of the register remain unchanged.

If the second operand is a finite number, it is rounded to an integer value by rounding as specified by the modifier in the M_3 field:

M_3 Effective Rounding Method

- 0 According to current BFP rounding mode
- 1 Round to nearest with ties away from 0
- 3 Round to prepare for shorter precision
- 4 Round to nearest with ties to even
- 5 Round toward 0
- 6 Round toward $+\infty$
- 7 Round toward $-\infty$

An M_3 modifier other than 0, 1, or 3-7 is invalid.

When the M_3 modifier field is zero, rounding is controlled by the current BFP rounding mode specified in the FPC register. When the field is not zero, rounding is performed as specified by the modifier, regardless of the current BFP rounding mode.

Bit 1 of the M_4 field is the IEEE-inexact-exception control (XxC). Bits 0, 2, and 3 are ignored. If XxC is zero, recognition of IEEE-inexact exception is not suppressed; if XxC is one, recognition of IEEE-inexact exception is suppressed.

The M_3 field must designate a valid modifier; otherwise, a specification exception is recognized. For CLFXBR and CLGXBR, the R_2 field must designate a valid floating-point-register pair; otherwise, a specification exception is recognized.

See Figure 19-19 for a detailed description of the results of this instruction.

Resulting Condition Code:

- 0 Source was zero
- 1 Source was less than zero
- 2 Source was greater than zero
- 3 Special case

IEEE Exceptions:

- Invalid operation
- Inexact

Program Exceptions:

- Data with DXC 2, BFP instruction
- Data with DXC for IEEE exception
- Operation (if the floating-point extension facility is not installed)
- Specification
- Transaction constraint

Programming Note: Unassigned bits in the M_4 field are reserved for future extensions and should be set to zeros; otherwise the program may not operate compatibly in the future.

Operand (a)	Is n Inexact (n≠a)	Inv.-Op. Mask (FPC 0.0)	IEEE Inexact Exception Control (XxC)	Inexact Mask (FPC 0.4)	Is n Incremented (n > a)	Results
$-\infty \leq a < 0, n < 0$	–	0	1	–	–	T(0), SFi←1, cc3
$-\infty \leq a < 0, n < 0$	–	0	0	0	–	T(0), SFi←1, SFx←1, cc3 †
$-\infty \leq a < 0, n < 0$	–	0	0	1	–	T(0), SFi←1, cc3, PIDx(08) †
$-\infty \leq a < 0, n < 0$	–	1	–	–	–	PIDi(80)
$-\infty < a < 0, n = 0$	–	–	1	–	–	T(0), cc1
$-\infty < a < 0, n = 0$	–	–	0	0	–	T(0), SFx←1, cc1
$-\infty < a < 0, n = 0$	–	–	0	1	–	T(0), cc1, PIDx(08)
-0	No ¹	–	–	–	–	T(0), cc0
+0	No ¹	–	–	–	–	T(0), cc0
$0 < a \leq \text{MU}$	No	–	–	–	–	T(f), cc2
$0 < a \leq \text{MU}$	Yes	–	1	–	–	T(f), cc2
$0 < a \leq \text{MU}$	Yes	–	0	0	–	T(f), SFx←1, cc2
$0 < a \leq \text{MU}$	Yes	–	0	1	No	T(f), cc2, PIDx(08)
$0 < a \leq \text{MU}$	Yes	–	0	1	Yes	T(f), cc2, PIDy(0C)
$\text{MU} < a < +\infty, n = \text{MU}$	–	–	1	–	–	T(MU), cc2
$\text{MU} < a < +\infty, n = \text{MU}$	–	–	0	0	–	T(MU), SFx←1, cc2
$\text{MU} < a < +\infty, n = \text{MU}$	–	–	0	1	–	T(MU), cc2, PIDx(08)
$\text{MU} < a \leq +\infty, n > \text{MU}$	–	0	1	–	–	T(MU), SFi←1, cc3
$\text{MU} < a \leq +\infty, n > \text{MU}$	–	0	0	0	–	T(MU), SFi←1, SFx←1, cc3 †
$\text{MU} < a \leq +\infty, n > \text{MU}$	–	0	0	1	–	T(MU), SFi←1, cc3, PIDx(08) †
$\text{MU} < a \leq +\infty, n > \text{MU}$	–	1	–	–	–	PIDi(80)
NaN	–	0	1	–	–	T(0), SFi←1, cc3
NaN	–	0	0	0	–	T(0), SFi←1, SFx←1, cc3 †
NaN	–	0	0	1	–	T(0), SFi←1, cc3, PIDx(08) †
NaN	–	1	–	–	–	PIDi(80)

Explanation:

- The results do not depend on this condition or mask bit.
- ¹ This condition is true by virtue of the state of some condition to the left of this column.
- † Result differs from DFP CONVERT TO LOGICAL. The DFP instruction combines two cases as it does not recognize inexact for this case and does not test the inexact mask.
- ccn Condition code is set to n.
- f The value n converted to a fixed-point result.
- n The value derived when the source value (a) is rounded to a floating-point integer using the effective rounding method.
- MU Maximum unsigned number representable in the target fixed-point format.
- PIDc(h) Program interruption for data exception, condition c, with DXC of h in hex. Figure 19-10 on page 19-11.
- SFi IEEE invalid-operation flag, FPC 1.0.
- SFx IEEE inexact flag, FPC 1.4.
- T(x) The value x is placed at the target operand location.

Figure 19-19. Results: CONVERT TO LOGICAL

DIVIDE

Mnemonic1 R₁,R₂ [RRE]

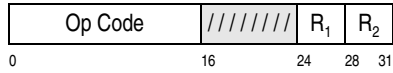

Mnemonic1	Op Code	Operands
DEBR	'B30D'	Short BFP
DDBR	'B31D'	Long BFP
DXBR	'B34D'	Extended BFP

Mnemonic2 R₁,D₂(X₂,B₂) [RXE]

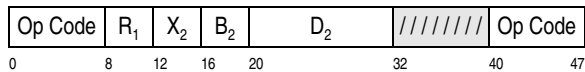

Mnemonic2	Op Code	Operands
DEB	'ED0D'	Short BFP
DDB	'ED1D'	Long BFP

The first operand (the dividend) is divided by the second operand (the divisor), and the quotient is placed at the first-operand location. No remainder is preserved.

If the divisor is nonzero and both the dividend and divisor are finite numbers, the first operand is divided

by the second operand to form an intermediate quotient. The intermediate quotient, if nonzero, is rounded to the target format according to the current BFP rounding mode.

When the dividend is a finite number and the divisor is infinity, the result is zero.

The sign of the quotient, if the quotient is numeric, is the exclusive or of the operand signs. This includes the sign of a zero or infinite quotient.

If the divisor is zero but the dividend is a finite number, an IEEE-division-by-zero exception is recognized. If the dividend and divisor are both zero, or if both are infinity, regardless of sign, an IEEE-invalid-operation exception is recognized.

See Figure 19-20 on page 19-27 for a detailed description of the results of this instruction.

For DXBR, the R fields must designate valid floating-point-register pairs; otherwise, a specification exception is recognized.

Condition Code: The code remains unchanged.

Dividend (a)	Results for DIVIDE (a÷b) when Divisor (b) Is							
	-∞	-Fn	-0	+0	+Fn	+∞	QNaN	SNaN
-∞	Xi: T(dNaN)	T(+∞)	T(+∞)	T(-∞)	T(-∞)	Xi: T(dNaN)	T(b)	Xi: T(b*)
-Fn	T(+0)	R(a÷b)	Xz: T(+∞)	Xz: T(-∞)	R(a÷b)	T(-0)	T(b)	Xi: T(b*)
-0	T(+0)	T(+0)	Xi: T(dNaN)	Xi: T(dNaN)	T(-0)	T(-0)	T(b)	Xi: T(b*)
+0	T(-0)	T(-0)	Xi: T(dNaN)	Xi: T(dNaN)	T(+0)	T(+0)	T(b)	Xi: T(b*)
+Fn	T(-0)	R(a÷b)	Xz: T(-∞)	Xz: T(+∞)	R(a÷b)	T(+0)	T(b)	Xi: T(b*)
+∞	Xi: T(dNaN)	T(-∞)	T(-∞)	T(+∞)	T(+∞)	Xi: T(dNaN)	T(b)	Xi: T(b*)
QNaN	T(a)	T(a)	T(a)	T(a)	T(a)	T(a)	T(a)	Xi: T(b*)
SNaN	Xi: T(a*)	Xi: T(a*)	Xi: T(a*)	Xi: T(a*)	Xi: T(a*)	Xi: T(a*)	Xi: T(a*)	Xi: T(a*)

Explanation:

* The SNaN is converted to the corresponding QNaN before it is placed at the target operand location.

Fn Finite nonzero number (includes both subnormal and normal).

R(v) Rounding and range action is performed on the value v. See Figure 19-8 on page 19-8.

T(x) The value x is placed at the target operand location.

Xi: IEEE invalid-operation exception. The results shown are produced only when FPC 0.0 is zero.

Xz: IEEE division-by-zero exception. The results shown are produced only when FPC 0.1 is zero.

Figure 19-20. Results: DIVIDE

IEEE Exceptions:

- Invalid operation
- Division by zero
- Overflow
- Underflow
- Inexact

Program Exceptions:

- Access (fetch, operand 2 of DEB and DDB only)
- Data with DXC 2, BFP instruction
- Data with DXC for IEEE exception
- Specification (DXBR only)
- Transaction constraint

DIVIDE TO INTEGER

Mnemonic R_1, R_3, R_2, M_4 [RRF-b]

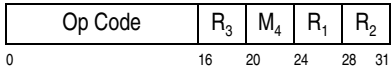

Mnemonic	Op Code	Operands
DIEBR	'B353'	Short BFP
DIDBR	'B35B'	Long BFP

The first operand (the dividend) is divided by the second operand (the divisor). An integer quotient in BFP form is produced and placed at the third-operand location. The remainder replaces the dividend at the first-operand location. The first, second, and third operands must be in different registers. The condition code indicates whether partial or final results have been produced.

The remainder result is

$$r = a - b \cdot n$$

where a is the dividend, b the divisor, and n an integer obtained by rounding the precise quotient

$$q = a \div b.$$

The first-operand result is r with the sign determined by the above expression. The third-operand result is n with a sign that is the exclusive or of the dividend and divisor signs.

If the precise quotient is not an integer and the two integers closest to this precise quotient cannot both be represented exactly in the precision of the quotient, then a partial quotient and partial remainder are formed. (In all other cases, a final quotient and final remainder are formed.) This partial quotient n and the corresponding partial remainder

$$r = a - b \cdot n$$

are used as the results. The sign of a partial remainder is the same as the sign of the dividend. The sign

of a partial quotient is the exclusive or of the dividend and divisor signs.

If the remainder is zero, then the precise quotient is an integer and can be represented exactly in the precision of the quotient.

The M₄ field, called the modifier field, specifies rounding of the final quotient. This rounding is called the “final-quotient-rounding method” as contrasted to the “current BFP rounding mode” specified by the BFP rounding-mode bits in the FPC register. The final quotient is rounded according to the final-quotient-rounding method. The final-quotient-rounding method affects only the final quotient; partial quotients are rounded toward zero.

Since the partial quotient is rounded toward zero, the partial remainder is always exact. For the final-quotient-rounding methods of round toward 0, round to nearest with ties to even, and round to nearest with ties away from 0, the final remainder is exact. For the final-quotient-rounding methods of round toward +∞ and round toward -∞, the final remainder may not be exact.

The final quotient is rounded to an integer by rounding as specified by the modifier in the M₄ field:

M₄ Final-Quotient-Rounding Method

- 0 According to current BFP rounding mode
- 1 Round to nearest with ties away from 0
- 3 Round to prepare for shorter precision
- 4 Round to nearest with ties to even
- 5 Round toward 0
- 6 Round toward +∞
- 7 Round toward -∞

When the floating-point extension facility is installed, a modifier of 2 and 8-15 is invalid. If the floating-point extension facility is not installed, a modifier of 2-3 and 8-15 is invalid.

When the modifier field is zero, rounding of the final quotient is controlled by the current BFP rounding mode specified in the FPC register. When the field is not zero, rounding is performed as specified by the modifier, regardless of the current BFP rounding mode.

Underflow is recognized only on the final remainder, not on the partial remainder.

For the final-quotient-rounding methods of round toward $+\infty$, round toward $-\infty$, and round to prepare for shorter precision, the final remainder may not be exact. When, in these cases, the final remainder is inexact, it is rounded according to the current BFP rounding mode specified in the FPC register.

The sign of a zero quotient is the exclusive or of the divisor and dividend signs.

A zero remainder has the sign of the dividend.

See Figure 19-21 on page 19-29 for a detailed description of the results of this instruction.

If the quotient exponent is greater than the largest exponent that can be represented in the operand format, the correct remainder or partial remainder still is produced, and the third-operand result is the correct value, but with the exponent reduced by 192 or 1536 for short or long operands, respectively. The condition code indicates this out-of-range condition.

If the M_4 field designates any of the following invalid modifier values: 2 and 8-15, then a specification exception is recognized. When the floating-point extension facility is not installed, if the M_4 field designates the invalid value 3, it is undefined whether a specification exception is recognized or an unpredictable rounding method is performed.

The R_1 , R_2 , and R_3 fields must designate different registers; otherwise, a specification exception is recognized.

Resulting Condition Code:

- 0 Remainder final; normal quotient
- 1 Remainder final; quotient overflow or NaN
- 2 Remainder partial; normal quotient
- 3 Remainder partial; quotient overflow

IEEE Exceptions:

- Invalid operation
- Underflow
- Inexact

Dividend (a)	Results for DIVIDE TO INTEGER (a+b) when Divisor (b) Is							
	$-\infty$	-Fn	-0	+0	+Fn	$+\infty$	QNaN	SNaN
$-\infty$	Xi: T(dNaN), cc1	Xi: T(dNaN), cc1	Xi: T(dNaN), cc1	Xi: T(dNaN), cc1	Xi: T(dNaN), cc1	Xi: T(dNaN), cc1	T(b), cc1	Xi: T(b*), cc1
-Fn	T(a,+0), cc0	D(a,b)	Xi: T(dNaN), cc1	Xi: T(dNaN), cc1	D(a,b)	T(a,-0), cc0	T(b), cc1	Xi: T(b*), cc1
-0	T(-0,+0), cc0	T(-0,+0), cc0	Xi: T(dNaN), cc1	Xi: T(dNaN), cc1	T(-0,-0), cc0	T(-0,-0), cc0	T(b), cc1	Xi: T(b*), cc1
+0	T(+0,-0), cc0	T(+0,-0), cc0	Xi: T(dNaN), cc1	Xi: T(dNaN), cc1	T(+0,+0), cc0	T(+0,+0), cc0	T(b), cc1	Xi: T(b*), cc1
+Fn	T(a,-0), cc0	D(a,b)	Xi: T(dNaN), cc1	Xi: T(dNaN), cc1	D(a,b)	T(a,+0), cc0	T(b), cc1	Xi: T(b*), cc1
$+\infty$	Xi: T(dNaN), cc1	Xi: T(dNaN), cc1	Xi: T(dNaN), cc1	Xi: T(dNaN), cc1	Xi: T(dNaN), cc1	Xi: T(dNaN), cc1	T(b), cc1	Xi: T(b*), cc1
QNaN	T(a), cc1	T(a), cc1	T(a), cc1	T(a), cc1	T(a), cc1	T(a), cc1	T(a), cc1	Xi: T(b*), cc1
SNaN	Xi: T(a*), cc1	Xi: T(a*), cc1	Xi: T(a*), cc1	Xi: T(a*), cc1	Xi: T(a*), cc1	Xi: T(a*), cc1	Xi: T(a*), cc1	Xi: T(a*), cc1

Explanation:

- * The SNaN is converted to the corresponding QNaN before it is placed at the target operand location.
- ccn Condition code is set to n.
- D(a,b) Basic divide-to-integer results. See Part 2 of this figure.
- Fn Finite nonzero number (includes both subnormal and normal).
- T(r,q) Results r (the remainder) and q (the quotient) are placed in target operands 1 and 3, respectively.
- T(x) Value x is placed in both target operands 1 and 3.
- Xi: IEEE invalid-operation exception. The results shown are produced only when FPC 0.0 is zero.

Figure 19-21. Results: DIVIDE TO INTEGER (Part 1 of 2)

$ q < 2^P$	$r = 0$	Case [#]	Is r Tiny	Is r Inexact	Underflow Mask (FPC 0.3)	Inexact mask (FPC 0.4)	Quotient Overflow	Is r Incremented	Results for D(a,b)
Yes	Yes	Final	No ¹	No ¹	–	–	No ¹	–	T(r,n), cc0
Yes	No	Final	No	No	–	–	No ¹	–	T(r,n), cc0
Yes	No	Final	Yes	No ¹	0	–	No ¹	–	T(r,n), cc0
Yes	No	Final	Yes	No ¹	1	–	No ¹	No ¹	T(r÷Ψ, n), cc0, PIDu(10)
Yes	No	Final	No	Yes	–	0	No ¹	–	T(r,n), SFx←1, cc0
Yes	No	Final	No	Yes	–	1	No ¹	No	T(r,n), cc0, PIDx(08)
Yes	No	Final	No	Yes	–	1	No ¹	Yes	T(r,n), cc0, PIDy(0C)
No	Yes	Final	No ¹	No ¹	–	–	No	–	T(r,n), cc0
No	Yes	Final	No ¹	No ¹	–	–	Yes	–	T(r, n÷Ψ), cc1
No	No	Partial	– ²	No ¹	–	–	No	–	T(r,n), cc2
No	No	Partial	– ²	No ¹	–	–	Yes	–	T(r, n÷Ψ), cc3

Explanation:

- The results do not depend on this condition or mask bit.
- ¹ This condition is true by virtue of the state of some condition to the left of this column. That is, when $|q| < 2^P$, there cannot be a quotient overflow; the cases of remainder is zero, tiny, or inexact are mutually exclusive; and when r is exact, it is not incremented.
- ² Underflow is not recognized for a partial remainder.
- # Each entry of this column is derived from the entries of the two left columns, and helps determine the specific rounding method used in some columns on the right and determine the resulting condition code setting.
- Ψ Scale factor. For overflow, $\Psi = 2^{+\alpha}$. For underflow, $\Psi = 2^{-\alpha}$. The unsigned scaling exponent (α) depends on the operand format and is 192 for short and 1536 for long.
- |q| The absolute value of q, where q is the precise intermediate value of a÷b before rounding, assuming unbounded precision and unbounded exponent range.
- cc0 Condition code is set to 0 (remainder final; normal quotient).
- cc1 Condition code is set to 1 (remainder final; quotient overflow).
- cc2 Condition code is set to 2 (remainder partial; normal quotient).
- cc3 Condition code is set to 3 (remainder partial; quotient overflow).
- n Integer quotient. $n = q$, rounded toward 0 for partial results and rounded according to the final-quotient-rounding method for final results. The sign of the integer quotient, including the cases of partial and final, scaled value, and zero, is the exclusive or of the signs of the dividend (a) and divisor (b).
- r Remainder. $r = a - b \cdot n$. A partial remainder is always exact; no rounding is necessary. The sign of a partial remainder is always the same as the sign of the dividend (a). A final remainder is rounded according to the current BFP rounding mode (if necessary) specified in the FPC register. The sign of a zero remainder is the same as the sign of the dividend (a). The sign of a nonzero final remainder is determined by the rules of algebra.
- P Precision of the operand, which depends on the target format: $P = 24$ for short and 53 for long.
- PIDc(h) Program interruption for data exception, condition c, with DXC of h in hex. See Figure 19-10 on page 19-11.
- SFi IEEE invalid-operation flag, FPC 1.0.
- SFu IEEE underflow flag, FPC 1.3.
- SFx IEEE inexact flag, FPC 1.4.
- T(r,n) Results r (the remainder) and n (the integer quotient) are placed in target operands 1 and 3, respectively.

Figure 19-21. Results: DIVIDE TO INTEGER (Part 2 of 2)

Program Exceptions:

- Data with DXC 2, BFP instruction
- Data with DXC for IEEE exception
- Specification
- Transaction constraint

Programming Notes:

1. The Remainder operation, as defined in ANSI/IEEE Standard 754-2008, is produced by issuing DIVIDE TO INTEGER in an iterative loop, with the M_4 field set to 4.

- The rounding specifications of round to nearest with ties to even, round toward 0, and round toward $-\infty$ permit the instruction to be used directly to produce the Remainder, MOD, and modulo functions, respectively.
- When DIVIDE TO INTEGER is used in an iterative loop, all quotients are produced in BFP format but may be considered as portions of a multiple-precision fixed-point number.
- In the case when the resulting remainder is sub-normal, ANSI/IEEE Standard 754-2008 requires that if traps are implemented and the underflow mask is one, then an underflow trap must occur. To accomplish this, DIVIDE TO INTEGER recognizes underflow on the final remainder but not on the partial remainder. Since in all cases when underflow exists on the partial remainder it will also exist on the final remainder, recognizing underflow on only the final remainder avoids two underflow traps to be reported for what ANSI/IEEE Standard 754-2008 considers a single Remainder operation.

LOAD AND TEST

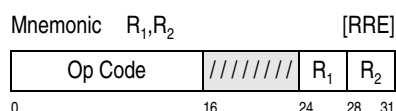

Mnemonic	Op Code	Operands
LTEBR	'B302'	Short BFP
LTDBR	'B312'	Long BFP
LTXBR	'B342'	Extended BFP

The second operand is placed at the first-operand location, and its sign and magnitude are tested to determine the setting of the condition code. The condition code is set the same as for a comparison of the second operand with zero.

The second operand is placed unchanged at the first-operand location. If the second operand is an SNaN, an IEEE-invalid-operation exception is recognized; if there is no interruption, the result is the corresponding QNaN.

See Figure 19-17 on page 19-21 for a detailed description of the results of this instruction.

For LTXBR, the R fields must designate valid floating-point-register pairs; otherwise, a specification exception is recognized.

Resulting Condition Code:

- Result is zero
- Result is less than zero
- Result is greater than zero
- Result is a NaN

IEEE Exceptions:

- Invalid operation

Program Exceptions:

- Data with DXC 2, BFP instruction
- Data with DXC for IEEE exception
- Specification (LTXBR only)
- Transaction constraint

Programming Note: LOAD AND TEST signals invalid operation when the operand is an SNaN. TEST DATA CLASS may be used to test an operand if signaling is not desired.

LOAD COMPLEMENT

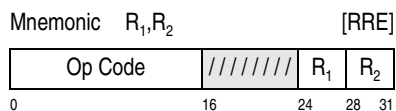

Mnemonic	Op Code	Operands
LCEBR	'B303'	Short BFP
LCDBR	'B313'	Long BFP
LCXBR	'B343'	Extended BFP

The second operand is placed at the first-operand location with the sign bit inverted.

The sign bit is inverted even if the operand is zero. The rest of the second operand is placed unchanged at the first-operand location. The sign is inverted for any operand, including a QNaN or SNaN, without causing an IEEE exception.

For LCXBR, the R fields must designate valid floating-point-register pairs; otherwise, a specification exception is recognized.

Resulting Condition Code:

- Result is zero
- Result is less than zero
- Result is greater than zero
- Result is a NaN

IEEE Exceptions: None.

Program Exceptions:

- Data with DXC 2, BFP instruction
- Specification (LCXBR only)
- Transaction constraint

Programming Note: LOAD COMPLEMENT does not signal invalid operation when the operand is an SNaN. LOAD AND TEST may be used in conjunction with this instruction if signaling is desired.

LOAD FP INTEGER

Mnemonic1 R₁,M₃,R₂ [RRF-e]

Op Code	M ₃	////	R ₁	R ₂
0	16	20	24	28 31

Mnemonic1	Op Code	Operands
FIEBR	'B357'	Short BFP
FIDBR	'B35F'	Long BFP
FIXBR	'B347'	Extended BFP

Mnemonic2 R₁,M₃,R₂,M₄ [RRF-e]

Op Code	M ₃	M ₄	R ₁	R ₂
0	16	20	24	28 31

Mnemonic2	Op Code	Operands
FIEBRA	'B357'	Short BFP
FIDBRA	'B35F'	Long BFP
FIXBRA	'B347'	Extended BFP

The second operand is rounded to an integer value in the same floating-point format, and the result is placed at the first-operand location.

The second operand, if a finite number, is rounded to an integer value as specified by the modifier in the M₃ field:

M₃ Effective Rounding Method

- 0 According to current BFP rounding mode
- 1 Round to nearest with ties away from 0
- 3 Round to prepare for shorter precision
- 4 Round to nearest with ties to even
- 5 Round toward 0
- 6 Round toward +∞
- 7 Round toward -∞

An M₃ modifier other than 0, 1, or 3-7 is invalid. If the floating-point extension facility is not installed, an M₃ modifier of 3 is also invalid.

When the M₃ modifier field is zero, rounding is controlled by the current BFP rounding mode in the FPC register. When the field is not zero, rounding is performed as specified by the modifier, regardless of the current BFP rounding mode.

In the absence of an interruption, if the second operand is an infinity or a QNaN, the result is that operand; if the second operand is an SNaN, the result is the corresponding QNaN.

The sign of the result is the sign of the second operand, even when the result is zero.

When the floating-point extension facility is installed, bit 1 of the M₄ field is the IEEE-inexact-exception control (XxC). Bits 0, 2, and 3 are ignored. If XxC is zero, recognition of IEEE-inexact exception is not suppressed; if XxC is one, recognition of IEEE-inexact exception is suppressed.

When the floating-point extension facility is not installed and if bits 20-23 of the instruction are zeros, recognition of IEEE-inexact exception is not suppressed; when the floating-point extension facility is not installed and if bits 20-23 of the instruction contain a nonzero value, it is unpredictable whether recognition of IEEE-inexact exception is suppressed.

See Figure 19-22 on page 19-33 for a detailed description of the results of this instruction.

If the M₃ field designates any of the following invalid modifier values: 2 and 8-15, then a specification exception is recognized. When the floating-point extension facility is not installed, if the M₃ field designates the invalid value 3, it is undefined whether a specification exception is recognized or an unpredictable rounding method is performed.

For FIXBR and FIXBRA, the R fields must designate valid floating-point-register pairs. Otherwise, a specification exception is recognized.

Condition Code: The code remains unchanged.

IEEE Exceptions:

- Invalid operation
- Inexact

Program Exceptions:

- Data with DXC 2, BFP instruction

- Data with DXC for IEEE exception
- Specification
- Transaction constraint

- If the BFP operand is a finite number with a large enough exponent so that it is already an integer, the result value remains the same.
- Unassigned bits in the M_4 field are reserved for future extensions and should be set to zeros; otherwise the program may not operate compatibly in the future.

Programming Notes:

- LOAD FP INTEGER rounds a BFP number to an integer value. These integers, which remain in the BFP format, should not be confused with binary integers, which have a fixed-point format.

Operand (a)	Is n Inexact (n≠a)	Inv.-Op. Mask (FPC 0.0)	IEEE Inexact Exception Control (XxC) ²	Inexact Mask (FPC 0.4)	Is n Incremented (n > a)	Results
-∞	No ¹	–	–	–	–	T(-∞)
-Fn	No	–	–	–	–	T(n)
-Fn	Yes	–	1	–	–	T(n)
-Fn	Yes	–	0	0	–	T(n), SFx←1
-Fn	Yes	–	0	1	No	T(n), PIDx(08)
-Fn	Yes	–	0	1	Yes	T(n), PIDy(0C)
-0	No ¹	–	–	–	–	T(-0)
+0	No ¹	–	–	–	–	T(+0)
+Fn	No	–	–	–	–	T(n)
+Fn	Yes	–	1	–	–	T(n)
+Fn	Yes	–	0	0	–	T(n), SFx←1
+Fn	Yes	–	0	1	No	T(n), PIDx(08)
+Fn	Yes	–	0	1	Yes	T(n), PIDy(0C)
+∞	No ¹	–	–	–	–	T(+∞)
QNaN	No ¹	–	–	–	–	T(a)
SNaN	No ¹	0	–	–	–	T(a*), SFi←1
SNaN	No ¹	1	–	–	–	PIDi(80)

Explanation:

- The results do not depend on this condition or mask bit.
- * The SNaN is converted to the corresponding QNaN before it is placed at the target operand location.
- ¹ This condition is true by virtue of the state of some condition to the left of this column.
- ² XxC is defined only if the Floating-point extension facility is installed.
- n The value derived when the source value, a, is rounded to a floating-point integer using the effective rounding mode.
- Fn Finite nonzero number (includes both subnormal and normal).
- PIDc(h) Program interruption for data exception, condition c, with DXC of h in hex. See Figure 19-10 on page 19-11.
- SFi IEEE invalid-operation flag, FPC 1.0.
- SFx IEEE inexact flag, FPC 1.4.
- T(x) The value x is placed at the target operand location.

Figure 19-22. Results: LOAD FP INTEGER

LOAD LENGTHENED

Mnemonic1 R₁,R₂ [RRE]

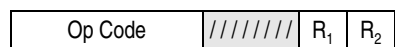

0 16 24 28 31

Mnemonic1	Op Code	Operands
LDEBR	'B304'	Short BFP operand 2, long BFP operand 1
LXDBR	'B305'	Long BFP operand 2, extended BFP operand 1
LXEBR	'B306'	Short BFP operand 2, extended BFP operand 1

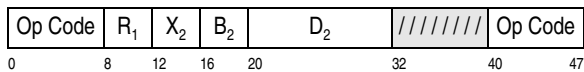
Mnemonic2 $R_1, D_2(X_2, B_2)$ [RXE]

Mnemonic2	Op Code	Operands
LDEB	'ED04'	Short BFP operand 2, long BFP operand 1
LXDB	'ED05'	Long BFP operand 2, extended BFP operand 1
LXEB	'ED06'	Short BFP operand 2, extended BFP operand 1

The second operand is converted to a longer format, and the result is placed at the first-operand location.

When the second operand is a finite number, the value of the second operand is placed in the target format. The exponent of the second operand is converted to the corresponding exponent in the result format, and the fraction is extended by appending zeros on the right.

If the second operand is an infinity, the result is an infinity of the same sign. If the second operand is an SNaN, an IEEE-invalid-operation exception is recognized; if there is no interruption, the result is the corresponding QNaN with the fraction extended.

The sign of the result is the same as the sign of the source.

See Figure 19-17 on page 19-21 for a detailed description of the results of this instruction.

For LXDB, LXDBR, LXEB, and LXEBR, the R₁ field must designate a valid floating-point-register pair; otherwise, a specification exception is recognized.

Condition Code: The code remains unchanged.

IEEE Exceptions:

- Invalid operation

Program Exceptions:

- Access (fetch, operand 2 of LDEB, LXEB, and LXDB only)
- Data with DXC 2, BFP instruction
- Data with DXC for IEEE exception
- Specification (LXEB, LXEBR, LXDB, LXDBR)

- Transaction constraint

LOAD NEGATIVE

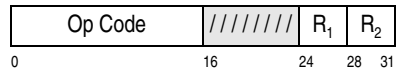
Mnemonic R_1, R_2 [RRE]

Mnemonic	Op Code	Operands
LNEBR	'B301'	Short BFP
LNDBR	'B311'	Long BFP
LNXBR	'B341'	Extended BFP

The second operand is placed at the first-operand location with the sign bit made one.

The sign bit is made one even if the operand is zero. The rest of the second operand is placed unchanged at the first-operand location. The sign is set for any operand, including a QNaN or SNaN, without causing an IEEE exception.

For LNXBR, the R fields must designate valid floating-point-register pairs; otherwise, a specification exception is recognized.

Resulting Condition Code:

- 0 Result is zero
- 1 Result is less than zero
- 2 --
- 3 Result is a NaN

IEEE Exceptions: None.

Program Exceptions:

- Data with DXC 2, BFP instruction
- Specification (LNXBR only)
- Transaction constraint

Programming Note: LOAD NEGATIVE does not signal invalid operation when the operand is an SNaN. LOAD AND TEST may be used in conjunction with this instruction if signaling is desired.

LOAD POSITIVE

Mnemonic R_1, R_2 [RRE]

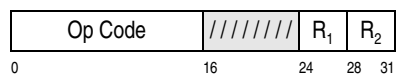

Mnemonic	Op Code	Operands
LPEBR	'B300'	Short BFP
LPDBR	'B310'	Long BFP
LPXBR	'B340'	Extended BFP

The second operand is placed at the first-operand location with the sign bit made zero.

The sign bit is made zero, and the rest of the second operand is placed unchanged at the first-operand location. The sign is set for any operand, including a QNaN or SNaN, without causing an IEEE exception.

For LPXBR, the R fields must designate valid floating-point-register pairs; otherwise, a specification exception is recognized.

Resulting Condition Code:

- 0 Result is zero
- 1 --
- 2 Result is greater than zero
- 3 Result is a NaN

IEEE Exceptions: None.

Program Exceptions:

- Data with DXC 2, BFP instruction
- Specification (LPXBR only)
- Transaction constraint

Programming Note: LOAD POSITIVE does not signal invalid operation when the operand is an SNaN. LOAD AND TEST may be used in conjunction with this instruction if signaling is desired.

LOAD ROUNDED

Mnemonic1 R_1, R_2 [RRE]

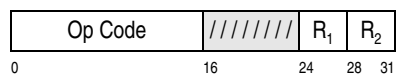

Mnemonic1	Op Code	Operands
LEDBR	'B344'	Long BFP source, short BFP target, short or long BFP result
LDXBR	'B345'	Extended BFP source, long BFP target, long or extended BFP result
LEXBR	'B346'	Extended BFP source, short BFP target, short or extended BFP result

Mnemonic2 R_1, M_3, R_2, M_4 [RRF-e]

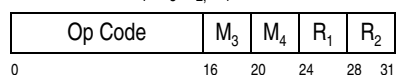

Mnemonic2	Op Code	Operands
LEDBRA	'B344'	Long BFP source, short BFP target, short or long BFP result
LDXBRA	'B345'	Extended BFP source, long BFP target, long or extended BFP result
LEXBRA	'B346'	Extended BFP source, short BFP target, short or extended BFP result

The second operand, in the format of the source, is rounded to the precision of the target, and the result is placed at the first-operand location.

When the floating-point extension facility is installed, the second operand, if a finite number, is rounded by rounding as specified by the modifier in the M_3 field:

M_3 Effective Rounding Method

- 0 According to current BFP rounding mode
- 1 Round to nearest with ties away from 0
- 3 Round to prepare for shorter precision
- 4 Round to nearest with ties to even
- 5 Round toward 0
- 6 Round toward $+\infty$
- 7 Round toward $-\infty$

An M_3 modifier other than 0, 1, or 3-7 is invalid. The M_3 field must designate a valid modifier; otherwise, a specification exception is recognized.

When the M_3 modifier field is zero, rounding is controlled by the current BFP rounding mode specified in the FPC register. When the field is not zero, rounding is performed as specified by the modifier, regardless of the current BFP rounding mode.

When the floating-point extension facility is not installed and bits 16-19 of the instruction contain a value of zero, the second operand is rounded according to the current BFP rounding mode. When the floating-point extension facility is not installed and bits 16-19 of the instruction contain a nonzero value, it is undefined whether a specification exception is recognized or an unpredictable rounding method is performed.

In the absence of IEEE-trap action for overflow or underflow, the result is in the format and length of the target. However, when an IEEE overflow or an IEEE underflow is recognized and the corresponding mask bit is one, the operation is completed by producing a scaled result in the same format and length as the source but rounded to the precision of the target. For LEDBR, LEDBRA, LEXBR and LEXBRA, the result has at most 23 significand fraction bits; for LDXBR and LDXBRA, the result has at most 52 significand fraction bits.

A short-format result replaces the leftmost 32 bits of the target register, and the rightmost 32 bit positions of the target register remain unchanged. A long-format result is placed in a floating-point register, and the other register of the floating-point register pair, if any, remains unchanged. An extended-format result is placed in a floating-point register pair.

The sign of the result is the same as the sign of the second operand.

When the floating-point extension facility is installed, bit 1 of the M_4 field is the IEEE-inexact-exception control (XxC). Bits 0, 2, and 3 are ignored. If XxC is zero, recognition of IEEE-inexact exception is not suppressed; if XxC is one, recognition of IEEE-inexact exception is suppressed.

When the floating-point extension facility is not installed and if bit 21 of the instruction is zero, recognition of IEEE-inexact exception is not suppressed; when the floating-point extension facility is not installed and if bit 21 of the instruction is one, then it is unpredictable whether recognition of IEEE-inexact exception is suppressed.

See Figure 19-17 on page 19-21 for a detailed description of the results of this instruction.

For LDXBR, LDXBRA, LEXBR, and LEXBRA, the R_1 and R_2 fields must designate valid floating-point-register pairs; otherwise, a specification exception is recognized.

Condition Code: The code remains unchanged.

IEEE Exceptions:

- Invalid operation
- Overflow
- Underflow
- Inexact

Program Exceptions:

- Data with DXC 2, BFP instruction
- Data with DXC for IEEE exception
- Specification
- Transaction constraint

Programming Notes:

1. The sign of the rounded result is the same as the sign of the operand, even when the result is zero.
2. The R_1 field for LDXBR, LDXBRA, LEXBR, and LEXBRA must designate a valid floating-point-register pair since in certain cases the result is in the extended format. In normal operation for LDXBR, LDXBRA, LEXBR and LEXBRA, the result format is long or short, respectively, and this result replaces the leftmost 32 bits or 64 bits of the target-register pair. However, when an IEEE overflow or an IEEE underflow is recognized and the corresponding mask bit is one, the operation is completed by placing a result in the extended format at the target location. Thus, the program must take into account the fact that these instructions sometimes update both registers of the pair.
3. Unassigned bits in the M_4 field are reserved for future extensions and should be set to zeros; otherwise the program may not operate compatibly in the future

MULTIPLY

Mnemonic1 R_1, R_2 [RRE]

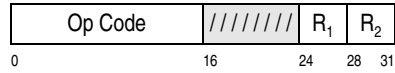

Mnemonic1	Op Code	Operands
MEEBR	'B317'	Short BFP
MDBR	'B31C'	Long BFP
MXBR	'B34C'	Extended BFP
MDEBR	'B30C'	Short BFP multiplier and multiplicand, long BFP product
MXDBR	'B307'	Long BFP multiplier and multiplicand, extended BFP product

Mnemonic2 $R_1, D_2(X_2, B_2)$ [RXE]

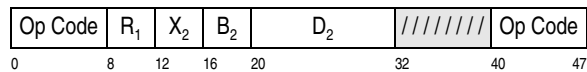

Mnemonic2	Op Code	Operands
MEEB	'ED17'	Short BFP
MDB	'ED1C'	Long BFP
MDEB	'ED0C'	Short BFP multiplier and multiplicand, long BFP product
MXDB	'ED07'	Long BFP multiplier and multiplicand, extended BFP product

The product of the second operand (the multiplier) and the first operand (the multiplicand) is placed at the first-operand location.

The two BFP operands, if finite numbers, are multiplied, forming an intermediate product. For MDEB, MDEBR, MXDB, and MXDBR, the intermediate product is converted to the longer target format; the result cannot overflow or underflow and is exact. For MDB, MDBR, MEEB, MEEBR, and MXBR, the result is rounded to the operand format according to the current BFP rounding mode. For MEEB and MEEBR, the result, as for all short-format results, replaces the leftmost 32 bits of the target register, and the rightmost 32 bit positions of the target register remain unchanged.

The sign of the product, if the product is numeric, is the exclusive or of the operand signs. This includes the sign of a zero or infinite product.

If one operand is a zero and the other an infinity, an IEEE-invalid-operation exception is recognized.

See Figure 19-23 on page 19-38 for a detailed description of the results of this instruction.

The R_1 field for MXDB, MXDBR, and MXBR, and the R_2 field for MXBR, must designate valid floating-point-register pairs. Otherwise, a specification exception is recognized.

Condition Code: The code remains unchanged.

IEEE Exceptions:

- Invalid operation
- Overflow (MDB, MDBR, MEEB, MEEBR, MXBR)
- Underflow (MDB, MDBR, MEEB, MEEBR, MXBR)
- Inexact (MDB, MDBR, MEEB, MEEBR, MXBR)

Program Exceptions:

- Access (fetch, operand 2 of MDEB, MEEB, MDB, and MXDB only)
- Data with DXC 2, BFP instruction
- Data with DXC for IEEE exception
- Specification (MXDB, MXDBR, MXBR)
- Transaction constraint

Programming Note: Interchanging the two operands in a BFP multiplication does not affect the value of the product when the result is numeric. This is not true, however, when both operands are QNaNs, in which case the result is the first operand; or when both operands are SNaNs and the IEEE-invalid-operation mask bit in the FPC register is zero, in which case the result is the QNaN derived from the first operand.

First Operand (a) Is	Results for MULTIPLY (a•b) when Second Operand (b) Is							
	$-\infty$	-Fn	-0	+0	+Fn	$+\infty$	QNaN	SNaN
$-\infty$	T(+∞)	T(+∞)	Xi: T(dNaN)	Xi: T(dNaN)	T(-∞)	T(-∞)	T(b)	Xi: T(b*)
-Fn	T(+∞)	R(a•b)	T(+0)	T(-0)	R(a•b)	T(-∞)	T(b)	Xi: T(b*)
-0	Xi: T(dNaN)	T(+0)	T(+0)	T(-0)	T(-0)	Xi: T(dNaN)	T(b)	Xi: T(b*)
+0	Xi: T(dNaN)	T(-0)	T(-0)	T(+0)	T(+0)	Xi: T(dNaN)	T(b)	Xi: T(b*)
+Fn	T(-∞)	R(a•b)	T(-0)	T(+0)	R(a•b)	T(+∞)	T(b)	Xi: T(b*)
$+\infty$	T(-∞)	T(-∞)	Xi: T(dNaN)	Xi: T(dNaN)	T(+∞)	T(+∞)	T(b)	Xi: T(b*)
QNaN	T(a)	T(a)	T(a)	T(a)	T(a)	T(a)	T(a)	Xi: T(b*)
SNaN	Xi: T(a*)	Xi: T(a*)	Xi: T(a*)	Xi: T(a*)	Xi: T(a*)	Xi: T(a*)	Xi: T(a*)	Xi: T(a*)

Explanation:

* The SNaN is converted to the corresponding QNaN before it is placed at the target operand location.
dNaN Default NaN.
Fn Finite nonzero number (includes both subnormal and normal).
R(v) Rounding and range action is performed on the value v. See Figure 19-8 on page 19-8.
T(x) The value x is placed at the target operand location.
Xi: IEEE invalid-operation exception. The results shown are produced only when FPC 0.0 is zero.

Figure 19-23. Results: MULTIPLY

MULTIPLY AND ADD

Mnemonic1 R_1, R_3, R_2 [RRD]

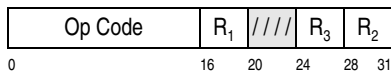

Mnemonic1	Op Code	Operands
MAEBR	'B30E'	Short BFP
MADBR	'B31E'	Long BFP

Mnemonic2 $R_1, R_3, D_2(X_2, B_2)$ [RXF]

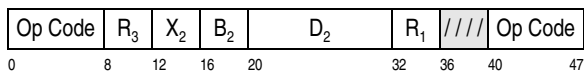

Mnemonic2	Op Code	Operands
MAEB	'ED0E'	Short BFP
MADB	'ED1E'	Long BFP

MULTIPLY AND SUBTRACT

Mnemonic1 R_1, R_3, R_2 [RRD]

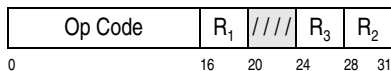

Mnemonic1	Op Code	Operands
MSEBR	'B30F'	Short BFP
MSDBR	'B31F'	Long BFP

Mnemonic2 $R_1, R_3, D_2(X_2, B_2)$ [RXF]

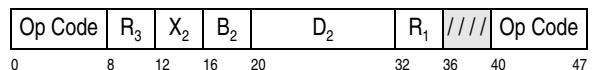

Mnemonic2	Op Code	Operands
MSEB	'ED0F'	Short BFP
MSDB	'ED1F'	Long BFP

The third operand is multiplied by the second operand, and then the first operand is added to or subtracted from the product. The sum or difference is placed at the first-operand location. The MULTIPLY AND ADD and MULTIPLY AND SUBTRACT operations may be summarized as:

$$op_1 = op_3 \cdot op_2 \pm op_1$$

When the operands are finite numbers, the third and second BFP operands are multiplied, forming an intermediate product, and the first operand is then added (or subtracted) algebraically to (or from) the intermediate product, forming an intermediate sum. The intermediate sum, if nonzero, is rounded to the operand format according to the current BFP rounding mode and then placed at the first-operand location. The exponent and fraction of the intermediate product are maintained exactly; rounding and range checking occur only on the intermediate sum.

See Figure 19-24 for a detailed description of the results of MULTIPLY AND ADD. The results of MUL-

Third Operand (a) Is	Results, Part 1, for MULTIPLY AND ADD ($a \cdot b + c$) when Second Operand (b) Is							
	$-\infty$	-Fn	-0	+0	+Fn	$+\infty$	QNaN	SNaN
$-\infty$	P(+ ∞)	P(+ ∞)	Xi: T(dNaN)	Xi: T(dNaN)	P(- ∞)	P(- ∞)	P(b)	Xi: T(b*)
-Fn	P(+ ∞)	P(a \cdot b)	P(+0)	P(-0)	P(a \cdot b)	P(- ∞)	P(b)	Xi: T(b*)
-0	Xi: T(dNaN)	P(+0)	P(+0)	P(-0)	P(-0)	Xi: T(dNaN)	P(b)	Xi: T(b*)
+0	Xi: T(dNaN)	P(-0)	P(-0)	P(+0)	P(+0)	Xi: T(dNaN)	P(b)	Xi: T(b*)
+Fn	P(- ∞)	P(a \cdot b)	P(-0)	P(+0)	P(a \cdot b)	P(+ ∞)	P(b)	Xi: T(b*)
$+\infty$	P(- ∞)	P(- ∞)	Xi: T(dNaN)	Xi: T(dNaN)	P(+ ∞)	P(+ ∞)	P(b)	Xi: T(b*)
QNaN	P(a)	P(a)	P(a)	P(a)	P(a)	P(a)	P(a)	Xi: T(b*)
SNaN	Xi: T(a*)	Xi: T(a*)	Xi: T(a*)	Xi: T(a*)	Xi: T(a*)	Xi: T(a*)	Xi: T(a*)	Xi: T(a*)

Figure 19-24. Results: MULTIPLY AND ADD (Part 1 of 2)

Value from Part 1 (p) Is	Results, Part 2, for MULTIPLY AND ADD ($a \cdot b + c$) when First Operand (c) Is							
	$-\infty$	-Fn	-0	+0	+Fn	$+\infty$	QNaN	SNaN
$-\infty$	T(- ∞)	T(- ∞)	T(- ∞)	T(- ∞)	T(- ∞)	Xi: T(dNaN)	T(c)	Xi: T(c*)
-Fn	T(- ∞)	R(p+c)	R(p)	R(p)	R(p+c)	T(+ ∞)	T(c)	Xi: T(c*)
-0	T(- ∞)	R(c)	T(-0)	Rezd	R(c)	T(+ ∞)	T(c)	Xi: T(c*)
+0	T(- ∞)	R(c)	Rezd	T(+0)	R(c)	T(+ ∞)	T(c)	Xi: T(c*)
+Fn	T(- ∞)	R(p+c)	R(p)	R(p)	R(p+c)	T(+ ∞)	T(c)	Xi: T(c*)
$+\infty$	Xi: T(dNaN)	T(+ ∞)	T(+ ∞)	T(+ ∞)	T(+ ∞)	T(+ ∞)	T(c)	Xi: T(c*)
QNaN	T(p)	T(p)	T(p)	T(p)	T(p)	T(p)	T(p)	Xi: T(c*)

Explanation:

- * The SNaN is converted to the corresponding QNaN before it is placed at the target operand location.
- dNaN Default NaN.
- Fn Finite nonzero number (includes both subnormal and normal).
- P(x) The value x is passed to Part 2 of this figure.
- R(v) Rounding and range action is performed on the value v. See Figure 19-8 on page 19-8.
- Rezd Exact zero-difference result. See Figure 19-8 on page 19-8.
- T(x) The value x is placed at the target operand location.
- Xi: IEEE invalid-operation exception. The results shown are produced only when FPC 0.0 is zero.

Figure 19-24. Results: MULTIPLY AND ADD (Part 2 of 2)

MULTIPLY AND SUBTRACT are the same, except that the first operand, if numeric, participates in the operation with its sign bit inverted. When the first operand is a NaN, it participates in the operation with its sign bit unchanged.

Condition Code: The code remains unchanged.

IEEE Exceptions:

- Invalid operation
- Overflow
- Underflow
- Inexact

Program Exceptions:

- Access (fetch, operand 2 of MAEB, MADB, MSEB, MSDB)
- Data with DXC 2, BFP instruction
- Data with DXC for IEEE exception
- Transaction constraint

Programming Note: MULTIPLY AND ADD and MULTIPLY AND SUBTRACT produce a precise intermediate value, and a single rounding operation is performed after the addition or subtraction. This definition is consistent with the Power architecture, and, in certain applications, can be used to great advantage, especially in algorithms used in math libraries.

SQUARE ROOT

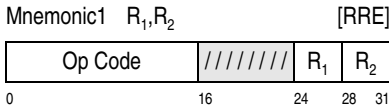

Mnemonic1	Op Code	Operands
SQEBR	'B314'	Short BFP
SQDBR	'B315'	Long BFP
SQXBR	'B316'	Extended BFP

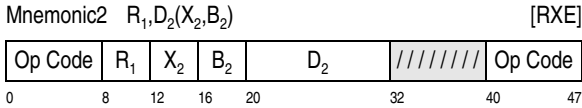

Mnemonic2	Op Code	Operands
SQEB	'ED14'	Short BFP
SQDB	'ED15'	Long BFP

The square root of the second operand is placed at the first-operand location.

The result rounded according to the current BFP rounding mode is placed at the first-operand location.

If the second operand is a positive finite number, the result is the square root of that number with a plus sign. If the operand is a zero of either sign, the result is a zero of the same sign. If the operand is $+\infty$, the result is $+\infty$.

If the second operand is less than zero, an IEEE-invalid-operation exception is recognized.

See Figure 19-17 on page 19-21 for a detailed description of the results of this instruction.

For SQXBR, the R fields must designate valid floating-point-register pairs; otherwise, a specification exception is recognized.

Condition Code: The code remains unchanged.

IEEE Exceptions:

- Invalid operation
- Inexact

Program Exceptions:

- Access (fetch, operand 2 of SQEB and SQDB only)
- Data with DXC 2, BFP instruction
- Data with DXC for IEEE exception
- Specification (SQXBR only)
- Transaction constraint

SUBTRACT

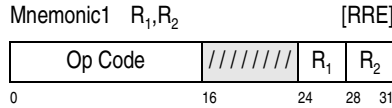

Mnemonic1	Op Code	Operands
SEBR	'B30B'	Short BFP
SDBR	'B31B'	Long BFP
SXBR	'B34B'	Extended BFP

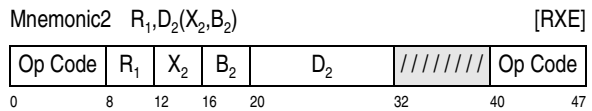

Mnemonic2	Op Code	Operands
SEB	'ED0B'	Short BFP
SDB	'ED1B'	Long BFP

The second operand is subtracted from the first operand, and the difference is placed at the first-operand location.

The execution of SUBTRACT is identical to that of ADD, except that the second operand, if numeric, participates in the operation with its sign bit inverted. When the second operand is a NaN, it participates in the operation with its sign bit unchanged. See Figure 19-13 on page 19-16 for the detailed results of ADD.

For SXBR, the R fields must designate valid floating-point-register pairs; otherwise, a specification exception is recognized.

Resulting Condition Code:

- 0 Result is zero
- 1 Result is less than zero
- 2 Result is greater than zero
- 3 Result is a NaN

IEEE Exceptions:

- Invalid operation
- Overflow
- Underflow
- Inexact

Program Exceptions:

- Access (fetch, operand 2 of SEB and SDB only)
- Data with DXC 2, BFP instruction
- Data with DXC for IEEE exception
- Specification (SXBR only)
- Transaction constraint

TEST DATA CLASS

Mnemonic	$R_1, D_2(X_2, B_2)$						[RXE]
Op Code	R ₁	X ₂	B ₂	D ₂		////////	Op Code
0	8	12	16	20	32	40	47

Mnemonic	Op Code	Operands
TCEB	'ED10'	Short BFP
TCDB	'ED11'	Long BFP
TCXB	'ED12'	Extended BFP

The class and sign of the first operand are examined to select one bit from the second-operand address. Condition code 0 or 1 is set according to whether the selected bit is zero or one, respectively.

The second-operand address is not used to address data; instead, the rightmost 12 bits of the address, bits 52-63, are used to specify 12 combinations of BFP data class and sign. Bits 0-51 of the second-operand address are ignored.

As shown in Figure 19-25, BFP operands are divided into six classes: zero, normal number, subnormal number, infinity, quiet NaN, and signaling NaN.

One or more of the second-operand-address bits may be set to one. If the second-operand-address bit corresponding to the class and sign of the first operand is one, condition code 1 is set; otherwise, condition code 0 is set.

BFP Operand Class	Bit Used when Sign Is	
	+	-
Zero	52	53
Normal number	54	55
Subnormal number	56	57
Infinity	58	59
Quiet NaN	60	61
Signaling NaN	62	63

Figure 19-25. Second-Operand-Address Bits for TEST DATA CLASS

Operands, including SNaNs and QNaNs, are examined without causing an IEEE exception.

For TCXB, the R₁ field must designate a valid floating-point-register pair; otherwise, a specification exception is recognized.

Resulting Condition Code:

- 0 Selected bit is 0 (no match)
- 1 Selected bit is 1 (match)
- 2 --
- 3 --

IEEE Exceptions: None.

Program Exceptions:

- Data with DXC 2, BFP instruction
- Specification (TCXB only)
- Transaction constraint

Programming Notes:

1. TEST DATA CLASS provides a way to test an operand without risk of an exception or setting the IEEE flags.
2. The bits used to specify the combinations of data class and sign are not all the same for BFP and DFP. Specifically, DFP TEST DATA CLASS uses bits 54 and 55 for subnormal number, and bits 56 and 57 for normal number.

Chapter 20. Decimal-Floating-Point Instructions

Decimal-Floating-Point Facility	20-1	Data-Exception Codes (DXC) and Abbreviations	20-15
DFP Arithmetic	20-2	Instructions	20-16
Finite Floating-Point Number	20-2	ADD	20-19
Cohort	20-2	COMPARE	20-22
Quantum	20-2	COMPARE AND SIGNAL	20-23
Preferred Quantum	20-2	COMPARE BIASED EXPONENT	20-23
Scaled Preferred Quantum	20-3	CONVERT FROM FIXED	20-24
Delivered Quantum	20-3	CONVERT FROM LOGICAL	20-25
Special Quantum-Handling Operations	20-3	CONVERT FROM PACKED	20-26
DFP Data Formats	20-3	CONVERT FROM SIGNED PACKED	20-28
DFP Short Format	20-3	CONVERT FROM UNSIGNED PACKED	20-28
DFP Long Format	20-3	CONVERT FROM ZONED	20-29
DFP Extended Format	20-4	CONVERT TO FIXED	20-29
Sign	20-4	CONVERT TO LOGICAL	20-32
Combination	20-4	CONVERT TO PACKED	20-33
Encoded Trailing Significand	20-5	CONVERT TO SIGNED PACKED	20-35
Values of Finite Numbers	20-5	CONVERT TO UNSIGNED PACKED	20-35
Significand	20-5	CONVERT TO ZONED	20-36
DFP Significant Digits	20-5	DIVIDE	20-37
Canonical Decls	20-6	EXTRACT BIASED EXPONENT	20-39
DFP Canonical Data	20-6	EXTRACT SIGNIFICANCE	20-39
Classes of DFP Data	20-6	INSERT BIASED EXPONENT	20-40
Zeros	20-6	LOAD AND TEST	20-41
Subnormal Numbers	20-6	LOAD FP INTEGER	20-42
Normal Numbers	20-7	LOAD LENGTHENED	20-45
Infinities	20-7	LOAD ROUNDED	20-46
Signaling and Quiet NaNs	20-7	MULTIPLY	20-47
Canonicalization	20-7	QUANTIZE	20-49
DFP-Format Conversion	20-7	REROUND	20-52
DFP Rounding	20-7	SHIFT SIGNIFICAND LEFT	20-54
DFP Comparison	20-7	SHIFT SIGNIFICAND RIGHT	20-54
DFP Formatting Instructions	20-8	SUBTRACT	20-55
Signed-Packed-Decimal Format	20-8	TEST DATA CLASS	20-56
Unsigned-Packed-Decimal Format	20-8	TEST DATA GROUP	20-57
Zoned-Decimal Format	20-9	Densely Packed Decimal (DPD)	20-58
IEEE Exceptions	20-9	Decimal-to-DPD Mapping	20-58
Summary of Preferred Quantum	20-10	DPD-to-Decimal Mapping	20-58
Summary of Rounding And Range Actions	20-10		
Result Figures	20-15		

Decimal-Floating-Point Facility

The decimal-floating-point (DFP) facility provides instructions to operate on decimal (radix-10) floating-point data. The facility was designed in cooperation with the IEEE floating-point working group.

Additionally, this facility was designed to support a common library for various systems. This facility in both the z/architecture and Power architectures supports the same data formats, the same rounding methods, the same functions, and the same exceptions.

DFP has a number of important characteristics:

- It produces results consistent with decimal arithmetic as taught in elementary school.
- It recognizes the quantum of a finite number, maintains quantum information through arithmetic operations, and provides special operations to extract, compare, and adjust the quantum.
- It provides greater exponent range than hexadecimal-floating-point (HFP) and binary-floating-point (BFP) while maintaining comparable precision.
- It provides greater precision and better space efficiency than provided by the decimal-arithmetic instructions and the packed-decimal format as described in Chapter 8, “Decimal Instructions.”
- It supports IEEE flags, exceptions, and special entities of “infinity” and “Not-a-Number” (NaN).
- It supports eight automatic rounding methods. For DFP computational instructions, an explicit rounding method can be specified in a modifier field in the instruction.
- It facilitates production of DFP results with a precision other than any supported format precision and with the effect of single rounding.
- It provides operations for conversion between fixed-point and DFP formats.
- It provides operations for conversion between packed-decimal and DFP formats.
- It provides three-operand nondestructive arithmetic operations by permitting different target-operand registers from source-operand registers.

The DFP facility uses the same 16 floating-point registers as those used by HFP and BFP. A set of radix-independent floating-point-support instructions can be used to load, store, or change the sign of a DFP operand. These instructions are defined in Chapter 9, “Floating-Point Overview and Support Instructions.”

The DFP facility uses the same floating-point-control (FPC) register as that used by BFP. The bits of the FPC register are often referred to as, for example, FPC1.0, meaning bit 0 of byte 1 of the register. The description of the FPC register, including the DFP-rounding-mode field, and the instructions that operate on the FPC register are provided in Chapter 9, “Floating-Point Overview and Support Instructions.”

The DFP computational model, a high-level overview of the computational steps, is described in the section “IEEE Computational Operations” of Chapter 9, “Floating-Point Overview and Support Instructions.” Detailed definitions of rounding methods and IEEE exceptions supported by DFP are also described in the section.

DFP Arithmetic

Finite Floating-Point Number

A finite floating-point number has three components: a sign, an exponent, and a significand. The magnitude of a finite number is the product of significand multiplied by the radix raised to the power of the exponent. The number is positive or negative depending on whether the sign bit is zero or one, respectively.

Cohort

Finite decimal-floating-point (DFP) numbers are not necessarily normalized; that is, the leftmost significand digit may be zero. This allows some values to have multiple representations; each with a different combination of the significand and the exponent. The set of different representations for a value of the same sign is called a cohort; and each representation in a cohort is called a cohort member. A positive zero and a negative zero have the same value but are in different cohorts.

Quantum

For a DFP finite number, the magnitude of a value of one in the rightmost digit position of the significand is called the quantum. Each cohort member of a cohort uses a different quantum to represent the same value. Regardless of whether the left-units view or right-units view is taken, the quantum of a cohort member is the same.

Preferred Quantum

For operations that produce a DFP result, when, in the absence of a trap overflow or a trap underflow, the delivered value is a finite number, a value, called the preferred quantum, is defined to select a cohort member to represent the delivered value. The preferred quantum for each of these operations is shown in Figure 20-4 on page 20-10. When the delivered value is exact, the preferred quantum depends on the

operation. When the delivered value is inexact, the preferred quantum is the smallest quantum of the cohort members, unless otherwise stated.

Scaled Preferred Quantum

For operations that produce a DFP result, when a trap overflow or a trap underflow occurs, a scaled preferred quantum is used to select a cohort member to represent the delivered value. The scaled preferred quantum is obtained by scaling the preferred quantum using the same scale factor as that used to obtain the delivered value.

Delivered Quantum

Normally, when the delivered value is a finite number, the result is selected from the cohort for the delivered value in the target format. However, in case of a trap overflow or trap underflow for LOAD ROUNDED, the result is selected from a subset of the cohort for the delivered value in the source format. This subset of the cohort consists of cohort members that have the number of DFP significand digits equal to or less than the precision of the target format.

In the absence of a trap overflow or trap underflow, if the delivered value is a finite number, the cohort member with the quantum closest to the preferred quantum is selected.

In case of a trap overflow or trap underflow, the cohort member with the quantum closest to the scaled preferred quantum is selected.

Special Quantum-Handling Operations

Special operations are provided to handle the quantum: COMPARE BIASED EXPONENT can be used to compare two quanta; EXTRACT BIASED EXPONENT can be used to determine the quantum of a finite number; and QUANTIZE can be used to adjust the quantum of a finite number.

Programming Notes:

1. Many financial applications and commercial databases use scaled integer representation of decimal data. Calculations are carried out by using integer arithmetic and scaling factors are tracked separately; the scaling factor is often an attribute of a column in the database.

This computational model can be supported by DFP by allowing the integer part of decimal data to map into the significand with a right-units view and the scaling factor to map into the quantum.

2. The term coefficient is used in some other documents to mean an integer value in significand; that is, significand in right-units view.

DFP Data Formats

Decimal-floating-point data may be represented in any of three data formats: short, long, or extended.

The contents of each data format represent encoded information. Special codes are assigned to distinguish finite numbers from NaNs and infinities.

For finite numbers, a biased exponent is used in the format. For each format, a different bias is used for right-units-view (RUV) exponents from that for left-units-view (LUV) exponents. The biased exponents are unsigned numbers and all biases are shown in Figure 20-3 on page 20-6. The biased exponent is encoded with the leftmost digit (LMD) of the significand in the combination field. The remaining digits of the significand are encoded in the encoded trailing-significand field.

DFP Short Format

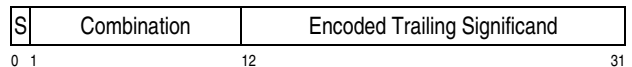

When an operand in the DFP short format is loaded into a floating-point register, it occupies the left half of the register, and the right half remains unchanged.

DFP Long Format

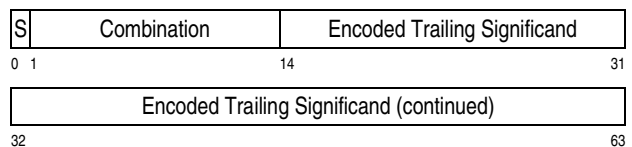

When an operand in the DFP long format is loaded into a floating-point register, it occupies the entire register.

DFP Extended Format

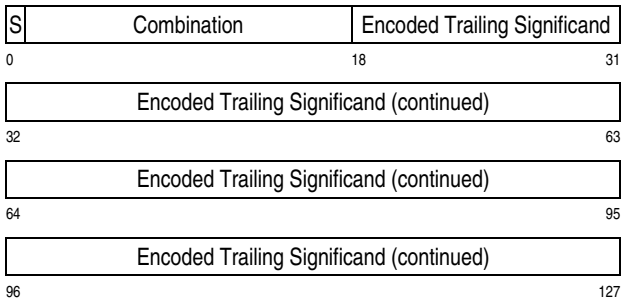

An operand in the DFP extended format occupies a register pair. The leftmost 64 bits occupy the entire lower-numbered register of the pair and the rightmost 64 bits occupy the entire higher-numbered register.

The properties of the three formats are tabulated in Figure 20-3 on page 20-6.

Sign

The sign bit is in bit 0 of each format, and is zero for plus and one for minus.

Combination

For finite numbers, this field contains the biased exponent and the leftmost digit of the significand; for NaNs and infinities, this field contains codes to identify them.

When bits 1-5 of the format are in the range of 00000 - 11101, the operand is a finite number. The two leftmost bits of the biased exponent and the leftmost digit of the significand are encoded in bits 1-5 of the format. Bit 6 through the end of the combination field contain the rest of the biased exponent.

When bits 1-5 of the format field are 11110, the operand is an infinity. All bits in the combination field to the right of bit 5 of the format constitute the reserved field for infinity. A nonzero value in the reserved field is accepted in a source infinity; the reserved field is set to zero in a resultant infinity.

When bits 1-5 of the format are 11111, the operand is a NaN and bit 6, called the SNaN bit, further distinguishes QNaN from SNaN. If bit 6 is zero, then it is QNaN; otherwise, it is SNaN. All bits in the combination field to the right of bit 6 of the format constitute the reserved field for NaN. A nonzero value in the reserved field is accepted in a source NaN; the reserved field is set to zero in a resultant NaN.

Figure 20-1 summarizes the encoding and layout of the combination field. In the figure, the biased exponent of a finite number is the concatenation of two parts: (1) two leftmost bits are derived from bits 1-5 of the format, and (2) the remaining bits in the combination field. For example, if the combination field of the DFP short format contains 101010101 binary, it represents a biased exponent of 10010101 binary and a leftmost significand digit of 5.

Bits 1 2 3 4 5	Bit 6	Type	Biased Exponent	LMD
00000	m	Finite number	00 RBE	0
00001	m	Finite number	00 RBE	1
00010	m	Finite number	00 RBE	2
00011	m	Finite number	00 RBE	3
00100	m	Finite number	00 RBE	4
00101	m	Finite number	00 RBE	5
00110	m	Finite number	00 RBE	6
00111	m	Finite number	00 RBE	7
01000	m	Finite number	01 RBE	0
01001	m	Finite number	01 RBE	1
01010	m	Finite number	01 RBE	2
01011	m	Finite number	01 RBE	3
01100	m	Finite number	01 RBE	4
01101	m	Finite number	01 RBE	5
01110	m	Finite number	01 RBE	6
01111	m	Finite number	01 RBE	7
10000	m	Finite number	10 RBE	0
10001	m	Finite number	10 RBE	1
10010	m	Finite number	10 RBE	2
10011	m	Finite number	10 RBE	3
10100	m	Finite number	10 RBE	4
10101	m	Finite number	10 RBE	5
10110	m	Finite number	10 RBE	6
10111	m	Finite number	10 RBE	7
11000	m	Finite number	00 RBE	8
11001	m	Finite number	00 RBE	9
11010	m	Finite number	01 RBE	8
11011	m	Finite number	01 RBE	9
11100	m	Finite number	10 RBE	8
11101	m	Finite number	10 RBE	9
11110	r	Infinity ¹	--	--
11111	0	QNaN ²	--	--

Figure 20-1. The Combination Field

Bits 1 2 3 4 5	Bit 6	Type	Biased Exponent	LMD
11111	1	SNaN ²	--	--
Explanation:				
--		Not applicable.		
		Concatenation.		
1		All bits in the combination field to the right of bit 5 of the format constitute the reserved field for infinity.		
2		All bits in the combination field to the right of bit 6 of the format constitute the reserved field for NaN.		
LMD		Leftmost digit of the significand.		
m		Bit 6 is a part of the remaining biased exponent.		
RBE		Remaining biased exponent. It includes all bits in the combination field to the right of bit 5 of the format.		
r		Bit 6 is a reserved bit for infinity.		

Figure 20-1. The Combination Field (Continued)

Encoded Trailing Significand

This field contains an encoded decimal number, which represents digits in the trailing significand. The trailing significand contains all significand digits, except the leftmost digit. For infinities, nonzero trailing-significand digits are accepted in a source infinity; all trailing-significand digits in a resultant infinity are set to zeros, unless otherwise stated. For NaNs, this field contains diagnostic information called the payload.

The encoded trailing-significand field is a multiple of 10-bit blocks called deplets. The number of deplets depends on the format. Each deplet represents three decimal digits in a 10-bit value. This is described in the section, “Densely Packed Decimal (DPD)” on page 20-58.

Values of Finite Numbers

The values of finite numbers in the various formats are shown in Figure 20-2.

Format	Value	
	Left-Units View	Right-Units View
Short	$\pm 10^{e-95} \times (d_0.d_1d_2\dots d_6)$	$\pm 10^{e-101} \times (d_0d_1d_2\dots d_6)$
Long	$\pm 10^{e-383} \times (d_0.d_1d_2\dots d_{15})$	$\pm 10^{e-398} \times (d_0d_1d_2\dots d_{15})$
Extended	$\pm 10^{e-6143} \times (d_0.d_1d_2\dots d_{33})$	$\pm 10^{e-6176} \times (d_0d_1d_2\dots d_{33})$
Explanation:		
$d_0.d_1d_2\dots d_{p-1}$ Significand in left-units view. The decimal point is to the immediate right of the leftmost digit and d_i is a decimal digit, where $0 \leq i \leq (p - 1)$ and p is the format precision.		
$d_0d_1d_2\dots d_{p-1}$ Significand in right-units view. The decimal point is to the right of the rightmost digit and d_i is a decimal digit, where $0 \leq i \leq (p - 1)$ and p is the format precision.		
e Biased exponent.		

Figure 20-2. Values of Finite Numbers

Programming Note: The RUV exponent, Q , is related to the LUV exponent, E , as follows: $Q = E - p + 1$, where p is the format precision.

Significand

Hereafter, the term significand is used to mean the following:

1. For finite numbers, the significand contains all trailing significand digits padded on the left with the leftmost digit of significand derived from the combination field.
2. For infinities and NaNs, the significand contains all trailing significand digits padded on the left with a zero digit.

DFP Significant Digits

For a finite number, the DFP significant digits begin with the leftmost nonzero significand digit and end with the rightmost significand digit.

For a finite number, the number of DFP significant digits is the difference of subtracting the number of leading zeros from the format precision. The number of leading zeros is the number of zeros in the significand to the left of the leftmost nonzero digit.

Programming Note: The number of DFP significant digits of the value zero is zero.

Property	Format		
	Short	Long	Extended
Format length (bits)	32	64	128
Combination length (bits)	11	13	17
Encoded Trailing significand length (bits)	20	50	110
Precision (p)	7	16	34
Maximum left-units-view (LUV) exponent (Emax)	96	384	6144
Minimum left-units-view (LUV) exponent (Emin)	-95	-383	-6143
Left-units-view (LUV) bias	95	383	6143
Maximum right-units-view (RUV) exponent (Qmax)	90	369	6111
Minimum right-units-view (RUV) exponent (Qmin)	-101	-398	-6176
Right-units-view (RUV) bias	101	398	6176
Maximum biased exponent	191	767	12,287
Nmax	$(10^7 - 1) \times 10^{90}$	$(10^{16} - 1) \times 10^{369}$	$(10^{34} - 1) \times 10^{6111}$
Nmin	1×10^{-95}	1×10^{-383}	1×10^{-6143}
Dmin	1×10^{-101}	1×10^{-398}	1×10^{-6176}
Explanation:			
Dmin	Smallest (in magnitude) subnormal number.		
Nmax	Largest (in magnitude) normal number.		
Nmin	Smallest (in magnitude) normal number,		

Figure 20-3. Summary of DFP Formats

Canonical Declets

The trailing significand digits in a DFP data format are encoded by representing three decimal digits with a 10-bit declet. Of the 1024 possible declets, 1000 canonical declets are produced in resultant DFP operands, and 24 noncanonical declets are not produced as DFP results. Both canonical and noncanonical declets are accepted in source DFP operands. The encoding of a canonical declet or noncanonical declet is described in the section, “Densely Packed Decimal (DPD)” on page 20-58.

DFP Canonical Data

A finite number is canonical when all declets are canonical declets.

An infinity is canonical when the reserved field is zero and all digits in the trailing significand are zeros.

A NaN is canonical when the reserved field is zero and all declets are canonical declets.

Programming Note: To ensure compatibility with future extensions and interchangeability between software routines, only DFP canonical data should be used.

Classes of DFP Data

There are six classes of DFP data: zero, subnormal number, normal number, infinity, signaling NaN, and quiet NaN. The zero, subnormal number, and normal number data classes are collectively called finite numbers. The instruction TEST DATA CLASS may be used to determine the class of a DFP operand.

Zeros

Zeros have a zero significand and any representable value in the biased exponent. A +0 is distinct from a -0 and zeros with different biased exponents are distinct, except that comparison treats them as equal.

Subnormal Numbers

Subnormal numbers are numbers which are smaller than Nmin and larger than zero in magnitude.

Normal Numbers

Normal numbers are numbers whose magnitude is between N_{min} and N_{max} inclusively.

Infinities

An infinity is represented by 11110 binary in bits 1-5 of the data format. Infinities can participate in most arithmetic operations and give a consistent result, usually infinity. In comparisons, $+\infty$ compares greater than any finite number, and $-\infty$ compares less than any finite number. All $+\infty$ are compared equal and all $-\infty$ are compared equal.

Signaling and Quiet NaNs

A NaN (Not-a-Number) is represented by 11111 binary in bits 1-5 of the data format. NaNs are produced in place of a numeric result after an invalid operation when there is no interruption. NaNs may also be used by the program to flag special operands, such as the contents of an uninitialized storage area.

There are two types of NaNs, signaling and quiet. A signaling NaN (SNaN) is distinguished from a quiet NaN (QNaN) by bit 6, the SNaN bit, of the data format: zero for the QNaN and one for the SNaN. A special QNaN, called the default QNaN, is supplied as the nontrap result for an IEEE-invalid-operation exception; it has a plus sign, and the SNaN bit, the reserved field, and the payload are set to zeros.

Normally, source QNaNs are canonicalized to become the resultant QNaN that has the same sign and payload as the source during operations so that they will remain visible at the end. (See the section “Canonicalization” on page 20-7 for details.) An SNaN operand causes an IEEE invalid-operation exception, unless otherwise stated. When the exception is recognized for a SNaN, the nontrap result is the corresponding QNaN, which is produced by setting the SNaN bit in the source SNaN to zero and then the converted QNaN is canonicalized, and the IEEE-invalid-operation flag (FPC 1.0) is set to one.

Where applicable, the propagation of NaNs is illustrated in the action figure for an instruction.

Canonicalization

For operations that are defined to produce a DFP result, the result placed at the target operand location is canonical, unless otherwise stated.

Programming Notes:

1. The following instructions may produce a noncanonical infinity as the result:
 - INSERT BIASED EXPONENT
 - LOAD LENGTHENED
 - LOAD ROUNDED
 - SHIFT SIGNIFICAND LEFT
 - SHIFT SIGNIFICAND RIGHT

Infinities produced as a DFP result have the reserved field set to zero and have canonical declets in the encoded trailing-significand field. However, the infinity produced by the above instructions does not necessarily have zeros in all digits in the trailing significand. Such an infinity is not canonical.

2. Only canonical operands should be used, as it is possible that some libraries or software routines reject noncanonical operands.
3. Except for INSERT BIASED EXPONENT, if only canonical source operands are used, the result is canonical. INSERT BIASED EXPONENT may produce a noncanonical result even if all source operands are canonical. Special precautions should be taken to avoid producing a noncanonical result from INSERT BIASED EXPONENT.

DFP-Format Conversion

DFP format conversion is described in the section “IEEE Same-Radix Format Conversion” of Chapter 9, “Floating-Point Overview and Support Instructions.”

DFP Rounding

DFP rounding is described in the section “IEEE DFP Rounding” of Chapter 9, “Floating-Point Overview and Support Instructions.”

DFP Comparison

DFP comparison is described in the section “IEEE Comparison” of Chapter 9, “Floating-Point Overview and Support Instructions.”

DFP Formatting Instructions

A set of instructions are provided to compose and decompose DFP data. These instructions do not recognize any IEEE exceptions. They are:

- CONVERT FROM PACKED
- CONVERT FROM SIGNED PACKED
- CONVERT FROM UNSIGNED PACKED
- CONVERT FROM ZONED
- CONVERT TO PACKED
- CONVERT TO SIGNED PACKED
- CONVERT TO UNSIGNED PACKED
- CONVERT TO ZONED
- EXTRACT BIASED EXPONENT
- INSERT BIASED EXPONENT
- SHIFT SIGNIFICAND LEFT
- SHIFT SIGNIFICAND RIGHT

Conversion of data between character strings in an external format and the DFP format may be performed in several steps. At certain steps, for finite numbers, the significand is kept in the packed-decimal format and the biased exponent in the fixed-point format. See Chapter 8, “Decimal Instructions,” for a detailed description of the zoned and packed-decimal formats.

It takes 17 packed-decimal digits to hold the 16 significand digits and one sign of a long DFP format; it takes 35 packed-decimal digits for an extended DFP format. To facilitate the conversion, the significand is divided into pieces and only one piece contains the sign. Each piece fits into a register or a register pair, and each piece is converted separately. To support this piecemeal conversion, two formats, signed-packed-decimal and unsigned-packed-decimal, are used to hold the pieces.

To facilitate the conversion between packed-decimal format data in memory and the DFP format, the CONVERT FROM PACKED and CONVERT TO PACKED instructions are provided. It takes up to 9 bytes to hold the 16 significand digits and one sign digit of a long DFP format. It takes up to 18 bytes to hold the 34 significand digits and one sign digit for an extended DFP format. Any unused digits in a packed-decimal format operand of CONVERT FROM PACKED must be zero.

For a zoned-decimal format, it takes 16 bytes to hold the 16 significand digits and one sign digit of a long DFP format; it takes 34 bytes for an extended DFP

format. To facilitate the conversion, the CONVERT FROM ZONED and CONVERT TO ZONED instructions are provided.

Signed-Packed-Decimal Format

In the signed-packed-decimal format, each byte contains two 4-bit decimal digits (D), except for the rightmost byte, which contains a 4-bit sign (S) to the right of a 4-bit decimal digit.

When a signed-packed-decimal operand resides in a general register (GR), the operand is 64 bits (15 digits and sign), as shown below.

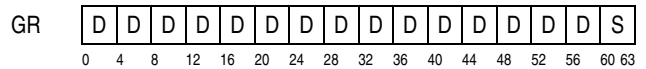

When a signed-packed-decimal operand resides in a general-register pair, the leftmost 64 bits of the operand occupy the even-numbered register of the pair and the rightmost 64 bits occupy the odd-numbered register, as shown below.

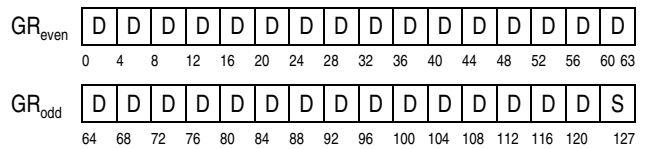

Unsigned-Packed-Decimal Format

In the unsigned-packed-decimal format, each byte contains two 4-bit decimal digits (D) and there is no sign.

When an unsigned-packed-decimal operand resides in a general register, the operand is 64 bits (16 digits), as shown below.

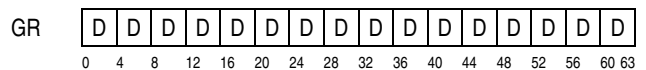

When an unsigned-packed-decimal operand resides in a general-register pair, the leftmost 64 bits of the operand occupy the even-numbered register of the pair and the rightmost 64 bits occupy the odd-numbered register, as shown below.

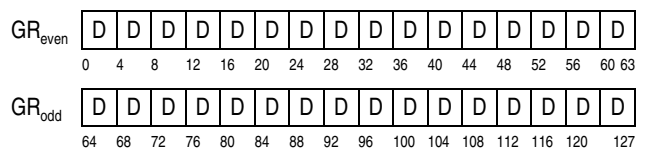

Zoned-Decimal Format

In the unsigned zoned-decimal format, each byte contains two fields, a zone field in the leftmost four bit positions and a decimal digit in the rightmost four bit positions. The signed zoned-decimal format is similar to the unsigned zoned-decimal format except that the zone field of the rightmost byte instead contains a 4-bit sign. A zoned-decimal operand is a storage oper-

and. See “Zoned Format” on page 8-1 for more details.

IEEE Exceptions

The IEEE exceptions for the DFP instructions are described in the section “IEEE Exceptions” on page 9-18. This also includes the quantum exception.

Summary of Preferred Quantum

Figure 20-4 summarizes all preferred quanta.

Operations	Delivered value	Preferred Quantum
ADD	Exact	The smaller quantum of the two source operands†
	Inexact	The smallest quantum of cohort members
CONVERT FROM FIXED	Exact	One†
	Inexact	The smallest quantum of cohort members
CONVERT FROM LOGICAL	Exact	One†
	Inexact	The smallest quantum of cohort members
CONVERT FROM PACKED	—	One
CONVERT FROM SIGNED PACKED	—	One
CONVERT FROM UNSIGNED PACKED	—	One
CONVERT FROM ZONED	—	One
DIVIDE	Exact	The quantum of the dividend divided by the quantum of the divisor†
	Inexact	The smallest quantum of cohort members
INSERT BIASED EXPONENT	—	The quantum corresponds to the requested biased exponent
LOAD AND TEST	—	The quantum of the source operand
LOAD FP INTEGER	Exact	The larger value of one and the quantum of the source operand
	Inexact	One
LOAD LENGTHENED	Exact*	The quantum of the source operand
LOAD ROUNDED	Exact	The quantum of the source operand†
	Inexact	The smallest quantum of cohort members
PERFORM FLOATING POINT OPERATION (DPQC=0)‡	Exact	The largest quantum of cohort members†
	Inexact	The smallest quantum of cohort members
PERFORM FLOATING POINT OPERATION (DPQC=1)‡	Exact	One†
	Inexact	The smallest quantum of cohort members
MULTIPLY	Exact	The product of the quanta of the two source operands†
	Inexact	The smallest quantum of cohort members
QUANTIZE	Exact	The requested quantum
	Inexact	The requested quantum
REROUND	Exact	See the instruction description
	Inexact	The quantum that corresponds to the requested significance
SHIFT SIGNIFICAND LEFT	—	The quantum of the source operand
SHIFT SIGNIFICAND RIGHT	—	The quantum of the source operand
SUBTRACT	Exact	The smaller quantum of the two source operands†
	Inexact	The smallest quantum of cohort members

Explanation:

* This is true due to a condition to the left of the column.
 — For these operations, the concept of exact result or inexact result does not apply.
 † If the delivered value cannot be represented with the preferred quantum, it is represented with the quantum closest to the preferred quantum.
 ‡ Applicable only when the operation-type code is 01 hex (PFPO Convert Floating-Point Radix).
 DPQC DFP preferred quantum control.

Figure 20-4. Summary of Preferred Quantum

Summary of Rounding And Range Actions

page 20-12 summarizes rounding and range actions.

Figure 20-5 on page 20-11 and Figure 20-6 on

Range of v	Case	Nontrap Result (r) when Effective Rounding Method Is							
		RNTE	RNTZ	RNTA	RA	RM	RFS	RP	RZ
$v < -N_{max}, g < -N_{max}$	Overflow	$-\infty^1$	$-\infty^1$	$-\infty^1$	$-\infty^1$	$-\infty^1$	-Nmax	-Nmax	-Nmax
$v < -N_{max}, g = -N_{max}$	Normal	-Nmax	-Nmax	-Nmax	—	—	-Nmax	-Nmax	-Nmax
$-N_{max} \leq v \leq -N_{min}$	Normal	g	g	g	g	g	g	g	g
$-N_{min} < v \leq -D_{min}$	Tiny	d*	d*	d*	d*	d*	d*	d	d
$-D_{min} < v < -D_{min}/2$	Tiny	-Dmin	-Dmin	-Dmin	-Dmin	-Dmin	-Dmin	-0	-0
$v = -D_{min}/2$	Tiny	-0	-0	-Dmin	-Dmin	-Dmin	-Dmin	-0	-0
$-D_{min}/2 < v < 0$	Tiny	-0	-0	-0	-Dmin	-Dmin	-Dmin	-0	-0
$v = 0$	EZD	+0	+0	+0	+0	-0	+0	+0	+0
$0 < v < +D_{min}/2$	Tiny	+0	+0	+0	+Dmin	+0	+Dmin	+Dmin	+0
$v = +D_{min}/2$	Tiny	+0	+0	+Dmin	+Dmin	+0	+Dmin	+Dmin	+0
$+D_{min}/2 < v < +D_{min}$	Tiny	+Dmin	+Dmin	+Dmin	+Dmin	+0	+Dmin	+Dmin	+0
$+D_{min} \leq v < +N_{min}$	Tiny	d*	d*	d*	d*	d	d*	d*	d
$+N_{min} \leq v \leq +N_{max}$	Normal	g	g	g	g	g	g	g	g
$+N_{max} < v, g = +N_{max}$	Normal	+Nmax	+Nmax	+Nmax	—	+Nmax	+Nmax	—	+Nmax
$+N_{max} < v, +N_{max} < g$	Overflow	$+\infty^1$	$+\infty^1$	$+\infty^1$	$+\infty^1$	+Nmax	+Nmax	$+\infty^1$	+Nmax

Explanation:

— This situation cannot occur.

* The rounded value, in the extreme case, may be Nmin. In this case, the exceptions are underflow, inexact and incremented.

¹ The nontrap result r is considered to have been incremented.

d The value derived when the precise intermediate value (v) is rounded to the format of the target, including both precision and bounded exponent range. Except as explained in note *, this is a subnormal number.

g The precision-rounded value. The value derived when the precise intermediate value (v) is rounded to the precision of the target, but assuming an unbounded exponent range.

v Precise intermediate value. This is the value, before rounding, assuming unbounded precision and an unbounded exponent range. For LOAD ROUNDED, v is the source value.

EZD Exact zero difference. The case applies only to ADD and SUBTRACT. For all other DFP operations, a zero result is detected by inspection of the source operands without use of the R(v) function.

Dmin Smallest (in magnitude) representable subnormal number in the target format.

Nmax Largest (in magnitude) representable finite number in the target format.

Nmin Smallest (in magnitude) representable normal number in the target format.

RNTA Round to nearest with ties away from 0.

RNTE Round to nearest with ties to even.

RNTZ Round to nearest with ties toward 0.

RA Round away from 0.

RFS Round to prepare for shorter precision.

RM Round toward $-\infty$.

RP Round toward $+\infty$.

RZ Round toward 0.

Figure 20-5. Action for R(v): Rounding and Range Actions

Case	Is r inexact (r≠v)	Overflow Mask (FPC 0.2)	Underflow Mask (FPC 0.3)	IEEE Inexact Exception Control (XxC)	Inexact Mask (FPC 0.4)	Is QX recognized ³	Quantum Exception Control ² (XqC)	Quantum Mask ² (FPC 0.5)	Is r Incremented (r > v)	Is g inexact (g≠v)	Is g Incremented (g > v)	Results
Overflow	Yes ¹	0	—	0	0	Yes ¹	0	0	—	—	—	T(r), SFo ← 1, SFx ← 1, SFq ← 1
Overflow	Yes ¹	0	—	0	0	Yes ¹	1	—	—	—	—	T(r), SFo ← 1, SFx ← 1
Overflow	Yes ¹	0	—	1	—	Yes ¹	0	0	—	—	—	T(r), SFo ← 1, SFq ← 1
Overflow	Yes ¹	0	—	1	—	Yes ¹	1	—	—	—	—	T(r), SFo ← 1
Overflow	Yes ¹	0	—	0	0	Yes ¹	0	1	—	—	—	T(r), SFo ← 1, SFx ← 1, PIDq(04)
Overflow	Yes ¹	0	—	1	—	Yes ¹	0	1	—	—	—	T(r), SFo ← 1, PIDq(04)
Overflow	Yes ¹	0	—	0	1	No ¹	—	—	No	—	—	T(r), SFo ← 1, PIDx(08)
Overflow	Yes ¹	0	—	0	1	No ¹	—	—	Yes	—	—	T(r), SFo ← 1, PIDy(0C)
Overflow	Yes ¹	1	—	—	—	No ¹	—	—	—	No	No ¹	Tw(g ÷ Ψ), PIDo(20)
Overflow	Yes ¹	1	—	—	—	No ¹	—	—	—	Yes	No	Tw(g ÷ Ψ), PIDox(28)
Overflow	Yes ¹	1	—	—	—	No ¹	—	—	—	Yes	Yes	Tw(g ÷ Ψ), PIDoy(2C)
Normal	No	—	—	—	—	No	—	—	—	—	—	T(r)
Normal	No	—	—	—	—	Yes	0	0	—	—	—	T(r), SFq ← 1
Normal	No	—	—	—	—	Yes	1	—	—	—	—	T(r)
Normal	No	—	—	—	—	Yes	0	1	—	—	—	T(r), PIDq(04)
Normal	Yes	—	—	0	0	Yes ¹	0	0	—	—	—	T(r), SFx ← 1, SFq ← 1
Normal	Yes	—	—	0	0	Yes ¹	1	—	—	—	—	T(r), SFx ← 1

Explanation:

- The results do not depend on this condition or mask bit.
- ¹ This condition is true by virtue of the state of some condition to the left of this column.
- ² The quantum exception mask bit and the quantum exception control are defined only when the floating-point extension facility is installed.
- ³ This column specifies whether a QX is recognized by considering all columns to the left of this column and the existence of the quantum exception condition. The specification in this column does not include the effects of the quantum-exception mask bit and the quantum-exception control.
- Ψ Scale factor. For overflow, $\Psi=2^{+\alpha}$. For underflow, $\Psi=2^{-\alpha}$. The unsigned scaling exponent (α) depends on the type of operation and operand format. For all DFP operations except LOAD ROUNDED, α depends on the target format and is 576 for long, and 9216 for extended. For LOAD ROUNDED, α depends on the source format and is 192 for long and 3072 for extended.
- g The precision-rounded value. The value derived when the precise intermediate value (v) is rounded to the precision of the target, but assuming an unbounded exponent range.
- r Nontrap result as defined in Part 1 of this figure.
- v Precise intermediate value. This is the value, before rounding, assuming unbounded precision and unbounded exponent range.
- PIDc(h) Program interruption for data exception, condition c, with DXC of h in hex. See Figure 20-8 on page 20-16.
- PIDq(04) DXC 04 is defined only when the floating-point extension facility is installed.
- QX Quantum exception. This exception is defined only when the floating-point extension facility is installed.
- SFo IEEE overflow flag, FPC 1.2.
- SFq Quantum-exception status flag, FPC 1.5. This flag is defined only when the floating-point extension facility is installed
- SFu IEEE underflow flag, FPC 1.3.
- SFx IEEE inexact flag, FPC 1.4.
- T(x) The value x is placed at the target operand location.
- Tw(x) The scaled result x is placed at the target operand location. For all DFP operations except LOAD ROUNDED, the scaled result is in the format and length of the target and rounded to the precision of the target. For LOAD ROUNDED, the scaled result is in the format and length of the source, but rounded to the precision of the target.

Figure 20-6. (Part 1 of 3) Rounding and Range Actions

Case	Is r inexact (r≠v)	Overflow Mask (FPC 0.2)	Underflow Mask (FPC 0.3)	IEEE Inexact Exception Control (XxC)	Inexact Mask (FPC 0.4)	Is QX recognized ³	Quantum Exception Control ² (XqC)	Quantum Mask ² (FPC 0.5)	Is r Incremented (r > v)	Is g inexact (g≠v)	Is g Incremented (g > v)	Results
Normal	Yes	—	—	1	—	Yes ¹	0	0	—	—	—	T(r), SFq ← 1
Normal	Yes	—	—	1	—	Yes ¹	1	—	—	—	—	T(r)
Normal	Yes	—	—	0	0	Yes ¹	0	1	—	—	—	T(r), SFx ← 1, PIDq(04)
Normal	Yes	—	—	1	—	Yes ¹	0	1	—	—	—	T(r), PIDq(04)
Normal	Yes	—	—	0	1	No ¹	—	—	No	—	—	T(r), PIDx(08)
Normal	Yes	—	—	0	1	No ¹	—	—	Yes	—	—	T(r), PIDy(0C)
Tiny	No	—	0	—	—	No	—	—	—	—	—	T(r)
Tiny	No	—	0	—	—	Yes	0	0	—	—	—	T(r), SFq ← 1
Tint	No	—	0	—	—	Yes	1	—	—	—	—	T(r)
Tiny	No	—	0	—	—	Yes	0	1	—	—	—	T(r), PIDq(04)
Tiny	No	—	1	—	—	No ¹	—	—	—	No ¹	No ¹	Tw(g ÷ Ψ), PIDu(10)
Tiny	Yes	—	0	0	0	Yes ¹	0	0	—	—	—	T(r), SFu ← 1, SFx ← 1, SFq ← 1
Tiny	Yes	—	0	0	0	Yes ¹	1	—	—	—	—	T(r), SFu ← 1, SFx ← 1
Tiny	Yes	—	0	1	—	Yes ¹	0	0	—	—	—	T(r), SFu ← 1, SFq ← 1
Tiny	Yes	—	0	1	—	Yes ¹	1	—	—	—	—	T(r), SFu ← 1
Tiny	Yes	—	0	0	0	Yes ¹	0	1	—	—	—	T(r), SFu ← 1, SFx ← 1, PIDq(04)
Tiny	Yes	—	0	1	—	Yes ¹	0	1	—	—	—	T(r), SFu ← 1, PIDq(04)

Explanation:

- The results do not depend on this condition or mask bit.
- ¹ This condition is true by virtue of the state of some condition to the left of this column.
- ² The quantum exception mask bit and the quantum exception control are defined only when the floating-point extension facility is installed.
- ³ This column specifies whether a QX is recognized by considering all columns to the left of this column and the existence of the quantum exception condition. The specification in this column does not include the effects of the quantum-exception mask bit and the quantum-exception control.
- Ψ Scale factor. For overflow, $\Psi=2^{+\alpha}$. For underflow, $\Psi=2^{-\alpha}$. The unsigned scaling exponent (α) depends on the type of operation and operand format. For all DFP operations except LOAD ROUNDED, α depends on the target format and is 576 for long, and 9216 for extended. For LOAD ROUNDED, α depends on the source format and is 192 for long and 3072 for extended.
- g The precision-rounded value. The value derived when the precise intermediate value (v) is rounded to the precision of the target, but assuming an unbounded exponent range.
- r Nontrap result as defined in Part 1 of this figure.
- v Precise intermediate value. This is the value, before rounding, assuming unbounded precision and unbounded exponent range.
- PIDc(h) Program interruption for data exception, condition c, with DXc of h in hex. See Figure 20-8 on page 20-16.
- PIDq(04) DXC 04 is defined only when the floating-point extension facility is installed.
- QX Quantum exception. This exception is defined only when the floating-point extension facility is installed.
- SFo IEEE overflow flag, FPC 1.2.
- SFq Quantum-exception status flag, FPC 1.5. This flag is defined only when the floating-point extension facility is installed
- SFu IEEE underflow flag, FPC 1.3.
- SFx IEEE inexact flag, FPC 1.4.
- T(x) The value x is placed at the target operand location.
- Tw(x) The scaled result x is placed at the target operand location. For all DFP operations except LOAD ROUNDED, the scaled result is in the format and length of the target and rounded to the precision of the target. For LOAD ROUNDED, the scaled result is in the format and length of the source, but rounded to the precision of the target.

Figure 20-6. (Part 2 of 3) Rounding and Range Actions

Case	Is r inexact (r≠v)	Overflow Mask (FPC 0.2)	Underflow Mask (FPC 0.3)	IEEE Inexact Exception Control (XxC)	Inexact Mask (FPC 0.4)	Is QX recognized ³	Quantum Exception Control ² (XqC)	Quantum Mask ² (FPC 0.5)	Is r Incremented (r > v)	Is g inexact (g≠v)	Is g Incremented (g > v)	Results
Tiny	Yes	—	0	0	1	No ¹	—	—	No	—	—	T(r), SFu ← 1, PIDx(08)
Tiny	Yes	—	0	0	1	No ¹	—	—	Yes	—	—	T(r), SFu ← 1, PIDy(0C)
Tiny	Yes	—	1	—	—	No ¹	—	—	—	No	No ¹	Tw(g ÷Ψ), PIDu(10)
Tiny	Yes	—	1	—	—	No ¹	—	—	—	Yes	No	Tw(g ÷Ψ), PIDux(18)
Tiny	Yes	—	1	—	—	No ¹	—	—	—	Yes	Yes	Tw(g ÷Ψ), PIDuy(1C)

Explanation:

- The results do not depend on this condition or mask bit.
- ¹ This condition is true by virtue of the state of some condition to the left of this column.
- ² The quantum exception mask bit and the quantum exception control are defined only when the floating-point extension facility is installed.
- ³ This column specifies whether a QX is recognized by considering all columns to the left of this column and the existence of the quantum exception condition. The specification in this column does not include the effects of the quantum-exception mask bit and the quantum-exception control.
- Ψ Scale factor. For overflow, $\Psi=2^{+\alpha}$. For underflow, $\Psi=2^{-\alpha}$. The unsigned scaling exponent (α) depends on the type of operation and operand format. For all DFP operations except LOAD ROUNDED, α depends on the target format and is 576 for long, and 9216 for extended. For LOAD ROUNDED, α depends on the source format and is 192 for long and 3072 for extended.
- g The precision-rounded value. The value derived when the precise intermediate value (v) is rounded to the precision of the target, but assuming an unbounded exponent range.
- r Nontrap result as defined in Part 1 of this figure.
- v Precise intermediate value. This is the value, before rounding, assuming unbounded precision and unbounded exponent range.
- PIDc(h) Program interruption for data exception, condition c, with DXC of h in hex. See Figure 20-8 on page 20-16.
- PIDq(04) DXC 04 is defined only when the floating-point extension facility is installed.
- QX Quantum exception. This exception is defined only when the floating-point extension facility is installed.
- SFo IEEE overflow flag, FPC 1.2.
- SFq Quantum-exception status flag, FPC 1.5. This flag is defined only when the floating-point extension facility is installed
- SFu IEEE underflow flag, FPC 1.3.
- SFx IEEE inexact flag, FPC 1.4.
- T(x) The value x is placed at the target operand location.
- Tw(x) The scaled result x is placed at the target operand location. For all DFP operations except LOAD ROUNDED, the scaled result is in the format and length of the target and rounded to the precision of the target. For LOAD ROUNDED, the scaled result is in the format and length of the source, but rounded to the precision of the target.

Figure 20-6. (Part 3 of 3) Rounding and Range Actions

Result Figures

Concise descriptions of the results produced by many of the DFP instructions are made by means of figures which contain columns and rows representing all possible combinations of DFP data class for the source operands of an instruction. The information shown at the intersection of a row and a column is one or more symbols representing the result or results produced for that particular combination of source-operand data classes. Explanations of the symbols used are contained in each figure. In many cases, the explanation of a particular result is in the form of a cross-reference to another figure. In many cases, the information shown at the intersection consists of several symbols separated by commas. All such results are produced unless one of the results is a program interruption. In the case of a program interruption, the operation is suppressed or completed as shown in Figure 20-8 on page 20-16.

Data-Exception Codes (DXC) and Abbreviations

Figure 20-7 shows IEEE exceptions and flag abbreviations that are used in the result figures, and it explains the symbols “Xi:” and “Xz:” that are used in the figures. Bits 0-4 (i,z,o,u,x) of the eight-bit data-exception code (DXC) in byte 2 of the FPC register are trap flags and correspond to the same bits in bytes 0 and 1 of the register (IEEE masks and IEEE flags). The trap flag for an exception, instead of the IEEE flag, is set to one when an interruption for the exception is enabled by the corresponding IEEE mask bit. Bit 5 (y) of byte 2 is used in conjunction with bit 4, inexact (x), to indicate that the result has been incremented in magnitude.

When the floating-point extension facility is installed, bit 5 of DXC also has a second meaning. When DXC bits 0-4 are zero, DXC bit 5 is the quantum-exception trap flag and corresponds to the quantum-exception mask IMq and its status flag SFq.

Figure 20-8 on page 20-16 shows the various DXCs that can be indicated, the associated instruction endings, and abbreviations that are used for the DXCs in the result figures. (The abbreviation “PID” stands for “program interruption for a data exception.”)

Exception		FPC IEEE Mask bit	IEEE Flag	
Name	Abbr.		FPC Bit	Abbr.
IEEE invalid operation	Xi ¹	0.0	1.0	SFi
IEEE division by zero	Xz ²	0.1	1.1	SFz
IEEE overflow	Xo	0.2	1.2	SFo
IEEE underflow	Xu	0.3	1.3	SFu
IEEE inexact	Xx	0.4	1.4	SFx
Quantum-exception	Xq	0.5	1.5	SFq

Explanation:

¹ The symbol “Xi:” followed by a list of results in a figure indicates that, when FPC 0.0 is zero, then instruction execution is completed by setting SFi (FPC 1.0) to one and producing the indicated results; and when FPC 0.0 is one, then instruction execution is suppressed, the data exception code (DXC) is set to 80 hex, and a program interruption for a data exception occurs.

² The symbol “Xz:” followed by a list of results in a figure indicates that, when FPC 0.1 is zero, then instruction execution is completed by setting SFz (FPC 1.1) to one and producing the indicated results; and when FPC 0.1 is one, then instruction execution is suppressed, the data exception code (DXC) is set to 40 hex, and a program interruption for a data exception occurs.

Figure 20-7. IEEE Exception and Flag Abbreviations

Abbr.	DXC (hex)	Data-Exception-Code Name	Instruction Ending
PIDq	04	Quantum exception	Complete
PIDx	08	IEEE inexact and truncated	Complete
PIDy	0C	IEEE inexact and incremented	Complete
PIDu	10	IEEE underflow, exact	Complete, wrap exponent
PIDux	18	IEEE underflow, inexact and truncated	Complete, wrap exponent
PIDuy	1C	IEEE underflow, inexact and incremented	Complete, wrap exponent
PIDo	20	IEEE overflow, exact	Complete, wrap exponent
PIDox	28	IEEE overflow, inexact and truncated	Complete, wrap exponent
PIDoy	2C	IEEE overflow, inexact and incremented	Complete, wrap exponent
PIDz	40	IEEE division by zero	Suppress
PIDi	80	IEEE invalid operation	Suppress

Figure 20-8. IEEE Data-Exception Codes (DXC) and Abbreviations

Instructions

The Decimal-Floating-Point (DFP) instructions and their mnemonics and operation codes are listed in Figure 20-9 on page 20-17.

The figure indicates, in the column labeled “Characteristics,” the instruction format, when the condition code is set, and the exceptional conditions in operand designations, data, or results that cause a program interruption.

All DFP instructions are subject to the AFP-register-control bit, bit 45 of control register 0. For the DFP instructions to be executed successfully, the AFP-register-control bit must be one; otherwise, a DFP-instruction data exception, DXC 3, is recognized.

Mnemonics for the DFP instructions are distinguished from corresponding HFP or BFP instructions by a T in the mnemonic. Mnemonics for the DFP instructions have an R as the last letter or the letter next to the last letter when the instruction is in the RRE or RRF format. Mnemonics for the DFP instructions have an A as the last letter when the instruction

is an alternate instruction, which uses additional modifier fields not available to the original instruction. Certain letters are used for DFP instructions to represent operand format and operand-format length, as follows:

- E Short
- F Thirty-two-bit fixed point
- G Sixty-four-bit fixed point
- D Long
- P Packed
- X Extended
- Z Zoned

Note: In the detailed descriptions of the individual instructions, the mnemonic and the symbolic operand designation for the assembler language are shown with each instruction. For a register-to-register operation using COMPARE (long), for example, CDTR is the mnemonic and R₁,R₂ the operand designation.

Programming Notes:

1. The floating-point extension facility includes the following:
 - The following new DFP instructions:
 - CONVERT FROM FIXED (CXFTR, CDFTR)
 - CONVERT FROM LOGICAL (CXLGTR, CDLGTR, CXLFTR, CDLFTR)
 - CONVERT TO FIXED (CFXTR, CFDTR)
 - CONVERT TO LOGICAL (CLGXTR, CLGDTR, CLFXTR, CLFDTR)
 - All reserved values in the effective rounding method field and a quantum-exception control (XqC) are assigned for LOAD FP INTEGER, LOAD ROUNDED, QUANTIZE, and REROUND.
 - All reserved values in the effective rounding method field are assigned for CONVERT TO FIXED.
 - An IEEE-inexact-exception control (XxC) is added to CONVERT TO FIXED and LOAD ROUNDED.
 - An effective rounding method field and a quantum-exception control (XqC) are added to ADD, DIVIDE, MULTIPLY, and SUBTRACT.
 - An effective rounding method field, an IEEE-inexact-exception control (XxC), and a quantum-exception control (XqC) are added to CONVERT FROM FIXED.

2. The following instructions are available when the DFP-zoned-conversion facility is installed:

- CONVERT FROM ZONED (CDZT, CXZT)
- CONVERT TO ZONED (CZDT, CZXT)

3. The following instructions are available when the DFP-packed-conversion facility is installed:

- CONVERT FROM PACKED (CDPT, CXPT)
- CONVERT TO PACKED (CPDT, CPXT)

Name	Mnemonic	Characteristics										Op Code	Page			
ADD (extended DFP)	AXTR	RRF-a	C	TF	a ^{7,9}	SP	Dt	Xi	Xo	Xu	Xx			B3DA	20-19	
ADD (extended DFP)	AXTRA	RRF-a	C	F	a ^{7,9}	SP	Dt	Xi	Xo	Xu	Xx	Xq			B3DA	20-19
ADD (long DFP)	ADTR	RRF-a	C	TF	a ^{7,9}		Dt	Xi	Xo	Xu	Xx			B3D2	20-19	
ADD (long DFP)	ADTRA	RRF-a	C	F	a ^{7,9}		Dt	Xi	Xo	Xu	Xx	Xq			B3D2	20-19
COMPARE (extended DFP)	CXTR	RRE	C	TF	a ^{7,9}	SP	Dt	Xi							B3EC	20-22
COMPARE (long DFP)	CDTR	RRE	C	TF	a ^{7,9}		Dt	Xi							B3E4	20-22
COMPARE AND SIGNAL (extended DFP)	KXTR	RRE	C	TF	a ^{7,9}	SP	Dt	Xi							B3E8	20-23
COMPARE AND SIGNAL (long DFP)	KDTR	RRE	C	TF	a ^{7,9}		Dt	Xi							B3E0	20-23
COMPARE BIASED EXPONENT (extended DFP)	CEXTR	RRE	C	TF	a ^{7,9}	SP	Dt								B3FC	20-23
COMPARE BIASED EXPONENT (long DFP)	CEDTR	RRE	C	TF	a ^{7,9}		Dt								B3F4	20-23
CONVERT FROM FIXED (32 to extended DFP)	CXFTR	RRE		F	a ^{7,9}	SP	Dt								B959	20-24
CONVERT FROM FIXED (32 to long DFP)	CDFTR	RRF-e		F	a ^{7,9}		Dt								B951	20-24
CONVERT FROM FIXED (64 to extended DFP)	CXGTR	RRE		TF	a ^{7,9}	SP	Dt								B3F9	20-24
CONVERT FROM FIXED (64 to extended DFP)	CXGTRA	RRF-e		F	a ^{7,9}	SP	Dt								B3F9	20-24
CONVERT FROM FIXED (64 to long DFP)	CDGTR	RRE		TF	a ^{7,9}		Dt				Xx				B3F1	20-24
CONVERT FROM FIXED (64 to long DFP)	CDGTRA	RRF-e		F	a ^{7,9}		Dt			Xx	Xq				B3F1	20-24
CONVERT FROM LOGICAL (32 to extended DFP)	CXLFTR	RRF-e		F	a ^{7,9}	SP	Dt								B95B	20-25
CONVERT FROM LOGICAL (32 to long DFP)	CDLFTR	RRF-e		F	a ^{7,9}		Dt								B953	20-25
CONVERT FROM LOGICAL (64 to extended DFP)	CXLGTR	RRF-e		F	a ^{7,9}	SP	Dt								B95A	20-25
CONVERT FROM LOGICAL (64 to long DFP)	CDLGTR	RRF-e		F	a ^{7,9}		Dt			Xx	Xq				B952	20-25
CONVERT FROM PACKED (to long DFP)	CDPT	RSL-b	PC	a ^{7,9}	A	SP	Dt	Dg					B ₂	EDAE	20-26	
CONVERT FROM PACKED (to extended DFP)	CXPT	RSL-b	PC	a ^{7,9}	A	SP	Dt	Dg					B ₂	EDAF	20-26	
CONVERT FROM SIGNED PACKED (128 to extended DFP)	CXSTR	RRE		TF	a ^{7,9}	SP	Dt	Dg							B3FB	20-28
CONVERT FROM SIGNED PACKED (64 to long DFP)	CDSTR	RRE		TF	a ^{7,9}		Dt	Dg							B3F3	20-28
CONVERT FROM UNSIGNED PACKED (128 to ext. DFP)	CXUTR	RRE		TF	a ^{7,9}	SP	Dt	Dg							B3FA	20-28
CONVERT FROM UNSIGNED PACKED (64 to long DFP)	CDUTR	RRE		TF	a ^{7,9}		Dt	Dg							B3F2	20-28
CONVERT FROM ZONED (to extended DFP)	CXZT	RSL-b	ZF	a ^{7,9}	A	SP	Dt	Dg					B ₂	EDAB	20-29	
CONVERT FROM ZONED (to long DFP)	CDZT	RSL-b	ZF	a ^{7,9}	A	SP	Dt	Dg					B ₂	EDAA	20-29	
CONVERT TO FIXED (extended DFP to 32)	CFXTR	RRF-e	C	F	a ^{7,9}	SP	Dt	Xi		Xx					B949	20-30
CONVERT TO FIXED (extended DFP to 64)	CGXTR	RRF-e	C	TF	a ^{7,9}	SP	Dt	Xi		Xx					B3E9	20-29
CONVERT TO FIXED (extended DFP to 64)	CGXTRA	RRF-e	C	F	a ^{7,9}	SP	Dt	Xi		Xx					B3E9	20-30
CONVERT TO FIXED (long DFP to 32)	CFDTR	RRF-e	C	F	a ^{7,9}		Dt	Xi		Xx					B941	20-30
CONVERT TO FIXED (long DFP to 64)	CGDTR	RRF-e	C	TF	a ^{7,9}		Dt	Xi		Xx					B3E1	20-29
CONVERT TO FIXED (long DFP to 64)	CGDTRA	RRF-e	C	F	a ^{7,9}		Dt	Xi		Xx					B3E1	20-30
CONVERT TO LOGICAL (extended DFP to 32)	CLFXTR	RRF-e	C	F	a ^{7,9}	SP	Dt	Xi		Xx					B94B	20-32
CONVERT TO LOGICAL (extended DFP to 64)	CLGXTR	RRF-e	C	F	a ^{7,9}	SP	Dt	Xi		Xx					B94A	20-32
CONVERT TO LOGICAL (long DFP to 32)	CLFDTR	RRF-e	C	F	a ^{7,9}		Dt	Xi		Xx					B943	20-32
CONVERT TO LOGICAL (long DFP to 64)	CLGDTR	RRF-e	C	F	a ^{7,9}		Dt	Xi		Xx					B942	20-32
CONVERT TO PACKED (from long DFP)	CPDT	RSL-b	C	PC	a ^{7,9}	A	SP	Dt	DF			ST	B ₂	EDAC	20-33	

Figure 20-9. Summary of Decimal Instructions (Part 1 of 3)

Name	Mnemonic	Characteristics										Op Code	Page			
CONVERT TO PACKED (from extended DFP)	CPXT	RSL-b	C	PC	$\alpha^{7,9}$	A	SP	Dt	DF			ST	B_2	EDAD	20-33	
CONVERT TO SIGNED PACKED (extended DFP to 128)	CSXTR	RRF-d		TF	$\alpha^{7,9}$		SP	Dt						B3EB	20-35	
CONVERT TO SIGNED PACKED (long DFP to 64)	CSDTR	RRF-d		TF	$\alpha^{7,9}$			Dt						B3E3	20-35	
CONVERT TO UNSIGNED PACKED (extended DFP to 128)	CUXTR	RRE		TF	$\alpha^{7,9}$		SP	Dt						B3EA	20-35	
CONVERT TO UNSIGNED PACKED (long DFP to 64)	CUDTR	RRE		TF	$\alpha^{7,9}$			Dt						B3E2	20-35	
CONVERT TO ZONED (from extended DFP)	CZXT	RSL-b	C	ZF	$\alpha^{7,9}$	A	SP					ST	B_2	EDA9	20-36	
CONVERT TO ZONED (from long DFP)	CZDT	RSL-b	C	ZF	$\alpha^{7,9}$	A	SP					ST	B_2	EDA8	20-36	
DIVIDE (extended DFP)	DXTR	RRF-a		TF	$\alpha^{7,9}$		SP	Dt	Xi	Xz	Xo	Xu	Xx	B3D9	20-37	
DIVIDE (extended DFP)	DXTRA	RRF-a		F	$\alpha^{7,9}$		SP	Dt	Xi	Xz	Xo	Xu	Xx	Xq	B3D9	20-37
DIVIDE (long DFP)	DDTR	RRF-a		TF	$\alpha^{7,9}$			Dt	Xi	Xz	Xo	Xu	Xx	B3D1	20-37	
DIVIDE (long DFP)	DDTRA	RRF-a		F	$\alpha^{7,9}$			Dt	Xi	Xz	Xo	Xu	Xx	Xq	B3D1	20-37
EXTRACT BIASED EXPONENT (extended DFP to 64)	EEXTR	RRE		TF	$\alpha^{7,9}$		SP	Dt						B3ED	20-39	
EXTRACT BIASED EXPONENT (long DFP to 64)	EEDTR	RRE		TF	$\alpha^{7,9}$			Dt						B3E5	20-39	
EXTRACT SIGNIFICANCE (extended DFP to 64)	ESXTR	RRE		TF	$\alpha^{7,9}$		SP	Dt						B3EF	20-39	
EXTRACT SIGNIFICANCE (long DFP to 64)	ESDTR	RRE		TF	$\alpha^{7,9}$			Dt						B3E7	20-39	
INSERT BIASED EXPONENT (64 to extended DFP)	IEXTR	RRF-b		TF	$\alpha^{7,9}$		SP	Dt						B3FE	20-40	
INSERT BIASED EXPONENT (64 to long DFP)	IEDTR	RRF-b		TF	$\alpha^{7,9}$			Dt						B3F6	20-40	
LOAD AND TEST (extended DFP)	LTXTR	RRE	C	TF	$\alpha^{7,9}$		SP	Dt	Xi					B3DE	20-41	
LOAD AND TEST (long DFP)	LTDTR	RRE	C	TF	$\alpha^{7,9}$			Dt	Xi					B3D6	20-41	
LOAD FP INTEGER (extended DFP)	FIXTR	RRF-e		TF	$\alpha^{7,9}$		SP	Dt	Xi			Xx	Xq	B3DF	20-42	
LOAD FP INTEGER (long DFP)	FIDTR	RRF-e		TF	$\alpha^{7,9}$			Dt	Xi			Xx	Xq	B3D7	20-42	
LOAD LENGTHENED (long to extended DFP)	LXDTR	RRF-d		TF	$\alpha^{7,9}$		SP	Dt	Xi					B3DC	20-45	
LOAD LENGTHENED (short to long DFP)	LDETR	RRF-d		TF	$\alpha^{7,9}$			Dt	Xi					B3D4	20-45	
LOAD ROUNDED (extended to long DFP)	LDXTR	RRF-e		TF	$\alpha^{7,9}$		SP	Dt	Xi	Xo	Xu	Xx	Xq	B3DD	20-46	
LOAD ROUNDED (long to short DFP)	LEDTR	RRF-e		TF	$\alpha^{7,9}$			Dt	Xi	Xo	Xu	Xx	Xq	B3D5	20-46	
MULTIPLY (extended DFP)	MXTR	RRF-a		TF	$\alpha^{7,9}$		SP	Dt	Xi	Xo	Xu	Xx		B3D8	20-47	
MULTIPLY (extended DFP)	MXTRA	RRF-a		F	$\alpha^{7,9}$		SP	Dt	Xi	Xo	Xu	Xx	Xq	B3D8	20-48	
MULTIPLY (long DFP)	MDTR	RRF-a		TF	$\alpha^{7,9}$			Dt	Xi	Xo	Xu	Xx		B3D0	20-47	
MULTIPLY (long DFP)	MDTRA	RRF-a		F	$\alpha^{7,9}$			Dt	Xi	Xo	Xu	Xx	Xq	B3D0	20-48	
QUANTIZE (extended DFP)	QAXTR	RRF-b		TF	$\alpha^{7,9}$		SP	Dt	Xi			Xx	Xq	B3FD	20-49	
QUANTIZE (long DFP)	QADTR	RRF-b		TF	$\alpha^{7,9}$			Dt	Xi			Xx	Xq	B3F5	20-49	
REROUND (extended DFP)	RRXTR	RRF-b		TF	$\alpha^{7,9}$		SP	Dt	Xi			Xx	Xq	B3FF	20-52	
REROUND (long DFP)	RRDTR	RRF-b		TF	$\alpha^{7,9}$			Dt	Xi			Xx	Xq	B3F7	20-52	
SHIFT SIGNIFICAND LEFT (extended DFP)	SLXT	RXF		TF	$\alpha^{7,9}$		SP	Dt						ED48	20-54	
SHIFT SIGNIFICAND LEFT (long DFP)	SLDT	RXF		TF	$\alpha^{7,9}$			Dt						ED40	20-54	
SHIFT SIGNIFICAND RIGHT (extended DFP)	SRXT	RXF		TF	$\alpha^{7,9}$		SP	Dt						ED49	20-54	
SHIFT SIGNIFICAND RIGHT (long DFP)	SRDT	RXF		TF	$\alpha^{7,9}$			Dt						ED41	20-54	
SUBTRACT (extended DFP)	SXTR	RRF-a	C	TF	$\alpha^{7,9}$		SP	Dt	Xi	Xo	Xu	Xx		B3DB	20-55	
SUBTRACT (extended DFP)	SXTRA	RRF-a	C	F	$\alpha^{7,9}$		SP	Dt	Xi	Xo	Xu	Xx	Xq	B3DB	20-55	
SUBTRACT (long DFP)	SDTR	RRF-a	C	TF	$\alpha^{7,9}$			Dt	Xi	Xo	Xu	Xx		B3D3	20-55	
SUBTRACT (long DFP)	SDTRA	RRF-a	C	F	$\alpha^{7,9}$			Dt	Xi	Xo	Xu	Xx	Xq	B3D3	20-55	
TEST DATA CLASS (extended DFP)	TDCXT	RXE	C	TF	$\alpha^{7,9}$		SP	Dt						ED58	20-56	
TEST DATA CLASS (long DFP)	TDCDT	RXE	C	TF	$\alpha^{7,9}$			Dt						ED54	20-56	
TEST DATA CLASS (short DFP)	TDCET	RXE	C	TF	$\alpha^{7,9}$			Dt						ED50	20-56	
TEST DATA GROUP (extended DFP)	TDGXT	RXE	C	TF	$\alpha^{7,9}$		SP	Dt						ED59	20-57	
TEST DATA GROUP (long DFP)	TDGDT	RXE	C	TF	$\alpha^{7,9}$			Dt						ED55	20-57	
TEST DATA GROUP (short DFP)	TDGET	RXE	C	TF	$\alpha^{7,9}$			Dt						ED51	20-57	

Figure 20-9. Summary of Decimal Instructions (Part 2 of 3)

Name	Mnemonic	Characteristics	Op Code	Page
Explanation:				
α^7		Restricted from transactional execution when the effective allow-floating-point-operation control is zero.		
α^9		Restricted in the constrained transactional-execution mode; a transaction-constraint program exception may be recognized.		
A		Access exceptions for logical addresses.		
B_2		B_2 field designates an access register in the access-register mode.		
C		Condition code is set.		
Dg		General-operand data exception.		
Dt		DFP-instruction data exception.		
F		Floating-point extension facility.		
PC		DFP packed-conversion facility .		
RRE		RRE instruction format.		
RRF		RRF instruction format.		
RSL		RSL instruction format.		
RXE		RXE instruction format.		
RXF		RXF instruction format.		
S		S instruction format.		
SP		Specification exception.		
ST		PER storage-alteration event.		
TF		Decimal-Floating-Point facility.		
Xi		IEEE invalid-operation data exception.		
Xo		IEEE overflow data exception.		
Xq		Quantum data exception (if the floating-point extension facility is installed).		
Xu		IEEE underflow data exception.		
Xx		IEEE inexact data exception.		
Xz		IEEE division-by-zero data exception.		
ZF		DFP zoned-conversion facility.		

Figure 20-9. Summary of Decimal Instructions (Part 3 of 3)

ADD

Mnemonic1 R_1, R_2, R_3 [RRF-a]

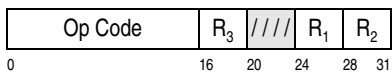

Mnemonic1	Op Code	Operands
ADTR	'B3D2'	Long DFP
AXTR	'B3DA'	Extended DFP

Mnemonic2 R_1, R_2, R_3, M_4 [RRF-a]

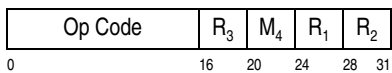

Mnemonic2	Op Code	Operands
ADTRA	'B3D2'	Long DFP
AXTRA	'B3DA'	Extended DFP

The third operand is added to the second operand, and the sum is placed at the first-operand location.

If both operands are finite numbers, they are added algebraically, forming an intermediate sum. The intermediate sum, if nonzero, is rounded to the operand format and the rounded value is then placed at the result location.

When the floating-point extension facility is installed, the intermediate sum is rounded by rounding as specified by the modifier in the M_4 field:

M_4	Effective Rounding Method
0	According to the current DFP rounding mode
1	Round to nearest with ties away from 0
2	According to the current DFP rounding mode
3	Round to prepare for shorter precision

M₄ Effective Rounding Method

- 4 Round to nearest with ties to even
- 5 Round toward 0
- 6 Round toward $+\infty$
- 7 Round toward $-\infty$
- 8 Round to nearest with ties to even
- 9 Round toward 0
- 10 Round toward $+\infty$
- 11 Round toward $-\infty$
- 12 Round to nearest with ties away from 0
- 13 Round to nearest with ties toward 0
- 14 Round away from 0
- 15 Round to prepare for shorter precision

When the modifier field is zero or two, rounding is controlled by the current DFP rounding mode specified in the FPC register. When the field is 1, or 3-15, rounding is performed as specified by the modifier, regardless of the current DFP rounding mode.

If the modifier field is 0 or 8-15, the quantum-exception control (XqC) is one and recognition of the quantum exception is suppressed; if the modifier field is 1-7, the quantum-exception control is zero and recognition of the exception is not suppressed.

When the floating-point extension facility is not installed, no quantum exception is recognized. If bits 20-23 of the instruction contain a value of zero, the intermediate sum is rounded according to the current DFP rounding mode; if bits 20-23 of the instruction contain a nonzero value, it is unpredictable which rounding method is performed.

The sign of the sum is determined by the rules of algebra. This also applies to a result of zero, as follows:

- If the result of rounding a nonzero intermediate sum is zero, the sign of the zero result is the sign of the intermediate sum.
- If the sum of two operands with opposite signs is exactly zero, the sign of the result is plus in all rounding methods except round toward $-\infty$, in which method the sign is minus.
- The sign of the sum x plus x is the sign of x , even when x is zero.

If one operand is an infinity and the other is a finite number, the result is an infinity with the sign of the

source infinity. If both operands are infinities of the same sign, the result is an infinity with the same sign. If the two operands are infinities of opposite signs, an IEEE-invalid-operation exception is recognized.

When the delivered value is exact, the preferred quantum is the smaller quantum of the two source operands; when the delivered value is inexact, the preferred quantum is the smallest quantum.

The result placed at the first-operand location is canonical.

See Figure 20-11 on page 20-21 for a detailed description of the results of this instruction. (Figure 20-10 is referred to by Figure 20-11.)

For AXTR and AXTRA, the R fields designate valid floating-point-register pairs; otherwise, a specification exception is recognized.

Resulting Condition Code:

- 0 Result is zero
- 1 Result is less than zero
- 2 Result is greater than zero
- 3 Result is a NaN

IEEE Exceptions:

- Invalid operation
- Overflow
- Underflow
- Inexact
- Quantum (if the floating-point extension facility is installed)

Program Exceptions:

- Data with DXC 3, DFP instruction
- Data with DXC for IEEE exception
- Operation (if the DFP facility is not installed)
- Specification (AXTR and AXTRA only)
- Transaction constraint

Value of Result (r)	Condition code
$r = 0$	0
$r < 0$	1
$r > 0$	2

Figure 20-10. Condition Code for Resultant Sum

Programming Notes:

1. Interchanging the two operands in a DFP addition does not affect the value of the sum when the result is numeric. This is not true, however, when both operands are QNaNs; or when both operands are SNaNs and the IEEE invalid-operation mask bit in the FPC register is zero, in these

cases, the result is the canonical QNaN derived from the second operand.

2. For ADD or SUBTRACT, when the delivered value is inexact, the preferred quantum is the smallest quantum which is the same quantum as that closest to the smaller quantum of the two source operands.

Second Operand (b) is	Results for ADD (b+c) when Third Operand (c) is									
	$-\infty$	-Nn	-Dn	-0	+0	+Dn	+Nn	$+\infty$	QNaN	SNaN
$-\infty$	T($-\infty$), cc1	T($-\infty$), cc1	T($-\infty$), cc1	T($-\infty$), cc1	T($-\infty$), cc1	T($-\infty$), cc1	T($-\infty$), cc1	Xi: T(dNaN), cc3	T(c), cc3	Xi: T(c*), cc3
-Nn	T($-\infty$), cc1	R(b+c), cc1	R(b+c), cc1	T(b), cc1	T(b), cc1	R(b+c), cc1	R(b+c), cc2	T($+\infty$), cc2	T(c), cc3	Xi: T(c*), cc3
-Dn	T($-\infty$), cc1	R(b+c), cc1	R(b+c), cc1	R(b), cc1	R(b), cc1	R(b+c), cc2	R(b+c), cc2	T($+\infty$), cc2	T(c), cc3	Xi: T(c*), cc3
-0	T($-\infty$), cc1	T(c), cc1	R(c), cc1	T(-0), cc0	Rezd, cc0	R(c), cc2	T(c), cc2	T($+\infty$), cc2	T(c), cc3	Xi: T(c*), cc3
+0	T($-\infty$), cc1	T(c), cc1	R(c), cc1	Rezd, cc0	T(+0), cc0	R(c), cc2	T(c), cc2	T($+\infty$), cc2	T(c), cc3	Xi: T(c*), cc3
+Dn	T($-\infty$), cc1	R(b+c), cc1	R(b+c), cc2	R(b), cc2	R(b), cc2	R(b+c), cc2	R(b+c), cc2	T($+\infty$), cc2	T(c), cc3	Xi: T(c*), cc3
+Nn	T($-\infty$), cc1	R(b+c), cc2	R(b+c), cc2	T(b), cc2	T(b), cc2	R(b+c), cc2	R(b+c), cc2	T($+\infty$), cc2	T(c), cc3	Xi: T(c*), cc3
$+\infty$	Xi: T(dNaN), cc3	T($+\infty$), cc2	T($+\infty$), cc2	T($+\infty$), cc2	T($+\infty$), cc2	T($+\infty$), cc2	T($+\infty$), cc2	T($+\infty$), cc2	T(c), cc3	Xi: T(c*), cc3
QNaN	T(b), cc3	T(b), cc3	T(b), cc3	T(b), cc3	T(b), cc3	T(b), cc3	T(b), cc3	T(b), cc3	T(b), cc3	Xi: T(c*), cc3
SNaN	Xi: T(b*), cc3	Xi: T(b*), cc3	Xi: T(b*), cc3	Xi: T(b*), cc3	Xi: T(b*), cc3	Xi: T(b*), cc3	Xi: T(b*), cc3	Xi: T(b*), cc3	Xi: T(b*), cc3	Xi: T(b*), cc3

Explanation:

* The SNaN is converted to the corresponding QNaN before it is placed at the target operand location.

ccn Condition code is set to n.

ccrs Condition code is set according to the resultant sum. See Figure 20-10 on page 20-20.

dNaN Default NaN.

Nn Normal number.

R(v) Rounding and range action is performed on the value v. See Figure 20-5 on page 20-11. The result is canonical.

Rezd Exact zero-difference result. See Figure 20-5 on page 20-11.

Dn Subnormal number.

T(x) The canonical result x is placed at the target operand location.

Xi: IEEE invalid-operation exception. The results shown are produced only when FPC 0.0 is zero.

Figure 20-11. Results: ADD

COMPARE

Mnemonic R_1, R_2 [RRE]

Op Code	//////	R_1	R_2
0	16	24	28 31

Mnemonic	Op Code	Operands
CDTR	'B3E4'	Long DFP
CXTR	'B3EC'	Extended DFP

The first operand is compared with the second operand, and the condition code is set to indicate the result.

If both operands are finite numbers, the comparison is algebraic and follows the procedure for DFP subtraction, except that the difference is discarded after setting the condition code, and both operands remain unchanged. If the difference is exactly zero with either sign, the operands are equal; this includes zero operands (so $+0$ equals -0). If a nonzero difference is positive or negative, the first operand is high or low, respectively.

$+\infty$ compares greater than any finite number, and all finite numbers compare greater than $-\infty$. Two infinity operands of like sign compare equal.

Numeric comparison is exact, and the condition code is determined for finite operands as if range and precision were unlimited. No overflow or underflow exception can occur.

If either or both operands are QNaNs and neither operand is an SNaN, the comparison result is unordered, and condition code 3 is set.

If either or both operands are SNaNs, an IEEE-invalid-operation exception is recognized. If the IEEE invalid-operation mask bit is one, a program interruption for a data exception with DXC 80 hex (IEEE invalid operation) occurs. If the IEEE-invalid-operation mask bit is zero, the IEEE-invalid-operation flag bit is set to one, and instruction execution is completed by setting condition code 3.

See Figure 20-12 on page 20-22 for a detailed description of the results of this instruction.

For CXTR, the R fields must designate valid floating-point-register pairs; otherwise, a specification exception is recognized.

First Operand (a) is	Results for COMPARE (a:b) when Second Operand (b) is							
	$-\infty$	-Fn	-0	+0	+Fn	$+\infty$	QNaN	SNaN
$-\infty$	cc0	cc1	cc1	cc1	cc1	cc1	cc3	Xi: cc3
-Fn	cc2	C(a:b)	cc1	cc1	cc1	cc1	cc3	Xi: cc3
-0	cc2	cc2	cc0	cc0	cc1	cc1	cc3	Xi: cc3
+0	cc2	cc2	cc0	cc0	cc1	cc1	cc3	Xi: cc3
+Fn	cc2	cc2	cc2	cc2	C(a:b)	cc1	cc3	Xi: cc3
$+\infty$	cc2	cc2	cc2	cc2	cc2	cc0	cc3	Xi: cc3
QNaN	cc3	cc3	cc3	cc3	cc3	cc3	cc3	Xi: cc3
SNaN	Xi: cc3	Xi: cc3	Xi: cc3	Xi: cc3	Xi: cc3	Xi: cc3	Xi: cc3	Xi: cc3

Explanation:

ccn Condition code is set to n.
 C(a:b) Basic compare results. See Figure 20-13.
 Fn Nonzero finite number (includes both subnormal and normal).
 Xi: IEEE invalid-operation exception. The results shown are produced only when FPC 0.0 is zero.

Figure 20-12. Results: COMPARE

Relation of value (a) to value (b)	Condition code for C(a:b)
$a = b$	0
$a < b$	1
$a > b$	2

Figure 20-13. Basic Compare Results

Resulting Condition Code:

- 0 Operands equal
- 1 First operand low
- 2 First operand high
- 3 Operands unordered

IEEE Exceptions:

- Invalid operation

Program Exceptions:

- Data with DXC 3, DFP instruction
- Data with DXC for IEEE exception
- Operation (if the DFP facility is not installed)
- Specification (CXTR only)
- Transaction constraint

COMPARE AND SIGNALMnemonic R_1, R_2 [RRE]

Op Code	//////	R_1	R_2
0	16	24	28 31

Mnemonic	Op Code	Operands
KDTR	'B3E0'	Long DFP
KXTR	'B3E8'	Extended DFP

The first operand is compared with the second operand, and the condition code is set to indicate the result. The operation is the same as for COMPARE except that QNaN operands cause an IEEE-invalid-

operation exception to be recognized. Thus QNaN operands are treated as if they were SNaNs.

See Figure 20-14 on page 20-23 for a detailed description of the results of this instruction.

For KXTR, the R fields must designate valid floating-point-register pairs; otherwise, a specification exception is recognized.

Resulting Condition Code:

- 0 Operands equal
- 1 First operand low
- 2 First operand high
- 3 Operands unordered

IEEE Exceptions:

- Invalid operation

Program Exceptions:

- Data with DXC 3, DFP instruction
- Data with DXC for IEEE exception
- Operation (if the DFP facility is not installed)
- Specification (KXTR only)
- Transaction constraint

First Operand (a) is	Results for COMPARE AND SIGNAL (a:b) when Second Operand (b) is						
	$-\infty$	-Fn	-0	+0	+Fn	$+\infty$	NaN
$-\infty$	cc0	cc1	cc1	cc1	cc1	cc1	Xi: cc3
-Fn	cc2	C(a:b)	cc1	cc1	cc1	cc1	Xi: cc3
-0	cc2	cc2	cc0	cc0	cc1	cc1	Xi: cc3
+0	cc2	cc2	cc0	cc0	cc1	cc1	Xi: cc3
+Fn	cc2	cc2	cc2	cc2	C(a:b)	cc1	Xi: cc3
$+\infty$	cc2	cc2	cc2	cc2	cc2	cc0	Xi: cc3
NaN	Xi: cc3	Xi: cc3	Xi: cc3	Xi: cc3	Xi: cc3	Xi: cc3	Xi: cc3

Explanation:

ccn	Condition code is set to n.
C(a:b)	Basic compare results. See Figure 20-13.
Fn	Nonzero finite number (includes both subnormal and normal).
Xi:	IEEE invalid-operation exception. The results shown are produced only when FPC 0.0 is zero.

Figure 20-14. Results: COMPARE AND SIGNAL

COMPARE BIASED EXPONENTMnemonic R_1, R_2 [RRE]

Op Code	//////	R_1	R_2
0	16	24	28 31

Mnemonic	Op Code	Operands
----------	---------	----------

CEDTR	'B3F4'	Long DFP
CEXTR	'B3FC'	Extended DFP

The biased exponent of the first operand is compared with the biased exponent of the second operand, and the condition code is set to indicate the result.

This operation is performed for any second operand, including an infinity, QNaN, or SNaN, without causing an IEEE exception.

See Figure 20-15 on page 20-24 for a detailed description of the results of this instruction.

For CEXTR, the R fields must designate valid floating-point-register pairs; otherwise, a specification exception is recognized.

Resulting Condition Code:

- 0 Biased exponents equal
- 1 First-operand biased exponent low
- 2 First-operand biased exponent high
- 3 Unordered

IEEE Exceptions: None.

Program Exceptions:

- Data with DXC 3, DFP instruction
- Operation (if the DFP facility is not installed)
- Specification (CEXTR only)
- Transaction constraint

First operand (a) is	Result for COMPARE BIASED EXPONENT when second operand (b) is			
	F	∞	QNaN	SNaN
F	$C(e_a:e_b)$	cc3	cc3	cc3
∞	cc3	cc0	cc3	cc3
QNaN	cc3	cc3	cc0	cc0
SNaN	cc3	cc3	cc0	cc0

Explanation:

$C(e_a:e_b)$ Biased-exponent compare results. See Figure 20-16 on page 20-24.

ccn Condition code is set to n.

F All finite numbers, including zeros.

Figure 20-15. Results: COMPARE BIASED EXPONENT

Relation of value e_a to value e_b	Condition Code for $C(e_a:e_b)$
$e_a = e_b$	cc0
$e_a < e_b$	cc1
$e_a > e_b$	cc2

Explanation:

ccn Condition code is set to n.

e_a Biased exponent of the first operand

e_b Biased exponent of the second operand

Figure 20-16. Biased-Exponent Compare Results

CONVERT FROM FIXED

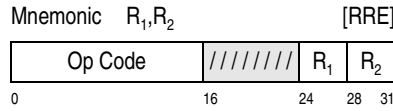

Mnemonic	Op Code	Operands
CDGTR	'B3F1'	64-bit binary-integer source, long DFP result
CXGTR	'B3F9'	64-bit binary-integer source, extended DFP result

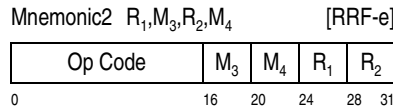

Mnemonic2	Op Code	Operands
CDGTRA	'B3F1'	64-bit binary-integer source, long DFP result
CXGTRA	'B3F9'	64-bit binary-integer source, extended DFP result
CDFTR	'B951'	32-bit binary-integer source, long DFP result
CXFTR	'B959'	32-bit binary-integer source, extended DFP result

The fixed-point second operand is converted to the DFP format, and the result is placed at the first-operand location.

The second operand is a signed binary integer that is located in the general register designated by R_2 . A 32-bit operand is in bit positions 32-63 of the register.

The converted result is rounded and then the rounded value is placed at the first-operand location.

When the floating-point extension facility is installed, the converted result is rounded by rounding as specified by the modifier in the M_3 field:

M_3 Effective Rounding Method

- 0 According to the current DFP rounding mode
- 1 Round to nearest with ties away from 0
- 2 According to the current DFP rounding mode
- 3 Round to prepare for shorter precision
- 4 Round to nearest with ties to even
- 5 Round toward 0
- 6 Round toward $+\infty$
- 7 Round toward $-\infty$
- 8 Round to nearest with ties to even
- 9 Round toward 0
- 10 Round toward $+\infty$
- 11 Round toward $-\infty$
- 12 Round to nearest with ties away from 0

M₃	Effective Rounding Method
13	Round to nearest with ties toward 0
14	Round away from 0
15	Round to prepare for shorter precision

When the modifier field is zero or two, rounding is controlled by the current DFP rounding mode specified in the FPC register. When the field is 1, or 3-15, rounding is performed as specified by the modifier, regardless of the current DFP rounding mode.

If the modifier field is 0 or 8-15, the quantum-exception control (XqC) is one and recognition of the quantum exception is suppressed; if the modifier field is 1-7, the quantum-exception control is zero and recognition of the exception is not suppressed.

When the floating-point extension facility is not installed, no quantum exception is recognized. If bits 16-19 of the instruction contain a value of zero, the converted result is rounded according to the current DFP rounding mode; if bits 16-19 of the instruction contain a nonzero value, it is unpredictable which rounding method is performed.

When the delivered value is exact, the preferred quantum is one; when the delivered value is inexact, the preferred quantum is the smallest quantum.

The result placed at the first-operand location is canonical.

See Figure 20-24 on page 20-42 for a detailed description of the results of this instruction.

When the floating-point extension facility is installed, bit 1 of the M₄ field is the IEEE-inexact-exception control (XxC), and bits 0, 2, and 3 are ignored. If XxC is zero, recognition of IEEE-inexact exception is not suppressed; if XxC is one, recognition of the exception is suppressed.

When the floating-point extension facility is not installed, and if bits 20-23 of the instruction are zeros, then recognition of IEEE-inexact exception is not suppressed; if bits 20-23 of the instruction contain a nonzero value, it is unpredictable whether recognition of IEEE-inexact exception is suppressed.

For CXGTR, CXGTRA, and CXFTR, the R₁ field must designate a valid floating-point-register pair; otherwise, a specification exception is recognized.

An operation exception is recognized if the DFP facility is not installed. For CDFTR and CXFTR, the operation exception is also recognized if the floating-point extension facility is not installed.

Condition Code: The code remains unchanged.

IEEE Exceptions:

- Inexact (CDGTR and CDGTRA only)
- Quantum (CDGTR and CDGTRA only, if the floating-point extension facility is installed)

Program Exceptions:

- Data with DXC 3, DFP instruction
- Data with DXC for IEEE exception
- Operation (if the DFP facility is not installed)
- Specification (CXGTR, CXGTRA, and CXFTR only)
- Transaction constraint

Programming Note: Unassigned bits in the M₄ field are reserved for future extensions and should be set to zeros; otherwise, the program may not operate compatibly in the future.

CONVERT FROM LOGICAL

Mnemonic R₁,M₃,R₂,M₄ [RRF-e]

Op Code	M ₃	M ₄	R ₁	R ₂
0	16	20	24	28 31

Mnemonic	Op Code	Operands
CDLGTR	'B952'	64-bit binary-integer source, long DFP result
CXLGTR	'B95A'	64-bit binary-integer source, extended DFP result
CDLFTR	'B953'	32-bit binary-integer source, long DFP result
CXLFTR	'B95B'	32-bit binary-integer source, extended DFP result

The fixed-point second operand is converted to the DFP format, and the result is placed at the first-operand location.

The second operand is an unsigned binary integer that is located in the general register designated by R₂. A 32-bit operand is in bit positions 32-63 of the register.

The converted result is rounded to an integer value by rounding as specified by the modifier in the M_3 field:

M_3	Effective Rounding Method
0	According to the current DFP rounding mode
1	Round to nearest with ties away from 0
2	According to the current DFP rounding mode
3	Round to prepare for shorter precision
4	Round to nearest with ties to even
5	Round toward 0
6	Round toward $+\infty$
7	Round toward $-\infty$
8	Round to nearest with ties to even
9	Round toward 0
10	Round toward $+\infty$
11	Round toward $-\infty$
12	Round to nearest with ties away from 0
13	Round to nearest with ties toward 0
14	Round away from 0
15	Round to prepare for shorter precision

When the modifier field is zero or two, rounding is controlled by the current DFP rounding mode specified in the FPC register. When the field is 1, or 3-15, rounding is performed as specified by the modifier, regardless of the current DFP rounding mode.

If the modifier field is 0 or 8-15, the quantum-exception control (XqC) is one and recognition of the quantum exception is suppressed; if the modifier field is 1-7, the quantum-exception control is zero and recognition of the exception is not suppressed.

Bit 1 of the M_4 field is the IEEE-inexact-exception control (XxC). Bits 0, 2, and 3 are ignored. If XxC is zero, recognition of IEEE-inexact exception is not suppressed; if XxC is one, recognition of the exception is suppressed.

The result always has a plus sign.

When the delivered value is exact, the preferred quantum is one; when the delivered value is inexact, the preferred quantum is the smallest quantum.

The result placed at the first-operand location is canonical.

See Figure 20-24 on page 20-42 for a detailed description of the results of this instruction.

For CXLGTR and CXLFTR, the R_1 field must designate a valid floating-point-register pair; otherwise, a specification exception is recognized.

Condition Code: The code remains unchanged.

IEEE Exceptions:

- Inexact (CDLGTR only)
- Quantum (CDLGTR only)

Program Exceptions:

- Data with DXC 3, DFP instruction
- Data with DXC for IEEE exception
- Operation (if the floating-point extension facility is not installed)
- Specification (CXLGTR and CXLFTR only)
- Transaction constraint

Programming Notes:

1. Unassigned bits in the M_4 field are reserved for future extensions and should be set to zeros; otherwise, the program may not operate compatibly in the future.
2. Using either the round toward 0 or the round toward $-\infty$ rounding method produces the same result; using either the round away from 0 or the round toward $+\infty$ rounding method produces the same result.

CONVERT FROM PACKED



Mnemonic	Op Code	Operands
CDPT	'EDAE'	Packed source, long DFP result
CXPT	'EDAF'	Packed source, extended DFP result

The second operand in the packed-decimal format is converted to the DFP format, and the result is placed at the first-operand location.

The preferred quantum is one, and the delivered value is always represented with the preferred quantum.

The result placed at the first-operand location is canonical.

For CXPT the length in bytes of the second operand is 1-18, corresponding to a length code in L_2 of 0-17. For CDPT the length in bytes of the second operand is 1-9, corresponding to a length code in L_2 of 0-8. See Figure 20-17 for valid L_2 values along with the corresponding number of digits converted.

The M_3 field has the following format:



The bits of the M_3 field are defined as follows:

- **Sign-Control (S):** Bit 0 of the M_3 field is the sign control (S). When the S bit is zero, the second operand does not have a sign field and the sign bit of the DFP first-operand result is set to zero.

When the S bit is one, the second operand contains a sign field in the rightmost four bit positions of the rightmost byte. The sign bit of the DFP first-operand result is set to zero when the sign field of the second operand indicates a positive value, or when the ignore-sign-digit control is one. The sign bit of the DFP first-operand result is set to one when the sign field of the second operand indicates a negative value and the ignore-sign-digit control is zero.

- **Reserved:** Bits 1-2 of the M_3 field are reserved.
- **Ignore-Sign-Digit Control (I):** Bit 3 of the M_3 field is the ignore-sign-digit control (I). When the I bit is zero, no special action is taken. When the I bit is one, the sign field of the second operand is ignored, it is not checked for invalid digits, and the sign bit of the DFP first-operand result is set to zero. When the S-bit is zero, the I bit is ignored.

Special Conditions

When an invalid digit or sign code is detected in the second operand, or an unused digit is not zero, a general-operand data exception is recognized. If the sign control and the ignore-sign-digit control are one, no sign code checking is performed on the sign digit.

A specification exception is recognized, and the operation is suppressed, when any of the following is true.

- For CDPT, the L_2 field is greater than 8

- For CXPT, the R_1 field designates an invalid floating-point-register pair, or the L_2 field is greater than 17

Condition Code: The code remains unchanged.

Program Exceptions:

- Access (Fetch operand 2)
- Data with DXC 0, general operand
- Data with DXC 3, DFP instruction
- Operation (if the DFP packed-conversion facility is not installed)
- Specification
- Transaction constraint

Programming Notes:

1. Depending on the model, for CXPT, when the L_2 field specifies 16 or 17 (meaning 32-34 digits), performance may be significantly worse than if shorter lengths are specified.
2. When trying to convert 16 packed digits and a sign digit for CDPT, a L_2 value of 8 should be used and the S bit in the M_3 field should be set to one. When trying to convert 34 packed digits and a sign digit for CXPT an L_2 value of 17 should be used and the S bit in the M_3 field should be set to one. In both of these cases, bits 0-3 of the first byte of the second operand should be zero; otherwise, a general-operand data exception will occur.

L_2	S=0	S=1
0	2	1
1	4	3
2	6	5
3	8	7
4	10	9
5	12	11
6	14	13
7	16	15
For CDPT only:		
8	16*	16*
CXPT only below		
8	18	17
9	20	19
10	22	21
11	24	23
12	26	25
13	28	27

Figure 20-17. Valid L_2 Values for Signed and Unsigned Digit Combinations

L_2	$S=0$	$S=1$
14	30	29
15	32	31
16	34	33
17	34*	34*

Explanation:

* Unused digits must be zero.

Figure 20-17. Valid L_2 Values for Signed and Unsigned Digit Combinations

CONVERT FROM SIGNED PACKED

Mnemonic R_1, R_2 [RRE]

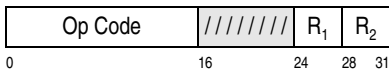

Mnemonic	Op Code	Operands
CDSTR	'B3F3'	64-bit signed-packed-decimal source in GR, long DFP result
CXSTR	'B3FB'	128-bit signed-packed-decimal source in GRs, extended DFP result

The second operand in the signed-packed-decimal format is converted to the DFP format, and the result is placed at the first-operand location.

The second operand is located in the general register or general-register pair designated by R_2 .

The preferred quantum is one, and the delivered value is always represented with the preferred quantum.

The result placed at the first-operand location is canonical.

When an invalid digit or sign code is detected in the second operand, a general-operand data exception is recognized.

For CXSTR, the R_1 field must designate a valid floating-point-register pair; otherwise, a specification exception is recognized. Also, the R_2 field designates an even-odd pair of general registers and must designate an even-numbered register; otherwise, a specification exception is recognized.

Condition Code: The code remains unchanged.

IEEE Exceptions: None.

Program Exceptions:

- Data with DXC 0, general operand
- Data with DXC 3, DFP instruction
- Operation (if the DFP facility is not installed)
- Specification (CXSTR only)
- Transaction constraint

CONVERT FROM UNSIGNED PACKED

Mnemonic R_1, R_2 [RRE]

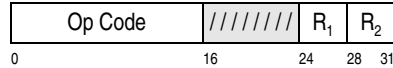

Mnemonic	Op Code	Operands
CDUTR	'B3F2'	64-bit unsigned-packed-decimal source in GR, long DFP result
CXUTR	'B3FA'	128-bit unsigned-packed-decimal source in GRs, extended DFP result

The second operand in the unsigned-packed-decimal format is converted to the DFP format with a positive sign, and the result is placed at the first-operand location.

The second operand is located in the general register or general-register pair designated by R_2 .

The preferred quantum is one, and the delivered value is always represented with the preferred quantum.

The result placed at the first-operand location is canonical.

When an invalid digit code is detected in the second operand, a general-operand data exception is recognized.

For CXUTR, the R_1 field must designate a valid floating-point-register pair; otherwise, a specification exception is recognized. Also, the R_2 field designates an even-odd pair of general registers and must designate an even-numbered register; otherwise, a specification exception is recognized.

Condition Code: The code remains unchanged.

IEEE Exceptions: None.

Program Exceptions:

- Data with DXC 0, general operand
- Data with DXC 3, DFP instruction

- Operation (if the DFP facility is not installed)
- Specification (CXUTR only)
- Transaction constraint

CONVERT FROM ZONED

Mnemonic $R_1, D_2(L_2, B_2), M_3$ [RSL-b]

Op Code	L_2	B_2	D_2	R_1	M_3	Op Code
0	8	16	20	32	36	40
						47

Mnemonic	Op Code	Operands
CDZT	'EDAA'	Zoned source, long DFP result
CXZT	'EDAB'	Zoned source, extended DFP result

The second operand in the zoned format is converted to the DFP format, and the result is placed at the first-operand location.

The preferred quantum is one, and the delivered value is always represented with the preferred quantum.

The result placed at the first-operand location is canonical.

The length in bytes of the second operand is 1-34 for CXZT, corresponding to a length code in L_2 of 0-33. The length in bytes of the second operand is 1-16 for CDZT, corresponding to a length code in L_2 of 0-15.

The M_3 field has the following format:



The bits of the M_3 field are defined as follows:

- **Sign-Control (S):** Bit 0 of the M_3 field is the sign control (S). When zero, the second operand does not have a sign field and the sign bit of the DFP first-operand result is set to zero. When one, the second operand is signed. That is, the leftmost four bit positions of the rightmost byte are a sign. The sign bit of the DFP first-operand result is set to zero when the sign field indicates a positive value and one when the sign field indicates a negative value.
- **Reserved:** Bits 1-3 of the M_3 field are ignored.

Special Conditions:

When an invalid digit or sign code is detected in the second operand, a general-operand data exception is recognized.

A specification exception is recognized, and the operation is suppressed, when any of the following is true.

- For CDZT, the L_2 field is greater than or equal to 16.
- For CXZT, the R_1 field designates an invalid floating-point-register pair, or the L_2 field is greater than or equal to 34.

Condition Code: The code remains unchanged.

Program Exceptions:

- Access (Fetch operand 2)
- Data with DXC 0, general operand
- Data with DXC 3, DFP instruction
- Operation (if the DFP zoned-conversion facility is not installed)
- Specification
- Transaction constraint

Programming Notes:

1. When an ASCII second operand is specified, bit 0 of the M_3 field must be zero, otherwise a general-operand data exception is recognized. That is, a sign value of 0011 binary is not a valid sign.
2. Depending on the model, for CXZT, when the L_2 field specifies 32 or 33 (meaning 33 or 34 digits), performance may be significantly worse than if shorter lengths are specified.
3. Bits 1-3 of the M_3 field should be set to zeros, otherwise the program may not operate compatibly in the future.

CONVERT TO FIXED

Mnemonic1 R_1, M_3, R_2 [RRF-e]

Op Code	M_3	/	/	/	R_1	R_2
0	16	20	24	28	31	

Mnemonic1	Op Code	Operands
CGDTR	'B3E1'	Long DFP source, 64-bit binary-integer result
CGXTR	'B3E9'	Extended DFP source, 64-bit binary-integer result

Mnemonic2 R₁,M₃,R₂,M₄ [RRF-e]

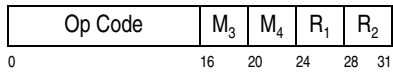

Mnemonic2 Op Code	Operands
CGDTRA 'B3E1'	Long DFP source, 64-bit binary-integer result
CGXTRA 'B3E9'	Extended DFP source, 64-bit binary-integer result
CFDTR 'B941'	Long DFP source, 32-bit binary-integer result
CFXTR 'B949'	Extended DFP source, 32-bit binary-integer result

The DFP second operand is rounded to an integer value and then converted to the fixed-point format. The result is placed at the first-operand location.

The result is a signed binary integer that is placed in the general register designated by R₁. A 32-bit result replaces bits 32-63 of the register, and bits 0-31 of the register remain unchanged.

If the second operand is numeric and finite, it is rounded to an integer value by rounding as specified by the modifier in the M₃ field:

M₃ Effective Rounding Method

- 0 According to the current DFP rounding mode
- 1 Round to nearest with ties away from 0
- 2 According to the current DFP rounding mode
- 3 Round to prepare for shorter precision
- 4 Round to nearest with ties to even
- 5 Round toward 0
- 6 Round toward +∞
- 7 Round toward -∞
- 8 Round to nearest with ties to even
- 9 Round toward 0
- 10 Round toward +∞
- 11 Round toward -∞
- 12 Round to nearest with ties away from 0
- 13 Round to nearest with ties toward 0
- 14 Round away from 0
- 15 Round to prepare for shorter precision

When the modifier field is zero, rounding is controlled by the current DFP rounding mode specified in the FPC register. When the field is 8-15, rounding is performed as specified by the modifier, regardless of the current DFP rounding mode.

When the floating-point extension facility is installed and if the modifier field is 2, rounding is controlled by

the current DFP rounding mode specified in the FPC register; if the field is 1, or 3-7, rounding is performed as specified by the modifier, regardless of the current DFP rounding mode.

When the floating-point extension facility is not installed, and if the M₃ modifier field is 1-7, it is unpredictable which rounding method is performed.

The sign of the result is the sign of the second operand, except that a zero result has a plus sign.

This operation performs a functionally-constrained rounding. Neither overflow nor underflow condition can occur.

When the floating-point extension facility is installed, bit 1 of the M₄ field is the IEEE-inexact-exception control (XxC), and bits 0, 2, and 3 are ignored. If XxC is zero, recognition of IEEE-inexact exception is not suppressed; if XxC is one, recognition of the exception is suppressed.

When the floating-point extension facility is not installed, and if bits 20-23 of the instruction are zeros, then recognition of IEEE-inexact exception is not suppressed; if bits 20-23 of the instruction contain a nonzero value, it is unpredictable whether recognition of IEEE-inexact exception is suppressed.

See Figure 20-18 for a detailed description of the results of this instruction.

For CGXTR, CGXTRA, and CFXTR, the R₂ field must designate a valid floating-point-register pair; otherwise, a specification exception is recognized.

An operation exception is recognized if the DFP facility is not installed. For CFDTR, CFXTR, CGDTRA, and CGXTRA, the operation exception is also recognized if the floating-point extension facility is not installed.

Resulting Condition Code:

- 0 Source was zero
- 1 Source was less than zero
- 2 Source was greater than zero
- 3 Special case

IEEE Exceptions:

- Invalid operation
- Inexact

Program Exceptions:

- Data with DXC 3, DFP instruction
- Data with DXC for IEEE exception
- Operation
- Specification (CGXTR, CGXTRA, and CFXTR only)

- Transaction constraint

Programming Note: Unassigned bits in the M_4 field are reserved for future extensions and should be set to zeros; otherwise, the program may not operate compatibly in the future.

Operand (b)	Is n Inexact (n ≠ b)	Inv.-Op. Mask (FPC 0.0)	IEEE Inexact Exception Control ² (XxC)	Inexact Mask (FPC 0.4)	Is n Incremented (n > b)	Results
$-\infty \leq b < MN, n < MN$	—	0	—	—	—	T(MN), SFi←1, cc3 †
$-\infty \leq b < MN, n < MN$	—	1	—	—	—	PIDi(80)
$-\infty < b < MN, n = MN$	—	—	1	—	—	T(MN), cc1
$-\infty < b < MN, n = MN$	—	—	0	0	—	T(MN), SFx←1, cc1
$-\infty < b < MN, n = MN$	—	—	0	1	—	T(MN), cc1, PIDx(08)
$MN \leq b < 0$	No	—	—	—	—	T(f), cc1
$MN \leq b < 0$	Yes	—	1	—	—	T(f), cc1
$MN \leq b < 0$	Yes	—	0	0	—	T(f), SFx←1, cc1
$MN \leq b < 0$	Yes	—	0	1	No	T(f), cc1, PIDx(08)
$MN \leq b < 0$	Yes	—	0	1	Yes	T(f), cc1, PIDy(0C)
-0	No ¹	—	—	—	—	T(0), cc0
+0	No ¹	—	—	—	—	T(0), cc0
$0 < b \leq MP$	No	—	—	—	—	T(f), cc2
$0 < b \leq MP$	Yes	—	1	—	—	T(f), cc2
$0 < b \leq MP$	Yes	—	0	0	—	T(f), SFx←1, cc2
$0 < b \leq MP$	Yes	—	0	1	No	T(f), cc2, PIDx(08)
$0 < b \leq MP$	Yes	—	0	1	Yes	T(f), cc2, PIDy(0C)
$MP < b < +\infty, n = MP$	—	—	1	—	—	T(MP), cc2
$MP < b < +\infty, n = MP$	—	—	0	0	—	T(MP), SFx←1, cc2
$MP < b < +\infty, n = MP$	—	—	0	1	—	T(MP), cc2, PIDx(08)
$MP < b \leq +\infty, n > MP$	—	0	—	—	—	T(MP), SFi←1, cc3 †
$MP < b \leq +\infty, n > MP$	—	1	—	—	—	PIDi(80)
NaN	—	0	—	—	—	T(MN), SFi←1, cc3 †
NaN	—	1	—	—	—	PIDi(80)

Explanation:

- The results do not depend on this condition or mask bit.
- ¹ This condition is true by virtue of the state of some condition to the left of this column.
- ² XxC is defined only when the floating-point extension facility is installed.
- ccn Condition code is set to n.
- † Result differs from BFP CONVERT TO FIXED. The BFP instruction recognizes inexact for this case and takes different actions depending on the inexact mask. The DFP implementation is intended to be more in keeping with the spirit of the IEEE standard.
- f The value n converted to a fixed-point result.
- n The value derived when the source value (b) is rounded to a floating-point integer using the effective rounding method.
- MN Maximum negative number representable in the target fixed-point format.
- MP Maximum positive number representable in the target fixed-point format.
- PIDc(h) Program interruption for data exception, condition c, with DXC of h in hex. Figure 20-8 on page 20-16
- SFi IEEE invalid-operation flag, FPC 1.0.
- SFx IEEE inexact flag, FPC 1.4.
- T(x) The value x is placed at the target operand location

Figure 20-18. Results: CONVERT TO FIXED

CONVERT TO LOGICAL

Mnemonic R_1, M_3, R_2, M_4 [RRF-e]

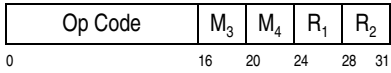

Mnemonic	Op Code	Operands
CLGDTR	'B942'	Long DFP source, 64-bit binary-integer result
CLGXTR	'B94A'	Extended DFP source, 64-bit binary-integer result
CLFDTR	'B943'	Long DFP source, 32-bit binary-integer result
CLFXTR	'B94B'	Extended DFP source, 32-bit binary-integer result

The DFP second operand is rounded to an integer value and then converted to the fixed-point format. The result is placed at the first-operand location.

The result is an unsigned binary integer that is placed in the general register designated by R_1 . A 32-bit result replaces bits 32-63 of the register, and bits 0-31 of the register remain unchanged.

If the second operand is numeric and finite, it is rounded to an integer value by rounding as specified by the modifier in the M_3 field:

M_3	Effective Rounding Method
0	According to the current DFP rounding mode
1	Round to nearest with ties away from 0
2	According to the current DFP rounding mode
3	Round to prepare for shorter precision
4	Round to nearest with ties to even
5	Round toward 0
6	Round toward $+\infty$
7	Round toward $-\infty$
8	Round to nearest with ties to even
9	Round toward 0
10	Round toward $+\infty$
11	Round toward $-\infty$
12	Round to nearest with ties away from 0
13	Round to nearest with ties toward 0
14	Round away from 0
15	Round to prepare for shorter precision

When the modifier field is zero or two, rounding is controlled by the current DFP rounding mode specified in the FPC register. When the field is 1, or 3-15, rounding is performed as specified by the modifier, regardless of the current DFP rounding mode.

This operation performs a functionally-constrained rounding. Neither overflow nor underflow condition can occur.

Bit 1 of the M_4 field is the IEEE-inexact-exception control (XxC). Bits 0, 2, and 3 are ignored. If XxC is zero, recognition of IEEE-inexact exception is not suppressed; if XxC is one, recognition of the exception is suppressed.

See Figure 20-19 for a detailed description of the results of this instruction.

For CLGXTR and CLFXTR, the R_2 field must designate a valid floating-point-register pair; otherwise, a specification exception is recognized.

Resulting Condition Code:

- 0 Source was zero
- 1 Source was less than zero
- 2 Source was greater than zero
- 3 Special case

IEEE Exceptions:

- Invalid operation
- Inexact

Program Exceptions:

- Data with DXC 3, DFP instruction
- Data with DXC for IEEE exception
- Operation (if the floating-point extension facility is not installed.)
- Specification (CLGXTR and CLFXTR only)
- Transaction constraint

Programming Note: Unassigned bits in the M_4 field are reserved for future extensions and should be set

to zeros; otherwise, the program may not operate compatibly in the future.

Operand (b)	Is n Inexact (n ≠ b)	Inv.-Op. Mask (FPC 0.0)	IEEE Inexact Exception Control ² (XxC)	Inexact Mask (FPC 0.4)	Is n Incremented (n > b)	Results
$-\infty \leq b < 0, n < 0$	—	0	—	—	—	T(0), SFi←-1, cc3 †
$-\infty \leq b < 0, n < 0$	—	1	—	—	—	PIDi(80)
$-\infty < b < 0, n = 0$	—	—	1	—	—	T(0), cc1
$-\infty < b < 0, n = 0$	—	—	0	0	—	T(0), SFx←-1, cc1
$-\infty < b < 0, n = 0$	—	—	0	1	—	T(0), cc1, PIDx(08)
-0	No ¹	—	—	—	—	T(0), cc0
+0	No ¹	—	—	—	—	T(0), cc0
$0 < b \leq \text{MU}$	No	—	—	—	—	T(f), cc2
$0 < b \leq \text{MU}$	Yes	—	1	—	—	T(f), cc2
$0 < b \leq \text{MU}$	Yes	—	0	0	—	T(f), SFx←-1, cc2
$0 < b \leq \text{MU}$	Yes	—	0	1	No	T(f), cc2, PIDx(08)
$0 < b \leq \text{MU}$	Yes	—	0	1	Yes	T(f), cc2, PIDy(0C)
$\text{MU} < b < +\infty, n = \text{MU}$	—	—	1	—	—	T(MU), cc2
$\text{MU} < b < +\infty, n = \text{MU}$	—	—	0	0	—	T(MU), SFx←-1, cc2
$\text{MU} < b < +\infty, n = \text{MU}$	—	—	0	1	—	T(MU), cc2, PIDx(08)
$\text{MU} < b \leq +\infty, n > \text{MU}$	—	0	—	—	—	T(MU), SFi←-1, cc3 †
$\text{MU} < b \leq +\infty, n > \text{MU}$	—	1	—	—	—	PIDi(80)
NaN	—	0	—	—	—	T(0), SFi←-1, cc3 †
NaN	—	1	—	—	—	PIDi(80)

Explanation:

- The results do not depend on this condition or mask bit.
- ¹ This condition is true by virtue of the state of some condition to the left of this column.
- ² XxC is defined only when the floating-point extension facility is installed.
- ccn Condition code is set to n.
- † Result differs from BFP CONVERT TO LOGICAL. The BFP instruction recognizes inexact for this case and takes different actions depending on the inexact mask. The DFP implementation is intended to be more in keeping with the spirit of the IEEE standard.
- f The value n converted to a fixed-point result.
- n The value derived when the source value (b) is rounded to a floating-point integer using the effective rounding method.
- MU Maximum unsigned number representable in the target fixed-point format.
- PIDc(h) Program interruption for data exception, condition c, with DXC of h in hex. Figure 20-8 on page 20-16
- SFi IEEE invalid-operation flag, FPC 1.0.
- SFx IEEE inexact flag, FPC 1.4.
- T(x) The value x is placed at the target operand location

Figure 20-19. Results: CONVERT TO LOGICAL

CONVERT TO PACKED

Mnemonic $R_1, D_2(L_2, B_2), M_3$ [RSL-b]

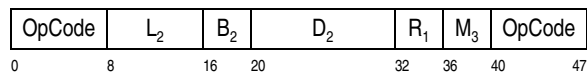

Mnemonic	Op Code	Operands
CPDT	'EDAC'	Long DFP source, packed result
CPXT	'EDAD'	Extended DFP source, packed result

The significant digits of the DFP first operand and the sign bit of the first operand are converted to the

packed format. The exponent in the combination field is ignored. The specified number of rightmost bytes of packed digits are placed at the second-operand location.

If there are not enough significant digits to fill all of the packed bytes, zero digits are appended to the significant as leftmost digits.

The number of bytes containing rightmost significant digits of the converted first operand is specified by L₂. The length in bytes of the second operand is 1-18 for

CPXT, corresponding to a length code in L_2 of 0-17. The length in bytes of the second operand is 1-9 for CPDT, corresponding to a length code in L_2 of 0-8.

The M_3 field has the following format:



The bits of the M_3 field are defined as follows:

- **Sign Control (S):** Bit 0 of the M_3 field is the sign control (S). When S is zero, the second operand does not have a sign field. When S is one, the second operand has a sign field. That is, the rightmost four bit positions of the rightmost byte are a sign.
- **Reserved:** Bit 1 of the M_3 field is reserved and should be zero.
- **Plus-Sign-Code Control (P):** Bit 2 of the M_3 field is the plus-sign-code control (P). When P is zero, the plus sign is encoded as 1100 binary. When P is one, the plus sign is encoded as 1111 binary. When the S bit is zero, the P bit is ignored.
- **Force-Plus-Zero Control (F):** Bit 3 of the M_3 field is the force-plus-zero control (F). When F is zero and a signed value of negative zero results, no action is taken. When F is one and the absolute value of the result placed in the second operand location is zero, the result is set to indicate a positive zero with the sign code specified by the P bit. When the S bit is zero, the F bit is ignored.

Special Conditions

The operation is performed for any first operand, including an infinity, QNaN, or SNaN, without causing an IEEE exception.

If the first operand is an infinity or a NaN, a zero digit is appended as the leftmost digit (LMD) of the significand, thereby conceptually forming the effective significand to be converted. The specified number of rightmost effective significand digits and the sign bit are converted to the packed format, the result is

placed at the second-operand location, and execution completes with condition code 3.

For any type of first operand, including an infinity and a NaN, when one or more leftmost nonzero digits of the significand are lost because the second operand field is too short, the result is obtained by ignoring the overflow digits, condition code 3 is set, and, if the decimal-overflow mask bit is one, a program interruption for decimal overflow occurs. The operand lengths alone are not an indication of overflow; non-zero digits must have been lost during the operation.

A specification exception is recognized, and the operation is suppressed, when any of the following is true.

- For CPDT, the L_2 field is greater than 8.
- For CPXT, the R_1 field designates an invalid floating-point-register pair, or the L_2 field is greater than 17.

Resulting Condition Code:

- 0 Source is zero
- 1 Source is not special and is less than zero
- 2 Source is not special and is greater than zero
- 3 Source is special which is infinity, QNaN, SNaN, or a partial result

Program Exceptions:

- Access (Store operand 2)
- Data with DXC 3, DFP instruction
- Decimal overflow
- Operation (if the DFP packed-conversion facility is not installed)
- Specification
- Transaction constraint

Programming Notes:

1. If the number of significant digits of a significand exceeds the specified number, one or more leftmost digits of the significand are ignored except for the detection of a decimal overflow exception.
2. A completion with condition code 0 indicates that the absolute value of the first operand is zero.

CONVERT TO SIGNED PACKED

Mnemonic R_1, R_2, M_4 [RRF-d]

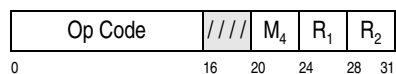

Mnemonic	Op Code	Operands
CSDTR	'B3E3'	Long DFP source, 64-bit signed packed-decimal result in GR
CSXTR	'B3EB'	Extended DFP source, 128-bit signed-packed-decimal result in GRs

Rightmost significant digits of the DFP second operand are converted to the signed-packed-decimal format, and the result is placed at the first-operand location.

For CSDTR, the rightmost 15 digits in the trailing significant and the sign bit of the second operand are converted to a 64-bit result (15 4-bit decimal digits and a 4-bit sign); for CSXTR, the rightmost 31 digits in the trailing significant and the sign bit of the second operand are converted to a 128-bit result (31 4-bit decimal digits and a 4-bit sign). The sign of the result is the sign of the second operand.

Bit 3 of the M_4 field is the plus sign-code selection bit. When the bit is zero, the plus sign is encoded as 1100; when the bit is one, the plus sign is encoded as 1111. Bits 0-2 are ignored.

The result is placed in the general register or general-register pair designated by R_1 .

This operation is performed for any second operand, including an infinity, QNaN, or SNaN, without causing an IEEE exception.

For CSXTR, the R_2 field must designate a valid floating-point-register pair; otherwise, a specification exception is recognized. Also, the R_1 field designates an even-odd pair of general registers and must designate an even-numbered register; otherwise, a specification exception is recognized.

Condition Code: The code remains unchanged.

IEEE Exceptions: None.

Program Exceptions:

- Data with DXC 3, DFP instruction
- Operation (if the DFP facility is not installed)
- Specification (CSXTR only)

- Transaction constraint

Programming Notes:

1. See also the programming note under CONVERT FROM FIXED.
2. The sign code 1100 is the preferred plus sign in IBM z Systems products, and 1111 is the preferred plus sign in IBM System i products.

CONVERT TO UNSIGNED PACKED

Mnemonic R_1, R_2 [RRE]

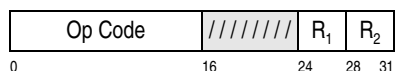

Mnemonic	Op Code	Operands
CUDTR	'B3E2'	Long DFP source, 64-bit unsigned-packed-decimal result in GR
CUXTR	'B3EA'	Extended DFP source, 128-bit unsigned-packed-decimal result in GRs

Rightmost significant digits of the DFP second operand are converted to the unsigned-packed-decimal format, and the result is placed at the first-operand location.

For CUDTR, 16 significant digits of the second operand are converted to a 64-bit result (16 4-bit decimal digits). If the second operand is an infinity or NaN, the 15 digits in the trailing significant are padded with a zero digit on the left to form a 16 significant digits.

For CUXTR, the rightmost 32 digits in the trailing significant of the second operand are converted to a 128-bit result (32 4-bit decimal digits).

The result is placed in the general register or general-register pair designated by R_1 .

This operation is performed for any second operand, including an infinity, QNaN, or SNaN, without causing an IEEE exception.

For CUXTR, the R_2 field must designate a valid floating-point-register pair; otherwise, a specification exception is recognized. Also, the R_1 field designates an even-odd pair of general registers and must designate an even-numbered register; otherwise, a specification exception is recognized.

Condition Code: The code remains unchanged.

IEEE Exceptions: None.

Program Exceptions:

- Data with DXC 3, DFP instruction
- Operation (if the DFP facility is not installed)
- Specification (CUXTR only)
- Transaction constraint

CONVERT TO ZONED

Mnemonic $R_1, D_2(L_2, B_2), M_3$ [RSL-b]

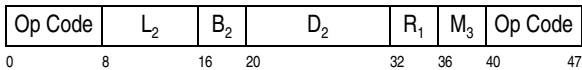

Mnemonic	Op Code	Operands
CZDT	'EDA8'	Long DFP source, zoned result
CZXT	'EDA9'	Extended DFP source, zoned result

The specified number of rightmost significant digits of the DFP first operand and the sign bit of the first operand are converted to the zoned format, and the result is placed at the second-operand location. The exponent in the combination field is ignored.

The number of rightmost significant digits of the first operand to be converted is specified by L₂. The length in bytes of the second operand is 1-34 for CZXT, corresponding to a length code in L₂ of 0-33, meaning 1-34 digits. The length in bytes of the second operand is 1-16 for CZDT, corresponding to a length code in L₂ of 0-15, meaning 1-16 digits.

The M₃ field has the following format:



The bits of the M₃ field are defined as follows:

- **Sign Control (S):** Bit 0 of the M₃ field is the sign control (S). When S is zero, the second operand does not have a sign field, and the zone field is set as determined by the Z bit. When S is one, the second operand has a sign field. That is, the leftmost four bit positions of the rightmost byte are a sign.
- **Zone Control (Z):** Bit 1 of the M₃ field is the zone control (Z). When Z is zero, each zone field of the second operand is stored as 1111 binary, except that the zone field of the rightmost byte is set to

the sign when the S bit is one. When Z is one, each zone field of the second operand is stored as 0011 binary, except that the zone field of the rightmost byte is set to the sign when the S bit is one.

- **Plus-Sign-Code Control (P):** Bit 2 of the M₃ field is the plus-sign-code control (P). When P is zero, the plus sign is encoded as 1100 binary. When P is one, the plus sign is encoded as 1111 binary.

When the S bit is zero, the P bit is ignored and assumed to be zero. The zone of the rightmost digit is set as determined by the Z bit.

- **Force-Plus-Zero Control (F):** Bit 3 of the M₃ field is the force-plus-zero control (F). When F is zero, no action is taken. When F is one and the absolute value of the result placed at the second-operand location is zero, the sign of the result is set to indicate a plus value with the sign code specified by the P bit.

When the S bit is zero, the F bit is ignored and assumed to be zero.

Special Conditions

The operation is performed for any first operand, including an infinity, QNaN, or SNaN, without causing an IEEE exception.

If the first operand is an infinity or a NaN, a zero digit is assumed to be the leftmost digit (LMD) of the significant, thereby conceptually forming the effective significant to be converted. The specified number of rightmost effective-significant digits and the sign bit are converted to the zoned format, the result is placed at the second-operand location, and execution completes with condition code 3.

For any type of first operand, including an infinity, and a NaN, when one or more leftmost nonzero digits of the significant are lost because the second-operand field is too short, the result is obtained by ignoring the overflow digits, condition code 3 is set, and, if the decimal-overflow mask bit is one, a program interruption for decimal overflow occurs. The operand lengths alone are not an indication of overflow; non-zero digits must have been lost during the operation.

A specification exception is recognized, and the operation is suppressed, when any of the following is true:

- For CZDT, the L_2 field is greater than or equal to 16, meaning 17 or more digits.
- For CZXT, the R_1 field designates an invalid floating-point-register pair, or the L_2 field is greater than or equal to 34, meaning 35 or more digits.

Resulting Condition Code:

- 0 Source is zero
- 1 Source is less than zero
- 2 Source is greater than zero
- 3 Infinity, QNaN, SNaN, Partial result

Program Exceptions:

- Access (Store operand 2)
- Data with DXC 3, DFP instruction
- Decimal overflow
- Operation (if the DFP zoned-conversion facility is not installed)
- Specification
- Transaction constraint

Programming Notes:

1. An ASCII zoned-decimal operand may be stored as signed when the S bit is one. This is entirely up to the program as ASCII representations are usually unsigned and positive with no concept of a rightmost zone being used as a sign.
2. If the number of significant digits of a significand exceeds the specified number, one or more left-most digits of the significand are ignored.
3. Depending on the model, for CZXT, when the L_2 field specifies 32 or 33 (meaning 33 or 34 digits), performance may be significantly worse than if shorter lengths are specified.
4. A completion with condition code 0 indicates that the absolute value of the first operand is zero.

DIVIDE

Mnemonic1 R_1, R_2, R_3 [RRF-a]

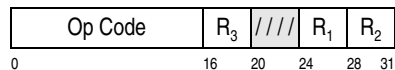

Mnemonic1	Op Code	Operands
DDTR	'B3D1'	Long DFP
DXTR	'B3D9'	Extended DFP

Mnemonic2 R_1, R_2, R_3, M_4 [RRF-a]

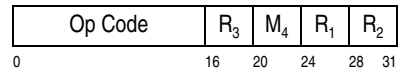

Mnemonic2	Op Code	Operands
DDTRA	'B3D1'	Long DFP
DXTRA	'B3D9'	Extended DFP

The second operand (the dividend) is divided by the third operand (the divisor), and the quotient is placed at the first-operand location. No remainder is preserved.

If divisor is nonzero and both the dividend and divisor are finite numbers, the second operand is divided by the third operand to form an intermediate quotient. The intermediate quotient, if nonzero, is rounded to the target format and the rounded value is then placed at the first-operand location.

When the floating-point extension facility is installed, the intermediate quotient is rounded by rounding as specified by the modifier in the M_4 field:

M₄ Effective Rounding Method

- 0 According to the current DFP rounding mode
- 1 Round to nearest with ties away from 0
- 2 According to the current DFP rounding mode
- 3 Round to prepare for shorter precision
- 4 Round to nearest with ties to even
- 5 Round toward 0
- 6 Round toward $+\infty$
- 7 Round toward $-\infty$
- 8 Round to nearest with ties to even
- 9 Round toward 0
- 10 Round toward $+\infty$
- 11 Round toward $-\infty$
- 12 Round to nearest with ties away from 0
- 13 Round to nearest with ties toward 0
- 14 Round away from 0
- 15 Round to prepare for shorter precision

When the modifier field is zero or two, rounding is controlled by the current DFP rounding mode specified in the FPC register. When the field is 1, or 3-15, rounding is performed as specified by the modifier, regardless of the current DFP rounding mode.

If the modifier field is 0 or 8-15, the quantum-exception control (XqC) is one and recognition of the quantum exception is suppressed; if the modifier field is 1-

7, the quantum-exception control is zero and recognition of the exception is not suppressed.

When the floating-point extension facility is not installed, no quantum exception is recognized. If bits 20-23 of the instruction contain a value of zero, the intermediate quotient is rounded according to the current DFP rounding mode; if bits 20-23 of the instruction contain a nonzero value, it is unpredictable which rounding method is performed.

When the dividend is a finite number and the divisor is infinity, then a value of zero with zero significand and zero biased exponent is produced.

The sign of the quotient, if the quotient is numeric, is the exclusive or of the operand signs. This includes the sign of a zero or infinite quotient.

When the delivered value is exact, the preferred quantum is the quantum of the dividend divided by the quantum of the divisor; when the delivered value is inexact, the preferred quantum is the smallest quantum.

The result placed at the first-operand location is canonical.

If the divisor is zero but the dividend is nonzero and finite, an IEEE-division-by-zero exception is recog-

nized. If the dividend and divisor are both zero, or if both are infinite, regardless of sign, an IEEE-invalid-operation exception is recognized.

See Figure 20-20 on page 20-38 for a detailed description of the results of this instruction.

For DXTR, the R fields must designate valid floating-point-register pairs; otherwise, a specification exception is recognized.

Condition Code: The code remains unchanged.

IEEE Exceptions:

- Invalid operation
- Division by zero
- Overflow
- Underflow
- Inexact
- Quantum (if the floating-point extension facility is installed)

Program Exceptions:

- Data with DXC 3, DFP instruction
- Data with DXC for IEEE exception
- Operation (if the DFP facility is not installed)
- Specification (DXTR and DXTRA only)
- Transaction constraint

Dividend (b) is	Results for DIVIDE (b ÷ c) when divisor (c) is							
	-∞	-Fn	-0	+0	+Fn	+∞	QNaN	SNaN
-∞	Xi: T(dNaN)	T(+∞)	T(+∞)	T(-∞)	T(-∞)	Xi: T(dNaN)	T(c)	Xi: T(c*)
-Fn	T(+zt)	R(b÷c)	Xz: T(+∞)	Xz: T(-∞)	R(b÷c)	T(-zt)	T(c)	Xi: T(c*)
-0	T(+zt)	T(+0)	Xi: T(dNaN)	Xi: T(dNaN)	T(-0)	T(-zt)	T(c)	Xi: T(c*)
+0	T(-zt)	T(-0)	Xi: T(dNaN)	Xi: T(dNaN)	T(+0)	T(+zt)	T(c)	Xi: T(c*)
+Fn	T(-zt)	R(b÷c)	Xz: T(-∞)	Xz: T(+∞)	R(b÷c)	T(+zt)	T(c)	Xi: T(c*)
+∞	Xi: T(dNaN)	T(-∞)	T(-∞)	T(+∞)	T(+∞)	Xi: T(dNaN)	T(c)	Xi: T(c*)
QNaN	T(b)	T(b)	T(b)	T(b)	T(b)	T(b)	T(b)	Xi: T(c*)
SNaN	Xi: T(b*)	Xi: T(b*)	Xi: T(b*)	Xi: T(b*)	Xi: T(b*)	Xi: T(b*)	Xi: T(b*)	Xi: T(b*)

Explanation:

* The SNaN is converted to the corresponding QNaN before it is placed at the target operand location.

dNaN Default NaN.

Fn Nonzero finite number (includes both subnormal and normal numbers).

R(x) Rounding and range action is performed on the value x. See Figure 20-5 on page 20-11. The result is canonical.

T(x) The canonical result x is placed at the target operand location.

Xi: IEEE invalid-operation exception. The results shown are produced only when FPC 0.0 is zero.

Xz: IEEE division-by-zero exception. The results shown are produced only when FPC 0.1 is zero.

zt A value of zero with zero significand and zero biased exponent.

Figure 20-20. Results: DIVIDE

Programming Note: For DIVIDE, when the delivered value is inexact, the preferred quantum is the smallest quantum which is not always the same quantum as that closest to the quantum of the dividend divided by the quantum of the divisor.

For example, with the short data format, when 5000001×10^{-7} is divided by 400×10^0 , the smallest quantum for the delivered value is 1×10^{-9} . However, the quantum that is closest to the quantum of the dividend divided by the quantum of the divisor is 1×10^{-7} .

EXTRACT BIASED EXPONENT

Mnemonic	R_1, R_2	[RRE]
Op Code	//////	R_1 R_2
0	16	24 28 31

Mnemonic	Op Code	Operands
EEDTR	'B3E5'	Long DFP source, 64-bit binary-integer result
EEXTR	'B3ED'	Extended DFP source, 64-bit binary-integer result

The biased exponent of the DFP second operand is placed at the first-operand location.

When the second operand is a finite number, the biased exponent of the second operand is placed at the first-operand location. When the second operand is an infinity, QNaN, or SNaN, a special value is placed at the first-operand location.

The result is a 64-bit signed binary integer that is placed in the general register designated by R_1 .

This operation is performed for any second operand, including an infinity, QNaN, or SNaN, without causing an IEEE exception.

See Figure 20-21 for a detailed description of the results of this instruction.

Second-operand data	First-operand value
Finite number	e
Infinity	-1
QNaN	-2
SNaN	-3
Explanation:	
e	Biased exponent

Figure 20-21. Results: EXTRACT BIASED EXPONENT

For EEXTR, the R_2 field must designate a valid floating-point-register pair; otherwise, a specification exception is recognized.

Condition Code: The code remains unchanged.

IEEE Exceptions: None.

Program Exceptions:

- Data with DXC 3, DFP instruction
- Operation (if the DFP facility is not installed)
- Specification (EEXTR only)
- Transaction constraint

EXTRACT SIGNIFICANCE

Mnemonic	R_1, R_2	[RRE]
Op Code	//////	R_1 R_2
0	16	24 28 31

Mnemonic	Op Code	Operands
ESDTR	'B3E7'	Long DFP source, 64-bit binary-integer result
ESXTR	'B3EF'	Extended DFP source, 64-bit binary-integer result

The number of DFP significant digits of the DFP second operand is placed at the first-operand location.

When the second operand is a finite number, the result is set to the number of DFP significant digits of the second operand. When the second operand is an infinity, QNaN, or SNaN, the result is set to -1, -2, or -3, respectively.

The result is a 64-bit signed binary integer that is placed in the general register designated by R_1 .

See Figure 20-22 for a detailed description of the results of this instruction.

Second-operand data	First-operand value
Nonzero finite number	NSD
Zero	0
Infinity	-1
QNaN	-2
SNaN	-3
Explanation:	
NSD	The number of DFP significant digits of the second operand.

Figure 20-22. Results: EXTRACT SIGNIFICANCE

This operation is performed for any second operand, including an infinity, QNaN, or SNaN, without causing an IEEE exception.

For ESXTR, the R_2 field must designate a valid floating-point-register pair; otherwise, a specification exception is recognized.

Condition Code: The code remains unchanged.

IEEE Exceptions: None.

Program Exceptions:

- Data with DXC 3, DFP instruction
- Operation (if the DFP facility is not installed)
- Specification (ESXTR only)
- Transaction constraint

INSERT BIASED EXPONENT

Mnemonic R_1, R_3, R_2 [RRF-b]

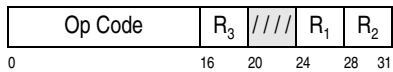

Mnemonic	Op Code	Operands
IEDTR	'B3F6'	Long DFP
IEXTR	'B3FE'	Extended DFP

A DFP operand is produced by combining the requested biased exponent with the sign bit and the significand of the DFP third operand, and the result is placed in the first-operand location.

The value of the requested biased exponent is a 64-bit signed binary integer and is located in the general register designated by R_2 .

When the value of the requested biased exponent is in the range between zero and the maximum biased exponent, inclusively, for the target format, the result is a finite number. The biased exponent of the result is set to the value of the requested biased exponent; the significand of the result is set to the significand of the third operand. If the third operand is an infinity or NaN, the significand of the third operand contains the digits in the trailing significand of the third operand padded with a zero digit on the left.

When the value of the requested biased exponent is -1, the result is an infinity. The reserved field of the result is set to zero; the trailing significand of the

result is set to the trailing significand of the third operand.

When the value of the requested biased exponent is equal to -2, less than -3, or greater than the maximum biased exponent for the target format, the result is a QNaN; when the value of the requested biased exponent is -3, the result is an SNaN. When a NaN is produced as the result, the reserved field of the result is set to zero, and the trailing significand of the result is set to the trailing significand of the third operand.

The sign of the result is the same as the sign of the third operand.

The preferred quantum is the quantum that corresponds to the requested biased exponent. If the delivered value is a finite number, it is always represented with the preferred quantum.

The result placed at the first-operand location is canonical, except for infinity. When the result is an infinity, if all digits in the trailing significand of the third operand are zeros, then the result is a canonical infinity; otherwise, the result is an infinity that has the reserved field set to zero, canonical declets in the encoded trailing-significand field, and some nonzero digits in the trailing significand.

See Figure 20-23 for a detailed description of the results of this instruction.

This operation is performed for any requested biased exponent and any third operand without causing an IEEE exception.

For IEXTR, the R_1 and R_3 fields must designate valid floating-point-register pairs; otherwise, a specification exception is recognized.

Condition Code: The code remains unchanged.

IEEE Exceptions: None.

Program Exceptions:

- Data with DXC 3, DFP instruction
- Operation (if the DFP facility is not installed)
- Specification (IEXTR only)
- Transaction constraint

Programming Note: Infinities produced as DFP results have the reserved field set to zero and have canonical declets in the encoded trailing-significand

Value (b) in second operand	Results ¹ for INSERT BIASED EXPONENT when third operand (c) is			
	F	∞	QNaN	SNaN
$b > \text{MBE}$	T(QNaN)	T(QNaN)	T(QNaN)	T(QNaN)
$\text{MBE} \geq b \geq 0$	T(F)	T(F ²)	T(F ²)	T(F ²)
$b = -1$	N(∞)	N(∞)	N(∞)	N(∞)
$b = -2$	T(QNaN)	T(QNaN)	T(QNaN)	T(QNaN)
$b = -3$	T(SNaN)	T(SNaN)	T(SNaN)	T(SNaN)
$b \leq -4$	T(QNaN)	T(QNaN)	T(QNaN)	T(QNaN)

Explanation:

¹ The sign of the result is the same as the sign of the third operand.

² The leftmost digit of the significand is zero.

F All finite numbers, including zeros.

MBE Maximum biased exponent for the target format.

N(∞) The result is a canonical infinity if all digits in the trailing significand of the third operand are zeros; otherwise, the resultant infinity has the reserved field set to zero, canonical declets in the encoded trailing-significand field, and some nonzero digits in the trailing significand.

T(x) The canonical result x is placed at the target operand location.

Figure 20-23. Results: INSERT BIASED EXPONENT

field. An infinity is not considered canonical unless all digits in the trailing significand are zeros.

LOAD AND TEST

Mnemonic R_1, R_2 [RRE]

Op Code	//////	R_1	R_2
0	16	24	28 31

Mnemonic	Op Code	Operands
LTDTR	'B3D6'	Long DFP
LTXTR	'B3DE'	Extended DFP

The second operand is placed at the first-operand location, and its sign and magnitude are tested to determine the setting of the condition code. The con-

dition code is set the same as for a comparison of the second operand with zero.

The second operand is canonicalized before it is placed at the first-operand location. If the second operand is an SNaN, an IEEE-invalid-operation exception is recognized; if there is no interruption, the result is the corresponding QNaN.

The preferred quantum is the quantum of the second operand. If the delivered value is a finite number, it is always represented with the preferred quantum.

The result placed at the first-operand location is canonical.

See Figure 20-24 for a detailed description of the results of this instruction.

For LTXTR, the R fields must designate valid floating-point-register pairs; otherwise, a specification exception is recognized.

Resulting Condition Code:

- 0 Result is zero
- 1 Result is less than zero
- 2 Result is greater than zero
- 3 Result is a NaN

IEEE Exceptions:

- Invalid operation

Program Exceptions:

- Data with DXC 3, DFP instruction
- Data with DXC for IEEE exception
- Operation (if the DFP facility is not installed)
- Specification (LTXTR only)
- Transaction constraint

Instruction	Results for some instructions with a single operand (b) when second operand (b) is							
	$-\infty$	$-Fn$	-0	$+0$	$+Fn$	$+\infty$	QNaN	SNaN
CONVERT FROM FIXED	—	Rf(b)	—	T(+0)	Rf(b)	—	—	—
CONVERT FROM LOGICAL	—	—	—	T(+0)	Rf(b)	—	—	—
LOAD AND TEST	T($-\infty$)	T(b)	T(-0)	T(+0)	T(b)	T(+ ∞)	T(b)	Xi: T(b [*])
LOAD LENGTHENED (XiC = 0)	T($-\infty$)	T(b) ¹	T(-0)	T(+0)	T(b) ¹	T(+ ∞)	T(b) ¹	Xi: T(b [*]) ¹
LOAD LENGTHENED (XiC = 1)	N($-\infty$) ¹	T(b) ¹	T(-0)	T(+0)	T(b) ¹	N(+ ∞) ¹	T(b) ¹	T(b) ¹
LOAD ROUNDED (XiC = 0)	T($-\infty$)	R(b)	T(-0)	T(+0)	R(b)	T(+ ∞)	T(b) ²	Xi: T(b [*]) ²
LOAD ROUNDED (XiC = 1)	N($-\infty$) ²	R(b)	T(-0)	T(+0)	R(b)	N(+ ∞) ²	T(b) ²	T(b) ²

Explanation:

— The results do not depend on this condition.

* The SNaN is converted to the corresponding QNaN before it is placed at the target operand location.

¹ The operand is extended to the longer format by appending zeros on the left before it is placed at the target operand location.

² The operand is shortened to the target format by truncating the leftmost digits.

Fn Nonzero finite number (includes both subnormal and normal).

N($\pm\infty$) The resultant infinity has the reserved field set to zero and has canonical declets in the encoded trailing-significand field. The result is not considered canonical unless all digits in the trailing significand are zeros.

R(v) Rounding and range action is performed on the value v. See Figure 20-5 on page 20-11. The result is canonical.

Rf(b) The value b is converted to the exact floating-point number v, and then action R(v) is performed. The result is canonical.

T(x) The canonical result x is placed at the target operand location.

Xi: IEEE invalid-operation exception. The results shown are produced only when FPC 0.0 is zero.

XiC IEEE-invalid-operation-exception control, bit 0 of the M₄ field.

Figure 20-24. Results: Some Single-Operand Instructions

LOAD FP INTEGER

Mnemonic R₁,M₃,R₂,M₄ [RRF-e]

Op Code	M ₃	M ₄	R ₁	R ₂
0	16	20	24	28 31

Mnemonic	Op Code	Operands
FIDTR	'B3D7'	Long DFP
FIXTR	'B3DF'	Extended DFP

The second operand is rounded to an integer value in the same floating-point format, and the result is placed at the first-operand location.

The second operand, if a finite number, is rounded to an integer value as specified by the modifier in the M₃ field:

M ₃	Effective Rounding Method
0	According to the current DFP rounding mode
1	Round to nearest with ties away from 0
2	According to the current DFP rounding mode
3	Round to prepare for shorter precision
4	Round to nearest with ties to even
5	Round toward 0
6	Round toward + ∞

M ₃	Effective Rounding Method
7	Round toward $-\infty$
8	Round to nearest with ties to even
9	Round toward 0
10	Round toward + ∞
11	Round toward $-\infty$
12	Round to nearest with ties away from 0
13	Round to nearest with ties toward 0
14	Round away from 0
15	Round to prepare for shorter precision

When the modifier field is zero, rounding is controlled by the current DFP rounding mode specified in the FPC register. When the field is 8-15, rounding is performed as specified by the modifier, regardless of the current DFP rounding mode.

When the floating-point extension facility is installed and if the modifier field is 2, rounding is controlled by the current DFP rounding mode specified in the FPC register; if the field is 1, or 3-7, rounding is performed as specified by the modifier, regardless of the current DFP rounding mode. If the modifier field is 0 or 8-15, the quantum-exception control (XqC) is one and recognition of the quantum exception is suppressed; if the modifier field is 1-7, the quantum-exception con-

control is zero and recognition of the exception is not suppressed.

When the floating-point extension facility is not installed, no quantum exception is recognized. If the M_3 modifier field is 1-7, it is unpredictable which rounding method is performed.

In the absence of an interruption, if the second operand is an infinity, the result is the canonical infinity; if the second operand is a QNaN, the result is the canonicalized source QNaN that has the same sign and payload as the source; if the second operand is an SNaN, the result is the corresponding QNaN.

The sign of the result is the sign of the second operand, even when the result is zero.

Bit 1 of the M_4 field is the IEEE-inexact-exception control (XxC). Bits 0, 2, and 3 are ignored.

When the result differs in value from the second operand, if XxC is zero, an IEEE-inexact exception is recognized. If XxC one, then no IEEE-inexact exception is recognized.

This operation performs a functionally-constrained rounding. Neither overflow nor underflow condition can occur.

When the delivered value is exact, the preferred quantum is the larger value of one and the quantum of the second operand; when the delivered value is inexact, the preferred quantum is one. If the delivered

value is a finite number, it is always represented with the preferred quantum.

The result placed at the first-operand location is canonical.

See Figure 20-25 on page 20-43 for a detailed description of the results of FIDTR and FIXTR.

When the floating-point extension facility is installed, if the quantum of the delivered finite number is not equal to the quantum of the second operand and if XqC is zero, then a quantum exception is recognized.

For FIXTR, the R fields must designate valid floating-point-register fields; otherwise, a specification exception is recognized.

Condition Code: The code remains unchanged.

IEEE Exceptions:

- Invalid operation
- Inexact
- Quantum (if the floating-point extension facility is installed)

Program Exceptions:

- Data with DXC 3, DFP instruction
- Data with DXC for IEEE exception
- Operation (if the DFP facility is not installed)
- Specification (FIXTR only)
- Transaction constraint

Second Operand (b)	Is n Inexact (n ≠ b)	IEEE Inexact Exception Control (XxC)	Inexact Mask (FPC 0.4)	Is n Incremented (n > b)	Is Q < 1	Quantum-Exception Control (XqC) ²	Quantum Exception Mask (FPC 0.5)	Inv.-Op. Mask (FPC 0.0)	Results
-∞	No ¹	—	—	—	—	—	—	—	T(-∞)
-Fn	No	—	—	—	No	—	—	—	T(n)
-Fn	No	—	—	—	Yes	1	—	—	T(n)
-Fn	No	—	—	—	Yes	0	0	—	T(n), SFq←1
-Fn	No	—	—	—	Yes	0	1	—	T(n), PIDq(04)
-Fn	Yes	0	0	—	Yes	1	—	—	T(n), SFx←1
-Fn	Yes	0	0	—	Yes	0	0	—	T(n), SFx←1, SFq←1
-Fn	Yes	0	0	—	Yes	0	1	—	T(n), SFx←1, PIDq(04)
-Fn	Yes	0	1	No	—	—	—	—	T(n), PIDx(08)
-Fn	Yes	0	1	Yes	—	—	—	—	T(n), PIDy(0C)
-Fn	Yes	1	—	—	Yes	1	—	—	T(n)
-Fn	Yes	1	—	—	Yes	0	0	—	T(n), SFq←1
-Fn	Yes	1	—	—	Yes	0	1	—	T(n), PIDq(04)

Figure 20-25. Results: LOAD FP INTEGER

Second Operand (b)	Is n Inexact (n ≠ b)	IEEE Inexact Exception Control (XxC)	Inexact Mask (FPC 0.4)	Is n Incremented (nl > bl)	Is Q < 1	Quantum-Exception Control (XqC) ²	Quantum Exception Mask (FPC 0.5)	Inv.-Op. Mask (FPC 0.0)	Results
-0	No ¹	—	—	—	No	—	—	—	T(-0)
-0	No ¹	—	—	—	Yes	1	—	—	T(-0)
-0	No ¹	—	—	—	Yes	0	0	—	T(-0), SFq←-1
-0	No ¹	—	—	—	Yes	0	1	—	T(-0), PIDq(04)
+0	No ¹	—	—	—	No	—	—	—	T(+0)
+0	No ¹	—	—	—	Yes	1	—	—	T(+0)
+0	No ¹	—	—	—	Yes	0	0	—	T(+0), SFq←-1
+0	No ¹	—	—	—	Yes	0	1	—	T(+0), PIDq(04)
+Fn	No	—	—	—	No	—	—	—	T(n)
+Fn	No	—	—	—	Yes	1	—	—	T(n)
+Fn	No	—	—	—	Yes	0	0	—	T(n), SFq←-1
+Fn	No	—	—	—	Yes	0	1	—	T(n), PIDq(04)
+Fn	Yes	0	0	—	Yes	1	—	—	T(n), SFx←-1
+Fn	Yes	0	0	—	Yes	0	0	—	T(n), SFx←-1, SFq←-1
+Fn	Yes	0	0	—	Yes	0	1	—	T(n), SFx←-1, PIDq(04)
+Fn	Yes	0	1	No	—	—	—	—	T(n), PIDx(08)
+Fn	Yes	0	1	Yes	—	—	—	—	T(n), PIDy(0C)
+Fn	Yes	1	—	—	Yes	1	—	—	T(n)
+Fn	Yes	1	—	—	Yes	0	0	—	T(n), SFq←-1
+Fn	Yes	1	—	—	Yes	0	1	—	T(n), PIDq(04)
+∞	No ¹	—	—	—	—	—	—	—	T(+∞)
QNaN	No ¹	—	—	—	—	—	—	—	T(b)
SNaN	No ¹	—	—	—	—	—	—	0	T(b*), SFi←-1
SNaN	No ¹	—	—	—	—	—	—	1	PIDi(80)

Explanation:

— The results do not depend on this condition or mask bit.

* The SNaN is converted to the corresponding QNaN before it is placed at the target operand location.

¹ This condition is true by virtue of the state of some condition to the left of this column.

² XqC is defined only if the floating-point extension facility is installed.

n The value derived when the source value, b, is rounded to an integer using the effective rounding method.

Fn Finite nonzero number (includes both subnormal and normal).

PIDc(h) Program interruption for data exception, condition c, with DXC of h in hex. See Figure 20-8 on page 20-16.

PIDq(04) Program interruption for data exception, quantum-exception condition q, with DXC of 04 in hex. It is defined only if the floating-point extension facility is installed.

Q Quantum of the second operand.

SFi IEEE invalid-operation flag, FPC 1.0.

SFq Quantum exception flag, FPC 1.5. The flag is defined only if the floating-point extension facility is installed.

SFx IEEE inexact flag, FPC 1.4.

T(x) The canonical result x is placed at the target operand location. The result, when it is a finite number, is always represented with the preferred quantum.

Figure 20-25. Results: LOAD FP INTEGER

Programming Notes:

1. Unassigned bits in the M₄ field are reserved for future extensions and should be set to zeros; otherwise, the program may not operate compatibly in the future.
2. If the DFP source operand is numeric with a quantum of at least one so that it is already an integer, the result value and quantum remain the same. Other numeric DFP source operands that are integers with a quantum less than one are

converted to the same value with a quantum of one.

LOAD LENGTHENED

Mnemonic R_1, R_2, M_4 [RRF-d]

Op Code	////	M_4	R_1	R_2
0	16	24	28	31

Mnemonic	Op Code	Operands
LDETR	'B3D4'	Short DFP source, long DFP result
LXDTR	'B3DC'	Long DFP source, extended DFP result

The second operand is converted to a longer format, and the result is placed at the first-operand location.

Bit 0 of the M_4 field controls the handling of SNaN and infinity, and is called the IEEE-invalid-operation-exception control (XiC). Bits 1-3 are ignored. When XiC is zero, recognition of IEEE-invalid-operation exception is not suppressed; when XiC is one, recognition of the exception is suppressed.

When the second operand is a finite number, the value of the second operand is placed in the target format.

When the second operand is an infinity, if XiC is zero, the result is the canonical infinity for the target format; if XiC is one, the result is the source infinity with the reserved field of the target format being set to zero, the trailing significand being extended by appending zeros on the left, and all declets in the encoded trailing-significand field being canonicalized.

When the second operand is a QNaN, the result is the canonicalized source QNaN with the payload extended by appending zeros on the left.

When the second operand is an SNaN, if XiC is zero, an invalid-operation exception is recognized and the nontrap result is the corresponding QNaN with the payload extended by appending zeros on the left; if XiC is one, no invalid-operation exception is recognized, and the result is the canonicalized source SNaN with the payload extended by appending zeros on the left.

The sign of the result is the same as the sign of the second operand.

The delivered value is always exact and the preferred quantum is the quantum of the second operand.

When XiC is zero, the result placed at the first-operand location is canonical. When XiC is one, the result is canonical, except for infinity. See the detailed description above for producing an infinity when XiC is one.

See Figure 20-24 on page 20-42 for a detailed description of the results of this instruction.

For LXDTR, the R_1 field must designate a valid floating-point-register pair; otherwise, a specification exception is recognized.

Condition Code: The code remains unchanged.

IEEE Exceptions:

- Invalid operation

Program Exceptions:

- Data with DXC 3, DFP instruction
- Data with DXC for IEEE exception
- Operation (if the DFP facility is not installed)
- Specification (LXDTR only)
- Transaction constraint

Programming Notes:

1. Unassigned bits in the M_4 field are reserved for future extensions and should be set to zeros; otherwise, the program may not operate compatibly in the future.
2. The equivalent operations of LOAD LENGTHENED (short to long) in the Power architecture do not recognize the invalid-operation exception for both BFP and DFP. The equivalent operations of LOAD LENGTHENED in z/Architecture do recognize the exception for BFP. The IEEE-invalid-operation-exception control (XiC) is provided for compatibility.
3. Infinities produced as DFP results have the reserved field set to zero and have canonical declets in the encoded trailing-significand field. An infinity is not considered canonical unless all digits in the trailing significand are zeros.

LOAD ROUNDED

Mnemonic R_1, M_3, R_2, M_4 [RRF-e]

Op Code	M_3	M_4	R_1	R_2
0	16	20	24	28 31

Mnemonic	Op Code	Operands
LEDTR	'B3D5'	Long DFP source, short DFP target, short or long DFP result
LDXTR	'B3DD'	Extended DFP source, long DFP target, long or extended DFP result

The second operand, in the format of the source, is rounded to the precision of the target, and the result is placed at the first-operand location.

The second operand, if it is a finite number, is rounded as specified by the modifier in the M_3 field:

M_3 Effective Rounding Method

0	According to the current DFP rounding mode
1	Round to nearest with ties away from 0
2	According to the current DFP rounding mode
3	Round to prepare for shorter precision
4	Round to nearest with ties to even
5	Round toward 0
6	Round toward $+\infty$
7	Round toward $-\infty$
8	Round to nearest with ties to even
9	Round toward 0
10	Round toward $+\infty$
11	Round toward $-\infty$
12	Round to nearest with ties away from 0
13	Round to nearest with ties toward 0
14	Round away from 0
15	Round to prepare for shorter precision

When the modifier field is zero, rounding is controlled by the current DFP rounding mode specified in the FPC register. When the field is 8-15, rounding is performed as specified by the modifier, regardless of the current DFP rounding mode.

When the floating-point extension facility is installed and if the modifier field is 2, rounding is controlled by the current DFP rounding mode specified in the FPC register; if the field is 1, or 3-7, rounding is performed as specified by the modifier, regardless of the current DFP rounding mode. If the modifier field is 0 or 8-15, the quantum-exception control (XqC) is one and recognition of the quantum exception is suppressed; if the modifier field is 1-7, the quantum-exception con-

trol is zero and recognition of the exception is not suppressed.

When the floating-point extension facility is not installed, no quantum exception is recognized. If the M_3 modifier field is 1-7, it is unpredictable which rounding method is performed.

Bit 0 of the M_4 field controls the handling of SNaN and infinity, and is called the IEEE-invalid-operation-exception control (XiC). When XiC is zero, recognition of IEEE-invalid-operation exception is not suppressed; when XiC is one, recognition of IEEE-invalid-operation exception is suppressed.

When the floating-point extension facility is installed, bit 1 of the M_4 field is the IEEE-inexact-exception control (XxC), and bits 2-3 are ignored. If XxC is zero, recognition of IEEE-inexact exception is not suppressed; if XxC is one, recognition of the exception is suppressed.

When the floating-point extension facility is not installed, and if bits 21-23 of the instruction are zeros, then recognition of IEEE-inexact exception is not suppressed; if bits 21-23 of the instruction contain a nonzero value, it is unpredictable whether recognition of IEEE-inexact exception is suppressed.

In the absence of a trap overflow or trap underflow, the result is in the format and length of the target. However, when a trap overflow or trap underflow occurs, the operation is completed by producing a scaled result in the same format and length as the source but rounded to the precision of the target. In this case, the result is selected from a subset of the cohort for the delivered value in the source format. This subset of the cohort consists of cohort members that have the number of DFP significand digits equal to or less than the precision of the target format. For LEDTR, the result has at most seven DFP significant digits; for LDXTR, the result has at most 16 DFP significant digits.

When the second operand is an infinity, if XiC is zero, the result is the canonical infinity for the target format; if XiC is one, the result is the source infinity with the reserved field of the target format being set to zero, the trailing significand being shortened by removing leftmost digits, and declets corresponding to the shortened trailing significand being canonicalized.

When the second operand is a QNaN, the result is the canonicalized source QNaN with the payload shortened by removing leftmost digits.

When the second operand is an SNaN, if XiC is zero, an invalid-operation exception is recognized and the nontrap result is the corresponding QNaN with the payload shortened by removing leftmost digits; if XiC is one, no invalid-operation exception is recognized, and the result is the canonicalized source SNaN with the payload shortened by removing leftmost digits.

The sign of the result is the same as the sign of the second operand.

When the delivered value is exact, the preferred quantum is the quantum of the second operand; when the delivered value is inexact, the preferred quantum is the smallest quantum.

When XiC is zero, the result placed at the first-operand location is canonical. When XiC is one, the result is canonical, except for infinity. See the detailed description above for producing an infinity when XiC is one.

See Figure 20-24 on page 20-42 for a detailed description of the results of this instruction.

For LDXTR, the R fields must designate valid floating-point-register pairs; otherwise, a specification exception is recognized.

Condition Code: The code remains unchanged.

IEEE Exceptions:

- Invalid operation
- Overflow
- Underflow
- Inexact
- Quantum (if the floating-point extension facility is installed)

Program Exceptions:

- Data with DXC 3, DFP instruction
- Data with DXC for IEEE exception
- Operation (if the DFP facility is not installed)
- Specification (LDXTR only)
- Transaction constraint

Programming Notes:

1. LOAD ROUNDED and the round-to-prepare-for-shorter-precision rounding method can be used to simulate a DFP operation with the precision of a shorter format and with the effect of single rounding. The round-to-prepare-for-shorter-precision rounding method is used by the operation, and the desirable rounding method is used by the subsequent LOAD ROUNDED instruction.
2. Unassigned bits in the M_4 field are reserved for future extensions and should be set to zeros; otherwise, the program may not operate compatibly in the future.
3. The equivalent operation of LOAD ROUNDED (long to short) in the Power architecture does not recognize the invalid-operation exception. IEEE-invalid-operation-exception control (XiC) is provided for compatibility.
4. Infinities produced as DFP results have the reserved field set to zero and have canonical declets in the encoded trailing-significand field. An infinity is not considered canonical unless all digits in the trailing significand are zeros.
5. In case of a trap overflow or a trap underflow, the number of DFP significand digits of the delivered result is limited to the precision of the target format. For example, when the source operand is 75958100×10^{369} and is represented with the quantum of 10^{369} , execution of LEDTR using the round-away-from-0 rounding method produces a value of 7595810×10^{178} with the delivered quantum of 10^{178} as the trap overflow result.

MULTIPLY

Mnemonic1 R_1, R_2, R_3 [RRF-a]

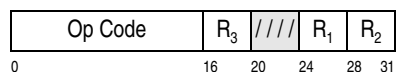

Mnemonic2	Op Code	Operands
MDTR	'B3D0'	Long DFP
MXTR	'B3D8'	Extended DFP

Mnemonic2 R_1, R_2, R_3, M_4 [RRF-a]

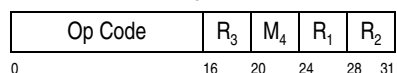

Mnemonic	Op Code	Operands
MDTRA	'B3D0'	Long DFP
MXTRA	'B3D8'	Extended DFP

The product of the second operand (the multiplicand) and the third operand (the multiplier) is placed at the first-operand location.

If both source operands are finite numbers, they are multiplied to form an intermediate product. The intermediate product is rounded to the target format and the rounded value is then placed at the first-operand location.

When the floating-point extension facility is installed, the intermediate product is rounded by rounding as specified by the modifier in the M_4 field:

M_4	Effective Rounding Method
0	According to the current DFP rounding mode
1	Round to nearest with ties away from 0
2	According to the current DFP rounding mode
3	Round to prepare for shorter precision
4	Round to nearest with ties to even
5	Round toward 0
6	Round toward $+\infty$
7	Round toward $-\infty$
8	Round to nearest with ties to even
9	Round toward 0
10	Round toward $+\infty$
11	Round toward $-\infty$
12	Round to nearest with ties away from 0
13	Round to nearest with ties toward 0
14	Round away from 0
15	Round to prepare for shorter precision

When the modifier field is zero or two, rounding is controlled by the current DFP rounding mode specified in the FPC register. When the field is 1, or 3-15, rounding is performed as specified by the modifier, regardless of the current DFP rounding mode.

If the modifier field is 0 or 8-15, the quantum-exception control (XqC) is one and recognition of the quantum exception is suppressed; if the modifier field is 1-7, the quantum-exception control is zero and recognition of the exception is not suppressed.

When the floating-point extension facility is not installed, no quantum exception is recognized. If bits 20-23 of the instruction contain a value of zero, the intermediate product is rounded according to the current DFP rounding mode; if bits 20-23 of the instruc-

tion contain a nonzero value, it is unpredictable which rounding method is performed.

The sign of the product, if the product is numeric, is the exclusive or of the operand signs. This includes the sign of a zero or infinite product.

When the delivered value is exact, the preferred quantum is the product of the quanta of the two source operands; when the delivered value is inexact, the preferred quantum is the smallest quantum.

The result placed at the first-operand location is canonical.

See Figure 20-26 on page 20-49 for a detailed description of the results of this instruction.

If one source operand is a zero and the other an infinity, an IEEE-invalid-operation exception is recognized

For MXTR and MXTRA, the R fields must designate valid floating-point-register pairs; otherwise, a specification exception is recognized.

Condition Code: The code remains unchanged.

IEEE Exceptions:

- Invalid operation
- Overflow
- Underflow
- Inexact
- Quantum (if the floating-point extension facility is installed)

Program Exceptions:

- Data with DXC 3, DFP instruction
- Data with DXC for IEEE exception
- Operation (if the DFP facility is not installed)
- Specification (MXTR and MXTRA only)
- Transaction constraint

Programming Notes:

1. Interchanging the two operands in a DFP multiplication does not affect the value of the product when the result is numeric. This is not true, however, when both operands are QNaNs. In which case the result is the canonical QNaN derived from the second operand; or when both operands are SNaNs and the IEEE invalid-operation

Multiplicand (b) is	Results for MULTIPLY (b • c) when multiplier (c) is							
	-∞	-Fn	-0	+0	+Fn	+∞	QNaN	SNaN
-∞	T(+∞)	T(+∞)	Xi: T(dNaN)	Xi: T(dNaN)	T(-∞)	T(-∞)	T(c)	Xi: T(c*)
-Fn	T(+∞)	R(b • c)	T(+0)	T(-0)	R(b • c)	T(-∞)	T(c)	Xi: T(c*)
-0	Xi: T(dNaN)	T(+0)	T(+0)	T(-0)	T(-0)	Xi: T(dNaN)	T(c)	Xi: T(c*)
+0	Xi: T(dNaN)	T(-0)	T(-0)	T(+0)	T(+0)	Xi: T(dNaN)	T(c)	Xi: T(c*)
+Fn	T(-∞)	R(b • c)	T(-0)	T(+0)	R(b • c)	T(+∞)	T(c)	Xi: T(c*)
+∞	T(-∞)	T(-∞)	Xi: T(dNaN)	Xi: T(dNaN)	T(+∞)	T(+∞)	T(c)	Xi: T(c*)
QNaN	T(b)	T(b)	T(b)	T(b)	T(b)	T(b)	T(b)	Xi: T(c*)
SNaN	Xi: T(b*)	Xi: T(b*)	Xi: T(b*)	Xi: T(b*)	Xi: T(b*)	Xi: T(b*)	Xi: T(b*)	Xi: T(b*)

Explanation:

* The SNaN is converted to the corresponding QNaN before it is placed at the target operand location.
dNaN Default NaN.
Fn Nonzero finite number (includes both subnormal and normal).
R(v) Rounding and range action is performed on the value v. See Figure 20-5 on page 20-11. The result is canonical.
T(x) The canonical result x is placed at the target operand location.
Xi: IEEE invalid-operation exception. The results shown are produced only when FPC 0.0 is zero.

Figure 20-26. Results: MULTIPLY

mask bit in the FPC register is zero, in which case the result is the canonical QNaN derived from the second operand.

- For MULTIPLY, when the delivered value is inexact, the preferred quantum is the smallest quantum which is the same quantum as that closest to the product of the quanta of the two source operands.

QUANTIZE

Mnemonic R_1, R_3, R_2, M_4 [RRF-b]

Op Code	R_3	M_4	R_1	R_2
0	16	20	24	28 31

Mnemonic	Op Code	Operands
QADTR	'B3F5'	Long DFP
QAXTR	'B3FD'	Extended DFP

The third operand is rounded to a requested quantum, and the result is placed at the first-operand location.

The requested quantum is the quantum of the second operand.

When both the second and third operands are finite numbers, if the quantum of the third operand is equal to or larger than the requested quantum, the value of the third operand with the requested quantum is placed at the first-operand location. If the quantum of the third operand is smaller than the requested quan-

tum, the third operand is rounded to the requested quantum by rounding as specified by the modifier in the M_4 field, and the result with the requested quantum is placed at the first-operand location.

M_4 Effective Rounding Method

- 0 According to the current DFP rounding mode
- 1 Round to nearest with ties away from 0
- 2 According to the current DFP rounding mode
- 3 Round to prepare for shorter precision
- 4 Round to nearest with ties to even
- 5 Round toward 0
- 6 Round toward +∞
- 7 Round toward -∞
- 8 Round to nearest with ties to even
- 9 Round toward 0
- 10 Round toward +∞
- 11 Round toward -∞
- 12 Round to nearest with ties away from 0
- 13 Round to nearest with ties toward 0
- 14 Round away from 0
- 15 Round to prepare for shorter precision

When the modifier field is zero, rounding is controlled by the current DFP rounding mode specified in the FPC register. When the field is 8-15, rounding is performed as specified by the modifier, regardless of the current DFP rounding mode.

When the floating-point extension facility is installed and if the modifier field is 2, rounding is controlled by the current DFP rounding mode specified in the FPC

register; if the field is 1, or 3-7, rounding is performed as specified by the modifier, regardless of the current DFP rounding mode. If the modifier field is 0 or 8-15, the quantum-exception control (XqC) is one and recognition of the quantum exception is suppressed; if the modifier field is 1-7, the quantum-exception control is zero and recognition of the exception is not suppressed.

When the floating-point extension facility is not installed, no quantum exception is recognized. If the M_4 modifier field is 1-7, it is unpredictable which rounding method is performed.

The sign of the result, if numeric, is the same as the sign of the third operand.

This operation performs a functionally-constrained rounding, and does not recognize an underflow exception. No overflow condition can occur.

The preferred quantum is the requested quantum. If the delivered value is a finite number, it is always represented with the preferred quantum.

The result placed at the first-operand location is canonical.

See Figure 20-27 on page 20-51 for a detailed description of the results of this instruction.

An invalid-operation exception is recognized when the resultant value cannot be represented in the tar-

get format with the requested quantum. When the invalid-operation exception is recognized, and if the exception is disabled, the result is the default QNaN.

An IEEE inexact exception is recognized when the result differs in value from the third operand,

When the floating-point extension facility is installed, if the quantum of the delivered finite number is not equal to the quantum of the third operand and if XqC is zero, then a quantum exception is recognized.

For QAXTR, the R fields must designate valid floating-point-register pairs; otherwise, a specification exception is recognized.

Condition Code: The code remains unchanged.

IEEE Exceptions:

- Invalid operation
- Inexact
- Quantum (if the floating-point extension facility is installed)

Program Exceptions:

- Data with DXC 3, DFP instruction
- Data with DXC for IEEE exception
- Operation (if the DFP facility is not installed)
- Specification (QAXTR only)
- Transaction constraint

When second operand (b) is	Result for QUANTIZE when third operand (c) is							
	$-\infty$	-Fn	-0	+0	+Fn	$+\infty$	QNaN	SNaN
$-\infty$	T($-\infty$)	Xi: T(dNaN)	Xi: T(dNaN)	Xi: T(dNaN)	Xi: T(dNaN)	T($+\infty$)	T(c)	Xi: T(c*)
-Fn	Xi: T(dNaN)	Q(b:c)	E(-0)	E(+0)	Q(b:c)	Xi: T(dNaN)	T(c)	Xi: T(c*)
-0	Xi: T(dNaN)	Q(b:c)	E(-0)	E(+0)	Q(b:c)	Xi: T(dNaN)	T(c)	Xi: T(c*)
+0	Xi: T(dNaN)	Q(b:c)	E(-0)	E(+0)	Q(b:c)	Xi: T(dNaN)	T(c)	Xi: T(c*)
+Fn	Xi: T(dNaN)	Q(b:c)	E(-0)	E(+0)	Q(b:c)	Xi: T(dNaN)	T(c)	Xi: T(c*)
$+\infty$	T($-\infty$)	Xi: T(dNaN)	Xi: T(dNaN)	Xi: T(dNaN)	Xi: T(dNaN)	T($+\infty$)	T(c)	Xi: T(c*)
QNaN	T(b)	T(b)	T(b)	T(b)	T(b)	T(b)	T(b)	Xi: T(c*)
SNaN	Xi: T(b*)	Xi: T(b*)	Xi: T(b*)	Xi: T(b*)	Xi: T(b*)	Xi: T(b*)	Xi: T(b*)	Xi: T(b*)

Explanation:

* The SNaN is converted to the corresponding QNaN before it is placed at the target operand location.
dNaN Default NaN.
E(0) The value zero with the quantum of operand b is placed at the target operand location.
Fn Finite nonzero number (includes both subnormal and normal).
Q(b:c) See Figure 20-28.
T(x) The canonical result x is placed at the target operand location.
Xi: IEEE invalid-operation exception. The results shown are produced only when FPC 0.0 is zero.

Figure 20-27. Results: QUANTIZE

Relation ¹	Is $ Vc > (10^p - 1) \times 10^{Qb}$?	Result for Q(b:c)
$10^{Qb} < 10^{Qc}$	Yes	Xi: T(dNaN)
	No	L(c)
$10^{Qb} = 10^{Qc}$		T(c)
$10^{Qb} > 10^{Qc}$		Rq(c)

Explanation:

¹ The quantum of the second operand and the third operand is 10^{Qb} and 10^{Qc} , respectively.
dNaN Default NaN.
p Format precision.
Qb The right-units-view exponent of the second operand (b).
Qc The right-units-view exponent of the third operand (c).
|Vc| The absolute value of the third operand (c).
L(c) The third operand (c) is represented with the requested quantum. The result is represented with the preferred quantum and is canonical.
Rq(c) The third operand (c) is rounded to the requested quantum. The result is represented with the preferred quantum and is canonical.
T(x) The canonical result x is placed at the target operand location. The result, when it is a finite number, is represented with the preferred quantum and is canonical.
Xi: IEEE invalid-operation exception. The results shown are produced only when FPC 0.0 is zero.

Figure 20-28. Results: Q(b:c)

Programming Notes:

1. When the third operand is larger than $(10^p - 1) \times 10^{Qb}$ in magnitude, an invalid-operation exception is recognized, where p is the format precision and 10^{Qb} is the requested quantum.

The expression, $(10^p - 1) \times 10^{Qb}$, specifies the largest magnitude that can be represented with the requested quantum in the format. A value larger than $(10^p - 1) \times 10^{Qb}$ in magnitude will have more than p digits when the value is represented with the requested quantum.

2. When both source operands are finite numbers, an invalid-operation exception can occur only if the requested quantum is smaller than the quantum of the third operand; and an inexact exception can occur only if the requested quantum is larger than the quantum of the third operand.

REROUND

Mnemonic R_1, R_3, R_2, M_4 [RRF-b]

Op Code	R_3	M_4	R_1	R_2
0	16	20	24	28 31

Mnemonic	Op Code	Operands
RRDTR	'B3F7'	Long DFP
RRXTR	'B3FF'	Extended DFP

The third operand is rounded to the requested significance, and the result is placed at the first-operand location.

The requested significance, which specifies a number of DFP significant digits, is an unsigned binary integer and is in bit positions 58-63 of general register R_2 . The contents of bit positions 0-57 of general register R_2 are ignored.

When the third operand is a finite number, if the requested significance is zero, then the value of the third operand with the original quantum is placed at the first-operand location.

When the third operand is a finite number, if the requested significance is nonzero, and if the number of DFP significant digits of the third operand is equal to or less than the requested significance, then the value of the third operand with the original quantum is placed at the first-operand location.

When the third operand is a finite number, if the requested significance is nonzero, and if the number of DFP significant digits of the third operand is greater than the requested significance, then the third operand is rounded to the requested significance, and the result with the requested significance is placed at the first-operand location.

The third operand is rounded to the requested significance by rounding as specified by the modifier in the M_4 field:

M_4	Effective Rounding Method
0	According to the current DFP rounding mode
1	Round to nearest with ties away from 0
2	According to the current DFP rounding mode
3	Round to prepare for shorter precision
4	Round to nearest with ties to even
5	Round toward 0
6	Round toward $+\infty$

M_4 Effective Rounding Method

7	Round toward $-\infty$
8	Round to nearest with ties to even
9	Round toward 0
10	Round toward $+\infty$
11	Round toward $-\infty$
12	Round to nearest with ties away from 0
13	Round to nearest with ties toward 0
14	Round away from 0
15	Round to prepare for shorter precision

When the modifier field is zero, rounding is controlled by the current DFP rounding mode specified in the FPC register. When the field is 8-15, rounding is performed as specified by the modifier, regardless of the current DFP rounding mode.

When the floating-point extension facility is installed and if the modifier field is 2, rounding is controlled by the current DFP rounding mode specified in the FPC register; if the field is 1, or 3-7, rounding is performed as specified by the modifier, regardless of the current DFP rounding mode. If the modifier field is 0 or 8-15, the quantum-exception control (XqC) is one and recognition of the quantum exception is suppressed; if the modifier field is 1-7, the quantum-exception control is zero and recognition of the exception is not suppressed.

When the floating-point extension facility is not installed, no quantum exception is recognized. If the M_4 modifier field is 1-7, it is unpredictable which rounding method is performed.

The sign of the result, if numeric, is the same as the sign of the third operand.

This operation performs a functionally-constrained rounding, and does not recognize an underflow exception. No overflow condition can occur.

When the delivered value is exact, if the requested significance is zero, or if the requested significance is nonzero and the number of DFP significant digits of the third operand is equal to or less than the requested significance, then the preferred quantum is the quantum of the third operand. When the delivered value is exact, if the requested significance is nonzero and the number of DFP significant digits of the third operand is greater than the requested significance, then the preferred quantum is the quantum that corresponds to the requested significance.

When the delivered value is inexact, the preferred quantum is the quantum that corresponds to the requested significance.

The result placed at the first-operand location is canonical.

If the delivered value is a finite number, it is always represented with the preferred quantum.

See Figure 20-29 for a detailed description of the results of this instruction.

Significance Comparison	Is $ Rp(c) > (10^k - 1) \times 10^{Q_{max}}$?	Results for REROUND when the Third Operand (c) is							
		$-\infty$	-Fn	-0	+0	+Fn	$+\infty$	QNaN	SNaN
$k = 0$	--	T($-\infty$)	T(c)	T(c)	T(c)	T(c)	T($+\infty$)	T(c)	Xi: T(c*)
$k \neq 0; k > m$	--	T($-\infty$)	T(c)	T(c)	T(c)	T(c)	T($+\infty$)	T(c)	Xi: T(c*)
$k \neq 0; k = m$	--	T($-\infty$)	T(c)	--	--	T(c)	T($+\infty$)	T(c)	Xi: T(c*)
$k \neq 0; k < m$	No	T($-\infty$)	Rp(c)	--	--	Rp(c)	T($+\infty$)	T(c)	Xi: T(c*)
	Yes	T($-\infty$)	Xi:T(dNaN)	--	--	Xi:T(dNaN)	T($+\infty$)	T(c)	Xi: T(c*)

Explanation:

-- Not applicable.
 * The SNaN is converted to the corresponding QNaN and placed at the target operand location.
 dNaN Default NaN.
 Fn Nonzero finite numbers (includes both subnormal and normal).
 k The requested significance.
 m Number of DFP significant digits in the third operand (c).
 Qmax Maximum right-units-view exponent.
 Rp(c) The third operand (c) is rounded to the requested significance. The result is canonical and is represented with the preferred quantum.
 |Rp(c)| The absolute value of Rp(c).
 T(x) The canonical result x is placed at the target operand location. The result is canonical and, when it is a finite number, is represented with the preferred quantum.
 Xi: IEEE invalid-operation exception. The results shown are produced only when FPC 0.0 is zero.

Figure 20-29. Results: REROUND

An invalid-operation exception is recognized when the resultant value cannot be represented in the target format with the requested significance. When the invalid-operation exception is recognized, and if the exception is disabled, the result is the default QNaN.

IEEE Exceptions:

- Invalid operation
- Inexact
- Quantum (if the floating-point extension facility is installed)

When an invalid-operation exception is recognized, the IEEE inexact exception is not recognized.

Program Exceptions:

- Data with DXC 3, DFP instruction
- Data with DXC for IEEE exception
- Operation (if the DFP facility is not installed)
- Specification (RRXTR only)
- Transaction constraint

In the absence of an invalid-operation exception, if the result differs in value from the third operand, an IEEE inexact exception is recognized.

When the floating-point extension facility is installed, if the quantum of the delivered finite number is not equal to the quantum of the third operand and if XqC is zero, then a quantum exception is recognized.

Programming Notes:

1. REROUND and the round-to-prepare-for-shorter-precision rounding method can be used to simulate a DFP operation with a precision other than any supported format precision and with the effect of single rounding. The round-to-prepare-for-shorter-precision rounding method is used by the operation, and the desirable round-

For RRXTR, the R₁ and R₃ fields must designate valid floating-point-register pairs; otherwise, a specification exception is recognized.

Condition Code: The code remains unchanged.

ing method is used by the subsequent REROUND instruction.

- When the rounded intermediate value is larger than $(10^k - 1) \times 10^{Q_{\max}}$ in magnitude, an invalid-operation exception is recognized, where k is the requested significance and $10^{Q_{\max}}$ is the largest quantum for the format.

The expression, $(10^k - 1) \times 10^{Q_{\max}}$, specifies the largest magnitude that can be represented with the requested significance in the format. A value larger than $(10^p - 1) \times 10^{Q_b}$ in magnitude will have a quantum larger than $10^{Q_{\max}}$ when the value is represented with the requested significance.

SHIFT SIGNIFICAND LEFT

Mnemonic $R_1, R_3, D_2(X_2, B_2)$ [RXF]

OpCode	R ₃	X ₂	B ₂	D ₂	R ₁	////	OpCode
0	8	12	16	20	32	36	40
							47

Mnemonic	Op Code	Operands
SLDT	'ED40'	Long DFP
SLXT	'ED48'	Extended DFP

The significand of the third operand is shifted left the number of digits specified by the second-operand address, and the result is placed at the first-operand location.

Digits shifted out of the leftmost digit are lost. Zeros are supplied to the vacated positions on the right. The sign of the result is the same as the sign of the third operand.

For a finite number, all digits in the significand participate in the shift and the result is a finite number with the same biased exponent as the third operand and the shifted significand. For an infinity, all digits in the trailing significand participate in the shift, and the result is an infinity with the shifted trailing significand and a zero in the reserved field of the format. For a QNaN or SNaN, all digits in the payload participate in the shift and the result is a QNaN or SNaN, respectively, with the shifted payload and a zero in the reserved field of the format.

The second-operand address is not used to address data; its rightmost six bits indicate the number of digit positions to be shifted. The remainder of the address is ignored.

The preferred quantum is the quantum of the third operand. If the delivered value is a finite number, it is always represented with the preferred quantum.

The result placed at the first-operand location is canonical, except for infinity. When the result is an infinity, if all digits in the trailing significand of the result are zeros, then the result is canonical; otherwise, the result is an infinity that has the reserved field set to zero, canonical declets in the encoded trailing-significand field, and some nonzero digits in the trailing significand.

This operation is performed for any second operand, including an infinity, QNaN, or SNaN, without causing an IEEE exception.

For SLXT, the R_1 and R_3 fields must designate valid floating-point-register pairs; otherwise, a specification exception is recognized.

Condition Code: The code remains unchanged.

IEEE Exceptions: None.

Program Exceptions:

- Data with DXC 3, DFP instruction
- Operation (if the DFP facility is not installed)
- Specification (SLXT only)
- Transaction constraint

Programming Note: Infinities produced as DFP results have the reserved field set to zero and have canonical declets in the encoded trailing-significand field. An infinity is not considered canonical unless all digits in the trailing significand are zeros.

SHIFT SIGNIFICAND RIGHT

Mnemonic $R_1, R_3, D_2(X_2, B_2)$ [RXF]

OpCode	R ₃	X ₂	B ₂	D ₂	R ₁	////	OpCode
0	8	12	16	20	32	36	40
							47

Mnemonic	Op Code	Operands
SRDT	'ED41'	Long DFP
SRXT	'ED49'	Extended DFP

The significand of the third operand is shifted right the number of digits specified by the second-operand address, and the result is placed at the first-operand location.

Digits shifted out of the rightmost digit are lost. Zeros are supplied to the vacated positions on the left. The sign of the result is the same as the sign of the third operand.

For a finite number, all digits in the significand participate in the shift and the result is a finite number with the same biased exponent as the third operand and the shifted significand. For an infinity, all digits in the trailing significand participate in the shift, and the result is an infinity with the shifted trailing significand and a zero in the reserved field of the format. For a QNaN or SNaN, all digits in the payload participate in the shift and the result is a QNaN or SNaN, respectively, with the shifted payload and a zero in the reserved field of the format.

The second-operand address is not used to address data; its rightmost six bits indicate the number of digit positions to be shifted. The remainder of the address is ignored.

The preferred quantum is the quantum of the third operand. If the delivered value is a finite number, it is always represented with the preferred quantum.

The result placed at the first-operand location is canonical, except for infinity. When the result is an infinity, if all digits in the trailing significand of the result are zeros, then the result is canonical; otherwise, the result is an infinity that has the reserved field set to zero, canonical declets in the encoded trailing-significand field, and some nonzero digits in the trailing significand.

This operation is performed for any second operand, including an infinity, QNaN, or SNaN, without causing an IEEE exception.

For SRXT, the R_1 and R_3 fields must designate valid floating-point-register pairs; otherwise, a specification exception is recognized.

Condition Code: The code remains unchanged.

IEEE Exceptions: None.

Program Exceptions:

- Data with DXC 3, DFP instruction
- Operation (if the DFP facility is not installed)
- Specification (SRXT only)
- Transaction constraint

Programming Note: Infinities produced as DFP results have the reserved field set to zero and have canonical declets in the encoded trailing-significand field. An infinity is not considered canonical unless all digits in the trailing significand are zeros.

SUBTRACT

Mnemonic1 R_1, R_2, R_3 [RRF-a]



Mnemonic1	Op Code	Operands
SDTR	'B3D3'	Long DFP
SXTR	'B3DB'	Extended DFP

Mnemonic2 R_1, R_2, R_3, M_4 [RRF-a]

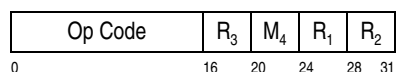

Mnemonic2	Op Code	Operands
SDTRA	'B3D3'	Long DFP
SXTRA	'B3DB'	Extended DFP

The third operand is subtracted from the second operand, and the difference is placed at the first-operand location.

The execution of SUBTRACT is identical to that of ADD, except that the third operand, if numeric, participates in the operation with its sign bit inverted. When the third operand is a NaN, it participates in the operation with its sign bit unchanged. See Figure 20-11 on page 20-21 for the detailed results of ADD.

When the delivered value is exact, the preferred quantum is the smaller quantum of the two source operands; when the delivered value is inexact, the preferred quantum is the smallest quantum.

The result placed at the first-operand location is canonical.

For SXTR and SXTRA, the R fields must designate valid floating-point-register pairs; otherwise, a specification exception is recognized.

Resulting Condition Code:

- 0 Result is zero
- 1 Result is less than zero
- 2 Result is greater than zero

3 Result is a NaN

IEEE Exceptions:

- Invalid operation
- Overflow
- Underflow
- Inexact
- Quantum (if the floating-point extension facility is installed)

Program Exceptions:

- Data with DXC 3, DFP instruction
- Data with DXC for IEEE exception
- Operation (if the DFP facility is not installed)
- Specification (SXTR and SXTRA only)
- Transaction constraint

Programming Note: See the programming notes for ADD.

TEST DATA CLASS

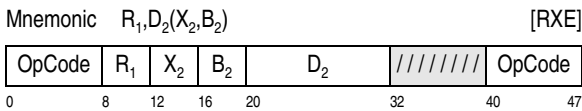

Mnemonic	Op Code	Operands
TDCET	'ED50'	Short DFP
TDCDT	'ED54'	Long DFP
TDCXT	'ED58'	Extended DFP

The class and sign of the first operand are examined to select one bit from the second-operand address. Condition code 0 or 1 is set according to whether the selected bit is zero or one, respectively.

The second-operand address is not used to address data; instead, the rightmost 12 bits of the address, bits 52-63, are used to specify 12 combinations of data class and sign. Bits 0-51 of the second-operand address are ignored.

As shown in Figure 20-30, DFP operands are divided into six classes: zero, subnormal, normal, infinity, quiet NaN, and signaling NaN:

One or more of the second-operand-address bits may be set to one. If the second-operand-address bit

DFP data class	Bit used when sign is	
	+	-
Zero	52	53
Subnormal	54	55
Normal	56	57
Infinity	58	59
Quiet NaN	60	61
Signaling NaN	62	63

Figure 20-30. Second-Operand-Address Bits for TEST DATA CLASS

corresponding to the class and sign of the first operand is one, condition code 1 is set; otherwise, condition code 0 is set.

Operands, including SNaNs and QNaNs, are examined without causing an IEEE exception.

For TDCXT, the R₁ field must designate a valid floating-point-register pair; otherwise, a specification exception is recognized.

Resulting Condition Code:

- 0 Selected bit is 0 (no match)
- 1 Selected bit is 1 (match)
- 2 --
- 3 --

IEEE Exceptions: None.

Program Exceptions:

- Data with DXC 3, DFP instruction
- Operation (if the DFP facility is not installed)
- Specification (TDCXT only)
- Transaction constraint

Programming Notes:

1. TEST DATA CLASS provides a way to test an operand without risk of an exception or setting the IEEE flags.
2. The bits used to specify the combinations of data class and sign are not all the same for BFP and DFP. Specifically, BFP TEST DATA CLASS uses bits 54 and 55 for normal number, and bits 56 and 57 for subnormal number.

TEST DATA GROUP

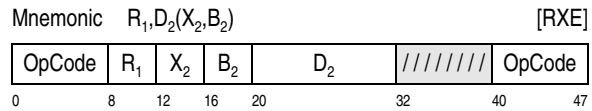

Mnemonic	Op Code	Operands
TDGET	'ED51'	Short DFP
TGDGT	'ED55'	Long DFP
TDGXT	'ED59'	Extended DFP

The group and sign of the first operand are examined to select one bit from the second-operand address. Condition code 0 or 1 is set according to whether the selected bit is zero or one, respectively.

The second-operand address is not used to address data; instead, the rightmost 12 bits of the address, bits 52-63, are used to specify 12 combinations of data group and sign. Bits 0-51 of the second-operand address are ignored.

TEST DATA GROUP is used to determine whether a finite number is safe. A finite number is safe if the exponent is neither maximum nor minimum, and the leftmost significand digit is zero.

Figure 20-31 on page 20-58 shows the data groups and the bit assignment. There are six data groups: safe zero, zero with extreme exponent, nonzero with extreme exponent, safe nonzero, nonzero leftmost significand digit with nonextreme exponent, and special. The special group is defined for infinity and NaN. Depending on the model, subnormal with nonextreme exponent may be placed in the nonzero-with-extreme-exponent group or the safe-nonzero group.

One or more of the second-operand-address bits may be set to one. If the second-operand-address bit corresponding to the group and sign of the first operand is one, condition code 1 is set; otherwise, condition code 0 is set.

Operands, including SNaNs and QNaNs, are examined without causing an IEEE exception.

For TDGXT, the R₁ field must designate a valid floating-point-register pair; otherwise, a specification exception is recognized.

Resulting Condition Code:

- 0 Selected bit is 0 (no match)
- 1 Selected bit is 1 (match)
- 2 --
- 3 --

IEEE Exceptions: None.

Program Exceptions:

- Data with DXC 3, DFP instruction
- Operation (if the DFP facility is not installed)
- Specification (TDGXT only)
- Transaction constraint

Programming Notes:

1. TEST DATA GROUP provides a way to test an operand without risk of an exception or setting the IEEE flags.
2. TEST DATA GROUP can be issued after an operation that produces a DFP result to quickly determine if the result is safe. For DFP results that are finite numbers, the result is safe if using a wider data format by the operation would have produced the same value and quantum. A safe result has two important characteristics: (1) the exponent is neither the maximum exponent nor the minimum exponent, and (2) the leftmost significand digit is zero.
3. TEST DATA GROUP may be used to test whether a nonzero finite number is safe by setting bits 58 and 59 of the second-operand address to ones.
4. TEST DATA GROUP may be used to test whether a nonzero finite number has reached the limit of the format precision but not the limit of the format range by setting bits 60 and 61 of the second-operand address to ones.
5. Subnormal with nonextreme exponent may be grouped with either the nonzero-with-extreme-exponent group or the safe-nonzero group. The

program shouldn't depend on which group sub-normal with nonextreme exponent is in.

DFP Operand	Exponent	LMD	Data Group	Bit used when sign is	
				+	-
Zero	Nonextreme	z ¹	Safe zero	52	53
	Extreme	z ¹	Zero with extreme exponent	54	55
Nonzero finite	Extreme	--	Nonzero with extreme exponent	56	57
	Nonextreme	z	Safe nonzero	58	59
	Nonextreme	nz	Nonzero leftmost significand digit with nonextreme exponent	60	61
Infinity or NaN	na	na	Special	62	63
Explanation:					
--	The result does not depend on this condition.				
1	This condition is true by virtue of the condition to the left of this column.				
Extreme	Maximum right-units-view (RUV) exponent, Qmax, or minimum right-units-view (RUV) exponent, Qmin.				
Nonextreme	Qmax < right-units-view (RUV) exponent < Qmin.				
LMD	Leftmost significand digit.				
na	Not applicable.				
nz	Nonzero.				
z	Zero.				

Figure 20-31. Second-Operand-Address Bits for TEST DATA GROUP

Densely Packed Decimal (DPD)

Decimal-to-DPD Mapping

The mapping of a 3-digit decimal number (000 - 999) to a 10-bit value, called a declet is shown in Figure 20-32 on page 20-59. The DPD entries are shown in hexadecimal. The first two digits of the decimal number are shown in the leftmost column and the third digit along the top row. The table is split into two halves, with the right half being a continuation of the left half.

DPD-to-Decimal Mapping

The mapping of the 10-bit declet to a 3-digit decimal number is shown in Figure 20-33 on page 20-60. The 10-bit declet value is split into a 6-bit index shown in the left column and a 4-bit index shown along the top row, both represented in hexadecimal. The values marked with an asterisk are results mapped from noncanonical declets and are explained further in the following section.

	0	1	2	3	4	5	6	7	8	9	A	B	C	D	E	F
00_	000	001	002	003	004	005	006	007	008	009	080	081	800	801	880	881
01_	010	011	012	013	014	015	016	017	018	019	090	091	810	811	890	891
02_	020	021	022	023	024	025	026	027	028	029	082	083	820	821	808	809
03_	030	031	032	033	034	035	036	037	038	039	092	093	830	831	818	819
04_	040	041	042	043	044	045	046	047	048	049	084	085	840	841	088	089
05_	050	051	052	053	054	055	056	057	058	059	094	095	850	851	098	099
06_	060	061	062	063	064	065	066	067	068	069	086	087	860	861	888	889
07_	070	071	072	073	074	075	076	077	078	079	096	097	870	871	898	899
08_	100	101	102	103	104	105	106	107	108	109	180	181	900	901	980	981
09_	110	111	112	113	114	115	116	117	118	119	190	191	910	911	990	991
0A_	120	121	122	123	124	125	126	127	128	129	182	183	920	921	908	909
0B_	130	131	132	133	134	135	136	137	138	139	192	193	930	931	918	919
0C_	140	141	142	143	144	145	146	147	148	149	184	185	940	941	188	189
0D_	150	151	152	153	154	155	156	157	158	159	194	195	950	951	198	199
0E_	160	161	162	163	164	165	166	167	168	169	186	187	960	961	988	989
0F_	170	171	172	173	174	175	176	177	178	179	196	197	970	971	998	999
10_	200	201	202	203	204	205	206	207	208	209	280	281	802	803	882	883
11_	210	211	212	213	214	215	216	217	218	219	290	291	812	813	892	893
12_	220	221	222	223	224	225	226	227	228	229	282	283	822	823	828	829
13_	230	231	232	233	234	235	236	237	238	239	292	293	832	833	838	839
14_	240	241	242	243	244	245	246	247	248	249	284	285	842	843	288	289
15_	250	251	252	253	254	255	256	257	258	259	294	295	852	853	298	299
16_	260	261	262	263	264	265	266	267	268	269	286	287	862	863	888*	889*
17_	270	271	272	273	274	275	276	277	278	279	296	297	872	873	898*	899*
18_	300	301	302	303	304	305	306	307	308	309	380	381	902	903	982	983
19_	310	311	312	313	314	315	316	317	318	319	390	391	912	913	992	993
1A_	320	321	322	323	324	325	326	327	328	329	382	383	922	923	928	929
1B_	330	331	332	333	334	335	336	337	338	339	392	393	932	933	938	939
1C_	340	341	342	343	344	345	346	347	348	349	384	385	942	943	388	389
1D_	350	351	352	353	354	355	356	357	358	359	394	395	952	953	398	399
1E_	360	361	362	363	364	365	366	367	368	369	386	387	962	963	988*	989*
1F_	370	371	372	373	374	375	376	377	378	379	396	397	972	973	998*	999*
20_	400	401	402	403	404	405	406	407	408	409	480	481	804	805	884	885
21_	410	411	412	413	414	415	416	417	418	419	490	491	814	815	894	895
22_	420	421	422	423	424	425	426	427	428	429	482	483	824	825	848	849
23_	430	431	432	433	434	435	436	437	438	439	492	493	834	835	858	859
24_	440	441	442	443	444	445	446	447	448	449	484	485	844	845	488	489
25_	450	451	452	453	454	455	456	457	458	459	494	495	854	855	498	499
26_	460	461	462	463	464	465	466	467	468	469	486	487	864	865	888*	889*
27_	470	471	472	473	474	475	476	477	478	479	496	497	874	875	898*	899*
28_	500	501	502	503	504	505	506	507	508	509	580	581	904	905	984	985
29_	510	511	512	513	514	515	516	517	518	519	590	591	914	915	994	995
2A_	520	521	522	523	524	525	526	527	528	529	582	583	924	925	948	949
2B_	530	531	532	533	534	535	536	537	538	539	592	593	934	935	958	959
2C_	540	541	542	543	544	545	546	547	548	549	584	585	944	945	588	589
2D_	550	551	552	553	554	555	556	557	558	559	594	595	954	955	598	599
2E_	560	561	562	563	564	565	566	567	568	569	586	587	964	965	988*	989*
2F_	570	571	572	573	574	575	576	577	578	579	596	597	974	975	998*	999*
30_	600	601	602	603	604	605	606	607	608	609	680	681	806	807	886	887
31_	610	611	612	613	614	615	616	617	618	619	690	691	816	817	896	897
32_	620	621	622	623	624	625	626	627	628	629	682	683	826	827	868	869
33_	630	631	632	633	634	635	636	637	638	639	692	693	836	837	878	879
34_	640	641	642	643	644	645	646	647	648	649	684	685	846	847	688	689
35_	650	651	652	653	654	655	656	657	658	659	694	695	856	857	698	699
36_	660	661	662	663	664	665	666	667	668	669	686	687	866	867	888*	889*
37_	670	671	672	673	674	675	676	677	678	679	696	697	876	877	898*	899*
38_	700	701	702	703	704	705	706	707	708	709	780	781	906	907	986	987
39_	710	711	712	713	714	715	716	717	718	719	790	791	916	917	996	997
3A_	720	721	722	723	724	725	726	727	728	729	782	783	926	927	968	969
3B_	730	731	732	733	734	735	736	737	738	739	792	793	936	937	978	979
3C_	740	741	742	743	744	745	746	747	748	749	784	785	946	947	788	789
3D_	750	751	752	753	754	755	756	757	758	759	794	795	956	957	798	799
3E_	760	761	762	763	764	765	766	767	768	769	786	787	966	967	988*	989*
3F_	770	771	772	773	774	775	776	777	778	779	796	797	976	977	998*	999*

* Result mapped from a noncanonical delect.

Figure 20-33. DPD-to-Decimal Mapping

Chapter 21. Vector Overview and Support Instructions

Overview	21-1	VECTOR LOAD VR FROM GRS DISJOINT	21-14
Vector Registers and Controls	21-1	VECTOR LOAD WITH LENGTH	21-15
Vector Enablement Control	21-1	VECTOR MERGE HIGH	21-15
Vector Storage Accesses	21-2	VECTOR MERGE LOW	21-15
Saturating Arithmetic	21-2	VECTOR PACK	21-16
Instructions	21-2	VECTOR PACK SATURATE	21-16
VECTOR BIT PERMUTE	21-4	VECTOR PACK LOGICAL SATURATE	21-17
VECTOR GATHER ELEMENT	21-5	VECTOR PERMUTE	21-18
VECTOR GENERATE BYTE MASK	21-5	VECTOR PERMUTE DOUBLEWORD	
VECTOR GENERATE MASK	21-6	IMMEDIATE	21-18
VECTOR LOAD	21-6	VECTOR REPLICATE	21-19
VECTOR LOAD AND REPLICATE	21-7	VECTOR REPLICATE IMMEDIATE	21-19
VECTOR LOAD BYTE REVERSED		VECTOR SCATTER ELEMENT	21-20
ELEMENT	21-7	VECTOR SELECT	21-20
VECTOR LOAD BYTE REVERSED ELEMENT		VECTOR SIGN EXTEND TO	
AND REPLICATE	21-7	DOUBLEWORD	21-20
VECTOR LOAD BYTE REVERSED ELEMENT		VECTOR STORE	21-21
AND ZERO	21-8	VECTOR STORE BYTE REVERSED	
VECTOR LOAD BYTE REVERSED		ELEMENT	21-21
ELEMENTS	21-9	VECTOR STORE BYTE REVERSED	
VECTOR LOAD ELEMENT	21-9	ELEMENTS	21-22
VECTOR LOAD ELEMENT IMMEDIATE ..	21-10	VECTOR STORE ELEMENT	21-23
VECTOR LOAD ELEMENTS REVERSED ..	21-10	VECTOR STORE ELEMENTS REVERSED	21-23
VECTOR LOAD GR FROM VR ELEMENT ..	21-11	VECTOR STORE MULTIPLE	21-24
VECTOR LOAD LOGICAL ELEMENT AND		VECTOR STORE RIGHTMOST WITH	
ZERO	21-11	LENGTH	21-24
VECTOR LOAD MULTIPLE	21-12	VECTOR STORE WITH LENGTH	21-25
VECTOR LOAD RIGHTMOST WITH		VECTOR UNPACK HIGH	21-25
LENGTH	21-13	VECTOR UNPACK LOGICAL HIGH	21-26
VECTOR LOAD TO BLOCK BOUNDARY ..	21-13	VECTOR UNPACK LOW	21-26
VECTOR LOAD VR ELEMENT FROM GR ..	21-14	VECTOR UNPACK LOGICAL LOW	21-27

Overview

The vector facility provided in the z/Architecture architectural mode provides fixed-sized vectors ranging from one to sixteen elements. For most instructions, all of the data contained in a vector is operated on by the instructions defined in this facility. Some

instructions only operate on a subset of the elements within a vector. If a vector is made up of multiple elements, each element is processed in parallel with the others. Instruction completion does not occur until processing of all elements is complete.

Vector Registers and Controls

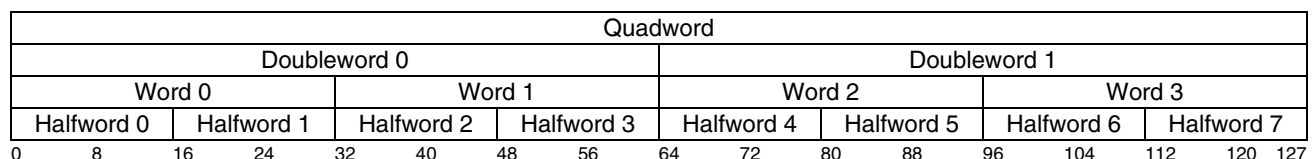

Figure 21-1. Vector Register Element Representations

Byte 0	Byte 1	Byte 2	Byte 3	Byte 4	Byte 5	Byte 6	Byte 7	Byte 8	Byte 9	Byte 10	Byte 11	Byte 12	Byte 13	Byte 14	Byte 15	
0	8	16	24	32	40	48	56	64	72	80	88	96	104	112	120	127

Figure 21-1. Vector Register Element Representations

Vector Enablement Control

The vector instructions should only be used if both the vector enablement control (bit 46) and the AFP-register-control (bit 45) in control register zero are set to one. If the vector facility for z/Architecture is installed and a vector instruction is executed without the vector enablement control set, a data exception with DXC FE hex is recognized. If bit 45 of control register zero is not also set to one, it is unpredictable if a data exception is recognized. If the vector facility for z/Architecture is not installed, an operation exception is recognized.

Programming Note: When a control program initially enables the vector facility for z/Architecture for a task, which may occur in response to a data exception with DXC FE, it should ensure that newly enabled full vector registers as well as the rightmost portions of vector registers that overlap with any enabled floating-point registers are zeroed.

Vector Storage Accesses

All vector data appears in storage in the same left-to-right sequence as all other data formats. Bits of a data format that are numbered 0-7 constitute the byte in the leftmost (lowest-numbered) byte location in storage, bits 8-15 form the byte in the next sequential location, and so on. (See also “Storage Addressing” on page 3-2.)

Saturating Arithmetic

Some vector operations perform saturating operations. Saturation for signed binary integers means that if there is an overflow, the result is set to the largest positive number; if there is an underflow, the result is set to the largest negative number. Saturation for unsigned binary integers means that if there is an overflow, the result is set to the largest representable number; if there is an underflow, the result is set to zero.

Instructions

All vector instructions, defined in chapters 21-25, have a field in bits 36-39 of the instruction labeled as RXB. This field contains the most significant bit for each of the vector register designated operands. Bits for register designations not specified by the instruction are reserved and should be set to zero; otherwise the program may not operate compatibly in the future.

The bits are defined as follows:

Bit	MSB of Vector Register in Instruction Bits
36	8-11
37	12-15
38	16-19
39	32-35

Programming Note: It is assumed that the assembler will set these bits whenever a vector register designation greater than 15 is specified.

Unless otherwise specified, all operands are vector-register operands. A “V” in the assembler syntax designates a vector operand.

Each instruction has an extended-mnemonic section which describes recommended extended mnemonics and their corresponding machine assembler syntax.

Programming Note: The vector-enhancements facility 2 includes the following new instructions to handle load and store of elements or arrays of elements in the little endian format:

- VECTOR LOAD BYTE REVERSED ELEMENTS (VLBR), VECTOR LOAD ELEMENTS REVERSED (VLER), VECTOR LOAD BYTE REVERSED ELEMENT AND ZERO (VLLEBRZ), VECTOR LOAD BYTE REVERSED ELEMENT (VLEBRH, VLEBRF, VLEBRG), VECTOR LOAD BYTE REVERSED ELEMENT AND REPLI-

CATE (VLBRREP), VECTOR STORE BYTE REVERSED ELEMENTS (VSTBR), VECTOR STORE ELEMENTS REVERSED (VSTER), and

VECTOR STORE BYTE REVERSED ELEMENT (VSTEBRH, VSTEBRF, VSTEBRG)

Name	Mnemonic	Characteristics						Op-code	Page
VECTOR BIT PERMUTE	VBPERM	VRR-c	V1	$\alpha^{7,9}$		Dv	E785	21-4	
VECTOR GATHER ELEMENT (32)	VGEF	VRV	VF	$\alpha^{7,9}$	A SP	Dv	B ₂ E713	21-5	
VECTOR GATHER ELEMENT (64)	VGEG	VRV	VF	$\alpha^{7,9}$	A SP	Dv	B ₂ E712	21-5	
VECTOR GENERATE BYTE MASK	VGBM	VRI-a	VF	$\alpha^{7,9}$		Dv	E744	21-5	
VECTOR GENERATE MASK	VGM	VRI-b	VF	$\alpha^{7,9}$	SP	Dv	E746	21-6	
VECTOR LOAD	VL	VRX	VF	$\alpha^{7,9}$	A	Dv	B ₂ E706	21-6	
VECTOR LOAD	VLR	VRR-a	VF	$\alpha^{7,9}$		Dv	E756	21-6	
VECTOR LOAD AND REPLICATE	VLREP	VRX	VF	$\alpha^{7,9}$	A SP	Dv	B ₂ E705	21-7	
VECTOR LOAD BYTE REVERSED ELEMENT (16)	VLEBRH	VRX	V2	$\alpha^{7,9}$	A SP	Dv	B ₂ E601	21-7	
VECTOR LOAD BYTE REVERSED ELEMENT (32)	VLEBRF	VRX	V2	$\alpha^{7,9}$	A SP	Dv	B ₂ E603	21-7	
VECTOR LOAD BYTE REVERSED ELEMENT (64)	VLEBRG	VRX	V2	$\alpha^{7,9}$	A SP	Dv	B ₂ E602	21-7	
VECTOR LOAD BYTE REVERSED ELEMENT AND REPLICATE	VLBRREP	VRX	V2	$\alpha^{7,9}$	A SP	Dv	B ₂ E605	21-8	
VECTOR LOAD BYTE REVERSED ELEMENT AND ZERO	VLLBRZ	VRX	V2	$\alpha^{7,9}$	A SP	Dv	B ₂ E604	21-8	
VECTOR LOAD BYTE REVERSED ELEMENTS	VLBR	VRX	V2	$\alpha^{7,9}$	A SP	Dv	B ₂ E606	21-9	
VECTOR LOAD ELEMENT (16)	VLEH	VRX	VF	$\alpha^{7,9}$	A SP	Dv	B ₂ E701	21-9	
VECTOR LOAD ELEMENT (32)	VLEF	VRX	VF	$\alpha^{7,9}$	A SP	Dv	B ₂ E703	21-9	
VECTOR LOAD ELEMENT (64)	VLEG	VRX	VF	$\alpha^{7,9}$	A SP	Dv	B ₂ E702	21-9	
VECTOR LOAD ELEMENT (8)	VLEB	VRX	VF	$\alpha^{7,9}$	A SP	Dv	B ₂ E700	21-9	
VECTOR LOAD ELEMENT IMMEDIATE (16)	VLEIH	VRI-a	VF	$\alpha^{7,9}$	SP	Dv	E741	21-10	
VECTOR LOAD ELEMENT IMMEDIATE (32)	VLEIF	VRI-a	VF	$\alpha^{7,9}$	SP	Dv	E743	21-10	
VECTOR LOAD ELEMENT IMMEDIATE (64)	VLEIG	VRI-a	VF	$\alpha^{7,9}$	SP	Dv	E742	21-10	
VECTOR LOAD ELEMENT IMMEDIATE (8)	VLEIB	VRI-a	VF	$\alpha^{7,9}$	SP	Dv	E740	21-10	
VECTOR LOAD ELEMENTS REVERSED	VLER	VRX	V2	$\alpha^{7,9}$	A SP	Dv	B ₂ E607	21-10	
VECTOR LOAD GR FROM VR ELEMENT	VLGV	VRS-c	VF	$\alpha^{7,9}$	SP	Dv	E721	21-11	
VECTOR LOAD LOGICAL ELEMENT AND ZERO	VLLEZ	VRX	VF	$\alpha^{7,9}$	A SP	Dv	B ₂ E704	21-12	
VECTOR LOAD MULTIPLE	VLM	VRS-a	VF	$\alpha^{7,9}$	A SP	Dv	B ₂ E736	21-12	
VECTOR LOAD RIGHTMOST WITH LENGTH	VLRL	VSI	VD	$\alpha^{7,9}$	A SP	Dv	B ₂ E635	21-13	
VECTOR LOAD RIGHTMOST WITH LENGTH	VLRLR	VRS-d	VD	$\alpha^{7,9}$	A	Dv	B ₂ E637	21-13	
VECTOR LOAD TO BLOCK BOUNDARY	VLBB	VRX	VF	$\alpha^{7,9}$	A SP	Dv	B ₂ E707	21-14	
VECTOR LOAD VR ELEMENT FROM GR	VLVG	VRS-b	VF	$\alpha^{7,9}$	SP	Dv	E722	21-14	
VECTOR LOAD VR FROM GRS DISJOINT	VLVGP	VRR-f	VF	$\alpha^{7,9}$		Dv	E762	21-15	
VECTOR LOAD WITH LENGTH	VLL	VRS-b	VF	$\alpha^{7,9}$	A	Dv	B ₂ E737	21-15	
VECTOR MERGE HIGH	VMRH	VRR-c	VF	$\alpha^{7,9}$	SP	Dv	E761	21-15	
VECTOR MERGE LOW	VMRL	VRR-c	VF	$\alpha^{7,9}$	SP	Dv	E760	21-16	
VECTOR PACK	VPK	VRR-c	VF	$\alpha^{7,9}$	SP	Dv	E794	21-16	
VECTOR PACK LOGICAL SATURATE	VPKLS	VRR-b C*	VF	$\alpha^{7,9}$	SP	Dv	E795	21-18	
VECTOR PACK SATURATE	VPKS	VRR-b C*	VF	$\alpha^{7,9}$	SP	Dv	E797	21-17	
VECTOR PERMUTE	VPERM	VRR-e	VF	$\alpha^{7,9}$		Dv	E78C	21-18	
VECTOR PERMUTE DOUBLEWORD IMMEDIATE	VPDI	VRR-c	VF	$\alpha^{7,9}$		Dv	E784	21-19	
VECTOR REPLICATE	VREP	VRI-c	VF	$\alpha^{7,9}$	SP	Dv	E74D	21-19	
VECTOR REPLICATE IMMEDIATE	VREPI	VRI-a	VF	$\alpha^{7,9}$	SP	Dv	E745	21-20	
VECTOR SCATTER ELEMENT (32)	VSCEF	VRV	VF	$\alpha^{7,9}$	A SP	Dv	ST B ₂ E71B	21-20	
VECTOR SCATTER ELEMENT (64)	VSCEG	VRV	VF	$\alpha^{7,9}$	A SP	Dv	ST B ₂ E71A	21-20	
VECTOR SELECT	VSEL	VRR-e	VF	$\alpha^{7,9}$		Dv	E78D	21-21	
VECTOR SIGN EXTEND TO DOUBLEWORD	VSEG	VRR-a	VF	$\alpha^{7,9}$	SP	Dv	E75F	21-21	
VECTOR STORE	VST	VRX	VF	$\alpha^{7,9}$	A	Dv	ST B ₂ E70E	21-21	
VECTOR STORE BYTE REVERSED ELEMENT (16)	VSTEBRH	VRX	V2	$\alpha^{7,9}$	A SP	Dv	ST B ₂ E609	21-22	

Figure 21-2. Summary of Vector Support Instructions (Part 1 of 2)

Name	Mnemonic	Characteristics								Op-code	Page	
		VRX	V2	$\alpha^{7,9}$	A	SP	Dv	ST	B ₂			
VECTOR STORE BYTE REVERSED ELEMENT (32)	VSTEBR F	VRX	V2	$\alpha^{7,9}$	A	SP	Dv		ST	B ₂	E60B	21-22
VECTOR STORE BYTE REVERSED ELEMENT (64)	VSTEBR G	VRX	V2	$\alpha^{7,9}$	A	SP	Dv		ST	B ₂	E60A	21-22
VECTOR STORE BYTE REVERSED ELEMENTS	VSTBR	VRX	V2	$\alpha^{7,9}$	A	SP	Dv		ST	B ₂	E60E	21-22
VECTOR STORE ELEMENT (16)	VSTEH	VRX	VF	$\alpha^{7,9}$	A	SP	Dv		ST	B ₂	E709	21-23
VECTOR STORE ELEMENT (32)	VSTEF	VRX	VF	$\alpha^{7,9}$	A	SP	Dv		ST	B ₂	E70B	21-23
VECTOR STORE ELEMENT (64)	VSTEG	VRX	VF	$\alpha^{7,9}$	A	SP	Dv		ST	B ₂	E70A	21-23
VECTOR STORE ELEMENT (8)	VSTEB	VRX	VF	$\alpha^{7,9}$	A	SP	Dv		ST	B ₂	E708	21-23
VECTOR STORE ELEMENTS REVERSED	VSTER	VRX	V2	$\alpha^{7,9}$	A	SP	Dv		ST	B ₂	E60F	21-24
VECTOR STORE MULTIPLE	VSTM	VRS-a	VF	$\alpha^{7,9}$	A	SP	Dv		ST	B ₂	E73E	21-24
VECTOR STORE RIGHTMOST WITH LENGTH	VSTRL	VSI	VD	$\alpha^{7,9}$	A	SP	Dv		ST	B ₂	E63D	21-25
VECTOR STORE RIGHTMOST WITH LENGTH	VSTRLR	VRS-d	VD	$\alpha^{7,9}$	A		Dv		ST	B ₂	E63F	21-25
VECTOR STORE WITH LENGTH	VSTL	VRS-b	VF	$\alpha^{7,9}$	A		Dv		ST	B ₂	E73F	21-26
VECTOR UNPACK HIGH	VUPH	VRR-a	VF	$\alpha^{7,9}$		SP	Dv				E7D7	21-26
VECTOR UNPACK LOGICAL HIGH	VUPLH	VRR-a	VF	$\alpha^{7,9}$		SP	Dv				E7D5	21-26
VECTOR UNPACK LOGICAL LOW	VUPLL	VRR-a	VF	$\alpha^{7,9}$		SP	Dv				E7D4	21-27
VECTOR UNPACK LOW	VUPL	VRR-a	VF	$\alpha^{7,9}$		SP	Dv				E7D6	21-27

Explanation:

α^7 Restricted from transactional execution when the effective allow-floating-point-operation control is zero.

α^9 Restricted in the constrained transactional-execution mode; a transaction-constraint program exception may be recognized.

A Access exceptions for logical addresses.

B₂ B₂ field designates an access register in the access-register mode.

C* Condition code optionally set.

Dv Vector-instruction data exception

SP Specification exception.

ST PER storage-alteration event.

V1 Vector-enhancements facility 1

V2 Vector-enhancements facility 2

VD Vector packed-decimal facility

VF Vector facility for z/Architecture

VRI VRI instruction format

VRR VRR instruction format

VRS VRS instruction format

VRX VRX instruction format

VRV VRV instruction format

VSI VSI instruction format

Figure 21-2. Summary of Vector Support Instructions (Part 2 of 2)

VECTOR BIT PERMUTE

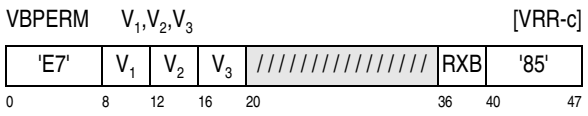

A source vector is created from the concatenation of the second operand followed by 128 binary zeros. The byte sized elements of the third operand contain unsigned integers which are used to select bits from

the source vector to create a halfword result which is placed in bits 48 to 63 of the first operand, other halfwords are set to zero. Each bit of the halfword result is selected from the source vector by the corresponding byte in the third operand.

If the same register is used to designate the first operand as either the second or third operands, the original source value is used throughout the operation with no intermediate updates.

Condition Code: The code remains unchanged.

Program Exceptions:

- Data with DXC FE, Vector Instruction
- Operation (if the vector-enhancements facility 1 is not installed)
- Transaction constraint

Programming Note: The fact that the source vector contains 128 bits of zeros following the second operand permits the permuted bits to be selected from a 256-bit quantity using a single index register. Assume the 256-bit quantity is in vector registers 0 and 1, the indices are in vector register 2, and each byte of vector register 3 contains the value 128. The following code sequence selects sixteen bits from the 256-bit quantity.

```
VBPERM  v4,v0,v2
VX      v2,v2,v3
VBPERM  v5,v1,v2
VO      v4,v4,v5
```

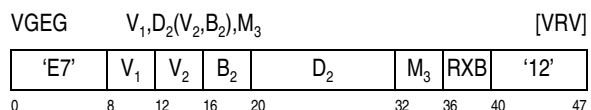
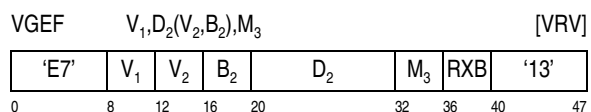
VECTOR GATHER ELEMENT

The element-sized second operand replaces the specified element of the first operand indexed by the M_3 field. The remaining elements are left unchanged. If the M_3 field specifies a value greater than the highest numbered element in the first operand, of the specified element size, a specification exception is recognized.

For VGEF the elements in all operands are 4-bytes in size; for VGEG the elements in all operands are 8-bytes in size.

The second-operand address is generated by adding the unsigned binary integer value from the element in vector-register V_2 indexed by the M_3 field with the address in the B_2 register along with the D_2 value.

The displacement for VECTOR GATHER ELEMENT is treated as a 12-bit unsigned integer.

Condition Code: The code remains unchanged.

Program Exceptions:

- Access (fetch, operand 2)
- Data with DXC FE, Vector Instruction
- Operation (if the vector facility for z/Architecture is not installed)
- Specification
- Transaction constraint

Programming Notes:

1. The VECTOR GATHER ELEMENT instruction can be used to perform a load when doing scalar computation in vector registers and the address resides in a vector register. However, depending on the model, performance may be better if address computations are done in general registers.
2. For VGEF care must be taken to ensure that the values in the second operand elements are unsigned. Otherwise, when running in 64-bit addressing mode program behavior might not be as expected.

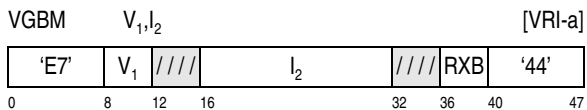
VECTOR GENERATE BYTE MASK

For each bit in the second operand, if the bit is one, all bit positions in the corresponding byte element of the first operand are set to ones. If the bit is zero, all bit positions in the corresponding byte element of the first operand are set to zeros.

Condition Code: The code remains unchanged.

Program Exceptions:

- Data with DXC FE, Vector Instruction
- Operation (if the vector facility for z/Architecture is not installed)
- Transaction constraint

Extended Mnemonics:

Extended Mnemonic	Base Mnemonic
VZERO V_1	VGBM $V_1, 0$

Extended Mnemonic **Base Mnemonic**
VONE V₁ VGBM V₁,X'FFFF'

Programming Note: VECTOR GENERATE BYTE MASK is the preferred method for setting a vector register to all zeros or ones.

VECTOR GENERATE MASK

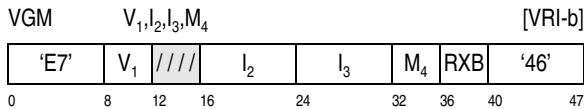

For each element in the first operand a bit mask is generated. The mask consists of bits set to one starting at the bit position specified by the unsigned integer value in I₂ and ending with the bit position specified by the unsigned integer value in I₃ all other bit positions are set to zero. Only the number of bits needed to represent all of the bit positions for the specified element size are used from the I₂ and I₃ fields, other bits are ignored. If the bit position in the I₂ field is greater than the bit position in the I₃ field, the range of bits wraps at the maximum bit position for the specified element size.

The M₄ field specifies the element size control (ES). The ES control specifies the size of the elements in the vector register operands. If a reserved value is specified, a specification exception is recognized.

M ₄	Element Size
0	Byte
1	Halfword
2	Word
3	Doubleword
4-15	Reserved

Condition Code: The code remains unchanged.

Program Exceptions:

- Data with DXC FE, Vector Instruction
- Operation (if the vector facility for z/Architecture is not installed)
- Specification
- Transaction constraint

Extended Mnemonics:

Extended Mnemonic	Base Mnemonic
VGMB V ₁ ,I ₂ ,I ₃	VGM V ₁ ,I ₂ ,I ₃ ,0
VGMH V ₁ ,I ₂ ,I ₃	VGM V ₁ ,I ₂ ,I ₃ ,1
VGMF V ₁ ,I ₂ ,I ₃	VGM V ₁ ,I ₂ ,I ₃ ,2
VGMG V ₁ ,I ₂ ,I ₃	VGM V ₁ ,I ₂ ,I ₃ ,3

VECTOR LOAD

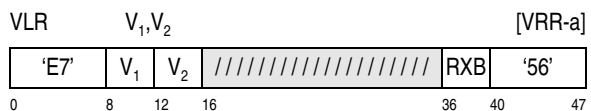

The 128-bit second operand is placed unchanged in the first-operand location.

The displacement for VL is treated as a 12-bit unsigned integer.

For VL the M₃ field contains a 4-bit unsigned binary integer specifying the alignment of the second operand. Reserved values should not be specified; otherwise, the program may not operate compatibly in the future.

M ₃	Alignment Hint
0	No alignment indicated
1-2	Reserved
3	Doubleword aligned
4	Quadword aligned
5-15	Reserved

Condition Code: The code remains unchanged.

Program Exceptions:

- Access (fetch, operand 2 for VL)
- Data with DXC FE, Vector Instruction
- Operation (if the vector facility for z/Architecture is not installed)
- Transaction constraint

Programming Notes:

1. If the alignment of the address specified by the second operand is known to be either on a dou-

bleword or quadword boundary and alignment hint is set to 3 or 4 respectively, performance may be improved on some models. If the alignment of the second operand is not on a doubleword or quadword boundary, or is unknown, the alignment hint should be set to 0.

- Setting the alignment hint to a non-zero value that doesn't correspond to the alignment of the second operand may reduce performance on some models.

VECTOR LOAD AND REPLICATE

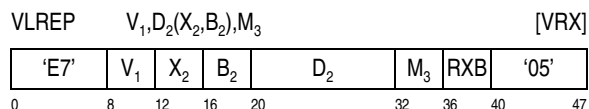

The element-sized second operand is replicated into all elements of the first operand.

The M₃ field specifies the element size control (ES). The ES control specifies the size of the elements in the vector register operands. If a reserved value is specified, a specification exception is recognized.

M ₃	Element Size
0	Byte
1	Halfword
2	Word
3	Doubleword
4-15	Reserved

Condition Code: The code remains unchanged.

Program Exceptions:

- Access (fetch, operand 2)
- Data with DXC FE, Vector Instruction
- Operation (if the vector facility for z/Architecture is not installed)
- Specification
- Transaction constraint

Extended Mnemonics:

Extended Mnemonic	Base Mnemonic
VLREPB $V_1, D_2(X_2, B_2)$	VLREP $V_1, D_2(X_2, B_2), 0$
VLREPH $V_1, D_2(X_2, B_2)$	VLREP $V_1, D_2(X_2, B_2), 1$
VLREPF $V_1, D_2(X_2, B_2)$	VLREP $V_1, D_2(X_2, B_2), 2$

Extended Mnemonic	Base Mnemonic
VLREPG $V_1, D_2(X_2, B_2)$	VLREP $V_1, D_2(X_2, B_2), 3$

VECTOR LOAD BYTE REVERSED ELEMENT

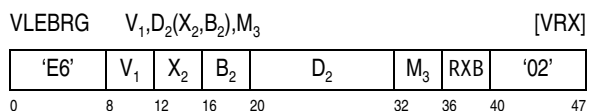
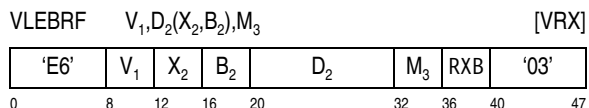
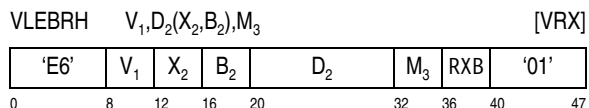

The element-sized second operand replaces the first-operand element, indexed by the M₃ field, with the left-to-right sequence of bytes reversed. The remaining elements are left unchanged. If the M₃ field specifies a value greater than the highest numbered element in the first operand, of the specified element size, a specification exception is recognized.

The displacement for VECTOR LOAD BYTE REVERSED ELEMENT is treated as a 12-bit unsigned integer.

For VLEBRH the elements are halfword sized. For VLEBRF the elements are word sized. For VLEBRG the elements are doubleword sized.

Condition Code: The code remains unchanged.

Program Exceptions:

- Access (fetch, operand 2)
- Data with DXC FE, Vector Instruction
- Operation (if the vector enhancements facility 2 is not installed)
- Specification
- Transaction constraint

Programming Note: No byte-sized element are supported by this instruction as the result would be same as VLEB.

VECTOR LOAD BYTE REVERSED ELEMENT AND REPLICATE

VLBRREP $V_1, D_2(X_2, B_2), M_3$ [VRX]

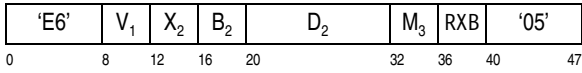

The element-sized second operand is loaded and replicated into all elements of the first operand with the left-to-right sequence of bytes reversed within the elements.

The M₃ field specifies the element size control (ES). The ES control specifies the size of the elements in the vector register operands. If a reserved value is specified, a specification exception is recognized.

M ₃	Element Size
0	Reserved
1	Halfword
2	Word
3	Doubleword
4-15	Reserved

Condition Code: The code remains unchanged.

Program Exceptions:

- Access (fetch, operand 2)
- Data with DXC FE, Vector Instruction
- Operation (if the vector enhancements facility 2 is not installed)
- Specification
- Transaction constraint

Extended Mnemonics:

Extended Mnemonic	Base Mnemonic
VLBRREPH $V_1, D_2(X_2, B_2)$	VLBRREP $V_1, D_2(X_2, B_2), 1$
VLBRREPF $V_1, D_2(X_2, B_2)$	VLBRREP $V_1, D_2(X_2, B_2), 2$
VLBRREPG $V_1, D_2(X_2, B_2)$	VLBRREP $V_1, D_2(X_2, B_2), 3$

VECTOR LOAD BYTE REVERSED ELEMENT AND ZERO

VLEBRZ $V_1, D_2(X_2, B_2), M_3$ [VRX]

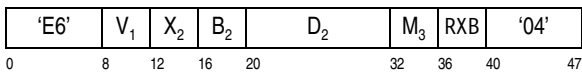

An element, of the size specified by the M₃ field, is loaded from the second-operand location in storage and placed into an element in the first-operand vector register, with the left-to-right sequence of bytes reversed within that element. When the M₃ value is in the range 1-3, the unsigned element-sized second operand is placed in the rightmost sub-element or element of the leftmost doubleword element of the vector-register specified first operand with the left-to-right sequence of the bytes reversed. When the M₃ value is 6 the unsigned 4-byte second operand is placed in word 0 of the vector-register specified first operand, with its byte order reversed.

The displacement for VLLEBRZ is treated as a 12-bit unsigned integer.

The M₃ field specifies the size of the element to be loaded. If a reserved value is specified, a specification exception is recognized.

M ₃	Element Size
0	Reserved
1	Halfword
2	Word
3	Doubleword
4-5	Reserved
6	Word - Left Aligned
7-15	Reserved

The illustration below shows the resulting register content of this instruction:

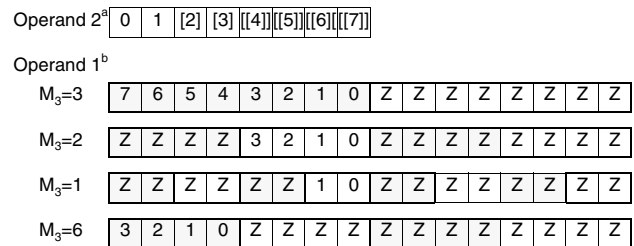

- a. only the number of bytes corresponding to the element size specified by M₃ are accessed.
- b. a 'Z' in the table denotes a byte with the value of zero.

Condition Code: The code remains unchanged.

Program Exceptions:

- Access (fetch, operand 2)
- Data with DXC FE, Vector Instruction
- Operation (if the vector enhancements facility 2 is not installed)
- Specification

- Transaction constraint

Extended Mnemonics:

Extended Mnemonic	Base Mnemonic
VLEBRZH $V_1, D_2(X_2, B_2)$	VLEBRZ $V_1, D_2(X_2, B_2), 1$
VLEBRZF $V_1, D_2(X_2, B_2)$	VLEBRZ $V_1, D_2(X_2, B_2), 2$
VLEBRZG $V_1, D_2(X_2, B_2)$	VLEBRZ $V_1, D_2(X_2, B_2), 3$
VLEBRZE $V_1, D_2(X_2, B_2)$	VLEBRZ $V_1, D_2(X_2, B_2), 6$
LDRV $V_1, D_2(X_2, B_2)$	VLEBRZ $V_1, D_2(X_2, B_2), 3$
LERV $V_1, D_2(X_2, B_2)$	VLEBRZ $V_1, D_2(X_2, B_2), 6$

Programming Note: This instruction is similar to the VECTOR LOAD LOGICAL ELEMENT AND ZERO but is useful for operating on data in storage in the little endian format

VECTOR LOAD BYTE REVERSED ELEMENTS

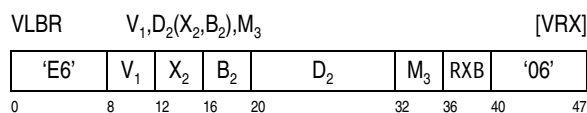

The 16-byte second operand is loaded into the first-operand location. For each element of the second operand, the left-to-right sequence of the bytes is reversed and placed into the corresponding first-operand element location.

The displacement for VLBR is treated as a 12-bit unsigned integer.

The M_3 field specifies the size of the element to be loaded. If a reserved value is specified, a specification exception is recognized.

M_3	Element Size
0	Reserved
1	Halfword
2	Word
3	Doubleword
4	Quadword
5-15	Reserved

The illustration below shows the resulting byte position of this instruction:

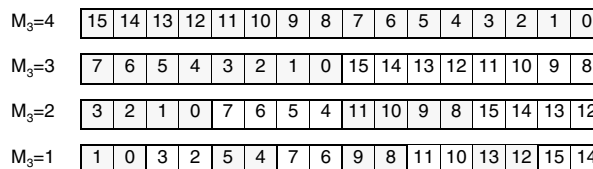
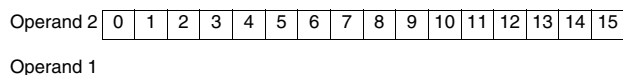

Condition Code: The code remains unchanged.

Program Exceptions:

- Access (fetch, operand 2)
- Data with DXC FE, Vector Instruction
- Operation (if the vector enhancements facility 2 is not installed)
- Specification
- Transaction constraint

Extended Mnemonics:

Extended Mnemonic	Base Mnemonic
VLBRH $V_1, D_2(X_2, B_2)$	VLBR $V_1, D_2(X_2, B_2), 1$
VLBRF $V_1, D_2(X_2, B_2)$	VLBR $V_1, D_2(X_2, B_2), 2$
VLBRG $V_1, D_2(X_2, B_2)$	VLBR $V_1, D_2(X_2, B_2), 3$
VLBRQ $V_1, D_2(X_2, B_2)$	VLBR $V_1, D_2(X_2, B_2), 4$

Programming Note: This instruction is similar to the VECTOR LOAD but is useful for operating on data in storage in the little endian format.

VECTOR LOAD ELEMENT

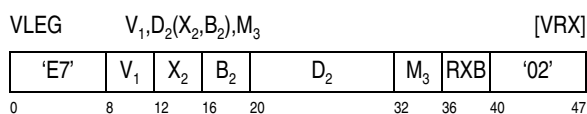
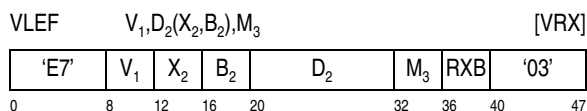
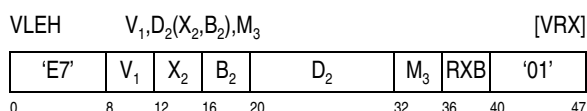
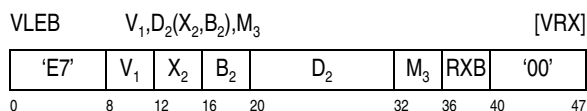

The element-sized second operand replaces the specified element of the first operand indexed by the

M_3 field. The remaining elements are left unchanged. If the third operand specifies a value greater than the highest numbered element in the first operand, of the specified element size, a specification exception is recognized.

The displacement for VECTOR LOAD ELEMENT is treated as a 12-bit unsigned integer.

For VLEB the elements are byte sized. For VLEH the elements are halfword sized. For VLEF the elements are word sized. For VLEG the elements are doubleword sized.

Condition Code: The code remains unchanged.

Program Exceptions:

- Access (fetch, operand 2)
- Data with DXC FE, Vector Instruction
- Operation (if the vector facility for z/Architecture is not installed)
- Specification
- Transaction constraint

Programming Note: For VLEB a specification is not recognized since the third operand cannot designate an index greater than the number of elements.

VECTOR LOAD ELEMENT IMMEDIATE

VLEIB V_1, I_2, M_3 [VRI-a]

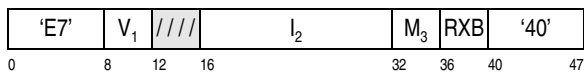

VLEIH V_1, I_2, M_3 [VRI-a]

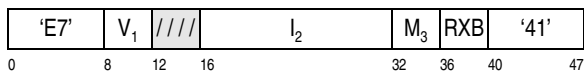

VLEIF V_1, I_2, M_3 [VRI-a]

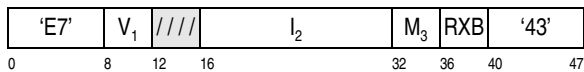

VLEIG V_1, I_2, M_3 [VRI-a]

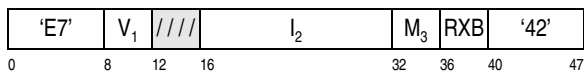

The signed binary integer second operand is sign extended, if necessary, and replaces the specified element of the first operand. The remaining elements are left unchanged. The M_3 field specifies the element index of the first operand for the second operand to replace. For VLEIB, only bits 8-15 of the second operand are placed into the byte element; bits 0-7 are ignored. If the third operand specifies a value greater than the highest numbered element in the first operand, of the specified element size, a specification exception is recognized.

For VLEIB the elements are byte sized. For VLEIH the elements are halfword sized. For VLEIF the elements are word sized. For VLEIG the elements are doubleword sized.

Condition Code: The code remains unchanged.

Program Exceptions:

- Data with DXC FE, Vector Instruction
- Operation (if the vector facility for z/Architecture is not installed)
- Specification
- Transaction constraint

Programming Note: For VLEIB a specification is not recognized since the third operand cannot designate an index greater than the number of elements.

VECTOR LOAD ELEMENTS REVERSED

VLER $V_1, D_2(X_2, B_2), M_3$ [VRX]

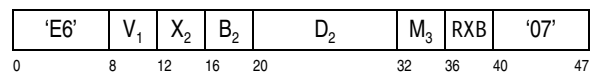

The 16-byte second operand is loaded into the first-operand location. The left-to-right sequence of the elements is reversed when loading into the vector register. The bytes within the elements themselves are not reversed.

The displacement for VLER is treated as a 12-bit unsigned integer.

The M_3 field specifies the size of the element to be loaded. If a reserved value is specified, a specification exception is recognized.

M_3	Element Size
0	Reserved
1	Halfword
2	Word
3	Doubleword
4-15	Reserved

The illustration below shows the resulting byte position of this instruction:

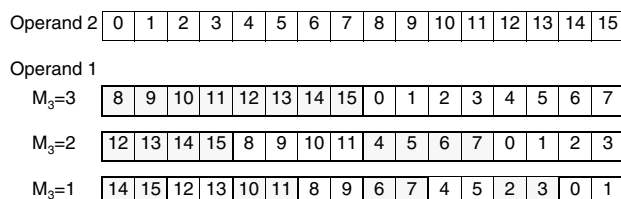

Condition Code: The code remains unchanged.

Program Exceptions:

- Access (fetch, operand 2)
- Data with DXC FE, Vector Instruction
- Operation (if the vector enhancements facility 2 is not installed)
- Specification
- Transaction constraint

Extended Mnemonics:

Extended Mnemonic	Base Mnemonic
VLERH $V_1, D_2(X_2, B_2)$	VLER $V_1, D_2(X_2, B_2), 1$
VLERF $V_1, D_2(X_2, B_2)$	VLER $V_1, D_2(X_2, B_2), 2$
VLERG $V_1, D_2(X_2, B_2)$	VLER $V_1, D_2(X_2, B_2), 3$

Programming Notes:

1. VECTOR LOAD BYTE REVERSED ELEMENTS with an M_3 value of 4 can be used to reverse the elements when the elements are byte-sized.
2. This instruction is useful in the context of large precision arithmetic.

VECTOR LOAD GR FROM VR ELEMENT

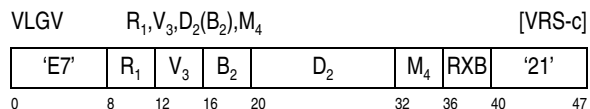

The element of the third operand indexed by the second-operand address is placed in the first-operand location. The third operand is a vector register. The first operand is a general register. If the index specified by the second-operand address is greater than the highest numbered element in the third operand, of the specified element size, the result in the first operand is unpredictable.

If the vector register element is smaller than a doubleword, the element is right aligned in the 64-bit general register and zeros fill the remaining bits.

The second-operand address is not used to address data; instead the rightmost 12 bits of the address are used to specify the index of an element within the third operand.

The M_4 field specifies the element size control (ES). The ES control specifies the size of the elements in the vector register operands. If a reserved value is specified, a specification exception is recognized.

M_4	Element Size
0	Byte
1	Halfword
2	Word
3	Doubleword
4-15	Reserved

Condition Code: The code remains unchanged.

Program Exceptions:

- Data with DXC FE, Vector Instruction
- Operation (if the vector facility for z/Architecture is not installed)
- Specification
- Transaction constraint

Extended Mnemonics:

Extended Mnemonic	Base Mnemonic
VLGVB $R_1, V_3, D_2(B_2)$	VLGV $R_1, V_3, D_2(B_2), 0$

Extended Mnemonic		Base Mnemonic	
VLGVH	$R_1, V_3, D_2(B_2)$	VLGV	$R_1, V_3, D_2(B_2), 1$
VLGVF	$R_1, V_3, D_2(B_2)$	VLGV	$R_1, V_3, D_2(B_2), 2$
VLGVG	$R_1, V_3, D_2(B_2)$	VLGV	$R_1, V_3, D_2(B_2), 3$

VECTOR LOAD LOGICAL ELEMENT AND ZERO

VLLEZ	$V_1, D_2(X_2, B_2), M_3$	[VRX]																	
<table border="1" style="border-collapse: collapse; width: 100%; text-align: center;"> <tr> <td style="width: 8%;">'E7'</td> <td style="width: 4%;">V₁</td> <td style="width: 4%;">X₂</td> <td style="width: 4%;">B₂</td> <td style="width: 12%;">D₂</td> <td style="width: 4%;">M₃</td> <td style="width: 4%;">RXB</td> <td style="width: 4%;">'04'</td> </tr> <tr> <td>0</td> <td>8</td> <td>12</td> <td>16</td> <td>20</td> <td>32</td> <td>36</td> <td>40</td> <td>47</td> </tr> </table>			'E7'	V ₁	X ₂	B ₂	D ₂	M ₃	RXB	'04'	0	8	12	16	20	32	36	40	47
'E7'	V ₁	X ₂	B ₂	D ₂	M ₃	RXB	'04'												
0	8	12	16	20	32	36	40	47											

When the M_3 value is in the range of 0-3, the unsigned element-sized second operand is placed in the rightmost sub-element or element of the leftmost doubleword element of the vector-register specified first operand. When the vector-enhancements facility 1 is installed and the M_3 value is 6 the unsigned element-sized second operand is placed in the leftmost sub-element of the leftmost doubleword element of the vector-register specified first operand. The bit positions of all other elements are set to zero. The element size is determined by the ES value in the M_3 field.

The displacement for VLLEZ is treated as a 12-bit unsigned binary integer.

The M_3 field specifies the element size control (ES). The ES control specifies the size of the element in the vector register operands. If a reserved value is specified, a specification exception is recognized. When the vector-enhancements facility 1 is not installed the M_3 value of 6 is also reserved.

M_3	Element Size
0	Byte
1	Halfword
2	Word
3	Doubleword
4-5	Reserved
6	Word - Left Aligned
7-15	Reserved

Condition Code: The code remains unchanged.

Program Exceptions:

- Access (fetch, operand 2)

- Data with DXC FE, Vector Instruction
- Operation (if the vector facility for z/Architecture is not installed)
- Specification
- Transaction constraint

Extended Mnemonics:

Extended Mnemonic		Base Mnemonic	
VLLEZB	$V_1, D_2(X_2, B_2)$	VLLEZ	$V_1, D_2(X_2, B_2), 0$
VLLEZH	$V_1, D_2(X_2, B_2)$	VLLEZ	$V_1, D_2(X_2, B_2), 1$
VLLEZF	$V_1, D_2(X_2, B_2)$	VLLEZ	$V_1, D_2(X_2, B_2), 2$
VLLEZG	$V_1, D_2(X_2, B_2)$	VLLEZ	$V_1, D_2(X_2, B_2), 3$
VLLEZLF	$V_1, D_2(X_2, B_2)$	VLLEZ	$V_1, D_2(X_2, B_2), 6$

Programming Note: This instruction can be used for loading scalar values into vector registers.

VECTOR LOAD MULTIPLE

VLM	$V_1, V_3, D_2(B_2), M_4$	[VRS-a]																	
<table border="1" style="border-collapse: collapse; width: 100%; text-align: center;"> <tr> <td style="width: 8%;">'E7'</td> <td style="width: 4%;">V₁</td> <td style="width: 4%;">V₃</td> <td style="width: 4%;">B₂</td> <td style="width: 12%;">D₂</td> <td style="width: 4%;">M₄</td> <td style="width: 4%;">RXB</td> <td style="width: 4%;">'36'</td> </tr> <tr> <td>0</td> <td>8</td> <td>12</td> <td>16</td> <td>20</td> <td>32</td> <td>36</td> <td>40</td> <td>47</td> </tr> </table>			'E7'	V ₁	V ₃	B ₂	D ₂	M ₄	RXB	'36'	0	8	12	16	20	32	36	40	47
'E7'	V ₁	V ₃	B ₂	D ₂	M ₄	RXB	'36'												
0	8	12	16	20	32	36	40	47											

The set of vector registers starting with the first operand and vector register designation and ending with the third operand vector register designation are loaded from storage beginning at the location specified by the second-operand address and continuing through as many locations as needed.

The vector registers are loaded in ascending order of their register numbers starting with the first operand vector register designation and continuing up to and including the third operand vector register designation. If the third operand vector register designation is less than the first operand vector register designation, a specification exception is recognized. The number of registers to be loaded is at most sixteen. If a range of more than sixteen registers is specified, a specification exception is recognized.

The displacement for VLM is treated as a 12-bit unsigned binary number.

The M_4 field contains a 4-bit unsigned binary integer specifying the alignment of the second operand. Reserved values should not be specified; otherwise,

the program may not operate compatibly in the future.

M₄ Alignment Hint

0	No alignment indicated
1-2	Reserved
3	Doubleword aligned
4	Quadword aligned
5-15	Reserved

Condition Code: The code remains unchanged.

Program Exceptions:

- Access (fetch, operand 2)
- Data with DXC FE, Vector Instruction
- Operation (if the vector facility for z/Architecture is not installed)
- Specification
- Transaction constraint

Programming Notes:

1. If the first operand vector register designation and the third operand vector register designation specify the same vector register only 16-bytes are loaded.
2. If the alignment of the address specified by the second operand is known to be either on a doubleword or quadword boundary and alignment hint is set to 3 or 4 respectively, performance may be improved on some models. If the alignment of the second operand is not on a doubleword or quadword boundary, or is unknown, the alignment hint should be set to 0.
3. Setting the alignment hint to a non-zero value that doesn't correspond to the alignment of the second operand may reduce performance on some models.

VECTOR LOAD RIGHTMOST WITH LENGTH

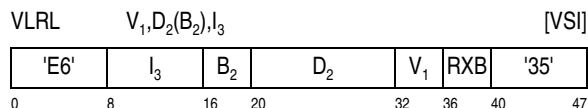
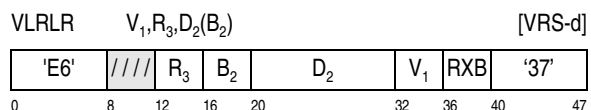

Proceeding from left to right, the specified number of bytes from the second-operand location are placed in the first operand location.

For VLRLR, bits 32-63 of the general-register specified third operand contain an unsigned integer value that when subtracted from fifteen represents the index of the first byte of the vector register to load. If the third operand contains a value greater than or equal to fifteen, all bytes of the first operand are loaded. Bits 0-31 of the third operand are ignored.

For VLRL, the I₃ field has the following format:

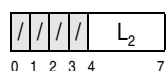

The bits of the I₃ field are defined as follows:

- **Reserved:** Bits 0-3 are reserved and must contain zeros. Otherwise, a specification exception is recognized.
- **Operand 2 Length Code(L₂):** Bits 4-7 contain an unsigned integer value that when subtracted from fifteen represents the index of the first byte of the vector register to load. If the L₂ field contains a value equal to fifteen, all bytes of the first operand are loaded.

Zeros are placed in any bytes of the first operand that are not loaded from the second operand. Access exceptions are only recognized for the bytes of the second operand that are loaded from storage.

The displacement is a 12-bit unsigned integer.

Condition Code: The code remains unchanged.

Program Exceptions:

- Access (fetch, operand 2)
- Data with DXC FE, Vector Instruction
- Operation (if the vector-packed-decimal facility for z/Architecture is not installed)
- Specification (VLRL only)
- Transaction constraint

VECTOR LOAD TO BLOCK BOUNDARY

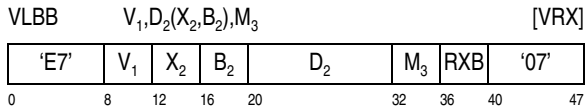

The single vector-register first operand is loaded starting at the zero indexed byte element with bytes from the second operand. If a boundary condition is encountered, the rest of the first operand is unpredictable. Access exceptions are not recognized for second-operand locations beyond the specified boundary. If no boundary is encountered, all byte elements of the first operand are loaded with data from storage.

The displacement for VLBB is treated as a 12-bit unsigned integer.

The M_3 field specifies a code indicating the boundary at which the second operand ends. If a reserved value is specified, a specification exception is recognized.

Code Boundary

0	64 Byte
1	128 Byte
2	256 Byte
3	512 Byte
4	1 K-byte
5	2 K-Byte
6	4 K-Byte
7-15	Reserved

Condition Code: The code remains unchanged.

Program Exceptions:

- Access (fetch, operand 2)
- Data with DXC FE, Vector Instruction
- Operation (if the vector facility for z/Architecture is not installed)
- Specification
- Transaction constraint

Programming Notes:

1. In certain circumstances, data may be loaded past the block boundary. However, this will only occur if there are no access exceptions on that

data. The program should not depend on the unpredictable data being loaded by a particular model.

2. This instruction can be used for loading null-terminated character data without crossing a page, segment, or region boundary unnecessarily.
3. If a block size code equal to the cache line size of the processor is specified, performance may be improved due to the fact that subsequent accesses will be aligned.
4. The LOAD COUNT TO BLOCK BOUNDARY instruction may be used with the same specified boundary to obtain a count of the number of bytes loaded.

VECTOR LOAD VR ELEMENT FROM GR

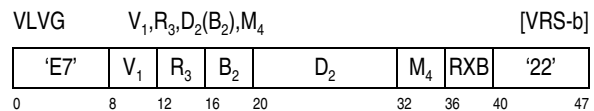

The third operand of size specified by the ES value in the M_4 field is placed into the element of the first operand indexed by the second-operand address. The third operand is a general register. The first operand is a vector register. If the index, specified by the second-operand address, is greater than the highest numbered element in the first operand, of the specified element size, it is unpredictable which element, if any, is replaced.

For element sizes less than doubleword the rightmost bits of the third operand are used.

The second operand is not used to address data; instead the rightmost 12 bits of the address are used to specify the index of an element within the first operand.

The M_4 field specifies the element size control (ES). The ES control specifies the size of the elements in the vector register operands. If a reserved value is specified, a specification exception is recognized.

M_4 Element Size

0	Byte
1	Halfword
2	Word

M₄	Element Size
3	Doubleword
4-15	Reserved

Condition Code: The code remains unchanged.

Program Exceptions:

- Data with DXC FE, Vector Instruction
- Operation (if the vector facility for z/Architecture is not installed)
- Specification
- Transaction constraint

Extended Mnemonics:

Extended Mnemonic	Base Mnemonic
VLVGB V ₁ ,R ₃ ,D ₂ (B ₂)	VLVG V ₁ ,R ₃ ,D ₂ (B ₂),0
VLVGH V ₁ ,R ₃ ,D ₂ (B ₂)	VLVG V ₁ ,R ₃ ,D ₂ (B ₂),1
VLVGF V ₁ ,R ₃ ,D ₂ (B ₂)	VLVG V ₁ ,R ₃ ,D ₂ (B ₂),2
VLVGG V ₁ ,R ₃ ,D ₂ (B ₂)	VLVG V ₁ ,R ₃ ,D ₂ (B ₂),3

VECTOR LOAD VR FROM GRS DISJOINT

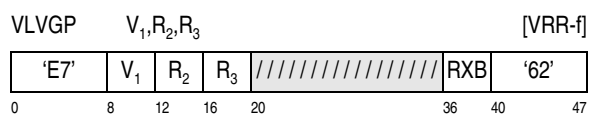

The general register specified second operand placed unchanged into bit positions 0-63 of the first operand. The general register specified third operand is placed unchanged into bit positions 64-127 of the first operand.

Condition Code: The code remains unchanged.

Program Exceptions:

- Data with DXC FE, Vector Instruction
- Operation (if the vector facility for z/Architecture is not installed)
- Transaction constraint

VECTOR LOAD WITH LENGTH

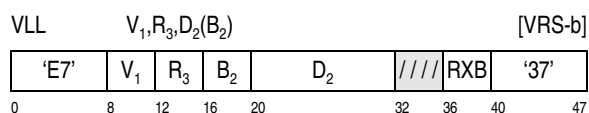

Proceeding from left to right, bytes of the first operand are loaded from the second-operand location. The third operand (in general register R₃) contains a 32-bit unsigned integer that represents the highest indexed byte to load. If the third operand contains a value greater than or equal to the highest byte index of the vector, all bytes of the first operand are loaded. Zeros are placed in any bytes that are not loaded.

Access exceptions are only recognized for the bytes of the second operand that are loaded from storage.

Condition Code: The code remains unchanged.

Program Exceptions:

- Access (fetch, operand 2)
- Data with DXC FE, Vector Instruction
- Operation (if the vector facility for z/Architecture is not installed)
- Transaction constraint

VECTOR MERGE HIGH

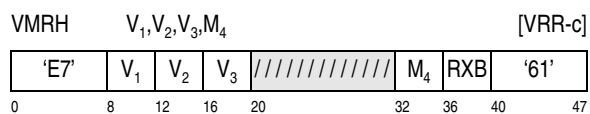

Proceeding from left to right, the elements in the leftmost half of the second operand are placed into the even indexed elements of the first operand. Proceeding from left to right, the elements in the leftmost half of the third operand are placed into the odd indexed elements of the first operand. The elements in the low order half of the second and third operands are ignored.

If the same register is used to designate the first operand as either the second or third operands the source value is used throughout the operation with no intermediate updates.

The M₄ field specifies the element size control (ES). The ES control specifies the size of the elements in the vector register operands. If a reserved value is specified, a specification exception is recognized.

M₄	Element Size
0	Byte

M_4	Element Size
1	Halfword
2	Word
3	Doubleword
4-15	Reserved

Condition Code: The code remains unchanged.

Program Exceptions:

- Data with DXC FE, Vector Instruction
- Operation (if the vector facility for z/Architecture is not installed)
- Specification
- Transaction constraint

Extended Mnemonics:

Extended Mnemonic	Base Mnemonic
VMRHB V_1, V_2, V_3	VMRH $V_1, V_2, V_3, 0$
VMRHH V_1, V_2, V_3	VMRH $V_1, V_2, V_3, 1$
VMRHF V_1, V_2, V_3	VMRH $V_1, V_2, V_3, 2$
VMRHG V_1, V_2, V_3	VMRH $V_1, V_2, V_3, 3$

VECTOR MERGE LOW

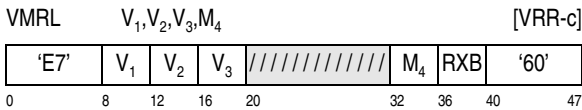

Proceeding from left to right, the elements in the rightmost half of the second operand are placed into the even indexed elements of first operand. Proceeding from left to right, the elements in the rightmost half of the third operand are placed into the odd indexed elements of the first operand. The elements in the high order half of the second and third operands are ignored.

If the same register is used to designate the first operand as either the second or third operands the source value is used throughout the operation with no intermediate updates.

The M_4 field specifies the element size control (ES). The ES control specifies the size of the elements in

the vector register operands. If a reserved value is specified, a specification exception is recognized.

M_4	Element Size
0	Byte
1	Halfword
2	Word
3	Doubleword
4-15	Reserved

Condition Code: The code remains unchanged.

Program Exceptions:

- Data with DXC FE, Vector Instruction
- Operation (if the vector facility for z/Architecture is not installed)
- Specification
- Transaction constraint

Extended Mnemonics:

Extended Mnemonic	Base Mnemonic
VMRLB V_1, V_2, V_3	VMRL $V_1, V_2, V_3, 0$
VMRLH V_1, V_2, V_3	VMRL $V_1, V_2, V_3, 1$
VMRLF V_1, V_2, V_3	VMRL $V_1, V_2, V_3, 2$
VMRLG V_1, V_2, V_3	VMRL $V_1, V_2, V_3, 3$

VECTOR PACK

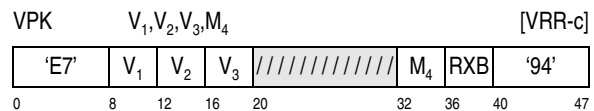

A source vector is created from the concatenation of the vector register-specified second operand followed by the vector-register-specified third operand. In a left to right fashion, each element in the source vector is reduced in size by half. The rightmost half of each element of the source vector is placed into the corresponding element of the vector-register-specified first operand.

If the same register is used to designate the first operand as either the second or third operands the source value is used throughout the operation with no intermediate updates.

The M_4 field specifies the element size control (ES). The ES control specifies the size of the elements in the second and third operands. The first operand

contains elements half the size of those specified by the ES control. If a reserved value is specified, a specification exception is recognized.

M_4 Element Size

0	Reserved
1	Halfword
2	Word
3	Doubleword
4-15	Reserved

Condition Code: The code remains unchanged.

Program Exceptions:

- Data with DXC FE, Vector Instruction
- Operation (if the vector facility for z/Architecture is not installed)
- Specification
- Transaction constraint

Extended Mnemonics:

Extended Mnemonic		Base Mnemonic	
VPKH	V_1, V_2, V_3	VPK	$V_1, V_2, V_3, 1$
VPKF	V_1, V_2, V_3	VPK	$V_1, V_2, V_3, 2$
VPKG	V_1, V_2, V_3	VPK	$V_1, V_2, V_3, 3$

VECTOR PACK SATURATE

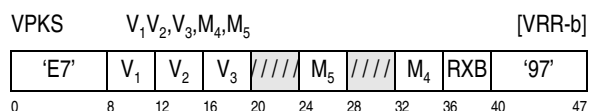

A source vector is created from the concatenation of the second operand followed by the third operand. In a left to right fashion each signed element in the source vector is reduced in size by half and placed in the corresponding element of the first operand. If the element in the source vector is outside of the allowable range of the target element, the target element is set to the maximum value in the target format in the direction of the overflow.

If the same register is used to designate the first operand as either the second or third operands, the original source value is used throughout the operation with no intermediate updates.

The M_4 field specifies the element size control (ES). The ES control specifies the size of the elements in

the second and third operands. The first operand contains elements half the size of those specified by the ES control. If a reserved value is specified, a specification exception is recognized.

M_4 Element Size

0	Reserved
1	Halfword
2	Word
3	Doubleword
4-15	Reserved

The M_5 field has the following format:



The bits of the M_5 field are defined as follows:

- **Reserved:** Bits 0, 1, and 2 are reserved and should contain zeros; otherwise, the program may not operate compatibly in the future.
- **Condition Code Set (CS):** If bit 3 is 0, the code remains unchanged. If the bit is one, the code is set as described below.

Resulting Condition Code: When bit 3 of the M_5 field is one, the condition code is set as follows:

- | | |
|---|---|
| 0 | No saturation |
| 1 | At least one but not all elements saturated |
| 2 | -- |
| 3 | Saturation on all elements |

When bit 3 of the M_5 field is zero, the code remains unchanged.

Program Exceptions:

- Data with DXC FE, Vector Instruction
- Operation (if the vector facility for z/Architecture is not installed)
- Specification
- Transaction constraint

Extended Mnemonics:

Extended Mnemonic		Base Mnemonic	
VPKSH	V_1, V_2, V_3	VPKS	$V_1, V_2, V_3, 1, 0$
VPKSF	V_1, V_2, V_3	VPKS	$V_1, V_2, V_3, 2, 0$
VPKSG	V_1, V_2, V_3	VPKS	$V_1, V_2, V_3, 3, 0$

Extended Mnemonic	Base Mnemonic
VPKSHS V_1, V_2, V_3	VPKS $V_1, V_2, V_3, 1, 1$
VPKSFSS V_1, V_2, V_3	VPKS $V_1, V_2, V_3, 2, 1$
VPKSGS V_1, V_2, V_3	VPKS $V_1, V_2, V_3, 3, 1$

VECTOR PACK LOGICAL SATURATE

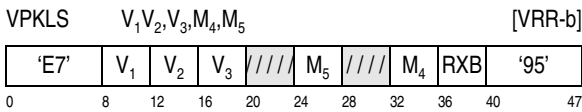

A source vector is created from the concatenation of the second operand followed by the third operand. In a left to right fashion, each unsigned integer element in the source vector is reduced in size by half and placed in the corresponding element in the first operand. If the magnitude of the element in the source vector is greater than the largest magnitude representable in the target element, the target element is set to the largest representable magnitude value.

If the same register is used to designate the first operand as either the second or third operands, the original source value is used throughout the operation with no intermediate updates.

The M_4 field specifies the element size control (ES). The ES control specifies the size of the elements in the second and third operands. The first operand contains elements half the size of those specified by the ES control. If a reserved value is specified, a specification exception is recognized.

M_4	Element Size
0	Reserved
1	Halfword
2	Word
3	Doubleword
4-15	Reserved

The M_5 field has the following format:



The bits of the M_5 field are defined as follows:

- **Reserved:** Bits 0, 1, and 2 are reserved and should contain zeros; otherwise, the program may not operate compatibly in the future.
- **Condition Code Set (CS):** If bit 3 is 0, the code remains unchanged. If the bit is one, the code is set as described below.

Resulting Condition Code: When bit 3 of the M_5 field is one, the condition code is set as follows:

- 0 No saturation
- 1 At least one but not all elements saturated
- 2 --
- 3 Saturation on all elements

When bit 3 of the M_5 field is zero, the code remains unchanged.

Program Exceptions:

- Data with DXC FE, Vector Instruction
- Operation (if the vector facility for z/Architecture is not installed)
- Specification
- Transaction constraint

Extended Mnemonics:

Extended Mnemonic	Base Mnemonic
VPKLSH V_1, V_2, V_3	VPKLS $V_1, V_2, V_3, 1, 0$
VPKLSF V_1, V_2, V_3	VPKLS $V_1, V_2, V_3, 2, 0$
VPKLSG V_1, V_2, V_3	VPKLS $V_1, V_2, V_3, 3, 0$
VPKLSHS V_1, V_2, V_3	VPKLS $V_1, V_2, V_3, 1, 1$
VPKLSFSS V_1, V_2, V_3	VPKLS $V_1, V_2, V_3, 2, 1$
VPKLSGS V_1, V_2, V_3	VPKLS $V_1, V_2, V_3, 3, 1$

VECTOR PERMUTE

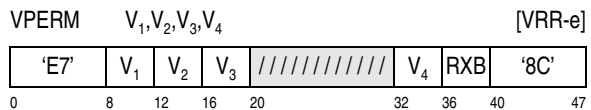

A source vector is created from the concatenation of the second operand followed by the third operand. The byte element of the source vector indexed by the five least significant bits of each byte element of the fourth operand is placed into the byte element of the first operand corresponding to the byte element in the fourth operand.

If the same register is used to designate the first operand as either the second, third, or fourth operands the original source value is used throughout the operation with no intermediate updates.

Condition Code: The code remains unchanged.

Program Exceptions:

- Data with DXC FE, Vector Instruction
- Operation (if the vector facility for z/Architecture is not installed)
- Transaction constraint

VECTOR PERMUTE DOUBLEWORD IMMEDIATE

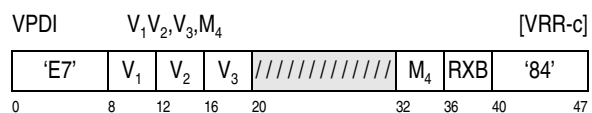

The first, second and third operands consist of double word elements. Bit 1 of the M₄ field is the index which selects which doubleword of the second operand is placed into the zero indexed doubleword of the first operand. Bit 3 of the M₄ field is the index which selects which doubleword of the third operand is placed in the doubleword element with index one of the first operand.

The M₄ field has the following format:



The bits of the M₄ field are defined as follows:

- **Reserved:** Bits 0 and 2 are reserved and should be zeros; otherwise, the program may not operate compatibly in the future.
- **Second Operand Index (I2):** Bit 1 provides the index of the doubleword in the second operand to be placed in the first operand.
- **Third operand index (I3):** Bit 3 provides the index of the doubleword in the third operand to be placed in the first operand.

If the same register is used to designate the first operand as either the second or third operands, the

original source value is used throughout the operation with no intermediate updates.

Condition Code: The code remains unchanged.

Program Exceptions:

- Data with DXC FE, Vector Instruction
- Operation (if the vector facility for z/Architecture is not installed)
- Transaction constraint

VECTOR REPLICATE

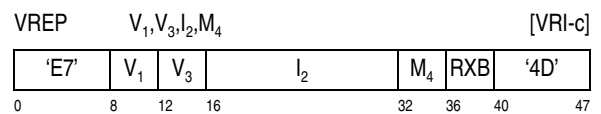

The element of the third operand indexed by the unsigned integer in I₂ is replicated across all elements of the first operand. If the value of the unsigned integer in I₂ is greater than the highest element number in the third operand, of the specified element size, a specification exception is recognized.

The M₄ field specifies the element size control (ES). The ES control specifies the size of the elements in the vector register operands. If a reserved value is specified, a specification exception is recognized.

M₄ Element Size

- 0 Byte
- 1 Halfword
- 2 Word
- 3 Doubleword
- 4-15 Reserved

Condition Code: The code remains unchanged.

Program Exceptions:

- Data with DXC FE, Vector Instruction
- Operation (if the vector facility for z/Architecture is not installed)
- Specification
- Transaction constraint

Extended Mnemonics:

Extended Mnemonic	Base Mnemonic
VREP V_1, V_3, I_2	VREP $V_1, V_3, I_2, 0$

Extended Mnemonic		Base Mnemonic	
VREPH	V_1, V_3, I_2	VREP	$V_1, V_3, I_2, 1$
VREPF	V_1, V_3, I_2	VREP	$V_1, V_3, I_2, 2$
VREPG	V_1, V_3, I_2	VREP	$V_1, V_3, I_2, 3$

VECTOR REPLICATE IMMEDIATE

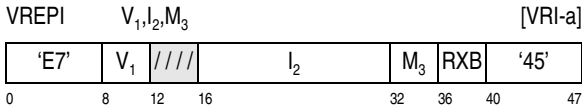

The signed integer immediate value in I_2 is sign extended, if necessary, and replicated across all elements of the first operand. If the element size is less than a halfword, only bits 8 through 15 of the I_2 field are used; bits zero through seven are ignored.

The M_3 field specifies the element size control (ES). The ES control specifies the size of the elements in the vector register operands. If a reserved value is specified, a specification exception is recognized.

M_3	Element Size
0	Byte
1	Halfword
2	Word
3	Doubleword
4-15	Reserved

Condition Code: The code remains unchanged.

Program Exceptions:

- Data with DXC FE, Vector Instruction
- Operation (if the vector facility for z/Architecture is not installed)
- Specification
- Transaction constraint

Extended Mnemonics:

Extended Mnemonic		Base Mnemonic	
VREPIB	V_1, I_2	VREPI	$V_1, I_2, 0$
VREPIH	V_1, I_2	VREPI	$V_1, I_2, 1$
VREPIF	V_1, I_2	VREPI	$V_1, I_2, 2$
VREPIG	V_1, I_2	VREPI	$V_1, I_2, 3$

VECTOR SCATTER ELEMENT

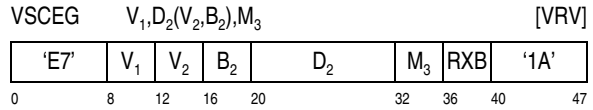
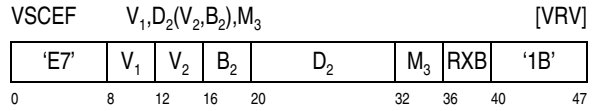

The element of the first operand designated by the M_3 field is placed unchanged into the second-operand location. If the third operand specifies a value greater than the highest numbered element in the first operand, of the specified element size, a specification exception is recognized.

For VSCEF the elements are 4-bytes in size; for VSCEG the elements are 8-bytes in size.

The second-operand address is generated by adding the unsigned binary integer value from the element in vector-register V_2 indexed by the M_3 field with the address in the B_2 register along with the D_2 value.

The displacement for VECTOR SCATTER ELEMENT is treated as a 12-bit unsigned integer.

Condition Code: The code remains unchanged.

Program Exceptions:

- Access (store, operand 2)
- Data with DXC FE, Vector Instruction
- Operation (if the vector facility for z/Architecture is not installed)
- Specification
- Transaction constraint

Programming Notes:

1. The VECTOR SCATTER ELEMENT instruction can be used to perform a store when doing scalar computation in vector registers and the address resides in a vector register. However, depending on the model, performance may be better if address computations are done in general registers.
2. For VSCEF care must be taken to ensure that the values in the second operand elements are unsigned. Otherwise, when running in 64-bit

addressing mode program behavior might not be as expected.

VECTOR SELECT

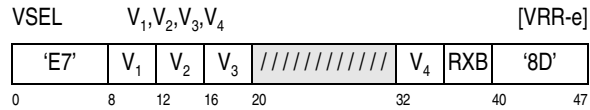

For each bit in the fourth operand that contains a zero, the corresponding bit from the third operand is placed in the corresponding bit of the first operand. For each bit in the fourth operand that contains a one, the corresponding bit from the second operand is placed in the corresponding bit of the first operand.

Condition Code: The code remains unchanged.

Program Exceptions:

- Data with DXC FE, Vector Instruction
- Operation (if the vector facility for z/Architecture is not installed)
- Transaction constraint

VECTOR SIGN EXTEND TO DOUBLEWORD

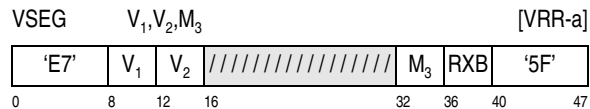

The leftmost bit of the rightmost element-sized subelement of each doubleword of the second operand is replicated across all bit positions of all other elements in the doubleword. The result is placed in the corresponding doubleword of the first operand.

The M_3 field specifies the element size control (ES). The ES control specifies the size of the element in each doubleword of the second operand. If a reserved value is specified, a specification exception is recognized.

M_3	Element Size
0	Byte
1	Halfword
2	Word
3-15	Reserved

Condition Code: The code remains unchanged.

Program Exceptions:

- Data with DXC FE, Vector Instruction
- Operation (if the vector facility for z/Architecture is not installed)
- Specification
- Transaction constraint

Extended Mnemonics:

Extended Mnemonic	Base Mnemonic
VSEGB V_1, V_2	VSEG $V_1, V_2, 0$
VSEGH V_1, V_2	VSEG $V_1, V_2, 1$
VSEGF V_1, V_2	VSEG $V_1, V_2, 2$

Programming Notes:

1. This instruction allows for a value to be sign extended after being loaded with VECTOR LOAD LOGICAL ELEMENT AND ZERO.
2. To sign extend to smaller element sizes the VECTOR UNPACK instructions can be used.

VECTOR STORE



The 128-bit value in the first operand is stored to the storage location specified by the second operand.

The displacement for VST is treated as a 12-bit unsigned integer.

The M_3 field specifies an alignment hint (AH). The AH control specifies the alignment of the first byte of the second operand. Reserved values should not be specified; otherwise, the program may not operate compatibly in the future.

M_3	Alignment Hint
0	No alignment indicated
1-2	Reserved
3	Doubleword aligned
4	Quadword aligned
5-15	Reserved

Condition Code: The code remains unchanged.

Program Exceptions:

- Access (store, operand 2)
- Data with DXC FE, Vector Instruction
- Operation (if the vector facility for z/Architecture is not installed)
- Transaction constraint

Programming Notes:

1. If the alignment of the address specified by the second operand is known to be either on a doubleword or quadword boundary and alignment hint is set to 3 or 4 respectively, performance may be improved on some models. If the alignment of the second operand is not on a doubleword or quadword boundary, or is unknown, the alignment hint should be set to 0.
2. Setting the alignment hint to a non-zero value that doesn't correspond to the alignment of the second operand may reduce performance on some models.

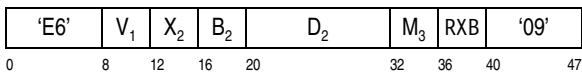
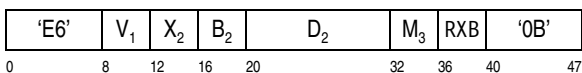
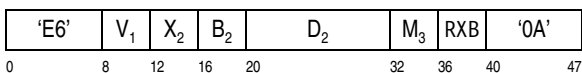
VECTOR STORE BYTE REVERSED ELEMENTVSTEBRH $V_1, D_2(X_2, B_2), M_3$ [VRX]VSTEBRF $V_1, D_2(X_2, B_2), M_3$ [VRX]VSTEBRG $V_1, D_2(X_2, B_2), M_3$ [VRX]

The first-operand element, indexed by the M_3 field, is stored into the element-sized second-operand. The left-to-right sequence of bytes within the elements is reversed when storing into the storage location. If the M_3 field specifies a value greater than the highest numbered element in the first operand, of the speci-

fied element size, a specification exception is recognized.

The displacement for VECTOR STORE BYTE REVERSED ELEMENT is treated as a 12-bit unsigned integer.

For VSTEBRH the elements are halfword sized. For VSTEBRF the elements are word sized. For VSTEBRG the elements are doubleword sized.

Condition Code: The code remains unchanged.

Program Exceptions:

- Access (store, operand 2)
- Data with DXC FE, Vector Instruction
- Operation (if the vector enhancements facility 2 is not installed)
- Specification
- Transaction constraint

Extended Mnemonics:

Extended Mnemonic	Base Mnemonic
STERV $V_1, D_2(X_2, B_2)$	VSTEBRF $V_1, D_2(X_2, B_2), 0$
STDRV $V_1, D_2(X_2, B_2)$	VSTEBRG $V_1, D_2(X_2, B_2), 0$

Programming Note: No byte-sized element version of this instruction exists as it would deliver the same result as VSTEB.

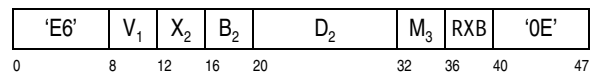
VECTOR STORE BYTE REVERSED ELEMENTSVSTBR $V_1, D_2(X_2, B_2), M_3$ [VRX]

The first operand is stored into the 16-bytes second operand. For each element of the first operand, the left-to-right sequence of bytes is reversed as that element is placed into the corresponding element of the 16-byte storage.

The displacement for VSTBR is treated as a 12-bit unsigned integer.

The M_3 field specifies the size of the element to be stored. If a reserved value is specified, a specification exception is recognized.

M_3 Element Size

0	Reserved
1	Halfword
2	Word
3	Doubleword
4	Quadword
5-15	Reserved

The illustration below shows the resulting byte position of this instruction:

Operand 1	0	1	2	3	4	5	6	7	8	9	10	11	12	13	14	15
Operand 2																
$M_3=4$	15	14	13	12	11	10	9	8	7	6	5	4	3	2	1	0
$M_3=3$	7	6	5	4	3	2	1	0	15	14	13	12	11	10	9	8
$M_3=2$	3	2	1	0	7	6	5	4	11	10	9	8	15	14	13	12
$M_3=1$	1	0	3	2	5	4	7	6	9	8	11	10	13	12	15	14

Condition Code: The code remains unchanged.

Program Exceptions:

- Access (store, operand 2)
- Data with DXC FE, Vector Instruction
- Operation (if the vector enhancements facility 2 is not installed)
- Specification
- Transaction constraint

Extended Mnemonics:

Extended Mnemonic	Base Mnemonic
VSTBRH $V_1, D_2(X_2, B_2)$	VSTBR $V_1, D_2(X_2, B_2), 1$
VSTBRF $V_1, D_2(X_2, B_2)$	VSTBR $V_1, D_2(X_2, B_2), 2$
VSTBRG $V_1, D_2(X_2, B_2)$	VSTBR $V_1, D_2(X_2, B_2), 3$
VSTBRQ $V_1, D_2(X_2, B_2)$	VSTBR $V_1, D_2(X_2, B_2), 4$

Programming Note: This instruction is similar to the VECTOR STORE but is useful for operating on data in storage in the little endian format.

VECTOR STORE ELEMENT

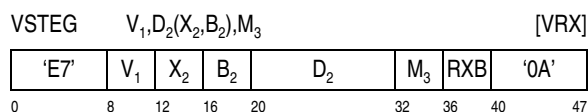
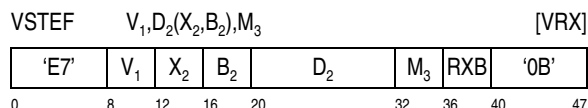
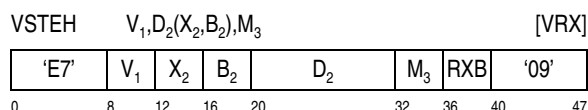
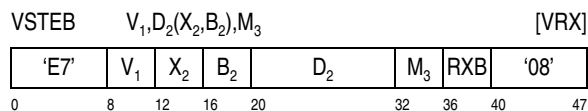

The element of the first operand designated by the M_3 field is placed unchanged into the second-operand location. If the third operand specifies a value greater than the highest numbered element in the first operand, of the specified element size, a specification exception is recognized. For VSTEB a specification is not recognized since the third operand cannot designate an index greater than the number of elements.

The displacement for VECTOR STORE ELEMENT is treated as a 12-bit unsigned integer.

For VSTEB the elements are byte sized. For VSTEH the elements are halfword sized. For VSTEF the elements are word sized. For VSTEG the elements are doubleword sized.

Condition Code: The code remains unchanged.

Program Exceptions:

- Access (store, operand 2)
- Data with DXC FE, Vector Instruction
- Operation (if the vector facility for z/Architecture is not installed)
- Specification
- Transaction constraint

VECTOR STORE ELEMENTS REVERSED

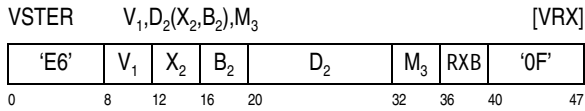

The first operand is stored into the 16-bytes second operand. The left-to-right sequence of the elements is reversed when storing into the storage location.

The displacement for VSTER is treated as a 12-bit unsigned integer.

The M_3 field specifies the size of the element to be stored. If a reserved value is specified, a specification exception is recognized.

M_3	Element Size
0	Reserved
1	Halfword
2	Word
3	Doubleword
4-15	Reserved

The illustration below shows the resulting byte position of this instruction:

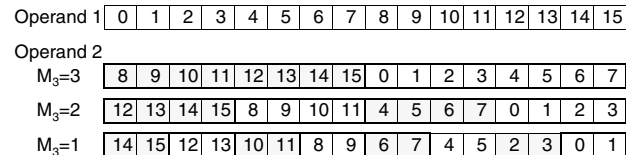

Condition Code: The code remains unchanged.

Program Exceptions:

- Access (store, operand 2)
- Data with DXC FE, Vector Instruction
- Operation (if the vector enhancements facility 2 is not installed)
- Specification
- Transaction constraint

Extended Mnemonics:

Extended Mnemonic	Base Mnemonic
VSTERH $V_1, D_2(X_2, B_2)$	VSTER $V_1, D_2(X_2, B_2), 1$
VSTERF $V_1, D_2(X_2, B_2)$	VSTER $V_1, D_2(X_2, B_2), 2$
VSTERG $V_1, D_2(X_2, B_2)$	VSTER $V_1, D_2(X_2, B_2), 3$

Programming Notes:

1. VECTOR STORE BYTE REVERSED ELEMENTS with an M_3 value of 4 can be used to reverse the elements when the elements are byte-sized.
2. This instruction is useful in the context of large precision arithmetic.

VECTOR STORE MULTIPLE

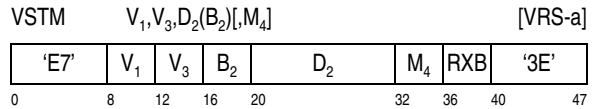

The set of vector registers starting with the first operand and vector register designation and ending with the third operand vector register designation are placed in the storage area beginning at the location specified by the second-operand address and continuing through as many locations as needed.

The contents of bit positions 0-127 of the vector registers are stored in successive 16-byte fields beginning at the second-operand address.

The vector registers are stored in the ascending order of their register numbers, starting with the first operand vector register designation and continuing up to and including the third operand vector register designation. If the third operand vector register designation is less than the first operand vector register designation, a specification exception is recognized. The number of registers to be stored is at most sixteen. If a range of more than sixteen registers is specified, a specification exception is recognized.

The displacement for VSTM is treated as a 12-bit unsigned binary number.

The M_4 field specifies an alignment hint (AH). The AH control specifies the alignment of the first byte of the second operand. Reserved values should not be

specified; otherwise, the program may not operate compatibly in the future.

M₄ Alignment Hint

0	No alignment indicated
1-2	Reserved
3	Doubleword aligned
4	Quadword aligned
5-15	Reserved

Condition Code: The code remains unchanged.

Program Exceptions:

- Access (store, operand 2)
- Data with DXC FE, Vector Instruction
- Operation (if the vector facility for z/Architecture is not installed)
- Specification
- Transaction constraint

Programming Notes:

1. If the first operand vector register designation and the third operand vector register designation specify the same vector register only 16-bytes are stored.
2. If the alignment of the address specified by the second operand is known to be either on a doubleword or quadword boundary and alignment hint is set to 3 or 4 respectively, performance may be improved on some models. If the alignment of the second operand is not on a doubleword or quadword boundary, or is unknown, the alignment hint should be set to 0.
3. Setting the alignment hint to a non-zero value that doesn't correspond to the alignment of the second operand may reduce performance on some models.

VECTOR STORE RIGHTMOST WITH LENGTH

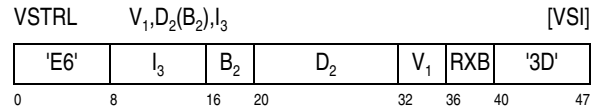
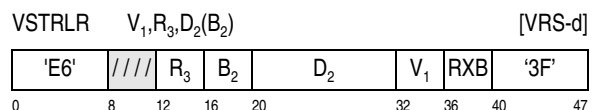

Proceeding from left to right, the specified number of rightmost bytes from the first operand are stored at the second-operand location.

For VSTRLR, bits 32-63 of the general register specified third operand contain an unsigned integer value that when subtracted from fifteen represents the index of the first byte of the vector register to store. If the third operand contains a value greater than or equal to fifteen, all bytes of the first operand are stored. Bits 0-31 of the third operand are ignored.

For VSTRL, the I₃ field has the following format:



The bits of the I₃ field are defined as follows:

- **Reserved:** Bits 0-3 are reserved and must contain zeros. Otherwise, a specification exception is recognized.
- **Operand 2 Length Code(L₂):** Bits 4-7 contain an unsigned integer value that when subtracted from fifteen represents the index of the first byte of the vector register to store. If the L₂ field contains a value equal to fifteen, all bytes of the first operand are stored.

Access exceptions are only recognized on bytes stored.

The displacement is treated as a 12-bit unsigned integer.

Condition Code: The code remains unchanged.

Program Exceptions:

- Access (store, operand 2)
- Data with DXC FE, Vector Instruction
- Operation (if the vector-packed-decimal facility for z/Architecture is not installed)
- Specification (VSTRL only)
- Transaction constraint

VECTOR STORE WITH LENGTH

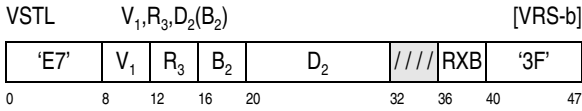

Proceeding from left to right, bytes from the first operand are stored at the second-operand location. The general register specified third operand contains a 32-bit unsigned integer containing a value that represents the highest indexed byte to store. If the third operand contains a value greater than or equal to the highest byte index of the vector, all bytes of the first operand are stored.

Access exceptions are only recognized on bytes stored.

The displacement for VECTOR STORE WITH LENGTH is treated as a 12-bit unsigned integer.

Condition Code: The code remains unchanged.

Program Exceptions:

- Access (store, operand 2)
- Data with DXC FE, Vector Instruction
- Operation (if the vector facility for z/Architecture is not installed)
- Transaction constraint

VECTOR UNPACK HIGH

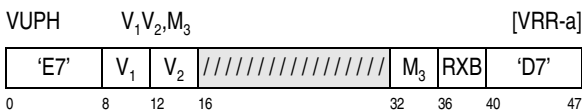

The elements of the left-most half of the vector-register second operand are sign extended and placed into double-sized elements in the first operand. The right-most half of the second operand are ignored.

If the same register is used to designate the first operand as the second operand the original source value is used throughout the operation with no intermediate updates.

The M_3 field specifies the element size control (ES). The ES control specifies the size of the elements in

the second operand. The first operand contains elements twice the size of those specified by the ES control. If a reserved value is specified, a specification exception is recognized.

M_3 Element Size

- | | |
|------|----------|
| 0 | Byte |
| 1 | Halfword |
| 2 | Word |
| 3-15 | Reserved |

Condition Code: The code remains unchanged.

Program Exceptions:

- Data with DXC FE, Vector Instruction
- Operation (if the vector facility for z/Architecture is not installed)
- Specification
- Transaction constraint

Extended Mnemonics:

Extended Mnemonic	Base Mnemonic
VUPHB V_1, V_2	VUPH $V_1, V_2, 0$
VUPHH V_1, V_2	VUPH $V_1, V_2, 1$
VUPHF V_1, V_2	VUPH $V_1, V_2, 2$

VECTOR UNPACK LOGICAL HIGH

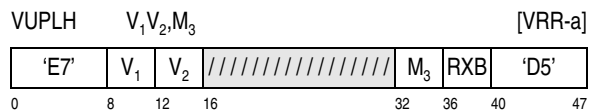

The elements of the left-most half of the second operand are zero extended and placed into double-sized elements in the first operand. The right-most half of the second operand is ignored.

If the same register is used to designate the first operand as the second operand the original source value is used throughout the operation with no intermediate updates.

The M_3 field specifies the element size control (ES). The ES control specifies the size of the elements in the second operand. The first operand contains elements double the size of those specified in the ES

control. If a reserved value is specified, a specification exception is recognized.

M_3	Element Size
0	Byte
1	Halfword
2	Word
3-15	Reserved

Condition Code: The code remains unchanged.

Program Exceptions:

- Data with DXC FE, Vector Instruction
- Operation (if the vector facility for z/Architecture is not installed)
- Specification
- Transaction constraint

Extended Mnemonics:

Extended Mnemonic	Base Mnemonic
VUPLHB V_1, V_2	VUPLH $V_1, V_2, 0$
VUPLHH V_1, V_2	VUPLH $V_1, V_2, 1$
VUPLHF V_1, V_2	VUPLH $V_1, V_2, 2$

VECTOR UNPACK LOW

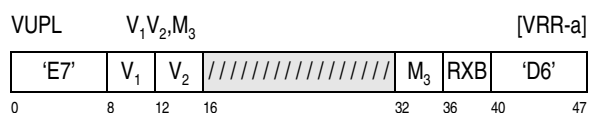

The elements of the right-most half of the second operand are sign extended and placed into double-sized elements in the first operand. The left-most half of the second operand is ignored.

If the same register is used to designate the first operand as the second operand the original source value is used throughout the operation with no intermediate updates.

The M_3 field specifies the element size control (ES). The ES control specifies the size of the elements in the second operand. The first operand contains elements double the size of those specified by the ES

control. If a reserved value is specified, a specification exception is recognized.

M_3	Element Size
0	Byte
1	Halfword
2	Word
3-15	Reserved

Condition Code: The code remains unchanged.

Program Exceptions:

- Data with DXC FE, Vector Instruction
- Operation (if the vector facility for z/Architecture is not installed)
- Specification
- Transaction constraint

Extended Mnemonics:

Extended Mnemonic	Base Mnemonic
VUPLB V_1, V_2	VUPL $V_1, V_2, 0$
VUPLHW V_1, V_2	VUPL $V_1, V_2, 1$
VUPLF V_1, V_2	VUPL $V_1, V_2, 2$

VECTOR UNPACK LOGICAL LOW

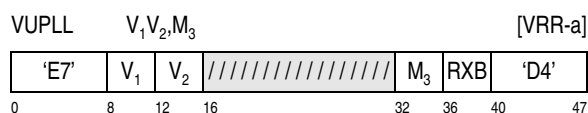

The elements of the right-most half of the second operand are zero extended and placed into double-sized elements in the first operand. The left-most half of the second operand is ignored.

If the same register is used to designate the first operand as the second operand the original source value is used throughout the operation with no intermediate updates.

The M_3 field specifies the element size control (ES). The ES control specifies the size of the elements in the second operand. The first operand contains elements double the size of those specified by the ES

control. If a reserved value is specified, a specification exception is recognized.

M_3	Element Size
0	Byte
1	Halfword
2	Word
3-15	Reserved

Condition Code: The code remains unchanged.

Program Exceptions:

- Data with DXC FE, Vector Instruction

- Operation (if the vector facility for z/Architecture is not installed)
- Specification
- Transaction constraint

Extended Mnemonics:

Extended Mnemonic	Base Mnemonic
VUPLLB V_1, V_2	VUPLL $V_1, V_2, 0$
VUPLLH V_1, V_2	VUPLL $V_1, V_2, 1$
VUPLLF V_1, V_2	VUPLL $V_1, V_2, 2$

Chapter 22. Vector Integer Instructions

Instructions	22-1	VECTOR MULTIPLY LOGICAL EVEN.....	22-18
VECTOR ADD.....	22-3	VECTOR MULTIPLY ODD.....	22-18
VECTOR ADD COMPUTE CARRY.....	22-4	VECTOR MULTIPLY LOGICAL ODD.....	22-18
VECTOR ADD WITH CARRY.....	22-4	VECTOR MULTIPLY SUM LOGICAL.....	22-19
VECTOR ADD WITH CARRY COMPUTE		VECTOR NAND.....	22-20
CARRY.....	22-5	VECTOR NOR.....	22-20
VECTOR AND.....	22-5	VECTOR NOT EXCLUSIVE OR.....	22-20
VECTOR AND WITH COMPLEMENT.....	22-5	VECTOR OR.....	22-20
VECTOR AVERAGE.....	22-6	VECTOR OR WITH COMPLEMENT.....	22-21
VECTOR AVERAGE LOGICAL.....	22-6	VECTOR POPULATION COUNT.....	22-21
VECTOR CHECKSUM.....	22-6	VECTOR ELEMENT ROTATE LEFT	
VECTOR ELEMENT COMPARE.....	22-7	LOGICAL.....	22-21
VECTOR ELEMENT COMPARE LOGICAL.....	22-7	VECTOR ELEMENT ROTATE AND INSERT	
VECTOR COMPARE EQUAL.....	22-7	UNDER MASK.....	22-22
VECTOR COMPARE HIGH.....	22-8	VECTOR ELEMENT SHIFT LEFT.....	22-23
VECTOR COMPARE HIGH LOGICAL.....	22-9	VECTOR ELEMENT SHIFT RIGHT	
VECTOR COUNT LEADING ZEROS.....	22-10	ARITHMETIC.....	22-23
VECTOR COUNT TRAILING ZEROS.....	22-10	VECTOR ELEMENT SHIFT RIGHT	
VECTOR EXCLUSIVE OR.....	22-11	LOGICAL.....	22-24
VECTOR GALOIS FIELD MULTIPLY SUM.....	22-11	VECTOR SHIFT LEFT.....	22-25
VECTOR GALOIS FIELD MULTIPLY SUM		VECTOR SHIFT LEFT BY BYTE.....	22-25
AND ACCUMULATE.....	22-12	VECTOR SHIFT LEFT DOUBLE BY BIT.....	22-25
VECTOR LOAD COMPLEMENT.....	22-12	VECTOR SHIFT LEFT DOUBLE BY BYTE.....	22-26
VECTOR LOAD POSITIVE.....	22-12	VECTOR SHIFT RIGHT ARITHMETIC.....	22-26
VECTOR MAXIMUM.....	22-13	VECTOR SHIFT RIGHT ARITHMETIC BY	
VECTOR MAXIMUM LOGICAL.....	22-13	BYTE.....	22-26
VECTOR MINIMUM.....	22-13	VECTOR SHIFT RIGHT DOUBLE BY BIT.....	22-26
VECTOR MINIMUM LOGICAL.....	22-14	VECTOR SHIFT RIGHT LOGICAL.....	22-27
VECTOR MULTIPLY AND ADD LOW.....	22-14	VECTOR SHIFT RIGHT LOGICAL BY	
VECTOR MULTIPLY AND ADD HIGH.....	22-15	BYTE.....	22-27
VECTOR MULTIPLY AND ADD LOGICAL		VECTOR SUBTRACT.....	22-27
HIGH.....	22-15	VECTOR SUBTRACT COMPUTE BORROW	
VECTOR MULTIPLY AND ADD EVEN.....	22-15	INDICATION.....	22-28
VECTOR MULTIPLY AND ADD LOGICAL		VECTOR SUBTRACT WITH BORROW	
EVEN.....	22-15	INDICATION.....	22-28
VECTOR MULTIPLY AND ADD ODD.....	22-16	VECTOR SUBTRACT WITH BORROW	
VECTOR MULTIPLY AND ADD LOGICAL		COMPUTE BORROW INDICATION.....	22-29
ODD.....	22-16	VECTOR SUM ACROSS DOUBLEWORD.....	22-29
VECTOR MULTIPLY HIGH.....	22-16	VECTOR SUM ACROSS QUADWORD.....	22-30
VECTOR MULTIPLY LOGICAL HIGH.....	22-17	VECTOR SUM ACROSS WORD.....	22-30
VECTOR MULTIPLY LOW.....	22-17	VECTOR TEST UNDER MASK.....	22-31
VECTOR MULTIPLY EVEN.....	22-18		

Instructions

Many instructions have an extended mnemonic sec-

tion which describe recommended extended mnemonics and their corresponding machine assembler syntax.

Unless otherwise specified all operands are vector-register operands. A “V” in the assembler syntax designates a vector operand.

Programming Note: The vector-enhancements facility 2 includes the following shift features:

- VECTOR SHIFT LEFT/RIGHT DOUBLE BY BIT (VSLD, VSRD)
- The behavior for different per byte element shift amount has been defined:
 - VECTOR SHIFT LEFT (VSL), VECTOR SHIFT RIGHT LOGICAL (VSRL)

- The following new instructions are added:

Name	Mnemonic	Characteristics						Op-code	Page
VECTOR ADD	VA	VRR-c	VF	$\alpha^{7,9}$	SP	Dv	E7F3	22-3	
VECTOR ADD COMPUTE CARRY	VACC	VRR-c	VF	$\alpha^{7,9}$	SP	Dv	E7F1	22-4	
VECTOR ADD WITH CARRY	VAC	VRR-d	VF	$\alpha^{7,9}$	SP	Dv	E7BB	22-4	
VECTOR ADD WITH CARRY COMPUTE CARRY	VACCC	VRR-d	VF	$\alpha^{7,9}$	SP	Dv	E7B9	22-5	
VECTOR AND	VN	VRR-c	VF	$\alpha^{7,9}$		Dv	E768	22-5	
VECTOR AND WITH COMPLEMENT	VNC	VRR-c	VF	$\alpha^{7,9}$		Dv	E769	22-5	
VECTOR AVERAGE	VAVG	VRR-c	VF	$\alpha^{7,9}$	SP	Dv	E7F2	22-6	
VECTOR AVERAGE LOGICAL	VAVGL	VRR-c	VF	$\alpha^{7,9}$	SP	Dv	E7F0	22-6	
VECTOR CHECKSUM	VCKSM	VRR-c	VF	$\alpha^{7,9}$		Dv	E766	22-6	
VECTOR COMPARE EQUAL	VCEQ	VRR-b C*	VF	$\alpha^{7,9}$	SP	Dv	E7F8	22-7	
VECTOR COMPARE HIGH	VCH	VRR-b C*	VF	$\alpha^{7,9}$	SP	Dv	E7FB	22-8	
VECTOR COMPARE HIGH LOGICAL	VCHL	VRR-b C*	VF	$\alpha^{7,9}$	SP	Dv	E7F9	22-9	
VECTOR COUNT LEADING ZEROS	VLZ	VRR-a	VF	$\alpha^{7,9}$	SP	Dv	E753	22-10	
VECTOR COUNT TRAILING ZEROS	VCTZ	VRR-a	VF	$\alpha^{7,9}$	SP	Dv	E752	22-10	
VECTOR ELEMENT COMPARE	VEC	VRR-a C	VF	$\alpha^{7,9}$		Dv	E7DB	22-7	
VECTOR ELEMENT COMPARE LOGICAL	VECL	VRR-a C	VF	$\alpha^{7,9}$	SP	Dv	E7D9	22-7	
VECTOR ELEMENT ROTATE AND INSERT UNDER MASK	VERIM	VRI-d	VF	$\alpha^{7,9}$		Dv	E772	22-22	
VECTOR ELEMENT ROTATE LEFT LOGICAL	VERLL	VRS-a	VF	$\alpha^{7,9}$	SP	Dv	E733	22-21	
VECTOR ELEMENT ROTATE LEFT LOGICAL	VERLLV	VRR-c	VF	$\alpha^{7,9}$	SP	Dv	E773	22-21	
VECTOR ELEMENT SHIFT LEFT	VESLV	VRR-c	VF	$\alpha^{7,9}$	SP	Dv	E770	22-23	
VECTOR ELEMENT SHIFT LEFT	VESL	VRS-a	VF	$\alpha^{7,9}$	SP	Dv	E730	22-23	
VECTOR ELEMENT SHIFT RIGHT ARITHMETIC	VESRA	VRS-a	VF	$\alpha^{7,9}$	SP	Dv	E73A	22-23	
VECTOR ELEMENT SHIFT RIGHT ARITHMETIC	VESRAV	VRR-c	VF	$\alpha^{7,9}$	SP	Dv	E77A	22-23	
VECTOR ELEMENT SHIFT RIGHT LOGICAL	VESRL	VRS-a	VF	$\alpha^{7,9}$	SP	Dv	E738	22-24	
VECTOR ELEMENT SHIFT RIGHT LOGICAL	VESRLV	VRR-c	VF	$\alpha^{7,9}$	SP	Dv	E778	22-24	
VECTOR EXCLUSIVE OR	VX	VRR-c	VF	$\alpha^{7,9}$		Dv	E76D	22-11	
VECTOR GALOIS FIELD MULTIPLY SUM	VGFM	VRR-c	VF	$\alpha^{7,9}$	SP	Dv	E7B4	22-11	
VECTOR GALOIS FIELD MULTIPLY SUM AND ACCUMULATE	VGFMA	VRR-d	VF	$\alpha^{7,9}$	SP	Dv	E7BC	22-12	
VECTOR LOAD COMPLEMENT	VLC	VRR-a	VF	$\alpha^{7,9}$	SP	Dv	E7DE	22-12	
VECTOR LOAD POSITIVE	VLP	VRR-a	VF	$\alpha^{7,9}$	SP	Dv	E7DF	22-12	
VECTOR MAXIMUM	VMX	VRR-c	VF	$\alpha^{7,9}$	SP	Dv	E7FF	22-13	
VECTOR MAXIMUM LOGICAL	VMXL	VRR-c	VF	$\alpha^{7,9}$	SP	Dv	E7FD	22-13	
VECTOR MINIMUM	VMN	VRR-c	VF	$\alpha^{7,9}$	SP	Dv	E7FE	22-13	
VECTOR MINIMUM LOGICAL	VMNL	VRR-c	VF	$\alpha^{7,9}$	SP	Dv	E7FC	22-14	
VECTOR MULTIPLY AND ADD EVEN	VMAE	VRR-d	VF	$\alpha^{7,9}$	SP	Dv	E7AE	22-15	
VECTOR MULTIPLY AND ADD HIGH	VMAH	VRR-d	VF	$\alpha^{7,9}$	SP	Dv	E7AB	22-15	
VECTOR MULTIPLY AND ADD LOGICAL EVEN	VMALE	VRR-d	VF	$\alpha^{7,9}$	SP	Dv	E7AC	22-15	
VECTOR MULTIPLY AND ADD LOGICAL HIGH	VMALH	VRR-d	VF	$\alpha^{7,9}$	SP	Dv	E7A9	22-15	
VECTOR MULTIPLY AND ADD LOGICAL ODD	VMALO	VRR-d	VF	$\alpha^{7,9}$	SP	Dv	E7AD	22-16	
VECTOR MULTIPLY AND ADD LOW	VMAL	VRR-d	VF	$\alpha^{7,9}$	SP	Dv	E7AA	22-14	
VECTOR MULTIPLY AND ADD ODD	VMAO	VRR-d	VF	$\alpha^{7,9}$	SP	Dv	E7AF	22-16	
VECTOR MULTIPLY EVEN	VME	VRR-c	VF	$\alpha^{7,9}$	SP	Dv	E7A6	22-18	
VECTOR MULTIPLY HIGH	VMH	VRR-c	VF	$\alpha^{7,9}$	SP	Dv	E7A3	22-16	
VECTOR MULTIPLY LOGICAL EVEN	VMLE	VRR-c	VF	$\alpha^{7,9}$	SP	Dv	E7A4	22-18	

Figure 22-1. Summary of Vector Integer Instructions (Part 1 of 2)

Name	Mnemonic	Characteristics						Op-code	Page
VECTOR MULTIPLY LOGICAL HIGH	VMLH	VRR-c	VF	$\alpha^{7,9}$	SP	Dv	E7A1	22-17	
VECTOR MULTIPLY LOGICAL ODD	VMLO	VRR-c	VF	$\alpha^{7,9}$	SP	Dv	E7A5	22-18	
VECTOR MULTIPLY LOW	VML	VRR-c	VF	$\alpha^{7,9}$	SP	Dv	E7A2	22-17	
VECTOR MULTIPLY ODD	VMO	VRR-c	VF	$\alpha^{7,9}$	SP	Dv	E7A7	22-18	
VECTOR MULTIPLY SUM LOGICAL	VMSL	VRR-d	V1	$\alpha^{7,9}$	SP	Dv	E7B8	22-19	
VECTOR NAND	VNN	VRR-c	V1	$\alpha^{7,9}$		Dv	E76E	22-20	
VECTOR NOR	VNO	VRR-c	VF	$\alpha^{7,9}$		Dv	E76B	22-20	
VECTOR NOT EXCLUSIVE OR	VNX	VRR-c	V1	$\alpha^{7,9}$		Dv	E76C	22-20	
VECTOR OR	VO	VRR-c	VF	$\alpha^{7,9}$		Dv	E76A	22-20	
VECTOR OR WITH COMPLEMENT	VOC	VRR-c	V1	$\alpha^{7,9}$		Dv	E76F	22-21	
VECTOR POPULATION COUNT	VPOPCT	VRR-a	VF	$\alpha^{7,9}$	SP	Dv	E750	22-21	
VECTOR SHIFT LEFT	VSL	VRR-c	VF	$\alpha^{7,9}$		Dv	E774	22-25	
VECTOR SHIFT LEFT BY BYTE	VSLB	VRR-c	VF	$\alpha^{7,9}$		Dv	E775	22-25	
VECTOR SHIFT LEFT DOUBLE BY BIT	VSLD	VRI-d	V2	$\alpha^{7,9}$	SP	Dv	E786	22-25	
VECTOR SHIFT LEFT DOUBLE BY BYTE	VSLDB	VRI-d	VF	$\alpha^{7,9}$		Dv	E777	22-26	
VECTOR SHIFT RIGHT ARITHMETIC	VSRA	VRR-c	VF	$\alpha^{7,9}$		Dv	E77E	22-26	
VECTOR SHIFT RIGHT ARITHMETIC BY BYTE	VSRAB	VRR-c	VF	$\alpha^{7,9}$		Dv	E77F	22-26	
VECTOR SHIFT RIGHT DOUBLE BY BIT	VSRD	VRI-d	V2	$\alpha^{7,9}$	SP	Dv	E787	22-26	
VECTOR SHIFT RIGHT LOGICAL	VSRL	VRR-c	VF	$\alpha^{7,9}$		Dv	E77C	22-27	
VECTOR SHIFT RIGHT LOGICAL BY BYTE	VSRLB	VRR-c	VF	$\alpha^{7,9}$		Dv	E77D	22-27	
VECTOR SUBTRACT	VS	VRR-c	VF	$\alpha^{7,9}$	SP	Dv	E7F7	22-27	
VECTOR SUBTRACT COMPUTE BORROW INDICATION	VSCBI	VRR-c	VF	$\alpha^{7,9}$	SP	Dv	E7F5	22-28	
VECTOR SUBTRACT WITH BORROW COMPUTE BORROW INDICATION	VSBCBI	VRR-d	VF	$\alpha^{7,9}$	SP	Dv	E7BD	22-29	
VECTOR SUBTRACT WITH BORROW INDICATION	VSBI	VRR-d	VF	$\alpha^{7,9}$	SP	Dv	E7BF	22-28	
VECTOR SUM ACROSS DOUBLEWORD	VSUMG	VRR-c	VF	$\alpha^{7,9}$	SP	Dv	E765	22-29	
VECTOR SUM ACROSS QUADWORD	VSUMQ	VRR-c	VF	$\alpha^{7,9}$	SP	Dv	E767	22-30	
VECTOR SUM ACROSS WORD	VSUM	VRR-c	VF	$\alpha^{7,9}$	SP	Dv	E764	22-30	
VECTOR TEST UNDER MASK	VTM	VRR-a C	VF	$\alpha^{7,9}$		Dv	E7D8	22-31	

Explanation:

- α^7 Restricted from transactional execution when the effective allow-floating-point-operation control is zero.
- α^9 Restricted in the constrained transactional-execution mode; a transaction-constraint program exception may be recognized.
- C Condition code set.
- C* Condition code optionally set.
- Dv Vector-instruction data exception
- SP Specification exception.
- V1 Vector-enhancements facility 1
- V2 Vector-enhancements facility 2
- VF Vector facility for z/Architecture
- VRI VRI instruction format
- VRR VRR instruction format
- VRS VRS instruction format

Figure 22-1. Summary of Vector Integer Instructions (Part 2 of 2)

VECTOR ADD

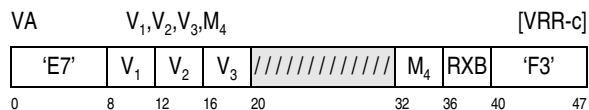

The contents of each element of the second operand are added to the contents of each corresponding element of the third operand and the resulting sum or sums are placed in the first operand. Each element is treated as a signed binary integer of size specified by the element size control in the M_4 field.

When there is an overflow, the result is obtained by allowing any carry into the sign-bit position and ignoring any carry out of the sign-bit position.

No fixed point overflow exceptions are recognized.

The M_4 field specifies the element size control (ES). The ES control specifies the size of the element or elements in the vector register operands. If a reserved value is specified, a specification exception is recognized.

M_4	Element Size
0	Byte
1	Halfword
2	Word
3	Doubleword
4	Quadword
5-15	Reserved

Condition Code: The code remains unchanged.

Program Exceptions:

- Data with DXC FE, Vector Instruction
- Operation (if the vector facility for z/Architecture is not installed)
- Specification
- Transaction constraint

Extended Mnemonics:

Extended Mnemonic	Base Mnemonic
VAB V_1, V_2, V_3	VA $V_1, V_2, V_3, 0$
VAH V_1, V_2, V_3	VA $V_1, V_2, V_3, 1$
VAF V_1, V_2, V_3	VA $V_1, V_2, V_3, 2$
VAG V_1, V_2, V_3	VA $V_1, V_2, V_3, 3$
VAQ V_1, V_2, V_3	VA $V_1, V_2, V_3, 4$

Programming Note: The same results are obtained if the contents of each element contain unsigned binary integers.

VECTOR ADD COMPUTE CARRY

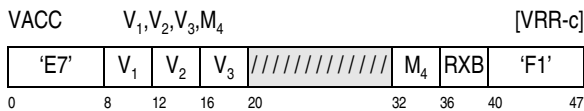

The contents of each element of the second operand are added to the contents of each corresponding ele-

ment of the third operand. If the addition of two elements results in a carry out of bit zero, a value of one is placed in the corresponding element of the first operand. If there is no carry out of bit zero, a value of zero is placed in the corresponding element of the first operand. Each element is treated as an unsigned binary integer of size specified by the element size in the M_4 field.

The M_4 field specifies the element size control (ES). The ES control specifies the size of the element or elements in the vector register operands. If a reserved value is specified, a specification exception is recognized.

M_4	Element Size
0	Byte
1	Halfword
2	Word
3	Doubleword
4	Quadword
5-15	Reserved

Condition Code: The code remains unchanged.

Program Exceptions:

- Data with DXC FE, Vector Instruction
- Operation (if the vector facility for z/Architecture is not installed)
- Specification
- Transaction constraint

Extended Mnemonics:

Extended Mnemonic	Base Mnemonic
VACCB V_1, V_2, V_3	VACC $V_1, V_2, V_3, 0$
VACCH V_1, V_2, V_3	VACC $V_1, V_2, V_3, 1$
VACCF V_1, V_2, V_3	VACC $V_1, V_2, V_3, 2$
VACCG V_1, V_2, V_3	VACC $V_1, V_2, V_3, 3$
VACCQ V_1, V_2, V_3	VACC $V_1, V_2, V_3, 4$

VECTOR ADD WITH CARRY

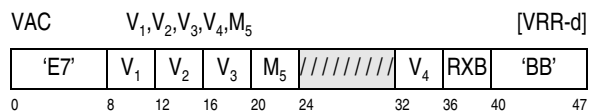

The contents of the second operand are added to the third operand to form an intermediate quadword sum. Subsequently, the rightmost bit of the fourth operand

concatenated with 127 bits of zero on its left are added to the intermediate sum and the resulting sum is placed in the first operand. All bits except for the rightmost bit position of the fourth operand are ignored. Each operand is treated as a 128-bit unsigned binary integer.

When there is an overflow, the result is obtained by allowing any carry into the leftmost-bit position and ignoring any carry out of the leftmost-bit position.

No fixed point overflow exceptions are recognized.

The M_5 field must contain a value of 4; otherwise, a specification exception is recognized.

Condition Code: The code remains unchanged.

Program Exceptions:

- Data with DXC FE, Vector Instruction
- Operation (if the vector facility for z/Architecture is not installed)
- Specification
- Transaction constraint

Extended Mnemonics:

Extended Mnemonic	Base Mnemonic
VACQ V_1, V_2, V_3, V_4	VAC $V_1, V_2, V_3, V_4, 4$

VECTOR ADD WITH CARRY COMPUTE CARRY

VACCC	V_1, V_2, V_3, V_4, M_5	[VRR-d]
'E7'	V_1 V_2 V_3 M_5 // // // // // // // //	V_4 RXB 'B9'
0	8 12 16 20 24	32 36 40 47

The contents of the second operand are added to the third operand to form an intermediate quadword sum. Subsequently, the rightmost bit of the fourth operand concatenated with 127 bits of zero on its left are added to the intermediate sum. All bits except for the rightmost bit position of the fourth operand are ignored. If the addition results in a carry out of the leftmost bit, a value of one is placed in the first operand. If there is no carry out of the leftmost bit, a value of zero is placed in the first operand. Each operand is treated as a 128-bit unsigned binary integer.

The M_5 field must contain a value of 4; otherwise, a specification exception is recognized.

Condition Code: The code remains unchanged.

Program Exceptions:

- Data with DXC FE, Vector Instruction
- Operation (if the vector facility for z/Architecture is not installed)
- Specification
- Transaction constraint

Extended Mnemonics:

Extended Mnemonic	Base Mnemonic
VACCCQ V_1, V_2, V_3, V_4	VACCC $V_1, V_2, V_3, V_4, 4$

VECTOR AND

VN	V_1, V_2, V_3	[VRR-c]
'E7'	V_1 V_2 V_3 // // // // // // // //	RXB '68'
0	8 12 16 20	36 40 47

The AND of the second and third operands is placed in the first operand.

The connective AND is applied to the operands bit by bit. The contents of a bit position in the result are set to one if the corresponding bit positions in both operands contain ones; otherwise, the result bit is set to zero.

Condition Code: The code remains unchanged.

Program Exceptions:

- Data with DXC FE, Vector Instruction
- Operation (if the vector facility for z/Architecture is not installed)
- Transaction constraint

VECTOR AND WITH COMPLEMENT

VNC	V_1, V_2, V_3	[VRR-c]
'E7'	V_1 V_2 V_3 // // // // // // // //	RXB '69'
0	8 12 16 20	36 40 47

The AND of the second operand and the bit-wise complement of the third operand is placed in the first operand.

The connective AND is applied to the second operand and bit-wise complemented third operand bit by bit. The contents of a bit position in the result are set to one if the corresponding bit positions in the second operand contains a one and the third operand contains a zero; otherwise, the result bit is set to zero.

Condition Code: The code remains unchanged.

Program Exceptions:

- Data with DXC FE, Vector Instruction
- Operation (if the vector facility for z/Architecture is not installed)
- Transaction constraint

Programming Note: This instruction is useful for zeroing out bits under a mask.

VECTOR AVERAGE

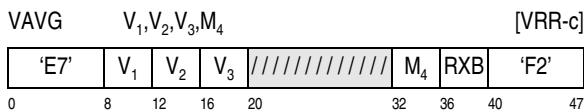

VECTOR AVERAGE LOGICAL

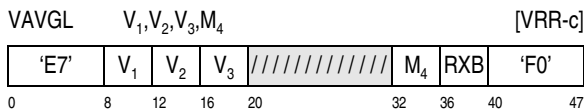

The average of the corresponding elements of the second and third operands is placed in the corresponding element of the first operand.

For VECTOR AVERAGE, each element of the second operand and the corresponding element of the third operand are sign extended by one bit. The elements are then added together along with an additional value of one. The sum is then shifted right by one bit to produce an element sized result in the corresponding element of the first operand.

For VECTOR AVERAGE LOGICAL, each element of the second operand and the corresponding element of the third operand are extended by one bit by appending a zero on the left. The elements are then added together along with an additional value of one. The sum is then shifted right by one bit to produce an element sized result in the corresponding element of the first operand.

The M_4 field specifies the element size control (ES). The ES control specifies the size of the elements in the vector register operands. If a reserved value is specified, a specification exception is recognized.

M₄ Element Size

0	Byte
1	Halfword
2	Word
3	Doubleword
4-15	Reserved

Condition Code: The code remains unchanged.

Program Exceptions:

- Data with DXC FE, Vector Instruction
- Operation (if the vector facility for z/Architecture is not installed)
- Specification
- Transaction constraint

Extended Mnemonics:

Extended Mnemonic	Base Mnemonic
VAVGB V_1, V_2, V_3	VAVG $V_1, V_2, V_3, 0$
VAVGH V_1, V_2, V_3	VAVG $V_1, V_2, V_3, 1$
VAVGF V_1, V_2, V_3	VAVG $V_1, V_2, V_3, 2$
VAVGG V_1, V_2, V_3	VAVG $V_1, V_2, V_3, 3$
VAVGLB V_1, V_2, V_3	VAVGL $V_1, V_2, V_3, 0$
VAVGLH V_1, V_2, V_3	VAVGL $V_1, V_2, V_3, 1$
VAVGLF V_1, V_2, V_3	VAVGL $V_1, V_2, V_3, 2$
VAVGLG V_1, V_2, V_3	VAVGL $V_1, V_2, V_3, 3$

VECTOR CHECKSUM

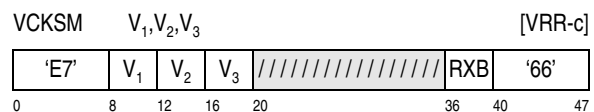

The word-sized elements from the second operand are added together one-by-one along with the element in word one of the third operand. The sum is placed in word one of the first operand. Zeros are placed in word elements 0, and 2-3 of the first operand. The word-sized elements are all treated as 32-bit unsigned binary integers. After each addition of an element, a carry out of bit position 0 of the sum is added to bit position 31 of the result in word element one of the first operand.

Condition Code: The code remains unchanged.

Program Exceptions:

- Data with DXC FE, Vector Instruction
- Operation (if the vector facility for z/Architecture is not installed)
- Transaction constraint

Programming Notes:

1. The contents of the third operand should contain zero at the start of a checksum computation algorithm.
2. A16-bit checksum is used in, for example, the TCP/IP application. The following program can be executed after a 32-bit checksum has been computed:

```
VERLLF V2,V1,16(0)
VAF V2,V1,V2
```

The halfword in element 2 will contain the 16-bit checksum.

Element Size	Element Index
Byte	7
Halfword	3
Word	1
Doubleword	0

Figure 22-2. Element Sizes and Indexes

The M_3 field specifies the element size control (ES). The ES control specifies the size of the element in the vector register operands. If a reserved value is specified, a specification exception is recognized.

M_3	Element Size
0	Byte
1	Halfword
2	Word
3	Doubleword
4-15	Reserved

Resulting Condition Code:

- 0 Operand elements equal
- 1 First operand element low
- 2 First operand element high
- 3 --

Program Exceptions:

- Data with DXC FE, Vector Instruction
- Operation (if the vector facility for z/Architecture is not installed)
- Specification
- Transaction constraint

Extended Mnemonics:

Extended Mnemonic		Base Mnemonic	
VECB	V_1, V_2	VEC	$V_1, V_2, 0$
VECH	V_1, V_2	VEC	$V_1, V_2, 1$
VECF	V_1, V_2	VEC	$V_1, V_2, 2$
VECG	V_1, V_2	VEC	$V_1, V_2, 3$
VECLB	V_1, V_2	VECL	$V_1, V_2, 0$
VECLH	V_1, V_2	VECL	$V_1, V_2, 1$
VECLF	V_1, V_2	VECL	$V_1, V_2, 2$
VECLG	V_1, V_2	VECL	$V_1, V_2, 3$

VECTOR ELEMENT COMPARE

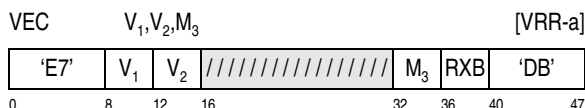

VECTOR ELEMENT COMPARE LOGICAL

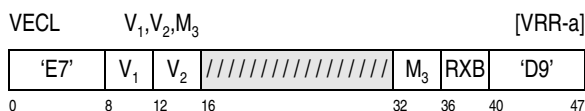

The single element of specified size of the first and second operands are compared and the result is indicated in the condition code.

The elements compared are treated as signed binary integers for VEC and unsigned binary integers for VECL.

The index of the element that is being compared is dependent on the size of the element being compared. Figure 22-2 specifies what element is compared for each element size.

VECTOR COMPARE EQUAL

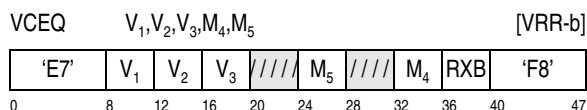

The unsigned binary integer elements of the second operand are compared with the corresponding unsigned binary integer elements of the third operand. If the element in the second operand is equal to the element in the third operand, all of the bit positions of the corresponding element in the first operand are set to ones; otherwise they are all set to zeros.

The M_4 field specifies the element size control (ES). The ES control specifies the size of the elements in the vector register operands. If a reserved value is specified, a specification exception is recognized.

M_4	Element Size
0	Byte
1	Halfword
2	Word
3	Doubleword
4-15	Reserved

The M_5 field has the following format:



The bits of the M_5 field are defined as follows:

- **Reserved:** Bits 0, 1, and 2 are reserved and should contain zeros; otherwise, the program may not operate compatibly in the future.
- **Condition Code Set (CS):** If bit 3 is 0, the code remains unchanged. If the bit is one, the code is set as described below.

Resulting Condition Code:

When bit 3 of the M_5 field is one, the condition code is set as follows:

0	All elements equal
1	At least one, but not all elements equal
2	--
3	No element equal

When bit 3 of the M_5 field is zero, the code remains unchanged.

Program Exceptions:

- Data with DXC FE, Vector Instruction
- Operation (if the vector facility for z/Architecture is not installed)
- Specification
- Transaction constraint

Extended Mnemonics:

Extended Mnemonic	Base Mnemonic
VCEQB V_1, V_2, V_3	VCEQ $V_1, V_2, V_3, 0, 0$
VCEQH V_1, V_2, V_3	VCEQ $V_1, V_2, V_3, 1, 0$
VCEQF V_1, V_2, V_3	VCEQ $V_1, V_2, V_3, 2, 0$
VCEQG V_1, V_2, V_3	VCEQ $V_1, V_2, V_3, 3, 0$
VCEQBS V_1, V_2, V_3	VCEQ $V_1, V_2, V_3, 0, 1$
VCEQHS V_1, V_2, V_3	VCEQ $V_1, V_2, V_3, 1, 1$
VCEQFS V_1, V_2, V_3	VCEQ $V_1, V_2, V_3, 2, 1$
VCEQGS V_1, V_2, V_3	VCEQ $V_1, V_2, V_3, 3, 1$

Programming Note: Depending on the model, setting the condition code may result in reduced performance.

VECTOR COMPARE HIGH

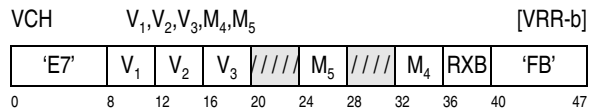

The signed elements of the second operand are compared to the corresponding signed elements of the third operand. If the element in the second operand is greater than the element in the third operand, all of the bit positions of the corresponding element in the first operand are set to ones; otherwise, they are all set to zeros.

The M_4 field specifies the element size control (ES). The ES control specifies the size of the elements in the vector register operands. If a reserved value is specified, a specification exception is recognized.

M_4	Element Size
0	Byte
1	Halfword
2	Word
3	Doubleword
4-15	Reserved

The M_5 field has the following format:



The bits of the M_5 field are defined as follows:

- **Reserved:** Bits 0, 1, and 2 are reserved and should contain zeros; otherwise, the program may not operate compatibly in the future.
- **Condition Code Set (CS):** If bit 3 is 0, the code remains unchanged. If the bit is one, the code is set as described below.

Resulting Condition Code:

When bit 3 of the M_5 field is one, the condition code is set as follows:

- 0 All elements high
- 1 Some elements high
- 2 --
- 3 No element high

When bit 3 of the M_5 field is zero, the code remains unchanged.

Program Exceptions:

- Data with DXC FE, Vector Instruction
- Operation (if the vector facility for z/Architecture is not installed)
- Specification
- Transaction constraint

Extended Mnemonics:

Extended Mnemonic	Base Mnemonic
VCHB V_1, V_2, V_3	VCH $V_1, V_2, V_3, 0, 0$
VCHH V_1, V_2, V_3	VCH $V_1, V_2, V_3, 1, 0$
VCHF V_1, V_2, V_3	VCH $V_1, V_2, V_3, 2, 0$
VCHG V_1, V_2, V_3	VCH $V_1, V_2, V_3, 3, 0$
VCHBS V_1, V_2, V_3	VCH $V_1, V_2, V_3, 0, 1$
VCHHS V_1, V_2, V_3	VCH $V_1, V_2, V_3, 1, 1$
VCHFS V_1, V_2, V_3	VCH $V_1, V_2, V_3, 2, 1$
VCHGS V_1, V_2, V_3	VCH $V_1, V_2, V_3, 3, 1$

Programming Notes:

1. Depending on the model, setting the condition code may result in reduced performance.

2. To do a COMPARE NOT HIGH, reverse the second and third operands.

VECTOR COMPARE HIGH LOGICAL

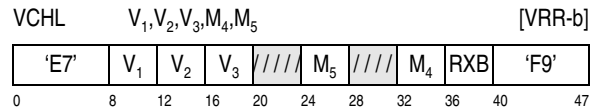

The unsigned elements of the second operand are compared to the corresponding unsigned elements of the third operand. If the element in the second operand is greater than the element in the third operand, all of the bit positions of the corresponding element in the first operand are set to ones; otherwise, they are all set to zeros.

The M_4 field specifies the element size control (ES). The ES control specifies the size of the elements in the vector register operands. If a reserved value is specified, a specification exception is recognized.

M_4 Element Size

- 0 Byte
- 1 Halfword
- 2 Word
- 3 Doubleword
- 4-15 Reserved

The M_5 field has the following format:



The bits of the M_5 field are defined as follows:

- **Reserved:** Bits 0, 1, and 2 are reserved and should contain zeros; otherwise, the program may not operate compatibly in the future.
- **Condition Code Set (CS):** If bit 3 is 0, the code remains unchanged. If the bit is one, the code is set as described below.

Resulting Condition Code:

When bit 3 of the M_5 field is one, the condition code is set as follows:

- 0 All elements high
- 1 Some elements high
- 2 --
- 3 No element high

When bit 3 of the M_5 field is zero, the code remains unchanged.

Program Exceptions:

- Data with DXC FE, Vector Instruction
- Operation (if the vector facility for z/Architecture is not installed)
- Specification
- Transaction constraint

Extended Mnemonics:

Extended Mnemonic		Base Mnemonic	
VCHLB	V_1, V_2, V_3	VCHL	$V_1, V_2, V_3, 0, 0$
VCHLH	V_1, V_2, V_3	VCHL	$V_1, V_2, V_3, 1, 0$
VCHLF	V_1, V_2, V_3	VCHL	$V_1, V_2, V_3, 2, 0$
VCHLG	V_1, V_2, V_3	VCHL	$V_1, V_2, V_3, 3, 0$
VCHLBS	V_1, V_2, V_3	VCHL	$V_1, V_2, V_3, 0, 1$
VCHLHS	V_1, V_2, V_3	VCHL	$V_1, V_2, V_3, 1, 1$
VCHLFS	V_1, V_2, V_3	VCHL	$V_1, V_2, V_3, 2, 1$
VCHLGS	V_1, V_2, V_3	VCHL	$V_1, V_2, V_3, 3, 1$

Programming Notes:

1. Depending on the model, setting the condition code may result in reduced performance.
2. To do a COMPARE NOT HIGH LOGICAL, reverse the second and third operands.

VECTOR COUNT LEADING ZEROS

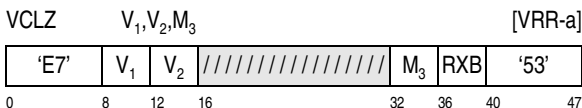

For each element in the second operand, the number of leftmost zeros are counted and placed in the corresponding element of the first operand.

The bits of each element in the second operand are scanned left to right for the leftmost one bit. A binary integer designating the bit position of the leftmost one bit, or the number of bits in the element if there is no one bit, is placed in the corresponding element of the first operand.

The M_3 field specifies the element size control (ES). The ES control specifies the size of the elements in the vector register operands. If a reserved value is specified, a specification exception is recognized.

M_3 Element Size

0	Byte
1	Halfword
2	Word
3	Doubleword
4-15	Reserved

Condition Code: The code remains unchanged.

Program Exceptions:

- Data with DXC FE, Vector Instruction
- Operation (if the vector facility for z/Architecture is not installed)
- Specification
- Transaction constraint

Extended Mnemonics:

Extended Mnemonic		Base Mnemonic	
VCLZB	V_1, V_2	VCLZ	$V_1, V_2, 0$
VCLZH	V_1, V_2	VCLZ	$V_1, V_2, 1$
VCLZF	V_1, V_2	VCLZ	$V_1, V_2, 2$
VCLZG	V_1, V_2	VCLZ	$V_1, V_2, 3$

VECTOR COUNT TRAILING ZEROS

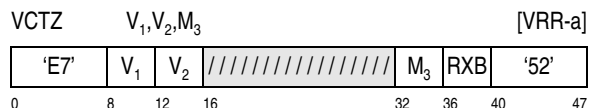

For each element in the second operand the number of rightmost zeros are counted and placed in the corresponding element of the first operand.

The bits of each element in the second operand are scanned right to left for the rightmost one bit. A binary integer designating the number of bits scanned to reach the rightmost one bit, or the number of bits in the element if there is no one bit, is placed in the corresponding element of the first operand.

The M_3 field specifies the element size control (ES). The ES control specifies the size of the elements in

the vector register operands. If a reserved value is specified, a specification exception is recognized.

M_3	Element Size
0	Byte
1	Halfword
2	Word
3	Doubleword
4-15	Reserved

Condition Code: The code remains unchanged.

Program Exceptions:

- Data with DXC FE, Vector Instruction
- Operation (if the vector facility for z/Architecture is not installed)
- Specification
- Transaction constraint

Extended Mnemonics:

Extended Mnemonic	Base Mnemonic
VCTZB V_1, V_2	VCTZ $V_1, V_2, 0$
VCTZH V_1, V_2	VCTZ $V_1, V_2, 1$
VCTZF V_1, V_2	VCTZ $V_1, V_2, 2$
VCTZG V_1, V_2	VCTZ $V_1, V_2, 3$

VECTOR EXCLUSIVE OR

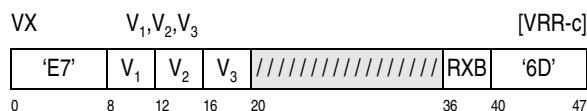

The EXCLUSIVE OR of the second and third operands is placed at the first-operand location.

The connective EXCLUSIVE OR is applied to the operands bit by bit. The contents of a bit position in the result are set to one if the bits in the corresponding bit positions in the two operands are unlike; otherwise, the result bit is set to zero.

Condition Code: The code remains unchanged.

Program Exceptions:

- Data with DXC FE, Vector Instruction
- Operation (if the vector facility for z/Architecture is not installed)
- Transaction constraint

VECTOR GALOIS FIELD MULTIPLY SUM

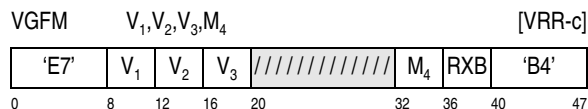

Each element of the second operand is multiplied in a Galois field with the corresponding element of the third operand. The Galois field has an order of two. This multiplication is similar to standard binary multiplication, but instead of adding the shifted multiplicand it is exclusive ORed. The resulting even-odd pairs of double element-sized products are exclusive ORed with each other and placed in the corresponding double-wide element of the first operand.

The M_4 field specifies the element size control (ES). The ES control specifies the size of the elements in vector register operands two and three; the elements in the first operand are twice the size of those specified by the ES control. If a reserved value is specified, a specification exception is recognized.

M_4	Element Size
0	Byte
1	Halfword
2	Word
3	Doubleword
4-15	Reserved

Condition Code: The code remains unchanged.

Program Exceptions:

- Data with DXC FE, Vector Instruction
- Operation (if the vector facility for z/Architecture is not installed)
- Specification
- Transaction constraint

Extended Mnemonics:

Extended Mnemonic	Base Mnemonic
VGFM B V_1, V_2, V_3	VGFM $V_1, V_2, V_3, 0$
VGFM H V_1, V_2, V_3	VGFM $V_1, V_2, V_3, 1$
VGFM F V_1, V_2, V_3	VGFM $V_1, V_2, V_3, 2$
VGFM G V_1, V_2, V_3	VGFM $V_1, V_2, V_3, 3$

VECTOR GALOIS FIELD MULTIPLY SUM AND ACCUMULATE

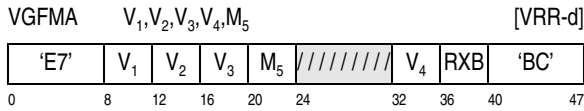

Each element of the second operand is multiplied in a Galois field with the corresponding element of the third operand. The Galois field has an order of two. This multiplication is similar to standard binary multiplication, but instead of adding the shifted multiplicand it is exclusive ORed. The resulting even-odd pairs of double element-sized products are exclusive ORed with each other and exclusive ORed with the corresponding double-wide element of the fourth operand. The results are placed in the double-wide elements of the first operand.

The M_5 field specifies the element size control (ES). The ES control specifies the size of the elements in vector register operands two and three; the elements in the first and fourth operand are twice the size of those specified by the ES control. If a reserved value is specified, a specification exception is recognized.

M_5	Element Size
0	Byte
1	Halfword
2	Word
3	Doubleword
4-15	Reserved

Condition Code: The code remains unchanged.

Program Exceptions:

- Data with DXC FE, Vector Instruction
- Operation (if the vector facility for z/Architecture is not installed)
- Specification
- Transaction constraint

Extended Mnemonics:

Extended Mnemonic	Base Mnemonic
VGFMAB V_1, V_2, V_3, V_4	VGFMMA $V_1, V_2, V_3, V_4, 0$
VGFMAB V_1, V_2, V_3, V_4	VGFMMA $V_1, V_2, V_3, V_4, 1$
VGFMAB V_1, V_2, V_3, V_4	VGFMMA $V_1, V_2, V_3, V_4, 2$
VGFMAB V_1, V_2, V_3, V_4	VGFMMA $V_1, V_2, V_3, V_4, 3$

VECTOR LOAD COMPLEMENT

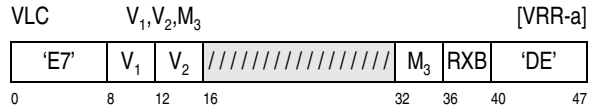

The two's complement of each element in the second operand is placed in the corresponding element in the first operand. The operands are treated as signed binary integers.

When there is an overflow, the result is obtained by allowing any carry into the sign bit position and ignoring any carry out of the sign-bit position.

The M_3 field specifies the element size control (ES). The ES control specifies the size of the elements in the vector register operands. If a reserved value is specified, a specification exception is recognized.

M_3	Element Size
0	Byte
1	Halfword
2	Word
3	Doubleword
4-15	Reserved

Condition Code: The code remains unchanged.

Program Exceptions:

- Data with DXC FE, Vector Instruction
- Operation (if the vector facility for z/Architecture is not installed)
- Specification
- Transaction constraint

Extended Mnemonics:

Extended Mnemonic	Base Mnemonic
VLCB V_1, V_2	VLC $V_1, V_2, 0$
VLCH V_1, V_2	VLC $V_1, V_2, 1$
VLCF V_1, V_2	VLC $V_1, V_2, 2$
VLGG V_1, V_2	VLC $V_1, V_2, 3$

VECTOR LOAD POSITIVE

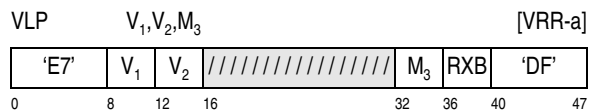

The absolute value of each element in the second operand is placed in the corresponding element in the first operand. The operands are treated as signed binary integers.

When there is an overflow, the result is obtained by allowing any carry into the sign bit position and ignoring any carry out of the sign-bit position.

The M_3 field specifies the element size control (ES). The ES control specifies the size of the elements in the vector register operands. If a reserved value is specified, a specification exception is recognized.

M_3	Element Size
0	Byte
1	Halfword
2	Word
3	Doubleword
4-15	Reserved

Condition Code: The code remains unchanged.

Program Exceptions:

- Data with DXC FE, Vector Instruction
- Operation (if the vector facility for z/Architecture is not installed)
- Specification
- Transaction constraint

Extended Mnemonics:

Extended Mnemonic	Base Mnemonic
VLPB V_1, V_2	VLP $V_1, V_2, 0$
VLPH V_1, V_2	VLP $V_1, V_2, 1$
VLPF V_1, V_2	VLP $V_1, V_2, 2$
VLPG V_1, V_2	VLP $V_1, V_2, 3$

VECTOR MAXIMUM

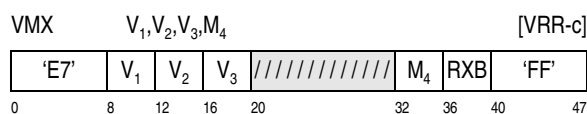

VECTOR MAXIMUM LOGICAL

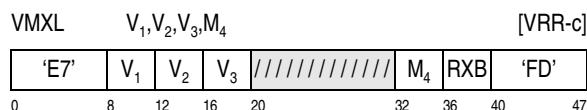

Each element of the second operand is compared to the corresponding element of the third operand. The greater of the two values is placed into the corresponding element of the first operand. If the operands are equal the value of both elements is placed in the corresponding element of the first operand.

For VECTOR MAXIMUM the operands are treated as signed integer elements. For VECTOR MAXIMUM LOGICAL the operands are treated as unsigned integer elements.

The M_4 field specifies the element size control (ES). The ES control specifies the size of the elements in the vector register operands. If a reserved value is specified, a specification exception is recognized.

M_4	Element Size
0	Byte
1	Halfword
2	Word
3	Doubleword
4-15	Reserved

Condition Code: The code remains unchanged.

Program Exceptions:

- Data with DXC FE, Vector Instruction
- Operation (if the vector facility for z/Architecture is not installed)
- Specification
- Transaction constraint

Extended Mnemonics:

Extended Mnemonic	Base Mnemonic
VMXB V_1, V_2, V_3	VMX $V_1, V_2, V_3, 0$
VMXH V_1, V_2, V_3	VMX $V_1, V_2, V_3, 1$
VMXF V_1, V_2, V_3	VMX $V_1, V_2, V_3, 2$
VMXG V_1, V_2, V_3	VMX $V_1, V_2, V_3, 3$
VMXLB V_1, V_2, V_3	VMXL $V_1, V_2, V_3, 0$
VMXLH V_1, V_2, V_3	VMXL $V_1, V_2, V_3, 1$
VMXLF V_1, V_2, V_3	VMXL $V_1, V_2, V_3, 2$
VMXLG V_1, V_2, V_3	VMXL $V_1, V_2, V_3, 3$

VECTOR MINIMUM

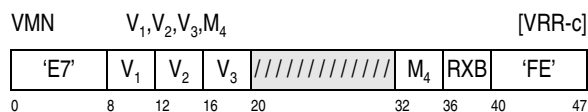

VECTOR MINIMUM LOGICAL

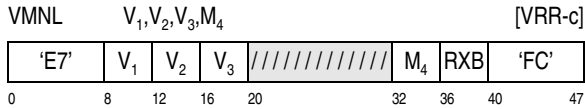

Each element of the second operand is compared to the corresponding element of the third operand. The smaller of the two values is placed into the corresponding element of the first operand. If the operands are equal the value of both elements is placed in the corresponding element of the first operand.

For VECTOR MINIMUM the operands contain signed integer elements, for VECTOR MINIMUM LOGICAL the operands contain unsigned integer elements.

The M_4 field specifies the element size control (ES). The ES control specifies the size of the elements in the vector register operands. If a reserved value is specified, a specification exception is recognized.

M_4	Element Size
0	Byte
1	Halfword
2	Word
3	Doubleword
4-15	Reserved

Condition Code: The code remains unchanged.

Program Exceptions:

- Data with DXC FE, Vector Instruction
- Operation (if the vector facility for z/Architecture is not installed)
- Specification
- Transaction constraint

Extended Mnemonics:

Extended Mnemonic	Base Mnemonic
VMNB V_1, V_2, V_3	VMN $V_1, V_2, V_3, 0$
VMNH V_1, V_2, V_3	VMN $V_1, V_2, V_3, 1$
VMNF V_1, V_2, V_3	VMN $V_1, V_2, V_3, 2$
VMNG V_1, V_2, V_3	VMN $V_1, V_2, V_3, 3$
VMNLB V_1, V_2, V_3	VMNL $V_1, V_2, V_3, 0$
VMNLH V_1, V_2, V_3	VMNL $V_1, V_2, V_3, 1$
VMNLF V_1, V_2, V_3	VMNL $V_1, V_2, V_3, 2$

Extended Mnemonic	Base Mnemonic
VMNLG V_1, V_2, V_3	VMNL $V_1, V_2, V_3, 3$

VECTOR MULTIPLY AND ADD LOW

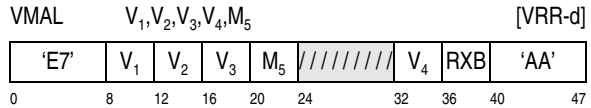

The integer elements of the second operand are multiplied by the corresponding integer elements of the third operand producing a double element-sized intermediate product. This intermediate product is then added to the corresponding element of the fourth operand. The least significant half of the resulting sum is placed into the corresponding element of the first operand.

The M_5 field specifies the element size control (ES). The ES control specifies the size of the elements in the vector register operands. If a reserved value is specified, a specification exception is recognized.

M_5	Element Size
0	Byte
1	Halfword
2	Word
3-15	Reserved

Condition Code: The code remains unchanged.

Program Exceptions:

- Data with DXC FE, Vector Instruction
- Operation (if the vector facility for z/Architecture is not installed)
- Specification
- Transaction constraint

Extended Mnemonics:

Extended Mnemonic	Base Mnemonic
VMALB V_1, V_2, V_3, V_4	VMAL $V_1, V_2, V_3, V_4, 0$
VMALHW V_1, V_2, V_3, V_4	VMAL $V_1, V_2, V_3, V_4, 1$
VMALF V_1, V_2, V_3, V_4	VMAL $V_1, V_2, V_3, V_4, 2$

Programming Note: The results of VMAL are the same for signed and unsigned binary integers.

VECTOR MULTIPLY AND ADD HIGH

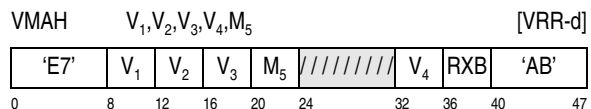

VECTOR MULTIPLY AND ADD LOGICAL HIGH

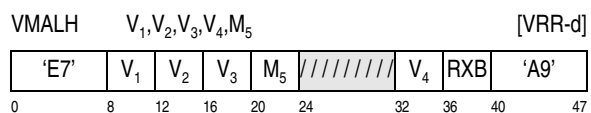

The integer elements of the second operand are multiplied by the corresponding integer elements of the third operand producing a double element-sized intermediate product. This intermediate product is then added to the corresponding element of the fourth operand. The most significant half of the resulting sum is placed into the corresponding element of the first operand.

For VECTOR MULTIPLY AND ADD HIGH the elements are treated as signed binary integers. For VECTOR MULTIPLY AND ADD HIGH LOGICAL the elements are treated as unsigned binary integers.

The M_5 field specifies the element size control (ES). The ES control specifies the size of the elements in the vector register operands. If a reserved value is specified, a specification exception is recognized.

M_5	Element Size
0	Byte
1	Halfword
2	Word
3-15	Reserved

Condition Code: The code remains unchanged.

Program Exceptions:

- Data with DXC FE, Vector Instruction
- Operation (if the vector facility for z/Architecture is not installed)
- Specification

- Transaction constraint

Extended Mnemonics:

Extended Mnemonic	Base Mnemonic
VMAHB V_1, V_2, V_3, V_4	VMAH $V_1, V_2, V_3, V_4, 0$
VMAHH V_1, V_2, V_3, V_4	VMAH $V_1, V_2, V_3, V_4, 1$
VMAHF V_1, V_2, V_3, V_4	VMAH $V_1, V_2, V_3, V_4, 2$
VMALHB V_1, V_2, V_3, V_4	VMALH $V_1, V_2, V_3, V_4, 0$
VMALHH V_1, V_2, V_3, V_4	VMALH $V_1, V_2, V_3, V_4, 1$
VMALHF V_1, V_2, V_3, V_4	VMALH $V_1, V_2, V_3, V_4, 2$

VECTOR MULTIPLY AND ADD EVEN

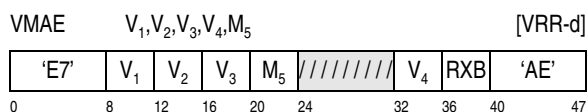

VECTOR MULTIPLY AND ADD LOGICAL EVEN

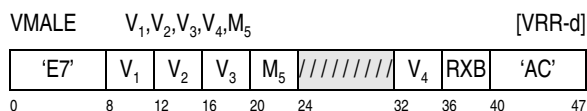

The even indexed elements of the second operand are multiplied by the corresponding elements of the third operand. The intermediate product is added to the corresponding double-wide even-odd element pair of the fourth operand. The result is placed into the double-wide even-odd element pair of the first operand. The odd elements of the second and third operands are ignored. Any overflow or carry from the final addition is ignored.

For VECTOR MULTIPLY AND ADD EVEN the elements are treated as signed binary integers. For VECTOR MULTIPLY AND ADD LOGICAL EVEN the elements are treated as unsigned binary integers.

The M_5 field specifies the element size control (ES). The ES control specifies the size of the elements in vector register operands two and three; the elements in the first and fourth operand are twice the size of

those specified by the ES control. If a reserved value is specified, a specification exception is recognized.

M_5	Element Size
0	Byte
1	Halfword
2	Word
3-15	Reserved

Condition Code: The code remains unchanged.

Program Exceptions:

- Data with DXC FE, Vector Instruction
- Operation (if the vector facility for z/Architecture is not installed)
- Specification
- Transaction constraint

Extended Mnemonics:

Extended Mnemonic	Base Mnemonic
VMAEB V_1, V_2, V_3, V_4	VMAE $V_1, V_2, V_3, V_4, 0$
VMAEH V_1, V_2, V_3, V_4	VMAE $V_1, V_2, V_3, V_4, 1$
VMAEF V_1, V_2, V_3, V_4	VMAE $V_1, V_2, V_3, V_4, 2$
VMALEB V_1, V_2, V_3, V_4	VMALE $V_1, V_2, V_3, V_4, 0$
VMALEH V_1, V_2, V_3, V_4	VMALE $V_1, V_2, V_3, V_4, 1$
VMALEF V_1, V_2, V_3, V_4	VMALE $V_1, V_2, V_3, V_4, 2$

VECTOR MULTIPLY AND ADD ODD

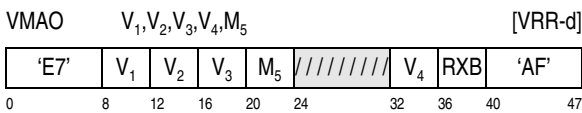

VECTOR MULTIPLY AND ADD LOGICAL ODD

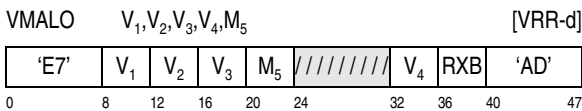

The odd indexed elements of the second operand are multiplied by the corresponding elements of the third operand. The intermediate product is added to the corresponding double-wide even-odd element pair of the fourth operand. The result is placed into

the even-odd double-wide element pair of the first operand. The even elements of the second and third operands are ignored. Any overflow or carry from the final addition is ignored.

For VECTOR MULTIPLY AND ADD ODD the elements are treated as signed binary integers. For VECTOR MULTIPLY AND ADD LOGICAL ODD the elements are treated as unsigned binary integers.

The M_5 field specifies the element size control (ES). The ES control specifies the size of the elements in vector register operands two and three; the elements in the first and fourth operand are twice the size of those specified by the ES control. If a reserved value is specified, a specification exception is recognized.

M_5	Element Size
0	Byte
1	Halfword
2	Word
3-15	Reserved

Condition Code: The code remains unchanged.

Program Exceptions:

- Data with DXC FE, Vector Instruction
- Operation (if the vector facility for z/Architecture is not installed)
- Specification
- Transaction constraint

Extended Mnemonics:

Extended Mnemonic	Base Mnemonic
VMAOB V_1, V_2, V_3, V_4	VMAO $V_1, V_2, V_3, V_4, 0$
VMAOH V_1, V_2, V_3, V_4	VMAO $V_1, V_2, V_3, V_4, 1$
VMAOF V_1, V_2, V_3, V_4	VMAO $V_1, V_2, V_3, V_4, 2$
VMALOB V_1, V_2, V_3, V_4	VMALO $V_1, V_2, V_3, V_4, 0$
VMALOH V_1, V_2, V_3, V_4	VMALO $V_1, V_2, V_3, V_4, 1$
VMALOF V_1, V_2, V_3, V_4	VMALO $V_1, V_2, V_3, V_4, 2$

VECTOR MULTIPLY HIGH

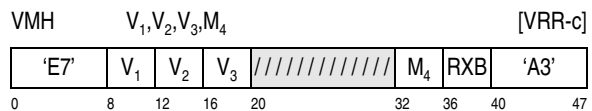

VECTOR MULTIPLY LOGICAL HIGH

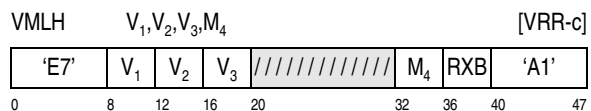

The integer elements of the second operand are multiplied by the corresponding integer elements of the third operand. The high-order element-sized portion of the product is placed in the first operand.

For VECTOR MULTIPLY HIGH, the elements are treated as signed binary integers. For VECTOR MULTIPLY LOGICAL HIGH, the elements are treated as unsigned binary integers.

The M_4 field specifies the element size control (ES). The ES control specifies the size of the elements in the vector register operands. If a reserved value is specified, a specification exception is recognized.

M_4	Element Size
0	Byte
1	Halfword
2	Word
3-15	Reserved

Condition Code: The code remains unchanged.

Program Exceptions:

- Data with DXC FE, Vector Instruction
- Operation (if the vector facility for z/Architecture is not installed)
- Specification
- Transaction constraint

Extended Mnemonics:

Extended Mnemonic	Base Mnemonic
VMHB V_1, V_2, V_3	VMH $V_1, V_2, V_3, 0$
VMHH V_1, V_2, V_3	VMH $V_1, V_2, V_3, 1$
VMHF V_1, V_2, V_3	VMH $V_1, V_2, V_3, 2$
VMLHB V_1, V_2, V_3	VMLH $V_1, V_2, V_3, 0$
VMLHH V_1, V_2, V_3	VMLH $V_1, V_2, V_3, 1$
VMLHF V_1, V_2, V_3	VMLH $V_1, V_2, V_3, 2$

VECTOR MULTIPLY LOW

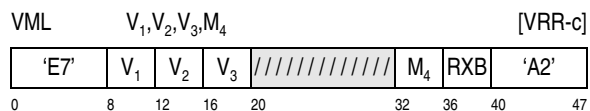

The integer elements of the second operand are multiplied by the corresponding integer elements of the third operand producing a double element-sized intermediate product. The least-significant half of the resulting product is placed into the corresponding element of the first operand. Any overflow or carry from the final addition is ignored.

The M_4 field specifies the element size control (ES). The ES control specifies the size of the elements in the vector register operands. If a reserved value is specified, a specification exception is recognized.

M_4	Element Size
0	Byte
1	Halfword
2	Word
3-15	Reserved

Condition Code: The code remains unchanged.

Program Exceptions:

- Data with DXC FE, Vector Instruction
- Operation (if the vector facility for z/Architecture is not installed)
- Specification
- Transaction constraint

Extended Mnemonics:

Extended Mnemonic	Base Mnemonic
VMLB V_1, V_2, V_3	VML $V_1, V_2, V_3, 0$
VMLHW V_1, V_2, V_3	VML $V_1, V_2, V_3, 1$
VMLF V_1, V_2, V_3	VML $V_1, V_2, V_3, 2$

Programming Notes:

1. The results from VML are the same if the elements are treated as unsigned binary integers or signed binary integers.
2. VECTOR MULTIPLY LOW is analogous to MULTIPLY SINGLE in chapter 7.

3. The extended mnemonic VMLHW is not VMLH because that would conflict with VECTOR MULTIPLY LOW

VECTOR MULTIPLY EVEN

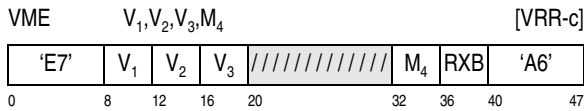

VECTOR MULTIPLY LOGICAL EVEN

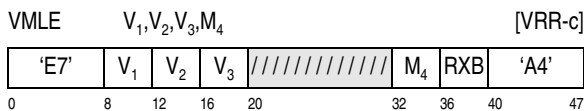

The even indexed elements of the second operand are multiplied with the corresponding even indexed elements of the third operand and the resulting double element width product is placed into the corresponding even and odd indexed element pair of the first operand. The odd elements of the second and third operands are ignored.

For VECTOR MULTIPLY EVEN the elements are treated as signed binary integers. For VECTOR MULTIPLY LOGICAL EVEN the elements are treated as unsigned binary integers.

The M_4 field specifies the element size control (ES). The ES control specifies the size of the elements in vector register operands two and three; the elements in the first operand are twice the size of those specified by the ES control. If a reserved value is specified, a specification exception is recognized.

M_4 Element Size

0	Byte
1	Halfword
2	Word
3-15	Reserved

Condition Code: The code remains unchanged.

Program Exceptions:

- Data with DXC FE, Vector Instruction
- Operation (if the vector facility for z/Architecture is not installed)

- Specification
- Transaction constraint

Extended Mnemonics:

Extended Mnemonic		Base Mnemonic	
VMEB	V_1, V_2, V_3	VME	$V_1, V_2, V_3, 0$
VMEH	V_1, V_2, V_3	VME	$V_1, V_2, V_3, 1$
VMEF	V_1, V_2, V_3	VME	$V_1, V_2, V_3, 2$
VMLEB	V_1, V_2, V_3	VMLE	$V_1, V_2, V_3, 0$
VMLEH	V_1, V_2, V_3	VMLE	$V_1, V_2, V_3, 1$
VMLEF	V_1, V_2, V_3	VMLE	$V_1, V_2, V_3, 2$

VECTOR MULTIPLY ODD

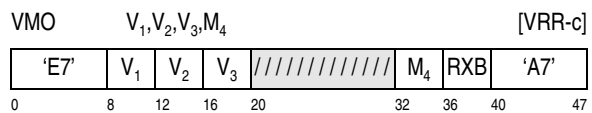

VECTOR MULTIPLY LOGICAL ODD

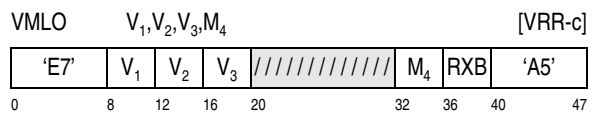

The odd indexed elements of the second operand are multiplied with the corresponding odd indexed elements of the third operand and the resulting double element width product is placed into the corresponding even and odd indexed element pair of the first operand. The even elements of the second and third operands are ignored.

For VECTOR MULTIPLY ODD the elements are treated as signed binary integers. For VECTOR MULTIPLY LOGICAL ODD the elements are treated as unsigned binary integers.

The M_4 field specifies the element size control (ES). The ES control specifies the size of the elements in vector register operands two and three; the elements in the first operand are twice the size of those specified by the ES control. If a reserved value is specified, a specification exception is recognized.

M_4 Element Size

0	Byte
1	Halfword
2	Word
3-15	Reserved

Condition Code: The code remains unchanged.

Program Exceptions:

- Data with DXC FE, Vector Instruction
- Operation (if the vector facility for z/Architecture is not installed)
- Specification
- Transaction constraint

Extended Mnemonics:

Extended Mnemonic	Base Mnemonic
VMOB V_1, V_2, V_3	VMO $V_1, V_2, V_3, 0$
VMOH V_1, V_2, V_3	VMO $V_1, V_2, V_3, 1$
VMOF V_1, V_2, V_3	VMO $V_1, V_2, V_3, 2$
VMLOB V_1, V_2, V_3	VMLO $V_1, V_2, V_3, 0$
VMLOH V_1, V_2, V_3	VMLO $V_1, V_2, V_3, 1$
VMLOF V_1, V_2, V_3	VMLO $V_1, V_2, V_3, 2$

VECTOR MULTIPLY SUM LOGICAL

VMSL $V_1, V_2, V_3, V_4, M_5, M_6$ [VRR-d]

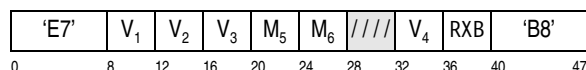

The even indexed unsigned integer elements of the second and third operands are multiplied to create a double element wide first intermediate result. The odd indexed elements of the second and third operands are multiplied together to create a double element wide second intermediate result. The first and second double-element-wide intermediate results are each shifted to the left by the values specified in the M_6 field and then added together along with the corresponding double-wide even-odd element pair value in the fourth operand and the corresponding even-odd element pair sums are placed in the first operand. Any carry outs or overflows from the additions are ignored.

The M_5 field specifies the element size control (ES). The ES control specifies the size of the elements in the vector register operands. If a reserved value is specified, a specification exception is recognized.

M_5	Element Size
0-2	Reserved
3	Doubleword
4-15	Reserved

The M_6 field has the following format:



The bits of the M_6 field are defined as follows:

- **Even Shift Indication (ES):** When bit 0 is one, the first intermediate result is shifted left one bit before the addition; when bit 0 is zero shifting of the first intermediate result is not performed.
- **Odd Shift Indication (OS):** When bit 1 is one, the second intermediate result is shifted left one bit before the addition; when bit 1 is zero shifting of the second intermediate result is not performed.
- **Reserved:** Bits 2 and 3 are reserved and should be zeros; otherwise, the program may not operate compatibly in the future.

Condition Code: The code remains unchanged.

Program Exceptions:

- Data with DXC FE, Vector Instruction
- Operation (vector-enhancements facility 1 not installed)
- Specification
- Transaction constraint

Extended Mnemonics:

Extended Mnemonic	Base Mnemonic
VMSLG V_1, V_2, V_3, V_4, M_6	VMSL $V_1, V_2, V_3, V_4, 3, M_6$

Programming Notes:

1. On some models when a doubleword element size is specified, if the most significant eight bits of the elements in the second and third operands are non-zero performance may be significantly reduced.
2. The primary intended use of this instruction is as a building block for software implementation of larger multiplications.
3. The shift controls in the M_6 field may be used for software implementations of squaring of large binary numbers.

VECTOR NAND

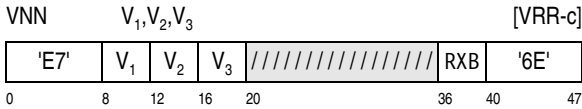

The NAND of the second and third operands is placed in the first operand.

The connective NAND is applied to the operands bit-by-bit. The contents of a bit position in the result are set to zero if the corresponding bit positions in both source operands contain ones; otherwise, the result bit is set to one.

Condition Code: The code remains unchanged.

Program Exceptions:

- Data with DXC FE, Vector Instruction
- Operation (vector-enhancements facility 1 not installed)
- Transaction constraint

VECTOR NOR

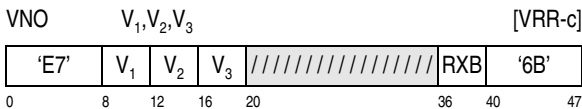

The NOR of the second and third operands is placed at the first-operand location.

The connective NOR is applied to the operand bit by bit. The contents of a bit position in the result are set to one if the corresponding bit in both operands contains zero; otherwise, the result bit is set to zero.

Condition Code: The code remains unchanged.

Program Exceptions:

- Data with DXC FE, Vector Instruction
- Operation (if the vector facility for z/Architecture is not installed)
- Transaction constraint

Programming Note: VNO can be used to provide the functionality of a bit-wise NOT operation by specifying the same vector-register for V_2 and V_3 .

Extended Mnemonics:

Extended Mnemonic		Base Mnemonic	
VNOT	V_1, V_2	VNO	V_1, V_2, V_2

VECTOR NOT EXCLUSIVE OR

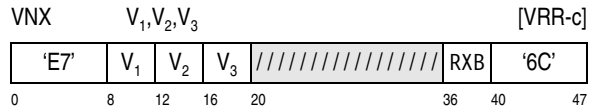

The complement of the EXCLUSIVE OR of the second and third operands is placed at the first-operand location.

The connective EXCLUSIVE OR and complementation is applied to the operands bit-by-bit. The contents of a bit position in the result are set to zero if the bits in the corresponding bit positions in the two source operands are unlike; otherwise, the result bit is set to one.

Condition Code: The code remains unchanged.

Program Exceptions:

- Data with DXC FE, Vector Instruction
- Operation (vector-enhancements facility 1 not installed)
- Transaction constraint

VECTOR OR

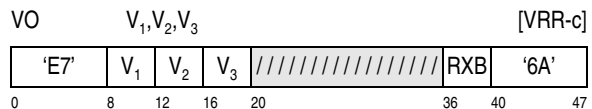

The OR of the second and third operands is placed at the first-operand location.

The connective OR is applied to the operand bit by bit. The contents of a bit position in the result are set to one if the corresponding bit in one or both operands contains a one; otherwise, the result bit is set to zero.

Condition Code: The code remains unchanged.

Program Exceptions:

- Data with DXC FE, Vector Instruction
- Operation (if the vector facility for z/Architecture is not installed)
- Transaction constraint

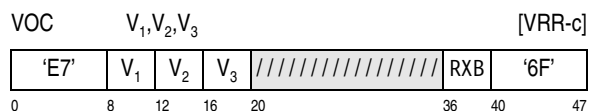
VECTOR OR WITH COMPLEMENT

The OR of the second operand and the bit-wise complement of the third operand is placed in the first operand.

The connective OR is applied to the second operand and bit-wise complemented third operand bit-by-bit. The contents of a bit position in the result are set to zero if the corresponding bit positions in the second operand contains a zero and the third operand contains a one; otherwise, the result bit is set to one.

Condition Code: The code remains unchanged.

Program Exceptions:

- Data with DXC FE, Vector Instruction
- Operation (vector-enhancements facility 1 not installed)
- Transaction constraint

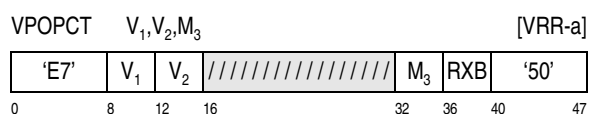
VECTOR POPULATION COUNT

For each element of the second operand the count of the number of bits that are one is stored in the corresponding element of the first operand. Each element in the result contains an binary integer.

The M_3 field specifies the element size control (ES). The ES control specifies the size of the element in the vector register operands. If a reserved value is specified, a specification exception is recognized. If

the vector enhancement facility 1 is not installed the values 1-3 are reserved.

 M_3 Element Size

0	Byte
1	Halfword
2	Word
3	Doubleword
4-15	Reserved

Condition Code: The code remains unchanged.

Program Exceptions:

- Data with DXC FE, Vector Instruction
- Operation (if the vector facility for z/Architecture is not installed)
- Specification
- Transaction constraint

Extended Mnemonics:

Extended Mnemonic	Base Mnemonic
VPOPCTB V_1, V_2	VPOPCT $V_1, V_2, 0$
VPOPCTH V_1, V_2	VPOPCT $V_1, V_2, 1$
VPOPCTF V_1, V_2	VPOPCT $V_1, V_2, 2$
VPOPCTG V_1, V_2	VPOPCT $V_1, V_2, 3$

Programming Note: To count all of the ones in a vector register, a VECTOR SUM ACROSS instruction may be used.

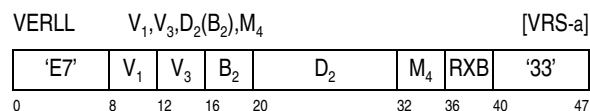
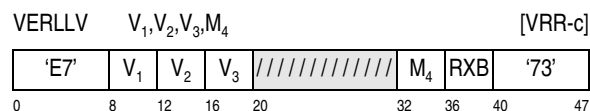
VECTOR ELEMENT ROTATE LEFT LOGICAL

For VERLLV, each element in the second operand is rotated left by the number of bits specified in the corresponding element of the third operand modulo the element size in bits. For VERLL, each element in the third operand is rotated left by the number of bits specified by the second-operand address, modulo the number of bits in the specified element size.

Each bit shifted out of the leftmost bit position of the element reenters in the rightmost bit position of the element. The result is placed in the corresponding element in the first operand.

For VERLL, The displacement is treated as a 12-bit unsigned integer.

For VERLL, The second-operand address is not used to address data; its rightmost bits indicate the number of bit positions to be rotated. The remainder of the address is ignored.

The M_4 field specifies the element size control (ES). The ES control specifies the size of the elements in the vector register operands. If a reserved value is specified, a specification exception is recognized.

M_4	Element Size
0	Byte
1	Halfword
2	Word
3	Doubleword
4-15	Reserved

Condition Code: The code remains unchanged.

Program Exceptions:

- Data with DXC FE, Vector Instruction
- Operation (if the vector facility for z/Architecture is not installed)
- Specification
- Transaction constraint

Programming Note: Although the rotate amount is defined to be an unsigned integer of the number of bits necessary to specify a full rotate left amount for an element, a negative value may be encoded which effectively specifies a rotate-right amount.

Extended Mnemonics:

Extended Mnemonic	Base Mnemonic
VERLLVB V_1, V_2, V_3	VERLLV $V_1, V_2, V_3, 0$
VERLLVH V_1, V_2, V_3	VERLLV $V_1, V_2, V_3, 1$
VERLLVF V_1, V_2, V_3	VERLLV $V_1, V_2, V_3, 2$
VERLLVG V_1, V_2, V_3	VERLLV $V_1, V_2, V_3, 3$
VERLLB $V_1, V_3, D_2(B_2)$	VERLL $V_1, V_3, D_2(B_2), 0$
VERLLH $V_1, V_3, D_2(B_2)$	VERLL $V_1, V_3, D_2(B_2), 1$
VERLLF $V_1, V_3, D_2(B_2)$	VERLL $V_1, V_3, D_2(B_2), 2$
VERLLG $V_1, V_3, D_2(B_2)$	VERLL $V_1, V_3, D_2(B_2), 3$

VECTOR ELEMENT ROTATE AND INSERT UNDER MASK

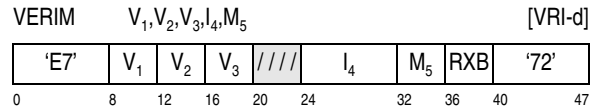

Each element of the second operand is rotated left by the number of bits specified by the fourth operand. Each bit shifted out of the leftmost bit position of the element reenters in the rightmost bit position of the element. The third operand contains a mask in each element. For each bit in the third operand that is one, the corresponding bit of the rotated elements in the second operand replaces the corresponding bit in the first operand. For each bit in the third operand that is zero, the corresponding bit of the first operand remains unchanged. Except for the case when the first operand is the same as either the second or third operand, the second and third operands remain unchanged.

The fourth operand is an unsigned binary integer specifying the number of bits to rotate each element in the second operand by. If the value is larger than the number of bits in the specified element size, the value is reduced modulo the number of bits in the element.

The M_5 field specifies the element size control (ES). The ES control specifies the size of the elements in the vector register operands. If a reserved value is specified, a specification exception is recognized.

M_5	Element Size
0	Byte
1	Halfword
2	Word
3	Doubleword
4-15	Reserved

Condition Code: The code remains unchanged.

Program Exceptions:

- Data with DXC FE, Vector Instruction
- Operation (if the vector facility for z/Architecture is not installed)
- Specification
- Transaction constraint

Extended Mnemonics:

Extended Mnemonic	Base Mnemonic
VERIMB V_1, V_2, V_3, I_4	VERIM $V_1, V_2, V_3, I_4, 0$
VERIMH V_1, V_2, V_3, I_4	VERIM $V_1, V_2, V_3, I_4, 1$
VERIMF V_1, V_2, V_3, I_4	VERIM $V_1, V_2, V_3, I_4, 2$
VERIMG V_1, V_2, V_3, I_4	VERIM $V_1, V_2, V_3, I_4, 3$

Programming Notes:

1. A combination of VERIM and VGM may be used to accomplish the full functionality of ROTATE AND INSERT SELECTED BITS in Chapter 7.
2. Although the bits of the I_4 field are defined to contain an unsigned binary integer specifying the number of bits to rotate each element left, a negative value may be coded which effectively specifies a rotate-right amount.

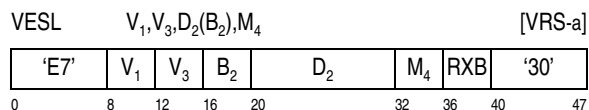
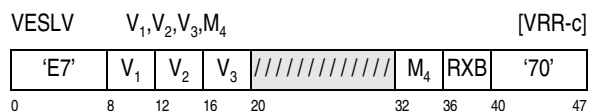
VECTOR ELEMENT SHIFT LEFT

For VESLV, each element in the second operand is shifted left by the number of bits specified in the corresponding element in the third operand modulo the number of bits in an element. For VESL, each element in the third operand is shifted left by the number of bits specified by the second-operand address modulo the number of bits in the specified element size. Bits shifted out of bit 0 of each element are lost and zeros are supplied to the vacated bit positions to the right of each element. The result is placed in the first operand.

For VESL, the displacement is treated as a 12-bit unsigned integer.

For VESL, the second-operand address is not used to address data; its rightmost bits indicate the number of bit positions to be shifted. The leftmost bits of the address are ignored.

The M_4 field specifies the element size control (ES). The ES control specifies the size of the elements in the vector register operands. If a reserved value is specified, a specification exception is recognized.

 M_4 Element Size

0	Byte
1	Halfword
2	Word
3	Doubleword
4-15	Reserved

Condition Code: The code remains unchanged.

Program Exceptions:

- Data with DXC FE, Vector Instruction
- Operation (if the vector facility for z/Architecture is not installed)
- Specification
- Transaction constraint

Programming Note: The same results are obtained if the second operand contains either signed or unsigned binary integers.

Extended Mnemonics:

Extended Mnemonic	Base Mnemonic
VESLVB V_1, V_2, V_3	VESLV $V_1, V_2, V_3, 0$
VESLVH V_1, V_2, V_3	VESLV $V_1, V_2, V_3, 1$
VESLVF V_1, V_2, V_3	VESLV $V_1, V_2, V_3, 2$
VESLVG V_1, V_2, V_3	VESLV $V_1, V_2, V_3, 3$
VESLVB $V_1, V_3, D_2(B_2)$	VESL $V_1, V_3, D_2(B_2), 0$
VESLVH $V_1, V_3, D_2(B_2)$	VESL $V_1, V_3, D_2(B_2), 1$
VESLVF $V_1, V_3, D_2(B_2)$	VESL $V_1, V_3, D_2(B_2), 2$
VESLVG $V_1, V_3, D_2(B_2)$	VESL $V_1, V_3, D_2(B_2), 3$

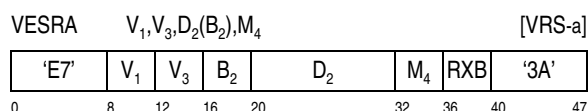
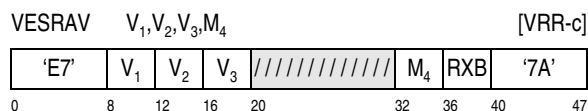
VECTOR ELEMENT SHIFT RIGHT ARITHMETIC

For VESRAV, each element in the second operand is shifted right by the number of bits specified in the corresponding element of the third operand modulo the number of bits in the specified element size. For VESRA, each element in the third operand is shifted right by the number of bits specified in the second-operand address modulo the number of bits in the specified element size. The result is placed in the corresponding element of the first operand with the vacated bits replaced with the original high order bit of each element.

For VESRA, the displacement is treated as a 12-bit unsigned integer.

For VESRA, the second-operand address is not used to address data; its rightmost bits indicate the number of bit positions to be shifted. The leftmost bits of the address are ignored.

The M_4 field specifies the element size control (ES). The ES control specifies the size of the elements in the vector register operands. If a reserved value is specified, a specification exception is recognized.

M_4	Element Size
0	Byte
1	Halfword
2	Word
3	Doubleword
4-15	Reserved

Condition Code: The code remains unchanged.

Program Exceptions:

- Data with DXC FE, Vector Instruction
- Operation (if the vector facility for z/Architecture is not installed)
- Specification
- Transaction constraint

Extended Mnemonics:

Extended Mnemonic	Base Mnemonic
VESRAVB V_1, V_2, V_3	VESRAV $V_1, V_2, V_3, 0$
VESRAVH V_1, V_2, V_3	VESRAV $V_1, V_2, V_3, 1$
VESRAVF V_1, V_2, V_3	VESRAV $V_1, V_2, V_3, 2$
VESRAVG V_1, V_2, V_3	VESRAV $V_1, V_2, V_3, 3$
VESRAB $V_1, V_3, D_2(B_2)$	VESRA $V_1, V_3, D_2(B_2), 0$
VESRAH $V_1, V_3, D_2(B_2)$	VESRA $V_1, V_3, D_2(B_2), 1$
VESRAF $V_1, V_3, D_2(B_2)$	VESRA $V_1, V_3, D_2(B_2), 2$
VESRAG $V_1, V_3, D_2(B_2)$	VESRA $V_1, V_3, D_2(B_2), 3$

VECTOR ELEMENT SHIFT RIGHT LOGICAL

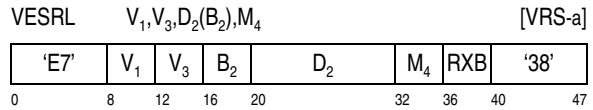
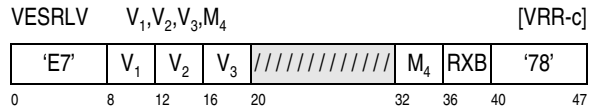

For VESRLV, each element in the second operand is shifted right by the number of bits specified in the corresponding element of the third operand modulo the number of bits in the specified element size. For VESRL, each element in the third operand is shifted right by the number of bits specified in the second-operand address modulo the specified element size. The result is placed in the corresponding element of the first operand with the vacated bits replaced with zeros.

For VESRL, the displacement is treated as a 12-bit unsigned integer.

For VESRL, the second-operand address is not used to address data; its rightmost bits indicate the number of bit positions to be shifted. The leftmost bits of the address are ignored.

The M_4 field specifies the element size control (ES). The ES control specifies the size of the elements in the vector register operands. If a reserved value is specified, a specification exception is recognized.

M_4	Element Size
0	Byte
1	Halfword
2	Word
3	Doubleword
4-15	Reserved

Condition Code: The code remains unchanged.

Program Exceptions:

- Data with DXC FE, Vector Instruction

- Operation (if the vector facility for z/Architecture is not installed)
- Specification
- Transaction constraint

Extended Mnemonics:

Extended Mnemonic	Base Mnemonic
VESRLVB V_1, V_2, V_3	VESRLV $V_1, V_2, V_3, 0$
VESRLVH V_1, V_2, V_3	VESRLV $V_1, V_2, V_3, 1$
VESRLVF V_1, V_2, V_3	VESRLV $V_1, V_2, V_3, 2$
VESRLVG V_1, V_2, V_3	VESRLV $V_1, V_2, V_3, 3$
VESRLB $V_1, V_3, D_2(B_2)$	VESRL $V_1, V_3, D_2(B_2), 0$
VESRLH $V_1, V_3, D_2(B_2)$	VESRL $V_1, V_3, D_2(B_2), 1$
VESRLF $V_1, V_3, D_2(B_2)$	VESRL $V_1, V_3, D_2(B_2), 2$
VESRLG $V_1, V_3, D_2(B_2)$	VESRL $V_1, V_3, D_2(B_2), 3$

VECTOR SHIFT LEFT

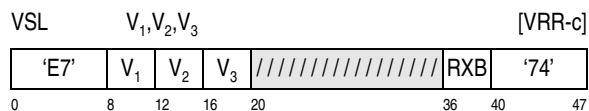

Each byte elements of the second operand are shifted left by the number of bits specified by an unsigned binary integer in bits 5-7 of the corresponding byte element of the third operand. If the vector-enhancements facility 2 is not installed and all bytes of the third operand are not equal, then the result is unpredictable. Bits shifted out of bit 0 of each byte are lost and the leftmost bits of the byte element located right of each byte element are supplied to the vacated bit positions to the right. For the rightmost byte element of the second operand, zeros are supplied to the vacated bit positions to the right. The result is placed in the first operand.

Condition Code: The code remains unchanged.

Program Exceptions:

- Data with DXC FE, Vector Instruction
- Operation (if the vector facility for z/Architecture is not installed)
- Transaction constraint

Engineering Notes:

VECTOR SHIFT LEFT BY BYTE

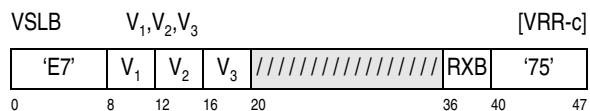

The second operand is shifted left by the number of bytes specified by the unsigned integer in bits 1-4 of byte element seven of the third operand. Bits shifted out of bit 0 are lost and zeros are supplied to the vacated bit positions to the right. The result is placed in the first operand.

Condition Code: The code remains unchanged.

Program Exceptions:

- Data with DXC FE, Vector Instruction
- Operation (if the vector facility for z/Architecture is not installed)
- Transaction constraint

VECTOR SHIFT LEFT DOUBLE BY BIT

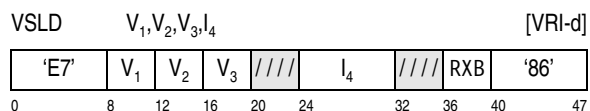

A double-wide source vector is created by concatenating the second operand followed by the third operand. Bits 5-7 of the fourth operand contain an unsigned binary integer that specifies the start index of the 128 consecutive bits from the source vector which are placed into the first operand vector register.

If bits 0-4 of the fourth operand are non zero, a specification exception is recognized.

Condition Code: The code remains unchanged.

Program Exceptions:

- Data with DXC FE, Vector Instruction
- Operation (if the vector-enhancements facility 2 is not installed)
- Transaction constraint

- Specification

Programming Note: The illustration below shows an example:

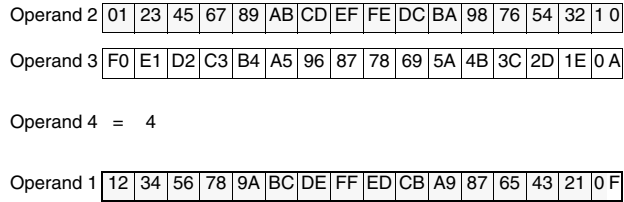

VECTOR SHIFT LEFT DOUBLE BY BYTE

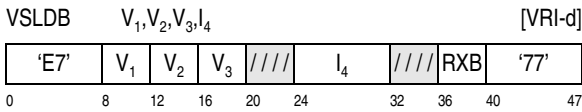

A double-wide source vector of byte elements is created by concatenating the second operand followed by the third operand. Bits 4-7 of the fourth operand contain an unsigned binary integer that specifies the starting index of sixteen consecutive bytes from the source vector which are placed into vector register V_1 . Bits 0-3 of the fourth operand should contain zeros; otherwise the results are unpredictable.

Condition Code: The code remains unchanged.

Program Exceptions:

- Data with DXC FE, Vector Instruction
- Operation (if the vector facility for z/Architecture is not installed)
- Transaction constraint

VECTOR SHIFT RIGHT ARITHMETIC

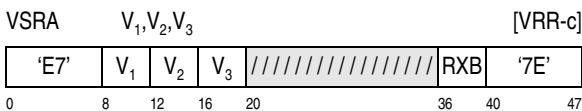

Each byte elements of the second operand is shifted right by the number of bits specified by an unsigned binary integer in bits 5-7 of each byte of the third operand. If the vector-enhancements facility 2 is not installed and all bytes of the third operand are not

equal, then the result is unpredictable. Bits shifted out of bit 7 of each byte are lost and the rightmost bits of the byte element located left of each byte element are supplied to the vacated bit positions to the left. For the byte element zero of the second operand, bits equal to bit zero of byte element zero are supplied to the vacated bit positions to the left. The result is placed in the first operand.

Condition Code: The code remains unchanged.

Program Exceptions:

- Data with DXC FE, Vector Instruction
- Operation (if the vector facility for z/Architecture is not installed)
- Transaction constraint

Engineering Notes:

VECTOR SHIFT RIGHT ARITHMETIC BY BYTE

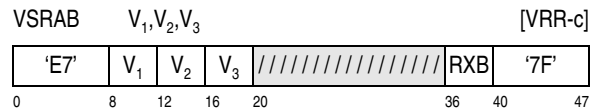

The second operand is shifted right by the number of bytes specified by the unsigned integer in bits 1-4 of byte seven of the third operand. Bits shifted out of bit 127 are lost, and bits equal to bit zero are supplied to the vacated bit positions to the left. The result is placed in the first operand.

Condition Code: The code remains unchanged.

Program Exceptions:

- Data with DXC FE, Vector Instruction
- Operation (if the vector facility for z/Architecture is not installed)
- Transaction constraint

VECTOR SHIFT RIGHT DOUBLE BY BIT

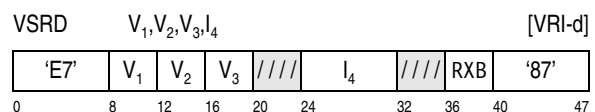

A double-wide source vector is created by concatenating the second operand followed by the third operand. Bits 5-7 of the fourth operand contain an unsigned binary integer that subtracted from 128 specifies the start index of the 128 consecutive bits from the source vector which are placed into the first operand vector register.

If bits 0-4 of the fourth operand are non zero, a specification exception is recognized.

Condition Code: The code remains unchanged.

Program Exceptions:

- Data with DXC FE, Vector Instruction
- Operation (if the vector-enhancements facility 2 is not installed)
- Transaction constraint
- Specification

Programming Note: This instruction is intended to extract arbitrary length data elements not on a byte boundary into SIMD elements for parallel processing.

VECTOR SHIFT RIGHT LOGICAL

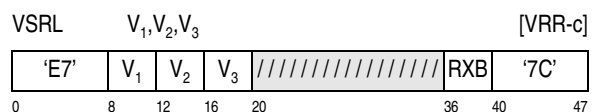

Each byte elements of the second operand are shifted right by the number of bits specified by an unsigned binary integer in bits 5-7 of the corresponding byte element of the third operand. If the vector-enhancements facility 2 is not installed and all bytes of the third operand are not equal, then the result is unpredictable. Bits shifted out of bit 7 of each byte are lost and the rightmost bits of the byte element located left of each byte element are supplied to the vacated bit positions to the left. For the byte element zero of the second operand, zeros are supplied to the vacated bit positions to the left. The result is placed in the first operand.

Condition Code: The code remains unchanged.

Program Exceptions:

- Data with DXC FE, Vector Instruction
- Operation (if the vector facility for z/Architecture is not installed)

- Transaction constraint

Engineering Notes:

VECTOR SHIFT RIGHT LOGICAL BY BYTE

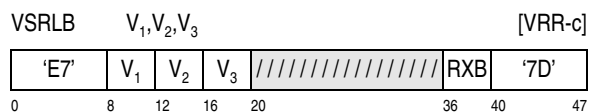

The second operand is shifted right by the number of bytes specified by the unsigned integer in bits 1-4 of byte element seven of the third operand. Bits shifted out of bit 127 are lost and zeros are supplied to the vacated bit positions to the left. The result is placed in the first operand.

Condition Code: The code remains unchanged.

Program Exceptions:

- Data with DXC FE, Vector Instruction
- Operation (if the vector facility for z/Architecture is not installed)
- Transaction constraint

VECTOR SUBTRACT

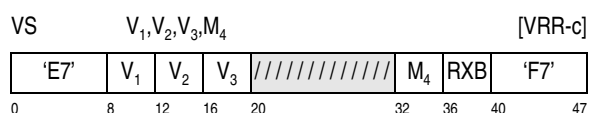

The contents of each element of the third operand are subtracted from the contents of each corresponding element of the second operand and the resulting difference is placed in the corresponding element of the first operand. Each element is treated as a signed binary integer specified by the element size control in the M₄ field.

When there is an overflow, the result is obtained by allowing any carry into the sign-bit position and ignoring any carry out of the sign-bit position.

The M₄ field specifies the element size control (ES). The ES control specifies the size of the element or elements in the vector register operands. If a

reserved value is specified, a specification exception is recognized.

M_4	Element Size
0	Byte
1	Halfword
2	Word
3	Doubleword
4	Quadword
5-15	Reserved

Condition Code: The code remains unchanged.

Program Exceptions:

- Data with DXC FE, Vector Instruction
- Operation (if the vector facility for z/Architecture is not installed)
- Specification
- Transaction constraint

Programming Note: The same results are obtained if the contents of each element contain unsigned binary integers.

Extended Mnemonics:

Extended Mnemonic	Base Mnemonic
VSB V_1, V_2, V_3	VS $V_1, V_2, V_3, 0$
VSH V_1, V_2, V_3	VS $V_1, V_2, V_3, 1$
VSF V_1, V_2, V_3	VS $V_1, V_2, V_3, 2$
VSG V_1, V_2, V_3	VS $V_1, V_2, V_3, 3$
VSQ V_1, V_2, V_3	VS $V_1, V_2, V_3, 4$

VECTOR SUBTRACT COMPUTE BORROW INDICATION

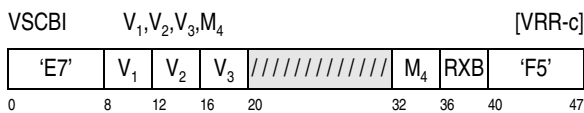

The contents of each element of the third operand are subtracted from the contents of each corresponding element of the second operand. An indication of borrow is placed in the corresponding element of the first operand.

If the resulting subtraction results in a carry out of bit zero, a value of one is placed in the corresponding element of the first operand; otherwise, a value of zero is placed in the corresponding element of the

first operand. The operands are treated as unsigned binary integers of size specified by the element size control in the M_4 field.

The M_4 field specifies the element size control (ES). The ES control specifies the size of the element or elements in the vector register operands. If a reserved value is specified, a specification exception is recognized.

M_4	Element Size
0	Byte
1	Halfword
2	Word
3	Doubleword
4	Quadword
5-15	Reserved

Condition Code: The code remains unchanged.

Program Exceptions:

- Data with DXC FE, Vector Instruction
- Operation (if the vector facility for z/Architecture is not installed)
- Specification
- Transaction constraint

Extended Mnemonics:

Extended Mnemonic	Base Mnemonic
VSCBIB V_1, V_2, V_3	VSCBI $V_1, V_2, V_3, 0$
VSCBIH V_1, V_2, V_3	VSCBI $V_1, V_2, V_3, 1$
VSCBIF V_1, V_2, V_3	VSCBI $V_1, V_2, V_3, 2$
VSCBIG V_1, V_2, V_3	VSCBI $V_1, V_2, V_3, 3$
VSCBIQ V_1, V_2, V_3	VSCBI $V_1, V_2, V_3, 4$

VECTOR SUBTRACT WITH BORROW INDICATION

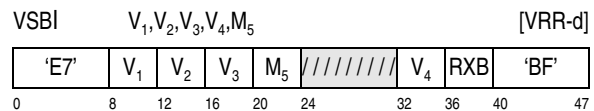

A subtraction is performed by adding the contents of the second operand with the bitwise complement of the third operand along with a borrow indication from the rightmost bit position of the fourth operand and the result is placed in the first operand. All bit positions to the left of the rightmost bit position of the

fourth operand are ignored. Each operand is treated as an unsigned binary integer.

When there is an overflow, the result is obtained by allowing any carry into the leftmost-bit position and ignoring any carry out of the leftmost-bit position.

No fixed point overflow exceptions are recognized.

The M_5 field must contain a value of 4; otherwise, a specification exception is recognized.

Condition Code: The code remains unchanged.

Program Exceptions:

- Data with DXC FE, Vector Instruction
- Operation (if the vector facility for z/Architecture is not installed)
- Specification
- Transaction constraint

Extended Mnemonics:

Extended Mnemonic	Base Mnemonic
VSBIQ V_1, V_2, V_3, V_4	VSBI $V_1, V_2, V_3, V_4, 4$

VECTOR SUBTRACT WITH BORROW COMPUTE BORROW INDICATION

VSBCBI V_1, V_2, V_3, V_4, M_5 [VRR-d]

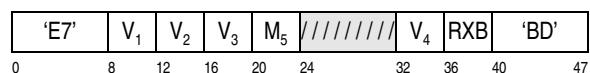

A subtraction is performed by adding the contents of the second operand with the bitwise complement of the third operand along with a borrow indication from the rightmost bit of the fourth operand. All bit positions to the left of the rightmost bit position of the fourth operand are ignored. If the addition results in a carry out of the leftmost bit, a value of one is placed in the first operand. If there is no carry out of the leftmost bit, a value of zero is placed in the first operand. Each operand is treated as an unsigned binary integer.

The M_5 field must contain a value of 4; otherwise, a specification exception is recognized.

Condition Code: The code remains unchanged.

Program Exceptions:

- Data with DXC FE, Vector Instruction
- Operation (if the vector facility for z/Architecture is not installed)
- Specification
- Transaction constraint

Extended Mnemonics:

Extended Mnemonic	Base Mnemonic
VSBCBIQ V_1, V_2, V_3, V_4	VSBCBI $V_1, V_2, V_3, V_4, 4$

Programming Note: VECTOR SUBTRACT WITH BORROW COMPUTE BORROW INDICATION in conjunction with VECTOR SUBTRACT WITH BORROW INDICATION can be used to perform subtractions on values with a precision greater than a quadword.

VECTOR SUM ACROSS DOUBLEWORD

VSUMG V_1, V_2, V_3, M_4 [VRR-c]

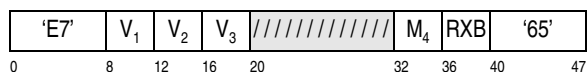

The four halfword or two word sub-elements in each of the doubleword elements of the second operand are summed and then added to the corresponding rightmost sub-element of the corresponding doubleword of the third operand. The full-precision intermediate-sum is extended on the left with zeros to a doubleword and the results are placed in the corresponding doubleword of the first operand.

The M_4 field specifies the element size control (ES). The ES control specifies the size of the sub-elements in the vector register operands. If a reserved value is specified, a specification exception is recognized.

M_4 Element Size

- | | |
|------|----------|
| 0 | Reserved |
| 1 | Halfword |
| 2 | Word |
| 3-15 | Reserved |

Condition Code: The code remains unchanged.

Program Exceptions:

- Data with DXC FE, Vector Instruction
- Operation (if the vector facility for z/Architecture is not installed)
- Specification
- Transaction constraint

Extended Mnemonics:

Extended Mnemonic	Base Mnemonic
VSUMGH V_1, V_2, V_3	VSUMG $V_1, V_2, V_3, 1$
VSUMGF V_1, V_2, V_3	VSUMG $V_1, V_2, V_3, 2$

VECTOR SUM ACROSS QUADWORD

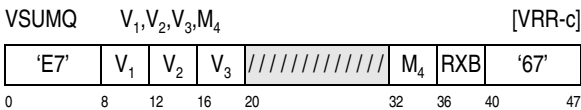

The two doubleword elements or four word elements of the second operand are added together along with the corresponding right-most word or doubleword element of the third operand. The full-precision intermediate-sum is extended on the left with zeros to a quadword and the result is placed in the first operand.

The M₄ field specifies the element size control (ES). The ES control specifies the size of the sub-elements in the vector register operands. If a reserved value is specified, a specification exception is recognized.

M ₄	Element Size
0-1	Reserved
2	Word
3	Doubleword
4-15	Reserved

Condition Code: The code remains unchanged.

Program Exceptions:

- Data with DXC FE, Vector Instruction
- Operation (if the vector facility for z/Architecture is not installed)
- Specification

- Transaction constraint

Extended Mnemonics:

Extended Mnemonic	Base Mnemonic
VSUMQF V_1, V_2, V_3	VSUMQ $V_1, V_2, V_3, 2$
VSUMQG V_1, V_2, V_3	VSUMQ $V_1, V_2, V_3, 3$

VECTOR SUM ACROSS WORD

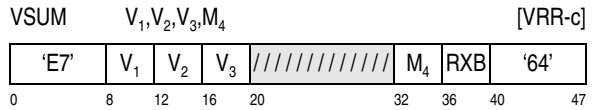

The two halfword elements or four byte elements of each word element of the second operand are added together along with the corresponding right-most sub-element of each word in the third operand. The full-precision intermediate-sum is extended on the left with zeros to a word and the result is placed in the corresponding word element of the first operand.

The M₄ field specifies the element size control (ES). The ES control specifies the size of the sub-elements in the vector register operand. If a reserved value is specified, a specification exception is recognized.

M ₄	Element Size
0	Byte
1	Halfword
2-15	Reserved

Condition Code: The code remains unchanged.

Program Exceptions:

- Data with DXC FE, Vector Instruction
- Operation (if the vector facility for z/Architecture is not installed)
- Specification
- Transaction constraint

Extended Mnemonics:

Extended Mnemonic	Base Mnemonic
VSUMB V_1, V_2, V_3	VSUM $V_1, V_2, V_3, 0$
VSUMH V_1, V_2, V_3	VSUM $V_1, V_2, V_3, 1$

VECTOR TEST UNDER MASK

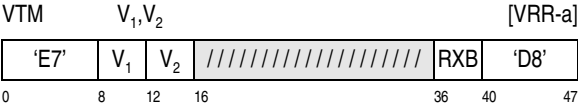

The second operand contains a mask. The bits in the mask correspond one for one with the bits of the first operand. A mask bit of one indicates that the first-operand bit is to be tested. When a mask bit is zero, the first operand bit is ignored. When all first-operand bits thus selected are zero, condition code 0 is set. Condition code 0 is also set when the mask is all

zeros. When the selected bits are all ones, condition code 3 is set; otherwise, condition code 1 is set.

Resulting Condition Code:

- 0 Selected bits all zeros; or all mask bits zero
- 1 Selected bits a mix of zeros and ones
- 2 --
- 3 Selected bits all ones

Program Exceptions:

- Data with DXC FE, Vector Instruction
- Operation (if the vector facility for z/Architecture is not installed)
- Transaction constraint

Chapter 23. Vector String Instructions

Vector String Facility	23-1	VECTOR FIND ELEMENT NOT EQUAL	23-4
Instructions	23-1	VECTOR ISOLATE STRING	23-5
VECTOR FIND ANY ELEMENT EQUAL	23-2	VECTOR STRING RANGE COMPARE	23-6
VECTOR FIND ELEMENT EQUAL	23-3	VECTOR STRING SEARCH	23-8

Vector String Facility

The vector string facility provides instructions to accelerate the processing of strings of character data.

Unless otherwise specified, all operands are vector-register operands. A “V” in the assembler syntax designates a vector operand.

Each instruction has an Extended Mnemonic section which describe recommended extended mnemonics and their corresponding machine assembler syntax.

Instructions

All of the instructions except for VECTOR ISOLATE STRING have the ability to produce an index to a character element within a vector. This index is always placed in the rightmost bits of the leftmost doubleword of the vector. This index will often be used in scalar computation for address generation and will need to be transferred to a general register. If an element index is needed the index will have to be shifted right by the appropriate number of bits.

Programming Notes:

1. For all instructions that optionally set the condition code, performance may be degraded if the condition code is set.
2. The following additional instruction is available when the vector-enhancements facility 2 is installed:
 - VECTOR STRING SEARCH (VSTRS)

Name	Mnemonic	Characteristics						Op-code	Page
VECTOR FIND ANY ELEMENT EQUAL	VFAE	VRR-b	C*	VF	$\alpha^{7,9}$	SP	Dv	E782	23-2
VECTOR FIND ELEMENT EQUAL	VFEE	VRR-b	C*	VF	$\alpha^{7,9}$	SP	Dv	E780	23-3
VECTOR FIND ELEMENT NOT EQUAL	VFENE	VRR-b	C*	VF	$\alpha^{7,9}$	SP	Dv	E781	23-4
VECTOR ISOLATE STRING	VISTR	VRR-a	C*	VF	$\alpha^{7,9}$	SP	Dv	E75C	23-5
VECTOR STRING RANGE COMPARE	VSTRC	VRR-d	C*	VF	$\alpha^{7,9}$	SP	Dv	E78A	23-6
VECTOR STRING SEARCH	VSTRS	VRR-d	C	V2	$\alpha^{7,9}$	SP	Dv	E78B	23-8

Explanation:

- α^7 Restricted from transactional execution when the effective allow-floating-point-operation control is zero.
- α^9 Restricted in the constrained transactional-execution mode; a transaction-constraint program exception may be recognized.
- C* Condition code optionally set.
- Dv Vector-instruction data exception
- SP Specification exception.
- V2 Vector enhancements facility 2
- VF Vector facility for z/Architecture
- VRR VRR instruction format

Figure 23-1. Summary of Vector String Instructions

VECTOR FIND ANY ELEMENT EQUAL

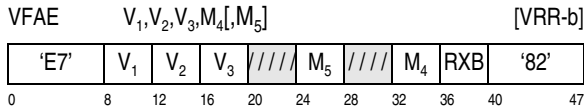

Proceeding from left to right, each element of the second operand is compared for equality with every element of the third operand. A first intermediate result is created from this comparison with an indication for each element in the second operand if the element was equal to any element in the third operand.

If the invert-result (IN) flag in the M_5 field is one, then each indication in the first intermediate result is inverted.

If the zero-search (ZS) flag in the M_5 field is one, each element in the second operand is also compared with zeros and a second intermediate result is created with an indication for each element if that element is equal to zero. If the ZS flag is zero, the second intermediate result contains all false indications.

If the result-type (RT) flag is zero, for each of the two intermediate results, the index of the lowest indexed true result is obtained. The index is then converted to a byte index by multiplying by the number of bytes in an element. The minimum of the indices obtained from the two intermediate results is then computed. If no true result is found in either intermediate result, a final index equal to the number of bytes in the vector is produced. The index is placed into byte seven of the first operand; all other bytes of the first operand are set to zero.

If the RT flag in the M_5 field is one, for each element in the second operand, if the indication in the first intermediate result is true, the bit positions of the corresponding element in first operand are set to ones. If the first intermediate result element contains a false indication the bit positions of the corresponding element in the first operand are set to zero. No indication of true results in the second intermediate value are indicated in the first operand.

The M_4 field specifies the element size control (ES). The ES control specifies the size of the elements in

the vector register operands. If a reserved value is specified, a specification exception is recognized.

M_4 Element Size

0	Byte
1	Halfword
2	Word
3-15	Reserved

The M_5 field has the following format:



The bits of the M_5 field are defined as follows:

- **Invert Result (IN):** If bit 0 is zero, the operation proceeds using the comparison indication values in the first intermediate result. If one, the operation proceeds with the comparison indication values in the first intermediate result inverted.
- **Result Type (RT):** If bit 1 is zero, a byte index is stored into byte seven of the first operand and zeros are stored in all other elements. If bit 1 is one, each resulting element is a bit-vector.
- **Zero Search (ZS):** If bit 2 is one, each element of the second operand is also compared for equality with zero.
- **Condition Code Set (CS):** If bit 3 is zero, the condition code is not set and remains unchanged. If one, the condition code is set as specified in the resulting condition code section below.

Resulting Condition Code:

If the CS-bit is zero, the code remains unchanged.

If the CS-bit is one, the code is set as follows:

- 0 If the ZS-bit is one, there are no true indications in a lower indexed element in the first intermediate result than a true indication in the second intermediate result. That is, there were no matching elements before an element containing zero in the second operand.
- 1 At least one indication in the first intermediate result is true. All indications in the second intermediate result are false. That is, there was at

least one match in the second operand and, if the ZS-bit is one, no zero matches.

- If the ZS-bit is one and at least one indication in the first intermediate result is true with a lower index than a true indication in the second intermediate result.
- All indications in the first intermediate and second intermediate results are false.

Program Exceptions:

- Data with DXC FE, Vector Instruction
- Operation (if the vector facility for z/Architecture is not installed)
- Specification
- Transaction constraint

Extended Mnemonics:

Extended Mnemonic	Base Mnemonic
VFAEB $V_1, V_2, V_3, [M_5]$	VFAE $V_1, V_2, V_3, 0, [M_5]$
VFAEH $V_1, V_2, V_3, [M_5]$	VFAE $V_1, V_2, V_3, 1, [M_5]$
VFAEF $V_1, V_2, V_3, [M_5]$	VFAE $V_1, V_2, V_3, 2, [M_5]$
VFAEBS $V_1, V_2, V_3, [M_5]$	VFAE $V_1, V_2, V_3, 0, ([M_5] X'1')$
VFAEHS $V_1, V_2, V_3, [M_5]$	VFAE $V_1, V_2, V_3, 1, ([M_5] X'1')$
VFAEFS $V_1, V_2, V_3, [M_5]$	VFAE $V_1, V_2, V_3, 2, ([M_5] X'1')$
VFAEZB $V_1, V_2, V_3, [M_5]$	VFAE $V_1, V_2, V_3, 0, ([M_5] X'2')$
VFAEZH $V_1, V_2, V_3, [M_5]$	VFAE $V_1, V_2, V_3, 1, ([M_5] X'2')$
VFAEZF $V_1, V_2, V_3, [M_5]$	VFAE $V_1, V_2, V_3, 2, ([M_5] X'2')$
VFAEZBS $V_1, V_2, V_3, [M_5]$	VFAE $V_1, V_2, V_3, 0, ([M_5] X'3')$
VFAEZH $V_1, V_2, V_3, [M_5]$	VFAE $V_1, V_2, V_3, 1, ([M_5] X'3')$
VFAEZFS $V_1, V_2, V_3, [M_5]$	VFAE $V_1, V_2, V_3, 2, ([M_5] X'3')$

Programming Notes:

- If the RT flag is zero, a byte index is always stored into the first operand for any element size. For example, if the specified element size is halfword and the 2nd indexed halfword compared equal, a byte index of 4 would be stored.
- If the CS bit is one, conditions codes 0 and 2 can only be set if the ZS-bit is one.

VECTOR FIND ELEMENT EQUAL

VFEE $V_1, V_2, V_3, M_4, [M_5]$ [VRR-b]

'E7'	V_1	V_2	V_3	////	M_5	////	M_4	RXB	'80'	
0	8	12	16	20	24	28	32	36	40	47

Proceeding from left to right, the elements of the second operand are compared with the corresponding elements of the third operand and optionally with zero.

If two elements are equal, the byte index of the first byte of the left-most equal element is placed in byte seven of the first operand. Zeros are stored in the remaining bytes of the first operand. If no bytes are found to be equal, or are equal to zero if the zero search (ZS) bit is one, an index equal to the number of bytes in the vector is stored in byte seven of the first operand. Zeros are stored in the remaining bytes.

If the ZS bit is one in the M_5 field, each element in the second operand is also compared for equality with zero. If a zero element is found in the second operand before any other elements of the second and third operands are found to be equal, the byte index of the first byte of the element found to be zero is stored in byte seven of the first operand and zeros are stored in all other byte locations. If the condition-code-set (CS) flag is one, the condition code is set to zero.

The M_4 field specifies the element size control (ES). The ES control specifies the size of the elements in the vector register operands. If a reserved value is specified, a specification exception is recognized.

M_4	Element Size
0	Byte
1	Halfword
2	Word
3-15	Reserved

The M_5 field has the following format:



The bits of the M_5 field are defined as follows:

- Reserved:** Bits 0-1 are reserved and must be zero. Otherwise, a specification exception is recognized.
- Zero Search (ZS):** If bit 2 is one, each element of the second operand is also compared for equality with zero.

- **Condition Code Set (CS):** If bit 3 is zero, the condition code remains unchanged. If one, the condition code is set as specified in the following section.

Resulting Condition Code:

If the CS-bit is zero, the code remains unchanged.

If the CS-bit is one, the code is set as follows:

- 0 If the ZS-bit is one, in the second operand there were no equal comparisons in an element with an index less than an element whose contents are zero.
- 1 Comparison detected a match between the second and third operands in some element. If the ZS-bit is one, there were no zero comparisons in the second operand.
- 2 If the ZS-bit is one, there was a match between the second and third operands with a lower index than a match with zero in the second operand.
- 3 No elements compared equal. Additionally, if the ZS-bit is one, no elements contain zero.

Program Exceptions:

- Data with DXC FE, Vector Instruction
- Operation (if the vector facility for z/Architecture is not installed)
- Specification
- Transaction constraint

Extended Mnemonics:

Extended Mnemonic	Base Mnemonic
VFEEB $V_1, V_2, V_3, [M_5]$	VFEE $V_1, V_2, V_3, 0, [M_5]$
VFEEH $V_1, V_2, V_3, [M_5]$	VFEE $V_1, V_2, V_3, 1, [M_5]$
VFEEF $V_1, V_2, V_3, [M_5]$	VFEE $V_1, V_2, V_3, 2, [M_5]$
VFEEBS V_1, V_2, V_3	VFEE $V_1, V_2, V_3, 0, 1$
VFEEHS V_1, V_2, V_3	VFEE $V_1, V_2, V_3, 1, 1$
VFEEFS V_1, V_2, V_3	VFEE $V_1, V_2, V_3, 2, 1$
VFEEZB V_1, V_2, V_3	VFEE $V_1, V_2, V_3, 0, 2$
VFEEZH V_1, V_2, V_3	VFEE $V_1, V_2, V_3, 1, 2$
VFEEZF V_1, V_2, V_3	VFEE $V_1, V_2, V_3, 2, 2$
VFEEZBS V_1, V_2, V_3	VFEE $V_1, V_2, V_3, 0, 3$
VFEEZHS V_1, V_2, V_3	VFEE $V_1, V_2, V_3, 1, 3$
VFEEZFS V_1, V_2, V_3	VFEE $V_1, V_2, V_3, 2, 3$

Programming Notes:

1. A byte index is always stored into the first operand for any element size. For example, if the specified element size is halfword and the 2nd indexed halfword compared equal, a byte index of 4 would be stored.
2. Depending on the model, VECTOR FIND ELEMENT EQUAL may have better performance than VECTOR FIND ANY EQUAL when searching for a single character by replicating the character across all elements of the third operand.

VECTOR FIND ELEMENT NOT EQUAL

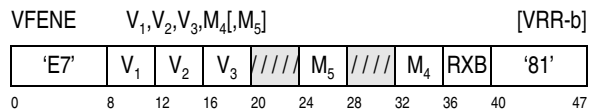

Proceeding from left to right, the elements of the second operand are compared with the corresponding elements of the third operand and optionally with zeros. The elements of the second and third operands are treated as unsigned binary integers.

If two elements are not equal, the byte index of the leftmost not-equal element is placed in byte seven of the first operand and zeros are stored to all other bytes. If the condition code set (CS) bit in the M_5 field is one, the condition code is set to indicate which operand was greater. If all elements were equal, a byte index equal to the vector size is placed in byte seven of the first operand and zeros are placed in all other byte locations and if the CS bit is one, condition code 3 is set.

If the zero search (ZS) bit is one in the M_5 field, each element in the second operand is also compared for equality with zero. If a zero element is found in the second operand with a lower index than any other element of the second operand found to be unequal, the byte index of the first byte of the element found to be zero is stored in byte seven of the first operand. Zeros are stored in all other bytes and condition code 0 is set.

The M_4 field specifies the element size control (ES). The ES control specifies the size of the elements in

the vector register operands. If a reserved value is specified, a specification exception is recognized.

M_4	Element Size
0	Byte
1	Halfword
2	Word
3-15	Reserved

The M_5 field has the following format:



The bits of the M_5 field are defined as follows:

- **Reserved:** Bits 0 and 1 are reserved and must be zero, otherwise a specification exception is recognized.
- **Zero Search (ZS):** If bit 2 is one, each element of the second operand is also compared for equality with zero.
- **Condition Code Set (CS):** If bit 3 is zero, the condition code is not set and remains unchanged. If one, the condition code is set as specified in the following section.

Resulting Condition Code:

If the CS-bit is zero, the code remains unchanged.

If the CS-bit is one, the code is set as follows:

- 0 If the ZS-bit is one, comparison detected a zero element in both operands in a lower indexed element than any unequal compares.
- 1 An element mismatch was detected and the element in the second operand is less than the element in the third operand.
- 2 An element mismatch was detected and the element in the second operand is greater than the element in the third operand.
- 3 All elements compared equal, and if the ZS-bit is one, no zero elements were found in the second operand.

Program Exceptions:

- Data with DXC FE, Vector Instruction

- Operation (if the vector facility for z/Architecture is not installed)
- Specification
- Transaction constraint

Extended Mnemonics:

Extended Mnemonic	Base Mnemonic
VFENEB $V_1, V_2, V_3[M_5]$	VFENE $V_1, V_2, V_3, 0[M_5]$
VFENEH $V_1, V_2, V_3[M_5]$	VFENE $V_1, V_2, V_3, 1[M_5]$
VFENEF $V_1, V_2, V_3[M_5]$	VFENE $V_1, V_2, V_3, 2[M_5]$
VFENEBS V_1, V_2, V_3	VFENE $V_1, V_2, V_3, 0, 1$
VFENEHS V_1, V_2, V_3	VFENE $V_1, V_2, V_3, 1, 1$
VFENEFS V_1, V_2, V_3	VFENE $V_1, V_2, V_3, 2, 1$
VFENEZB V_1, V_2, V_3	VFENE $V_1, V_2, V_3, 0, 2$
VFENEZH V_1, V_2, V_3	VFENE $V_1, V_2, V_3, 1, 2$
VFENEZF V_1, V_2, V_3	VFENE $V_1, V_2, V_3, 2, 2$
VFENEZBS V_1, V_2, V_3	VFENE $V_1, V_2, V_3, 0, 3$
VFENEZHS V_1, V_2, V_3	VFENE $V_1, V_2, V_3, 1, 3$
VFENEZFS V_1, V_2, V_3	VFENE $V_1, V_2, V_3, 2, 3$

VECTOR ISOLATE STRING

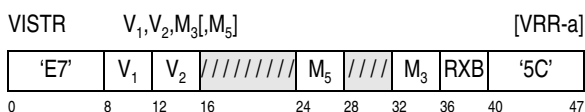

Proceeding from left to right, the elements of the second operand are compared with zero. The elements of the second operand are treated as unsigned binary integers. If a zero comparison is not found, the element is copied into the corresponding element of the first operand. If a zero comparison is found, comparison stops and the corresponding element and all elements to the right in the first operand are set to zero.

The M_3 field specifies the element size control (ES). The ES control specifies the size of the elements in the vector register operands. If a reserved value is specified, a specification exception is recognized.

M_3	Element Size
0	Byte
1	Halfword
2	Word
3-15	Reserved

The M_5 field has the following format:



The bits of the M_5 field are defined as follows:

- **Reserved:** Bits 0-2 are reserved and must be zero, otherwise a specification exception is recognized.
- **Condition Code Set (CS):** If bit 3 is zero, the condition code is not set and remains unchanged. If one, the condition code is set as specified in the following section.

Resulting Condition Code:

If the CS-bit is zero, the code remains unchanged.

If the CS-bit is one, the code is set as follows:

- | | |
|---|---|
| 0 | A zero element was found in the second operand |
| 1 | -- |
| 2 | -- |
| 3 | All elements of the second operand are non-zero |

Program Exceptions:

- Data with DXC FE, Vector Instruction
- Operation (if the vector facility for z/Architecture is not installed)
- Specification
- Transaction constraint

Extended Mnemonics:

Extended Mnemonic	Base Mnemonic
VISTRB V_1, V_2, M_5	VISTR $V_1, V_2, 0, M_5$
VISTRH V_1, V_2, M_5	VISTR $V_1, V_2, 1, M_5$
VISTRF V_1, V_2, M_5	VISTR $V_1, V_2, 2, M_5$
VISTRBS V_1, V_2	VISTR $V_1, V_2, 0, 1$
VISTRHS V_1, V_2	VISTR $V_1, V_2, 1, 1$
VISTRFS V_1, V_2	VISTR $V_1, V_2, 2, 1$

VECTOR STRING RANGE COMPARE

VSTRC $V_1, V_2, V_3, V_4, M_5, M_6$ [VRR-d]

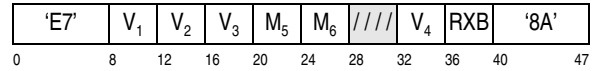

Proceeding from left to right, the elements of the second operand are compared to ranges specified by values in even-odd element pairs of the third and fourth operands and, optionally, against an element containing zero. The element in the second and third operand are treated as unsigned binary integers.

The elements of the third and fourth operands form range comparisons to which are applied to elements of the second operand. The even-odd pairs of elements in the third operand define values for the limits of the ranges. The corresponding even-odd pair of elements in the fourth operand contain control information to specify the comparison to be done with each value in the third operand. A range comparison is said to be true if the comparisons on both elements in the even-odd pair are true.

Each element in the second operand is compared against every range specified by the even-odd element pairs in the third and fourth operands. A first intermediate result is created from this comparison with an indication for each element in the second operand if the element was contained in any of the specified ranges.

If the invert-result (IN) flag in the M_6 field is one, then each indication in the first intermediate result is inverted.

If the zero-search (ZS) flag in the M_6 field is one, each element in the second operand is also compared with zeros and a second intermediate result is created with an indication for each element if that element is equal to zero. If the ZS flag is zero the second intermediate result contains all false indications.

If the result-type (RT) flag is zero, for each of the two intermediate results, the index of the lowest indexed true result is obtained. The index is then converted to a byte index by multiplying by the number of bytes in an element. The minimum of the indices obtained from the two intermediate results is then computed. If no true result is found in either intermediate result, a final index equal to the number of bytes in the vector

is produced. The index is placed into byte seven of the first operand; all other bytes of the first operand are set to zero.

If the RT flag in the M_6 field is one, for each element in the second operand, if the indication in the first intermediate result is true, the bit positions of the corresponding element in first operand are set to ones. If the first intermediate result element contains a false indication the bit positions of the corresponding element in the first operand are set to zero. No indication of true results in the second intermediate value are indicated in the first operand.

The fourth operand elements have the following format:

If ES equals 0:

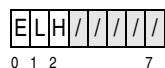

If ES equals 1:

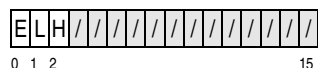

If ES equals 2:

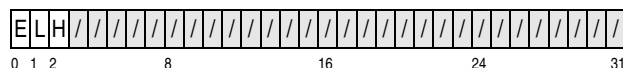

The bits in the fourth operand elements are defined as follows:

- **Equal (E):** When one, a comparison for equality is made.
- **Low (L):** When one, a less than comparison is performed.
- **High (H):** When one, a greater than comparison is performed.
- All other bits are reserved and should be zero to ensure future compatibility.

The control bits may be used in any combination. If none of the bits are set, the comparison will always produce a false result. If all of the bits are set, the comparison will always produce a true result.

The M_5 field specifies the element size control (ES). The ES control specifies the size of the elements in the vector register operands. If a reserved value is specified, a specification exception is recognized.

M_5 Element Size

0	Byte
1	Halfword
2	Word
3-15	Reserved

The M_6 field has the following format:



The bits of the M_6 field are defined as follows:

- **Invert Result (IN):** If bit 0 is zero, the operation proceeds using the comparison indication values in the first intermediate result. If one, the operation proceeds with the comparison indication values in the first intermediate result inverted.
- **Result Type (RT):** If bit 1 is zero, a byte index is stored into byte seven of the first operand and zeros are stored in all other elements. If bit 1 is one, each resulting element is a bit-vector.
- **Zero Search (ZS):** If bit 2 is one, each element of the second operand is also compared for equality with zero.
- **Condition Code Set (CS):** If bit 3 is zero, the condition code is not set and remains unchanged. If one, the condition code is set as specified in the following section.

Resulting Condition Code:

If the CS-bit is zero, the code remains unchanged.

If the CS-bit is one, the code is set as follows:

- 0 If the ZS-bit is one, there are no true indications in a lower indexed element in the first intermediate result than a true indication in the second intermediate result. That is, there were no matching elements before an element containing zero in the second operand.
- 1 At least one indication in the first intermediate result is true. All indications in the second intermediate result are false. That is, there was at

- least one match in the second operand and, if the ZS-bit is one, no zero matches.
- If the ZS-bit is one and at least one indication in the first intermediate result is true with a lower index than a true indication in the second intermediate result.
 - All indications in the first intermediate and second intermediate results are false.

Program Exceptions:

- Data with DXC FE, Vector Instruction
- Operation (if the vector facility for z/Architecture is not installed)
- Specification
- Transaction constraint

Extended Mnemonics:

Extended Mnemonic	Base Mnemonic
VSTRCB $V_1, V_2, V_3, V_4, [M_6]$	VSTRC $V_1, V_2, V_3, V_4, 0, [M_6]$
VSTRCH $V_1, V_2, V_3, V_4, [M_6]$	VSTRC $V_1, V_2, V_3, V_4, 1, [M_6]$
VSTRCF $V_1, V_2, V_3, V_4, [M_6]$	VSTRC $V_1, V_2, V_3, V_4, 2, [M_6]$
VSTRCBS $V_1, V_2, V_3, V_4, [M_6]$	VSTRC $V_1, V_2, V_3, V_4, 0, ([M_6] X'1')$
VSTRCHS $V_1, V_2, V_3, V_4, [M_6]$	VSTRC $V_1, V_2, V_3, V_4, 1, ([M_6] X'1')$
VSTRCFS $V_1, V_2, V_3, V_4, [M_6]$	VSTRC $V_1, V_2, V_3, V_4, 2, ([M_6] X'1')$
VSTRCZB $V_1, V_2, V_3, V_4, [M_6]$	VSTRC $V_1, V_2, V_3, V_4, 0, ([M_6] X'2')$
VSTRCZH $V_1, V_2, V_3, V_4, [M_6]$	VSTRC $V_1, V_2, V_3, V_4, 1, ([M_6] X'2')$
VSTRCZF $V_1, V_2, V_3, V_4, [M_6]$	VSTRC $V_1, V_2, V_3, V_4, 2, ([M_6] X'2')$
VSTRCZBS $V_1, V_2, V_3, V_4, [M_6]$	VSTRC $V_1, V_2, V_3, V_4, 0, ([M_6] X'3')$
VSTRCZHS $V_1, V_2, V_3, V_4, [M_6]$	VSTRC $V_1, V_2, V_3, V_4, 1, ([M_6] X'3')$
VSTRCZFS $V_1, V_2, V_3, V_4, [M_6]$	VSTRC $V_1, V_2, V_3, V_4, 2, ([M_6] X'3')$

Programming Notes:

- To create a comparison that is a range with only one bound, either place that comparison in both the even and odd elements of the pair in the third and fourth operands or place the operand in a single element of the pair with the comparison needed in the corresponding element of the fourth operand, and set the other element in the fourth operand to have all three control bits set.
- To create a comparison for equality place the same value in the even-odd pair in the third operand. The corresponding even-odd element pair in the fourth operand should contain elements with only a one in the EQ bit.
- If all available ranges are not needed, the control bits in the fourth operand should all be zero for the elements in the unneeded range. The corre-

sponding elements in the third operand are ignored.

VECTOR STRING SEARCH

VSTRS $V_1, V_2, V_3, V_4, M_5, [M_6]$ [VRR-d]

'E7'	V ₁	V ₂	V ₃	M ₅	M ₆	////	V ₄	RXB	'8B'	
0	8	12	16	20	24	28	32	36	40	47

The substring specified in the third operand is searched for in the second operand. The length of the substring in the third operand is dependent on the zero-search (ZS) flag in the M_6 field. When the ZS flag is zero, the length in bytes is specified as an unsigned binary integer in bits 56-63 of the fourth operand. When the ZS flag is one, the length in bytes is specified by the smaller of, the unsigned binary integer in bits 56-63 of the fourth operand, or the number of leftmost bytes of the third operand that contain nonzero values (from 0 to 16). See Figure 23-2 and Figure 23-3 for the dataflow of the instruction.

If the zero search (ZS) flag in the M_6 field is one and a zero element is contained in the third operand at a position less than the length specified by the fourth operand, then the position of the leftmost byte of the zero element is used as the length of the substring. If the ZS flag is zero, then the length specified in the fourth operand is used.

A first intermediate result is computed as the leftmost byte position in the second operand where the elements, left to right, of the substring are matching the elements in the second operand for the length of the substring. If such a position exists, then a full match exists. Otherwise, the longest partial string, left to right, of the substring matching the rightmost elements of the second operand is computed as the intermediate result. If such a match is found, it is called a partial match. Otherwise, there is no match and the intermediate result is 16.

If the zero search (ZS) flag in the M_6 is one and the index of the first substring matching position is greater than the position of the leftmost byte of the leftmost zero element in the second operand then the match is ignored.

If a non-ignored match is found then the starting position in bytes of the match in the second operand is stored in byte element seven of the first operand

else a value of 16 is stored. All other bytes of the first operand are set to zero.

Byte element seven of the fourth operand specifies the length of the substring in bytes and must be in the range of 0-16. Other values will result in an unpredictable result.

The M_5 field specifies the size of the elements in the vector register operands. If a reserved value is specified, a specification exception is recognized.

M_5	Element Size
0	Byte
1	Halfword
2	Word
3-15	Reserved

If the M_5 field specifies a halfword or word element size and the length of the substring in bytes is not a multiple of this element size, then results are unpredictable .

The M_6 field has the following format:



The bits of the M_6 field are defined as follows:

- **Reserved:** Bits 0,1,3 are reserved and must be zero, otherwise a specification exception is recognized.
- **Zero Search (ZS):** If bit 2 is one, the position of the leftmost zero byte element marks the string length.

Resulting Condition Code:

- 0 No match or partial match of the substring was found, and either the ZS flag is zero or no zero byte was detected in the second operand.
- 1 No match of the substring was found, and the ZS flag is one and a zero byte was detected in the second operand.
- 2 A full match was found.
- 3 A partial match was found but no full match.

Program Exceptions:

- Data with DXC FE, Vector Instruction
- Operation (if the vector enhancements facility 2 for the z/Architecture is not installed)
- Specification
- Transaction constraint

Extended Mnemonics:

Extended Mnemonic	Base Mnemonic
VSTRSB $V_1, V_2, V_3, V_4, [M_6]$	VSTRS $V_1, V_2, V_3, V_4, 0, [M_6]$
VSTRSH $V_1, V_2, V_3, V_4, [M_6]$	VSTRS $V_1, V_2, V_3, V_4, 1, [M_6]$
VSTRSF $V_1, V_2, V_3, V_4, [M_6]$	VSTRS $V_1, V_2, V_3, V_4, 2, [M_6]$
VSTRSZB V_1, V_2, V_3, V_4	VSTRS $V_1, V_2, V_3, V_4, 0, 2$
VSTRSZH V_1, V_2, V_3, V_4	VSTRS $V_1, V_2, V_3, V_4, 1, 2$
VSTRSZF V_1, V_2, V_3, V_4	VSTRS $V_1, V_2, V_3, V_4, 2, 2$

Programming Notes:

1. In accordance to C11 and java programming language standard a zero length substring is recognized as a full match.
2. If the ZS flag is one and a zero byte was detected in the second operand, then there can not be a partial match as the end of the string has been reached.
3. For proper usage, if the M_5 field specifies a halfword size then bit 63 of the fourth operand must be zero, and if the M_5 field specifies a word size then bits 62 and 63 of the fourth operand must both be zero.

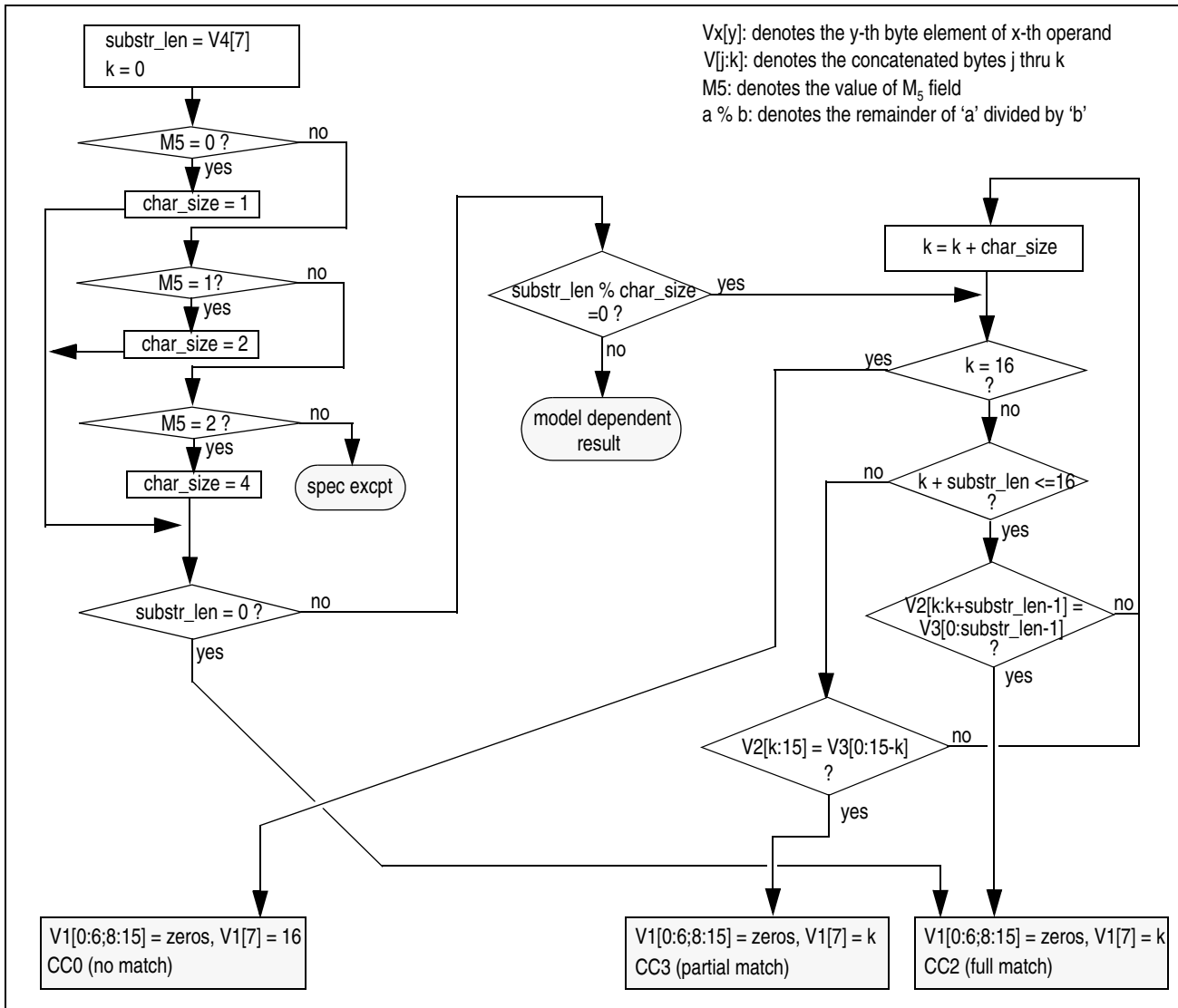

Figure 23-2. Execution of the VSTRS instruction for ZS=0

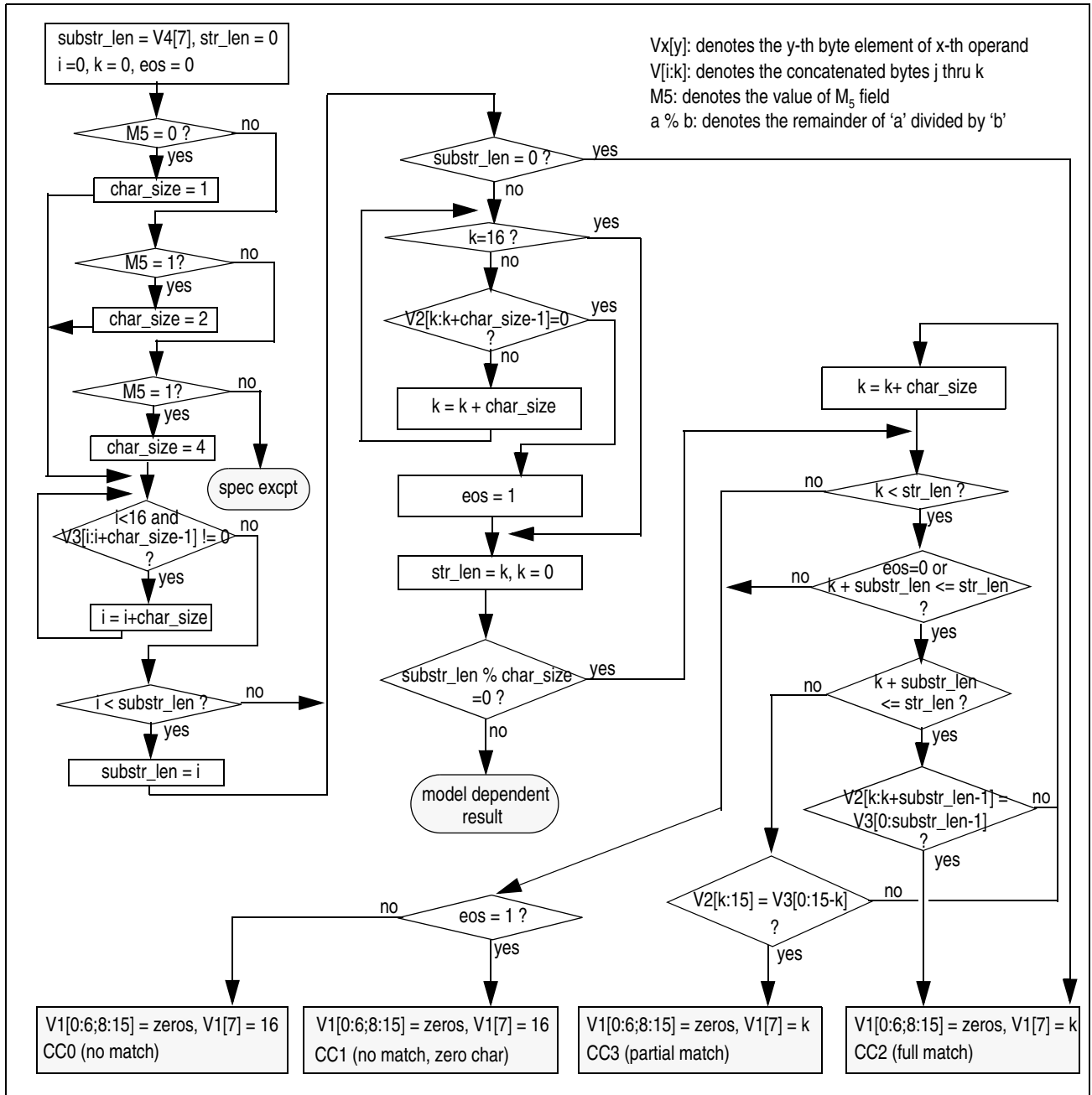

Figure 23-3. Execution of the VSTRS instruction for ZS=1

Chapter 24. Vector Floating-Point Instructions

IEEE Exception Handling	24-1	VECTOR FP MAXIMUM	24-28
Result Figures	24-1	VECTOR FP MINIMUM	24-34
Instructions	24-2	VECTOR FP MULTIPLY	24-40
VECTOR FP ADD	24-4	VECTOR FP MULTIPLY AND ADD	24-42
VECTOR FP COMPARE SCALAR	24-7	VECTOR FP MULTIPLY AND SUBTRACT	24-42
VECTOR FP COMPARE AND SIGNAL		VECTOR FP NEGATIVE MULTIPLY AND	
SCALAR	24-8	ADD	24-42
VECTOR FP COMPARE EQUAL	24-9	VECTOR FP NEGATIVE MULTIPLY AND	
VECTOR FP COMPARE HIGH	24-11	SUBTRACT	24-42
VECTOR FP COMPARE HIGH OR EQUAL	24-13	VECTOR FP PERFORM SIGN	
VECTOR FP CONVERT FROM FIXED	24-15	OPERATION	24-44
VECTOR FP CONVERT FROM LOGICAL	24-17	VECTOR FP SQUARE ROOT	24-45
VECTOR FP CONVERT TO FIXED	24-18	VECTOR FP SUBTRACT	24-46
VECTOR FP CONVERT TO LOGICAL	24-20	VECTOR FP TEST DATA CLASS	
VECTOR FP DIVIDE	24-22	IMMEDIATE	24-47
VECTOR LOAD FP INTEGER	24-24		
VECTOR FP LOAD LENGTHENED	24-26		
VECTOR FP LOAD ROUNDED	24-27		

The vector facility for z/Architecture provides support for short-format, long-format, and extended format binary-floating-point (BFP) operations. Numerically, the results in each element are the same as would occur as if an instruction in Chapter 19 was used to compute the result. Some instructions have different result figures noting changes due to different exception handling described below.

IEEE Exception Handling

When a vector instruction is executed and a trapping IEEE exception condition is encountered, instruction execution is suppressed for all elements, except that the floating-point-control register is updated with the VXC. The index in the VXC is always the index of the source element that caused the trapping exception except for once special case in VECTOR LOAD LENGTHENED (see the programming note on page 24-27). If trapping vector-processing exception conditions exist for multiple elements, the exception of the lowest-indexed source element is recognized.

When either a trapping IEEE overflow or IEEE underflow exception occur concurrently on the same element with a trapping IEEE inexact exception, only the IEEE overflow or IEEE underflow exception is recognized.

When a vector instruction is executed, no trapping IEEE exceptions are encountered on any elements, and a non-trapping IEEE exception condition is encountered on an element, the flag bit for that exception is set in the floating-point-control (FPC) register and the IEEE defined default value is placed in the corresponding element of the target operand. If multiple elements have non-trapping IEEE exception conditions then each element sets the flag bit in the FPC register and the defined default values are placed in the corresponding elements of the target operand.

Result Figures

Concise descriptions of the results produced by many of the vector floating point instructions are made by means of figures which contain columns and rows representing all possible combinations of data class for the source operand elements of an instruction. The information shown at the intersection of a row and a column is one or more symbols representing the result or results produced for that particular combination of source-operand element data classes. Explanations of the symbols used are contained in each figure. In many cases, the explanation of a particular result is in the form of a cross reference to another figure. In many cases, the informa-

tion shown at the intersection consists of several symbols separated by commas. All such results are produced unless one of the results for an element is a program interruption. In the case of a program interruption on any element, the operation is suppressed.

Figure 24-1, “IEEE Exception and Flag Abbreviations” on page 24-2 shows IEEE exceptions and flag abbreviations that are used in the result figures.

Exception		FPC IEEE Mask Bit	IEEE Flag	
Name	Abbr.		FPC Bit	Abbr.
IEEE invalid operation	Xi ¹	0.0	1.0	SFi
IEEE division by zero	Xz ²	0.1	1.1	SFz
IEEE overflow	Xo	0.2	1.2	SFo
IEEE underflow	Xu	0.3	1.3	SFu
IEEE inexact	Xx	0.4	1.4	SFx

Explanation:

¹ The symbol “Xi:” followed by a list of results in a figure indicates that, when FPC 0.0 is zero, then instruction execution is completed by setting SFi (FPC 1.0) to one and producing the indicated results; and when FPC 0.0 is one, then instruction execution is suppressed, if the element is the leftmost element upon which an exception is recognized the vector interrupt code (VIC) in the vector exception code (VXC) is set to 1 hex, the VIX is set to the index of the element recognizing the exception, and a program interruption for a vector-processing exception occurs.

² The symbol “Xz:” followed by a list of results in a figure indicates that, when FPC 0.1 is zero, then instruction execution is completed by setting SFz (FPC 1.1) to one and producing the indicated results; and when FPC 0.1 is one, then instruction execution is suppressed if the element is the leftmost element upon which an exception is recognized the vector interrupt code (VIC) in the vector exception code (VXC) is set to 2 hex, the VIX is set to the index of the element recognizing the exception, and a program interruption for a data exception occurs.

Figure 24-1. IEEE Exception and Flag Abbreviations

Instructions

Each instruction has an Extended Mnemonic section which describes recommended extended mnemonics and their corresponding machine assembler syntax. Not all assemblers may provide these mnemonics.

Most vector floating-point instructions have a single element control bit. If this bit is set to one, indicating only one element is to be executed, performance may be improved on some models. When the single element control bit is set the bit positions of all other elements besides the zero indexed element are unpredictable A mnemonic with the initial V replaced with a W indicates the instruction will only operate on a single element.

Programming Note: When the vector-enhancements facility 2 is installed, the following instructions are extended to provide conversion between BFP short format and word sized integer:

- VECTOR FP CONVERT FROM FIXED
- VECTOR FP CONVERT FROM LOGICAL
- VECTOR FP CONVERT TO FIXED
- VECTOR FP CONVERT TO LOGICAL

To distinguish which functions are provided, alternative names and mnemonics are assigned to these instructions.

Name	Mnemonic	Characteristics										Op-code	Page	
		VRR-c	VF	$\alpha^{7,9}$	SP	Dv	Xi	Xo	Xu	Xx				
VECTOR FP ADD	VFA	VRR-c	VF	$\alpha^{7,9}$	SP	Dv	Xi	Xo	Xu	Xx			E7E3	24-4
VECTOR FP COMPARE SCALAR	WFC	VRR-a	C VF	$\alpha^{7,9}$	SP	Dv	Xi						E7CB	24-7
VECTOR FP COMPARE AND SIGNAL SCALAR	WFK	VRR-a	C VF	$\alpha^{7,9}$	SP	Dv	Xi						E7CA	24-8
VECTOR FP COMPARE EQUAL	VFCE	VRR-c	C* VF	$\alpha^{7,9}$	SP	Dv	Xi						E7E8	24-9
VECTOR FP COMPARE HIGH	VFCH	VRR-c	C* VF	$\alpha^{7,9}$	SP	Dv	Xi						E7EB	24-11
VECTOR FP COMPARE HIGH OR EQUAL	VFCHE	VRR-c	C* VF	$\alpha^{7,9}$	SP	Dv	Xi						E7EA	24-13
VECTOR FP CONVERT FROM FIXED	VCFPS	VRR-a	V2	$\alpha^{7,9}$	SP	Dv				Xx			E7C3	24-15
VECTOR FP CONVERT FROM FIXED 64-BIT	VCDG	VRR-a	VF	$\alpha^{7,9}$	SP	Dv				Xx			E7C3	24-15
VECTOR FP CONVERT FROM LOGICAL	VCFPL	VRR-a	V2	$\alpha^{7,9}$	SP	Dv				Xx			E7C1	24-17
VECTOR FP CONVERT FROM LOGICAL 64-BIT	VCDLG	VRR-a	VF	$\alpha^{7,9}$	SP	Dv				Xx			E7C1	24-17
VECTOR FP CONVERT TO FIXED	VCSFP	VRR-a	V2	$\alpha^{7,9}$	SP	Dv	Xi			Xx			E7C2	24-18
VECTOR FP CONVERT TO FIXED 64-BIT	VCGD	VRR-a	VF	$\alpha^{7,9}$	SP	Dv	Xi			Xx			E7C2	24-18
VECTOR FP CONVERT TO LOGICAL	VCLFP	VRR-a	V2	$\alpha^{7,9}$	SP	Dv	Xi			Xx			E7C0	24-20
VECTOR FP CONVERT TO LOGICAL 64-BIT	VCLGD	VRR-a	VF	$\alpha^{7,9}$	SP	Dv	Xi			Xx			E7C0	24-20
VECTOR FP DIVIDE	VFD	VRR-c	VF	$\alpha^{7,9}$	SP	Dv	Xi	Xz	Xo	Xu	Xx		E7E5	24-22
VECTOR LOAD FP INTEGER	VFI	VRR-a	VF	$\alpha^{7,9}$	SP	Dv	Xi			Xx			E7C7	24-24
VECTOR FP LOAD LENGTHENED	VFLL	VRR-a	VF	$\alpha^{7,9}$	SP	Dv	Xi						E7C4	24-26
VECTOR FP LOAD ROUNDED	VFLR	VRR-a	VF	$\alpha^{7,9}$	SP	Dv	Xi	Xo	Xu	Xx			E7C5	24-27
VECTOR FP MAXIMUM	VFMAX	VRR-c	V1	$\alpha^{7,9}$	SP	Dv	Xi						E7EF	24-28
VECTOR FP MINIMUM	VFMIN	VRR-c	V1	$\alpha^{7,9}$	SP	Dv	Xi						E7EE	24-34
VECTOR FP MULTIPLY	VFM	VRR-c	VF	$\alpha^{7,9}$	SP	Dv	Xi	Xo	Xu	Xx			E7E7	24-40
VECTOR FP MULTIPLY AND ADD	VFMA	VRR-e	VF	$\alpha^{7,9}$	SP	Dv	Xi	Xo	Xu	Xx			E78F	24-42
VECTOR FP MULTIPLY AND SUBTRACT	VFMS	VRR-e	VF	$\alpha^{7,9}$	SP	Dv	Xi	Xo	Xu	Xx			E78E	24-42
VECTOR FP NEGATIVE MULTIPLY AND ADD	VFNMA	VRR-e	V1	$\alpha^{7,9}$	SP	Dv	Xi	Xo	Xu	Xx			E79F	24-42
VECTOR FP NEGATIVE MULTIPLY AND SUBTRACT	VFNMS	VRR-e	V1	$\alpha^{7,9}$	SP	Dv	Xi	Xo	Xu	Xx			E79E	24-42
VECTOR FP PERFORM SIGN OPERATION	VFPSO	VRR-a	VF	$\alpha^{7,9}$	SP	Dv							E7CC	24-44
VECTOR FP SQUARE ROOT	VFSQ	VRR-a	VF	$\alpha^{7,9}$	SP	Dv	Xi			Xx			E7CE	24-45
VECTOR FP SUBTRACT	VFS	VRR-c	VF	$\alpha^{7,9}$	SP	Dv	Xi	Xo	Xu	Xx			E7E2	24-46
VECTOR FP TEST DATA CLASS IMMEDIATE	VFTCI	VRI-e	C VF	$\alpha^{7,9}$	SP	Dv							E74A	24-47
Explanation:														
α^7	Restricted from transactional execution when the effective allow-floating-point-operation control is zero.													
α^9	Restricted in the constrained transactional-execution mode; a transaction-constraint program exception may be recognized.													
C	Condition code set.													
C*	Condition code optionally set.													
Dv	Vector-instruction data exception													
SP	Specification exception.													
V1	Vector-enhancements facility 1													
V2	Vector-enhancements facility 2													
VF	Vector facility for z/Architecture													
VRI	VRI instruction format													
VRR	VRR instruction format													
Xi	IEEE invalid-operation vector processing exception.													
Xo	IEEE overflow vector processing exception.													
Xu	IEEE underflow vector processing exception.													
Xx	IEEE inexact vector processing exception.													
Xz	IEEE division-by-zero vector processing exception.													

Figure 24-2. Summary of Vector Floating-Point Instructions

VECTOR FP ADD

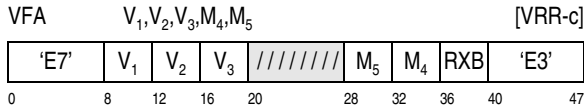

The floating-point element or elements of the third operand are added to the corresponding floating-point element or elements of the second operand. The results are placed in the corresponding elements of the first operand. The size of the operand elements is determined by the floating-point-format control in the M_4 field. The operand elements all are treated as BFP numbers of the specified format.

If the corresponding elements of both operands are finite numbers, they are added algebraically, forming an intermediate sum. The intermediate sum, if non-zero, is rounded to the operand format according to the current BFP rounding mode. The sum is then placed at the result location.

The sign of the sum is determined by the rules of algebra. This also applies to a result of zero:

- If the result of rounding a nonzero intermediate sum is zero, the sign of the zero result is the sign of the intermediate sum.
- If the sum of two operand elements with opposite signs is exactly zero, the sign of the result is plus in all rounding methods except round toward $-\infty$, in which method the sign is minus.
- The sign of the sum x plus x is the sign of x , even when x is zero.

If one operand element is an infinity and the other is a finite number, the result is that infinity. If both operand elements are infinities of the same sign, the result is the same infinity. If the two operand elements are infinities of opposite signs, an IEEE-invalid-operation exception is recognized.

See Figure 24-3 on page 24-5 for detailed information on the results for each element.

The M_4 field specifies the floating-point format. The floating-point format determines the size of the elements within the vector register operands. If a reserved value is specified, a specification exception

is recognized. If the vector-enhancements facility 1 is not installed the values 2 and 4 are reserved.

M_4 Floating-Point Format

- | | |
|------|-----------------|
| 0-1 | Reserved |
| 2 | Short format |
| 3 | Long format |
| 4 | Extended format |
| 5-15 | Reserved |

The M_5 field has the following format:



The bits of the M_5 field are defined as follows:

- **Single-Element-Control (S):** If bit 0 is set to one, the operation takes place only on the zero-indexed element in the vector. In the absence of a trapping exception condition, the bit positions of all other elements in the first operand vector are unpredictable. If bit 0 is set to zero, the operation occurs on all elements in the vector.
- **Reserved:** Bits 1 to 3 are reserved and must be zero. Otherwise, a specification exception is recognized.

Condition Code: The code remains unchanged.

IEEE Exceptions:

- Invalid Operation
- Overflow
- Underflow
- Inexact

Program Exceptions:

- Data with DXC FE, Vector Instruction
- Operation (if the vector facility for z/Architecture is not installed)
- Specification
- Transaction constraint
- Vector processing with VXC for IEEE exception and element index

Extended Mnemonics:

Extended Mnemonic		Base Mnemonic	
VFASB	V_1, V_2, V_3	VFA	$V_1, V_2, V_3, 2, 0$
VFADB	V_1, V_2, V_3	VFA	$V_1, V_2, V_3, 3, 0$

Extended Mnemonic		Base Mnemonic	
WFASB	V ₁ ,V ₂ ,V ₃	VFA	V ₁ ,V ₂ ,V ₃ ,2,8
WFADB	V ₁ ,V ₂ ,V ₃	VFA	V ₁ ,V ₂ ,V ₃ ,3,8
WFAXB	V ₁ ,V ₂ ,V ₃	VFA	V ₁ ,V ₂ ,V ₃ ,4,8

Second Operand Element (a) Is	Results for VECTOR FP ADD (a+b) when Third Operand Element (b) Is									
	-∞	-Nn	-Dn	-0	+0	+Dn	+Nn	+∞	QNaN	SNaN
-∞	T(-∞)	T(-∞)	T(-∞)	T(-∞)	T(-∞)	T(-∞)	T(-∞)	Xi: T(dNaN)	T(b)	Xi: T(b*)
-Nn	T(-∞)	R(a+b)	R(a+b)	T(a)	T(a)	R(a+b)	R(a+b)	T(+∞)	T(b)	Xi: T(b*)
-Dn	T(-∞)	R(a+b)	R(a+b)	R(a)	R(a)	R(a+b)	R(a+b)	T(+∞)	T(b)	Xi: T(b*)
-0	T(-∞)	T(b)	R(b)	T(-0)	Rezd	R(b)	T(b)	T(+∞)	T(b)	Xi: T(b*)
+0	T(-∞)	T(b)	R(b)	Rezd	T(+0)	R(b)	T(b)	T(+∞)	T(b)	Xi: T(b*)
+Dn	T(-∞)	R(a+b)	R(a+b)	R(a)	R(a)	R(a+b)	R(a+b)	T(+∞)	T(b)	Xi: T(b*)
+Nn	T(-∞)	R(a+b)	R(a+b)	T(a)	T(a)	R(a+b)	R(a+b)	T(+∞)	T(b)	Xi: T(b*)
+∞	Xi: T(dNaN)	T(+∞)	T(+∞)	T(+∞)	T(+∞)	T(+∞)	T(+∞)	T(+∞)	T(b)	Xi: T(b*)
QNaN	T(a)	T(a)	T(a)	T(a)	T(a)	T(a)	T(a)	T(a)	T(a)	Xi: T(b*)
SNaN	Xi: T(a*)	Xi: T(a*)	Xi: T(a*)	Xi: T(a*)	Xi: T(a*)	Xi: T(a*)	Xi: T(a*)	Xi: T(a*)	Xi: T(a*)	Xi: T(a*)

Explanation:

- * The SNaN is converted to the corresponding QNaN before it is placed at the target operand element location.
- dNaN Default NaN.
- Dn Subnormal number.
- Nn Normal number.
- R(v) Rounding and range action is performed on the value v. See Figure 24-4 on page 24-6.
- Rezd Exact zero-difference result. See Figure 24-4 on page 24-6.
- T(x) The value x is placed at the target operand element location if no trapping exceptions on other elements.
- Xi: IEEE invalid-operation exception. The results shown are produced only when FPC 0.0 is zero.

Figure 24-3. Results: VECTOR FP ADD

Range of v	Case	Nontrap Result (r) when Effective Rounding Method Is				Prepare for shorter precision
		To Nearest with ties to even	Toward 0	Toward +∞	Toward -∞	
$v < -N_{\max}, g < -N_{\max}$	Overflow	$-\infty^1$	-Nmax	-Nmax	$-\infty^1$	-Nmax
$v < -N_{\max}, g = -N_{\max}$	Normal	-Nmax	-Nmax	-Nmax	–	-Nmax
$-N_{\max} \leq v \leq -N_{\min}$	Normal	g	g	g	g	g
$-N_{\min} < v \leq -D_{\min}$	Tiny	d*	d	d	d*	d
$-D_{\min} < v < -D_{\min}/2$	Tiny	-Dmin	-0	-0	-Dmin	-Dmin
$-D_{\min}/2 \leq v < 0$	Tiny	-0	-0	-0	-Dmin	-Dmin
$v = 0$	Exact zero difference ²	+0	+0	+0	-0	+0
$0 < v \leq +D_{\min}/2$	Tiny	+0	+0	+Dmin	+0	+Dmin
$+D_{\min}/2 < v < +D_{\min}$	Tiny	+Dmin	+0	+Dmin	+0	+Dmin
$+D_{\min} \leq v < +N_{\min}$	Tiny	d*	d	d*	d	d
$+N_{\min} \leq v \leq +N_{\max}$	Normal	g	g	g	g	g
$+N_{\max} < v, g = +N_{\max}$	Normal	+Nmax	+Nmax	–	+Nmax	+Nmax
$+N_{\max} < v, +N_{\max} < g$	Overflow	$+\infty^1$	+Nmax	$+\infty^1$	+Nmax	+Nmax

Explanation:

– This situation cannot occur.

* The rounded value, in the extreme case, may be Nmin. In this case, the exceptions are underflow, inexact and incremented.

¹ The nontrap result r is considered to have been incremented.

² The exact-zero-difference case applies only to VECTOR FP ADD, VECTOR FP SUBTRACT, VECTOR FP MULTIPLY AND ADD, and VECTOR FP MULTIPLY AND SUBTRACT. For all other vector BFP operations, a zero result is detected by inspection of the source operand elements without use of the R(v) function.

d The denormalized value. The value derived when the precise intermediate value (v) is rounded to the format of the target, including both precision and bounded exponent range. Except as explained in note *, this is a subnormal number.

g The precision-rounded value. The value derived when the precise intermediate value (v) is rounded to the precision of the target, but assuming an unbounded exponent range.

v Precise intermediate value. This is the value, before rounding, assuming unbounded precision and an unbounded exponent range. For VECTOR LOAD ROUNDED, v is the source value (a).

Dmin Smallest (in magnitude) representable subnormal number in the target format.

Nmax Largest (in magnitude) representable finite number in the target format.

Nmin Smallest (in magnitude) representable normal number in the target format.

Figure 24-4. Action for R(v): Rounding and Range Function (Part 1 of 2)

Case	Is r Inexact (r≠v)	Overflow Mask (FPC 0.2)	Underflow Mask (FPC 0.3)	IEEE Inexact Exception Control (XxC) ²	Inexact Mask (FPC 0.4)	Results
Overflow	Yes ¹	0	–	1	–	T(r), SFo←1
Overflow	Yes ¹	0	–	0	0	T(r), SFo←1, SFx←1
Overflow	Yes ¹	0	–	0	1	PIV(5)
Overflow	Yes ¹	1	–	–	–	PIV(3)
Normal	No	–	–	–	–	T(r)
Normal	Yes	–	–	1	–	T(r)
Normal	Yes	–	–	0	0	T(r), SFx←1
Normal	Yes	–	–	0	1	PIV(5)
Tiny	No	–	0	–	–	T(r)
Tiny	No	–	1	–	–	PIV(4)
Tiny	Yes	–	0	1	–	T(r), SFu←1
Tiny	Yes	–	0	0	0	T(r), SFu←1, SFx←1
Tiny	Yes	–	0	0	1	PIV(5)
Tiny	Yes	–	1	–	–	PIV(4)

Explanation:

– The results do not depend on this condition or mask bit.
¹ This condition is true by virtue of the state of some condition to the left of this column.
² If no XxC is defined for an instruction it is assumed to be zero.
r Nontrap result as defined in Part 1 of this figure.
v Precise intermediate value. This is the value, before rounding, assuming unbounded precision and unbounded exponent range.
PIV(h) Program interruption for vector-processing exception, with VXC containing the element index and a VIC of h in hex.
SFo IEEE overflow flag, FPC 1.2.
SFu IEEE underflow flag, FPC 1.3.
SFx IEEE inexact flag, FPC 1.4.
T(x) The value x is placed at the target operand element location.

Figure 24-4. Action for R(v): Rounding and Range Function (Part 2 of 2)

VECTOR FP COMPARE SCALAR

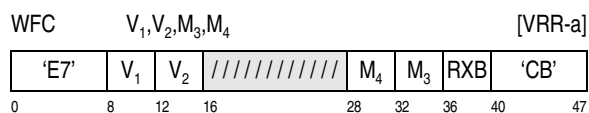

The zero-indexed floating-point element of the first operand is compared with the zero-indexed floating-point element of the second operand, and the condition code is set to indicate the result. The operand elements are all treated as BFP numbers of the specified format.

If both operand elements are finite numbers, the comparison is algebraic and follows the procedure for BFP subtraction, except that the difference is discarded after setting the condition code, and both operand elements remain unchanged. If the difference is exactly zero with either sign, the operand ele-

ments are equal; this includes zero operand elements (so +0 equals -0). If a nonzero difference is positive or negative, the first operand element is high or low, respectively.

+∞ compares greater than any finite number, and all finite numbers compare greater than -∞. Two infinity operand elements of like sign compare equal.

Numeric comparison is exact, and the condition code is determined for finite operand elements as if range and precision were unlimited. No overflow or underflow exception can occur.

If either or both operand elements are QNaNs and neither operand element is an SNaN, the comparison result is unordered, and condition code 3 is set.

If either or both operand elements are SNaNs, an IEEE-invalid-operation exception is recognized. If the IEEE invalid-operation mask bit is one, a program

interruption for a vector-processing exception with a VXC indicating an IEEE invalid-operation occurs. If the IEEE-invalid-operation mask bit is zero, the IEEE-invalid-operation flag bit is set to one, and instruction execution is completed by setting condition code 3.

See Figure 19-14, “Results: COMPARE” on page 19-18 for a detailed description of the results of this instruction substituting the first operand element for (a) and the second operand element for (b).

The M_3 field specifies the floating-point format. The floating-point format determines the size of the elements within the vector register operands. If a reserved value is specified, a specification exception is recognized. If the vector-enhancements facility 1 is not installed the values 2 and 4 are reserved.

M_3 Floating-Point Format

0-1	Reserved
2	Short format
3	Long format
4	Extended format
5-15	Reserved

The M_4 field must be zero otherwise a specification exception is recognized.

Resulting Condition Code:

- 0 Operand elements equal
- 1 First operand element low
- 2 First operand element high
- 3 Operand elements unordered

IEEE Exceptions:

- Invalid operation

Program Exceptions:

- Data with DXC FE, Vector instruction
- Operation (if the vector facility for z/Architecture is not installed)
- Specification
- Transaction constraint
- Vector processing with VXC for IEEE exception and element index

Extended Mnemonics:

Extended Mnemonic		Base Mnemonic	
WFCSB	V_1, V_2	WFC	$V_1, V_2, 2, 0$
WFCDB	V_1, V_2	WFC	$V_1, V_2, 3, 0$
WFCXB	V_1, V_2	WFC	$V_1, V_2, 4, 0$

Programming Notes:

- VECTOR FP COMPARE SCALAR may be used to set a condition code to be used by a subsequent branch for program control flow.
- VECTOR FP COMPARE SCALAR may be used to implement those comparisons which are required by ANSI/IEEE Standard 754-2008 to not recognize an exception when the result is unordered due to a QNaN.

VECTOR FP COMPARE AND SIGNAL SCALAR

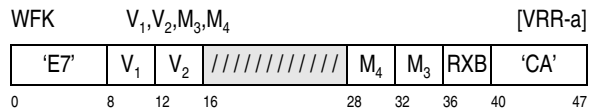

The zero-indexed first operand floating-point element is compared with the zero-indexed second operand floating-point element, and the condition code is set to indicate the result. The operand elements are all treated as BFP numbers of the specified format. The operation is the same as for VECTOR FP COMPARE SCALAR except that QNaN operand elements cause an IEEE-invalid-operation exception to be recognized. Thus, QNaN operand elements are treated as if they were SNaNs.

See Figure 19-16, “Results: COMPARE AND SIGNAL” on page 19-19 for a detailed description of the results of this instruction substituting the first operand element for (a) and the second operand element for (b).

The M_3 field specifies the floating-point format. The floating-point format determines the size of the elements within the vector register operands. If a reserved value is specified, a specification exception

is recognized. If the vector-enhancements facility 1 is not installed the values 2 and 4 are reserved.

M₃ Floating-Point Format

- | | |
|------|-----------------|
| 0-1 | Reserved |
| 2 | Short format |
| 3 | Long format |
| 4 | Extended format |
| 5-15 | Reserved |

The M₄ field must be zero otherwise a specification exception is recognized.

Resulting Condition Code:

- | | |
|---|----------------------------|
| 0 | Operand elements equal |
| 1 | First operand element low |
| 2 | First operand element high |
| 3 | Operand elements unordered |

IEEE Exceptions:

- Invalid operation

Program Exceptions:

- Data with DXC FE, Vector Instruction
- Operation (if the vector facility for z/Architecture is not installed)
- Specification
- Transaction constraint
- Vector processing with VXC for IEEE exception and element index

Extended Mnemonics:

Extended Mnemonic		Base Mnemonic	
WFKSB	V ₁ ,V ₂	WFK	V ₁ ,V ₂ ,2,0
WFKDB	V ₁ ,V ₂	WFK	V ₁ ,V ₂ ,3,0
WFKXB	V ₁ ,V ₂	WFK	V ₁ ,V ₂ ,4,0

Programming Notes:

1. VECTOR FP COMPARE AND SIGNAL SCALAR may be used to set a condition code to be used by a subsequent branch for program control flow.
2. VECTOR FP COMPARE AND SIGNAL SCALAR may be used to implement those comparisons which are required by ANSI/IEEE Standard 754-2008 to recognize an exception when the result is unordered due to a QNaN.

VECTOR FP COMPARE EQUAL

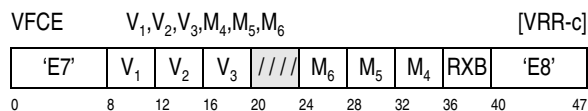

The floating-point element or elements of the second operand are compared for equality with the corresponding element or elements of the third operand. If equal, the bits of the corresponding element in the first operand are set to all ones, otherwise the bits are set to all zeros. The size of the operand elements is determined by the floating-point-format control in the M₄ field. The second and third operand elements are treated as BFP numbers of the specified format.

If any of the elements in the second or third operands used in the comparison are SNaNs, an IEEE invalid-operation exception is recognized. If the vector-enhancements facility 1 is installed and the signal-if-QNaN (SQ) control is one and any of the elements in the second or third operands used in the comparison are QNaNs, an IEEE invalid-operation exception is also recognized. If the IEEE invalid-operation mask bit is one, a program interruption with VXC set for IEEE invalid-operation and the corresponding element index occurs and the operation is suppressed. If the IEEE invalid-operation mask bit is zero, the bits of the corresponding element in the first operand are set to zeros and the IEEE invalid-operation flag bit is set in the FPC register.

See Figure 24-5 on page 24-11 for a detailed description of the results for each element.

The M₄ field specifies the floating-point format. The floating-point format determines the size of the elements within the vector register operands. If a reserved value is specified, a specification exception is recognized. If the vector-enhancements facility 1 is not installed the values 2 and 4 are reserved.

M₄ Floating-Point Format

- | | |
|------|-----------------|
| 0-1 | Reserved |
| 2 | Short format |
| 3 | Long format |
| 4 | Extended format |
| 5-15 | Reserved |

The M_5 field has the following format:



The bits of the M_5 field are defined as follows:

- **Single-Element-Control (S):** If bit 0 is set to one, the operation takes place only on the zero-indexed element in the vector. In the absence of a trapping exception condition, the bit positions of all other elements in the first operand vector are unpredictable. The values of all other elements in the second and third operands are ignored. If bit 0 is set to zero, the operation occurs on all elements in the vector.
- **Signal-on-QNaN (SQ):** If bit 1 is set to one, a QNaN in any element of the second or third operands will signal an IEEE invalid-operation exception. If bit 1 is set to zero a QNaN will not signal an IEEE invalid-operation exception.
- **Reserved:** Bits 2, 3, and if the vector-enhancements facility 1 is not installed, bit 1 are reserved and must be zero. Otherwise, a specification exception is recognized.

The M_6 field has the following format:



The bits of the M_6 field are defined as follows:

- **Reserved:** Bits 0, 1, and 2 are reserved and must be zero. Otherwise, a specification exception is recognized.
- **Condition Code Set (CS):** If bit 3 is 0, the code remains unchanged. If the bit is one, the code is set as described below.

Resulting Condition Code: When Bit 3 of the M_6 field is one, the code is set as follows:

- 0 All elements equal (All T results in Figure 24-5)
- 1 Mix of equal, and unequal or unordered elements (A mix of T and F results in Figure 24-5)
- 2 --
- 3 All elements not equal or unordered (All F results in Figure 24-5)

Otherwise, the code remains unchanged.

IEEE Exceptions:

- Invalid Operation

Program Exceptions:

- Data with DXC FE, Vector Instruction
- Operation (if the vector facility for z/Architecture is not installed)
- Specification
- Transaction constraint
- Vector processing with VXC for IEEE exception and element index

Extended Mnemonics:

Extended Mnemonic	Base Mnemonic
VFCE SB V_1, V_2, V_3	VFCE $V_1, V_2, V_3, 2, 0, 0$
VFCE SBS V_1, V_2, V_3	VFCE $V_1, V_2, V_3, 2, 0, 1$
VFCE EDB V_1, V_2, V_3	VFCE $V_1, V_2, V_3, 3, 0, 0$
VFCE EDBS V_1, V_2, V_3	VFCE $V_1, V_2, V_3, 3, 0, 1$
WFCE SB V_1, V_2, V_3	VFCE $V_1, V_2, V_3, 2, 8, 0$
WFCE SBS V_1, V_2, V_3	VFCE $V_1, V_2, V_3, 2, 8, 1$
WFCE EDB V_1, V_2, V_3	VFCE $V_1, V_2, V_3, 3, 8, 0$
WFCE EDBS V_1, V_2, V_3	VFCE $V_1, V_2, V_3, 3, 8, 1$
WFCE EXB V_1, V_2, V_3	VFCE $V_1, V_2, V_3, 4, 8, 0$
WFCE EXBS V_1, V_2, V_3	VFCE $V_1, V_2, V_3, 4, 8, 1$
VFKE SB V_1, V_2, V_3	VFCE $V_1, V_2, V_3, 2, 4, 0$
VFKE SBS V_1, V_2, V_3	VFCE $V_1, V_2, V_3, 2, 4, 1$
VFKE EDB V_1, V_2, V_3	VFCE $V_1, V_2, V_3, 3, 4, 0$
VFKE EDBS V_1, V_2, V_3	VFCE $V_1, V_2, V_3, 3, 4, 1$
WFKE SB V_1, V_2, V_3	VFCE $V_1, V_2, V_3, 2, 12, 0$
WFKE SBS V_1, V_2, V_3	VFCE $V_1, V_2, V_3, 2, 12, 1$
WFKE EDB V_1, V_2, V_3	VFCE $V_1, V_2, V_3, 3, 12, 0$
WFKE EDBS V_1, V_2, V_3	VFCE $V_1, V_2, V_3, 3, 12, 1$
WFKE EXB V_1, V_2, V_3	VFCE $V_1, V_2, V_3, 4, 12, 0$
WFKE EXBS V_1, V_2, V_3	VFCE $V_1, V_2, V_3, 4, 12, 1$

Programming Note: Condition code 1 will never be presented if the S-bit is set to one.

Second Operand Element (a) Is	Results for VECTOR FP COMPARE EQUAL (a:b) when Third Operand Element (b) Is							
	$-\infty$	-Fn	-0	+0	+Fn	$+\infty$	QNaN	SNaN
$-\infty$	T	F	F	F	F	F	CXi: F	Xi: F
-Fn	F	C(a=b)	F	F	F	F	CXi: F	Xi: F
-0	F	F	T	T	F	F	CXi: F	Xi: F
+0	F	F	T	T	F	F	CXi: F	Xi: F
+Fn	F	F	F	F	C(a=b)	F	CXi: F	Xi: F
$+\infty$	F	F	F	F	F	T	CXi: F	Xi: F
QNaN	CXi: F	CXi: F	CXi: F	CXi: F	CXi: F	CXi: F	CXi: F	Xi: F
SNaN	Xi: F	Xi: F	Xi: F	Xi: F	Xi: F	Xi: F	Xi: F	Xi: F

Explanation:

T Corresponding element in operand one is set to all ones
 F Corresponding element in operand one is set to all zeros
 C(a=b) Basic compare result. T if a=b and F if a≠b.
 Fn Finite nonzero number (includes both subnormal and normal).
 Xi: IEEE invalid-operation exception. The results shown are produced only when FPC 0.0 is zero.
 CXi: IEEE invalid-operation exception if the vector-enhancements facility 1 is installed and the SQ control in M₅ is one. The results shown are produced only when FPC 0.0 is zero.

Figure 24-5. Results: VECTOR FP COMPARE EQUAL

VECTOR FP COMPARE HIGH

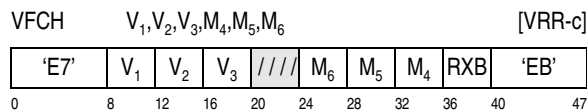

The floating-point element or elements of the second operand are compared with each corresponding floating-point element or elements of the third operand. If the element in the second operand is greater than the element in the third operand, the bit positions of the corresponding element in the first operand are set to one. Otherwise, the bit positions in the corresponding element of the first operand are set to zeros. The size of the operand elements is determined by the floating-point-format control in the M₄ field. The second and third operand elements are treated as BFP numbers of the specified format.

If any of the elements in the second or third operands used in the comparison are SNaNs, an IEEE invalid-operation exception is recognized. If the vector-enhancements facility 1 is installed and the signal-if-QNaN (SQ) control is one and any of the elements in the second or third operands used in the comparison

are QNaNs, an IEEE invalid-operation exception is also recognized. If the IEEE invalid-operation mask bit is one, a program interruption with a VXC indicating and IEEE invalid-operation and the corresponding element index occurs and the operation is suppressed. If the IEEE invalid-operation mask bit is zero, the bits of the corresponding element in the first operand are set to zeros and the IEEE invalid-operation flag bit is set in the FPC register.

See Figure 24-6 on page 24-13 for a detailed description of the results for each element.

The M₄ field specifies the floating-point format. The floating-point format determines the size of the elements within the vector register operands. If a reserved value is specified, a specification exception is recognized. If the vector-enhancements facility 1 is not installed the values 2 and 4 are reserved.

- M₄ Floating-Point Format**
- 0-1 Reserved

M₄ Floating-Point Format

- 2 Short format
- 3 Long format
- 4 Extended format
- 5-15 Reserved

The M₅ field has the following format:



The bits of the M₅ field are defined as follows:

- **Single-Element-Control (S):** If bit 0 is set to one, the operation takes place only on the zero-indexed element in the vector. In the absence of a trapping exception condition, the bit positions of all other elements in the first operand vector are unpredictable. The values of all other elements in the second and third operands are ignored. If bit 0 is set to zero, the operation occurs on all elements in the vector.
- **Signal-on-QNaN (SQ):** If bit 1 is set to one, a QNaN in any element of the second or third operands will signal an IEEE invalid-operation exception. If bit 1 is set to zero a QNaN will not signal an IEEE invalid-operation exception.
- **Reserved:** Bits 2, 3, and if the vector-enhancements facility 1 is not installed, bit 1 are reserved and must be zero. Otherwise, a specification exception is recognized.

The M₆ field has the following format:



The bits of the M₆ field are defined as follows:

- **Reserved:** Bits 0, 1, and 2 are reserved and must be zero. Otherwise, a specification exception is recognized.
- **Condition Code Set (CS):** If bit 3 is 0, the code remains unchanged. If the bit is one, the code is set as described below.

Resulting Condition Code: When Bit 3 of the M₆ field is one, the code is set as follows:

- 0 All elements greater than (All T results in Figure 24-6)
- 1 Mix of greater than, and non-greater than or unordered elements (A mix of T and F results in Figure 24-6)
- 2 --
- 3 All elements not greater than, or unordered (All F results in Figure 24-6)

Otherwise, the code remains unchanged.

IEEE Exceptions:

- Invalid operation

Program Exceptions:

- Data with DXC FE, Vector Instruction
- Operation (if the vector facility for z/Architecture is not installed)
- Specification
- Transaction constraint
- Vector processing with VXC for IEEE exception and element index

Extended Mnemonics:

Extended Mnemonic	Base Mnemonic
VFCHSB V ₁ ,V ₂ ,V ₃	VFCH V ₁ ,V ₂ ,V ₃ ,2,0,0
VFCHSBS V ₁ ,V ₂ ,V ₃	VFCH V ₁ ,V ₂ ,V ₃ ,2,0,1
VFCHDB V ₁ ,V ₂ ,V ₃	VFCH V ₁ ,V ₂ ,V ₃ ,3,0,0
VFCHDBS V ₁ ,V ₂ ,V ₃	VFCH V ₁ ,V ₂ ,V ₃ ,3,0,1
WFCHSB V ₁ ,V ₂ ,V ₃	VFCH V ₁ ,V ₂ ,V ₃ ,2,8,0
WFCHSBS V ₁ ,V ₂ ,V ₃	VFCH V ₁ ,V ₂ ,V ₃ ,2,8,1
WFCHDB V ₁ ,V ₂ ,V ₃	VFCH V ₁ ,V ₂ ,V ₃ ,3,8,0
WFCHDBS V ₁ ,V ₂ ,V ₃	VFCH V ₁ ,V ₂ ,V ₃ ,3,8,1
WFCHXB V ₁ ,V ₂ ,V ₃	VFCH V ₁ ,V ₂ ,V ₃ ,4,8,0
WFCHXBS V ₁ ,V ₂ ,V ₃	VFCH V ₁ ,V ₂ ,V ₃ ,4,8,1
VFKHSB V ₁ ,V ₂ ,V ₃	VFCH V ₁ ,V ₂ ,V ₃ ,2,4,0
VFKHSBS V ₁ ,V ₂ ,V ₃	VFCH V ₁ ,V ₂ ,V ₃ ,2,4,1
VFKHDB V ₁ ,V ₂ ,V ₃	VFCH V ₁ ,V ₂ ,V ₃ ,3,4,0
VFKHDBS V ₁ ,V ₂ ,V ₃	VFCH V ₁ ,V ₂ ,V ₃ ,3,4,1
WFKHSB V ₁ ,V ₂ ,V ₃	VFCH V ₁ ,V ₂ ,V ₃ ,2,12,0
WFKHSBS V ₁ ,V ₂ ,V ₃	VFCH V ₁ ,V ₂ ,V ₃ ,2,12,1
WFKHDB V ₁ ,V ₂ ,V ₃	VFCH V ₁ ,V ₂ ,V ₃ ,3,12,0
WFKHDBS V ₁ ,V ₂ ,V ₃	VFCH V ₁ ,V ₂ ,V ₃ ,3,12,1
WFKHXB V ₁ ,V ₂ ,V ₃	VFCH V ₁ ,V ₂ ,V ₃ ,4,12,0
WFKHXBBS V ₁ ,V ₂ ,V ₃	VFCH V ₁ ,V ₂ ,V ₃ ,4,12,1

Programming Note: Condition Code 1 will never be presented if the S-bit is set to one.

Second Operand (a) Is	Results for COMPARE HIGH (a:b) when Third Operand (b) Is							
	$-\infty$	-Fn	-0	+0	+Fn	$+\infty$	QNaN	SNaN
$-\infty$	F	F	F	F	F	F	CXi: F	Xi: F
-Fn	T	C(a>b)	F	F	F	F	CXi: F	Xi: F
-0	T	T	F	F	F	F	CXi: F	Xi: F
+0	T	T	F	F	F	F	CXi: F	Xi: F
+Fn	T	T	T	T	C(a>b)	F	CXi: F	Xi: F
$+\infty$	T	T	T	T	T	F	CXi: F	Xi: F
QNaN	CXi: F	CXi: F	CXi: F	CXi: F	CXi: F	CXi: F	CXi: F	Xi: F
SNaN	Xi: F	Xi: F	Xi: F	Xi: F	Xi: F	Xi: F	Xi: F	Xi: F

Explanation:

T Corresponding element in operand one is set to all ones
 F Corresponding element in operand one is set to all zeros
 C(a>b) Basic compare results. T if a>b, F if a≤b
 Fn Finite nonzero number (includes both subnormal and normal).
 Xi: IEEE invalid-operation exception. The results shown are produced only when FPC 0.0 is zero.
 CXi: IEEE invalid-operation exception if the vector-enhancements facility 1 is installed and the SQ control in M₅ is one. The results shown are produced only when FPC 0.0 is zero.

Figure 24-6. Results: VECTOR FP COMPARE HIGH

VECTOR FP COMPARE HIGH OR EQUAL

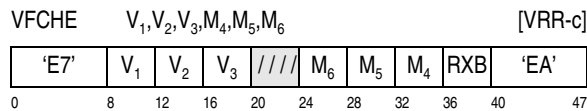

The floating-point element or elements of the second operand are compared with each corresponding floating-point element or elements of the third operand. If the element in the second operand is greater than or equal to the element in the third operand, the bit positions of the corresponding element in the first operand are set to one. Otherwise the bit positions in the corresponding element of the first operand are set to zeros. The size of the operand elements is determined by the floating-point-format control in the M₄ field. The second and third operand elements are treated as BFP numbers of the specified format.

If any of the elements in the second or third operands used in the comparison are SNaNs, an IEEE invalid-operation exception is recognized. If the vector-enhancements facility 1 is installed and the signal-if-QNaN (SQ) control is one and any of the elements in the second or third operands used in the comparison

are QNaNs, an IEEE invalid-operation exception is also recognized. If the IEEE invalid-operation mask bit is one, a program interruption with VXC set for IEEE invalid-operation and the corresponding element index occurs and the operation is suppressed. If the IEEE invalid-operation mask bit is zero, the bits of the corresponding element in the first operand are set to zeros and the IEEE invalid-operation flag bit is set in the FPC register.

See Figure 24-7 on page 24-15 for a detailed description of the results for each element.

The M₄ field specifies the floating-point format. The floating-point format determines the size of the elements within the vector register operands. If a reserved value is specified, a specification exception is recognized. If the vector-enhancements facility 1 is not installed the values 2 and 4 are reserved.

M₄ Floating-Point Format

- 0-1 Reserved
- 2 Short format
- 3 Long format
- 4 Extended format
- 5-15 Reserved

The M_5 field has the following format:



The bits of the M_5 field are defined as follows:

- **Single-Element-Control (S):** If bit 0 is set to one, the operation takes place only on the zero-indexed element in the vector. In the absence of a trapping exception condition, the bit positions of all other elements in the first operand vector are unpredictable. The values of all other elements in the second and third operands are ignored. If bit 0 is set to zero, the operation occurs on all elements in the vector.
- **Signal-on-QNaN (SQ):** If bit 1 is set to one, a QNaN in any element of the second or third operands will signal an IEEE invalid-operation exception. If bit 1 is set to zero a QNaN will not signal an IEEE invalid-operation exception.
- **Reserved:** Bits 2, 3, and if the vector-enhancements facility 1 is not installed, bit 1 are reserved and must be zero. Otherwise, a specification exception is recognized.

The M_6 field has the following format:



The bits of the M_6 field are defined as follows:

- **Reserved:** Bits 0, 1, and 2 are reserved and must be zero. Otherwise, a specification exception is recognized.
- **Condition Code Set (CS):** If bit 3 is 0, the code remains unchanged. If the bit is one, the code is set as described below.

Resulting Condition Code: When Bit 3 of the M_6 field is one, the code is set as follows:

- 0 All elements greater than or equal (All T results in Figure 24-7)

- 1 Mix of greater than or equal and less than or unordered elements (A mix of T and F results in Figure 24-7)
- 2 --
- 3 All elements less than or unordered (All F results in Figure 24-7)

Otherwise, the code remains unchanged.

IEEE Exceptions:

- Invalid operation

Program Exceptions:

- Data with DXC FE, Vector Instruction
- Operation (if the vector facility for z/Architecture is not installed)
- Specification
- Transaction constraint
- Vector processing with VXC for IEEE exception and element index

Extended Mnemonics:

Extended Mnemonic	Base Mnemonic
VFCHE SB V_1, V_2, V_3	VFCHE $V_1, V_2, V_3, 2, 0, 0$
VFCHE SBS V_1, V_2, V_3	VFCHE $V_1, V_2, V_3, 2, 0, 1$
VFCHE EDB V_1, V_2, V_3	VFCHE $V_1, V_2, V_3, 3, 0, 0$
VFCHE EDBS V_1, V_2, V_3	VFCHE $V_1, V_2, V_3, 3, 0, 1$
WFCHE SB V_1, V_2, V_3	VFCHE $V_1, V_2, V_3, 2, 8, 0$
WFCHE SBS V_1, V_2, V_3	VFCHE $V_1, V_2, V_3, 2, 8, 1$
WFCHE EDB V_1, V_2, V_3	VFCHE $V_1, V_2, V_3, 3, 8, 0$
WFCHE EDBS V_1, V_2, V_3	VFCHE $V_1, V_2, V_3, 3, 8, 1$
WFCHE EXB V_1, V_2, V_3	VFCHE $V_1, V_2, V_3, 4, 8, 0$
WFCHE EXBS V_1, V_2, V_3	VFCHE $V_1, V_2, V_3, 4, 8, 1$
VFKHE SB V_1, V_2, V_3	VFCHE $V_1, V_2, V_3, 2, 4, 0$
VFKHE SBS V_1, V_2, V_3	VFCHE $V_1, V_2, V_3, 2, 4, 1$
VFKHE EDB V_1, V_2, V_3	VFCHE $V_1, V_2, V_3, 3, 4, 0$
VFKHE EDBS V_1, V_2, V_3	VFCHE $V_1, V_2, V_3, 3, 4, 1$
WFKHE SB V_1, V_2, V_3	VFCHE $V_1, V_2, V_3, 2, 12, 0$
WFKHE SBS V_1, V_2, V_3	VFCHE $V_1, V_2, V_3, 2, 12, 1$
WFKHE EDB V_1, V_2, V_3	VFCHE $V_1, V_2, V_3, 3, 12, 0$
WFKHE EDBS V_1, V_2, V_3	VFCHE $V_1, V_2, V_3, 3, 12, 1$
WFKHE EXB V_1, V_2, V_3	VFCHE $V_1, V_2, V_3, 4, 12, 0$
WFKHE EXBS V_1, V_2, V_3	VFCHE $V_1, V_2, V_3, 4, 12, 1$

Programming Note: Condition Code 1 will never be presented if the S-bit is set to one.

Second Operand (a) Is	Results for COMPARE HIGH OR EQUAL (a:b) when Third Operand (b) Is							
	$-\infty$	-Fn	-0	+0	+Fn	$+\infty$	QNaN	SNaN
$-\infty$	T	F	F	F	F	F	CXi: F	Xi: F
-Fn	T	$C(a \geq b)$	F	F	F	F	CXi: F	Xi: F
-0	T	T	T	T	F	F	CXi: F	Xi: F
+0	T	T	T	T	F	F	CXi: F	Xi: F
+Fn	T	T	T	T	$C(a \geq b)$	F	CXi: F	Xi: F
$+\infty$	T	T	T	T	T	T	CXi: F	Xi: F
QNaN	CXi: F	CXi: F	CXi: F	CXi: F	CXi: F	CXi: F	CXi: F	Xi: F
SNaN	Xi: F	Xi: F	Xi: F	Xi: F	Xi: F	Xi: F	Xi: F	Xi: F

Explanation:

T Corresponding element in operand one is set to all ones
 F Corresponding element in operand one is set to all zeros
 $C(a \geq b)$ Basic compare results. See Figure 19-15 on page 19-18
 Fn Finite nonzero number (includes both subnormal and normal).
 Xi: IEEE invalid-operation exception. The results shown are produced only when FPC 0.0 is zero.
 CXi: IEEE invalid-operation exception if the vector-enhancements facility 1 is installed and the SQ control in M_5 is one. The results shown are produced only when FPC 0.0 is zero.

Figure 24-7. Results: VECTOR FP COMPARE HIGH OR EQUAL

VECTOR FP CONVERT FROM FIXED

VCFPS V_1, V_2, M_3, M_4, M_5 [VRR-a]

VCDG V_1, V_2, M_3, M_4, M_5 [VRR-a]

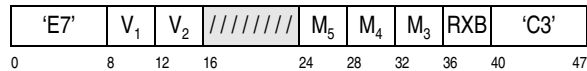

The signed binary integer element or elements of the second operand are converted to binary floating-point numbers. The results are placed in the corresponding element or elements of the first-operand location. The first operand elements are treated as BFP numbers.

The M_3 field specifies the floating-point format as well as the size of the binary integer. The floating-point format determines the size of the elements within the target vector register operand. If a reserved value is specified, a specification exception is recognized. If the vector-enhancements facility 2 is not installed, an

M_3 field value of two is also invalid and a specification exception is recognized.

M_3 Floating-Point Format

- 0-1 Reserved
- 2 Word to BFP short format
- 3 Doubleword to BFP long format
- 4-15 Reserved

The M_4 field has the following format:

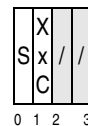

The bits of the M_4 field are defined as follows:

- **Single-Element-Control (S):** If bit 0 is set to one, the operation takes place only on the zero-indexed element in the vector and the result is placed in the zero-indexed element of the first operand. In the absence of a trapping exception condition, the bit positions of all other elements in the first operand vector are unpredictable. If bit 0 is set to zero, the operation occurs on all elements in the vector.

- **IEEE-inexact-exception control (XxC):** Bit 1 of the M_4 field is the XxC bit. If XxC is zero, recognition of IEEE-inexact exception is not suppressed; if XxC is one, recognition of IEEE-inexact exception is suppressed.
- **Reserved:** Bits 2 and 3 are reserved and must contain zeros otherwise a specification is recognized.

The converted result is rounded by the rounding method as specified by the modifier in the M_5 field:

M_5 Effective Rounding Method

- 0 According to current BFP rounding mode
- 1 Round to nearest with ties away from 0
- 3 Round to prepare for shorter precision
- 4 Round to nearest with ties to even
- 5 Round toward 0
- 6 Round toward $+\infty$
- 7 Round toward $-\infty$

An M_5 modifier other than 0, 1, or 3-7 is invalid. The M_5 field must designate a valid modifier; otherwise, a specification exception is recognized.

When the M_5 modifier field is zero, rounding is controlled by the current BFP rounding mode specified in the FPC register. When the field is not zero, rounding

is performed as specified by the modifier, regardless of the current BFP rounding mode.

See Figure 24-8 on page 24-17 for a detailed description of the results for each element.

Condition Code: The code remains unchanged.

IEEE Exceptions:

- Inexact

Program Exceptions:

- Data with DXC FE, Vector Instruction
- Operation (if the vector facility for z/Architecture is not installed)
- Specification
- Transaction constraint
- Vector processing with VXC for IEEE exception and element index

Extended Mnemonics:

Extended Mnemonic		Base Mnemonic	
VCDG	V_1, V_2, M_3, M_4, M_5	VCFPS	V_1, V_2, M_3, M_4, M_5
VCEFB	V_1, V_2, M_4, M_5	VCFPS	$V_1, V_2, 2, M_4, M_5$
VCDGB	V_1, V_2, M_4, M_5	VCFPS	$V_1, V_2, 3, M_4, M_5$
WCEFB	V_1, V_2, M_4, M_5	VCFPS	$V_1, V_2, 2, (8 M_4), M_5$
WCDGB	V_1, V_2, M_4, M_5	VCFPS	$V_1, V_2, 3, (8 M_4), M_5$

Instruction	Results for Instructions with a Single Operand when Operand Element (a) Is							
	$-\infty$	-Fn	-0	+0	+Fn	$+\infty$	QNaN	SNaN
VECTOR FP CONVERT FROM FIXED	–	Rf(a)	–	T(+0)	Rf(a)	–	–	–
VECTOR FP CONVERT FROM LOGICAL	–	–	–	T(+0)	Rf(a)	–	–	–
VECTOR FP LOAD LENGTHENED	T($-\infty$)	T(a) ¹	T(-0)	T(+0)	T(a) ¹	T($+\infty$)	T(a) ¹	Xi: T(a*) ¹
VECTOR FP LOAD ROUNDED	T($-\infty$)	R(a)	T(-0)	T(+0)	R(a)	T($+\infty$)	T(a) ²	Xi: T(a*) ²
VECTOR FP SQUARE ROOT	Xi: T(dNaN)	Xi: T(dNaN)	T(-0)	T(+0)	R(\sqrt{a})	T($+\infty$)	T(a)	Xi: T(a*)

Explanation:

– This situation cannot occur.
 * The SNaN is converted to the corresponding QNaN before it is placed at the target operand element location.
 1 The operand element is extended to the longer format by appending zeros on the right before it is placed at the target operand element location.
 2 The NaN is shortened to the target format by truncating the rightmost bits.
 dNaN Default NaN.
 Fn Finite nonzero number (includes both subnormal and normal).
 R(v) Rounding and range action is performed on the value v. See Figure 24-4 on page 24-6.
 Rf(a) The value a is converted to the precise intermediate value floating-point number v, and then action R(v) is performed.
 T(x) The value x is placed in the target operand element location if no trapping exceptions on other elements.
 Xi: IEEE invalid-operation exception. The results shown are produced only when FPC 0.0 is zero.

Figure 24-8. Results: Single-Operand Instructions

VECTOR FP CONVERT FROM LOGICAL

VCFFPL V_1, V_2, M_3, M_4, M_5 [VRR-a]

VCDLG V_1, V_2, M_3, M_4, M_5 [VRR-a]

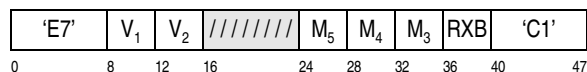

The unsigned binary integer element or elements in the second operand are converted to binary floating-point numbers. The results are placed in the corresponding element or elements of the first-operand location. The first operand elements are treated as BFP numbers.

The M₃ field specifies the floating-point format as well as the size of the binary integer. The floating-point format determines the size of the elements within the target vector register operand. If a reserved value is

specified, a specification exception is recognized. If the vector-enhancements facility 2 is not installed, an M₃ field value of two is also invalid and a specification exception is recognized.

M₃ Floating-Point Format

- 0-1 Reserved
- 2 Word to BFP short format
- 3 Doubleword to BFP long format
- 4-15 Reserved

The M₄ field has the following format:

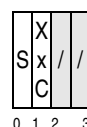

The bits of the M₄ field are defined as follows:

- **Single-Element-Control (S):** If bit 0 is set to one, the operation takes place only on the zero-indexed element in the vector and the result is placed in the zero-indexed element of the first operand. In the absence of a trapping exception condition, the bit positions of all other elements in the first operand vector are unpredictable. If bit 0 is set to zero, the operation occurs on all elements in the vector.
- **IEEE-inexact-exception control (XxC):** Bit 1 of the M₄ field is the XxC bit. If XxC is zero, recognition of IEEE-inexact exception is not suppressed; if XxC is one, recognition of IEEE-inexact exception is suppressed.
- **Reserved:** Bits 2 and 3 are reserved and must contain zeros otherwise a specification is recognized.

The converted result is rounded by the rounding method as specified by the modifier in the M₅ field:

M₅ Effective Rounding Method

- 0 According to current BFP rounding mode
- 1 Round to nearest with ties away from 0
- 3 Round to prepare for shorter precision
- 4 Round to nearest with ties to even
- 5 Round toward 0
- 6 Round toward +∞
- 7 Round toward -∞

An M₅ modifier other than 0, 1, or 3-7 is invalid. The M₅ field must designate a valid modifier; otherwise, a specification exception is recognized.

When the M₅ modifier field is zero, rounding is controlled by the current BFP rounding mode specified in the FPC register. When the field is not zero, rounding is performed as specified by the modifier, regardless of the current BFP rounding mode.

See Figure 24-8 on page 24-17 for a detailed description of the results for each element.

Condition Code: The code remains unchanged.

IEEE Exceptions:

- Inexact

Program Exceptions:

- Data with DXC FE, Vector Instruction

- Operation (if the vector facility for z/Architecture is not installed)
- Specification
- Transaction constraint
- Vector processing with VXC for IEEE exception and element index

Extended Mnemonics:

Extended Mnemonic	Base Mnemonic
VCDLG V ₁ ,V ₂ ,M ₃ ,M ₄ ,M ₅	VCFPL V ₁ ,V ₂ ,M ₃ ,M ₄ ,M ₅
VCELFB V ₁ ,V ₂ ,M ₄ ,M ₅	VCFPL V ₁ ,V ₂ ,2,M ₄ ,M ₅
VCDLGB V ₁ ,V ₂ ,M ₄ ,M ₅	VCFPL V ₁ ,V ₂ ,3,M ₄ ,M ₅
WCELFB V ₁ ,V ₂ ,M ₄ ,M ₅	VCFPL V ₁ ,V ₂ ,2,(8 M ₄),M ₅
WCDLGB V ₁ ,V ₂ ,M ₄ ,M ₅	VCFPL V ₁ ,V ₂ ,3,(8 M ₄),M ₅

VECTOR FP CONVERT TO FIXED

VCSFP V₁,V₂,M₃,M₄,M₅ [VRR-a]

VCGD V₁,V₂,M₃,M₄,M₅ [VRR-a]

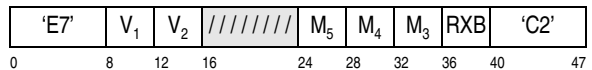

The BFP floating-point element or elements of the second operand are rounded to an integer value and then converted to the fixed-point format. The signed binary integer result is placed in the corresponding element of the first-operand location. The second operand elements are treated as BFP numbers.

If the second operand element is a finite number, it is rounded to an integer value by the rounding method as specified by the modifier in the M₅ field:

M₅ Effective Rounding Method

- 0 According to current BFP rounding mode
- 1 Round to nearest with ties away from 0
- 3 Round to prepare for shorter precision
- 4 Round to nearest with ties to even
- 5 Round toward 0
- 6 Round toward +∞
- 7 Round toward -∞

An M₅ modifier other than 0, 1, or 3-7 is invalid. The M₅ field must designate a valid modifier; otherwise, a specification exception is recognized.

When the M₅ modifier field is zero, rounding is controlled by the current BFP rounding mode specified in

the FPC register. When the field is not zero, rounding is performed as specified by the modifier, regardless of the current BFP rounding mode.

The sign of the result is the sign of the second operand element, except that a zero result has a plus sign.

See Figure 24-9 on page 24-19 for a detailed description of the results for each element.

The M_3 field specifies the floating-point format as well as the size of the binary integer. The floating-point format determines the size of the elements within the target vector register operand. If a reserved value is specified, a specification exception is recognized. If the vector-enhancements facility 2 is not installed, an M_3 field value of two is also invalid and a specification exception is recognized.

M_3 Floating-Point Format

0-1	Reserved
2	BFP short format to word
3	BFP long format to doubleword
4-15	Reserved

The M_4 field has the following format:

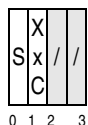

The bits of the M_4 field are defined as follows:

- **Single-Element-Control (S):** If bit 0 of the M_4 field is set to one, the operation takes place only on the zero-indexed element in the vector and the result is placed in the zero-indexed element of the first operand. In the absence of a trapping exception condition, the bit positions of all other

elements in the first operand vector are unpredictable. If bit 0 is set to zero, the operation occurs on all elements in the vector.

- **IEEE-inexact-exception control (XxC):** Bit 1 of the M_4 field is the XxC bit. If XxC is zero, recognition of IEEE-inexact exception is not suppressed; if XxC is one, recognition of IEEE-inexact exception is suppressed.
- **Reserved:** Bits 2 and 3 are reserved and must contain zeros otherwise a specification is recognized.

Condition Code: The code remains unchanged.

IEEE Exceptions:

- Inexact
- Invalid operation

Program Exceptions:

- Data with DXC FE, Vector Instruction
- Operation (if the vector facility for z/Architecture is not installed)
- Specification
- Transaction constraint
- Vector processing with VXC for IEEE exception and element index

Extended Mnemonics:

Extended Mnemonic	Base Mnemonic
VCGD V_1, V_2, M_3, M_4, M_5	VCSFP V_1, V_2, M_3, M_4, M_5
VCFEB V_1, V_2, M_4, M_5	VCSFP $V_1, V_2, 2, M_4, M_5$
VCGDB V_1, V_2, M_4, M_5	VCSFP $V_1, V_2, 3, M_4, M_5$
WCFEB V_1, V_2, M_4, M_5	VCSFP $V_1, V_2, 2, (8 M_4), M_5$
WCGDB V_1, V_2, M_4, M_5	VCSFP $V_1, V_2, 3, (8 M_4), M_5$

Operand Element (a)	Is n Inexact (n≠a)	Inv.-Op. Mask (FPC 0.0)	IEEE Inexact Exception Control (XxC)	Inexact Mask (FPC 0.4)	Results
$-\infty \leq a < MN, n < MN$	–	0	1	–	T(MN), SFi←1
$-\infty \leq a < MN, n < MN$	–	0	0	0	T(MN), SFi←1, SFx←1
$-\infty \leq a < MN, n < MN$	–	0	0	1	PIV(5)
$-\infty \leq a < MN, n < MN$	–	1	–	–	PIV(1)

Figure 24-9. Results: VECTOR FP CONVERT TO FIXED 64

Operand Element (a)	Is n Inexact (n≠a)	Inv.-Op. Mask (FPC 0.0)	IEEE Inexact Exception Control (XxC)	Inexact Mask (FPC 0.4)	Results
$MN \leq a < 0$	No	–	–	–	T(f)
$MN \leq a < 0$	Yes	–	1	–	T(f)
$MN \leq a < 0$	Yes	–	0	0	T(f), SFx←1
$MN \leq a < 0$	Yes	–	0	1	PIV(5)
-0	No ¹	–	–	–	T(0)
+0	No ¹	–	–	–	T(0)
$0 < a \leq MP$	No	–	–	–	T(f)
$0 < a \leq MP$	Yes	–	1	–	T(f)
$0 < a \leq MP$	Yes	–	0	0	T(f), SFx←1
$0 < a \leq MP$	Yes	–	0	1	T(f), PIV(5)
$MP < a \leq +\infty, n > MP$	–	0	1	–	T(MP), SFi←1
$MP < a \leq +\infty, n > MP$	–	0	0	0	T(MP), SFi←1, SFx←1
$MP < a \leq +\infty, n > MP$	–	0	0	1	PIV(5)
$MP < a \leq +\infty, n > MP$	–	1	–	–	PIV(1)
NaN	–	0	1	–	T(MN), SFi←1
NaN	–	0	0	0	T(MN), SFi←1, SFx←1
NaN	–	0	0	1	PIV(5)
NaN	–	1	–	–	PIV(1)

Explanation:

– The results do not depend on this condition or mask bit.
¹ This condition is true by virtue of the state of some condition to the left of this column.
f The value n converted to a fixed-point result.
n The value derived when the source value (a) is rounded to a floating-point integer using the effective rounding method.
MN Maximum negative number representable in the target fixed-point format.
MP Maximum positive number representable in the target fixed-point format.
PIV(h) Program interruption for vector-processing exception with VXC containing the element index and a VIC of h in hex.
SFi IEEE invalid-operation flag, FPC 1.0.
SFx IEEE inexact flag, FPC 1.4.
T(x) The value x is placed at the target operand element location if no trapping exceptions on other elements.

Figure 24-9. Results: VECTOR FP CONVERT TO FIXED 64 (Continued)

VECTOR FP CONVERT TO LOGICAL

VCLFP V_1, V_2, M_3, M_4, M_5 [VRR-a]

VCLGD V_1, V_2, M_3, M_4, M_5 [VRR-a]

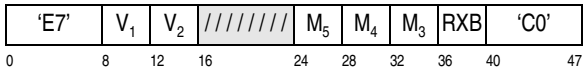

The BFP floating-point element or elements of the second operand are rounded to an integer value and then converted to the fixed-point format. The unsigned binary integer result is placed in the corresponding element of the first-operand location. The second operand elements are treated as BFP numbers.

If the second operand element is a finite number, it is rounded to an integer value by the rounding method as specified by the modifier in the M₅ field:

M₅ Effective Rounding Method

- 0 According to current BFP rounding mode
- 1 Round to nearest with ties away from 0
- 3 Round to prepare for shorter precision
- 4 Round to nearest with ties to even
- 5 Round toward 0
- 6 Round toward $+\infty$
- 7 Round toward $-\infty$

An M₅ modifier other than 0, 1, or 3-7 is invalid. The M₅ field must designate a valid modifier; otherwise, a specification exception is recognized.

When the M₅ modifier field is zero, rounding is controlled by the current BFP rounding mode specified in the FPC register. When the field is not zero, rounding is performed as specified by the modifier, regardless of the current BFP rounding mode.

See Figure 24-10 on page 24-22 for a detailed description of the results for each element.

The M₃ field specifies the floating-point format as well as the size of the binary integer. The floating-point format determines the size of the elements within the target vector register operand. If a reserved value is specified, a specification exception is recognized. If the vector-enhancements facility 2 is not installed, an M₃ field value of 2 is also invalid and a specification exception is recognized.

M₃ Floating-Point Format

- 0-1 Reserved
- 2 BFP short format to word
- 3 BFP long format to doubleword
- 4-15 Reserved

The M₄ field has the following format:

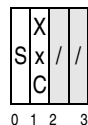

The bits of the M₄ field are defined as follows:

- **Single-Element-Control (S):** If bit 0 is set to one, the operation takes place only on the zero-indexed element in the vector and the result is placed in the zero-indexed element of the first operand. In the absence of a trapping exception condition, the bit positions of all other elements in the first operand vector are unpredictable. If bit 0 is set to zero, the operation occurs on all elements in the vector.
- **IEEE-inexact-exception control (XxC):** Bit 1 of the M₄ field is the XxC bit. If XxC is zero, recognition of IEEE-inexact exception is not suppressed; if XxC is one, recognition of IEEE-inexact exception is suppressed.
- **Reserved:** Bits 2 and 3 are reserved and must contain zeros otherwise a specification is recognized.

Condition Code: The code remains unchanged.

IEEE Exceptions:

- Inexact
- Invalid operation

Program Exceptions:

- Data with DXC FE, Vector Instruction
- Operation (if the vector facility for z/Architecture is not installed)
- Specification
- Transaction constraint
- Vector processing with VXC for IEEE exception and element index

Extended Mnemonics:

Extended Mnemonic	Base Mnemonic
VCLGD V ₁ ,V ₂ ,M ₃ ,M ₄ ,M ₅	VCLFP V ₁ ,V ₂ ,M ₃ ,M ₄ ,M ₅
VCLFEB V ₁ ,V ₂ ,M ₄ ,M ₅	VCLFP V ₁ ,V ₂ ,2,M ₄ ,M ₅
VCLGDB V ₁ ,V ₂ ,M ₄ ,M ₅	VCLFP V ₁ ,V ₂ ,3,M ₄ ,M ₅
WCLFEB V ₁ ,V ₂ ,M ₄ ,M ₅	VCLFP V ₁ ,V ₂ ,2,(8 M ₄),M ₅
WCLGDB V ₁ ,V ₂ ,M ₄ ,M ₅	VCLFP V ₁ ,V ₂ ,3,(8 M ₄),M ₅

Operand Element (a)	Is n Inexact (n≠a)	Inv.-Op. Mask (FPC 0.0)	IEEE Inexact Exception Control (XxC)	Inexact Mask (FPC 0.4)	Results
$-\infty \leq a < 0, n < 0$	–	0	1	–	T(0), SFi←1
$-\infty \leq a < 0, n < 0$	–	0	0	0	T(0), SFi←1, SFx←1
$-\infty \leq a < 0, n < 0$	–	0	0	1	PIV(5)
$-\infty \leq a < 0, n < 0$	–	1	–	–	PIV(1)
$-\infty < a < 0, n = 0$	–	–	1	–	T(0)
$-\infty < a < 0, n = 0$	–	–	0	0	T(0), SFx←1
$-\infty < a < 0, n = 0$	–	–	0	1	PIV(5)
-0	No ¹	–	–	–	T(0)
+0	No ¹	–	–	–	T(0)
$0 < a \leq \text{MU}$	No	–	–	–	T(f)
$0 < a \leq \text{MU}$	Yes	–	1	–	T(f)
$0 < a \leq \text{MU}$	Yes	–	0	0	T(f), SFx←1
$0 < a \leq \text{MU}$	Yes	–	0	1	PIV(5)
$\text{MU} < a \leq +\infty, n > \text{MU}$	–	0	1	–	T(MU), SFi←1
$\text{MU} < a \leq +\infty, n > \text{MU}$	–	0	0	0	T(MU), SFi←1, SFx←1
$\text{MU} < a \leq +\infty, n > \text{MU}$	–	0	0	1	PIV(5)
$\text{MU} < a \leq +\infty, n > \text{MU}$	–	1	–	–	PIV(1)
NaN	–	0	1	–	T(0), SFi←1
NaN	–	0	0	0	T(0), SFi←1, SFx←1
NaN	–	0	0	1	PIV(5)
NaN	–	1	–	–	PIV(1)

Explanation:

– The results do not depend on this condition or mask bit.
¹ This condition is true by virtue of the state of some condition to the left of this column.
f The value n converted to a fixed-point result.
n The value derived when the source value (a) is rounded to a floating-point integer using the effective rounding method.
MU Maximum unsigned number representable in the target fixed-point format.
PIV(h) Program interruption for vector-processing exception with VXC containing the element index and a VIC of h in hex.
SFi IEEE invalid-operation flag, FPC 1.0.
SFx IEEE inexact flag, FPC 1.4.
T(x) The value x is placed at the target operand element location if no trapping exceptions on other elements.

Figure 24-10. Results: VECTOR FP CONVERT TO LOGICAL 64-BIT

VECTOR FP DIVIDE

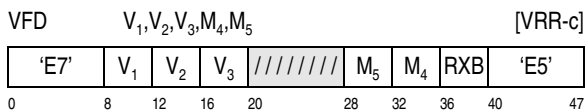

The floating-point element or elements of the second operand (the dividend) are divided by the corresponding floating-point element or elements in the third operand (the divisor), and the quotient or quotients are placed at the corresponding elements in first-operand location. No remainder is preserved.

The operand elements are all treated as BFP numbers of the specified format.

If the divisor is nonzero and both the dividend and divisor are finite numbers, the second operand element is divided by the third operand element to form an intermediate quotient. The intermediate quotient, if nonzero, is rounded to the target format according to the current BFP rounding mode.

When the dividend is a finite number and the divisor is infinity, the result is zero.

The sign of the quotient, if the quotient is numeric, is the exclusive or of the corresponding operand element signs. This includes the sign of a zero or infinite quotient.

If the divisor is zero but the dividend is a finite number, an IEEE-division-by-zero exception is recognized. If the dividend and divisor are both zero, or if both are infinity, regardless of sign, an IEEE-invalid-operation exception is recognized.

See Figure 24-11 on page 24-24 for a detailed description of the results of each element.

The M_4 field specifies the floating-point format. The floating-point format determines the size of the elements within the vector register operands. If a reserved value is specified, a specification exception is recognized. If the vector-enhancements facility 1 is not installed the values 2 and 4 are reserved.

M_4 Floating-Point Format

0-1	Reserved
2	Short format
3	Long format
4	Extended format
5-15	Reserved

The M_5 field has the following format:



The bits of the M_5 field are defined as follows:

- **Single-Element-Control (S):** If bit 0 is set to one, the operation takes place only on the zero-indexed element in the vector. In the absence of a trapping exception condition, the bit positions of all other elements in the first operand vector are unpredictable. If bit 0 is set to zero, the operation occurs on all elements in the vector.
- **Reserved:** Bits 1 to 3 are reserved and must be zero. Otherwise, a specification exception is recognized.

Condition Code: The code remains unchanged.

IEEE Exceptions:

- Invalid operation
- Division by zero
- Overflow
- Underflow
- Inexact

Program Exceptions:

- Data with DXC FE, Vector Instruction
- Operation (if the vector facility for z/Architecture is not installed)
- Specification
- Transaction constraint
- Vector processing with VXC for IEEE exception and element index

Extended Mnemonics:

Extended Mnemonic		Base Mnemonic	
VFDSB	V_1, V_2, V_3	VFD	$V_1, V_2, V_3, 2, 0$
WFDSB	V_1, V_2, V_3	VFD	$V_1, V_2, V_3, 2, 8$
VFDDB	V_1, V_2, V_3	VFD	$V_1, V_2, V_3, 3, 0$
WFDDB	V_1, V_2, V_3	VFD	$V_1, V_2, V_3, 3, 8$
WFDXB	V_1, V_2, V_3	VFD	$V_1, V_2, V_3, 4, 8$

Dividend Element (a)	Results for DIVIDE (a÷b) when Divisor Element (b) Is							
	$-\infty$	-Fn	-0	+0	+Fn	$+\infty$	QNaN	SNaN
$-\infty$	Xi: T(dNaN)	T($+\infty$)	T($+\infty$)	T($-\infty$)	T($-\infty$)	Xi: T(dNaN)	T(b)	Xi: T(b*)
-Fn	T(+0)	R(a÷b)	Xz: T($+\infty$)	Xz: T($-\infty$)	R(a÷b)	T(-0)	T(b)	Xi: T(b*)
-0	T(+0)	T(+0)	Xi: T(dNaN)	Xi: T(dNaN)	T(-0)	T(-0)	T(b)	Xi: T(b*)
+0	T(-0)	T(-0)	Xi: T(dNaN)	Xi: T(dNaN)	T(+0)	T(+0)	T(b)	Xi: T(b*)
+Fn	T(-0)	R(a÷b)	Xz: T($-\infty$)	Xz: T($+\infty$)	R(a÷b)	T(+0)	T(b)	Xi: T(b*)
$+\infty$	Xi: T(dNaN)	T($-\infty$)	T($-\infty$)	T($+\infty$)	T($+\infty$)	Xi: T(dNaN)	T(b)	Xi: T(b*)
QNaN	T(a)	T(a)	T(a)	T(a)	T(a)	T(a)	T(a)	Xi: T(b*)
SNaN	Xi: T(a*)	Xi: T(a*)	Xi: T(a*)	Xi: T(a*)	Xi: T(a*)	Xi: T(a*)	Xi: T(a*)	Xi: T(a*)

Explanation:

* The SNaN is converted to the corresponding QNaN before it is placed at the target operand location.
 Fn Finite nonzero number (includes both subnormal and normal).
 R(v) Rounding and range action is performed on the value v. See Figure 24-4 on page 24-6.
 T(x) The value x is placed at the target operand element location if no trapping exceptions on other elements.
 Xi: IEEE invalid-operation exception. The results shown are produced only when FPC 0.0 is zero.
 Xz: IEEE division-by-zero exception. The results shown are produced only when FPC 0.1 is zero.

Figure 24-11. Results: DIVIDE

VECTOR LOAD FP INTEGER

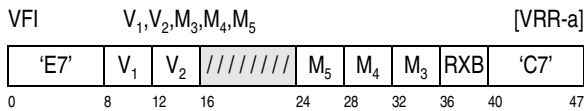

The floating-point element or elements of the second operand are rounded to integer values in the same floating-point format, and the results are placed in the corresponding elements of the first-operand. The size of the operand elements is determined by the floating-point-format control in the M_3 field. The first and second operands are treated as BFP numbers.

The second operand elements, if finite numbers, are rounded to an integer value by the rounding method specified by the modifier in the M_5 field:

M_5 Effective Rounding Method

- 0 According to current BFP rounding mode
- 1 Round to nearest with ties away from 0
- 3 Round to prepare for shorter precision
- 4 Round to nearest with ties to even
- 5 Round toward 0
- 6 Round toward $+\infty$
- 7 Round toward $-\infty$

is recognized. If the vector-enhancements facility 1 is

An M_5 modifier other than 0, 1, or 3-7 is invalid. The M_5 field must designate a valid modifier; otherwise, a specification exception is recognized.

When the M_5 modifier field is zero, rounding is controlled by the current BFP rounding mode in the FPC register. When the field is not zero, rounding is performed as specified by the modifier, regardless of the current BFP rounding mode.

In the absence of an interruption, if the second operand element is an infinity or a QNaN, the result is that operand element; if the second operand element is an SNaN, the result is the corresponding QNaN.

The sign of the result is the sign of the second operand element, even when the result is zero.

The M_3 field specifies the floating-point format. The floating-point format determines the size of the elements within the vector register operands. If a reserved value is specified, a specification exception

not installed the values 2 and 4 are reserved.

M_3 Floating-Point Format

0-1	Reserved
2	Short format
3	Long format
4	Extended format
5-15	Reserved

The M_4 field has the following format:

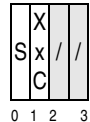

The bits of the M_4 field are defined as follows:

- **Single-Element-Control (S):** If bit 0 is set to one, the operation takes place only on the zero-indexed element in the vector. In the absence of a trapping exception condition, the bit positions of all other elements in the first operand vector are unpredictable. If bit 0 is set to zero, the operation occurs on all elements in the vector.
- **IEEE-inexact-exception control (XxC):** Bit 1 of the M_4 field is the XxC bit. If XxC is zero, recognition of IEEE-inexact exception is not suppressed; if XxC is one, recognition of IEEE-inexact exception is suppressed.
- **Reserved:** Bits 2 and 3 are reserved and must contain zeros otherwise a specification is recognized.

See Figure 24-12 on page 24-26 for a detailed description of the results for each element.

Condition Code: The code remains unchanged.

IEEE Exceptions:

- Invalid operation
- Inexact

Program Exceptions:

- Data with DXC FE, Vector Instruction
- Operation (if the vector facility for z/Architecture is not installed)
- Specification
- Transaction constraint
- Vector processing with VXC for IEEE exception and element index

Programming Notes:

1. VECTOR LOAD FP INTEGER rounds BFP numbers to an integer values. These integers, which remain in the BFP format, should not be confused with binary integers, which have a fixed-point format.
2. If the BFP operand element is a finite number with a large enough exponent so that it is already an integer, the result value remains the same.

Extended Mnemonics:

Extended Mnemonic		Base Mnemonic	
VFISB	V_1, V_2, M_4, M_5	VFI	$V_1, V_2, 2, M_4, M_5$
WFISB	V_1, V_2, M_4, M_5	VFI	$V_1, V_2, 2, (8 M_4), M_5$
VFIDB	V_1, V_2, M_4, M_5	VFI	$V_1, V_2, 3, M_4, M_5$
WFIDB	V_1, V_2, M_4, M_5	VFI	$V_1, V_2, 3, (8 M_4), M_5$
WFIXB	V_1, V_2, M_4, M_5	VFI	$V_1, V_2, 4, (8 M_4), M_5$

Operand Element (a)	Is n Inexact (n≠a)	Inv.-Op. Mask (FPC 0.0)	IEEE Inexact Exception Control (XxC)	Inexact Mask (FPC 0.4)	Results
$-\infty$	No ¹	–	–	–	T($-\infty$)
-Fn	No	–	–	–	T(n)
-Fn	Yes	–	1	–	T(n)
-Fn	Yes	–	0	0	T(n), SFx←1
-Fn	Yes	–	0	1	PIV(5)
-0	No ¹	–	–	–	T(-0)
+0	No ¹	–	–	–	T(+0)
+Fn	No	–	–	–	T(n)
+Fn	Yes	–	1	–	T(n)
+Fn	Yes	–	0	0	T(n), SFx←1
+Fn	Yes	–	0	1	PIV(5)
$+\infty$	No ¹	–	–	–	T($+\infty$)
QNaN	No ¹	–	–	–	T(a)
SNaN	No ¹	0	–	–	T(a*), SFi←1
SNaN	No ¹	1	–	–	PIV(1)

Explanation:

- The results do not depend on this condition or mask bit.
- * The SNaN is converted to the corresponding QNaN before it is placed at the target operand element location.
- ¹ This condition is true by virtue of the state of some condition to the left of this column.
- n The value derived when the source value, a, is rounded to a floating-point integer using the effective rounding mode.
- Fn Finite nonzero number (includes both subnormal and normal).
- PIV(h) Program interruption for vector-processing exception, with a VXC containing the element index and a VIC of h in hex.
- SFi IEEE invalid-operation flag, FPC 1.0.
- SFx IEEE inexact flag, FPC 1.4.
- T(x) The value x is placed at the target operand element location if no trapping exceptions on other elements.

Figure 24-12. Results: VECTOR LOAD FP INTEGER

VECTOR FP LOAD LENGTHENED

VFLL V_1, V_2, M_3, M_4 [VRR-a]

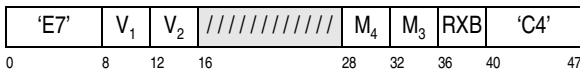

The even indexed floating-point element or elements of the second operand are converted to the next largest format floating point numbers, and the results are placed in the even-odd pair of elements in the first operand. The operand elements are all treated as BFP numbers of the specified format.

When the second operand element is numeric, the value of the second operand element is placed in the target format.

If the second operand element is an SNaN, an IEEE-invalid-operation exception is recognized; if there is no interruption, the result is the corresponding QNaN with the fraction extended.

The sign of the result is the same as the sign of the source.

See Figure 24-8 on page 24-17 for a detailed description of the results for each element.

The M_3 field specifies the floating-point format. The floating-point format determines the size of the elements within the second operand. If a reserved value is specified, a specification exception is recognized. If the vector-enhancements facility 1 is not installed the value 3 is reserved.

M_3 Floating-Point Format

0-1	Reserved
2	Short format
3	Long format
4-15	Reserved

The M_4 field has the following format:



The bits of the M_4 field are defined as follows:

- **Single-Element-Control (S):** If bit 0 is set to one, the operation takes place only on the zero-indexed element in the vector. In the absence of a trapping exception condition, the bit positions of all other elements in the first operand vector are unpredictable. If bit 0 is set to zero, the operation occurs on all elements in the vector.
- **Reserved:** Bits 1 to 3 are reserved and must be zero. Otherwise, a specification exception is recognized.

Condition Code: The code remains unchanged.

IEEE Exceptions:

- Invalid operation

Program Exceptions:

- Data with DXC FE, Vector Instruction
- Operation (if the vector facility for z/Architecture is not installed)
- Specification
- Transaction constraint
- Vector processing with VXC for IEEE exception and element index

Extended Mnemonics:

Extended Mnemonic		Base Mnemonic	
VLDE	V_1, V_2, M_3, M_4	VFLL	V_1, V_2, M_3, M_4
VLDEB	V_1, V_2	VFLL	$V_1, V_2, 2, 0$

Extended Mnemonic		Base Mnemonic	
WLDEB	V_1, V_2	VFLL	$V_1, V_2, 2, 8$
VFLLS	V_1, V_2	VFLL	$V_1, V_2, 2, 0$
WFLLS	V_1, V_2	VFLL	$V_1, V_2, 2, 8$
WFLLD	V_1, V_2	VFLL	$V_1, V_2, 3, 8$

Programming Note: If a trapping IEEE exception is encountered during execution of VECTOR LOAD LENGTHENED it is model dependent if the VIX in the VXC field is the index of the source or target element unless the The z/Architecture CPU Architecture is installed in which case it is always the index of the source element.

VECTOR FP LOAD ROUNDED

VFLR V_1, V_2, M_3, M_4, M_5 [VRR-a]



The floating-point element or elements of the second operand, are rounded to the precision of the next smallest element size, and the result is placed at the corresponding even elements in the first-operand location. The data in the odd elements of the first operand is unpredictable. The size of the second operand elements is determined by the floating-point-format control in the M_3 field. The operand elements are all treated as BFP numbers.

The sign of the resulting element or elements is the same as the corresponding element of the second operand.

The second operand element, if a finite number, is rounded by the rounding method as specified by the modifier in the M_5 field:

M_5 Effective Rounding Method

- | | |
|---|--|
| 0 | According to current BFP rounding mode |
| 1 | Round to nearest with ties away from 0 |
| 3 | Round to prepare for shorter precision |
| 4 | Round to nearest with ties to even |
| 5 | Round toward 0 |
| 6 | Round toward $+\infty$ |
| 7 | Round toward $-\infty$ |

An M_5 modifier other than 0, 1, or 3-7 is invalid. The M_5 field must designate a valid modifier; otherwise, a specification exception is recognized.

When the M_5 modifier field is zero, rounding is controlled by the current BFP rounding mode specified in the FPC register. When the field is not zero, rounding is performed as specified by the modifier, regardless of the current BFP rounding mode.

See Figure 24-8 on page 24-17 for a detailed description of the results for each element.

The M_3 field specifies the floating-point format. The floating-point format determines the size of the elements within the second operand. If a reserved value is specified, a specification exception is recognized. If the vector-enhancements facility 1 is not installed the value 4 is reserved.

M_3 Floating-Point Format

0-2	Reserved
3	Long format
4	Extended format
5-15	Reserved

The M_4 field has the following format:

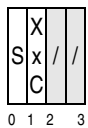

The bits of the M_4 field are defined as follows:

- **Single-Element-Control (S):** If bit 0 is set to one, the operation takes place only on the zero-indexed element in the vector. In the absence of a trapping exception condition, the bit positions of all other elements in the first operand vector are unpredictable. If bit 0 is set to zero, the operation occurs on all elements in the vector.
- **IEEE-inexact-exception control (XxC):** Bit 1 of the M_4 field is the XxC bit. If XxC is zero, recognition of IEEE-inexact exception is not suppressed; if XxC is one, recognition of IEEE-inexact exception is suppressed.
- **Reserved:** Bits 2 and 3 are reserved and must contain zeros otherwise a specification is recognized.

Condition Code: The code remains unchanged.

IEEE Exceptions:

- Invalid operation
- Overflow
- Underflow
- Inexact

Program Exceptions:

- Data with DXC FE, Vector Instruction
- Operation (if the vector facility for z/Architecture is not installed)
- Specification
- Transaction constraint
- Vector processing with VXC for IEEE exception and element index

Programming Note: The sign of the rounded result is the same as the sign of the operand element, even when the result is zero.

Extended Mnemonics:

Extended Mnemonic	Base Mnemonic
VLED V_1, V_2, M_3, M_4, M_5	VFLR V_1, V_2, M_4, M_4, M_5
VLEDB V_1, V_2, M_4, M_5	VFLR $V_1, V_2, 3, M_4, M_5$
WLEDB V_1, V_2, M_4, M_5	VFLR $V_1, V_2, 3, (8 M_4), M_5$
VFLRD V_1, V_2, M_4, M_5	VFLR $V_1, V_2, 3, M_4, M_5$
WFLRD V_1, V_2, M_4, M_5	VFLR $V_1, V_2, 3, (8 M_4), M_5$
WFLRX V_1, V_2, M_4, M_5	VFLR $V_1, V_2, 4, (8 M_4), M_5$

VECTOR FP MAXIMUM

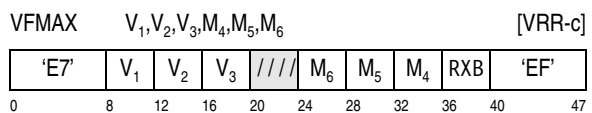

The floating point element or elements of the second operand are compared to the corresponding floating-point element or elements of the third operand. The greater of the two values is placed in the corresponding element of the first operand. The operand elements are all treated as BFP numbers of the specified format.

Depending on the maximum function performed, if any of the floating-point elements in the second or third operand are NaNs, an IEEE invalid-operation exception may be recognized as specified in the action figures. If the IEEE invalid-operation mask bit is one, a program interruption with VXC set for IEEE invalid-operation and the corresponding element index occurs and the operation is suppressed.

The M_6 field specifies the handling of special cases for the comparison, see Figure 24-13 to Figure 24-22 for detailed descriptions of the results for each element. If a reserved value is specified, a specification exception is recognized.

M_6	Maximum Function Performed
0	IEEE MaxNum
1	Java Math.Max()
2	C-Style Max Macro
3	C++ Algorithm.max()
4	fmax()
5-7	Reserved
8	IEEE MaxNumMag
9	Java Math.Max() of absolute values
10	C-Style Max Macro of absolute values
11	C++ Algorithm.max() of absolute values
12	fmax() of absolute values
13-15	Reserved

The M_4 field specifies the floating-point format. The floating-point format determines the size of the elements within the vector register operands. If a reserved value is specified, a specification exception is recognized.

M_4	Floating-Point Format
0-1	Reserved
2	Short format
3	Long format
4	Extended format
5-15	Reserved

The M_5 field has the following format:



The bits of the M_5 field are defined as follows:

- **Single-Element-Control (S):** If bit 0 is set to one, the operation takes place only on the zero-indexed element in the vector. In the absence of a trapping exception condition, the bit positions of all other elements in the first operand vector are unpredictable. The values of all other elements in the second and third operands are ignored. If bit 0 is set to zero, the operation occurs on all elements in the vector.
- **Reserved:** Bits 1, 2, and 3 are reserved and must be zero. Otherwise, a specification exception is recognized.

Condition Code: The code remains unchanged.

IEEE Exceptions:

- Invalid operation

Program Exceptions:

- Data with DXC FE, Vector Instruction
- Operation (if the vector-enhancements facility 1 is not installed)
- Specification
- Transaction constraint
- Vector processing with VXC for IEEE exception and element index

Extended Mnemonics:

Extended Mnemonic		Base Mnemonic	
VFMAXSB	V_1, V_2, V_3, M_6	VFMAX	$V_1, V_2, V_3, 2, 0, M_6$
VFMAXDB	V_1, V_2, V_3, M_6	VFMAX	$V_1, V_2, V_3, 3, 0, M_6$
WFMAXSB	V_1, V_2, V_3, M_6	VFMAX	$V_1, V_2, V_3, 2, 8, M_6$
WFMAXDB	V_1, V_2, V_3, M_6	VFMAX	$V_1, V_2, V_3, 3, 8, M_6$
WFMAXXB	V_1, V_2, V_3, M_6	VFMAX	$V_1, V_2, V_3, 4, 8, M_6$

Second Operand (a) Is	Results for VECTOR FP MAXIMUM (a:b) when Third Operand (b) Is							
	$-\infty$	-Fn	-0	+0	+Fn	$+\infty$	QNaN	SNaN
$-\infty$	T(a)	T(b)	T(b)	T(b)	T(b)	T(b)	T(a)	Xi: T(b*)
-Fn	T(a)	T(M(a,b))	T(b)	T(b)	T(b)	T(b)	T(a)	Xi: T(b*)
-0	T(a)	T(a)	T(a)	T(b)	T(b)	T(b)	T(a)	Xi: T(b*)
+0	T(a)	T(a)	T(a)	T(a)	T(b)	T(b)	T(a)	Xi: T(b*)
+Fn	T(a)	T(a)	T(a)	T(a)	T(M(a,b))	T(b)	T(a)	Xi: T(b*)
$+\infty$	T(a)	T(a)	T(a)	T(a)	T(a)	T(a)	T(a)	Xi: T(b*)
QNaN	T(b)	T(b)	T(b)	T(b)	T(b)	T(b)	T(a)	Xi: T(b*)
SNaN	Xi: T(a*)	Xi: T(a*)	Xi: T(a*)	Xi: T(a*)	Xi: T(a*)	Xi: T(a*)	Xi: T(a*)	Xi: T(a*)

Explanation:

- * The SNaN is converted to the corresponding QNaN before it is placed in the target operand location.
- T(x) The value x is placed at the target operand element location if no trapping exceptions on other elements.
- M(x,y) Return the greater of floating point value x and y.
- Fn Finite nonzero number (includes both subnormal and normal).
- Xi: IEEE invalid-operation exception. The results shown are produced only when FPC 0.0 is zero.

Figure 24-13. Results: VECTOR FP MAXIMUM with $M_6=0$ (IEEE MaxNum)

Second Operand (a) Is	Results for VECTOR FP MAXIMUM (a:b) when Third Operand (b) Is							
	$-\infty$	-Fn	-0	+0	+Fn	$+\infty$	QNaN	SNaN
$-\infty$	T(a)	T(b)	T(b)	T(b)	T(b)	T(b)	T(b)	Xi: T(b*)
-Fn	T(a)	T(M(a,b))	T(b)	T(b)	T(b)	T(b)	T(b)	Xi: T(b*)
-0	T(a)	T(a)	T(a)	T(b)	T(b)	T(b)	T(b)	Xi: T(b*)
+0	T(a)	T(a)	T(a)	T(a)	T(b)	T(b)	T(b)	Xi: T(b*)
+Fn	T(a)	T(a)	T(a)	T(a)	T(M(a,b))	T(b)	T(b)	Xi: T(b*)
$+\infty$	T(a)	T(a)	T(a)	T(a)	T(a)	T(a)	T(b)	Xi: T(b*)
QNaN	T(a)	T(a)	T(a)	T(a)	T(a)	T(a)	T(a)	Xi: T(b*)
SNaN	Xi: T(a*)	Xi: T(a*)	Xi: T(a*)	Xi: T(a*)	Xi: T(a*)	Xi: T(a*)	Xi: T(a*)	Xi: T(a*)

Explanation:

- * The SNaN is converted to the corresponding QNaN before it is placed in the target operand location.
- T(x) The value x is placed at the target operand element location if no trapping exceptions on other elements.
- M(x,y) Return the greater of floating point value x and y.
- Fn Finite nonzero number (includes both subnormal and normal).
- Xi: IEEE invalid-operation exception. The results shown are produced only when FPC 0.0 is zero.

Figure 24-14. Results: VECTOR FP MAXIMUM with $M_6=1$ (JAVA Math.Max())

Second Operand (a) Is	Results for VECTOR FP MAXIMUM (a:b) when Third Operand (b) Is							
	$-\infty$	-Fn	-0	+0	+Fn	$+\infty$	QNaN	SNaN
$-\infty$	T(b)	T(b)	T(b)	T(b)	T(b)	T(b)	Xi: T(b)	Xi: T(b)
-Fn	T(a)	T(M(a,b))	T(b)	T(b)	T(b)	T(b)	Xi: T(b)	Xi: T(b)
-0	T(a)	T(a)	T(b)	T(b)	T(b)	T(b)	Xi: T(b)	Xi: T(b)
+0	T(a)	T(a)	T(b)	T(b)	T(b)	T(b)	Xi: T(b)	Xi: T(b)
+Fn	T(a)	T(a)	T(a)	T(a)	T(M(a,b))	T(b)	Xi: T(b)	Xi: T(b)
$+\infty$	T(a)	T(a)	T(a)	T(a)	T(a)	T(b)	Xi: T(b)	Xi: T(b)
QNaN	Xi: T(b)	Xi: T(b)	Xi: T(b)	Xi: T(b)	Xi: T(b)	Xi: T(b)	Xi: T(b)	Xi: T(b)
SNaN	Xi: T(b)	Xi: T(b)	Xi: T(b)	Xi: T(b)	Xi: T(b)	Xi: T(b)	Xi: T(b)	Xi: T(b)

Explanation:

T(x) The value x is placed at the target operand element location if no trapping exceptions on other elements.
M(x,y) Return the greater of floating point value x and y.
Fn Finite nonzero number (includes both subnormal and normal).
Xi: IEEE invalid-operation exception. The results shown are produced only when FPC 0.0 is zero.

Figure 24-15. Results: VECTOR FP MAXIMUM with $M_6=2$ ("C-style Max Macro")

Second Operand (a) Is	Results for VECTOR FP MAXIMUM (a:b) when Third Operand (b) Is							
	$-\infty$	-Fn	-0	+0	+Fn	$+\infty$	QNaN	SNaN
$-\infty$	T(a)	T(b)	T(b)	T(b)	T(b)	T(b)	Xi: T(a)	Xi: T(a)
-Fn	T(a)	T(M(a,b))	T(b)	T(b)	T(b)	T(b)	Xi: T(a)	Xi: T(a)
-0	T(a)	T(a)	T(a)	T(a)	T(b)	T(b)	Xi: T(a)	Xi: T(a)
+0	T(a)	T(a)	T(a)	T(a)	T(b)	T(b)	Xi: T(a)	Xi: T(a)
+Fn	T(a)	T(a)	T(a)	T(a)	T(M(a,b))	T(b)	Xi: T(a)	Xi: T(a)
$+\infty$	T(a)	T(a)	T(a)	T(a)	T(a)	T(a)	Xi: T(a)	Xi: T(a)
QNaN	Xi: T(a)	Xi: T(a)	Xi: T(a)	Xi: T(a)	Xi: T(a)	Xi: T(a)	Xi: T(a)	Xi: T(a)
SNaN	Xi: T(a)	Xi: T(a)	Xi: T(a)	Xi: T(a)	Xi: T(a)	Xi: T(a)	Xi: T(a)	Xi: T(a)

Explanation:

T(x) The value x is placed at the target operand element location if no trapping exceptions on other elements.
M(x,y) Return the greater of floating point value x and y.
Fn Finite nonzero number (includes both subnormal and normal).
Xi: IEEE invalid-operation exception. The results shown are produced only when FPC 0.0 is zero.

Figure 24-16. Results: VECTOR FP MAXIMUM with $M_6=3$ ("C++ Algorithm.max()")

Second Operand (a) Is	Results for VECTOR FP MAXIMUM (a:b) when Third Operand (b) Is							
	$-\infty$	-Fn	-0	+0	+Fn	$+\infty$	QNaN	SNaN
$-\infty$	T(a)	T(b)	T(b)	T(b)	T(b)	T(b)	T(a)	Xi: T(a)
-Fn	T(a)	T(M(a,b))	T(b)	T(b)	T(b)	T(b)	T(a)	Xi: T(a)
-0	T(a)	T(a)	T(a)	T(b)	T(b)	T(b)	T(a)	Xi: T(a)
+0	T(a)	T(a)	T(a)	T(a)	T(b)	T(b)	T(a)	Xi: T(a)
+Fn	T(a)	T(a)	T(a)	T(a)	T(M(a,b))	T(b)	T(a)	Xi: T(a)
$+\infty$	T(a)	T(a)	T(a)	T(a)	T(a)	T(a)	T(a)	Xi: T(a)
QNaN	T(b)	T(b)	T(b)	T(b)	T(b)	T(b)	T(a)	Xi: T(a)
SNaN	Xi: T(b)	Xi: T(b)	Xi: T(b)	Xi: T(b)	Xi: T(b)	Xi: T(b)	Xi: T(a)	Xi: T(a)

Explanation:

T(x) The value x is placed at the target operand element location if no trapping exceptions on other elements.
M(x,y) Return the greater of floating point value x and y.
Fn Finite nonzero number (includes both subnormal and normal).
Xi: IEEE invalid-operation exception. The results shown are produced only when FPC 0.0 is zero.

Figure 24-17. Results: VECTOR FP MAXIMUM with $M_6=4$ ("fmax()")

Second Operand (a) Is	Results for VECTOR FP MAXIMUM (a:b) when Third Operand (b) Is							
	$-\infty$	-Fn	-0	+0	+Fn	$+\infty$	QNaN	SNaN
$-\infty$	T(a)	T(a)	T(a)	T(a)	T(a)	T(b)	T(a)	Xi: T(b*)
-Fn	T(b)	T(MS(a,b))	T(a)	T(a)	T(MS(a,b))	T(b)	T(a)	Xi: T(b*)
-0	T(b)	T(b)	T(a)	T(b)	T(b)	T(b)	T(a)	Xi: T(b*)
+0	T(b)	T(b)	T(a)	T(a)	T(b)	T(b)	T(a)	Xi: T(b*)
+Fn	T(b)	T(MS(a,b))	T(a)	T(a)	T(MS(a,b))	T(b)	T(a)	Xi: T(b*)
$+\infty$	T(a)	T(a)	T(a)	T(a)	T(a)	T(a)	T(a)	Xi: T(b*)
QNaN	T(b)	T(b)	T(b)	T(b)	T(b)	T(b)	T(a)	Xi: T(b*)
SNaN	Xi: T(a*)	Xi: T(a*)	Xi: T(a*)	Xi: T(a*)	Xi: T(a*)	Xi: T(a*)	Xi: T(a*)	Xi: T(a*)

Explanation:

* The SNaN is converted to the corresponding QNaN before it is placed in the target operand location.
T(x) The value x is placed at the target operand element location if no trapping exceptions on other elements.
M(x,y) Return the greater of floating point value x and y.
MS(x,y) If $|x| = |y|$ return M(x,y), return x if $|x| > |y|$, otherwise return y
Fn Finite nonzero number (includes both subnormal and normal).
Xi: IEEE invalid-operation exception. The results shown are produced only when FPC 0.0 is zero.

Figure 24-18. Results: VECTOR FP MAXIMUM with $M_6=8$ (IEEE MaxNumMag)

Second Operand (a) Is	Results for VECTOR FP MAXIMUM (a:b) when Third Operand (b) Is				
	0	Fn	∞	QNaN	SNaN
0	T(a)	T(b)	T(b)	T(b)	Xi: T(b*)
Fn	T(a)	T(M(a , b))	T(b)	T(b)	Xi: T(b*)
∞	T(a)	T(a)	T(a)	T(b)	Xi: T(b*)
QNaN	T(a)	T(a)	T(a)	T(a)	Xi: T(b*)
SNaN	Xi: T(a*)	Xi: T(a*)	Xi: T(a*)	Xi: T(a*)	Xi: T(a*)

Explanation:

* The SNaN is converted to the corresponding QNaN before it is placed in the target operand location.

|z| The value of z is used with the sign forced to be positive.

T(x) The value x is placed at the target operand element location if no trapping exceptions on other elements.

M(x,y) Return the greater of floating point value x and y.

Fn Finite nonzero number (includes both subnormal and normal).

Xi: IEEE invalid-operation exception. The results shown are produced only when FPC 0.0 is zero.

Figure 24-19. Results: VECTOR FP MAXIMUM with $M_6=9$ (JAVA Math.Max() of absolute values)

Second Operand (a) Is	Results for VECTOR FP MAXIMUM (a:b) when Third Operand (b) Is				
	0	Fn	∞	QNaN	SNaN
0	T(b)	T(b)	T(b)	Xi: T(b)	Xi: T(b)
Fn	T(a)	T(M(a , b))	T(b)	Xi: T(b)	Xi: T(b)
∞	T(a)	T(a)	T(b)	Xi: T(b)	Xi: T(b)
QNaN	Xi: T(b)	Xi: T(b)	Xi: T(b)	Xi: T(b)	Xi: T(b)
SNaN	Xi: T(b)	Xi: T(b)	Xi: T(b)	Xi: T(b)	Xi: T(b)

Explanation:

|z| The value of z is used with the sign forced to be positive.

T(x) The value x is placed at the target operand element location if no trapping exceptions on other elements.

M(x,y) Return the greater of floating point value x and y.

Fn Finite nonzero number (includes both subnormal and normal).

Xi: IEEE invalid-operation exception. The results shown are produced only when FPC 0.0 is zero.

Figure 24-20. Results: VECTOR FP MAXIMUM with $M_6=10$ ("C-style Max Macro of absolute values")

Second Operand (a) Is	Results for VECTOR FP MAXIMUM (a:b) when Third Operand (b) Is				
	0	Fn	∞	QNaN	SNaN
0	T(a)	T(b)	T(b)	Xi: T(a)	Xi: T(a)
Fn	T(a)	T(M(a , b))	T(b)	Xi: T(a)	Xi: T(a)
∞	T(a)	T(a)	T(a)	Xi: T(a)	Xi: T(a)
QNaN	Xi: T(a)	Xi: T(a)	Xi: T(a)	Xi: T(a)	Xi: T(a)
SNaN	Xi: T(a)	Xi: T(a)	Xi: T(a)	Xi: T(a)	Xi: T(a)

Explanation:

|z| The value of z is used with the sign forced to be positive.
T(x) The value x is placed at the target operand element location if no trapping exceptions on other elements.
M(x,y) Return the greater of floating point value x and y.
Fn Finite nonzero number (includes both subnormal and normal).
Xi: IEEE invalid-operation exception. The results shown are produced only when FPC 0.0 is zero.

Figure 24-21. Results: VECTOR FP MAXIMUM with $M_6=11$ (“C++ Algorithm.Max() of absolute values”)

Second Operand (a) Is	Results for VECTOR FP MAXIMUM (a:b) when Third Operand (b) Is				
	0	Fn	∞	QNaN	SNaN
0	T(a)	T(b)	T(b)	T(a)	Xi: T(a)
Fn	T(a)	T(M(a , b))	T(b)	T(a)	Xi: T(a)
∞	T(a)	T(a)	T(a)	T(a)	Xi: T(a)
QNaN	T(b)	T(b)	T(b)	T(a)	Xi: T(a)
SNaN	Xi: T(b)	Xi: T(b)	Xi: T(b)	Xi: T(a)	Xi: T(a)

Explanation:

T(x) The value x is placed at the target operand element location if no trapping exceptions on other elements.
M(x,y) Return the greater of floating point value x and y.
Fn Finite nonzero number (includes both subnormal and normal).
Xi: IEEE invalid-operation exception. The results shown are produced only when FPC 0.0 is zero.

Figure 24-22. Results: VECTOR FP MAXIMUM with $M_6=12$ (“fmax() of absolute values”)

VECTOR FP MINIMUM

VFMIN $V_1, V_2, V_3, M_4, M_5, M_6$ [VRR-c]

'E7'	V ₁	V ₂	V ₃	////	M ₆	M ₅	M ₄	RXB	'EE'	
0	8	12	16	20	24	28	32	36	40	47

The floating-point element or elements of the second operand are compared to the corresponding floating-point element or elements of the third operand. The lesser of the two values is placed in the corresponding element of the first operand. The operand elements are all treated as BFP numbers of the specified format.

Depending on the minimum function performed, if any of the floating-point elements in the second or third operand are NaNs, an IEEE invalid-operation exception may be recognized as specified in the action figures. If the IEEE invalid-operation mask bit is one, a program interruption with VXC set for IEEE invalid-operation and the corresponding element index occurs and the operation is suppressed.

The M_6 field specifies the handling of special cases for the comparison, see Figure 24-23 to Figure 24-32 for detailed descriptions of the results for each ele-

ment. If a reserved value is specified, a specification exception is recognized.

M₆	Minimum Function Performed
0	IEEE MinNum
1	Java Math.Min()
2	C-Style Min Macro
3	C++ algorithm.min()
4	fmin()
5-7	Reserved
8	IEEE MinNum of absolute values
9	Java Math.Min() of absolute values
10	C-Style Min Macro of absolute values
11	C++ algorithm.min() of absolute values
12	fmin() of absolute values
13-15	Reserved

The M₄ field specifies the floating-point format. The floating-point format determines the size of the elements within the vector register operands. If a reserved value is specified, a specification exception is recognized.

M₄	Floating-Point Format
0-1	Reserved
2	Short format
3	Long format
4	Extended format
5-15	Reserved

The M₅ field has the following format:



The bits of the M₅ field are defined as follows:

- **Single-Element-Control (S):** If bit 0 is set to one, the operation takes place only on the zero-indexed element in the vector. In the absence of a trapping exception condition, the bit positions of all other elements in the first operand vector are unpredictable. The values of all other elements in the second and third operands are ignored. If bit 0 is set to zero, the operation occurs on all elements in the vector.
- **Reserved:** Bits 1, 2, and 3 are reserved and must be zero. Otherwise, a specification exception is recognized.

Condition Code: The code remains unchanged.

IEEE Exceptions:

- Invalid operation

Program Exceptions:

- Data with DXC FE, Vector Instruction
- Operation (if the vector-enhancements facility 1 is not installed)
- Specification
- Transaction constraint
- Vector processing with VXC for IEEE exception and element index

Extended Mnemonics:

Extended Mnemonic		Base Mnemonic	
VFMINSB	V ₁ ,V ₂ ,V ₃ ,M ₆	VFMIN	V ₁ ,V ₂ ,V ₃ ,2,0,M ₆
VFMINDB	V ₁ ,V ₂ ,V ₃ ,M ₆	VFMIN	V ₁ ,V ₂ ,V ₃ ,3,0,M ₆
WFMINSB	V ₁ ,V ₂ ,V ₃ ,M ₆	VFMIN	V ₁ ,V ₂ ,V ₃ ,2,8,M ₆
WFMINDB	V ₁ ,V ₂ ,V ₃ ,M ₆	VFMIN	V ₁ ,V ₂ ,V ₃ ,3,8,M ₆
WFMINXB	V ₁ ,V ₂ ,V ₃ ,M ₆	VFMIN	V ₁ ,V ₂ ,V ₃ ,4,8,M ₆

Second Operand (a) Is	Results for VECTOR FP MINIMUM (a:b) when Third Operand (b) Is							
	$-\infty$	-Fn	-0	+0	+Fn	$+\infty$	QNaN	SNaN
$-\infty$	T(a)	T(a)	T(a)	T(a)	T(a)	T(a)	T(a)	Xi: T(b*)
-Fn	T(b)	T(M(a,b))	T(a)	T(a)	T(a)	T(a)	T(a)	Xi: T(b*)
-0	T(b)	T(b)	T(a)	T(a)	T(a)	T(a)	T(a)	Xi: T(b*)
+0	T(b)	T(b)	T(b)	T(a)	T(a)	T(a)	T(a)	Xi: T(b*)
+Fn	T(b)	T(b)	T(b)	T(b)	T(M(a,b))	T(a)	T(a)	Xi: T(b*)
$+\infty$	T(b)	T(b)	T(b)	T(b)	T(b)	T(a)	T(a)	Xi: T(b*)
QNaN	T(b)	T(b)	T(b)	T(b)	T(b)	T(b)	T(a)	Xi: T(b*)
SNaN	Xi: T(a*)	Xi: T(a*)	Xi: T(a*)	Xi: T(a*)	Xi: T(a*)	Xi: T(a*)	Xi: T(a*)	Xi: T(a*)

Explanation:

* The SNaN is converted to the corresponding QNaN before it is placed in the target operand location.
T(x) The value x is placed at the target operand element location if no trapping exceptions on other elements.
M(x,y) Return the lesser of floating point value x and y.
Fn Finite nonzero number (includes both subnormal and normal).
Xi: IEEE invalid-operation exception. The results shown are produced only when FPC 0.0 is zero.

Figure 24-23. Results: VECTOR FP MINIMUM with $M_6=0$ (IEEE MinNum)

Second Operand (a) Is	Results for VECTOR FP MINIMUM (a:b) when Third Operand (b) Is							
	$-\infty$	-Fn	-0	+0	+Fn	$+\infty$	QNaN	SNaN
$-\infty$	T(b)	T(a)	T(a)	T(a)	T(a)	T(a)	T(b)	Xi: T(b*)
-Fn	T(b)	T(M(a,b))	T(a)	T(a)	T(a)	T(a)	T(b)	Xi: T(b*)
-0	T(b)	T(b)	T(b)	T(a)	T(a)	T(a)	T(b)	Xi: T(b*)
+0	T(b)	T(b)	T(b)	T(b)	T(a)	T(a)	T(b)	Xi: T(b*)
+Fn	T(b)	T(b)	T(b)	T(b)	T(M(a,b))	T(a)	T(b)	Xi: T(b*)
$+\infty$	T(b)	T(b)	T(b)	T(b)	T(b)	T(b)	T(b)	Xi: T(b*)
QNaN	T(a)	T(a)	T(a)	T(a)	T(a)	T(a)	T(a)	Xi: T(b*)
SNaN	Xi: T(a*)	Xi: T(a*)	Xi: T(a*)	Xi: T(a*)	Xi: T(a*)	Xi: T(a*)	Xi: T(a*)	Xi: T(a*)

Explanation:

* The SNaN is converted to the corresponding QNaN before it is placed in the target operand location.
T(x) The value x is placed at the target operand element location if no trapping exceptions on other elements.
M(x,y) Return the lesser of floating point values x and y.
Fn Finite nonzero number (includes both subnormal and normal).
Xi: IEEE invalid-operation exception. The results shown are produced only when FPC 0.0 is zero.

Figure 24-24. Results: VECTOR FP MINIMUM with $M_6=1$ (JAVA Math.Min())

Second Operand (a) Is	Results for VECTOR FP MINIMUM (a:b) when Third Operand (b) Is							
	$-\infty$	-Fn	-0	+0	+Fn	$+\infty$	QNaN	SNaN
$-\infty$	T(b)	T(a)	T(a)	T(a)	T(a)	T(a)	Xi: T(b)	Xi: T(b)
-Fn	T(b)	T(M(a,b))	T(a)	T(a)	T(a)	T(a)	Xi: T(b)	Xi: T(b)
-0	T(b)	T(b)	T(b)	T(b)	T(a)	T(a)	Xi: T(b)	Xi: T(b)
+0	T(b)	T(b)	T(b)	T(b)	T(a)	T(a)	Xi: T(b)	Xi: T(b)
+Fn	T(b)	T(b)	T(b)	T(b)	T(M(a,b))	T(a)	Xi: T(b)	Xi: T(b)
$+\infty$	T(b)	T(b)	T(b)	T(b)	T(b)	T(a)	Xi: T(b)	Xi: T(b)
QNaN	Xi: T(b)	Xi: T(b)	Xi: T(b)	Xi: T(b)	Xi: T(b)	Xi: T(b)	Xi: T(b)	Xi: T(b)
SNaN	Xi: T(b)	Xi: T(b)	Xi: T(b)	Xi: T(b)	Xi: T(b)	Xi: T(b)	Xi: T(b)	Xi: T(b)

Explanation:

T(x) The value x is placed at the target operand element location if no trapping exceptions on other elements.
M(x,y) Return the lesser of floating point value x and y.
Fn Finite nonzero number (includes both subnormal and normal).
Xi: IEEE invalid-operation exception. The results shown are produced only when FPC 0.0 is zero.

Figure 24-25. Results: VECTOR FP MINIMUM with $M_e=2$ ("C-style Min Macro")

Second Operand (a) Is	Results for VECTOR FP MINIMUM (a:b) when Third Operand (b) Is							
	$-\infty$	-Fn	-0	+0	+Fn	$+\infty$	QNaN	SNaN
$-\infty$	T(b)	T(a)	T(a)	T(a)	T(a)	T(a)	Xi: T(a)	Xi: T(a)
-Fn	T(b)	T(M(a,b))	T(a)	T(a)	T(a)	T(a)	Xi: T(a)	Xi: T(a)
-0	T(b)	T(b)	T(a)	T(a)	T(a)	T(a)	Xi: T(a)	Xi: T(a)
+0	T(b)	T(b)	T(a)	T(a)	T(a)	T(a)	Xi: T(a)	Xi: T(a)
+Fn	T(b)	T(b)	T(b)	T(b)	T(M(a,b))	T(a)	Xi: T(a)	Xi: T(a)
$+\infty$	T(b)	T(b)	T(b)	T(b)	T(b)	T(a)	Xi: T(a)	Xi: T(a)
QNaN	Xi: T(a)	Xi: T(a)	Xi: T(a)	Xi: T(a)	Xi: T(a)	Xi: T(a)	Xi: T(a)	Xi: T(a)
SNaN	Xi: T(a)	Xi: T(a)	Xi: T(a)	Xi: T(a)	Xi: T(a)	Xi: T(a)	Xi: T(a)	Xi: T(a)

Explanation:

T(x) The value x is placed at the target operand element location if no trapping exceptions on other elements.
M(x,y) Return the lesser of floating point value x and y.
Fn Finite nonzero number (includes both subnormal and normal).
Xi: IEEE invalid-operation exception. The results shown are produced only when FPC 0.0 is zero.

Figure 24-26. Results: VECTOR FP MINIMUM with $M_e=3$ ("C++ algorithm.min()")

Second Operand (a) Is	Results for VECTOR FP MINIMUM (a:b) when Third Operand (b) Is							
	$-\infty$	-Fn	-0	+0	+Fn	$+\infty$	QNaN	SNaN
$-\infty$	T(a)	T(a)	T(a)	T(a)	T(a)	T(a)	T(a)	Xi:T(a)
-Fn	T(b)	T(M(a,b))	T(a)	T(a)	T(a)	T(a)	T(a)	Xi:T(a)
-0	T(b)	T(b)	T(a)	T(a)	T(a)	T(a)	T(a)	Xi:T(a)
+0	T(b)	T(b)	T(b)	T(a)	T(a)	T(a)	T(a)	Xi:T(a)
+Fn	T(b)	T(b)	T(b)	T(b)	T(M(a,b))	T(a)	T(a)	Xi:T(a)
$+\infty$	T(b)	T(b)	T(b)	T(b)	T(b)	T(a)	T(a)	Xi:T(a)
QNaN	T(b)	T(b)	T(b)	T(b)	T(b)	T(b)	T(a)	Xi:T(a)
SNaN	Xi:T(b)	Xi:T(b)	Xi:T(b)	Xi:T(b)	Xi:T(b)	Xi:T(b)	Xi:T(a)	Xi:T(a)

Explanation:

T(x) The value x is placed at the target operand element location if no trapping exceptions on other elements.
M(x,y) Return the lesser of floating point value x and y.
Fn Finite nonzero number (includes both subnormal and normal).
Xi: IEEE invalid-operation exception. The results shown are produced only when FPC 0.0 is zero.

Figure 24-27. Results: VECTOR FP MINIMUM with $M_6=4$ ("fmin()")

Second Operand (a) Is	Results for VECTOR FP MINIMUM (a:b) when Third Operand (b) Is							
	$-\infty$	-Fn	-0	+0	+Fn	$+\infty$	QNaN	SNaN
$-\infty$	T(a)	T(b)	T(b)	T(b)	T(b)	T(a)	T(a)	Xi: T(b*)
-Fn	T(a)	T(MS(a,b))	T(b)	T(b)	T(MS(a,b))	T(a)	T(a)	Xi: T(b*)
-0	T(a)	T(a)	T(a)	T(a)	T(a)	T(a)	T(a)	Xi: T(b*)
+0	T(a)	T(a)	T(b)	T(a)	T(a)	T(a)	T(a)	Xi: T(b*)
+Fn	T(a)	T(MS(a,b))	T(b)	T(b)	T(MS(a,b))	T(a)	T(a)	Xi: T(b*)
$+\infty$	T(b)	T(b)	T(b)	T(b)	T(b)	T(a)	T(a)	Xi: T(b*)
QNaN	T(b)	T(b)	T(b)	T(b)	T(b)	T(b)	T(a)	Xi: T(b*)
SNaN	Xi: T(a*)	Xi: T(a*)	Xi: T(a*)	Xi: T(a*)	Xi: T(a*)	Xi: T(a*)	Xi: T(a*)	Xi: T(a*)

Explanation:

* The SNaN is converted to the corresponding QNaN before it is placed in the target operand location.
T(x) The value x is placed at the target operand element location if no trapping exceptions on other elements.
M(x,y) Return the lesser of floating point value x and y.
MS(x,y) If $|x| = |y|$ return M(x,y), return x if $|x| < |y|$; otherwise return y.
Fn Finite nonzero number (includes both subnormal and normal).
Xi: IEEE invalid-operation exception. The results shown are produced only when FPC 0.0 is zero.

Figure 24-28. Results: VECTOR FP MINIMUM with $M_6=8$ (IEEE MinNumMag)

Second Operand (a) Is	Results for VECTOR FP MINIMUM (a:b) when Third Operand (b) Is				
	0	Fn	∞	QNaN	SNaN
0	T(a)	T(a)	T(a)	T(b)	Xi: T(b*)
Fn	T(b)	T(M(a , b))	T(a)	T(b)	Xi: T(b*)
∞	T(b)	T(b)	T(a)	T(b)	Xi: T(b*)
QNaN	T(a)	T(a)	T(a)	T(a)	Xi: T(b*)
SNaN	Xi: T(a*)	Xi: T(a*)	Xi: T(a*)	Xi: T(a*)	Xi: T(a*)

Explanation:

* The SNaN is converted to the corresponding QNaN before it is placed in the target operand location.

|z| The value of z is used with the sign forced to be positive.

T(x) The value x is placed at the target operand element location if no trapping exceptions on other elements.

M(x,y) Return the lesser of floating point value x and y.

Fn Finite nonzero number (includes both subnormal and normal).

Xi: IEEE invalid-operation exception. The results shown are produced only when FPC 0.0 is zero.

Figure 24-29. Results: VECTOR FP MINIMUM with $M_6=9$ (JAVA Math.Min() of absolute values)

Second Operand (a) Is	Results for VECTOR FP MINIMUM (a:b) when Third Operand (b) Is				
	0	Fn	∞	QNaN	SNaN
0	T(b)	T(a)	T(a)	Xi: T(b)	Xi: T(b)
Fn	T(b)	T(M(a , b))	T(a)	Xi: T(b)	Xi: T(b)
∞	T(b)	T(b)	T(b)	Xi: T(b)	Xi: T(b)
QNaN	Xi: T(b)	Xi: T(b)	Xi: T(b)	Xi: T(b)	Xi: T(b)
SNaN	Xi: T(b)	Xi: T(b)	Xi: T(b)	Xi: T(b)	Xi: T(b)

Explanation:

|z| The value of z is used with the sign forced to be positive.

T(x) The value x is placed at the target operand element location if no trapping exceptions on other elements.

M(x,y) Return the lesser of floating point value x and y.

Fn Finite nonzero number (includes both subnormal and normal).

Xi: IEEE invalid-operation exception. The results shown are produced only when FPC 0.0 is zero.

Figure 24-30. Results: VECTOR FP MINIMUM with $M_6=10$ ("C-Style Min Macro of absolute values")

Second Operand (a) Is	Results for VECTOR FP MINIMUM (a:b) when Third Operand (b) Is				
	0	Fn	∞	QNaN	SNaN
0	T(a)	T(a)	T(a)	Xi: T(a)	Xi: T(a)
Fn	T(b)	T(M(a , b))	T(a)	Xi: T(a)	Xi: T(a)
∞	T(b)	T(b)	T(a)	Xi: T(a)	Xi: T(a)
QNaN	Xi: T(a)	Xi: T(a)	Xi: T(a)	Xi: T(a)	Xi: T(a)
SNaN	Xi: T(a)	Xi: T(a)	Xi: T(a)	Xi: T(a)	Xi: T(a)

Explanation:

|z| The value of z is used with the sign forced to be positive.
T(x) The value x is placed at the target operand element location if no trapping exceptions on other elements.
M(x,y) Return the lesser of floating point value x and y.
Fn Finite nonzero number (includes both subnormal and normal).
Xi: IEEE invalid-operation exception. The results shown are produced only when FPC 0.0 is zero.

Figure 24-31. Results: VECTOR FP MINIMUM with $M_6=11$ (“C++ algorithm.min() of absolute values”)

Second Operand (a) Is	Results for VECTOR FP MINIMUM (a:b) when Third Operand (b) Is				
	0	Fn	∞	QNaN	SNaN
0	T(a)	T(a)	T(a)	T(a)	Xi:T(a)
Fn	T(b)	T(M(a , b))	T(a)	T(a)	Xi:T(a)
∞	T(b)	T(b)	T(a)	T(a)	Xi:T(a)
QNaN	T(b)	T(b)	T(b)	T(a)	Xi:T(a)
SNaN	Xi:T(b)	Xi:T(b)	Xi:T(b)	Xi:T(a)	Xi:T(a)

Explanation:

T(x) The value x is placed at the target operand element location if no trapping exceptions on other elements.
M(x,y) Return the lesser of floating point value x and y.
Fn Finite nonzero number (includes both subnormal and normal).
Xi: IEEE invalid-operation exception. The results shown are produced only when FPC 0.0 is zero.

Figure 24-32. Results: VECTOR FP MINIMUM with $M_6=12$ (“fmin() of absolute values”)

VECTOR FP MULTIPLY

VFM V_1, V_2, V_3, M_4, M_5 [VRR-c]

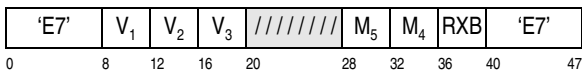

The product of the floating-point element or elements of the second operand (the multiplier) and the corresponding floating-point element or elements of the third operand (the multiplicand) are placed in the corresponding element or elements of the first-operand.

The size of the operand elements is determined by the floating-point-format control in the M_4 field. The operand elements are all treated as BFP numbers.

The two corresponding operand elements, if finite numbers, are multiplied, forming an intermediate product. The result is rounded to the operand format according to the current BFP rounding mode.

The sign of the product, if the product is numeric, is the exclusive OR of the operand element signs. This includes the sign of a zero or infinite product.

If one operand element is a zero and the other an infinity, an IEEE-invalid-operation exception is recognized.

See Figure 24-33 on page 24-42 for a detailed description of the results for each element.

The M_4 field specifies the floating-point format. The floating-point format determines the size of the elements within the vector register operands. If a reserved value is specified, a specification exception is recognized. If the vector-enhancements facility 1 is not installed the values 2 and 4 are reserved.

M_4 Floating-Point Format

0-1	Reserved
2	Short format
3	Long format
4	Extended format
5-15	Reserved

The M_5 field has the following format:



The bits of the M_5 field are defined as follows:

- **Single-Element-Control (S):** If bit 0 is set to one, the operation takes place only on the zero-indexed element in the vector. In the absence of a trapping exception condition, the bit positions of all other elements in the first operand vector are unpredictable. If bit 0 is set to zero, the operation occurs on all elements in the vector.
- **Reserved:** Bits 1 to 3 are reserved and must be zero. Otherwise, a specification exception is recognized.

Condition Code: The code remains unchanged.

IEEE Exceptions:

- Invalid operation
- Overflow
- Underflow
- Inexact

Program Exceptions:

- Data with DXC FE, Vector Instruction
- Operation (if the vector facility for z/Architecture is not installed)
- Specification
- Transaction constraint
- Vector processing with VXC for IEEE exception and element index

Extended Mnemonics:

Extended Mnemonic	Base Mnemonic
VFMSB V_1, V_2, V_3	VFM $V_1, V_2, V_3, 2, 0$
VFMDB V_1, V_2, V_3	VFM $V_1, V_2, V_3, 3, 0$
WFMSB V_1, V_2, V_3	VFM $V_1, V_2, V_3, 2, 8$
WFMDB V_1, V_2, V_3	VFM $V_1, V_2, V_3, 3, 8$
WFMXB V_1, V_2, V_3	VFM $V_1, V_2, V_3, 4, 8$

Programming Note: Interchanging the two operand elements in a BFP multiplication does not affect the value of the product when the result is numeric. This is not true, however, when both operand elements are QNaNs, in which case the result is the second operand element; or when both operand elements are SNaNs and the IEEE-invalid-operation mask bit in the FPC register is zero, in which case the result is the QNaN derived from the second operand element.

Second Operand Element (a) Is	Results for VECTOR FP MULTIPLY (a•b) when Third Operand Element (b) Is							
	$-\infty$	-Fn	-0	+0	+Fn	$+\infty$	QNaN	SNaN
$-\infty$	T(+∞)	T(+∞)	Xi: T(dNaN)	Xi: T(dNaN)	T(-∞)	T(-∞)	T(b)	Xi: T(b*)
-Fn	T(+∞)	R(a•b)	T(+0)	T(-0)	R(a•b)	T(-∞)	T(b)	Xi: T(b*)
-0	Xi: T(dNaN)	T(+0)	T(+0)	T(-0)	T(-0)	Xi: T(dNaN)	T(b)	Xi: T(b*)
+0	Xi: T(dNaN)	T(-0)	T(-0)	T(+0)	T(+0)	Xi: T(dNaN)	T(b)	Xi: T(b*)
+Fn	T(-∞)	R(a•b)	T(-0)	T(+0)	R(a•b)	T(+∞)	T(b)	Xi: T(b*)
$+\infty$	T(-∞)	T(-∞)	Xi: T(dNaN)	Xi: T(dNaN)	T(+∞)	T(+∞)	T(b)	Xi: T(b*)
QNaN	T(a)	T(a)	T(a)	T(a)	T(a)	T(a)	T(a)	Xi: T(b*)
SNaN	Xi: T(a*)	Xi: T(a*)	Xi: T(a*)	Xi: T(a*)	Xi: T(a*)	Xi: T(a*)	Xi: T(a*)	Xi: T(a*)

Explanation:

* The SNaN is converted to the corresponding QNaN before it is placed at the target operand element location.
dNaN Default NaN.
Fn Finite nonzero number (includes both subnormal and normal).
R(v) Rounding and range action is performed on the value v. See Figure 24-4 on page 24-6.
T(x) The value x is placed at the target operand element location if no trapping exceptions on other elements.
Xi: IEEE invalid-operation exception. The results shown are produced only when FPC 0.0 is zero.

Figure 24-33. Results: VECTOR FP MULTIPLY

VECTOR FP MULTIPLY AND ADD

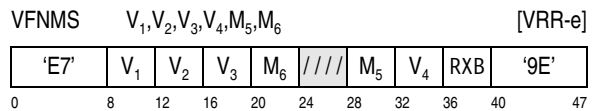
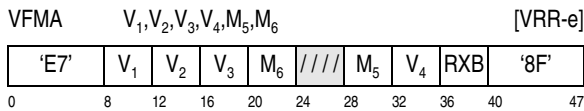

VECTOR FP MULTIPLY AND SUBTRACT

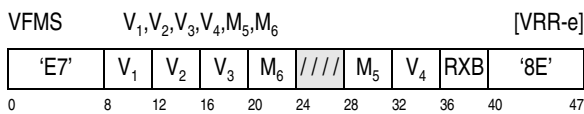

The floating-point element or elements of the third operand are multiplied by the corresponding floating-point element or elements of the second operand, and then the corresponding floating-point element or elements of the fourth operand are added to or subtracted from the products. The sum or differences are placed at the corresponding first-operand element locations. The size of the operand elements is determined by the floating-point-format control in the M₆ field. The operand elements are all treated as BFP numbers.

VECTOR FP NEGATIVE MULTIPLY AND ADD

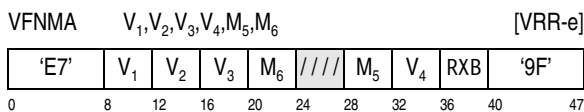

The VECTOR FP MULTIPLY AND ADD and VECTOR FP MULTIPLY AND SUBTRACT operations may be summarized below, where “(i)” represents the “i”th indexed element of the operand:

$$op_1(i) = op_3(i) \cdot op_2(i) \pm op_4(i)$$

VECTOR FP NEGATIVE MULTIPLY AND SUBTRACT

The VECTOR FP NEGATIVE MULTIPLY AND ADD and VECTOR FP NEGATIVE MULTIPLY AND SUBTRACT operations may be summarized as below where “(i)” represents the “i”th indexed element of the operand:

$$op_1(i) = -(op_3(i) \cdot op_2(i) \pm op_4(i))$$

When all of the corresponding operand elements are finite numbers, the third and second BFP operand elements are multiplied, forming an intermediate product, and the corresponding fourth operand element is then added (or subtracted) algebraically to (or from) the intermediate product, forming an intermediate sum. The intermediate sum, if nonzero, is rounded to the operand format according to the current BFP rounding mode and then placed at the corresponding element of the first-operand location. The exponent and fraction of the intermediate product are maintained exactly; rounding and range checking occur only on the intermediate sum.

See Figure 24-34 for a detailed description of the results for each element of VECTOR FP MULTIPLY AND ADD. The results for each element of VECTOR FP MULTIPLY AND SUBTRACT are the same, except that the fourth operand element, if numeric, participates in the operation with its sign bit inverted. When the fourth operand element is a NaN, it participates in the operation with its sign bit unchanged.

The results for each element of VECTOR FP NEGATIVE MULTIPLY AND ADD and VECTOR FP NEGATIVE MULTIPLY AND SUBTRACT are the same as for VECTOR FP MULTIPLY AND ADD and VECTOR FP MULTIPLY AND SUBTRACT, respectively, except the sign bit of numeric results are inverted. When the result is a NaN it's sign bit is unchanged.

The M_6 field specifies the floating-point format. The floating-point format determines the size of the elements within the vector register operands. If a reserved value is specified, a specification exception is recognized. For VECTOR FP MULTIPLY AND ADD and VECTOR FP MULTIPLY AND SUBTRACT, if the vector-enhancements facility 1 is not installed the values 2 and 4 are reserved.

M_6 Floating-Point Format

0-1	Reserved
2	Short format
3	Long format
4	Extended format
5-15	Reserved

The M_5 field has the following format:



The bits of the M_5 field are defined as follows:

- **Single-Element-Control (S):** If bit 0 is set to one, the operation takes place only on the zero-indexed element in the vector. In the absence of a trapping exception condition, the bit positions of all other elements in the first operand vector are unpredictable. If bit 0 is set to zero, the operation occurs on all elements in the vector.
- **Reserved:** Bits 1 to 3 are reserved and must be zero. Otherwise, a specification exception is recognized.

Condition Code: The code remains unchanged.

IEEE Exceptions:

- Invalid operation
- Overflow
- Underflow
- Inexact

Program Exceptions:

- Data with DXC FE, Vector Instruction
- Operation (VFMA and VFMS, if the vector facility for z/Architecture is not installed; VFNMA and VFNMS, if the vector-enhancements facility 1 is not installed)
- Specification
- Transaction constraint
- Vector processing with VXC for IEEE exception and element index

Extended Mnemonics:

Extended Mnemonic		Base Mnemonic	
VFMASB	V_1, V_2, V_3, V_4	VFMA	$V_1, V_2, V_3, V_4, 0, 2$
VFMADB	V_1, V_2, V_3, V_4	VFMA	$V_1, V_2, V_3, V_4, 0, 3$
WFMASB	V_1, V_2, V_3, V_4	VFMA	$V_1, V_2, V_3, V_4, 8, 2$
WFMADB	V_1, V_2, V_3, V_4	VFMA	$V_1, V_2, V_3, V_4, 8, 3$
WFMAXB	V_1, V_2, V_3, V_4	VFMA	$V_1, V_2, V_3, V_4, 8, 4$
VFMSSB	V_1, V_2, V_3, V_4	VFMS	$V_1, V_2, V_3, V_4, 0, 2$
VFMADB	V_1, V_2, V_3, V_4	VFMS	$V_1, V_2, V_3, V_4, 0, 3$
WFMSB	V_1, V_2, V_3, V_4	VFMS	$V_1, V_2, V_3, V_4, 8, 2$
WFMSDB	V_1, V_2, V_3, V_4	VFMS	$V_1, V_2, V_3, V_4, 8, 3$
WFMSXB	V_1, V_2, V_3, V_4	VFMS	$V_1, V_2, V_3, V_4, 8, 4$
VFNMASB	V_1, V_2, V_3, V_4	VFNMA	$V_1, V_2, V_3, V_4, 0, 2$
VFNMADB	V_1, V_2, V_3, V_4	VFNMA	$V_1, V_2, V_3, V_4, 0, 3$
WFNMASB	V_1, V_2, V_3, V_4	VFNMA	$V_1, V_2, V_3, V_4, 8, 2$
WFNMADB	V_1, V_2, V_3, V_4	VFNMA	$V_1, V_2, V_3, V_4, 8, 3$
WFNMAXB	V_1, V_2, V_3, V_4	VFNMA	$V_1, V_2, V_3, V_4, 8, 4$

Extended Mnemonic	Base Mnemonic
VFNMS SB V_1, V_2, V_3, V_4	VFNMS $V_1, V_2, V_3, V_4, 0, 2$
VFNMS DB V_1, V_2, V_3, V_4	VFNMS $V_1, V_2, V_3, V_4, 0, 3$
WFNMS SB V_1, V_2, V_3, V_4	VFNMS $V_1, V_2, V_3, V_4, 8, 2$
WFNMS DB V_1, V_2, V_3, V_4	VFNMS $V_1, V_2, V_3, V_4, 8, 3$
WFNMS XB V_1, V_2, V_3, V_4	VFNMS $V_1, V_2, V_3, V_4, 8, 4$

VECTOR FP NEGATIVE MULTIPLY AND ADD, and VECTOR NEGATIVE MULTIPLY AND SUBTRACT produce a precise intermediate value, and a single rounding operation is performed after the addition or subtraction. This definition is consistent with the Power architecture, and, in certain applications, can be used to great advantage, especially in algorithms used in math libraries.

Programming Note: VECTOR FP MULTIPLY AND ADD, VECTOR FP MULTIPLY AND SUBTRACT,

Third Operand Element (a) Is	Results, Part 1, for MULTIPLY AND ADD (a•b+c) when Second Operand Element (b) Is							
	$-\infty$	-Fn	-0	+0	+Fn	$+\infty$	QNaN	SNaN
$-\infty$	P(+∞)	P(+∞)	Xi: T(dNaN)	Xi: T(dNaN)	P(-∞)	P(-∞)	P(b)	Xi: T(b*)
-Fn	P(+∞)	P(a•b)	P(+0)	P(-0)	P(a•b)	P(-∞)	P(b)	Xi: T(b*)
-0	Xi: T(dNaN)	P(+0)	P(+0)	P(-0)	P(-0)	Xi: T(dNaN)	P(b)	Xi: T(b*)
+0	Xi: T(dNaN)	P(-0)	P(-0)	P(+0)	P(+0)	Xi: T(dNaN)	P(b)	Xi: T(b*)
+Fn	P(-∞)	P(a•b)	P(-0)	P(+0)	P(a•b)	P(+∞)	P(b)	Xi: T(b*)
$+\infty$	P(-∞)	P(-∞)	Xi: T(dNaN)	Xi: T(dNaN)	P(+∞)	P(+∞)	P(b)	Xi: T(b*)
QNaN	P(a)	P(a)	P(a)	P(a)	P(a)	P(a)	P(a)	Xi: T(b*)
SNaN	Xi: T(a*)	Xi: T(a*)	Xi: T(a*)	Xi: T(a*)	Xi: T(a*)	Xi: T(a*)	Xi: T(a*)	Xi: T(a*)

Figure 24-34. Results: VECTOR FP MULTIPLY AND ADD (Part 1 of 2)

Value from Part 1 (p) Is	Results, Part 2, for MULTIPLY AND ADD (a•b+c) when Fourth Operand Element (c) Is							
	$-\infty$	-Fn	-0	+0	+Fn	$+\infty$	QNaN	SNaN
$-\infty$	T(-∞)	T(-∞)	T(-∞)	T(-∞)	T(-∞)	Xi: T(dNaN)	T(c)	Xi: T(c*)
-Fn	T(-∞)	R(p+c)	R(p)	R(p)	R(p+c)	T(+∞)	T(c)	Xi: T(c*)
-0	T(-∞)	R(c)	T(-0)	Rezd	R(c)	T(+∞)	T(c)	Xi: T(c*)
+0	T(-∞)	R(c)	Rezd	T(+0)	R(c)	T(+∞)	T(c)	Xi: T(c*)
+Fn	T(-∞)	R(p+c)	R(p)	R(p)	R(p+c)	T(+∞)	T(c)	Xi: T(c*)
$+\infty$	Xi: T(dNaN)	T(+∞)	T(+∞)	T(+∞)	T(+∞)	T(+∞)	T(c)	Xi: T(c*)
QNaN	T(p)	T(p)	T(p)	T(p)	T(p)	T(p)	T(p)	Xi: T(c*)

Explanation:

- * The SNaN is converted to the corresponding QNaN before it is placed at the target operand element location.
- dNaN Default NaN.
- Fn Finite nonzero number (includes both subnormal and normal).
- P(x) The value x is passed to Part 2 of this figure.
- R(v) Rounding and range action is performed on the value v. See Figure 24-4 on page 24-6.
- Rezd Exact zero-difference result. See Figure 24-4 on page 24-6.
- T(x) The value x is placed at the target operand element location if no trapping exceptions on other elements.
- Xi: IEEE invalid-operation exception. The results shown are produced only when FPC 0.0 is zero.

Figure 24-34. Results: VECTOR FP MULTIPLY AND ADD (Part 2 of 2)

VECTOR FP PERFORM SIGN OPERATION

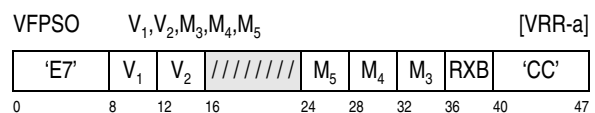

The sign of the floating-point element or elements of the second operand are modified in a manner specified by the value of the M_5 field. The modified sign bit and the rest of the unchanged second operand element are placed into the corresponding element in the first operand. The size of the operand elements is determined by the floating-point-format control in the M_3 field. The operand elements are all treated as BFP numbers.

The sign operation is performed even if the element contains zero. If the element contains a QNaN or SNaN, the sign is still set without causing an IEEE exception.

The M_5 field indicates the operation to perform on the sign bit.

M_5 Sign Operation Performed

- 0 The sign bit is inverted (complement)
- 1 The sign bit is set to one (negative)
- 2 The sign bit is set to zero (positive)

If any other M_5 values are specified, a specification exception is recognized.

The M_3 field specifies the floating-point format. The floating-point format determines the size of the elements within the vector register operands. If a reserved value is specified, a specification exception is recognized. If the vector-enhancements facility 1 is not installed the values 2 and 4 are reserved.

M_3 Floating-Point Format

- 0-1 Reserved
- 2 Short format
- 3 Long format
- 4 Extended format
- 5-15 Reserved

The M_4 field has the following format:



The bits of the M_4 field are defined as follows:

- **Single-Element-Control (S):** If bit 0 is set to one, the operation takes place only on the zero-indexed element in the vector. The bit positions of all other elements in the first operand vector

are unpredictable. If bit 0 is set to zero, the operation occurs on all elements in the vector.

- **Reserved:** Bits 1 to 3 are reserved and must be zero. Otherwise, a specification exception is recognized.

Condition Code: The code remains unchanged.

IEEE Exceptions: None

Program Exceptions:

- Data with DXC FE, Vector Instruction
- Operation (if the vector facility for z/Architecture is not installed)
- Specification
- Transaction constraint

Extended Mnemonics:

Extended Mnemonic	Base Mnemonic
VFPSOSB V_1, V_2, M_5	VFPSO $V_1, V_2, 2, 0, M_5$
WFPSOSB V_1, V_2, M_5	VFPSO $V_1, V_2, 2, 8, M_5$
VFLCSB V_1, V_2	VFPSO $V_1, V_2, 2, 0, 0$
WFLCSB V_1, V_2	VFPSO $V_1, V_2, 2, 8, 0$
VFLNSB V_1, V_2	VFPSO $V_1, V_2, 2, 0, 1$
WFLNSB V_1, V_2	VFPSO $V_1, V_2, 2, 8, 1$
VFLPSB V_1, V_2	VFPSO $V_1, V_2, 2, 0, 2$
WFLPSB V_1, V_2	VFPSO $V_1, V_2, 2, 8, 2$
VFPSODB V_1, V_2, M_5	VFPSO $V_1, V_2, 3, 0, M_5$
WFPSODB V_1, V_2, M_5	VFPSO $V_1, V_2, 3, 8, M_5$
VFLCDB V_1, V_2	VFPSO $V_1, V_2, 3, 0, 0$
WFLCDB V_1, V_2	VFPSO $V_1, V_2, 3, 8, 0$
VFLNDB V_1, V_2	VFPSO $V_1, V_2, 3, 0, 1$
WFLNDB V_1, V_2	VFPSO $V_1, V_2, 3, 8, 1$
VFLPDB V_1, V_2	VFPSO $V_1, V_2, 3, 0, 2$
WFLPDB V_1, V_2	VFPSO $V_1, V_2, 3, 8, 2$
WFPSOXB V_1, V_2, M_5	VFPSO $V_1, V_2, 4, 8, M_5$
WFLCXB V_1, V_2	VFPSO $V_1, V_2, 4, 8, 0$
WFLNXB V_1, V_2	VFPSO $V_1, V_2, 4, 8, 1$
WFLPXB V_1, V_2	VFPSO $V_1, V_2, 4, 8, 2$

VECTOR FP SQUARE ROOT

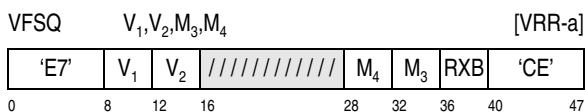

The square roots of the floating-point element or elements of the second operand are placed in the corre-

sponding elements of the first-operand location. The size of the operand elements is determined by the floating-point-format control in the M_3 field. The operand elements are all treated as BFP numbers.

The result rounded according to the current BFP rounding mode is placed at the first operand element location.

If the second operand element is a positive finite number, the result is the square root of that number with a plus sign. If the operand element is a zero of either sign, the result is a zero of the same sign. If the operand element is $+\infty$, the result is $+\infty$.

If the second operand element is less than zero, an IEEE-invalid-operation exception is recognized.

See Figure 24-8 on page 24-17 for a detailed description of the results for each element.

The M_3 field specifies the floating-point format. The floating-point format determines the size of the elements within the vector register operands. If a reserved value is specified, a specification exception is recognized. If the vector-enhancements facility 1 is not installed the values 2 and 4 are reserved.

M_3 Floating-Point Format

- 0-1 Reserved
- 2 Short format
- 3 Long format
- 4 Extended format
- 5-15 Reserved

The M_4 field has the following format:



The bits of the M_4 field are defined as follows:

- **Single-Element-Control (S):** If bit 0 is set to one, the operation takes place only on the zero-indexed element in the vector. In the absence of a trapping exception condition, the bit positions of all other elements in the first operand vector are unpredictable. If bit 0 is set to zero, the operation occurs on all elements in the vector.
- **Reserved:** Bits 1 to 3 are reserved and must be zero. Otherwise, a specification exception is recognized.

Condition Code: The code remains unchanged.

IEEE Exceptions:

- Invalid operation
- Inexact

Program Exceptions:

- Data with DXC FE, Vector Instruction
- Operation (if the vector facility for z/Architecture is not installed)
- Specification
- Transaction constraint
- Vector processing with VXC for IEEE exception and element index

Extended Mnemonics:

Extended Mnemonic	Base Mnemonic
VFSQSB V_1, V_2	VFSQ $V_1, V_2, 2, 0$
VFSQDB V_1, V_2	VFSQ $V_1, V_2, 3, 0$
WFSQSB V_1, V_2	VFSQ $V_1, V_2, 2, 8$
WFSQDB V_1, V_2	VFSQ $V_1, V_2, 3, 8$
WFSQXB V_1, V_2	VFSQ $V_1, V_2, 4, 8$

VECTOR FP SUBTRACT

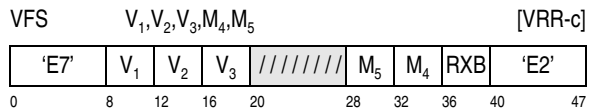

The floating-point element or elements in the third operand are subtracted from the floating-point element or elements of the second operand, and the difference is placed in the floating-point element or elements at the first-operand location. The size of the operand elements is determined by the floating-point-format control in the M_4 field. The operand elements are all treated as BFP numbers.

The execution of VECTOR FP SUBTRACT is identical to that of VECTOR FP ADD, except that the third operand element, if numeric, participates in the operation with its sign bit inverted. When the third operand contains an element that is a NaN, it participates in the operation with its sign bit unchanged. See Figure 24-3 on page 24-5 for the detailed results for each element of VECTOR FP ADD.

The M_4 field specifies the floating-point format. The floating-point format determines the size of the ele-

ments within the vector register operands. If a reserved value is specified, a specification exception is recognized. If the vector-enhancements facility 1 is not installed the values 2 and 4 are reserved.

M₄ Floating-Point Format

0-1	Reserved
2	Short format
3	Long format
4	Extended format
5-15	Reserved

The M₅ field has the following format:



The bits of the M₅ field are defined as follows:

- **Single-Element-Control (S):** If bit 0 is set to one, the operation takes place only on the zero-indexed element in the vector. In the absence of a trapping exception condition, the bit positions of all other elements in the first operand vector are unpredictable. If bit 0 is set to zero, the operation occurs on all elements in the vector.
- **Reserved:** Bits 1 to 3 are reserved and must be zero. Otherwise, a specification exception is recognized.

Condition Code: The code remains unchanged.

IEEE Exceptions:

- Invalid operation
- Overflow
- Underflow
- Inexact

Program Exceptions:

- Data with DXC FE, Vector Instruction
- Operation (if the vector facility for z/Architecture is not installed)
- Specification
- Transaction constraint
- Vector processing with VXC for IEEE exception and element index

Operand elements, including SNaNs and QNaNs,

Extended Mnemonics:

Extended Mnemonic	Base Mnemonic
VFSSB V ₁ ,V ₂ ,V ₃	VFS V ₁ ,V ₂ ,V ₃ ,2,0
VFSDDB V ₁ ,V ₂ ,V ₃	VFS V ₁ ,V ₂ ,V ₃ ,3,0
WFSSB V ₁ ,V ₂ ,V ₃	VFS V ₁ ,V ₂ ,V ₃ ,2,8
WFSDDB V ₁ ,V ₂ ,V ₃	VFS V ₁ ,V ₂ ,V ₃ ,3,8
WFSXB V ₁ ,V ₂ ,V ₃	VFS V ₁ ,V ₂ ,V ₃ ,4,8

VECTOR FP TEST DATA CLASS IMMEDIATE

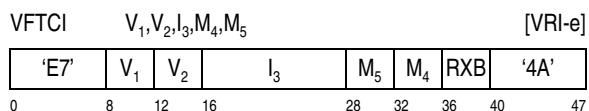

The class and sign of the floating-point element or elements of the second operand are examined to select one bit from the third-operand. If the selected bit is set, all bit positions of the corresponding element in the first operand are set to ones, otherwise they are set to zero. The size of the operand elements is determined by the floating-point-format control in the M₄ field. The second operand elements are treated as BFP numbers.

The 12 bits of the third operand, bits 16-27 of the instruction text, are used to specify 12 combinations of BFP data class and sign.

As shown in Figure 24-35, BFP operand elements are divided into six classes: zero, normal number, subnormal number, infinity, quiet NaN, and signaling NaN.

BFP Element Class	Bit Used when Sign Is	
	+	-
Zero	0	1
Normal number	2	3
Subnormal number	4	5
Infinity	6	7
Quiet NaN	8	9
Signaling NaN	10	11

Figure 24-35. Third-Operand Bits for VECTOR FP TEST DATA CLASS

One or more of the third-operand bits may be set to one.

are examined without causing an IEEE exception.

The M_4 field specifies the floating-point format. The floating-point format determines the size of the elements within the vector register operands. If a reserved value is specified, a specification exception is recognized. If the vector-enhancements facility 1 is not installed the values 2 and 4 are reserved.

M_4 Floating-Point Format

0-1	Reserved
2	Short format
3	Long format
4	Extended format
5-15	Reserved

The M_5 field has the following format:



The bits of the M_5 field are defined as follows:

- **Single-Element-Control (S):** If bit 0 is set to one, the operation takes place only on the zero-indexed element in the vector. The bit positions of all other elements in the first operand vector are unpredictable. If bit 0 is set to zero, the operation occurs on all elements in the vector.
- **Reserved:** Bits 1 to 3 are reserved and must be zero. Otherwise, a specification exception is recognized.

Resulting Condition Code:

- 0 Selected bit is 1 for all elements (match)

- 1 Selected bit is 1 for at least one but not all elements (when S-bit is zero)
- 2 --
- 3 Selected bit is 0 for all elements (no match)

IEEE Exceptions: None.

Program Exceptions:

- Data with DXC FE, Vector Instruction
- Operation (if the vector facility for z/Architecture is not installed)
- Specification
- Transaction constraint

Extended Mnemonics:

Extended Mnemonic		Base Mnemonic	
VFTCISB	V_1, V_2, I_3	VFTCI	$V_1, V_2, I_3, 2, 0$
VFTCIDB	V_1, V_2, I_3	VFTCI	$V_1, V_2, I_3, 3, 0$
WFTCISB	V_1, V_2, I_3	VFTCI	$V_1, V_2, I_3, 2, 8$
WFTCIDB	V_1, V_2, I_3	VFTCI	$V_1, V_2, I_3, 3, 8$
WFTCIXB	V_1, V_2, I_3	VFTCI	$V_1, V_2, I_3, 4, 8$

Programming Notes:

1. VECTOR TEST DATA CLASS provides a way to test operand elements without risk of an exception or setting the IEEE flags.
2. When the S bit is set it is impossible to get a Condition Code of 1.
3. Use VECTOR FP COMPARE EQUAL if you want behavior similar to LOAD AND TEST in Chapter 19.

Chapter 25. Vector Decimal Instructions

Vector-Packed-Decimal Facility	25-1	VECTOR MULTIPLY DECIMAL	25-10
Vector Decimal Control	25-1	VECTOR MULTIPLY AND SHIFT DECIMAL	25-12
Vector Decimal Registers	25-1	VECTOR PACK ZONED	25-13
Decimal Digits and Signs	25-2	VECTOR PERFORM SIGN OPERATION DECIMAL	25-14
Instructions	25-2	VECTOR REMAINDER DECIMAL	25-16
VECTOR ADD DECIMAL	25-3	VECTOR SHIFT AND DIVIDE DECIMAL	25-18
VECTOR COMPARE DECIMAL	25-5	VECTOR SHIFT AND ROUND DECIMAL	25-19
VECTOR CONVERT TO BINARY	25-5	VECTOR SUBTRACT DECIMAL	25-21
VECTOR CONVERT TO DECIMAL	25-7	VECTOR TEST DECIMAL	25-22
VECTOR DIVIDE DECIMAL	25-8	VECTOR UNPACK ZONED	25-22
VECTOR LOAD IMMEDIATE DECIMAL	25-10		

Vector-Packed-Decimal Facility

The vector-packed-decimal facility provides instructions to operate on signed-packed-decimal format data in register operands. Decimal numbers and decimal instructions are introduced in Chapter 8, “Decimal Instructions.” The decimal-arithmetic instructions described in Chapter 8 operate on decimal data in storage operands. Since the delay between instructions encountered to ensure sequential order of operand accesses is likely less between register accesses than between storage accesses, a sequence of vector decimal instructions referencing operands in registers may achieve better performance than a comparable sequence of decimal instructions referencing operands in storage. Additionally, a program performing sign manipulation can use the force operand positive controls of the vector decimal-arithmetic instructions described in this chapter to reduce the program instruction count.

Vector Decimal Control

The vector decimal instructions described in this chapter are available to use when the vector-packed-decimal facility for z/Architecture is installed (which requires the vector facility for z/Architecture to also be installed), the vector enablement control (bit 46) in control register zero is one, and the AFP-register control (bit 45) in control register zero is one. If the vector-packed-decimal facility for z/Architecture is not

installed and a vector decimal instruction is executed, then an operation exception is recognized. If the vector-packed-decimal facility for z/Architecture is installed, the vector enablement control (bit 46) in control register zero is zero, and a vector decimal instruction is executed, a data exception with DXC FE hex is recognized. When the vector-packed-decimal facility for z/Architecture is installed, and the AFP-register control (bit 45) in control register zero is zero, and a vector decimal instruction is executed, it is unpredictable whether a data exception is recognized.

Vector Decimal Registers

The vector-packed-decimal facility uses the same 32 vector registers as the vector facility. When a decimal operand occupies a vector register, the operand is in the signed-packed-decimal format and occupies all 16 bytes (31 digits and a sign), as illustrated in Figure 25-1 on page 25-2. Decimal numbers with fewer than 31 significant digits are right-aligned with zeros supplied in the remaining leftmost digits. Several vector decimal-arithmetic instructions described in this chapter provide a result digits count (RDC) control to specify the number of rightmost digits of an operation to place in the result register.

The vector registers are used by the vector-packed-decimal facility to support decimal operand lengths up to 16 bytes. The vector-packed-decimal facility

does not support multiple elements within a vector register for the purpose of parallel processing.

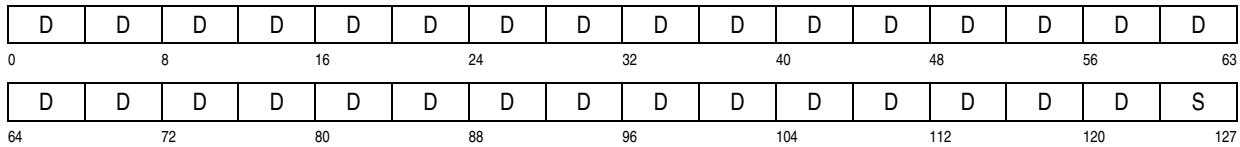

Figure 25-1. Signed-Packed-Decimal Format Number in Vector Registers

Decimal Digits and Signs

Decimal digits 0-9 have codes 0000-1001 binary.

The preferred positive sign has code 1100 binary (C hex). The preferred negative sign has code 1101 binary (D hex). The vector decimal-arithmetic instructions and VECTOR CONVERT TO DECIMAL instructions generate a preferred sign code when the force operand 1 positive control (P1) is zero and generate alternate positive sign code 1111 binary (F hex) when the P1 control is one. VECTOR LOAD IMMEDIATE generates a preferred sign code. The VECTOR PACK ZONED and VECTOR UNPACK ZONED instructions move the source sign to the result sign unchanged.

The vector decimal-arithmetic instructions provide the option to treat source sign codes as positive and ignore source sign codes during operation and validity checks. The force operand positive (P) controls enable this option.

The vector decimal-arithmetic instructions and VECTOR CONVERT TO DECIMAL instructions generate a positive sign when the resulting magnitude is zero. VECTOR LOAD IMMEDIATE can produce a zero magnitude with a negative sign code. The VECTOR PACK ZONED and VECTOR UNPACK ZONED instructions move the source sign to the result sign unchanged.

Instructions

The vector decimal-arithmetic instructions perform addition, subtraction, multiplication, division, comparison and shifting. The set of vector decimal instructions includes the vector decimal-arithmetic instructions, VECTOR CONVERT TO BINARY, VECTOR CONVERT TO DECIMAL, VECTOR PACK ZONED, VECTOR UNPACK ZONED, VECTOR LOAD IMMEDIATE DECIMAL, and VECTOR TEST DECIMAL instructions.

Programming Note: The vector-packed-decimal-enhancement facility provides the following enhancements:

- Support for negative zero and digit code validity check for VECTOR PERFORM SIGN OPERATION DECIMAL (VPSOP).
- Support on the following instructions to suppress a decimal overflow exception: VECTOR ADD DECIMAL (VAP), VECTOR CONVERT TO BINARY (VCVB, VCVBG), VECTOR CONVERT TO DECIMAL (VCVD, VCVDG), VECTOR [SHIFT AND] DIVIDE DECIMAL (VDP, VSDP), VECTOR MULTIPLY [AND SHIFT] DECIMAL (VMSP, VMP), VECTOR REMAINDER DECIMAL (VRP), VECTOR SHIFT AND ROUND DECIMAL (VSRP), VECTOR SUBTRACT DECIMAL (VSP).

Name	Mnemonic	Characteristics						Op Code	Page
VECTOR ADD DECIMAL	VAP	VRI-f	C*	VD	$\alpha^{7,9}$	SP	Dv Dg DF*	E671	25-3
VECTOR COMPARE DECIMAL	VCP	VRR-h	C	VD	$\alpha^{7,9}$		Dv Dg	E677	25-5
VECTOR CONVERT TO BINARY	VCVB	VRR-i	C*	VD	$\alpha^{7,9}$		Dv Dg IF*	E650	25-5
VECTOR CONVERT TO BINARY	VCVBG	VRR-i	C*	VD	$\alpha^{7,9}$		Dv Dg IF*	E652	25-5
VECTOR CONVERT TO DECIMAL	VCVD	VRI-i	C*	VD	$\alpha^{7,9}$	SP	Dv DF*	E658	25-7

Figure 25-2. Summary of Vector Decimal Instructions (Part 1 of 2)

Name	Mnemonic	Characteristics							Op Code	Page
VECTOR CONVERT TO DECIMAL	VCVDG	VRI-i	C*	VD	$\alpha^{7,9}$	SP	Dv	DF*	E65A	25-7
VECTOR DIVIDE DECIMAL	VDP	VRI-f	C*	VD	$\alpha^{7,9}$	SP	Dv	Dg DF* DK	E67A	25-8
VECTOR LOAD IMMEDIATE DECIMAL	VLIP	VRI-h		VD	$\alpha^{7,9}$		Dv	Dg	E649	25-10
VECTOR MULTIPLY AND SHIFT DECIMAL	VMSP	VRI-f	C*	VD	$\alpha^{7,9}$	SP	Dv	Dg DF*	E679	25-12
VECTOR MULTIPLY DECIMAL	VMP	VRI-f	C*	VD	$\alpha^{7,9}$	SP	Dv	Dg DF*	E678	25-10
VECTOR PACK ZONED	VPKZ	VSI		VD	$\alpha^{7,9}$	A SP	Dv	B ₂	E634	25-13
VECTOR PERFORM SIGN OPERATION DECIMAL	VPSOP	VRI-g	C*	VD	$\alpha^{7,9}$	SP	Dv	Dg DF*	E65B	25-14
VECTOR REMAINDER DECIMAL	VRP	VRI-f	C*	VD	$\alpha^{7,9}$	SP	Dv	Dg DF* DK	E67B	25-16
VECTOR SHIFT AND DIVIDE DECIMAL	VSDP	VRI-f	C*	VD	$\alpha^{7,9}$	SP	Dv	Dg DF* DK	E67E	25-18
VECTOR SHIFT AND ROUND DECIMAL	VSRP	VRI-g	C*	VD	$\alpha^{7,9}$	SP	Dv	Dg DF*	E659	25-19
VECTOR SUBTRACT DECIMAL	VSP	VRI-f	C*	VD	$\alpha^{7,9}$	SP	Dv	Dg DF*	E673	25-21
VECTOR TEST DECIMAL	VTP	VRR-g	C	VD	$\alpha^{7,9}$		Dv		E65F	25-22
VECTOR UNPACK ZONED	VUPKZ	VSI		VD	$\alpha^{7,9}$	A SP	Dv	ST B ₂	E63C	25-22

Explanation:

α^7 Restricted from transactional execution when the effective allow-floating-point-operation control is zero.

α^9 Restricted in the constrained transactional-execution mode; a transaction-constraint program exception may be recognized.

A Access exceptions for logical addresses.

B₂ B₂ field designates an access register in the access-register mode.

C* Condition code is optionally set.

C Condition code is set.

DF* Decimal-overflow exception conditionally recognized.

Dg General-operand data exception.

DK Decimal-divide exception.

Dv Vector-instruction data exception.

IF* Fixed-point-overflow exception conditionally recognized.

SP Specification exception.

ST PER storage-alteration event.

VD Vector-packed-decimal facility.

VRI VRI instruction format.

VRR VRR instruction format.

VSI VSI instruction format.

Figure 25-2. Summary of Vector Decimal Instructions (Part 2 of 2)

VECTOR ADD DECIMAL

VAP V_1, V_2, V_3, I_4, M_5 [VRI-f]

'E6'	V ₁	V ₂	V ₃	////	M ₅	I ₄	RXB	'71'	
0	8	12	16	20	24	28	36	40	47

The second operand is added to the third operand. The sign and specified number of rightmost digits of the sum are placed in the first operand location with other digits set to zero. The operands are in the signed-packed-decimal format.

The sign codes of the second and third operands may be modified for use in the add operation by the force operand two positive (P2) and force operand three positive (P3) controls respectively.

Addition is algebraic, taking into account the signs and all digits of the second and third operands.

All digit codes are checked for validity. The sign codes are checked for validity unless overridden by the force operand two positive (P2) or force operand three positive (P3) controls.

If the result digits count (RDC) control does not specify enough digits to contain all leftmost nonzero digits of the sum, decimal overflow occurs. The operation is completed. The result is obtained by ignoring the overflow digits, and if the condition code set (CS) control is one, condition code 3 is set. If the decimal-overflow mask in the PSW is one and the instruction-overflow mask (IOM) is zero, a program interruption for decimal overflow occurs.

If the RDC control specifies less than thirty one digits, zeros are placed in the remaining leftmost digits of the first operand.

When the result, after the RDC control is applied, is nonzero and the force operand one positive (P1) control is zero, rules of algebra determine the sign of the result and a preferred sign code is used. When the result, after the RDC control is applied, is zero and the P1 control is zero, the sign of the result is made positive with preferred sign code 1100. When the P1 control is one, the sign of the result is made positive with sign code 1111.

The I_4 field has the following format:



The bits of the I_4 field are defined as follows:

- **Instruction-Overflow Mask (IOM):** When the vector-packed-decimal-enhancement facility is not installed, bit 0 is reserved and must contain zero; otherwise, a specification exception is recognized. When the vector-packed-decimal-enhancement facility is installed, bit 0 is the instruction-overflow mask. When the instruction-overflow mask is one, recognition of a decimal overflow program interrupt is suppressed.
- **Reserved:** Bits 1-2 are reserved and must contain zeros. Otherwise, a specification exception is recognized.
- **Result Digits Count (RDC):** Bits 3-7 contain an unsigned binary number specifying the number of rightmost digits of the sum to be placed in the first operand. If the magnitude of the sum is larger than the largest decimal number that can be represented with the specified number of digits, decimal overflow occurs, and if the decimal-

overflow mask is one, a program interruption for decimal overflow occurs. If the RDC field is zero, a specification exception is recognized.

The M_5 field has the following format:



The bits of the M_5 field are:

- **Force Operand 2 Positive (P2):** When bit 0 is one, the second operand sign is treated as a positive sign and is not checked for validity. When bit 0 is zero, the second operand sign is used in the operation and is checked for validity.
- **Force Operand 3 Positive (P3):** When bit 1 is one, the third operand sign is treated as a positive sign and is not checked for validity. When bit 1 is zero, the third operand sign is used in the operation and is checked for validity.
- **Force Operand 1 Positive (P1):** When bit 2 is one, the sign of the result placed in the first operand is forced to positive and a sign code of 1111 is used. When bit 2 is zero, the sign of the result placed in the first operand is the preferred sign code for the sign of the sum.
- **Condition Code Set (CS):** When bit 3 is zero, the condition code is not set and remains unchanged. When bit 3 is one, the condition code is set as specified in the resulting condition code section below.

Resulting Condition Code:

When the CS bit is one, the condition code is set as follows:

- 0 Result zero; no overflow
- 1 Result less than zero; no overflow
- 2 Result greater than zero; no overflow
- 3 Overflow

When the CS bit is zero, the condition code remains unchanged.

Program Exceptions:

- Data with DXC FE, vector instruction
- Data with DXC 00, general operand

- Decimal overflow
- Operation (if the vector-packed-decimal facility for z/Architecture is not installed)
- Specification
- Transaction constraint

VECTOR COMPARE DECIMAL

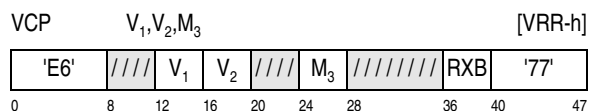

The first operand is compared with the second operand, and the result is indicated in the condition code. The operands are in the signed-packed-decimal format.

The sign codes of the first and second operands may be modified for use in the compare operation by the force operand one positive (P1) and force operand two positive (P2) controls respectively.

Comparison is algebraic and follows the procedure for decimal subtraction with operand two subtracted from operand one. When the difference is zero the operands are equal. When a nonzero difference is positive or negative, the first operand is high or low, respectively.

All digit codes are checked for validity. The sign codes are checked for validity unless overridden by the force operand one positive (P1) or force operand two positive (P2) controls.

Overflow cannot occur because the difference is discarded.

The M₃ field has the following format:



The bits of the M₃ field are defined as follows:

- **Force Operand 1 Positive (P1):** When bit 0 is one, the first operand sign is treated as a positive sign and is not checked for validity. When bit 0 is zero, the first operand sign is used in the operation and is checked for validity.

- **Force Operand 2 Positive (P2):** When bit 1 is one, the second operand sign is treated as a positive sign and is not checked for validity. When bit 1 is zero, the second operand sign is used in the operation and is checked for validity.
- **Reserved:** Bits 2-3 are ignored but should contain zeros; otherwise, the program may not operate compatibly in the future.

Resulting Condition Code:

The condition code is set as follows:

- | | |
|---|--------------------|
| 0 | Operands equal |
| 1 | First operand low |
| 2 | First operand high |
| 3 | -- |

Program Exceptions:

- Data with DXC FE, vector instruction
- Data with DXC 00, general operand
- Operation (if the vector-packed-decimal facility for z/Architecture is not installed)
- Transaction constraint

Programming Notes:

1. The preferred and alternate sign codes for a particular sign are treated as equivalent for comparison purposes.
2. A negative zero and positive zero compare equal.

VECTOR CONVERT TO BINARY

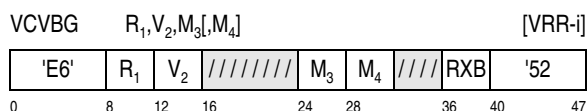
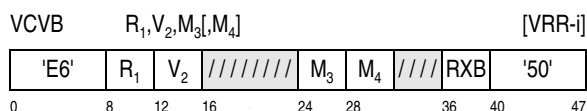

The second operand is changed from decimal to binary, and the result is placed at the first-operand location. The second operand is in a vector register, and the first operand is in a general register.

The second operand has the format of signed-packed-decimal data. The sign of the second operand may be modified for use before conversion by the force operand 2 positive (P2) control or the logical binary (LB) control. All digit codes of the second operand are checked for validity. The sign code of the second operand is checked for validity unless overridden by the force operand 2 positive (P2) control.

For VECTOR CONVERT TO BINARY (VCVB) when the LB control is zero, the result of the conversion is a 32-bit signed binary integer, which is placed in bit positions 32-63 of general register R_1 . Bits 0-31 of general register R_1 remain unchanged. The maximum positive number that can be converted and still be contained in 32 bit positions is 2,147,483,647; the maximum negative number (the negative number with the greatest absolute value) that can be converted is -2,147,483,648.

For VECTOR CONVERT TO BINARY (VCVB) when the LB control is one, the second operand sign is treated as a positive sign, and the result of the conversion is a 32-bit unsigned binary integer, which is placed in bit positions 32-63 of general register R_1 . Bits 0-31 of general register R_1 remain unchanged. The maximum number that can be converted and still be contained in 32 bit positions is 4,294,967,295.

For VECTOR CONVERT TO BINARY (VCVBG) when the LB control is zero, the result of the conversion is a 64-bit signed binary integer, which is placed in bit positions 0-63 of general register R_1 . The maximum positive number that can be converted and still be contained in a 64-bit register is 9,223,372,036,854,775,807; the maximum negative number (the negative number with the greatest absolute value) that can be converted is -9,223,372,036,854,775,808.

For VECTOR CONVERT TO BINARY (VCVBG) when the LB control is one, the second operand sign is treated as a positive sign, and the result of the conversion is a 64-bit unsigned binary integer, which is placed in bit positions 0-63 of general register R_1 . The maximum positive number that can be converted and still be contained in a 64-bit register is 18,446,744,073,709,551,615.

For any decimal number outside these ranges (overflow case), the 32 or 64 rightmost bits of the binary result are placed in the register. Condition code three is optionally set depending on the value of the condition code set (CS) control. If the fixed-point-overflow

mask is one and the instruction-overflow mask (IOM) is zero a program interruption for fixed-point overflow occurs.

The M_3 field has the following format:



The bits of the M_3 field are defined as follows:

- **Force Operand 2 Positive (P2):** When bit 0 is one, the second operand sign is treated as a positive sign and is not checked for validity. When bit 0 is zero, the second operand sign code is checked for validity, and is used in the operation if the LB control is zero.
- **Reserved:** Bit 1 is ignored but should contain zero; otherwise, the program may not operate compatibly in the future.
- **Logical Binary (LB):** When bit 2 is one, the first operand result is an unsigned binary integer, which is considered positive. When bit 2 is zero, the first operand result is a signed binary integer. When the LB control is one and the P2 control is zero, the sign code of the second operand is checked for validity but is treated as a positive sign code in the conversion.
- **Condition Code Set (CS):** When bit 3 is zero, the condition code is not set and remains unchanged. When bit 3 is one, the condition code is set as specified in the resulting condition code section below.

The M_4 field has the following format:

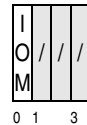

The bits of the M_4 field are defined as follows:

- **Instruction-Overflow Mask (IOM):** When the vector-packed-decimal-enhancement facility is not installed, bit 0 is reserved and must contain zero; otherwise, a specification exception is recognized. When the vector-packed-decimal-enhancement facility is installed, bit 0 is the instruction-overflow mask. When the instruction-

overflow mask is one, recognition of a fixed-point overflow program interrupt is suppressed.

- **Reserved:** Bits 1-3 are ignored but should contain zeros; otherwise, the program may not operate compatibly in the future.

Resulting Condition Code:

When the CS bit is one, the condition code is set as follows:

- 0 No overflow
- 1 --
- 2 --
- 3 Overflow

When the CS bit is zero, the condition code remains unchanged.

Program Exceptions:

- Data with DXC FE, vector instruction
- Data with DXC 00, general operand
- Fixed-point overflow
- Operation (if the vector-packed-decimal facility for z/Architecture is not installed)
- Transaction constraint

Programming Notes:

1. When the second operand is negative and the LB bit is zero, the result is in two's-complement notation.
2. VECTOR CONVERT TO BINARY (VCVB, VCVBG) differs from CONVERT TO BINARY (CVB, CVBY, CVBG) when the converted value is larger than the first operand can represent. For VECTOR CONVERT TO BINARY, in the overflow case, the operation is completed and results in a program interrupt for fixed-point-overflow if the fixed-point-overflow mask is one. For CONVERT TO BINARY, in the overflow case, the operation is suppressed and results in a program interrupt for fixed-point-divide.

VECTOR CONVERT TO DECIMAL

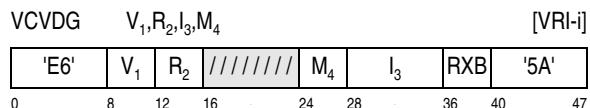
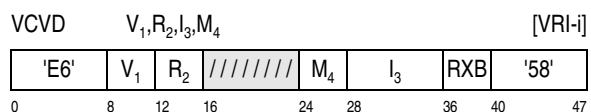

The second operand is changed from binary to decimal, and the result is placed at the first-operand location. The second operand is in a general register, and the first operand is in a vector register.

For VECTOR CONVERT TO DECIMAL (VCVD), the second operand is treated as a 32-bit binary integer that is either signed or unsigned depending on the logical binary (LB) control. For VECTOR CONVERT TO DECIMAL (VCVDG), the second operand is treated as a 64-bit binary integer that is either signed or unsigned depending on the logical binary (LB) control.

The result is in the format for signed-packed-decimal data, as described in Chapter 8, "Decimal Instructions." The number of rightmost digits of the conversion, as specified by the result digits count (RDC) control, is placed in the first-operand location.

If the result digits count (RDC) control does not specify enough digits to contain all leftmost nonzero digits of the conversion, decimal overflow occurs. The operation is completed, the specified number of digits are placed in the first-operand location, and if the condition code set (CS) control is one, condition code 3 is set. If the decimal-overflow mask in the PSW is one and the instruction-overflow mask (IOM) is zero, a program interruption for decimal overflow occurs.

If the RDC control specifies less than thirty one digits, zeros are placed in the remaining leftmost digits of the first operand.

The rightmost four bits of the result represent the sign. When the result, after the RDC control is applied, is nonzero and the force operand one positive (P1) control is zero, the sign of the result is the preferred sign code corresponding to the sign of the second operand. When the result, after the RDC control is applied, is zero and the P1 control is zero, the sign of the result is made positive with preferred sign code 1100. When the P1 control is one, the sign of the result is made positive with sign code 1111.

The I_3 field has the following format:

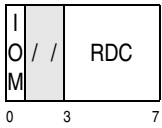

The bits of the I_3 field are defined as follows:

- **Instruction-Overflow Mask (IOM):** When the vector-packed-decimal-enhancement facility is not installed, bit 0 is reserved and must contain zero; otherwise, a specification exception is recognized. When the vector-packed-decimal-enhancement facility is installed, bit 0 is the instruction-overflow mask. When the instruction-overflow mask is one, recognition of a decimal overflow program interrupt is suppressed.
- **Reserved:** Bits 1-2 are reserved and must contain zeros. Otherwise, a specification exception is recognized.
- **Result Digits Count (RDC):** Bits 3-7 contain an unsigned binary number specifying the number of rightmost digits of the conversion to be placed in the first operand. If the magnitude of the conversion is larger than the largest decimal number that can be represented with the specified number of digits decimal overflow occurs, and if the decimal-overflow mask is one, a program interruption for decimal overflow occurs. If the RDC field is zero, a specification exception is recognized.

The M_4 field has the following format:



The bits of the M_4 field are defined as follows:

- **Logical Binary (LB):** When bit 0 is one, the second operand contains an unsigned binary integer. When bit 0 is zero, the second operand contains a signed binary integer.
- **Reserved:** Bit 1 is ignored but should contain zero; otherwise, the program may not operate compatibly in the future.
- **Force Operand 1 Positive (P1):** When bit 2 is one, the sign of the result placed in the first oper-

and is forced to positive and a sign code of 1111 is used. When bit 2 is zero, the sign of the result placed in the first operand is the preferred sign code for the sign of the conversion.

- **Condition Code Set (CS):** When bit 3 is zero, the condition code is not set and remains unchanged. When bit 3 is one, the condition code is set as specified in the resulting condition code section below.

Resulting Condition Code:

When the CS bit is one, the condition code is set as follows:

0	No overflow
1	--
2	--
3	Overflow

When the CS bit is zero, the condition code remains unchanged.

Program Exceptions:

- Data with DXC FE, vector instruction
- Decimal overflow
- Operation (if the vector-packed-decimal facility for z/Architecture is not installed)
- Specification
- Transaction constraint

VECTOR DIVIDE DECIMAL

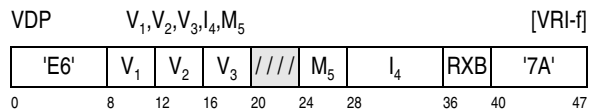

The second operand (the dividend) is divided by the third operand (the divisor). The sign and specified number of rightmost digits of the quotient are placed in the first-operand location with other digits set to zero. The operands and result are in the signed-packed-decimal format.

The sign codes of the second and third operands may be modified for use in the operation by the force operand two positive (P2) and force operand three positive (P3) controls respectively.

All digit codes are checked for validity. The sign codes are checked for validity unless overridden by the force operand two positive (P2) or force operand three positive (P3) controls.

When the result, after the result digits count (RDC) control is applied, is nonzero and the force operand one positive (P1) control is zero, rules of algebra determine the sign of the result and a preferred sign code is used. When the result, after the RDC control is applied, is zero and the P1 control is zero, the sign of the result is made positive with preferred sign code 1100. When the P1 control is one, the sign of the result is made positive with sign code 1111.

If the divisor is zero and the divisor sign code used is valid, a decimal-divide exception is recognized. This includes the case of division of zero by zero. The divisor sign code used is the third operand sign code when the force operand 3 positive (P3) bit is zero, and is a positive sign code when the force operand 3 positive (P3) bit is one.

If the RDC control does not specify enough digits to contain all leftmost nonzero digits of the quotient, decimal overflow occurs. The operation is completed. The result is obtained by ignoring the overflow digits, and if the condition code set (CS) control is one, condition code 3 is set. If the decimal-overflow mask in the PSW is one and the instruction-overflow mask (IOM) is zero, a program interruption for decimal overflow occurs.

If the RDC control specifies less than thirty one digits, zeros are placed in the remaining leftmost digits of the first operand.

The I_4 field has the following format:

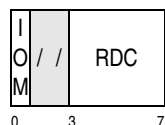

The bits of the I_4 field are defined as follows:

- **Instruction-Overflow Mask (IOM):** When the vector-packed-decimal-enhancement facility is not installed, bit 0 is reserved and must contain zero; otherwise, a specification exception is recognized. When the vector-packed-decimal-enhancement facility is installed, bit 0 is the instruction-overflow mask. When the instruction-

overflow mask is one, recognition of a decimal overflow program interrupt is suppressed.

- **Reserved:** Bits 1-2 are reserved and must contain zeros. Otherwise, a specification exception is recognized.
- **Result Digits Count (RDC):** Bits 3-7 contain an unsigned binary number specifying the number of rightmost digits of the quotient to be placed in the first operand. If the magnitude of the quotient is larger than the largest decimal number that can be represented with the specified number of digits, decimal overflow occurs, and if the decimal-overflow mask is one, a program interruption for decimal overflow occurs. If the RDC field is zero, a specification exception is recognized.

The M_5 field has the following format:



The bits of the M_5 field are:

- **Force Operand 2 Positive (P2):** When bit 0 is one, the second operand sign is treated as a positive sign and is not checked for validity. When bit 0 is zero, the second operand sign is used in the operation and is checked for validity.
- **Force Operand 3 Positive (P3):** When bit 1 is one, the third operand sign is treated as a positive sign and is not checked for validity. When bit 1 is zero, the third operand sign is used in the operation and is checked for validity.
- **Force Operand 1 Positive (P1):** When bit 2 is one, the sign of the result placed in the first operand is forced to positive and a sign code of 1111 is used. When bit 2 is zero, the sign of the result placed in the first operand is the preferred sign code for the sign of the quotient.
- **Condition Code Set (CS):** When bit 3 is zero, the condition code is not set and remains unchanged. When bit 3 is one, the condition code is set as specified in the resulting condition code section below.

Resulting Condition Code:

When the CS bit is one, the condition code is set as follows:

- 0 Result zero; no overflow
- 1 Result less than zero; no overflow
- 2 Result greater than zero; no overflow
- 3 Overflow

When the CS bit is zero, the condition code remains unchanged.

Program Exceptions:

- Data with DXC FE, vector instruction
- Data with DXC 00, general operand
- Decimal divide
- Decimal overflow
- Operation (if the vector-packed-decimal facility for z/Architecture is not installed)
- Specification
- Transaction constraint

Programming Notes:

1. Unlike DIVIDE DECIMAL, VECTOR DIVIDE DECIMAL will recognize a decimal-overflow exception instead of a decimal-divide exception if the first operand is too short to contain all of the quotient digits.
2. VECTOR DIVIDE DECIMAL may recognize a decimal-divide exception when the divisor is zero, depending on the divisor sign code used, unlike DIVIDE DECIMAL, which may recognize a decimal-divide exception when the divisor is zero, depending on all sign and digit codes of both divisor and dividend. Also note, if the divisor is zero, all divisor digits are valid.

VECTOR LOAD IMMEDIATE DECIMAL

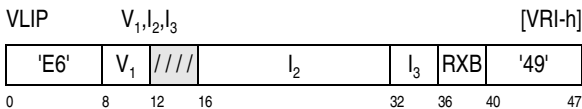

The four decimal digits of the second operand, shifted left by the specified number of digits, and concatenated on the right with the specified sign form a signed-packed-decimal format number placed at the first-operand location.

The four digit second operand is shifted left the number of digit positions specified by the shift amount (SHAMT) control. Zeros are supplied for vacated digit positions. The shifted value is placed in the magnitude of the signed-packed-decimal format first operand. Zeros are placed in the remaining leftmost digits of the first operand.

The sign code of the result placed at the first-operand is determined by the sign control (SC) bit.

All digits of the second operand are checked for validity.

The I₃ field has the following format:

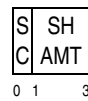

The bits of the I₃ field are:

- **Sign Control (SC):** When bit 0 is zero, the result is positive with a sign code of 1100. When bit 0 is one, the result is negative with a sign code of 1101.
- **Shift Amount (SHAMT):** Bits 1-3 specify a three bit unsigned binary number specifying the number of digits to shift the second operand left.

Condition Code: The code remains unchanged.

Program Exceptions:

- Data with DXC FE, vector instruction
- Data with DXC 00, general operand
- Operation (if the vector-packed-decimal facility for z/Architecture is not installed)
- Transaction constraint

Programming Note: VECTOR LOAD IMMEDIATE DECIMAL can produce a negative zero, a zero value with a negative sign, which is a valid operand.

VECTOR MULTIPLY DECIMAL

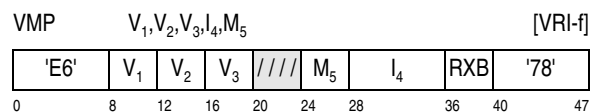

The second operand (the multiplicand) is multiplied by the third operand (the multiplier). The sign and specified number of rightmost digits of the product are placed in the first-operand location with other digits set to zero. The operands and result are in the signed-packed-decimal format.

The sign codes of the second and third operands may be modified for use in the operation by the force operand two positive (P2) and force operand three positive (P3) controls respectively.

All digit codes are checked for validity. The sign codes are checked for validity unless overridden by the force operand two positive (P2) or force operand three positive (P3) controls.

When the result, after the result digits count (RDC) control is applied, is nonzero and the force operand one positive (P1) control is zero, rules of algebra from the multiplier and multiplicand signs determine the sign of the result and a preferred sign code is used. When the result, after the RDC control is applied, is zero and the P1 control is zero, the sign of the result is made positive with preferred sign code 1100. When the P1 control is one, the sign of the result is made positive with sign code 1111.

If the RDC control does not specify enough digits to contain all leftmost nonzero digits of the product, decimal overflow occurs. The operation is completed. The result is obtained by ignoring the overflow digits, and if the condition code set (CS) flag is one, condition code 3 is set. If the decimal-overflow mask in the PSW is one and the instruction-overflow mask (IOM) is zero, a program interruption for decimal overflow occurs.

If the RDC control specifies less than thirty one digits, zeros are placed in the remaining leftmost digits of the first operand.

The I_4 field has the following format



The bits of the I_4 field are defined as follows:

- **Instruction-Overflow Mask (IOM):** When the vector-packed-decimal-enhancement facility is

not installed, bit 0 is reserved and must contain zero; otherwise, a specification exception is recognized. When the vector-packed-decimal-enhancement facility is installed, bit 0 is the instruction-overflow mask. When the instruction-overflow mask is one, recognition of a decimal overflow program interrupt is suppressed.

- **Reserved:** Bits 1-2 are reserved and must contain zeros. Otherwise, a specification exception is recognized.
- **Result Digits Count (RDC):** Bits 3-7 contain an unsigned binary number specifying the number of rightmost digits of the product to be placed in the first operand. If the magnitude of the product is larger than the largest decimal number that can be represented with the specified number of digits, decimal overflow occurs, and if the decimal-overflow mask is one, a program interruption for decimal overflow occurs. If the RDC field is zero, a specification exception is recognized.

The M_5 field has the following format:

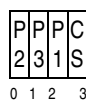

The bits of the M_5 field are:

- **Force Operand 2 Positive (P2):** When bit 0 is one, the second operand sign is treated as a positive sign and is not checked for validity. When bit 0 is zero, the second operand sign is used in the operation and is checked for validity.
- **Force Operand 3 Positive (P3):** When bit 1 is one, the third operand sign is treated as a positive sign and is not checked for validity. When bit 1 is zero, the third operand sign is used in the operation and is checked for validity.
- **Force Operand 1 Positive (P1):** When bit 2 is one, the sign of the result placed in the first operand is forced to positive and a sign code of 1111 is used. When bit 2 is zero, the sign of the result placed in the first operand is the preferred sign code for the sign of the product.
- **Condition Code Set (CS):** When bit 3 is zero, the condition code is not set and remains unchanged. When bit 3 is one, the condition code is set as specified in the resulting condition code section below.

Resulting Condition Code:

When the CS bit is one, the condition code is set as follows:

- 0 Result zero; no overflow
- 1 Result less than zero; no overflow
- 2 Result greater than zero; no overflow
- 3 Overflow

When the CS bit is zero, the condition code remains unchanged.

Program Exceptions:

- Data with DXC FE, vector instruction
- Data with DXC 00, general operand
- Decimal overflow
- Operation (if the vector-packed-decimal facility for z/Architecture is not installed)
- Specification
- Transaction constraint

VECTOR MULTIPLY AND SHIFT DECIMAL

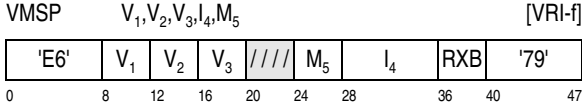

The product of the second operand (the multiplicand) and the third operand (the multiplier) is shifted right by the number of digits specified in the fourth operand and is placed at the first-operand location. The operands and result are in the signed-packed-decimal format.

The sign codes of the second and third operands may be modified for use in the operation by the force operand two positive (P2) and force operand three positive (P3) controls respectively.

All digit codes are checked for validity, including digits with no effect on the result due to the shift amount. The sign codes are checked for validity unless overridden by the force operand two positive (P2) or force operand three positive (P3) controls.

When the result, after being shifted, is nonzero and the force operand one positive (P1) control is zero, rules of algebra from the multiplier and multiplicand signs determine the sign of the result and a preferred

sign code is used. When the result, after being shifted, is zero and the P1 control is zero, the sign of the result is made positive with preferred sign code 1100. When the P1 control is one, the sign of the result is made positive with sign code 1111.

The I_4 field has the following format:

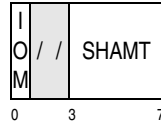

The bits of the I_4 field are defined as follows:

- **Instruction-Overflow Mask (IOM):** When the vector-packed-decimal-enhancement facility is not installed, bit 0 is reserved and must contain zero; otherwise, a specification exception is recognized. When the vector-packed-decimal-enhancement facility is installed, bit 0 is the instruction-overflow mask. When the instruction-overflow mask is one, recognition of a decimal overflow program interrupt is suppressed.
- **Reserved:** Bits 1-2 are reserved and must contain zeros. Otherwise, a specification exception is recognized.
- **Shift Amount (SHAMT):** Bits 3-7 contain an unsigned binary number specifying the number of digits the product is shifted right before the rightmost thirty one digits are placed in the first operand. The sign position does not participate in the shift.

If the first operand does not contain all leftmost non-zero digits of the shifted product, decimal overflow occurs. The operation is completed. Condition code 3 is set if the Condition Code Set (CS) bit is one. If the decimal-overflow mask in the PSW is one and the instruction-overflow mask (IOM) is zero, a program interrupt for decimal overflow occurs.

The M_5 field has the following format:



The bits of the M_5 field are:

- **Force Operand 2 Positive (P2):** When bit 0 is one, the second operand sign is treated as a

positive sign and is not checked for validity. When bit 0 is zero, the second operand sign is used in the operation and is checked for validity.

- **Force Operand 3 Positive (P3):** When bit 1 is one, the third operand sign is treated as a positive sign and is not checked for validity. When bit 1 is zero, the third operand sign is used in the operation and is checked for validity.
- **Force Operand 1 Positive (P1):** When bit 2 is one, the sign of the result placed in the first operand is forced to positive and a sign code of 1111 is used. When bit 2 is zero, the sign of the result placed in the first operand is the preferred sign code for the sign of the product.
- **Condition Code Set (CS):** When bit 3 is zero, the condition code is not set and remains unchanged. When bit 3 is one, the condition code is set as specified in the resulting condition code section below.

Resulting Condition Code:

When the CS bit is one, the condition code is set as follows:

- 0 Result zero; no overflow
- 1 Result less than zero; no overflow
- 2 Result greater than zero; no overflow
- 3 Overflow

When the CS bit is zero, the condition code remains unchanged.

Program Exceptions:

- Data with DXC FE, vector instruction
- Data with DXC 00, general operand
- Decimal overflow
- Operation (if the vector-packed-decimal facility for z/Architecture is not installed)
- Specification
- Transaction constraint

VECTOR PACK ZONED



The format of the second operand is changed from the zoned format to the signed-packed-decimal format and placed in the first operand. The zoned and signed-packed-decimal formats are described in Chapter 8, “Decimal Instructions.”

The second operand is treated as having the zoned format. The numeric bits of each byte are treated as a digit. The zone bits are ignored, except the zone bits in the rightmost byte, which are treated as a sign.

The sign and digits are moved unchanged to the first operand and are not checked for valid codes. The sign is placed in the rightmost four bit positions of the first operand, and the digits are placed adjacent to the sign and to each other in the remainder of the result field. The number of bytes the second operand occupies in storage is specified by the operand 2 length code (L2) control. When necessary, the second operand is considered to be extended on the left with zeros.

The I_3 field has the following format:

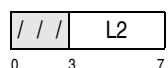

The bits of the I_3 field are defined as follows:

- **Reserved:** Bits 0-2 are reserved and must contain zeros. Otherwise, a specification exception is recognized.
- **Operand 2 Length Code (L2):** Bits 3-7 contain the length code of the second-operand. The length of the second-operand is 1-31 bytes, corresponding to a length code in L2 of 0-30. The second-operand length must not exceed 31 bytes (L2 must be less than or equal to 30); otherwise, a specification exception is recognized.

Special Conditions:

If the L2 field is larger than 30 a specification exception is recognized.

Condition Code: The code remains unchanged.

Program Exceptions:

- Access (fetch, operand 2)
- Data with DXC FE, vector instruction
- Operation (if the vector-packed-decimal facility for z/Architecture is not installed)

- Specification
- Transaction constraint

VECTOR PERFORM SIGN OPERATION DECIMAL

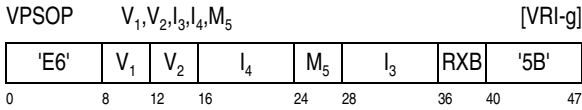

The modified sign and specified number of rightmost digits of the second operand are placed in the first operand location with other digits set to zero. The

operand and result are in the signed-packed-decimal format.

All digit codes of the second operand are checked for validity, unless the operand 2 no validation (NV) control is one. The sign code of the second operand is checked for validity based on the SO control, the operand 2 sign validation (SV) control, and the operand 2 no validation (NV) control, as specified in Figure 25-3.

The result sign code is a function of the SO control, the second operand sign, the second operand digits, the result digits count (RDC) control, the positive sign code (PC) control, and the negative zero (NZ) control, as specified in Figure 25-3.

Sign Operation (SO)	Result Magnitude (after RDC applied)	V ₂ Sign	Positive Sign Code (PC)	Negative Zero (NZ)	V2 Sign Code Validity Check	V2 Digit Code Validity Check perform if...	Result Sign Code (hex)	Condition Code ^d
00 (maintain)	nonzero ^a	positive	0	–	NV=0	NV=0	C positive	2
00 (maintain)	nonzero ^a	positive	1	–	NV=0	NV=0	F positive	2
00 (maintain)	nonzero ^a	negative	–	–	NV=0	NV=0	D negative	1
00 (maintain)	nonzero ^a	invalid ^b	–	–	NV=0	NV=0	2 nd operand sign	2
00 (maintain)	zero ^a	positive	0	–	NV=0	NV=0	C positive	0
00 (maintain)	zero ^a	positive	1	–	NV=0	NV=0	F positive	0
00 (maintain)	zero ^a	negative	0	0	NV=0	NV=0	C positive	0
00 (maintain)	zero ^a	negative	1	0	NV=0	NV=0	F positive	0
00 (maintain)	zero ^a	negative	–	1	NV=0	NV=0	D negative	0
00 (maintain)	zero ^a	invalid ^b	–	–	NV=0	NV=0	2 nd operand sign	0
01 (complement)	nonzero ^a	positive	–	–	always	NV=0	D negative	1
01 (complement)	nonzero ^a	negative	0	–	always	NV=0	C positive	2
01 (complement)	nonzero ^a	negative	1	–	always	NV=0	F positive	2
01 (complement)	–	invalid ^b	–	–	always	NV=0	– ^c	– ^c
01 (complement)	zero ^a	positive	0	0	always	NV=0	C positive	0
01 (complement)	zero ^a	positive	1	0	always	NV=0	F positive	0
01 (complement)	zero ^a	positive	–	1	always	NV=0	D negative	0
01 (complement)	zero ^a	negative	0	–	always	NV=0	C positive	0
01 (complement)	zero ^a	negative	1	–	always	NV=0	F positive	0
10 (force positive)	nonzero ^a	–	0	–	SV=1	NV=0	C positive	2
10 (force positive)	nonzero ^a	–	1	–	SV=1	NV=0	F positive	2
10 (force positive)	zero ^a	–	0	–	SV=1	NV=0	C positive	0
10 (force positive)	zero ^a	–	1	–	SV=1	NV=0	F positive	0

Figure 25-3. Operation of VECTOR PERFORM SIGN OPERATION DECIMAL (Part 1 of 2)

Sign Operation (SO)	Result Magnitude (after RDC applied)	V ₂ Sign	Positive Sign Code (PC)	Negative Zero (NZ)	V2 Sign Code Validity Check	V2 Digit Code Validity Check perform if...	Result Sign Code (hex)	Condition Code ^d
11 (force negative)	nonzero ^a	–	–	–	SV=1	NV=0	D negative	1
11 (force negative)	zero ^a	–	0	0	SV=1	NV=0	C positive	0
11 (force negative)	zero ^a	–	1	0	SV=1	NV=0	F positive	0
11 (force negative)	zero ^a	–	–	1	SV=1	NV=0	D negative	0

Explanation:

- Results do not depend on this value
- a A result magnitude is considered nonzero if any bits of the result are nonzero
- b A sign code between 0-9 is considered invalid
- c Produces a suppressing data exception
- d Table is showing the condition code for the non-overflow case. Overflow case will deliver a CC3.

Figure 25-3. Operation of VECTOR PERFORM SIGN OPERATION DECIMAL (Part 2 of 2)

If the RDC control does not specify enough digits to contain all leftmost nonzero digits of the second operand, decimal overflow occurs. The operation is completed. The result is obtained by ignoring the overflow digits, and if the condition code set (CS) flag is one, condition code 3 is set. If the decimal-overflow mask in the PSW is one and the instruction-overflow mask (IOM) is zero, a program interruption for decimal overflow occurs.

If the RDC control specifies less than thirty one digits, zeros are placed in the remaining leftmost digits of the first operand.

The I₃ field has the following format:

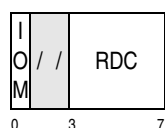

The bits of the I₃ field are defined as follows:

- **Instruction-Overflow Mask (IOM):** When the vector-packed-decimal-enhancement facility is not installed, bit 0 is reserved and must contain zero; otherwise, a specification exception is recognized. When the vector-packed-decimal-enhancement facility is installed, bit 0 is the instruction-overflow mask. When the instruction-overflow mask is one, recognition of a decimal overflow program interrupt is suppressed.
- **Reserved:** Bits 1-2 are reserved and must contain zeros. Otherwise, a specification exception is recognized.

- **Result Digits Count (RDC):** Bits 3-7 contain an unsigned binary number specifying the number of rightmost digits of the second operand to be placed in the first operand. If the magnitude of the second operand is larger than the largest decimal number that can be represented with the specified number of digits, decimal overflow occurs, and if the decimal-overflow mask is one, a program interruption for decimal overflow occurs. If the RDC field is zero, a specification exception is recognized.

The I₄ field has the following format:

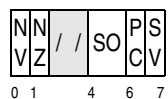

The bits of the I₄ field are defined as follows:

- **No Validation (NV):** When bit 0 is zero or the vector-packed-decimal-enhancement facility is not installed, the second operand digits are checked for validity; if the SO control specifies maintain sign, then the second operand sign code is also checked for validity. Sign code validity is always checked when the SO control specifies complement sign and dependent on SV control if the SO control specifies force positive or force negative. If the validity check fails, a data exception is recognized. If bit 0 is one, then the second operand digits are not checked for validity; and if the SO control specifies maintain sign, then the second operand sign code is also not checked.

- **Negative Zero (NZ):** When bit 1 is zero or the vector-packed-decimal-enhancement facility is not installed, a zero result after applying the RDC will result in a positive sign. If bit 1 is one, then the sign of a zero result after applying the RDC will be dependent of the second operand sign if the SO control does not specify force positive or force negative.
- **Reserved:** Bits 2-3 are ignored but should contain zeros; otherwise, the program may not operate compatibly in the future.
- **Sign Operation (SO):** Bits 4-5 specify the sign operation used in determining the result sign code. The result sign code is a function of the SO control, the second operand sign, the second operand digits, the RDC control, and the PC bit, as specified in Figure 25-3.
- **Positive Sign Code (PC):** When bit 6 is one, sign code 1111 is used when the result is positive. When bit 6 is zero, sign code 1100 is used when the result is positive.
- **Operand 2 Sign Validation (SV):** If bit 7 is one and the SO control specifies force positive or force negative, then the second operand sign code is checked for validity. If bit 7 is zero and the SO control specifies force positive or force negative, then the second operand sign code is not checked for validity. When the SO control specifies maintain or complement sign, the second operand sign code is checked for validity, based on the NV bit value. If the validity check fails, a data exception is recognized.

The M_5 field has the following format:



The bits of the M_5 field are:

- **Reserved:** Bits 0-2 are ignored but should contain zeros; otherwise, the program may not operate compatibly in the future.
- **Condition Code Set (CS):** When bit 3 is zero, the condition code is not set and remains unchanged. When bit 3 is one, the condition code is set as specified in the resulting condition code section below.

Resulting Condition Code:

When the CS bit is one, the condition code is set as follows:

- 0 Result zero; no overflow
- 1 Result less than zero; no overflow
- 2 Result greater than zero, or nonzero result and invalid sign code; no overflow
- 3 Overflow

When the CS bit is zero, the condition code remains unchanged.

Program Exceptions:

- Data with DXC FE, vector instruction
- Data with DXC 00, general operand
- Decimal overflow
- Operation (if the vector-packed-decimal facility for z/Architecture is not installed)
- Specification
- Transaction constraint

Programming Note: A zero result after applying the RDC will always result in setting condition code 0 if the CS bit is one, independent of the positive or negative sign of the zero.

VECTOR REMAINDER DECIMAL

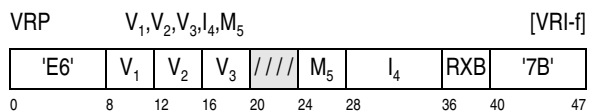

The second operand (the dividend) is divided by the third operand (the divisor). The sign and specified number of rightmost digits of the remainder are placed in the first-operand location with other digits set to zero. The operands and result are in the signed-packed-decimal format.

The sign codes of the second and third operands may be modified for use in the operation by the force operand two positive (P2) and force operand three positive (P3) controls respectively.

All digit codes are checked for validity. The sign codes are checked for validity unless overridden by the force operand two positive (P2) or force operand three positive (P3) controls.

When the result, after the result digits count (RDC) control is applied, is nonzero and the force operand one positive (P1) control is zero, the sign of the dividend after P2 is applied is the sign of the result and a preferred sign code is used. When the result, after the RDC control is applied, is zero and the P1 control is zero, the sign of the result is made positive with preferred sign code 1100. When the P1 control is one, the sign of the result is made positive with sign code 1111.

If the divisor is zero and the divisor sign code used is valid, a decimal-divide exception is recognized. This includes the case of division of zero by zero. The divisor sign code used is the third operand sign code when the force operand 3 positive (P3) bit is zero, and is a positive sign code when the force operand 3 positive (P3) bit is one.

If the RDC control does not specify enough digits to contain all leftmost nonzero digits of the remainder, decimal overflow occurs. The operation is completed. The result is obtained by ignoring the overflow digits, and if the condition code set (CS) flag is one, condition code 3 is set. If the decimal-overflow mask in the PSW is one and the instruction-overflow mask (IOM) is zero, a program interruption for decimal overflow occurs.

If the RDC control specifies less than thirty one digits, zeros are placed in the remaining leftmost digits of the first operand.

The I_4 field has the following format:



The bits of the I_4 field are defined as follows:

- **Instruction-Overflow Mask (IOM):** When the vector-packed-decimal-enhancement facility is not installed, bit 0 is reserved and must contain zero; otherwise, a specification exception is recognized. When the vector-packed-decimal-enhancement facility is installed, bit 0 is the instruction-overflow mask. When the instruction-overflow mask is one, recognition of a decimal overflow program interrupt is suppressed.

- **Reserved:** Bits 1-2 are reserved and must contain zeros. Otherwise, a specification exception is recognized.
- **Result Digits Count (RDC):** Bits 3-7 contain an unsigned binary number specifying the number of rightmost digits of the remainder to be placed in the first operand. If the magnitude of the remainder is larger than the largest decimal number that can be represented with the specified number of digits, decimal overflow occurs, and if the decimal-overflow mask is one, a program interruption for decimal overflow occurs. If the RDC field is zero, a specification exception is recognized.

The M_5 field has the following format:



The bits of the M_5 field are:

- **Force Operand 2 Positive (P2):** When bit 0 is one, the second operand sign is treated as a positive sign and is not checked for validity. When bit 0 is zero, the second operand sign is used in the operation and is checked for validity.
- **Force Operand 3 Positive (P3):** When bit 1 is one, the third operand sign is treated as a positive sign and is not checked for validity. When bit 1 is zero, the third operand sign is used in the operation and is checked for validity.
- **Force Operand 1 Positive (P1):** When bit 2 is one, the sign of the result placed in the first operand is forced to positive and a sign code of 1111 is used. When bit 2 is zero, the sign of the result placed in the first operand is the preferred sign code for the sign of the remainder.
- **Condition Code Set (CS):** When bit 3 is zero, the condition code is not set and remains unchanged. When bit 3 is one, the condition code is set as specified in the resulting condition code section below.

Resulting Condition Code:

When the CS bit is one, the condition code is set as follows:

- 0 Result zero; no overflow

- 1 Result less than zero; no overflow
- 2 Result greater than zero; no overflow
- 3 Overflow

When the CS bit is zero, the condition code remains unchanged.

Program Exceptions:

- Data with DXC FE, vector instruction
- Data with DXC 00, general operand
- Decimal divide
- Decimal overflow
- Operation (if the vector-packed-decimal facility for z/Architecture is not installed)
- Specification
- Transaction constraint

VECTOR SHIFT AND DIVIDE DECIMAL

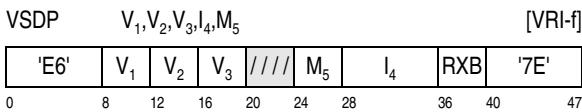

The second operand, shifted left (the dividend) by the number of digits specified in the fourth operand, is divided by the third operand (the divisor), and the rightmost thirty one digits of the quotient are placed in the first-operand location. The operands and result are in the signed-packed-decimal format.

The sign codes of the second and third operands may be modified for use in the operation by the force operand two positive (P2) and force operand three positive (P3) controls respectively.

All digit codes are checked for validity. The sign codes are checked for validity unless overridden by the force operand two positive (P2) or force operand three positive (P3) controls.

If the first operand can not contain all leftmost non-zero digits of the quotient, decimal overflow occurs. The operation is completed. The result is obtained by ignoring the overflow digits, and if the condition code set (CS) flag is one, condition code 3 is set. If the decimal-overflow mask in the PSW is one and the instruction-overflow mask (IOM) is zero, a program interrupt for decimal overflow occurs.

When the rightmost thirty one digits of the quotient are nonzero and the force operand one positive (P1) control is zero, rules of algebra from the dividend and divisor signs determine the sign of the result and a preferred sign code is used. When the rightmost thirty one digits of the quotient are zero and the P1 control is zero, the sign of the result is made positive with preferred sign code 1100. When the P1 control is one, the sign of the result is made positive with sign code 1111.

If the divisor is zero and the divisor sign code used is valid, a decimal-divide exception is recognized. This includes the case of division of zero by zero. The divisor sign code used is the third operand sign code when the force operand 3 positive (P3) bit is zero, and is a positive sign code when the force operand 3 positive (P3) bit is one.

The I₄ field has the following format:

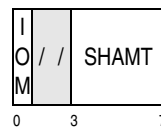

The bits of the I₄ field are defined as follows:

- **Instruction-Overflow Mask (IOM):** When the vector-packed-decimal-enhancement facility is not installed, bit 0 is reserved and must contain zero; otherwise, a specification exception is recognized. When the vector-packed-decimal-enhancement facility is installed, bit 0 is the instruction-overflow mask. When the instruction-overflow mask is one, recognition of a decimal overflow program interrupt is suppressed.
- **Reserved:** Bits 1-2 are reserved and must contain zeros. Otherwise, a specification exception is recognized.
- **Shift Amount (SHAMT):** Bits 3-7 contain an unsigned binary number specifying the number of digits the second operand is shifted left to form the dividend. The second operand sign position does not participate in the shift. Zeros are supplied for the vacated digit positions.

The M₅ field has the following format:



The bits of the M_5 field are:

- **Force Operand 2 Positive (P2):** When bit 0 is one, the second operand sign is treated as a positive sign and is not checked for validity. When bit 0 is zero, the second operand sign is used in the operation and is checked for validity.
- **Force Operand 3 Positive (P3):** When bit 1 is one, the third operand sign is treated as a positive sign and is not checked for validity. When bit 1 is zero, the third operand sign is used in the operation and is checked for validity.
- **Force Operand 1 Positive (P1):** When bit 2 is one, the sign of the result placed in the first operand is forced to positive and a sign code of 1111 is used. When bit 2 is zero, the sign of the result placed in the first operand is the preferred sign code for the sign of the quotient.
- **Condition Code Set (CS):** When bit 3 is zero, the condition code is not set and remains unchanged. When bit 3 is one, the condition code is set as specified in the resulting condition code section below.

Resulting Condition Code:

When the CS bit is one, the condition code is set as follows:

- 0 Result zero; no overflow
- 1 Result less than zero; no overflow
- 2 Result greater than zero; no overflow
- 3 Overflow

When the CS bit is zero, the condition code remains unchanged.

Program Exceptions:

- Data with DXC FE, vector instruction
- Data with DXC 00, general operand
- Decimal divide
- Decimal overflow
- Operation (if the vector-packed-decimal facility for z/Architecture is not installed)
- Specification
- Transaction constraint

VECTOR SHIFT AND ROUND DECIMAL

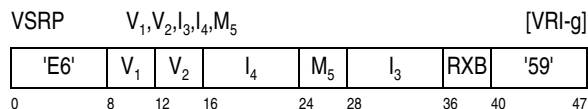

The second operand is shifted in the direction and for the number of decimal-digit positions specified by the fourth operand, and, when shifting to the right is specified, the absolute value of the second operand is rounded by the rounding digit, and the result is placed at the first-operand location. The first and second operands are in the signed-packed-decimal format.

The sign code of the second operand may be modified for use in the operation by the force operand two positive control (P2).

All digit codes are checked for validity, including digits with no effect on the result due to the shift amount. The sign code is checked for validity unless overridden by the force operand two positive control (P2).

Only the digit portion of the second operand is shifted; the sign position does not participate in the shifting. Zeros are supplied for the vacated digit positions. The result is stored in the first operand.

The shift amount (SHAMT) control specifies a 7-bit signed binary integer, indicating the direction and number of decimal-digit positions to be shifted. Positive shift values specify shifting to the left. Negative shift values, which are represented in two's complement notation, specify shifting to the right. The following are examples of the interpretation of shift values:

SHAMT (binary)	amount and direction
0011111	31 digits to the left
0000001	1 digit to the left
0000000	No shift
1111111	1 digit to the right
1100000	32 digits to the right

For a right shift, the second operand is rounded by treating the second operand as positive, regardless of the sign, and decimally adding the rounding digit, as specified by the decimal rounding digit control (DRD), to the leftmost of the digits to be shifted out and by propagating the carry, if any, to the left. The sum is then shifted to the right. Except for validity

checking and participation in rounding, the digits shifted out of the rightmost decimal-digit position are ignored and are lost.

If one or more nonzero digits are shifted out during a left shift, or if the result digits count (RDC) control does not specify enough digits to contain all leftmost nonzero digits of the shifted value, decimal overflow occurs. The operation is completed. The result is obtained by ignoring the overflow digits, and if the condition code set (CS) flag is one condition code 3 is set. If the decimal-overflow mask in the PSW is one and the instruction-overflow mask (IOM) is zero, a program interruption for a decimal overflow occurs.

When the result, after the RDC control is applied, is nonzero and the force operand one positive (P1) control is zero, the sign of the second operand after P2 is applied determines the sign of the result and a preferred sign code is used. When the result, after being shifted, is zero and the P1 control is zero, the sign of the result is made positive with preferred sign code 1100. When the P1 control is one, the sign of the result is made positive with sign code 1111.

If the RDC control specifies less than thirty one digits, zeros are placed in the remaining leftmost digits of the first operand.

The I_3 field has the following format:

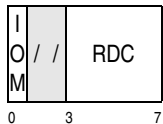

The bits of the I_3 field are defined as follows:

- **Instruction-Overflow Mask (IOM):** When the vector-packed-decimal-enhancement facility is not installed, bit 0 is reserved and must contain zero; otherwise, a specification exception is recognized. When the vector-packed-decimal-enhancement facility is installed, bit 0 is the instruction-overflow mask. When the instruction-overflow mask is one, recognition of a decimal overflow program interrupt is suppressed.
- **Reserved:** Bits 1-2 are reserved and must contain zeros. Otherwise, a specification exception is recognized.
- **Result Digits Count (RDC):** Bits 3-7 contain an unsigned binary number specifying the number

of rightmost digits of the shifted value to be placed in the first operand. If the magnitude of the shifted value is larger than the largest decimal number that can be represented with the specified number of digits, decimal overflow occurs. If the RDC field is zero, a specification exception is recognized.

The I_4 field has the following format:

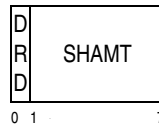

The bits of the I_4 field are defined as follows:

- **Decimal Rounding Digit (DRD):** When bit 0 is zero, the rounding digit is zero, when bit 0 is one, the rounding digit is 5.
- **Shift Amount: (SHAMT):** Bits 1-7 specify a signed binary integer representing the shift amount and direction. Bit 1 must equal bit 2 or results are unpredictable.

The M_5 field has the following format:



The bits of the M_5 field are:

- **Force Operand 2 Positive (P2):** When bit 0 is one, the second operand sign is treated as a positive sign and is not checked for validity. When bit 0 is zero, the second operand sign is used in the operation and is checked for validity.
- **Reserved:** Bit 1 is ignored but should contain zero; otherwise, the program may not operate compatibly in the future.
- **Force Operand 1 Positive (P1):** When bit 2 is one, the sign of the result placed in the first operand is forced to positive and a sign code of 1111 is used. When bit 2 is zero, the sign of the result placed in the first operand is the preferred sign code for the sign of the shifted value.
- **Condition Code Set (CS):** When bit 3 is zero, the condition code is not set and remains unchanged. When bit 3 is one, the condition

code is set as specified in the resulting condition code section below.

Resulting Condition Code:

When the CS bit is one, the condition code is set as follows:

- 0 Result zero; no overflow
- 1 Result less than zero; no overflow
- 2 Result greater than zero; no overflow
- 3 Overflow

When the CS bit is zero, the condition code remains unchanged.

Program Exceptions:

- Data with DXC FE, vector instruction
- Data with DXC 00, general operand
- Decimal overflow
- Operation (if the vector-packed-decimal facility for z/Architecture is not installed)
- Specification
- Transaction constraint

VECTOR SUBTRACT DECIMAL

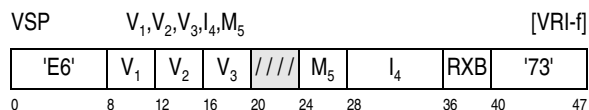

The third operand is subtracted from the second operand. The sign and specified number of rightmost digits of the difference are placed in the first operand location with other digits set to zero. The operands and result are in the signed-packed-decimal format.

VECTOR SUBTRACT DECIMAL is executed the same as VECTOR ADD DECIMAL, except that the third operand is considered to have a sign opposite to the sign in the potentially modified operand.

The sign codes of the second and third operands may be modified for use in the operation by the force operand two positive (P2) and force operand three positive (P3) controls respectively.

All digit codes are checked for validity. The sign codes are checked for validity unless overridden by the force operand two positive (P2) or force operand three positive (P3) controls.

When the result, after the result digits count (RDC) control is applied, is nonzero and the force operand one positive (P1) control is zero, rules of algebra determine the sign of the result and a preferred sign code is used. When the result, after the RDC control is applied, is zero and the P1 control is zero, the sign of the result is made positive with preferred sign code 1100. When the P1 control is one, the sign of the result is made positive with sign code 1111.

If the RDC control does not specify enough digits to contain all leftmost nonzero digits of the difference, decimal overflow occurs. The operation is completed. The result is obtained by ignoring the overflow digits, and if the condition code set (CS) control is one, condition code 3 is set. If the decimal-overflow mask in the PSW is one and the instruction-overflow mask (IOM) is zero, a program interruption for decimal overflow occurs.

If the RDC control specifies less than thirty one digits, zeros are placed in the remaining leftmost digits of the first operand.

The I₄ field has the following format:

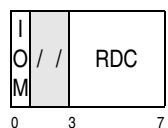

The bits of the I₄ field are defined as follows:

- **Instruction-Overflow Mask (IOM):** When the vector-packed-decimal-enhancement facility is not installed, bit 0 is reserved and must contain zero; otherwise, a specification exception is recognized. When the vector-packed-decimal-enhancement facility is installed, bit 0 is the instruction-overflow mask. When the instruction-overflow mask is one, recognition of a decimal overflow program interrupt is suppressed.
- **Reserved:** Bits 1-2 are reserved and must contain zeros. Otherwise, a specification exception is recognized.
- **Result Digits Count (RDC):** Bits 3-7 contain an unsigned binary number specifying the number of rightmost digits of the difference to be placed in the first operand. If the magnitude of the difference is larger than the largest decimal number that can be represented with the specified number of digits, decimal overflow occurs, and if the

decimal-overflow mask is one, a program interruption for decimal overflow occurs. If the RDC field is zero, a specification exception is recognized.

The M_5 field has the following format:



The bits of the M_5 field are:

- **Force Operand 2 Positive (P2):** When bit 0 is one, the second operand sign is treated as a positive sign and is not checked for validity. When bit 0 is zero, the second operand sign is used in the operation and is checked for validity.
- **Force Operand 3 Positive (P3):** When bit 1 is one, the third operand sign is treated as a positive sign and is not checked for validity. When bit 1 is zero, the third operand sign is used in the operation and is checked for validity.
- **Force Operand 1 Positive (P1):** When bit 2 is one, the sign of the result placed in the first operand is forced to positive and a sign code of 1111 is used. When bit 2 is zero, the sign of the result placed in the first operand is the preferred sign code for the sign of the difference.
- **Condition Code Set (CS):** When bit 3 is zero, the condition code is not set and remains unchanged. When bit 3 is one, the condition code is set as specified in the resulting condition code section below.

Resulting Condition Code:

When the CS bit is one, the condition code is set as follows:

- 0 Result zero; no overflow
- 1 Result less than zero; no overflow
- 2 Result greater than zero; no overflow
- 3 Overflow

When the CS bit is zero, the condition code remains unchanged.

Program Exceptions:

- Data with DXC FE, vector instruction

- Data with DXC 00, general operand
- Decimal overflow
- Operation (if the vector-packed-decimal facility for z/Architecture is not installed)
- Specification
- Transaction constraint

VECTOR TEST DECIMAL

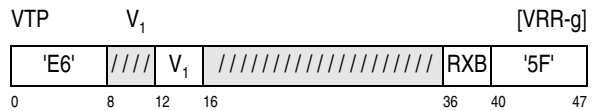

The first operand is tested for valid decimal digits and a valid sign code, and the result is indicated in the condition code. The operand is in the signed-packed-decimal format.

Resulting Condition Code:

- 0 All digit codes and the sign valid
- 1 All digit codes valid and sign invalid
- 2 At least one digit code invalid and sign valid
- 3 At least one digit code invalid and sign invalid

Program Exceptions:

- Data with DXC FE, vector instruction
- Operation (if the vector-packed-decimal facility for z/Architecture is not installed)
- Transaction constraint

VECTOR UNPACK ZONED

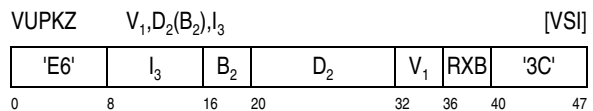

The format of the first operand is changed from the signed-packed-decimal format to the zoned format and placed in the second-operand location. The signed-packed-decimal and zoned formats are described in Chapter 8, "Decimal Instructions."

The first operand is treated as having the signed-packed-decimal format. Its digits and sign are placed unchanged in the second-operand location, using the zoned format. Zone bits with coding of 1111 binary are supplied for all bytes except the rightmost byte, the zone of which receives the sign of the first oper-

and. The sign and digits are not checked for valid codes.

The number of bytes the second operand occupies in storage is specified by the operand 2 length code (L2) control. If the second-operand field is too short to contain all digits of the first operand, the remaining leftmost portion of the first operand is ignored.

The I_3 field has the following format:

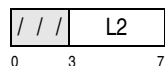

The bits of the I_3 field are defined as follows:

- **Reserved:** Bits 0-2 are reserved and must contain zeros. Otherwise, a specification exception is recognized.
- **Operand 2 Length Code (L2):** Bits 3-7 contain the length code of the second-operand. The

length of the second-operand is 1-31 bytes, corresponding to a length code in L2 of 0-30. The second-operand length must not exceed 31 bytes (L2 must be less than or equal to 30); otherwise, a specification exception is recognized.

Special Conditions:

If the L2 field is larger than 30 a specification exception is recognized.

Condition Code: The code remains unchanged.

Program Exceptions:

- Access (store, operand 2)
- Data with DXC FE, vector instruction
- Operation (if the vector-packed-decimal facility for z/Architecture is not installed)
- Specification
- Transaction constraint

Chapter 26. Specialized-Function-Assist Instructions

Instructions	26-1	DEFLATE CONVERSION CALL	26-16
COMPUTE DIGITAL SIGNATURE AUTHENTICATION	26-2		

The specialized-function-assist instructions described in this chapter are intended to provide performance improvements for specific operations used in software libraries, utilities, and operating system services. The facilities and instructions described in this chapter may be replaced or removed in the future. As a result, it is recommended that when a software library, utility, or operating system service provides an implementation using one or more of the specialized-function-assist instructions in this chapter, the software library also provides an alternate implementation which does not rely on any specialized-function-assist instruction in case the corresponding facility is not available to the program. It is also recommended that application programs use provided software libraries, utilities, or operating system services rather than use specialized-function-assist instructions directly.

The description for each instruction in this chapter specifies whether the instruction is a privileged or unprivileged instruction.

Instructions

The instructions described in this chapter are summarized in Figure 26-1 on page 26-1. The figure lists each instruction and indicates the instruction name, mnemonic, operation code, format, and other noteworthy characteristics.

Programming Notes:

1. The COMPUTE DIGITAL SIGNATURE AUTHENTICATION instruction is available when the message-security-assist extension 9 is installed.
2. The DEFLATE CONVERSION CALL instruction is available when the DEFLATE-conversion facility is installed.

Name	Mnemonic	Characteristics											Op-code	Page
		RRE	C	M9	$\alpha^{5,9}$	A	SP	IC	GM	I1	ST	R ₂		
COMPUTE DIGITAL SIGNATURE AUTHENTICATION	KDSA	RRE	C	M9	$\alpha^{5,9}$	A	SP	IC	GM	I1	ST	R ₂	B93A	26-2
DEFLATE CONVERSION CALL	DFLTCC	RRF-a	C	GZ	$\alpha^{5,9}$	A	SP	IC	GM	I1	ST	R ₁ R ₂ R ₃	B939	26-16

Explanation:

- α^5 Model dependent whether the instruction is restricted from transactional execution.
- α^9 Restricted in the constrained transactional-execution mode; a transaction-constraint program exception may be recognized. For PFD and PFDRL, the instruction is restricted only when the code in the M₁ field is 6 or 7; for STCMH, the instruction is restricted only when the M₃ field is zero and the code in the R₁ field is 6 or 7.
- A Access exceptions for logical addresses.
- C Condition code is set.
- Dg General-operand data exception.
- GM Instruction execution includes the implied use of multiple general registers:
 - General registers 0 and 1 for COMPUTE DIGITAL SIGNATURE AUTHENTICATION and DEFLATE CONVERSION CALL.
- GZ DEFLATE-conversion facility.
- I1 Access register 1 is implicitly designated in the access-register mode.
- IC Condition code alternative to interruptible instruction
- M9 Message-security-assist extension 9.
- R₁ R₁ field designates an access register in the access-register mode.

Figure 26-1. Summary of Specialized-Function-Assist Instructions (Part 1 of 2)

Name	Mnemonic	Characteristics	Op-code	Page
R ₂		R ₂ field designates an access register in the access-register mode.		
R ₃		R ₃ field designates an access register in the access-register mode.		
RRE		RRE instruction format.		
RRF		RRF instruction format.		
SP		Specification exception.		
ST		PER storage-alteration event.		

Figure 26-1. Summary of Specialized-Function-Assist Instructions (Part 2 of 2)

COMPUTE DIGITAL SIGNATURE AUTHENTICATION

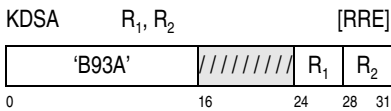

A function specified by the function code in general register 0 is performed.

Bits 16-23 of the instruction and the R₁ field are reserved and should contain zeros; otherwise, the program may not operate compatibly in the future.

General register 0 contains various controls affecting the operation of the instruction, as follows:

Function Code (FC): Bit positions 57-63 of general register 0 contain the function code. Figure 26-2 shows the assigned function codes for COMPUTE DIGITAL SIGNATURE AUTHENTICATION. All other function codes are unassigned. A specification

exception is recognized if an unassigned or uninstalled function code is specified.

Code	Function	Param. Block Size (bytes)	Data Block Size (bytes)
0	KDSA-Query	16	—
1	KDSA-ECDSA-Verify-P256	4096	—
2	KDSA-ECDSA-Verify-P384	4096	—
3	KDSA-ECDSA-Verify-P521	4096	—
9	KDSA-ECDSA-Sign-P256	4096	—
10	KDSA-ECDSA-Sign-P384	4096	—
11	KDSA-ECDSA-Sign-P521	4096	—
17	KDSA-Encrypted-ECDSA-Sign-P256	4096	—
18	KDSA-Encrypted-ECDSA-Sign-P384	4096	—
19	KDSA-Encrypted-ECDSA-Sign-P521	4096	—
32	KDSA-EdDSA-Verify-Ed25519	4096	32
36	KDSA-EdDSA-Verify-Ed448	4096	64
40	KDSA-EdDSA-Sign-Ed25519	4096	32
44	KDSA-EdDSA-Sign-Ed448	4096	64
48	KDSA-Encrypted-EdDSA-Sign-Ed25519	4096	32
52	KDSA-Encrypted-EdDSA-Sign-Ed448	4096	64
Explanation:			
— Not applicable			

Figure 26-2. Function Codes for COMPUTE DIGITAL SIGNATURE AUTHENTICATION

Deterministic (D): Bit position 56 of general register 0 contains the deterministic bit which effects the KDSA-ECDSA-Sign-P256, KDSA-ECDSA-Sign-P384, and KDSA-ECDSA-Sign-P521 function codes. When the deterministic bit is equal to zero the source random number is used to generate a secret random number within the execution of the instruction, hidden

to the user. This adds security to the signature process and the signature will vary with each execution. When the deterministic bit is equal to a one the source random number is used directly and will provide the same signature for each execution with the same input. Other function codes are unaffected by the deterministic bit.

Bits 0-31 of general register 0 are ignored. Bits 32-55 of general register 0 are reserved and should contain zeros; otherwise, the program may not operate compatibly in the future.

General register 1 contains the logical address of the leftmost byte of the parameter block in storage. In the 24-bit addressing mode, the contents of bit positions 40-63 of general register 1 constitute the address, and the contents of bit positions 0-39 are ignored. In the 31-bit addressing mode, the contents of bit positions 33-63 of general register 1 constitute the address, and the contents of bit positions 0-32 are ignored. In the 64-bit addressing mode, the contents of bit positions 0-63 of general register 1 constitute the address.

Figure 26-3 on page 26-3 shows the contents of the general registers just described.

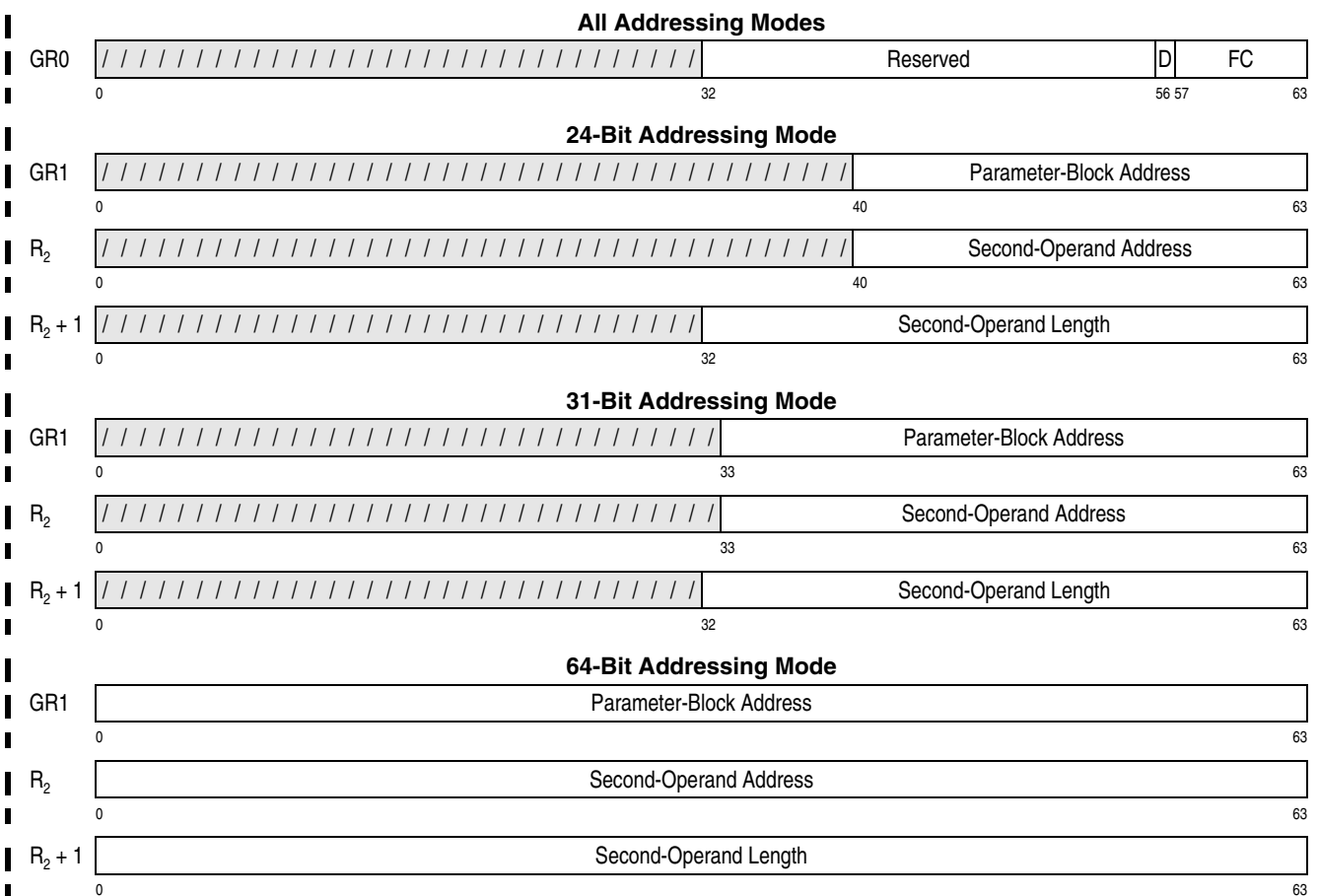

Figure 26-3. General Register Assignment for COMPUTE DIGITAL SIGNATURE AUTHENTICATION

In the access-register mode, access register 1 specifies the address space containing the parameter block.

The query function provides the means of indicating the availability of the other functions. The contents of

general registers R₂ and R₂ + 1 are ignored for the query function.

The verify functions check the validity of the signature of the hashed message and reports whether the credentials are valid via the condition code. The sign functions create a signature for the hashed message.

Note: The description of the COMPUTE DIGITAL SIGNATURE AUTHENTICATION (KDSA) instruction assumes that the reader is familiar with the Elliptic Curve Digital Signal Algorithm (ECDSA) described in Reference [24.] on page xxx and in the Edwards-curve Digital Signature Algorithm (EdDSA) described in Reference [25.] on page xxx.

In the case of ECDSA, three Weierstrass curves over prime fields are supported: NIST P256, P384, and P521. In Reference [24.] on page xxx these curves are actually referred to as P-256, P-384, and P-521, respectively. In Reference [32.] on page xxxi and Reference [33.] on page xxxi they are referred to as secp256r1, secp384r1, and secp521r1, respectively. Also see Reference [27.] on page xxx section 5.4 p.17-18 for algorithm details and see D.1.2.3-5 in Reference [24.] on page xxx p.100 for the curve parameter values including the prime modulus, the order, the coefficient, the base point x coordinate, and the base point y coordinate used by these function codes. Two other prime fields are supported which use the EdDSA algorithm in Reference [25.] on page xxx and Reference [26.] on page xxx referred to as Ed25519 and Ed448 though they use the curve Curve255-19 and Curve448, respectively. Also see Reference [25.] on page xxx for algorithm details and curve parameter values, section 5.1.7 and 5.2.7 describe the verify function and 5.1 and 5.2 describe the curve parameters for Ed25519 and Ed448 respectively which are used by these function codes. The following is the definition of the moduli of these fields:

- $P256 = 2^{256} - 2^{224} + 2^{192} + 2^{96} - 1$
- $P384 = 2^{384} - 2^{128} - 2^{96} + 2^{32} - 1$
- $P521 = 2^{521} - 1$
- $Ed25519 = 2^{255} - 19$
- $Ed448 = 2^{448} - 2^{224} - 1$

The sign and verify function codes (1, 2, 3, 9, 10, 11, 17, 18, and 19), which use the ECDSA algorithm on NIST curves, ignore the contents of general registers R_2 and $R_2 + 1$. These functions utilize a hashed message of fixed size which is contained in the parameter block.

The Edwards curve functions: KDSA-EdDSA-Verify, KDSA-EdDSA-Sign, and KDSA-Encrypted-EdDSA-Sign (function codes 32, 36, 40, 44, 48, and 52), use the EdDSA algorithm, and the message is not pre-hashed Reference [25.] on page xxx. The second operand is the message. The PureEdDSA variant is supported for the curves Ed25519 and Ed448. Other

variants such as the HashEdDSA variants Ed25519ph and Ed448ph and the context variant Ed25519ctx are not supported. The context is assumed to be null and the prehash function is the identity function and the flag is 0.

The R_2 field designates an even-odd pair of general registers and must designate an even-numbered register other than general register 0; otherwise, a specification exception is recognized.

The location of the leftmost byte of the second operand is specified by the contents of the R_2 general register. The number of bytes in the second-operand location is specified in general register $R_2 + 1$. Note the second-operand can have a length of zero bytes.

In the 24-bit addressing mode, the contents of bit positions 40-63 of general register R_2 constitute the address of the second operand, and the contents of bit positions 0-39 are ignored; bits 40-63 of the updated address replace the corresponding bits in general register R_2 , carries out of bit position 40 of the updated address are ignored, and the contents of bit positions 32-39 of general register R_2 are set to zeros. In the 31-bit addressing mode, the contents of bit positions 33-63 of general register R_2 constitute the address of the second operand, and the contents of bit positions 0-32 are ignored; bits 33-63 of the updated address replace the corresponding bits in general register R_2 , carries out of bit position 33 of the updated address are ignored, and the content of bit position 32 of general register R_2 is set to zero. In the 64-bit addressing mode, the contents of bit positions 0-63 of general register R_2 constitute the address of the second operand; bits 0-63 of the updated address replace the contents of general register R_2 and carries out of bit position 0 are ignored.

In both the 24-bit and the 31-bit addressing modes, the contents of bit positions 32-63 of general register $R_2 + 1$ form a 32-bit unsigned binary integer which specifies the number of bytes in the second operand; and the updated value replaces the contents of bit positions 32-63 of general register $R_2 + 1$. In the 64-bit addressing mode, the contents of bit positions 0-63 of general register $R_2 + 1$ form a 64-bit unsigned binary integer which specifies the number of bytes in the second operand; and the updated value replaces the contents of general register $R_2 + 1$.

In the 24-bit or 31-bit addressing mode, the contents of bit positions 0-31 of general registers R_2 and $R_2 + 1$, always remain unchanged. In the access register

mode, access register R_2 specifies the address space for the second operand.

These functions will be described in more detail along with their parameter blocks.

KDSA-Query (Function Code 0)

The location of the operands and addresses used by the instruction are shown in Figure 26-3 on page 26-3.

The parameter block used for the function has the following format shown in Figure 26-4:

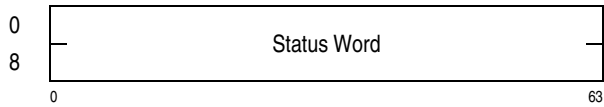

Figure 26-4. Parameter Block for KDSA-Query

A 128-bit status word is stored in the parameter block. Bits 0-127 of this field correspond to function codes 0-127, respectively, of the COMPUTE DIGITAL SIGNATURE AUTHENTICATION instruction. When a bit is one, the corresponding function is installed; otherwise, the function is not installed.

Condition code 0 is set when execution of the KDSA-Query function completes; condition codes 1, 2, and 3 are not applicable to this function.

KDSA-ECDSA-Verify Functions

This section describes the function codes for three KDSA-ECDSA-Verify functions for Weierstrass curves with NIST primes:

- KDSA-ECDSA-Verify-P256 (function code 1)
- KDSA-ECDSA-Verify-P384 (function code 2)
- KDSA-ECDSA-Verify-P521 (function code 3)

The locations of the operands and addresses used by each of these functions are as shown in Figure 26-3 on page 26-3. The parameter block contains the operands used by the KDSA-ECDSA-Verify functions and is addressed by general register 1.

The KDSA-ECDSA-Verify function checks the validity of a signed message. The originator of the message has a public key that can be used to see if the signature matches the hashed message. The signature consists of two integers in the prime field designated by R and S. The originator and receiver agree on a hashing scheme for creating the signature. The KDSA-ECDSA-Verify function operates on the already hashed message represented as $H(msg)$ in the parameter block. The hashed message is reduced to be less than the order of the curve by modulo reduction by the order of the curve. The originator's public key is represented by K. An elliptic curve public key is actually a point on the curve and has X and Y coordinates (represented by X_k and Y_k) within the prime field making it twice as big as other parameters. These operands are supplied to the function in the parameter block. The operation results in a true or false validity indication which is represented by a condition code equal to zero versus two respectively.

The parameter block used for KDSA-ECDSA-Verify-P256 function has the format as shown in Figure 26-5, below.

Offset	Dec	Hex	Field
00	00		Signature (R)
32	20		Signature (S)
64	40		Hashed Message - H(msg)
96	60		Public Cryptographic Key X component (X_k)
128	80		Public Cryptographic Key Y component (Y_k)
160	A0	C	RIBM
168	A8		Continuation State Buffer(CSB)
4088	FF8		

Figure 26-5. Parameter Block for KDSA-ECDSA-Verify-P256 Function

The parameter block for KDSA-ECDSA-Verify-P384 is shown in Figure 26-6, below. Each field is 48 bytes

Offset		
Dec	Hex	
00	00	Signature(R)
48	30	Signature(S)
96	60	Hashed Message - H(msg)
144	90	Public Cryptographic Key X component (Xk)
192	C0	Public Cryptographic Key Y component (Yk)
240	F0	C RIBM
248	F8	Continuation State Buffer(CSB)
4088	FF8	
		0 4 32 63

Figure 26-6. Parameter Block for KDSA-ECDSA-Verify-P384 Function

or 384 bits wide.

The parameter block for KDSA-ECDSA-Verify-P521 is shown in Figure 26-7, below. The NIST standard

Offset		
Dec	Hex	
00	00	Signature(R)
80	50	Signature(S)
160	A0	Hashed Message - H(msg)
240	F0	Public Cryptographic Key X component (Xk)
320	140	Public Cryptographic Key Y component (Yk)
400	190	C RIBM
408	198	Continuation State Buffer(CSB)
4088	FF8	
		0 4 32 63

Figure 26-7. Parameter Block for KDSA-ECDSA-Verify-P521 Function

defines data to be passed in “octets” which are 8 bits wide. 521-bit operands need to be padded on the leftmost significant bits with 7 zeros to form 528 bits or 66 bytes (octets). Each parameter is 66 bytes

which is right-aligned in the 80-byte field. The 14 remaining bytes are ignored and not updated. The hashed message is 66 bytes wide and upper bits can be non-zero which may require the function to perform modulo reduction by the order of the curve.

The reserved for IBM use (RIBM) field is 60 bits and the information code (C) is 4 bits for a total of 8 bytes, and must be initialized to zero prior to the first invocation of the instruction. The RIBM holds status and control information and continuation state buffer (CSB) is provided to hold intermediate results for partial completion reported by setting the condition code equal to 3. The parameter block should not be altered by the programmer after partial completion and before subsequent invocation. Corruption of the CSB is handled by the CPU clearing the intermediate results and status in the CSB and ending in partial completion which will allow a clean re-execution of the instruction. Also the CSB is cleared by the CPU of any intermediate state if the KDSA instruction ends with neither a condition code 3 nor an access exception. The information code is utilized by the KDSA Encrypted Sign functions to distinguish between different condition code one cases and is reserved for future use on other function codes.

Condition code 1 is set when the public key is invalid due to a coordinate not being greater than or equal to zero and less than the prime of the curve, or the point not on the curve. Condition code 2 is set if the signature is invalid, and condition code 0 is set if the signature is valid. Condition code 3 is set if the operation ends in partial completion.

KDSA-ECDSA-Sign Functions

Note: The description of the KDSA-ECDSA-Sign function assumes that the reader is familiar with the Elliptic Curve Digital Signal Algorithm (ECDSA) described in Reference [24.] on page xxx.

This section illustrates the operation for three KDSA-ECDSA-Sign and three KDSA-Encrypted-ECDSA-Sign functions:

- KDSA-ECDSA-Sign-P256 (function code 9)
- KDSA-ECDSA-Sign-P384 (function code 10)
- KDSA-ECDSA-Sign-P521 (function code 11)
- KDSA-Encrypted-ECDSA-Sign-P256 (function code 17)
- KDSA-Encrypted-ECDSA-Sign-P384 (function code 18)

- KDSA-Encrypted-ECDSA-Sign-P521 (function code 19)

The KDSA-ECDSA-Sign function uses a cryptographic key (K) that is a plain text key for the author's private key. The KDSA-Encrypted-ECDSA-Sign function uses an encrypted key to hold the author's private key and has a corresponding Wrapping Key Verification Pattern (WK_eVP) to test the key.

The ECDSA algorithm uses a random number to randomize the signature. KDSA-ECDSA-Sign and KDSA-Encrypted-ECDSA-Sign functions for NIST curves (P256, P384, and P521) utilize a user specified random number, RN, in the parameter block. For KDSA-ECDSA-Sign with the deterministic bit equal to zero and for KDSA-Encrypted-ECDSA-Sign, the specified random number is hashed with a CPU-generated random number that varies on each invocation. For KDSA-ECDSA-Sign with the deterministic bit equal to one the user specified random number is used directly, which makes every execution with the same input produce the same signature. The EdDSA algorithm does not use a random number.

The result of the sign function is a signature which is represented by two integers, R and S, which are between a value of zero and the order of the curve for the particular function and is stored in the designated location in the parameter block.

The parameter block for KDSA-ECDSA-Sign-P256 function with plain text key is shown in Figure 26-8, below.

Offset		
Dec	Hex	
00	00	Signature(R)
32	20	Signature(S)
64	40	Hashed Message - H(msg)
96	60	Private Cryptographic Key(K) in Plain Text
128	80	Random Number(RN)
160	A0	C RIBM
168	A8	Continuation State Buffer(CSB)
4088	FF8	
		0 4 32 63

Figure 26-8. Parameter Block for KDSA-ECDSA-Sign-P256 Function

The parameter block for KDSA-ECDSA-Sign-P384 function with plain text key is shown in Figure 26-9, below.

Offset		
Dec	Hex	
00	00	Signature(R)
48	30	Signature(S)
96	60	Hashed Message - H(msg)
144	90	Private Cryptographic Key(K) in Plain Text
192	C0	Random Number(RN)
240	F0	C RIBM
248	F8	Continuation State Buffer(CSB)
4088	FF8	
		0 4 32 63

Figure 26-9. Parameter Block for KDSA-ECDSA-Sign-P384 Function

The parameter block for KDSA-ECDSA-Sign-P521 function for with plain text key is shown in Figure 26-10. The NIST standard defines data to be

Offset		
Dec	Hex	
00	00	Signature(R)
80	50	Signature(S)
160	A0	Hashed Message - H(msg)
240	F0	Private Cryptographic Key(K) in Plain Text
320	140	Random Number(RN)
400	190	C RIBM
408	198	Continuation State Buffer(CSB)
4088	FF8	
		0 4 32 63

Figure 26-10. Parameter Block for KDSA-ECDSA-Sign-P521 Function

passed in “octets” which are 8 bits wide. 521-bit operands need to be padded on the leftmost significant bits with 7 zeros to form 528 bits or 66 bytes (octets). Each parameter is 66 bytes which is right-aligned in the 80-byte field. The 14 remaining bytes are ignored and not updated. The hashed message is 66 bytes wide and leftmost bits can be non-zero which may

require the function to perform modulo reduction by the order of the curve.

The parameter block for KDSA-Encrypted-ECDSA-Sign-P256 which uses an encrypted key is shown in Figure 26-11, below.

Offset		
Dec	Hex	
00	00	Signature(R)
32	20	Signature(S)
64	40	Hashed Message - H(msg)
96	60	Encrypted Private Cryptographic Key ($WK_a(K)$)
128	80	Random Number(RN)
160	A0	AES Wrapping-Key Verification Pattern (WK_aVP)
192	C0	C RIBM
200	C8	Continuation State Buffer(CSB)
4088	FF8	
		0 4 32 63

Figure 26-11. Parameter Block for KDSA-Encrypted-ECDSA-Sign-P256 Function

The parameter block for KDSA-Encrypted-ECDSA-Sign-P384 function is shown in Figure 26-12, below.

Offset		
Dec	Hex	
00	00	Signature(R)
48	30	Signature(S)
96	60	Hashed Message - H(msg)
144	90	Encrypted Private Cryptographic Key ($WK_a(K)$)
192	C0	Random Number(RN)
240	F0	AES Wrapping-Key Verification Pattern ($WK_a(VP)$)
272	110	C RIBM
280	118	Continuation State Buffer(CSB)
4088	FF8	
		0 4 32 63

Figure 26-12. Parameter Block for KDSA-Encrypted-ECDSA-Sign-P384 Function

The parameter block for KDSA-Encrypted-ECDSA-Sign-P521 function is shown in Figure 26-13, below.

Offset		
Dec	Hex	
00	00	Signature(R)
80	50	Signature(S)
160	A0	Hashed Message - H(msg)
240	F0	Encrypted Private Cryptographic Key ($WK_a(K)$)
320	140	Random Number(RN)
400	190	AES Wrapping-Key Verification Pattern ($WK_a(VP)$)
432	1B0	C RIBM
440	1B8	Continuation State Buffer(CSB)
4088	FF8	
		0 4 32 63

Figure 26-13. Parameter Block for KDSA-Encrypted-ECDSA-Sign-P521 Function

P521 format has 521 bits with an additional most significant 7 bits of zeros for R, S, and operands for 66 bytes which are right aligned within the 80 byte field. The remaining 14 bytes of the R and S fields are unchanged. The hashed message is the width of the whole 80-byte field.

Condition code 1 is set and C is set to 0001 binary if the verification pattern mismatches. The condition code is set to 1 and C is set to 0000 binary if the private key is zero or greater than or equal to the order of the curve. Condition code 2 is set if the random number is not invertible for ECDSA-Sign with the deterministic bit set to one but not when the deterministic bit is zero or for Encrypted-ECDSA-Sign. For ECDSA-Sign with the deterministic bit set to zero and for Encrypted-ECDSA-Sign the CPU generated random number will be invertible. Condition code 0 is set if signature generation is successful. Condition code 3 is set if the operation ends in partial completion.

KDSA-EdDSA-Verify Functions

This section illustrates the operation for two KDSA-EdDSA-Verify functions for Edwards curves:

- KDSA-EdDSA-Verify-Ed25519 (function code 32)
- KDSA-EdDSA-Verify-Ed448 (function code 36)

The locations of the operands and addresses used by each of these functions are as shown in Figure 26-3 on page 26-3. The parameter block contains the operands used by the KDSA-EdDSA-Verify functions and is addressed by general register 1.

Note that EdDSA is defined in RFC-8032 Reference [25.] on page xxx to have integers encoded in little-endian form as opposed to most cryptographic algorithms. Transformation from little-endian to big-endian can be accomplished by a MOVE INVERSE (MVCIN) instruction and KDSA is assumed to have operands in big-endian form.

For Ed25519 the most significant bit of the most significant byte is not needed for 255 bit format though the standard requires this bit to be a zero. For compressed points the y-coordinate is placed in the 255 least significant bits and the x-coordinate least significant bit is placed in the remaining most significant bit. Ed448 encodes a compressed point with the 56 byte y-coordinate in the least significant 56 bytes of the 57 bytes and the x-coordinate least significant bit

is placed in the most significant bit of the most significant byte and the remaining bits of the byte are filled with zeros. Note that the integer representation of a compressed point can not take on all values, and there are some values which are invalid and can not be decompressed. In the case of input that can not be decompressed, such as the signature R or the public key, a condition code is produced indicating the input is invalid.

The KDSA-EdDSA-Verify function checks the validity of a signed message. The originator of the message has a public key that can be used to see if the signature matches the hashed message. The signature consists of two integers in the prime field designated by R and S. The originator and receiver agree on a hashing scheme for creating the signature. The KDSA-EdDSA-Verify function operates on full message which is addressed by operand 2. The originator's public key is represented by K in the parameter block and it is in compressed format where the least significant bit of the x coordinate is concatenated to all the bits of the y coordinate. Therefore the public key is slightly wider than the prime of the curve taking 57 bytes for the Ed448 curve. The operation results in a true or false validity indication in the condition code represented by condition code equal to zero or two respectively.

Note the public key and signature R are compressed points that are represented in big-endian form in the parameter block, though the RFC-8032 algorithm Reference [25.] on page xxx requires these compressed points to be hashed in little-endian format in compressed format. This requires byte reversing the public key and signature R.

The parameter block used for KDSA-EdDSA-Verify-Ed25519 function has the format as shown in

Figure 26-14, below. R, S, and K are represented as

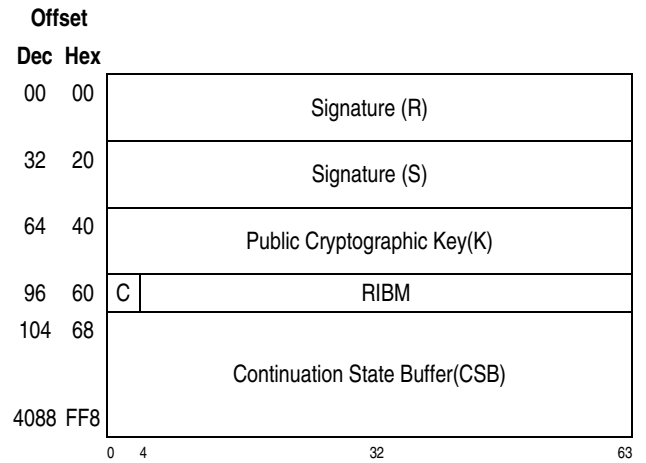

Figure 26-14. Parameter Block for KDSA-EdDSA-Verify-Ed25519 Function

32 bytes or 256 bits wide.

The parameter block for KDSA-EdDSA-Verify-Ed448 is shown in Figure 26-15, below. R, S, and K fields

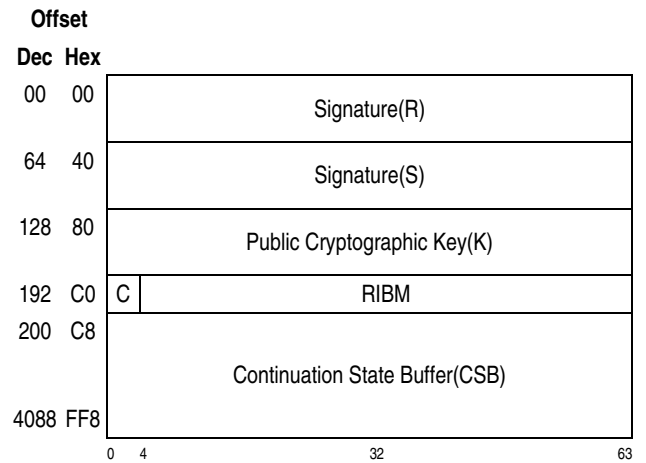

Figure 26-15. Parameter Block for KDSA-EdDSA-Verify-Ed448 Function

are 64 bytes or 512 bits wide. The S parameter is represented by the right most 456 bits of the 512 bit field and the R and K field which are compressed points are represented by the right most 456 bits of the 512 bit field.

The second operand address in general register R_2 and the second operand length in general register R_2+1 are not updated as the message is processed.

Condition code 1 is set when the public key is invalid due to the compressed point not being decompressable or the Y coordinate not being greater than or

equal to zero and less than the prime of the curve, or the point not on the curve. Condition code 2 is set if the signature is invalid and condition code 0 is set if the signature is valid. There are several cases of the signature being invalid such as the compressed point R not being decompressible or its resulting Y coordinate not greater than zero and less than the prime or the signature S not being greater than zero and less than the prime or the signature not matching. Note for Ed448 S is 57 bytes and the most significant byte must be zero otherwise condition code 2 is set. Condition code 3 is set if the operation ends with partial completion.

KDSA-EdDSA-Sign Functions

Note: The description of the KDSA-EdDSA-Sign function assumes that the reader is familiar with the Edwards-curve Digital Signature Algorithm (EdDSA) described in Reference [25.] on page xxx.

This section illustrates the operation for two KDSA-EdDSA-Sign functions and the two KDSA-Encrypted-EdDSA-Sign functions:

- KDSA-EdDSA-Sign-Ed25519 (function code 40)
- KDSA-EdDSA-Sign-Ed448 (function code 44)
- KDSA-Encrypted-EdDSA-Sign-Ed25519 (function code 48)
- KDSA-Encrypted-EdDSA-Sign-Ed448 (function code 52)

The KDSA-EdDSA-Sign function uses a cryptographic key (K) that is a plain text key for the author's private key. This key must be protected by software. The KDSA-Encrypted-EdDSA-Sign function uses an encrypted key to hold the author's private key and has a corresponding Wrapping Key Verification Pattern (WK_aVP) to test the key.

The EdDSA algorithm does not use a random number and therefore none is specified for KDSA-EdDSA-Sign functions.

The result of the KDSA-EdDSA-Sign function is a signature which is represented by two integers, R and S, where S is between a value of zero and the

order of the curve for the particular function and is stored in the designated location in the parameter block.

Note that for EdDSA the private key is not checked for range since it is directly hashed and does not need to be in a certain range.

Note the public key and signature R are compressed points that are created internal to the sign operation in big-endian form, though the RFC-8032 algorithm Reference [25.] on page xxx requires these compressed points to be hashed in little-endian format in compressed format. This requires byte reversing the public key and signature R.

The parameter block for KDSA-EdDSA-Sign-Ed25519 with plain text key is shown in Figure 26-16, below. The R, S, and K parameters are 32 byte

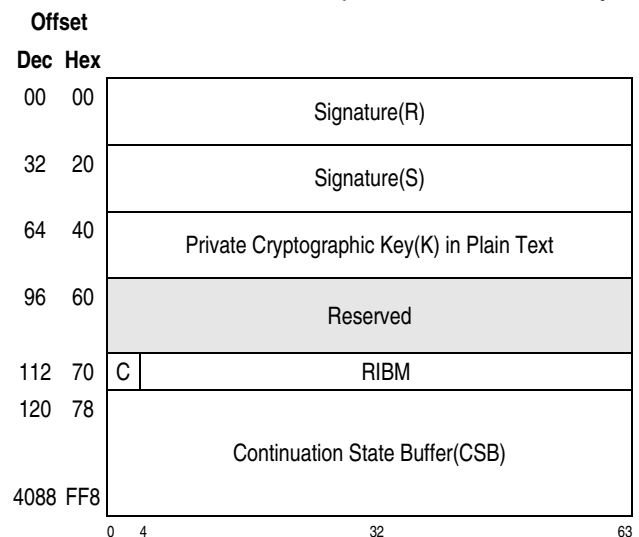

Figure 26-16. Parameter Block for KDSA-EdDSA-Sign-Ed25519 Functions

fields. Note that the S parameter has the most significant bit of the field forced to zero. No random number is specified since EdDSA algorithm does not require one.

The parameter block for KDSA-EdDSA-Sign-Ed448 function with plain text key is shown in Figure 26-17,

below. The R, S, and the K parameters are 456 bits

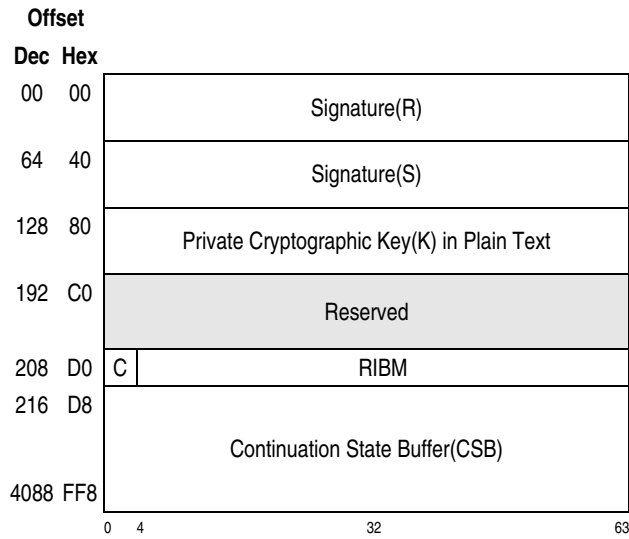

Figure 26-17. Parameter Block for KDSA-EdDSA-Sign-Ed448 Function

or 57 bytes and are right aligned. The remaining bytes of the R and S fields are unchanged. The Ed448 format also uses the EdDSA algorithm which does not utilize a random number.

The reserved for IBM use (RIBM) field is 60 bits and the information code (C) is 4 bits for a total of 8 bytes, and must be initialized to zero prior to the first invocation of the instruction. The RIBM holds status and control information and continuation state buffer (CSB) is provided to hold intermediate results for partial completion reported by setting the condition code equal to 3. The parameter block should not be altered by the programmer after partial completion and before subsequent invocation. Corruption of the CSB is handled by the CPU clearing the intermediate results and status in the CSB and ending in partial completion which will allow a clean re-execution of the instruction. Also the CSB is cleared by the CPU of any intermediate state if the KDSA instruction ends with neither a condition code 3 nor an access exception. The information code is utilized by the KDSA Encrypted Sign functions to distinguish between different condition code one cases and is reserved for future use on other function codes.

The parameter block for KDSA-Encrypted-EdDSA-Sign-Ed25519 for encrypted key is shown in

Figure 26-18, below. Note the Ed25519 format uti-

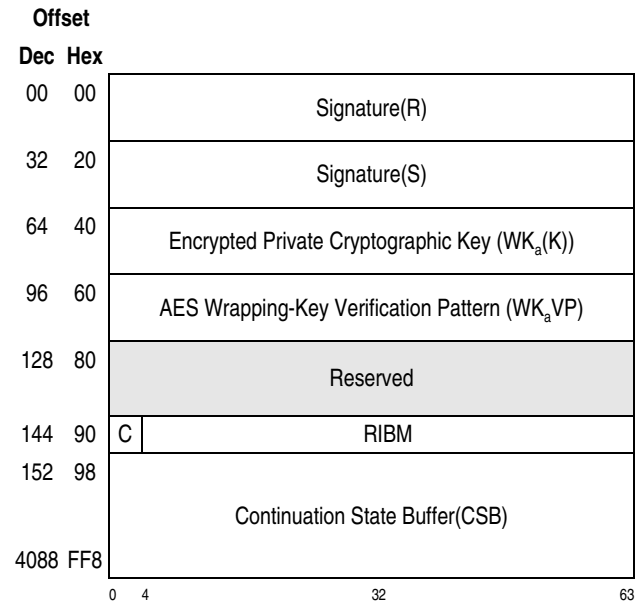

Figure 26-18. Parameter Block for KDSA-Encrypted-EdDSA-Sign-Ed25519 Function

lizes 32 bytes for each parameter including the S field which has a zero for the most significant bit.

The parameter block for KDSA-Encrypted-EdDSA-Sign-Ed448 is shown in Figure 26-19, below. The R

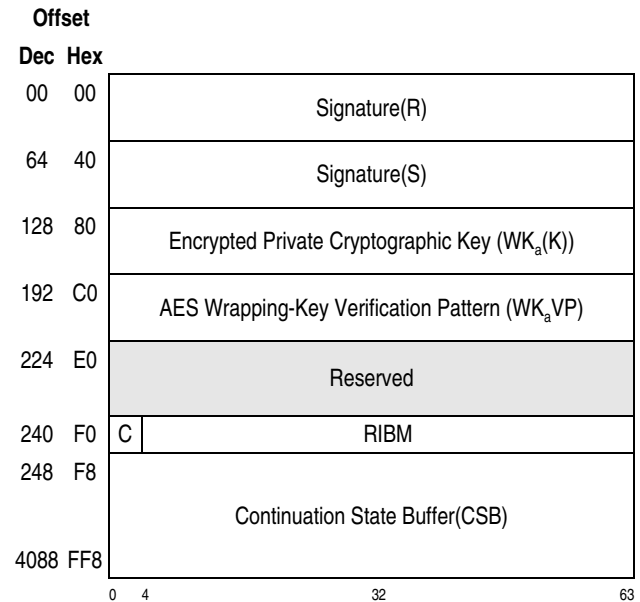

Figure 26-19. Parameter Block for KDSA-EdDSA-Sign-Ed448 Function

and S parameters require 456 bits or 57 bytes and they are right aligned within the 64 byte fields.

The second operand address in general register R_2 and the second operand length in general register $R_2 + 1$ are not updated as the message is processed which is twice for the KDSA-EdDSA-Sign and KDSA-Encrypted-EdDSA-Sign functions.

Condition code 1 is set and C is set to 0001 binary, if the verification pattern mismatches. The condition code is set to 1 and C is set to 0000 binary, if the private key is zero or greater than or equal to the order of the curve. And condition code 0 is set if signature generation is successful. Condition code 3 is set if the operation ends with partial completion.

Operand Field Description

The fields of the parameter block for all KDSA-Verify and KDSA-Sign functions are as follows where each parameter is right aligned in the field and extracted to byte boundaries (P521 parameters are 66 bytes or 528 bits with the most significant 7 bits equal to zeros, except for the hashed message which allows these 7 bits to be non-zero):

Signature (R): The first part of the signature is represented by R. For ECDSA, R is an unsigned integer which is greater than zero and less than the order of the curve, otherwise it is considered an invalid signature and for the ECDSA Verify function results in a condition code equal to 2. For EdDSA functions, R is a compressed point where the least significant bit of X is concatenated with the Y. R must be decompressable or the condition code is set to 2. For Ed25519, R is 256 bits consisting of 1 bit of X concatenated on the left of 255 bits of Y and for Ed448 an extra byte is added on the left with 1 bit X concatenated with 7 zeros, followed by 448 bits of Y. The Y coordinate must be greater than or equal to zero and less than the prime otherwise it is considered an invalid signature resulting in a condition code equal to 2.

Signature (S): The second part of the signature is represented by S. S is an unsigned integer for both ECDSA and EdDSA functions and is greater than zero and less than the order of the curve, otherwise for the Verify functions it is considered an invalid signature resulting in a condition code equal to 2.

Hashed Message - H(msg): The sign and verify operation utilize a hashed version of the author's message for ECDSA curves. Hashing for ECDSA is performed prior to the KDSA instruction to allow greater flexibility in supported encryption. The hashed message is an unsigned integer and can be

any value including zero or greater than the prime. The hashed message is reduced by the function modulo the order of the curve to be greater than or equal to zero and less than the order of the curve. This parameter is not available on EdDSA curves, since they do not prehash the message, and instead operand 2 addresses the encrypted message.

Cryptographic Key (K): The cryptographic key used in the sign and verify operations begins at various bytes of the parameter block. The size of the key field and its offset in the parameter block are dependent on the function code, as shown in Figure 26-20.

Function Code	Function	Key Length (bytes)	Key Offset (bytes)
1	KDSA-ECDSA-Verify-P256	32x2	96-159
2	KDSA-ECDSA-Verify-P384	48x2	144-239
3	KDSA-ECDSA-Verify-P521	66x2	254-319, 334-399
9	KDSA-ECDSA-Sign-P256	32	96-127
10	KDSA-ECDSA-Sign-P384	48	144-191
11	KDSA-ECDSA-Sign-P521	66	254-319
17	KDSA-Encrypted-ECDSA-Sign-P256	32	96-127
18	KDSA-Encrypted-ECDSA-Sign-P384	48	144-191
19	KDSA-Encrypted-ECDSA-Sign-P521	80	240-319
32	KDSA-EdDSA-Verify-Ed25519	32	64-127
36	KDSA-EdDSA-Verify-Ed448	57	135-191
40	KDSA-EdDSA-Sign-Ed25519	32	64-95
44	KDSA-EdDSA-Sign-Ed448	57	135-191
48	KDSA-Encrypted-EdDSA-Sign-Ed25519	32	64-95
52	KDSA-Encrypted-EdDSA-Sign-Ed448	64	128-191

Figure 26-20. Summary of Key Lengths and Offsets for KDSA Functions

The key used for KDSA-EdDSA-Verify functions is a compressed point whereas the other functions use an integer key. If the compressed point public key can not be decompressed or if the Y coordinate is greater than or equal to the prime the condition code is set to 1. Note that Ed25519 requires 255 least significant bits of the 256-bit, 32-byte field. The KDSA-Sign for P521 and Ed448 require different key widths for encrypted key and plain text functions. The encrypted key is encoded into blocks of 128 bits. The P521 plain text key for sign and for verify are 521 bits which is 65 bytes and 1 bit, which is aligned in the

right most bits of the 66 byte key and the 66 byte key is aligned in the right most bytes of the 80 byte field in the parameter block.

For KDSA-ECDSA-Sign the key must be greater than zero and less than the order of the curve or the condition code is set to 1. For KDSA-ECDSA-Verify the public key point has to be on the curve and the coordinates must be less than the order of the curve or the condition code is set to 1.

AES Wrapping-Key Verification Pattern (WK_aVP): For the KDSA-Encrypted-Sign functions (codes 17-19, 48, and 52), the 32 bytes immediately following the key in the parameter block contain the AES wrapping-key verification pattern (WK_aVP).

For the KDSA-Verify functions and the plain text key KDSA-Sign functions, the WK_aVP field is not present in the parameter block.

Wrapping-Key Verification: For the KDSA-Sign with encrypted key functions (function codes 17-19, 48, and 52), the contents of the 32-byte WK_aVP field are compared with the contents of the AES wrapping-key verification-pattern register. If they mismatch, the parameter-block location remains unchanged, and the operation is completed by setting condition code 1. If they match, the contents of the key field of the parameter block are deciphered using the AES wrapping key to obtain the cryptographic key, K. (See the “Protection of Cryptographic Keys” on page 7-431 for details.) Note encrypted ECC keys are protected by AES-256 encryption.

For the KDSA functions that do not use encrypted keys, wrapping-key verification is not performed.

Random Number (RN): The KDSA-ECDSA-Sign and KDSA-Encrypted-Sign functions have an input random number. For KDSA-ECDSA-Sign functions with the deterministic bit set equal to one the random number must be greater than zero. Bits more significant than number bits in the prime number are forced to zero and if not less than the order of the curve of the function, the order of curve is subtracted from the random number. The random number must be invertible by the order of curve otherwise the parameter-block location remains unchanged, and the operation is completed by setting condition code 2.

For KDSA-ECDSA-Sign with the deterministic bit equal to zero and for KDSA-Encrypted-ECDSA-Sign

functions the random number can be any value including zero, since it is not used directly but instead is used as a seed to create an invertible, hidden, random number.

RIBM, C, and Continuation State Buffer (CSB):

The RIBM and C must be initialized to zero prior to the first invocation of the instruction. This reserved area and continuation state buffer (CSB) are provided to hold intermediate results for partial completion reported by setting the condition code equal to 3. The parameter block should not be altered by the programmer after partial completion and before subsequent invocation. If corruption is detected in the RIBM and CSB the CPU clears the CSB intermediate state and status and ends the instruction in partial completion which will allow a clean re-execution of the instruction. Also, the CSB is cleared by the CPU of any intermediate state when the ends in neither partial completion nor an access exception. The C field is an information code field defined for the KDSA Encrypted Sign functions to distinguish the condition code one cases of private key not in range, C=0000 binary, and the WKVP mismatch, C=0001 binary and is reserved for other functions.

Reserved: As an input to an operation, reserved fields should contain zeros; otherwise, the program may not operate compatibly in the future. When an operation ends, reserved fields may be stored as zeros or may remain unchanged.

Common Operation

When the entire parameter block overlaps the PER storage-area designation, a PER storage-alteration event is recognized, when applicable, for the parameter block. When only a portion of the parameter block overlaps the PER storage-area designation, it is model-dependent which of the following occurs:

- A PER storage-alteration event is recognized, when applicable, for the entire parameter block.
- A PER storage-alteration event is recognized, when applicable, for the portion of the parameter block that is stored.

A PER zero-address-detection event is recognized, when applicable, for the second-operand location and for the parameter block.

For functions that perform a comparison of the wrapping-key verification pattern field in the parameter

block with the wrapping-key verification-pattern register, it is unpredictable whether access exceptions and PER zero-address-detection events are recognized for the second operand when the comparison results in a mismatch.

When the contents of general register R_2 are zero, multiple PER zero-address-detection events will be detected if the instruction ends in partial completion.

Access exceptions may be reported for a larger portion of an operand than is processed in a single execution of the instruction; however, access exceptions are not recognized for locations beyond the length of an operand nor for locations more than 4 K-bytes beyond the current location being processed. The entire parameter block may be tested for store-type accesses even though part of it may not be stored. All KDSA function codes may test for store-type accesses including KDSA-Verify since it could store to the RIBM and CSB fields on partial completion.

Special Conditions for KDSA

If the second operand overlaps the parameter block, results are unpredictable.

A specification exception is recognized and no other action is taken if any of the following occurs:

1. Bits 57-63 of general register 0 specify an unassigned or uninstalled function code.
2. The R_2 field designates an odd-numbered register or general register 0.

Resulting Condition Code:

- 0 Query: function completes; Verify: signature verified for function; Sign: normal completion.
- 1 Verify: public key not on curve, or not decompressable, or coordinate greater than the prime of the curve; Sign: key verification-pattern mismatch, or for ECDSA-Sign the private key is equal to zero or greater than the prime of the curve.
- 2 Verify: signature is incorrect, or for EdDSA R not decompressable, or for non-Encrypted ECDSA sign with $D=1$: random number not invertible or out of range ($0 < RN < \text{order of curve}$).
- 3 Partial completion

Program Exceptions:

- Access (fetch, parameter block fields, operand 2 (EdDSA functions only); store, parameter block fields)
- Operation (if the message-security-assist extension 9 is not installed)
- Specification
- Transaction constraint

1.-6.	Exceptions with the same priority as the priority of program-interruption conditions for the general case.
7.A	Access exceptions for second instruction halfword.
7.B	Operation exception.
7.C	Transaction constraint.
8.	Specification exception due to invalid function code or invalid register number.
9.A.1	Access exceptions for an access to the parameter block.
9.A.2	Sign function with condition code 1 due to verification-pattern mismatch, or ECDSA private key equal to zero or greater than the order of the curve. Verification function for ECDSA with condition code 1 due to the public key not on the curve or one or more of the coordinates greater than or equal to the order. Verification function for EdDSA with condition code 1 due to the public key not decompressable, or one or more of the coordinates greater than or equal to the prime.
9.A.3	ECDSA Sign (non-encrypted) function and $D = 1$ with condition code 2 due to a non-invertible random number or out of range ($0 < RN < \text{order of curve}$). Verification function for ECDSA with condition code 2 due to the signature equal to zero or greater than or equal to the prime of the curve. Verification function for EdDSA with condition code 2 due to the signature S equal to zero or greater than or equal to the order of the curve or signature R not decompressable or the Y coordinate greater than or equal to the prime.
9.B	Access exceptions for an access to the second operand.

Figure 26-21. Priority of Execution: KDSA

10.	Condition code 3 due to partial processing.
11.	Condition code 0 due to normal completion or condition code 2 due to signature incorrect.

Figure 26-21. Priority of Execution: KDSA (Continued)

Programming Notes:

1. The performance of the query function (code 0) may be significantly slower than that of simply examining a location in storage. If the program needs to frequently test for the availability of a function, it should perform the query function once during initialization; subsequently it should examine the stored results of the query function in memory with an instruction such as TEST UNDER MASK.
2. When condition code 3 is set, the general registers containing the operand addresses and lengths, and the parameter block, are updated such that the program can simply branch back to the instruction to continue the operation.
3. The R₁ field is not used by this instruction for any function codes.
4. Software should clear fields in the parameter block that are sensitive such as the Private Key and the Random Number to limit the time exposed in storage. The CPU will zero out the CSB upon restart of the instruction and full completion.
5. The reserved field should be initialized to zero otherwise the program may not operate compatibly in the future.

DEFLATE CONVERSION CALL

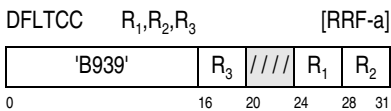

DEFLATE CONVERSION CALL performs functions related to transforming the state of data between the original (uncompressed) form of the data, and a compressed representation of the data, as specified by the standard described in Reference [23.] on page xxx. The uncompressed data is a sequence of bytes. The compressed representation of the data includes symbols. Symbols represent an individual byte of uncompressed data, referred to as a literal byte, or

represent a reoccurring sequence of bytes of uncompressed data, referred to as a duplicate string. A Huffman table specifies the encoding and decoding between compressed-data symbols and uncompressed data. There are two types of Huffman tables. A fixed-Huffman table (FHT) is a predetermined specification which includes all possible codings. A dynamic-Huffman table (DHT) is a set of codings created specifically for the data to be compressed, which may be a subset of all possible codings. A compressed representation of data generated with a DHT is typically smaller than a compressed representation of the same data generated with an FHT. A portion of the most recently processed uncompressed data, referred to as history, is maintained for encoding and decoding compressed-data symbols representing duplicate strings. The history is the reference source for duplicate strings. The history is updated as data is processed during an operation.

The definition of DEFLATE CONVERSION CALL assumes knowledge of the DEFLATE compressed data format, which is described in Reference [23.] on page xxx. Noteworthy attributes of the DEFLATE standard which apply to DEFLATE CONVERSION CALL are as follows:

- A compressed-data set consists of a series of blocks. There are three types of blocks. One type consists of a 3-bit header followed by length information and uncompressed data. Two types of blocks consists of a 3-bit header followed by compressed-data elements.
- Compressed-data elements may include a compressed representation of a dynamic-Huffman table, compressed-data symbols, and an end-of-block (EOB) symbol.
- Compressed-data elements have various bit lengths.
- Compressed-data elements may begin or end between byte boundaries in storage.
- Compressed-data elements are loaded into bytes in order from the rightmost bit position to the leftmost bit position.

Refer to “Descriptions for Compressed-data Blocks” on page 26-43 for details on boundaries and orderings for bytes and bits of the various blocks encountered in a compressed-data set.

When a compressed-data element occupies part of, and not all of, a byte in storage, the entire byte in storage is accessed. Storage-operand lengths specify the number of addressable bytes, which may

specify more bits than the compressed-data occupies.

DEFLATE CONVERSION CALL is an unprivileged instruction. It may be executed when the CPU is in the problem or supervisor state.

Bits 20-23 of the instruction are reserved and should contain zeros; otherwise, the program may not operate compatibly in the future.

A function specified by the function code in bit positions 57-63 of general register 0 is performed. Figure 26-22 shows the assigned function codes for DEFLATE CONVERSION CALL. All other function codes are unassigned. When the specified function is DFLTCC-CMPR or DFLTCC-XPND, bit 56 of general register 0 specifies the history-buffer type (HBT) used during the operation. When HBT is zero, the history buffer is called an in-line history buffer. When using an in-line history buffer, the history is immediately to the left of the second operand when DFLTCC-CMPR is specified, and is immediately to the left of the first operand when DFLTCC-XPND is specified. When HBT is one, the history-buffer is called a circular history buffer. When using a circular history buffer, the history is a portion of, or all of, the third operand when either DFLTCC-CMPR or DFLTCC-XPND is specified. When the DFLTCC-QAF or DFLTCC-GDHT function is specified, bit 56 of general register 0 is ignored. Bit positions 0-31 of general register 0 are ignored. Bit positions 32-55 of general register 0 are reserved and should contain zeros; otherwise, the program may not operate compatibly in the future.

Code	Function	Parameter Block Size (bytes)
0	DFLTCC-QAF	32
1	DFLTCC-GDHT	384
2	DFLTCC-CMPR	1536
4	DFLTCC-XPND	1536

Figure 26-22. Function Codes for DEFLATE COMPRESSION CALL

When bits 57-63 of general register 0 designate an unassigned or uninstalled function code, a specification exception is recognized.

The contents of general register 1 specify the logical address of the leftmost byte of the parameter block in storage. The parameter block must be designated on

a doubleword boundary; otherwise a specification exception is recognized.

When the specified function is DFLTCC-CMPR or DFLTCC-XPND, the contents of general register R_1 specify the logical address of the leftmost byte of the first operand. When the specified function is DFLTCC-CMPR, the contents of general register $R_1 + 1$, in conjunction with the values of the NT and SBB fields of the parameter block, specify the length of the first operand. Figure 26-23 on page 26-17 provides examples which demonstrate the length of the first operand for the DFLTCC-CMPR function as a function of the contents of general register $R_1 + 1$, the NT field, and the SBB field. When the specified function is DFLTCC-XPND, the contents of general register $R_1 + 1$ specify the length of the first operand. When the specified function is DFLTCC-CMPR or DFLTCC-XPND the results of compressing or uncompressing data are stored at the first-operand location. When the DFLTCC-QAF or DFLTCC-GDHT function is specified, the contents of general registers R_1 and $R_1 + 1$ are ignored. For all functions, the R_1 field designates an even-odd pair of general registers. For all functions, the R_1 field must not designate general register 0 and must designate an even-numbered register; otherwise, a specification exception is recognized.

contents of GR $R_1 + 1$ (hex)	NT	SBB (binary)	length of first operand
00000000 00000002	0	001	15 bits
00000000 00000001	1	---	8 bits
00000000 00000001	0	000	8 bits
00000000 00000001	0	011	5 bits
00000000 00000001	0	111	1 bit
00000000 00000000	-	---	0 bits

Figure 26-23. Examples Illustrating how NT and SBB Apply to the length of the first operand for the DFLTCC-CMPR function

When the specified function is DFLTCC-GDHT, DFLTCC-CMPR, or DFLTCC-XPND, the contents of general register R_2 specify the logical address of the leftmost byte of the second operand. When the specified function is DFLTCC-CMPR or DFLTCC-GDHT, the contents of general register $R_2 + 1$ specify the length of the second operand. When the specified

function is DFLTCC-XPND, the contents of general register $R_2 + 1$, in conjunction with the values of the NT and SBB fields of the parameter block, specify the length of the second operand. When the second-operand length is referenced and has a non-zero value at the beginning of the execution of the instruction, data is fetched from the second-operand location. When the second-operand length is referenced, has a value of zero at the beginning of the execution of the instruction, and the continuation flag (CF) field of the parameter block is one at the beginning of the execution of the instruction, the second operand is not accessed. Refer to page 26-50 and page 26-57 for additional details. When the DFLTCC-QAF function is specified, the contents of general registers R_2 and $R_2 + 1$ are ignored. When the DFLTCC-GDHT function is specified and the contents of general register $R_2 + 1$ specify a length equal to zero, a specification exception is recognized and the second operand is not accessed. When the DFLTCC-CMPR or DFLTCC-XPND function is specified, the continuation flag (CF) field of the parameter block is zero at the beginning of the execution of the instruction, and the contents of general register $R_2 + 1$ specify a length equal to zero, a specification exception is recognized and the second operand is not accessed. For all functions, the R_2 field designates an even-odd pair of general registers. For all functions, the R_2 field must not designate general register 0 and must designate an even-numbered register; otherwise, a specification exception is recognized.

When the specified function is DFLTCC-CMPR or DFLTCC-XPND and the history-buffer type (HBT) is circular, the contents of general register R_3 specify the logical address of the leftmost byte of the third operand, and must designate a 4 K-byte boundary; otherwise a specification exception is recognized. The circular history buffer is a 32 K-byte buffer located at the third-operand location. When the specified function is DFLTCC-CMPR or DFLTCC-XPND and the HBT is zero, the contents of general register R_3 are ignored. When the DFLTCC-QAF or DFLTCC-GDHT function is specified, the contents of general register R_3 are ignored. For all functions, the R_3 field must not designate general register 0 or general register 1; otherwise, a specification exception is recognized.

As part of the operation when the specified function is DFLTCC-CMPR, the address in general register R_1 is incremented by the number of bytes processed of the first operand that included processing bit position 0, and the length in general register $R_1 + 1$ is decre-

mented by the same number; the address in general register R_2 is incremented by the number of bytes processed of the second operand, and the length in general register $R_2 + 1$ is decremented by the same number. The number of bytes processed of the first operand that included processing bit position 0 is the integer quotient resulting from an integer division with the dividend being the sum of the number of output bits processed and the original value of the SBB, and the divisor being a value of eight. The formation and updating of the addresses and lengths are dependent on the addressing mode.

As part of the operation when the specified function is DFLTCC-XPND, the address in general register R_1 is incremented by the number of bytes processed of the first operand, and the length in general register $R_1 + 1$ is decremented by the same number; the address in general register R_2 is incremented by the number of bytes processed of the second operand that included processing bit position 0, and the length in general register $R_2 + 1$ is decremented by the same number. The number of bytes processed of the second operand that included processing bit position 0 is the integer quotient resulting from an integer division with the dividend being the sum of the number of input bits processed and the original value of the SBB, and the divisor being a value of eight. The formation and updating of the addresses and lengths are dependent on the addressing mode.

For all functions, the contents of general registers 0, 1, and R_3 are not modified.

In the 24-bit addressing mode, the following apply:

- The contents of bit positions 40-63 of general registers 1, R_1 , R_2 , and R_3 constitute the addresses of the parameter block, first operand, second operand, and circular history buffer, respectively, and the contents of bit positions 0-39 are ignored.
- Bits 40-63 of the updated first-operand and second-operand addresses replace the corresponding bits in general registers R_1 and R_2 , respectively. Carries out of bit position 40 of the updated addresses are ignored, and the contents of bit positions 32-39 of general registers R_1 and R_2 are set to zeros. The contents of bit positions 0-31 of general registers R_1 and R_2 remain unchanged. When the instruction ends with partial or normal completion, and an updated operand address equals the operand address at the beginning of the execution of the

instruction, bit positions 32-39 of the corresponding general register are set to zeros.

- The contents of bit positions 32-63 of general registers $R_1 + 1$ and $R_2 + 1$ form 32-bit unsigned binary integers which specify the number of bytes in the first and second operands, respectively. The contents of bit positions 0-31 of general registers $R_1 + 1$ and $R_2 + 1$ are ignored.
- Bits 32-63 of the updated first-operand and second-operand lengths replace the corresponding bits in general registers $R_1 + 1$ and $R_2 + 1$, respectively. The contents of bit positions 0-31 of general registers $R_1 + 1$ and $R_2 + 1$ remain unchanged.

In the 31-bit addressing mode, the following apply:

- The contents of bit positions 33-63 of general registers 1, R_1 , R_2 , and R_3 constitute the addresses of the parameter block, first operand, second operand, and circular history buffer, respectively, and the contents of bit positions 0-32 are ignored.
- Bits 33-63 of the updated first-operand and second-operand addresses replace the corresponding bits in general registers R_1 and R_2 , respectively. Carries out of bit position 33 of the updated addresses are ignored, and the content of bit position 32 of general registers R_1 and R_2 is set to zero. The contents of bit positions 0-31 of general registers R_1 and R_2 remain unchanged. When the instruction ends with partial or normal completion, and an updated operand address equals the operand address at the beginning of the execution of the instruction, bit position 32 of the corresponding general register are set to zero.
- The contents of bit positions 32-63 of general registers $R_1 + 1$ and $R_2 + 1$ form 32-bit unsigned binary integers which specify the number of bytes in the first and second operands, respectively. The contents of bit positions 0-31 of general registers $R_1 + 1$ and $R_2 + 1$ are ignored.

- Bits 32-63 of the updated first-operand and second-operand lengths replace the corresponding bits in general registers $R_1 + 1$ and $R_2 + 1$, respectively. The contents of bit positions 0-31 of general registers $R_1 + 1$ and $R_2 + 1$ remain unchanged.

In the 64-bit addressing mode, the following apply:

- The contents of bit positions 0-63 of general registers 1, R_1 , R_2 , and R_3 constitute the addresses of the parameter block, first operand, second operand, and circular history buffer, respectively.
- Bits 0-63 of the updated first-operand and second-operand addresses replace the corresponding bits in general registers R_1 and R_2 , respectively. Carries out of bit position 0 of the updated addresses are ignored.
- The contents of bit positions 0-63 of general registers $R_1 + 1$ and $R_2 + 1$ form 64-bit unsigned binary integers which specify the number of bytes in the first and second operands, respectively.
- Bits 0-63 of the updated first-operand and second-operand lengths replace the corresponding bits in general registers $R_1 + 1$ and $R_2 + 1$, respectively.

In the access-register mode, access registers 1, R_1 , R_2 , and R_3 specify the address spaces containing the parameter block, first operand, second operand, and circular history buffer, respectively. When DFTCC-CMPR with an in-line history buffer is specified in the access-register mode, access register R_2 specifies the address space containing the in-line history. When DFTCC-XPND with an in-line history buffer is specified in the access-register mode, access register R_1 specifies the address space containing the in-line history.

Figure 26-24 on page 26-19 shows the contents of the general registers just described.

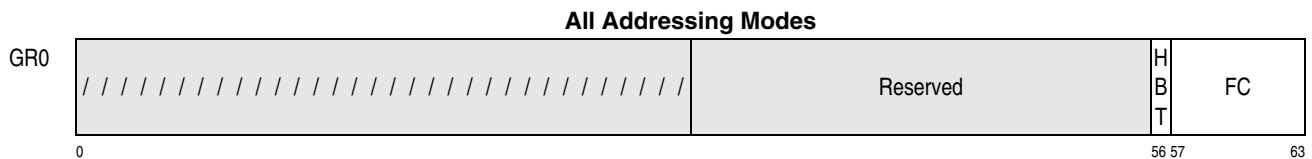
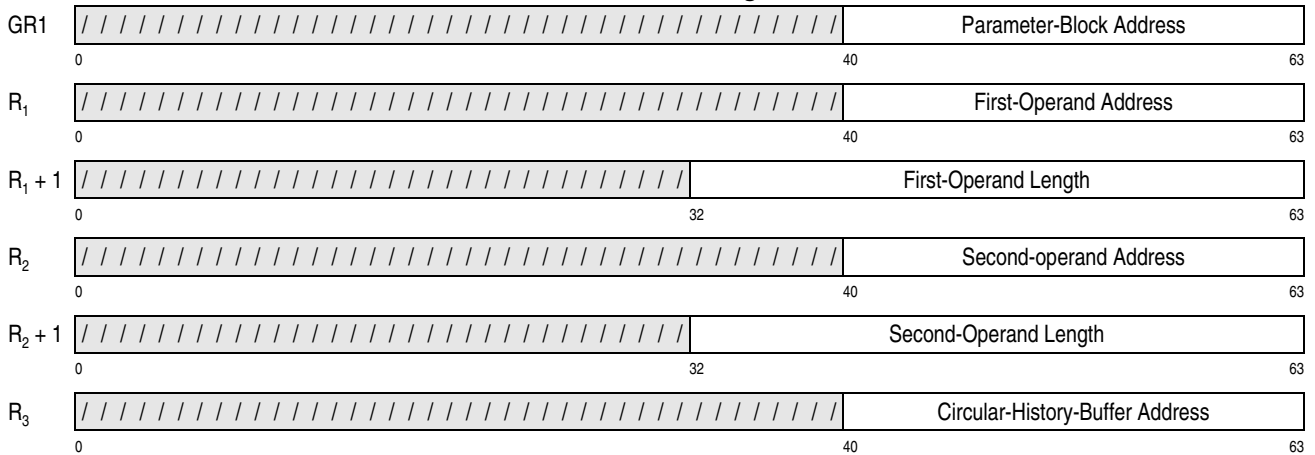
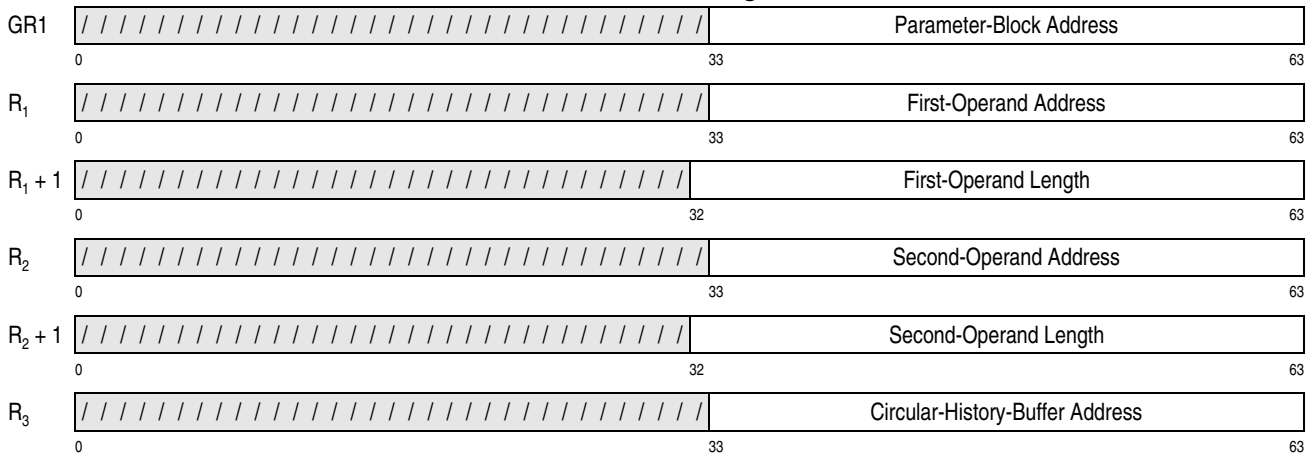

Figure 26-24. General Register Assignment for DFLTCC (Part 1 of 2)

24-Bit Addressing Mode



31-Bit Addressing Mode



64-Bit Addressing Mode

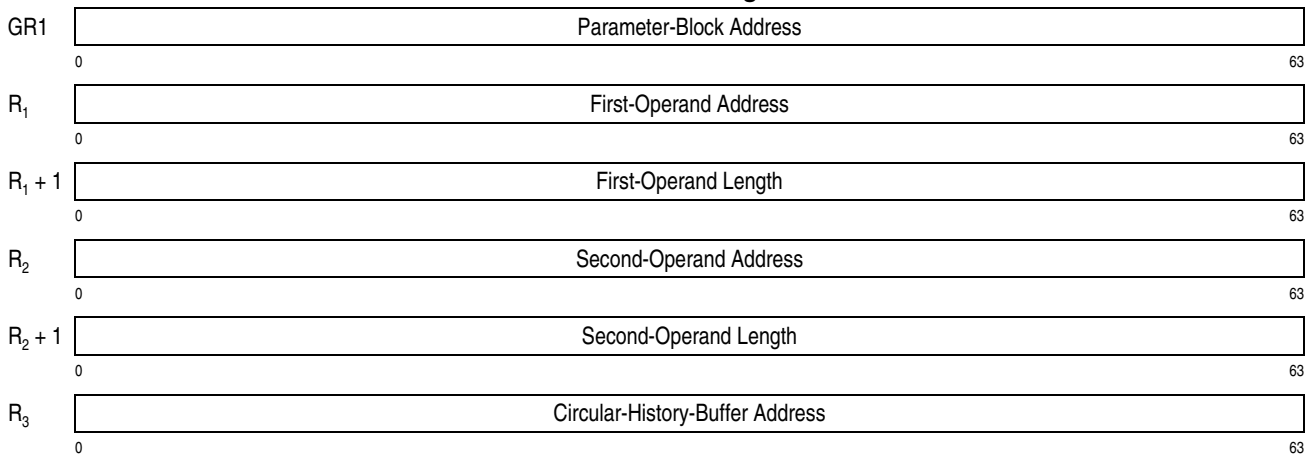

Explanation:

- FC Function code
- HBT History buffer type

Figure 26-24. General Register Assignment for DFLTCC (Part 2 of 2)

Function Code 0: DFLTCC-QAF (Query Available Functions)

The DFLTCC-QAF (query) function provides the means of indicating the availability of all installed functions and installed parameter block formats.

The parameter block for the query function has the following format:

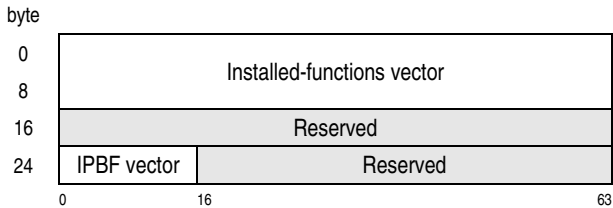

Explanation

IPBF Installed-parameter-block-formats

Figure 26-25. Parameter Block for DFLTCC-QAF

An installed-functions vector and an installed-parameter-block-formats vector are stored to bytes 0-15 and bytes 24-25, respectively, of the parameter block, as illustrated in Figure 26-25.

Bits 0-127 of the installed-functions vector correspond to function codes 0-127, respectively, of the DEFLATE CONVERSION CALL instruction. When a bit is one, the corresponding function is installed; otherwise, the function is not installed.

Bits 0-15 of the installed-parameter-block-formats vector correspond to parameter-block formats 0-15, respectively, for the DFLTCC-GDHT, DFLTCC-CMPR, and DFLTCC-XPND functions. When a bit is one, the corresponding parameter-block format is installed; otherwise, the parameter-block format is not installed.

Zeros are stored to reserved bytes 16-23 and 26-31 of the parameter block.

The contents of general registers R_1 , $R_1 + 1$, R_2 , $R_2 + 1$, and R_3 are ignored when the DFLTCC-QAF function is specified.

A PER storage-alteration event is recognized, when applicable, for the parameter block. A PER zero-

address-detection event is recognized, when applicable, for the parameter block.

Condition code 0 is set when execution of the DFLTCC-QAF function completes; condition codes 1, 2, and 3 are not applicable to the query function.

Function Code 1: DFLTCC-GDHT (Generate Dynamic-Huffman Table)

When the DFLTCC-GDHT function is specified, the second operand is used as a source to generate a compressed representation of a dynamic-Huffman table (DHT), as specified by the DEFLATE standard. Aspects of DHT generation are specified by the program to the machine using the DHTGC field of the parameter block. It is intended that the source contains uncompressed data and subsequent to completing the operation, the generated result is specified with the DFLTCC-CMPR function to compress the same source.

There is no history to reference from prior operations while processing the current operation.

When the contents of general register $R_2 + 1$ specify a length greater than 32 K-bytes, the following applies:

- Only the first 32 K-bytes of the second operand are used to generate the DHT.
- Access exceptions are not recognized for locations beyond the first 32 K-bytes of the second operand.

When the contents of general register $R_2 + 1$ specify a length equal to zero, a specification exception is recognized and the second operand is not accessed.

The parameter block for the DFLTCC-GDHT function is shown in Figure 26-26 on page 26-22. The fields of the parameter block are described in section "Parameter Block for Data Conversion" on page 26-33. Fields of the parameter block designated as preserved are not modified by the DFLTCC-GDHT function. Preserved fields are distinguished from reserved fields to enable a program to initialize a single storage location, use that storage location for the parameter block of a DFLTCC-GDHT function, and subsequently use the same storage location for the parameter block of a DFLTCC-CMPR function.

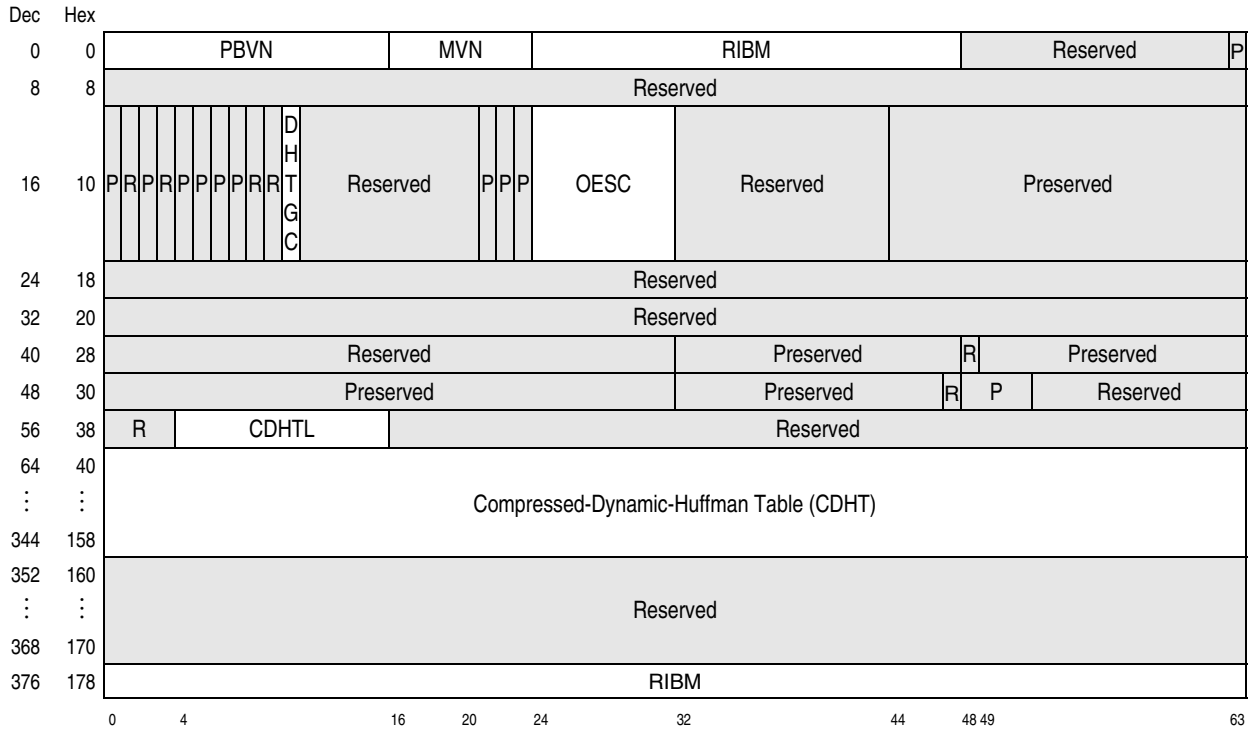

Explanation:

- CDHTL Compressed-Dynamic-Huffman Table Length
- DHTGC Dynamic-Huffman-Table Generation Control
- MVN Model-Version Number
- OESC Operation-Ending-Supplemental Code
- P Preserved
- PBVN Parameter-Block-Version Number
- R Reserved
- RIBM Reserved for IBM use

Figure 26-26. Parameter Block (format 0 hex) for the DFLTCC-GDHT function

An invalid-input condition exists when the DFLTCC-GDHT function is specified and the following occurs:

- The format of the parameter block, as specified by the parameter-block-version number, is not supported by the model.

When an invalid-input condition is encountered, a dynamic-Huffman table (DHT) is not generated, the operation ends, and the following occurs:

- A model-dependent value is stored to the model-version number (MVN) field of the parameter block.
- The operation-ending-supplemental code (OESC) field of the parameter block is set to 01 hex.

- Condition code 2 is set.

Normal completion occurs when a dynamic-Huffman table (DHT) is generated. When the operation ends due to normal completion, the following occurs:

- A model-dependent value is stored to the model-version number (MVN) field of the parameter block.
- A compressed format of the generated DHT is stored to the CDHT field of the parameter block. The resulting compressed format of the DHT includes a Huffman code representing an end-of-block (EOB) symbol.
- The length of the compressed format of the generated DHT is stored to the CDHTL field of the parameter block.

- The operation-ending-supplemental code (OESC) field of the parameter block is set to 00 hex.
- Condition code 0 is set.

Condition codes 1 and 3 are not applicable to the DFLTCC-GDHT function.

General registers R_2 and $R_2 + 1$ are not modified by the operation.

The contents of general registers R_1 , $R_1 + 1$, and R_3 are ignored when the DFLTCC-GDHT function is specified.

When the entire parameter block overlaps the PER storage-area designation, a PER storage-alteration event is recognized, when applicable, for the parameter block. When only a portion of the parameter block overlaps the PER storage-area designation, it is model-dependent which of the following occurs:

- A PER storage-alteration event is recognized, when applicable, for the entire parameter block.
- A PER storage-alteration event is recognized, when applicable, for the portion of the parameter block that is stored.

A PER zero-address-detection event is recognized, when applicable, for the second-operand location and for the parameter block.

Function Code 2: DFLTCC-CMPR (Compress)

When the DFLTCC-CMPR function is specified, a compressing operation is performed. The operation consists of encoding data from the second-operand location into compressed-data symbols, which are stored to the first-operand location.

The operation proceeds as described in section "Compressing Data" on page 26-49.

Normal completion occurs when the entire second operand is compressed and stored to the first-operand location. When the operation ends due to normal completion, the following occurs:

- A model-dependent value is stored to the model-version number (MVN) field of the parameter block.
- The continuation flag (CF) field of the parameter block is set to zero.

- The sub-byte boundary (SBB) field of the parameter block is updated.
- The operation-ending-supplemental code (OESC) field of the parameter block is set to zeros.
- The history length (HL) field of the parameter block is updated.
- The history offset (HO) field of the parameter block is updated, when applicable.
- The check value field of the parameter block is updated.
- The end-of-block length (EOBL) and end-of-block symbol (EOBS) fields of the parameter block are updated.
- The address in general register R_1 is incremented by the number of bytes processed of the first operand that included processing bit 0, and the length in general register $R_1 + 1$ is decremented by the same number. The number of bytes processed of the first operand that included processing bit 0 is the integer quotient resulting from an integer division with the dividend being the sum of the number of output bits processed and the original value of the SBB, and the divisor being a value of eight.
- The address in general register R_2 is incremented by the number of source bytes processed, and the length in general register $R_2 + 1$ is decremented by the same number.
- Condition code 0 is set.

The formation and updating of the addresses and lengths are dependent on the addressing mode.

When normal completion occurs, the NT and CSB fields of the parameter block are undefined, but may be modified.

When a CPU-determined number of bytes have been processed and an invalid-input condition, as defined on page 26-25, has not been encountered, the operation ends and the following occurs:

- A model-dependent value is stored to the model-version number (MVN) field of the parameter block.
- The continuation flag (CF) bit in the parameter block is set to one.
- The new task (NT) field of the parameter block is set to zero when the CPU-determined number of bytes processed is greater than zero.
- The sub-byte boundary (SBB) field of the parameter block is updated.

- The operation-ending-supplemental code (OESC) field of the parameter block is set to zeros.
- The history length (HL) field of the parameter block is updated.
- The history offset (HO) field of the parameter block is updated, when applicable.
- The check value field of the parameter block is updated.
- The end-of-block length (EOBL) and end-of-block symbol (EOBS) fields of the parameter block are updated.
- The continuation-state buffer (CSB) field in the parameter block is updated.
- The address in general register R_1 is incremented by the number of bytes processed of the first operand that included processing bit 0, and the length in general register $R_1 + 1$ is decremented by the same number. The number of bytes processed of the first operand that included processing bit 0 is the integer quotient resulting from an integer division with the dividend being the sum of the number of output bits processed and the original value of the SBB, and the divisor being a value of eight.
- The address in general register R_2 is incremented by the number of source bytes processed, and the length in general register $R_2 + 1$ is decremented by the same number.
- Condition code 3 is set.

The formation and updating of the addresses and lengths are dependent on the addressing mode.

The CPU-determined number of bytes depends on the model, and may be a different number each time the instruction is executed.

Subsequent to the instruction ending with condition code 3 set, it is expected the program does not modify any input or output specification for the instruction and branches back to reexecute the instruction to resume the operation.

In certain unusual situations, despite ending the instruction with condition code 3 set, the parameter block and general registers are not updated. These situations may occur when the CPU performs a quiescing operation or CPU retry while executing DEFLATE CONVERSION CALL. In these cases, the CPU-determined number of bytes processed is zero, data may have been stored to the first-operand location, data may have been stored to the third-operand

location, when applicable, and corresponding change bits have been set.

The first-operand length is insufficient to complete the operation when any of the following conditions apply:

- The first-operand length, as specified by the contents of general register $R_1 + 1$, is zero at the beginning of the execution of the instruction.
- The first-operand length becomes equal to zero during the execution of the instruction and normal completion does not occur.

Note: The first-operand length is zero when the content of general register $R_1 + 1$ is zero, regardless of the values in the NT and SBB fields of the parameter block.

When the first-operand length becomes equal to zero during the execution of the instruction and an invalid-input condition, as defined on page 26-25, has not been encountered, the operation ends and the following occurs:

- A model-dependent value is stored to the model-version number (MVN) field of the parameter block.
- The continuation flag (CF) bit in the parameter block is set to one.
- The new task (NT) field of the parameter block is set to zero.
- The sub-byte boundary (SBB) field of the parameter block is updated.
- The operation-ending-supplemental code (OESC) field of the parameter block is set to zeros.
- The history length (HL) field of the parameter block is updated.
- The history offset (HO) field of the parameter block is updated, when applicable.
- The check value field of the parameter block is updated.
- The end-of-block length (EOBL) and end-of-block symbol (EOBS) fields of the parameter block are updated.
- The continuation-state buffer (CSB) field in the parameter block is updated.
- The address in general register R_1 is incremented by the number of bytes processed of the first operand that included processing bit 0, and the length in general register $R_1 + 1$ is decremented by the same number. The number of bytes processed of the first operand that

included processing bit 0 is the integer quotient resulting from an integer division with the dividend being the sum of the number of output bits processed and the original value of the SBB, and the divisor being a value of eight.

- The address in general register R_2 is incremented by the number of source bytes processed, and the length in general register $R_2 + 1$ is decremented by the same number.
- Condition code 1 is set.

The formation and updating of the addresses and lengths are dependent on the addressing mode.

When the first-operand length is zero at the beginning of the execution of the instruction and an invalid-input condition, as defined on page 26-25, has not been encountered, the operation ends and the following occurs:

- Condition code 1 is set.

Subsequent to the instruction ending with condition code 1 set, it is expected the program modifies the first-operand length, first-operand address, or both and reexecute the instruction to resume the operation.

An invalid-input condition exists when the DFLTCC-CMPR function is specified and any of the following occurs:

1. The format of the parameter block, as specified by the parameter-block-version number, is not supported by the model.
2. NT is zero and HL is greater than 32,768.
3. The HTT is one and the CDHTL is less than 42 or greater than 2283.
4. The HTT is one and the CDHTL does not equal the length of the compressed format of the DHT specified in the CDHT field.
5. The HTT is one and the HLIT sub-element of the compressed format of the DHT is greater than 29 (invalid DHT).
6. The HTT is one and the HDIST sub-element of the compressed format of the DHT is greater than 29 (invalid DHT).
7. The HTT is one and the compressed format of the DHT (contents of the CDHT field) specifies a

code which is in the sequence of codes specifying the bit lengths for the 19 possible code lengths defined for a compressed DHT, and is less than the length required by the Huffman algorithm to specify a functional Huffman tree (invalid DHT).

8. The HTT is one and the compressed format of the DHT (contents of the CDHT field) specifies code length 16 (copy previous code length) as the first code length for the set of elements consisting of literal bytes, an EOB symbol, and duplicate-string lengths (invalid DHT).
9. The HTT is one and the compressed format of the DHT (contents of the CDHT field) specifies a code which is in the sequence of codes specifying code lengths for literal bytes, and the code does not match any of the codes determined to represent the set of referenced code lengths, as specified earlier in the compressed DHT (invalid DHT).
10. The HTT is one and the compressed format of the DHT (contents of the CDHT field) specifies a code which assigns code length 0 (CL0) to the EOB symbol. In this case, the corresponding DHT does not specify a Huffman code to represent an EOB symbol (invalid DHT).
11. The HTT is one and the compressed format of the DHT (contents of the CDHT field) specifies a code which is in the sequence of codes specifying code lengths for duplicate-string lengths and pointer distances, and the code does not match any of the codes determined to represent the set of referenced code lengths, as specified earlier in the compressed DHT (invalid DHT).
12. The HTT is one and the compressed format of the DHT (contents of the CDHT field) specifies a number of code lengths which is greater than the number of Huffman codes in the DHT, as specified by the sum of the values in the HLIT field, the HDIST field, and 258. This is possible with an improper uses of code lengths 16, 17, and 18 (invalid DHT).
13. The HTT is one and the compressed format of the DHT (contents of the CDHT field) specifies a code length for the set of literal bytes, EOB symbol, and duplicate-string lengths, which is less than the length required by the Huffman algorithm to specify a functional Huffman tree. (invalid DHT).

14. The HTT is one and the compressed format of the DHT (contents of the CDHT field) specifies a code length for the set of duplicate-string pointer distances, which is less than the length required by the Huffman algorithm to specify a functional Huffman tree. (invalid DHT).
15. The HTT is one and the CPU attempts to generate a compressed-data symbol to represent a literal byte in the second operand, and the DHT derived from the contents of the CDHT field is non-universal and does not specify a Huffman code corresponding to that literal byte.
16. The HTT is one and the CPU attempts to generate a compressed-data symbol to represent a duplicate-string in the second operand, and the DHT derived from the contents of the CDHT field is non-universal and does not specify a Huffman code corresponding to that duplicate-string length or pointer distance.

When an invalid-input condition is encountered while attempting to generate a compressed-data symbol to represent a literal byte or duplicate-string in the second operand, no results associated with that literal byte or duplicate-string are generated, and the length of the second operand is not reduced by the size of that literal byte or duplicate-string.

When an invalid-input condition is encountered and neither the first-operand length (specified by the contents of general register $R_1 + 1$, NT, and SBB) nor the second-operand length is reduced, during the execution of the instruction, the operation ends, and the following occurs:

- A model-dependent value is stored to the model-version number (MVN) field of the parameter block.
- A nonzero value is stored to the operation-ending-supplemental code (OESC) field of the parameter block.
- Condition code 2 is set.

When an invalid-input condition is encountered and the first-operand length (specified by the contents of general register $R_1 + 1$, NT, and SBB) or second-operand length is reduced during the execution of the instruction, the operation ends, and the following occurs:

- A model-dependent value is stored to the model-version number (MVN) field of the parameter block.
- The continuation flag (CF) bit in the parameter block is set to one.
- The new task (NT) field of the parameter block is set to zero.
- The sub-byte boundary (SBB) field of the parameter block is updated.
- A nonzero value is stored to the operation-ending-supplemental code (OESC) field of the parameter block.
- The history length (HL) field of the parameter block is updated.
- The history offset (HO) field of the parameter block is updated, when applicable.
- The check value field of the parameter block is updated.
- The end-of-block length (EOBL) and end-of-block symbol (EOBS) fields of the parameter block are updated.
- The continuation-state buffer (CSB) field in the parameter block is updated.
- The address in general register R_1 is incremented by the number of bytes processed of the first operand that included processing bit 0, and the length in general register $R_1 + 1$ is decremented by the same number. The number of bytes processed of the first operand that included processing bit 0 is the integer quotient resulting from an integer division with the dividend being the sum of the number of output bits processed and the original value of the SBB, and the divisor being a value of eight.
- The address in general register R_2 is incremented by the number of source bytes which are successfully encoded to compressed-data symbols, and the length in general register $R_2 + 1$ is decremented by the same number. Source bytes causing the invalid-input condition cannot be encoded and do not contribute to the update of general registers R_2 and $R_2 + 1$.
- Condition code 2 is set.

The formation and updating of the addresses and lengths are dependent on the addressing mode.

Subsequent to processing any portion of the first or second operand, and invalid-input condition 15 or 16 is due to be recognized, the result is that either the invalid-data condition is recognized, or the operation ends with partial completion and condition code 3 is set. If condition code 3 is set, the invalid-data condition will be recognized when the instruction is exe-

cuted again, to continue processing the same operands, and the invalid-data condition still exists.

A PER storage-alteration event is recognized, when applicable, for the following:

- Stores to the parameter block, as described below.
- Stores to the first-operand location.
- Stores to the third-operand location, which only occur when the history-buffer type (HBT) is one (circular).

When the entire parameter block overlaps the PER storage-area designation, a PER storage-alteration event is recognized, when applicable, for the parameter block. When only a portion of the parameter block overlaps the PER storage-area designation, it is model-dependent which of the following occurs:

- A PER storage-alteration event is recognized, when applicable, for the entire parameter block.
- A PER storage-alteration event is recognized, when applicable, for the portion of the parameter block that is stored.

A PER zero-address-detection event is recognized, when applicable, for the parameter block, first-operand location, second-operand location, and third-operand location when the HBT is one (circular).

When the instruction ends with a nonzero condition code set, input data referenced from the second-operand location may be completely, or only partially, processed. When input data is only partially processed, results in the first-operand location, first-operand address, first-operand length, and SBB field of the parameter block do not represent a state consistent with the updated second-operand address and length. In these cases, partially processed data and internal-state information may be placed in the CSB field of the parameter block. The amount of partially processed data depends on conditions existing at the time the operation ends and the model. Although some data may only be partially processed, results stored to the left of the location designated by the updated first-operand address are complete and will not be modified when the operation resumes. Furthermore, when the instruction ends with condition code 1 or 3 set, it is expected the program subsequently reexecutes the instruction to resume the operation, at which time the contents of the CSB field are referenced prior to resuming the operation. When the instruction ends with condition code 0 set, all

data is completely processed and all results associated with input and output data represent a consistent state.

Subsequent to the instruction ending with a nonzero condition code set, and without encountering an invalid-input condition, and prior to reexecuting the instruction for the purpose of resuming the operation, the program should not modify any fields of the parameter block; otherwise results are unpredictable.

Function Code 4: DFLTCC-XPND (Expand)

When the DFLTCC-XPND function is specified, an uncompressing operation is performed. The operation consists of decoding compressed-data symbols from the second-operand location into uncompressed data, which is stored to the first-operand location.

The operation proceeds as described in section “Uncompressing Data” on page 26-54.

Normal completion occurs when all elements of the final block of the compressed-data set in the second operand are decoded and all uncompressed data is stored to the first-operand location. The last block of the compressed-data set is identified when the BFINAL bit of the block header is one. When the operation ends due to normal completion, the following occurs:

- A model-dependent value is stored to the model-version number (MVN) field of the parameter block.
- The continuation flag (CF) field of the parameter block is set to zero.
- The sub-byte boundary (SBB) field of the parameter block is updated.
- The operation-ending-supplemental code (OESC) field of the parameter block is set to zeros.
- The incomplete-function status (IFS) field of the parameter block is set to zeros.
- The incomplete-function length (IFL) field of the parameter block is updated, when applicable.
- The history length (HL) field of the parameter block is updated.
- The history offset (HO) field of the parameter block is updated, when applicable.
- The check value field of the parameter block is updated.

- The compressed dynamic-Huffman table (CDHT) and compressed dynamic-Huffman-table length (CDHTL) fields of the parameter block are set to zeros.
- The address in general register R_1 is incremented by the number of bytes stored at the first-operand location, and the length in general register $R_1 + 1$ is decremented by the same number.
- The address in general register R_2 is incremented by the number of bytes processed of the second operand that included processing bit 0, and the length in general register $R_2 + 1$ is decremented by the same number. The number of bytes processed of the second operand that included processing bit 0 is the integer quotient resulting from an integer division with the dividend being the sum of the number of input bits processed and the original value of the SBB, and the divisor being a value of eight.
- Condition code 0 is set.

The formation and updating of the addresses and lengths are dependent on the addressing mode.

When normal completion occurs, the NT and CSB fields of the parameter block are undefined, but may be modified.

When a CPU-determined amount of data has been processed and an invalid-input condition, as defined on page 26-30, has not been encountered, the operation ends and the following occurs:

- A model-dependent value is stored to the model-version number (MVN) field of the parameter block.
- The continuation flag (CF) bit in the parameter block is set to one.
- The new task (NT) field of the parameter block is set to zero when the CPU-determined amount of data processed is greater than zero.
- The sub-byte boundary (SBB) field of the parameter block is updated.
- The operation-ending-supplemental code (OESC) field of the parameter block is set to zeros.
- The incomplete-function status (IFS) field of the parameter block is updated.
- The incomplete-function length (IFL) field of the parameter block is updated, when applicable.
- The history length (HL) field of the parameter block is updated.
- The history offset (HO) field of the parameter block is updated, when applicable.

- The check value field of the parameter block is updated.
- The compressed dynamic-Huffman table (CDHT) and compressed dynamic-Huffman-table length (CDHTL) fields of the parameter block are updated. When partial completion occurs while processing a block with BTYPE value of 10 binary, the bytes of the CDHT field not required to represent the table are stored as zeros. When partial completion occurs while processing a block with BTYPE value of 00 or 01 binary, zeros are stored to the CDHT and CDHTL fields.
- The continuation-state buffer (CSB) field in the parameter block is updated.
- The address in general register R_1 is incremented by the number of bytes stored at the first-operand location, and the length in general register $R_1 + 1$ is decremented by the same number.
- The address in general register R_2 is incremented by the number of bytes processed of the second operand that included processing bit 0, and the length in general register $R_2 + 1$ is decremented by the same number. The number of bytes processed of the second operand that included processing bit 0 is the integer quotient resulting from an integer division with the dividend being the sum of the number of input bits processed and the original value of the SBB, and the divisor being a value of eight.
- Condition code 3 is set.

The formation and updating of the addresses and lengths are dependent on the addressing mode.

The CPU-determined amount of data depends on the model, and may be a different number each time the instruction is executed.

Subsequent to the instruction ending with condition code 3 set, it is expected the program does not modify any input or output specification for the instruction and branches back to reexecute the instruction to resume the operation.

In certain unusual situations, despite ending the instruction with condition code 3 set, the parameter block and general registers are not updated. These situations may occur when the CPU performs a quiescing operation or CPU retry while executing DEFLATE CONVERSION CALL. In these cases, the CPU-determined amount of data processed is zero, data may have been stored to the first-operand location, data may have been stored to the third-operand

location, when applicable, and corresponding change bits have been set.

The second-operand length is insufficient to complete the operation when the following applies:

- The last element of a compressed-data block with BFINAL equal to one has not been decoded during the operation, and the number of bits in the second operand, as designated by the second-operand length and SBB, is less than the number of bits of the next element to decode, and all results from decoding data from the second-operand location have been placed at the first-operand location.

When the second-operand length is insufficient to complete the operation, the operation has been partially completed, and an invalid-input condition, as defined on page 26-30, has not been encountered, the operation ends, and the following occurs:

- A model-dependent value is stored to the model-version number (MVN) field of the parameter block.
- The continuation flag (CF) bit in the parameter block is set to one.
- The new task (NT) field of the parameter block is set to zero.
- The sub-byte boundary (SBB) field of the parameter block is updated.
- The operation-ending-supplemental code (OESC) field of the parameter block is set to zeros.
- The incomplete-function status (IFS) field of the parameter block is updated.
- The incomplete-function length (IFL) field of the parameter block is updated, when applicable.
- The history length (HL) field of the parameter block is updated.
- The history offset (HO) field of the parameter block is updated, when applicable.
- The check value field of the parameter block is updated.
- The compressed dynamic-Huffman table (CDHT) and compressed dynamic-Huffman-table length (CDHTL) fields of the parameter block are updated. When partial completion occurs while processing a block with BTYPE value of 10 binary, the bytes of the CDHT field not required to represent the table are stored as zeros. When partial completion occurs while processing a block with BTYPE value of 00 or 01 binary, zeros are stored to the CDHT and CDHTL fields.

- The continuation-state buffer (CSB) field in the parameter block is updated.
- The address in general register R_1 is incremented by the number of bytes stored at the first-operand location, and the length in general register $R_1 + 1$ is decremented by the same number.
- The address in general register R_2 is incremented by the number of bytes processed of the second operand that included processing bit 0, and the length in general register $R_2 + 1$ is decremented by the same number. The number of bytes processed of the second operand that included processing bit 0 is the integer quotient resulting from an integer division with the dividend being the sum of the number of input bits processed and the original value of the SBB, and the divisor being a value of eight.
- Condition code 2 is set.

The formation and updating of the addresses and lengths are dependent on the addressing mode.

Subsequent to the instruction ending with condition code 2 set and the OESC field of the parameter block set to zeros, it is expected the program modifies the second-operand length, second-operand address, or both and reexecute the instruction to resume the operation.

The first-operand length is insufficient to complete the operation when the following applies:

- Results from decoding data from the second-operand location can not be placed at the first-operand location due to the first-operand length being equal to zero.

Note: Since decoding data from the second-operand location may not generate result data to place at the first-operand location, an updated first-operand length being equal to zero is not the only criteria which defines when condition code 1 is set. It is possible for some operations to proceed with a first-operand length being equal to zero.

When the first-operand length is insufficient to complete the operation, the operation has been partially completed, and an invalid-input condition, as defined on page 26-30, has not been encountered, the operation ends, and the following occurs:

- A model-dependent value is stored to the model-version number (MVN) field of the parameter block.

- The continuation flag (CF) bit in the parameter block is set to one.
- The new task (NT) field of the parameter block is set to zero.
- The sub-byte boundary (SBB) field of the parameter block is updated.
- The operation-ending-supplemental code (OESC) field of the parameter block is set to zeros.
- The incomplete-function status (IFS) field of the parameter block is updated.
- The incomplete-function length (IFL) field of the parameter block is updated, when applicable.
- The history length (HL) field of the parameter block is updated.
- The history offset (HO) field of the parameter block is updated, when applicable.
- The check value field of the parameter block is updated.
- The compressed dynamic-Huffman table (CDHT) and compressed dynamic-Huffman-table length (CDHTL) fields of the parameter block are updated. When partial completion occurs while processing a block with BTYPE value of 10 binary, the bytes of the CDHT field not required to represent the table are stored as zeros. When partial completion occurs while processing a block with BTYPE value of 00 or 01 binary, zeros are stored to the CDHT and CDHTL fields.
- The continuation-state buffer (CSB) field in the parameter block is updated.
- The address in general register R_1 is incremented by the number of bytes stored at the first-operand location, and the length in general register $R_1 + 1$ is decremented by the same number.
- The address in general register R_2 is incremented by the number of bytes processed of the second operand that included processing bit 0, and the length in general register $R_2 + 1$ is decremented by the same number. The number of bytes processed of the second operand that included processing bit 0 is the integer quotient resulting from an integer division with the dividend being the sum of the number of input bits processed and the original value of the SBB, and the divisor being a value of eight.
- Condition code 1 is set.

The formation and updating of the addresses and lengths are dependent on the addressing mode.

Subsequent to the instruction ending with condition code 1 set, it is expected the program modifies the first-operand length, first-operand address, or both

and reexecute the instruction to resume the operation.

An invalid-input condition exists when the DFLTCC-XPND function is specified and any of the following occurs:

1. The format of the parameter block, as specified by the parameter-block-version number, is not supported by the model.
2. NT is zero and HL is greater than 32,768.
3. A compressed-data block with BTYPE equal 11 binary is encountered.
4. A compressed-data block with BTYPE equal 00 binary and NLEN not equal to the one's complement of LEN is encountered.
5. A compressed format of a DHT (contents of a compressed-data block with BTYPE equal 10 binary) is encountered and the HLIT sub-element of the compressed DHT is greater than 29 (invalid DHT).
6. A compressed format of a DHT (contents of a compressed-data block with BTYPE equal 10 binary) is encountered and the HDIST sub-element of the compressed DHT is greater than 29 (invalid DHT).
7. A compressed format of a DHT (contents of a compressed-data block with BTYPE equal 10 binary) is encountered which specifies a code which is in the sequence of codes specifying the bit lengths for the 19 possible code lengths defined for a compressed DHT, and is less than the length required by the Huffman algorithm to specify a functional Huffman tree (invalid DHT).
8. A compressed format of a DHT (contents of a compressed-data block with BTYPE equal 10 binary) is encountered which specifies code length 16 (copy previous code length) as the first code length for the set of elements consisting of literal bytes, an EOB symbol, and duplicate-string lengths (invalid DHT).
9. A compressed format of a DHT (contents of a compressed-data block with BTYPE equal 10 binary) is encountered which specifies a code which is in the sequence of codes specifying code lengths for literal bytes, and the code does not match any of the codes determined to represent the set of referenced code lengths, as spec-

ified earlier in the compressed DHT (invalid DHT).

10. A compressed format of a DHT (contents of a compressed-data block with BTYPE equal 10 binary) is encountered which specifies a code which assigns code length 0 (CL0) to the EOB symbol. In this case, the corresponding DHT does not specify a Huffman code to represent an EOB symbol (invalid DHT).
11. A compressed format of a DHT (contents of a compressed-data block with BTYPE equal 10 binary) is encountered which specifies a code which is in the sequence of codes specifying code lengths for duplicate-string lengths and pointer distances, and the code does not match any of the codes determined to represent the set of referenced code lengths, as specified earlier in the compressed DHT (invalid DHT).
12. A compressed format of a DHT (contents of a compressed-data block with BTYPE equal 10 binary) is encountered which specifies a number of code lengths which is greater than the number of Huffman codes in the DHT, as specified by the sum of the values in the HLIT field, the HDIST field, and 258. This is possible with an improper uses of code lengths 16, 17, and 18 (invalid DHT).
13. A compressed format of a DHT (contents of a compressed-data block with BTYPE equal 10 binary) is encountered which specifies a code length for the set of literal bytes, EOB symbol, and duplicate-string lengths, which is less than the length required by the Huffman algorithm to specify a functional Huffman tree. (invalid DHT).
14. A compressed format of a DHT (contents of a compressed-data block with BTYPE equal 10 binary) is encountered which specifies a code length for the set of duplicate-string pointer distances, which is less than the length required by the Huffman algorithm to specify a functional Huffman tree. (invalid DHT).
15. A compressed-data symbol, which is encountered in a compressed-data block with BTYPE equal 10 binary, specifies a Huffman code which is not defined by the non-universal DHT derived from the compressed format of the DHT in the same block. In this case, the number of bits of the second operand which must be available to process, for the purpose of recognizing the invalid-input condition, is model-dependent.

More specifically, a model attempting to decode an undefined code may process 15 bits prior to recognizing the exception, even though the exception could be determined after processing less bits.

16. A compressed-data symbol is encountered which is a duplicate-string pointer and specifies a distance greater than the length of history available at the point of processing the symbol.
17. A compressed-data symbol, which is encountered in a compressed-data block with BTYPE equal 01 binary, specifies an invalid code (a code of 11000110 or 11000111 binary for a duplicate-string length, or a code of 11110 or 11111 binary for a duplicate-string-pointer distance). In this case, the number of bits of the second operand which must be available to process, for the purpose of recognizing the invalid-input condition, is model-dependent. More specifically, a model attempting to decode an invalid code may process 8 bits, in the case of a duplicate-string length, or 5 bits, in the case of a duplicate-string-pointer distance, prior to recognizing the exception, even though the exception could be determined after processing less bits.

When an invalid-input condition is encountered while attempting to decode an element of a compressed-data block, no results associated with that element are generated, and the length of the second operand (specified by the contents of general register $R_2 + 1$, NT, and SBB) is not reduced by the size of that element. However, it is possible a prior execution of the instruction ended with partially processing only a fraction of an element of input data. In that case, during the prior execution of the instruction, it had not yet been determined as to whether or not an invalid-input condition may exist with that element and the length of the second operand was reduced by the fraction of that element.

When an invalid-input condition is encountered and neither the first-operand length nor the second-operand length (specified by the contents of general register $R_2 + 1$, NT, and SBB) is reduced, during the execution of the instruction, the operation ends, and the following occurs:

- A model-dependent value is stored to the model-version number (MVN) field of the parameter block.

- A nonzero value is stored to the operation-ending-supplemental code (OESC) field of the parameter block.
- Condition code 2 is set.

When an invalid-input condition is encountered and the first-operand length or the second-operand length (specified by the contents of general register $R_2 + 1$, NT, and SBB) is reduced, during the execution of the instruction, the operation ends, and the following occurs:

- A model-dependent value is stored to the model-version number (MVN) field of the parameter block.
- The continuation flag (CF) bit in the parameter block is set to one.
- The new task (NT) field of the parameter block is set to zero.
- The sub-byte boundary (SBB) field of the parameter block is updated.
- A nonzero value is stored to the operation-ending-supplemental code (OESC) field of the parameter block.
- The incomplete-function status (IFS) field of the parameter block is updated.
- The incomplete-function length (IFL) field of the parameter block is updated, when applicable.
- The history length (HL) field of the parameter block is updated.
- The history offset (HO) field of the parameter block is updated, when applicable.
- The check value field of the parameter block is updated.
- The compressed dynamic-Huffman table (CDHT) and compressed dynamic-Huffman-table length (CDHTL) fields of the parameter block are updated. When partial completion occurs while processing a block with BTYPE value of 10 binary, the bytes of the CDHT field not required to represent the table are stored as zeros. When partial completion occurs while processing a block with BTYPE value of 00 or 01 binary, zeros are stored to the CDHT and CDHTL fields. An invalid DHT is not successfully processed and does not get placed into the CDHT field.
- The continuation-state buffer (CSB) field in the parameter block is updated.
- The address in general register R_1 is incremented by the number of bytes stored at the first-operand location, and the length in general register $R_1 + 1$ is decremented by the same number.
- The address in general register R_2 is incremented by the number of bytes of the second

operand that were successfully processed (decoded) and included processing bit 0, and the length in general register $R_2 + 1$ is decremented by the same number. The number of bytes processed of the second operand that included processing bit 0 is the integer quotient resulting from an integer division with the dividend being the sum of the number of input bits processed and the original value of the SBB, and the divisor being a value of eight. Source data causing the invalid-input condition cannot be decoded successfully and does not contribute to the update of general registers R_2 and $R_2 + 1$.

- Condition code 2 is set.

The formation and updating of the addresses and lengths are dependent on the addressing mode.

Subsequent to processing any portion of the first or second operand, and any of the invalid-input conditions 3-17 is due to be recognized, the result is that either the invalid-data condition is recognized, or the operation ends with partial completion and condition code 3 is set. If condition code 3 is set, the invalid-data condition will be recognized when the instruction is executed again, to continue processing the same operands, and the invalid-data condition still exists.

A PER storage-alteration event is recognized, when applicable, for the following:

- Stores to the parameter block, as described below.
- Stores to the first-operand location.
- Stores to the third-operand location, which only occur when the history-buffer type (HBT) is one (circular).

When the entire parameter block overlaps the PER storage-area designation, a PER storage-alteration event is recognized, when applicable, for the parameter block. When only a portion of the parameter block overlaps the PER storage-area designation, it is model-dependent which of the following occurs:

- A PER storage-alteration event is recognized, when applicable, for the entire parameter block.
- A PER storage-alteration event is recognized, when applicable, for the portion of the parameter block that is stored.

A PER zero-address-detection event is recognized, when applicable, for the parameter block, first-oper-

and location, second-operand location, and third-operand location when the HBT is one (circular).

When the instruction ends with a nonzero condition code set, input data referenced from the second-operand location may be completely, or only partially, processed. When input data is only partially processed, results in the first-operand location, first-operand address, first-operand length, SBB field of the parameter block, check value field of the parameter block, HL field of the parameter block, IFS field of the parameter block, and when applicable, the third-operand location and HO field of the parameter block, do not represent a state consistent with the updated second-operand address and length. In these cases, partially processed data and internal-state information may be placed in the CSB field of the parameter block. The amount of partially processed data depends on conditions existing at the time the operation ends and the model. Although some data may only be partially processed, results stored to the left of the location designated by the updated first-operand address are complete and will not be modified when the operation resumes. Fur-

thermore, when the instruction ends with a nonzero condition code set and without encountering an invalid-input condition, it is expected the program subsequently reexecutes the instruction to resume the operation, at which time the contents of the CSB field are referenced prior to resuming the operation. When the operation ends with condition code 0 set, all data is completely processed and all results associated with input and output data represent a consistent state.

Subsequent to the instruction ending with a nonzero condition code set, and without encountering an invalid-input condition, and prior to reexecuting the instruction for the purpose of resuming the operation, the program should not modify any fields of the parameter block; otherwise results are unpredictable.

Parameter Block for Data Conversion

The parameter block with format 0 hex for the DFLTCC-CMPR and DFLTCC-XPND functions is shown in Figure 26-27 on page 26-34.

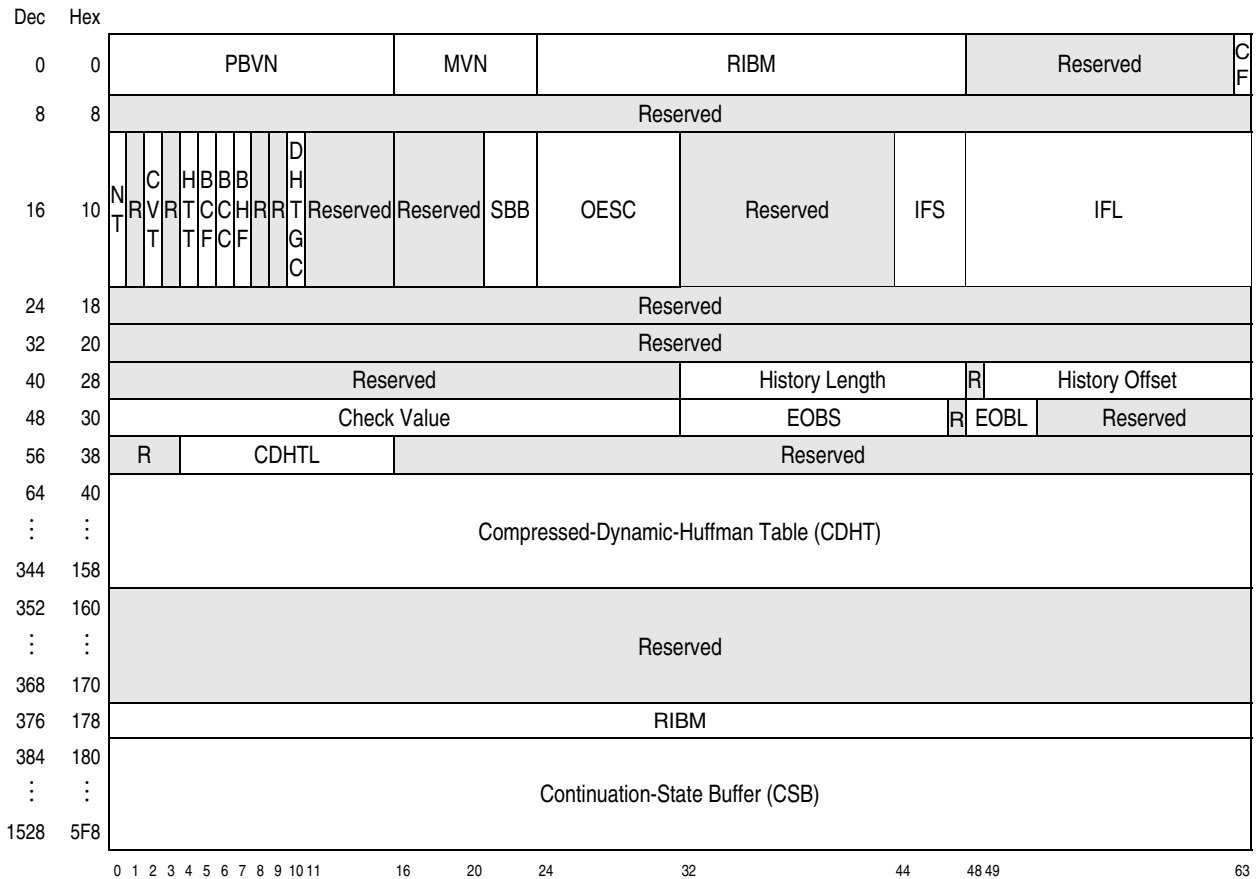

Explanation:

- BCC Block-Closing Control
- BCF Block-Continuation Flag
- BHF Block-Header Final bit
- CDHTL Compressed-Dynamic-Huffman Table Length
- CF Continuation Flag
- CVT Check Value Type
- DHTGC Dynamic-Huffman Table Generation Control
- EOBL End-of-block Length
- EOBS End-of-block Symbol
- HTT Huffman-Table Type
- IFL Incomplete-Function Length
- IFS Incomplete-Function Status
- MVN Model-Version Number
- NT New Task
- OESC Operation-Ending-Supplemental Code
- PBVN Parameter-Block-Version Number
- R Reserved
- RIBM Reserved for IBM use
- SBB Sub-Byte Boundary

Figure 26-27. Parameter Block (format 0 hex) for the DFLTCC-CMPR and DFLTCC-XPND functions

The fields of the parameter block are defined as follows:

Reserved: As an input to an operation, reserved fields should contain zeros; otherwise, the program may not operate compatibly in the future. When an operation ends, reserved fields may be stored as zeros or may remain unchanged.

Parameter-Block-Version Number (PBVN): Bytes 0-1 of the parameter block specify the version of the parameter block. Bits 0-11 of the PBVN are reserved and should contain zeros; otherwise, the program may not operate compatibly in the future. Bits 12-15 of the PBVN contain an unsigned binary integer specifying the format of the parameter block. The DFLTCC-QAF function provides the means of indicating the parameter block formats available. When the format of the parameter block specified is not supported by the model, an invalid-input condition is recognized (condition code 2 is set and a non-zero value is stored to the OESC field). The PBVN is specified by the program and is not modified during the execution of the instruction.

Model-Version Number (MVN): Byte 2 of the parameter block is an unsigned binary integer identifying the model which executed the instruction. The program is not required to initialize the MVN. The MVN is updated during the execution of the instruction. The value stored in the MVN is model-dependent.

When the continuation flag (CF) is one, the MVN may be an input to the operation for the purpose of interpreting the contents of the CSB field of the parameter block to resume the operation.

Reserved for IBM use (RIBM): Bytes 3-5 and 376-383 of the parameter block are reserved for IBM use and must contain zeros; otherwise results are unpredictable. The RIBM field is not modified during the execution of the instruction.

Continuation Flag (CF): Bit 63 of the parameter block, when one, indicates the operation is partially complete and the contents of the continuation-state buffer may be used to resume the operation. It is required for the program to initialize the continuation flag (CF) to zero and not modify CF in the event the

instruction is to be reexecuted for the purpose of resuming the operation; otherwise results are unpredictable.

New Task (NT): Bit 0 of byte 16 of the parameter block, when one, indicates the operation applies to the beginning of a compressed-data set. Therefore, no history and no check value from a prior operation applies to the current operation. When NT is one at the beginning of the operation, and the operation ends after partial completion, zero is stored to the NT field. When NT is zero, history and a check value from a prior operation apply to the current operation.

When the specified function is DFLTCC-CMPR, the meaning for each combination of values of the NT and CF fields is as follows:

NT CF meaning

1	0	Generate an individual block of a compressed-data set, which is the first block of the set.
0	0	Generate an individual block of a compressed-data set, which is not the first block of the set.
0	1	Continue to generate a block which is currently partially generated.
1	1	Invalid combination.

Check Value Type (CVT): Bit 2 of byte 16 of the parameter block specifies the type of check value contained in the check value field of the parameter block. When CVT is zero, the check value type is a 32-bit cyclic-redundancy-check (CRC-32). When CVT is one, the check value type is a 32-bit Adler checksum (Adler-32). The CVT bit is not modified during the execution of the instruction.

Huffman-Table Type (HTT): Bit 4 of byte 16 of the parameter block, when zero, specifies a table containing fixed-Huffman codes (FHT), as defined by the DEFLATE standard, is used during a compression operation. When the HTT is one, a table containing dynamic-Huffman codes (DHT), as specified in the CDHT field of the parameter block, is used during a compression operation. The HTT does not apply to uncompressing operations. The HTT bit is not modified during the execution of the instruction.

Block-Continuation Flag (BCF): Bit 5 of byte 16 of the parameter block applies when the DFLTCC-CMPR function is specified. When zero, a 3-bit block header, and when applicable, the compressed format of a dynamic-Huffman table, as specified in the CDHT field of the parameter block, is stored to the

first-operand location prior to storing any compressed-data elements. When one, neither a block header nor a compressed format of a DHT is stored to the first-operand location. When NT is one, BCF is treated as equal to zero. The BCF bit is not modified during the execution of the instruction.

Block Closing Control (BCC): Bit 6 of byte 16 of the parameter block applies when the DFLTCC-CMPR function is specified. When one, subsequent to storing all compressed-data symbols, an end-of-block (EOB) symbol is stored to the first-operand location. When the HTT specifies using an FHT, Huffman code 0000000 binary (which corresponds to the intermediate integer representation of 256 in the table specifying codes for literal bytes, an EOB symbol, and duplicate-string lengths) is used for the EOB symbol. When the HTT specifies using a DHT, the Huffman code for the EOB symbol is specified in the DHT. When the BCC bit is zero, an EOB symbol is not stored to the first-operand location.

The BCC bit is not modified during the execution of the instruction.

Block Header Final (BHF): Bit 7 of byte 16 of the parameter block applies when the DFLTCC-CMPR function is specified and either BCF is zero or NT is one; otherwise the BHF does not apply. When applicable and one, the first bit of the block header (BFINAL) is set to one before storing the block header to the first-operand location. When applicable and zero, the first bit of the block header (BFINAL) is set to zero before storing the block header to the first-operand location. The BHF bit is not modified during the execution of the instruction.

DHT Generation Control (DHTGC): Bit 2 of byte 17 of the parameter block applies to generating a dynamic-Huffman table (DHT). The DHT specifies Huffman codes for symbols representing literal bytes, duplicate-string lengths, an EOB symbol, and duplicate-string-pointer distances. The value of a Huffman code for a particular symbol is a function of the count of occurrences for the entity, which the symbol represents, in the uncompressed form of the data. When the count for a symbol is zero, there is no Huffman

code in the DHT for the symbol. The DHTGC specifies counts equal to zero will be treated as follows:

DHTGC	meaning
0	Treat counts of literal bytes, duplicate-string lengths, and pointer distances equal to zero as equal to one (generate a universal DHT).
1	Treat counts of duplicate-string lengths and pointer distances equal to zero as equal to one.

A DHT which specifies a Huffman code for every possible value of literal bytes, an EOB symbol, duplicate-string lengths, and duplicate-string-pointer distances is called a universal DHT. A DHT which does not specify Huffman codes for values of literal bytes, duplicate-string lengths, or duplicate-string-pointer distances which do not occur in the uncompressed form of the data is called a non-universal DHT.

For all values of the DHTGC, the resulting DHT specifies Huffman codes for all possible duplicate-string lengths and pointer distances, as defined by the DEFLATE standard. Therefore, the HLIT and HDIST sub-elements of the resulting compressed form of the DHT each contain the value of 29. For definitions of the HLIT and HDIST sub-elements, refer to section “Descriptions for Compressed-data Blocks”, beginning on page 26-43.

The DHTGC is an input to the operation when the DFLTCC-GDHT function is specified. The DHTGC does not apply to the operation when the DFLTCC-CMPR or DFLTCC-XPND function is specified. The DHTGC is not modified during the execution of the instruction.

Sub-Byte Boundary (SBB): Bits 5-7 of byte 18 of the parameter block contain an unsigned binary integer specifying the boundary between processed and unprocessed bits within a byte of the compressed-data stream. The byte of the stream referenced is the last byte referenced, meaning the rightmost byte, when an operation ends, and is the first byte to be referenced, meaning the leftmost byte, when an operation begins or resumes. When the DFLTCC-CMPR function is specified, the SBB applies to the byte designated by the first-operand address. When the DFLTCC-XPND function is specified, the SBB applies to the byte designated by the second-operand address. The SBB specifies the number of rightmost bits that have been processed. The SBB is an input to the operation and an output of the operation. Figure 26-28 on page 26-42 illustrates a com-

pressed-data stream when SBB has the value of 011 binary. Figure 26-29 on page 26-42 provides examples which demonstrate how the SBB applies to the DFLTCC-CMPR function. When NT is one, SBB is treated as equal to 000 binary.

Operation-Ending-Supplemental Code (OESC): When execution of DEFLATE CONVERSION CALL ends, a code is stored to byte 19 of the parameter block. The code conveys information about invalid-input conditions encountered during execution. When an invalid-input condition is not encountered, zeros are stored to the OESC field. When an invalid-input condition is encountered, a nonzero value is stored to the OESC field, which indicates the cause of the invalid-input condition recognized during execution. The codes stored to the OESC field are defined as follows:

OESC (hex)	meaning
00	An invalid-input condition was not encountered.
01	The format of the parameter block, as specified by the parameter-block-version number, is not supported by the model.
02	The DFLTCC-CMPR or DFLTCC-XPND function is specified, the history length field is greater than 32,768, and the new task field is zero.
11	A compressed-data block with BTYPE equal to 11 binary is encountered.
12	A compressed-data block with BTYPE equal to 00 binary and NLEN not equal to the one's complement of LEN is encountered.
21	The CDHTL field applies and is less than 42 or greater than 2283.
22	The HLIT sub-element of a compressed DHT used during the operation is greater than 29 (invalid DHT).
23	The HDIST sub-element of a compressed DHT used during the operation is greater than 29 (invalid DHT).
24	A compressed DHT used during the operation specifies a code which is in the sequence of codes specifying the bit lengths for the 19 possible code lengths defined for a compressed DHT, and is less than the length required by the Huffman algorithm to specify a functional Huffman tree (invalid DHT).

OESC (hex)	meaning
26	A compressed DHT used during the operation specifies code length 16 (copy previous code length) as the first code length for the set of elements consisting of literal bytes, an EOB symbol, and duplicate-string lengths (invalid DHT).
27	A compressed DHT used during the operation specifies a code which is in the sequence of codes specifying code lengths for literal bytes, and the code does not match any of the codes determined to represent the set of referenced code lengths, as specified earlier in the compressed DHT (invalid DHT).
28	A compressed DHT used during the operation specifies a code which assigns code length 0 (CL0) to the EOB symbol. In this case, the corresponding DHT does not specify a Huffman code to represent an EOB symbol (invalid DHT).
29	A compressed DHT used during the operation specifies a code which is in the sequence of codes specifying code lengths for duplicate-string lengths and pointer distances, and the code does not match any of the codes determined to represent the set of referenced code lengths, as specified earlier in the compressed DHT (invalid DHT).
2A	A compressed DHT used during the operation specifies a number of code lengths which is greater than the number of Huffman codes in the DHT, as specified by the sum of the values in the HLIT field, the HDIST field, and 258. This is possible with an improper uses of code lengths 16, 17, and 18. (invalid DHT).
2B	A compressed DHT used during the operation specifies a code length for the set of literal bytes, EOB symbol, and duplicate-string lengths, which is less than the length required by the Huffman algorithm to specify a functional Huffman tree. (invalid DHT).
2D	A compressed DHT used during the operation specifies a code length for the set of duplicate-string pointer distances, which is less than the length required by the Huffman algorithm to specify a functional Huffman tree. (invalid DHT).
2F	The CDHTL field applies and does not equal the length of the compressed DHT in the CDHT field used during the operation.

OESC (hex)	meaning
31	A compressed DHT used during the operation does not specify a Huffman code corresponding to a literal byte or a duplicate-string length processed during the operation (deficient non-universal DHT), or the DFLTCC-XPND function is specified and a compressed-data symbol, which is encountered in a compressed-data block with BTYPE equal 01 binary, specifies an invalid code for a duplicate-string length (11000110 or 11000111 binary).
32	A compressed DHT used during the operation does not specify a Huffman code corresponding to a duplicate-string-pointer distance processed during the operation (deficient non-universal DHT), or the DFLTCC-XPND function is specified and a compressed-data symbol, which is encountered in a compressed-data block with BTYPE equal 01 binary, specifies an invalid code for a duplicate-string-pointer distance (11110 or 11111 binary).
40	A compressed-data symbol is encountered which is a duplicate-string pointer and specifies a distance greater than the length of history available at the point of processing the symbol.
FF	No additional information is provided.

Support for codes other than zero and FF hex is model-dependent. When multiple invalid-input conditions exist, it is model-dependent which code is reported in the OESC field.

Incomplete-Function Status (IFS): Bits 4-7 of byte 21 of the parameter block contain status information when certain operations end. When an

uncompressing operation ends, the IFS conveys information about the second operand as follows:

IFS (binary)	meaning
0000	The operation ended after decoding the last element of a block with BFINAL equal to one.
1000	The operation ended after decoding an element, other than the last element, of a block with BTYPE equal 00 binary and BFINAL equal to zero.
1001	The operation ended after decoding an element, other than the last element, of a block with BTYPE equal 00 binary and BFINAL equal to one.
1010	The operation ended after decoding an element, other than the last element, of a block with BTYPE equal 01 binary and BFINAL equal to zero.
1011	The operation ended after decoding an element, other than the last element, of a block with BTYPE equal 01 binary and BFINAL equal to one.
1100	The operation ended after decoding an element, other than the last element, of a block with BTYPE equal 10 binary and BFINAL equal to zero.
1101	The operation ended after decoding an element, other than the last element, of a block with BTYPE equal 10 binary and BFINAL equal to one.
1110	The operation ended at a block boundary, the last element of a block with BFINAL equal to one has not been decoded, and the first element of the subsequent block has not yet been processed.

Note: An uncompressing operation may end with IFS equal 0000 binary and not satisfy normal completion. In such cases, the operation ends with condition code 1 or 3 set.

When a compressing operation ends, the IFS field is undefined, but may be modified.

The IFS is not an input to the operation.

Incomplete-Function Length (IFL): Bytes 22-23 of the parameter block contain length information when certain operations end. For an uncompressing operation, the IFL applies to the second operand. When an uncompressing operation ends after decoding some, but not all of a block with BTYPE equal 00 binary, the IFL contains an unsigned binary integer

specifying the number of bytes of the block in the second operand, which have not yet been processed. Bytes 22-23 contain the IFL in big-endian byte order, unlike the LEN field of a block with BTYPE equal 00 binary, which is in little-endian byte order.

When an uncompressing operation ends after decoding a complete block with BTYPE equal 00 binary and BFINAL equal to one, zeros are stored to the IFL field. When an uncompressing operation ends after decoding some, but not all of a block with a non-zero BTYPE, or ends at a block boundary, the IFL field is undefined, but may be modified.

When a compressing operation ends, the IFL field is undefined, but may be modified.

The IFL is not an input to the operation.

History Length (HL): Bytes 44-45 of the parameter block contain an unsigned binary integer specifying the number of bytes of history in the history buffer which can be referenced during an operation. The HL applies to in-line and circular history buffers. When new task (NT) equals one, no history applies to the beginning of the operation and the history length is treated as zero as an input to the operation.

An invalid-input condition is recognized (condition code 2 is set and a nonzero value is stored to the OESC field) when the history length is greater than 32,768 and NT equals zero.

The history length is modified during compressing and uncompressing operations. When the sum of the original HL and the number of uncompressed data bytes processed during the operation is less than, or equal to 32,768, the updated HL is equal to the sum of the original HL and the number of uncompressed data bytes processed during the operation; otherwise the updated HL is equal to the value of 32,768.

History Offset (HO): Fifteen bits, starting with bit 1 of byte 46, through bit 7 of byte 47, of the parameter block, contain an unsigned binary integer specifying an offset in the third operand when the history-buffer type is circular. The sum of the contents of R_3 and the history offset designates the location of the first byte of history within the circular-history buffer, which is the least recently processed byte of uncompressed data in the buffer. When the history-buffer type is circular, history offset is an input to the operation and is updated at the end of the operation. When the sum of the original HL and the number of uncompressed

data bytes processed during the operation is less than, or equal to 32,768, the updated HO is equal to the original HO; otherwise, the updated HO is equal to the sum of the original HO, the original HL, and the number of uncompressed data bytes processed during the operation, modulo 32,768.

When the history-buffer type is in-line, the HO field of the parameter block is undefined, but may be modified.

Check Value: Bytes 48-51 of the parameter block contain a check value. As part of the operation, a check value is generated. The check value applies to the uncompressed data operand. That is, the check value applies to the second operand for the DFLTCC-CMPR function and applies to the first operand for the DFLTCC-XPND function. When the CVT bit is zero, a 32-bit cyclic-redundancy-check check value (CRC-32) is generated. When the CVT bit is one, a 32-bit Adler checksum check value (Adler-32) is generated.

The inputs to generating a check value are a 4 byte base and the uncompressed data processed during the operation. The base input provides the means to compute a single and consistent check value for a set of compressed-data blocks, regardless of the number of times the DFLTCC instruction is executed to process the complete set of compressed-data blocks. When the NT bit is zero, the original value in the check value field is used for the base input in generating a check value.

When an Adler-32 check value is generated, the following apply:

- When the NT bit is one, a value of one is used for the 4 byte base input.
- The sums defined in the Adler-32 check value generation are modulo 65,521.
- The result is stored to the check value field in big-endian byte order. That is, the most significant byte of the check value is located in byte 48 and the least significant byte of the check value is located in byte 51.

When a CRC-32 check value is generated, the following apply:

- When the NT bit is one, a value of zero is used for the 4 byte base input.
- The polynomial used as the divisor in generating a CRC-32 check value is

$x^{32} + x^{26} + x^{23} + x^{22} + x^{16} + x^{12} + x^{11} + x^{10} + x^8 + x^7 + x^5 + x^4 + x^2 + x^1 + x^0$, which is represented as 104C11DB7 hex. In this representation, the left-most bit corresponds to the most significant bit.

- The first and final stages of generating the check value are computing the one's complement of the base input and computing the one's complement of the result, prior to storing the result, respectively.
- The result is stored to the check value field in little-endian byte order. That is, the least significant byte of the check value is located in byte 48 and the most significant byte of the check value is located in byte 51.

The check value is only meaningful to the program when the operation ends with condition code 0 set; otherwise, the check value is only an intermediate result and only meaningful to resume the operation. When the DFLTCC-CMPR function is specified and the operation ends with condition code 1, 2, or 3 set, some bytes to the left of the byte designated by the second-operand address may not be included in the computation of the resulting check value. When the DFLTCC-XPND function is specified and the operation ends with condition code 1, 2, or 3 set, some result bytes not yet stored to the right of the byte designated by the first-operand address may already be included in the computation of the resulting check value.

End-Of-Block Symbol (EOBS): Fifteen bits, starting with bit 0 of byte 52, through bit 6 of byte 53, of the parameter block, contain an end-of-block (EOB) symbol. The EOBL field of the parameter block specifies the length of the EOB symbol in the EOBS field. The EOB symbol is left justified in the EOBS field. Bits of the EOBS field not occupied by the EOB symbol are stored as zeros. The EOBS field is an output of the operation when compressing data, regardless which type of Huffman table applies. The EOBS field is not used as an input to the operation.

Bit 0 of byte 52 contains the most significant bit of the EOB symbol. When the length of the EOB symbol is 7 bits, bit 6 of byte 52 contains the least significant bit of the EOB symbol. When the length of the EOB symbol is 15 bits, bit 6 of byte 53 contains the least significant bit of the EOB symbol.

For blocks using a FHT, the EOB symbol is 0000000 binary, as defined by the DEFLATE standard. For blocks using a DHT, the EOB symbol is defined by the DHT. The EOB symbol is conveyed in order to

provide the capability for the program to close a block.

The EOBS field is undefined when the DFLTCC-XPND function is specified, but may be modified.

End-Of-Block Length (EOBL): Bits 0-3 of byte 54 of the parameter block contain an unsigned binary integer specifying the length of the end-of-block (EOB) symbol in the EOBS field of the parameter block. The length specifies the number of bits which the EOB symbol occupies in the EOBS field. The EOBL field is an output of the operation when compressing data, regardless which type of Huffman table applies. The EOBL field is not used as an input to the operation.

The EOBL field is undefined when the DFLTCC-XPND function is specified, but may be modified.

Compressed Dynamic-Huffman-Table Length (CDHTL): Twelve bits, starting with bit 4 of byte 56, through bit 7 of byte 57, of the parameter block contain an unsigned binary integer which specifies the length, as a bit count, of the compressed format of the DHT in the CDHT field of the parameter block.

The CDHTL is an output from the operation when the DFLTCC-GDHT function is specified.

The CDHTL is an input to the operation when the DFLTCC-CMPR function is specified and HTT is one. When the CDHTL does not specify an appropriate length for the CDHT, an invalid-input condition is recognized (condition code 2 is set and a nonzero value is stored to the OESC field). The CDHTL is not modified when the DFLTCC-CMPR function is specified.

When the DFLTCC-XPND function is specified and the operation ends after decoding only a portion of a block with BTYPE 10 binary, the length of the compressed representation of the DHT in the block is stored to this field. When the DFLTCC-XPND function is specified and the operation ends at a block boundary or after decoding only a portion of a block with BTYPE 00 or 01 binary, zeros are stored to this field. When an uncompressing operation is resumed within a block with BTYPE 10 binary (that is when CF equals one and IFS equals C or D hex), this field is an input to the operation.

Compressed Dynamic-Huffman Table (CDHT): Bytes 64-351 of the parameter block contain a compressed format of a dynamic-Huffman table (DHT).

The DHT specifies Huffman codes (bit sequences) to represent two sets of elements. The elements for one set include literal bytes, an EOB symbol, and duplicate-string lengths. The elements for the other set include duplicate-string pointer distances. The compressed representation of the DHT defines a set of code lengths and specifies a code length (CL) for each element of each set. The Huffman code for an element expected to be referenced during an operation is derived from the CL specified for that element and the number of elements in the same set with the same specified CL. Specifically, the compressed representation of the DHT includes the following:

- An HLIT field to specify the number of Huffman codes representing literal bytes, an EOB symbol, and duplicate-string lengths.
- An HDIST field to specify the number of Huffman codes representing and duplicate-string pointer distances.
- An HCLLEN field to specify the number of Huffman codes representing code lengths.
- A sequence of codes specifying a bit length for each of the 19 code lengths defined for the compressed DHT.
- A sequence of codes specifying a code length for each of the elements of the set consisting of literal bytes, an EOB symbol, and duplicate-string lengths.
- A sequence of codes specifying a code length for each of the elements of the set consisting of duplicate-string pointer distances.

Refer to the description of a compressed-data block with block type 10 binary, starting on page 26-45 for a detailed description of the compressed representation of a DHT.

The compressed representation of the DHT is left justified in the CDHT field. That is, the rightmost bit of byte 64 contains the least-significant bit of the HLIT sub-element of the compressed representation of the DHT.

The compressed representation of a DHT is an output from the operation when the DFLTCC-GDHT function is specified.

The compressed representation of a DHT is an input to the operation when the DFLTCC-CMPR function is specified and HTT is one. The CDHT field is not modified by the DFLTCC-CMPR function.

When the DFLTCC-XPND function is specified and the operation ends after decoding only a portion of a block with BTYPE 10 binary, the compressed representation of the DHT in the block is stored to this field. When the DFLTCC-XPND function is specified and the operation ends at a block boundary or after decoding only a portion of a block with BTYPE 00 or 01 binary, zeros are stored to this field. When an uncompressing operation is resumed within a block with BTYPE 10 binary (that is when CF equals one and IFS equals C or D hex), this field is an input to the operation.

When the CDHT is modified, bits of the field not required to represent the compressed representation of the DHT are stored as zeros.

Continuation-State Buffer (CSB): When conditions cause a value of one to be stored in the CF field, internal-state data is stored to bytes 384-1535 of the parameter block; otherwise bytes 384-1535 of the parameter block are undefined and may be modified. The internal-state data stored is model-dependent and may be used subsequently to resume the operation. It is expected, but not required, for the program to initialize the continuation-state buffer to contain all zeros. Subsequent to the instruction ending with a nonzero condition code set, and prior to reexecuting the instruction for the purpose of resuming the operation, the program should not modify the continuation-state buffer; otherwise results are unpredictable.

Sub-byte boundary (SBB) value of 011 binary:

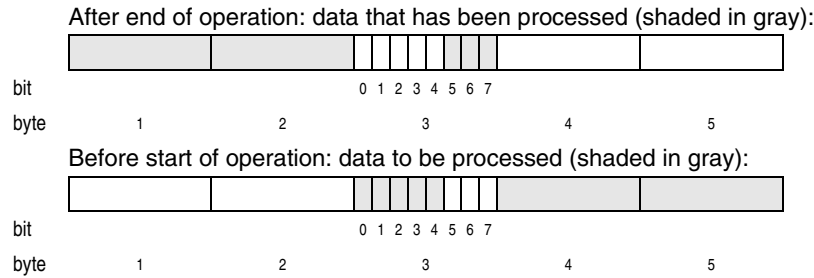

Figure 26-28. Sub-byte Boundary (SBB) Example

example 1:

	before executing DFLTCC-CMPR:	after executing DFLTCC-CMPR:
GR R _i	1	2
GR R _i + 1	9	8
NT	0	0
SBB	1	6
results generated	not applicable	13 bits (shaded in gray)
first operand		
bit	0 1 2 3 4 5 6 7 0 1 2 3 4 5 6 7 0 1 2 3 4 5 6 7	0 1 2 3 4 5 6 7 0 1 2 3 4 5 6 7 0 1 2 3 4 5 6 7
byte	1 2 3	1 2 3

example 2:

	before executing DFLTCC-CMPR:	after executing DFLTCC-CMPR:
GR R _i	1	2
GR R _i + 1	9	8
NT	0	0
SBB	6	2
results generated	not applicable	4 bits (shaded in gray)
first operand		
bit	0 1 2 3 4 5 6 7 0 1 2 3 4 5 6 7 0 1 2 3 4 5 6 7	0 1 2 3 4 5 6 7 0 1 2 3 4 5 6 7 0 1 2 3 4 5 6 7
byte	1 2 3	1 2 3

example 3:

	before executing DFLTCC-CMPR:	after executing DFLTCC-CMPR:
GR R _i	1	1
GR R _i + 1	9	9
NT	0	0
SBB	1	7
results generated	not applicable	6 bits (shaded in gray)
first operand		
bit	0 1 2 3 4 5 6 7 0 1 2 3 4 5 6 7 0 1 2 3 4 5 6 7	0 1 2 3 4 5 6 7 0 1 2 3 4 5 6 7 0 1 2 3 4 5 6 7
byte	1 2 3	1 2 3

Figure 26-29. Examples Illustrating how SBB Applies to the DFLTCC-CMPR function

Descriptions for Compressed-data Blocks

The bytes of a compressed-data block in storage are processed from left to right. Compressed-data blocks are not required to start or end on byte boundaries. A compressed-data block is a bit stream. Elements of the block are loaded into storage one bit at a time. The bit stream is loaded from right to left within each

byte of storage and in byte order from left to right. When the element is a Huffman code, the bits are stored in order from most significant bit to least significant bit of the element. When the element is not a Huffman code, the bits are stored in order from least significant bit to most significant bit of the element.

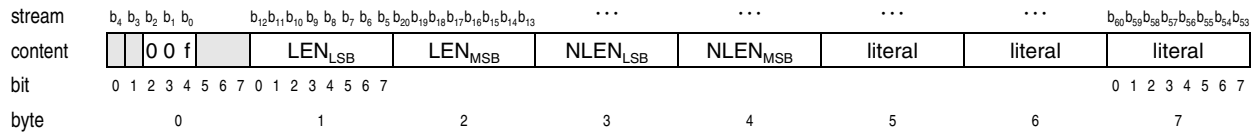

Explanation:

- b Bits of the stream processed in order of subscripts, starting with b_0
- f Block header final bit (BFINAL)
- LEN Number of bytes in the block with literal data
- NLEN The one's complement of LEN
- LSB Least Significant Byte
- MSB Most Significant Byte
- literal uncompressed byte of data

Figure 26-30. Block Type 00 (no compression) Example

Figure 26-30 illustrates an example of a block with block type 00 binary, which contains no compressed-data symbols. The following applies to this example:

- The compressed-data block consists of a bit stream which begins with bit 4 of byte 0, identified as b_0 , and ends with bit 0 of byte 7, identified as b_{60} .
- The first element encountered in the bit stream is BFINAL in bit 4 of byte 0.
- The second element encountered in the bit stream is BTYPE in bits 2-3 of byte 0. In this example, the BTYPE is 00 binary.
- Bits to the left of the BTYPE and to the right of a byte boundary are ignored when the BTYPE is 00 binary, which is bits 0-1 of byte 0 in this example.
- The third element encountered in the bit stream is the least significant byte of the LEN field, which is followed by the most significant byte of the LEN field. Bytes 1-2 contain the LEN field in little-endian byte order. The LEN field specifies the number of bytes in the block with literal data. Literal data is uncompressed data. The bytes with literal data follow the NLEN field in the bit stream.
- The elements encountered in the bit stream following the LEN field are the least significant byte of the NLEN field, followed by the most signifi-

cant byte of the NLEN field, respectively. Bytes 3-4 contain the NLEN field in little-endian byte order. The NLEN field is the one's complement of the LEN field.

- Elements encountered in the bit stream following the NLEN field are uncompressed data, identified as literal bytes. Bytes 5-7 contain uncompressed data, which is unchanged from the source data used to generate this block.
- None of the elements contained in this block are Huffman codes. Every element in this block is stored to the bit stream order in order from least significant bit to most significant bit of the element, as defined by the DEFLATE standard. Since the LEN, NLEN, and literal elements are each an integral number of bytes aligned on byte boundaries, these elements may be processed as units of bytes, and not necessarily as units of bits.

Figure 26-31 on page 26-44 illustrates an example of a block with block type 01 binary, which contains compressed-data symbols generated using a fixed-Huffman table (FHT). The following applies to this example:

- The compressed-data block consists of a bit stream which begins with bit 4 of byte 0, identi-

fied as b_0 , and ends with bit 3 of byte 11, identified as b_{89} .

- The first element encountered in the bit stream is BFINAL in bit 4 of byte 0.
- The second element encountered in the bit stream is BTYPE in bits 2-3 of byte 0. In this example, the BTYPE is 01 binary.
- The fixed-Huffman table (FHT) is not a component of the block.
- The third element encountered in the bit stream is the first compressed-data symbol, which begins in bit 1 of byte 0. A compressed-data symbol consists of the following sub-elements, which are encountered in the bit stream in the order which they are listed:

1. A Huffman code of variable length. The most significant bits of the code designate the length of the code. The code is encountered in the bit stream starting with the most significant bit of the code and ending with the least significant bit of the code. When the code represents a literal value or the end-of-block symbol, the code is the only sub-element of the compressed-data symbol. When the code represents a length of a pointer to the history buffer, the code is followed by subsequent sub-elements of the compressed-data symbol.
2. When applicable, as specified by the DEFLATE standard, extra length bits may follow the Huffman code representing a pointer length. Extra length bits are encountered in the bit stream starting with the least signifi-

cant bit and ending with the most significant bit of the extra length bits.

3. The next sub-element encountered in the bit stream is a 5-bit distance code of a pointer to the history buffer. The distance code is encountered in the bit stream starting with the most significant bit of the code and ending with the least significant bit of the distance code.
4. When applicable, as specified by the DEFLATE standard, extra distance bits may follow the distance code. Extra distance bits are encountered in the bit stream starting with the least significant bit and ending with the most significant bit of the extra distance bits.

- Bits 0-1 of byte 0, all bits of bytes 1 through 9, and bits 2-7 of byte 10 contain bits of compressed-data symbols.
- The last element encountered in the bit stream is a compressed-data symbol containing a single sub-element, which is the Huffman code representing the end-of-block (EOB) symbol. The EOB symbol for a block with BTYPE 01 binary is 0000000 binary. In this example, bit 1 of byte 10 contains the most significant bit of the EOB symbol and bit 3 of byte 11 contains the least significant bit of the EOB symbol.
- Bit 3 of byte 11 contains the last bit of the bit stream, which is the last bit of the compressed-data block.

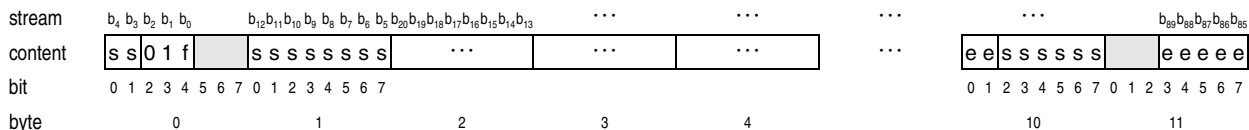

Explanation:

- b Bits of the stream processed in order of subscripts, starting with b_0
- f Block header final bit (BFINAL)
- s A bit of a compressed-data symbol
- e A bit of the end-of-block (EOB) symbol

Figure 26-31. Block Type 01 (compressed data using FHT) Example

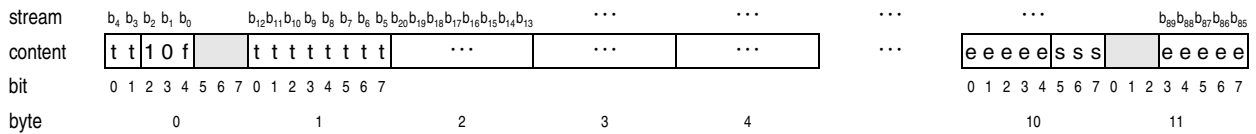

Explanation:

- b Bits of the stream processed in order of subscripts, starting with b_0
- f Block header final bit (BFINAL)
- s A bit of a compressed-data symbol
- e A bit of the end-of-block (EOB) symbol
- t A bit of the compressed dynamic-Huffman table

Figure 26-32. Block Type 10 (compressed data using DHT) Example

Figure 26-32 on page 26-45 illustrates an example of a block with block type 10 binary, which contains compressed-data symbols generated using a dynamic-Huffman table (DHT). The following applies to this example:

- The compressed-data block consists of a bit stream which begins with bit 4 of byte 0, identified as b_0 , and ends with bit 3 of byte 11, identified as b_{89} .
- The first element encountered in the bit stream is BFINAL in bit 4 of byte 0.
- The second element encountered in the bit stream is BTYPE in bits 2-3 of byte 0. In this example, the BTYPE is 10 binary.
- The third element encountered in the bit stream is the compressed representation of the dynamic-Huffman table (DHT), which begins in bit 1 of byte 0. The compressed representation of the DHT consists of the following sub-elements, which are encountered in the bit stream in the order which they are listed:
 1. HLIT: The sum of the 5-bit HLIT sub-element and 257 specifies the number of Huffman codes representing literal bytes, an EOB symbol, and duplicate-string lengths. Valid values of HLIT range from 0 to 29. HLIT bits are encountered in the bit stream starting with the least significant bit and ending with the most significant bit of the HLIT sub-element. In this example, bit 1 of byte 0, identified as b_3 is the least significant bit of the HLIT sub-element.
 2. HDIST: The sum of the 5-bit HDIST sub-element and 1 specifies the number of Huffman codes representing duplicate-string pointer

distances. Valid values of HDIST range from 0 to 29. HDIST bits are encountered in the bit stream starting with the least significant bit and ending with the most significant bit of the HDIST sub-element.

3. HCLEN: The sum of the 4-bit HCLEN sub-element and 4 specifies the number of Huffman codes representing code lengths. Valid values of HCLEN range from 0 to 15. HCLEN bits are encountered in the bit stream starting with the least significant bit and ending with the most significant bit of the HCLEN sub-element.
4. A sequence of codes specifying a bit length for each of the code lengths defined for the compressed DHT. The number of codes is equal to the sum of HCLEN and 4. Each code is 3 bits.
5. A sequence of codes specifying a code length for each of the elements of the set consisting of literal bytes, an EOB symbol, and duplicate-string lengths. The number of code lengths specified is equal to the sum of HLIT and 257.

When the last code length (CL) for the set of literal bytes, an EOB symbol, and duplicate-string lengths is 16, 17, or 18, and the extra bits following the CL specify repeating the CL for more elements than are defined for the set, the code length also applies to the set of duplicate-string pointer distances. The sequence of codes specifying code lengths for the set of literal bytes, an EOB symbol, and duplicate-string lengths, followed by the sequence of codes specifying code lengths

for duplicate-string pointer distances is a contiguous sequence for both sets.

6. A sequence of codes specifying a code length for each of the elements of the set consisting of duplicate-string pointer distances. The number of code lengths specified is equal to the sum of HDIST and 1.
- The fourth element encountered in the bit stream is the first compressed-data symbol. A compressed-data symbol consists of the following sub-elements, which are encountered in the bit stream in the order which they are listed:
 1. A Huffman code of variable length. The most significant bits of the code designate the length of the code. The code is encountered in the bit stream starting with the most significant bit of the code and ending with the least significant bit of the code. When the code represents a literal value or the end-of-block symbol, the code is the only sub-element of the compressed-data symbol. When the code represents a length of a pointer to the history buffer, the code is followed by subsequent sub-elements of the compressed-data symbol.
 2. When applicable, as specified by the DEFLATE standard, extra length bits may follow the Huffman code representing a pointer length. Extra length bits are encountered in the bit stream starting with the least significant bit and ending with the most significant bit of the extra length bits.
 3. The next sub-element encountered in the bit stream is a 5-bit distance code of a pointer to

the history buffer. The distance code is encountered in the bit stream starting with the most significant bit of the code and ending with the least significant bit of the distance code.

4. When applicable, as specified by the DEFLATE standard, extra distance bits may follow the distance code. Extra distance bits are encountered in the bit stream starting with the least significant bit and ending with the most significant bit of the extra distance bits.
 - Subsequent bits encountered in the bit stream, up to and including bit 5 of byte 10, contain bits of compressed-data symbols.
 - The last element encountered in the bit stream is a compressed-data symbol containing a single sub-element, which is the Huffman code representing the end-of-block (EOB) symbol. In this example, bit 4 of byte 10 contains the most significant bit of the EOB symbol and bit 3 of byte 11 contains the least significant bit of the EOB symbol.
 - Bit 3 of byte 11 contains the last bit of the bit stream, which is the last bit of the compressed-data block.

Processing a Compressed-Data Set

This section describes examples of processing a compressed-data set to illustrate intended uses of DEFLATE CONVERSION CALL and augment the descriptions of various fields of the parameter block. The examples are simplistic and do not describe all possible scenarios, requirements, and capabilities.

The following examples and descriptions apply to a compressed-data set in storage, as illustrated in Figure 26-33 on page 26-47.

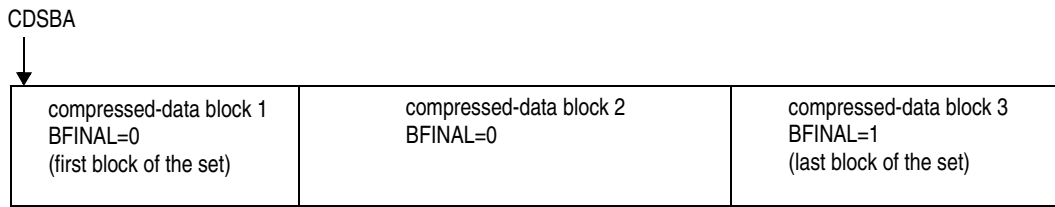

Explanation:

CDSBA: Compressed-Data Set Begin Address
 BFINAL: The BFINAL element of each compressed-data block

Figure 26-33. An Example of a Compressed-Data Set in Storage.

For the examples in this section, it is intended for a program processing the compressed-data set to consider the following:

- A single parameter block may be defined and referenced by multiple usages of DEFLATE CONVERSION CALL to process the entire compressed-data set. The check value and check value type fields of the parameter block shall apply to all compressed-data blocks in the compressed-data set. The sub-byte boundary field of the parameter block shall apply to transitions between individual blocks. The history length and history offset may apply to multiple blocks. The remaining fields of the parameter block only apply to the individual compressed-data block being processed by a specific execution of a DEFLATE CONVERSION CALL instruction.
- An individual check value applies to all of the uncompressed data represented by the compressed-data set.
- There is no history for the first compressed-data symbol in block 1 to reference. Subsequent sym-

bols in block 1 may reference history corresponding to previously encountered symbols in block 1. Symbols in block 2 may reference history corresponding to previously encountered symbols in blocks 2 and 1. Symbols in block 3 may reference history corresponding to previously encountered symbols in blocks 3, 2, and 1.

Figure 26-34 on page 26-47 lists a portion of a sample program used to compress data into the compressed-data set described in Figure 26-33. Figure 26-35 lists the values for certain fields of the parameter block used during the execution of the DFLTCC instruction located at the instruction address labeled IABLK1. Figure 26-36 lists the values for certain fields of the parameter block used during the execution of the DFLTCC instruction located at the instruction address labeled IABLK2. These figures demonstrate some of the details associated with using DEFLATE CONVERSION CALL multiple times to process an entire compressed-data set.

	L	1,PBLKADDR	Load parameter block address into GR1.
	IILL	0,2	Set GR0(56:63)=02 for DFLTCC-CMPR function.
	L	2,CDSBADDR	Load compressed-data set output address into GR2.
	L	4,UD1ADDR	Load uncompressed-data input address into GR4.
IABLK1	DFLTCC	2,4,10	Compress data into block1.
	BRC	1,IABLK1	If operation ends with CC=3, branch back to resume the operation.
	:		

Figure 26-34. Sample of a Program Compressing Data into Three Blocks of a Compressed-Data Set (Part 1 of 2)

IABLK2	L	6,UD2ADDR	Load next uncompressed-data input address into GR6.
	DFLTCC	2,6,10	Compress data into block2.
	BRC	1,IABLK2	If operation ends with CC=3, branch back to resume the operation.
	⋮		
IABLK3	L	8,UD3ADDR	Load next uncompressed-data input address into GR8.
	DFLTCC	2,8,10	Compress data into block3.
	BRC	1,IABLK3	If operation ends with CC=3, branch back to resume the operation.
	⋮		

Figure 26-34. Sample of a Program Compressing Data into Three Blocks of a Compressed-Data Set (Part 2 of 2)

parameter block field	field value at start of operation	field value at end of operation when condition code 1 or 3 is set (also the value at the start of resuming the operation)	field value at end of operation when condition code 0 is set
new task (NT)	1 (specified by the program)	0	0
continuation flag (CF)	initialized to zero by the program	1	0
continuation state buffer (CSB)	initialized to all zeros by the program	internal-state data recorded at the end of the operation, which is required when the operation later resumes	undefined
check value	treated as an initial value, since NT is one	value generated from portion of data processed since the start of the operation and starting value for resuming the operation	value generated from all data processed by the operation and starting value for a subsequent operation
sub-byte boundary (SBB)	treated as equal to zero, since NT is one	applies to the last byte processed by the operation and the first byte when the operation later resumes	applies to the last byte processed by the operation and the first byte for a subsequent operation

Figure 26-35. Parameter Block Contents for a DFLTCC-CMPR Function Operating on the First Compressed-Data Block of a Set.

parameter block field	field value at start of operation	field value at end of operation when condition code 1 or 3 is set (also the value at the start of resuming the operation)	field value at end of operation when condition code 0 is set
new task (NT)	0 (specified by the program)	0	0
continuation flag (CF)	initialized to zero by the program	1	0

Figure 26-36. Parameter Block Contents for a DFLTCC-CMPR Function Operating on the Second Compressed-Data Block of a Set. (Part 1 of 2)

continuation state buffer (CSB)	initialized to all zeros by the program	internal-state data recorded at the end of the operation, which is required when the operation later resumes	undefined
check value	value generated from prior operation (preserved by the program)	value generated from portion of data processed since the start of the current operation and starting value for resuming the current operation	value generated from all data processed by the operation and starting value for a subsequent operation
sub-byte boundary (SBB)	value associated with last byte processed by the prior operation (preserved by the program)	applies to the last byte processed by the current operation and the first byte when the current operation later resumes	applies to the last byte processed by the operation and the first byte for a subsequent operation

Figure 26-36. Parameter Block Contents for a DFLTCC-CMPR Function Operating on the Second Compressed-Data Block of a Set. (Part 2 of 2)

Figure 26-37 on page 26-49 lists a portion of a sample program used to uncompress data from the compressed-data set described in Figure 26-33.

	L	1,PBLKADDR	Load parameter block address into GR1.
	IILL	0,4	Set GR0(56:63)=04 for DFLTCC-XPND function.
	L	2,UDADDR	Load uncompressed-data output address into GR2.
	L	4,CDSBADDR	Load compressed-data set input address into GR4.
IASET	DFLTCC	2,4,10	Uncompress all blocks of the compressed-data set.
	BRC	1,IASET	If operation ended with CC=3, branch back to resume the operation.
	:		

Figure 26-37. Sample of a Program Uncompressing Data from a Compressed-Data Set

Compressing Data

The process of compressing data includes generating one or more compressed-data blocks. The compress function of DEFLATE CONVERSION CALL is used to construct a portion of an individual block. The portion may be the entire block. This function generates portions of a block with block type (BTYPE) 01 or 10 binary, and not 00 binary. When the new task bit (NT) of the parameter block is one, the first block of compressed data is generated and there is no history to reference from previously performed compressing operations.

An individual block contains the following elements in the order which they are listed:

1. Final block indication (BFINAL).
2. Block type (BTYPE).
3. Compressed format of a Dynamic-Huffman Table, when applicable.
4. Compressed-data symbols.

5. End-of-block (EOB) symbol.

The compression operation generates the elements specified in the order defined for a block. The elements may begin or end between byte boundaries in storage. The sub-byte boundary (SBB) applies to storing of the first element to the first-operand location. A compressed-data block is a bit stream. Components of the block are loaded into storage one bit at a time. The bit stream is loaded from right to left within each byte of storage and in byte order from left to right.

When the SBB is nonzero, the reference to the first byte at the first-operand location is an update reference.

Uncompressed data from the second-operand location is compressed and stored as compressed-data symbols to the first-operand location.

When the first-operand length is zero at the beginning of the execution of the instruction, the first operand is not accessed, and the first-operand address

and first-operand length in general registers R_1 and $R_1 + 1$, respectively, are not changed. This applies when the value of the CF field is zero or one at the beginning of the execution of the instruction.

When the second-operand length is zero at the beginning of the execution of the instruction, the second operand is not accessed, and the second-operand address and second-operand length in general registers R_2 and $R_2 + 1$, respectively, are not changed. The second-operand length is zero at the beginning of the execution of the instruction for the following case:

- The instruction is being reexecuted to resume the operation (the CF field of the parameter block is one at the beginning of the execution of the instruction) and completing the operation can be performed with references to the CSB field of the parameter block, and without references to the second operand.

Note: The program can not use DEFLATE CONVERSION CALL to perform the following operations:

- Generate an empty compressed-data block. An empty compressed data block consists of a block header, a compressed format of a DHT when applicable, and an EOB symbol.
- Close an open compressed-data block. That is, only store an EOB symbol to the end of the compressed-data block.

The compression algorithm includes searching an updated history of recently compressed data for a string of bytes which matches data currently being compressed from the second-operand location. Before the compression operation begins or resumes, the following applies:

- When new task (NT) is one, there is no initial history available to reference.
- When NT is zero, and bit 56 of general register 0 (HBT) is zero (in-line), the initial history available to reference is located to the left of, and adjacent to, the leftmost byte of the second operand, and the length of the initial history is specified by the history length (HL) field of the parameter block.

- When NT is zero, and bit 56 of general register 0 (HBT) is one (circular), the initial history available to reference is located in the third-operand location, as specified by the history offset (HO) and history length (HL) fields of the parameter block.

During the compression operation, fetch-type references to the entire history may be made, regardless which bytes of history are required to perform the operation. Furthermore, when the history-buffer type is circular, fetch-type references to the entire 32 K-byte history buffer may be made, regardless which bytes of history are required to perform the operation.

During the compression operation, history is updated. Subsequent to encoding one or more bytes of source data into a compressed-data symbol without encountering an invalid-input condition, the source bytes are concatenated to the end of the history. The most recently processed bytes of source data, up to a maximum of 32 K-bytes, constitute the updated history available to reference while processing subsequent bytes of source data.

When the compression operation ends, the following applies to the resulting history available to subsequently resume the operation, or begin another operation:

- When the HBT is in-line, storage updates to the second-operand location are not required when the history is updated. The updated second-operand address and updated HL specify the updated location and updated length of the resulting history.
- When the HBT is circular, storage updates to the third-operand location are required when the history is updated. The third-operand address, updated HO, and updated HL specify the updated location and updated length of the resulting history.

Figure 26-38 on page 26-51 illustrates the location of in-line history with respect to the second operand before and after multiple executions of a DEFLATE CONVERSION CALL instruction with DFLTCC-

CMPR function and an in-line history specified, when each execution ends with partial completion.

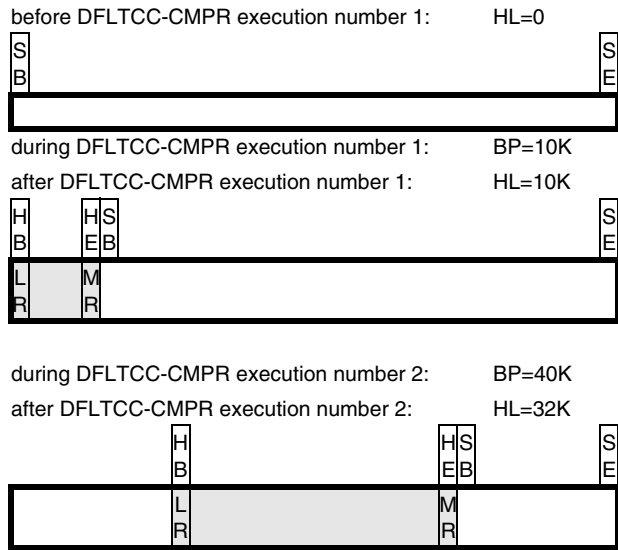

Explanation:

shaded areas: bytes of history

- SB source-begin address: location specified by R₂
- SE source-end address: location specified by R₂ + (R₂ + 1) - 1
- HB history-begin address: location specified by R₂ - HL
- HE history-end address: location specified by R₂ - 1
- LR least recently processed byte in history
- MR most recently processed byte in history
- BP bytes of uncompressed data processed
- HL history length

Figure 26-38. In-line History before and after executing DFLTCC-CMPR multiple times

When the HBT specified by bit 56 of general register 0 is circular, the history is maintained in a 32 K-byte buffer located at the third-operand location. The location of the first byte of history within the buffer (HB) is designated by the sum of the contents of general register R₃ and the history offset (HO). The first byte of history is the least recently processed byte of uncompressed data in the buffer. The location of the last byte of history within the buffer (HE) is designated by the following equation:

$$HE = R_3 + \text{modulo}32K(HO + HL - 1)$$

The last byte of history is the most recently processed byte of uncompressed data in the buffer. When the sum of the history offset (HO) and history length (HL) exceeds the size of the third operand (32 K-bytes), the history wraps from the end of the third operand to the beginning of the third operand. Figure 26-39 on page 26-52 illustrates the location of the history within a circular history buffer before and after multiple executions of a DEFLATE CONVERSION CALL instruction with DFLTCC-CMPR function

and a circular history buffer specified, when each execution ends with partial completion.

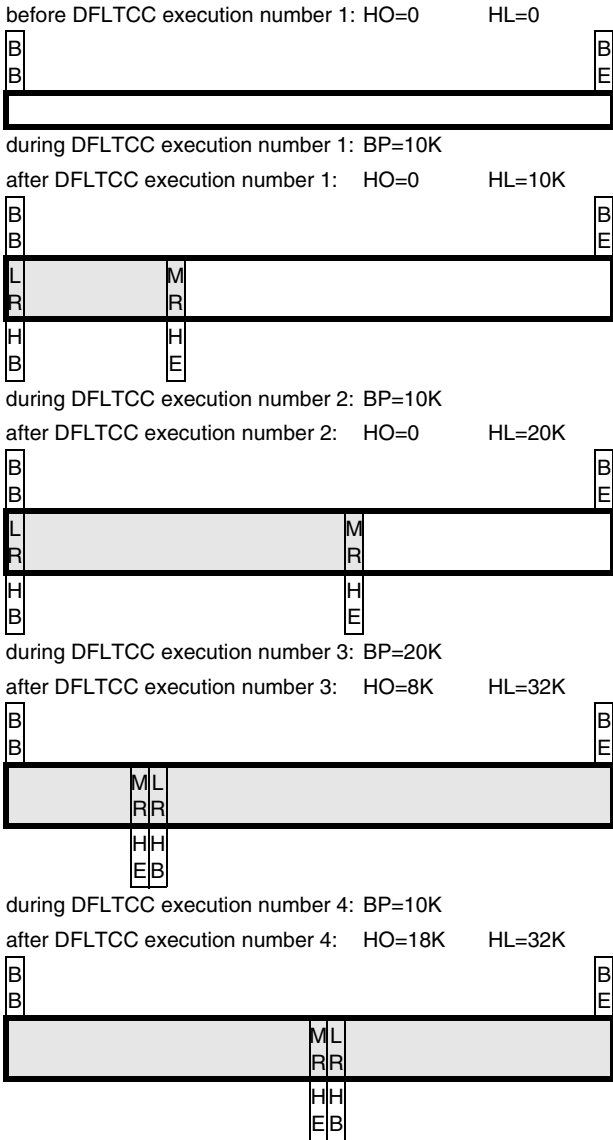

Explanation:

- shaded areas: bytes of history within the circular history buffer
- BB buffer-begin address: location specified by R_3
- BE buffer-end address: location specified by $R_3 + 32K - 1$
- HB history-begin address: location specified by $R_3 + HO$
- HE history-end address: location specified by $R_3 + \text{modulo}32K(HO + HL - 1)$
- LR least recently processed byte in history
- MR most recently processed byte in history
- BP bytes of uncompressed data processed
- HO history offset
- HL history length

Figure 26-39. Circular History Buffer before and after executing DFLTCC multiple times

When the HBT is circular and the number of bytes processed from the second-operand location is less than 32,768, the following applies:

- Stores are made to a range of bytes in the third-operand location. The range of bytes includes and starts with the location designated by:

$$R_3 + \text{modulo}32K(HOO + HLO)$$

The range of bytes includes and ends with the location designated by:

$$R_3 + \text{modulo}32K(HOO + HLO + BP - 1)$$

The definitions of the variables in the previous equations are:

- HOO: The history offset before the instruction executes.
- HLO: The history length before the instruction executes.
- BP: The number of bytes processed from the second-operand location during the execution of the instruction.

Stores made to the range of bytes just described are subject to store-type access exceptions, PER storage-alteration events, and setting change bits.

- Stores which do not modify the contents of storage locations and are not necessary, may be made to bytes in the third-operand location which are not included in the range just described. Stores to such locations are also subject to store-type access exceptions, PER storage-alteration events, and setting change bits.

When the HBT is circular and the number of bytes processed from the second-operand location is more than, or equal to 32,768, stores are made to all bytes of the third-operand location and subject to store-type access exceptions, PER storage-alteration events, and setting change bits.

When the block-continuation flag (BCF) is zero, a 3-bit block header, consisting of BFINAL followed by BTYPE, is stored to the first-operand location. The BFINAL bit of the block header is set equal to the block header final bit (BHF) of the parameter block. When the Huffman-table type (HTT) is zero, the BTYPE field of the block header is set to 01 binary and when the HTT is one, BTYPE field of the block header is set to 10 binary. When a block header is stored, the BFINAL bit is stored to the bit specified by the SBB in the first byte of the first operand. Subse-

quently, the BTYPE is stored to the first-operand location. Refer to section “Descriptions for Compressed-data Blocks” on page 26-43 for details on ordering of bits, as elements of a block are stored. When the BCF is one, a block header is not stored.

When the Huffman-table type (HTT) is one, the compressed format of the dynamic-Huffman table (DHT) specified in the parameter block is examined for invalid-input conditions. When an invalid-input condition exists for the specified compressed format of the DHT, the compressed DHT is referred to as invalid and can not be used to compress data. Refer to page 26-25 for a list of invalid-input conditions which may occur when the DFLTCC-CMPR function is specified. When the compressed format of the DHT specifies a bit length for a code length, or a code length for a literal byte, the EOB symbol, a duplicate-string length, or a duplicate-string pointer distance, which is greater than the length required by the Huffman algorithm to specify a proper and functional Huffman tree, the compressed DHT is still used to derive a functional DHT and compress data. When the block-continuation flag (BCF) is zero and the HTT is one, the compressed format of the DHT, as specified in the CDHT field of the parameter block is stored to the first-operand location.

During the compression operation, source data from the second-operand location is encoded into compressed-data symbols. As part of the encoding, source data is compared to the history. When no match is found, the intermediate representation of the source data is literal bytes, which is the same as the source data. When a match is found, the intermediate representation of the source data is a pointer to a location within the history which contains a duplicate copy of the source data. A pointer consists of a length and a distance. The length is the number of source data bytes which match a string in the history. The distance is the number of bytes from the end of the history to the beginning of the string which matches the source data. Two Huffman code trees from the Huffman table are used to encode the intermediate representation of the source data into compressed-data symbols. When the Huffman-table type (HTT) is zero, a fixed-Huffman table (FHT), as described by the DEFLATE standard, specifies the two Huffman code trees used for encoding intermediate results. When the HTT is one, the dynamic-Huffman table (DHT), which is derived from the compressed representation of the DHT, specified in the CDHT field of the parameter block, specifies the two Huffman code trees used for encoding intermedi-

ate results. The encoding is performed as described by the DEFLATE standard. When a non-universal DHT is used which does not specify a Huffman code required to encode the intermediate representation of the source data, an invalid-input condition is recognized. The bits of the resulting compressed-data symbol are arranged in the order specified by the DEFLATE standard before storing the result to the first-operand location.

Note: Duplicate-string lengths range from 3 to 258 bytes, as defined in Reference [23.] on page xxx.

Prior to processing further source data, the history is updated as described previously.

The process is repeated until all source bytes have been processed.

After all source bytes have been processed and the block closing control (BCC) is one, an end-of-block (EOB) symbol is stored to the first-operand location. When a fixed-Huffman table is used, Huffman code 0000000 binary is used for the EOB symbol. When a dynamic-Huffman table (DHT) is used, the Huffman code used for the EOB symbol is specified by the DHT. The bits of the EOB symbol are arranged in the order specified by the DEFLATE standard before storing the EOB symbol to the first-operand location.

When the last compressed-data symbol of the operation (including the EOB symbol), only occupies a portion of the last byte to store, the bits that do not contain a portion of the last symbol are stored as zeros.

Subsequent to processing the last compressed-data symbol, the following occurs:

- A model-dependent value is stored to the model-version number (MVN) field of the parameter block.
- The sub-byte boundary (SBB) field of the parameter block is updated.
- The end-of-block length (EOBL) and end-of-block symbol (EOBS) fields of the parameter block are updated.
- The address in general register R_1 is incremented by the number of bytes processed of the first operand that included processing bit 0, and the length in general register $R_1 + 1$ is decremented by the same number. The number of bytes processed of the first operand that included processing bit 0 is the integer quotient

resulting from an integer division with the dividend being the sum of the number of output bits processed and the original value of the SBB, and the divisor being a value of eight.

- The address in general register R_2 is incremented by the number of source bytes processed, and the length in general register $R_2 + 1$ is decremented by the same number.

The formation and updating of the addresses and lengths are dependent on the addressing mode.

Coincident with compressing the source data, the source data is an input to generating a 32-bit check value. Refer to “Check Value” on page 26-39 for details on generating a check value. The resulting check value is stored to the check value field of the parameter block.

Uncompressing Data

The expand function of DEFLATE CONVERSION CALL is used to decode a compressed-data set into uncompressed data. The compressed-data set in the second-operand location consists of one or more consecutive compressed-data blocks. The blocks of the compressed-data set are processed from left to right. The bytes of a block are processed from left to right. The blocks are not required to start or end on byte boundaries. Each block is decoded independent of other blocks in the compressed-data set. General register R_2 specifies the logical address of the leftmost byte of the first block in the compressed-data set. The last block in the compressed-data set is the block encountered during processing with the BFINAL bit equal to one. There are three types of blocks to process. The method of decoding the contents of a block is a function of the block type (BTYPE).

When the operation begins (when the continuation flag field of the parameter block is zero), the bit designated by general register R_2 , the new task (NT) field, and the sub-byte boundary (SBB) field is interpreted as the first bit of a compressed-data block (the BFINAL bit of a block header).

The expand function includes referencing an updated history of recently decoded uncompressed data. Before the uncompressing operation begins or resumes, the following applies:

- When new task (NT) is one, there is no initial history available to reference.

- When NT is zero, and bit 56 of general register 0 (HBT) is zero (in-line), the initial history available to reference is located to the left of, and adjacent to, the leftmost byte of the first operand, and the length of the initial history is specified by the history length (HL) field of the parameter block.
- When NT is zero, and bit 56 of general register 0 (HBT) is one (circular), the initial history available to reference is located in the third-operand location, as specified by the history offset (HO) and history length (HL) fields of the parameter block.

During the operation, fetch-type references to the entire history may be made, regardless which bytes of history are required to perform the operation. Furthermore, when the history-buffer type is circular, fetch-type references to the entire 32 K-byte history buffer may be made, regardless which bytes of history are required to perform the operation.

During the uncompressing operation, history is updated. Subsequent to decoding source data without encountering an invalid-input condition, the resulting bytes of uncompressed data are concatenated to the end of the history. The most recently decoded bytes of uncompressed data, up to a maximum of 32 K-bytes, constitute the updated history available to reference while processing subsequent source data.

When the uncompressing operation ends, the following applies to the resulting history available to subsequently resume the operation, or begin another operation:

- When the HBT is in-line, storage updates to the first-operand location also constitute updates to the resulting history. The updated first-operand address and updated HL specify the updated location and updated length of the resulting history.
- When the HBT is circular, storage updates to the third-operand location are required when the history is updated. The third-operand address, updated HO, and updated HL specify the updated location and updated length of the resulting history.

Figure 26-40 on page 26-55 illustrates the location of in-line history with respect to the first operand before and after multiple executions of a DEFLATE CONVERSION CALL instruction with DFLTCC-XPND function and an in-line history specified, when each

execution ends with partial completion. The history length (HL) is modified during the operation.

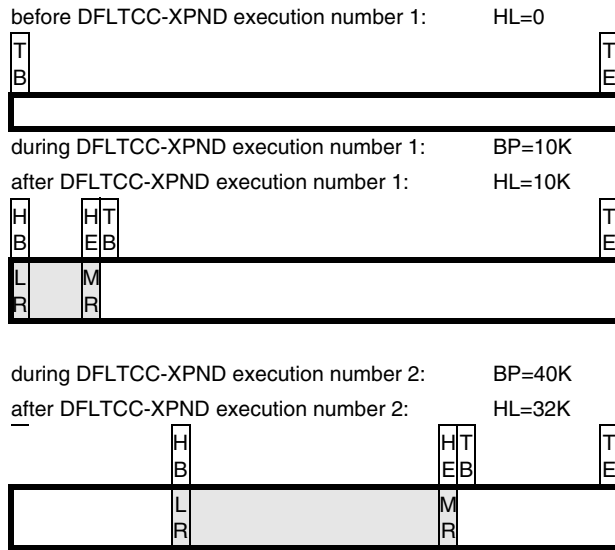

Explanation:

shaded areas: bytes of history

- TB target-begin address: location specified by R₁
- TE target-end address: location specified by R₁ + (R₁ + 1) - 1
- HB history-begin address: location specified by R₁ - HL
- HE history-end address: location specified by R₁ - 1
- LR least recently processed byte in history
- MR most recently processed byte in history
- BP bytes of uncompressed data processed
- HL history length

Figure 26-40. In-line History before and after executing DFLTCC-XPND multiple times

When bit 56 of general register 0 specifies a circular history buffer, the history is maintained in a 32 K-byte buffer located at the third-operand location. The location of the first byte of history within the buffer (HB) is designated by the sum of the contents of general register R₃ and the history offset (HO). The first byte of history is the least recently processed byte of uncompressed data in the buffer. The location of the last byte of history within the buffer (HE) is designated by the following equation:

$$HE = R_3 + \text{modulo}32K(HO + HL - 1)$$

The last byte of history is the most recently processed byte of uncompressed data in the buffer. When the sum of the history offset (HO) and history length (HL) exceeds the size of the third operand (32 K-bytes), the history wraps from the end of the

third operand to the beginning of the third operand. Figure 26-39 on page 26-52 illustrates the location of the history within a circular history buffer before and after multiple executions of a DEFLATE CONVERSION CALL instruction with DFLTCC-XPND function and a circular history buffer specified, when each execution ends with partial completion.

When the HBT is circular and the number of bytes stored to the first-operand location is less than 32,768, the following applies:

- Stores are made to a range of bytes in the third-operand location. The range of bytes includes and starts with the location designated by:

$$R_3 + \text{modulo}32K(HOO + HLO)$$

The range of bytes includes and ends with the location designated by:

$$R_3 + \text{modulo}32K(HOO + HLO + BP - 1)$$

The definitions of the variables in the previous equations are:

- HOO: The history offset before the instruction executes.
- HLO: The history length before the instruction executes.
- BP: The number of bytes stored to the first-operand location during the execution of the instruction.

Stores made to the range of bytes just described are subject to store-type access exceptions, PER storage-alteration events, and setting change bits.

- Stores which do not modify the contents of storage locations and are not necessary, may be made to bytes in the third-operand location which are not included in the range just described. Stores to such locations are also subject to store-type access exceptions, PER storage-alteration events, and setting change bits.

When the HBT is circular and the number of bytes stored to the first-operand location is more than, or equal to 32,768, stores are made to all bytes of the third-operand location and subject to store-type access exceptions, PER storage-alteration events, and setting change bits.

When the BTYPE is 00 binary, the block does not contain compressed data. Figure 26-30 on page 26-43 illustrates a block with BTYPE equal 00

binary. The LEN field specifies the number of literal bytes in the block. The byte order of the LEN field is little-endian. The LEN field may specify zero literal bytes. The literal bytes of the block are placed at the first-operand location. The history is also updated, as previously described, with each literal byte of the block.

When the BTYPE is 01 binary, the block contains compressed-data symbols that were generated using a fixed-Huffman table (FHT). The FHT is defined by the DEFLATE standard and is not part of the block. Figure 26-31 on page 26-44 illustrates a block with BTYPE equal 01 binary. Subsequent to interpreting the block header, compressed-data symbols are decoded in the order in which they appear in the block. Bytes of the block are processed from left to right. Bits within each byte of the block are processed from right to left. Each symbol is completely processed prior to processing the next symbol in the block. Each symbol which is not the end-of-block (EOB) symbol represents a literal value or a pointer to a substring previously decoded in the history buffer. A previously decoded substring is also referred to as a duplicate string. A pointer consists of codes representing the substring length and the distance from the end of the history to the beginning of the substring. When a symbol represents a substring in the history, the substring is referenced from the history buffer. The uncompressed data resulting from decoding a symbol is placed at the first-operand location.

Note: Duplicate-string lengths range from 3 to 258 bytes, as defined in Reference [23.] on page xxx.

Prior to processing further source data, the history is updated as previously described.

The updated history applies to decoding the next symbol of the block. When the EOB symbol is encountered, processing of the block is complete.

When the BTYPE is 10 binary, the block contains compressed-data symbols that were generated using a dynamic-Huffman table (DHT). A compressed format of the DHT used is an element of the compressed-data block. Figure 26-32 on page 26-45 illustrates a block with BTYPE equal 10 binary. Subsequent to interpreting the block header, the compressed format of the DHT provided within the compressed-data block is examined for invalid-input conditions. When an invalid-input condition exists for the provided compressed format of the DHT, the compressed format of the DHT is referred to as invalid

and can not be used to uncompress data. Refer to page 26-30 for a list of invalid-input conditions which may occur when the DFLTCC-XPND function is specified. When the compressed format of the DHT specifies a bit length for a code length, or a code length for a literal byte, the EOB symbol, a duplicate-string length, or a duplicate-string pointer distance, which is greater than the length required by the Huffman algorithm to specify a proper and functional Huffman tree, the compressed DHT is still used to derive a functional DHT and compress data. Subsequent to examining the compressed format of the DHT, compressed-data symbols are decoded in the order in which they appear in the block. Bytes of the block are processed from left to right. Bits within each byte of the block are processed from right to left. Each symbol is completely processed prior to processing the next symbol in the block. The processing of symbols in a block with BTYPE 10 binary is the same as previously described for processing symbols in a block with BTYPE 01, except the former uses the DHT provided to decode symbols, and the latter uses the FHT to decode symbols. When a non-universal DHT is provided which does not specify a Huffman code required to decode a compressed-data symbol, an invalid-input condition is recognized.

Coincident with uncompressing the second operand, the uncompressed data is an input to generating a 32-bit check value. Refer to “Check Value” on page 26-39 for details on generating a check value. The resulting check value is stored to the check value field of the parameter block.

Subsequent to processing the last block of the compressed-data set, the following occurs:

- A model-dependent value is stored to the model-version number (MVN) field of the parameter block.
- The sub-byte boundary (SBB) field of the parameter block is updated.
- The address in general register R_1 is incremented by the number of bytes stored at the first-operand location, and the length in general register $R_1 + 1$ is decremented by the same number.
- The address in general register R_2 is incremented by the number of bytes processed of the second operand that included processing bit 0, and the length in general register $R_2 + 1$ is decremented by the same number. The number of bytes processed of the second operand that included processing bit 0 is the integer quotient resulting from an integer division with the divi-

dend being the sum of the number of input bits processed and the original value of the SBB, and the divisor being a value of eight.

The formation and updating of the addresses and lengths are dependent on the addressing mode.

When the first-operand length is zero at the beginning of the execution of the instruction, the first operand is not accessed, and the first-operand address and first-operand length in general registers R_1 and $R_1 + 1$, respectively, are not changed. This applies when the value of the CF field is zero or one at the beginning of the execution of the instruction.

When the second-operand length is zero at the beginning of the execution of the instruction, the second operand is not accessed, and the second-operand address and second-operand length in general registers R_2 and $R_2 + 1$, respectively, are not changed. The second-operand length is zero at the beginning of the execution of the instruction for the following case:

- The instruction is being reexecuted (the CF field of the parameter block is one at the beginning of the execution of the instruction) and the entire second operand was processed when the instruction was previously executed.

The uncompressing operation may end without storing any results to the first-operand location, even though data was processed from the second-operand location. This occurs when the data processed from the second-operand location only contains any of the following compressed-data block elements:

- A block header.
- The LEN field of a block with block type 00 binary.
- The NLEN field of a block with block type 00 binary.
- A compressed format of a dynamic-Huffman table.
- An end-of-block (EOB) symbol.

Other Conditions

When the DFLTCC-CMPR or DFLTCC-XPND function is specified, execution of the instruction ends after processing a CPU-determined amount of data. This permits interruptions to occur. When the instruction ends with partial completion, the addresses in

general registers R_1 and R_2 , the lengths in general registers $R_1 + 1$ and $R_2 + 1$, and specific fields of the parameter block are updated, so that the instruction, when reexecuted, resumes the operation at the point it was suspended.

When a DFLTCC-CMPR or DFLTCC-XPND function is being executed and an access exception is due to be recognized for the first or second operand, the result is that either the exception is recognized, or the operation ends with partial completion and condition code 3 is set. If condition code 3 is set, the exception will be recognized when the instruction is executed again to continue processing the same operands and the exception condition still exists.

As observed by this CPU, other CPUs, and channel programs, references to the parameter block, first, second, and third operands may be multiple-access references, accesses to these storage locations are not necessarily block-concurrent, and the sequence of these accesses or references is undefined.

Results are unpredictable if the DFLTCC-CMPR or DFLTCC-XPND function is specified and any of the following apply:

- The parameter block overlaps the first or second operand.
- The first operand overlaps the second operand.
- The specified history-buffer type (HBT) is circular and the third operand overlaps the first operand, the second operand, or the parameter block.
- The specified history-buffer type (HBT) is in-line, the DFLTCC-CMPR function is specified, and the history overlaps the first operand or the parameter block.
- The specified history-buffer type (HBT) is in-line, the DFLTCC-XPND function is specified, and the history overlaps the second operand or the parameter block.

In certain unusual situations, despite ending the execution of DEFLATE CONVERSION CALL with a CPU-determined amount of data processed being zero, data may have been stored to the first-operand location, data may have been stored to the third-operand location, when applicable, and corresponding change bits have been set, when applicable. In these cases, the contents of the parameter block and general registers have not been modified from original values. These situations may occur when the CPU performs a quiescing operation or CPU retry while executing DEFLATE CONVERSION CALL.

Resulting Condition Code:

- 0 Normal completion
- 1 The first-operand length is insufficient to complete the operation
- 2 The second-operand length is insufficient to complete the operation (DFLTCC-XPND) or invalid-input condition
- 3 CPU-determined amount of data processed

Program Exceptions:

- Access (fetch, operand 2, in-line history; fetch and store, parameter block, operand 1, operand 3)
- Operation (if the DEFLATE-conversion facility is not installed)
- Specification
- Transaction constraint

The priority of execution for the DEFLATE CONVERSION CALL instruction is shown in Figure 26-41 on page 26-58.

Prior to usage, the compressed format of a DHT is examined for the existence of invalid-input conditions. When the length of the compressed format of a DHT is not precisely defined due to an invalid-input condition, the interpreted length may depend on the condition, be model dependent, and does not exceed 286 bytes. As a result, when the DFLTCC-XPND function is specified, the current second-operand length is 287, or less bytes, and a compressed format of a DHT with an invalid-input condition is encountered in the second operand, it is model dependent whether the invalid-input condition (priority 14.A) or insufficient second-operand length (condition code 2 - priority 14.B) is recognized.

1.-6.	Exceptions with the same priority as the priority of program-interruption conditions for the general case.
7.A	Access exceptions for second instruction halfword.
7.B	Operation exception.
7.C	Transaction constraint.
8.A	Specification exception due to invalid function code or invalid register number.

Figure 26-41. Priority of Execution: DFLTCC (Part 1 of 2)

8.B	Specification exception due to parameter block not designated on doubleword boundary.
8.C	Specification exception due to circular history buffer not designated on 4 K-byte boundary.
9.	Access exceptions for an access to the parameter block.
10.	Condition code 2 due to specified format of the parameter block is not supported by the model.
11.	Specification exception due to second-operand length equal to zero and CF equal to zero at the beginning of the execution of the instruction.
12.	Condition code 1 due to first-operand length equal to zero at the beginning of the execution of the instruction and DFLTCC-CMPR is specified.
13.A	Condition code 2 due to the history length field greater than 32,768 and the new task field is zero when DFLTCC-CMPR or DFLTCC-XPND is specified.
13.B	Access exceptions for an access to the first operand and the first-operand length is nonzero.
13.C	Access exceptions for an access to the second operand and the second-operand length is nonzero.
13.D	Access exceptions for an access to in-line history specified at the beginning of the execution of the instruction.
13.E	Access exceptions for an access to the third operand.
14.A	Condition code 2 due to invalid-input conditions other than those included in items 10 and 13.A above.
14.B	Condition codes 1, 2, or 3 due to conditions other than those included in items 10, 12, 13.A, and 14.A above.
15.	Condition code 0.

Figure 26-41. Priority of Execution: DFLTCC (Part 2 of 2)

Programming Notes:

- 1. There is no partial completion for the DFLTCC-GDHT function. To complete the function, all pages designated by the second operand must be accessible.
- 2. When the program references the end-of-block (EOB) symbol in the parameter block to close a compressed-data block, the program is responsi-

ble for reversing the bit order of the EOB symbol, which is a Huffman code.

3. When compressing or uncompressing data, it may be significantly more efficient overall when the operation can be performed with the minimum number of times DEFLATE CONVERSION CALL (DFTLCC) is executed. In other words, executing DFLTCC with a large operand may be significantly more efficient than executing DFLTCC with small operands multiple times.
4. For the compressing and uncompressing operations, when condition code 3 is set, the general registers used by the instruction and the parameter block have been updated such that the program can simply branch back to the instruction to continue the operation.
5. When the program anticipates referencing the first or second operand of DEFLATE CONVERSION CALL (DFTLCC), subsequent to executing the instruction, there may be a performance advantage associated with the subsequent reference when DFLTCC is immediately preceded by NEXT INSTRUCTION ACCESS INTENT (NIAI) specifying an access intent corresponding to the operand of interest with an access intent code value of one or two.
6. When DFLTCC-XPND is specified and the instruction ends with condition code 2 set, the value stored to the OESC field of the parameter block distinguishes between ending due to an insufficient second-operand length (zero stored to OESC field) and ending due to an invalid-input condition (nonzero value stored to OESC field).
7. The Huffman codes of a non-universal DHT may be shorter than the Huffman codes of a universal DHT generated from the same data. As a result, compressed-data symbols generated when using a non-universal DHT may occupy less bits than those generated when using a universal DHT.
8. A program may encounter an invalid-input condition (condition code 2 set with a nonzero value stored to the OESC field of the parameter block) when using a non-universal DHT to compress data which was not the same data used as an input to generating the non-universal DHT.
9. Different compressed representations may be generated from the same uncompressed input. However, all compressed representations comply

with the cited DEFLATE standard and can be decoded to the original (uncompressed) form of the data by any decoder which complies to the same standard. Varying results may be observed on the same model and between different models. Generated results may depend on the following:

- Variations of boundaries in storage for the input data.
- Variations of the CPU-determined amount of data processed during the execution of the instruction.
- Variations of the algorithms implementing the functions.

Differences to compressed-data symbols primarily include, but are not limited to, representations of duplicate strings.

10. A compressing operation may end with: the location of the last byte stored being equal to the location of first byte of the PER storage-area designation, a nonzero value in the sub-byte boundary (SBB) field of the parameter block, and a PER storage-alteration event being recognized. In this case, the address in general register R_1 is equal to the starting address of the PER storage-area designation.
11. Performance may be significantly degraded when the CPU is enabled to recognize PER storage-alteration events and the PER storage-area designation overlaps with the first-operand location or the third-operand location.
12. When the DFLTCC-CMPR function is specified and the operation ends with a nonzero value in the sub-byte boundary (SBB) field of the parameter block, the operation included storing to the byte designated by the resulting first-operand address. When the DFLTCC-XPND function is specified and the operation ends with a nonzero value in the SBB, the operation included fetching the byte designated by the resulting second-operand address.
13. When the operation ends with a nonzero condition code set and the OESC field contains zeros, the CSB field of the parameter block may contain partially processed data, and it is expected the program reexecutes the instruction to resume the operation.
14. Subsequent to an operation ending with a nonzero condition code set, and prior to reexecuting

the instruction for the purpose of resuming the operation, the program should not modify any fields of the parameter block; otherwise results are unpredictable.

15. When the DFLTCC-GDHT function is specified, the compressed representation of a DHT generated describes three proper-full Huffman code trees, according to the Huffman algorithm. That is, no under-full Huffman code trees are described. An under-full Huffman code tree is derived from a compressed representation of a DHT which specifies a code length for an element which is greater than the length required by the Huffman algorithm to specify a proper and functional Huffman tree.

When the DFLTCC-CMPR function is specified, HTT is one, and the compressed representation of the DHT includes a description of an under-full Huffman code tree, the compressed-data results can be transformed to the original uncompressed data by using the DFLTCC-XPND function, but not all decoders, which comply to the DEFLATE standard may be able to transform the results to the original uncompressed data. This may occur when the compressed representation of a DHT, specified by the program, for the DFLTCC-CMPR function was not generated as a result of performing the DFLTCC-GDHT function.

16. When the DFLTCC-CMPR function ends with condition code 1 set, the result stored to the sub-byte boundary (SBB) field of the parameter block

is 000 binary. Recognizing this scenario may be relevant to a program allocating output buffers for use with DEFLATE CONVERSION CALL.

17. When the DFLTCC-XPND function is specified with a circular history buffer and two different logical addresses in the first operand translate to the same absolute address, the results stored to the circular history buffer are unpredictable. Depending on the model, the implementation for updating the circular history buffer may include fetching decoded data stored to the first-operand location.
18. Although not explicitly stated in Reference [23.] on page xxx, two representations for the duplicate-string length of 258 bytes are possible, which are as follows:
 - Symbol code with value 284 followed by 5 extra bits with value 11111 binary.
 - Symbol code with value 285, which is the preferred representation, since it may occur frequently.

When uncompressing data, both representations are successfully decoded.

Appendix A. Number Representation and Instruction-Use Examples

Number Representation	A-2	FIND LEFTMOST ONE (FLOGR)	A-22
Binary Integers	A-2	INSERT CHARACTERS UNDER MASK	
Signed Binary Integers	A-2	(ICM)	A-23
Unsigned Binary Integers	A-3	LOAD (L, LR)	A-23
Decimal Integers	A-4	LOAD ADDRESS (LA)	A-23
Hexadecimal-Floating-Point Numbers	A-5	LOAD HALFWORD (LH)	A-24
Conversion Example	A-6	MOVE (MVC, MVI)	A-24
Instruction-Use Examples	A-7	MVC Example	A-24
Machine Format	A-7	MVI Example	A-25
Assembler-Language Format	A-7	MOVE INVERSE (MVCIN)	A-25
Addressing Mode in Examples	A-7	MOVE LONG (MVCL)	A-26
General Instructions	A-7	MOVE NUMERICS (MVN)	A-26
ADD HALFWORD (AH)	A-8	MOVE STRING (MVST)	A-27
AND (N, NC, NI, NR)	A-8	MOVE WITH OFFSET (MVO)	A-27
NI Example	A-8	MOVE ZONES (MVZ)	A-28
Linkage Instructions (BAL, BALR, BAS, BASR,		MULTIPLY (M, MR)	A-28
BASSM, BSM)	A-8	MULTIPLY HALFWORD (MH)	A-29
Other BALR and BASR Examples	A-10	OR (O, OC, OI, OR)	A-29
BRANCH AND STACK (BAKR)	A-10	OI Example	A-29
BAKR Example 1	A-11	PACK (PACK)	A-29
BAKR Example 2	A-11	ROTATE THEN EXCLUSIVE OR SELECTED	
BAKR Example 3	A-11	BITS	A-30
BRANCH ON CONDITION (BC, BCR)	A-12	ROTATE THEN INSERT SELECTED BITS	A-30
BRANCH ON COUNT (BCT, BCTR)	A-12	ROTATE THEN OR SELECTED BITS	A-30
BRANCH ON INDEX HIGH (BXH)	A-12	SEARCH STRING (SRST)	A-31
BXH Example 1	A-12	SRST Example 1	A-31
BXH Example 2	A-13	SRST Example 2	A-31
BRANCH ON INDEX LOW OR EQUAL		SHIFT LEFT DOUBLE (SLDA)	A-31
(BXLE)	A-13	SHIFT LEFT SINGLE (SLA)	A-32
BXLE Example 1	A-14	STORE CHARACTERS UNDER MASK	
BXLE Example 2	A-14	(STCM)	A-32
COMPARE AND FORM CODEWORD (CFC)	A-14	STORE MULTIPLE (STM)	A-32
COMPARE HALFWORD (CH)	A-14	TEST UNDER MASK (TM)	A-33
COMPARE LOGICAL (CL, CLC, CLI, CLR)	A-15	TRANSLATE (TR)	A-33
CLC Example	A-15	TRANSLATE AND TEST (TRT)	A-34
CLI Example	A-15	UNPACK (UNPK)	A-35
CLR Example	A-16	UPDATE TREE (UPT)	A-36
COMPARE LOGICAL CHARACTERS UNDER		Decimal Instructions	A-36
MASK (CLM)	A-16	ADD DECIMAL (AP)	A-36
COMPARE LOGICAL LONG (CLCL)	A-16	COMPARE DECIMAL (CP)	A-36
COMPARE LOGICAL STRING (CLST)	A-18	DIVIDE DECIMAL (DP)	A-36
CONVERT TO BINARY (CVB)	A-18	EDIT (ED)	A-37
CONVERT TO DECIMAL (CVD)	A-19	EDIT AND MARK (EDMK)	A-38
DIVIDE (D, DR)	A-19	MULTIPLY DECIMAL (MP)	A-39
EXCLUSIVE OR (X, XC, XI, XR)	A-20	SHIFT AND ROUND DECIMAL (SRP)	A-39
XC Example	A-20	Decimal Left Shift	A-39
XI Example	A-21	Decimal Right Shift	A-39
EXECUTE (EX)	A-21	Decimal Right Shift and Round	A-40

Multiplying by a Variable Power of 10	A-40
ZERO AND ADD (ZAP)	A-40
Hexadecimal-Floating-Point Instructions	A-41
ADD NORMALIZED (AD, ADR, AE, AER, AXR)	A-41
ADD UNNORMALIZED (AU, AUR, AW, AWR)	A-41
COMPARE (CD, CDR, CE, CER)	A-42
DIVIDE (DD, DDR, DE, DER)	A-42
HALVE (HDR, HER)	A-43
MULTIPLY (MD, MDR, MDE, MDER, MXD, MXDR, MXR)	A-43
Hexadecimal-Floating-Point-Number Conversion	A-44
Fixed Point to Hexadecimal Floating Point .	A-44
Hexadecimal Floating Point to Fixed Point .	A-44
Multiprogramming and Multiprocessing Examples	A-45

Example of a Program Failure Using OR Immediate	A-45
Conditional Swapping Instructions (CS, CDS) .	A-46
Setting a Single Bit	A-46
Updating Counters	A-47
Bypassing Post and Wait	A-47
Lock/Unlock	A-47
Lock/Unlock with LIFO Queuing for Contentions	A-48
Lock/Unlock with FIFO Queuing for Contentions	A-49
Free-Pool Manipulation	A-50
PERFORM LOCKED OPERATION (PLO) . .	A-51
Sorting Instructions	A-53
Tree Format	A-53
Example of Use of Sort Instructions	A-55

This appendix (except for the examples for FIND LEFTMOST ONE, ROTATE THEN EXCLUSIVE OR SELECTED BITS, ROTATE THEN INSERT SELECTED BITS, ROTATE THEN OR SELECTED BITS, and changes in the terminology for signed-packed decimal and unsigned-packed decimal) is the same as in *Enterprise Systems Architecture/390 Principles of Operation, SA22-7201*; it has not been revised to show the enlargement of register sizes or the 64-bit addressing mode.

Number Representation

Binary Integers

Signed Binary Integers

Signed binary integers are most commonly represented as halfwords (16 bits) or words (32 bits). In both lengths, the leftmost bit (bit 0) is the sign of the number. The remaining bits (bits 1-15 for halfwords and 1-31 for words) are used to specify the magnitude of the number. Binary integers are also referred to as fixed-point numbers, because the radix point (binary point) is considered to be fixed at the right, and any scaling is done by the programmer.

Positive binary integers are in true binary notation with a zero sign bit. Negative binary integers are in two's-complement notation with a one bit in the sign

position. In all cases, the bits between the sign bit and the leftmost significant bit of the integer are the same as the sign bit (that is, all zeros for positive numbers, all ones for negative numbers).

Negative binary integers are formed in two's-complement notation by inverting each bit of the positive binary integer and adding one. As an example using the halfword format, the binary number with the decimal value +26 is made negative (-26) in the following manner:

```

+26    0 000 0000 0001 1010
Invert 1 111 1111 1110 0101
Add 1      1
-----
-26    1 111 1111 1110 0110 (Two's complement
                                form)
(S is the sign bit.)

```

This is equivalent to subtracting the number:

```

      00000000 00011010
from  1 00000000 00000000

```

Negative binary integers are changed to positive in the same manner.

The following addition examples illustrate two's-complement arithmetic and overflow conditions. Only eight bit positions are used.

1. $+57 = 0011\ 1001$
 $+35 = 0010\ 0011$

 $+92 = 0101\ 1100$
2. $+57 = 0011\ 1001$
 $-35 = 1101\ 1101$

 $+22 = 0001\ 0110$ No overflow – carry into leftmost position and carry out
3. $+35 = 0010\ 0011$
 $-57 = 1100\ 0111$

 $-22 = 1110\ 1010$ Sign change only – no carry into leftmost position and no carry out
4. $-57 = 1100\ 0111$
 $-35 = 1101\ 1101$

 $-92 = 1010\ 0100$ No overflow – carry into leftmost position and carry out
5. $+57 = 0011\ 1001$
 $+92 = 0101\ 1100$

 $+149 = *1001\ 0101$ *Overflow – carry into leftmost position, no carry out
6. $-57 = 1100\ 0111$
 $-92 = 1010\ 0100$

 $-149 = *0110\ 1011$ *Overflow – no carry into leftmost position but carry out

The presence or absence of an overflow condition may be recognized from the carries:

- There is no overflow:
 1. If there is no carry into the leftmost bit position and no carry out (examples 1 and 3).
 2. If there is a carry into the leftmost position and also a carry out (examples 2 and 4).
- There is an overflow:
 1. If there is a carry into the leftmost position but no carry out (example 5).
 2. If there is no carry into the leftmost position but there is a carry out (example 6).

The following are 16-bit signed binary integers. The first is the maximum positive 16-bit binary integer. The last is the maximum negative 16-bit binary integer (the negative 16-bit binary integer with the greatest absolute value).

$$\begin{aligned}
 2^{15}-1 &= 32,767 = 0\ 111\ 1111\ 1111\ 1111 \\
 2^0 &= 1 = 0\ 000\ 0000\ 0000\ 0001 \\
 0 &= 0 = 0\ 000\ 0000\ 0000\ 0000 \\
 -2^0 &= -1 = 1\ 111\ 1111\ 1111\ 1111 \\
 -2^{15} &= -32,768 = 1\ 000\ 0000\ 0000\ 0000
 \end{aligned}$$

Figure A-1 illustrates several 32-bit signed binary integers arranged in descending order. The first is the maximum positive binary integer that can be represented by 32 bits, and the last is the maximum negative binary integer that can be represented by 32 bits.

$2^{31}-1$	= 2 147 483 647	= 0 111 1111 1111 1111 1111 1111 1111 1111 1111 1111 1111
2^{16}	= 65 536	= 0 000 0000 0000 0001 0000 0000 0000 0000 0000 0000 0000
2^0	= 1	= 0 000 0000 0000 0000 0000 0000 0000 0000 0000 0001 0000
0	= 0	= 0 000 0000 0000 0000 0000 0000 0000 0000 0000 0000 0000
-2^0	= -1	= 1 111 1111 1111 1111 1111 1111 1111 1111 1111 1111 1111
-2^1	= -2	= 1 111 1111 1111 1111 1111 1111 1111 1111 1111 1110 1110
-2^{16}	= -65 536	= 1 111 1111 1111 1111 1111 0000 0000 0000 0000 0000 0000
$-2^{31}+1$	= -2 147 483 647	= 1 000 0000 0000 0000 0000 0000 0000 0000 0000 0000 0001
-2^{31}	= -2 147 483 648	= 1 000 0000 0000 0000 0000 0000 0000 0000 0000 0000 0000

Figure A-1. 32-Bit Signed Binary Integers

Unsigned Binary Integers

Certain instructions, such as ADD LOGICAL, treat

binary integers as unsigned rather than signed. Unsigned binary integers have the same format as

signed binary integers, except that the leftmost bit is interpreted as another numeric bit rather than a sign bit. There is no complement notation because all unsigned binary integers are considered positive.

The following examples illustrate the addition of unsigned binary integers. Only eight bit positions are used. The examples are numbered the same as the corresponding examples for signed binary integers.

$$\begin{array}{r} 1. \quad 57 = 0011 \ 1001 \\ \quad 35 = 0010 \ 0011 \\ \hline \quad 92 = 0101 \ 1100 \end{array}$$

$$\begin{array}{r} 2. \quad 57 = 0011 \ 1001 \\ \quad 221 = 1101 \ 1101 \\ \hline \quad 278 = *0001 \ 0110 \text{ *Carry out of leftmost} \\ \quad \quad \quad \text{position} \end{array}$$

$$\begin{array}{r} 3. \quad 35 = 0010 \ 0011 \\ \quad 199 = 1100 \ 0111 \\ \hline \quad 234 = 1110 \ 1010 \end{array}$$

$$\begin{array}{r} 4. \quad 199 = 1100 \ 0111 \\ \quad 221 = 1101 \ 1101 \\ \hline \quad 420 = *1010 \ 0100 \text{ *Carry out of leftmost} \\ \quad \quad \quad \text{position} \end{array}$$

$$\begin{array}{r} 5. \quad 57 = 0011 \ 1001 \\ \quad 92 = 0101 \ 1100 \\ \hline \quad 149 = 1001 \ 0101 \end{array}$$

$$\begin{array}{r} 6. \quad 199 = 1100 \ 0111 \\ \quad 164 = 1010 \ 0100 \\ \hline \quad 363 = *0110 \ 1011 \text{ *Carry out of leftmost} \\ \quad \quad \quad \text{position} \end{array}$$

A carry out of the leftmost bit position may or may not imply an overflow, depending on the application.

Figure A-2 illustrates several 32-bit unsigned binary integers arranged in descending order.

$2^{32}-1$	= 4 294 967 295	= 1111 1111 1111 1111 1111 1111 1111 1111
2^{31}	= 2 147 483 648	= 1000 0000 0000 0000 0000 0000 0000 0000
$2^{31}-1$	= 2 147 483 647	= 0111 1111 1111 1111 1111 1111 1111 1111
2^{16}	= 65 536	= 0000 0000 0000 0001 0000 0000 0000 0000
2^0	= 1	= 0000 0000 0000 0000 0000 0000 0000 0001
0	= 0	= 0000 0000 0000 0000 0000 0000 0000 0000

Figure A-2. 32-Bit Unsigned Binary Integers

Decimal Integers

Decimal integers consist of one or more decimal digits and a sign. Each digit and the sign are represented by a 4-bit code. The decimal digits are in binary-coded decimal (BCD) form, with the values 0-9 encoded as 0000-1001. The sign is usually represented as 1100 (C hex) for plus and 1101 (D hex) for minus. These are the preferred sign codes, which are generated by the machine for the results of decimal-arithmic operations. There are also several alternate sign codes (1010, 1110, and 1111 for plus; 1011 for minus). The alternate sign codes are accepted by the machine as valid in source operands but are not generated for results.

Decimal integers may have different lengths, from one to 16 bytes. Of the many decimal formats, only

two will be considered here: signed-packed-decimal and zoned. In the signed-packed-decimal format, each byte contains two decimal digits, except for the rightmost byte, which contains the sign code in the right half. For decimal arithmetic, the number of decimal digits in the signed-packed-decimal format can vary from one to 31. Because decimal integers must consist of whole bytes and there must be a sign code on the right, the number of decimal digits in this format is always odd. If an even number of significant digits is desired, a leading zero must be inserted on the left.

In the zoned format, each byte consists of a decimal digit on the right and the zone code 1111 (F hex) on the left, except for the rightmost byte where the sign code replaces the zone code. Thus, a decimal integer in the zoned format can have from one to 16 digits. The zoned format may be used directly for input

and output in the extended binary-coded-decimal interchange code (EBCDIC), except that the sign must be separated from the rightmost digit and handled as a separate character. For positive (unsigned) numbers, however, the sign can simply be represented by the zone code of the rightmost digit because the zone code is one of the acceptable alternate codes for plus.

In either format, negative decimal integers are represented in true notation with a separate sign. As for binary integers, the radix point (decimal point) of decimal integers is considered to be fixed at the right, and any scaling is done by the programmer.

The following are some examples of decimal integers shown in hexadecimal notation:

Decimal Value	Signed Packed Format	Zoned Format
+123	12 3C or 12 3F	F1 F2 C3 or F1 F2 F3
-4321	04 32 1D	F4 F3 F2 D1
+000050	00 00 05 0C or 00 00 05 0F	F0 F0 F0 F0 F5 C0 or F0 F0 F0 F0 F5 F0
-7	7D	D7
00000	00 00 0C or 00 00 0F	F0 F0 F0 F0 C0 or F0 F0 F0 F0 F0

Under some circumstances, a zero with a minus sign (negative zero) is produced. For example, the multiplicand:

00 12 3D (-123)

times the multiplier:

0C (+0)

generates the product:

00 00 0D (-0)

because the product sign follows the algebraic rule of signs even when the value is zero. A negative zero,

however, is equivalent to a positive zero in that they compare equal in a decimal comparison.

Hexadecimal-Floating-Point Numbers

A hexadecimal-floating-point (HFP) number is expressed as a hexadecimal fraction multiplied by a separate power of 16. The term floating point indicates that the placement, of the radix (hexadecimal) point, or scaling, is automatically maintained by the machine.

The part of an HFP number which represents the significant digits of the number is called the fraction. A second part specifies the power (exponent) to which 16 is raised and indicates the location of the radix point of the number. The fraction and exponent may be represented by 32 bits (short format), 64 bits (long format), or 128 bits (extended format).

Short HFP Number

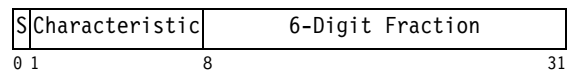

Long HFP Number

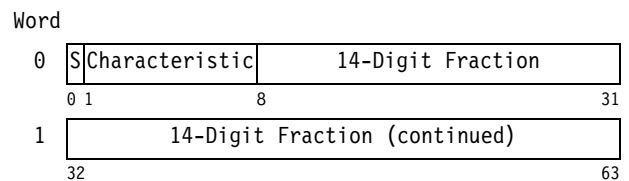

Extended HFP Number

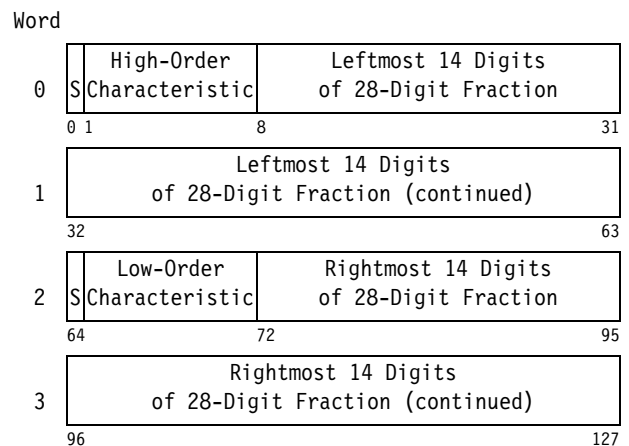

An HFP number has two signs: one for the fraction and one for the exponent. The fraction sign, which is also the sign of the entire number, is the leftmost bit of each format (0 for plus, 1 for minus). The numeric part of the fraction is in true notation regardless of the sign. The numeric part is contained in bits 8-31 for the short format, in bits 8-63 for the long format, and in bits 8-63 followed by bits 72-127 for the extended format.

The exponent sign is obtained by expressing the exponent in excess-64 notation; that is, the exponent is added as a signed number to 64. The resulting number is called the characteristic. It is located in bits 1-7 for all formats. The characteristic can vary from 0 to 127, permitting the exponent to vary from -64 through 0 to +63. This provides a scale multiplier in the range of 16^{-64} to 16^{+63} . A nonzero fraction, if normalized, has a value less than one and greater than or equal to 1/16, so that the range covered by the magnitude M of a normalized floating-point number is:

$$16^{-65} \leq M < 16^{63}$$

In decimal terms:

$$16^{-65} \text{ is approximately } 5.4 \times 10^{-79}$$

$$16^{63} \text{ is approximately } 7.2 \times 10^{75}$$

1.0	= +1/16x16 ¹	= 0 100 0001 0001 0000 0000 0000 0000 0000 ₂
0.5	= +8/16x16 ⁰	= 0 100 0000 1000 0000 0000 0000 0000 0000 ₂
1/64	= +4/16x16 ⁻¹	= 0 011 1111 0100 0000 0000 0000 0000 0000 ₂
0.0	= +0 x16 ⁻⁶⁴	= 0 000 0000 0000 0000 0000 0000 0000 0000 ₂
-15.0	= -15/16x16 ¹	= 1 100 0001 1111 0000 0000 0000 0000 0000 ₂
5.4x10 ⁻⁷⁹	≈ +1/16x16 ⁻⁶⁴	= 0 000 0000 0001 0000 0000 0000 0000 0000 ₂
7.2x10 ⁷⁵	≈ (1-16 ⁻⁶)x16 ⁶³	= 0 111 1111 1111 1111 1111 1111 1111 1111 ₂

Figure A-3. Normalized Short Hexadecimal-Floating-Point Numbers

Conversion Example

Convert the decimal number 59.25 to a short HFP number. (In another appendix are tables for the conversion of hexadecimal and decimal integers and fractions.)

1. The number is separated into a decimal integer and a decimal fraction.

$$59.25 = 59 \text{ plus } 0.25$$

More precisely,

In the short format:

$$16^{-65} \leq M \leq (1 - 16^{-6}) \times 16^{63}$$

In the long format:

$$16^{-65} \leq M \leq (1 - 16^{-14}) \times 16^{63}$$

In the extended format:

$$16^{-65} \leq M \leq (1 - 16^{-28}) \times 16^{63}$$

Within a given fraction length (6, 14, or 28 digits), an HFP operation will provide the greatest precision if the fraction is normalized. A fraction is normalized when the leftmost digit (bit positions 8, 9, 10, and 11) is nonzero. It is unnormalized if the leftmost digit contains all zeros.

If normalization of the operand is desired, the HFP instructions that provide automatic normalization are used. This automatic normalization is accomplished by left-shifting the fraction (four bits per shift) until a nonzero digit occupies the leftmost digit position. The characteristic is reduced by one for each digit shifted.

Figure A-3 illustrates sample normalized short HFP numbers. The last two numbers represent the smallest and the largest positive normalized numbers.

2. The decimal integer is converted to its hexadecimal representation.

$$59_{10} = 3B_{16}$$

3. The decimal fraction is converted to its hexadecimal representation.

$$0.25_{10} = 0.4_{16}$$

4. The integral and fractional parts are combined and expressed as a fraction times a power of 16 (exponent).

$$3B.4_{16} = 0.3B4_{16} \times 16^2$$

- The characteristic is developed from the exponent and converted to binary.

$$\begin{array}{rcl} \text{base} + \text{exponent} & = & \text{characteristic} \\ 64 + 2 & = & 66 = 1000010 \end{array}$$

- The fraction is converted to binary and grouped hexadecimally.

$$.3B4_{16} = .0011\ 1011\ 0100$$

- The characteristic and the fraction are stored in the short format. The sign position contains the sign of the fraction.

S	Char	Fraction
0	1000010	0011 1011 0100 0000 0000 0000

Examples of instruction sequences that may be used to convert between signed binary integers and HFP numbers are shown in “Hexadecimal-Floating-Point-Number Conversion” on page A-44.

Instruction-Use Examples

The following examples illustrate the use of many of the unprivileged instructions. Before studying one of these examples, the reader should consult the instruction description.

The instruction-use examples are written principally for assembler-language programmers, to be used in conjunction with the appropriate assembler-language publications.

Most examples present one particular instruction, both as it is written in an assembler-language statement and as it appears when assembled in storage (machine format).

Machine Format

All machine-format values are given in hexadecimal notation unless otherwise specified. Storage addresses are also given in hexadecimal. Hexadecimal operands are shown converted into binary, decimal, or both if such conversion helps to clarify the example for the reader.

Assembler-Language Format

In assembler-language statements, registers and lengths are presented in decimal. Displacements, immediate operands, and masks may be shown in decimal, hexadecimal, or binary notation; for example, 12, X'C', and B'1100' represent the same value. Whenever the value in a register or storage location is referred to as “not significant,” this value is replaced during the execution of the instruction.

When SS-format instructions are written in the assembler language, lengths are given as the total number of bytes in the field. This differs from the machine definition, in which the length field specifies the number of bytes to be added to the field address to obtain the address of the last byte of the field. Thus, the machine length is one less than the assembler-language length. The assembler program automatically subtracts one from the length specified when the instruction is assembled.

In some of the examples, symbolic addresses are used in order to simplify the examples. In assembler-language statements, a symbolic address is represented as a mnemonic term written in all capitals, such as FLAGS, which may denote the address of a storage location containing data or program-control information. When symbolic addresses are used, the assembler supplies actual base and displacement values according to the programmer’s specifications. Therefore, the actual values for base and displacement are not shown in the assembler-language format or in the machine-language format. For assembler-language formats, in the labels that designate instruction fields, the letter “S” is used to indicate the combination of base and displacement fields for an operand address. (For example, S2 represents the combination of B2 and D2.) In the machine-language format, the base and displacement address components are shown as asterisks (****).

Addressing Mode in Examples

Except where otherwise specified, the examples assume the 24-bit addressing mode.

General Instructions

(See Chapter 7, “General Instructions” for a complete description of the general instructions.)

ADD HALFWORD (AH)

The ADD HALFWORD instruction algebraically adds the contents of a two-byte field in storage to the contents of a register. The storage operand is expanded to 32 bits after it is fetched and before it is used in the add operation. The expansion consists in propagating the leftmost (sign) bit 16 positions to the left. For example, assume that the contents of storage locations 2000-2001 are to be added to register 5. Initially:

Register 5 contains $00\ 00\ 00\ 19 = 25_{10}$.

Storage locations 2000-2001 contain FF FE = -2_{10} .

Register 12 contains $00\ 00\ 18\ 00$.

Register 13 contains $00\ 00\ 01\ 50$.

The format of the required instruction is:

Machine Format

Op Code	R ₁	X ₂	B ₂	D ₂
4A	5	D	C	6B0

Assembler Format

Op Code R₁,D₂(X₂,B₂)

AH 5,X'6B0'(13,12)

After the instruction is executed, register 5 contains $00\ 00\ 00\ 17 = 23_{10}$. Condition code 2 is set to indicate a result greater than zero.

AND (N, NC, NI, NR)

When the Boolean operator AND is applied to two bits, the result is one when both bits are one; otherwise, the result is zero. When two bytes are ANDed, each pair of bits is handled separately; there is no connection from one bit position to another. The following is an example of ANDING two bytes:

First-operand byte:	0011 0101 ₂
Second-operand byte:	0101 1100 ₂
<hr/>	
Result byte:	0001 0100 ₂

NI Example

A frequent use of the AND instruction is to set a particular bit to zero. For example, assume that storage location 4891 contains $0100\ 0011_2$. To set the rightmost bit of this byte to zero without affecting the other bits, the following instruction can be used (assume that register 8 contains $00\ 00\ 48\ 90$):

Machine Format

Op Code	I ₂	B ₁	D ₁
94	FE	8	001

Assembler Format

Op Code D₁(B₁),I₂

NI 1(8),X'FE'

When this instruction is executed, the byte in storage is ANDed with the immediate byte (the I₂ field of the instruction):

Location 4891:	0100 0011 ₂
Immediate byte:	1111 1110 ₂

Result: 0100 0010₂

The resulting byte, with bit 7 set to zero, is stored back in location 4891. Condition code 1 is set.

Linkage Instructions (BAL, BALR, BAS, BASR, BASSM, BSM)

Four unprivileged instructions (BRANCH AND LINK, BRANCH AND SAVE, BRANCH AND SAVE AND SET MODE, and BRANCH AND SET MODE) are available, together with the unconditional branch (BRANCH ON CONDITION with a mask of 15), to provide linkage between subroutines. BRANCH AND LINK (BAL or BALR) is provided primarily for compatibility with programs written for System/370; BRANCH AND SAVE (BAS or BASR) is recommended instead for programs which are to be executed using ESA/370. The instructions BRANCH AND SAVE AND SET MODE (BASSM) and BRANCH AND SET MODE (BSM) provide subroutine linkage together with switching between the 24-bit and the 31-bit addressing modes. The use of these instructions is discussed in a programming note at the end of the section "Subroutine Linkage without the Linkage Stack" on page 5-14 (See also

the semiprivileged instruction BRANCH AND STACK.)

The following example compares the operation of these instructions and of the unconditional-branch instruction BRANCH ON CONDITION (BC or BCR with a mask of 15). Assume that each instruction in turn is located at the current instruction address, ready to be executed next. For the first set of examples, the addressing-mode bit, PSW bit 32, is initially zero (24-bit addressing in effect). For the second set, PSW bit 32 is initially one (31-bit addressing). Assume also that general register 5 is to receive the linkage information, and that general register 6 contains the branch address.

The format of the BALR instruction is:

Machine Format

Op Code	R ₁	R ₂
05	5	6

Assembler Format

Op Code	R ₁ ,R ₂
BALR	5,6

The other linkage instructions in the RR format have the same format but different op codes:

BASR 0D
 BASSM 0C
 BSM 0B

For comparison with the RR-format instructions, the results of two RX-format instructions are also shown.

The format of the BAL instruction is:

Machine Format

Op Code	R ₁	X ₂	B ₂	D ₂
45	5	0	6	000

Assembler Format

Op Code	R ₁ ,D ₂ (X ₂ ,B ₂)
BAL	5,0(0,6)

The BAS instruction has the same format, but the op code is 4D.

The BCR instruction specifies only one register:

Machine Format

Op Code	M ₁	R ₂
07	F	6

Assembler Format

Op Code	M ₁ ,R ₂
BCR	15,6

Assume that:

Register 5 contains BB BB BB BB.

Register 6 contains 82 46 8A CE.

PSW bits 32-63 contain

00 00 10 D6 (for 24-bit addressing).
 80 00 10 D6 (for 31-bit addressing).

Condition code is 01₂.

Program mask is 1100₂.

The effect of executing each instruction in turn is as follows:

24-Bit Mode Initially

Instruction	Register 5	PSW (32-63)
Before	BB BB BB BB	00 00 10 D6
BCR 15,6	BB BB BB BB	00 46 8A CE
BAL 5,0(0,6)	9C 00 10 DA	00 46 8A CE
BAS 5,0(0,6)	00 00 10 DA	00 46 8A CE
BALR 5,6	5C 00 10 D8	00 46 8A CE
BASR 5,6	00 00 10 D8	00 46 8A CE
BASSM 5,6	00 00 10 D8	82 46 8A CE
BSM 5,6	3B BB BB BB	82 46 8A CE

31-Bit Mode Initially

Instruction	Register 5	PSW (32-63)
Before	BB BB BB BB	80 00 10 D6
BCR 15,6	BB BB BB BB	82 46 8A CE
BAL 5,0(0,6)	80 00 10 DA	82 46 8A CE
BAS 5,0(0,6)	80 00 10 DA	82 46 8A CE
BALR 5,6	80 00 10 D8	82 46 8A CE
BASR 5,6	80 00 10 D8	82 46 8A CE
BASSM 5,6	80 00 10 D8	82 46 8A CE
BSM 5,6	BB BB BB BB	82 46 8A CE

Note that a value of zero in the R₂ field of any of the RR-format instructions indicates that the branching function is not to be performed; it does not refer to

register 0. Likewise, a value of zero in the R_1 field of the BSM instruction indicates that the old value of PSW bit 32 is not to be saved and that register 0 is to be left unchanged. Register 0 can be designated by the R_1 field of instructions BAL, BALR, BAS, BASR, and BASSM, however. In the RX-format branch instructions, branching occurs independent of whether there is a value of zero in the B_2 field or X_2 field of the instruction. However, when the field is zero, instead of using the contents of general register 0, a value of zero is used for that component of address generation.

Programming Note: It should be noted that execution of BAL in the 24-bit addressing mode results in bit 0 of register 5 being set to one. This is because the ILC for an RX-format instruction is 10. This is the only case in which bit zero of the return register does not correctly reflect the addressing mode of the caller. Thus, BSM may be used to return for BALR, BAS, BASR, and BASSM in both the 24-bit and the 31-bit addressing modes, but it cannot be used to return if the program was called by using BAL in the 24-bit addressing mode.

Other BALR and BASR Examples

The BALR or BASR instruction with the R_2 field set to zero may be used to load a register for use as a base register. For example, in the assembler language, the two statements:

```
BALR    15,0
USING  *,15
```

or

```
BASR    15,0
USING  *,15
```

indicate that the address of the next sequential instruction following the BALR or BASR instruction will be placed in register 15, and that the assembler may use register 15 as a base register until otherwise instructed. (The USING statement is an “assembler instruction” and is thus not a part of the object program.)

BRANCH AND STACK (BAKR)

The semiprivileged BRANCH AND STACK instruction facilitates linkage between subroutines by saving

status in a linkage-stack state entry (sometimes called a branch state entry to distinguish it from a program-call state entry). When BRANCH AND STACK has been used, the return from the called program is made by means of the PROGRAM RETURN instruction. PROGRAM RETURN restores access registers 2-14, general registers 2-14, and the PSW with values saved in the state entry, except that it leaves the PER mask unchanged and sets the condition code to an unpredictable value. The use of BRANCH AND STACK is discussed in “Branching Using the Linkage Stack” on page 5-73.

BRANCH AND STACK can be used to perform a calling linkage, or it can be used at or near the entry point of the called program, depending on whether the R_1 field of the instruction is zero or nonzero, respectively. If the R_1 field is zero, bits 32-63 of the PSW saved in the state entry indicate the current addressing mode (24-bit or 31-bit) and the address of the next sequential instruction after the BRANCH AND STACK instruction or an EXECUTE instruction. If the R_1 field is nonzero, bits 32-63 of the PSW saved in the state entry are set with a value generated from the contents of general register R_1 : bit 32 of the PSW is set equal to bit 0 of the register, and bits 1-31 of the PSW are set with an address generated from bits 1-31 of the register under the control of bit 0 of the register. Bits 32-63 of the PSW saved in the state entry are referred to in the following examples as the return value.

The branch address for the instruction is generated from the contents of general register R_2 under the control of the current addressing mode. Bit 0 of general register R_2 does not affect the operation. If the R_2 field of the instruction is zero, the operation is performed without branching.

In addition to saving a complete PSW (except with an unpredictable PER mask) in the state entry, BRANCH AND STACK saves the new value of bits 32-63 of the current PSW in the state entry. Bits 32-63 are referred to in the following examples as the branch value.

The following examples contain cases in which bit 32 of the current PSW is either zero or one (24-bit or 31-bit addressing) before BRANCH AND STACK is executed and in which bit 0 of the general register designated by a nonzero R_1 or R_2 field is either zero or one.

BAKR Example 1

This example shows BAKR used in a calling program. BAKR performs a branch, and the return is to be to the next sequential instruction.

The format of the BAKR instruction is:

Machine Format

Op Code	R ₁	R ₂
B240	0	6

Assembler Format

Op Code	R ₁ ,R ₂
BAKR	0,6

Assume four cases of initial values, as follows:

	PSW (32-63)	Register 6
1.	00 00 10 D6	02 46 8A CE
2.	00 00 10 D6	82 46 8A CE
3.	80 00 10 D6	02 46 8A CE
4.	80 00 10 D6	82 46 8A CE

The results in the four cases are as follows:

	Return Value	Branch Value and PSW (32-63)
1.	00 00 10 DA	00 46 8A CE
2.	00 00 10 DA	00 46 8A CE
3.	80 00 10 DA	82 46 8A CE
4.	80 00 10 DA	82 46 8A CE

BAKR Example 2

This example shows BAKR used in a called program. BAKR does not perform a branch, and the return is to be as specified in general register R₁.

The format of the BAKR instruction is:

Machine Format

Op Code	R ₁	R ₂
B240	5	0

Assembler Format

Op Code	R ₁ ,R ₂
BAKR	5,0

Assume four cases of initial values, as follows:

	Register 5	PSW (32-63)
1.	04 00 10 D6	00 46 8A CE
2.	04 00 10 D6	82 46 8A CE
3.	84 00 10 D6	00 46 8A CE
4.	84 00 10 D6	82 46 8A CE

The results in the four cases are as follows:

	Return Value	Branch Value and PSW (32-63)
1.	00 00 10 D6	00 46 8A D2
2.	00 00 10 D6	82 46 8A D2
3.	84 00 10 D6	00 46 8A D2
4.	84 00 10 D6	82 46 8A D2

BAKR Example 3

This example shows BAKR used in a called program. BAKR performs a branch, and the return is to be as specified in general register R₁.

The format of the BAKR instruction is:

Machine Format

Op Code	R ₁	R ₂
B240	5	6

Assembler Format

Op Code	R ₁ ,R ₂
BAKR	5,6

Assume eight cases of initial values, as follows:

	Register 5	Register 6	PSW (32-63)
1.	04 00 10 D6	06 99 99 00	00 46 8A CE
2.	04 00 10 D6	06 99 99 00	82 46 8A CE
3.	04 00 10 D6	86 99 99 00	00 46 8A CE
4.	04 00 10 D6	86 99 99 00	82 46 8A CE
5.	84 00 10 D6	06 99 99 00	00 46 8A CE
6.	84 00 10 D6	06 99 99 00	82 46 8A CE
7.	84 00 10 D6	86 99 99 00	00 46 8A CE
8.	84 00 10 D6	86 99 99 00	82 46 8A CE

The results in the eight cases are as follows:

	Return Value	Branch Value and PSW (32-63)
1.	00 00 10 D6	00 99 99 00
2.	00 00 10 D6	86 99 99 00
3.	00 00 10 D6	00 99 99 00
4.	00 00 10 D6	86 99 99 00

5. 84 00 10 D6 00 99 99 00
6. 84 00 10 D6 86 99 99 00
7. 84 00 10 D6 00 99 99 00
8. 84 00 10 D6 86 99 99 00

BRANCH ON CONDITION (BC, BCR)

The BRANCH ON CONDITION instruction tests the condition code to see whether a branch should or should not occur. The branch occurs only if the current condition code corresponds to a one bit in a mask specified by the instruction.

Condition Code	Instruction (Mask) Bit	Mask Value
0	8	8
1	9	4
2	10	2
3	11	1

For example, assume that an ADD (A or AR) operation has been performed and that a branch to address 6050 is desired if the sum is zero or less (condition code is 0 or 1). Also assume:

Register 10 contains 00 00 50 00.

Register 11 contains 00 00 10 00.

The RX form of the instruction performs the required test (and branch if necessary) when written as:

Machine Format

Op Code	M ₁	X ₂	B ₂	D ₂
47	C	B	A	050

Assembler Format

Op Code M₁,D₂(X₂,B₂)

BC 12,X'50'(11,10)

A mask of 12₁₀ means that there are ones in instruction bits 8 and 9 and zeros in bits 10 and 11, so that branching takes place when the condition code is either 0 or 1.

A mask of 15 would indicate a branch on any condition (an unconditional branch). A mask of zero would indicate that no branch is to occur (a no-operation).

(See also "Linkage Instructions (BAL, BALR, BAS, BASR, BASSM, BSM)" on page A-8 for an example of the BCR instruction.)

BRANCH ON COUNT (BCT, BCTR)

The BRANCH ON COUNT instruction is often used to execute a program loop for a specified number of times. For example, assume that the following represents some lines of coding in an assembler-language program:

```

:
LUPE AR 8,1
:
BACK BCT 6,LUPE
:

```

where register 6 contains 00 00 00 03 and the address of LUPE is 6826. Assume that, in order to address this location, register 10 is used as a base register and contains 00 00 68 00.

The format of the BCT instruction is:

Machine Format

Op Code	R ₁	X ₂	B ₂	D ₂
46	6	0	A	026

Assembler Format

Op Code R₁,D₂(X₂,B₂)

BCT 6,X'26'(0,10)

The effect of the coding is to execute three times the loop defined by the instructions labeled LUPE through BACK, while register 6 is decremented from three to zero.

BRANCH ON INDEX HIGH (BXH)

BXH Example 1

The BRANCH ON INDEX HIGH instruction is an index-incrementing and loop-controlling instruction that causes a branch whenever the sum of an index value and an increment value is greater than some compare value. For example, assume that:

Register 4 contains 00 00 00 8A = 138₁₀ = the index.

Register 6 contains $00\ 00\ 00\ 02 = 2_{10}$ = the increment.

Register 7 contains $00\ 00\ 00\ AA = 170_{10}$ = the compare value.

Register 10 contains $00\ 00\ 71\ 30$ = the branch address.

The format of the BXH instruction is:

Machine Format

Op Code	R ₁	R ₃	B ₂	D ₂
86	4	6	A	000

Assembler Format

Op Code	R ₁ , R ₃ , D ₂ (B ₂)
BXH	4, 6, 0(10)

When the instruction is executed, first the contents of register 6 are added to register 4, second the sum is compared with the contents of register 7, and third the decision whether to branch is made. After execution:

Register 4 contains $00\ 00\ 00\ 8C = 140_{10}$.

Registers 6 and 7 are unchanged.

Since the new value in register 4 is not yet greater than the value in register 7, the branch to address 7130 is not taken. Repeated use of the instruction will eventually cause the branch to be taken when the value in register 4 reaches 172_{10} .

BXH Example 2

When the register used to contain the increment is odd, that register also becomes the compare-value register. The following assembler-language subroutine illustrates how this may be used to search a table.

Table	
2 Bytes	2 Bytes
ARG1	FUNCT1
ARG2	FUNCT2
ARG3	FUNCT3
ARG4	FUNCT4
ARG5	FUNCT5
ARG6	FUNCT6

Assume that:

Register 8 contains the search argument.

Register 9 contains the width of the table in bytes (00 00 00 04).

Register 10 contains the length of the table in bytes (00 00 00 18).

Register 11 contains the starting address of the table.

Register 14 contains the return address to the main program.

As the following subroutine is executed, the argument in register 8 is successively compared with the arguments in the table, starting with argument 6 and working backward to argument 1. If an equality is found, the corresponding function replaces the argument in register 8. If an equality is not found, zero replaces the argument in register 8.

SEARCH	LNR	9, 9
NOTEQUAL	BXH	10, 9, LOOP
NOTFOUND	SR	8, 8
	BCR	15, 14
LOOP	CH	8, 0(10, 11)
	BC	7, NOTEQUAL
	LH	8, 2(10, 11)
	BCR	15, 14

The first instruction (LNR) causes the value in register 9 to be made negative. After execution of this instruction, register 9 contains $FF\ FF\ FF\ FC = -4_{10}$. Considering the case when no equality is found, the BXH instruction will be executed seven times. Each time BXH is executed, a value of -4 is added to register 10, thus reducing the value in register 10 by 4. The new value in register 10 is compared with the -4 value in register 9. The branch is taken each time until the value in register 10 is -4. Then the branch is not taken, and the SR instruction sets register 8 to zero.

BRANCH ON INDEX LOW OR EQUAL (BXLE)

The BRANCH ON INDEX LOW OR EQUAL instruction performs the same operation as BRANCH ON INDEX HIGH, except that branching occurs when the sum is lower than or equal to (instead of higher than) the compare value. As the instruction which increments and tests an index value in a program loop, BXLE is useful at the end of the loop and BXH at the

beginning. The following assembler-language routines illustrate loops with BXLE.

BXLE Example 1

Assume that a group of ten 32-bit signed binary integers are stored at consecutive locations, starting at location GROUP. The integers are to be added together, and the sum is to be stored at location SUM.

```

SR 5,5      Set sum to zero
LA 6,GROUP  Load first address
SR 7,7      Set index to zero
LA 8,4      Load increment 4
LA 9,39     Load compare value
LOOP A 5,0(7,6) Add integer to sum
BXLE 7,8,LOOP Test end of loop
ST 5,SUM    Store sum

```

The two-instruction loop contains an ADD (A) instruction which adds each integer to the contents of general register 5. The ADD instruction uses the contents of general register 7 as an index value to modify the starting address obtained from register 6. Next, BXLE increments the index value by 4, the increment previously loaded into register 8, and compares it with the compare value in register 9, the odd register of this even-odd pair. The compare value was previously set to 39, which is one less than the number of bytes in the data area; this is also the address, relative to the starting address, of the rightmost byte of the last integer to be added. When the last integer has been added, BXLE increments the index value to the next relative address (40), which is found to be greater than the compare value (39) so that no branching takes place.

BXLE Example 2

The technique illustrated in Example 1 is restricted to loops containing instructions in the RX instruction format. That format allows both a base register and an index register to be specified (double indexing).

For instructions in other formats, where an index register cannot be specified, the previous technique may be modified by having the address itself serve as the index value in a BXLE instruction and by using as the compare value the address of the last byte rather than its relative address. The base register then provides the address directly at each iteration of the loop, and it is not necessary to specify a second register to hold the index value (single indexing).

In the following example, an AND (NI) instruction in the SI instruction format sets to zero the rightmost bit of each of the same group of integers as in Example 1, thus making all of them even. The I_2 field of the NI instruction contains the byte X'FE', which consists of seven ones and a zero. That byte is ANDed into byte 3, the rightmost byte, of each of the integers in turn.

```

LA 6,GROUP  Load first address
LA 8,4      Load increment 4
LA 9,GROUP+39 Load compare value
LOOP NI 3(6),X'FE' AND immediate
BXLE 6,8,LOOP Test end of loop

```

The technique shown in Example 2 does not work, however, on an ESA/370 system when it is in the 31-bit addressing mode and the data is located at the rightmost end of a 31-bit address space. In this case, the compare value would be set to $2^{31}-1$, which is the largest possible 32-bit signed binary value. The reason the technique does not work is that the BXLE and BXH instructions treat their operands as 32-bit signed binary integers. When the address in general register 6 reaches the value $2^{31}-4$, BXLE increments it to a value that is interpreted as -2^{31} , rather than 2^{31} , and the comparison remains low, which causes looping to continue indefinitely.

This situation can be avoided by not allowing data areas to extend to the rightmost location in a 31-bit address space or by using other techniques; these may include double indexing when possible, as in Example 1, or starting at the end and stepping downward through the data area with a negative increment.

COMPARE AND FORM CODEWORD (CFC)

See "Sorting Instructions" on page A-53.

COMPARE HALFWORD (CH)

The COMPARE HALFWORD instruction compares a 16-bit signed binary integer in storage with the contents of a register. For example, assume that:

Register 4 contains FF FF 80 00 = $-32,768_{10}$.

Register 13 contains 00 01 60 50.

Storage locations 16080-16081 contain 8000 = -32,768₁₀.

When the instruction:

Machine Format

Op Code	R ₁	X ₂	B ₂	D ₂
49	4	0	D	030

Assembler Format

Op Code R₁,D₂(X₂,B₂)

CH 4,X'30'(0,13)

is executed, the contents of locations 16080-16081 are fetched, expanded to 32 bits (the sign bit is propagated to the left), and compared with the contents of register 4. Because the two numbers are equal, condition code 0 is set.

COMPARE LOGICAL (CL, CLC, CLI, CLR)

The COMPARE LOGICAL instruction differs from the signed-binary comparison instructions (C, CH, CR) in that all quantities are handled as unsigned binary integers or as unstructured data.

CLC Example

The COMPARE LOGICAL (CLC) instruction can be used to perform the byte-by-byte comparison of storage fields up to 256 bytes in length. For example, assume that the following two fields of data are in storage:

Field 1

1886												1891											
D1	D6	C8	D5	E2	D6	D5	6B	C1	4B	C2	4B	D1	D6	C8	D5	E2	D6	D5	6B	C1	4B	C2	4B

Field 2

1900												190B											
D1	D6	C8	D5	E2	D6	D5	6B	C1	4B	C3	4B	D1	D6	C8	D5	E2	D6	D5	6B	C1	4B	C3	4B

Also assume:

Register 9 contains 00 00 18 80.

Register 7 contains 00 00 19 00.

Execution of the instruction:

Machine Format

Op Code	L	B ₁	D ₁	B ₂	D ₂
D5	0B	9	006	7	000

Assembler Format

Op Code D₁(L,B₁),D₂(B₂)

CLC 6(12,9),0(7)

sets condition code 1, indicating that the contents of field 1 are lower in value than the contents of field 2.

Because the collating sequence of the EBCDIC code is determined simply by a logical comparison of the bits in the code, the CLC instruction can be used to collate EBCDIC-coded fields. For example, in EBCDIC, the above two data fields are:

Field 1: JOHNSON,A.B.

Field 2: JOHNSON,A.C.

Condition code 1 indicates that JOHNSON,A.B. should precede JOHNSON,A.C. for the fields to be in alphabetic sequence.

CLI Example

The COMPARE LOGICAL (CLI) instruction compares a byte from the instruction stream with a byte from storage. For example, assume that:

Register 10 contains 00 00 17 00.

Storage location 1703 contains 7E.

Execution of the instruction:

Machine Format

Op Code	I ₂	B ₁	D ₁
95	AF	A	003

Assembler Format

Op Code D₁(B₁),I₂

CLI 3(10),X'AF'

sets condition code 1, indicating that the first operand (the quantity in main storage) is lower than the second (immediate) operand.

CLR Example

Assume that:

Register 4 contains 00 00 00 01 = 1.

Register 7 contains FF FF FF FF = $2^{32} - 1$.

Execution of the instruction:

Machine Format

Op Code	R ₁	R ₂
15	4	7

Assembler Format

Op Code	R ₁ , R ₂
CLR	4,7

sets condition code 1. Condition code 1 indicates that the first operand is lower than the second.

If, instead, the signed-binary comparison instruction COMPARE (CR) had been executed, the contents of register 4 would have been interpreted as +1 and the contents of register 7 as -1. Thus, the first operand would have been higher, so that condition code 2 would have been set.

COMPARE LOGICAL CHARACTERS UNDER MASK (CLM)

The COMPARE LOGICAL CHARACTERS UNDER MASK (CLM) instruction provides a means of comparing bytes selected from a general register to a contiguous field of bytes in storage. The M₃ field of the CLM instruction is a four-bit mask that selects zero to four bytes from a general register, each mask bit corresponding, left to right, to a register byte. In the comparison, the register bytes corresponding to ones in the mask are treated as a contiguous field. The operation proceeds left to right. For example, assume that:

Storage locations 10200-10202 contain F0 BC 7B.

Register 12 contains 00 01 00 00.

Register 6 contains F0 BC 5C 7B.

Execution of the instruction:

Machine Format

Op Code	R ₁	M ₃	B ₂	D ₂
BD	6	D	C	200

Assembler Format

Op Code	R ₁ , M ₃ , D ₂ (B ₂)
CLM	6, B'1101', X'200' (12)

causes the following comparison:

Register 6:	F0	BC	5C	7B
Mask M ₃ :	1	1	0	1
	--	--		--

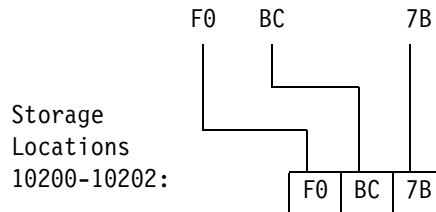

Because the selected bytes are equal, condition code 0 is set.

COMPARE LOGICAL LONG (CLCL)

The COMPARE LOGICAL LONG instruction is used to compare two operands in storage, byte by byte. Each operand can be of any length. Two even-odd pairs of general registers (four registers in all) are used to locate the operands and to control the execution of the CLCL instruction, as illustrated in the following diagram. The first register of each pair must be an even register, and it contains the storage address of an operand. The odd register of each pair contains the length of the operand it covers, and the leftmost byte of the second-operand odd register contains a padding byte which is used to extend the shorter operand, if any, to the same length as the longer operand.

The following illustrates the assignment of registers in the 24-bit addressing mode:

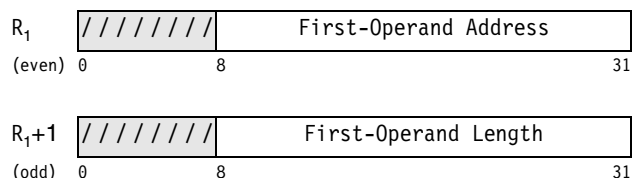

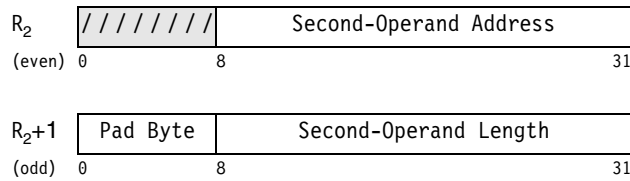

In the 31-bit addressing mode, the operand addresses would be in bit positions 1-31 of the even registers shown above.

Since the CLCL instruction may be interrupted during execution, the interrupting program must preserve the contents of the four registers for use when the instruction is resumed.

The following instructions set up two register pairs to control a text-string comparison. For example, assume:

Operand 1
 Address: 20800₁₆
 Length: 100₁₀

Operand 2
 Address: 20A00₁₆
 Length: 132₁₀

Padding Byte
 Address: 20003₁₆
 Length: 1
 Value: 40₁₆

Register 12 contains 00 02 00 00.

The setup instructions are:

- LA 4,X'800'(12) Set register 4 to start of first operand
- LA 5,100 Set register 5 to length of first operand
- LA 8,X'A00'(12) Set register 8 to start of second operand
- LA 9,132 Set register 9 to length of second operand
- ICM 9,B'1000',3(12) Insert padding byte in leftmost byte position of register 9

Register pair 4,5 defines the first operand. Bits 8-31 of register 4 contain the storage address of the start of an EBCDIC text string, and bits 8-31 of register 5 contain the length of the string, in this case 100 bytes.

Register pair 8,9 defines the second operand, with bits 8-31 of register 8 containing the starting location of the second operand and bits 8-31 of register 9 containing the length of the second operand, in this case 132 bytes. Bits 0-7 of register 9 contain an EBCDIC blank character (X'40') to pad the shorter operand. In this example, the padding byte is used in the first operand, after the 100th byte, to compare with the remaining bytes in the second operand.

With the register pairs thus set up, the format of the CLCL instruction is:

Machine Format

Op Code	R_1	R_2
0F	4	8

Assembler Format

Op Code	R_1, R_2
CLCL	4,8

When this instruction is executed, the comparison starts at the left end of each operand and proceeds to the right. The operation ends as soon as an inequality is detected or the end of the longer operand is reached.

If this CLCL instruction is interrupted after 60 bytes have compared equal, the operand lengths in registers 5 and 9 will have been decremented to 40 and 72, respectively. The operand addresses in registers 4 and 8 will have been incremented to X'2083C' and X'20A3C'; the leftmost byte of registers 4 and 8 will have been set to zero. The padding byte X'40' remains in register 9. When the CLCL instruction is reexecuted with these register contents, the comparison resumes at the point of interruption.

Now, assume that the instruction is interrupted after 110 bytes. That is, the first 100 bytes of the second operand have compared equal to the first operand, and the next 10 bytes of the second operand have compared equal to the padding byte (blank). The residual operand lengths in registers 5 and 9 are 0 and 22, respectively, and the operand addresses in registers 4 and 8 are X'20864' (the value when the first operand was exhausted) and X'20A6E' (the current value for the second operand).

When the comparison ends, the condition code is set to 0, 1, or 2, depending on whether the first operand

is equal to, less than, or greater than the second operand, respectively.

When the operands are unequal, the addresses in registers 4 and 8 indicate the bytes that caused the mismatch.

COMPARE LOGICAL STRING (CLST)

The COMPARE LOGICAL STRING instruction is used to compare a first operand designated by general register R_1 and a second operand designated by general register R_2 . The comparison is made left to right, byte by byte, until unequal bytes are compared, an ending character specified in general register 0 is encountered in either operand, or a CPU-determined number of bytes have been compared. The condition code is set to 0 if the two operands are equal, to 1 if the first operand is low, to 2 if the second operand is low, or to 3 if a CPU-determined number of bytes have been compared. If the ending character is found in both operands simultaneously, the operands are equal. If it is found in only one operand, that operand is low.

When condition code 1 or 2 is set, the addresses of the last bytes processed in the first and second operands are placed in general registers R_1 and R_2 , respectively. These are the addresses of unequal bytes in the two operands, or they are the address of an ending character in one operand and of the byte in the corresponding byte position in the other operand. When condition code 3 is set, the addresses of the next bytes to be processed are placed in the registers. When condition code 0 is set, the contents of the registers remain unchanged.

Following are examples of first and second operands beginning at decimal locations 1000 and 2000, respectively. The addresses in general registers R_1 and R_2 are 1000 and 2000, respectively. The ending character in general register 0 is 00 hex (as in the C programming language). The values of the operand bytes are shown in hex, and the resulting condition code and final contents of general registers R_1 and R_2 are shown.

Example 1

```
1000          2000
C1 C2 C3 00  C1 C2 C3 00
```

CC: 0; (R_1): 1000; (R_2): 2000

Example 2

```
1000          2000
40 40 40 C1  40 40 40 C2
```

CC: 1; (R_1): 1003; (R_2): 2003

Example 3

```
1000          2000
40 40 40 C2  40 40 40 C1
```

CC: 2; (R_1): 1003; (R_2): 2003

Example 4

```
1000          2000
C1 C2 C3 00  C1 C2 C3 C4
```

CC: 1; (R_1): 1003; (R_2): 2003

Example 5

```
1000          2000
C1 C2 C3 C4  C1 C2 C3 00
```

CC: 2; (R_1): 1003; (R_2): 2003

Example 6

Assuming that the CPU-determined number of bytes compared is 256:

```
1000    1256 2000    2256
40 .. 40 00  40 .. 40 00
```

CC: 3; (R_1): 1256; (R_2): 2256

Example 7

```
1000          2000
00 40 40 40  40 40 40 40
```

CC: 1; (R_1): 1000; (R_2): 2000

Example 8

```
1000          2000
40 40 40 40  00 40 40 40
```

CC: 2; (R_1): 1000; (R_2): 2000

Example 9

```
1000          2000
00 40 40 40  00 40 40 40
```

CC: 0; (R_1): 1000; (R_2): 2000

CONVERT TO BINARY (CVB)

The CONVERT TO BINARY instruction converts an eight-byte, signed-packed-decimal number into a signed binary integer and loads the result into a gen-

eral register. After the conversion operation is completed, the number is in the proper form for use as an operand in signed binary arithmetic. For example, assume:

Storage locations 7608-760F contain a decimal number in the signed-packed-decimal format: 00 00 00 00 25 59 4C (+25,594).

The contents of register 7 are not significant.

Register 13 contains 00 00 76 00.

The format of the conversion instruction is:

Machine Format

Op Code	R ₁	X ₂	B ₂	D ₂
4F	7	0	D	008

Assembler Format

Op Code	R ₁ , D ₂ (X ₂ , B ₂)
CVB	7,8(0,13)

After the instruction is executed, register 7 contains 00 00 63 FA.

CONVERT TO DECIMAL (CVD)

The CONVERT TO DECIMAL instruction is the opposite of the CONVERT TO BINARY instruction. CVD converts a signed binary integer in a register to signed-packed-decimal number and stores the eight-byte result. For example, assume:

Register 1 contains the signed binary integer: 00 00 0F 0F.

Register 13 contains 00 00 76 00.

The format of the instruction is:

Machine Format

Op Code	R ₁	X ₂	B ₂	D ₂
4E	1	0	D	008

Assembler Format

Op Code	R ₁ , D ₂ (X ₂ , B ₂)
CVD	1,8(0,13)

After the instruction is executed, storage locations 7608-760F contain 00 00 00 00 00 03 85 5C (+3855).

The plus sign generated is the preferred plus sign, 1100₂.

DIVIDE (D, DR)

The DIVIDE instruction divides the dividend in an even-odd register pair by the divisor in a register or in storage. Since the instruction assumes the dividend to be 64 bits long, it is important first to extend a 32-bit dividend on the left with bits equal to the sign bit. For example, assume that:

Storage locations 3550-3553 contain 00 00 08 DE = 2270₁₀ (the dividend).

Storage locations 3554-3557 contain 00 00 00 32 = 50₁₀ (the divisor).

The initial contents of registers 6 and 7 are not significant.

Register 8 contains 00 00 35 50.

The following assembler-language statements load the registers properly and perform the divide operation:

Statement	Comments
L 6,0(0,8)	Places 00 00 08 DE into register 6.
SRDA 6,32(0)	Shifts 00 00 08 DE into register 7. Register 6 is filled with zeros (sign bits).
D 6,4(0,8)	Performs the division.

The machine format of the above DIVIDE instruction is:

Machine Format

Op Code	R ₁	X ₂	B ₂	D ₂
5D	6	0	8	004

After the instructions listed above are executed:

Register 6 contains 00 00 00 14 = 20₁₀ = the remainder.

Register 7 contains 00 00 00 2D = 45₁₀ = the quotient.

Note that if the dividend had not been first placed in register 6 and shifted into register 7, register 6 might not have been filled with the proper dividend-sign bits (zeros in this example), and the DIVIDE instruction might not have given the expected results.

EXCLUSIVE OR (X, XC, XI, XR)

When the Boolean operator EXCLUSIVE OR is applied to two bits, the result is one when either, but not both, of the two bits is one; otherwise, the result is zero. When two bytes are EXCLUSIVE ORed, each pair of bits is handled separately; there is no connection from one bit position to another. The following is an example of the EXCLUSIVE OR of two bytes:

First-operand byte: 0011 0101₂
 Second-operand byte: 0101 1100₂

Result byte: 0110 1001₂

XC Example

The EXCLUSIVE OR (XC) instruction can be used to exchange the contents of two areas in storage without the use of an intermediate storage area. For example, assume two three-byte fields in storage:

Field 1

359	35B
00	90

Field 2

360	362
00	01

Execution of the instruction (assume that register 7 contains 00 00 03 58):

Machine Format

Op Code	L	B ₁	D ₁	B ₂	D ₂
D7	02	7	001	7	008

Assembler Format

Op Code D₁(L, B₁), D₂(B₂)

XC 1(3,7),8(7)

Field 1 is EXCLUSIVE ORed with field 2 as follows:

Field 1: 00000000 00010111 10010000₂ = 00 17 90₁₆
 Field 2: 00000000 00010100 00000001₂ = 00 14 01₁₆

Result: 00000000 00000011 10010001₂ = 00 03 91₁₆

The result replaces the former contents of field 1. Condition code 1 is set to indicate a nonzero result.

Now, execution of the instruction:

Machine Format

Op Code	L	B ₁	D ₁	B ₂	D ₂
D7	02	7	008	7	001

Assembler Format

Op Code D₁(L, B₁), D₂(B₂)

XC 8(3,7),1(7)

produces the following result:

Field 1: 00000000 00000011 10010001₂ = 00 03 91₁₆
 Field 2: 00000000 00010100 00000001₂ = 00 14 01₁₆

Result: 00000000 00010111 10010000₂ = 00 17 90₁₆

The result of this operation replaces the former contents of field 2. Field 2 now contains the original value of field 1. Condition code 1 is set to indicate a nonzero result.

Lastly, execution of the instruction:

Machine Format

Op Code	L	B ₁	D ₁	B ₂	D ₂
D7	02	7	001	7	008

Assembler Format

Op Code D₁(L, B₁), D₂(B₂)

XC 1(3,7),8(7)

produces the following result:

Field 1: 00000000 00000011 10010001₂ = 00 03 91₁₆
 Field 2: 00000000 00010111 10010000₂ = 00 17 90₁₆

Result: 00000000 00010100 00000001₂ = 00 14 01₁₆

The result of this operation replaces the former contents of field 1. Field 1 now contains the original value of field 2. Condition code 1 is set to indicate a nonzero result.

XI Example

A frequent use of the EXCLUSIVE OR (XI) instruction is to invert a bit (change a zero bit to a one or a one bit to a zero). For example, assume that storage location 8082 contains $0110\ 1001_2$. To invert the leftmost and rightmost bits without affecting any of the other bits, the following instruction can be used (assume that register 9 contains $00\ 00\ 80\ 80$):

Machine Format

Op Code	I_2	B_1	D_1
97	81	9	002

Assembler Format

Op Code $D_1(B_1), I_2$

XI 2(9), X'81'

When the instruction is executed, the byte in storage is EXCLUSIVE ORed with the immediate byte (the I_2 field of the instruction):

Location 8082: $0110\ 1001_2$
 Immediate byte: $1000\ 0001_2$

Result: $1110\ 1000_2$

The resulting byte is stored back in location 8082. Condition code 1 is set to indicate a nonzero result.

Notes:

1. With the XC instruction, fields up to 256 bytes in length can be exchanged.
2. With the XR instruction, the contents of two registers can be exchanged.
3. Because the X instruction operates storage to register only, an exchange cannot be made solely by the use of X.
4. A field EXCLUSIVE ORed with itself is cleared to zeros.
5. For additional examples of the use of EXCLUSIVE OR, see "Hexadecimal-Floating-Point-Number Conversion" on page A-44.

EXECUTE (EX)

The EXECUTE instruction causes one *target instruction* in main storage to be executed out of sequence

without actually branching to the target instruction. Unless the R_1 field of the EXECUTE instruction is zero, bits 8-15 of the target instruction are ORed with bits 56-63 of the R_1 register before the target instruction is executed. Thus, EXECUTE may be used to supply the length field for an SS instruction without modifying the SS instruction in storage. For example, assume that a MOVE (MVC) instruction is the target that is located at address 3820, with a format as follows:

Machine Format

Op Code	L	B_1	D_1	B_2	D_2
D2	00	C	003	D	000

Assembler Format

Op Code $D_1(L, B_1), D_2(B_2)$

MVC 3(1,12), 0(13)

where register 12 contains $00\ 00\ 89\ 13$ and register 13 contains $00\ 00\ 90\ A0$.

Further assume that at storage address 5000, the following EXECUTE instruction is located:

Machine Format

Op Code	R_1	X_2	B_2	D_2
44	1	0	A	000

Assembler Format

Op Code $R_1, D_2(X_2, B_2)$

EX 1, 0(0,10)

where register 10 contains $00\ 00\ 38\ 20$ and register 1 contains $00\ 0F\ F0\ 03$.

When the instruction at 5000 is executed, the rightmost byte of register 1 is ORed with the second byte of the target instruction:

Instruction byte: $0000\ 0000_2 = 00$
 Register byte: $0000\ 0011_2 = 03$

Result: $0000\ 0011_2 = 03$

causing the instruction at 3820 to be executed as if it originally were:

Machine Format

Op Code	L	B ₁	D ₁	B ₂	D ₂
D2	03	C	003	D	000

Assembler Format

Op Code D₁(L,B₁),D₂(B₂)

MVC 3(4,12),0(13)

However, after execution:

Register 1 is unchanged.

The instruction at 3820 is unchanged.

The contents of the four bytes starting at location 90A0 have been moved to the four bytes starting at location 8916.

The CPU next executes the instruction at address 5004 (PSW bits 104-127 contain 00 50 04).

FIND LEFTMOST ONE (FLOGR)

FIND LEFTMOST ONE may be used to locate free objects, the availability of which is tracked in a hierarchical bit map.

In the following example, the hierarchical bit map consists of multiple levels of bits, each level having 64 times the number of bits as the next lower-numbered level. This example shows four levels, mapping a total of 16M objects, however additional levels may be added to manage larger numbers of objects.

The highest-numbered bit map level (L3 in this illustration) represents the availability of individual objects, for example, records or pages. A one bit indicates that the object is available, and a zero bit means that the object is not available.

In lower-numbered bit map levels (L0, L1, and L2 in this illustration), a bit position corresponds to a doubleword in the next higher-numbered level. When a bit in a lower-numbered bit map level is one, at least one bit of the corresponding doubleword in the higher-level is one. When a bit in a lower-number bit

map level is zero, no bits in the corresponding higher-level doubleword are one.

An example of using FIND LEFTMOST ONES to quickly locate the next available lowest-numbered object, as mapped by such a hierarchical bit map, is shown below. Upon completion, at the label "FOUND", general register 15 contains the number of the located object. If no objects are available, the code branches to the label "NOTFND".

```

LA 15,0          Zero accumulator
LA 9,OFFSET      Point to table
LA 10,4          Load increment
LA 11,ENDOFF-1  Load compare value
FIND LGR 7,15     Copy accum. to R7
ALGF 7,0(,9)    Add # DWs to bits
SLLG 7,7,3      Get byte offset
LG 1,BITS(7)    Get DW to test
FLOGR 0,1       Find leftmost one
BZ NOTFND       No one bits found
SLLG 15,15,6    Times # bits in DW
AGR 15,0        Add bit just found
BXLEG 9,10,FIND Do for each level
FOUND STG 1,BITS(7) Update changed bit
...
NOTFND [Any instruction]

```

```

OFFSET DC A((L0-BITS)/8) Offset to level 0
DC A((L1-BITS)/8) Offset to level 1
DC A((L2-BITS)/8) Offset to level 2
DC A((L3-BITS)/8) Offset to level 3
ENDOFF EQU * End of table

```

```

BITS DS 0D Start of bit map
L0 DS FD -L0 (64 objects)
L1 DS 64FD -L1 (4K objects)
L2 DS (64*64)FD -L2 (256K objects)
L3 DS (64*64*64)FD -L3 (16M objects)

```

This code sequence shows the zeroing of the found bit with the STORE (STG) instruction at the label "FOUND". Proper maintenance of such a hierarchical bit map requires that when all bits of a doubleword become zeros, the corresponding bit in the next lower-numbered level is set to zeros. Similarly, when adding a free object to the highest level, the corresponding bits in lower-numbered levels must be set to one. These maintenance functions are not shown.

Note, in a multiprocessing environment, access to the bit map is assumed to be serialized for the duration of the update process.

INSERT CHARACTERS UNDER MASK (ICM)

The INSERT CHARACTERS UNDER MASK (ICM) instruction may be used to replace all or selected bytes in a general register with bytes from storage and to set the condition code to indicate the value of the inserted field.

For example, if it is desired to insert a three-byte address from FIELD A into register 5 and leave the leftmost byte of the register unchanged, assume:

Machine Format

Op Code	R ₁	M ₃	S ₂
BF	5	7	* * * *

Assembler Format

Op Code R₁,M₃,S₂

ICM 5,B'0111',FIELD A

FIELD A: FE DC BA
 Register 5 (before): 12 34 56 78
 Register 5 (after): 12 FE DC BA
 Condition code (after): 1 (leftmost bit of inserted field is one)

As another example:

Machine Format

Op Code	R ₁	M ₃	S ₂
BF	6	9	* * * *

Assembler Format

Op Code R₁,M₃,S₂

ICM 6,B'1001',FIELD B

FIELD B: 12 34
 Register 6 (before): 00 00 00 00
 Register 6 (after): 12 00 00 34
 Condition code (after): 2 (inserted field is nonzero with leftmost zero bit)

When the mask field contains 1111, the ICM instruction produces the same result as LOAD (L) (provided that the indexing capability of the RX format is not

needed), except that ICM also sets the condition code. The condition-code setting is useful when an all-zero field (condition code 0) or a leftmost one bit (condition code 1) is used as a flag.

LOAD (L, LR)

The LOAD instruction takes four bytes from storage or from a general register and place them unchanged into a general register. For example, assume that the four bytes starting with location 21003 are to be loaded into register 10. Initially:

Register 5 contains 00 02 00 00.

Register 6 contains 00 00 10 03.

The contents of register 10 are not significant.

Storage locations 21003-21006 contain 00 00 AB CD.

To load register 10, the RX form of the instruction can be used:

Machine Format

Op Code	R ₁	X ₂	B ₂	D ₂
58	A	5	6	000

Assembler Format

Op Code R₁,D₂(X₂,B₂)

L 10,0(5,6)

After the instruction is executed, register 10 contains 00 00 AB CD.

LOAD ADDRESS (LA)

The LOAD ADDRESS instruction provides a convenient way to place a nonnegative binary integer up to 4095₁₀ in a register without first defining a constant and then using it as an operand. For example, the following instruction places the number 2048₁₀ in register 1:

Machine Format

Op Code	R ₁	X ₂	B ₂	D ₂
41	1	0	0	800

Assembler Format

Op Code $R_1, D_2(X_2, B_2)$

LA 1,2048(0,0)

The LOAD ADDRESS instruction can also be used to increment a register by an amount up to 4095_{10} specified in the D_2 field. Depending on the addressing mode, only the rightmost 24 or 31 bits of the sum are retained, however. The leftmost bits of the 32-bit result are set to zeros. For example, assume that register 5 contains 00 12 34 56.

The instruction:

Machine Format

Op Code	R_1	X_2	B_2	D_2
41	5	0	5	00A

Assembler Format

Op Code $R_1, D_2(X_2, B_2)$

LA 5,10(0,5)

adds 10 (decimal) to the contents of register 5 as follows:

Register 5 (old): 00 12 34 56
 D_2 field: 00 00 00 0A

Register 5 (new): 00 12 34 60

The register may be specified as either B_2 or X_2 . Thus, the instruction LA 5,10(5,0) produces the same result.

As the most general example, the instruction LA 6,10(5,4) forms the sum of three values: the contents of register 4, the contents of register 5, and a displacement of 10 and places the 24-bit or 31-bit sum with zeros appended on the left in register 6.

LOAD HALFWORD (LH)

The LOAD HALFWORD instruction places unchanged a halfword from storage into the right half of a register. The left half of the register is loaded with zeros or ones according to the sign (leftmost bit) of the halfword.

For example, assume that the two bytes in storage locations 1803-1804 are to be loaded into register 6. Also assume:

The contents of register 6 are not significant.

Register 14 contains 00 00 18 03.

Locations 1803-1804 contain 00 20.

The instruction required to load the register is:

Machine Format

Op Code	R_1	X_2	B_2	D_2
48	6	0	E	000

Assembler Format

Op Code $R_1, D_2(X_2, B_2)$

LH 6,0(0,14)

After the instruction is executed, register 6 contains 00 00 00 20. If locations 1803-1804 had contained a negative number, for example, A7 B6, a minus sign would have been propagated to the left, giving FF FF A7 B6 as the final result in register 6.

MOVE (MVC, MVI)

MVC Example

The MOVE (MVC) instruction can be used to move data from one storage location to another. For example, assume that the following two fields are in storage:

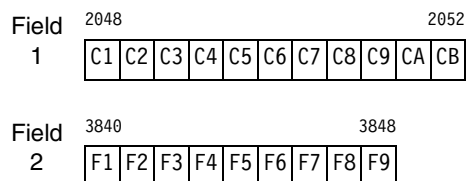

Also assume:

Register 1 contains 00 00 20 48.

Register 2 contains 00 00 38 40.

With the following instruction, the first eight bytes of field 2 replace the first eight bytes of field 1:

Machine Format

Op Code	L	B ₁	D ₁	B ₂	D ₂
D2	07	1	000	2	000

Assembler Format

Op Code D₁(L,B₁),D₂(B₂)

MVC 0(8,1),0(2)

After the instruction is executed, field 1 becomes:

Field	2048									2052	
1	F1	F2	F3	F4	F5	F6	F7	F8	C9	CA	CB

Field 2 is unchanged.

MVC can also be used to propagate a byte through a field by starting the first-operand field one byte location to the right of the second-operand field. For example, suppose that an area in storage starting with address 358 contains the following data:

358									360
00	F1	F2	F3	F4	F5	F6	F7	F8	

With the following MVC instruction, the zeros in location 358 can be propagated throughout the entire field (assume that register 11 contains 00 00 03 58):

Machine Format

Op Code L B₁ D₁ B₂ D₂

D2 07 B 001 B 000

Assembler Format

Op Code D₁(L,B₁),D₂(B₂)

MVC 1(8,11),0(11)

Because MVC is executed as if one byte were processed at a time, the above instruction, in effect, takes the byte at address 358 and stores it at 359 (359 now contains 00), takes the byte at 359 and stores it at 35A, and so on, until the entire field is filled with zeros. Note that an MVI instruction could have been used originally to place the byte of zeros in location 358.

Notes:

1. Although the field occupying locations 358-360 contains nine bytes, the length coded in the assembler format is equal to the number of moves (one less than the field length).
2. The order of operands is important even though only one field is involved.

MVI Example

The MOVE (MVI) instruction places one byte of information from the instruction stream into storage. For example, the instruction:

Machine Format

Op Code	I ₂	B ₁	D ₁
92	5B	1	000

Assembler Format

Op Code D₁(B₁),I₂

MVI 0(1),C'\$'

may be used, in conjunction with the instruction EDIT AND MARK, to insert the EBCDIC code for a dollar symbol at the storage address contained in general register 1 (see also the example for EDIT AND MARK).

MOVE INVERSE (MVCIN)

The MOVE INVERSE (MVCIN) instruction can be used to move data from one storage location to another while reversing the order of the bytes within the field. For example, assume that the following two fields are in storage:

Field	2048									2052	
1	C1	C2	C3	C4	C5	C6	C7	C8	C9	CA	CB

Field	3840									3848
2	F1	F2	F3	F4	F5	F6	F7	F8	F9	

Also assume:

Register 1 contains 00 00 20 48.

Register 2 contains 00 00 38 40.

With the following instruction, the first eight bytes of field 2 replace the first eight bytes of field 1:

Machine Format

Op Code	L	B ₁	D ₁	B ₂	D ₂
E8	07	1	000	2	007

Assembler Format

Op Code D₁(L, B₁), D₂(B₂)

MVCIN 0(8,1),7(2)

After the instruction is executed, field 1 becomes:

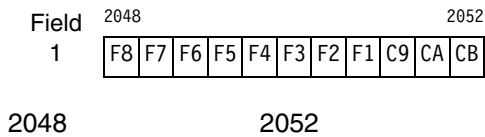

Field 2 is unchanged.

Note: This example uses the same general registers, storage locations, and original values as the first example for MVC. For MVCIN, the second-operand address must designate the rightmost byte of the field to be moved, in this case location 3847. This is accomplished by means of the 7 in the D₂ field of the instruction.

MOVE LONG (MVCL)

The MOVE LONG (MVCL) instruction can be used for moving data in storage as in the first example of the MVC instruction, provided that the two operands do not overlap. MVCL differs from MVC in that the address and length of each operand are specified in an even-odd pair of general registers. Consequently, MVCL can be used to move more than 256 bytes of data with one instruction. As an example, assume:

Register 2 contains 00 0A 00 00.

Register 3 contains 00 00 08 00.

Register 8 contains 00 06 00 00.

Register 9 contains 00 00 08 00.

Execution of the instruction:

Machine Format

Op Code	R ₁	R ₂
0E	8	2

Assembler Format

Op Code R₁, R₂

MVCL 8,2

moves 2,048₁₀ bytes from locations A0000-A07FF to locations 60000-607FF. Assuming that the CPU is in the 24-bit addressing mode, bits 8-31 of registers 2 and 8 are incremented by 800₁₆, and bits 0-7 of registers 2 and 8 are set to zeros. Bits 8-31 of registers 3 and 9 are decremented to zero. Condition code 0 is set to indicate that the operand lengths are equal.

If register 3 had contained F0 00 04 00, only the 1,024₁₀ bytes from locations A0000-A03FF would have been moved to locations 60000-603FF. The remaining locations 60400-607FF of the first operand would have been filled with 1,024 copies of the padding byte X'F0', as specified by the leftmost byte of register 3. Bits 8-31 of register 2 would have been incremented by 400₁₆, bits 8-31 of register 8 would have been incremented by 800₁₆, and bits 0-7 of registers 2 and 8 would have been set to zeros. Bits 8-31 of registers 3 and 9 would still have been decremented to zero. Condition code 2 would have been set to indicate that the first operand was longer than the second.

The technique for setting a field to zeros that is illustrated in the second example of MVC cannot be used with MVCL. If the registers were set up to attempt such an operation with MVCL, no data movement would take place and condition code 3 would indicate destructive overlap.

Instead, MVCL may be used to clear a storage area to zeros as follows. Assume register 8 and 9 are set up as before. Register 3 contains only zeros, specifying zero length for the second operand and a zero padding byte. Register 2 is not used to access storage, and its contents are not significant. Executing the instruction MVCL 8,2 causes locations 60000-607FF to be filled with zeros. Bits 8-31 of register 8 are incremented by 800₁₆, and bits 0-7 of registers 2 and 8 are set to zeros. Bits 8-31 of register 9 are decremented to zero, and condition code 2 is set to indicate that the first operand is longer than the second.

MOVE NUMERICS (MVN)

Two related instructions, MOVE NUMERICS and MOVE ZONES, may be used with decimal data in the zoned format to operate separately on the rightmost

four bits (the numeric bits) and the leftmost four bits (the zone bits) of each byte. Both are similar to MOVE (MVC), except that MOVE NUMERICS moves only the numeric bits and MOVE ZONES moves only the zone bits.

To illustrate the operation of the MOVE NUMERICS instruction, assume that the following two fields are in storage:

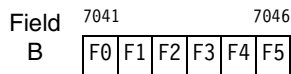
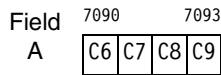

Also assume:

Register 14 contains 00 00 70 90.

Register 15 contains 00 00 70 40.

After the instruction:

Machine Format

Op Code	L	B ₁	D ₁	B ₂	D ₂
D1	03	F	001	E	000

Assembler Format

Op Code D₁(L, B₁), D₂(B₂)

MVN 1(4, 15), 0(14)

is executed, field B becomes:

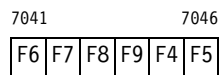

The numeric bits of the bytes at locations 7090-7093 have been stored in the numeric bits of the bytes at locations 7041-7044. The contents of locations 7090-7093 and 7045-7046 are unchanged.

MOVE STRING (MVST)

The MOVE STRING instruction is used to move a second operand designated by general register R₂ to a first-operand location designated by general register R₁. The movement is made left to right until an ending character specified in general register 0 has been moved or a CPU-determined number of bytes

have been moved. The condition code is set to 1 if the ending character was moved or to 3 if a CPU-determined number of bytes were moved.

When condition code 1 is set, the address of the ending character in the first operand is placed in general register R₁, and the contents of general register R₂ remain unchanged. When condition code 3 is set, the address of the next byte to be processed in the first and second operands is placed in general registers R₁ and R₂, respectively.

Following is an example program that sets string A equal to the concatenation of string B followed by string C, where the length of each of strings B and C is unknown, and the end of each of strings B and C is indicated by an ending character of 00 hex (as in the C programming language). The program is not written for execution in the access-register mode.

```

L      4, STRADDR
L      5, STRBADR
SR     0, 0
LOOP1  MVST  4, 5
BC     1, LOOP1
L      5, STRCADR
LOOP2  MVST  4, 5
BC     1, LOOP2
[Any instruction]

```

MOVE WITH OFFSET (MVO)

MOVE WITH OFFSET may be used to shift a signed-packed-decimal number an odd number of digit positions or to concatenate a sign to an unsigned-packed-decimal number.

Assume that the three-byte unsigned-packed-decimal number in storage locations 4500-4502 is to be moved to locations 5600-5603 and given the sign of the signed-packed-decimal number ending at location 5603. Also assume:

Register 12 contains 00 00 56 00.

Register 15 contains 00 00 45 00.

Storage locations 5600-5603 contain 77 88 99 0C.

Storage locations 4500-4502 contain 12 34 56.

After the instruction:

Machine Format

Op Code	L ₁	L ₂	B ₁	D ₁	B ₂	D ₂
F1	3	2	C	000	F	000

Assembler Format

Op Code D₁(L₁,B₁),D₂(L₂,B₂)

MV0 0(4,12),0(3,15)

is executed, the storage locations 5600-5603 contain 01 23 45 6C. Note that the second operand is extended on the left with one zero to fill out the first-operand field.

MOVE ZONES (MVZ)

The MOVE ZONES instruction can operate on overlapping or nonoverlapping fields, as can the instructions MOVE (MVC) and MOVE NUMERIC. When operating on nonoverlapping fields, MOVE ZONES works like the MOVE NUMERIC instruction (see its example), except that MOVE ZONES moves only the zone bits of each byte. To illustrate the use of MOVE ZONES with overlapping fields, assume that the following data field is in storage:

800		805			
F1	C2	F3	C4	F5	C6

Also assume that register 15 contains 00 00 08 00. The instruction:

Machine Format

Op Code	L	B ₁	D ₁	B ₂	D ₂
D3	04	F	001	F	000

Assembler Format

Op Code D₁(L,B₁),D₂(B₂)

MVZ 1(5,15),0(15)

propagates the zone bits from the byte at address 800 through the entire field, so that the field becomes:

800		805			
F1	F2	F3	F4	F5	F6

MULTIPLY (M, MR)

Assume that a number in register 5 is to be multiplied by the contents of a four-byte field at address 3750. Initially:

The contents of register 4 are not significant.

Register 5 contains 00 00 00 9A = 154₁₀ = the multiplicand.

Register 11 contains 00 00 06 00.

Register 12 contains 00 00 30 00.

Storage locations 3750-3753 contain 00 00 00 83 = 131₁₀ = the multiplier.

The instruction required for performing the multiplication is:

Machine Format

Op Code	R ₁	X ₂	B ₂	D ₂
5C	4	B	C	150

Assembler Format

Op Code R₁,D₂(X₂,B₂)

M 4,X'150'(11,12)

After the instruction is executed, the product is in the register pair 4 and 5:

Register 4 contains 00 00 00 00.

Register 5 contains 00 00 4E CE = 20,174₁₀.

Storage locations 3750-3753 are unchanged.

The RR format of the instruction can be used to square the number in a register. Assume that register 7 contains 00 01 00 05. The contents of register 6 are not significant. The instruction:

Machine Format

Op Code	R ₁	R ₂
1C	6	7

Assembler Format

Op Code R₁,R₂

MR 6,7

multiplies the number in register 7 by itself and places the result in the pair of registers 6 and 7:

Register 6 contains 00 00 00 01.

Register 7 contains 00 0A 00 19.

MULTIPLY HALFWORD (MH)

The MULTIPLY HALFWORD instruction is used to multiply the contents of a register by a two-byte field in storage. For example, assume that:

Register 11 contains 00 00 00 15 = 21_{10} = the multiplicand.

Register 14 contains 00 00 01 00.

Register 15 contains 00 00 20 00.

Storage locations 2102-2103 contain FF D9 = -39_{10} = the multiplier.

The instruction:

Machine Format

Op Code	R ₁	X ₂	B ₂	D ₂
4C	B	E	F	002

Assembler Format

Op Code R₁,D₂(X₂,B₂)

MH 11,2(14,15)

multiplies the two numbers. The product, FF FF FC CD = -819_{10} , replaces the original contents of register 11.

Only the rightmost 32 bits of a product are stored in a register; any significant bits on the left are lost. No program interruption occurs on overflow.

OR (O, OC, OI, OR)

When the Boolean operator OR is applied to two bits, the result is one when either bit is one; otherwise, the result is zero. When two bytes are ORed, each pair of bits is handled separately; there is no connection from one bit position to another. The following is an example of ORing two bytes:

First-operand byte: 0011 0101₂

Second-operand byte: 0101 1100₂

Result byte: 0111 1101₂

OI Example

A frequent use of the OR instruction is to set a particular bit to one. For example, assume that storage location 4891 contains 0100 0010₂. To set the rightmost bit of this byte to one without affecting the other bits, the following instruction can be used (assume that register 8 contains 00 00 48 90):

Machine Format

Op Code	I ₂	B ₁	D ₁
96	01	8	001

Assembler Format

Op Code D₁(B₁), I₂

OI 1(8),X'01'

When this instruction is executed, the byte in storage is ORed with the immediate byte (the I₂ field of the instruction):

Location 4891: 0100 0010₂

Immediate byte: 0000 0001₂

Result: 0100 0011₂

The resulting byte with bit 7 set to one is stored back in location 4891. Condition code 1 is set.

PACK (PACK)

Assume that storage locations 1000-1003 contain the following zoned-decimal number that is to be converted to a signed-packed-decimal number and left in the same location:

Zoned number

1000	1003		
F1	F2	F3	C4

Also assume that register 12 contains 00 00 10 00. After the instruction:

Machine Format

Op Code	L ₁	L ₂	B ₁	D ₁	B ₂	D ₂
F2	3	3	C	000	C	000

Assembler Format

Op Code $D_1(L_1, B_1), D_2(L_2, B_2)$

PACK 0(4,12),0(4,12)

is executed, the result in locations 1000-1003 is in the signed-packed-decimal format:

	1000	1003	
Signed-packed number	00	01	23 4C

Notes:

1. This example illustrates the operation of PACK when the first- and second-operand fields overlap completely.
2. During the operation, the second operand was extended on the left with zeros.

ROTATE THEN EXCLUSIVE OR SELECTED BITS

The following example illustrates the use of ROTATE THEN EXCLUSIVE OR SELECTED BITS to determine if the access-control bits of a page's storage-protection key match the key in the PSW. In this example, only the condition code is set; the result is not placed in the first-operand register.

```
LAY 9,BLOCK Point to storage block.
IVSK 14,9 Insert key into bits 56-63.
EPSW 4,0 Extract PSW key (bits 40-43).
RXSBG 4,14,128+40,43,16 Compare keys.
```

On completion, the condition code will be set to zero if the PSW key matches the access-control bits in the storage key of page addressed by general register 9. Condition code 1 will be set if the keys do not match.

ROTATE THEN INSERT SELECTED BITS

1. The following example illustrates the use of ROTATE THEN INSERT SELECTED BITS to extract the various DAT-table indices of a virtual address contained in general register 8. This example shows the use of the zero-remaining-bits control to set the remaining bits of the result registers to zero.

The virtual address in general register 8 is assumed to be 123456789ABCDEF0 hex.

```
RISBG 1,8,53,128+63,11 Get reg. 1st index.
RISBG 2,8,53,128+63,22 Get reg. 2nd index.
RISBG 3,8,53,128+63,33 Get reg. 3rd index.
RISBG 4,8,53,128+63,44 Get segment index.
RISBG 5,8,56,128+63,52 Get page index.
RISBG 6,8,52,128+63,0 Get byte index.
```

The condition code following each RISBG is 2. On completion, general registers 1-6 contain the region-first index, region-second index, region-third index, segment index, page index, and byte index, respectively, as follows:

```
GR1: 0000000000000091 (RFX)
GR2: 0000000000000515 (RSX)
GR3: 00000000000004F1 (RTX)
GR4: 00000000000001AB (SX)
GR5: 00000000000000CD (PX)
GR6: 0000000000000EF0 (BX)
```

2. The following example illustrates shifting a 64-bit value to the left by L bits:

RISBG $R_1, R_2, 0, X'80'+63-L, L$

3. The following example illustrates shifting a 32-bit value to the right by R bits and setting the left-most 32 bits to zero:

RISBG $R_1, R_2, 32+R, X'80'+63, -R$

4. The following example illustrates zeroing bits S through E of general register 3.

RISBG 3,3,mod64($E+1$),128+mod64($S-1$),0

$Mod64$ represents a modulo function which effectively ANDs the value in parentheses with 3F hex.

ROTATE THEN OR SELECTED BITS

The following example illustrates the use of ROTATE THEN OR SELECTED BITS to rotate and combine selected bits of general registers 6 and 8.

```
LG 6,=X'004C487040CF4600'
LG 8,=X'C07FAF37FC968280'
ROSBG 6,8,8,54,32
```

On completion, condition code 1 is set, and general register 6 is as follows:

```
GR6: 00DECAF0C0FFEE00
```

Note that only bits 8-54 of the registers are ORed; bits 0-7 and 55-63 of general register 6 are not modified.

SEARCH STRING (SRST)

The SEARCH STRING instruction is used to search a second operand designated by general register R_2 for a character specified in general register 0. The length of the second operand is known — the address of the first byte after the second operand is in general register R_1 .

When the specified character is found, condition code 1 is set, the address of the character is placed in general register R_1 , and the contents of general register R_2 remain unchanged. When the address of the next second-operand byte to be examined equals the address in general register R_1 , condition code 2 is set, and the contents of general register R_1 and R_2 remain unchanged. When a CPU-determined number of second-operand bytes have been examined, condition code 3 is set, the address of the next byte to be processed in the second operand is placed in general register R_2 , and the contents of general register R_1 remain unchanged.

SRST Example 1

Following is an example program that determines the end of string A, as indicated by an ending character equal to 00 hex (as in the C programming language), and then determines the address of the first character equal to C1 hex in the string. The program is based on the assumption that the second operand does not begin at location 0 or wrap around in storage, and, therefore, condition code 2 will not be set by the first SEARCH STRING instruction because of the address in general register 0. The program is not written for execution in the access-register mode.

```
L      5,STRAADR
SR     0,0
LOOP1 SRST 0,5
BC     1,LOOP1
L      5,STRAADR
LR     4,0
LA     0,X'C1'
```

```
LOOP2 SRST 4,5
BC     1,LOOP2
BC     2,NOTFND
FOUND [Any instruction]
...
NOTFND [Any instruction]
```

SRST Example 2

Following is an example program that determines the address of the first character equal to C1 hex in the string A whose length is known. The program is not written for execution in the access-register mode.

```
L      5,STRAADR
L      4,STRALEN
AR     4,5
LA     0,X'C1'
LOOP1 SRST 4,5
BC     1,LOOP1
BC     2,NOTFND
FOUND [Any instruction]
...
NOTFND [Any instruction]
```

In this example, the value in STRALEN may be a length that either does or does not include an ending character at the end of the string, provided that the ending character is not the character for which the search is made.

SHIFT LEFT DOUBLE (SLDA)

The SHIFT LEFT DOUBLE instruction shifts the 63 numeric bits of an even-odd register pair to the left, leaving the sign bit unchanged. Thus, the instruction performs an algebraic left shift of a 64-bit signed binary integer.

For example, if the contents of registers 2 and 3 are:

```
00 7F 0A 72   FE DC BA 98 =
00000000 01111111 00001010 01110010
11111110 11011100 10111010 100110002
```

The instruction:

Machine Format

Op Code	R_1	B_2	D_2
8F	2	////	01F

Assembler Format

Op Code R₁,D₂(B₂)

SLDA 2,31(0)

results in registers 2 and 3 both being left-shifted 31 bit positions, so that their new contents are:

7F 6E 5D 4C 00 00 00 00 =
01111111 01101110 01011101 01001100
00000000 00000000 00000000 00000000₂

Because significant bits are shifted out of bit position 1 of register 2, overflow is indicated by setting condition code 3, and, if the fixed-point-overflow mask bit in the PSW is one, a fixed-point-overflow program interruption occurs.

SHIFT LEFT SINGLE (SLA)

The SHIFT LEFT SINGLE instruction is similar to SHIFT LEFT DOUBLE, except that it shifts only the 31 numeric bits of a single register. Therefore, this instruction performs an algebraic left shift of a 32-bit signed binary integer.

For example, if the contents of register 2 are:

00 7F 0A 72 = 00000000 01111111 00001010 01110010₂

The instruction:

Machine Format

Op Code	R ₁	B ₂	D ₂
8B	2	////	008

Assembler Format

Op Code R₁,D₂(B₂)

SLA 2,8(0)

results in register 2 being shifted left eight bit positions so that its new contents are:

7F 0A 72 00 = 01111111 00001010 01110010 00000000₂

Condition code 2 is set to indicate that the result is greater than zero.

If a left shift of nine places had been specified, a significant bit would have been shifted out of bit position 1. Condition code 3 would have been set to

indicate this overflow and, if the fixed-point-overflow mask bit in the PSW were one, a fixed-point overflow interruption would have occurred.

STORE CHARACTERS UNDER MASK (STCM)

STORE CHARACTERS UNDER MASK (STCM) may be used to place selected bytes from a register into storage. For example, if it is desired to store a three-byte address from general register 8 into location FIELD3, assume:

Machine Format

Op Code	R ₁	M ₃	S ₂
BE	8	7	* * * *

Register Format

Op Code R₁,M₃,S₂

STCM 8,B'0111',FIELD3

Register 8: 12 34 56 78
FIELD3 (before): not significant
FIELD3 (after): 34 56 78

As another example:

Machine Format

Op Code	R ₁	M ₃	S ₂
BE	9	5	* * * *

Register Format

Op Code R₁,M₃,S₂

STCM 9,B'0101',FIELD2

Register 9: 01 23 45 67
FIELD2 (before): not significant
FIELD2 (after): 23 67

STORE MULTIPLE (STM)

Assume that the contents of general registers 14, 15, 0, and 1 are to be stored in consecutive four-byte fields starting with location 4050 and that:

Register 14 contains 00 00 25 63.

Register 15 contains 00 01 27 36.

Register 0 contains 12 43 00 62.

Register 1 contains 73 26 12 57.

Register 6 contains 00 00 40 00.

The initial contents of locations 4050-405F are not significant.

The STORE MULTIPLE instruction allows the use of just one instruction to store the contents of the four registers:

Machine Format

Op Code	R ₁	R ₃	B ₂	D ₂
90	E	1	6	050

Assembler Format

Op Code R₁,R₃,D₂(B₂)

STM 14,1,X'50'(6)

After the instruction is executed:

Locations 4050-4053 contain 00 00 25 63.

Locations 4054-4057 contain 00 01 27 36.

Locations 4058-405B contain 12 43 00 62.

Locations 405C-405F contain 73 26 12 57.

TEST UNDER MASK (TM)

The TEST UNDER MASK instruction examines selected bits of a byte and sets the condition code accordingly. For example, assume that:

Storage location 9999 contains FB.

Register 7 contains 00 00 99 90.

Assume the instruction to be:

Machine Format

Op Code	I ₂	B ₁	D ₁
91	C3	7	009

Assembler Format

Op Code D₁(B₁),I₂

TM 9(7),B'11000011'

The instruction tests only those bits of the byte in storage for which the mask bits are ones:

FB = 1111 1011₂

Mask = 1100 0011₂

Test = 11xx xx11₂

Condition code 3 is set: all selected bits in the test result are ones. (The bits marked "x" are ignored.)

If location 9999 had contained B9, the test would have been:

B9 = 1011 1001₂

Mask = 1100 0011₂

Test = 10xx xx01₂

Condition code 1 is set: the selected bits are both zeros and ones.

If location 9999 had contained 3C, the test would have been:

3C = 0011 1100₂

Mask = 1100 0011₂

Test = 00xx xx00₂

Condition code 0 is set: all selected bits are zeros.

Note: Storage location 9999 remains unchanged.

TRANSLATE (TR)

The TRANSLATE instruction can be used to translate data from any character code to any other desired code, provided that each character code consists of eight bits or fewer. An appropriate translation table is required in storage.

In the following example, EBCDIC code is translated to ASCII code. The first step is to create a 256-byte table in storage locations 1000-10FF. This table contains the characters of the ASCII code in the sequence of the binary representation of the EBCDIC code; that is, the ASCII representation of a char-

acter is placed in storage at the starting address of the table plus the binary value of the EBCDIC representation of the same character.

For simplicity, the example shows only the part of the table containing the decimal digits:

10F0	10F9								
30	31	32	33	34	35	36	37	38	39

Assume that the four-byte field at storage location 2100 contains the EBCDIC code for the digits 1984:

Locations 2100-2103 contain F1 F9 F8 F4.

Register 12 contains 00 00 21 00.

Register 15 contains 00 00 10 00.

As the instruction:

Machine Format

Op Code	L	B ₁	D ₁	B ₂	D ₂
DC	03	C	000	F	000

Assembler Format

Op Code D₁(L, B₁), D₂(B₂)

TR 0(4, 12), 0(15)

is executed, the binary value of each EBCDIC byte is added to the starting address of the table, and the resulting address is used to fetch an ASCII byte:

Table starting address: 1000

First EBCDIC byte: F1

Address of ASCII byte: 10F1

After execution of the instruction:

Locations 2100-2103 contain 31 39 38 34.

Thus, the ASCII code for the digits 1984 has replaced the EBCDIC code in the four-byte field at storage location 2100.

TRANSLATE AND TEST (TRT)

The TRANSLATE AND TEST instruction can be used to scan a data field for characters with a special meaning. To indicate which characters have a special

meaning, a table similar to the one used for the TRANSLATE instruction is set up, except that zeros in the table indicate characters without any special meaning and nonzero values indicate characters with a special meaning.

Figure A-4 on page A-34 has been set up to distinguish alphameric characters (A to Z and 0 to 9) from blanks, certain special symbols, and all other characters which are considered invalid. EBCDIC coding is assumed. The 256-byte table is assumed stored at locations 2000-20FF.

	0	1	2	3	4	5	6	7	8	9	A	B	C	D	E	F
200_	40	40	40	40	40	40	40	40	40	40	40	40	40	40	40	40
201_	40	40	40	40	40	40	40	40	40	40	40	40	40	40	40	40
202_	40	40	40	40	40	40	40	40	40	40	40	40	40	40	40	40
203_	40	40	40	40	40	40	40	40	40	40	40	40	40	40	40	40
204_	04	40	40	40	40	40	40	40	40	40	40	08	40	0C	10	40
205_	14	40	40	40	40	40	40	40	40	40	40	18	1C	20	40	40
206_	24	28	40	40	40	40	40	40	40	40	40	2C	40	40	40	40
207_	40	40	40	40	40	40	40	40	40	40	40	30	34	38	3C	40
208_	40	40	40	40	40	40	40	40	40	40	40	40	40	40	40	40
209_	40	40	40	40	40	40	40	40	40	40	40	40	40	40	40	40
20A_	40	40	40	40	40	40	40	40	40	40	40	40	40	40	40	40
20B_	40	40	40	40	40	40	40	40	40	40	40	40	40	40	40	40
20C_	40	00	00	00	00	00	00	00	00	00	40	40	40	40	40	40
20D_	40	00	00	00	00	00	00	00	00	00	40	40	40	40	40	40
20E_	40	40	00	00	00	00	00	00	00	00	40	40	40	40	40	40
20F_	00	00	00	00	00	00	00	00	00	00	40	40	40	40	40	40

Note: If the character codes in the statement being translated occupy a range smaller than 00 through FF₁₆, a table of fewer than 256 bytes can be used.

Figure A-4. Translate and Test Table

The table entries for the alphameric characters in EBCDIC are 00; thus, the letter A (code C1) corresponds to byte location 20C1, which contains 00.

The 15 special symbols have nonzero entries from 04₁₆ to 3C₁₆ in increments of 4. Thus, the blank (code 40) has the entry 04₁₆, the period (code 4B) has the entry 08₁₆, and so on.

All other table positions have the entry 40₁₆ to indicate an invalid character.

The table entries are chosen so that they may be used to select one of a list of 16 words containing

addresses of different routines to be entered for each special symbol or invalid character encountered during the scan.

Assume that this list of 16 branch addresses is stored at locations 3004-3043.

Starting at storage location CA80, there is the following sequence of 21₁₀ EBCDIC characters, where "b" stands for a blank.

Locations CA80-CA94:
UNPKbPROUT(9),WORD(5)

Also assume:

Register 1 contains 00 00 CA 7F.

Register 2 contains 00 00 30 00.

Register 15 contains 00 00 20 00.

As the instruction:

Machine Format

Op Code	L	B ₁	D ₁	B ₂	D ₂
DD	14	1	001	F	000

Assembler Format

Op Code D₁(L,B₁),D₂(B₂)

TRT 1(21,1),0(15)

is executed, the value of the first source byte, the EBCDIC code for the letter U, is added to the starting address of the table to produce the address of the table entry to be examined:

Table starting address	2000
First source byte (U)	E4
<hr/>	
Address of table entry	20E4

Because zeros were placed in storage location 20E4, no special action occurs. The operation continues with the second and subsequent source bytes until it reaches the blank in location CA84. When this symbol is reached, its value is added to the starting address of the table, as usual:

Table starting address	2000
Source byte (blank)	40
<hr/>	
Address of table entry	2040

Because location 2040 contains a nonzero value, the following actions occur:

The address of the source byte, 00CA84, is placed in the rightmost 24 bits of register 1.

The table entry, 04, is placed in the rightmost eight bits of register 2, which now contains 00 00 30 04.

Condition code 1 is set (scan not completed).

The TRANSLATE AND TEST instruction may be followed by instructions to branch to the routine at the address found at location 3004, which corresponds to the blank character encountered in the scan. When this routine is completed, program control may return to the TRANSLATE AND TEST instruction to continue the scan, except that the length must first be adjusted for the characters already scanned.

For this purpose, the TRANSLATE AND TEST may be executed by the use of an EXECUTE instruction, which supplies the length specification from a general register. In this way, a complete statement scan can be performed with a single TRANSLATE AND TEST instruction used repeatedly by means of EXECUTE, and without modifying any instructions in storage. In the example, after the first execution of TRANSLATE AND TEST, register 1 contains the address of the last source byte translated. It is then a simple matter to subtract this address from the address of the last source byte (CA94) to produce a length specification. This length minus one is placed in the register that is referenced as the R₁ field of the EXECUTE instruction. (Note that the length code in the machine format is one less than the total number of bytes in the field.) The second-operand address of the EXECUTE instruction points to the TRANSLATE AND TEST instruction, which is the same as illustrated above, except for the length (L) which is set to zero.

UNPACK (UNPK)

Assume that storage locations 2501-2502 contain a signed-packed-decimal number that is to be unpacked and placed in storage locations 1000-1004. Also assume:

Register 12 contains 00 00 10 00.

Register 13 contains 00 00 25 00.

Storage locations 2501-2502 contain 12 3D.

The initial contents of storage locations 1000-1004 are not significant.

After the instruction:

Machine Format

Op Code	L ₁	L ₂	B ₁	D ₁	B ₂	D ₂
F3	4	1	C	000	D	001

Assembler Format

Op Code $D_1(L_1, B_1), D_2(L_2, B_2)$

UNPK 0(5,12),1(2,13)

is executed, the storage locations 1000-1004 contain F0 F0 F1 F2 D3.

UPDATE TREE (UPT)

See "Sorting Instructions" on page A-53.

Decimal Instructions

(See Chapter 8, "Decimal Instructions" for a complete description of the decimal instructions.)

ADD DECIMAL (AP)

Assume that the signed-packed-decimal number at storage locations 500-503 is to be added to the signed-packed-decimal number at locations 2000-2002. Also assume:

Register 12 contains 00 00 20 00.

Register 13 contains 00 00 05 00.

Storage locations 2000-2002 contain 38 46 0D (a negative number).

Storage locations 500-503 contain 01 12 34 5C (a positive number).

After the instruction:

Machine Format

Op Code	L ₁	L ₂	B ₁	D ₁	B ₂	D ₂
FA	2	3	C	000	D	000

Assembler Format

Op Code $D_1(L_1, B_1), D_2(L_2, B_2)$

AP 0(3,12),0(4,13)

is executed, the storage locations 2000-2002 contain 73 88 5C; condition code 2 is set to indicate that the result is greater than zero. Note that:

1. Because the two numbers had different signs, they were in effect subtracted.
2. Although the second operand is longer than the first operand, no overflow interruption occurs because the result can be entirely contained within the first operand.

COMPARE DECIMAL (CP)

Assume that the signed-packed-decimal contents of storage locations 700-703 are to be algebraically compared with the signed-packed-decimal contents of locations 500-502. Also assume:

Register 12 contains 00 00 06 00.

Register 13 contains 00 00 03 00.

Storage locations 700-703 contain 17 25 35 6D.

Storage locations 500-502 contain 72 14 2D.

After the instruction:

Machine Format

Op Code	L ₁	L ₂	B ₁	D ₁	B ₂	D ₂
F9	3	2	C	100	D	200

Assembler Format

Op Code $D_1(L_1, B_1), D_2(L_2, B_2)$

CP X'100'(4,12),X'200'(3,13)

is executed, condition code 1 is set, indicating that the first operand (the contents of locations 700-703) is less than the second.

DIVIDE DECIMAL (DP)

Assume that the signed-packed-decimal number at storage locations 2000-2004 (the dividend) is to be divided by the signed-packed-decimal number at locations 3000-3001 (the divisor). Also assume:

Register 12 contains 00 00 20 00.

Register 13 contains 00 00 30 00.

Storage locations 2000-2004 contain 01 23 45 67 8C.

Storage locations 3000-3001 contain 32 1D.

After the instruction:

Machine Format

Op Code	L ₁	L ₂	B ₁	D ₁	B ₂	D ₂
FD	4	1	C	000	D	000

Assembler Format

Op Code D₁(L₁,B₁),D₂(L₂,B₂)

DP 0(5,12),0(2,13)

is executed, the dividend is entirely replaced by the signed quotient and remainder, as follows:

	2000	2001	2002	2003	2004
Locations 2000-2004	38	46	0D	01	8C
	quotient			remainder	

Notes:

1. Because the dividend and divisor have different signs, the quotient receives a negative sign.
2. The remainder receives the sign of the dividend and the length of the divisor.
3. If an attempt were made to divide the dividend by the one-byte field at location 3001, the quotient would be too long to fit within the four bytes allotted to it. A decimal-divide exception would exist, causing a program interruption.

EDIT (ED)

Before data in the signed-packed-decimal or unsigned-packed-decimal format can be used in a

printed report, digits and signs must be converted to printable characters. Moreover, punctuation marks, such as commas and decimal points, may have to be inserted in appropriate places. The highly flexible EDIT instruction performs these functions in a single instruction execution.

This example shows step-by-step one way that the EDIT instruction can be used. The field to be edited (the source) is four bytes long; it is edited against a pattern 13 bytes long. The following symbols are used:

Symbol	Meaning
b (Hexadecimal 40)	Blank character
((Hexadecimal 21)	Significance starter
d (Hexadecimal 20)	Digit selector

Assume that register 12 contains:

00 00 10 00

and that the source and pattern fields are:

Source

1200 1203

02	57	42	6C
----	----	----	----

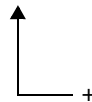

Pattern

1000 100C

40	20	20	6B	20	21	20	4B	20	20	40	C3	D9
----	----	----	----	----	----	----	----	----	----	----	----	----

b d d , d (d . d d b C R

Execution of the instruction:

Machine Format

Op Code	L	B ₁	D ₁	B ₂	D ₂
DE	0C	C	000	C	200

Assembler Format

Op Code D₁(L,B₁),D₂(B₂)

ED 0(13,12),X'200'(12)

alters the pattern field as follows:

Pattern	Digit	Significance Indicator (Before/After)	Rule	Location 1000-100C
b		off/off	leave(1)	bdd,d(d.ddbCR
d	0	off/off	fill	bbd,d(d.ddbCR
d	2	off/on(2)	digit	bb2,d(d.ddbCR
,		on/on	leave	same
d	5	on/on	digit	bb2,5(d.ddbCR
(7	on/on	digit	bb2,57d.ddbCR
d	4	on/on	digit	bb2,574.ddbCR
.		on/on	leave	same
d	2	on/on	digit	bb2,574.2dbCR
d	6+	on/off(3)	digit	bb2,574.26bCR
b		off/off	fill	same
C		off/off	fill	bb2,574.26bbR
R		off/off	fill	bb2,574.26bbb

Notes:

1. This character is the fill byte.
2. First nonzero decimal source digit turns on significance indicator.
3. Plus sign in the four rightmost bits of the byte turns off significance indicator.

Thus, after the instruction is executed, the pattern field contains the result as follows:

Pattern

1000												100C		
40	40	F2	6B	F5	F7	F4	4B	F2	F6	40	40	40		
b	b	2	,	5	7	4	.	2	6	b	b	b		

This pattern field prints as:

2,574.26

The source field remains unchanged. Condition code 2 is set because the number was greater than zero.

If the number in the source field is changed to the negative number 00 00 02 6D and the original pattern is used, the edited result this time is:

Pattern

1000												100C		
40	40	40	40	40	40	F0	4B	F2	F6	40	C3	D9		
b	b	b	b	b	b	0	.	2	6	b	C	R		

This pattern field prints as:

0.26 CR

The significance starter forces the significance indicator to the on state and hence causes a leading zero and the decimal point to be preserved. Because the minus-sign code has no effect on the significance indicator, the characters CR are printed to show a negative (credit) amount.

Condition code 1 is set (number less than zero).

EDIT AND MARK (EDMK)

The EDIT AND MARK instruction may be used, in addition to the functions of EDIT, to insert a currency symbol, such as a dollar sign, at the appropriate position in the edited result. Assume the same source in storage locations 1200-1203, the same pattern in locations 1000-100C, and the same contents of general register 12 as for the EDIT instruction above. The previous contents of general register 1 (GR1) are not significant; a LOAD ADDRESS instruction is used to set up the first digit position that is forced to print if no significant digits occur to the left.

The instructions:

LA	1,6(0,12)	Load address of forced significant digit into GR1
EDMK	0(13,12),X'200'(12)	Leave address of first significant digit in GR1
BCTR	1,0	Subtract 1 from address in GR1
MVI	0(1),C '\$'	Store dollar sign at address in GR1

produce the following results for the two examples under EDIT:

Pattern

1000												100C		
40	5B	F2	6B	F5	F7	F4	4B	F2	F6	40	40	40		
b	\$	2	,	5	7	4	.	2	6	b	b	b		

This pattern field prints as:

\$2,574.26

Condition code 2 is set to indicate that the number edited was greater than zero.

Pattern

1000										100C				
40	40	40	40	40	5B	F0	4B	F2	F6	40	C3	D9		
b	b	b	b	b	\$	0	.	2	6	b	C	R		

This pattern field prints as:

\$0.26 CR

Condition code 1 is set because the number is less than zero.

MULTIPLY DECIMAL (MP)

Assume that the signed-packed-decimal number in storage locations 1202-1204 (the multiplicand) is to be multiplied by the signed-packed-decimal number in locations 500-501 (the multiplier).

	1202	1204
Multiplicand	38	46 0D

	500	501
Multiplier	32	1D

The multiplicand must first be extended to have at least two bytes of leftmost zeros, corresponding to the multiplier length, so as to avoid a data exception during the multiplication. ZERO AND ADD can be used to move the multiplicand into a longer field. Assume:

Register 4 contains 00 00 12 00.

Register 6 contains 00 00 05 00.

Then execution of the instruction:

ZAP X'100'(5,4),2(3,4)

sets up a new multiplicand in storage locations 1300-1304:

	1300	1304
Multiplicand (new)	00	00 38 46 0D

Now, after the instruction:

Machine Format

Op Code	L ₁	L ₂	B ₁	D ₁	B ₂	D ₂
FC	4	1	4	100	6	000

Assembler Format

Op Code D₁(L₁,B₁),D₂(L₂,B₂)

MP X'100'(5,4),0(2,6)

is executed, storage locations 1300-1304 contain the product: 01 23 45 66 0C.

SHIFT AND ROUND DECIMAL (SRP)

The SHIFT AND ROUND DECIMAL (SRP) instruction can be used for shifting decimal numbers in storage to the left or right. When a number is shifted right, rounding can also be done.

Decimal Left Shift

In this example, the contents of storage location FIELD1 are shifted three places to the left, effectively multiplying the contents of FIELD1 by 1000. FIELD1 is six bytes long. The following instruction performs the operation:

Machine Format

Op Code	L ₁	I ₃	S ₁	B ₂	D ₂
F0	5	0	***	0	003

Assembler Format

Op Code S₁(L₁),S₂,I₃

SRP FIELD1(6),3,0

FIELD1 (before): 00 01 23 45 67 8C

FIELD1 (after): 12 34 56 78 00 0C

The second-operand address in this instruction specifies the shift amount (three places). The rounding digit, I₃, is not used in a left shift, but it must be a valid decimal digit. After execution, condition code 2 is set to show that the result is greater than zero.

Decimal Right Shift

In this example, the contents of storage location FIELD2 are shifted one place to the right, effectively

dividing the contents of FIELD2 by 10 and discarding the remainder. FIELD2 is five bytes in length. The following instruction performs this operation:

Machine Format

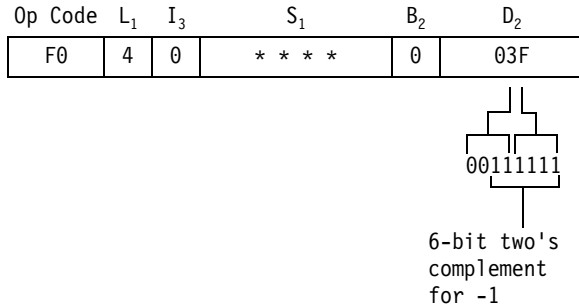

Assembler Format

Op Code S₁(L₁), S₂, I₃

SRP FIELD2(5), 64-1, 0

FIELD 2 (before): 01 23 45 67 8C

FIELD 2 (after): 00 12 34 56 7C

In the SRP instruction, shifts to the right are specified in the second-operand address by negative shift values, which are represented as a six-bit value in two's complement form.

The six-bit two's complement of a number, n, can be specified as 64 - n. In this example, a right shift of one is represented as 64 - 1.

Condition code 2 is set.

Decimal Right Shift and Round

In this example, the contents of storage location FIELD3 are shifted three places to the right and rounded, in effect dividing by 1000 and rounding up. FIELD3 is four bytes in length.

Machine Format

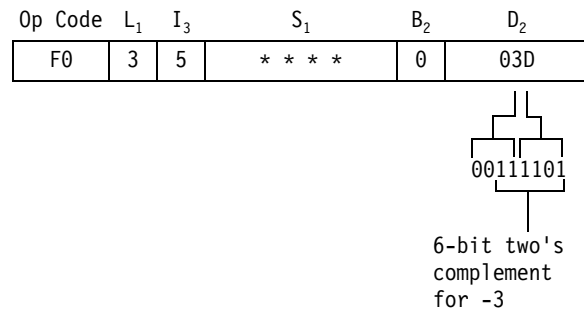

Assembler Format

Op Code S₁(L₁), S₂, I₃

SRP FIELD3(4), 64-3, 5

FIELD 3 (before): 12 39 60 0D

FIELD 3 (after): 00 01 24 0D

The shift amount (three places) is specified in the D₂ field. The I₃ field specifies a rounding digit of 5. The rounding digit is added to the last digit shifted out (which is a 6), and the carry is propagated to the left. The sign is ignored during the addition.

Condition code 1 is set because the result is less than zero.

Multiplying by a Variable Power of 10

Since the shift value specified by the SRP instruction specifies both the direction and amount of the shift, the operation is equivalent to multiplying the decimal first operand by 10 raised to the power specified by the shift value.

If the shift value is to be variable, it may be specified by the B₂ field instead of the displacement D₂ of the SRP instruction. The general register designated by B₂ should contain the shift value (power of 10) as a signed binary integer.

A fixed scale factor modifying the variable power of 10 may be specified by using both the B₂ field (variable part in a general register) and the D₂ field (fixed part in the displacement).

The SRP instruction uses only the rightmost six bits of the effective address D₂(B₂) and interprets them as a six-bit signed binary integer to control the left or right shift as in the preceding shift examples.

ZERO AND ADD (ZAP)

Assume that the signed-packed-decimal number at storage locations 4500-4502 is to be moved to locations 4000-4004 with four leading zeros in the result field. Also assume:

Register 9 contains 00 00 40 00.

Storage locations 4000-4004 contain 12 34 56 78 90.

Storage locations 4500-4502 contain 38 46 0D.

After the instruction:

Machine Format

Op Code	L ₁	L ₂	B ₁	D ₁	B ₂	D ₂
F8	4	2	9	000	9	500

Assembler Format

Op Code D₁(L₁,B₁),D₂(L₂,B₂)

ZAP 0(5,9),X'500'(3,9)

is executed, the storage locations 4000-4004 contain 00 00 38 46 0D; condition code 1 is set to indicate a negative result without overflow.

Note that, because the first operand is not checked for valid sign and digit codes, it may contain any combination of hexadecimal digits before the operation.

Hexadecimal-Floating-Point Instructions

(See Chapter 9, "Floating-Point Overview and Support Instructions" for a complete description of the hexadecimal-floating-point instructions.)

In this section, the abbreviations FPR0, FPR2, FPR4, and FPR6 stand for floating-point registers 0, 2, 4, and 6 respectively.

ADD NORMALIZED (AD, ADR, AE, AER, AXR)

The ADD NORMALIZED instruction performs the addition of two HFP numbers and places the normal-

ized result in a floating-point register. Neither of the two numbers to be added must necessarily be in normalized form before addition occurs. For example, assume that:

FPR6 contains the unnormalized number C3 08 21 00 00 00 00 00 = $-82.1_{16} = -130.06_{10}$ approximately.

Storage locations 2000-2007 contain the normalized number 41 12 34 56 00 00 00 00 = $+1.23456_{16} = +1.14_{10}$ approximately.

Register 13 contains 00 00 20 00.

The instruction:

Machine Format

Op Code	R ₁	X ₂	B ₂	D ₂
7A	6	0	D	000

Assembler Format

Op Code R₁,D₂(X₂,B₂)

AE 6,0(0,13)

performs the short-precision addition of the two operands, as follows.

The characteristics of the two numbers (43 and 41) are compared. Since the number in storage has a characteristic that is smaller by 2, it is right-shifted two hexadecimal digit positions. One guard digit is retained on the right. The fractions of the two numbers are then added algebraically:

	Fraction GD ¹
FPR6	-43 08 21 00
Shifted number from storage	+43 00 12 34 5
<hr/>	
Intermediate sum	-43 08 0E CB B
Left-shifted sum	-42 80 EC BB

¹ Guard digit

Because the intermediate sum is unnormalized, it is left-shifted to form the normalized HFP number $-80.ECBB_{16} = -128.92_{10}$ approximately. Combining the sign with the characteristic, the result is C2 80 EC BB, which replaces the left half of FPR6. The right half of FPR6 and the contents of storage locations 2000-2007 are unchanged. Condition code 1 is set to indicate a result less than zero.

If the long-precision instruction AD were used, the result in FPR6 would be C2 80 EC BA A0 00 00 00. Note that use of the long-precision instruction would avoid a loss of precision in this example.

ADD UNNORMALIZED (AU, AUR, AW, AWR)

The ADD UNNORMALIZED instruction operates the same as the ADD NORMALIZED instruction, except that the final result is not normalized. For example, using the same operands as in the example for ADD NORMALIZED, when the short-precision instruction:

Machine Format

Op Code	R ₁	X ₂	B ₂	D ₂
7E	6	0	D	000

Assembler Format

Op Code	R ₁ , D ₂ (X ₂ , B ₂)
AU	6, 0(0, 13)

is executed, the two numbers are added as follows:

	Fraction	GD ¹
FPR6	-43 08 21 00	
Shifted number from storage	+43 00 12 34	5
Intermediate sum	-43 08 0E CB	B

¹ Guard digit

The guard digit participates in the addition but is discarded. The unnormalized sum replaces the left half of FPR6. Condition code 1 is set because the result is less than zero.

The truncated result in FPR6 (C3 08 0E CB 00 00 00 00) shows a loss of a significant digit when compared to the result of short-precision normalized addition.

COMPARE (CD, CDR, CE, CER)

Assume that FPR4 contains 43 00 00 00 00 00 00 00 (zero), and FPR6 contains 35 12 34 56 78 9A BC DE (a positive number). The contents of the two registers are to be compared using a long-precision COMPARE instruction.

Machine Format

Op Code	R ₁	R ₂
29	4	6

Assembler Format

Op Code	R ₁ , R ₂
CDR	4, 6

The number with the smaller characteristic, which is in register FPR6, is right-shifted 43 - 35 hex (67 - 53 decimal) or 14 digit positions, so that the two characteristics agree. The shifted number is 43 00 00 00 00 00 00 00, with a guard digit of one. Therefore, when the two numbers are compared, condition code 1 is set, indicating that operand 1 in FPR4 is less than operand 2 in FPR6.

If the example is changed to a second operand with a characteristic of 34 instead of 35, so that FPR6 contains 34 12 34 56 78 9A BC DE, the operand is right-shifted 15 positions, leaving all fraction digits and the guard digit as zeros. Condition code 0 is set, indicating equality. This example shows that two HFP numbers with different characteristics or fractions may compare equal if the numbers are unnormalized or zero.

As another example of comparing unnormalized HFP numbers, 41 00 12 34 56 78 9A BC compares equal to all numbers of the form 3F 12 34 56 78 9A BC 0X (X represents any hexadecimal digit). When the COMPARE instruction is executed, the two rightmost digits are shifted right two places, the 0 becomes the guard digit, and the X does not participate in the comparison.

However, when two normalized HFP numbers are compared, the relationship between numbers that compare equal is unique: each digit in one number must be the same as the corresponding digit in the other number.

DIVIDE (DD, DDR, DE, DER)

Assume that the first operand (the dividend) is in FPR2 and the second operand (the divisor) in FPR0. If the operands are in the short-precision format, the resulting quotient is returned to FPR2 by the instruction:

Machine Format

Op Code	R ₁	R ₂
3D	2	0

Assembler Format

Op Code	R ₁ ,R ₂
DER	2,0

Several examples of short-precision HFP division, with the dividend in FPR2 and the divisor in FPR0, are shown below. For case A, the result, which replaces the dividend, is obtained in the following steps.

.123400	821000	7.2522F
	7F6C00	
	2A400 0	
	24680 0	
	5D80 00	
	5B04 00	
	27C 000	
	246 800	
	35 8000	
	24 6800	
	11 18000	
	11 10C00	
	7400	

Case	FPR2 Before (Dividend)	FPR0 (Divisor)	FPR2 After (Quotient)
A	-43 082100	+43 001234	-42 72522F
B	+42 101010	+45 111111	+3D F0F0F0
C	+48 30000F	+41 400000	+47 C0003C
D	+48 30000F	+41 200000	+48 180007
E	+48 180007	+41 200000	+47 C00038

Case C shows a number being divided by 4.0. Case D divides the same number by 2.0, and case E divides the result of case D again by 2.0. The results of cases C and E differ in the rightmost hexadecimal digit position, which illustrates an effect of result truncation.

HALVE (HDR, HER)

HALVE produces the same result as HFP DIVIDE with a divisor of 2.0. Assume FPR2 contains the long-precision number +48 30 00 00 00 00 0F. The following HALVE instruction produces the result +48 18 00 00 00 00 07 in FPR2:

Machine Format

Op Code	R ₁	R ₂
24	2	2

Assembler Format

Op Code	R ₁ ,R ₂
HDR	2,2

MULTIPLY (MD, MDR, MDE, MDER, MXD, MXDR, MXR)

For this example, the following long-precision operands are in FPR0 and FPR2:

FPR0: -33 606060 60606060
 FPR2: -5A 200000 20000020

A long-precision product is generated by the instruction:

Machine Format

Op Code	R ₁	R ₂
2C	0	2

Assembler Format

Op Code	R ₁ ,R ₂
MDR	0,2

If the operands were not already normalized, the instruction would first normalize them. It then generates an intermediate result consisting of the full 28-digit hexadecimal product fraction obtained by multiplying the 14-digit hexadecimal operand fractions, together with the appropriate sign and a characteristic that is the sum of the operand characteristics less 64 (40 hex):

The fraction multiplication is performed as follows:

$$\begin{array}{r}
 .60606060606060 \\
 .20000020000020 \\
 \hline
 C0C0C0C0C0C0C0 \\
 C0C0C0C0C0C0C0 \\
 C0C0C0C0C0C0C0 \\
 \hline
 .0C0C0C181818241818180C0C0C00
 \end{array}$$

Attaching the sign and characteristic to the fraction gives:

```
+4D 0C0C0C 18181824 1818180C 0C0C00
```

Because this intermediate product has a leading zero, it is then normalized. The truncated final result placed in FPR0 is:

```
+4C C0C0C1 81818241
```

Hexadecimal-Floating-Point-Number Conversion

The following examples illustrate one method of converting between binary fixed-point numbers (32-bit signed binary integers) and normalized HFP numbers. Conversion must provide for the different representations used with negative numbers: the two's-complement form for signed binary integers, and the signed-absolute-value form for the fractions of HFP numbers.

Fixed Point to Hexadecimal Floating Point

The method used here inverts the leftmost bit of the 32-bit signed binary integer, which is equivalent to adding 2^{31} to the number and considering the result to be positive. This changes the number from a signed integer in the range $2^{31} - 1$ through -2^{31} to an unsigned integer in the range $2^{32} - 1$ through 0. After conversion to the long HFP format, the value 2^{31} is subtracted again.

Assume that general register 9 (GR9) contains the integer -59 in two's-complement form:

```
GR9:    FF FF FF C5
```

Further, assume two eight-byte fields in storage: TEMP, for use as temporary storage, and TWO31,

which contains the floating-point constant 2^{31} in the following format:

```
TWO31:  4E 00 00 00 80 00 00 00
```

This is an unnormalized long HFP number with the characteristic 4E, which corresponds to a radix point (hexadecimal point) to the right of the number.

The following instruction sequence performs the conversion:

		Result
X	9,TWO31+4	GR9: 7FFF FFC5
ST	9,TEMP+4	TEMP: xxxx xxxx 7FFF FFC5
MVC	TEMP(4),TWO31	TEMP: 4E00 0000 7FFF FFC5
LD	2,TEMP	FPR2: 4E00 0000 7FFF FFC5
SD	2,TWO31	FPR2: C23B 0000 0000 0000

The EXCLUSIVE OR (X) instruction inverts the leftmost bit in general register 9, using the right half of the constant as the source for a leftmost one bit. The next two instructions assemble the modified number in an unnormalized long HFP format, using the left half of the constant as the plus sign, the characteristic, and the leading zeros of the fraction. LOAD (LD) places the number unchanged in floating-point register 2. The SUBTRACT NORMALIZED (SD) instruction performs the final two steps by subtracting 2^{31} in HFP form and normalizing the result.

Hexadecimal Floating Point to Fixed Point

The procedure described here consists basically in reversing the steps of the previous procedure. Two additional considerations must be taken into account. First: the HFP number may not be an exact integer. Truncating the excess hexadecimal digits on the right requires shifting the number one digit position farther to the right than desired for the final result, so that the units digit occupies the position of the guard digit. Second: the HFP number may have to be tested as to whether it is outside the range of numbers representable as a 32-bit signed binary integer.

Assume that floating-point register 6 contains the number $59.25_{10} = 3B.4_{16}$ in normalized form:

```
FPR6:  42 3B 40 00 00 00 00 00
```

Further, assume three eight-byte fields in storage: TEMP, for use as temporary storage, and the constants 2^{32} (TWO32) and 2^{31} (TWO31R) in the following formats:

```
TWO32:    4E 00 00 01 00 00 00 00
TWO31R:   4F 00 00 00 08 00 00 00
```

The constant TWO31R is shifted right one more position than the constant TWO31 of the previous example, so as to force the units digit into the guard-digit position.

The following instruction sequence performs the integer truncation, range tests, and conversion to a signed binary integer in general register 8 (GR8):

		Result
SD	6,TWO31R	FPR6: C87F FFFF C500 0000
BC	11,OVERFLOW	Branch to overflow routine if result is greater than or equal to zero
AW	6,TWO32	FPR6: 4E00 0000 8000 003B
BC	4,OVERFLOW	Branch to overflow routine if result is less than zero
STD	6,TEMP	TEMP: 4E00 0000 8000 003B
XI	TEMP+4,X'80'	TEMP: 4E00 0000 0000 003B
L	8,TEMP+4	GR8: 0000 003B

The SUBTRACT NORMALIZED (SD) instruction shifts the fraction of the number to the right until it lines up with TWO31R, which causes the fraction digit 4 to fall to the right of the guard digit and be lost; the result of subtracting 2^{31} from the remaining digits is renormalized. The result should be less than zero; if not, the original number was too large in the positive direction. The first BRANCH ON CONDITION (BC) performs this test.

The ADD UNNORMALIZED (AW) instruction adds 2^{32} : 2^{31} to correct for the previous subtraction and another 2^{31} to change to an all-positive range. The second BC tests for a result less than zero, showing that the original number was too large in the negative direction. The unnormalized result is placed in temporary storage by the STORE (STD) instruction. There the leftmost bit of the binary integer is inverted by the EXCLUSIVE OR (XI) instruction to subtract 2^{31}

and thus convert the unsigned number to the signed format. The final result is loaded into GR8.

Multiprogramming and Multiprocessing Examples

When two or more programs sharing common storage locations are being executed concurrently in a multiprogramming or multiprocessing environment, one program may, for example, set a flag bit in the common-storage area for testing by another program. It should be noted that the instructions AND (NI, NIY, or NC), EXCLUSIVE OR (XI, XIY, or XC), and OR (OI, OIY, or OC) could be used to set flag bits in a multiprogramming environment; but when the interlocked-access facility 2 is not installed, the same instructions may cause program logic errors in a multiprocessing configuration where two or more CPUs can fetch, modify, and store data in the same storage locations simultaneously.

Example of a Program Failure Using OR Immediate

The following example assumes that the interlocked-access facility 2 is not installed.

Assume that two independent programs try to set different bits to one in a common byte in storage. The following example shows how the use of the instruction OR immediate (OI) can fail to accomplish this, if the programs are executed simultaneously on two different CPUs. One of the possible error situations is depicted.

Execution of instruction OI FLAGS,X'01' on CPU A	FLAGS	Execution of instruction OI FLAGS,X'80' on CPU B
Fetch FLAGS X'00'	X'00'	Fetch FLAGS X'00'
OR X'01' into X'00'	X'00'	OR X'80' into X'00'
Store X'01' into FLAGS	X'80'	Store X'80' into FLAGS
FLAGS should have value of X'81' following both updates.		

The problem shown here is that the value stored by the OI instruction executed on CPU A overlays the value that was stored by CPU B. The X'80' flag bit

was erroneously turned off, and the data is now invalid.

The COMPARE AND SWAP instruction has been provided to overcome this and similar problems.

When the interlocked-access facility 2 is installed, the update performed by OR (OI) instruction is an interlocked-update reference, and the problem illustrated here does not occur.

Conditional Swapping Instructions (CS, CDS)

The COMPARE AND SWAP (CS) and COMPARE DOUBLE AND SWAP (CDS) instructions can be used in multiprogramming or multiprocessing environments to serialize access to counters, flags, control words, and other common storage areas.

The following examples of the use of the COMPARE AND SWAP and COMPARE DOUBLE AND SWAP instructions illustrate the applications for which the instructions are intended. It is important to note that these are examples of functions that can be performed by programs while the CPU is enabled for interruption (multiprogramming) or by programs that are being executed in a multiprocessing configuration. That is, the routine allows a program to modify the contents of a storage location while the CPU is enabled, even though the routine may be interrupted by another program on the same CPU that will update the location, and even though the possibility exists that another CPU may simultaneously update the same location.

The COMPARE AND SWAP instruction first checks the value of a storage location and then modifies it only if the value is what the program expects; normally this would be a previously fetched value. If the value in storage is not what the program expects, then the location is not modified; instead, the current value of the location is loaded into a general register, in preparation for the program to loop back and try again. During the execution of COMPARE AND SWAP, no other CPU can perform a store access or interlocked-update access at the specified location.

To ensure successful updating of a common storage field by two or more CPUs, all updates must be done by means of an interlocked-update reference. See the programming notes of COMPARE AND SWAP for

an example of how COMPARE AND SWAP can be unsuccessful due to an OR IMMEDIATE instruction executed by another CPU.

Setting a Single Bit

The following instruction sequence shows how the COMPARE AND SWAP instruction can be used to set a single bit in storage to one. Assume that the first byte of a word in storage called "WORD" contains eight flag bits.

```

LA 6,X'80' Put bit to be 0Red into GR6
SLL 6,24 Shift left 24 places to
           align the byte to be 0Red
           with the location of the
           flag bits within WORD
L 7,WORD Fetch current flag values
RETRY LR 8,7 Load flags into GR8
OR 8,6 Set bit to one
CS 7,8,WORD Store new flags if current
            flags unchanged, or re-
            fetch current flag values
            if changed
BC 4,RETRY If new flags are not stored,
            try again

```

The format of the COMPARE AND SWAP instruction is:

Machine Format

Op Code	R ₁	R ₃	S ₂
BA	7	8	* * * *

Assembler Format

```

Op Code  R1,R3,S2
-----
CS      7,8,WORD

```

The COMPARE AND SWAP instruction compares the first operand (general register 7 containing the current flag values) to the second operand in storage (WORD) while no CPU other than the one executing the COMPARE AND SWAP instruction is permitted to perform a store access or interlocked-update access at the specified storage location.

If the comparison is successful, indicating that the flag bits have not been changed since they were fetched, the modified copy in general register 8 is stored into WORD. If the flags have been changed, the compare will not be successful, and their new values are loaded into general register 7.

The conditional branch (BC) instruction tests the condition code and reexecutes the flag-modifying instructions if the COMPARE AND SWAP instruction indicated an unsuccessful comparison (condition code 1). When the COMPARE AND SWAP instruction is successful (condition code 0), the flags contain valid data, and the program exits from the loop.

The branch to RETRY will be taken only if some other program modifies the contents of WORD. This type of a loop differs from the typical “bit-spin” loop. In a bit-spin loop, the program continues to loop until the bit changes. In this example, the program continues to loop only if the value does change during each iteration. If a number of CPUs simultaneously attempt to modify a single location by using the sample instruction sequence, one CPU will fall through on the first try, another will loop once, and so on until all CPUs have succeeded.

Updating Counters

In this example, a 32-bit counter is updated by a program using the COMPARE AND SWAP instruction to ensure that the counter will be correctly updated. The original value of the counter is obtained by loading the word containing the counter into general register 7. This value is moved into general register 8 to provide a modifiable copy, and general register 6 (containing an increment to the counter) is added to the modifiable copy to provide the updated counter value. The COMPARE AND SWAP instruction is used to ensure valid storing of the counter.

The program updating the counter checks the result by examining the condition code. The condition code 0 indicates a successful update, and the program can proceed. If the counter had been changed between the time that the program loaded its original value and the time that it executed the COMPARE AND SWAP instruction, the execution would have loaded the new counter value into general register 7 and set the condition code to 1, indicating an unsuccessful update. The program must then repeat the update sequence until the execution of the COMPARE AND SWAP instruction results in a successful update.

The following instruction sequence performs the above procedure:

```

LA 6,1      Put increment (1) into GR6
L 7,CNTR    Put original counter value
             into GR7

```

```

LOOP LR 8,7      Set up copy in GR8 to modify
AR 8,6          Increment copy
CS 7,8,CNTR     Update counter in storage
BC 4,LOOP       If original value had
                 changed, update new value

```

The following shows two CPUs, A and B, executing this instruction sequence simultaneously: both CPUs attempt to add one to CNTR.

CPU A			CPU B		Comments
GR7	GR8	CNTR	GR7	GR8	
		16			
16	16				CPU A loads GR7 and GR8 from CNTR
			16	16	CPU B loads GR7 and GR8 from CNTR
				17	CPU B adds one to GR8
	17				CPU A adds one to GR8
		17			CPU A executes CS; successful match, store
			17		CPU B executes CS; no match, GR7 changed to CNTR value
				18	CPU B loads GR8 from GR7, adds one to GR8
		18			CPU B executes CS; successful match, store

Bypassing Post and Wait

See the *MVS Programming: Authorized Assembler Services Guide (SA22-7608)* for details on bypassing the z/OS WAIT and POST routines.

Lock/Unlock

When a common storage area larger than a doubleword is to be updated, it is usually necessary to provide special interlocks to ensure that a single program at a time updates the common area. Such an area is called a serially reusable resource (SRR).

In general, updating a list, or even scanning a list, cannot be safely accomplished without first “freezing” the list. However, the COMPARE AND SWAP and COMPARE DOUBLE AND SWAP instructions can be used in certain restricted situations to perform queuing and list manipulation. Of prime importance is the capability to perform the lock/unlock functions and to provide sufficient queuing to resolve contentions, either in a LIFO or FIFO manner. The lock/unlock

functions can then be used as the interlock mechanism for updating an SRR of any complexity.

The lock/unlock functions are based on the use of a “header” associated with the SRR. The header is the common starting point for determining the states of the SRR, either free or in use, and also is used for queuing requests when contentions occur. Contentions are resolved using WAIT and POST. The general programming technique requires that the program that encounters a “locked” SRR must “leave a mark on the wall” indicating the address of an ECB on which it will WAIT. The “unlocking” program sees the mark and posts the ECB, thus permitting the waiting program to continue. In the two examples given, all programs using a particular SRR must use either the LIFO queuing scheme or the FIFO scheme; the two cannot be mixed. When more complex queuing is required, it is suggested that the queue for the SRR be locked using one of the two methods shown.

Lock/Unlock with LIFO Queuing for Contentions

The header consists of a word, that is, a four-byte field aligned on a word boundary. The word can contain zero, a positive value, or a negative value.

- A zero value indicates that the serially reusable resource (SRR) is free.
- A negative value indicates that the SRR is in use but no additional programs are waiting for the SRR.
- A positive value indicates that the SRR is in use and that one or more additional programs are waiting for the SRR. Each waiting program is identified by an element in a chained list. The positive value in the header is the address of the element most recently added to the list.

Each element consists of two words. The first word is used as an ECB; the second word is used as a pointer to the next element in the list. A negative value in a pointer indicates that the element is the last element in the list. The element is required only if the program finds the SRR locked and desires to be placed in the list.

The following chart describes the action taken for LIFO LOCK and LIFO UNLOCK routines. The rou-

tines following the chart allow enabled code to perform the actions described in the chart.

Function	Action		
	Header Contains Zero	Header Contains Positive Value	Header Contains Negative Value
LIFO LOCK (the incoming element is at location A)	SRR is free. Set the header to a negative value. Use the SRR.	SRR is in use. Store the contents of the header into location A+4. Store address A into the header. WAIT; the ECB is at location A.	
LIFO UNLOCK	Error	Some program is waiting for the SRR. Move the pointer from the “last in” element into the header. POST; the ECB is in the “last in” element.	The list is empty. Store zeros into the header. The SRR is free.

LIFO LOCK Routine:

Initial Conditions:

- GR1 contains the address of the incoming element.
- GR2 contains the address of the header.

```

LLOCK SR 3,3 GR3 = 0
      ST 3,0(1) Initialize the ECB
      LNR 0,1 GR0 = a negative value
TRYAGN CS 3,0,0(2) Set the header to a
                  negative value if the
                  header contains zeros
      BC 8,USE Did the header contain
                  zeros?
      ST 3,4(1) No, store the value of
                  the header into the
                  pointer in the in-
                  coming element
      CS 3,1,0(2) Store the address of
                  the incoming element
                  into the header
      LA 3,0(0) GR3 = 0
      BC 7,TRYAGN Did the header get up-
                  dated?
      WAIT ECB=(1) Yes, wait for the re-
                  source; the ECB is in
                  the incoming element
      USE [Any instruction]

```

LIFO UNLOCK Routine:

Initial Conditions:

- GR2 contains the address of the header.

```
LUNLK L    1,0(2)  GR1 = the contents of
                  the header
A   LTR 1,1      Does the header contain
   BC  4,B      a negative value?
   L   0,4(1)   No, load the pointer
   CS  1,0,0(2) from the 'last in'
                  element and store it in
                  the header
   BC  7,A      Did the header get
                  updated?
   POST (1)     Yes, post the 'last in'
                  element
   BC  15,EXIT  Continue
B   SR  0,0      The header contains a
   CS  1,0,0(2) negative value; free
   BC  7,A      the header and continue
EXIT [Any instruction]
```

Note that the LOAD instruction L 1,0(2) at location LUNLK would have to be CS 1,1,0(2) if it were not for the rule concerning storage-operand consistency. This rule requires the LOAD instruction to fetch a four-byte operand aligned on a word boundary such that, if another CPU changes the word being fetched by an operation which is also at least word-consistent, either the entire new or the entire old value of the word is obtained, and not a combination of the two. (See "Storage-Operand Consistency" on page 5-125.)

Lock/Unlock with FIFO Queuing for Contentions

The header always contains the address of the most recently entered element. The header is originally initialized to contain the address of a posted ECB. Each program using the serially reusable resource (SRR) must provide an element regardless of whether contention occurs. Each program then enters the address of the element which it has provided into the header, while simultaneously it removes the address previously contained in the header. Thus, associated with any particular program attempting to use the SRR are two elements, called the "entered element" and the "removed element". The "entered element" of one program becomes the "removed element" for the immediately following program. Each program then waits on the removed element, uses the SRR, and then posts the entered element.

When no contention occurs, that is, when the second program does not attempt to use the SRR until after the first program is finished, then the POST of the first program occurs before the WAIT of the second program. In this case, the bypass-post and bypass-wait routines described in the preceding section are applicable. For simplicity, these two routines are shown only by name rather than as individual instructions.

In the example, the element need be only a single word, that is, an ECB. However, in actual practice, the element could be made larger to include a pointer to the previous element, along with a program identification. Such information would be useful in an error situation to permit starting with the header and chaining through the list of elements to find the program currently holding the SRR.

It should be noted that the element provided by the program remains pointed to by the header until the next program attempts to lock. Thus, in general, the entered element cannot be reused by the program. However, the removed element is available, so each program gives up one element and gains a new one. It is expected that the element removed by a particular program during one use of the SRR would then be used by that program as the entry element for the next request to the SRR.

It should be noted that, since the elements are exchanged from one program to the next, the elements cannot be allocated from storage that would be freed and reused when the program ends. It is expected that a program would obtain its first element and release its last element by means of the routines described in "Free-Pool Manipulation".

The following chart describes the action taken for FIFO LOCK and FIFO UNLOCK.

Function	Action
FIFO LOCK (the incoming element is at location A)	Store address A into the header. WAIT; the ECB is at the location addressed by the old contents of the header.
FIFO UNLOCK	POST; the ECB is at location A.

The following routines allow enabled code to perform the actions described in the previous chart.

FIFO Lock Routine:

Initial conditions:

- GR3 contains the address of the header.
- GR4 contains the address, A, of the element currently owned by this program. This element becomes the entered element.

FLOCK	LR	2,4	GR2 now contains address of element to be entered
	SR	1,1	GR1 = 0
	ST	1,0(2)	Initialize the ECB
	L	1,0(3)	GR1 = contents of the header
TRYAGN	CS	1,2,0(3)	Enter address A into header while remembering old contents of header into GR1; GR1 now contains address of removed element
	BC	7,TRYAGN	
	LR	4,1	Removed element becomes new currently owned element
	HSWAIT		Perform bypass-wait routine; if ECB already posted, continue; if not, wait; GR1 contains the address of the ECB
USE		[Any instruction]	

FIFO Unlock Routine:

Initial conditions:

- GR2 contains the address of the removed element, obtained during the FLOCK routine.
- GR5 contains 40 00 00 00₁₆

FUNLK	LR	1,2	Place address of entered element in GR1; GR1 = address of ECB to be posted
	SR	0,0	GR0 = 0; GR0 has a post code of zero
	OR	0,5	Set bit 1 of GR0 to one
	HSPPOST		Perform bypass-post routine; if ECB has not been waited on, then mark posted and continue; if it has been waited on, then post
CONTINUE		[Any instruction]	

Free-Pool Manipulation

It is anticipated that a program will need to add and delete items from a free list without using the lock/unlock routines. This is especially likely since the lock/unlock routines require storage elements for queuing and may require working storage. The lock/unlock routines discussed previously allow simultaneous lock routines but permit only one unlock routine at a time. In such a situation, multiple additions and a single deletion to the list may all occur simultaneously, but multiple deletions cannot occur at the same time. In the case of a chain of pointers containing free storage buffers, multiple deletions along with additions can occur simultaneously. In this case, the removal cannot be done using the COMPARE AND SWAP instruction without a certain degree of exposure.

Consider a chained list of the type used in the example in section “Lock/Unlock with LIFO Queuing for Contentions” on page A-48. Assume that the first two elements are at locations A and B, respectively. If one program attempted to remove the first element and was interrupted between the fourth and fifth instructions of the LUNLK routine, the list could be changed so that elements A and C are the first two elements when the interrupted program resumes execution. The COMPARE AND SWAP instruction would then succeed in storing the value B into the header, thereby destroying the list.

The probability of the occurrence of such list destruction can be reduced to *near* zero by appending to the header a counter that indicates the number of times elements have been added to the list. The use of a 32-bit counter guarantees that the list will not be destroyed unless the following events occur, in the exact sequence:

1. An unlock routine is interrupted between the fetch of the pointer from the first element and the update of the header.
2. The list is manipulated, including the deletion of the element referenced in 1, and exactly 2^{32} (or an integer multiple of 2^{32}) additions to the list are performed. Note that this takes on the order of days to perform in any practical situation.
3. The element referenced in 1 is added to the list.
4. The unlock routine interrupted in 1 resumes execution.

The following routines use such a counter in order to allow multiple, simultaneous additions and removals at the head of a chain of pointers.

The list consists of a doubleword header and a chain of elements. The first word of the header contains a pointer to the first element in the list. The second word of the header contains a 32-bit counter indicating the number of additions that have been made to the list. Each element contains a pointer to the next element in the list. A zero value indicates the end of the list.

The following chart describes the free-pool-list manipulation.

Function	Action	
	Header = 0,Count	Header = A,Count
ADD TO LIST (the incoming element is at location A)	Store the first word of the header into location A. Store the address A into the first word of the header. Decrement the second word of the header by one.	
DELETE FROM LIST	The list is empty.	Set the first word of the header to the value of the contents of location A. Use element A.

The following routines allow enabled code to perform the free-pool-list manipulation described in the above chart.

ADD TO FREE LIST Routine:

Initial Conditions:

- GR2 contains the address of the element to be added.
- GR4 contains the address of the header.

```

ADDQ  LM  0,1,0(4) GR0,GR1 = contents of
                        the header
TRYAGN ST  0,4(2)  Point the new element to
                        the top of the list
      LR  3,1      Move the count to GR3
      AHI 3,1      Increment the count
      CDS 0,2,0(4) Update the header
      BC  7,TRYAGN
  
```

DELETE FROM FREE LIST Routine:

Initial conditions:

- GR4 contains the address of the header.

```

DELETQ LM  2,3,0(4) GR2,GR3 = contents
                        of the header
TRYAGN LTR 2,2      Is the list empty?
      BC  8,EMPTY  Yes, get help
      L  0,4(2)   No, GR0 = the pointer
                        from the first
                        element
      LR  1,3      Move the count to GR1
      CDS 2,0,0(4) Update the header
      BC  7,TRYAGN
USE    [Any instruction] The address of the re-
                        moved element is in
                        GR2
  
```

Notes:

1. The LM (LOAD MULTIPLE) instructions at locations ADDQ and DELETQ would have to be CDS (COMPARE DOUBLE AND SWAP) instructions if it were not for the rule concerning storage-operand consistency. This rule requires the LOAD MULTIPLE instructions to fetch an eight-byte operand aligned on a doubleword boundary such that, if another CPU changes the doubleword being fetched by an operation which is also at least doubleword-consistent, either the entire new or the entire old value of the doubleword is obtained, and not a combination of the two. (See "Storage-Operand Consistency" on page 5-125.)
2. The add-to-free-list and delete-from-free-list examples shown above assume that the pointer to the next element in the list is in the second word of the element, as described "Lock/Unlock with LIFO Queuing for Contentions" on page A-48.

PERFORM LOCKED OPERATION (PLO)

The PERFORM LOCKED OPERATION instruction can be used in a multiprogramming or multiprocessing environment to perform compare, load, compare-and-swap, and store operations on two or more discontinuous locations that can be words or doublewords. The operations are performed as an atomic set of operations under the control of a lock that is held only for the duration of the execution of a single PERFORM LOCKED OPERATION instruction, as opposed to across the execution of multiple instructions. Since lock contention is resolved by the CPU and is very brief, the program need not include a method for dealing with the case when the lock to be

used is held by a program being executed by another CPU. Also, there need be no concern that the program may be interrupted while it holds a lock, since PERFORM LOCKED OPERATION will complete its operation and release its lock before an interruption can occur.

PERFORM LOCKED OPERATION can be thought of as performing concurrent interlocked updates of multiple operands. However, the instruction does not actually perform any interlocked update, and a serially reusable resource cannot be updated predictably through the use of both PERFORM LOCKED OPERATION and conditional-swapping instructions (CS and CDS).

Following is an example of how PERFORM LOCKED OPERATION can be used to add an element at the beginning of a queue.

Assume the following variables associated with the queue: S, which is a sequence number that is incremented anytime the queue is changed; H (for head), which is the address of the first element on the queue; and C, which is a count of the number of elements on the queue. Assume a queue element contains a variable, F (for forward), which is the address of the next element on the queue. If a new element, N, is to be enqueued at the head of the queue, that can be done by setting F in N to H and then performing the following atomic set of operations:

S+1 → S
 A(N) → H
 C+1 → C

where A(N) is the address of N.

The enqueueing of N can be done by means of the following steps:

1. Obtain consistent values of S, H, and C, meaning obtain S and obtain the H and C that are consistent with that value of S.
2. Store H in N.F.
3. By means of PLO.csdst (PERFORM LOCKED OPERATION performing compare and swap and double store), with S as the swap variable and H and C as the store variables, add one to S, set H to A(N), and add one to C, provided that S still has the value obtained in step 1. If S has already been changed, go back to step 1.

Consistent values of S, H, and C cannot necessarily be obtained simply by using three LOAD instructions because a PERFORM LOCKED OPERATION instruction being executed by another CPU may have completed an update of S but not yet of H or C. In this case, the three LOAD instructions will obtain the new S but the old H or C. However, as will be described, it may be possible to use three LOAD instructions.

If S is obtained while holding the lock, meaning by means of PERFORM LOCKED OPERATION, then H and C can be obtained by LOAD instructions since no other CPU can subsequently change H or C without changing S, as observed when the lock is held.

The parameter list used by the PLO.csdst is as follows, assuming the access-register mode is not used:

0	
8	
:	
48	
56	A(N)
64	
72	A(H)
80	
88	C+1
96	
104	A(C)

The program is as follows:

```

LA   RT,H      Initialize addresses in
                    PL (T = temp)
ST   RT,PL+76  Op4 address (address of
                    H)

LA   RT,C
ST   RT,PL+108 Op6 address (address of
                    C)

LA   RN,N      Address of N
ST   RN,PL+60  Initialize op3 in PL
                    (address of N)

LA   R1,S      PLT address = address
                    of S
-----
SR   RS,RS     Dummy S. CC1 will
                    probably be set
SR   R0,R0     Function code 0
                    (compare and load)

```

	PLO	RS,S,RS,S	Obtain S while holding lock

	LA	R0,16	Function code 16 (csdst)
LOOP	L	RT,H	Consistent H
	ST	RT,OFSTF(,RN)	OFSTF = offset of F in N
	L	RT,C	Consistent C
	LA	RT,1(,RT)	C+1
	ST	RT,PL+92	Initialize op5 in PL (C+1)
	LA	RSP,1(,RS)	RS/RSP = even-odd pair. S+1 in RSP
	PLO	RS,S,0,PL	
	BNZ	LOOP	Br if S changed (if CC not 0)

Note the following about the first PERFORM LOCKED OPERATION instruction (PLO.cl). If S is not zero (which is probably true), S (the second operand, op2) is loaded into RS (the first-operand comparison value, op1c). If S is zero, S (the fourth operand, op4) is loaded into RS (the third operand, op3). Either of these loads occurs while the lock is held. It is unnecessary to test the condition code to determine which load occurred.

The above program may be a simplification. If the queue has associated with it a variable, T (for tail), that is the address of the last element on the queue, and the queue is currently empty, T also must be set when N is added to the queue. This would require a different program using a compare-and-swap-and-triple-store operation.

If the queue is added to, deleted from, and rearranged by means of PERFORM LOCKED OPERATION instructions in which the sequence number, S, is always the second operand, then, since the definition of PERFORM LOCKED OPERATION specifies that the second operand is always stored last, the first PERFORM LOCKED OPERATION instruction in the above program can be replaced by a LOAD instruction. The three instructions within the dashed lines would be replaced by L RS,S.

Sorting Instructions

Tree Format

Two instructions, COMPARE AND FORM CODEWORD and UPDATE TREE, refer to a tree — a data structure with a specific format. A tree consists of some number (always odd) of consecutively numbered nodes. Node 1 is the root of the tree. Every node except the root has one parent node in the same tree. Every parent node has two son nodes. Every even-numbered node is the *leftson* of its parent node, and every odd-numbered node (except node 1) is the *rightson* of its parent node. Division by two (ignoring remainder) of the node number gives the parent node number. Nodes with sons are also called internal nodes, and nodes without sons are called terminal nodes. Figure A-5 on page A-54 illustrates schematically a 21-node tree with arrows drawn from each parent node to each son node.

A tree is used for merging several sorted sequences of records into a single merged sequence of records. At each step in the merging process, there exists the initial part of the merged sequence and the remaining parts of each of the sorted sequences that are being merged. Each step consists in selecting the lowest record (the record with the lowest key when sorting in ascending sequence) from all of the as yet unmerged parts of the sorted sequences and adding it to the merged sequence. Each terminal node in the tree represents one of the sorted sequences. The number of internal nodes in the tree is one less than the number of sorted sequences. Each internal node conceptually contains one record from each of the sorted sequences but one; these are the lowest records, from all but one of the sorted sequences, that have not yet been added to the merged sequence. In addition, there is the lowest record from the one remaining sorted sequence. This additional record is compared and interchanged with nodes of the tree to select the record to be added next to the merged sequence. This processing begins with the parent of the terminal node that represents the one remaining sorted sequence, and it continues from that node along the path to the root of the tree. The selected record emerges from the root of the tree.

The tree may perhaps be most easily explained by considering each node to represent a comparison operation in an “elimination tournament” to find the lowest record. After the tournament has been com-

pleted, each node has an associated “loser” record which had a higher key in the comparison represented by that node. Besides a loser record at each node, there is one record (the “winner”) which is not associated with any node since it never compared high. The next step would be to introduce a new record from the same sorted sequence from which the winner record originated and replay the tournament with the new record in place of the former winner. It can be seen that it is unnecessary to do all the comparisons represented by all the nodes in the tree — most of them are unaffected by the new record replacing the former winner. In fact, it is sufficient to redo only those node comparisons in which the former winner record participated. Each new record is inserted into the tree at the terminal node that represents the sorted sequence containing the record. The use of the tree assumes that programming provides a method of remembering at which terminal node each winning record originated. The instruction UPDATE TREE allows for a new record to be inserted at a terminal node and the tree to be updated so that a new winner record is left in the general registers.

Rather than comparing the actual keys of records, much of the merge logic can be performed using “codewords” to represent a record key rather than referring to actual keys. The value of a codeword at a node in the tree depends not only on the record’s key but also on the key of the winning record in the last comparison at that node. The codeword consists of two parts:

1. Bits 16-31 contain the one’s complement of the first halfword in which the record key differs from that of the node’s winning record.
2. Bits 0-15 specify the byte offset of the halfword in this record’s key just beyond the halfword value (complemented) in bit positions 16-31.

When comparing records in the path of the last winner record, if the new record is also represented by a codeword resulting from a comparison with the last winner, all codewords in the update path are with respect to the same winner. When comparing such codewords, a high codeword represents a low key and vice versa. Thus, when codewords are unequal, a node entry with a high codeword (representing a low actual key) should move up the tree.

In the case of a tie value of codewords, it is necessary to refer to the actual keys. This is done by the instruction COMPARE AND FORM CODEWORD, which resolves the ambiguity and computes a new codeword for the high-key (loser) record.

The eight bytes at each node of a tree consist of (1) a codeword for this record, computed with respect to the last record which compared low against this record and (2) a parameter usable to locate this record, for example, a direct or indirect address.

The instruction UPDATE TREE is so defined that tree updating stops after equal codewords are detected and the tie-breaking instruction COMPARE AND FORM CODEWORD can be used, after which UPDATE TREE can resume tree updating at the point where equal codewords were previously found.

COMPARE AND FORM CODEWORD may alternatively be used for merging in descending sequence. In that case, bits 16-31 of the codeword at a node contain the true value of the first halfword in which the record key differs from that of the node’s winning record. When the descending option of COMPARE AND FORM CODEWORD is used, the higher of two codewords represents the higher key.

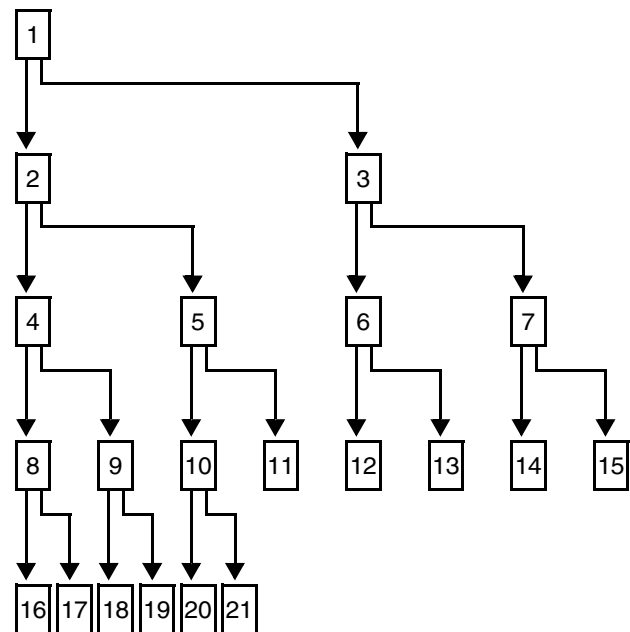

Figure A-5. Schematic Diagram of Merge Control Tree with 21 Nodes

Example of Use of Sort Instructions

An example illustrates how the instructions UPDATE TREE and COMPARE AND FORM CODEWORD may be used in the merge operation within a sort program. A five-way merge requires a tree data structure with four internal nodes and five terminal-node positions. The schematic diagram shown later in this section illustrates such a tree, containing four internal nodes (not counting the dummy node) and five input sequences for a merge, one sequence at each terminal-node position. Each record in an input sequence in the diagram is indicated by its address. The actual record contents are shown in Figure A-7 on page A-58. Each record contains 16 bytes, consisting of the following fields:

Byte Offset (hexadecimal)	Field
0-5	Six-byte record key.
6-7	Halfword node index specifying the input sequence of the next record of this input sequence.
8-B	Address of the next record in the same input sequence.
C-F	This chaining field is initially zero. At the completion of the merge, this field is to contain the address of the next record in the merged sequence.

The merge process forms a single sorted sequence from five input sequences, each of which is in sorted order. This process can be subdivided into three steps:

1. A priming step takes the first record from each of the five input sequences and places them in the tree data structure. For each record to be introduced into the tree, first its codeword value is computed with respect to the lowest possible key value of all zeros. This codeword, with a second word which contains the address of the actual record, forms a doubleword node value that can be placed at the appropriate node. After priming, the node values, one each from each of the five input sequences, will have been placed in the tree so that each of the four internal nodes contains one node value and the node value for a winner record has emerged from the root of the tree.
2. After each winner emerges from the tree, the main merge process is performed repeatedly.

Each iteration introduces the node value for one new record into the tree and produces a node value for a new winner record. The tree plus the winner must at all times contain precisely one node value from each input sequence being merged. Therefore, the new node value that is introduced into the tree on each iteration must come from the same input sequence from which the winner node value in the preceding iteration originated.

3. When the node value for the last record of an input sequence emerges as a winner, there is no successor record from that input sequence to be introduced into the tree on the next iteration. Hence, the order of the merge must be reduced by one for each such occurrence. This runout process will consist of one or more iterations for each of a four-way, three-way, two-way, and one-way merge. The onset of runout occurs in the example when it is found that the next input record from a sequence is lower than its predecessor (a sequence break).

The priming process is discussed next, and the state of the tree is shown after priming is complete. Then, a short program that uses the instructions UPDATE TREE and COMPARE AND FORM CODEWORD to perform the main merge is described. An abbreviated trace is then presented to show the status of the tree and certain general registers for 16 iterations of the main merge. The runout process is not discussed in this example.

Priming begins by forming the node value for the first record of each input sequence. The first word of the node value is the codeword formed by executing COMPARE AND FORM CODEWORD on a record key containing all binary zeros. The second word of the node value is the address of the record represented by that node value. The node values for the first record of each input sequence are:

Sequence Index	Node Values
28	0006 FFFC 0000 1030
30	0006 FFFB 0000 1040
38	0006 FFFA 0000 1050
40	0004 FFFE 0000 1080
48	0006 FFF0 0000 1060

In the example, the tree data structure is assumed to have base address X'1000', which is kept in general register 4 (to match the expected use in UPDATE TREE). Similarly, internal-node index values and

input-sequence index values are always used from general register 5.

Although the tree-priming program is not part of this example, the UPDATE TREE instruction is used in creating it as follows. First, the codeword position for each internal node of the tree is initialized to all ones (X'FFFF FFFF'). This artificer fills the tree with dummy low records. Then, for each record in the table, (1) the sequence index is loaded into general register 5, (2) the node value is loaded into general registers 0 and 1, and (3) UPDATE TREE is executed. At the completion of this priming process, the tree-node contents in the example are as shown on line 0 of Figure A-9 on page A-60. The contents of the general registers are as shown on the first line of Figure A-8 on page A-59.

The figure illustrating the program for the main merge is divided into three groups of columns, containing the absolute program, the general-register trace, and the symbolic program. The first part of the program extends from symbolic locations L1 through L2; it introduces a new record into the tree and executes an UPDATE TREE instruction. If no tied codewords are encountered in UPDATE TREE, then the BRANCH ON CONDITION instruction following UPDATE TREE loops back to L1 to introduce the next record into the tree. This BRANCH ON CONDITION instruction is suitable for use when UPDATE TREE operates in accordance with either its method 1 (setting condition code 1) or its method 2 (setting condition code 3). (The preceding sentence applies to 370-XA. In ESA/370 and ESA/390, UPDATE TREE operates in accordance with only method 2, which is not to say that it cannot set condition code 1. Method 2, but not method 1, tests for the condition that sets condition code 3.)

If UPDATE TREE encounters tied codewords, then the UPDATE TREE instruction is completed, the subsequent BRANCH ON CONDITION instruction does not branch, and control falls through to the second part of the program, which handles entries with tied codewords. This part then branches back to UPDATE TREE at L2, which resumes the tree updating. It is possible for tied codewords to be encountered at any level in the tree (or indeed at all levels), so that the tied-codeword part of the program may be entered up to three times for each record introduced.

The general-register trace for the first part of the main merge shows the contents of the first seven general registers after each instruction is executed

during the first iteration. Note that the merged-chain field (at 1140) serves as the anchor for the merged-chain address chain through the records. The trace shows only the lower half of certain general registers, whose upper half is always zero.

Figure A-9 on page A-60 gives an abbreviated trace of the entire main merge of 16 records. For each record introduced into the tree, there are one or more lines (always an odd number) given in the figure to show the tree updating, which results finally in a winner in GR0 and GR1. The first line for each record shows the values of GR5, GR2, and GR3 before the first or only execution of UPDATE TREE. For the even-numbered lines, the storage updating by UPDATE TREE of tree nodes is shown (read left to right to follow the order of swapping). For example, consider line 10 and the corresponding UPDATE TREE: since GR5 contains 28, the first storage node examined is 1010 (refer to the schematic diagram). Since the codeword in GR0 is 0004 FFFE (same as for GR2), which is less than that of the word at 1010 (0006 FFF0), the doubleword at 1010 is swapped with that in GR0 and GR1. A second comparison at 1008 in the same execution of UPDATE TREE causes another register-storage doubleword swap, which leaves the winner (record 1040) in GR1 at the completion of UPDATE TREE (see the column at the far right of Figure A-9 on page A-60).

When a codeword comparison is made which does not result in a tie or a swap (that is, when the storage-codeword value is low), an asterisk appears in the trace for that storage entry.

When equal codewords are found, the execution of UPDATE TREE is completed. The following line in each such case shows the result of the tied-codeword routine, which always stores a new codeword and may also store a new record address before branching back to L2 to execute UPDATE TREE again. In this line, the notation "loses" or "wins" means that the node loses or wins, respectively.

The tie-break trace part of Figure A-8 on page A-59 shows the treatment of the third record (that is, the first record for which UPDATE TREE encounters a tied codeword). This corresponds to line 31 in Figure A-9 on page A-60.

The following is a summary of the steps that are needed to use this example for verification purposes:

1. Initialize storage as follows:

- a. 1008 through 102F from line 0 of Figure A-9 on page A-60
 - b. 1030 through 114F from Figure A-7 on page A-58
 - c. 1150 through 1189 from Figure A-8 on page A-59
2. Initialize GRs per first line in Figure A-8 and trace first record per Figure A-8.
 3. Trace to completion of each UPT or BC 15,L2 (once for each line of Figure A-9). A detailed trace of the GRs for the tied-codeword part of line 31 of Figure A-9 is given in the lower part of Figure A-8.
 4. Verify that addresses in the chain beginning at 103C and continuing through 114C are as shown in the right-hand column of Figure A-7.

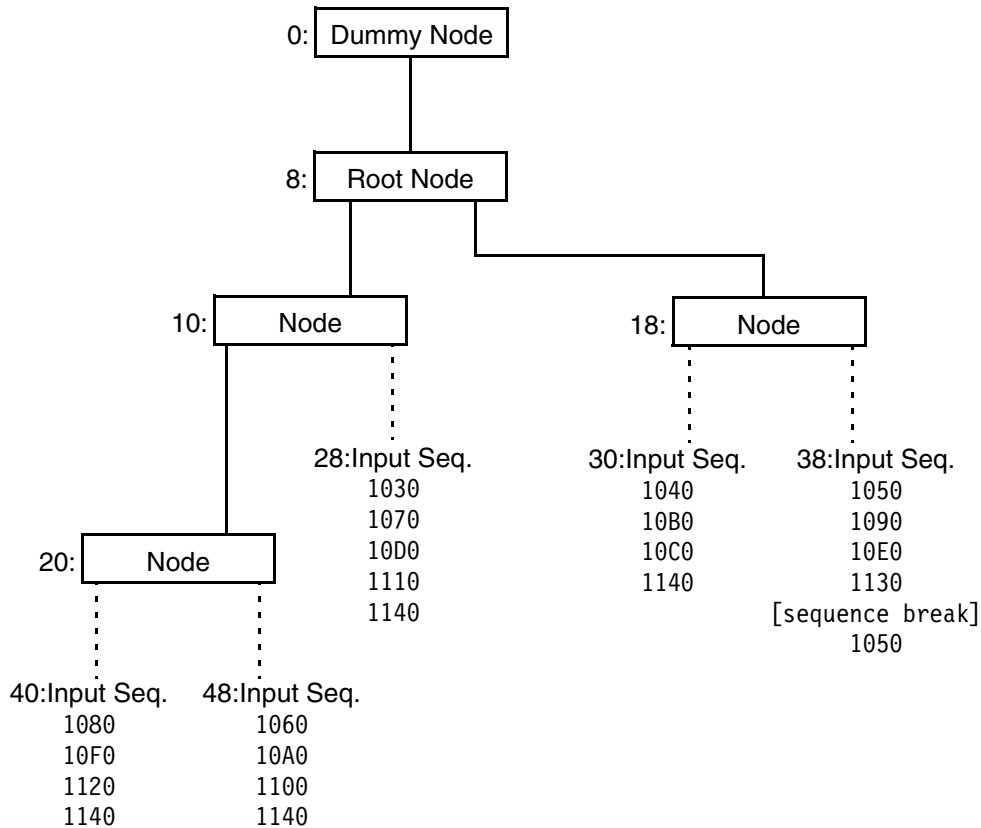

Note: Each node and input sequence is identified by a number which is the hexadecimal node index. Each input sequence is given as a list of record addresses (also in hexadecimal).

Figure A-6. Schematic Diagram for Example of Merge to Be Performed

Location	Record Key at Hex Byte Offset						Successor Record						Merged-Chain Address														
							Index		Location																		
	0	1	2	3	4	5	6	7	8	9	A	B	C	D	E	F											
1030	0	0	0	0	0	3	0	0	2	8	0	0	0	0	1	0	7	0	0	0	0	0	1	0	4	0	
1040	0	0	0	0	0	4	0	0	3	0	0	0	0	0	1	0	B	0	0	0	0	0	0	1	0	5	0
1050	0	0	0	0	0	5	0	0	3	8	0	0	0	0	1	0	9	0	0	0	0	0	0	1	0	6	0
1060	0	0	0	0	0	F	0	0	4	8	0	0	0	0	1	0	A	0	0	0	0	0	0	1	0	8	0
1070	0	0	0	0	1	F	0	0	2	8	0	0	0	0	1	0	D	0	0	0	0	0	0	1	0	9	0
1080	0	0	0	0	1	F	0	0	4	0	0	0	0	0	1	0	F	0	0	0	0	0	0	1	0	7	0
1090	0	0	0	0	F	0	0	0	3	8	0	0	0	0	1	0	E	0	0	0	0	0	0	1	0	A	0
10A0	0	0	0	0	F	0	0	0	4	8	0	0	0	0	1	1	0	0	0	0	0	0	0	1	0	B	0
10B0	0	0	0	0	F	0	0	0	3	0	0	0	0	0	1	0	C	0	0	0	0	0	0	1	0	C	0
10C0	0	0	0	0	F	0	0	0	3	0	0	0	0	0	1	1	4	0	0	0	0	0	0	1	0	D	0
10D0	0	0	0	1	0	0	0	0	2	8	0	0	0	0	1	1	1	0	0	0	0	0	0	1	0	E	0
10E0	0	0	8	0	0	0	0	0	3	8	0	0	0	0	1	1	3	0	0	0	0	0	0	1	0	F	0
10F0	0	0	8	0	0	0	2	0	0	4	0	0	0	0	1	1	2	0	0	0	0	0	0	1	1	0	0
1100	0	0	8	0	0	0	2	0	0	5	0	0	0	0	1	1	4	0	0	0	0	0	0	1	1	1	0
1110	0	0	8	0	0	0	3	0	0	0	0	0	0	0	1	1	4	0	0	0	0	0	0	1	1	2	0
1120	0	0	9	0	0	0	0	0	0	4	0	0	0	0	1	1	4	0	0	0	0	0	0	1	1	3	0
1130	F	F	F	F	F	F	F	F	0	0	3	8	0	0	0	0	0	0	0	0	0	0	0	0	0	0	0
1140	F	F	F	F	F	F	F	F	0	0	0	0	0	0	0	0	0	0	0	0	0	0	0	0	0	0	0

Figure A-7. Contents of Records to Be Merged

Absolute		General-Register Trace							Symbolic Program		
Loc	INSTR	GR0	GR1	GR2	GR3	GR4	GR5	GR6	Loc	Instruction	
		0006FFFC	1030		0000	1000	0000	1140		Using X'1000',4	
1150	5010600C	'	'		'	'	↓	'	L1	ST 1,12(,6) Store merged-chain address	
1154	48501006	'	'		'	'	0028	'	LH 5,6(,1)	Load node index of input sequence of winner	
1158	58301008	'	'		↓	'	'	↓	L 3,8(,1)	Load successor-record address	
115C	1861	'	'			'	'	1030	LR 6,1	Save old winner address for next merged-chain store	
115E	1B22	'	'	00000000	'	'	'	'	SR 2,2	Zero GR2 as initial offset	
1160	B21A0004	'	'	0004FFFE	'	'	'	'	CFC 4	Compute codeword of new record based on new winner	
1164	4720418A	'	↓	'	'	'	'	'	BC 2,L3	Exit on CC=2 (sequence break)	
1168	1813	'	1070	'	'	'	'	'	LR 1,3	} Move new record entry to GRs 0-1	
116A	1802	0004FFFE	↓	'	'	'	↓	'	LR 0,2		
116C	0102	0006FFFB	1040	'	'	'	0000	'	L2	UPT	Update tree data structure
116E	47504150	'	'	'	'	'	'	'	BC 5,L1	If no codeword tie found, branch to next iteration	
		↓	↓	↓	↓	'	↓	↓			
		00040000	1090	00040000	10B0	'	0018	1050	*	Fall through on tied codewords	
		'	'		'	'	'	'	*	← GR values for tie-break trace	
1172	88200010	'	'	00000004	'	'	'	'	SRL 2,16	Shift codeword offset to initial offset position for CFC	
1176	B21A0004	'	'	0006FFFD	'	'	'	'	CFC 4	Compute loser codeword	
117A	50254000	'	'	[CC=1]	'	'	'	'	ST 2,0(5,4)	Store loser codeword in current storage node	
117E	47C0416C	↓	↓	branch taken	↓	'	↓	↓	BC 12,L2	Resume tree update if old storage-node entry is loser	
1182	50354004	'	'		'	'	'	'	ST 3,4(5,4)	Store loser record address	
1186	47F0416C	'	'		'	'	'	'	BC 15,L2	Resume tree update	
118A	...	'	'		'	↓	'	'	L3	... Control reaches here at end	

Figure A-8. Program for Main Merge

L#	General Regs after CFC at Location 1160				Storage Trace of Node Entries								General Regs after UPT or BC 15,L2	
	GR5	GR2	GR3	Comment	1020		1018		1010		1008		GR0	GR1
0 ¹					0004FFFE	1080	0006FFFA	1050	0006FFFO	1060	0006FFFB	1040	0006FFFC	1030
10	28	0004FFFE	1070	No tie					0004FFFE	1070	0006FFFO	1060	0006FFFB	1040
20	30	00040000	10B0	No tie			00040000	10B0			*		0006FFFA	1050
30	38	00040000	1090	CC = 0			Tie						00040000	1090
31				Loses			0006FFFD						00040000	1090
32				No tie							00040000	1090	0006FFFO	1060
40	48	00040000	10A0	CC = 0	00040000	10A0			Tie				0004FFFE	1080
41				Equal					80001070				0004FFFE	1080
42				No tie							*		0004FFFE	1080
50	40	0002FF7F	10F0	No tie	0002FF7F	10F0			00040000	10A0	**		80001070	1070
60	28	0002FFFE	10D0	CC = 0					0002FFFE	10D0	Tie		00040000	10A0
61				Wins							0006FFFE	10A0	00040000	1090
62				No comp									00040000	1090
70	38	0002FF7F	10E0	No tie			0002FF7F	10E0				0006FFFD	10B0	0006FFFE
80	48	0002FF7F	1100	CC = 0	Tie								0002FF7F	1100
81				Wins	0006FFAF	1100							0002FF7F	10F0
82				No tie					0002FF7F	10F0	0002FFFE	10D0	0006FFFD	10B0
90	30	800010C0	10C0	No tie			*				*		800010C0	10C0
100	30	00020000	1140	No tie			00020000	1140				0002FF7F	10E0	0002FFFE
110	28	0002FF7F	1110	CC = 0					Tie				0002FF7F	1110
111				Wins					0004FFFC	1110			0002FF7F	10F0
112				CC = 0							Tie		0002FF7F	10F0
113				Wins							0004FFFD	10F0	0002FF7F	10E0
114				No comp									0002FF7F	10E0
120	38	00020000	1130	CC = 0			Tie						00020000	1130
121				Loses			00060000						00020000	1130
122				No tie							00020000	1130	0004FFFD	10F0
130	40	0002FF6F	1120	No tie	0002FF6F	1120			*		*		0006FFAF	1100
140	48	00020000	1140	No tie	00020000	1140			0002FF6F	1120	*		0004FFFC	1110
150	28	00020000	1140	No tie					00020000	1140	*		0002FF6F	1120
160	40	00020000	1140	CC = 0	Tie								00020000	1140
161				Equal	80001140								00020000	1140
162				CC = 0					Tie				00020000	1140
163				Equal					80001140				00020000	1140
164				CC = 0							Tie		00020000	1140
165				Wins							00060000	1140	00020000	1130
166				No comp									00020000	1130
170	38	00020000	1050	Branch										

Explanation:

- ¹ Line 0 shows the values in the tree after it is primed.
- * Means no swap.
- ** Means no swap if UPDATE TREE method 1 is used or no examination if UPDATE TREE method 2 is used. Only method 2 is included in ESA/370 and ESA/390.
- CC = 0 UPDATE TREE finds a tie and sets condition code 0.
- Loses The tied-codeword routine finds that the node loses.
- Wins The tied-codeword routine finds that the node wins.
- Equal The tied-codeword routine finds that the keys are equal.
- Branch Branches to terminate at 118A on sequence break.
- No comp No compare.

Figure A-9. Abbreviated Trace of Main Merge Processing

Appendix B. Lists of Instructions

The following figures list instructions by name, mnemonic, and operation code. Some models may offer instructions that do not appear in the figures, such as those provided for assists or as part of special or custom features.

The operation code for the interpretive execution facility is not included in this appendix. See the publication *IBM System/370 Extended Architecture Interpretive Execution*, SA22-7095, for the operation code associated with that facility.

The operation code 00 hex with a two-byte instruction format is allocated for use by the program when an indication of an invalid operation is required. Operation code 00 hex will never be assigned to an instruction implemented in the CPU.

Explanation of Symbols in “Characteristics” Columns:

\$	Causes serialization.
¢	Causes serialization and checkpoint synchronization.
£	Causes specific-operand serialization.
¢ ¹	Causes serialization and checkpoint synchronization when the M ₁ and R ₂ fields contain 1111 binary and 0000 binary, respectively. Causes only serialization when the fast-BCR-serialization facility is installed, and the M ₁ and R ₂ fields contain 1110 binary and 0000 binary, respectively.
£ ¹	Causes specific-operand serialization when the interlocked-access facility 1 is installed and the storage operand is aligned on an integral boundary corresponding to its size.
α ¹	Restricted from transactional execution.
¢ ²	Causes serialization and checkpoint synchronization when the state entry to be unstacked is a program-call state entry.
£ ²	Causes specific-operand serialization when the interlocked-access facility 2 is installed.
α ²	Restricted from transactional execution when R ₂ nonzero and branch tracing is enabled.
¢ ³	Causes serialization and checkpoint synchronization when the set-key control is one.
α ³	Restricted from transactional execution when mode tracing is enabled.

¢ ⁴	Causes serialization and checkpoint synchronization when the KFC value is 4 or 5.
α ⁴	Restricted from transactional execution when a monitor-event condition occurs.
α ⁵	Model dependent whether the instruction is restricted from transactional execution.
α ⁶	Restricted from transactional execution when the effective allow-AR-modification control is zero.
α ⁷	Restricted from transactional execution when the effective allow-floating-point-operation control is zero.
α ⁸	May be restricted from transactional execution depending on machine conditions.
α ⁹	Restricted in the constrained transactional-execution mode; a transaction-constraint program exception may be recognized. For STCMH, the instruction is restricted only when the M ₃ field is zero.
α ¹⁰	Restricted to forward branches in the constrained transactional-execution mode.
α ¹¹	For PFD and PFDRL, it is model dependent whether the instruction is restricted from transactional execution when the code in the M ₁ field is 6 or 7; for STCMH, it is model dependent whether the instruction is restricted when the M ₃ field is zero and the code in the R ₁ field is 6 or 7.
α ¹²	Restricted from transactional execution when a guarded-storage event is recognized. When in the transactional-execution mode, the transaction is aborted, and the guarded-storage event is processed.
A*	Access exceptions for logical addresses. The optional asterisk indicates that a PER ZAD event is not recognized.
A ^{1*}	Access exceptions; not all access exceptions may occur; see instruction description for details. The optional asterisk indicates that a PER ZAD event is not recognized.
AI	Access exceptions for instruction address.
B	PER branch event. (For LGG and LLGFSG, the PER branch event is only recognized coincident with a guarded-storage event.)

B†	B ₁ field designates an access register when bit 47 of GR0 is zero, and bits 16-17 of the current PSW are 01 binary; or when bit 47 of GR0 is one, and bits 40-41 of GR0 are 01 binary.	EI	Extended-immediate facility.
B‡	B ₂ field designates an access register when bit 63 of GR0 is zero, and bits 16-17 of the current PSW are 01 binary; or when bit 63 of GR0 is one, and bits 56-57 of GR0 are 01 binary.	EO	HFP-exponent-overflow exception.
B ₁	B ₁ field designates an access register in the access-register mode.	ES	Expanded-storage facility.
B ₂	B ₂ field designates an access register in the access-register mode.	ET	Extract-CPU-time facility.
B ₄	B ₄ field designates an access register in the access-register mode.	EU	HFP-exponent-underflow exception.
BP	B ₂ field designates an access register when PSW bits 16 and 17 have the value 01.	EX	Execute exception.
C	Condition code is set.	F	Floating-point-extension facility.
C*	Condition code is optionally set.	FC	Designation of access registers depends on the function code of the instruction.
C ¹	Condition code is set when the conditional-SSKE facility is installed, and either or both of the MR and MC bits are one.	FG	FPR-GR-transfer facility.
CS	Compare-and-swap-and-store facility.	FK	HFP-divide exception.
CT	Configuration-topology facility.	FL	Store-facility-list-extended facility.
CX	Constrained transactional-execution facility.	FS	Floating-point-support-sign-handling facility.
D2	DAT-enhancement facility 2.	G0	Instruction execution includes the implied use of general register 0.
Da	AFP-register data exception.	G1	Instruction execution includes the implied use of general register 1.
Db	BFP-instruction data exception.	G2	Instruction execution includes the implied use of general register 2.
Dc	Compare-and-trap data exception.	G4	Instruction execution includes the implied use of general register 4.
DE	DAT-enhancement facility.	GE	General-instructions-extension facility.
DF	Decimal-overflow exception.	GF	Guarded-storage facility.
DF*	Decimal-overflow exception conditionally recognized.	GM	Instruction execution includes the implied use of multiple general registers.
Dg	General-operand data exception.	GS	Instruction execution includes the implied use of general register 1 as the subsystem-identification word.
DK	Decimal-divide exception.	GZ	DEFLATE-conversion facility.
DM	Depending on the model, DIAGNOSE may generate various program exceptions and may change the condition code.	HM	HFP-multiply-add/subtract facility.
DO	Distinct-operands facility.	HW	High-word facility.
Dt	DFP-instruction data exception.	I	I instruction format.
Dv	Vector-instruction data exception.	I1	Access register 1 is implicitly designated in the access-register mode.
E	E instruction format.	I4	Access register 4 is implicitly designated in the access-register mode.
E2	Extended-translation facility 2.	IA	Interlocked-access facility.
E3	Extended-translation facility 3.	IC	Condition code alternative to interruptible instruction.
ED1	Enhanced-DAT facility 1.	IE	IE instruction format.
ED2	Enhanced-DAT facility 2.	IF	Fixed-point-overflow exception.
EH	Execution-hint facility.	IF*	Fixed-point-overflow exception conditionally recognized.
		II	Interruptible instruction.
		IK	Fixed-point-divide exception.
		IM	Insert-reference-bits-multiple facility
		K	PER storage-key-alteration event.
		L	New condition code is loaded.

L1	Load/store-on-condition facility 1.	RIL	RIL instruction format.
L2	Load/store-on-condition facility 2.	RIS	RIS instruction format.
LD	Long-displacement facility.	RM	R ₁ field designates an access register in the access-register mode, and access-register 1 also is used in the access-register mode.
LS	HFP-significance exception.		
LT	Load-and-trap facility.	RR	RR instruction format.
LZ	Load-and-zero-rightmost-byte facility.	RRD	RRD instruction format.
M3	Message-security assist extension 3.	RRE	RRE instruction format.
M4	Message-security assist extension 4.	RRF	RRF instruction format.
M5	Message-security assist extension 5.	RRS	RRS instruction format.
M8	Message-security assist extension 8.	RS	RS instruction format.
M9	Message-security assist extension 9.	RSI	RSI instruction format.
MD	Designation of access registers in the access-register mode is model-dependent.	RSL	RSL instruction format.
ME	Monitor event.	RSY	RSY instruction format.
MI1	Miscellaneous-instruction-extensions facility 1.	RX	RX instruction format.
MI2	Miscellaneous-instruction-extensions facility 2.	RXE	RXE instruction format.
MI3	Miscellaneous-instruction-extensions facility 3.	RXF	RXF instruction format.
MII	MII instruction format.	RXY	RXY instruction format.
MO	Move-with-optional-specifications facility.	S	S instruction format.
MS	Message-security assist.	SC	Store-clock-fast facility.
N	Instruction is new in z/Architecture as compared to ESA/390.	SE	Special operation, stack-empty, stack-specification, and stack-type exceptions.
N3	Instruction is new in z/Architecture and has been added to ESA/390.	SF	Special-operation, stack-full, and stack-specification exceptions.
OP	Operand exception.	SI	SI instruction format.
P	Privileged-operation exception; also, restricted from transactional execution.	SIL	SIL instruction format.
PA	Processor-assist facility.	SIY	SIY instruction format.
PC	DFP packed-conversion facility.	SMI	SMI instruction format.
PE	Parsing-enhancement facility.	SO	Special-operation exception.
PF	PFPO facility.	SP	Specification exception.
PK	Population-count facility.	SQ	HFP-square-root exception.
Q	Privileged-operation exception for semiprivileged instructions; also, restricted from transactional execution.	SS	SS instruction format.
R ₁	R ₁ field designates an access register in the access-register mode.	SSE	SSE instruction format.
R ₂	R ₂ field designates an access register in the access-register mode.	SSF	SSF instruction format.
R ₃	R ₃ field designates an access register in the access-register mode.	ST	PER storage-alteration event. (For LGG and LLGFSG, the PER storage-alteration event is only recognized coincident with a guarded-storage event.)
RA	Reusable-ASN-and-LX facility.	SU	PER store-using-real-address event.
RB	Reset-reference-bits-multiple facility.	SW	Special-operation exception and space-switch event.
RI	RI instruction format.	T	Trace exceptions (which include trace table, addressing, and low-address protection).
RIE	RIE instruction format.	TE	Test-pending-external-interruption facility.
		TF	Decimal-floating-point facility.
		TR	Decimal-floating-point-rounding facility.
		TS	TOD-clock-steering facility.

TX	Transactional-execution facility.		
U	Condition code is unpredictable.		
U ₁	R ₁ field designates an access register unconditionally.		
U ₂	R ₂ field designates an access register unconditionally.		
UB	R ₁ and R ₃ fields designate access registers unconditionally, and B ₂ field designates an access register in the access-register mode.		
UE	HFP unnormalized-extensions facility.		
V1	Vector-enhancements facility 1.		
V2	Vector-enhancements facility 2.		
VD	Vector packed-decimal facility.		
VF	Vector facility for z/Architecture.		
VRI	VRI instruction format.		
VRR	VRR instruction format.		
VRS	VRS instruction format.		
VRV	VRV instruction format.		
VRX	VRX instruction format.		
VSI	VSI instruction format.		
WE	Space-switch event.		
XF	IEEE-exception-simulation facility.		
Xg	Simulated IEEE exception.		
Xi	IEEE invalid-operation data or vector-processing exception.		
Xo	IEEE overflow data or vector-processing exception.		
Xq	Quantum data exception (if the floating-point extension facility is installed).		
Xu	IEEE underflow data or vector-processing exception.		
XX	Execute-extension facility.		
Xx	IEEE inexact data or vector-processing exception.		
Xz	IEEE division-by-zero data or vector-processing exception.		
Z ¹	Additional exceptions and events for PROGRAM CALL (which include ASX-translation, EX-translation, LX-translation, PC-translation-specification, special-operation, stack-full, and stack-specification exceptions and space-switch event).		
Z ²	Additional exceptions and events for PROGRAM TRANSFER (which include AFX-translation, ASX-translation, primary-authority, and special-operation exceptions and space-switch event).		
		Z ³	Additional exceptions for SET SECONDARY ASN (which include AFX translation, ASX translation, secondary authority, and special operation).
		Z ⁴	Additional exceptions and events for PROGRAM RETURN (which include AFX-translation, ASX-translation, secondary-authority, special-operation, stack-empty, stack-operation, stack-specification, and stack-type exceptions and space-switch event).
		Z ⁵	Additional exceptions for BRANCH AND STACK (which include special operation, stack full, and stack specification).
		Z ⁶	Additional exceptions and events for PROGRAM TRANSFER WITH INSTANCE (which include AFX-translation, ASTE-instance, ASX-translation, primary-authority, special-operation, and subspace-replacement exceptions and space-switch event).
		Z ⁷	Additional exceptions for SET SECONDARY ASN WITH INSTANCE (which include AFX translation, ASTE instance, ASX translation, secondary authority, special operation, and subspace replacement).
		ZF	Decimal-floating-point-zoned-conversion facility.

Instructions Arranged by Name

Name	Mnemonic	Characteristics						Op-code	Page
ADD (32)	A	RX-a	C	A	IF		B ₂	5A	7-26
ADD (32)	AR	RR	C		IF			1A	7-25
ADD (32)	ARK	RRF-a	C DO		IF			B9F8	7-25
ADD (32)	AY	RXY-a	C LD	A	IF		B ₂	E35A	7-26
ADD (64)	AG	RXY-a	C N	A	IF		B ₂	E308	7-26
ADD (64)	AGR	RRE	C N		IF			B908	7-25
ADD (64)	AGRK	RRF-a	C DO		IF			B9E8	7-25
ADD (64←32)	AGF	RXY-a	C N	A	IF		B ₂	E318	7-26
ADD (64←32)	AGFR	RRE	C N		IF			B918	7-25
ADD (extended BFP)	AXBR	RRE	C	$\alpha^{7,9}$ SP	Db Xi	Xo Xu Xx		B34A	19-15
ADD (extended DFP)	AXTR	RRF-a	C TF	$\alpha^{7,9}$ SP	Dt Xi	Xo Xu Xx		B3DA	20-19
ADD (extended DFP)	AXTRA	RRF-a	C F	$\alpha^{7,9}$ SP	Dt Xi	Xo Xu Xx Xq		B3DA	20-19
ADD (long BFP)	ADB	RXE	C	$\alpha^{7,9}$ A	Db Xi	Xo Xu Xx	B ₂	ED1A	19-15
ADD (long BFP)	ADBR	RRE	C	$\alpha^{7,9}$	Db Xi	Xo Xu Xx		B31A	19-15
ADD (long DFP)	ADTR	RRF-a	C TF	$\alpha^{7,9}$	Dt Xi	Xo Xu Xx		B3D2	20-19
ADD (long DFP)	ADTRA	RRF-a	C F	$\alpha^{7,9}$	Dt Xi	Xo Xu Xx Xq		B3D2	20-19
ADD (short BFP)	AEB	RXE	C	$\alpha^{7,9}$ A	Db Xi	Xo Xu Xx	B ₂	ED0A	19-15
ADD (short BFP)	AEBR	RRE	C	$\alpha^{7,9}$	Db Xi	Xo Xu Xx		B30A	19-15
ADD DECIMAL	AP	SS-b	C	α^9 A	Dg DF		ST B ₁ B ₂	FA	8-6
ADD HALFWORD (32←16)	AH	RX-a	C	A	IF		B ₂	4A	7-27
ADD HALFWORD (32←16)	AHY	RXY-a	C LD	A	IF		B ₂	E37A	7-27
ADD HALFWORD (64←16)	AGH	RXY-a	C MI2	A	IF		B ₂	E338	7-28
ADD HALFWORD IMMEDIATE (32←16)	AHI	RI-a	C		IF			A7A	7-28
ADD HALFWORD IMMEDIATE (64←16)	AGHI	RI-a	C N		IF			A7B	7-28
ADD HIGH (32)	AHHHR	RRF-a	C HW		IF			B9C8	7-28
ADD HIGH (32)	AHHLR	RRF-a	C HW		IF			B9D8	7-28
ADD IMMEDIATE (32)	AFI	RIL-a	C EI		IF			C29	7-26
ADD IMMEDIATE (32←16)	AHIK	RIE-d	C DO		IF			ECD8	7-26
ADD IMMEDIATE (32←8)	ASI	SIY	C GE	A	IF ξ^1		ST B ₁	EB6A	7-26
ADD IMMEDIATE (64←16)	AGHIK	RIE-d	C DO		IF			ECD9	7-26
ADD IMMEDIATE (64←32)	AGFI	RIL-a	C EI		IF			C28	7-26
ADD IMMEDIATE (64←8)	AGSI	SIY	C GE	A	IF ξ^1		ST B ₁	EB7A	7-26
ADD IMMEDIATE HIGH (32)	AIH	RIL-a	C HW		IF			CC8	7-29
ADD LOGICAL (32)	AL	RX-a	C	A			B ₂	5E	7-29
ADD LOGICAL (32)	ALR	RR	C					1E	7-29
ADD LOGICAL (32)	ALRK	RRF-a	C DO					B9FA	7-29
ADD LOGICAL (32)	ALY	RXY-a	C LD	A			B ₂	E35E	7-29
ADD LOGICAL (64)	ALG	RXY-a	C N	A			B ₂	E30A	7-29
ADD LOGICAL (64)	ALGR	RRE	C N					B90A	7-29
ADD LOGICAL (64)	ALGRK	RRF-a	C DO					B9EA	7-29
ADD LOGICAL (64←32)	ALGF	RXY-a	C N	A			B ₂	E31A	7-29
ADD LOGICAL (64←32)	ALGFR	RRE	C N					B91A	7-29
ADD LOGICAL HIGH (32)	ALHHR	RRF-a	C HW					B9CA	7-30
ADD LOGICAL HIGH (32)	ALHHLR	RRF-a	C HW					B9DA	7-30
ADD LOGICAL IMMEDIATE (32)	ALFI	RIL-a	C EI					C2B	7-29
ADD LOGICAL IMMEDIATE (64←32)	ALGFI	RIL-a	C EI					C2A	7-29
ADD LOGICAL WITH CARRY (32)	ALC	RXY-a	C N3	A			B ₂	E398	7-30
ADD LOGICAL WITH CARRY (32)	ALCR	RRE	C N3					B998	7-30
ADD LOGICAL WITH CARRY (64)	ALCG	RXY-a	C N	A			B ₂	E388	7-30
ADD LOGICAL WITH CARRY (64)	ALCGR	RRE	C N					B988	7-30

Figure B-1. Instructions Arranged by Name (Part 1 of 24)

Name	Mnemonic	Characteristics							Op-code	Page
ADD LOGICAL WITH SIGNED IMMEDIATE (32←16)	ALHSIK	RIE-d	C	DO					ECDA	7-31
ADD LOGICAL WITH SIGNED IMMEDIATE (32←8)	ALSI	SIY	C	GE	A		£ ¹	ST	B ₁	EB6E 7-31
ADD LOGICAL WITH SIGNED IMMEDIATE (64←16)	ALGHSIK	RIE-d	C	DO					ECDB	7-31
ADD LOGICAL WITH SIGNED IMMEDIATE (64←8)	ALGSI	SIY	C	GE	A		£ ¹	ST	B ₁	EB7E 7-31
ADD LOGICAL WITH SIGNED IMMEDIATE HIGH (32)	ALSIH	RIL-a	C	HW					CCA	7-32
ADD LOGICAL WITH SIGNED IMMEDIATE HIGH (32)	ALSIHN	RIL-a		HW					CCB	7-32
ADD NORMALIZED (extended HFP)	AXR	RR	C		$\alpha^{7,9}$	SP	Da EU EO LS			36 18-8
ADD NORMALIZED (long HFP)	AD	RX-a	C		$\alpha^{7,9}$	A	Da EU EO LS		B ₂	6A 18-8
ADD NORMALIZED (long HFP)	ADR	RR	C		$\alpha^{7,9}$		Da EU EO LS			2A 18-8
ADD NORMALIZED (short HFP)	AE	RX-a	C		$\alpha^{7,9}$	A	Da EU EO LS		B ₂	7A 18-8
ADD NORMALIZED (short HFP)	AER	RR	C		$\alpha^{7,9}$		Da EU EO LS			3A 18-8
ADD UNNORMALIZED (long HFP)	AW	RX-a	C		$\alpha^{7,9}$	A	Da EO LS		B ₂	6E 18-9
ADD UNNORMALIZED (long HFP)	AWR	RR	C		$\alpha^{7,9}$		Da EO LS			2E 18-9
ADD UNNORMALIZED (short HFP)	AU	RX-a	C		$\alpha^{7,9}$	A	Da EO LS		B ₂	7E 18-9
ADD UNNORMALIZED (short HFP)	AUR	RR	C		$\alpha^{7,9}$		Da EO LS			3E 18-9
AND (32)	N	RX-a	C		A				B ₂	54 7-32
AND (32)	NR	RR	C							14 7-32
AND (32)	NRK	RRF-a	C	DO						B9F4 7-32
AND (32)	NY	RXY-a	C	LD	A				B ₂	E354 7-33
AND (64)	NG	RXY-a	C	N	A				B ₂	E380 7-33
AND (64)	NGR	RRE	C	N						B980 7-32
AND (64)	NGRK	RRF-a	C	DO						B9E4 7-32
AND (character)	NC	SS-a	C		α^9	A		ST	B ₁ B ₂	D4 7-33
AND (immediate)	NI	SI	C		A		£ ²	ST	B ₁	94 7-33
AND (immediate)	NIY	SIY	C	LD	A		£ ²	ST	B ₁	EB54 7-33
AND IMMEDIATE (high high)	NIHH	RI-a	C	N						A54 7-34
AND IMMEDIATE (high low)	NIHL	RI-a	C	N						A55 7-34
AND IMMEDIATE (high)	NIHF	RIL-a	C	EI						C0A 7-34
AND IMMEDIATE (low high)	NILH	RI-a	C	N						A56 7-34
AND IMMEDIATE (low low)	NILL	RI-a	C	N						A57 7-34
AND IMMEDIATE (low)	NILF	RIL-a	C	EI						C0B 7-34
AND WITH COMPLEMENT(32)	NCRK	RRF-a	C	MI3						B9F5 7-34
AND WITH COMPLEMENT(64)	NCGRK	RRF-a	C	MI3						B9E5 7-34
BRANCH AND LINK	BAL	RX-a			α^9				B	45 7-35
BRANCH AND LINK	BALR	RR			$\alpha^{2,9}$		T		B	05 7-35
BRANCH AND SAVE	BAS	RX-a			α^9				B	4D 7-36
BRANCH AND SAVE	BASR	RR			$\alpha^{2,9}$		T		B	0D 7-36
BRANCH AND SAVE AND SET MODE	BASSM	RR			$\alpha^{2,3,9}$		T		B	0C 7-36
BRANCH AND SET AUTHORITY	BSA	RRE			Q	A ^{1*}	SO T		B	B25A 10-7
BRANCH AND SET MODE	BSM	RR			$\alpha^{3,9}$		T		B	0B 7-37
BRANCH AND STACK	BAKR	RRE			α^1	A ^{1*}	Z ^o T		B ST	B240 10-11
BRANCH IN SUBSPACE GROUP	BSG	RRE			α^1	A ^{1*}	SO T		B	B258 10-13
BRANCH INDIRECT ON CONDITION	BIC	RXY-b		MI2	α^9	A			B ₂	E347 7-38
BRANCH ON CONDITION	BC	RX-b			α^9				B	47 7-39
BRANCH ON CONDITION	BCR	RR			α^9		£ ¹		B	07 7-39
BRANCH ON COUNT (32)	BCT	RX-a			α^9				B	46 7-40
BRANCH ON COUNT (32)	BCTR	RR			α^9				B	06 7-40
BRANCH ON COUNT (64)	BCTG	RXY-a		N	α^9				B	E346 7-40
BRANCH ON COUNT (64)	BCTGR	RRE		N	α^9				B	B946 7-40
BRANCH ON INDEX HIGH (32)	BXH	RS-a			α^9				B	86 7-41
BRANCH ON INDEX HIGH (64)	BXHG	RSY-a		N	α^9				B	EB44 7-41
BRANCH ON INDEX LOW OR EQUAL (32)	BXLE	RS-a			α^9				B	87 7-41

Figure B-1. Instructions Arranged by Name (Part 2 of 24)

Name	Mnemonic	Characteristics						Op-code	Page
BRANCH ON INDEX LOW OR EQUAL (64)	BXLEG	RSY-a	N	α^9			B	EB45	7-41
BRANCH PREDICTION PRELOAD	BPP	SMI	EH	α^9				C7	7-42
BRANCH PREDICTION RELATIVE PRELOAD	BPRP	MII	EH	α^9				C5	7-42
BRANCH RELATIVE AND SAVE	BRAS	RI-b		α^9			B	A75	7-45
BRANCH RELATIVE AND SAVE LONG	BRASL	RIL-b	N3	α^9			B	C05	7-45
BRANCH RELATIVE ON CONDITION	BRC	RI-c		α^{10}			B	A74	7-46
BRANCH RELATIVE ON CONDITION LONG	BRCL	RIL-c	N3	α^{10}			B	C04	7-46
BRANCH RELATIVE ON COUNT (32)	BRCT	RI-b		α^9			B	A76	7-47
BRANCH RELATIVE ON COUNT (64)	BRCTG	RI-b	N	α^9			B	A77	7-47
BRANCH RELATIVE ON COUNT HIGH (32)	BRCTH	RIL-b	HW	α^9			B	CC6	7-47
BRANCH RELATIVE ON INDEX HIGH (32)	BRXH	RSI		α^9			B	84	7-47
BRANCH RELATIVE ON INDEX HIGH (64)	BRXHG	RIE-e	N	α^9			B	EC44	7-47
BRANCH RELATIVE ON INDEX LOW OR EQ. (32)	BRXLE	RSI		α^9			B	85	7-47
BRANCH RELATIVE ON INDEX LOW OR EQ. (64)	BRXLG	RIE-e	N	α^9			B	EC45	7-48
CANCEL SUBCHANNEL	XSCH	S	C	P		OP ϵ GS		B241	14-3
CHECKSUM	CKSM	RRE	C	α^9	A SP	IC		R ₂ B276	7-49
CIPHER MESSAGE	KM	RRE	C MS	$\alpha^{5,9}$	A SP	IC GM I1	ST	R ₁ R ₂ B92E	7-52
CIPHER MESSAGE WITH AUTHENTICATION	KMA	RRF-b	C M8	$\alpha^{5,9}$	A SP	IC GM I1	ST	R ₁ R ₂ R ₃ B929	7-77
CIPHER MESSAGE WITH CHAINING	KMC	RRE	C MS	$\alpha^{5,9}$	A SP	IC GM I1	ST	R ₁ R ₂ B92F	7-52
CIPHER MESSAGE WITH CIPHER FEEDBACK	KMF	RRE	C M4	$\alpha^{5,9}$	A SP	IC GM I1	ST	R ₁ R ₂ B92A	7-91
CIPHER MESSAGE WITH COUNTER	KMCTR	RRF-b	C M4	$\alpha^{5,9}$	A SP	IC GM I1	ST	R ₁ R ₂ R ₃ B92D	7-106
CIPHER MESSAGE WITH OUTPUT FEEDBACK	KMO	RRE	C M4	$\alpha^{5,9}$	A SP	IC GM I1	ST	R ₁ R ₂ B92B	7-119
CLEAR SUBCHANNEL	CSCH	S	C	P		OP ϵ GS		B230	14-5
COMPARE (32)	C	RX-a	C		A			B ₂ 59	7-133
COMPARE (32)	CR	RR	C					19	7-133
COMPARE (32)	CY	RXY-a	C LD		A			B ₂ E359	7-133
COMPARE (64)	CG	RXY-a	C N		A			B ₂ E320	7-133
COMPARE (64)	CGR	RRE	C N					B920	7-133
COMPARE (64←32)	CGF	RXY-a	C N		A			B ₂ E330	7-133
COMPARE (64←32)	CGFR	RRE	C N					B930	7-133
COMPARE (extended BFP)	CXBR	RRE	C	$\alpha^{7,9}$	SP	Db Xi		B349	19-17
COMPARE (extended DFP)	CXTR	RRE	C TF	$\alpha^{7,9}$	SP	Dt Xi		B3EC	20-22
COMPARE (extended HFP)	CXR	RRE	C	$\alpha^{7,9}$	SP	Da		B369	18-10
COMPARE (long BFP)	CDB	RXE	C	$\alpha^{7,9}$	A	Db Xi		B ₂ ED19	19-17
COMPARE (long BFP)	CDBR	RRE	C	$\alpha^{7,9}$		Db Xi		B319	19-17
COMPARE (long DFP)	CDTR	RRE	C TF	$\alpha^{7,9}$		Dt Xi		B3E4	20-22
COMPARE (long HFP)	CD	RX-a	C	$\alpha^{7,9}$	A	Da		B ₂ 69	18-10
COMPARE (long HFP)	CDR	RR	C	$\alpha^{7,9}$		Da		29	18-10
COMPARE (short BFP)	CEB	RXE	C	$\alpha^{7,9}$	A	Db Xi		B ₂ ED09	19-17
COMPARE (short BFP)	CEBR	RRE	C	$\alpha^{7,9}$		Db Xi		B309	19-17
COMPARE (short HFP)	CE	RX-a	C	$\alpha^{7,9}$	A	Da		B ₂ 79	18-10
COMPARE (short HFP)	CER	RR	C	$\alpha^{7,9}$		Da		39	18-10
COMPARE AND BRANCH (32)	CRB	RRS	GE	α^9			B	ECF6	7-134
COMPARE AND BRANCH (64)	CGRB	RRS	GE	α^9			B	ECE4	7-134
COMPARE AND BRANCH RELATIVE (32)	CRJ	RIE-b	GE	α^{10}			B	EC76	7-134
COMPARE AND BRANCH RELATIVE (64)	CGRJ	RIE-b	GE	α^{10}			B	EC64	7-135
COMPARE AND FORM CODEWORD	CFC	S	C	α^9	A SP	II GM I1		B21A	7-136
COMPARE AND REPLACE DAT TABLE ENTRY	CRDTE	RRF-b	ED2	P	A ¹ SP	\$		B98F	10-17
COMPARE AND SIGNAL (extended BFP)	KXBR	RRE	C	$\alpha^{7,9}$	SP	Db Xi		B348	19-18
COMPARE AND SIGNAL (extended DFP)	KXTR	RRE	C TF	$\alpha^{7,9}$	SP	Dt Xi		B3E8	20-23
COMPARE AND SIGNAL (long BFP)	KDB	RXE	C	$\alpha^{7,9}$	A	Db Xi		B ₂ ED18	19-18
COMPARE AND SIGNAL (long BFP)	KDBR	RRE	C	$\alpha^{7,9}$		Db Xi		B318	19-18
COMPARE AND SIGNAL (long DFP)	KDTR	RRE	C TF	$\alpha^{7,9}$		Dt Xi		B3E0	20-23
COMPARE AND SIGNAL (short BFP)	KEB	RXE	C	$\alpha^{7,9}$	A	Db Xi		B ₂ ED08	19-18
COMPARE AND SIGNAL (short BFP)	KEBR	RRE	C	$\alpha^{7,9}$		Db Xi		B308	19-18

Figure B-1. Instructions Arranged by Name (Part 3 of 24)

Name	Mnemonic	Characteristics							Op-code	Page		
COMPARE AND SWAP (32)	CS	RS-a	C		α^9	A	SP	\$	ST	B ₂	BA	7-143
COMPARE AND SWAP (32)	CSY	RSY-a	C	LD	α^9	A	SP	\$	ST	B ₂	EB14	7-143
COMPARE AND SWAP (64)	CSG	RSY-a	C	N	α^9	A	SP	\$	ST	B ₂	EB30	7-143
COMPARE AND SWAP AND PURGE (32)	CSP	RRE	C		P	A ¹	SP	\$	ST	R ₂	B250	10-21
COMPARE AND SWAP AND PURGE (64)	CSPG	RRE	C	DE	P	A ¹	SP	\$	ST	R ₂	B98A	10-21
COMPARE AND SWAP AND STORE	CSST	SSF	C	CS	α^1	A	SP	\$ GM	ST	B ₁ B ₂	C82	7-145
COMPARE AND TRAP (32)	CRT	RRF-c		GE				Dc			B972	7-148
COMPARE AND TRAP (64)	CGRT	RRF-c		GE				Dc			B960	7-148
COMPARE BIASED EXPONENT (extended DFP)	CEXTR	RRE	C	TF	$\alpha^{7,9}$		SP	Dt			B3FC	20-23
COMPARE BIASED EXPONENT (long DFP)	CEDTR	RRE	C	TF	$\alpha^{7,9}$			Dt			B3F4	20-23
COMPARE DECIMAL	CP	SS-b	C		α^9	A		Dg		B ₁ B ₂	F9	8-7
COMPARE DOUBLE AND SWAP (32)	CDS	RS-a	C		α^9	A	SP	\$	ST	B ₂	BB	7-143
COMPARE DOUBLE AND SWAP (32)	CDSY	RSY-a	C	LD	α^9	A	SP	\$	ST	B ₂	EB31	7-143
COMPARE DOUBLE AND SWAP (64)	CDSG	RSY-a	C	N	α^9	A	SP	\$	ST	B ₂	EB3E	7-143
COMPARE HALFWORD (32←16)	CH	RX-a	C			A				B ₂	49	7-149
COMPARE HALFWORD (32←16)	CHY	RXY-a	C	LD		A				B ₂	E379	7-149
COMPARE HALFWORD (64←16)	CGH	RXY-a	C	GE		A				B ₂	E334	7-149
COMPARE HALFWORD IMMEDIATE (16←16)	CHHSI	SIL	C	GE		A				B ₁	E554	7-149
COMPARE HALFWORD IMMEDIATE (32←16)	CHI	RI-a	C								A7E	7-149
COMPARE HALFWORD IMMEDIATE (32←16)	CHSI	SIL	C	GE		A				B ₁	E55C	7-149
COMPARE HALFWORD IMMEDIATE (64←16)	CGHI	RI-a	C	N							A7F	7-149
COMPARE HALFWORD IMMEDIATE (64←16)	CGHSI	SIL	C	GE		A				B ₁	E558	7-149
COMPARE HALFWORD RELATIVE LONG (32←16)	CHRL	RIL-b	C	GE		A*					C65	7-149
COMPARE HALFWORD RELATIVE LONG (64←16)	CGHRL	RIL-b	C	GE		A*					C64	7-149
COMPARE HIGH (32)	CHF	RXY-a	C	HW		A				B ₂	E3CD	7-150
COMPARE HIGH (32)	CHHR	RRE	C	HW							B9CD	7-150
COMPARE HIGH (32)	CHLR	RRE	C	HW							B9DD	7-150
COMPARE IMMEDIATE (32)	CFI	RIL-a	C	EI							C2D	7-133
COMPARE IMMEDIATE (64←32)	CGFI	RIL-a	C	EI							C2C	7-134
COMPARE IMMEDIATE AND BRANCH (32←8)	CIB	RIS		GE	α^9				B		ECFE	7-135
COMPARE IMMEDIATE AND BRANCH (64←8)	CGIB	RIS		GE	α^9				B		ECFC	7-135
COMPARE IMMEDIATE AND BRANCH RELATIVE (32←8)	CIJ	RIE-c		GE	α^{10}				B		EC7E	7-135
COMPARE IMMEDIATE AND BRANCH RELATIVE (64←8)	CGIJ	RIE-c		GE	α^{10}				B		EC7C	7-135
COMPARE IMMEDIATE AND TRAP (32←16)	CIT	RIE-a		GE				Dc			EC72	7-148
COMPARE IMMEDIATE AND TRAP (64←16)	CGIT	RIE-a		GE				Dc			EC70	7-148
COMPARE IMMEDIATE HIGH (32)	CIH	RIL-a	C	HW							CCD	7-150
COMPARE LOGICAL (32)	CL	RX-a	C			A				B ₂	55	7-151
COMPARE LOGICAL (32)	CLR	RR	C								15	7-151
COMPARE LOGICAL (32)	CLY	RXY-a	C	LD		A				B ₂	E355	7-151
COMPARE LOGICAL (64)	CLG	RXY-a	C	N		A				B ₂	E321	7-151
COMPARE LOGICAL (64)	CLGR	RRE	C	N							B921	7-151
COMPARE LOGICAL (64←32)	CLGF	RXY-a	C	N		A				B ₂	E331	7-151
COMPARE LOGICAL (64←32)	CLGFR	RRE	C	N							B931	7-151
COMPARE LOGICAL (character)	CLC	SS-a	C		α^9	A				B ₁ B ₂	D5	7-151
COMPARE LOGICAL (immediate)	CLI	SI	C			A				B ₁	95	7-151
COMPARE LOGICAL (immediate)	CLiy	SIY	C	LD		A				B ₁	EB55	7-151
COMPARE LOGICAL AND BRANCH (32)	CLRB	RRS		GE	α^9				B		ECF7	7-153
COMPARE LOGICAL AND BRANCH (64)	CLGRB	RRS		GE	α^9				B		ECE5	7-153
COMPARE LOGICAL AND BRANCH RELATIVE (32)	CLRJ	RIE-b		GE	α^{10}				B		EC77	7-153
COMPARE LOGICAL AND BRANCH RELATIVE (64)	CLGRJ	RIE-b		GE	α^{10}				B		EC65	7-153
COMPARE LOGICAL AND TRAP (32)	CLRT	RRF-c		GE				Dc			B973	7-154
COMPARE LOGICAL AND TRAP (32)	CLT	RSY-b		MI1		A		Dc		B ₂	EB23	7-154

Figure B-1. Instructions Arranged by Name (Part 4 of 24)

Name	Mnemonic	Characteristics						Op-code	Page	
COMPARE LOGICAL AND TRAP (64)	CLGRT	RRF-c	GE			Dc		B961	7-154	
COMPARE LOGICAL AND TRAP (64)	CLGT	RSY-b	MI1	A		Dc	B ₂	EB2B	7-154	
COMPARE LOGICAL CHAR. UNDER MASK (high)	CLMH	RSY-b	C N	A			B ₂	EB20	7-156	
COMPARE LOGICAL CHAR. UNDER MASK (low)	CLM	RS-b	C	A			B ₂	BD	7-156	
COMPARE LOGICAL CHAR. UNDER MASK (low)	CLMY	RSY-b	C LD	A			B ₂	EB21	7-156	
COMPARE LOGICAL HIGH (32)	CLHF	RXY-a	C HW	A			B ₂	E3CF	7-156	
COMPARE LOGICAL HIGH (32)	CLHHR	RRE	C HW					B9CF	7-156	
COMPARE LOGICAL HIGH (32)	CLHLR	RRE	C HW					B9DF	7-156	
COMPARE LOGICAL IMMEDIATE (16←16)	CLHHSI	SIL	C GE	A			B ₁	E555	7-151	
COMPARE LOGICAL IMMEDIATE (32)	CLFI	RIL-a	C EI					C2F	7-151	
COMPARE LOGICAL IMMEDIATE (32←16)	CLFHSI	SIL	C GE	A			B ₁	E55D	7-151	
COMPARE LOGICAL IMMEDIATE (64←16)	CLGHSI	SIL	C GE	A			B ₁	E559	7-151	
COMPARE LOGICAL IMMEDIATE (64←32)	CLGFI	RIL-a	C EI					C2E	7-151	
COMPARE LOGICAL IMMEDIATE AND BRANCH (32←8)	CLIB	RIS	GE	α^9			B	ECFF	7-153	
COMPARE LOGICAL IMMEDIATE AND BRANCH (64←8)	CLGIB	RIS	GE	α^9			B	ECFD	7-153	
COMPARE LOGICAL IMMEDIATE AND BRANCH RELATIVE (32←8)	CLIJ	RIE-c	GE	α^{10}			B	EC7F	7-153	
COMPARE LOGICAL IMMEDIATE AND BRANCH RELATIVE (64←8)	CLGIJ	RIE-c	GE	α^{10}			B	EC7D	7-153	
COMPARE LOGICAL IMMEDIATE AND TRAP (32←16)	CLFIT	RIE-a	GE			Dc		EC73	7-155	
COMPARE LOGICAL IMMEDIATE AND TRAP (64←16)	CLGIT	RIE-a	GE			Dc		EC71	7-155	
COMPARE LOGICAL IMMEDIATE HIGH (32)	CLIH	RIL-a	C HW					CCF	7-157	
COMPARE LOGICAL LONG	CLCL	RR	C	α^9	A SP	II	R ₁ R ₂	0F	7-157	
COMPARE LOGICAL LONG EXTENDED	CLCLE	RS-a	C	α^9	A SP	IC	R ₁ R ₃	A9	7-159	
COMPARE LOGICAL LONG UNICODE	CLCLU	RSY-a	C E2	α^9	A SP	IC	R ₁ R ₂	EB8F	7-162	
COMPARE LOGICAL RELATIVE LONG (32)	CLRL	RIL-b	C GE		A* SP			C6F	7-152	
COMPARE LOGICAL RELATIVE LONG (32←16)	CLHRL	RIL-b	C GE		A* SP			C67	7-152	
COMPARE LOGICAL RELATIVE LONG (64)	CLGRL	RIL-b	C GE		A* SP			C6A	7-152	
COMPARE LOGICAL RELATIVE LONG (64←16)	CLGHRL	RIL-b	C GE		A* SP			C66	7-152	
COMPARE LOGICAL RELATIVE LONG (64←32)	CLGFRL	RIL-b	C GE		A* SP			C6E	7-152	
COMPARE LOGICAL STRING	CLST	RRE	C	α^9	A SP	IC	G0	R ₁ R ₂	B25D	7-165
COMPARE RELATIVE LONG (32)	CRL	RIL-b	C GE		A* SP			C6D	7-134	
COMPARE RELATIVE LONG (64)	CGRL	RIL-b	C GE		A* SP			C68	7-134	
COMPARE RELATIVE LONG (64←32)	CGFRL	RIL-b	C GE		A* SP			C6C	7-134	
COMPARE UNTIL SUBSTRING EQUAL	CUSE	RRE	C	α^9	A SP	II	GM	R ₁ R ₂	B257	7-166
COMPRESSION CALL	CMPSC	RRE	C	$\alpha^{5,9}$	A SP	II	Dg GM	ST R ₁ R ₂	B263	7-169
COMPUTE DIGITAL SIGNATURE AUTHENTICATION	KDSA	RRE	C M9	$\alpha^{5,9}$	A SP	IC	GM I1	ST R ₂	B93A	26-2
COMPUTE INTERMEDIATE MESSAGE DIGEST	KIMD	RRE	C MS	$\alpha^{5,9}$	A SP	IC	GM I1	ST R ₂	B93E	7-187
COMPUTE LAST MESSAGE DIGEST	KLMD	RRE	C MS	$\alpha^{5,9}$	A SP	IC	GM I1	ST R ₂	B93F	7-200
COMPUTE MESSAGE AUTHENTICATION CODE	KMAC	RRE	C MS	$\alpha^{5,9}$	A SP	IC	GM I1	ST R ₂	B91E	7-218
CONVERT BFP TO HFP (long)	THDR	RRE	C	$\alpha^{7,9}$		Da			B359	9-27
CONVERT BFP TO HFP (short to long)	THDER	RRE	C	$\alpha^{7,9}$		Da			B358	9-27
CONVERT FROM FIXED (32 to extended BFP)	CXFBR	RRE		$\alpha^{7,9}$	SP	Db			B396	19-19
CONVERT FROM FIXED (32 to extended BFP)	CXFBRA	RRF-e	F	$\alpha^{7,9}$	SP	Db			B396	19-19
CONVERT FROM FIXED (32 to extended DFP)	CXFTR	RRE	F	$\alpha^{7,9}$	SP	Dt			B959	20-24
CONVERT FROM FIXED (32 to extended HFP)	CXFR	RRE		$\alpha^{7,9}$	SP	Da			B3B6	18-11
CONVERT FROM FIXED (32 to long BFP)	CDFBR	RRE		$\alpha^{7,9}$		Db			B395	19-19
CONVERT FROM FIXED (32 to long BFP)	CDFBRA	RRF-e	F	$\alpha^{7,9}$	SP	Db			B395	19-19
CONVERT FROM FIXED (32 to long DFP)	CDFTR	RRE	F	$\alpha^{7,9}$		Dt			B951	20-24
CONVERT FROM FIXED (32 to long HFP)	CDFR	RRE		$\alpha^{7,9}$		Da			B3B5	18-11
CONVERT FROM FIXED (32 to short BFP)	CEFBR	RRE		$\alpha^{7,9}$		Db	Xx		B394	19-19

Figure B-1. Instructions Arranged by Name (Part 5 of 24)

Name	Mnemonic	Characteristics							Op-code	Page	
CONVERT FROM FIXED (32 to short BFP)	CEFBRA	RRF-e	F	$\alpha^{7,9}$	SP	Db	Xx		B394	19-19	
CONVERT FROM FIXED (32 to short HFP)	CEFR	RRE		$\alpha^{7,9}$		Da			B3B4	18-11	
CONVERT FROM FIXED (64 to extended BFP)	CXGBR	RRE	N	$\alpha^{7,9}$	SP	Db			B3A6	19-19	
CONVERT FROM FIXED (64 to extended BFP)	CXGBRA	RRF-e	F	$\alpha^{7,9}$	SP	Db			B3A6	19-19	
CONVERT FROM FIXED (64 to extended DFP)	CXGTR	RRE	TF	$\alpha^{7,9}$	SP	Dt			B3F9	20-24	
CONVERT FROM FIXED (64 to extended DFP)	CXGTRA	RRF-e	F	$\alpha^{7,9}$	SP	Dt			B3F9	20-24	
CONVERT FROM FIXED (64 to extended HFP)	CXGR	RRE	N	$\alpha^{7,9}$	SP	Da			B3C6	18-11	
CONVERT FROM FIXED (64 to long BFP)	CDGBR	RRE	N	$\alpha^{7,9}$		Db	Xx		B3A5	19-19	
CONVERT FROM FIXED (64 to long BFP)	CDGBRA	RRF-e	F	$\alpha^{7,9}$	SP	Db	Xx		B3A5	19-19	
CONVERT FROM FIXED (64 to long DFP)	CDGTR	RRE	TF	$\alpha^{7,9}$		Dt	Xx		B3F1	20-24	
CONVERT FROM FIXED (64 to long DFP)	CDGTRA	RRF-e	F	$\alpha^{7,9}$		Dt	Xx Xq		B3F1	20-24	
CONVERT FROM FIXED (64 to long HFP)	CDGR	RRE	N	$\alpha^{7,9}$		Da			B3C5	18-11	
CONVERT FROM FIXED (64 to short BFP)	CEGBR	RRE	N	$\alpha^{7,9}$		Db	Xx		B3A4	19-19	
CONVERT FROM FIXED (64 to short BFP)	CEGBRA	RRF-e	F	$\alpha^{7,9}$	SP	Db	Xx		B3A4	19-19	
CONVERT FROM FIXED (64 to short HFP)	CEGR	RRE	N	$\alpha^{7,9}$		Da			B3C4	18-11	
CONVERT FROM LOGICAL (32 to extended BFP)	CXLFBR	RRF-e	F	$\alpha^{7,9}$	SP	Db			B392	19-21	
CONVERT FROM LOGICAL (32 to extended DFP)	CXLFTR	RRF-e	F	$\alpha^{7,9}$	SP	Dt			B95B	20-25	
CONVERT FROM LOGICAL (32 to long BFP)	CDLFBR	RRF-e	F	$\alpha^{7,9}$	SP	Db			B391	19-21	
CONVERT FROM LOGICAL (32 to long DFP)	CDLFTR	RRF-e	F	$\alpha^{7,9}$		Dt			B953	20-25	
CONVERT FROM LOGICAL (32 to short BFP)	CELFBR	RRF-e	F	$\alpha^{7,9}$	SP	Db	Xx		B390	19-21	
CONVERT FROM LOGICAL (64 to extended BFP)	CXLGBR	RRF-e	F	$\alpha^{7,9}$	SP	Db			B3A2	19-21	
CONVERT FROM LOGICAL (64 to extended DFP)	CXLGTR	RRF-e	F	$\alpha^{7,9}$	SP	Dt			B95A	20-25	
CONVERT FROM LOGICAL (64 to long BFP)	CDLGBR	RRF-e	F	$\alpha^{7,9}$	SP	Db	Xx		B3A1	19-21	
CONVERT FROM LOGICAL (64 to long DFP)	CDLGTR	RRF-e	F	$\alpha^{7,9}$		Dt	Xx Xq		B952	20-25	
CONVERT FROM LOGICAL (64 to short BFP)	CELGBR	RRF-e	F	$\alpha^{7,9}$	SP	Db	Xx		B3A0	19-21	
CONVERT FROM PACKED (to extended DFP)	CXPT	RSL-b	PC	$\alpha^{7,9}$	A SP	Dt Dg		B ₂	EDAF	20-26	
CONVERT FROM PACKED (to long DFP)	CDPT	RSL-b	PC	$\alpha^{7,9}$	A SP	Dt Dg		B ₂	EDAE	20-26	
CONVERT FROM SIGNED PACKED (128 to extended DFP)	CXSTR	RRE	TF	$\alpha^{7,9}$	SP	Dt Dg			B3FB	20-28	
CONVERT FROM SIGNED PACKED (64 to long DFP)	CDSTR	RRE	TF	$\alpha^{7,9}$		Dt Dg			B3F3	20-28	
CONVERT FROM UNSIGNED PACKED (128 to ext. DFP)	CXUTR	RRE	TF	$\alpha^{7,9}$	SP	Dt Dg			B3FA	20-28	
CONVERT FROM UNSIGNED PACKED (64 to long DFP)	CDUTR	RRE	TF	$\alpha^{7,9}$		Dt Dg			B3F2	20-28	
CONVERT FROM ZONED (to extended DFP)	CXZT	RSL-b	ZF	$\alpha^{7,9}$	A SP	Dt Dg		B ₂	EDAB	20-29	
CONVERT FROM ZONED (to long DFP)	CDZT	RSL-b	ZF	$\alpha^{7,9}$	A SP	Dt Dg		B ₂	EDAA	20-29	
CONVERT HFP TO BFP (long to short)	TBEDR	RRF-e	C	$\alpha^{7,9}$	SP	Da			B350	9-28	
CONVERT HFP TO BFP (long)	TBDR	RRF-e	C	$\alpha^{7,9}$	SP	Da			B351	9-28	
CONVERT TO BINARY (32)	CVB	RX-a		α^9	A	Dg IK		B ₂	4F	7-229	
CONVERT TO BINARY (32)	CVBY	RXY-a	LD	α^9	A	Dg IK		B ₂	E306	7-229	
CONVERT TO BINARY (64)	CVBG	RXY-a	N	α^9	A	Dg IK		B ₂	E30E	7-229	
CONVERT TO DECIMAL (32)	CVD	RX-a		α^9	A			ST	B ₂	4E	7-230
CONVERT TO DECIMAL (32)	CVDY	RXY-a	LD	α^9	A			ST	B ₂	E326	7-230
CONVERT TO DECIMAL (64)	CVDG	RXY-a	N	α^9	A			ST	B ₂	E32E	7-230
CONVERT TO FIXED (extended BFP to 32)	CFXBR	RRF-e	C	$\alpha^{7,9}$	SP	Db Xi	Xx		B39A	19-22	
CONVERT TO FIXED (extended BFP to 32)	CFXBRA	RRF-e	C F	$\alpha^{7,9}$	SP	Db Xi	Xx		B39A	19-22	
CONVERT TO FIXED (extended BFP to 64)	CGXBR	RRF-e	C N	$\alpha^{7,9}$	SP	Db Xi	Xx		B3AA	19-22	
CONVERT TO FIXED (extended BFP to 64)	CGXBRA	RRF-e	C F	$\alpha^{7,9}$	SP	Db Xi	Xx		B3AA	19-22	
CONVERT TO FIXED (extended DFP to 32)	CFXTR	RRF-e	C F	$\alpha^{7,9}$	SP	Dt Xi	Xx		B949	20-30	
CONVERT TO FIXED (extended DFP to 64)	CGXTR	RRF-e	C TF	$\alpha^{7,9}$	SP	Dt Xi	Xx		B3E9	20-29	
CONVERT TO FIXED (extended DFP to 64)	CGXTRA	RRF-e	C F	$\alpha^{7,9}$	SP	Dt Xi	Xx		B3E9	20-30	
CONVERT TO FIXED (extended HFP to 32)	CFXR	RRF-e	C	$\alpha^{7,9}$	SP	Da			B3BA	18-11	
CONVERT TO FIXED (extended HFP to 64)	CGXR	RRF-e	C N	$\alpha^{7,9}$	SP	Da			B3CA	18-11	
CONVERT TO FIXED (long BFP to 32)	CFDBR	RRF-e	C	$\alpha^{7,9}$	SP	Db Xi	Xx		B399	19-22	
CONVERT TO FIXED (long BFP to 32)	CFDBRA	RRF-e	C F	$\alpha^{7,9}$	SP	Db Xi	Xx		B399	19-22	

Figure B-1. Instructions Arranged by Name (Part 6 of 24)

Name	Mnemonic	Characteristics								Op-code	Page		
CONVERT TO FIXED (long BFP to 64)	CGDBR	RRF-e	C	N	$\alpha^{7,9}$	SP	Db	Xi	Xx			B3A9	19-22
CONVERT TO FIXED (long BFP to 64)	CGDBRA	RRF-e	C	F	$\alpha^{7,9}$	SP	Db	Xi	Xx			B3A9	19-22
CONVERT TO FIXED (long DFP to 32)	CFDTR	RRF-e	C	F	$\alpha^{7,9}$		Dt	Xi	Xx			B941	20-30
CONVERT TO FIXED (long DFP to 64)	CGDTR	RRF-e	C	TF	$\alpha^{7,9}$		Dt	Xi	Xx			B3E1	20-29
CONVERT TO FIXED (long DFP to 64)	CGDTRA	RRF-e	C	F	$\alpha^{7,9}$		Dt	Xi	Xx			B3E1	20-30
CONVERT TO FIXED (long HFP to 32)	CFDR	RRF-e	C		$\alpha^{7,9}$	SP	Da					B3B9	18-11
CONVERT TO FIXED (long HFP to 64)	CGDR	RRF-e	C	N	$\alpha^{7,9}$	SP	Da					B3C9	18-11
CONVERT TO FIXED (short BFP to 32)	CFEBR	RRF-e	C		$\alpha^{7,9}$	SP	Db	Xi	Xx			B398	19-22
CONVERT TO FIXED (short BFP to 32)	CFEBRA	RRF-e	C	F	$\alpha^{7,9}$	SP	Db	Xi	Xx			B398	19-22
CONVERT TO FIXED (short BFP to 64)	CGEBR	RRF-e	C	N	$\alpha^{7,9}$	SP	Db	Xi	Xx			B3A8	19-22
CONVERT TO FIXED (short BFP to 64)	CGEBRA	RRF-e	C	F	$\alpha^{7,9}$	SP	Db	Xi	Xx			B3A8	19-22
CONVERT TO FIXED (short HFP to 32)	CFER	RRF-e	C		$\alpha^{7,9}$	SP	Da					B3B8	18-11
CONVERT TO FIXED (short HFP to 64)	CGER	RRF-e	C	N	$\alpha^{7,9}$	SP	Da					B3C8	18-11
CONVERT TO LOGICAL (extended BFP to 32)	CLFXBR	RRF-e	C	F	$\alpha^{7,9}$	SP	Db	Xi	Xx			B39E	19-25
CONVERT TO LOGICAL (extended BFP to 64)	CLGXBR	RRF-e	C	F	$\alpha^{7,9}$	SP	Db	Xi	Xx			B3AE	19-25
CONVERT TO LOGICAL (extended DFP to 32)	CLFXTR	RRF-e	C	F	$\alpha^{7,9}$	SP	Dt	Xi	Xx			B94B	20-32
CONVERT TO LOGICAL (extended DFP to 64)	CLGXTR	RRF-e	C	F	$\alpha^{7,9}$	SP	Dt	Xi	Xx			B94A	20-32
CONVERT TO LOGICAL (long BFP to 32)	CLFDBR	RRF-e	C	F	$\alpha^{7,9}$	SP	Db	Xi	Xx			B39D	19-25
CONVERT TO LOGICAL (long BFP to 64)	CLGDBR	RRF-e	C	F	$\alpha^{7,9}$	SP	Db	Xi	Xx			B3AD	19-25
CONVERT TO LOGICAL (long DFP to 32)	CLFDTR	RRF-e	C	F	$\alpha^{7,9}$		Dt	Xi	Xx			B943	20-32
CONVERT TO LOGICAL (long DFP to 64)	CLGDTR	RRF-e	C	F	$\alpha^{7,9}$		Dt	Xi	Xx			B942	20-32
CONVERT TO LOGICAL (short BFP to 32)	CLFEBR	RRF-e	C	F	$\alpha^{7,9}$	SP	Db	Xi	Xx			B39C	19-25
CONVERT TO LOGICAL (short BFP to 64)	CLGEBR	RRF-e	C	F	$\alpha^{7,9}$	SP	Db	Xi	Xx			B3AC	19-25
CONVERT TO PACKED (from extended DFP)	CPXT	RSL-b	C	PC	$\alpha^{7,9}$	A SP	Dt	DF		ST	B ₂	EDAD	20-33
CONVERT TO PACKED (from long DFP)	CPDT	RSL-b	C	PC	$\alpha^{7,9}$	A SP	Dt	DF		ST	B ₂	EDAC	20-33
CONVERT TO SIGNED PACKED (extended DFP to 128)	CSXTR	RRF-d		TF	$\alpha^{7,9}$	SP	Dt					B3EB	20-35
CONVERT TO SIGNED PACKED (long DFP to 64)	CSDTR	RRF-d		TF	$\alpha^{7,9}$		Dt					B3E3	20-35
CONVERT TO UNSIGNED PACKED (extended DFP to 128)	CUXTR	RRE		TF	$\alpha^{7,9}$	SP	Dt					B3EA	20-35
CONVERT TO UNSIGNED PACKED (long DFP to 64)	CUDTR	RRE		TF	$\alpha^{7,9}$		Dt					B3E2	20-35
CONVERT TO ZONED (from extended DFP)	CZXT	RSL-b	C	ZF	$\alpha^{7,9}$	A SP				ST	B ₂	EDA9	20-36
CONVERT TO ZONED (from long DFP)	CZDT	RSL-b	C	ZF	$\alpha^{7,9}$	A SP				ST	B ₂	EDA8	20-36
CONVERT UNICODE TO UTF-8	CUUTF	RRF-c	C		$\alpha^{5,9}$	A SP	IC			ST	R ₁ R ₂	B2A6	7-233
CONVERT UTF-16 TO UTF-32	CU24	RRF-c	C	E3	$\alpha^{5,9}$	A SP	IC			ST	R ₁ R ₂	B9B1	7-230
CONVERT UTF-16 TO UTF-8	CU21	RRF-c	C		$\alpha^{5,9}$	A SP	IC			ST	R ₁ R ₂	B2A6	7-233
CONVERT UTF-8 TO UNICODE	CUTFU	RRF-c	C		$\alpha^{5,9}$	A SP	IC			ST	R ₁ R ₂	B2A7	7-243
CONVERT UTF-8 TO UTF-16	CU12	RRF-c	C		$\alpha^{5,9}$	A SP	IC			ST	R ₁ R ₂	B2A7	7-243
CONVERT UTF-8 TO UTF-32	CU14	RRF-c	C	E3	$\alpha^{5,9}$	A SP	IC			ST	R ₁ R ₂	B9B0	7-247
CONVERT UTF-32 TO UTF-16	CU42	RRE	C	E3	$\alpha^{5,9}$	A SP	IC			ST	R ₁ R ₂	B9B3	7-237
CONVERT UTF-32 TO UTF-8	CU41	RRE	C	E3	$\alpha^{5,9}$	A SP	IC			ST	R ₁ R ₂	B9B2	7-240
COPY ACCESS	CPYA	RRE			α^6						U ₁ U ₂	B24D	7-251
COPY SIGN (long)	CPSDR	RRF-b		FS	$\alpha^{7,9}$		Da					B372	9-30
DEFLATE CONVERSION CALL	DFLTCC	RRF-a	C	GZ	$\alpha^{5,9}$	A SP	IC		GM I1	ST	R ₁ R ₂ R ₃	B939	26-16
DIAGNOSE	—			DM	P	DM					MD	83	10-23
DIVIDE (32←64)	D	RX-a			α^9	A SP			IK		B ₂	5D	7-251
DIVIDE (32←64)	DR	RR			α^9	SP			IK			1D	7-251
DIVIDE (extended BFP)	DXBR	RRE			$\alpha^{7,9}$	SP	Db	Xi	Xz Xo Xu Xx			B34D	19-27
DIVIDE (extended DFP)	DXTR	RRF-a		TF	$\alpha^{7,9}$	SP	Dt	Xi	Xz Xo Xu Xx			B3D9	20-37
DIVIDE (extended DFP)	DXTRA	RRF-a		F	$\alpha^{7,9}$	SP	Dt	Xi	Xz Xo Xu Xx Xq			B3D9	20-37
DIVIDE (extended HFP)	DXR	RRE			$\alpha^{7,9}$	SP	Da	EU	EO FK			B22D	18-12
DIVIDE (long BFP)	DDB	RXE			$\alpha^{7,9}$	A	Db	Xi	Xz Xo Xu Xx		B ₂	ED1D	19-27
DIVIDE (long BFP)	DDBR	RRE			$\alpha^{7,9}$		Db	Xi	Xz Xo Xu Xx			B31D	19-27
DIVIDE (long DFP)	DDTR	RRF-a		TF	$\alpha^{7,9}$		Dt	Xi	Xz Xo Xu Xx			B3D1	20-37

Figure B-1. Instructions Arranged by Name (Part 7 of 24)

Name	Mnemonic	Characteristics							Op-code	Page		
DIVIDE (long DFP)	DDTRA	RRF-a	F	$\alpha^{7,9}$					B ₂	B3D1	20-37	
DIVIDE (long HFP)	DD	RX-a		$\alpha^{7,9}$	A					6D	18-12	
DIVIDE (long HFP)	DDR	RR		$\alpha^{7,9}$						2D	18-12	
DIVIDE (short BFP)	DEB	RXE		$\alpha^{7,9}$	A					B ₂	ED0D	19-27
DIVIDE (short BFP)	DEBR	RRE		$\alpha^{7,9}$							B30D	19-27
DIVIDE (short HFP)	DE	RX-a		$\alpha^{7,9}$	A					B ₂	7D	18-12
DIVIDE (short HFP)	DER	RR		$\alpha^{7,9}$							3D	18-12
DIVIDE DECIMAL	DP	SS-b		α^9	A	SP			ST	B ₁ B ₂	FD	8-7
DIVIDE LOGICAL (32←64)	DL	RXY-a	N3	α^9	A	SP		IK		B ₂	E397	7-252
DIVIDE LOGICAL (32←64)	DLR	RRE	N3	α^9		SP		IK			B997	7-252
DIVIDE LOGICAL (64←128)	DLG	RXY-a	N	α^9	A	SP		IK		B ₂	E387	7-252
DIVIDE LOGICAL (64←128)	DLGR	RRE	N	α^9		SP		IK			B987	7-252
DIVIDE SINGLE (64)	DSG	RXY-a	N	α^9	A	SP		IK		B ₂	E30D	7-253
DIVIDE SINGLE (64)	DSGR	RRE	N	α^9		SP		IK			B90D	7-253
DIVIDE SINGLE (64←32)	DSGF	RXY-a	N	α^9	A	SP		IK		B ₂	E31D	7-253
DIVIDE SINGLE (64←32)	DSGFR	RRE	N	α^9		SP		IK			B91D	7-253
DIVIDE TO INTEGER (long BFP)	DIDBR	RRF-b	C	$\alpha^{7,9}$		SP	Db Xi	Xu Xx			B35B	19-28
DIVIDE TO INTEGER (short BFP)	DIEBR	RRF-b	C	$\alpha^{7,9}$		SP	Db Xi	Xu Xx			B353	19-28
EDIT	ED	SS-a	C	α^9	A		Dg		ST	B ₁ B ₂	DE	8-8
EDIT AND MARK	EDMK	SS-a	C	α^9	A		Dg	G1	ST	B ₁ B ₂	DF	8-11
EXCLUSIVE OR (32)	X	RX-a	C		A					B ₂	57	7-253
EXCLUSIVE OR (32)	XR	RR	C								17	7-253
EXCLUSIVE OR (32)	XRK	RRF-a	C DO								B9F7	7-253
EXCLUSIVE OR (32)	XY	RXY-a	C LD		A					B ₂	E357	7-253
EXCLUSIVE OR (64)	XG	RXY-a	C N		A					B ₂	E382	7-253
EXCLUSIVE OR (64)	XGR	RRE	C N								B982	7-253
EXCLUSIVE OR (64)	XGRK	RRF-a	C DO								B9E7	7-253
EXCLUSIVE OR (character)	XC	SS-a	C	α^9	A				ST	B ₁ B ₂	D7	7-254
EXCLUSIVE OR (immediate)	XI	SI	C		A				ST	B ₁	97	7-254
EXCLUSIVE OR (immediate)	XIY	SIY	C LD		A				ST	B ₁	EB57	7-254
EXCLUSIVE OR IMMEDIATE (high)	XIHF	RIL-a	C EI								C06	7-255
EXCLUSIVE OR IMMEDIATE (low)	XILF	RIL-a	C EI								C07	7-255
EXECUTE	EX	RX-a		α^9	AI	SP		EX			44	7-255
EXECUTE RELATIVE LONG	EXRL	RIL-b	XX	α^9	AI*			EX			C60	7-255
EXTRACT ACCESS	EAR	RRE								U ₂	B24F	7-256
EXTRACT AND SET EXTENDED AUTHORITY	ESEA	RRE	N	P							B99D	10-24
EXTRACT BIASED EXPONENT (extended DFP to 64)	EEXTR	RRE	TF	$\alpha^{7,9}$		SP	Dt				B3ED	20-39
EXTRACT BIASED EXPONENT (long DFP to 64)	EEDTR	RRE	TF	$\alpha^{7,9}$			Dt				B3E5	20-39
EXTRACT CPU ATTRIBUTE	ECAG	RSY-a	GE	α^9					R ₃	B ₁ B ₂	EB4C	7-256
EXTRACT CPU TIME	ECTG	SSF	ET	$\alpha^{8,9}$	A			GM			C81	7-259
EXTRACT FPC	EFPC	RRE		$\alpha^{7,9}$			Db				B38C	9-30
EXTRACT PRIMARY ASN	EPAR	RRE		Q			SO				B226	10-24
EXTRACT PRIMARY ASN AND INSTANCE	EPAIR	RRE	RA	Q			SO				B99A	10-24
EXTRACT PSW	EPSW	RRE	N3	$\alpha^{8,9}$							B98D	7-260
EXTRACT SECONDARY ASN	ESAR	RRE		Q			SO				B227	10-24
EXTRACT SECONDARY ASN AND INSTANCE	ESAIR	RRE	RA	Q			SO				B99B	10-25
EXTRACT SIGNIFICANCE (extended DFP to 64)	ESXTR	RRE	TF	$\alpha^{7,9}$		SP	Dt				B3EF	20-39
EXTRACT SIGNIFICANCE (long DFP to 64)	ESDTR	RRE	TF	$\alpha^{7,9}$			Dt				B3E7	20-39
EXTRACT STACKED REGISTERS (32)	EREG	RRE		α^1	A ^{1*}		SE			U ₁ U ₂	B249	10-25
EXTRACT STACKED REGISTERS (64)	EREGG	RRE	N	α^1	A ^{1*}		SE			U ₁ U ₂	B90E	10-25
EXTRACT STACKED STATE	ESTA	RRE	C	α^1	A ^{1*}	SP	SE				B24A	10-26
EXTRACT TRANSACTION NESTING DEPTH	ETND	RRE	TX	α^9			SO				B2EC	7-260
FIND LEFTMOST ONE	FLOGR	RRE	C EI			SP					B983	7-261
HALT SUBCHANNEL	HSCH	S	C	P			OP	¢ GS			B231	14-6

Figure B-1. Instructions Arranged by Name (Part 8 of 24)

Name	Mnemonic	Characteristics						Op-code	Page
HALVE (long HFP)	HDR	RR			$\alpha^{7,9}$	Da EU	24	18-13	
HALVE (short HFP)	HER	RR			$\alpha^{7,9}$	Da EU	34	18-13	
INSERT ADDRESS SPACE CONTROL	IAC	RRE	C		Q	SO	B224	10-29	
INSERT BIASED EXPONENT (64 to extended DFP)	IEXTR	RRF-b	TF		$\alpha^{7,9}$	SP Dt	B3FE	20-40	
INSERT BIASED EXPONENT (64 to long DFP)	IEDTR	RRF-b	TF		$\alpha^{7,9}$	Dt	B3F6	20-40	
INSERT CHARACTER	IC	RX-a			A		B ₂	43 7-261	
INSERT CHARACTER	ICY	RXY-a	LD		A		B ₂	E373 7-261	
INSERT CHARACTERS UNDER MASK (high)	ICMH	RSY-b	C N		A		B ₂	EB80 7-261	
INSERT CHARACTERS UNDER MASK (low)	ICM	RS-b	C		A		B ₂	BF 7-261	
INSERT CHARACTERS UNDER MASK (low)	ICMY	RSY-b	C LD		A		B ₂	EB81 7-261	
INSERT IMMEDIATE (high high)	IHH	Rl-a	N				A50	7-262	
INSERT IMMEDIATE (high low)	IHL	Rl-a	N				A51	7-262	
INSERT IMMEDIATE (high)	IHF	RIL-a	EI				C08	7-262	
INSERT IMMEDIATE (low high)	IILH	Rl-a	N				A52	7-262	
INSERT IMMEDIATE (low low)	IILL	Rl-a	N				A53	7-262	
INSERT IMMEDIATE (low)	IILF	RIL-a	EI				C09	7-262	
INSERT PROGRAM MASK	IPM	RRE					B222	7-263	
INSERT PSW KEY	IPK	S			Q	G2	B20B	10-30	
INSERT REFERENCE BITS MULTIPLE	IRBM	RRE	IM		P A ^{1*}		B9AC	10-30	
INSERT STORAGE KEY EXTENDED	ISKE	RRE			P A ^{1*}		B229	10-30	
INSERT VIRTUAL STORAGE KEY	IVSK	RRE			Q A ^{1*}	SO	R ₂	B223 10-31	
INVALIDATE DAT TABLE ENTRY	IDTE	RRF-b	U DE		P A ¹	SP \$	B98E	10-32	
INVALIDATE PAGE TABLE ENTRY	IPTE	RRF-a			P A ¹	SP \$	B221	10-37	
LOAD (32)	L	RX-a			A		B ₂	58 7-263	
LOAD (32)	LR	RR					18	7-263	
LOAD (32)	LY	RXY-a	LD		A		B ₂	E358 7-263	
LOAD (64)	LG	RXY-a	N		A		B ₂	E304 7-263	
LOAD (64)	LGR	RRE	N				B904	7-263	
LOAD (64←32)	LGF	RXY-a	N		A		B ₂	E314 7-263	
LOAD (64←32)	LGFR	RRE	N				B914	7-263	
LOAD (extended)	LXR	RRE			$\alpha^{7,9}$	SP Da	B365	9-31	
LOAD (long)	LD	RX-a			$\alpha^{7,9}$	A Da	B ₂	68 9-31	
LOAD (long)	LDR	RR			$\alpha^{7,9}$	Da	28	9-31	
LOAD (long)	LDY	RXY-a	LD		$\alpha^{7,9}$	A Da	B ₂	ED65 9-31	
LOAD (short)	LE	RX-a			$\alpha^{7,9}$	A Da	B ₂	78 9-31	
LOAD (short)	LER	RR			$\alpha^{7,9}$	Da	38	9-31	
LOAD (short)	LEY	RXY-a	LD		$\alpha^{7,9}$	A Da	B ₂	ED64 9-31	
LOAD ACCESS MULTIPLE	LAM	RS-a			α^6	A SP	UB	9A 7-264	
LOAD ACCESS MULTIPLE	LAMY	RSY-a	LD		α^6	A SP	UB	EB9A 7-264	
LOAD ADDRESS	LA	RX-a						41 7-265	
LOAD ADDRESS	LAY	RXY-a	LD					E371 7-265	
LOAD ADDRESS EXTENDED	LAE	RX-a			α^6		U ₁ BP	51 7-265	
LOAD ADDRESS EXTENDED	LAEY	RXY-a	GE		α^6		U ₁ BP	E375 7-265	
LOAD ADDRESS RELATIVE LONG	LARL	RIL-b	N3				C00	7-266	
LOAD ADDRESS SPACE PARAMETERS	LASP	SSE	C		P A ¹	SP SO	B ₁	E500 10-41	
LOAD AND ADD (32)	LAA	RSY-a	C IA		α^9	A SP IF £	ST B ₂	EBF8 7-267	
LOAD AND ADD (64)	LAAG	RSY-a	C IA		α^9	A SP IF £	ST B ₂	EBE8 7-267	
LOAD AND ADD LOGICAL (32)	LAAL	RSY-a	C IA		α^9	A SP £	ST B ₂	EBFA 7-267	
LOAD AND ADD LOGICAL (64)	LAALG	RSY-a	C IA		α^9	A SP £	ST B ₂	EBEA 7-267	
LOAD AND AND (32)	LAN	RSY-a	C IA		α^9	A SP £	ST B ₂	EBF4 7-268	
LOAD AND AND (64)	LANG	RSY-a	C IA		α^9	A SP £	ST B ₂	EBE4 7-268	
LOAD AND EXCLUSIVE OR (32)	LAX	RSY-a	C IA		α^9	A SP £	ST B ₂	EBF7 7-268	
LOAD AND EXCLUSIVE OR (64)	LAXG	RSY-a	C IA		α^9	A SP £	ST B ₂	EBE7 7-268	
LOAD AND OR (32)	LAO	RSY-a	C IA		α^9	A SP £	ST B ₂	EBF6 7-269	
LOAD AND OR (64)	LAOG	RSY-a	C IA		α^9	A SP £	ST B ₂	EBE6 7-269	

Figure B-1. Instructions Arranged by Name (Part 9 of 24)

Name	Mnemonic	Characteristics							Op-code	Page		
LOAD AND TEST (32)	LT	RXY-a	C	EI	A			B ₂	E312	7-270		
LOAD AND TEST (32)	LTR	RR	C						12	7-269		
LOAD AND TEST (64)	LTG	RXY-a	C	EI	A			B ₂	E302	7-270		
LOAD AND TEST (64)	LTGR	RRE	C	N					B902	7-269		
LOAD AND TEST (64←32)	LTGF	RXY-a	C	GE	A			B ₂	E332	7-270		
LOAD AND TEST (64←32)	LTGFR	RRE	C	N					B912	7-269		
LOAD AND TEST (extended BFP)	LTXBR	RRE	C		$\alpha^{7,9}$	SP	Db Xi		B342	19-31		
LOAD AND TEST (extended DFP)	LTXTR	RRE	C	TF	$\alpha^{7,9}$	SP	Dt Xi		B3DE	20-41		
LOAD AND TEST (extended HFP)	LTXR	RRE	C		$\alpha^{7,9}$	SP	Da		B362	18-14		
LOAD AND TEST (long BFP)	LTDBR	RRE	C		$\alpha^{7,9}$		Db Xi		B312	19-31		
LOAD AND TEST (long DFP)	LTDTR	RRE	C	TF	$\alpha^{7,9}$		Dt Xi		B3D6	20-41		
LOAD AND TEST (long HFP)	LTDR	RR	C		$\alpha^{7,9}$		Da		22	18-13		
LOAD AND TEST (short BFP)	LTEBR	RRE	C		$\alpha^{7,9}$		Db Xi		B302	19-31		
LOAD AND TEST (short HFP)	LTERR	RR	C		$\alpha^{7,9}$		Da		32	18-13		
LOAD AND TRAP (32L←32)	LAT	RXY-a		LT	A		Dc		B ₂	E39F	7-270	
LOAD AND TRAP (64)	LGAT	RXY-a		LT	A		Dc		B ₂	E385	7-270	
LOAD AND ZERO RIGHTMOST BYTE (32)	LZRF	RXY-a		LZ	A				B ₂	E33B	7-270	
LOAD AND ZERO RIGHTMOST BYTE (64)	LZRG	RXY-a		LZ	A				B ₂	E32A	7-270	
LOAD BYTE (32←8)	LB	RXY-a		LD	A					E376	7-271	
LOAD BYTE (32←8)	LBR	RRE		EI						B926	7-271	
LOAD BYTE (64←8)	LGB	RXY-a		LD	A					E377	7-271	
LOAD BYTE (64←8)	LGBR	RRE		EI						B906	7-271	
LOAD BYTE HIGH (32←8)	LBH	RXY-a		HW	A			B ₂	E3C0	7-271		
LOAD COMPLEMENT (32)	LCR	RR		C			IF			13	7-271	
LOAD COMPLEMENT (64)	LCGR	RRE	C	N			IF			B903	7-272	
LOAD COMPLEMENT (64←32)	LCGFR	RRE	C	N						B913	7-272	
LOAD COMPLEMENT (extended BFP)	LCXBR	RRE	C		$\alpha^{7,9}$	SP	Db			B343	19-31	
LOAD COMPLEMENT (extended HFP)	LCXR	RRE	C		$\alpha^{7,9}$	SP	Da			B363	18-14	
LOAD COMPLEMENT (long BFP)	LCDBR	RRE	C		$\alpha^{7,9}$		Db			B313	19-31	
LOAD COMPLEMENT (long HFP)	LCDR	RR		C	$\alpha^{7,9}$		Da			23	18-14	
LOAD COMPLEMENT (long)	LCDFR	RRE		FS	$\alpha^{7,9}$		Da			B373	9-31	
LOAD COMPLEMENT (short BFP)	LCEBR	RRE		C	$\alpha^{7,9}$		Db			B303	19-31	
LOAD COMPLEMENT (short HFP)	LCER	RR		C	$\alpha^{7,9}$		Da			33	18-14	
LOAD CONTROL (32)	LCTL	RS-a			P	A	SP		B ₂	B7	10-50	
LOAD CONTROL (64)	LCTLG	RSY-a		N	P	A	SP		B ₂	EB2F	10-50	
LOAD COUNT TO BLOCK BOUNDARY	LCBB	RXE	C	VF			SP			E727	7-272	
LOAD FP INTEGER (extended BFP)	FIXBR	RRF-e			$\alpha^{7,9}$		SP	Db Xi	Xx	B347	19-32	
LOAD FP INTEGER (extended BFP)	FIXBRA	RRF-e		F	$\alpha^{7,9}$		SP	Db Xi	Xx	B347	19-32	
LOAD FP INTEGER (extended DFP)	FIXTR	RRF-e		TF	$\alpha^{7,9}$		SP	Dt Xi	Xx Xq	B3DF	20-42	
LOAD FP INTEGER (extended HFP)	FIXR	RRE			$\alpha^{7,9}$		SP	Da		B367	18-15	
LOAD FP INTEGER (long BFP)	FIDBR	RRF-e			$\alpha^{7,9}$		SP	Db Xi	Xx	B35F	19-32	
LOAD FP INTEGER (long BFP)	FIDBRA	RRF-e		F	$\alpha^{7,9}$		SP	Db Xi	Xx	B35F	19-32	
LOAD FP INTEGER (long DFP)	FIDTR	RRF-e		TF	$\alpha^{7,9}$			Dt Xi	Xx Xq	B3D7	20-42	
LOAD FP INTEGER (long HFP)	FIDR	RRE			$\alpha^{7,9}$			Da		B37F	18-15	
LOAD FP INTEGER (short BFP)	FIEBR	RRF-e			$\alpha^{7,9}$		SP	Db Xi	Xx	B357	19-32	
LOAD FP INTEGER (short BFP)	FIEBRA	RRF-e		F	$\alpha^{7,9}$		SP	Db Xi	Xx	B357	19-32	
LOAD FP INTEGER (short HFP)	FIER	RRE			$\alpha^{7,9}$			Da		B377	18-15	
LOAD FPC	LFPC	S			$\alpha^{7,9}$	A	SP	Db		B ₂	B29D	9-31
LOAD FPC AND SIGNAL	LFAS	S		XF	$\alpha^{7,9}$	A	SP	Dt Xg		B ₂	B2BD	9-32
LOAD FPR FROM GR (64 to long)	LDGR	RRE		FG	$\alpha^{7,9}$			Da		B3C1	9-34	
LOAD GR FROM FPR (long to 64)	LGDR	RRE		FG	$\alpha^{7,9}$			Da		B3CD	9-34	
LOAD GUARDED (64)	LGG	RXY-a		GF	α^{12}	A	SP		B ST	B ₂	E34C	7-273
LOAD GUARDED STORAGE CONTROLS	LGSC	RXY-a		GF	α^1	A		SO		B ₂	E34D	7-274
LOAD HALFWORD (32←16)	LH	RX-a			A					B ₂	48	7-275
LOAD HALFWORD (32←16)	LHR	RRE		EI							B927	7-275

Figure B-1. Instructions Arranged by Name (Part 10 of 24)

Name	Mnemonic	Characteristics						Op-code	Page
LOAD HALFWORD (32←16)	LHY	RXY-a	LD	A			B ₂	E378	7-275
LOAD HALFWORD (64←16)	LGH	RXY-a	N	A			B ₂	E315	7-275
LOAD HALFWORD (64←16)	LGHR	RRE	EI					B907	7-275
LOAD HALFWORD HIGH (32←16)	LHH	RXY-a	HW	A			B ₂	E3C4	7-276
LOAD HALFWORD HIGH IMMEDIATE ON CONDITION (32←16)	LOCHHI	RIE-g	L2					EC4E	7-276
LOAD HALFWORD IMMEDIATE (32←16)	LHI	RI-a						A78	7-275
LOAD HALFWORD IMMEDIATE (64←16)	LGHI	RI-a	N					A79	7-275
LOAD HALFWORD IMMEDIATE ON CONDITION (32←16)	LOCHI	RIE-g	L2					EC42	7-276
LOAD HALFWORD IMMEDIATE ON CONDITION (64←16)	LOGCHI	RIE-g	L2					EC46	7-276
LOAD HALFWORD RELATIVE LONG (32←16)	LHRL	RIL-b	GE	A*				C45	7-275
LOAD HALFWORD RELATIVE LONG (64←16)	LGHRL	RIL-b	GE	A*				C44	7-275
LOAD HIGH (32)	LFH	RXY-a	HW	A			B ₂	E3CA	7-277
LOAD HIGH AND TRAP (32H←32)	LFHAT	RXY-a	LT	A		Dc	B ₂	E3C8	7-277
LOAD HIGH ON CONDITION (32)	LOCFH	RSY-b	L2	A			B ₂	EBE0	7-283
LOAD HIGH ON CONDITION (32)	LOCFHR	RRF-c	L2					B9E0	7-283
LOAD IMMEDIATE (64←32)	LGFI	RIL-a	EI					C01	7-263
LOAD LENGTHENED (long to extended BFP)	LXDB	RXE		$\alpha^{7,9}$ A	SP	Db Xi	B ₂	ED05	19-34
LOAD LENGTHENED (long to extended BFP)	LXDBR	RRE		$\alpha^{7,9}$	SP	Db Xi		B305	19-33
LOAD LENGTHENED (long to extended DFP)	LXDTR	RRF-d	TF	$\alpha^{7,9}$	SP	Dt Xi		B3DC	20-45
LOAD LENGTHENED (long to extended HFP)	LXD	RXE		$\alpha^{7,9}$ A	SP	Da	B ₂	ED25	18-15
LOAD LENGTHENED (long to extended HFP)	LXDR	RRE		$\alpha^{7,9}$	SP	Da		B325	18-15
LOAD LENGTHENED (short to extended BFP)	LXEB	RXE		$\alpha^{7,9}$ A	SP	Db Xi	B ₂	ED06	19-34
LOAD LENGTHENED (short to extended BFP)	LXEBr	RRE		$\alpha^{7,9}$	SP	Db Xi		B306	19-33
LOAD LENGTHENED (short to extended HFP)	LXE	RXE		$\alpha^{7,9}$ A	SP	Da	B ₂	ED26	18-15
LOAD LENGTHENED (short to extended HFP)	LXER	RRE		$\alpha^{7,9}$	SP	Da		B326	18-15
LOAD LENGTHENED (short to long BFP)	LDEB	RXE		$\alpha^{7,9}$ A		Db Xi	B ₂	ED04	19-34
LOAD LENGTHENED (short to long BFP)	LDEBR	RRE		$\alpha^{7,9}$		Db Xi		B304	19-33
LOAD LENGTHENED (short to long DFP)	LDETR	RRF-d	TF	$\alpha^{7,9}$		Dt Xi		B3D4	20-45
LOAD LENGTHENED (short to long HFP)	LDE	RXE		$\alpha^{7,9}$ A		Da	B ₂	ED24	18-15
LOAD LENGTHENED (short to long HFP)	LDER	RRE		$\alpha^{7,9}$		Da		B324	18-15
LOAD LOGICAL (64←32)	LLGF	RXY-a	N	A			B ₂	E316	7-277
LOAD LOGICAL (64←32)	LLGFR	RRE	N					B916	7-277
LOAD LOGICAL AND SHIFT GUARDED (64←32)	LLGFSG	RXY-a	GF	α^{12} A	SP		B ST B ₂	E348	7-273
LOAD LOGICAL AND TRAP (64←32)	LLGFAT	RXY-a	LT	A		Dc	B ₂	E39D	7-278
LOAD LOGICAL AND ZERO RIGHTMOST BYTE (64←32)	LLZRGF	RXY-a	LZ	A			B ₂	E33A	7-278
LOAD LOGICAL CHARACTER (32←8)	LLC	RXY-a	EI	A			B ₂	E394	7-278
LOAD LOGICAL CHARACTER (32←8)	LLCR	RRE	EI					B994	7-278
LOAD LOGICAL CHARACTER (64←8)	LLGC	RXY-a	N	A			B ₂	E390	7-278
LOAD LOGICAL CHARACTER (64←8)	LLGCR	RRE	EI					B984	7-278
LOAD LOGICAL CHARACTER HIGH (32←8)	LLCH	RXY-a	HW	A			B ₂	E3C2	7-279
LOAD LOGICAL HALFWORD (32←16)	LLH	RXY-a	EI	A			B ₂	E395	7-279
LOAD LOGICAL HALFWORD (32←16)	LLHR	RRE	EI					B995	7-279
LOAD LOGICAL HALFWORD (64←16)	LLGH	RXY-a	N	A			B ₂	E391	7-279
LOAD LOGICAL HALFWORD (64←16)	LLGHR	RRE	EI					B985	7-279
LOAD LOGICAL HALFWORD HIGH (32←16)	LLHH	RXY-a	HW	A			B ₂	E3C6	7-280
LOAD LOGICAL HALFWORD RELATIVE LONG (32←16)	LLHRL	RIL-b	GE	A*				C42	7-279
LOAD LOGICAL HALFWORD RELATIVE LONG (64←16)	LLGHRL	RIL-b	GE	A*				C46	7-279
LOAD LOGICAL IMMEDIATE (high high)	LLIHH	RI-a	N					A5C	7-280
LOAD LOGICAL IMMEDIATE (high low)	LLIHL	RI-a	N					A5D	7-280
LOAD LOGICAL IMMEDIATE (high)	LLIHF	RIL-a	EI					C0E	7-280

Figure B-1. Instructions Arranged by Name (Part 11 of 24)

Name	Mnemonic	Characteristics										Op-code	Page	
LOAD LOGICAL IMMEDIATE (low high)	LLILH	RI-a	N									A5E	7-280	
LOAD LOGICAL IMMEDIATE (low low)	LLILL	RI-a	N									A5F	7-280	
LOAD LOGICAL IMMEDIATE (low)	LLILF	RIL-a	EI									C0F	7-280	
LOAD LOGICAL RELATIVE LONG (64←32)	LLGFRL	RIL-b	GE	A*	SP							C4E	7-277	
LOAD LOGICAL THIRTY ONE BITS (64←31)	LLGT	RXY-a	N	A							B ₂	E317	7-281	
LOAD LOGICAL THIRTY ONE BITS (64←31)	LLGTR	RRE	N									B917	7-280	
LOAD LOGICAL THIRTY ONE BITS AND TRAP (64←31)	LLGTAT	RXY-a	LT	A		Dc					B ₂	E39C	7-281	
LOAD MULTIPLE (32)	LM	RS-a		A							B ₂	98	7-281	
LOAD MULTIPLE (32)	LMY	RSY-a	LD	A							B ₂	EB98	7-281	
LOAD MULTIPLE (64)	LMG	RSY-a	N	A							B ₂	EB04	7-281	
LOAD MULTIPLE DISJOINT (64←32&32)	LMD	SS-e	N	α ⁹	A						B ₂	B ₄	EF	7-282
LOAD MULTIPLE HIGH (32)	LMH	RSY-a	N	A							B ₂	EB96	7-282	
LOAD NEGATIVE (32)	LNR	RR	C									11	7-282	
LOAD NEGATIVE (64)	LNGR	RRE	C N									B901	7-282	
LOAD NEGATIVE (64←32)	LNGFR	RRE	C N									B911	7-283	
LOAD NEGATIVE (extended BFP)	LNXBR	RRE	C	α ^{7,9}	SP	Db						B341	19-34	
LOAD NEGATIVE (extended HFP)	LNXR	RRE	C	α ^{7,9}	SP	Da						B361	18-16	
LOAD NEGATIVE (long BFP)	LNDBR	RRE	C	α ^{7,9}		Db						B311	19-34	
LOAD NEGATIVE (long HFP)	LNDR	RR	C	α ^{7,9}		Da						21	18-16	
LOAD NEGATIVE (long)	LNDFR	RRE	FS	α ^{7,9}		Da						B371	9-34	
LOAD NEGATIVE (short BFP)	LNEBR	RRE	C	α ^{7,9}		Db						B301	19-34	
LOAD NEGATIVE (short HFP)	LNER	RR	C	α ^{7,9}		Da						31	18-16	
LOAD ON CONDITION (32)	LOC	RSY-b	L1	A							B ₂	EBF2	7-283	
LOAD ON CONDITION (32)	LOCR	RRF-c	L1									B9F2	7-283	
LOAD ON CONDITION (64)	LOCG	RSY-b	L1	A							B ₂	EBE2	7-283	
LOAD ON CONDITION (64)	LOCGR	RRF-c	L1									B9E2	7-283	
LOAD PAGE TABLE ENTRY ADDRESS	LPTEA	RRF-b	C D2	P A ^{1*}	SP	SO					R ₂	B9AA	10-50	
LOAD PAIR DISJOINT (32)	LPD	SSF	C IA	α ⁹	A SP						B ₁	B ₂	C84	7-284
LOAD PAIR DISJOINT (64)	LPDG	SSF	C IA	α ⁹	A SP						B ₁	B ₂	C85	7-284
LOAD PAIR FROM QUADWORD (64&64←128)	LPQ	RXY-a	N	α ⁹	A SP						B ₂	E38F	7-285	
LOAD POSITIVE (32)	LPR	RR	C			IF						10	7-286	
LOAD POSITIVE (64)	LPGR	RRE	C N			IF						B900	7-286	
LOAD POSITIVE (64←32)	LPGFR	RRE	C N									B910	7-286	
LOAD POSITIVE (extended BFP)	LPXBR	RRE	C	α ^{7,9}	SP	Db						B340	19-35	
LOAD POSITIVE (extended HFP)	LPXR	RRE	C	α ^{7,9}	SP	Da						B360	18-16	
LOAD POSITIVE (long BFP)	LPDBR	RRE	C	α ^{7,9}		Db						B310	19-35	
LOAD POSITIVE (long HFP)	LPDR	RR	C	α ^{7,9}		Da						20	18-16	
LOAD POSITIVE (long)	LPDFR	RRE	FS	α ^{7,9}		Da						B370	9-34	
LOAD POSITIVE (short BFP)	LPEBR	RRE	C	α ^{7,9}		Db						B300	19-35	
LOAD POSITIVE (short HFP)	LPER	RR	C	α ^{7,9}		Da						30	18-16	
LOAD PSW	LPSW	SI	L	P A	SP	¢					B ₂	82	10-54	
LOAD PSW EXTENDED	LPSWE	S	L N	P A	SP	¢					B ₂	B2B2	10-55	
LOAD REAL ADDRESS (32)	LRA	RX-a	C	P A ^{1*}		SO					BP	B1	10-56	
LOAD REAL ADDRESS (32)	LRAY	RXY-a	C LD	P A ^{1*}		SO					BP	E313	10-56	
LOAD REAL ADDRESS (64)	LRAG	RXY-a	C N	P A ^{1*}							BP	E303	10-56	
LOAD RELATIVE LONG (32)	LRL	RIL-b	GE	A	SP							C4D	7-263	
LOAD RELATIVE LONG (64)	LGRL	RIL-b	GE	A*	SP							C48	7-263	
LOAD RELATIVE LONG (64←32)	LGFR	RIL-b	GE	A*	SP							C4C	7-263	
LOAD REVERSED (16)	LRVH	RXY-a	N3	A							B ₂	E31F	7-286	
LOAD REVERSED (32)	LRV	RXY-a	N3	A							B ₂	E31E	7-286	
LOAD REVERSED (32)	LRVR	RRE	N3									B91F	7-286	
LOAD REVERSED (64)	LRVG	RXY-a	N	A							B ₂	E30F	7-286	
LOAD REVERSED (64)	LRVGR	RRE	N									B90F	7-286	
LOAD ROUNDED (extended to long BFP)	LDXBR	RRE		α ^{7,9}	SP	Db Xi	Xo Xu Xx					B345	19-35	

Figure B-1. Instructions Arranged by Name (Part 12 of 24)

Name	Mnemonic	Characteristics										Op-code	Page				
LOAD ROUNDED (extended to long BFP)	LDXBRA	RRF-e	F	$\alpha^{7,9}$	SP	Db	Xi	Xo	Xu	Xx			B345	19-35			
LOAD ROUNDED (extended to long DFP)	LDXTR	RRF-e	TF	$\alpha^{7,9}$	SP	Dt	Xi	Xo	Xu	Xx	Xq		B3DD	20-46			
LOAD ROUNDED (extended to long HFP)	LDXR	RR		$\alpha^{7,9}$	SP	Da		EO					25	18-17			
LOAD ROUNDED (extended to long HFP)	LRDR	RR		$\alpha^{7,9}$	SP	Da		EO					25	18-17			
LOAD ROUNDED (extended to short BFP)	LEXBR	RRE		$\alpha^{7,9}$	SP	Db	Xi	Xo	Xu	Xx			B346	19-35			
LOAD ROUNDED (extended to short BFP)	LEXBRA	RRF-e	F	$\alpha^{7,9}$	SP	Db	Xi	Xo	Xu	Xx			B346	19-35			
LOAD ROUNDED (extended to short HFP)	LEXR	RRE		$\alpha^{7,9}$	SP	Da		EO					B366	18-17			
LOAD ROUNDED (long to short BFP)	LEDBR	RRE		$\alpha^{7,9}$		Db	Xi	Xo	Xu	Xx			B344	19-35			
LOAD ROUNDED (long to short BFP)	LEDBRA	RRF-e	F	$\alpha^{7,9}$	SP	Db	Xi	Xo	Xu	Xx			B344	19-35			
LOAD ROUNDED (long to short DFP)	LEDTR	RRF-e	TF	$\alpha^{7,9}$		Dt	Xi	Xo	Xu	Xx	Xq		B3D5	20-46			
LOAD ROUNDED (long to short HFP)	LEDR	RR		$\alpha^{7,9}$		Da		EO					35	18-17			
LOAD ROUNDED (long to short HFP)	LRER	RR		$\alpha^{7,9}$		Da		EO					35	18-17			
LOAD USING REAL ADDRESS (32)	LURA	RRE		P	A ¹	SP							B24B	10-60			
LOAD USING REAL ADDRESS (64)	LURAG	RRE	N	P	A ¹	SP							B905	10-60			
LOAD ZERO (extended)	LZXR	RRE		$\alpha^{7,9}$	SP	Da							B376	9-35			
LOAD ZERO (long)	LZDR	RRE		$\alpha^{7,9}$		Da							B375	9-35			
LOAD ZERO (short)	LZER	RRE		$\alpha^{7,9}$		Da							B374	9-35			
MODIFY STACKED STATE	MSTA	RRE		α^1	A*	SP	SE					ST	B247	10-61			
MODIFY SUBCHANNEL	MSCH	S	C	P	A	SP	OP	ϵ	GS				B ₂	B232	14-7		
MONITOR CALL	MC	SI		$\alpha^{4,8,9}$	SP				ME				AF	7-287			
MOVE (16←16)	MVHHI	SIL	GE		A							ST	B ₁	E544	7-288		
MOVE (32←16)	MVHI	SIL	GE		A							ST	B ₁	E54C	7-288		
MOVE (64←16)	MVGHI	SIL	GE		A							ST	B ₁	E548	7-288		
MOVE (character)	MVC	SS-a		α^9	A							ST	B ₁	B ₂	D2	7-288	
MOVE (immediate)	MVI	SI			A							ST	B ₁	92	7-288		
MOVE (immediate)	MVIY	SIY	LD		A							ST	B ₁	EB52	7-288		
MOVE INVERSE	MVCIN	SS-a		α^9	A							ST	B ₁	B ₂	E8	7-289	
MOVE LONG	MVCL	RR	C	α^9	A	SP	II					ST	R ₁	R ₂	OE	7-289	
MOVE LONG EXTENDED	MVCLE	RS-a	C	α^9	A	SP	IC					ST	R ₁	R ₃	A8	7-293	
MOVE LONG UNICODE	MVCLU	RSY-a	C	E2	α^9	A	SP	IC				ST	R ₁	R ₃	EB8E	7-296	
MOVE NUMERICS	MVN	SS-a		α^9	A							ST	B ₁	B ₂	D1	7-300	
MOVE PAGE	MVPG	RRE	C	Q	A	SP	OP	ϵ^4	G0			K	ST	R ₁	R ₂	B254	10-62
MOVE RIGHT TO LEFT	MVCRL	SSE	MI3	α^9	A				G0			ST	B ₁	B ₂	E50A	7-300	
MOVE STRING	MVST	RRE	C	α^9	A	SP	IC		G0			ST	R ₁	R ₂	B255	7-301	
MOVE TO PRIMARY	MVCP	SS-d	C	Q	A		SO	ϵ				ST			DA	10-65	
MOVE TO SECONDARY	MVCS	SS-d	C	Q	A		SO	ϵ				ST			DB	10-65	
MOVE WITH DESTINATION KEY	MVCDK	SSE		Q	A				GM			ST	B ₁	B ₂	E50F	10-67	
MOVE WITH KEY	MVCK	SS-d	C	Q	A							ST	B ₁	B ₂	D9	10-67	
MOVE WITH OFFSET	MVO	SS-b		α^9	A							ST	B ₁	B ₂	F1	7-302	
MOVE WITH OPTIONAL SPECIFICATIONS	MVCOS	SSF	C	MO	Q	A	SO		G0			ST	B ₁	B ₂	C80	10-69	
MOVE WITH SOURCE KEY	MVCSK	SSE		Q	A				GM			ST	B ₁	B ₂	E50E	10-72	
MOVE ZONES	MVZ	SS-a		α^9	A							ST	B ₁	B ₂	D3	7-303	
MULTIPLY (128←64)	MG	RXY-a	MI2		A	SP							B ₂	E384	7-304		
MULTIPLY (128←64)	MGRK	RRF-a	MI2			SP								B9EC	7-304		
MULTIPLY (64←32)	M	RX-a			A	SP							B ₂	5C	7-304		
MULTIPLY (64←32)	MFY	RXY-a	GE		A	SP							B ₂	E35C	7-304		
MULTIPLY (64←32)	MR	RR				SP							1C	7-304			
MULTIPLY (extended BFP)	MXBR	RRE		$\alpha^{7,9}$	SP	Db	Xi	Xo	Xu	Xx			B34C	19-37			
MULTIPLY (extended DFP)	MXTR	RRF-a	TF	$\alpha^{7,9}$	SP	Dt	Xi	Xo	Xu	Xx			B3D8	20-47			
MULTIPLY (extended DFP)	MXTRA	RRF-a	F	$\alpha^{7,9}$	SP	Dt	Xi	Xo	Xu	Xx	Xq		B3D8	20-48			
MULTIPLY (extended HFP)	MXR	RR		$\alpha^{7,9}$	SP	Da	EU	EO					26	18-17			
MULTIPLY (long BFP)	MDB	RXE		$\alpha^{7,9}$	A	Db	Xi	Xo	Xu	Xx			B ₂	ED1C	19-37		
MULTIPLY (long BFP)	MDBR	RRE		$\alpha^{7,9}$		Db	Xi	Xo	Xu	Xx			B31C	19-37			
MULTIPLY (long DFP)	MDTR	RRF-a	TF	$\alpha^{7,9}$		Dt	Xi	Xo	Xu	Xx			B3D0	20-47			
MULTIPLY (long DFP)	MDTRA	RRF-a	F	$\alpha^{7,9}$		Dt	Xi	Xo	Xu	Xx	Xq		B3D0	20-48			

Figure B-1. Instructions Arranged by Name (Part 13 of 24)

Name	Mnemonic	Characteristics						Op-code	Page
MULTIPLY (long HFP)	MD	RX-a		$\alpha^{7,9}$ A	Da	EU EO	B ₂	6C	18-18
MULTIPLY (long HFP)	MDR	RR		$\alpha^{7,9}$	Da	EU EO		2C	18-17
MULTIPLY (long to extended BFP)	MXDB	RXE		$\alpha^{7,9}$ A SP	Db	Xi	B ₂	ED07	19-37
MULTIPLY (long to extended BFP)	MXDBR	RRE		$\alpha^{7,9}$	Db	Xi		B307	19-37
MULTIPLY (long to extended HFP)	MXD	RX-a		$\alpha^{7,9}$ A SP	Da	EU EO	B ₂	67	18-18
MULTIPLY (long to extended HFP)	MXDR	RR		$\alpha^{7,9}$ SP	Da	EU EO		27	18-17
MULTIPLY (short BFP)	MEEB	RXE		$\alpha^{7,9}$ A	Db	Xi Xo Xu Xx	B ₂	ED17	19-37
MULTIPLY (short BFP)	MEEBR	RRE		$\alpha^{7,9}$	Db	Xi Xo Xu Xx		B317	19-37
MULTIPLY (short HFP)	MEE	RXE		$\alpha^{7,9}$ A	Da	EU EO	B ₂	ED37	18-18
MULTIPLY (short HFP)	MEER	RRE		$\alpha^{7,9}$	Da	EU EO		B337	18-17
MULTIPLY (short to long BFP)	MDEB	RXE		$\alpha^{7,9}$ A	Db	Xi	B ₂	ED0C	19-37
MULTIPLY (short to long BFP)	MDEBR	RRE		$\alpha^{7,9}$	Db	Xi		B30C	19-37
MULTIPLY (short to long HFP)	MDE	RX-a		$\alpha^{7,9}$ A	Da	EU EO	B ₂	7C	18-18
MULTIPLY (short to long HFP)	MDER	RR		$\alpha^{7,9}$	Da	EU EO		3C	18-17
MULTIPLY (short to long HFP)	ME	RX-a		$\alpha^{7,9}$ A	Da	EU EO	B ₂	7C	18-18
MULTIPLY (short to long HFP)	MER	RR		$\alpha^{7,9}$	Da	EU EO		3C	18-18
MULTIPLY & ADD UNNORMALIZED (long to ext. HFP)	MAY	RXF	UE	$\alpha^{7,9}$ A	Da		B ₂	ED3A	18-20
MULTIPLY & ADD UNNORMALIZED (long to ext. HFP)	MAYR	RRD	UE	$\alpha^{7,9}$	Da			B33A	18-20
MULTIPLY AND ADD (long BFP)	MADB	RXF		$\alpha^{7,9}$ A	Db	Xi Xo Xu Xx	B ₂	ED1E	19-38
MULTIPLY AND ADD (long BFP)	MADBR	RRD		$\alpha^{7,9}$	Db	Xi Xo Xu Xx		B31E	19-38
MULTIPLY AND ADD (long HFP)	MAD	RXF	HM	$\alpha^{7,9}$ A	Da	EU EO	B ₂	ED3E	18-19
MULTIPLY AND ADD (long HFP)	MADR	RRD	HM	$\alpha^{7,9}$	Da	EU EO		B33E	18-19
MULTIPLY AND ADD (short BFP)	MAEB	RXF		$\alpha^{7,9}$ A	Db	Xi Xo Xu Xx	B ₂	ED0E	19-38
MULTIPLY AND ADD (short BFP)	MAEBR	RRD		$\alpha^{7,9}$	Db	Xi Xo Xu Xx		B30E	19-38
MULTIPLY AND ADD (short HFP)	MAE	RXF	HM	$\alpha^{7,9}$ A	Da	EU EO	B ₂	ED2E	18-19
MULTIPLY AND ADD (short HFP)	MAER	RRD	HM	$\alpha^{7,9}$	Da	EU EO		B32E	18-19
MULTIPLY AND ADD UNNRM. (long to ext. high HFP)	MAYH	RXF	UE	$\alpha^{7,9}$ A	Da		B ₂	ED3C	18-20
MULTIPLY AND ADD UNNRM. (long to ext. high HFP)	MAYHR	RRD	UE	$\alpha^{7,9}$	Da			B33C	18-20
MULTIPLY AND ADD UNNRM. (long to ext. low HFP)	MAYL	RXF	UE	$\alpha^{7,9}$ A	Da		B ₂	ED38	18-20
MULTIPLY AND ADD UNNRM. (long to ext. low HFP)	MAYLR	RRD	UE	$\alpha^{7,9}$	Da			B338	18-20
MULTIPLY AND SUBTRACT (long BFP)	MSDB	RXF		$\alpha^{7,9}$ A	Db	Xi Xo Xu Xx	B ₂	ED1F	19-38
MULTIPLY AND SUBTRACT (long BFP)	MSDBR	RRD		$\alpha^{7,9}$	Db	Xi Xo Xu Xx		B31F	19-38
MULTIPLY AND SUBTRACT (long HFP)	MSD	RXF	HM	$\alpha^{7,9}$ A	Da	EU EO	B ₂	ED3F	18-19
MULTIPLY AND SUBTRACT (long HFP)	MSDR	RRD	HM	$\alpha^{7,9}$	Da	EU EO		B33F	18-19
MULTIPLY AND SUBTRACT (short BFP)	MSEB	RXF		$\alpha^{7,9}$ A	Db	Xi Xo Xu Xx	B ₂	ED0F	19-38
MULTIPLY AND SUBTRACT (short BFP)	MSEBR	RRD		$\alpha^{7,9}$	Db	Xi Xo Xu Xx		B30F	19-38
MULTIPLY AND SUBTRACT (short HFP)	MSE	RXF	HM	$\alpha^{7,9}$ A	Da	EU EO	B ₂	ED2F	18-19
MULTIPLY AND SUBTRACT (short HFP)	MSEB	RRD	HM	$\alpha^{7,9}$	Da	EU EO		B32F	18-19
MULTIPLY DECIMAL	MP	SS-b		α^9 A SP	Dg		ST B ₁ B ₂	FC	8-12
MULTIPLY HALFWORD (32←16)	MH	RX-a		A			B ₂	4C	7-305
MULTIPLY HALFWORD (32←16)	MHY	RXY-a	GE	A			B ₂	E37C	7-305
MULTIPLY HALFWORD (64←16)	MGH	RXY-a	MI2	A			B ₂	E33C	7-305
MULTIPLY HALFWORD IMMEDIATE (32←16)	MHI	RI-a						A7C	7-305
MULTIPLY HALFWORD IMMEDIATE (64←16)	MGHI	RI-a	N					A7D	7-305
MULTIPLY LOGICAL (128←64)	MLG	RXY-a	N	A SP			B ₂	E386	7-306
MULTIPLY LOGICAL (128←64)	MLGR	RRE	N		SP			B986	7-306
MULTIPLY LOGICAL (64←32)	ML	RXY-a	N3	A SP			B ₂	E396	7-306
MULTIPLY LOGICAL (64←32)	MLR	RRE	N3		SP			B996	7-305
MULTIPLY SINGLE (32)	MS	RX-a		A			B ₂	71	7-307
MULTIPLY SINGLE (32)	MSC	RXY-a	C MI2	A		IF	B ₂	E353	7-307

Figure B-1. Instructions Arranged by Name (Part 14 of 24)

Name	Mnemonic	Characteristics							Op-code	Page
MULTIPLY SINGLE (32)	MSR	RRE						B252	7-307	
MULTIPLY SINGLE (32)	MSRKC	RRF-a	C	MI2			IF	B9FD	7-307	
MULTIPLY SINGLE (32)	MSY	RXY-a		LD	A			E351	7-307	
MULTIPLY SINGLE (64)	MSG	RXY-a		N	A			B ₂ E30C	7-307	
MULTIPLY SINGLE (64)	MSGC	RXY-a	C	MI2	A		IF	B ₂ E383	7-307	
MULTIPLY SINGLE (64)	MSGR	RRE		N				B90C	7-307	
MULTIPLY SINGLE (64)	MSGRKC	RRF-a	C	MI2			IF	B9ED	7-307	
MULTIPLY SINGLE (64←32)	MSGF	RXY-a		N	A			B ₂ E31C	7-307	
MULTIPLY SINGLE (64←32)	MSGFR	RRE		N				B91C	7-307	
MULTIPLY SINGLE IMMEDIATE (32)	MSFI	RIL-a		GE				C21	7-307	
MULTIPLY SINGLE IMMEDIATE (64←32)	MSGFI	RIL-a		GE				C20	7-307	
MULTIPLY UNNORM. (long to ext. high HFP)	MYH	RXF		UE	$\alpha^{7,9}$ A		Da	B ₂ ED3D	18-22	
MULTIPLY UNNORM. (long to ext. high HFP)	MYHR	RRD		UE	$\alpha^{7,9}$ A		Da	B33D	18-22	
MULTIPLY UNNORM. (long to ext. low HFP)	MYL	RXF		UE	$\alpha^{7,9}$ A		Da	B ₂ ED39	18-22	
MULTIPLY UNNORM. (long to ext. low HFP)	MYLR	RRD		UE	$\alpha^{7,9}$ A		Da	B339	18-22	
MULTIPLY UNNORMALIZED (long to ext. HFP)	MY	RXF		UE	$\alpha^{7,9}$ A	SP	Da	B ₂ ED3B	18-22	
MULTIPLY UNNORMALIZED (long to ext. HFP)	MYR	RRD		UE	$\alpha^{7,9}$ A	SP	Da	B33B	18-22	
NAND (32)	NNRK	RRF-a	C	MI3				B974	7-308	
NAND (64)	NNGRK	RRF-a	C	MI3				B964	7-308	
NEXT INSTRUCTION ACCESS INTENT	NIAI	IE		EH				B2FA	7-309	
NONTRANSACTIONAL STORE (64)	NTSTG	RXY-a		TX	α^9 A	SP		ST B ₂ E325	7-310	
NOR (32)	NORK	RRF-a	C	MI3				B976	7-311	
NOR (64)	NOGRK	RRF-a	C	MI3				B966	7-311	
NOT EXCLUSIVE OR (32)	NXRK	RRF-a	C	MI3				B977	7-311	
NOT EXCLUSIVE OR (64)	NXGRK	RRF-a	C	MI3				B967	7-311	
OR (32)	O	RX-a	C		A			B ₂ 56	7-312	
OR (32)	OR	RR	C					16	7-312	
OR (32)	ORK	RRF-a	C	DO				B9F6	7-312	
OR (32)	OY	RXY-a	C	LD	A			B ₂ E356	7-312	
OR (64)	OG	RXY-a	C	N	A			B ₂ E381	7-312	
OR (64)	OGR	RRE	C	N				B981	7-312	
OR (64)	OGRK	RRF-a	C	DO				B9E6	7-312	
OR (character)	OC	SS-a	C		α^9 A		ST	B ₁ B ₂ D6	7-312	
OR (immediate)	OI	SI	C		A		ST	B ₁ 96	7-312	
OR (immediate)	OIY	SIY	C	LD	A		ST	B ₁ EB56	7-312	
OR IMMEDIATE (high high)	OIHH	RI-a	C	N				A58	7-313	
OR IMMEDIATE (high low)	OIHL	RI-a	C	N				A59	7-313	
OR IMMEDIATE (high)	OIHF	RIL-a	C	EI				C0C	7-313	
OR IMMEDIATE (low high)	OILH	RI-a	C	N				A5A	7-313	
OR IMMEDIATE (low low)	OILL	RI-a	C	N				A5B	7-313	
OR IMMEDIATE (low)	OILF	RIL-a	C	EI				C0D	7-313	
OR WITH COMPLEMENT (32)	OCRK	RRF-a	C	MI3				B975	7-314	
OR WITH COMPLEMENT (64)	OCGRK	RRF-a	C	MI3				B965	7-314	
PACK	PACK	SS-b			α^9 A		ST	B ₁ B ₂ F2	7-314	
PACK ASCII	PKA	SS-f		E2	α^9 A	SP	ST	B ₁ B ₂ E9	7-315	
PACK UNICODE	PKU	SS-f		E2	α^9 A	SP	ST	B ₁ B ₂ E1	7-316	
PAGE IN	PGIN	RRE	C	ES	P A ¹		¢	B22E	10-73	
PAGE OUT	PGOUT	RRE	C	ES	P A ¹		¢	B22F	10-74	
PERFORM CRYPTOGRAPHIC COMPUTATION	PCC	RRE	C	M4	$\alpha^{5,9}$ A	SP	IC	GM I1	B92C	7-316
PERFORM CRYPTOGRAPHIC KEY MGMT. OPERATIONS	PCKMO	RRE		M3	P A	SP		GM	B928	10-75
PERFORM FLOATING-POINT OPERATION	PFPO	E		PF	$\alpha^{7,9}$	SP	Da Xi X0 GM Xu Xx Xq		010A	9-35
PERFORM FRAME MANAGEMENT FUNCTION	PFMF	RRE		ED1	P A ¹	SP	II	¢ ³	K B9AF	10-80
PERFORM LOCKED OPERATION	PLO	SS-e	C		α^1 A	SP		\$ GM	ST EE	7-337
PERFORM PROCESSOR ASSIST	PPA	RRF-c		PA	α^1				FC B2E8	7-351

Figure B-1. Instructions Arranged by Name (Part 15 of 24)

Name	Mnemonic	Characteristics										Op-code	Page			
PERFORM RANDOM NUMBER OPERATION	PRNO	RRE	C	M5	$\alpha^{5,9}$	A	SP	IC	Dg	GM	I1	ST	R ₁	R ₂	B93C	7-352
PERFORM TIMING FACILITY FUNCTION	PTFF	E	C	TS	Q	A	SP			GM		ST			0104	10-83
PERFORM TOPOLOGY FUNCTION	PTF	RRE	C	CT	P		SP								B9A2	10-92
POPULATION COUNT	POPCNT	RRF-c	C	PK											B9E1	7-365
PREFETCH DATA	PFD	RXY-b		GE	$\alpha^{9,11}$									B ₂	E336	7-365
PREFETCH DATA RELATIVE LONG	PFDR	RIL-c		GE	$\alpha^{9,11}$										C62	7-366
PROGRAM CALL	PC	S			Q	A ^{1*}		Z ¹	T	ϵ	GM	B	ST		B218	10-93
PROGRAM RETURN	PR	E	L		α^1	A ^{1*}	SP	Z ⁴	T	ϵ^2		B	ST		0101	10-106
PROGRAM TRANSFER	PT	RRE			Q	A ^{1*}	SP	Z ²	T	ϵ		B			B228	10-110
PROGRAM TRANSFER WITH INSTANCE	PTI	RRE		RA	Q	A ^{1*}	SP	Z ⁶	T	ϵ		B			B99E	10-110
PURGE ALB	PALB	RRE			P					\$					B248	10-119
PURGE TLB	PTLB	S			P					\$					B20D	10-119
QUANTIZE (extended DFP)	QAXTR	RRF-b		TF	$\alpha^{7,9}$		SP	Dt	Xi		Xx	Xq			B3FD	20-49
QUANTIZE (long DFP)	QADTR	RRF-b		TF	$\alpha^{7,9}$			Dt	Xi		Xx	Xq			B3F5	20-49
REROUND (extended DFP)	RRXTR	RRF-b		TF	$\alpha^{7,9}$		SP	Dt	Xi		Xx	Xq			B3FF	20-52
REROUND (long DFP)	RRDTR	RRF-b		TF	$\alpha^{7,9}$			Dt	Xi		Xx	Xq			B3F7	20-52
RESET CHANNEL PATH	RCHP	S	C		P										B23B	14-9
RESET REFERENCE BIT EXTENDED	RRBE	RRE	C		P	A ^{1*}									B22A	10-119
RESET REFERENCE BITS MULTIPLE	RRBM	RRE		RB	P	A ^{1*}									B9AE	10-120
RESUME PROGRAM	RP	S	L		Q	A	SP	WE	T			B		B ₂	B277	10-120
RESUME SUBCHANNEL	RSCH	S	C		P			OP	ϵ	GS					B238	14-10
ROTATE LEFT SINGLE LOGICAL (32)	RLL	RSY-a		N3											EB1D	7-367
ROTATE LEFT SINGLE LOGICAL (64)	RLLG	RSY-a		N											EB1C	7-367
ROTATE THEN AND SELECTED BITS (64)	RNSBG	RIE-f	C	GE											EC54	7-368
ROTATE THEN EXCLUSIVE OR SELECT. BITS (64)	RXSBG	RIE-f	C	GE											EC57	7-368
ROTATE THEN INSERT SELECTED BITS (64)	RISBG	RIE-f	C	GE											EC55	7-369
ROTATE THEN INSERT SELECTED BITS (64)	RISBGN	RIE-f		MI1											EC59	7-369
ROTATE THEN INSERT SELECTED BITS HIGH (64)	RISBHG	RIE-f		HW											EC5D	7-371
ROTATE THEN INSERT SELECTED BITS LOW (64)	RISBLG	RIE-f		HW											EC51	7-371
ROTATE THEN OR SELECTED BITS (64)	ROSBG	RIE-f	C	GE											EC56	7-368
SEARCH STRING	SRST	RRE	C		α^9	A	SP	IC		G0				R ₂	B25E	7-372
SEARCH STRING UNICODE	SRSTU	RRE	C	E3	α^9	A	SP	IC		G0			R ₁	R ₂	B9BE	7-374
SELECT (32)	SELR	RRF-a		MI3											B9F0	7-376
SELECT (64)	SELGR	RRF-a		MI3											B9E3	7-376
SELECT HIGH (32)	SELFHR	RRF-a		MI3											B9C0	7-376
SET ACCESS	SAR	RRE			α^6								U ₁		B24E	7-377
SET ADDRESS LIMIT	SAL	S			P			OP	ϵ	G1					B237	14-12
SET ADDRESS SPACE CONTROL	SAC	S			Q		SP	SW	ϵ						B219	10-123
SET ADDRESS SPACE CONTROL FAST	SACF	S			Q		SP	SW							B279	10-123
SET ADDRESSING MODE (24)	SAM24	E		N3	$\alpha^{3,9}$		SP	T							010C	7-377
SET ADDRESSING MODE (31)	SAM31	E		N3	$\alpha^{3,9}$		SP	T							010D	7-377
SET ADDRESSING MODE (64)	SAM64	E		N	$\alpha^{3,9}$			T							010E	7-377
SET BFP ROUNDING MODE (2 bit)	SRNM	S			$\alpha^{7,9}$			Db							B299	9-47
SET BFP ROUNDING MODE (3 bit)	SRNMB	S		F	$\alpha^{7,9}$		SP	Db							B2B8	9-47
SET CHANNEL MONITOR	SCHM	S			P			OP	ϵ	GM					B23C	14-13
SET CLOCK	SCK	S	C		P	A	SP						B ₂		B204	10-124
SET CLOCK COMPARATOR	SCKC	S			P	A	SP						B ₂		B206	10-125
SET CLOCK PROGRAMMABLE FIELD	SCKPF	E			P		SP			G0					0107	10-126
SET CPU TIMER	SPT	S			P	A	SP						B ₂		B208	10-126
SET DFP ROUNDING MODE	SRNMT	S		TR	$\alpha^{7,9}$			Dt							B2B9	9-47
SET FPC	SFPC	RRE			$\alpha^{7,9}$		SP	Db							B384	9-47
SET FPC AND SIGNAL	SFASR	RRE		XF	$\alpha^{7,9}$		SP	Dt	Xg						B385	9-48
SET PREFIX	SPX	S			P	A	SP			\$			B ₂		B210	10-126
SET PROGRAM MASK	SPM	RR	L												04	7-378

Figure B-1. Instructions Arranged by Name (Part 16 of 24)

Name	Mnemonic	Characteristics						Op-code	Page
SET PSW KEY FROM ADDRESS	SPKA	S		Q				B20A	10-127
SET SECONDARY ASN	SSAR	RRE		α^1	A ^{1*}	Z ³ T ϵ		B225	10-128
SET SECONDARY ASN WITH INSTANCE	SSAIR	RRE	RA	α^1	A ^{1*}	Z' T ϵ		B99F	10-128
SET STORAGE KEY EXTENDED	SSKE	RRF-c	C ¹	P	A ^{1*}	II ϵ	K	B22B	10-133
SET SYSTEM MASK	SSM	SI		P	A	SP		B ₂	80
SHIFT AND ROUND DECIMAL	SRP	SS-c	C	α^9	A	SO	ST	B ₁ B ₂	F0
SHIFT LEFT DOUBLE (64)	SLDA	RS-a	C			Dg DF			8F
SHIFT LEFT DOUBLE LOGICAL (64)	SLDL	RS-a				IF			8D
SHIFT LEFT SINGLE (32)	SLA	RS-a	C			IF			8B
SHIFT LEFT SINGLE (32)	SLAK	RSY-a	C DO			IF			EBDD
SHIFT LEFT SINGLE (64)	SLAG	RSY-a	C N			IF			EB0B
SHIFT LEFT SINGLE LOGICAL (32)	SLL	RS-a							89
SHIFT LEFT SINGLE LOGICAL (32)	SLLK	RSY-a	DO						EBDF
SHIFT LEFT SINGLE LOGICAL (64)	SLLG	RSY-a	N						EB0D
SHIFT RIGHT DOUBLE (64)	SRDA	RS-a	C			SP			8E
SHIFT RIGHT DOUBLE LOGICAL (64)	SRDL	RS-a				SP			8C
SHIFT RIGHT SINGLE (32)	SRA	RS-a	C						8A
SHIFT RIGHT SINGLE (32)	SRAK	RSY-a	C DO						EBDC
SHIFT RIGHT SINGLE (64)	SRAG	RSY-a	C N						EB0A
SHIFT RIGHT SINGLE LOGICAL (32)	SRL	RS-a							88
SHIFT RIGHT SINGLE LOGICAL (32)	SRLK	RSY-a	DO						EBDE
SHIFT RIGHT SINGLE LOGICAL (64)	SRLG	RSY-a	N						EB0C
SHIFT SIGNIFICAND LEFT (extended DFP)	SLXT	RXF	TF	$\alpha^{7,9}$		SP	Dt		ED48
SHIFT SIGNIFICAND LEFT (long DFP)	SLDT	RXF	TF	$\alpha^{7,9}$			Dt		ED40
SHIFT SIGNIFICAND RIGHT (extended DFP)	SRXT	RXF	TF	$\alpha^{7,9}$		SP	Dt		ED49
SHIFT SIGNIFICAND RIGHT (long DFP)	SRDT	RXF	TF	$\alpha^{7,9}$			Dt		ED41
SIGNAL PROCESSOR	SIGP	RS-a	C	P			\$		AE
SQUARE ROOT (extended BFP)	SQXBR	RRE		$\alpha^{7,9}$		SP	Db Xi Xx		B316
SQUARE ROOT (extended HFP)	SQXR	RRE		$\alpha^{7,9}$		SP	Da SQ		B336
SQUARE ROOT (long BFP)	SQDB	RXE		$\alpha^{7,9}$	A		Db Xi Xx	B ₂	ED15
SQUARE ROOT (long BFP)	SQDBR	RRE		$\alpha^{7,9}$			Db Xi Xx		B315
SQUARE ROOT (long HFP)	SQD	RXE		$\alpha^{7,9}$	A		Da SQ	B ₂	ED35
SQUARE ROOT (long HFP)	SQDR	RRE		$\alpha^{7,9}$			Da SQ		B244
SQUARE ROOT (short BFP)	SQEB	RXE		$\alpha^{7,9}$	A		Db Xi Xx	B ₂	ED14
SQUARE ROOT (short BFP)	SQEBR	RRE		$\alpha^{7,9}$			Db Xi Xx		B314
SQUARE ROOT (short HFP)	SQE	RXE		$\alpha^{7,9}$	A		Da SQ	B ₂	ED34
SQUARE ROOT (short HFP)	SQER	RRE		$\alpha^{7,9}$			Da SQ		B245
START SUBCHANNEL	SSCH	S	C	P	A	SP	OP ϵ GS	B ₂	B233
STORE (32)	ST	RX-a			A			ST	B ₂
STORE (32)	STY	RXY-a	LD		A			ST	B ₂
STORE (64)	STG	RXY-a	N		A			ST	B ₂
STORE (long)	STD	RX-a		$\alpha^{7,9}$	A		Da	ST	B ₂
STORE (long)	STDY	RXY-a	LD	$\alpha^{7,9}$	A		Da	ST	B ₂
STORE (short)	STE	RX-a		$\alpha^{7,9}$	A		Da	ST	B ₂
STORE (short)	STEY	RXY-a	LD	$\alpha^{7,9}$	A		Da	ST	B ₂
STORE ACCESS MULTIPLE	STAM	RS-a			A	SP		ST	UB
STORE ACCESS MULTIPLE	STAMY	RSY-a	LD		A	SP		ST	UB
STORE CHANNEL PATH STATUS	STCPS	S		P	A	SP	ϵ	ST	B ₂
STORE CHANNEL REPORT WORD	STCRW	S	C	P	A	SP	ϵ	ST	B ₂
STORE CHARACTER	STC	RX-a			A			ST	B ₂
STORE CHARACTER	STCY	RXY-a	LD		A			ST	B ₂
STORE CHARACTER HIGH (8)	STCH	RXY-a	HW		A			ST	B ₂
STORE CHARACTERS UNDER MASK (high)	STCMH	RSY-b	N	$\alpha^{9,11}$	A			ST	B ₂
STORE CHARACTERS UNDER MASK (low)	STCM	RS-b			A			ST	B ₂
STORE CHARACTERS UNDER MASK (low)	STCMY	RSY-b	LD		A			ST	B ₂

Figure B-1. Instructions Arranged by Name (Part 17 of 24)

Name	Mnemonic	Characteristics										Op-code	Page
STORE CLOCK	STCK	S	C	$\alpha^{8,9}$	A		\$		ST	B ₂	B205	7-386	
STORE CLOCK COMPARATOR	STCKC	S		P	A	SP			ST	B ₂	B207	10-138	
STORE CLOCK EXTENDED	STCKE	S	C	$\alpha^{8,9}$	A		\$		ST	B ₂	B278	7-387	
STORE CLOCK FAST	STCKF	S	C	SC	$\alpha^{8,9}$	A			ST	B ₂	B27C	7-386	
STORE CONTROL (32)	STCTL	RS-a		P	A	SP			ST	B ₂	B6	10-138	
STORE CONTROL (64)	STCTG	RSY-a	N	P	A	SP			ST	B ₂	EB25	10-138	
STORE CPU ADDRESS	STAP	S		P	A	SP			ST	B ₂	B212	10-139	
STORE CPU ID	STIDP	S		P	A	SP			ST	B ₂	B202	10-139	
STORE CPU TIMER	STPT	S		P	A	SP			ST	B ₂	B209	10-141	
STORE FACILITY LIST	STFL	S		N3	P						B2B1	10-141	
STORE FACILITY LIST EXTENDED	STFLE	S	C	FL	α^1	A	SP	G0	ST	B ₂	B2B0	7-389	
STORE FPC	STFPC	S		$\alpha^{7,9}$	A		Db		ST	B ₂	B29C	9-49	
STORE GUARDED STORAGE CONTROLS	STGSC	RXY-a	GF	α^1	A		SO		ST	B ₂	E349	7-390	
STORE HALFWORD (16)	STH	RX-a			A				ST	B ₂	40	7-390	
STORE HALFWORD (16)	STHY	RXY-a	LD		A				ST	B ₂	E370	7-391	
STORE HALFWORD HIGH (16)	STHH	RXY-a	HW		A				ST	B ₂	E3C7	7-391	
STORE HALFWORD RELATIVE LONG (16)	STHRL	RIL-b	GE		A*				ST		C47	7-391	
STORE HIGH (32)	STFH	RXY-a	HW		A				ST	B ₂	E3CB	7-391	
STORE HIGH ON CONDITION	STOCFH	RSY-b	L2		A				ST	B ₂	EBE1	7-393	
STORE MULTIPLE (32)	STM	RS-a			A				ST	B ₂	90	7-392	
STORE MULTIPLE (32)	STMY	RSY-a	LD		A				ST	B ₂	EB90	7-392	
STORE MULTIPLE (64)	STMG	RSY-a	N		A				ST	B ₂	EB24	7-392	
STORE MULTIPLE HIGH (32)	STMH	RSY-a	N		A				ST	B ₂	EB26	7-392	
STORE ON CONDITION (32)	STOC	RSY-b	L1		A				ST	B ₂	EBF3	7-392	
STORE ON CONDITION (64)	STOCG	RSY-b	L1		A				ST	B ₂	EBE3	7-392	
STORE PAIR TO QUADWORD	STPQ	RXY-a	N	α^9	A	SP			ST	B ₂	E38E	7-393	
STORE PREFIX	STPX	S		P	A	SP			ST	B ₂	B211	10-142	
STORE REAL ADDRESS	STRAG	SSE	N	P	A ¹	SP			ST	B ₁	BP	E502	10-142
STORE RELATIVE LONG (32)	STRL	RIL-b	GE		A*	SP			ST		C4F	7-384	
STORE RELATIVE LONG (64)	STGRL	RIL-b	GE		A*	SP			ST		C4B	7-384	
STORE REVERSED (16)	STRVH	RXY-a	N3		A				ST	B ₂	E33F	7-394	
STORE REVERSED (32)	STRV	RXY-a	N3		A				ST	B ₂	E33E	7-394	
STORE REVERSED (64)	STRVG	RXY-a	N		A				ST	B ₂	E32F	7-394	
STORE SUBCHANNEL	STSCH	S	C	P	A	SP	OP	ϕ GS	ST	B ₂	B234	14-18	
STORE SYSTEM INFORMATION	STSI	S	C	P	A	SP		GM	ST	B ₂	B27D	10-143	
STORE THEN AND SYSTEM MASK	STNSM	SI		P	A				ST	B ₁	AC	10-167	
STORE THEN OR SYSTEM MASK	STOSM	SI		P	A	SP			ST	B ₁	AD	10-167	
STORE USING REAL ADDRESS (32)	STURA	RRE		P	A ¹	SP			SU		B246	10-168	
STORE USING REAL ADDRESS (64)	STURG	RRE	N	P	A ¹	SP			SU		B925	10-168	
SUBTRACT (32)	S	RX-a	C		A			IF		B ₂	5B	7-395	
SUBTRACT (32)	SR	RR	C					IF			1B	7-394	
SUBTRACT (32)	SRK	RRF-a	C	DO				IF			B9F9	7-394	
SUBTRACT (32)	SY	RXY-a	C	LD		A		IF		B ₂	E35B	7-395	
SUBTRACT (64)	SG	RXY-a	C	N		A		IF		B ₂	E309	7-395	
SUBTRACT (64)	SGR	RRE	C	N				IF			B909	7-394	
SUBTRACT (64)	SGRK	RRF-a	C	DO				IF			B9E9	7-394	
SUBTRACT (64←32)	SGF	RXY-a	C	N		A		IF		B ₂	E319	7-395	
SUBTRACT (64←32)	SGFR	RRE	C	N				IF			B919	7-394	
SUBTRACT (extended BFP)	SXBR	RRE	C	$\alpha^{7,9}$		SP	Db	Xi Xo Xu Xx			B34B	19-40	
SUBTRACT (extended DFP)	SXTR	RRF-a	C	TF	$\alpha^{7,9}$		SP	Dt Xi Xo Xu Xx			B3DB	20-55	
SUBTRACT (extended DFP)	SXTRA	RRF-a	C	F	$\alpha^{7,9}$		SP	Dt Xi Xo Xu Xx Xq			B3DB	20-55	
SUBTRACT (long BFP)	SDB	RXE	C	$\alpha^{7,9}$	A			Db Xi Xo Xu Xx		B ₂	ED1B	19-40	
SUBTRACT (long BFP)	SDBR	RRE	C	$\alpha^{7,9}$				Db Xi Xo Xu Xx			B31B	19-40	
SUBTRACT (long DFP)	SDTR	RRF-a	C	TF	$\alpha^{7,9}$			Dt Xi Xo Xu Xx			B3D3	20-55	
SUBTRACT (long DFP)	SDTRA	RRF-a	C	F	$\alpha^{7,9}$			Dt Xi Xo Xu Xx Xq			B3D3	20-55	

Figure B-1. Instructions Arranged by Name (Part 18 of 24)

Name	Mnemonic	Characteristics							Op-code	Page
SUBTRACT (short BFP)	SEB	RXE C	$\alpha^{7,9}$ A	Db Xi	Xo Xu Xx			B ₂	ED0B	19-40
SUBTRACT (short BFP)	SEBR	RRE C	$\alpha^{7,9}$	Db Xi	Xo Xu Xx				B30B	19-40
SUBTRACT DECIMAL	SP	SS-b C	α^9 A	Dg DF			ST	B ₁ B ₂	FB	8-13
SUBTRACT HALFWORD (32←16)	SH	RX-a C	A	IF				B ₂	4B	7-395
SUBTRACT HALFWORD (32←16)	SHY	RXY-a C LD	A	IF				B ₂	E37B	7-395
SUBTRACT HALFWORD (64←16)	SGH	RXY-a C MI2	A	IF				B ₂	E339	7-395
SUBTRACT HIGH (32)	SHHHR	RRF-a C HW		IF					B9C9	7-396
SUBTRACT HIGH (32)	SHHLR	RRF-a C HW		IF					B9D9	7-396
SUBTRACT LOGICAL (32)	SL	RX-a C	A					B ₂	5F	7-396
SUBTRACT LOGICAL (32)	SLR	RR C							1F	7-396
SUBTRACT LOGICAL (32)	SLRK	RRF-a C DO							B9FB	7-396
SUBTRACT LOGICAL (32)	SLY	RXY-a C LD	A					B ₂	E35F	7-396
SUBTRACT LOGICAL (64)	SLG	RXY-a C N	A					B ₂	E30B	7-397
SUBTRACT LOGICAL (64)	SLGR	RRE C N							B90B	7-396
SUBTRACT LOGICAL (64)	SLGRK	RRF-a C DO							B9EB	7-396
SUBTRACT LOGICAL (64←32)	SLGF	RXY-a C N	A					B ₂	E31B	7-397
SUBTRACT LOGICAL (64←32)	SLGFR	RRE C N							B91B	7-396
SUBTRACT LOGICAL HIGH (32)	SLHHHR	RRF-a C HW							B9CB	7-397
SUBTRACT LOGICAL HIGH (32)	SLHHLR	RRF-a C HW							B9DB	7-397
SUBTRACT LOGICAL IMMEDIATE (32)	SLFI	RIL-a C EI							C25	7-397
SUBTRACT LOGICAL IMMEDIATE (64←32)	SLGFI	RIL-a C EI							C24	7-397
SUBTRACT LOGICAL WITH BORROW (32)	SLB	RXY-a C N3	A					B ₂	E399	7-398
SUBTRACT LOGICAL WITH BORROW (32)	SLBR	RRE C N3							B999	7-398
SUBTRACT LOGICAL WITH BORROW (64)	SLBG	RXY-a C N	A					B ₂	E389	7-398
SUBTRACT LOGICAL WITH BORROW (64)	SLBGR	RRE C N							B989	7-398
SUBTRACT NORMALIZED (extended HFP)	SXR	RR C	$\alpha^{7,9}$ SP	Da EU EO	LS				37	18-24
SUBTRACT NORMALIZED (long HFP)	SD	RX-a C	$\alpha^{7,9}$ A	Da EU EO	LS			B ₂	6B	18-24
SUBTRACT NORMALIZED (long HFP)	SDR	RR C	$\alpha^{7,9}$	Da EU EO	LS				2B	18-24
SUBTRACT NORMALIZED (short HFP)	SE	RX-a C	$\alpha^{7,9}$ A	Da EU EO	LS			B ₂	7B	18-24
SUBTRACT NORMALIZED (short HFP)	SER	RR C	$\alpha^{7,9}$	Da EU EO	LS				3B	18-24
SUBTRACT UNNORMALIZED (long HFP)	SW	RX-a C	$\alpha^{7,9}$ A	Da	EO LS			B ₂	6F	18-25
SUBTRACT UNNORMALIZED (long HFP)	SWR	RR C	$\alpha^{7,9}$	Da	EO LS				2F	18-25
SUBTRACT UNNORMALIZED (short HFP)	SU	RX-a C	$\alpha^{7,9}$ A	Da	EO LS			B ₂	7F	18-25
SUBTRACT UNNORMALIZED (short HFP)	SUR	RR C	$\alpha^{7,9}$	Da	EO LS				3F	18-25
SUPERVISOR CALL	SVC	I	α^1		¢				0A	7-398
TEST ACCESS	TAR	RRE C	α^1 A ^{1*}					U ₁	B24C	10-168
TEST ADDRESSING MODE	TAM	E C N3	α^9						010B	7-399
TEST AND SET	TS	SI C	α^9 A		\$		ST	B ₂	93	7-399
TEST BLOCK	TB	RRE C	P A ^{1*}	II	\$ GO		K		B22C	10-170
TEST DATA CLASS (extended BFP)	TCXB	RXE C	$\alpha^{7,9}$ SP	Db					ED12	19-41
TEST DATA CLASS (extended DFP)	TDCXT	RXE C TF	$\alpha^{7,9}$ SP	Dt					ED58	20-56
TEST DATA CLASS (long BFP)	TCDB	RXE C	$\alpha^{7,9}$	Db					ED11	19-41
TEST DATA CLASS (long DFP)	TDCDT	RXE C TF	$\alpha^{7,9}$	Dt					ED54	20-56
TEST DATA CLASS (short BFP)	TCEB	RXE C	$\alpha^{7,9}$	Db					ED10	19-41
TEST DATA CLASS (short DFP)	TDCET	RXE C TF	$\alpha^{7,9}$	Dt					ED50	20-56
TEST DATA GROUP (extended DFP)	TDGXT	RXE C TF	$\alpha^{7,9}$ SP	Dt					ED59	20-57
TEST DATA GROUP (long DFP)	TDGDT	RXE C TF	$\alpha^{7,9}$	Dt					ED55	20-57
TEST DATA GROUP (short DFP)	TDGET	RXE C TF	$\alpha^{7,9}$	Dt					ED51	20-57
TEST DECIMAL	TP	RSL-a C E2	α^9 A					B ₁ B ₂	EB0C	8-14
TEST PENDING EXTERNAL INTERRUPTION	TPEI	RRE C TE	P						B9A1	10-172
TEST PENDING INTERRUPTION	TPI	S C	P A ^{1*} SP		¢		ST	B ₂	B236	14-19
TEST PROTECTION	TPROT	SSE C	P A ^{1*}					B ₁	E501	10-173
TEST SUBCHANNEL	TSCH	S C	P A SP	OP	¢ GS		ST	B ₂	B235	14-21
TEST UNDER MASK	TM	SI C	A					B ₁	91	7-400
TEST UNDER MASK	TMY	SIY C LD	A					B ₁	EB51	7-400

Figure B-1. Instructions Arranged by Name (Part 19 of 24)

Name	Mnemonic	Characteristics										Op-code	Page	
TEST UNDER MASK (high high)	TMHH	RI-a	C	N								A72	7-400	
TEST UNDER MASK (high low)	TMHL	RI-a	C	N								A73	7-400	
TEST UNDER MASK (low high)	TMLH	RI-a	C	N								A70	7-400	
TEST UNDER MASK (low low)	TMLL	RI-a	C	N								A71	7-400	
TEST UNDER MASK HIGH	TMH	RI-a	C									A70	7-400	
TEST UNDER MASK LOW	TML	RI-a	C									A71	7-400	
TRACE (32)	TRACE	RS-a			P	A	SP	T	¢		B ₂	99	10-176	
TRACE (64)	TRACG	RSY-a	N		P	A	SP	T	¢		B ₂	EB0F	10-176	
TRANSACTION ABORT	TABORT	S		TX	α ⁹		SP	SO	\$	EX		B2FC	7-401	
TRANSACTION BEGIN (constrained)	TBEGINC	SIL	C	CX	α ⁹		SP	SO	\$	EX		E561	7-406	
TRANSACTION BEGIN (nonconstrained)	TBEGIN	SIL	C	TX	α ⁹	A	SP	SO	\$	EX	ST	E560	7-401	
TRANSACTION END	TEND	S	C	TX				SO	\$	EX		B2F8	7-408	
TRANSLATE	TR	SS-a			α ⁹	A					ST	B ₁ B ₂	DC	7-408
TRANSLATE AND TEST	TRT	SS-a	C		α ⁹	A				GM		B ₁ B ₂	DD	7-409
TRANSLATE AND TEST EXTENDED	TRTE	RRF-c	C	PE	α ⁹	A	SP	IC			ST	RM	B9BF	7-410
TRANSLATE AND TEST REVERSE	TRTR	SS-a	C	E3	α ⁹	A				GM		B ₁ B ₂	D0	7-415
TRANSLATE AND TEST REVERSE EXTENDED	TRTRE	RRF-c	C	PE	α ⁹	A	SP	IC			ST	RM	B9BD	7-410
TRANSLATE EXTENDED	TRE	RRE	C		α ⁹	A	SP	IC			ST	R ₁ R ₂	B2A5	7-415
TRANSLATE ONE TO ONE	TROO	RRF-c	C	E2	α ⁹	A	SP	IC		GM	ST	RM R ₂	B993	7-418
TRANSLATE ONE TO TWO	TROT	RRF-c	C	E2	α ⁹	A	SP	IC		GM	ST	RM R ₂	B992	7-418
TRANSLATE TWO TO ONE	TRTO	RRF-c	C	E2	α ⁹	A	SP	IC		GM	ST	RM R ₂	B991	7-418
TRANSLATE TWO TO TWO	TRTT	RRF-c	C	E2	α ⁹	A	SP	IC		GM	ST	RM R ₂	B990	7-418
TRAP	TRAP2	E			α ¹	A*		SO	T		B	ST	01FF	10-177
TRAP	TRAP4	S			α ¹	A*		SO	T		B	ST	B2FF	10-177
UNPACK	UNPK	SS-b			α ⁹	A					ST	B ₁ B ₂	F3	7-423
UNPACK ASCII	UNPKA	SS-a	C	E2	α ⁹	A	SP				ST	B ₁ B ₂	EA	7-423
UNPACK UNICODE	UNPKU	SS-a	C	E2	α ⁹	A	SP				ST	B ₁ B ₂	E2	7-424
UPDATE TREE	UPT	E	C		α ⁹	A	SP	II		GM I4	ST		0102	7-425
VECTOR ADD	VA	VRR-c		VF	α ^{7,9}		SP	Dv					E7F3	22-3
VECTOR ADD COMPUTE CARRY	VACC	VRR-c		VF	α ^{7,9}		SP	Dv					E7F1	22-4
VECTOR ADD DECIMAL	VAP	VRI-f	C*	VD	α ^{7,9}		SP	Dv	Dg	DF*			E671	25-3
VECTOR ADD WITH CARRY	VAC	VRR-d		VF	α ^{7,9}		SP	Dv					E7BB	22-4
VECTOR ADD WITH CARRY COMPUTE CARRY	VACCC	VRR-d		VF	α ^{7,9}		SP	Dv					E7B9	22-5
VECTOR AND	VN	VRR-c		VF	α ^{7,9}			Dv					E768	22-5
VECTOR AND WITH COMPLEMENT	VNC	VRR-c		VF	α ^{7,9}			Dv					E769	22-5
VECTOR AVERAGE	VAVG	VRR-c		VF	α ^{7,9}		SP	Dv					E7F2	22-6
VECTOR AVERAGE LOGICAL	VAVGL	VRR-c		VF	α ^{7,9}		SP	Dv					E7F0	22-6
VECTOR BIT PERMUTE	VBPERM	VRR-c		V1	α ^{7,9}			Dv					E785	21-4
VECTOR CHECKSUM	VCKSM	VRR-c		VF	α ^{7,9}			Dv					E766	22-6
VECTOR COMPARE DECIMAL	VCP	VRR-h	C	VD	α ^{7,9}			Dv	Dg				E677	25-5
VECTOR COMPARE EQUAL	VCEQ	VRR-b	C*	VF	α ^{7,9}		SP	Dv					E7F8	22-7
VECTOR COMPARE HIGH	VCH	VRR-b	C*	VF	α ^{7,9}		SP	Dv					E7FB	22-8
VECTOR COMPARE HIGH LOGICAL	VCHL	VRR-b	C*	VF	α ^{7,9}		SP	Dv					E7F9	22-9
VECTOR CONVERT TO BINARY	VCVB	VRR-i	C*	VD	α ^{7,9}			Dv	Dg	IF*			E650	25-5
VECTOR CONVERT TO BINARY	VCVBG	VRR-i	C*	VD	α ^{7,9}			Dv	Dg	IF*			E652	25-5
VECTOR CONVERT TO DECIMAL	VCVD	VRI-i	C*	VD	α ^{7,9}		SP	Dv		DF*			E658	25-7
VECTOR CONVERT TO DECIMAL	VCVDG	VRI-i	C*	VD	α ^{7,9}		SP	Dv		DF*			E65A	25-7
VECTOR COUNT LEADING ZEROS	VCLZ	VRR-a		VF	α ^{7,9}		SP	Dv					E753	22-10
VECTOR COUNT TRAILING ZEROS	VCTZ	VRR-a		VF	α ^{7,9}		SP	Dv					E752	22-10
VECTOR DIVIDE DECIMAL	VDP	VRI-f	C*	VD	α ^{7,9}		SP	Dv	Dg	DF* DK			E67A	25-8
VECTOR ELEMENT COMPARE	VEC	VRR-a	C	VF	α ^{7,9}		SP	Dv					E7DB	22-7
VECTOR ELEMENT COMPARE LOGICAL	VECL	VRR-a	C	VF	α ^{7,9}		SP	Dv					E7D9	22-7
VECTOR ELEMENT ROTATE AND INSERT UNDER MASK	VERIM	VRI-d		VF	α ^{7,9}		SP	Dv					E772	22-22
VECTOR ELEMENT ROTATE LEFT LOGICAL	VERLL	VRS-a		VF	α ^{7,9}		SP	Dv					E733	22-21

Figure B-1. Instructions Arranged by Name (Part 20 of 24)

Name	Mnemonic	Characteristics							Op-code	Page
VECTOR ELEMENT ROTATE LEFT LOGICAL	VERLLV	VRR-c	VF	$\alpha^{7,9}$	SP	Dv			E773	22-21
VECTOR ELEMENT SHIFT LEFT	VESLV	VRR-c	VF	$\alpha^{7,9}$	SP	Dv			E770	22-23
VECTOR ELEMENT SHIFT LEFT	VESL	VRS-a	VF	$\alpha^{7,9}$	SP	Dv			E730	22-23
VECTOR ELEMENT SHIFT RIGHT ARITHMETIC	VESRA	VRS-a	VF	$\alpha^{7,9}$	SP	Dv			E73A	22-23
VECTOR ELEMENT SHIFT RIGHT ARITHMETIC	VESRAV	VRR-c	VF	$\alpha^{7,9}$	SP	Dv			E77A	22-23
VECTOR ELEMENT SHIFT RIGHT LOGICAL	VESRL	VRS-a	VF	$\alpha^{7,9}$	SP	Dv			E738	22-24
VECTOR ELEMENT SHIFT RIGHT LOGICAL	VESRLV	VRR-c	VF	$\alpha^{7,9}$	SP	Dv			E778	22-24
VECTOR EXCLUSIVE OR	VX	VRR-c	VF	$\alpha^{7,9}$		Dv			E76D	22-11
VECTOR FIND ANY ELEMENT EQUAL	VFAE	VRR-b C*	VF	$\alpha^{7,9}$	SP	Dv			E782	23-2
VECTOR FIND ELEMENT EQUAL	VFEE	VRR-b C*	VF	$\alpha^{7,9}$	SP	Dv			E780	23-3
VECTOR FIND ELEMENT NOT EQUAL	VFENE	VRR-b C*	VF	$\alpha^{7,9}$	SP	Dv			E781	23-4
VECTOR FP ADD	VFA	VRR-c	VF	$\alpha^{7,9}$	SP	Dv Xi	Xo Xu Xx		E7E3	24-4
VECTOR FP COMPARE AND SIGNAL SCALAR	WFK	VRR-a C	VF	$\alpha^{7,9}$	SP	Dv Xi			E7CA	24-8
VECTOR FP COMPARE EQUAL	VFCE	VRR-c C*	VF	$\alpha^{7,9}$	SP	Dv Xi			E7E8	24-9
VECTOR FP COMPARE HIGH	VFCH	VRR-c C*	VF	$\alpha^{7,9}$	SP	Dv Xi			E7EB	24-11
VECTOR FP COMPARE HIGH OR EQUAL	VFCH	VRR-c C*	VF	$\alpha^{7,9}$	SP	Dv Xi			E7EA	24-13
VECTOR FP COMPARE SCALAR	WFC	VRR-a C	VF	$\alpha^{7,9}$	SP	Dv Xi			E7CB	24-7
VECTOR FP CONVERT FROM FIXED	VCFPS	VRR-a	V2	$\alpha^{7,9}$	SP	Dv	Xx		E7C3	24-15
VECTOR FP CONVERT FROM FIXED 64-BIT	VCDG	VRR-a	VF	$\alpha^{7,9}$	SP	Dv	Xx		E7C3	24-15
VECTOR FP CONVERT FROM LOGICAL	VCFPL	VRR-a	V2	$\alpha^{7,9}$	SP	Dv	Xx		E7C1	24-17
VECTOR FP CONVERT FROM LOGICAL 64-BIT	VCDLG	VRR-a	VF	$\alpha^{7,9}$	SP	Dv	Xx		E7C1	24-17
VECTOR FP CONVERT TO FIXED	VCSFP	VRR-a	V2	$\alpha^{7,9}$	SP	Dv Xi	Xx		E7C2	24-18
VECTOR FP CONVERT TO FIXED 64-BIT	VCGD	VRR-a	VF	$\alpha^{7,9}$	SP	Dv Xi	Xx		E7C2	24-18
VECTOR FP CONVERT TO LOGICAL	VCLFP	VRR-a	V2	$\alpha^{7,9}$	SP	Dv Xi	Xx		E7C0	24-20
VECTOR FP CONVERT TO LOGICAL 64-BIT	VCLGD	VRR-a	VF	$\alpha^{7,9}$	SP	Dv Xi	Xx		E7C0	24-20
VECTOR FP DIVIDE	VFD	VRR-c	VF	$\alpha^{7,9}$	SP	Dv Xi Xz	Xo Xu Xx		E7E5	24-22
VECTOR FP LOAD LENGTHENED	VFL	VRR-a	VF	$\alpha^{7,9}$	SP	Dv Xi			E7C4	24-26
VECTOR FP LOAD ROUNDED	VFLR	VRR-a	VF	$\alpha^{7,9}$	SP	Dv Xi	Xo Xu Xx		E7C5	24-27
VECTOR FP MAXIMUM	VFM	VRR-c	V1	$\alpha^{7,9}$	SP	Dv Xi			E7EF	24-28
VECTOR FP MINIMUM	VFMIN	VRR-c	V1	$\alpha^{7,9}$	SP	Dv Xi			E7EE	24-34
VECTOR FP MULTIPLY	VFM	VRR-c	VF	$\alpha^{7,9}$	SP	Dv Xi	Xo Xu Xx		E7E7	24-40
VECTOR FP MULTIPLY AND ADD	VFMA	VRR-e	VF	$\alpha^{7,9}$	SP	Dv Xi	Xo Xu Xx		E78F	24-42
VECTOR FP MULTIPLY AND SUBTRACT	VFMS	VRR-e	VF	$\alpha^{7,9}$	SP	Dv Xi	Xo Xu Xx		E78E	24-42
VECTOR FP NEGATIVE MULTIPLY AND ADD	VFNMA	VRR-e	V1	$\alpha^{7,9}$	SP	Dv Xi	Xo Xu Xx		E79F	24-42
VECTOR FP NEGATIVE MULTIPLY AND SUBTRACT	VFNMS	VRR-e	V1	$\alpha^{7,9}$	SP	Dv Xi	Xo Xu Xx		E79E	24-42
VECTOR FP PERFORM SIGN OPERATION	VFPSO	VRR-a	VF	$\alpha^{7,9}$	SP	Dv			E7CC	24-44
VECTOR FP SQUARE ROOT	VFSQ	VRR-a	VF	$\alpha^{7,9}$	SP	Dv Xi	Xx		E7CE	24-45
VECTOR FP SUBTRACT	VFS	VRR-c	VF	$\alpha^{7,9}$	SP	Dv Xi	Xo Xu Xx		E7E2	24-46
VECTOR FP TEST DATA CLASS IMMEDIATE	VFTCI	VRI-e C	VF	$\alpha^{7,9}$	SP	Dv			E74A	24-47
VECTOR GALOIS FIELD MULTIPLY SUM	VGFM	VRR-c	VF	$\alpha^{7,9}$	SP	Dv			E7B4	22-11
VECTOR GALOIS FIELD MULTIPLY SUM AND ACCUMULATE	VGFMA	VRR-d	VF	$\alpha^{7,9}$	SP	Dv			E7BC	22-12
VECTOR GATHER ELEMENT (32)	VGEF	VRV	VF	$\alpha^{7,9}$	A SP	Dv		B ₂	E713	21-5
VECTOR GATHER ELEMENT (64)	VGEG	VRV	VF	$\alpha^{7,9}$	A SP	Dv		B ₂	E712	21-5
VECTOR GENERATE BYTE MASK	VGBM	VRI-a	VF	$\alpha^{7,9}$		Dv			E744	21-5
VECTOR GENERATE MASK	VGM	VRI-b	VF	$\alpha^{7,9}$	SP	Dv			E746	21-6
VECTOR ISOLATE STRING	VISTR	VRR-a C*	VF	$\alpha^{7,9}$	SP	Dv			E75C	23-5
VECTOR LOAD	VL	VRX	VF	$\alpha^{7,9}$	A	Dv		B ₂	E706	21-6
VECTOR LOAD	VLR	VRR-a	VF	$\alpha^{7,9}$		Dv			E756	21-6
VECTOR LOAD AND REPLICATE	VLREP	VRX	VF	$\alpha^{7,9}$	A SP	Dv		B ₂	E705	21-7
VECTOR LOAD BYTE REVERSED ELEMENT (16)	VLEBRH	VRX	V2	$\alpha^{7,9}$	A SP	Dv		B ₂	E601	21-7
VECTOR LOAD BYTE REVERSED ELEMENT (32)	VLEBRF	VRX	V2	$\alpha^{7,9}$	A SP	Dv		B ₂	E603	21-7
VECTOR LOAD BYTE REVERSED ELEMENT (64)	VLEBRG	VRX	V2	$\alpha^{7,9}$	A SP	Dv		B ₂	E602	21-7

Figure B-1. Instructions Arranged by Name (Part 21 of 24)

Name	Mnemonic	Characteristics							Op-code	Page	
VECTOR LOAD BYTE REVERSED ELEMENT AND REPLICATE	VLBRREP	VRX	V2	$\alpha^{7,9}$	A	SP	Dv	B ₂	E605	21-8	
VECTOR LOAD BYTE REVERSED ELEMENT AND ZERO	VLEBRZ	VRX	V2	$\alpha^{7,9}$	A	SP	Dv	B ₂	E604	21-8	
VECTOR LOAD BYTE REVERSED ELEMENTS	VLBR	VRX	V2	$\alpha^{7,9}$	A	SP	Dv	B ₂	E606	21-9	
VECTOR LOAD COMPLEMENT	VLC	VRR-a	VF	$\alpha^{7,9}$		SP	Dv		E7DE	22-12	
VECTOR LOAD ELEMENT (16)	VLEH	VRX	VF	$\alpha^{7,9}$	A	SP	Dv	B ₂	E701	21-9	
VECTOR LOAD ELEMENT (32)	VLEF	VRX	VF	$\alpha^{7,9}$	A	SP	Dv	B ₂	E703	21-9	
VECTOR LOAD ELEMENT (64)	VLEG	VRX	VF	$\alpha^{7,9}$	A	SP	Dv	B ₂	E702	21-9	
VECTOR LOAD ELEMENT (8)	VLEB	VRX	VF	$\alpha^{7,9}$	A	SP	Dv	B ₂	E700	21-9	
VECTOR LOAD ELEMENT IMMEDIATE (16)	VLEIH	VRI-a	VF	$\alpha^{7,9}$		SP	Dv		E741	21-10	
VECTOR LOAD ELEMENT IMMEDIATE (32)	VLEIF	VRI-a	VF	$\alpha^{7,9}$		SP	Dv		E743	21-10	
VECTOR LOAD ELEMENT IMMEDIATE (64)	VLEIG	VRI-a	VF	$\alpha^{7,9}$		SP	Dv		E742	21-10	
VECTOR LOAD ELEMENT IMMEDIATE (8)	VLEIB	VRI-a	VF	$\alpha^{7,9}$		SP	Dv		E740	21-10	
VECTOR LOAD ELEMENTS REVERSED	VLER	VRX	V2	$\alpha^{7,9}$	A	SP	Dv	B ₂	E607	21-10	
VECTOR LOAD FP INTEGER	VFI	VRR-a	VF	$\alpha^{7,9}$		SP	Dv	Xi	Xx	E7C7	24-24
VECTOR LOAD GR FROM VR ELEMENT	VLGV	VRS-c	VF	$\alpha^{7,9}$		SP	Dv			E721	21-11
VECTOR LOAD IMMEDIATE DECIMAL	VLIP	VRI-h	VD	$\alpha^{7,9}$			Dv	Dg		E649	25-10
VECTOR LOAD LOGICAL ELEMENT AND ZERO	VLEZ	VRX	VF	$\alpha^{7,9}$	A	SP	Dv	B ₂	E704	21-12	
VECTOR LOAD MULTIPLE	VLM	VRS-a	VF	$\alpha^{7,9}$	A	SP	Dv	B ₂	E736	21-12	
VECTOR LOAD POSITIVE	VLP	VRR-a	VF	$\alpha^{7,9}$		SP	Dv		E7DF	22-12	
VECTOR LOAD RIGHTMOST WITH LENGTH	VLRL	VSI	VD	$\alpha^{7,9}$	A	SP	Dv	B ₂	E635	21-13	
VECTOR LOAD RIGHTMOST WITH LENGTH	VLRLR	VRS-d	VD	$\alpha^{7,9}$	A		Dv	B ₂	E637	21-13	
VECTOR LOAD TO BLOCK BOUNDARY	VLBB	VRX	VF	$\alpha^{7,9}$	A	SP	Dv	B ₂	E707	21-14	
VECTOR LOAD VR ELEMENT FROM GR	VLVG	VRS-b	VF	$\alpha^{7,9}$		SP	Dv		E722	21-14	
VECTOR LOAD VR FROM GRS DISJOINT	VLVGP	VRR-f	VF	$\alpha^{7,9}$			Dv		E762	21-15	
VECTOR LOAD WITH LENGTH	VLL	VRS-b	VF	$\alpha^{7,9}$	A		Dv	B ₂	E737	21-15	
VECTOR MAXIMUM	VMX	VRR-c	VF	$\alpha^{7,9}$		SP	Dv		E7FF	22-13	
VECTOR MAXIMUM LOGICAL	VMXL	VRR-c	VF	$\alpha^{7,9}$		SP	Dv		E7FD	22-13	
VECTOR MERGE HIGH	VMRH	VRR-c	VF	$\alpha^{7,9}$		SP	Dv		E761	21-15	
VECTOR MERGE LOW	VMRL	VRR-c	VF	$\alpha^{7,9}$		SP	Dv		E760	21-16	
VECTOR MINIMUM	VMN	VRR-c	VF	$\alpha^{7,9}$		SP	Dv		E7FE	22-13	
VECTOR MINIMUM LOGICAL	VMNL	VRR-c	VF	$\alpha^{7,9}$		SP	Dv		E7FC	22-14	
VECTOR MULTIPLY AND ADD EVEN	VMAE	VRR-d	VF	$\alpha^{7,9}$		SP	Dv		E7AE	22-15	
VECTOR MULTIPLY AND ADD HIGH	VMAH	VRR-d	VF	$\alpha^{7,9}$		SP	Dv		E7AB	22-15	
VECTOR MULTIPLY AND ADD LOGICAL EVEN	VMALE	VRR-d	VF	$\alpha^{7,9}$		SP	Dv		E7AC	22-15	
VECTOR MULTIPLY AND ADD LOGICAL HIGH	VMALH	VRR-d	VF	$\alpha^{7,9}$		SP	Dv		E7A9	22-15	
VECTOR MULTIPLY AND ADD LOGICAL ODD	VMALO	VRR-d	VF	$\alpha^{7,9}$		SP	Dv		E7AD	22-16	
VECTOR MULTIPLY AND ADD LOW	VMAL	VRR-d	VF	$\alpha^{7,9}$		SP	Dv		E7AA	22-14	
VECTOR MULTIPLY AND ADD ODD	VMAO	VRR-d	VF	$\alpha^{7,9}$		SP	Dv		E7AF	22-16	
VECTOR MULTIPLY AND SHIFT DECIMAL	VMSP	VRI-f	C* VD	$\alpha^{7,9}$		SP	Dv	Dg	DF*	E679	25-12
VECTOR MULTIPLY DECIMAL	VMP	VRI-f	C* VD	$\alpha^{7,9}$		SP	Dv	Dg	DF*	E678	25-10
VECTOR MULTIPLY EVEN	VME	VRR-c	VF	$\alpha^{7,9}$		SP	Dv		E7A6	22-18	
VECTOR MULTIPLY HIGH	VMH	VRR-c	VF	$\alpha^{7,9}$		SP	Dv		E7A3	22-16	
VECTOR MULTIPLY LOGICAL EVEN	VMLE	VRR-c	VF	$\alpha^{7,9}$		SP	Dv		E7A4	22-18	
VECTOR MULTIPLY LOGICAL HIGH	VMLH	VRR-c	VF	$\alpha^{7,9}$		SP	Dv		E7A1	22-17	
VECTOR MULTIPLY LOGICAL ODD	VMLO	VRR-c	VF	$\alpha^{7,9}$		SP	Dv		E7A5	22-18	
VECTOR MULTIPLY LOW	VML	VRR-c	VF	$\alpha^{7,9}$		SP	Dv		E7A2	22-17	
VECTOR MULTIPLY ODD	VMO	VRR-c	VF	$\alpha^{7,9}$		SP	Dv		E7A7	22-18	
VECTOR MULTIPLY SUM LOGICAL	VMSL	VRR-d	V1	$\alpha^{7,9}$		SP	Dv		E7B8	22-19	
VECTOR NAND	VNN	VRR-c	V1	$\alpha^{7,9}$			Dv		E76E	22-20	
VECTOR NOR	VNO	VRR-c	VF	$\alpha^{7,9}$			Dv		E76B	22-20	
VECTOR NOT EXCLUSIVE OR	VNX	VRR-c	V1	$\alpha^{7,9}$			Dv		E76C	22-20	
VECTOR OR	VO	VRR-c	VF	$\alpha^{7,9}$			Dv		E76A	22-20	
VECTOR OR WITH COMPLEMENT	VOC	VRR-c	V1	$\alpha^{7,9}$			Dv		E76F	22-21	

Figure B-1. Instructions Arranged by Name (Part 22 of 24)

Name	Mnemonic	Characteristics							Op-code	Page	
VECTOR PACK	VPK	VRR-c	VF	$\alpha^{7,9}$	SP	Dv			E794	21-16	
VECTOR PACK LOGICAL SATURATE	VPKLS	VRR-b C*	VF	$\alpha^{7,9}$	SP	Dv			E795	21-18	
VECTOR PACK SATURATE	VPKS	VRR-b C*	VF	$\alpha^{7,9}$	SP	Dv			E797	21-17	
VECTOR PACK ZONED	VPKZ	VSI	VD	$\alpha^{7,9}$	A SP	Dv		B ₂	E634	25-13	
VECTOR PERFORM SIGN OPERATION DECIMAL	VPSOP	VRI-g C*	VD	$\alpha^{7,9}$	SP	Dv	Dg DF*		E65B	25-14	
VECTOR PERMUTE	VPERM	VRR-e	VF	$\alpha^{7,9}$		Dv			E78C	21-18	
VECTOR PERMUTE DOUBLEWORD IMMEDIATE	VPDI	VRR-c	VF	$\alpha^{7,9}$		Dv			E784	21-19	
VECTOR POPULATION COUNT	VPOPCT	VRR-a	VF	$\alpha^{7,9}$	SP	Dv			E750	22-21	
VECTOR REMAINDER DECIMAL	VRP	VRI-f C*	VD	$\alpha^{7,9}$	SP	Dv	Dg DF* DK		E67B	25-16	
VECTOR REPLICATE	VREP	VRI-c	VF	$\alpha^{7,9}$	SP	Dv			E74D	21-19	
VECTOR REPLICATE IMMEDIATE	VREPI	VRI-a	VF	$\alpha^{7,9}$	SP	Dv			E745	21-20	
VECTOR SCATTER ELEMENT (32)	VSCEF	VRV	VF	$\alpha^{7,9}$	A SP	Dv		ST	B ₂	E71B	21-20
VECTOR SCATTER ELEMENT (64)	VSCEG	VRV	VF	$\alpha^{7,9}$	A SP	Dv		ST	B ₂	E71A	21-20
VECTOR SELECT	VSEL	VRR-e	VF	$\alpha^{7,9}$		Dv			E78D	21-21	
VECTOR SHIFT AND DIVIDE DECIMAL	VSDP	VRI-f C*	VD	$\alpha^{7,9}$	SP	Dv	Dg DF* DK		E67E	25-18	
VECTOR SHIFT AND ROUND DECIMAL	VSRP	VRI-g C*	VD	$\alpha^{7,9}$	SP	Dv	Dg DF*		E659	25-19	
VECTOR SHIFT LEFT	VSL	VRR-c	VF	$\alpha^{7,9}$		Dv			E774	22-25	
VECTOR SHIFT LEFT BY BYTE	VSLB	VRR-c	VF	$\alpha^{7,9}$		Dv			E775	22-25	
VECTOR SHIFT LEFT DOUBLE BY BIT	VSLD	VRI-d	V2	$\alpha^{7,9}$	SP	Dv			E786	22-25	
VECTOR SHIFT LEFT DOUBLE BY BYTE	VSLDB	VRI-d	VF	$\alpha^{7,9}$		Dv			E777	22-26	
VECTOR SHIFT RIGHT ARITHMETIC	VSRA	VRR-c	VF	$\alpha^{7,9}$		Dv			E77E	22-26	
VECTOR SHIFT RIGHT ARITHMETIC BY BYTE	VSRA B	VRR-c	VF	$\alpha^{7,9}$		Dv			E77F	22-26	
VECTOR SHIFT RIGHT DOUBLE BY BIT	VSRD	VRI-d	V2	$\alpha^{7,9}$	SP	Dv			E787	22-26	
VECTOR SHIFT RIGHT LOGICAL	VSRL	VRR-c	VF	$\alpha^{7,9}$		Dv			E77C	22-27	
VECTOR SHIFT RIGHT LOGICAL BY BYTE	VSRLB	VRR-c	VF	$\alpha^{7,9}$		Dv			E77D	22-27	
VECTOR SIGN EXTEND TO DOUBLEWORD	VSEG	VRR-a	VF	$\alpha^{7,9}$	SP	Dv			E75F	21-21	
VECTOR STORE	VST	VRX	VF	$\alpha^{7,9}$	A	Dv		ST	B ₂	E70E	21-21
VECTOR STORE BYTE REVERSED ELEMENT (16)	VSTEBR H	VRX	V2	$\alpha^{7,9}$	A SP	Dv		ST	B ₂	E609	21-22
VECTOR STORE BYTE REVERSED ELEMENT (32)	VSTEBR F	VRX	V2	$\alpha^{7,9}$	A SP	Dv		ST	B ₂	E60B	21-22
VECTOR STORE BYTE REVERSED ELEMENT (64)	VSTEBR G	VRX	V2	$\alpha^{7,9}$	A SP	Dv		ST	B ₂	E60A	21-22
VECTOR STORE BYTE REVERSED ELEMENTS	VSTBR	VRX	V2	$\alpha^{7,9}$	A SP	Dv		ST	B ₂	E60E	21-22
VECTOR STORE ELEMENT (16)	VSTEH	VRX	VF	$\alpha^{7,9}$	A SP	Dv		ST	B ₂	E709	21-23
VECTOR STORE ELEMENT (32)	VSTEF	VRX	VF	$\alpha^{7,9}$	A SP	Dv		ST	B ₂	E70B	21-23
VECTOR STORE ELEMENT (64)	VSTEG	VRX	VF	$\alpha^{7,9}$	A SP	Dv		ST	B ₂	E70A	21-23
VECTOR STORE ELEMENT (8)	VSTEB	VRX	VF	$\alpha^{7,9}$	A SP	Dv		ST	B ₂	E708	21-23
VECTOR STORE ELEMENTS REVERSED	VSTER	VRX	V2	$\alpha^{7,9}$	A SP	Dv		ST	B ₂	E60F	21-24
VECTOR STORE MULTIPLE	VSTM	VRS-a	VF	$\alpha^{7,9}$	A SP	Dv		ST	B ₂	E73E	21-24
VECTOR STORE RIGHTMOST WITH LENGTH	VSTRL	VSI	VD	$\alpha^{7,9}$	A SP	Dv		ST	B ₂	E63D	21-25
VECTOR STORE RIGHTMOST WITH LENGTH	VSTRLR	VRS-d	VD	$\alpha^{7,9}$	A	Dv		ST	B ₂	E63F	21-25
VECTOR STORE WITH LENGTH	VSTL	VRS-b	VF	$\alpha^{7,9}$	A	Dv		ST	B ₂	E73F	21-26
VECTOR STRING RANGE COMPARE	VSTRC	VRR-d C*	VF	$\alpha^{7,9}$	SP	Dv			E78A	23-6	
VECTOR STRING SEARCH	VSTRS	VRR-d C	V2	$\alpha^{7,9}$	SP	Dv			E78B	23-8	
VECTOR SUBTRACT	VS	VRR-c	VF	$\alpha^{7,9}$	SP	Dv			E7F7	22-27	
VECTOR SUBTRACT COMPUTE BORROW INDICATION	VSCBI	VRR-c	VF	$\alpha^{7,9}$	SP	Dv			E7F5	22-28	
VECTOR SUBTRACT DECIMAL	VSP	VRI-f C*	VD	$\alpha^{7,9}$	SP	Dv	Dg DF*		E673	25-21	
VECTOR SUBTRACT WITH BORROW COMPUTE BORROW INDICATION	VSBCBI	VRR-d	VF	$\alpha^{7,9}$	SP	Dv			E7BD	22-29	
VECTOR SUBTRACT WITH BORROW INDICATION	VSBI	VRR-d	VF	$\alpha^{7,9}$	SP	Dv			E7BF	22-28	
VECTOR SUM ACROSS DOUBLEWORD	VSUMG	VRR-c	VF	$\alpha^{7,9}$	SP	Dv			E765	22-29	
VECTOR SUM ACROSS QUADWORD	VSUMQ	VRR-c	VF	$\alpha^{7,9}$	SP	Dv			E767	22-30	
VECTOR SUM ACROSS WORD	VSUM	VRR-c	VF	$\alpha^{7,9}$	SP	Dv			E764	22-30	

Figure B-1. Instructions Arranged by Name (Part 23 of 24)

Name	Mnemonic	Characteristics										Op-code	Page			
VECTOR TEST DECIMAL	VTP	VRR-g	C	VD	$\alpha^{7,9}$					Dv			E65F	25-22		
VECTOR TEST UNDER MASK	VTM	VRR-a	C	VF	$\alpha^{7,9}$					Dv			E7D8	22-31		
VECTOR UNPACK HIGH	VUPH	VRR-a		VF	$\alpha^{7,9}$			SP		Dv			E7D7	21-26		
VECTOR UNPACK LOGICAL HIGH	VUPLH	VRR-a		VF	$\alpha^{7,9}$			SP		Dv			E7D5	21-26		
VECTOR UNPACK LOGICAL LOW	VUPLL	VRR-a		VF	$\alpha^{7,9}$			SP		Dv			E7D4	21-27		
VECTOR UNPACK LOW	VUPL	VRR-a		VF	$\alpha^{7,9}$			SP		Dv			E7D6	21-27		
VECTOR UNPACK ZONED	VUPKZ	VSI		VD	$\alpha^{7,9}$	A		SP		Dv	ST		B ₂	E63C	25-22	
ZERO AND ADD	ZAP	SS-b	C		α^9	A				Dg	DF	ST	B ₁	B ₂	F8	8-14

Figure B-1. Instructions Arranged by Name (Part 24 of 24)

Instructions Arranged by Mnemonic

Mnemonic	Name	Characteristics						Op-code	Page
—	DIAGNOSE	DM	P	DM			MD	83	10-23
A	ADD (32)	RX-a C	A		IF		B ₂	5A	7-26
AD	ADD NORMALIZED (long HFP)	RX-a C	$\alpha^{7,9}$ A		Da EU EO LS		B ₂	6A	18-8
ADB	ADD (long BFP)	RXE C	$\alpha^{7,9}$ A		Db Xi Xo Xu Xx		B ₂	ED1A	19-15
ADBR	ADD (long BFP)	RRE C	$\alpha^{7,9}$		Db Xi Xo Xu Xx			B31A	19-15
ADR	ADD NORMALIZED (long HFP)	RR C	$\alpha^{7,9}$		Da EU EO LS			2A	18-8
ADTR	ADD (long DFP)	RRF-a C TF	$\alpha^{7,9}$		Dt Xi Xo Xu Xx			B3D2	20-19
ADTRA	ADD (long DFP)	RRF-a C F	$\alpha^{7,9}$		Dt Xi Xo Xu Xx Xq			B3D2	20-19
AE	ADD NORMALIZED (short HFP)	RX-a C	$\alpha^{7,9}$ A		Da EU EO LS		B ₂	7A	18-8
AEB	ADD (short BFP)	RXE C	$\alpha^{7,9}$ A		Db Xi Xo Xu Xx		B ₂	ED0A	19-15
AEBR	ADD (short BFP)	RRE C	$\alpha^{7,9}$		Db Xi Xo Xu Xx			B30A	19-15
AER	ADD NORMALIZED (short HFP)	RR C	$\alpha^{7,9}$		Da EU EO LS			3A	18-8
AFI	ADD IMMEDIATE (32)	RIL-a C EI			IF			C29	7-26
AG	ADD (64)	RXY-a C N	A		IF		B ₂	E308	7-26
AGF	ADD (64←32)	RXY-a C N	A		IF		B ₂	E318	7-26
AGFI	ADD IMMEDIATE (64←32)	RIL-a C EI			IF			C28	7-26
AGFR	ADD (64←32)	RRE C N			IF			B918	7-25
AGH	ADD HALFWORD (64←16)	RXY-a C MI2	A		IF		B ₂	E338	7-28
AGHI	ADD HALFWORD IMMEDIATE (64←16)	RI-a C N			IF			A7B	7-28
AGHIK	ADD IMMEDIATE (64←16)	RIE-d C DO			IF			ECD9	7-26
AGR	ADD (64)	RRE C N			IF			B908	7-25
AGRK	ADD (64)	RRF-a C DO			IF			B9E8	7-25
AGSI	ADD IMMEDIATE (64←8)	SIY C GE	A		IF ξ^1	ST	B ₁	EB7A	7-26
AH	ADD HALFWORD (32←16)	RX-a C	A		IF		B ₂	4A	7-27
AHHHR	ADD HIGH (32)	RRF-a C HW			IF			B9C8	7-28
AHHLR	ADD HIGH (32)	RRF-a C HW			IF			B9D8	7-28
AHI	ADD HALFWORD IMMEDIATE (32←16)	RI-a C			IF			A7A	7-28
AHIK	ADD IMMEDIATE (32←16)	RIE-d C DO			IF			ECD8	7-26
AHY	ADD HALFWORD (32←16)	RXY-a C LD	A		IF		B ₂	E37A	7-27
AIH	ADD IMMEDIATE HIGH (32)	RIL-a C HW			IF			CC8	7-29
AL	ADD LOGICAL (32)	RX-a C	A				B ₂	5E	7-29
ALC	ADD LOGICAL WITH CARRY (32)	RXY-a C N3	A				B ₂	E398	7-30
ALCG	ADD LOGICAL WITH CARRY (64)	RXY-a C N	A				B ₂	E388	7-30
ALCGR	ADD LOGICAL WITH CARRY (64)	RRE C N						B988	7-30
ALCR	ADD LOGICAL WITH CARRY (32)	RRE C N3						B998	7-30
ALFI	ADD LOGICAL IMMEDIATE (32)	RIL-a C EI						C2B	7-29
ALG	ADD LOGICAL (64)	RXY-a C N	A				B ₂	E30A	7-29
ALGF	ADD LOGICAL (64←32)	RXY-a C N	A				B ₂	E31A	7-29
ALGFI	ADD LOGICAL IMMEDIATE (64←32)	RIL-a C EI						C2A	7-29
ALGFR	ADD LOGICAL (64←32)	RRE C N						B91A	7-29
ALGHSIK	ADD LOGICAL WITH SIGNED IMMEDIATE (64←16)	RIE-d C DO						ECDB	7-31
ALGR	ADD LOGICAL (64)	RRE C N						B90A	7-29
ALGRK	ADD LOGICAL (64)	RRF-a C DO						B9EA	7-29
ALGSI	ADD LOGICAL WITH SIGNED IMMEDIATE (64←8)	SIY C GE	A		ξ^1	ST	B ₁	EB7E	7-31
ALHHHR	ADD LOGICAL HIGH (32)	RRF-a C HW						B9CA	7-30
ALHHLR	ADD LOGICAL HIGH (32)	RRF-a C HW						B9DA	7-30
ALHSIK	ADD LOGICAL WITH SIGNED IMMEDIATE (32←16)	RIE-d C DO						ECDA	7-31
ALR	ADD LOGICAL (32)	RR C						1E	7-29
ALRK	ADD LOGICAL (32)	RRF-a C DO						B9FA	7-29
ALSI	ADD LOGICAL WITH SIGNED IMMEDIATE (32←8)	SIY C GE	A		ξ^1	ST	B ₁	EB6E	7-31

Figure B-2. Instructions Arranged by Mnemonic (Part 1 of 24)

Mnemonic	Name	Characteristics							Op-code	Page
ALSIH	ADD LOGICAL WITH SIGNED IMMEDIATE HIGH (32)	RIL-a	C	HW					CCA	7-32
ALSIHN	ADD LOGICAL WITH SIGNED IMMEDIATE HIGH (32)	RIL-a		HW					CCB	7-32
ALY	ADD LOGICAL (32)	RXY-a	C	LD	α	A			B ₂ E35E	7-29
AP	ADD DECIMAL	SS-b	C		α^9	A	Dg DF	ST	B ₁ B ₂ FA	8-6
AR	ADD (32)	RR		C			IF		1A	7-25
ARK	ADD (32)	RRF-a	C	DO			IF		B9F8	7-25
ASI	ADD IMMEDIATE (32←8)	SIY	C	GE		A	IF ξ^1	ST	B ₁ EB6A	7-26
AU	ADD UNNORMALIZED (short HFP)	RX-a	C		$\alpha^{7,9}$	A	Da EO LS		B ₂ 7E	18-9
AUR	ADD UNNORMALIZED (short HFP)	RR		C	$\alpha^{7,9}$		Da EO LS		3E	18-9
AW	ADD UNNORMALIZED (long HFP)	RX-a	C		$\alpha^{7,9}$	A	Da EO LS		B ₂ 6E	18-9
AWR	ADD UNNORMALIZED (long HFP)	RR		C	$\alpha^{7,9}$		Da EO LS		2E	18-9
AXBR	ADD (extended BFP)	RRE		C	$\alpha^{7,9}$	SP	Db Xi Xo Xu Xx		B34A	19-15
AXR	ADD NORMALIZED (extended HFP)	RR		C	$\alpha^{7,9}$	SP	Da EU EO LS		36	18-8
AXTR	ADD (extended DFP)	RRF-a	C	TF	$\alpha^{7,9}$	SP	Dt Xi Xo Xu Xx		B3DA	20-19
AXTRA	ADD (extended DFP)	RRF-a	C	F	$\alpha^{7,9}$	SP	Dt Xi Xo Xu Xx Xq		B3DA	20-19
AY	ADD (32)	RXY-a	C	LD	α	A	IF		B ₂ E35A	7-26
BAKR	BRANCH AND STACK	RRE			α^1	A ^{1*}	Z ⁵ T	B ST	B240	10-11
BAL	BRANCH AND LINK	RX-a			α^9			B	45	7-35
BALR	BRANCH AND LINK	RR			$\alpha^{2,9}$		T	B	05	7-35
BAS	BRANCH AND SAVE	RX-a			α^9			B	4D	7-36
BASR	BRANCH AND SAVE	RR			$\alpha^{2,9}$		T	B	0D	7-36
BASSM	BRANCH AND SAVE AND SET MODE	RR			$\alpha^{2,3,9}$		T	B	0C	7-36
BC	BRANCH ON CONDITION	RX-b			α^9			B	47	7-39
BCR	BRANCH ON CONDITION	RR			α^9		ϕ^1	B	07	7-39
BCT	BRANCH ON COUNT (32)	RX-a			α^9			B	46	7-40
BCTG	BRANCH ON COUNT (64)	RXY-a		N	α^9			B	E346	7-40
BCTGR	BRANCH ON COUNT (64)	RRE		N	α^9			B	B946	7-40
BCTR	BRANCH ON COUNT (32)	RR			α^9			B	06	7-40
BIC	BRANCH INDIRECT ON CONDITION	RXY-b		MI2	α^9	A		B	B ₂ E347	7-38
BPP	BRANCH PREDICTION PRELOAD	SMI		EH	α^9				C7	7-42
BPRP	BRANCH PREDICTION RELATIVE PRELOAD	MII		EH	α^9				C5	7-42
BRAS	BRANCH RELATIVE AND SAVE	RI-b			α^9			B	A75	7-45
BRASL	BRANCH RELATIVE AND SAVE LONG	RIL-b		N3	α^9			B	C05	7-45
BRC	BRANCH RELATIVE ON CONDITION	RI-c			α^{10}			B	A74	7-46
BRCL	BRANCH RELATIVE ON CONDITION LONG	RIL-c		N3	α^{10}			B	C04	7-46
BRCT	BRANCH RELATIVE ON COUNT (32)	RI-b			α^9			B	A76	7-47
BRCTG	BRANCH RELATIVE ON COUNT (64)	RI-b		N	α^9			B	A77	7-47
BRCTH	BRANCH RELATIVE ON COUNT HIGH (32)	RIL-b		HW	α^9			B	CC6	7-47
BRXH	BRANCH RELATIVE ON INDEX HIGH (32)	RSI			α^9			B	84	7-47
BRXHG	BRANCH RELATIVE ON INDEX HIGH (64)	RIE-e		N	α^9			B	EC44	7-47
BRXLE	BRANCH RELATIVE ON INDEX LOW OR EQ. (32)	RSI			α^9			B	85	7-47
BRXLG	BRANCH RELATIVE ON INDEX LOW OR EQ. (64)	RIE-e		N	α^9			B	EC45	7-48
BSA	BRANCH AND SET AUTHORITY	RRE			Q	A ^{1*}	SO T	B	B25A	10-7
BSG	BRANCH IN SUBSPACE GROUP	RRE			α^1	A ^{1*}	SO T	B	R ₂ B258	10-13
BSM	BRANCH AND SET MODE	RR			$\alpha^{3,9}$		T	B	0B	7-37
BXH	BRANCH ON INDEX HIGH (32)	RS-a			α^9			B	86	7-41
BXHG	BRANCH ON INDEX HIGH (64)	RSY-a		N	α^9			B	EB44	7-41
BXLE	BRANCH ON INDEX LOW OR EQUAL (32)	RS-a			α^9			B	87	7-41
BXLEG	BRANCH ON INDEX LOW OR EQUAL (64)	RSY-a		N	α^9			B	EB45	7-41
C	COMPARE (32)	RX-a		C		A			B ₂ 59	7-133
CD	COMPARE (long HFP)	RX-a		C	$\alpha^{7,9}$	A	Da		B ₂ 69	18-10
CDB	COMPARE (long BFP)	RXE		C	$\alpha^{7,9}$	A	Db Xi		B ₂ ED19	19-17
CDBR	COMPARE (long BFP)	RRE		C	$\alpha^{7,9}$		Db Xi		B319	19-17

Figure B-2. Instructions Arranged by Mnemonic (Part 2 of 24)

Mnemonic	Name	Characteristics						Op-code	Page
CDFBR	CONVERT FROM FIXED (32 to long BFP)	RRE		$\alpha^{7,9}$		Db		B395	19-19
CDFBRA	CONVERT FROM FIXED (32 to long BFP)	RRF-e	F	$\alpha^{7,9}$	SP	Db		B395	19-19
CDFR	CONVERT FROM FIXED (32 to long HFP)	RRE		$\alpha^{7,9}$		Da		B3B5	18-11
CDFTR	CONVERT FROM FIXED (32 to long DFP)	RRE	F	$\alpha^{7,9}$		Dt		B951	20-24
CDGBR	CONVERT FROM FIXED (64 to long BFP)	RRE	N	$\alpha^{7,9}$		Db	Xx	B3A5	19-19
CDGBRA	CONVERT FROM FIXED (64 to long BFP)	RRF-e	F	$\alpha^{7,9}$	SP	Db	Xx	B3A5	19-19
CDGR	CONVERT FROM FIXED (64 to long HFP)	RRE	N	$\alpha^{7,9}$		Da		B3C5	18-11
CDGTR	CONVERT FROM FIXED (64 to long DFP)	RRE	TF	$\alpha^{7,9}$		Dt	Xx	B3F1	20-24
CDGTRA	CONVERT FROM FIXED (64 to long DFP)	RRF-e	F	$\alpha^{7,9}$		Dt	Xx Xq	B3F1	20-24
CDLFBR	CONVERT FROM LOGICAL (32 to long BFP)	RRF-e	F	$\alpha^{7,9}$	SP	Db		B391	19-21
CDLFTR	CONVERT FROM LOGICAL (32 to long DFP)	RRF-e	F	$\alpha^{7,9}$		Dt		B953	20-25
CDLGBR	CONVERT FROM LOGICAL (64 to long BFP)	RRF-e	F	$\alpha^{7,9}$	SP	Db	Xx	B3A1	19-21
CDLGTR	CONVERT FROM LOGICAL (64 to long DFP)	RRF-e	F	$\alpha^{7,9}$		Dt	Xx Xq	B952	20-25
CDPT	CONVERT FROM PACKED (to long DFP)	RSL-b	PC	$\alpha^{7,9}$	A SP	Dt Dg		B ₂	EDAE
CDR	COMPARE (long HFP)	RR	C	$\alpha^{7,9}$		Da		29	18-10
CDS	COMPARE DOUBLE AND SWAP (32)	RS-a	C	α^9	A SP		\$	ST	B ₂
CDSG	COMPARE DOUBLE AND SWAP (64)	RSY-a	C N	α^9	A SP		\$	ST	B ₂
CDSTR	CONVERT FROM SIGNED PACKED (64 to long DFP)	RRE	TF	$\alpha^{7,9}$		Dt Dg			B3F3
CDSY	COMPARE DOUBLE AND SWAP (32)	RSY-a	C LD	α^9	A SP		\$	ST	B ₂
CDTR	COMPARE (long DFP)	RRE	C TF	$\alpha^{7,9}$		Dt Xi			B3E4
CDUTR	CONVERT FROM UNSIGNED PACKED (64 to long DFP)	RRE	TF	$\alpha^{7,9}$		Dt Dg			B3F2
CDZT	CONVERT FROM ZONED (to long DFP)	RSL-b	ZF	$\alpha^{7,9}$	A SP	Dt Dg		B ₂	EDAA
CE	COMPARE (short HFP)	RX-a	C	$\alpha^{7,9}$	A	Da		B ₂	79
CEB	COMPARE (short BFP)	RXE	C	$\alpha^{7,9}$	A	Db Xi		B ₂	ED09
CEBR	COMPARE (short BFP)	RRE	C	$\alpha^{7,9}$		Db Xi			B309
CEDTR	COMPARE BIASED EXPONENT (long DFP)	RRE	C TF	$\alpha^{7,9}$		Dt			B3F4
CEFBR	CONVERT FROM FIXED (32 to short BFP)	RRE		$\alpha^{7,9}$		Db	Xx		B394
CEFBRA	CONVERT FROM FIXED (32 to short BFP)	RRF-e	F	$\alpha^{7,9}$	SP	Db	Xx		B394
CEFR	CONVERT FROM FIXED (32 to short HFP)	RRE		$\alpha^{7,9}$		Da			B3B4
CEGBR	CONVERT FROM FIXED (64 to short BFP)	RRE	N	$\alpha^{7,9}$		Db	Xx		B3A4
CEGBRA	CONVERT FROM FIXED (64 to short BFP)	RRF-e	F	$\alpha^{7,9}$	SP	Db	Xx		B3A4
CEGR	CONVERT FROM FIXED (64 to short HFP)	RRE	N	$\alpha^{7,9}$		Da			B3C4
CELFBR	CONVERT FROM LOGICAL (32 to short BFP)	RRF-e	F	$\alpha^{7,9}$	SP	Db	Xx		B390
CELGBR	CONVERT FROM LOGICAL (64 to short BFP)	RRF-e	F	$\alpha^{7,9}$	SP	Db	Xx		B3A0
CER	COMPARE (short HFP)	RR	C	$\alpha^{7,9}$		Da			39
CEXTR	COMPARE BIASED EXPONENT (extended DFP)	RRE	C TF	$\alpha^{7,9}$	SP	Dt			B3FC
CFC	COMPARE AND FORM CODEWORD	S	C	α^9	A SP	II	GM II		B21A
CFDBR	CONVERT TO FIXED (long BFP to 32)	RRF-e	C	$\alpha^{7,9}$	SP	Db Xi	Xx		B399
CFDBRA	CONVERT TO FIXED (long BFP to 32)	RRF-e	C F	$\alpha^{7,9}$	SP	Db Xi	Xx		B399
CFDR	CONVERT TO FIXED (long HFP to 32)	RRF-e	C	$\alpha^{7,9}$	SP	Da			B3B9
CFDTR	CONVERT TO FIXED (long DFP to 32)	RRF-e	C F	$\alpha^{7,9}$		Dt Xi	Xx		B941
CFEBR	CONVERT TO FIXED (short BFP to 32)	RRF-e	C	$\alpha^{7,9}$	SP	Db Xi	Xx		B398
CFEBRA	CONVERT TO FIXED (short BFP to 32)	RRF-e	C F	$\alpha^{7,9}$	SP	Db Xi	Xx		B398
CFER	CONVERT TO FIXED (short HFP to 32)	RRF-e	C	$\alpha^{7,9}$	SP	Da			B3B8
CFI	COMPARE IMMEDIATE (32)	RIL-a	C EI						C2D
CFXBR	CONVERT TO FIXED (extended BFP to 32)	RRF-e	C	$\alpha^{7,9}$	SP	Db Xi	Xx		B39A
CFXBRA	CONVERT TO FIXED (extended BFP to 32)	RRF-e	C F	$\alpha^{7,9}$	SP	Db Xi	Xx		B39A
CFXR	CONVERT TO FIXED (extended HFP to 32)	RRF-e	C	$\alpha^{7,9}$	SP	Da			B3BA
CFXTR	CONVERT TO FIXED (extended DFP to 32)	RRF-e	C F	$\alpha^{7,9}$	SP	Dt Xi	Xx		B949
CG	COMPARE (64)	RXY-a	C N		A			B ₂	E320
CGDBR	CONVERT TO FIXED (long BFP to 64)	RRF-e	C N	$\alpha^{7,9}$	SP	Db Xi	Xx		B3A9
CGDBRA	CONVERT TO FIXED (long BFP to 64)	RRF-e	C F	$\alpha^{7,9}$	SP	Db Xi	Xx		B3A9
CGDR	CONVERT TO FIXED (long HFP to 64)	RRF-e	C N	$\alpha^{7,9}$	SP	Da			B3C9

Figure B-2. Instructions Arranged by Mnemonic (Part 3 of 24)

Mnemonic	Name	Characteristics							Op-code	Page		
CGDTR	CONVERT TO FIXED (long DFP to 64)	RRF-e	C	TF	$\alpha^{7,9}$		Dt Xi	Xx		B3E1	20-29	
CGDTRA	CONVERT TO FIXED (long DFP to 64)	RRF-e	C	F	$\alpha^{7,9}$		Dt Xi	Xx		B3E1	20-30	
CGEBR	CONVERT TO FIXED (short BFP to 64)	RRF-e	C	N	$\alpha^{7,9}$	SP	Db Xi	Xx		B3A8	19-22	
CGEBRA	CONVERT TO FIXED (short BFP to 64)	RRF-e	C	F	$\alpha^{7,9}$	SP	Db Xi	Xx		B3A8	19-22	
CGER	CONVERT TO FIXED (short HFP to 64)	RRF-e	C	N	$\alpha^{7,9}$	SP	Da			B3C8	18-11	
CGF	COMPARE (64←32)	RXY-a	C	N		A			B ₂	E330	7-133	
CGFI	COMPARE IMMEDIATE (64←32)	RIL-a	C	EI						C2C	7-134	
CGFR	COMPARE (64←32)	RRE	C	N						B930	7-133	
CGFRL	COMPARE RELATIVE LONG (64←32)	RIL-b	C	GE		A* SP				C6C	7-134	
CGH	COMPARE HALFWORD (64←16)	RXY-a	C	GE		A			B ₂	E334	7-149	
CGHI	COMPARE HALFWORD IMMEDIATE (64←16)	Rl-a	C	N						A7F	7-149	
CGHRL	COMPARE HALFWORD RELATIVE LONG (64←16)	RIL-b	C	GE		A*				C64	7-149	
CGHSI	COMPARE HALFWORD IMMEDIATE (64←16)	SIL	C	GE		A			B ₁	E558	7-149	
CGIB	COMPARE IMMEDIATE AND BRANCH (64←8)	RIS		GE	α^9				B	ECFC	7-135	
CGIJ	COMPARE IMMEDIATE AND BRANCH RELATIVE (64←8)	RIE-c		GE	α^{10}				B	EC7C	7-135	
CGIT	COMPARE IMMEDIATE AND TRAP (64←16)	RIE-a		GE			Dc			EC70	7-148	
CGR	COMPARE (64)	RRE	C	N						B920	7-133	
CGRB	COMPARE AND BRANCH (64)	RRS		GE	α^9				B	ECE4	7-134	
CGRJ	COMPARE AND BRANCH RELATIVE (64)	RIE-b		GE	α^{10}				B	EC64	7-135	
CGRL	COMPARE RELATIVE LONG (64)	RIL-b	C	GE		A* SP				C68	7-134	
CGRT	COMPARE AND TRAP (64)	RRF-c		GE			Dc			B960	7-148	
CGXBR	CONVERT TO FIXED (extended BFP to 64)	RRF-e	C	N	$\alpha^{7,9}$	SP	Db Xi	Xx		B3AA	19-22	
CGXBRA	CONVERT TO FIXED (extended BFP to 64)	RRF-e	C	F	$\alpha^{7,9}$	SP	Db Xi	Xx		B3AA	19-22	
CGXR	CONVERT TO FIXED (extended HFP to 64)	RRF-e	C	N	$\alpha^{7,9}$	SP	Da			B3CA	18-11	
CGXTR	CONVERT TO FIXED (extended DFP to 64)	RRF-e	C	TF	$\alpha^{7,9}$	SP	Dt Xi	Xx		B3E9	20-29	
CGXTRA	CONVERT TO FIXED (extended DFP to 64)	RRF-e	C	F	$\alpha^{7,9}$	SP	Dt Xi	Xx		B3E9	20-30	
CH	COMPARE HALFWORD (32←16)	RX-a	C			A			B ₂	49	7-149	
CHF	COMPARE HIGH (32)	RXY-a	C	HW		A			B ₂	E3CD	7-150	
CHHR	COMPARE HIGH (32)	RRE	C	HW						B9CD	7-150	
CHHSI	COMPARE HALFWORD IMMEDIATE (16←16)	SIL	C	GE		A			B ₁	E554	7-149	
CHI	COMPARE HALFWORD IMMEDIATE (32←16)	Rl-a	C							A7E	7-149	
CHLR	COMPARE HIGH (32)	RRE	C	HW						B9DD	7-150	
CHRL	COMPARE HALFWORD RELATIVE LONG (32←16)	RIL-b	C	GE		A*				C65	7-149	
CHSI	COMPARE HALFWORD IMMEDIATE (32←16)	SIL	C	GE		A			B ₁	E55C	7-149	
CHY	COMPARE HALFWORD (32←16)	RXY-a	C	LD		A			B ₂	E379	7-149	
CIB	COMPARE IMMEDIATE AND BRANCH (32←8)	RIS		GE	α^9				B	ECFE	7-135	
CIH	COMPARE IMMEDIATE HIGH (32)	RIL-a	C	HW						CCD	7-150	
CIJ	COMPARE IMMEDIATE AND BRANCH RELATIVE (32←8)	RIE-c		GE	α^{10}				B	EC7E	7-135	
CIT	COMPARE IMMEDIATE AND TRAP (32←16)	RIE-a		GE			Dc			EC72	7-148	
CKSM	CHECKSUM	RRE	C		α^9	A SP	IC			R ₂	B241	7-49
CL	COMPARE LOGICAL (32)	RX-a	C			A				B ₂	55	7-151
CLC	COMPARE LOGICAL (character)	SS-a	C		α^9	A			B ₁	B ₂	D5	7-151
CLCL	COMPARE LOGICAL LONG	RR	C		α^9	A SP	II		R ₁	R ₂	0F	7-157
CLCLE	COMPARE LOGICAL LONG EXTENDED	RS-a	C		α^9	A SP	IC		R ₁	R ₃	A9	7-159
CLCLU	COMPARE LOGICAL LONG UNICODE	RSY-a	C	E2	α^9	A SP	IC		R ₁	R ₂	EB8F	7-162
CLFDBR	CONVERT TO LOGICAL (long BFP to 32)	RRF-e	C	F	$\alpha^{7,9}$	SP	Db Xi	Xx		B39D	19-25	
CLFDTR	CONVERT TO LOGICAL (long DFP to 32)	RRF-e	C	F	$\alpha^{7,9}$		Dt Xi	Xx		B943	20-32	
CLFEBR	CONVERT TO LOGICAL (short BFP to 32)	RRF-e	C	F	$\alpha^{7,9}$	SP	Db Xi	Xx		B39C	19-25	
CLFHSI	COMPARE LOGICAL IMMEDIATE (32←16)	SIL	C	GE		A			B ₁	E55D	7-151	
CLFI	COMPARE LOGICAL IMMEDIATE (32)	RIL-a	C	EI						C2F	7-151	
CLFIT	COMPARE LOGICAL IMMEDIATE AND TRAP (32←16)	RIE-a		GE			Dc			EC73	7-155	
CLFXBR	CONVERT TO LOGICAL (extended BFP to 32)	RRF-e	C	F	$\alpha^{7,9}$	SP	Db Xi	Xx		B39E	19-25	

Figure B-2. Instructions Arranged by Mnemonic (Part 4 of 24)

Mnemonic	Name	Characteristics										Op-code	Page			
CLFXTR	CONVERT TO LOGICAL (extended DFP to 32)	RRF-e	C	F	$\alpha^{7,9}$	SP	Dt	Xi		Xx		B ₂	B94B	20-32		
CLG	COMPARE LOGICAL (64)	RXY-a	C	N		A							E321	7-151		
CLGDBR	CONVERT TO LOGICAL (long BFP to 64)	RRF-e	C	F	$\alpha^{7,9}$	SP	Db	Xi		Xx			B3AD	19-25		
CLGDTR	CONVERT TO LOGICAL (long DFP to 64)	RRF-e	C	F	$\alpha^{7,9}$		Dt	Xi		Xx			B942	20-32		
CLGEBR	CONVERT TO LOGICAL (short BFP to 64)	RRF-e	C	F	$\alpha^{7,9}$	SP	Db	Xi		Xx			B3AC	19-25		
CLGF	COMPARE LOGICAL (64←32)	RXY-a	C	N		A						B ₂	E331	7-151		
CLGFI	COMPARE LOGICAL IMMEDIATE (64←32)	RIL-a	C	EI									C2E	7-151		
CLGFR	COMPARE LOGICAL (64←32)	RRE	C	N									B931	7-151		
CLGFRL	COMPARE LOGICAL RELATIVE LONG (64←32)	RIL-b	C	GE		A*	SP						C6E	7-152		
CLGHRL	COMPARE LOGICAL RELATIVE LONG (64←16)	RIL-b	C	GE		A*							C66	7-152		
CLGHSI	COMPARE LOGICAL IMMEDIATE (64←16)	SIL	C	GE		A						B ₁	E559	7-151		
CLGIB	COMPARE LOGICAL IMMEDIATE AND BRANCH (64←8)	RIS		GE		α^9					B		ECFD	7-153		
CLGIJ	COMPARE LOGICAL IMMEDIATE AND BRANCH RELATIVE (64←8)	RIE-c		GE		α^{10}					B		EC7D	7-153		
CLGIT	COMPARE LOGICAL IMMEDIATE AND TRAP (64←16)	RIE-a		GE				Dc					EC71	7-155		
CLGR	COMPARE LOGICAL (64)	RRE	C	N									B921	7-151		
CLGRB	COMPARE LOGICAL AND BRANCH (64)	RRS		GE		α^9					B		ECE5	7-153		
CLGRJ	COMPARE LOGICAL AND BRANCH RELATIVE (64)	RIE-b		GE		α^{10}					B		EC65	7-153		
CLGRL	COMPARE LOGICAL RELATIVE LONG (64)	RIL-b	C	GE		A*	SP						C6A	7-152		
CLGRT	COMPARE LOGICAL AND TRAP (64)	RRF-c		GE				Dc					B961	7-154		
CLGT	COMPARE LOGICAL AND TRAP (64)	RSY-b		MI1		A		Dc				B ₂	EB2B	7-154		
CLGXBR	CONVERT TO LOGICAL (extended BFP to 64)	RRF-e	C	F	$\alpha^{7,9}$	SP	Db	Xi		Xx			B3AE	19-25		
CLGXTR	CONVERT TO LOGICAL (extended DFP to 64)	RRF-e	C	F	$\alpha^{7,9}$	SP	Dt	Xi		Xx			B94A	20-32		
CLHF	COMPARE LOGICAL HIGH (32)	RXY-a	C	HW		A						B ₂	E3CF	7-156		
CLHHR	COMPARE LOGICAL HIGH (32)	RRE	C	HW									B9CF	7-156		
CLHHSI	COMPARE LOGICAL IMMEDIATE (16←16)	SIL	C	GE		A						B ₁	E555	7-151		
CLHLR	COMPARE LOGICAL HIGH (32)	RRE	C	HW									B9DF	7-156		
CLHRL	COMPARE LOGICAL RELATIVE LONG (32←16)	RIL-b	C	GE		A*							C67	7-152		
CLI	COMPARE LOGICAL (immediate)	SI	C			A						B ₁	95	7-151		
CLIB	COMPARE LOGICAL IMMEDIATE AND BRANCH (32←8)	RIS		GE		α^9					B		ECFF	7-153		
CLIH	COMPARE LOGICAL IMMEDIATE HIGH (32)	RIL-a	C	HW									CCF	7-157		
CLIJ	COMPARE LOGICAL IMMEDIATE AND BRANCH RELATIVE (32←8)	RIE-c		GE		α^{10}					B		EC7F	7-153		
CLIJ	COMPARE LOGICAL (immediate)	SIY	C	LD		A						B ₁	EB55	7-151		
CLM	COMPARE LOGICAL CHAR. UNDER MASK (low)	RS-b	C			A						B ₂	BD	7-156		
CLMH	COMPARE LOGICAL CHAR. UNDER MASK (high)	RSY-b	C	N		A						B ₂	EB20	7-156		
CLMY	COMPARE LOGICAL CHAR. UNDER MASK (low)	RSY-b	C	LD		A						B ₂	EB21	7-156		
CLR	COMPARE LOGICAL (32)	RR	C										15	7-151		
CLRB	COMPARE LOGICAL AND BRANCH (32)	RRS		GE		α^9					B		ECF7	7-153		
CLRJ	COMPARE LOGICAL AND BRANCH RELATIVE (32)	RIE-b		GE		α^{10}					B		EC77	7-153		
CLRL	COMPARE LOGICAL RELATIVE LONG (32)	RIL-b	C	GE		A*	SP						C6F	7-152		
CLRT	COMPARE LOGICAL AND TRAP (32)	RRF-c		GE				Dc					B973	7-154		
CLST	COMPARE LOGICAL STRING	RRE	C			α^9	A	SP	IC	G0		R ₁	R ₂	B25D	7-165	
CLT	COMPARE LOGICAL AND TRAP (32)	RSY-b		MI1		A			Dc			B ₂	EB23	7-154		
CLY	COMPARE LOGICAL (32)	RXY-a	C	LD		A							B ₂	E355	7-151	
CMPSC	COMPRESSION CALL	RRE	C			$\alpha^{5,9}$	A	SP	II	Dg	GM	ST	R ₁	R ₂	B263	7-169
CP	COMPARE DECIMAL	SS-b	C			α^9	A		Dg				B ₁	B ₂	F9	8-7
CPDT	CONVERT TO PACKED (from long DFP)	RSL-b	C	PC		$\alpha^{7,9}$	A	SP	Dt	DF		ST	B ₂	EDAC	20-33	
CPSDR	COPY SIGN (long)	RRF-b		FS		$\alpha^{7,9}$			Da					B372	9-30	
CPXT	CONVERT TO PACKED (from extended DFP)	RSL-b	C	PC		$\alpha^{7,9}$	A	SP	Dt	DF		ST	B ₂	EDAD	20-33	
CPYA	COPY ACCESS	RRE				α^6							U ₁	U ₂	B24D	7-251

Figure B-2. Instructions Arranged by Mnemonic (Part 5 of 24)

Mnemonic	Name	Characteristics						Op-code	Page
CR	COMPARE (32)	RR	C				19	7-133	
CRB	COMPARE AND BRANCH (32)	RRS	GE	α^9			ECF6	7-134	
CRDTE	COMPARE AND REPLACE DAT TABLE ENTRY	RRF-b	ED2	P	A ¹	SP	B98F	10-17	
CRJ	COMPARE AND BRANCH RELATIVE (32)	RIE-b	GE	α^{10}			EC76	7-134	
CRL	COMPARE RELATIVE LONG (32)	RIL-b	C GE		A*	SP	C6D	7-134	
CRT	COMPARE AND TRAP (32)	RRF-c	GE				B972	7-148	
CS	COMPARE AND SWAP (32)	RS-a	C	α^9	A	SP	BA	7-143	
CSCH	CLEAR SUBCHANNEL	S	C	P			B230	14-5	
CSDTR	CONVERT TO SIGNED PACKED (long DFP to 64)	RRF-d	TF	$\alpha^{7,9}$		Dt	B3E3	20-35	
CSG	COMPARE AND SWAP (64)	RSY-a	C N	α^9	A	SP	EB30	7-143	
CSP	COMPARE AND SWAP AND PURGE (32)	RRE	C	P	A ¹	SP	B250	10-21	
CSPG	COMPARE AND SWAP AND PURGE (64)	RRE	C DE	P	A ¹	SP	B98A	10-21	
CSST	COMPARE AND SWAP AND STORE	SSF	C CS	α^1	A	SP	C82	7-145	
CSXTR	CONVERT TO SIGNED PACKED (extended DFP to 128)	RRF-d	TF	$\alpha^{7,9}$		SP Dt	B3EB	20-35	
CSY	COMPARE AND SWAP (32)	RSY-a	C LD	α^9	A	SP	EB14	7-143	
CU12	CONVERT UTF-8 TO UTF-16	RRF-c	C	$\alpha^{5,9}$	A	SP IC	B2A7	7-243	
CU14	CONVERT UTF-8 TO UTF-32	RRF-c	C E3	$\alpha^{5,9}$	A	SP IC	B9B0	7-247	
CU21	CONVERT UTF-16 TO UTF-8	RRF-c	C	$\alpha^{5,9}$	A	SP IC	B2A6	7-233	
CU24	CONVERT UTF-16 TO UTF-32	RRF-c	C E3	$\alpha^{5,9}$	A	SP IC	B9B1	7-230	
CU41	CONVERT UTF-32 TO UTF-8	RRE	C E3	$\alpha^{5,9}$	A	SP IC	B9B2	7-240	
CU42	CONVERT UTF-32 TO UTF-16	RRE	C E3	$\alpha^{5,9}$	A	SP IC	B9B3	7-237	
CUDTR	CONVERT TO UNSIGNED PACKED (long DFP to 64)	RRE	TF	$\alpha^{7,9}$		Dt	B3E2	20-35	
CUSE	COMPARE UNTIL SUBSTRING EQUAL	RRE	C	α^9	A	SP II	B257	7-166	
CUTFU	CONVERT UTF-8 TO UNICODE	RRF-c	C	$\alpha^{5,9}$	A	SP IC	B2A7	7-243	
CUUTF	CONVERT UNICODE TO UTF-8	RRF-c	C	$\alpha^{5,9}$	A	SP IC	B2A6	7-233	
CUXTR	CONVERT TO UNSIGNED PACKED (extended DFP to 128)	RRE	TF	$\alpha^{7,9}$		SP Dt	B3EA	20-35	
CVB	CONVERT TO BINARY (32)	RX-a		α^9	A	Dg IK	B2 4F	7-229	
CVBG	CONVERT TO BINARY (64)	RXY-a	N	α^9	A	Dg IK	B2 E30E	7-229	
CVBY	CONVERT TO BINARY (32)	RXY-a	LD	α^9	A	Dg IK	B2 E306	7-229	
CVD	CONVERT TO DECIMAL (32)	RX-a		α^9	A		B2 4E	7-230	
CVDG	CONVERT TO DECIMAL (64)	RXY-a	N	α^9	A		B2 E32E	7-230	
CVDY	CONVERT TO DECIMAL (32)	RXY-a	LD	α^9	A		B2 E326	7-230	
CXBR	COMPARE (extended BFP)	RRE	C	$\alpha^{7,9}$		SP Db Xi	B349	19-17	
CXFBR	CONVERT FROM FIXED (32 to extended BFP)	RRE		$\alpha^{7,9}$		SP Db	B396	19-19	
CXFBR	CONVERT FROM FIXED (32 to extended BFP)	RRF-e	F	$\alpha^{7,9}$		SP Db	B396	19-19	
CXFR	CONVERT FROM FIXED (32 to extended HFP)	RRE		$\alpha^{7,9}$		SP Da	B3B6	18-11	
CXFTR	CONVERT FROM FIXED (32 to extended DFP)	RRE	F	$\alpha^{7,9}$		SP Dt	B959	20-24	
CXGBR	CONVERT FROM FIXED (64 to extended BFP)	RRE	N	$\alpha^{7,9}$		SP Db	B3A6	19-19	
CXGBRA	CONVERT FROM FIXED (64 to extended BFP)	RRF-e	F	$\alpha^{7,9}$		SP Db	B3A6	19-19	
CXGR	CONVERT FROM FIXED (64 to extended HFP)	RRE	N	$\alpha^{7,9}$		SP Da	B3C6	18-11	
CXGTR	CONVERT FROM FIXED (64 to extended DFP)	RRE	TF	$\alpha^{7,9}$		SP Dt	B3F9	20-24	
CXGTRA	CONVERT FROM FIXED (64 to extended DFP)	RRF-e	F	$\alpha^{7,9}$		SP Dt	B3F9	20-24	
CXLFB	CONVERT FROM LOGICAL (32 to extended BFP)	RRF-e	F	$\alpha^{7,9}$		SP Db	B392	19-21	
CXLFB	CONVERT FROM LOGICAL (32 to extended BFP)	RRF-e	F	$\alpha^{7,9}$		SP Dt	B95B	20-25	
CXLGTR	CONVERT FROM LOGICAL (64 to extended BFP)	RRF-e	F	$\alpha^{7,9}$		SP Db	B3A2	19-21	
CXLGTR	CONVERT FROM LOGICAL (64 to extended DFP)	RRF-e	F	$\alpha^{7,9}$		SP Dt	B95A	20-25	
CXPT	CONVERT FROM PACKED (to extended DFP)	RSL-b	PC	$\alpha^{7,9}$	A	SP Dt Dg	B2 EDAF	20-26	
CXR	COMPARE (extended HFP)	RRE	C	$\alpha^{7,9}$		SP Da	B369	18-10	
CXSTR	CONVERT FROM SIGNED PACKED (128 to extended DFP)	RRE	TF	$\alpha^{7,9}$		SP Dt Dg	B3FB	20-28	
CXTR	COMPARE (extended DFP)	RRE	C TF	$\alpha^{7,9}$		SP Dt Xi	B3EC	20-22	
CXUTR	CONVERT FROM UNSIGNED PACKED (128 to ext. DFP)	RRE	TF	$\alpha^{7,9}$		SP Dt Dg	B3FA	20-28	

Figure B-2. Instructions Arranged by Mnemonic (Part 6 of 24)

Mnemonic	Name	Characteristics										Op-code	Page
CXZT	CONVERT FROM ZONED (to extended DFP)	RSL-b	ZF	$\alpha^{7,9}$	A	SP	Dt	Dg			B ₂	EDAB	20-29
CY	COMPARE (32)	RXY-a	C LD		A						B ₂	E359	7-133
CZDT	CONVERT TO ZONED (from long DFP)	RSL-b	C ZF	$\alpha^{7,9}$	A	SP				ST	B ₂	EDA8	20-36
CZXT	CONVERT TO ZONED (from extended DFP)	RSL-b	C ZF	$\alpha^{7,9}$	A	SP				ST	B ₂	EDA9	20-36
D	DIVIDE (32←64)	RX-a		α^9	A	SP		IK			B ₂	5D	7-251
DD	DIVIDE (long HFP)	RX-a		$\alpha^{7,9}$	A		Da	EU EO FK			B ₂	6D	18-12
DDB	DIVIDE (long BFP)	RXE		$\alpha^{7,9}$	A		Db	Xi Xz Xo Xu Xx			B ₂	ED1D	19-27
DDBR	DIVIDE (long BFP)	RRE		$\alpha^{7,9}$			Db	Xi Xz Xo Xu Xx				B31D	19-27
DDR	DIVIDE (long HFP)	RR		$\alpha^{7,9}$			Da	EU EO FK				2D	18-12
DDTR	DIVIDE (long DFP)	RRF-a	TF	$\alpha^{7,9}$			Dt	Xi Xz Xo Xu Xx				B3D1	20-37
DDTRA	DIVIDE (long DFP)	RRF-a	F	$\alpha^{7,9}$			Dt	Xi Xz Xo Xu Xx Xq				B3D1	20-37
DE	DIVIDE (short HFP)	RX-a		$\alpha^{7,9}$	A		Da	EU EO FK			B ₂	7D	18-12
DEB	DIVIDE (short BFP)	RXE		$\alpha^{7,9}$	A		Db	Xi Xz Xo Xu Xx			B ₂	ED0D	19-27
DEBR	DIVIDE (short BFP)	RRE		$\alpha^{7,9}$			Db	Xi Xz Xo Xu Xx				B30D	19-27
DER	DIVIDE (short HFP)	RR		$\alpha^{7,9}$			Da	EU EO FK				3D	18-12
DFLTCC	DEFLATE CONVERSION CALL	RRF-a	C GZ	$\alpha^{5,9}$	A	SP	IC	GM I1		ST	R ₁ R ₂ R ₃	B939	26-16
DIDBR	DIVIDE TO INTEGER (long BFP)	RRF-b	C	$\alpha^{7,9}$		SP	Db	Xi Xu Xx				B35B	19-28
DIEBR	DIVIDE TO INTEGER (short BFP)	RRF-b	C	$\alpha^{7,9}$		SP	Db	Xi Xu Xx				B353	19-28
DL	DIVIDE LOGICAL (32←64)	RXY-a	N3	α^9	A	SP		IK			B ₂	E397	7-252
DLG	DIVIDE LOGICAL (64←128)	RXY-a	N	α^9	A	SP		IK			B ₂	E387	7-252
DLGR	DIVIDE LOGICAL (64←128)	RRE	N	α^9		SP		IK				B987	7-252
DLR	DIVIDE LOGICAL (32←64)	RRE	N3	α^9		SP		IK				B997	7-252
DP	DIVIDE DECIMAL	SS-b		α^9	A	SP	Dg	DK		ST	B ₁ B ₂	FD	8-7
DR	DIVIDE (32←64)	RR		α^9		SP		IK				1D	7-251
DSG	DIVIDE SINGLE (64)	RXY-a	N	α^9	A	SP		IK			B ₂	E30D	7-253
DSGF	DIVIDE SINGLE (64←32)	RXY-a	N	α^9	A	SP		IK			B ₂	E31D	7-253
DSGFR	DIVIDE SINGLE (64←32)	RRE	N	α^9		SP		IK				B91D	7-253
DSGR	DIVIDE SINGLE (64)	RRE	N	α^9		SP		IK				B90D	7-253
DXBR	DIVIDE (extended BFP)	RRE		$\alpha^{7,9}$		SP	Db	Xi Xz Xo Xu Xx				B34D	19-27
DXR	DIVIDE (extended HFP)	RRE		$\alpha^{7,9}$		SP	Da	EU EO FK				B22D	18-12
DXTR	DIVIDE (extended DFP)	RRF-a	TF	$\alpha^{7,9}$		SP	Dt	Xi Xz Xo Xu Xx				B3D9	20-37
DXTRA	DIVIDE (extended DFP)	RRF-a	F	$\alpha^{7,9}$		SP	Dt	Xi Xz Xo Xu Xx Xq				B3D9	20-37
EAR	EXTRACT ACCESS	RRE		α^9							U ₂	B24F	7-256
ECAG	EXTRACT CPU ATTRIBUTE	RSY-a	GE	α^9								EB4C	7-256
ECTG	EXTRACT CPU TIME	SSF	ET	$\alpha^{8,9}$	A			GM		R ₃	B ₁ B ₂	C81	7-259
ED	EDIT	SS-a	C	α^9	A		Dg			ST	B ₁ B ₂	DE	8-8
EDMK	EDIT AND MARK	SS-a	C	α^9	A		Dg	G1		ST	B ₁ B ₂	DF	8-11
EEDTR	EXTRACT BIASED EXPONENT (long DFP to 64)	RRE	TF	$\alpha^{7,9}$			Dt					B3E5	20-39
EEXTR	EXTRACT BIASED EXPONENT (extended DFP to 64)	RRE	TF	$\alpha^{7,9}$		SP	Dt					B3ED	20-39
EFPC	EXTRACT FPC	RRE		$\alpha^{7,9}$			Db					B38C	9-30
EPAIR	EXTRACT PRIMARY ASN AND INSTANCE	RRE	RA	Q			SO					B99A	10-24
EPAR	EXTRACT PRIMARY ASN	RRE		Q			SO					B226	10-24
EPSW	EXTRACT PSW	RRE	N3	$\alpha^{8,9}$								B98D	7-260
EREG	EXTRACT STACKED REGISTERS (32)	RRE		α^1	A ^{1*}		SE				U ₁ U ₂	B249	10-25
EREGG	EXTRACT STACKED REGISTERS (64)	RRE	N	α^1	A ^{1*}		SE				U ₁ U ₂	B90E	10-25
ESAIR	EXTRACT SECONDARY ASN AND INSTANCE	RRE	RA	Q			SO					B99B	10-25
ESAR	EXTRACT SECONDARY ASN	RRE		Q			SO					B227	10-24
ESDTR	EXTRACT SIGNIFICANCE (long DFP to 64)	RRE	TF	$\alpha^{7,9}$			Dt					B3E7	20-39
ESEA	EXTRACT AND SET EXTENDED AUTHORITY	RRE	N	P								B99D	10-24
ESTA	EXTRACT STACKED STATE	RRE	C	α^1	A ^{1*}	SP	SE					B24A	10-26
ESXTR	EXTRACT SIGNIFICANCE (extended DFP to 64)	RRE	TF	$\alpha^{7,9}$		SP	Dt					B3EF	20-39
ETND	EXTRACT TRANSACTION NESTING DEPTH	RRE	TX	α^9			SO					B2EC	7-260
EX	EXECUTE	RX-a		α^9	AI	SP		EX				44	7-255
EXRL	EXECUTE RELATIVE LONG	RIL-b	XX	α^9	AI*			EX				C60	7-255

Figure B-2. Instructions Arranged by Mnemonic (Part 7 of 24)

Mnemonic	Name	Characteristics							Op-code	Page	
FIDBR	LOAD FP INTEGER (long BFP)	RRF-e		$\alpha^{7,9}$	SP	Db Xi	Xx		B35F	19-32	
FIDBRA	LOAD FP INTEGER (long BFP)	RRF-e	F	$\alpha^{7,9}$	SP	Db Xi	Xx		B35F	19-32	
FIDR	LOAD FP INTEGER (long HFP)	RRE		$\alpha^{7,9}$		Da			B37F	18-15	
FIDTR	LOAD FP INTEGER (long DFP)	RRF-e	TF	$\alpha^{7,9}$		Dt Xi	Xx Xq		B3D7	20-42	
FIEBR	LOAD FP INTEGER (short BFP)	RRF-e		$\alpha^{7,9}$	SP	Db Xi	Xx		B357	19-32	
FIEBRA	LOAD FP INTEGER (short BFP)	RRF-e	F	$\alpha^{7,9}$	SP	Db Xi	Xx		B357	19-32	
FIER	LOAD FP INTEGER (short HFP)	RRE		$\alpha^{7,9}$		Da			B377	18-15	
FIXBR	LOAD FP INTEGER (extended BFP)	RRF-e		$\alpha^{7,9}$	SP	Db Xi	Xx		B347	19-32	
FIXBRA	LOAD FP INTEGER (extended BFP)	RRF-e	F	$\alpha^{7,9}$	SP	Db Xi	Xx		B347	19-32	
FIXR	LOAD FP INTEGER (extended HFP)	RRE		$\alpha^{7,9}$	SP	Da			B367	18-15	
FIXTR	LOAD FP INTEGER (extended DFP)	RRF-e	TF	$\alpha^{7,9}$	SP	Dt Xi	Xx Xq		B3DF	20-42	
FLOGR	FIND LEFTMOST ONE	RRE	C EI		SP				B983	7-261	
HDR	HALVE (long HFP)	RR		$\alpha^{7,9}$		Da EU			24	18-13	
HER	HALVE (short HFP)	RR		$\alpha^{7,9}$		Da EU			34	18-13	
HSCH	HALT SUBCHANNEL	S	C	P		OP	¢ GS		B231	14-6	
IAC	INSERT ADDRESS SPACE CONTROL	RRE	C	Q		SO			B224	10-29	
IC	INSERT CHARACTER	RX-a		A				B ₂	43	7-261	
ICM	INSERT CHARACTERS UNDER MASK (low)	RS-b	C	A				B ₂	BF	7-261	
ICMH	INSERT CHARACTERS UNDER MASK (high)	RSY-b	C N	A				B ₂	EB80	7-261	
ICMY	INSERT CHARACTERS UNDER MASK (low)	RSY-b	C LD	A				B ₂	EB81	7-261	
ICY	INSERT CHARACTER	RXY-a	LD	A				B ₂	E373	7-261	
IDTE	INVALIDATE DAT TABLE ENTRY	RRF-b	U DE	P A ¹	SP		\$		B98E	10-32	
IEDTR	INSERT BIASED EXPONENT (64 to long DFP)	RRF-b	TF	$\alpha^{7,9}$		Dt			B3F6	20-40	
IEXTR	INSERT BIASED EXPONENT (64 to extended DFP)	RRF-b	TF	$\alpha^{7,9}$	SP	Dt			B3FE	20-40	
IIHF	INSERT IMMEDIATE (high)	RIL-a	EI						C08	7-262	
IIHH	INSERT IMMEDIATE (high high)	RI-a	N						A50	7-262	
IIHL	INSERT IMMEDIATE (high low)	RI-a	N						A51	7-262	
IILF	INSERT IMMEDIATE (low)	RIL-a	EI						C09	7-262	
IILH	INSERT IMMEDIATE (low high)	RI-a	N						A52	7-262	
IILL	INSERT IMMEDIATE (low low)	RI-a	N						A53	7-262	
IPK	INSERT PSW KEY	S		Q			G2		B20B	10-30	
IPM	INSERT PROGRAM MASK	RRE							B222	7-263	
IPTE	INVALIDATE PAGE TABLE ENTRY	RRF-a		P A ¹	SP		\$		B221	10-37	
IRBM	INSERT REFERENCE BITS MULTIPLE	RRE	IM	P A ^{1*}					B9AC	10-30	
ISKE	INSERT STORAGE KEY EXTENDED	RRE		P A ^{1*}					B229	10-30	
IVSK	INSERT VIRTUAL STORAGE KEY	RRE		Q A ^{1*}		SO		R ₂	B223	10-31	
KDB	COMPARE AND SIGNAL (long BFP)	RXE	C	$\alpha^{7,9}$	A	Db Xi		B ₂	ED18	19-18	
KDBR	COMPARE AND SIGNAL (long BFP)	RRE	C	$\alpha^{7,9}$		Db Xi			B318	19-18	
KDSA	COMPUTE DIGITAL SIGNATURE AUTHENTICATION	RRE	C M9	$\alpha^{5,9}$	A SP	IC	GM I1	ST	R ₂	B93A	26-2
KDTR	COMPARE AND SIGNAL (long DFP)	RRE	C TF	$\alpha^{7,9}$		Dt Xi			B3E0	20-23	
KEB	COMPARE AND SIGNAL (short BFP)	RXE	C	$\alpha^{7,9}$	A	Db Xi		B ₂	ED08	19-18	
KEBR	COMPARE AND SIGNAL (short BFP)	RRE	C	$\alpha^{7,9}$		Db Xi			B308	19-18	
KIMD	COMPUTE INTERMEDIATE MESSAGE DIGEST	RRE	C MS	$\alpha^{5,9}$	A SP	IC	GM I1	ST	R ₂	B93E	7-187
KLMD	COMPUTE LAST MESSAGE DIGEST	RRE	C MS	$\alpha^{5,9}$	A SP	IC	GM I1	ST	R ₂	B93F	7-200
KM	CIPHER MESSAGE	RRE	C MS	$\alpha^{5,9}$	A SP	IC	GM I1	ST	R ₁ R ₂	B92E	7-52
KMA	CIPHER MESSAGE WITH AUTHENTICATION	RRF-b	C M8	$\alpha^{5,9}$	A SP	IC	GM I1	ST	R ₁ R ₂ R ₃	B929	7-77
KMAC	COMPUTE MESSAGE AUTHENTICATION CODE	RRE	C MS	$\alpha^{5,9}$	A SP	IC	GM I1	ST	R ₂	B91E	7-218
KMC	CIPHER MESSAGE WITH CHAINING	RRE	C MS	$\alpha^{5,9}$	A SP	IC	GM I1	ST	R ₁ R ₂	B92F	7-52
KMCTR	CIPHER MESSAGE WITH COUNTER	RRF-b	C M4	$\alpha^{5,9}$	A SP	IC	GM I1	ST	R ₁ R ₂ R ₃	B92D	7-106
KMF	CIPHER MESSAGE WITH CIPHER FEEDBACK	RRE	C M4	$\alpha^{5,9}$	A SP	IC	GM I1	ST	R ₁ R ₂	B92A	7-91
KMO	CIPHER MESSAGE WITH OUTPUT FEEDBACK	RRE	C M4	$\alpha^{5,9}$	A SP	IC	GM I1	ST	R ₁ R ₂	B92B	7-119
KXBR	COMPARE AND SIGNAL (extended BFP)	RRE	C	$\alpha^{7,9}$	SP	Db Xi			B348	19-18	
KXTR	COMPARE AND SIGNAL (extended DFP)	RRE	C TF	$\alpha^{7,9}$	SP	Dt Xi			B3E8	20-23	
L	LOAD (32)	RX-a		A				B ₂	58	7-263	

Figure B-2. Instructions Arranged by Mnemonic (Part 8 of 24)

Mnemonic	Name	Characteristics										Op-code	Page		
LA	LOAD ADDRESS	RX-a										41	7-265		
LAA	LOAD AND ADD (32)	RSY-a	C	IA	α^9	A	SP	IF	£		ST	B ₂	EBF8	7-267	
LAAG	LOAD AND ADD (64)	RSY-a	C	IA	α^9	A	SP	IF	£		ST	B ₂	EBE8	7-267	
LAAL	LOAD AND ADD LOGICAL (32)	RSY-a	C	IA	α^9	A	SP		£		ST	B ₂	EBFA	7-267	
LAALG	LOAD AND ADD LOGICAL (64)	RSY-a	C	IA	α^9	A	SP		£		ST	B ₂	EBEA	7-267	
LAE	LOAD ADDRESS EXTENDED	RX-a			α^6						U ₁	BP	51	7-265	
LAEY	LOAD ADDRESS EXTENDED	RXY-a		GE	α^6						U ₁	BP	E375	7-265	
LAM	LOAD ACCESS MULTIPLE	RS-a			α^6	A	SP					UB	9A	7-264	
LAMY	LOAD ACCESS MULTIPLE	RSY-a		LD	α^6	A	SP					UB	EB9A	7-264	
LAN	LOAD AND AND (32)	RSY-a	C	IA	α^9	A	SP		£		ST	B ₂	EBF4	7-268	
LANG	LOAD AND AND (64)	RSY-a	C	IA	α^9	A	SP		£		ST	B ₂	EBE4	7-268	
LAO	LOAD AND OR (32)	RSY-a	C	IA	α^9	A	SP		£		ST	B ₂	EBF6	7-269	
LAOG	LOAD AND OR (64)	RSY-a	C	IA	α^9	A	SP		£		ST	B ₂	EBE6	7-269	
LARL	LOAD ADDRESS RELATIVE LONG	RIL-b		N3									C00	7-266	
LASP	LOAD ADDRESS SPACE PARAMETERS	SSE	C		P	A ¹	SP	SO				B ₁	E500	10-41	
LAT	LOAD AND TRAP (32L←32)	RXY-a		LT		A		Dc				B ₂	E39F	7-270	
LAX	LOAD AND EXCLUSIVE OR (32)	RSY-a	C	IA	α^9	A	SP		£		ST	B ₂	EBF7	7-268	
LAXG	LOAD AND EXCLUSIVE OR (64)	RSY-a	C	IA	α^9	A	SP		£		ST	B ₂	EBE7	7-268	
LAY	LOAD ADDRESS	RXY-a		LD									E371	7-265	
LB	LOAD BYTE (32←8)	RXY-a		LD		A							E376	7-271	
LBH	LOAD BYTE HIGH (32←8)	RXY-a		HW		A						B ₂	E3C0	7-271	
LBR	LOAD BYTE (32←8)	RRE		EI									B926	7-271	
LCBB	LOAD COUNT TO BLOCK BOUNDARY	RXE	C	VF			SP						E727	7-272	
LCDBR	LOAD COMPLEMENT (long BFP)	RRE	C		$\alpha^{7,9}$			Db					B313	19-31	
LCDFR	LOAD COMPLEMENT (long)	RRE		FS	$\alpha^{7,9}$			Da					B373	9-31	
LCDR	LOAD COMPLEMENT (long HFP)	RR	C		$\alpha^{7,9}$			Da					23	18-14	
LCEBR	LOAD COMPLEMENT (short BFP)	RRE	C		$\alpha^{7,9}$			Db					B303	19-31	
LCER	LOAD COMPLEMENT (short HFP)	RR	C		$\alpha^{7,9}$			Da					33	18-14	
LCGFR	LOAD COMPLEMENT (64←32)	RRE	C	N									B913	7-272	
LCGR	LOAD COMPLEMENT (64)	RRE	C	N				IF					B903	7-272	
LCR	LOAD COMPLEMENT (32)	RR	C					IF					13	7-271	
LCTL	LOAD CONTROL (32)	RS-a			P	A	SP					B ₂	B7	10-50	
LCTLG	LOAD CONTROL (64)	RSY-a		N	P	A	SP					B ₂	EB2F	10-50	
LCXBR	LOAD COMPLEMENT (extended BFP)	RRE	C		$\alpha^{7,9}$		SP	Db					B343	19-31	
LCXR	LOAD COMPLEMENT (extended HFP)	RRE	C		$\alpha^{7,9}$		SP	Da					B363	18-14	
LD	LOAD (long)	RX-a			$\alpha^{7,9}$	A		Da				B ₂	68	9-31	
LDE	LOAD LENGTHENED (short to long HFP)	RXE			$\alpha^{7,9}$	A		Da				B ₂	ED24	18-15	
LDEB	LOAD LENGTHENED (short to long BFP)	RXE			$\alpha^{7,9}$	A		Db	Xi			B ₂	ED04	19-34	
LDEBR	LOAD LENGTHENED (short to long BFP)	RRE			$\alpha^{7,9}$			Db	Xi				B304	19-33	
LDER	LOAD LENGTHENED (short to long HFP)	RRE			$\alpha^{7,9}$			Da					B324	18-15	
LDETR	LOAD LENGTHENED (short to long DFP)	RRF-d		TF	$\alpha^{7,9}$			Dt	Xi				B3D4	20-45	
LDGR	LOAD FPR FROM GR (64 to long)	RRE		FG	$\alpha^{7,9}$			Da					B3C1	9-34	
LDR	LOAD (long)	RR			$\alpha^{7,9}$			Da					28	9-31	
LDXBR	LOAD ROUNDED (extended to long BFP)	RRE			$\alpha^{7,9}$		SP	Db	Xi	Xo	Xu	Xx	B345	19-35	
LDXBRA	LOAD ROUNDED (extended to long BFP)	RRF-e		F	$\alpha^{7,9}$		SP	Db	Xi	Xo	Xu	Xx	B345	19-35	
LDXR	LOAD ROUNDED (extended to long HFP)	RR			$\alpha^{7,9}$		SP	Da		EO			25	18-17	
LDXTR	LOAD ROUNDED (extended to long DFP)	RRF-e		TF	$\alpha^{7,9}$		SP	Dt	Xi	Xo	Xu	Xx	Xq	B3DD	20-46
LDY	LOAD (long)	RXY-a		LD	$\alpha^{7,9}$	A		Da				B ₂	ED65	9-31	
LE	LOAD (short)	RX-a			$\alpha^{7,9}$	A		Da				B ₂	78	9-31	
LEDBR	LOAD ROUNDED (long to short BFP)	RRE			$\alpha^{7,9}$			Db	Xi	Xo	Xu	Xx	B344	19-35	
LEDBRA	LOAD ROUNDED (long to short BFP)	RRF-e		F	$\alpha^{7,9}$		SP	Db	Xi	Xo	Xu	Xx	B344	19-35	
LEDR	LOAD ROUNDED (long to short HFP)	RR			$\alpha^{7,9}$			Da		EO			35	18-17	
LEDTR	LOAD ROUNDED (long to short DFP)	RRF-e		TF	$\alpha^{7,9}$			Dt	Xi	Xo	Xu	Xx	Xq	B3D5	20-46
LER	LOAD (short)	RR			$\alpha^{7,9}$			Da					38	9-31	
LEXBR	LOAD ROUNDED (extended to short BFP)	RRE			$\alpha^{7,9}$		SP	Db	Xi	Xo	Xu	Xx	B346	19-35	

Figure B-2. Instructions Arranged by Mnemonic (Part 9 of 24)

Mnemonic	Name	Characteristics							Op-code	Page			
LEXBRA	LOAD ROUNDED (extended to short BFP)	RRF-e	F	$\alpha^{7,9}$	SP	Db	Xi	Xo	Xu	Xx	B346	19-35	
LEXR	LOAD ROUNDED (extended to short HFP)	RRE		$\alpha^{7,9}$	A	SP	Da		EO		B366	18-17	
LEY	LOAD (short)	RXY-a	LD	$\alpha^{7,9}$	A		Da				B ₂	ED64	9-31
LFAS	LOAD FPC AND SIGNAL	S	XF	$\alpha^{7,9}$	A	SP	Dt	Xg			B ₂	B2BD	9-32
LFH	LOAD HIGH (32)	RXY-a	HW		A						B ₂	E3CA	7-277
LFHAT	LOAD HIGH AND TRAP (32H←32)	RXY-a	LT		A			Dc			B ₂	E3C8	7-277
LFPC	LOAD FPC	S		$\alpha^{7,9}$	A	SP	Db				B ₂	B29D	9-31
LG	LOAD (64)	RXY-a	N		A						B ₂	E304	7-263
LGAT	LOAD AND TRAP (64)	RXY-a	LT		A			Dc			B ₂	E385	7-270
LGB	LOAD BYTE (64←8)	RXY-a	LD		A							E377	7-271
LGBR	LOAD BYTE (64←8)	RRE	EI									B906	7-271
LGDR	LOAD GR FROM FPR (long to 64)	RRE	FG	$\alpha^{7,9}$			Da					B3CD	9-34
LGF	LOAD (64←32)	RXY-a	N		A						B ₂	E314	7-263
LGFI	LOAD IMMEDIATE (64←32)	RIL-a	EI									C01	7-263
LGFR	LOAD (64←32)	RRE	N									B914	7-263
LGFRLL	LOAD RELATIVE LONG (64←32)	RIL-b	GE		A*	SP						C4C	7-263
LGG	LOAD GUARDED (64)	RXY-a	GF	α^{12}	A	SP			B	ST	B ₂	E34C	7-273
LGH	LOAD HALFWORD (64←16)	RXY-a	N		A						B ₂	E315	7-275
LGHI	LOAD HALFWORD IMMEDIATE (64←16)	RI-a	N									A79	7-275
LGHR	LOAD HALFWORD (64←16)	RRE	EI									B907	7-275
LGHRL	LOAD HALFWORD RELATIVE LONG (64←16)	RIL-b	GE		A*							C44	7-275
LGR	LOAD (64)	RRE	N									B904	7-263
LGRL	LOAD RELATIVE LONG (64)	RIL-b	GE		A*	SP						C48	7-263
LGSC	LOAD GUARDED STORAGE CONTROLS	RXY-a	GF	α^1	A		SO				B ₂	E34D	7-274
LH	LOAD HALFWORD (32←16)	RX-a			A						B ₂	48	7-275
LHH	LOAD HALFWORD HIGH (32←16)	RXY-a	HW		A						B ₂	E3C4	7-276
LHI	LOAD HALFWORD IMMEDIATE (32)←16	RI-a										A78	7-275
LHR	LOAD HALFWORD (32←16)	RRE	EI									B927	7-275
LHRL	LOAD HALFWORD RELATIVE LONG (32←16)	RIL-b	GE		A*							C45	7-275
LHY	LOAD HALFWORD (32←16)	RXY-a	LD		A						B ₂	E378	7-275
LLC	LOAD LOGICAL CHARACTER (32←8)	RXY-a	EI		A						B ₂	E394	7-278
LLCH	LOAD LOGICAL CHARACTER HIGH (32←8)	RXY-a	HW		A						B ₂	E3C2	7-279
LLCR	LOAD LOGICAL CHARACTER (32←8)	RRE	EI									B994	7-278
LLGC	LOAD LOGICAL CHARACTER (64←8)	RXY-a	N		A						B ₂	E390	7-278
LLGCR	LOAD LOGICAL CHARACTER (64←8)	RRE	EI									B984	7-278
LLGF	LOAD LOGICAL (64←32)	RXY-a	N		A						B ₂	E316	7-277
LLGFAT	LOAD LOGICAL AND TRAP (64←32)	RXY-a	LT		A			Dc			B ₂	E39D	7-278
LLGFR	LOAD LOGICAL (64←32)	RRE	N									B916	7-277
LLGFRL	LOAD LOGICAL RELATIVE LONG (64←32)	RIL-b	GE		A*	SP						C4E	7-277
LLGFSG	LOAD LOGICAL AND SHIFT GUARDED (64←32)	RXY-a	GF	α^{12}	A	SP			B	ST	B ₂	E348	7-273
LLGH	LOAD LOGICAL HALFWORD (64←16)	RXY-a	N		A						B ₂	E391	7-279
LLGHR	LOAD LOGICAL HALFWORD (64←16)	RRE	EI									B985	7-279
LLGHRL	LOAD LOGICAL HALFWORD RELATIVE LONG (64←16)	RIL-b	GE		A*							C46	7-279
LLGT	LOAD LOGICAL THIRTY ONE BITS (64←31)	RXY-a	N		A						B ₂	E317	7-281
LLGTAT	LOAD LOGICAL THIRTY ONE BITS AND TRAP (64←31)	RXY-a	LT		A			Dc			B ₂	E39C	7-281
LLGTR	LOAD LOGICAL THIRTY ONE BITS (64←31)	RRE	N									B917	7-280
LLH	LOAD LOGICAL HALFWORD (32←16)	RXY-a	EI		A						B ₂	E395	7-279
LLHH	LOAD LOGICAL HALFWORD HIGH (32←16)	RXY-a	HW		A						B ₂	E3C6	7-280
LLHR	LOAD LOGICAL HALFWORD (32←16)	RRE	EI									B995	7-279
LLHRL	LOAD LOGICAL HALFWORD RELATIVE LONG (32←16)	RIL-b	GE		A*							C42	7-279
LLIHF	LOAD LOGICAL IMMEDIATE (high)	RIL-a	EI									C0E	7-280
LLIHH	LOAD LOGICAL IMMEDIATE (high high)	RI-a	N									A5C	7-280

Figure B-2. Instructions Arranged by Mnemonic (Part 10 of 24)

Mnemonic	Name	Characteristics						Op-code	Page
		RI-a	N						
LLIHL	LOAD LOGICAL IMMEDIATE (high low)	RI-a	N					A5D	7-280
LLILF	LOAD LOGICAL IMMEDIATE (low)	RIL-a	EI					C0F	7-280
LLILH	LOAD LOGICAL IMMEDIATE (low high)	RI-a	N					A5E	7-280
LLILL	LOAD LOGICAL IMMEDIATE (low low)	RI-a	N					A5F	7-280
LLZRGF	LOAD LOGICAL AND ZERO RIGHTMOST BYTE (64←32)	RXY-a	LZ	A			B ₂	E33A	7-278
LM	LOAD MULTIPLE (32)	RS-a		A			B ₂	98	7-281
LMD	LOAD MULTIPLE DISJOINT (64←32&32)	SS-e	N	α ⁹	A		B ₂ B ₄	EF	7-282
LMG	LOAD MULTIPLE (64)	RSY-a	N	A			B ₂	EB04	7-281
LMH	LOAD MULTIPLE HIGH (32)	RSY-a	N	A			B ₂	EB96	7-282
LMY	LOAD MULTIPLE (32)	RSY-a	LD	A			B ₂	EB98	7-281
LNDBR	LOAD NEGATIVE (long BFP)	RRE	C	α ^{7,9}		Db		B311	19-34
LNDFR	LOAD NEGATIVE (long)	RRE	FS	α ^{7,9}		Da		B371	9-34
LNDR	LOAD NEGATIVE (long HFP)	RR	C	α ^{7,9}		Da		21	18-16
LNEBR	LOAD NEGATIVE (short BFP)	RRE	C	α ^{7,9}		Db		B301	19-34
LNER	LOAD NEGATIVE (short HFP)	RR	C	α ^{7,9}		Da		31	18-16
LNGFR	LOAD NEGATIVE (64←32)	RRE	C N					B911	7-283
LNGR	LOAD NEGATIVE (64)	RRE	C N					B901	7-282
LNR	LOAD NEGATIVE (32)	RR	C					11	7-282
LNxBR	LOAD NEGATIVE (extended BFP)	RRE	C	α ^{7,9}	SP	Db		B341	19-34
LNxR	LOAD NEGATIVE (extended HFP)	RRE	C	α ^{7,9}	SP	Da		B361	18-16
LOC	LOAD ON CONDITION (32)	RSY-b	L1	A			B ₂	EBF2	7-283
LOCFH	LOAD HIGH ON CONDITION (32)	RSY-b	L2	A			B ₂	EBE0	7-283
LOCFHR	LOAD HIGH ON CONDITION (32)	RRF-c	L2					B9E0	7-283
LOCG	LOAD ON CONDITION (64)	RSY-b	L1	A			B ₂	EBE2	7-283
LOGCHI	LOAD HALFWORD IMMEDIATE ON CONDITION (64←16)	RIE-g	L2					EC46	7-276
LOGCR	LOAD ON CONDITION (64)	RRF-c	L1					B9E2	7-283
LOCHHI	LOAD HALFWORD HIGH IMMEDIATE ON CONDITION (32←16)	RIE-g	L2					EC4E	7-276
LOCHI	LOAD HALFWORD IMMEDIATE ON CONDITION (32←16)	RIE-g	L2					EC42	7-276
LOCR	LOAD ON CONDITION (32)	RRF-c	L1					B9F2	7-283
LPD	LOAD PAIR DISJOINT (32)	SSF	C IA	α ⁹	A SP		B ₁ B ₂	C84	7-284
LPDBR	LOAD POSITIVE (long BFP)	RRE	C	α ^{7,9}		Db		B310	19-35
LPDFR	LOAD POSITIVE (long)	RRE	FS	α ^{7,9}		Da		B370	9-34
LPDG	LOAD PAIR DISJOINT (64)	SSF	C IA	α ⁹	A SP		B ₁ B ₂	C85	7-284
LPDR	LOAD POSITIVE (long HFP)	RR	C	α ^{7,9}		Da		20	18-16
LPEBR	LOAD POSITIVE (short BFP)	RRE	C	α ^{7,9}		Db		B300	19-35
LPER	LOAD POSITIVE (short HFP)	RR	C	α ^{7,9}		Da		30	18-16
LPGFR	LOAD POSITIVE (64←32)	RRE	C N					B910	7-286
LPGR	LOAD POSITIVE (64)	RRE	C N	α ⁹	A SP	IF		B900	7-286
LPQ	LOAD PAIR FROM QUADWORD (64&64←128)	RXY-a	N	α ⁹	A SP		B ₂	E38F	7-285
LPR	LOAD POSITIVE (32)	RR	C			IF		10	7-286
LPSW	LOAD PSW	SI	L	P	A SP	¢	B ₂	82	10-54
LPSWE	LOAD PSW EXTENDED	S	L N	P	A SP	¢	B ₂	B2B2	10-55
LPTEA	LOAD PAGE TABLE ENTRY ADDRESS	RRF-b	C D2	P	A ^{1*} SP	SO	R ₂	B9AA	10-50
LPXBR	LOAD POSITIVE (extended BFP)	RRE	C	α ^{7,9}	SP	Db		B340	19-35
LPXR	LOAD POSITIVE (extended HFP)	RRE	C	α ^{7,9}	SP	Da		B360	18-16
LR	LOAD (32)	RR						18	7-263
LRA	LOAD REAL ADDRESS (32)	RX-a	C	P	A ^{1*}	SO	BP	B1	10-56
LRAG	LOAD REAL ADDRESS (64)	RXY-a	C N	P	A ^{1*}		BP	E303	10-56
LRAY	LOAD REAL ADDRESS (32)	RXY-a	C LD	P	A ^{1*}	SO	BP	E313	10-56
LRDR	LOAD ROUNDED (extended to long HFP)	RR		α ^{7,9}	SP	Da	EO	25	18-17
LRER	LOAD ROUNDED (long to short HFP)	RR		α ^{7,9}		Da	EO	35	18-17
LRL	LOAD RELATIVE LONG (32)	RIL-b	GE	A	SP			C4D	7-263

Figure B-2. Instructions Arranged by Mnemonic (Part 11 of 24)

Mnemonic	Name	Characteristics						Op-code	Page
MAYR	MULTIPLY & ADD UNNORMALIZED (long to ext. HFP)	RRD	UE	$\alpha^{7,9}$		Da		B33A	18-20
MC	MONITOR CALL	SI		$\alpha^{4,8,9}$	SP	ME		AF	7-287
MD	MULTIPLY (long HFP)	RX-a		$\alpha^{7,9}$	A	Da EU EO		B ₂	6C 18-18
MDB	MULTIPLY (long BFP)	RXE		$\alpha^{7,9}$	A	Db Xi Xo Xu Xx		B ₂	ED1C 19-37
MDBR	MULTIPLY (long BFP)	RRE		$\alpha^{7,9}$		Db Xi Xo Xu Xx			B31C 19-37
MDE	MULTIPLY (short to long HFP)	RX-a		$\alpha^{7,9}$	A	Da EU EO		B ₂	7C 18-18
MDEB	MULTIPLY (short to long BFP)	RXE		$\alpha^{7,9}$	A	Db Xi		B ₂	ED0C 19-37
MDEBR	MULTIPLY (short to long BFP)	RRE		$\alpha^{7,9}$		Db Xi			B30C 19-37
MDER	MULTIPLY (short to long HFP)	RR		$\alpha^{7,9}$		Da EU EO			3C 18-17
MDR	MULTIPLY (long HFP)	RR		$\alpha^{7,9}$		Da EU EO			2C 18-17
MDTR	MULTIPLY (long DFP)	RRF-a	TF	$\alpha^{7,9}$		Dt Xi Xo Xu Xx			B3D0 20-47
MDTRA	MULTIPLY (long DFP)	RRF-a	F	$\alpha^{7,9}$		Dt Xi Xo Xu Xx Xq			B3D0 20-48
ME	MULTIPLY (short to long HFP)	RX-a		$\alpha^{7,9}$	A	Da EU EO		B ₂	7C 18-18
MEE	MULTIPLY (short HFP)	RXE		$\alpha^{7,9}$	A	Da EU EO		B ₂	ED37 18-18
MEEB	MULTIPLY (short BFP)	RXE		$\alpha^{7,9}$	A	Db Xi Xo Xu Xx		B ₂	ED17 19-37
MEEBR	MULTIPLY (short BFP)	RRE		$\alpha^{7,9}$		Db Xi Xo Xu Xx			B317 19-37
MEER	MULTIPLY (short HFP)	RRE		$\alpha^{7,9}$		Da EU EO			B337 18-17
MER	MULTIPLY (short to long HFP)	RR		$\alpha^{7,9}$		Da EU EO			3C 18-18
MFY	MULTIPLY (64←32)	RXY-a	GE		A SP			B ₂	E35C 7-304
MG	MULTIPLY (128←64)	RXY-a	MI2		A SP			B ₂	E384 7-304
MGH	MULTIPLY HALFWORD (64←16)	RXY-a	MI2		A			B ₂	E33C 7-305
MGHI	MULTIPLY HALFWORD IMMEDIATE (64←16)	RI-a	N						A7D 7-305
MGRK	MULTIPLY (128←64)	RRF-a	MI2		SP				B9EC 7-304
MH	MULTIPLY HALFWORD (32←16)	RX-a			A			B ₂	4C 7-305
MHI	MULTIPLY HALFWORD IMMEDIATE (32←16)	RI-a							A7C 7-305
MHY	MULTIPLY HALFWORD (32←16)	RXY-a	GE		A			B ₂	E37C 7-305
ML	MULTIPLY LOGICAL (64←32)	RXY-a	N3		A SP			B ₂	E396 7-306
MLG	MULTIPLY LOGICAL (128←64)	RXY-a	N		A SP			B ₂	E386 7-306
MLGR	MULTIPLY LOGICAL (128←64)	RRE	N		SP				B986 7-306
MLR	MULTIPLY LOGICAL (64←32)	RRE	N3		SP				B996 7-305
MP	MULTIPLY DECIMAL	SS-b		α^9	A SP	Dg	ST	B ₁ B ₂	FC 8-12
MR	MULTIPLY (64←32)	RR			SP				1C 7-304
MS	MULTIPLY SINGLE (32)	RX-a			A			B ₂	71 7-307
MSC	MULTIPLY SINGLE (32)	RXY-a	C MI2		A	IF		B ₂	E353 7-307
MSCH	MODIFY SUBCHANNEL	S	C	P	A SP	OP ¢ GS		B ₂	B232 14-7
MSD	MULTIPLY AND SUBTRACT (long HFP)	RXF	HM	$\alpha^{7,9}$	A	Da EU EO		B ₂	ED3F 18-19
MSDB	MULTIPLY AND SUBTRACT (long BFP)	RXF		$\alpha^{7,9}$	A	Db Xi Xo Xu Xx		B ₂	ED1F 19-38
MSDBR	MULTIPLY AND SUBTRACT (long BFP)	RRD		$\alpha^{7,9}$		Db Xi Xo Xu Xx			B31F 19-38
MSDR	MULTIPLY AND SUBTRACT (long HFP)	RRD	HM	$\alpha^{7,9}$		Da EU EO			B33F 18-19
MSE	MULTIPLY AND SUBTRACT (short HFP)	RXF	HM	$\alpha^{7,9}$	A	Da EU EO		B ₂	ED2F 18-19
MSEB	MULTIPLY AND SUBTRACT (short BFP)	RXF		$\alpha^{7,9}$	A	Db Xi Xo Xu Xx		B ₂	ED0F 19-38
MSEBR	MULTIPLY AND SUBTRACT (short BFP)	RRD		$\alpha^{7,9}$		Db Xi Xo Xu Xx			B30F 19-38
MSER	MULTIPLY AND SUBTRACT (short HFP)	RRD	HM	$\alpha^{7,9}$		Da EU EO			B32F 18-19
MSFI	MULTIPLY SINGLE IMMEDIATE (32)	RIL-a	GE						C21 7-307
MSG	MULTIPLY SINGLE (64)	RXY-a	N		A			B ₂	E30C 7-307
MSGC	MULTIPLY SINGLE (64)	RXY-a	C MI2		A	IF		B ₂	E383 7-307
MSGF	MULTIPLY SINGLE (64←32)	RXY-a	N		A			B ₂	E31C 7-307
MSGFI	MULTIPLY SINGLE IMMEDIATE (64←32)	RIL-a	GE						C20 7-307
MSGFR	MULTIPLY SINGLE (64←32)	RRE	N						B91C 7-307
MSGR	MULTIPLY SINGLE (64)	RRE	N						B90C 7-307
MSGRKC	MULTIPLY SINGLE (64)	RRF-a	C MI2			IF			B9ED 7-307
MSR	MULTIPLY SINGLE (32)	RRE							B252 7-307
MSRKC	MULTIPLY SINGLE (32)	RRF-a	C MI2			IF			B9FD 7-307
MSTA	MODIFY STACKED STATE	RRE		α^1	A ^{1*} SP	SE	ST		B247 10-61

Figure B-2. Instructions Arranged by Mnemonic (Part 13 of 24)

Mnemonic	Name	Characteristics										Op-code	Page
MSY	MULTIPLY SINGLE (32)	RXY-a	LD	A							B ₂	E351	7-307
MVC	MOVE (character)	SS-a		A							B ₁ B ₂	D2	7-288
MVCDK	MOVE WITH DESTINATION KEY	SSE		A			GM				B ₁ B ₂	E50F	10-67
MVCIN	MOVE INVERSE	SS-a		A							B ₁ B ₂	E8	7-289
MVCK	MOVE WITH KEY	SS-d	C	A							B ₁ B ₂	D9	10-67
MVCL	MOVE LONG	RR	C	A	SP	II					R ₁ R ₂	0E	7-289
MVCLE	MOVE LONG EXTENDED	RS-a	C	A	SP	IC					R ₁ R ₃	A8	7-293
MVCLU	MOVE LONG UNICODE	RSY-a	C	A	SP	IC					R ₁ R ₃	EB8E	7-296
MVCOS	MOVE WITH OPTIONAL SPECIFICATIONS	SSF	C	A	MO	SO		G0			B† B†	C80	10-69
MVCP	MOVE TO PRIMARY	SS-d	C	A		SO		ϕ				DA	10-65
MVCR	MOVE RIGHT TO LEFT	SSE	MI3	A				G0			B ₁ B ₂	E50A	7-300
MVCS	MOVE TO SECONDARY	SS-d	C	A		SO		ϕ				DB	10-65
MVCSK	MOVE WITH SOURCE KEY	SSE		A				GM			B ₁ B ₂	E50E	10-72
MVGHI	MOVE (64←16)	SIL	GE	A							B ₁	E548	7-288
MVHHI	MOVE (16←16)	SIL	GE	A							B ₁	E544	7-288
MVHI	MOVE (32←16)	SIL	GE	A							B ₁	E54C	7-288
MVI	MOVE (immediate)	SI		A							B ₁	92	7-288
MVIY	MOVE (immediate)	SIY	LD	A							B ₁	EB52	7-288
MVN	MOVE NUMERICS	SS-a		A							B ₁ B ₂	D1	7-300
MVO	MOVE WITH OFFSET	SS-b		A							B ₁ B ₂	F1	7-302
MVPG	MOVE PAGE	RRE	C	A	SP	OP		ϕ ⁴ G0		K	R ₁ R ₂	B254	10-62
MVST	MOVE STRING	RRE	C	A	SP	IC		G0			R ₁ R ₂	B255	7-301
MVZ	MOVE ZONES	SS-a		A							B ₁ B ₂	D3	7-303
MXBR	MULTIPLY (extended BFP)	RRE		A	SP	Db	Xi	Xo Xu Xx				B34C	19-37
MXD	MULTIPLY (long to extended HFP)	RX-a		A	SP	Da	EU	EO			B ₂	67	18-18
MXDB	MULTIPLY (long to extended BFP)	RXE		A	SP	Db	Xi				B ₂	ED07	19-37
MXDBR	MULTIPLY (long to extended BFP)	RRE		A	SP	Db	Xi					B307	19-37
MXDR	MULTIPLY (long to extended HFP)	RR		A	SP	Da	EU	EO				27	18-17
MXR	MULTIPLY (extended HFP)	RR		A	SP	Da	EU	EO				26	18-17
MXTR	MULTIPLY (extended DFP)	RRF-a	TF	A	SP	Dt	Xi	Xo Xu Xx				B3D8	20-47
MXTRA	MULTIPLY (extended DFP)	RRF-a	F	A	SP	Dt	Xi	Xo Xu Xx Xq				B3D8	20-48
MY	MULTIPLY UNNORMALIZED (long to ext. HFP)	RXF	UE	A	SP	Da					B ₂	ED3B	18-22
MYH	MULTIPLY UNNORM. (long to ext. high HFP)	RXF	UE	A		Da					B ₂	ED3D	18-22
MYHR	MULTIPLY UNNORM. (long to ext. high HFP)	RRD	UE	A		Da						B33D	18-22
MYL	MULTIPLY UNNORM. (long to ext. low HFP)	RXF	UE	A		Da					B ₂	ED39	18-22
MYLR	MULTIPLY UNNORM. (long to ext. low HFP)	RRD	UE	A		Da						B339	18-22
MYR	MULTIPLY UNNORMALIZED (long to ext. HFP)	RRD	UE	A	SP	Da						B33B	18-22
N	AND (32)	RX-a	C	A							B ₂	54	7-32
NC	AND (character)	SS-a	C	A						ST	B ₁ B ₂	D4	7-33
NCGRK	AND WITH COMPLEMENT (64)	RRF-a	C	MI3								B9E5	7-34
NCRK	AND WITH COMPLEMENT (32)	RRF-a	C	MI3								B9F5	7-34
NG	AND (64)	RXY-a	C	N	A						B ₂	E380	7-33
NGR	AND (64)	RRE	C	N								B980	7-32
NGRK	AND (64)	RRF-a	C	DO								B9E4	7-32
NI	AND (immediate)	SI	C	A				£ ²		ST	B ₁	94	7-33
NIAI	NEXT INSTRUCTION ACCESS INTENT	IE	EH									B2FA	7-309
NIHF	AND IMMEDIATE (high)	RIL-a	C	EI								C0A	7-34
NIHH	AND IMMEDIATE (high high)	RI-a	C	N								A54	7-34
NIHL	AND IMMEDIATE (high low)	RI-a	C	N								A55	7-34
NILF	AND IMMEDIATE (low)	RIL-a	C	EI								C0B	7-34
NILH	AND IMMEDIATE (low high)	RI-a	C	N								A56	7-34
NILL	AND IMMEDIATE (low low)	RI-a	C	N								A57	7-34
NIY	AND (immediate)	SIY	C	LD	A			£ ²		ST	B ₁	EB54	7-33
NNGRK	NAND (64)	RRF-a	C	MI3								B964	7-308
NNRK	NAND (32)	RRF-a	C	MI3								B974	7-308

Figure B-2. Instructions Arranged by Mnemonic (Part 14 of 24)

Mnemonic	Name	Characteristics						Op-code	Page
NOGRK	NOR (64)	RRF-a	C	MI3				B966	7-311
NORK	NOR (32)	RRF-a	C	MI3				B976	7-311
NR	AND (32)	RR	C					14	7-32
NRK	AND (32)	RRF-a	C	DO				B9F4	7-32
NTSTG	NONTRANSACTIONAL STORE (64)	RXY-a	C	TX	α^9	A SP	ST	B ₂	E325 7-310
NXGRK	NOT EXCLUSIVE OR (64)	RRF-a	C	MI3				B967	7-311
NXRK	NOT EXCLUSIVE OR (32)	RRF-a	C	MI3				B977	7-311
NY	AND (32)	RXY-a	C	LD		A		B ₂	E354 7-33
O	OR (32)	RX-a	C			A		B ₂	56 7-312
OC	OR (character)	SS-a	C		α^9	A	ST	B ₁ B ₂	D6 7-312
OCGRK	OR WITH COMPLEMENT (64)	RRF-a	C	MI3				B965	7-314
OCRK	OR WITH COMPLEMENT (32)	RRF-a	C	MI3				B975	7-314
OG	OR (64)	RXY-a	C	N		A		B ₂	E381 7-312
OGR	OR (64)	RRE	C	N				B981	7-312
OGRK	OR (64)	RRF-a	C	DO				B9E6	7-312
OI	OR (immediate)	SI	C			A	ST	B ₁	96 7-312
OIHF	OR IMMEDIATE (high)	RIL-a	C	EI				C0C	7-313
OIHH	OR IMMEDIATE (high high)	RI-a	C	N				A58	7-313
OIHL	OR IMMEDIATE (high low)	RI-a	C	N				A59	7-313
OILF	OR IMMEDIATE (low)	RIL-a	C	EI				C0D	7-313
OILH	OR IMMEDIATE (low high)	RI-a	C	N				A5A	7-313
OILL	OR IMMEDIATE (low low)	RI-a	C	N			ST	A5B	7-313
OIY	OR (immediate)	SIY	C	LD		A	ST	B ₁	EB56 7-312
OR	OR (32)	RR	C					16	7-312
ORK	OR (32)	RRF-a	C	DO				B9F6	7-312
OY	OR (32)	RXY-a	C	LD		A	ST	B ₂	E356 7-312
PACK	PACK	SS-b			α^9	A	ST	B ₁ B ₂	F2 7-314
PALB	PURGE ALB	RRE			P				B248 10-119
PC	PROGRAM CALL	S			Q	A ^{1*}	Z ¹ T ϵ GM	B ST	B218 10-93
PCC	PERFORM CRYPTOGRAPHIC COMPUTATION	RRE	C	M4	$\alpha^{5,9}$	A SP	IC GM I1	ST	B92C 7-316
PCKMO	PERFORM CRYPTOGRAPHIC KEY MGMT. OPERATIONS	RRE		M3	P	A SP	GM	ST	B928 10-75
PF	PREFETCH DATA	RXY-b		GE	$\alpha^{9,11}$			B ₂	E336 7-365
PFDR	PREFETCH DATA RELATIVE LONG	RIL-c		GE	$\alpha^{9,11}$				C62 7-366
PFMF	PERFORM FRAME MANAGEMENT FUNCTION	RRE		ED1	P	A ¹ SP	II ϵ^3	K	B9AF 10-80
PFPO	PERFORM FLOATING-POINT OPERATION	E		PF	α^{7-9}	SP	Da Xi X0 GM Xu Xx Xq		010A 9-35
PGIN	PAGE IN	RRE	C	ES	P	A ¹	ϵ		B22E 10-73
PGOUT	PAGE OUT	RRE	C	ES	P	A ¹	ϵ		B22F 10-74
PKA	PACK ASCII	SS-f		E2	α^9	A SP		ST	B ₁ B ₂ E9 7-315
PKU	PACK UNICODE	SS-f		E2	α^9	A SP		ST	B ₁ B ₂ E1 7-316
PLO	PERFORM LOCKED OPERATION	SS-e		C	α^1	A SP	ϵ GM	ST	FC EE 7-337
POP CNT	POPULATION COUNT	RRF-c	C	PK					B9E1 7-365
PPA	PERFORM PROCESSOR ASSIST	RRF-c		PA	α^1				B2E8 7-351
PR	PROGRAM RETURN	E		L	α^1	A ^{1*} SP	Z ⁴ T ϵ^2	B ST	0101 10-106
PRNO	PERFORM RANDOM NUMBER OPERATION	RRE	C	M5	$\alpha^{5,9}$	A SP	IC Dg GM I1	ST	R ₁ R ₂ B93C 7-352
PT	PROGRAM TRANSFER	RRE			Q	A ^{1*} SP	Z ² T ϵ	B	B228 10-110
PTF	PERFORM TOPOLOGY FUNCTION	RRE	C	CT	P	SP			B9A2 10-92
PTFF	PERFORM TIMING FACILITY FUNCTION	E		C TS	Q	A SP	GM	ST	0104 10-83
PTI	PROGRAM TRANSFER WITH INSTANCE	RRE		RA	Q	A ^{1*} SP	Z ⁶ T ϵ	B	B99E 10-110
PTLB	PURGE TLB	S			P		ϵ		B20D 10-119
QADTR	QUANTIZE (long DFP)	RRF-b		TF	$\alpha^{7,9}$		Dt Xi Xx Xq		B3F5 20-49
QAXTR	QUANTIZE (extended DFP)	RRF-b		TF	$\alpha^{7,9}$	SP	Dt Xi Xx Xq		B3FD 20-49
RCHP	RESET CHANNEL PATH	S		C	P				B23B 14-9
RISBG	ROTATE THEN INSERT SELECTED BITS (64)	RIE-f	C	GE					EC55 7-369
RISBGN	ROTATE THEN INSERT SELECTED BITS (64)	RIE-f		MI1					EC59 7-369

Figure B-2. Instructions Arranged by Mnemonic (Part 15 of 24)

Mnemonic	Name	Characteristics						Op-code	Page
RISBHG	ROTATE THEN INSERT SELECTED BITS HIGH (64)	RIE-f	HW					EC5D	7-371
RISBLG	ROTATE THEN INSERT SELECTED BITS LOW (64)	RIE-f	HW					EC51	7-371
RLL	ROTATE LEFT SINGLE LOGICAL (32)	RSY-a	N3					EB1D	7-367
RLLG	ROTATE LEFT SINGLE LOGICAL (64)	RSY-a	N					EB1C	7-367
RNSBG	ROTATE THEN AND SELECTED BITS (64)	RIE-f	C GE					EC54	7-368
ROSBG	ROTATE THEN OR SELECTED BITS (64)	RIE-f	C GE					EC56	7-368
RP	RESUME PROGRAM	S	L	Q	A SP	WE T	B	B ₂	B277 10-120
RRBE	RESET REFERENCE BIT EXTENDED	RRE	C	P	A ^{1*}				B22A 10-119
RRBM	RESET REFERENCE BITS MULTIPLE	RRE	RB	P	A ^{1*}				B9AE 10-120
RRDTR	REROUND (long DFP)	RRF-b	TF	$\alpha^{7,9}$		Dt Xi Xx Xq			B3F7 20-52
RRXTR	REROUND (extended DFP)	RRF-b	TF	$\alpha^{7,9}$	SP	Dt Xi Xx Xq			B3FF 20-52
RSCH	RESUME SUBCHANNEL	S	C	P		OP ϵ GS			B238 14-10
RXSBG	ROTATE THEN EXCLUSIVE OR SELECT. BITS (64)	RIE-f	C GE						EC57 7-368
S	SUBTRACT (32)	RX-a	C		A	IF		B ₂	5B 7-395
SAC	SET ADDRESS SPACE CONTROL	S		Q	SP	SW ϵ			B219 10-123
SACF	SET ADDRESS SPACE CONTROL FAST	S		Q	SP	SW			B279 10-123
SAL	SET ADDRESS LIMIT	S		P		OP ϵ G1			B237 14-12
SAM24	SET ADDRESSING MODE (24)	E	N3	$\alpha^{3,9}$	SP	T			010C 7-377
SAM31	SET ADDRESSING MODE (31)	E	N3	$\alpha^{3,9}$	SP	T			010D 7-377
SAM64	SET ADDRESSING MODE (64)	E	N	$\alpha^{3,9}$		T			010E 7-377
SAR	SET ACCESS	RRE		α^6				U ₁	B24E 7-377
SCHM	SET CHANNEL MONITOR	S		P		OP ϵ GM			B23C 14-13
SCK	SET CLOCK	S	C	P	A SP			B ₂	B204 10-124
SCKC	SET CLOCK COMPARATOR	S		P	A SP			B ₂	B206 10-125
SCKPF	SET CLOCK PROGRAMMABLE FIELD	E		P	SP	G0			0107 10-126
SD	SUBTRACT NORMALIZED (long HFP)	RX-a	C	$\alpha^{7,9}$	A	Da EU EO LS		B ₂	6B 18-24
SDB	SUBTRACT (long BFP)	RXE	C	$\alpha^{7,9}$	A	Db Xi Xo Xu Xx		B ₂	ED1B 19-40
SDBR	SUBTRACT (long BFP)	RRE	C	$\alpha^{7,9}$		Db Xi Xo Xu Xx			B31B 19-40
SDR	SUBTRACT NORMALIZED (long HFP)	RR	C	$\alpha^{7,9}$		Da EU EO LS			2B 18-24
SDTR	SUBTRACT (long DFP)	RRF-a	C TF	$\alpha^{7,9}$		Dt Xi Xo Xu Xx			B3D3 20-55
SDTRA	SUBTRACT (long DFP)	RRF-a	C F	$\alpha^{7,9}$		Dt Xi Xo Xu Xx Xq			B3D3 20-55
SE	SUBTRACT NORMALIZED (short HFP)	RX-a	C	$\alpha^{7,9}$	A	Da EU EO LS		B ₂	7B 18-24
SEB	SUBTRACT (short BFP)	RXE	C	$\alpha^{7,9}$	A	Db Xi Xo Xu Xx		B ₂	ED0B 19-40
SEBR	SUBTRACT (short BFP)	RRE	C	$\alpha^{7,9}$		Db Xi Xo Xu Xx			B30B 19-40
SELFHR	SELECT HIGH (32)	RRF-a	MI3						B9C0 7-376
SELGR	SELECT (64)	RRF-a	MI3						B9E3 7-376
SELR	SELECT (32)	RRF-a	MI3						B9F0 7-376
SER	SUBTRACT NORMALIZED (short HFP)	RR	C	$\alpha^{7,9}$		Da EU EO LS			3B 18-24
SFASR	SET FPC AND SIGNAL	RRE	XF	$\alpha^{7,9}$	SP	Dt Xg			B385 9-48
SFPC	SET FPC	RRE		$\alpha^{7,9}$	SP	Db			B384 9-47
SG	SUBTRACT (64)	RXY-a	C N		A	IF		B ₂	E309 7-395
SGF	SUBTRACT (64 \leftarrow 32)	RXY-a	C N		A	IF		B ₂	E319 7-395
SGFR	SUBTRACT (64 \leftarrow 32)	RRE	C N			IF			B919 7-394
SGH	SUBTRACT HALFWORD (64 \leftarrow 16)	RXY-a	C MI2		A	IF		B ₂	E339 7-395
SGR	SUBTRACT (64)	RRE	C N			IF			B909 7-394
SGRK	SUBTRACT (64)	RRF-a	C DO			IF			B9E9 7-394
SH	SUBTRACT HALFWORD (32 \leftarrow 16)	RX-a	C		A	IF		B ₂	4B 7-395
SHHR	SUBTRACT HIGH (32)	RRF-a	C HW			IF			B9C9 7-396
SHLR	SUBTRACT HIGH (32)	RRF-a	C HW			IF			B9D9 7-396
SHY	SUBTRACT HALFWORD (32 \leftarrow 16)	RXY-a	C LD		A	IF		B ₂	E37B 7-395
SIGP	SIGNAL PROCESSOR	RS-a	C	P		\$			AE 10-136
SL	SUBTRACT LOGICAL (32)	RX-a	C		A			B ₂	5F 7-396
SLA	SHIFT LEFT SINGLE (32)	RS-a	C			IF			8B 7-379
SLAG	SHIFT LEFT SINGLE (64)	RSY-a	C N			IF			EB0B 7-379

Figure B-2. Instructions Arranged by Mnemonic (Part 16 of 24)

Mnemonic	Name	Characteristics						Op-code	Page
SLAK	SHIFT LEFT SINGLE (32)	RSY-a C DO			IF		EBDD	7-379	
SLB	SUBTRACT LOGICAL WITH BORROW (32)	RXY-a C N3	A				B ₂ E399	7-398	
SLBG	SUBTRACT LOGICAL WITH BORROW (64)	RXY-a C N	A				B ₂ E389	7-398	
SLBGR	SUBTRACT LOGICAL WITH BORROW (64)	RRE C N					B989	7-398	
SLBR	SUBTRACT LOGICAL WITH BORROW (32)	RRE C N3					B999	7-398	
SLDA	SHIFT LEFT DOUBLE (64)	RS-a C		SP	IF		8F	7-378	
SLDL	SHIFT LEFT DOUBLE LOGICAL (64)	RS-a		SP			8D	7-379	
SLDT	SHIFT SIGNIFICAND LEFT (long DFP)	RXF TF	$\alpha^{7,9}$		Dt		ED40	20-54	
SLFI	SUBTRACT LOGICAL IMMEDIATE (32)	RIL-a C EI					C25	7-397	
SLG	SUBTRACT LOGICAL (64)	RXY-a C N	A				B ₂ E30B	7-397	
SLGF	SUBTRACT LOGICAL (64←32)	RXY-a C N	A				B ₂ E31B	7-397	
SLGFI	SUBTRACT LOGICAL IMMEDIATE (64←32)	RIL-a C EI					C24	7-397	
SLGFR	SUBTRACT LOGICAL (64←32)	RRE C N					B91B	7-396	
SLGR	SUBTRACT LOGICAL (64)	RRE C N					B90B	7-396	
SLGRK	SUBTRACT LOGICAL (64)	RRF-a C DO					B9EB	7-396	
SLHHHR	SUBTRACT LOGICAL HIGH (32)	RRF-a C HW					B9CB	7-397	
SLHHLR	SUBTRACT LOGICAL HIGH (32)	RRF-a C HW					B9DB	7-397	
SLL	SHIFT LEFT SINGLE LOGICAL (32)	RS-a					89	7-380	
SLLG	SHIFT LEFT SINGLE LOGICAL (64)	RSY-a N					EB0D	7-380	
SLLK	SHIFT LEFT SINGLE LOGICAL (32)	RSY-a DO					EBDF	7-380	
SLR	SUBTRACT LOGICAL (32)	RR C					1F	7-396	
SLRK	SUBTRACT LOGICAL (32)	RRF-a C DO					B9FB	7-396	
SLXT	SHIFT SIGNIFICAND LEFT (extended DFP)	RXF TF	$\alpha^{7,9}$	SP	Dt		ED48	20-54	
SLY	SUBTRACT LOGICAL (32)	RXY-a C LD	A				B ₂ E35F	7-396	
SP	SUBTRACT DECIMAL	SS-b C	α^9	A	Dg DF		ST B ₁ B ₂ FB	8-13	
SPKA	SET PSW KEY FROM ADDRESS	S	Q				B20A	10-127	
SPM	SET PROGRAM MASK	RR L					04	7-378	
SPT	SET CPU TIMER	S	P A SP				B ₂ B208	10-126	
SPX	SET PREFIX	S	P A SP		\$		B ₂ B210	10-126	
SQD	SQUARE ROOT (long HFP)	RXE	$\alpha^{7,9}$	A	Da	SQ	B ₂ ED35	18-23	
SQDB	SQUARE ROOT (long BFP)	RXE	$\alpha^{7,9}$	A	Db Xi	Xx	B ₂ ED15	19-40	
SQDBR	SQUARE ROOT (long BFP)	RRE	$\alpha^{7,9}$		Db Xi	Xx	B315	19-40	
SQDR	SQUARE ROOT (long HFP)	RRE	$\alpha^{7,9}$		Da	SQ	B244	18-23	
SQE	SQUARE ROOT (short HFP)	RXE	$\alpha^{7,9}$	A	Da	SQ	B ₂ ED34	18-23	
SQEB	SQUARE ROOT (short BFP)	RXE	$\alpha^{7,9}$	A	Db Xi	Xx	B ₂ ED14	19-40	
SQEBR	SQUARE ROOT (short BFP)	RRE	$\alpha^{7,9}$		Db Xi	Xx	B314	19-40	
SQER	SQUARE ROOT (short HFP)	RRE	$\alpha^{7,9}$		Da	SQ	B245	18-23	
SQXBR	SQUARE ROOT (extended BFP)	RRE	$\alpha^{7,9}$	SP	Db Xi	Xx	B316	19-40	
SQXR	SQUARE ROOT (extended HFP)	RRE	$\alpha^{7,9}$	SP	Da	SQ	B336	18-23	
SR	SUBTRACT (32)	RR C			IF		1B	7-394	
SRA	SHIFT RIGHT SINGLE (32)	RS-a C					8A	7-382	
SRAG	SHIFT RIGHT SINGLE (64)	RSY-a C N					EB0A	7-382	
SRAK	SHIFT RIGHT SINGLE (32)	RSY-a C DO					EBDC	7-382	
SRDA	SHIFT RIGHT DOUBLE (64)	RS-a C		SP			8E	7-381	
SRDL	SHIFT RIGHT DOUBLE LOGICAL (64)	RS-a		SP			8C	7-381	
SRDT	SHIFT SIGNIFICAND RIGHT (long DFP)	RXF TF	$\alpha^{7,9}$		Dt		ED41	20-54	
SRK	SUBTRACT (32)	RRF-a C DO			IF		B9F9	7-394	
SRL	SHIFT RIGHT SINGLE LOGICAL (32)	RS-a					88	7-383	
SRLG	SHIFT RIGHT SINGLE LOGICAL (64)	RSY-a N					EB0C	7-383	
SRLK	SHIFT RIGHT SINGLE LOGICAL (32)	RSY-a DO					EBDE	7-383	
SRNM	SET BFP ROUNDING MODE (2 bit)	S	$\alpha^{7,9}$		Db		B299	9-47	
SRNMB	SET BFP ROUNDING MODE (3 bit)	S F	$\alpha^{7,9}$	SP	Db		B2B8	9-47	
SRNMT	SET DFP ROUNDING MODE	S TR	$\alpha^{7,9}$		Dt		B2B9	9-47	
SRP	SHIFT AND ROUND DECIMAL	SS-c C	α^9	A	Dg DF		ST B ₁ B ₂ F0	8-12	
SRST	SEARCH STRING	RRE C	α^9	A SP	IC	G0	B25E	7-372	

Figure B-2. Instructions Arranged by Mnemonic (Part 17 of 24)

Mnemonic	Name	Characteristics										Op-code	Page		
		RRE	C	E3	α^9	A	SP	IC	G0	R ₁	R ₂				
SRSTU	SEARCH STRING UNICODE	RRE	C	E3	α^9	A	SP	IC	G0		R ₁	R ₂	B9BE	7-374	
SRXT	SHIFT SIGNIFICAND RIGHT (extended DFP)	RXF		TF	$\alpha^{7,9}$		SP	Dt					ED49	20-54	
SSAIR	SET SECONDARY ASN WITH INSTANCE	RRE		RA	α^1	A ^{1*}		Z'	T	ϵ			B99F	10-128	
SSAR	SET SECONDARY ASN	RRE			α^1	A ^{1*}		Z ³	T	ϵ			B225	10-128	
SSCH	START SUBCHANNEL	S	C		P	A	SP	OP	ϵ	GS		B ₂	B233	14-15	
SSKE	SET STORAGE KEY EXTENDED	RRF-c		C ¹	P	A ^{1*}		II	ϵ		K		B22B	10-133	
SSM	SET SYSTEM MASK	SI			P	A	SP	SO				B ₂	80	10-136	
ST	STORE (32)	RX-a				A					ST	B ₂	50	7-383	
STAM	STORE ACCESS MULTIPLE	RS-a				A	SP				ST	UB	9B	7-384	
STAMY	STORE ACCESS MULTIPLE	RSY-a		LD		A	SP				ST	UB	EB9B	7-384	
STAP	STORE CPU ADDRESS	S			P	A	SP				ST	B ₂	B212	10-139	
STC	STORE CHARACTER	RX-a				A					ST	B ₂	42	7-385	
STCH	STORE CHARACTER HIGH (8)	RXY-a		HW		A					ST	B ₂	E3C3	7-385	
STCK	STORE CLOCK	S	C		$\alpha^{8,9}$	A			\$		ST	B ₂	B205	7-386	
STCKC	STORE CLOCK COMPARATOR	S			P	A	SP				ST	B ₂	B207	10-138	
STCKE	STORE CLOCK EXTENDED	S	C		$\alpha^{8,9}$	A			\$		ST	B ₂	B278	7-387	
STCKF	STORE CLOCK FAST	S	C	SC	$\alpha^{8,9}$	A					ST	B ₂	B27C	7-386	
STCM	STORE CHARACTERS UNDER MASK (low)	RS-b				A					ST	B ₂	BE	7-385	
STCMH	STORE CHARACTERS UNDER MASK (high)	RSY-b		N	$\alpha^{9,11}$	A					ST	B ₂	EB2C	7-385	
STCMY	STORE CHARACTERS UNDER MASK (low)	RSY-b		LD		A					ST	B ₂	EB2D	7-385	
STCPS	STORE CHANNEL PATH STATUS	S			P	A	SP		ϵ		ST	B ₂	B23A	14-16	
STCRW	STORE CHANNEL REPORT WORD	S	C		P	A	SP		ϵ		ST	B ₂	B239	14-17	
STCTG	STORE CONTROL (64)	RSY-a		N	P	A	SP				ST	B ₂	EB25	10-138	
STCTL	STORE CONTROL (32)	RS-a			P	A	SP				ST	B ₂	B6	10-138	
STCY	STORE CHARACTER	RXY-a		LD		A					ST	B ₂	E372	7-385	
STD	STORE (long)	RX-a			$\alpha^{7,9}$	A		Da			ST	B ₂	60	9-48	
STDY	STORE (long)	RXY-a		LD	$\alpha^{7,9}$	A		Da			ST	B ₂	ED67	9-49	
STE	STORE (short)	RX-a			$\alpha^{7,9}$	A		Da			ST	B ₂	70	9-48	
STEY	STORE (short)	RXY-a		LD	$\alpha^{7,9}$	A		Da			ST	B ₂	ED66	9-49	
STFH	STORE HIGH (32)	RXY-a		HW		A					ST	B ₂	E3CB	7-391	
STFL	STORE FACILITY LIST	S		N3	P								B2B1	10-141	
STFLE	STORE FACILITY LIST EXTENDED	S	C	FL	α^1	A	SP		G0		ST	B ₂	B2B0	7-389	
STFPC	STORE FPC	S			$\alpha^{7,9}$	A		Db			ST	B ₂	B29C	9-49	
STG	STORE (64)	RXY-a		N		A					ST	B ₂	E324	7-384	
STGRL	STORE RELATIVE LONG (64)	RIL-b		GE		A*	SP				ST		C4B	7-384	
STGSC	STORE GUARDED STORAGE CONTROLS	RXY-a		GF	α^1	A		SO			ST	B ₂	E349	7-390	
STH	STORE HALFWORD (16)	RX-a				A					ST	B ₂	40	7-390	
STHH	STORE HALFWORD HIGH (16)	RXY-a		HW		A					ST	B ₂	E3C7	7-391	
STHRL	STORE HALFWORD RELATIVE LONG (16)	RIL-b		GE		A*					ST		C47	7-391	
STHY	STORE HALFWORD (16)	RXY-a		LD		A					ST	B ₂	E370	7-391	
STIDP	STORE CPU ID	S			P	A	SP				ST	B ₂	B202	10-139	
STM	STORE MULTIPLE (32)	RS-a				A					ST	B ₂	90	7-392	
STMG	STORE MULTIPLE (64)	RSY-a		N		A					ST	B ₂	EB24	7-392	
STMH	STORE MULTIPLE HIGH (32)	RSY-a		N		A					ST	B ₂	EB26	7-392	
STMY	STORE MULTIPLE (32)	RSY-a		LD		A					ST	B ₂	EB90	7-392	
STNSM	STORE THEN AND SYSTEM MASK	SI			P	A					ST	B ₁	AC	10-167	
STOC	STORE ON CONDITION (32)	RSY-b		L1		A					ST	B ₂	EBF3	7-392	
STOCFH	STORE HIGH ON CONDITION	RSY-b		L2		A					ST	B ₂	EBE1	7-393	
STOCG	STORE ON CONDITION (64)	RSY-b		L1		A					ST	B ₂	EBE3	7-392	
STOSM	STORE THEN OR SYSTEM MASK	SI			P	A	SP				ST	B ₁	AD	10-167	
STPQ	STORE PAIR TO QUADWORD	RXY-a		N	α^9	A	SP				ST	B ₂	E38E	7-393	
STPT	STORE CPU TIMER	S			P	A	SP				ST	B ₂	B209	10-141	
STPX	STORE PREFIX	S			P	A	SP				ST	B ₂	B211	10-142	
STRAG	STORE REAL ADDRESS	SSE		N	P	A ¹	SP				ST	B ₁	BP	E502	10-142
STRL	STORE RELATIVE LONG (32)	RIL-b		GE		A*	SP				ST		C4F	7-384	

Figure B-2. Instructions Arranged by Mnemonic (Part 18 of 24)

Mnemonic	Name	Characteristics						Op-code	Page				
STRV	STORE REVERSED (32)	RXY-a	N3	A			ST	B ₂	E33E	7-394			
STRVG	STORE REVERSED (64)	RXY-a	N	A			ST	B ₂	E32F	7-394			
STRVH	STORE REVERSED (16)	RXY-a	N3	A			ST	B ₂	E33F	7-394			
STSCH	STORE SUBCHANNEL	S	C	P	A	SP	OP	ϕ	GS	B234	14-18		
STSI	STORE SYSTEM INFORMATION	S	C	P	A	SP			GM	B27D	10-143		
STURA	STORE USING REAL ADDRESS (32)	RRE		P	A ¹	SP				B246	10-168		
STURG	STORE USING REAL ADDRESS (64)	RRE	N	P	A ¹	SP				B925	10-168		
STY	STORE (32)	RXY-a	LD	A						E350	7-384		
SU	SUBTRACT UNNORMALIZED (short HFP)	RX-a	C	α ^{7,9}	A		Da	EO	LS	B ₂	7F	18-25	
SUR	SUBTRACT UNNORMALIZED (short HFP)	RR	C	α ^{7,9}			Da	EO	LS		3F	18-25	
SVC	SUPERVISOR CALL	I		α ¹				ϕ			0A	7-398	
SW	SUBTRACT UNNORMALIZED (long HFP)	RX-a	C	α ^{7,9}	A		Da	EO	LS	B ₂	6F	18-25	
SWR	SUBTRACT UNNORMALIZED (long HFP)	RR	C	α ^{7,9}			Da	EO	LS		2F	18-25	
SXBR	SUBTRACT (extended BFP)	RRE	C	α ^{7,9}		SP	Db	Xi	Xo Xu Xx		B34B	19-40	
SXR	SUBTRACT NORMALIZED (extended HFP)	RR	C	α ^{7,9}		SP	Da	EU	EO LS		37	18-24	
SXTR	SUBTRACT (extended DFP)	RRF-a	C	TF	α ^{7,9}	SP	Dt	Xi	Xo Xu Xx		B3DB	20-55	
SXTRA	SUBTRACT (extended DFP)	RRF-a	C	F	α ^{7,9}	SP	Dt	Xi	Xo Xu Xx Xq		B3DB	20-55	
SY	SUBTRACT (32)	RXY-a	C	LD	A			IF		B ₂	E35B	7-395	
TABORT	TRANSACTION ABORT	S	TX	α ⁹		SP	SO	\$	EX		B2FC	7-401	
TAM	TEST ADDRESSING MODE	E	C	N3	α ⁹						010B	7-399	
TAR	TEST ACCESS	RRE	C	α ¹	A ^{1*}					U ₁	B24C	10-168	
TB	TEST BLOCK	RRE	C	P	A ^{1*}		II	\$	G0	K	B22C	10-170	
TBDR	CONVERT HFP TO BFP (long)	RRF-e	C	α ^{7,9}		SP	Da				B351	9-28	
TBEDR	CONVERT HFP TO BFP (long to short)	RRF-e	C	α ^{7,9}		SP	Da				B350	9-28	
TBEGIN	TRANSACTION BEGIN (nonconstrained)	SIL	C	TX	α ⁹	A	SP	SO	\$ EX	ST	E560	7-401	
TBEGINC	TRANSACTION BEGIN (constrained)	SIL	C	CX	α ⁹		SP	SO	\$ EX		E561	7-406	
TCDB	TEST DATA CLASS (long BFP)	RXE	C	α ^{7,9}			Db				ED11	19-41	
TCEB	TEST DATA CLASS (short BFP)	RXE	C	α ^{7,9}			Db				ED10	19-41	
TCXB	TEST DATA CLASS (extended BFP)	RXE	C	α ^{7,9}		SP	Db				ED12	19-41	
TDCDT	TEST DATA CLASS (long DFP)	RXE	C	TF	α ^{7,9}		Dt				ED54	20-56	
TDCET	TEST DATA CLASS (short DFP)	RXE	C	TF	α ^{7,9}		Dt				ED50	20-56	
TDCXT	TEST DATA CLASS (extended DFP)	RXE	C	TF	α ^{7,9}	SP	Dt				ED58	20-56	
TDGDT	TEST DATA GROUP (long DFP)	RXE	C	TF	α ^{7,9}		Dt				ED55	20-57	
TDGET	TEST DATA GROUP (short DFP)	RXE	C	TF	α ^{7,9}		Dt				ED51	20-57	
TDGXT	TEST DATA GROUP (extended DFP)	RXE	C	TF	α ^{7,9}	SP	Dt				ED59	20-57	
TEND	TRANSACTION END	S	C	TX			SO	\$	EX		B2F8	7-408	
THDER	CONVERT BFP TO HFP (short to long)	RRE	C	α ^{7,9}			Da				B358	9-27	
THDR	CONVERT BFP TO HFP (long)	RRE	C	α ^{7,9}			Da				B359	9-27	
TM	TEST UNDER MASK	SI	C		A					B ₁	91	7-400	
TMH	TEST UNDER MASK HIGH	RI-a	C								A70	7-400	
TMHH	TEST UNDER MASK (high high)	RI-a	C	N							A72	7-400	
TMHL	TEST UNDER MASK (high low)	RI-a	C	N							A73	7-400	
TML	TEST UNDER MASK LOW	RI-a	C								A71	7-400	
TMLH	TEST UNDER MASK (low high)	RI-a	C	N							A70	7-400	
TMLL	TEST UNDER MASK (low low)	RI-a	C	N							A71	7-400	
TMY	TEST UNDER MASK	SIY	C	LD		A				B ₁	EB51	7-400	
TP	TEST DECIMAL	RSL-a	C	E2	α ⁹	A				B ₁ B ₂	EBC0	8-14	
TPEI	TEST PENDING EXTERNAL INTERRUPTION	RRE	C	TE	P			ϕ		ST	B ₂	B9A1	10-172
TPI	TEST PENDING INTERRUPTION	S	C	P	A ^{1*}	SP		ϕ		ST	B ₂	B236	14-19
TPROT	TEST PROTECTION	SSE	C	P	A ^{1*}					B ₁	E501	10-173	
TR	TRANSLATE	SS-a		α ⁹	A					ST	B ₁ B ₂	DC	7-408
TRACE	TRACE (32)	RS-a		P	A	SP	T	ϕ			B ₂	99	10-176
TRACG	TRACE (64)	RSY-a	N	P	A	SP	T	ϕ			B ₂	EB0F	10-176
TRAP2	TRAP	E		α ¹	A*		SO	T		B	ST	01FF	10-177
TRAP4	TRAP	S		α ¹	A*		SO	T		B	ST	B2FF	10-177

Figure B-2. Instructions Arranged by Mnemonic (Part 19 of 24)

Mnemonic	Name	Characteristics										Op-code	Page	
TRE	TRANSLATE EXTENDED	RRE	C		α^9	A	SP	IC			ST	R ₁ R ₂	B2A5	7-415
TROO	TRANSLATE ONE TO ONE	RRF-c	C	E2	α^9	A	SP	IC	GM		ST	RM R ₂	B993	7-418
TROT	TRANSLATE ONE TO TWO	RRF-c	C	E2	α^9	A	SP	IC	GM		ST	RM R ₂	B992	7-418
TRT	TRANSLATE AND TEST	SS-a	C		α^9	A			GM			B ₁ B ₂	DD	7-409
TRTE	TRANSLATE AND TEST EXTENDED	RRF-c	C	PE	α^9	A	SP	IC			ST	RM	B9BF	7-410
TRTO	TRANSLATE TWO TO ONE	RRF-c	C	E2	α^9	A	SP	IC	GM		ST	RM R ₂	B991	7-418
TRTR	TRANSLATE AND TEST REVERSE	SS-a	C	E3	α^9	A			GM			B ₁ B ₂	D0	7-415
TRTRE	TRANSLATE AND TEST REVERSE EXTENDED	RRF-c	C	PE	α^9	A	SP	IC			ST	RM	B9BD	7-410
TRTT	TRANSLATE TWO TO TWO	RRF-c	C	E2	α^9	A	SP	IC	GM		ST	RM R ₂	B990	7-418
TS	TEST AND SET	SI	C		α^9	A			\$		ST	B ₂	93	7-399
TSCH	TEST SUBCHANNEL	S	C		P	A	SP	OP	¢	GS	ST	B ₂	B235	14-21
UNPK	UNPACK	SS-b			α^9	A					ST	B ₁ B ₂	F3	7-423
UNPKA	UNPACK ASCII	SS-a	C	E2	α^9	A	SP				ST	B ₁ B ₂	EA	7-423
UNPKU	UNPACK UNICODE	SS-a	C	E2	α^9	A	SP				ST	B ₁ B ₂	E2	7-424
UPT	UPDATE TREE	E	C		α^9	A	SP	II	GM	I4	ST		0102	7-425
VA	VECTOR ADD	VRR-c		VF	$\alpha^{7,9}$		SP	Dv					E7F3	22-3
VAC	VECTOR ADD WITH CARRY	VRR-d		VF	$\alpha^{7,9}$		SP	Dv					E7BB	22-4
VACC	VECTOR ADD COMPUTE CARRY	VRR-c		VF	$\alpha^{7,9}$		SP	Dv					E7F1	22-4
VACCC	VECTOR ADD WITH CARRY COMPUTE CARRY	VRR-d		VF	$\alpha^{7,9}$		SP	Dv					E7B9	22-5
VAP	VECTOR ADD DECIMAL	VRI-f	C*	VD	$\alpha^{7,9}$		SP	Dv	Dg	DF*			E671	25-3
VAVG	VECTOR AVERAGE	VRR-c		VF	$\alpha^{7,9}$		SP	Dv					E7F2	22-6
VAVGL	VECTOR AVERAGE LOGICAL	VRR-c		VF	$\alpha^{7,9}$		SP	Dv					E7F0	22-6
VBPERM	VECTOR BIT PERMUTE	VRR-c		V1	$\alpha^{7,9}$			Dv					E785	21-4
VCDG	VECTOR FP CONVERT FROM FIXED 64-BIT	VRR-a		VF	$\alpha^{7,9}$		SP	Dv		Xx			E7C3	24-15
VCDLG	VECTOR FP CONVERT FROM LOGICAL 64-BIT	VRR-a		VF	$\alpha^{7,9}$		SP	Dv		Xx			E7C1	24-17
VCEQ	VECTOR COMPARE EQUAL	VRR-b	C*	VF	$\alpha^{7,9}$		SP	Dv					E7F8	22-7
VCFPL	VECTOR FP CONVERT FROM LOGICAL	VRR-a		V2	$\alpha^{7,9}$		SP	Dv		Xx			E7C1	24-17
VCFPS	VECTOR FP CONVERT FROM FIXED	VRR-a		V2	$\alpha^{7,9}$		SP	Dv		Xx			E7C3	24-15
VCGD	VECTOR FP CONVERT TO FIXED 64-BIT	VRR-a		VF	$\alpha^{7,9}$		SP	Dv	Xi	Xx			E7C2	24-18
VCH	VECTOR COMPARE HIGH	VRR-b	C*	VF	$\alpha^{7,9}$		SP	Dv					E7FB	22-8
VCHL	VECTOR COMPARE HIGH LOGICAL	VRR-b	C*	VF	$\alpha^{7,9}$		SP	Dv					E7F9	22-9
VCKSM	VECTOR CHECKSUM	VRR-c		VF	$\alpha^{7,9}$			Dv					E766	22-6
VCLFP	VECTOR FP CONVERT TO LOGICAL	VRR-a		V2	$\alpha^{7,9}$		SP	Dv	Xi	Xx			E7C0	24-20
VCLGD	VECTOR FP CONVERT TO LOGICAL 64-BIT	VRR-a		VF	$\alpha^{7,9}$		SP	Dv	Xi	Xx			E7C0	24-20
VCLZ	VECTOR COUNT LEADING ZEROS	VRR-a		VF	$\alpha^{7,9}$		SP	Dv					E753	22-10
VCP	VECTOR COMPARE DECIMAL	VRR-h	C	VD	$\alpha^{7,9}$			Dv	Dg				E677	25-5
VCSFP	VECTOR FP CONVERT TO FIXED	VRR-a		V2	$\alpha^{7,9}$		SP	Dv	Xi	Xx			E7C2	24-18
VCTZ	VECTOR COUNT TRAILING ZEROS	VRR-a		VF	$\alpha^{7,9}$		SP	Dv					E752	22-10
VCVB	VECTOR CONVERT TO BINARY	VRR-i	C*	VD	$\alpha^{7,9}$			Dv	Dg	IF*			E650	25-5
VCVBG	VECTOR CONVERT TO BINARY	VRR-i	C*	VD	$\alpha^{7,9}$			Dv	Dg	IF*			E652	25-5
VCVD	VECTOR CONVERT TO DECIMAL	VRI-i	C*	VD	$\alpha^{7,9}$		SP	Dv		DF*			E658	25-7
VCVDG	VECTOR CONVERT TO DECIMAL	VRI-i	C*	VD	$\alpha^{7,9}$		SP	Dv		DF*			E65A	25-7
VDP	VECTOR DIVIDE DECIMAL	VRI-f	C*	VD	$\alpha^{7,9}$		SP	Dv	Dg	DF* DK			E67A	25-8
VEC	VECTOR ELEMENT COMPARE	VRR-a	C	VF	$\alpha^{7,9}$		SP	Dv					E7DB	22-7
VECL	VECTOR ELEMENT COMPARE LOGICAL	VRR-a	C	VF	$\alpha^{7,9}$		SP	Dv					E7D9	22-7
VERIM	VECTOR ELEMENT ROTATE AND INSERT UNDER MASK	VRI-d		VF	$\alpha^{7,9}$		SP	Dv					E772	22-22
VERLL	VECTOR ELEMENT ROTATE LEFT LOGICAL	VRS-a		VF	$\alpha^{7,9}$		SP	Dv					E733	22-21
VERLLV	VECTOR ELEMENT ROTATE LEFT LOGICAL	VRR-c		VF	$\alpha^{7,9}$		SP	Dv					E773	22-21
VESL	VECTOR ELEMENT SHIFT LEFT	VRS-a		VF	$\alpha^{7,9}$		SP	Dv					E730	22-23
VESLV	VECTOR ELEMENT SHIFT LEFT	VRR-c		VF	$\alpha^{7,9}$		SP	Dv					E770	22-23
VESRA	VECTOR ELEMENT SHIFT RIGHT ARITHMETIC	VRS-a		VF	$\alpha^{7,9}$		SP	Dv					E73A	22-23
VESRAV	VECTOR ELEMENT SHIFT RIGHT ARITHMETIC	VRR-c		VF	$\alpha^{7,9}$		SP	Dv					E77A	22-23
VESRL	VECTOR ELEMENT SHIFT RIGHT LOGICAL	VRS-a		VF	$\alpha^{7,9}$		SP	Dv					E738	22-24
VESRLV	VECTOR ELEMENT SHIFT RIGHT LOGICAL	VRR-c		VF	$\alpha^{7,9}$		SP	Dv					E778	22-24

Figure B-2. Instructions Arranged by Mnemonic (Part 20 of 24)

Mnemonic	Name	Characteristics							Op-code	Page			
VFA	VECTOR FP ADD	VRR-c	VF	$\alpha^{7,9}$	SP	Dv	Xi	Xo	Xu	Xx	E7E3	24-4	
VFAE	VECTOR FIND ANY ELEMENT EQUAL	VRR-b	C* VF	$\alpha^{7,9}$	SP	Dv	Xi				E782	23-2	
VFCE	VECTOR FP COMPARE EQUAL	VRR-c	C* VF	$\alpha^{7,9}$	SP	Dv	Xi				E7E8	24-9	
VFCH	VECTOR FP COMPARE HIGH	VRR-c	C* VF	$\alpha^{7,9}$	SP	Dv	Xi				E7EB	24-11	
VFCHE	VECTOR FP COMPARE HIGH OR EQUAL	VRR-c	C* VF	$\alpha^{7,9}$	SP	Dv	Xi				E7EA	24-13	
VFD	VECTOR FP DIVIDE	VRR-c	VF	$\alpha^{7,9}$	SP	Dv	Xi	Xz	Xo	Xu	Xx	E7E5	24-22
VFEE	VECTOR FIND ELEMENT EQUAL	VRR-b	C* VF	$\alpha^{7,9}$	SP	Dv					E780	23-3	
VFENE	VECTOR FIND ELEMENT NOT EQUAL	VRR-b	C* VF	$\alpha^{7,9}$	SP	Dv					E781	23-4	
VFI	VECTOR LOAD FP INTEGER	VRR-a	VF	$\alpha^{7,9}$	SP	Dv	Xi			Xx	E7C7	24-24	
VFLL	VECTOR FP LOAD LENGTHENED	VRR-a	VF	$\alpha^{7,9}$	SP	Dv	Xi				E7C4	24-26	
VFLR	VECTOR FP LOAD ROUNDED	VRR-a	VF	$\alpha^{7,9}$	SP	Dv	Xi	Xo	Xu	Xx	E7C5	24-27	
VFM	VECTOR FP MULTIPLY	VRR-c	VF	$\alpha^{7,9}$	SP	Dv	Xi	Xo	Xu	Xx	E7E7	24-40	
VFMA	VECTOR FP MULTIPLY AND ADD	VRR-e	VF	$\alpha^{7,9}$	SP	Dv	Xi	Xo	Xu	Xx	E78F	24-42	
VFMAX	VECTOR FP MAXIMUM	VRR-c	V1	$\alpha^{7,9}$	SP	Dv	Xi				E7EF	24-28	
VFMIN	VECTOR FP MINIMUM	VRR-c	V1	$\alpha^{7,9}$	SP	Dv	Xi				E7EE	24-34	
VFMS	VECTOR FP MULTIPLY AND SUBTRACT	VRR-e	VF	$\alpha^{7,9}$	SP	Dv	Xi	Xo	Xu	Xx	E78E	24-42	
VFNMA	VECTOR FP NEGATIVE MULTIPLY AND ADD	VRR-e	V1	$\alpha^{7,9}$	SP	Dv	Xi	Xo	Xu	Xx	E79F	24-42	
VFNMS	VECTOR FP NEGATIVE MULTIPLY AND SUBTRACT	VRR-e	V1	$\alpha^{7,9}$	SP	Dv	Xi	Xo	Xu	Xx	E79E	24-42	
VFPSO	VECTOR FP PERFORM SIGN OPERATION	VRR-a	VF	$\alpha^{7,9}$	SP	Dv					E7CC	24-44	
VFS	VECTOR FP SUBTRACT	VRR-c	VF	$\alpha^{7,9}$	SP	Dv	Xi	Xo	Xu	Xx	E7E2	24-46	
VFSQ	VECTOR FP SQUARE ROOT	VRR-a	VF	$\alpha^{7,9}$	SP	Dv	Xi			Xx	E7CE	24-45	
VFTCI	VECTOR FP TEST DATA CLASS IMMEDIATE	VRI-e	C VF	$\alpha^{7,9}$	SP	Dv					E74A	24-47	
VGBM	VECTOR GENERATE BYTE MASK	VRI-a	VF	$\alpha^{7,9}$		Dv					E744	21-5	
VGEF	VECTOR GATHER ELEMENT (32)	VRV	VF	$\alpha^{7,9}$	A SP	Dv				B ₂	E713	21-5	
VGEG	VECTOR GATHER ELEMENT (64)	VRV	VF	$\alpha^{7,9}$	A SP	Dv				B ₂	E712	21-5	
VGFM	VECTOR GALOIS FIELD MULTIPLY SUM	VRR-c	VF	$\alpha^{7,9}$	SP	Dv					E7B4	22-11	
VGFMA	VECTOR GALOIS FIELD MULTIPLY SUM AND ACCUMULATE	VRR-d	VF	$\alpha^{7,9}$	SP	Dv					E7BC	22-12	
VGM	VECTOR GENERATE MASK	VRI-b	VF	$\alpha^{7,9}$	SP	Dv					E746	21-6	
VISTR	VECTOR ISOLATE STRING	VRR-a	C* VF	$\alpha^{7,9}$	SP	Dv					E75C	23-5	
VL	VECTOR LOAD	VRX	VF	$\alpha^{7,9}$	A	Dv				B ₂	E706	21-6	
VLBB	VECTOR LOAD TO BLOCK BOUNDARY	VRX	VF	$\alpha^{7,9}$	A SP	Dv				B ₂	E707	21-14	
VLBR	VECTOR LOAD BYTE REVERSED ELEMENTS	VRX	V2	$\alpha^{7,9}$	A SP	Dv				B ₂	E606	21-9	
VLBRREP	VECTOR LOAD BYTE REVERSED ELEMENT AND REPLICATE	VRX	V2	$\alpha^{7,9}$	A SP	Dv				B ₂	E605	21-8	
VLC	VECTOR LOAD COMPLEMENT	VRR-a	VF	$\alpha^{7,9}$	SP	Dv					E7DE	22-12	
VLEB	VECTOR LOAD ELEMENT (8)	VRX	VF	$\alpha^{7,9}$	A SP	Dv				B ₂	E700	21-9	
VLEBRF	VECTOR LOAD BYTE REVERSED ELEMENT (32)	VRX	V2	$\alpha^{7,9}$	A SP	Dv				B ₂	E603	21-7	
VLEBRG	VECTOR LOAD BYTE REVERSED ELEMENT (64)	VRX	V2	$\alpha^{7,9}$	A SP	Dv				B ₂	E602	21-7	
VLEBRH	VECTOR LOAD BYTE REVERSED ELEMENT (16)	VRX	V2	$\alpha^{7,9}$	A SP	Dv				B ₂	E601	21-7	
VLEF	VECTOR LOAD ELEMENT (32)	VRX	VF	$\alpha^{7,9}$	A SP	Dv				B ₂	E703	21-9	
VLEG	VECTOR LOAD ELEMENT (64)	VRX	VF	$\alpha^{7,9}$	A SP	Dv				B ₂	E702	21-9	
VLEH	VECTOR LOAD ELEMENT (16)	VRX	VF	$\alpha^{7,9}$	A SP	Dv				B ₂	E701	21-9	
VLEIB	VECTOR LOAD ELEMENT IMMEDIATE (8)	VRI-a	VF	$\alpha^{7,9}$	SP	Dv					E740	21-10	
VLEIF	VECTOR LOAD ELEMENT IMMEDIATE (32)	VRI-a	VF	$\alpha^{7,9}$	SP	Dv					E743	21-10	
VLEIG	VECTOR LOAD ELEMENT IMMEDIATE (64)	VRI-a	VF	$\alpha^{7,9}$	SP	Dv					E742	21-10	
VLEIH	VECTOR LOAD ELEMENT IMMEDIATE (16)	VRI-a	VF	$\alpha^{7,9}$	SP	Dv					E741	21-10	
VLER	VECTOR LOAD ELEMENTS REVERSED	VRX	V2	$\alpha^{7,9}$	A SP	Dv				B ₂	E607	21-7	
VLGV	VECTOR LOAD GR FROM VR ELEMENT	VRS-c	VF	$\alpha^{7,9}$	SP	Dv					E721	21-11	
VLIP	VECTOR LOAD IMMEDIATE DECIMAL	VRI-h	VD	$\alpha^{7,9}$		Dv	Dg				E649	25-10	
VLL	VECTOR LOAD WITH LENGTH	VRS-b	VF	$\alpha^{7,9}$	A	Dv				B ₂	E737	21-15	
VLLBRZ	VECTOR LOAD BYTE REVERSED ELEMENT AND ZERO	VRX	V2	$\alpha^{7,9}$	A SP	Dv				B ₂	E604	21-8	
VLLEZ	VECTOR LOAD LOGICAL ELEMENT AND ZERO	VRX	VF	$\alpha^{7,9}$	A SP	Dv				B ₂	E704	21-12	
VLM	VECTOR LOAD MULTIPLE	VRS-a	VF	$\alpha^{7,9}$	A SP	Dv				B ₂	E736	21-12	

Figure B-2. Instructions Arranged by Mnemonic (Part 21 of 24)

Mnemonic	Name	Characteristics						Op-code	Page
VLP	VECTOR LOAD POSITIVE	VRR-a	VF	$\alpha^{7,9}$	SP	Dv		E7DF	22-12
VLR	VECTOR LOAD	VRR-a	VF	$\alpha^{7,9}$		Dv		E756	21-6
VLREP	VECTOR LOAD AND REPLICATE	VRX	VF	$\alpha^{7,9}$	A SP	Dv	B ₂	E705	21-7
VLRL	VECTOR LOAD RIGHTMOST WITH LENGTH	VSI	VD	$\alpha^{7,9}$	A SP	Dv	B ₂	E635	21-13
VLRLR	VECTOR LOAD RIGHTMOST WITH LENGTH	VRS-d	VD	$\alpha^{7,9}$	A	Dv	B ₂	E637	21-13
VLVG	VECTOR LOAD VR ELEMENT FROM GR	VRS-b	VF	$\alpha^{7,9}$	SP	Dv		E722	21-14
VLVGP	VECTOR LOAD VR FROM GRS DISJOINT	VRR-f	VF	$\alpha^{7,9}$		Dv		E762	21-15
VMAE	VECTOR MULTIPLY AND ADD EVEN	VRR-d	VF	$\alpha^{7,9}$	SP	Dv		E7AE	22-15
VMAH	VECTOR MULTIPLY AND ADD HIGH	VRR-d	VF	$\alpha^{7,9}$	SP	Dv		E7AB	22-15
VMAL	VECTOR MULTIPLY AND ADD LOW	VRR-d	VF	$\alpha^{7,9}$	SP	Dv		E7AA	22-14
VMAL	VECTOR MULTIPLY AND ADD LOGICAL EVEN	VRR-d	VF	$\alpha^{7,9}$	SP	Dv		E7AC	22-15
VMALH	VECTOR MULTIPLY AND ADD LOGICAL HIGH	VRR-d	VF	$\alpha^{7,9}$	SP	Dv		E7A9	22-15
VMALO	VECTOR MULTIPLY AND ADD LOGICAL ODD	VRR-d	VF	$\alpha^{7,9}$	SP	Dv		E7AD	22-16
VMAO	VECTOR MULTIPLY AND ADD ODD	VRR-d	VF	$\alpha^{7,9}$	SP	Dv		E7AF	22-16
VME	VECTOR MULTIPLY EVEN	VRR-c	VF	$\alpha^{7,9}$	SP	Dv		E7A6	22-18
VMH	VECTOR MULTIPLY HIGH	VRR-c	VF	$\alpha^{7,9}$	SP	Dv		E7A3	22-16
VML	VECTOR MULTIPLY LOW	VRR-c	VF	$\alpha^{7,9}$	SP	Dv		E7A2	22-17
VMLE	VECTOR MULTIPLY LOGICAL EVEN	VRR-c	VF	$\alpha^{7,9}$	SP	Dv		E7A4	22-18
VMLH	VECTOR MULTIPLY LOGICAL HIGH	VRR-c	VF	$\alpha^{7,9}$	SP	Dv		E7A1	22-17
VMLO	VECTOR MULTIPLY LOGICAL ODD	VRR-c	VF	$\alpha^{7,9}$	SP	Dv		E7A5	22-18
VMN	VECTOR MINIMUM	VRR-c	VF	$\alpha^{7,9}$	SP	Dv		E7FE	22-13
VMNL	VECTOR MINIMUM LOGICAL	VRR-c	VF	$\alpha^{7,9}$	SP	Dv		E7FC	22-14
VMO	VECTOR MULTIPLY ODD	VRR-c	VF	$\alpha^{7,9}$	SP	Dv		E7A7	22-18
VMP	VECTOR MULTIPLY DECIMAL	VRI-f C*	VD	$\alpha^{7,9}$	SP	Dv Dg DF*		E678	25-10
VMRH	VECTOR MERGE HIGH	VRR-c	VF	$\alpha^{7,9}$	SP	Dv		E761	21-15
VMRL	VECTOR MERGE LOW	VRR-c	VF	$\alpha^{7,9}$	SP	Dv		E760	21-16
VMSL	VECTOR MULTIPLY SUM LOGICAL	VRR-d	V1	$\alpha^{7,9}$	SP	Dv		E7B8	22-19
VMSP	VECTOR MULTIPLY AND SHIFT DECIMAL	VRI-f C*	VD	$\alpha^{7,9}$	SP	Dv Dg DF*		E679	25-12
VMX	VECTOR MAXIMUM	VRR-c	VF	$\alpha^{7,9}$	SP	Dv		E7FF	22-13
VMXL	VECTOR MAXIMUM LOGICAL	VRR-c	VF	$\alpha^{7,9}$	SP	Dv		E7FD	22-13
VN	VECTOR AND	VRR-c	VF	$\alpha^{7,9}$		Dv		E768	22-5
VNC	VECTOR AND WITH COMPLEMENT	VRR-c	VF	$\alpha^{7,9}$		Dv		E769	22-5
VNN	VECTOR NAND	VRR-c	V1	$\alpha^{7,9}$		Dv		E76E	22-20
VNO	VECTOR NOR	VRR-c	VF	$\alpha^{7,9}$		Dv		E76B	22-20
VNX	VECTOR NOT EXCLUSIVE OR	VRR-c	V1	$\alpha^{7,9}$		Dv		E76C	22-20
VO	VECTOR OR	VRR-c	VF	$\alpha^{7,9}$		Dv		E76A	22-20
VOC	VECTOR OR WITH COMPLEMENT	VRR-c	V1	$\alpha^{7,9}$		Dv		E76F	22-21
VPDI	VECTOR PERMUTE DOUBLEWORD IMMEDIATE	VRR-c	VF	$\alpha^{7,9}$		Dv		E784	21-19
VPERM	VECTOR PERMUTE	VRR-e	VF	$\alpha^{7,9}$		Dv		E78C	21-18
VPK	VECTOR PACK	VRR-c	VF	$\alpha^{7,9}$	SP	Dv		E794	21-16
VPKLS	VECTOR PACK LOGICAL SATURATE	VRR-b C*	VF	$\alpha^{7,9}$	SP	Dv		E795	21-18
VPKS	VECTOR PACK SATURATE	VRR-b C*	VF	$\alpha^{7,9}$	SP	Dv		E797	21-17
VPKZ	VECTOR PACK ZONED	VSI	VD	$\alpha^{7,9}$	A SP	Dv	B ₂	E634	25-13
VPOPCT	VECTOR POPULATION COUNT	VRR-a	VF	$\alpha^{7,9}$	SP	Dv		E750	22-21
VPSOP	VECTOR PERFORM SIGN OPERATION DECIMAL	VRI-g C*	VD	$\alpha^{7,9}$	SP	Dv Dg DF*		E65B	25-14
VREP	VECTOR REPLICATE	VRI-c	VF	$\alpha^{7,9}$	SP	Dv		E74D	21-19
VREPI	VECTOR REPLICATE IMMEDIATE	VRI-a	VF	$\alpha^{7,9}$	SP	Dv		E745	21-20
VRP	VECTOR REMAINDER DECIMAL	VRI-f C*	VD	$\alpha^{7,9}$	SP	Dv Dg DF* DK		E67B	25-16
VS	VECTOR SUBTRACT	VRR-c	VF	$\alpha^{7,9}$	SP	Dv		E7F7	22-27
VSBCBI	VECTOR SUBTRACT WITH BORROW COMPUTE BORROW INDICATION	VRR-d	VF	$\alpha^{7,9}$	SP	Dv		E7BD	22-29
VSBI	VECTOR SUBTRACT WITH BORROW INDICATION	VRR-d	VF	$\alpha^{7,9}$	SP	Dv		E7BF	22-28
VSCBI	VECTOR SUBTRACT COMPUTE BORROW INDICATION	VRR-c	VF	$\alpha^{7,9}$	SP	Dv		E7F5	22-28

Figure B-2. Instructions Arranged by Mnemonic (Part 22 of 24)

Mnemonic	Name	Characteristics							Op-code	Page		
VSCEF	VECTOR SCATTER ELEMENT (32)	VRV	VF	$\alpha^{7,9}$	A	SP	Dv	ST	B ₂	E71B	21-20	
VSCEG	VECTOR SCATTER ELEMENT (64)	VRV	VF	$\alpha^{7,9}$	A	SP	Dv	ST	B ₂	E71A	21-20	
VSDP	VECTOR SHIFT AND DIVIDE DECIMAL	VRI-f	C*	VD	$\alpha^{7,9}$	SP	Dv Dg DF* DK			E67E	25-18	
VSEG	VECTOR SIGN EXTEND TO DOUBLEWORD	VRR-a	VF	$\alpha^{7,9}$		SP	Dv			E75F	21-21	
VSEL	VECTOR SELECT	VRR-e	VF	$\alpha^{7,9}$			Dv			E78D	21-21	
VSL	VECTOR SHIFT LEFT	VRR-c	VF	$\alpha^{7,9}$			Dv			E774	22-25	
VSLB	VECTOR SHIFT LEFT BY BYTE	VRR-c	VF	$\alpha^{7,9}$			Dv			E775	22-25	
VSLD	VECTOR SHIFT LEFT DOUBLE BY BIT	VRI-d	V2	$\alpha^{7,9}$		SP	Dv			E786	22-25	
VSLDB	VECTOR SHIFT LEFT DOUBLE BY BYTE	VRI-d	VF	$\alpha^{7,9}$			Dv			E777	22-26	
VSP	VECTOR SUBTRACT DECIMAL	VRI-f	C*	VD	$\alpha^{7,9}$	SP	Dv Dg DF*			E673	25-21	
VSRA	VECTOR SHIFT RIGHT ARITHMETIC	VRR-c	VF	$\alpha^{7,9}$			Dv			E77E	22-26	
VSRAB	VECTOR SHIFT RIGHT ARITHMETIC BY BYTE	VRR-c	VF	$\alpha^{7,9}$			Dv			E77F	22-26	
VSRD	VECTOR SHIFT RIGHT DOUBLE BY BIT	VRI-d	V2	$\alpha^{7,9}$		SP	Dv			E787	22-26	
VSRL	VECTOR SHIFT RIGHT LOGICAL	VRR-c	VF	$\alpha^{7,9}$			Dv			E77C	22-27	
VSRLB	VECTOR SHIFT RIGHT LOGICAL BY BYTE	VRR-c	VF	$\alpha^{7,9}$			Dv			E77D	22-27	
VSRP	VECTOR SHIFT AND ROUND DECIMAL	VRI-g	C*	VD	$\alpha^{7,9}$	SP	Dv Dg DF*			E659	25-19	
VST	VECTOR STORE	VRX	VF	$\alpha^{7,9}$	A		Dv	ST	B ₂	E70E	21-21	
VSTBR	VECTOR STORE BYTE REVERSED ELEMENTS	VRX	V2	$\alpha^{7,9}$	A	SP	Dv	ST	B ₂	E60E	21-22	
VSTEB	VECTOR STORE ELEMENT (8)	VRX	VF	$\alpha^{7,9}$	A	SP	Dv	ST	B ₂	E708	21-23	
VSTEBR F	VECTOR STORE BYTE REVERSED ELEMENT (32)	VRX	V2	$\alpha^{7,9}$	A	SP	Dv	ST	B ₂	E60B	21-22	
VSTEBR G	VECTOR STORE BYTE REVERSED ELEMENT (64)	VRX	V2	$\alpha^{7,9}$	A	SP	Dv	ST	B ₂	E60B	21-22	
VSTEBR H	VECTOR STORE BYTE REVERSED ELEMENT (16)	VRX	V2	$\alpha^{7,9}$	A	SP	Dv	ST	B ₂	E60B	21-22	
VSTEF	VECTOR STORE ELEMENT (32)	VRX	VF	$\alpha^{7,9}$	A	SP	Dv	ST	B ₂	E70B	21-23	
VSTEG	VECTOR STORE ELEMENT (64)	VRX	VF	$\alpha^{7,9}$	A	SP	Dv	ST	B ₂	E70A	21-23	
VSTEH	VECTOR STORE ELEMENT (16)	VRX	VF	$\alpha^{7,9}$	A	SP	Dv	ST	B ₂	E709	21-23	
VSTER	VECTOR STORE ELEMENTS REVERSED	VRX	V2	$\alpha^{7,9}$	A	SP	Dv	ST	B ₂	E60F	21-24	
VSTL	VECTOR STORE WITH LENGTH	VRS-b	VF	$\alpha^{7,9}$	A		Dv	ST	B ₂	E73F	21-26	
VSTM	VECTOR STORE MULTIPLE	VRS-a	VF	$\alpha^{7,9}$	A	SP	Dv	ST	B ₂	E73E	21-24	
VSTRC	VECTOR STRING RANGE COMPARE	VRR-d	C*	VF	$\alpha^{7,9}$	SP	Dv			E78A	23-6	
VSTRL	VECTOR STORE RIGHTMOST WITH LENGTH	VSI	VD	$\alpha^{7,9}$	A	SP	Dv	ST	B ₂	E63D	21-25	
VSTRLR	VECTOR STORE RIGHTMOST WITH LENGTH	VRS-d	VD	$\alpha^{7,9}$	A		Dv	ST	B ₂	E63F	21-25	
VSTRS	VECTOR STRING SEARCH	VRR-d	C	V2	$\alpha^{7,9}$	SP	Dv			E78B	23-8	
VSUM	VECTOR SUM ACROSS WORD	VRR-c	VF	$\alpha^{7,9}$		SP	Dv			E764	22-30	
VSUMG	VECTOR SUM ACROSS DOUBLEWORD	VRR-c	VF	$\alpha^{7,9}$		SP	Dv			E765	22-29	
VSUMQ	VECTOR SUM ACROSS QUADWORD	VRR-c	VF	$\alpha^{7,9}$		SP	Dv			E767	22-30	
VTM	VECTOR TEST UNDER MASK	VRR-a	C	VF	$\alpha^{7,9}$		Dv			E7D8	22-31	
VTP	VECTOR TEST DECIMAL	VRR-g	C	VD	$\alpha^{7,9}$		Dv			E65F	25-22	
VUPH	VECTOR UNPACK HIGH	VRR-a	VF	$\alpha^{7,9}$		SP	Dv			E7D7	21-26	
VUPKZ	VECTOR UNPACK ZONED	VSI	VD	$\alpha^{7,9}$	A	SP	Dv	ST	B ₂	E63C	25-22	
VUPL	VECTOR UNPACK LOW	VRR-a	VF	$\alpha^{7,9}$		SP	Dv			E7D6	21-27	
VUPLH	VECTOR UNPACK LOGICAL HIGH	VRR-a	VF	$\alpha^{7,9}$		SP	Dv			E7D5	21-26	
VUPLL	VECTOR UNPACK LOGICAL LOW	VRR-a	VF	$\alpha^{7,9}$		SP	Dv			E7D4	21-27	
VX	VECTOR EXCLUSIVE OR	VRR-c	VF	$\alpha^{7,9}$			Dv			E76D	22-11	
WFC	VECTOR FP COMPARE SCALAR	VRR-a	C	VF	$\alpha^{7,9}$	SP	Dv Xi			E7CB	24-7	
WFK	VECTOR FP COMPARE AND SIGNAL SCALAR	VRR-a	C	VF	$\alpha^{7,9}$	SP	Dv Xi			E7CA	24-8	
X	EXCLUSIVE OR (32)	RX-a	C		A				B ₂	57	7-253	
XC	EXCLUSIVE OR (character)	SS-a	C	α^9	A			ST	B ₁	B ₂	D7	7-254
XG	EXCLUSIVE OR (64)	RXY-a	C	N	A				B ₂	E382	7-253	
XGR	EXCLUSIVE OR (64)	RRE	C	N						B982	7-253	
XGRK	EXCLUSIVE OR (64)	RRF-a	C	DO						B9E7	7-253	
XI	EXCLUSIVE OR (immediate)	SI	C		A			ST	B ₁	97	7-254	
XIHF	EXCLUSIVE OR IMMEDIATE (high)	RIL-a	C	EI						C06	7-255	

Figure B-2. Instructions Arranged by Mnemonic (Part 23 of 24)

Mnemonic	Name	Characteristics						Op-code	Page
XILF	EXCLUSIVE OR IMMEDIATE (low)	RIL-a	C	EI				C07	7-255
XIY	EXCLUSIVE OR (immediate)	SIY	C	LD	A		ST	B ₁	EB57 7-254
XR	EXCLUSIVE OR (32)	RR	C					17	7-253
XRK	EXCLUSIVE OR (32)	RRF-a	C	DO				B9F7	7-253
XSCH	CANCEL SUBCHANNEL	S	C		P	OP ¢ GS		B276	14-3
XY	EXCLUSIVE OR (32)	RXY-a	C	LD	A			B ₂ E357	7-253
ZAP	ZERO AND ADD	SS-b	C		α ⁹ A	Dg DF	ST	B ₁ B ₂	F8 8-14

Figure B-2. Instructions Arranged by Mnemonic (Part 24 of 24)

Instructions Arranged by Operation Code

Op-code	Name	Mne-monic	Characteristics										Page	
			E	L	α^1	A*	SP	Z ⁴	T	ζ^2	B	ST		
0101	PROGRAM RETURN	PR	E	L	α^1	A*	SP	Z ⁴	T	ζ^2	B	ST		10-106
0102	UPDATE TREE	UPT	E	C	α^9	A	SP	II		GM I4	B	ST		7-425
0104	PERFORM TIMING FACILITY FUNCTION	PTFF	E	C	TS	Q	A	SP		GM		ST		10-83
0107	SET CLOCK PROGRAMMABLE FIELD	SCKPF	E			P		SP		G0				10-126
010A	PERFORM FLOATING-POINT OPERATION	PFPO	E		PF	α^{7-9}		SP	Da	Xi X0	GM Xu Xx Xq			9-35
010B	TEST ADDRESSING MODE	TAM	E	C	N3	α^9								7-399
010C	SET ADDRESSING MODE (24)	SAM24	E		N3	$\alpha^{3,9}$		SP	T					7-377
010D	SET ADDRESSING MODE (31)	SAM31	E		N3	$\alpha^{3,9}$		SP	T					7-377
010E	SET ADDRESSING MODE (64)	SAM64	E		N	$\alpha^{3,9}$			T					7-377
01FF	TRAP	TRAP2	E			α^1	A*		SO	T		B	ST	10-177
04	SET PROGRAM MASK	SPM	RR	L										7-378
05	BRANCH AND LINK	BALR	RR			$\alpha^{2,9}$			T			B		7-35
06	BRANCH ON COUNT (32)	BCTR	RR			α^9						B		7-40
07	BRANCH ON CONDITION	BCR	RR			α^9				ζ^1		B		7-39
0A	SUPERVISOR CALL	SVC	I			α^1				ζ				7-398
0B	BRANCH AND SET MODE	BSM	RR			$\alpha^{3,9}$			T			B		7-37
0C	BRANCH AND SAVE AND SET MODE	BASSM	RR			$\alpha^{2,3,9}$			T			B		7-36
0D	BRANCH AND SAVE	BASR	RR			$\alpha^{2,9}$			T			B		7-36
0E	MOVE LONG	MVCL	RR	C		α^9	A	SP	II			ST	R ₁ R ₂	7-289
0F	COMPARE LOGICAL LONG	CLCL	RR	C		α^9	A	SP	II				R ₁ R ₂	7-157
10	LOAD POSITIVE (32)	LPR	RR	C						IF				7-286
11	LOAD NEGATIVE (32)	LNR	RR	C										7-282
12	LOAD AND TEST (32)	LTR	RR	C										7-269
13	LOAD COMPLEMENT (32)	LCR	RR	C						IF				7-271
14	AND (32)	NR	RR	C										7-32
15	COMPARE LOGICAL (32)	CLR	RR	C										7-151
16	OR (32)	OR	RR	C										7-312
17	EXCLUSIVE OR (32)	XR	RR	C										7-253
18	LOAD (32)	LR	RR											7-263
19	COMPARE (32)	CR	RR	C										7-133
1A	ADD (32)	AR	RR	C						IF				7-25
1B	SUBTRACT (32)	SR	RR	C						IF				7-394
1C	MULTIPLY (64←32)	MR	RR					SP						7-304
1D	DIVIDE (32←64)	DR	RR			α^9		SP		IK				7-251
1E	ADD LOGICAL (32)	ALR	RR	C										7-29
1F	SUBTRACT LOGICAL (32)	SLR	RR	C										7-396
20	LOAD POSITIVE (long HFP)	LPDR	RR	C		$\alpha^{7,9}$			Da					18-16
21	LOAD NEGATIVE (long HFP)	LNDR	RR	C		$\alpha^{7,9}$			Da					18-16
22	LOAD AND TEST (long HFP)	LTDR	RR	C		$\alpha^{7,9}$			Da					18-13
23	LOAD COMPLEMENT (long HFP)	LCDR	RR	C		$\alpha^{7,9}$			Da					18-14
24	HALVE (long HFP)	HDR	RR			$\alpha^{7,9}$			Da	EU				18-13
25	LOAD ROUNDED (extended to long HFP)	LDXR	RR			$\alpha^{7,9}$		SP	Da	EO				18-17
25	LOAD ROUNDED (extended to long HFP)	LRDR	RR			$\alpha^{7,9}$		SP	Da	EO				18-17
26	MULTIPLY (extended HFP)	MXR	RR			$\alpha^{7,9}$		SP	Da	EU	EO			18-17
27	MULTIPLY (long to extended HFP)	MXDR	RR			$\alpha^{7,9}$		SP	Da	EU	EO			18-17
28	LOAD (long)	LDR	RR			$\alpha^{7,9}$			Da					9-31
29	COMPARE (long HFP)	CDR	RR	C		$\alpha^{7,9}$			Da					18-10
2A	ADD NORMALIZED (long HFP)	ADR	RR	C		$\alpha^{7,9}$			Da	EU	EO	LS		18-8
2B	SUBTRACT NORMALIZED (long HFP)	SDR	RR	C		$\alpha^{7,9}$			Da	EU	EO	LS		18-24
2C	MULTIPLY (long HFP)	MDR	RR			$\alpha^{7,9}$			Da	EU	EO			18-17
2D	DIVIDE (long HFP)	DDR	RR			$\alpha^{7,9}$			Da	EU	EO	FK		18-12

Figure B-3. Instructions Arranged by Opcode (Part 1 of 24)

Op-code	Name	Mnemonic	Characteristics						Page			
2E	ADD UNNORMALIZED (long HFP)	AWR	RR	C	$\alpha^{7,9}$	Da	EO	LS			18-9	
2F	SUBTRACT UNNORMALIZED (long HFP)	SWR	RR	C	$\alpha^{7,9}$	Da	EO	LS			18-25	
30	LOAD POSITIVE (short HFP)	LPER	RR	C	$\alpha^{7,9}$	Da					18-16	
31	LOAD NEGATIVE (short HFP)	LNER	RR	C	$\alpha^{7,9}$	Da					18-16	
32	LOAD AND TEST (short HFP)	LTER	RR	C	$\alpha^{7,9}$	Da					18-13	
33	LOAD COMPLEMENT (short HFP)	LCER	RR	C	$\alpha^{7,9}$	Da					18-14	
34	HALVE (short HFP)	HER	RR		$\alpha^{7,9}$	Da	EU				18-13	
35	LOAD ROUNDED (long to short HFP)	LEDR	RR		$\alpha^{7,9}$	Da	EO				18-17	
35	LOAD ROUNDED (long to short HFP)	LRER	RR		$\alpha^{7,9}$	Da	EO				18-17	
36	ADD NORMALIZED (extended HFP)	AXR	RR	C	$\alpha^{7,9}$	SP	Da	EU	EO	LS	18-8	
37	SUBTRACT NORMALIZED (extended HFP)	SXR	RR	C	$\alpha^{7,9}$	SP	Da	EU	EO	LS	18-24	
38	LOAD (short)	LER	RR		$\alpha^{7,9}$	Da					9-31	
39	COMPARE (short HFP)	CER	RR	C	$\alpha^{7,9}$	Da					18-10	
3A	ADD NORMALIZED (short HFP)	AER	RR	C	$\alpha^{7,9}$	Da	EU	EO	LS		18-8	
3B	SUBTRACT NORMALIZED (short HFP)	SER	RR	C	$\alpha^{7,9}$	Da	EU	EO	LS		18-24	
3C	MULTIPLY (short to long HFP)	MDER	RR		$\alpha^{7,9}$	Da	EU	EO			18-17	
3C	MULTIPLY (short to long HFP)	MER	RR		$\alpha^{7,9}$	Da	EU	EO			18-18	
3D	DIVIDE (short HFP)	DER	RR		$\alpha^{7,9}$	Da	EU	EO	FK		18-12	
3E	ADD UNNORMALIZED (short HFP)	AUR	RR	C	$\alpha^{7,9}$	Da	EO	LS			18-9	
3F	SUBTRACT UNNORMALIZED (short HFP)	SUR	RR	C	$\alpha^{7,9}$	Da	EO	LS			18-25	
40	STORE HALFWORD (16)	STH	RX-a		A				ST	B ₂	7-390	
41	LOAD ADDRESS	LA	RX-a								7-265	
42	STORE CHARACTER	STC	RX-a		A				ST	B ₂	7-385	
43	INSERT CHARACTER	IC	RX-a		A					B ₂	7-261	
44	EXECUTE	EX	RX-a		α^9	AI	SP	EX			7-255	
45	BRANCH AND LINK	BAL	RX-a		α^9				B		7-35	
46	BRANCH ON COUNT (32)	BCT	RX-a		α^9				B		7-40	
47	BRANCH ON CONDITION	BC	RX-b		α^9				B		7-39	
48	LOAD HALFWORD (32←16)	LH	RX-a		A					B ₂	7-275	
49	COMPARE HALFWORD (32←16)	CH	RX-a	C	A					B ₂	7-149	
4A	ADD HALFWORD (32←16)	AH	RX-a	C	A		IF			B ₂	7-27	
4B	SUBTRACT HALFWORD (32←16)	SH	RX-a	C	A		IF			B ₂	7-395	
4C	MULTIPLY HALFWORD (32←16)	MH	RX-a		A					B ₂	7-305	
4D	BRANCH AND SAVE	BAS	RX-a		α^9				B		7-36	
4E	CONVERT TO DECIMAL (32)	CVD	RX-a		α^9	A			ST	B ₂	7-230	
4F	CONVERT TO BINARY (32)	CVB	RX-a		α^9	A	Dg	IK		B ₂	7-229	
50	STORE (32)	ST	RX-a		A				ST	B ₂	7-383	
51	LOAD ADDRESS EXTENDED	LAE	RX-a		α^6					U ₁	BP	7-265
54	AND (32)	N	RX-a	C	A					B ₂	7-32	
55	COMPARE LOGICAL (32)	CL	RX-a	C	A					B ₂	7-151	
56	OR (32)	O	RX-a	C	A					B ₂	7-312	
57	EXCLUSIVE OR (32)	X	RX-a	C	A					B ₂	7-253	
58	LOAD (32)	L	RX-a		A					B ₂	7-263	
59	COMPARE (32)	C	RX-a	C	A					B ₂	7-133	
5A	ADD (32)	A	RX-a	C	A		IF			B ₂	7-26	
5B	SUBTRACT (32)	S	RX-a	C	A		IF			B ₂	7-395	
5C	MULTIPLY (64←32)	M	RX-a		A	SP				B ₂	7-304	
5D	DIVIDE (32←64)	D	RX-a		α^9	A	SP	IK		B ₂	7-251	
5E	ADD LOGICAL (32)	AL	RX-a	C	A					B ₂	7-29	
5F	SUBTRACT LOGICAL (32)	SL	RX-a	C	A					B ₂	7-396	
60	STORE (long)	STD	RX-a		$\alpha^{7,9}$	A	Da		ST	B ₂	9-48	
67	MULTIPLY (long to extended HFP)	MXD	RX-a		$\alpha^{7,9}$	A	SP	Da	EU	EO	B ₂	18-18
68	LOAD (long)	LD	RX-a		$\alpha^{7,9}$	A	Da			B ₂	9-31	
69	COMPARE (long HFP)	CD	RX-a	C	$\alpha^{7,9}$	A	Da			B ₂	18-10	
6A	ADD NORMALIZED (long HFP)	AD	RX-a	C	$\alpha^{7,9}$	A	Da	EU	EO	LS	B ₂	18-8

Figure B-3. Instructions Arranged by Opcode (Part 2 of 24)

Op-code	Name	Mne-monic	Characteristics						Page				
6B	SUBTRACT NORMALIZED (long HFP)	SD	RX-a	C	$\alpha^{7,9}$	A	Da	EU	EO	LS		B ₂	18-24
6C	MULTIPLY (long HFP)	MD	RX-a		$\alpha^{7,9}$	A	Da	EU	EO			B ₂	18-18
6D	DIVIDE (long HFP)	DD	RX-a		$\alpha^{7,9}$	A	Da	EU	EO	FK		B ₂	18-12
6E	ADD UNNORMALIZED (long HFP)	AW	RX-a	C	$\alpha^{7,9}$	A	Da		EO	LS		B ₂	18-9
6F	SUBTRACT UNNORMALIZED (long HFP)	SW	RX-a	C	$\alpha^{7,9}$	A	Da		EO	LS		B ₂	18-25
70	STORE (short)	STE	RX-a		$\alpha^{7,9}$	A	Da				ST	B ₂	9-48
71	MULTIPLY SINGLE (32)	MS	RX-a			A						B ₂	7-307
78	LOAD (short)	LE	RX-a		$\alpha^{7,9}$	A	Da					B ₂	9-31
79	COMPARE (short HFP)	CE	RX-a	C	$\alpha^{7,9}$	A	Da					B ₂	18-10
7A	ADD NORMALIZED (short HFP)	AE	RX-a	C	$\alpha^{7,9}$	A	Da	EU	EO	LS		B ₂	18-8
7B	SUBTRACT NORMALIZED (short HFP)	SE	RX-a	C	$\alpha^{7,9}$	A	Da	EU	EO	LS		B ₂	18-24
7C	MULTIPLY (short to long HFP)	MDE	RX-a		$\alpha^{7,9}$	A	Da	EU	EO			B ₂	18-18
7C	MULTIPLY (short to long HFP)	ME	RX-a		$\alpha^{7,9}$	A	Da	EU	EO			B ₂	18-18
7D	DIVIDE (short HFP)	DE	RX-a		$\alpha^{7,9}$	A	Da	EU	EO	FK		B ₂	18-12
7E	ADD UNNORMALIZED (short HFP)	AU	RX-a	C	$\alpha^{7,9}$	A	Da		EO	LS		B ₂	18-9
7F	SUBTRACT UNNORMALIZED (short HFP)	SU	RX-a	C	$\alpha^{7,9}$	A	Da		EO	LS		B ₂	18-25
80	SET SYSTEM MASK	SSM	SI		P	A	SP	SO				B ₂	10-136
82	LOAD PSW	LPSW	SI	L	P	A	SP		¢			B ₂	10-54
83	DIAGNOSE	—		DM	P	DM						MD	10-23
84	BRANCH RELATIVE ON INDEX HIGH (32)	BRXH	RSI		α^9						B		7-47
85	BRANCH RELATIVE ON INDEX LOW OR EQ. (32)	BRXLE	RSI		α^9						B		7-47
86	BRANCH ON INDEX HIGH (32)	BXH	RS-a		α^9						B		7-41
87	BRANCH ON INDEX LOW OR EQUAL (32)	BXLE	RS-a		α^9						B		7-41
88	SHIFT RIGHT SINGLE LOGICAL (32)	SRL	RS-a										7-383
89	SHIFT LEFT SINGLE LOGICAL (32)	SLL	RS-a										7-380
8A	SHIFT RIGHT SINGLE (32)	SRA	RS-a	C									7-382
8B	SHIFT LEFT SINGLE (32)	SLA	RS-a	C				IF					7-379
8C	SHIFT RIGHT DOUBLE LOGICAL (64)	SRDL	RS-a				SP						7-381
8D	SHIFT LEFT DOUBLE LOGICAL (64)	SLDL	RS-a				SP						7-379
8E	SHIFT RIGHT DOUBLE (64)	SRDA	RS-a	C			SP						7-381
8F	SHIFT LEFT DOUBLE (64)	SLDA	RS-a	C			SP	IF					7-378
90	STORE MULTIPLE (32)	STM	RS-a			A					ST	B ₂	7-392
91	TEST UNDER MASK	TM	SI	C		A						B ₁	7-400
92	MOVE (immediate)	MVI	SI			A					ST	B ₁	7-288
93	TEST AND SET	TS	SI	C	α^9	A		\$			ST	B ₂	7-399
94	AND (immediate)	NI	SI	C		A		£ ²			ST	B ₁	7-33
95	COMPARE LOGICAL (immediate)	CLI	SI	C		A						B ₁	7-151
96	OR (immediate)	OI	SI	C		A					ST	B ₁	7-312
97	EXCLUSIVE OR (immediate)	XI	SI	C		A					ST	B ₁	7-254
98	LOAD MULTIPLE (32)	LM	RS-a			A						B ₂	7-281
99	TRACE (32)	TRACE	RS-a		P	A	SP	T	¢			B ₂	10-176
9A	LOAD ACCESS MULTIPLE	LAM	RS-a		α^6	A	SP					UB	7-264
9B	STORE ACCESS MULTIPLE	STAM	RS-a			A	SP				ST	UB	7-384
A50	INSERT IMMEDIATE (high high)	IIHH	RI-a	N									7-262
A51	INSERT IMMEDIATE (high low)	IIHL	RI-a	N									7-262
A52	INSERT IMMEDIATE (low high)	IILH	RI-a	N									7-262
A53	INSERT IMMEDIATE (low low)	IILL	RI-a	N									7-262
A54	AND IMMEDIATE (high high)	NIHH	RI-a	C	N								7-34
A55	AND IMMEDIATE (high low)	NIHL	RI-a	C	N								7-34
A56	AND IMMEDIATE (low high)	NILH	RI-a	C	N								7-34
A57	AND IMMEDIATE (low low)	NILL	RI-a	C	N								7-34
A58	OR IMMEDIATE (high high)	OIHH	RI-a	C	N								7-313
A59	OR IMMEDIATE (high low)	OIHL	RI-a	C	N								7-313
A5A	OR IMMEDIATE (low high)	OILH	RI-a	C	N								7-313
A5B	OR IMMEDIATE (low low)	OILL	RI-a	C	N								7-313

Figure B-3. Instructions Arranged by Opcode (Part 3 of 24)

Op-code	Name	Mnemonic	Characteristics							Page
A5C	LOAD LOGICAL IMMEDIATE (high high)	LLIHH	RI-a	N						7-280
A5D	LOAD LOGICAL IMMEDIATE (high low)	LLIHL	RI-a	N						7-280
A5E	LOAD LOGICAL IMMEDIATE (low high)	LLILH	RI-a	N						7-280
A5F	LOAD LOGICAL IMMEDIATE (low low)	LLILL	RI-a	N						7-280
A70	TEST UNDER MASK (low high)	TMLH	RI-a	C N						7-400
A70	TEST UNDER MASK HIGH	TMH	RI-a	C						7-400
A71	TEST UNDER MASK (low low)	TMLL	RI-a	C N						7-400
A71	TEST UNDER MASK LOW	TML	RI-a	C						7-400
A72	TEST UNDER MASK (high high)	TMHH	RI-a	C N						7-400
A73	TEST UNDER MASK (high low)	TMHL	RI-a	C N						7-400
A74	BRANCH RELATIVE ON CONDITION	BRC	RI-c		α^{10}			B		7-46
A75	BRANCH RELATIVE AND SAVE	BRAS	RI-b		α^9			B		7-45
A76	BRANCH RELATIVE ON COUNT (32)	BRCT	RI-b		α^9			B		7-47
A77	BRANCH RELATIVE ON COUNT (64)	BRCTG	RI-b	N	α^9			B		7-47
A78	LOAD HALFWORD IMMEDIATE (32) \leftarrow 16	LHI	RI-a							7-275
A79	LOAD HALFWORD IMMEDIATE (64) \leftarrow 16	LGHI	RI-a	N						7-275
A7A	ADD HALFWORD IMMEDIATE (32) \leftarrow 16	AHI	RI-a	C			IF			7-28
A7B	ADD HALFWORD IMMEDIATE (64) \leftarrow 16	AGHI	RI-a	C N			IF			7-28
A7C	MULTIPLY HALFWORD IMMEDIATE (32) \leftarrow 16	MHI	RI-a							7-305
A7D	MULTIPLY HALFWORD IMMEDIATE (64) \leftarrow 16	MGHI	RI-a	N						7-305
A7E	COMPARE HALFWORD IMMEDIATE (32) \leftarrow 16	CHI	RI-a	C						7-149
A7F	COMPARE HALFWORD IMMEDIATE (64) \leftarrow 16	CGHI	RI-a	C N						7-149
A8	MOVE LONG EXTENDED	MVCL	RS-a	C	α^9	A SP	IC	ST	R ₁ R ₃	7-293
A9	COMPARE LOGICAL LONG EXTENDED	CLCL	RS-a	C	α^9	A SP	IC		R ₁ R ₃	7-159
AC	STORE THEN AND SYSTEM MASK	STNSM	SI		P A			ST	B ₁	10-167
AD	STORE THEN OR SYSTEM MASK	STOSM	SI		P A SP			ST	B ₁	10-167
AE	SIGNAL PROCESSOR	SIGP	RS-a	C	P		\$			10-136
AF	MONITOR CALL	MC	SI		$\alpha^{4,8,9}$	SP		ME		7-287
B1	LOAD REAL ADDRESS (32)	LRA	RX-a	C	P	A ^{1*}	SO		BP	10-56
B202	STORE CPU ID	STIDP	S		P A SP			ST	B ₂	10-139
B204	SET CLOCK	SCK	S	C	P A SP				B ₂	10-124
B205	STORE CLOCK	STCK	S	C	$\alpha^{8,9}$ A		\$	ST	B ₂	7-386
B206	SET CLOCK COMPARATOR	SCKC	S		P A SP				B ₂	10-125
B207	STORE CLOCK COMPARATOR	STCKC	S		P A SP			ST	B ₂	10-138
B208	SET CPU TIMER	SPT	S		P A SP				B ₂	10-126
B209	STORE CPU TIMER	STPT	S		P A SP			ST	B ₂	10-141
B20A	SET PSW KEY FROM ADDRESS	SPKA	S		Q					10-127
B20B	INSERT PSW KEY	IPK	S		Q		G2			10-30
B20D	PURGE TLB	PTLB	S		P		\$			10-119
B210	SET PREFIX	SPX	S		P A SP		\$		B ₂	10-126
B211	STORE PREFIX	STPX	S		P A SP			ST	B ₂	10-142
B212	STORE CPU ADDRESS	STAP	S		P A SP			ST	B ₂	10-139
B218	PROGRAM CALL	PC	S		Q A ^{1*}	Z ¹ T c	GM	B ST		10-93
B219	SET ADDRESS SPACE CONTROL	SAC	S		Q SP	SW c				10-123
B21A	COMPARE AND FORM CODEWORD	CFC	S	C	α^9 A SP	II	GM I1			7-136
B221	INVALIDATE PAGE TABLE ENTRY	IPTE	RRF-a		P A ¹ SP		\$			10-37
B222	INSERT PROGRAM MASK	IPM	RRE		Q					7-263
B223	INSERT VIRTUAL STORAGE KEY	IVSK	RRE		Q A ^{1*}	SO			R ₂	10-31
B224	INSERT ADDRESS SPACE CONTROL	IAC	RRE	C	Q	SO				10-29
B225	SET SECONDARY ASN	SSAR	RRE		α^1 A ^{1*}	Z ³ T c				10-128
B226	EXTRACT PRIMARY ASN	EPAR	RRE		Q	SO				10-24
B227	EXTRACT SECONDARY ASN	ESAR	RRE		Q	SO				10-24
B228	PROGRAM TRANSFER	PT	RRE		Q A ^{1*} SP	Z ² T c		B		10-110
B229	INSERT STORAGE KEY EXTENDED	ISKE	RRE		P A ^{1*}					10-30
B22A	RESET REFERENCE BIT EXTENDED	RRBE	RRE	C	P A ^{1*}					10-119

Figure B-3. Instructions Arranged by Opcode (Part 4 of 24)

Op-code	Name	Mne-monic	Characteristics							Page				
B22B	SET STORAGE KEY EXTENDED	SSKE	RRF-c	C ¹	P	A ^{1*}	II	¢		K		10-133		
B22C	TEST BLOCK	TB	RRE	C	P	A ^{1*}	II	\$	GO	K		10-170		
B22D	DIVIDE (extended HFP)	DXR	RRE		$\alpha^{7,9}$		Da	EU	EO FK			18-12		
B22E	PAGE IN	PGIN	RRE	C	ES	P	A ¹	¢				10-73		
B22F	PAGE OUT	PGOUT	RRE	C	ES	P	A ¹	¢				10-74		
B230	CLEAR SUBCHANNEL	CSCH	S	C		P		OP	¢ GS			14-5		
B231	HALT SUBCHANNEL	HSCH	S	C		P		OP	¢ GS			14-6		
B232	MODIFY SUBCHANNEL	MSCH	S	C		P	A	SP	OP	¢ GS	B ₂	14-7		
B233	START SUBCHANNEL	SSCH	S	C		P	A	SP	OP	¢ GS	B ₂	14-15		
B234	STORE SUBCHANNEL	STSCH	S	C		P	A	SP	OP	¢ GS	ST	B ₂	14-18	
B235	TEST SUBCHANNEL	TSCH	S	C		P	A	SP	OP	¢ GS	ST	B ₂	14-21	
B236	TEST PENDING INTERRUPTION	TPI	S	C		P	A ^{1*}	SP	¢		ST	B ₂	14-19	
B237	SET ADDRESS LIMIT	SAL	S			P			OP	¢ G1			14-12	
B238	RESUME SUBCHANNEL	RSCH	S	C		P			OP	¢ GS			14-10	
B239	STORE CHANNEL REPORT WORD	STCRW	S	C		P	A	SP	¢		ST	B ₂	14-17	
B23A	STORE CHANNEL PATH STATUS	STCPS	S			P	A	SP	¢		ST	B ₂	14-16	
B23B	RESET CHANNEL PATH	RCHP	S	C		P							14-9	
B23C	SET CHANNEL MONITOR	SCHM	S			P			OP	¢ GM			14-13	
B240	BRANCH AND STACK	BAKR	RRE			α^1	A ^{1*}		Z ⁵ T		B	ST	10-11	
B241	CHECKSUM	CKSM	RRE	C		α^9	A	SP	IC			R ₂	7-49	
B244	SQUARE ROOT (long HFP)	SQDR	RRE			$\alpha^{7,9}$			Da	SQ			18-23	
B245	SQUARE ROOT (short HFP)	SQER	RRE			$\alpha^{7,9}$			Da	SQ			18-23	
B246	STORE USING REAL ADDRESS (32)	STURA	RRE			P	A ¹	SP			SU		10-168	
B247	MODIFY STACKED STATE	MSTA	RRE			α^1	A ^{1*}	SP	SE		ST		10-61	
B248	PURGE ALB	PALB	RRE			P			\$				10-119	
B249	EXTRACT STACKED REGISTERS (32)	EREG	RRE			α^1	A ^{1*}		SE			U ₁ U ₂	10-25	
B24A	EXTRACT STACKED STATE	ESTA	RRE	C		α^1	A ^{1*}	SP	SE				10-26	
B24B	LOAD USING REAL ADDRESS (32)	LURA	RRE			P	A ¹	SP					10-60	
B24C	TEST ACCESS	TAR	RRE	C		α^1	A ^{1*}					U ₁	10-168	
B24D	COPY ACCESS	CPYA	RRE			α^6						U ₁ U ₂	7-251	
B24E	SET ACCESS	SAR	RRE			α^6						U ₁	7-377	
B24F	EXTRACT ACCESS	EAR	RRE									U ₂	7-256	
B250	COMPARE AND SWAP AND PURGE (32)	CSP	RRE	C		P	A ¹	SP	\$		ST	R ₂	10-21	
B252	MULTIPLY SINGLE (32)	MSR	RRE										7-307	
B254	MOVE PAGE	MVPG	RRE	C		Q	A	SP	OP	¢ ⁴ GO	K	ST	R ₁ R ₂	10-62
B255	MOVE STRING	MVST	RRE	C		α^9	A	SP	IC	GO	ST		R ₁ R ₂	7-301
B257	COMPARE UNTIL SUBSTRING EQUAL	CUSE	RRE	C		α^9	A	SP	II	GM			R ₁ R ₂	7-166
B258	BRANCH IN SUBSPACE GROUP	BSG	RRE			α^1	A ^{1*}		SO	T	B		R ₂	10-13
B25A	BRANCH AND SET AUTHORITY	BSA	RRE			Q	A ^{1*}		SO	T	B			10-7
B25D	COMPARE LOGICAL STRING	CLST	RRE	C		α^9	A	SP	IC	GO			R ₁ R ₂	7-165
B25E	SEARCH STRING	SRST	RRE	C		α^9	A	SP	IC	GO			R ₂	7-372
B263	COMPRESSION CALL	CMPSC	RRE	C		$\alpha^{5,9}$	A	SP	II	Dg GM	ST		R ₁ R ₂	7-169
B276	CANCEL SUBCHANNEL	XSCH	S	C		P			OP	¢ GS				14-3
B277	RESUME PROGRAM	RP	S	L		Q	A	SP	WE	T	B		B ₂	10-120
B278	STORE CLOCK EXTENDED	STCKE	S	C		$\alpha^{8,9}$	A		\$		ST		B ₂	7-387
B279	SET ADDRESS SPACE CONTROL FAST	SACF	S			Q		SP	SW					10-123
B27C	STORE CLOCK FAST	STCKF	S	C	SC	$\alpha^{8,9}$	A				ST		B ₂	7-386
B27D	STORE SYSTEM INFORMATION	STSI	S	C		P	A	SP		GM	ST		B ₂	10-143
B299	SET BFP ROUNDING MODE (2 bit)	SRNM	S			$\alpha^{7,9}$			Db					9-47
B29C	STORE FPC	STFPC	S			$\alpha^{7,9}$	A		Db		ST		B ₂	9-49
B29D	LOAD FPC	LFPC	S			$\alpha^{7,9}$	A	SP	Db				B ₂	9-31
B2A5	TRANSLATE EXTENDED	TRE	RRE	C		α^9	A	SP	IC		ST	R ₁ R ₂	7-415	
B2A6	CONVERT UNICODE TO UTF-8	CUUTF	RRF-c	C		$\alpha^{5,9}$	A	SP	IC		ST	R ₁ R ₂	7-233	
B2A6	CONVERT UTF-16 TO UTF-8	CU21	RRF-c	C		$\alpha^{5,9}$	A	SP	IC		ST	R ₁ R ₂	7-233	
B2A7	CONVERT UTF-8 TO UNICODE	CUTFU	RRF-c	C		$\alpha^{5,9}$	A	SP	IC		ST	R ₁ R ₂	7-243	

Figure B-3. Instructions Arranged by Opcode (Part 5 of 24)

Op-code	Name	Mnemonic	Characteristics										Page
			RRF-c	C	$\alpha^{5,9}$	A	SP	IC		ST	R ₁	R ₂	
B2A7	CONVERT UTF-8 TO UTF-16	CU12	RRF-c	C	$\alpha^{5,9}$	A	SP	IC		ST	R ₁	R ₂	7-243
B2B0	STORE FACILITY LIST EXTENDED	STFLE	S	C	FL	α^1	A	SP		ST		B ₂	7-389
B2B1	STORE FACILITY LIST	STFL	S		N3	P							10-141
B2B2	LOAD PSW EXTENDED	LPSWE	S	L	N	P	A	SP	¢			B ₂	10-55
B2B8	SET BFP ROUNDING MODE (3 bit)	SRNMB	S		F	$\alpha^{7,9}$		SP	Db				9-47
B2B9	SET DFP ROUNDING MODE	SRNMT	S		TR	$\alpha^{7,9}$			Dt				9-47
B2BD	LOAD FPC AND SIGNAL	LFAS	S		XF	$\alpha^{7,9}$	A	SP	Dt	Xg		B ₂	9-32
B2E8	PERFORM PROCESSOR ASSIST	PPA	RRF-c		PA	α^1							7-351
B2EC	EXTRACT TRANSACTION NESTING DEPTH	ETND	RRE		TX	α^9			SO				7-260
B2F8	TRANSACTION END	TEND	S	C	TX				SO	\$	EX		7-408
B2FA	NEXT INSTRUCTION ACCESS INTENT	NIAI	IE		EH								7-309
B2FC	TRANSACTION ABORT	TABORT	S		TX	α^9		SP	SO	\$	EX		7-401
B2FF	TRAP	TRAP4	S			α^1	A*		SO	T		B	10-177
B300	LOAD POSITIVE (short BFP)	LPEBR	RRE	C		$\alpha^{7,9}$			Db			ST	19-35
B301	LOAD NEGATIVE (short BFP)	LNEBR	RRE	C		$\alpha^{7,9}$			Db				19-34
B302	LOAD AND TEST (short BFP)	LTEBR	RRE	C		$\alpha^{7,9}$			Db	Xi			19-31
B303	LOAD COMPLEMENT (short BFP)	LCEBR	RRE	C		$\alpha^{7,9}$			Db				19-31
B304	LOAD LENGTHENED (short to long BFP)	LDEBR	RRE			$\alpha^{7,9}$			Db	Xi			19-33
B305	LOAD LENGTHENED (long to extended BFP)	LXDBR	RRE			$\alpha^{7,9}$		SP	Db	Xi			19-33
B306	LOAD LENGTHENED (short to extended BFP)	LXEBR	RRE			$\alpha^{7,9}$		SP	Db	Xi			19-33
B307	MULTIPLY (long to extended BFP)	MXDBR	RRE			$\alpha^{7,9}$		SP	Db	Xi			19-37
B308	COMPARE AND SIGNAL (short BFP)	KEBR	RRE	C		$\alpha^{7,9}$			Db	Xi			19-18
B309	COMPARE (short BFP)	CEBR	RRE	C		$\alpha^{7,9}$			Db	Xi			19-17
B30A	ADD (short BFP)	AEBR	RRE	C		$\alpha^{7,9}$			Db	Xi	Xo Xu Xx		19-15
B30B	SUBTRACT (short BFP)	SEBR	RRE	C		$\alpha^{7,9}$			Db	Xi	Xo Xu Xx		19-40
B30C	MULTIPLY (short to long BFP)	MDEBR	RRE			$\alpha^{7,9}$			Db	Xi			19-37
B30D	DIVIDE (short BFP)	DEBR	RRE			$\alpha^{7,9}$			Db	Xi	Xz Xo Xu Xx		19-27
B30E	MULTIPLY AND ADD (short BFP)	MAEBR	RRD			$\alpha^{7,9}$			Db	Xi	Xo Xu Xx		19-38
B30F	MULTIPLY AND SUBTRACT (short BFP)	MSEBR	RRD			$\alpha^{7,9}$			Db	Xi	Xo Xu Xx		19-38
B310	LOAD POSITIVE (long BFP)	LPDBR	RRE	C		$\alpha^{7,9}$			Db				19-35
B311	LOAD NEGATIVE (long BFP)	LNDBR	RRE	C		$\alpha^{7,9}$			Db				19-34
B312	LOAD AND TEST (long BFP)	LTDBR	RRE	C		$\alpha^{7,9}$			Db	Xi			19-31
B313	LOAD COMPLEMENT (long BFP)	LCDBR	RRE	C		$\alpha^{7,9}$			Db				19-31
B314	SQUARE ROOT (short BFP)	SQEBR	RRE			$\alpha^{7,9}$			Db	Xi	Xx		19-40
B315	SQUARE ROOT (long BFP)	SQDBR	RRE			$\alpha^{7,9}$			Db	Xi	Xx		19-40
B316	SQUARE ROOT (extended BFP)	SQXBR	RRE			$\alpha^{7,9}$		SP	Db	Xi	Xx		19-40
B317	MULTIPLY (short BFP)	MEEBR	RRE			$\alpha^{7,9}$			Db	Xi	Xo Xu Xx		19-37
B318	COMPARE AND SIGNAL (long BFP)	KDBR	RRE	C		$\alpha^{7,9}$			Db	Xi			19-18
B319	COMPARE (long BFP)	CDBR	RRE	C		$\alpha^{7,9}$			Db	Xi			19-17
B31A	ADD (long BFP)	ADBR	RRE	C		$\alpha^{7,9}$			Db	Xi	Xo Xu Xx		19-15
B31B	SUBTRACT (long BFP)	SDBR	RRE	C		$\alpha^{7,9}$			Db	Xi	Xo Xu Xx		19-40
B31C	MULTIPLY (long BFP)	MDBR	RRE			$\alpha^{7,9}$			Db	Xi	Xo Xu Xx		19-37
B31D	DIVIDE (long BFP)	DDBR	RRE			$\alpha^{7,9}$			Db	Xi	Xz Xo Xu Xx		19-27
B31E	MULTIPLY AND ADD (long BFP)	MADBR	RRD			$\alpha^{7,9}$			Db	Xi	Xo Xu Xx		19-38
B31F	MULTIPLY AND SUBTRACT (long BFP)	MSDBR	RRD			$\alpha^{7,9}$			Db	Xi	Xo Xu Xx		19-38
B324	LOAD LENGTHENED (short to long HFP)	LDER	RRE			$\alpha^{7,9}$			Da				18-15
B325	LOAD LENGTHENED (long to extended HFP)	LXDR	RRE			$\alpha^{7,9}$		SP	Da				18-15
B326	LOAD LENGTHENED (short to extended HFP)	LXER	RRE			$\alpha^{7,9}$		SP	Da				18-15
B32E	MULTIPLY AND ADD (short HFP)	MAER	RRD		HM	$\alpha^{7,9}$			Da	EU	EO		18-19
B32F	MULTIPLY AND SUBTRACT (short HFP)	MSEER	RRD		HM	$\alpha^{7,9}$			Da	EU	EO		18-19
B336	SQUARE ROOT (extended HFP)	SQXR	RRE			$\alpha^{7,9}$		SP	Da		SQ		18-23
B337	MULTIPLY (short HFP)	MEER	RRE			$\alpha^{7,9}$			Da	EU	EO		18-17
B338	MULTIPLY AND ADD UNNRM. (long to ext. low HFP)	MAYLR	RRD		UE	$\alpha^{7,9}$			Da				18-20
B339	MULTIPLY UNNORM. (long to ext. low HFP)	MYLR	RRD		UE	$\alpha^{7,9}$			Da				18-22

Figure B-3. Instructions Arranged by Opcode (Part 6 of 24)

Op-code	Name	Mne-monic	Characteristics						Page	
B33A	MULTIPLY & ADD UNNORMALIZED (long to ext. HFP)	MAYR	RRD	UE	$\alpha^{7,9}$		Da			18-20
B33B	MULTIPLY UNNORMALIZED (long to ext. HFP)	MYR	RRD	UE	$\alpha^{7,9}$	SP	Da			18-22
B33C	MULTIPLY AND ADD UNNRM. (long to ext. high HFP)	MAYHR	RRD	UE	$\alpha^{7,9}$		Da			18-20
B33D	MULTIPLY UNNORM. (long to ext. high HFP)	MYHR	RRD	UE	$\alpha^{7,9}$		Da			18-22
B33E	MULTIPLY AND ADD (long HFP)	MADR	RRD	HM	$\alpha^{7,9}$		Da	EU EO		18-19
B33F	MULTIPLY AND SUBTRACT (long HFP)	MSDR	RRD	HM	$\alpha^{7,9}$		Da	EU EO		18-19
B340	LOAD POSITIVE (extended BFP)	LPXBR	RRE	C	$\alpha^{7,9}$	SP	Db			19-35
B341	LOAD NEGATIVE (extended BFP)	LNXBR	RRE	C	$\alpha^{7,9}$	SP	Db			19-34
B342	LOAD AND TEST (extended BFP)	LTXBR	RRE	C	$\alpha^{7,9}$	SP	Db	Xi		19-31
B343	LOAD COMPLEMENT (extended BFP)	LCXBR	RRE	C	$\alpha^{7,9}$	SP	Db			19-31
B344	LOAD ROUNDED (long to short BFP)	LEDBR	RRE		$\alpha^{7,9}$		Db	Xi Xo Xu Xx		19-35
B344	LOAD ROUNDED (long to short BFP)	LEDBRA	RRF-e	F	$\alpha^{7,9}$	SP	Db	Xi Xo Xu Xx		19-35
B345	LOAD ROUNDED (extended to long BFP)	LDXBR	RRE		$\alpha^{7,9}$	SP	Db	Xi Xo Xu Xx		19-35
B345	LOAD ROUNDED (extended to long BFP)	LDXBRA	RRF-e	F	$\alpha^{7,9}$	SP	Db	Xi Xo Xu Xx		19-35
B346	LOAD ROUNDED (extended to short BFP)	LEXBR	RRE		$\alpha^{7,9}$	SP	Db	Xi Xo Xu Xx		19-35
B346	LOAD ROUNDED (extended to short BFP)	LEXBRA	RRF-e	F	$\alpha^{7,9}$	SP	Db	Xi Xo Xu Xx		19-35
B347	LOAD FP INTEGER (extended BFP)	FIXBR	RRF-e		$\alpha^{7,9}$	SP	Db	Xi Xx		19-32
B347	LOAD FP INTEGER (extended BFP)	FIXBRA	RRF-e	F	$\alpha^{7,9}$	SP	Db	Xi Xx		19-32
B348	COMPARE AND SIGNAL (extended BFP)	KXBR	RRE	C	$\alpha^{7,9}$	SP	Db	Xi		19-18
B349	COMPARE (extended BFP)	CXBR	RRE	C	$\alpha^{7,9}$	SP	Db	Xi		19-17
B34A	ADD (extended BFP)	AXBR	RRE	C	$\alpha^{7,9}$	SP	Db	Xi Xo Xu Xx		19-15
B34B	SUBTRACT (extended BFP)	SXBR	RRE	C	$\alpha^{7,9}$	SP	Db	Xi Xo Xu Xx		19-40
B34C	MULTIPLY (extended BFP)	MXBR	RRE		$\alpha^{7,9}$	SP	Db	Xi Xo Xu Xx		19-37
B34D	DIVIDE (extended BFP)	DXBR	RRE		$\alpha^{7,9}$	SP	Db	Xi Xz Xo Xu Xx		19-27
B350	CONVERT HFP TO BFP (long to short)	TBEDR	RRF-e	C	$\alpha^{7,9}$	SP	Da			9-28
B351	CONVERT HFP TO BFP (long)	TBDR	RRF-e	C	$\alpha^{7,9}$	SP	Da			9-28
B353	DIVIDE TO INTEGER (short BFP)	DIEBR	RRF-b	C	$\alpha^{7,9}$	SP	Db	Xi Xu Xx		19-28
B357	LOAD FP INTEGER (short BFP)	FIEBR	RRF-e		$\alpha^{7,9}$	SP	Db	Xi Xx		19-32
B357	LOAD FP INTEGER (short BFP)	FIEBRA	RRF-e	F	$\alpha^{7,9}$	SP	Db	Xi Xx		19-32
B358	CONVERT BFP TO HFP (short to long)	THDER	RRE	C	$\alpha^{7,9}$		Da			9-27
B359	CONVERT BFP TO HFP (long)	THDR	RRE	C	$\alpha^{7,9}$		Da			9-27
B35B	DIVIDE TO INTEGER (long BFP)	DIDBR	RRF-b	C	$\alpha^{7,9}$	SP	Db	Xi Xu Xx		19-28
B35F	LOAD FP INTEGER (long BFP)	FIDBR	RRF-e		$\alpha^{7,9}$	SP	Db	Xi Xx		19-32
B35F	LOAD FP INTEGER (long BFP)	FIDBRA	RRF-e	F	$\alpha^{7,9}$	SP	Db	Xi Xx		19-32
B360	LOAD POSITIVE (extended HFP)	LPXR	RRE	C	$\alpha^{7,9}$	SP	Da			18-16
B361	LOAD NEGATIVE (extended HFP)	LNXR	RRE	C	$\alpha^{7,9}$	SP	Da			18-16
B362	LOAD AND TEST (extended HFP)	LTXR	RRE	C	$\alpha^{7,9}$	SP	Da			18-14
B363	LOAD COMPLEMENT (extended HFP)	LCXR	RRE	C	$\alpha^{7,9}$	SP	Da			18-14
B365	LOAD (extended)	LXR	RRE		$\alpha^{7,9}$	SP	Da			9-31
B366	LOAD ROUNDED (extended to short HFP)	LEXR	RRE		$\alpha^{7,9}$	SP	Da	EO		18-17
B367	LOAD FP INTEGER (extended HFP)	FIXR	RRE		$\alpha^{7,9}$	SP	Da			18-15
B369	COMPARE (extended HFP)	CXR	RRE	C	$\alpha^{7,9}$	SP	Da			18-10
B370	LOAD POSITIVE (long)	LPDFR	RRE	FS	$\alpha^{7,9}$		Da			9-34
B371	LOAD NEGATIVE (long)	LNDFR	RRE	FS	$\alpha^{7,9}$		Da			9-34
B372	COPY SIGN (long)	CPSDR	RRF-b	FS	$\alpha^{7,9}$		Da			9-30
B373	LOAD COMPLEMENT (long)	LCDFR	RRE	FS	$\alpha^{7,9}$		Da			9-31
B374	LOAD ZERO (short)	LZER	RRE		$\alpha^{7,9}$		Da			9-35
B375	LOAD ZERO (long)	LZDR	RRE		$\alpha^{7,9}$		Da			9-35
B376	LOAD ZERO (extended)	LZXR	RRE		$\alpha^{7,9}$	SP	Da			9-35
B377	LOAD FP INTEGER (short HFP)	FIER	RRE		$\alpha^{7,9}$		Da			18-15
B37F	LOAD FP INTEGER (long HFP)	FIDR	RRE		$\alpha^{7,9}$		Da			18-15
B384	SET FPC	SFPC	RRE		$\alpha^{7,9}$	SP	Db			9-47
B385	SET FPC AND SIGNAL	SFASR	RRE	XF	$\alpha^{7,9}$	SP	Dt	Xg		9-48

Figure B-3. Instructions Arranged by Opcode (Part 7 of 24)

Op-code	Name	Mnemonic	Characteristics						Page
B38C	EXTRACT FPC	EFPC	RRE		$\alpha^{7,9}$		Db		9-30
B390	CONVERT FROM LOGICAL (32 to short BFP)	CELFBR	RRF-e	F	$\alpha^{7,9}$	SP	Db	Xx	19-21
B391	CONVERT FROM LOGICAL (32 to long BFP)	CDLFBR	RRF-e	F	$\alpha^{7,9}$	SP	Db		19-21
B392	CONVERT FROM LOGICAL (32 to extended BFP)	CXLFB	RRF-e	F	$\alpha^{7,9}$	SP	Db		19-21
B394	CONVERT FROM FIXED (32 to short BFP)	CEFB	RRE		$\alpha^{7,9}$		Db	Xx	19-19
B394	CONVERT FROM FIXED (32 to short BFP)	CEFBRA	RRF-e	F	$\alpha^{7,9}$	SP	Db	Xx	19-19
B395	CONVERT FROM FIXED (32 to long BFP)	CDFBR	RRE		$\alpha^{7,9}$		Db		19-19
B395	CONVERT FROM FIXED (32 to long BFP)	CDFBRA	RRF-e	F	$\alpha^{7,9}$	SP	Db		19-19
B396	CONVERT FROM FIXED (32 to extended BFP)	CXFBR	RRE		$\alpha^{7,9}$	SP	Db		19-19
B396	CONVERT FROM FIXED (32 to extended BFP)	CXFBRA	RRF-e	F	$\alpha^{7,9}$	SP	Db		19-19
B398	CONVERT TO FIXED (short BFP to 32)	CFEBR	RRF-e	C	$\alpha^{7,9}$	SP	Db	Xi Xx	19-22
B398	CONVERT TO FIXED (short BFP to 32)	CFEBRA	RRF-e	C F	$\alpha^{7,9}$	SP	Db	Xi Xx	19-22
B399	CONVERT TO FIXED (long BFP to 32)	CFDBR	RRF-e	C	$\alpha^{7,9}$	SP	Db	Xi Xx	19-22
B399	CONVERT TO FIXED (long BFP to 32)	CFDBRA	RRF-e	C F	$\alpha^{7,9}$	SP	Db	Xi Xx	19-22
B39A	CONVERT TO FIXED (extended BFP to 32)	CFXBR	RRF-e	C	$\alpha^{7,9}$	SP	Db	Xi Xx	19-22
B39A	CONVERT TO FIXED (extended BFP to 32)	CFXBRA	RRF-e	C F	$\alpha^{7,9}$	SP	Db	Xi Xx	19-22
B39C	CONVERT TO LOGICAL (short BFP to 32)	CLFEBR	RRF-e	C F	$\alpha^{7,9}$	SP	Db	Xi Xx	19-25
B39D	CONVERT TO LOGICAL (long BFP to 32)	CLFDBR	RRF-e	C F	$\alpha^{7,9}$	SP	Db	Xi Xx	19-25
B39E	CONVERT TO LOGICAL (extended BFP to 32)	CLFXBR	RRF-e	C F	$\alpha^{7,9}$	SP	Db	Xi Xx	19-25
B3A0	CONVERT FROM LOGICAL (64 to short BFP)	CELGBR	RRF-e	F	$\alpha^{7,9}$	SP	Db	Xx	19-21
B3A1	CONVERT FROM LOGICAL (64 to long BFP)	CDLGBR	RRF-e	F	$\alpha^{7,9}$	SP	Db	Xx	19-21
B3A2	CONVERT FROM LOGICAL (64 to extended BFP)	CXLGBR	RRF-e	F	$\alpha^{7,9}$	SP	Db	Xx	19-21
B3A4	CONVERT FROM FIXED (64 to short BFP)	CEGBR	RRE	N	$\alpha^{7,9}$		Db	Xx	19-19
B3A4	CONVERT FROM FIXED (64 to short BFP)	CEGBRA	RRF-e	F	$\alpha^{7,9}$	SP	Db	Xx	19-19
B3A5	CONVERT FROM FIXED (64 to long BFP)	CDGBR	RRE	N	$\alpha^{7,9}$		Db	Xx	19-19
B3A5	CONVERT FROM FIXED (64 to long BFP)	CDGBRA	RRF-e	F	$\alpha^{7,9}$	SP	Db	Xx	19-19
B3A6	CONVERT FROM FIXED (64 to extended BFP)	CXGBR	RRE	N	$\alpha^{7,9}$	SP	Db		19-19
B3A6	CONVERT FROM FIXED (64 to extended BFP)	CXGBRA	RRF-e	F	$\alpha^{7,9}$	SP	Db		19-19
B3A8	CONVERT TO FIXED (short BFP to 64)	CGEBR	RRF-e	C N	$\alpha^{7,9}$	SP	Db	Xi Xx	19-22
B3A8	CONVERT TO FIXED (short BFP to 64)	CGEBRA	RRF-e	C F	$\alpha^{7,9}$	SP	Db	Xi Xx	19-22
B3A9	CONVERT TO FIXED (long BFP to 64)	CGDBR	RRF-e	C N	$\alpha^{7,9}$	SP	Db	Xi Xx	19-22
B3A9	CONVERT TO FIXED (long BFP to 64)	CGDBRA	RRF-e	C F	$\alpha^{7,9}$	SP	Db	Xi Xx	19-22
B3AA	CONVERT TO FIXED (extended BFP to 64)	CGXBR	RRF-e	C N	$\alpha^{7,9}$	SP	Db	Xi Xx	19-22
B3AA	CONVERT TO FIXED (extended BFP to 64)	CGXBRA	RRF-e	C F	$\alpha^{7,9}$	SP	Db	Xi Xx	19-22
B3AC	CONVERT TO LOGICAL (short BFP to 64)	CLGEBR	RRF-e	C F	$\alpha^{7,9}$	SP	Db	Xi Xx	19-25
B3AD	CONVERT TO LOGICAL (long BFP to 64)	CLGDBR	RRF-e	C F	$\alpha^{7,9}$	SP	Db	Xi Xx	19-25
B3AE	CONVERT TO LOGICAL (extended BFP to 64)	CLGXBR	RRF-e	C F	$\alpha^{7,9}$	SP	Db	Xi Xx	19-25
B3B4	CONVERT FROM FIXED (32 to short HFP)	CEFR	RRE		$\alpha^{7,9}$		Da		18-11
B3B5	CONVERT FROM FIXED (32 to long HFP)	CDFR	RRE		$\alpha^{7,9}$		Da		18-11
B3B6	CONVERT FROM FIXED (32 to extended HFP)	CXFR	RRE		$\alpha^{7,9}$	SP	Da		18-11
B3B8	CONVERT TO FIXED (short HFP to 32)	CFER	RRF-e	C	$\alpha^{7,9}$	SP	Da		18-11
B3B9	CONVERT TO FIXED (long HFP to 32)	CFDR	RRF-e	C	$\alpha^{7,9}$	SP	Da		18-11
B3BA	CONVERT TO FIXED (extended HFP to 32)	CFXR	RRF-e	C	$\alpha^{7,9}$	SP	Da		18-11
B3C1	LOAD FPR FROM GR (64 to long)	LDGR	RRE	FG	$\alpha^{7,9}$		Da		9-34
B3C4	CONVERT FROM FIXED (64 to short HFP)	CEGR	RRE	N	$\alpha^{7,9}$		Da		18-11
B3C5	CONVERT FROM FIXED (64 to long HFP)	CDGR	RRE	N	$\alpha^{7,9}$		Da		18-11
B3C6	CONVERT FROM FIXED (64 to extended HFP)	CXGR	RRE	N	$\alpha^{7,9}$	SP	Da		18-11
B3C8	CONVERT TO FIXED (short HFP to 64)	CGER	RRF-e	C N	$\alpha^{7,9}$	SP	Da		18-11
B3C9	CONVERT TO FIXED (long HFP to 64)	CGDR	RRF-e	C N	$\alpha^{7,9}$	SP	Da		18-11
B3CA	CONVERT TO FIXED (extended HFP to 64)	CGXR	RRF-e	C N	$\alpha^{7,9}$	SP	Da		18-11
B3CD	LOAD GR FROM FPR (long to 64)	LGDR	RRE	FG	$\alpha^{7,9}$		Da		9-34
B3D0	MULTIPLY (long DFP)	MDTR	RRF-a	TF	$\alpha^{7,9}$		Dt	Xi Xo Xu Xx	20-47
B3D0	MULTIPLY (long DFP)	MDTRA	RRF-a	F	$\alpha^{7,9}$		Dt	Xi Xo Xu Xx Xq	20-48
B3D1	DIVIDE (long DFP)	DDTR	RRF-a	TF	$\alpha^{7,9}$		Dt	Xi Xz Xo Xu Xx	20-37
B3D1	DIVIDE (long DFP)	DDTRA	RRF-a	F	$\alpha^{7,9}$		Dt	Xi Xz Xo Xu Xx Xq	20-37

Figure B-3. Instructions Arranged by Opcode (Part 8 of 24)

Op-code	Name	Mne-monic	Characteristics							Page					
B3D2	ADD (long DFP)	ADTR	RRF-a	C	TF	$\alpha^{7,9}$		Dt	Xi	Xo	Xu	Xx			20-19
B3D2	ADD (long DFP)	ADTRA	RRF-a	C	F	$\alpha^{7,9}$		Dt	Xi	Xo	Xu	Xx	Xq		20-19
B3D3	SUBTRACT (long DFP)	SDTR	RRF-a	C	TF	$\alpha^{7,9}$		Dt	Xi	Xo	Xu	Xx			20-55
B3D3	SUBTRACT (long DFP)	SDTRA	RRF-a	C	F	$\alpha^{7,9}$		Dt	Xi	Xo	Xu	Xx	Xq		20-55
B3D4	LOAD LENGTHENED (short to long DFP)	LDETR	RRF-d		TF	$\alpha^{7,9}$		Dt	Xi						20-45
B3D5	LOAD ROUNDED (long to short DFP)	LEDTR	RRF-e		TF	$\alpha^{7,9}$		Dt	Xi	Xo	Xu	Xx	Xq		20-46
B3D6	LOAD AND TEST (long DFP)	LTDTR	RRE	C	TF	$\alpha^{7,9}$		Dt	Xi						20-41
B3D7	LOAD FP INTEGER (long DFP)	FIDTR	RRF-e		TF	$\alpha^{7,9}$		Dt	Xi			Xx	Xq		20-42
B3D8	MULTIPLY (extended DFP)	MXTR	RRF-a		TF	$\alpha^{7,9}$	SP	Dt	Xi	Xo	Xu	Xx			20-47
B3D8	MULTIPLY (extended DFP)	MXTRA	RRF-a		F	$\alpha^{7,9}$	SP	Dt	Xi	Xo	Xu	Xx	Xq		20-48
B3D9	DIVIDE (extended DFP)	DXTR	RRF-a		TF	$\alpha^{7,9}$	SP	Dt	Xi	Xz	Xo	Xu	Xx		20-37
B3D9	DIVIDE (extended DFP)	DXTRA	RRF-a		F	$\alpha^{7,9}$	SP	Dt	Xi	Xz	Xo	Xu	Xx	Xq	20-37
B3DA	ADD (extended DFP)	AXTR	RRF-a	C	TF	$\alpha^{7,9}$	SP	Dt	Xi	Xo	Xu	Xx			20-19
B3DA	ADD (extended DFP)	AXTRA	RRF-a	C	F	$\alpha^{7,9}$	SP	Dt	Xi	Xo	Xu	Xx	Xq		20-19
B3DB	SUBTRACT (extended DFP)	SXTR	RRF-a	C	TF	$\alpha^{7,9}$	SP	Dt	Xi	Xo	Xu	Xx			20-55
B3DB	SUBTRACT (extended DFP)	SXTRA	RRF-a	C	F	$\alpha^{7,9}$	SP	Dt	Xi	Xo	Xu	Xx	Xq		20-55
B3DC	LOAD LENGTHENED (long to extended DFP)	LXDTR	RRF-d		TF	$\alpha^{7,9}$	SP	Dt	Xi						20-45
B3DD	LOAD ROUNDED (extended to long DFP)	LDXTR	RRF-e		TF	$\alpha^{7,9}$	SP	Dt	Xi	Xo	Xu	Xx	Xq		20-46
B3DE	LOAD AND TEST (extended DFP)	LTXTR	RRE	C	TF	$\alpha^{7,9}$	SP	Dt	Xi						20-41
B3DF	LOAD FP INTEGER (extended DFP)	FIXTR	RRF-e		TF	$\alpha^{7,9}$	SP	Dt	Xi			Xx	Xq		20-42
B3E0	COMPARE AND SIGNAL (long DFP)	KDTR	RRE	C	TF	$\alpha^{7,9}$		Dt	Xi						20-23
B3E1	CONVERT TO FIXED (long DFP to 64)	CGDTR	RRF-e	C	TF	$\alpha^{7,9}$		Dt	Xi			Xx			20-29
B3E1	CONVERT TO FIXED (long DFP to 64)	CGDTRA	RRF-e	C	F	$\alpha^{7,9}$		Dt	Xi			Xx			20-30
B3E2	CONVERT TO UNSIGNED PACKED (long DFP to 64)	CUDTR	RRE		TF	$\alpha^{7,9}$		Dt							20-35
B3E3	CONVERT TO SIGNED PACKED (long DFP to 64)	CSDTR	RRF-d		TF	$\alpha^{7,9}$		Dt							20-35
B3E4	COMPARE (long DFP)	CDTR	RRE	C	TF	$\alpha^{7,9}$		Dt	Xi						20-22
B3E5	EXTRACT BIASED EXPONENT (long DFP to 64)	EEDTR	RRE		TF	$\alpha^{7,9}$		Dt							20-39
B3E7	EXTRACT SIGNIFICANCE (long DFP to 64)	ESDTR	RRE		TF	$\alpha^{7,9}$		Dt							20-39
B3E8	COMPARE AND SIGNAL (extended DFP)	KXTR	RRE	C	TF	$\alpha^{7,9}$	SP	Dt	Xi						20-23
B3E9	CONVERT TO FIXED (extended DFP to 64)	CGXTR	RRF-e	C	TF	$\alpha^{7,9}$	SP	Dt	Xi			Xx			20-29
B3E9	CONVERT TO FIXED (extended DFP to 64)	CGXTRA	RRF-e	C	F	$\alpha^{7,9}$	SP	Dt	Xi			Xx			20-30
B3EA	CONVERT TO UNSIGNED PACKED (extended DFP to 128)	CUXTR	RRE		TF	$\alpha^{7,9}$	SP	Dt							20-35
B3EB	CONVERT TO SIGNED PACKED (extended DFP to 128)	CSXTR	RRF-d		TF	$\alpha^{7,9}$	SP	Dt							20-35
B3EC	COMPARE (extended DFP)	CXTR	RRE	C	TF	$\alpha^{7,9}$	SP	Dt	Xi						20-22
B3ED	EXTRACT BIASED EXPONENT (extended DFP to 64)	EEXTR	RRE		TF	$\alpha^{7,9}$	SP	Dt							20-39
B3EF	EXTRACT SIGNIFICANCE (extended DFP to 64)	ESXTR	RRE		TF	$\alpha^{7,9}$	SP	Dt							20-39
B3F1	CONVERT FROM FIXED (64 to long DFP)	CDGTR	RRE		TF	$\alpha^{7,9}$		Dt				Xx			20-24
B3F1	CONVERT FROM FIXED (64 to long DFP)	CDGTRA	RRF-e		F	$\alpha^{7,9}$		Dt				Xx	Xq		20-24
B3F2	CONVERT FROM UNSIGNED PACKED (64 to long DFP)	CDUTR	RRE		TF	$\alpha^{7,9}$		Dt	Dg						20-28
B3F3	CONVERT FROM SIGNED PACKED (64 to long DFP)	CDSTR	RRE		TF	$\alpha^{7,9}$		Dt	Dg						20-28
B3F4	COMPARE BIASED EXPONENT (long DFP)	CEDTR	RRE	C	TF	$\alpha^{7,9}$		Dt							20-23
B3F5	QUANTIZE (long DFP)	QADTR	RRF-b		TF	$\alpha^{7,9}$		Dt	Xi			Xx	Xq		20-49
B3F6	INSERT BIASED EXPONENT (64 to long DFP)	IEDTR	RRF-b		TF	$\alpha^{7,9}$		Dt							20-40
B3F7	REROUND (long DFP)	RRDTR	RRF-b		TF	$\alpha^{7,9}$		Dt	Xi			Xx	Xq		20-52
B3F9	CONVERT FROM FIXED (64 to extended DFP)	CXGTR	RRE		TF	$\alpha^{7,9}$	SP	Dt							20-24
B3F9	CONVERT FROM FIXED (64 to extended DFP)	CXGTRA	RRF-e		F	$\alpha^{7,9}$	SP	Dt							20-24
B3FA	CONVERT FROM UNSIGNED PACKED (128 to ext. DFP)	CXUTR	RRE		TF	$\alpha^{7,9}$	SP	Dt	Dg						20-28
B3FB	CONVERT FROM SIGNED PACKED (128 to extended DFP)	CXSTR	RRE		TF	$\alpha^{7,9}$	SP	Dt	Dg						20-28

Figure B-3. Instructions Arranged by Opcode (Part 9 of 24)

Op-code	Name	Mnemonic	Characteristics										Page		
B3FC	COMPARE BIASED EXPONENT (extended DFP)	CEXTR	RRE	C	TF	$\alpha^{7,9}$	SP	Dt							20-23
B3FD	QUANTIZE (extended DFP)	QAXTR	RRF-b		TF	$\alpha^{7,9}$	SP	Dt	Xi		Xx	Xq			20-49
B3FE	INSERT BIASED EXPONENT (64 to extended DFP)	IEXTR	RRF-b		TF	$\alpha^{7,9}$	SP	Dt							20-40
B3FF	REROUND (extended DFP)	RRXTR	RRF-b		TF	$\alpha^{7,9}$	SP	Dt	Xi		Xx	Xq			20-52
B6	STORE CONTROL (32)	STCTL	RS-a				P A SP						ST	B ₂	10-138
B7	LOAD CONTROL (32)	LCTL	RS-a				P A SP							B ₂	10-50
B900	LOAD POSITIVE (64)	LPGR	RRE	C	N						IF				7-286
B901	LOAD NEGATIVE (64)	LNGR	RRE	C	N										7-282
B902	LOAD AND TEST (64)	LTGR	RRE	C	N										7-269
B903	LOAD COMPLEMENT (64)	LCGR	RRE	C	N						IF				7-272
B904	LOAD (64)	LGR	RRE		N										7-263
B905	LOAD USING REAL ADDRESS (64)	LURAG	RRE		N		P A ¹ SP								10-60
B906	LOAD BYTE (64←8)	LGBR	RRE		EI										7-271
B907	LOAD HALFWORD (64←16)	LGHR	RRE		EI										7-275
B908	ADD (64)	AGR	RRE	C	N						IF				7-25
B909	SUBTRACT (64)	SGR	RRE	C	N						IF				7-394
B90A	ADD LOGICAL (64)	ALGR	RRE	C	N										7-29
B90B	SUBTRACT LOGICAL (64)	SLGR	RRE	C	N										7-396
B90C	MULTIPLY SINGLE (64)	MSGR	RRE		N										7-307
B90D	DIVIDE SINGLE (64)	DSGR	RRE		N	α^9	SP				IK				7-253
B90E	EXTRACT STACKED REGISTERS (64)	EREGG	RRE		N	α^1	A ¹⁺	SE					U ₁	U ₂	10-25
B90F	LOAD REVERSED (64)	LRVGR	RRE		N										7-286
B910	LOAD POSITIVE (64←32)	LPGFR	RRE	C	N										7-286
B911	LOAD NEGATIVE (64←32)	LNGFR	RRE	C	N										7-283
B912	LOAD AND TEST (64←32)	LTGFR	RRE	C	N										7-269
B913	LOAD COMPLEMENT (64←32)	LCGFR	RRE	C	N										7-272
B914	LOAD (64←32)	LGFR	RRE		N										7-263
B916	LOAD LOGICAL (64←32)	LLGFR	RRE		N										7-277
B917	LOAD LOGICAL THIRTY ONE BITS (64←31)	LLGTR	RRE		N										7-280
B918	ADD (64←32)	AGFR	RRE	C	N						IF				7-25
B919	SUBTRACT (64←32)	SGFR	RRE	C	N						IF				7-394
B91A	ADD LOGICAL (64←32)	ALGFR	RRE	C	N										7-29
B91B	SUBTRACT LOGICAL (64←32)	SLGFR	RRE	C	N										7-396
B91C	MULTIPLY SINGLE (64←32)	MSGFR	RRE		N										7-307
B91D	DIVIDE SINGLE (64←32)	DSGFR	RRE		N	α^9	SP				IK				7-253
B91E	COMPUTE MESSAGE AUTHENTICATION CODE	KMAC	RRE	C	MS	$\alpha^{5,9}$	A SP	IC			GM I1		ST	R ₂	7-218
B91F	LOAD REVERSED (32)	LRVR	RRE		N3										7-286
B920	COMPARE (64)	CGR	RRE	C	N										7-133
B921	COMPARE LOGICAL (64)	CLGR	RRE	C	N										7-151
B925	STORE USING REAL ADDRESS (64)	STURG	RRE		N		P A ¹ SP						SU		10-168
B926	LOAD BYTE (32←8)	LBR	RRE		EI										7-271
B927	LOAD HALFWORD (32←16)	LHR	RRE		EI										7-275
B928	PERFORM CRYPTOGRAPHIC KEY MGMT. OPERATIONS	PCKMO	RRE		M3		P A SP				GM		ST		10-75
B929	CIPHER MESSAGE WITH AUTHENTICATION	KMA	RRF-b	C	M8	$\alpha^{5,9}$	A SP	IC			GM I1		ST	R ₁ R ₂ R ₃	7-77
B92A	CIPHER MESSAGE WITH CIPHER FEEDBACK	KMF	RRE	C	M4	$\alpha^{5,9}$	A SP	IC			GM I1		ST	R ₁ R ₂	7-91
B92B	CIPHER MESSAGE WITH OUTPUT FEEDBACK	KMO	RRE	C	M4	$\alpha^{5,9}$	A SP	IC			GM I1		ST	R ₁ R ₂	7-119
B92C	PERFORM CRYPTOGRAPHIC COMPUTATION	PCC	RRE	C	M4	$\alpha^{5,9}$	A SP	IC			GM I1		ST		7-316
B92D	CIPHER MESSAGE WITH COUNTER	KMCTR	RRF-b	C	M4	$\alpha^{5,9}$	A SP	IC			GM I1		ST	R ₁ R ₂ R ₃	7-106
B92E	CIPHER MESSAGE	KM	RRE	C	MS	$\alpha^{5,9}$	A SP	IC			GM I1		ST	R ₁ R ₂	7-52
B92F	CIPHER MESSAGE WITH CHAINING	KMC	RRE	C	MS	$\alpha^{5,9}$	A SP	IC			GM I1		ST	R ₁ R ₂	7-52
B930	COMPARE (64←32)	CGFR	RRE		N										7-133
B931	COMPARE LOGICAL (64←32)	CLGFR	RRE		N										7-151
B939	DEFLATE CONVERSION CALL	DFLTCC	RRF-a	C	GZ	$\alpha^{5,9}$	A SP	IC			GM I1		ST	R ₁ R ₂ R ₃	26-16

Figure B-3. Instructions Arranged by Opcode (Part 10 of 24)

Op-code	Name	Mne-monic	Characteristics										Page				
B93A	COMPUTE DIGITAL SIGNATURE AUTHENTICATION	KDSA	RRE	C	M9	$\alpha^{5,9}$	A	SP	IC		GM	I1		ST		R ₂	26-2
B93C	PERFORM RANDOM NUMBER OPERATION	PRNO	RRE	C	M5	$\alpha^{5,9}$	A	SP	IC	Dg	GM	I1		ST	R ₁	R ₂	7-352
B93E	COMPUTE INTERMEDIATE MESSAGE DIGEST	KIMD	RRE	C	MS	$\alpha^{5,9}$	A	SP	IC		GM	I1		ST		R ₂	7-187
B93F	COMPUTE LAST MESSAGE DIGEST	KLMD	RRE	C	MS	$\alpha^{5,9}$	A	SP	IC		GM	I1		ST		R ₂	7-200
B941	CONVERT TO FIXED (long DFP to 32)	CFDTR	RRF-e	C	F	$\alpha^{7,9}$			Dt	Xi		Xx					20-30
B942	CONVERT TO LOGICAL (long DFP to 64)	CLGDTR	RRF-e	C	F	$\alpha^{7,9}$			Dt	Xi		Xx					20-32
B943	CONVERT TO LOGICAL (long DFP to 32)	CLFDTR	RRF-e	C	F	$\alpha^{7,9}$			Dt	Xi		Xx					20-32
B946	BRANCH ON COUNT (64)	BCTGR	RRE		N	α^9								B			7-40
B949	CONVERT TO FIXED (extended DFP to 32)	CFXTR	RRF-e	C	F	$\alpha^{7,9}$		SP	Dt	Xi		Xx					20-30
B94A	CONVERT TO LOGICAL (extended DFP to 64)	CLGXTR	RRF-e	C	F	$\alpha^{7,9}$		SP	Dt	Xi		Xx					20-32
B94B	CONVERT TO LOGICAL (extended DFP to 32)	CLFXTR	RRF-e	C	F	$\alpha^{7,9}$		SP	Dt	Xi		Xx					20-32
B951	CONVERT FROM FIXED (32 to long DFP)	CDFTR	RRE		F	$\alpha^{7,9}$			Dt								20-24
B952	CONVERT FROM LOGICAL (64 to long DFP)	CDLGTR	RRF-e		F	$\alpha^{7,9}$			Dt			Xx	Xq				20-25
B953	CONVERT FROM LOGICAL (32 to long DFP)	CDLFTR	RRF-e		F	$\alpha^{7,9}$			Dt								20-25
B959	CONVERT FROM FIXED (32 to extended DFP)	CXFTR	RRE		F	$\alpha^{7,9}$		SP	Dt								20-24
B95A	CONVERT FROM LOGICAL (64 to extended DFP)	CXLGTR	RRF-e		F	$\alpha^{7,9}$		SP	Dt								20-25
B95B	CONVERT FROM LOGICAL (32 to extended DFP)	CXLFTR	RRF-e		F	$\alpha^{7,9}$		SP	Dt								20-25
B960	COMPARE AND TRAP (64)	CGRT	RRF-c		GE					Dc							7-148
B961	COMPARE LOGICAL AND TRAP (64)	CLGRT	RRF-c		GE					Dc							7-154
B964	NAND (64)	NNGRK	RRF-a	C	MI3												7-308
B965	OR WITH COMPLEMENT(64)	OCGRK	RRF-a	C	MI3												7-314
B966	NOR (64)	NOGRK	RRF-a	C	MI3												7-311
B967	NOT EXCLUSIVE OR (64)	NXGRK	RRF-a	C	MI3												7-311
B972	COMPARE AND TRAP (32)	CRT	RRF-c		GE					Dc							7-148
B973	COMPARE LOGICAL AND TRAP (32)	CLRT	RRF-c		GE					Dc							7-154
B974	NAND (32)	NNRK	RRF-a	C	MI3												7-308
B975	OR WITH COMPLEMENT(32)	OCRK	RRF-a	C	MI3												7-314
B976	NOR (32)	NORK	RRF-a	C	MI3												7-311
B977	NOT EXCLUSIVE OR (32)	NXRK	RRF-a	C	MI3												7-311
B980	AND (64)	NGR	RRE	C	N												7-32
B981	OR (64)	OGR	RRE	C	N												7-312
B982	EXCLUSIVE OR (64)	XGR	RRE	C	N												7-253
B983	FIND LEFTMOST ONE	FLOGR	RRE	C	EI			SP									7-261
B984	LOAD LOGICAL CHARACTER (64←8)	LLGCR	RRE		EI												7-278
B985	LOAD LOGICAL HALFWORD (64←16)	LLGHR	RRE		EI												7-279
B986	MULTIPLY LOGICAL (128←64)	MLGR	RRE		N			SP									7-306
B987	DIVIDE LOGICAL (64←128)	DLGR	RRE		N	α^9		SP			IK						7-252
B988	ADD LOGICAL WITH CARRY (64)	ALCGR	RRE	C	N												7-30
B989	SUBTRACT LOGICAL WITH BORROW (64)	SLBGR	RRE	C	N												7-398
B98A	COMPARE AND SWAP AND PURGE (64)	CSPG	RRE	C	DE	P	A ¹	SP			\$			ST		R ₂	10-21
B98D	EXTRACT PSW	EPSW	RRE		N3	$\alpha^{8,9}$											7-260
B98E	INVALIDATE DAT TABLE ENTRY	IDTE	RRF-b	U	DE	P	A ¹	SP			\$						10-32
B98F	COMPARE AND REPLACE DAT TABLE ENTRY	CRDTE	RRF-b		ED2	P	A ¹	SP			\$						10-17
B990	TRANSLATE TWO TO TWO	TRTT	RRF-c	C	E2	α^9	A	SP	IC		GM			ST	RM	R ₂	7-418
B991	TRANSLATE TWO TO ONE	TRTO	RRF-c	C	E2	α^9	A	SP	IC		GM			ST	RM	R ₂	7-418
B992	TRANSLATE ONE TO TWO	TROT	RRF-c	C	E2	α^9	A	SP	IC		GM			ST	RM	R ₂	7-418
B993	TRANSLATE ONE TO ONE	TROO	RRF-c	C	E2	α^9	A	SP	IC		GM			ST	RM	R ₂	7-418
B994	LOAD LOGICAL CHARACTER (32←8)	LLCR	RRE		EI												7-278
B995	LOAD LOGICAL HALFWORD (32←16)	LLHR	RRE		EI												7-279
B996	MULTIPLY LOGICAL (64←32)	MLR	RRE		N3			SP									7-305
B997	DIVIDE LOGICAL (32←64)	DLR	RRE		N3	α^9		SP			IK						7-252
B998	ADD LOGICAL WITH CARRY (32)	ALCR	RRE	C	N3												7-30
B999	SUBTRACT LOGICAL WITH BORROW (32)	SLBR	RRE	C	N3												7-398
B99A	EXTRACT PRIMARY ASN AND INSTANCE	EPAIR	RRE		RA	Q			SO								10-24

Figure B-3. Instructions Arranged by Opcode (Part 11 of 24)

Op-code	Name	Mnemonic	Characteristics							Page
			RRE	RA	Q	SO				
B99B	EXTRACT SECONDARY ASN AND INSTANCE	ESAIR	RRE	RA	Q		SO			10-25
B99D	EXTRACT AND SET EXTENDED AUTHORITY	ESEA	RRE	N	P					10-24
B99E	PROGRAM TRANSFER WITH INSTANCE	PTI	RRE	RA	Q A ^{1*} SP	Z ⁶ T ϕ		B		10-110
B99F	SET SECONDARY ASN WITH INSTANCE	SSAIR	RRE	RA	α^1 A ^{1*}	Z ⁷ T ϕ				10-128
B9A1	TEST PENDING EXTERNAL INTERRUPTION	TPEI	RRE	C TE	P					10-172
B9A2	PERFORM TOPOLOGY FUNCTION	PTF	RRE	C CT	P SP					10-92
B9AA	LOAD PAGE TABLE ENTRY ADDRESS	LPTEA	RRF-b	C D2	P A ^{1*} SP	SO			R ₂	10-50
B9AC	INSERT REFERENCE BITS MULTIPLE	IRBM	RRE	IM	P A ^{1*}					10-30
B9AE	RESET REFERENCE BITS MULTIPLE	RRBM	RRE	RB	P A ^{1*}					10-120
B9AF	PERFORM FRAME MANAGEMENT FUNCTION	PFMF	RRE	ED1	P A ¹ SP	II ϕ^3		K		10-80
B9B0	CONVERT UTF-8 TO UTF-32	CU14	RRF-c	C E3	$\alpha^{5,9}$ A SP	IC		ST	R ₁ R ₂	7-247
B9B1	CONVERT UTF-16 TO UTF-32	CU24	RRF-c	C E3	$\alpha^{5,9}$ A SP	IC		ST	R ₁ R ₂	7-230
B9B2	CONVERT UTF-32 TO UTF-8	CU41	RRE	C E3	$\alpha^{5,9}$ A SP	IC		ST	R ₁ R ₂	7-240
B9B3	CONVERT UTF-32 TO UTF-16	CU42	RRE	C E3	$\alpha^{5,9}$ A SP	IC		ST	R ₁ R ₂	7-237
B9BD	TRANSLATE AND TEST REVERSE EXTENDED	TRTRE	RRF-c	C PE	α^9 A SP	IC		ST	RM	7-410
B9BE	SEARCH STRING UNICODE	SRSTU	RRE	C E3	α^9 A SP	IC	G0		R ₁ R ₂	7-374
B9BF	TRANSLATE AND TEST EXTENDED	TRTE	RRF-c	C PE	α^9 A SP	IC		ST	RM	7-410
B9C0	SELECT HIGH (32)	SELFHR	RRF-a	MI3						7-376
B9C8	ADD HIGH (32)	AHHHR	RRF-a	C HW		IF				7-28
B9C9	SUBTRACT HIGH (32)	SHHHR	RRF-a	C HW		IF				7-396
B9CA	ADD LOGICAL HIGH (32)	ALHHHR	RRF-a	C HW						7-30
B9CB	SUBTRACT LOGICAL HIGH (32)	SLHHHR	RRF-a	C HW						7-397
B9CD	COMPARE HIGH (32)	CHHR	RRE	C HW						7-150
B9CF	COMPARE LOGICAL HIGH (32)	CLHHR	RRE	C HW						7-156
B9D8	ADD HIGH (32)	AHHLR	RRF-a	C HW		IF				7-28
B9D9	SUBTRACT HIGH (32)	SHHLR	RRF-a	C HW		IF				7-396
B9DA	ADD LOGICAL HIGH (32)	ALHHLR	RRF-a	C HW						7-30
B9DB	SUBTRACT LOGICAL HIGH (32)	SLHHLR	RRF-a	C HW						7-397
B9DD	COMPARE HIGH (32)	CHLR	RRE	C HW						7-150
B9DF	COMPARE LOGICAL HIGH (32)	CLHLR	RRE	C HW						7-156
B9E0	LOAD HIGH ON CONDITION (32)	LOCFHR	RRF-c	L2						7-283
B9E1	POPULATION COUNT	POPCNT	RRF-c	C PK						7-365
B9E2	LOAD ON CONDITION (64)	LOCGR	RRF-c	L1						7-283
B9E3	SELECT (64)	SELGR	RRF-a	MI3						7-376
B9E4	AND (64)	NGRK	RRF-a	C DO						7-32
B9E5	AND WITH COMPLEMENT (64)	NCGRK	RRF-a	C MI3						7-34
B9E6	OR (64)	OGRK	RRF-a	C DO						7-312
B9E7	EXCLUSIVE OR (64)	XGRK	RRF-a	C DO						7-253
B9E8	ADD (64)	AGRK	RRF-a	C DO		IF				7-25
B9E9	SUBTRACT (64)	SGRK	RRF-a	C DO		IF				7-394
B9EA	ADD LOGICAL (64)	ALGRK	RRF-a	C DO						7-29
B9EB	SUBTRACT LOGICAL (64)	SLGRK	RRF-a	C DO						7-396
B9EC	MULTIPLY (128←64)	MGRK	RRF-a	MI2	SP					7-304
B9ED	MULTIPLY SINGLE (64)	MSGRKC	RRF-a	C MI2		IF				7-307
B9F0	SELECT (32)	SELR	RRF-a	MI3						7-376
B9F2	LOAD ON CONDITION (32)	LOCR	RRF-c	L1						7-283
B9F4	AND (32)	NRK	RRF-a	C DO						7-32
B9F5	AND WITH COMPLEMENT (32)	NCRK	RRF-a	C MI3						7-34
B9F6	OR (32)	ORK	RRF-a	C DO						7-312
B9F7	EXCLUSIVE OR (32)	XRK	RRF-a	C DO						7-253
B9F8	ADD (32)	ARK	RRF-a	C DO		IF				7-25
B9F9	SUBTRACT (32)	SRK	RRF-a	C DO		IF				7-394
B9FA	ADD LOGICAL (32)	ALRK	RRF-a	C DO						7-29
B9FB	SUBTRACT LOGICAL (32)	SLRK	RRF-a	C DO						7-396
B9FD	MULTIPLY SINGLE (32)	MSRKC	RRF-a	C MI2		IF				7-307

Figure B-3. Instructions Arranged by Opcode (Part 12 of 24)

Op-code	Name	Mnemonic	Characteristics							Page	
			RS-a	C	α^9	A	SP	\$	ST		B_2
BA	COMPARE AND SWAP (32)	CS	RS-a	C	α^9	A	SP	\$	ST	B_2	7-143
BB	COMPARE DOUBLE AND SWAP (32)	CDS	RS-a	C	α^9	A	SP	\$	ST	B_2	7-143
BD	COMPARE LOGICAL CHAR. UNDER MASK (low)	CLM	RS-b	C		A				B_2	7-156
BE	STORE CHARACTERS UNDER MASK (low)	STCM	RS-b			A			ST	B_2	7-385
BF	INSERT CHARACTERS UNDER MASK (low)	ICM	RS-b	C		A				B_2	7-261
C00	LOAD ADDRESS RELATIVE LONG	LARL	RIL-b		N3						7-266
C01	LOAD IMMEDIATE (64←32)	LGFI	RIL-a		EI						7-263
C04	BRANCH RELATIVE ON CONDITION LONG	BRCL	RIL-c		N3	α^{10}			B		7-46
C05	BRANCH RELATIVE AND SAVE LONG	BRASL	RIL-b		N3	α^9			B		7-45
C06	EXCLUSIVE OR IMMEDIATE (high)	XIHF	RIL-a	C	EI						7-255
C07	EXCLUSIVE OR IMMEDIATE (low)	XILF	RIL-a	C	EI						7-255
C08	INSERT IMMEDIATE (high)	IIHF	RIL-a		EI						7-262
C09	INSERT IMMEDIATE (low)	IILF	RIL-a		EI						7-262
C0A	AND IMMEDIATE (high)	NIHF	RIL-a	C	EI						7-34
C0B	AND IMMEDIATE (low)	NILF	RIL-a	C	EI						7-34
C0C	OR IMMEDIATE (high)	OIHF	RIL-a	C	EI						7-313
C0D	OR IMMEDIATE (low)	OILF	RIL-a	C	EI						7-313
C0E	LOAD LOGICAL IMMEDIATE (high)	LLIHF	RIL-a		EI						7-280
C0F	LOAD LOGICAL IMMEDIATE (low)	LLILF	RIL-a		EI						7-280
C20	MULTIPLY SINGLE IMMEDIATE (64←32)	MSGFI	RIL-a		GE						7-307
C21	MULTIPLY SINGLE IMMEDIATE (32)	MSFI	RIL-a		GE						7-307
C24	SUBTRACT LOGICAL IMMEDIATE (64←32)	SLGFI	RIL-a	C	EI						7-397
C25	SUBTRACT LOGICAL IMMEDIATE (32)	SLFI	RIL-a	C	EI						7-397
C28	ADD IMMEDIATE (64←32)	AGFI	RIL-a	C	EI			IF			7-26
C29	ADD IMMEDIATE (32)	AFI	RIL-a	C	EI			IF			7-26
C2A	ADD LOGICAL IMMEDIATE (64←32)	ALGFI	RIL-a	C	EI						7-29
C2B	ADD LOGICAL IMMEDIATE (32)	ALFI	RIL-a	C	EI						7-29
C2C	COMPARE IMMEDIATE (64←32)	CGFI	RIL-a	C	EI						7-134
C2D	COMPARE IMMEDIATE (32)	CFI	RIL-a	C	EI						7-133
C2E	COMPARE LOGICAL IMMEDIATE (64←32)	CLGFI	RIL-a	C	EI						7-151
C2F	COMPARE LOGICAL IMMEDIATE (32)	CLFI	RIL-a	C	EI						7-151
C42	LOAD LOGICAL HALFWORD RELATIVE LONG (32←16)	LLHRL	RIL-b		GE	A*					7-279
C44	LOAD HALFWORD RELATIVE LONG (64←16)	LGHRL	RIL-b		GE	A*					7-275
C45	LOAD HALFWORD RELATIVE LONG (32←16)	LHRL	RIL-b		GE	A*					7-275
C46	LOAD LOGICAL HALFWORD RELATIVE LONG (64←16)	LLGHRL	RIL-b		GE	A*					7-279
C47	STORE HALFWORD RELATIVE LONG (16)	STHRL	RIL-b		GE	A*			ST		7-391
C48	LOAD RELATIVE LONG (64)	LGRL	RIL-b		GE	A* SP					7-263
C4B	STORE RELATIVE LONG (64)	STGRL	RIL-b		GE	A* SP			ST		7-384
C4C	LOAD RELATIVE LONG (64←32)	LGFR	RIL-b		GE	A* SP					7-263
C4D	LOAD RELATIVE LONG (32)	LRL	RIL-b		GE	A SP					7-263
C4E	LOAD LOGICAL RELATIVE LONG (64←32)	LLGFRL	RIL-b		GE	A* SP					7-277
C4F	STORE RELATIVE LONG (32)	STRL	RIL-b		GE	A* SP			ST		7-384
C5	BRANCH PREDICTION RELATIVE PRELOAD	BPRP	MII		EH	α^9					7-42
C60	EXECUTE RELATIVE LONG	EXRL	RIL-b		XX	α^9	AI*	EX			7-255
C62	PREFETCH DATA RELATIVE LONG	PFDR	RIL-c		GE	$\alpha^{9,11}$					7-366
C64	COMPARE HALFWORD RELATIVE LONG (64←16)	CGHRL	RIL-b	C	GE	A*					7-149
C65	COMPARE HALFWORD RELATIVE LONG (32←16)	CHRL	RIL-b	C	GE	A*					7-149
C66	COMPARE LOGICAL RELATIVE LONG (64←16)	CLGHRL	RIL-b	C	GE	A*					7-152
C67	COMPARE LOGICAL RELATIVE LONG (32←16)	CLHRL	RIL-b	C	GE	A*					7-152
C68	COMPARE RELATIVE LONG (64)	CGRL	RIL-b	C	GE	A* SP					7-134
C6A	COMPARE LOGICAL RELATIVE LONG (64)	CLGRL	RIL-b	C	GE	A* SP					7-152
C6C	COMPARE RELATIVE LONG (64←32)	CGFRL	RIL-b	C	GE	A* SP					7-134
C6D	COMPARE RELATIVE LONG (32)	CRL	RIL-b	C	GE	A* SP					7-134

Figure B-3. Instructions Arranged by Opcode (Part 13 of 24)

Op-code	Name	Mnemonic	Characteristics							Page			
C6E	COMPARE LOGICAL RELATIVE LONG (64←32)	CLGFRL	RIL-b	C	GE	A*	SP					7-152	
C6F	COMPARE LOGICAL RELATIVE LONG (32)	CLRL	RIL-b	C	GE	A*	SP					7-152	
C7	BRANCH PREDICTION PRELOAD	BPP	SMI		EH	α ⁹						7-42	
C80	MOVE WITH OPTIONAL SPECIFICATIONS	MVCOS	SSF	C	MO	Q	A	SO	G0	ST	B†	B‡	10-69
C81	EXTRACT CPU TIME	ECTG	SSF		ET	α ^{9,9}	A		GM	R ₃	B ₁	B ₂	7-259
C82	COMPARE AND SWAP AND STORE	CSST	SSF	C	CS	α ¹	A	SP	\$ GM	ST	B ₁	B ₂	7-145
C84	LOAD PAIR DISJOINT (32)	LPD	SSF	C	IA	α ⁹	A	SP			B ₁	B ₂	7-284
C85	LOAD PAIR DISJOINT (64)	LPDG	SSF	C	IA	α ⁹	A	SP			B ₁	B ₂	7-284
CC6	BRANCH RELATIVE ON COUNT HIGH (32)	BRCTH	RIL-b		HW	α ⁹				B			7-47
CC8	ADD IMMEDIATE HIGH (32)	AIH	RIL-a	C	HW				IF				7-29
CCA	ADD LOGICAL WITH SIGNED IMMEDIATE HIGH (32)	ALSIH	RIL-a	C	HW								7-32
CCB	ADD LOGICAL WITH SIGNED IMMEDIATE HIGH (32)	ALSIHN	RIL-a		HW								7-32
CCD	COMPARE IMMEDIATE HIGH (32)	CIH	RIL-a	C	HW								7-150
CCF	COMPARE LOGICAL IMMEDIATE HIGH (32)	CLIH	RIL-a	C	HW								7-157
D0	TRANSLATE AND TEST REVERSE	TRTR	SS-a	C	E3	α ⁹	A		GM		B ₁	B ₂	7-415
D1	MOVE NUMERICS	MVN	SS-a			α ⁹	A			ST	B ₁	B ₂	7-300
D2	MOVE (character)	MVC	SS-a			α ⁹	A			ST	B ₁	B ₂	7-288
D3	MOVE ZONES	MVZ	SS-a			α ⁹	A			ST	B ₁	B ₂	7-303
D4	AND (character)	NC	SS-a	C		α ⁹	A			ST	B ₁	B ₂	7-33
D5	COMPARE LOGICAL (character)	CLC	SS-a	C		α ⁹	A				B ₁	B ₂	7-151
D6	OR (character)	OC	SS-a	C		α ⁹	A			ST	B ₁	B ₂	7-312
D7	EXCLUSIVE OR (character)	XC	SS-a	C		α ⁹	A			ST	B ₁	B ₂	7-254
D9	MOVE WITH KEY	MVCK	SS-d	C		Q	A			ST	B ₁	B ₂	10-67
DA	MOVE TO PRIMARY	MVCP	SS-d	C		Q	A	SO	¢	ST			10-65
DB	MOVE TO SECONDARY	MVCS	SS-d	C		Q	A	SO	¢	ST			10-65
DC	TRANSLATE	TR	SS-a			α ⁹	A			ST	B ₁	B ₂	7-408
DD	TRANSLATE AND TEST	TRT	SS-a	C		α ⁹	A		GM		B ₁	B ₂	7-409
DE	EDIT	ED	SS-a	C		α ⁹	A	Dg		ST	B ₁	B ₂	8-8
DF	EDIT AND MARK	EDMK	SS-a	C		α ⁹	A	Dg	G1	ST	B ₁	B ₂	8-11
E1	PACK UNICODE	PKU	SS-f		E2	α ⁹	A	SP		ST	B ₁	B ₂	7-316
E2	UNPACK UNICODE	UNPKU	SS-a	C	E2	α ⁹	A	SP		ST	B ₁	B ₂	7-424
E302	LOAD AND TEST (64)	LTG	RXY-a	C	EI		A				B ₂		7-270
E303	LOAD REAL ADDRESS (64)	LRAG	RXY-a	C	N	P	A ^{1*}				BP		10-56
E304	LOAD (64)	LG	RXY-a		N		A				B ₂		7-263
E306	CONVERT TO BINARY (32)	CVBY	RXY-a		LD	α ⁹	A		Dg IK		B ₂		7-229
E308	ADD (64)	AG	RXY-a	C	N		A		IF		B ₂		7-26
E309	SUBTRACT (64)	SG	RXY-a	C	N		A		IF		B ₂		7-395
E30A	ADD LOGICAL (64)	ALG	RXY-a	C	N		A				B ₂		7-29
E30B	SUBTRACT LOGICAL (64)	SLG	RXY-a	C	N		A				B ₂		7-397
E30C	MULTIPLY SINGLE (64)	MSG	RXY-a		N		A				B ₂		7-307
E30D	DIVIDE SINGLE (64)	DSG	RXY-a		N	α ⁹	A	SP	IK		B ₂		7-253
E30E	CONVERT TO BINARY (64)	CVBG	RXY-a		N	α ⁹	A		Dg IK		B ₂		7-229
E30F	LOAD REVERSED (64)	LRVG	RXY-a		N		A				B ₂		7-286
E312	LOAD AND TEST (32)	LT	RXY-a	C	EI		A				B ₂		7-270
E313	LOAD REAL ADDRESS (32)	LRAY	RXY-a	C	LD	P	A ^{1*}	SO			BP		10-56
E314	LOAD (64←32)	LGF	RXY-a		N		A				B ₂		7-263
E315	LOAD HALFWORD (64←16)	LGH	RXY-a		N		A				B ₂		7-275
E316	LOAD LOGICAL (64←32)	LLGF	RXY-a		N		A				B ₂		7-277
E317	LOAD LOGICAL THIRTY ONE BITS (64←31)	LLGT	RXY-a		N		A				B ₂		7-281
E318	ADD (64←32)	AGF	RXY-a	C	N		A		IF		B ₂		7-26
E319	SUBTRACT (64←32)	SGF	RXY-a	C	N		A		IF		B ₂		7-395
E31A	ADD LOGICAL (64←32)	ALGF	RXY-a	C	N		A				B ₂		7-29
E31B	SUBTRACT LOGICAL (64←32)	SLGF	RXY-a	C	N		A				B ₂		7-397

Figure B-3. Instructions Arranged by Opcode (Part 14 of 24)

Op-code	Name	Mne-monic	Characteristics						Page
			RXY-a	N	A				
E31C	MULTIPLY SINGLE (64←32)	MSGF	RXY-a	N	A			B ₂	7-307
E31D	DIVIDE SINGLE (64←32)	DSGF	RXY-a	N	α^9 A	SP	IK	B ₂	7-253
E31E	LOAD REVERSED (32)	LRV	RXY-a	N3	A			B ₂	7-286
E31F	LOAD REVERSED (16)	LRVH	RXY-a	N3	A			B ₂	7-286
E320	COMPARE (64)	CG	RXY-a	C N	A			B ₂	7-133
E321	COMPARE LOGICAL (64)	CLG	RXY-a	C N	A			B ₂	7-151
E324	STORE (64)	STG	RXY-a	N	A			ST	B ₂ 7-384
E325	NONTRANSACTIONAL STORE (64)	NTSTG	RXY-a	TX	α^9 A	SP		ST	B ₂ 7-310
E326	CONVERT TO DECIMAL (32)	CVDY	RXY-a	LD	α^9 A			ST	B ₂ 7-230
E32A	LOAD AND ZERO RIGHTMOST BYTE (64)	LZRG	RXY-a	LZ	A			B ₂	7-270
E32E	CONVERT TO DECIMAL (64)	CVDG	RXY-a	N	α^9 A			ST	B ₂ 7-230
E32F	STORE REVERSED (64)	STRVG	RXY-a	N	A			ST	B ₂ 7-394
E330	COMPARE (64←32)	CGF	RXY-a	C N	A			B ₂	7-133
E331	COMPARE LOGICAL (64←32)	CLGF	RXY-a	C N	A			B ₂	7-151
E332	LOAD AND TEST (64←32)	LTGF	RXY-a	C GE	A			B ₂	7-270
E334	COMPARE HALFWORD (64←16)	CGH	RXY-a	C GE	A			B ₂	7-149
E336	PREFETCH DATA	PFD	RXY-b	GE	$\alpha^{9,11}$			B ₂	7-365
E338	ADD HALFWORD (64←16)	AGH	RXY-a	C MI2	A		IF	B ₂	7-28
E339	SUBTRACT HALFWORD (64←16)	SGH	RXY-a	C MI2	A		IF	B ₂	7-395
E33A	LOAD LOGICAL AND ZERO RIGHTMOST BYTE (64←32)	LLZRGF	RXY-a	LZ	A			B ₂	7-278
E33B	LOAD AND ZERO RIGHTMOST BYTE (32)	LZRF	RXY-a	LZ	A			B ₂	7-270
E33C	MULTIPLY HALFWORD (64←16)	MGH	RXY-a	MI2	A			B ₂	7-305
E33E	STORE REVERSED (32)	STRV	RXY-a	N3	A			ST	B ₂ 7-394
E33F	STORE REVERSED (16)	STRVH	RXY-a	N3	A			ST	B ₂ 7-394
E346	BRANCH ON COUNT (64)	BCTG	RXY-a	N	α^9			B	7-40
E347	BRANCH INDIRECT ON CONDITION	BIC	RXY-b	MI2	α^9 A			B	B ₂ 7-38
E348	LOAD LOGICAL AND SHIFT GUARDED (64←32)	LLGFSG	RXY-a	GF	α^{12} A	SP		B ST	B ₂ 7-273
E349	STORE GUARDED STORAGE CONTROLS	STGSC	RXY-a	GF	α^1 A		SO	ST	B ₂ 7-390
E34C	LOAD GUARDED (64)	LGG	RXY-a	GF	α^{12} A	SP		B ST	B ₂ 7-273
E34D	LOAD GUARDED STORAGE CONTROLS	LGSC	RXY-a	GF	α^1 A		SO	ST	B ₂ 7-274
E350	STORE (32)	STY	RXY-a	LD	A			ST	B ₂ 7-384
E351	MULTIPLY SINGLE (32)	MSY	RXY-a	LD	A			B ₂	7-307
E353	MULTIPLY SINGLE (32)	MSC	RXY-a	C MI2	A		IF	B ₂	7-307
E354	AND (32)	NY	RXY-a	C LD	A			B ₂	7-33
E355	COMPARE LOGICAL (32)	CLY	RXY-a	C LD	A			B ₂	7-151
E356	OR (32)	OY	RXY-a	C LD	A			B ₂	7-312
E357	EXCLUSIVE OR (32)	XY	RXY-a	C LD	A			B ₂	7-253
E358	LOAD (32)	LY	RXY-a	LD	A			B ₂	7-263
E359	COMPARE (32)	CY	RXY-a	C LD	A			B ₂	7-133
E35A	ADD (32)	AY	RXY-a	C LD	A		IF	B ₂	7-26
E35B	SUBTRACT (32)	SY	RXY-a	C LD	A		IF	B ₂	7-395
E35C	MULTIPLY (64←32)	MFY	RXY-a	GE	A	SP		B ₂	7-304
E35E	ADD LOGICAL (32)	ALY	RXY-a	C LD	A			B ₂	7-29
E35F	SUBTRACT LOGICAL (32)	SLY	RXY-a	C LD	A			B ₂	7-396
E370	STORE HALFWORD (16)	STHY	RXY-a	LD	A			ST	B ₂ 7-391
E371	LOAD ADDRESS	LAY	RXY-a	LD					7-265
E372	STORE CHARACTER	STCY	RXY-a	LD	A			ST	B ₂ 7-385
E373	INSERT CHARACTER	ICY	RXY-a	LD	A			B ₂	7-261
E375	LOAD ADDRESS EXTENDED	LAEY	RXY-a	GE	α^6			U ₁ BP	7-265
E376	LOAD BYTE (32←8)	LB	RXY-a	LD	A				7-271
E377	LOAD BYTE (64←8)	LGB	RXY-a	LD	A				7-271
E378	LOAD HALFWORD (32←16)	LHY	RXY-a	LD	A			B ₂	7-275
E379	COMPARE HALFWORD (32←16)	CHY	RXY-a	C LD	A			B ₂	7-149
E37A	ADD HALFWORD (32←16)	AHY	RXY-a	C LD	A		IF	B ₂	7-27

Figure B-3. Instructions Arranged by Opcode (Part 15 of 24)

Op-code	Name	Mnemonic	Characteristics							Page	
E37B	SUBTRACT HALFWORD (32←16)	SHY	RXY-a	C	LD	A		IF	B ₂	7-395	
E37C	MULTIPLY HALFWORD (32←16)	MHY	RXY-a		GE	A			B ₂	7-305	
E380	AND (64)	NG	RXY-a	C	N	A			B ₂	7-33	
E381	OR (64)	OG	RXY-a	C	N	A			B ₂	7-312	
E382	EXCLUSIVE OR (64)	XG	RXY-a	C	N	A			B ₂	7-253	
E383	MULTIPLY SINGLE (64)	MSGC	RXY-a	C	MI2	A		IF	B ₂	7-307	
E384	MULTIPLY (128←64)	MG	RXY-a		MI2	A	SP		B ₂	7-304	
E385	LOAD AND TRAP (64)	LGAT	RXY-a		LT	A		Dc	B ₂	7-270	
E386	MULTIPLY LOGICAL (128←64)	MLG	RXY-a		N	A	SP		B ₂	7-306	
E387	DIVIDE LOGICAL (64←128)	DLG	RXY-a		N	A ⁹	SP	IK	B ₂	7-252	
E388	ADD LOGICAL WITH CARRY (64)	ALCG	RXY-a	C	N	A			B ₂	7-30	
E389	SUBTRACT LOGICAL WITH BORROW (64)	SLBG	RXY-a	C	N	A			B ₂	7-398	
E38E	STORE PAIR TO QUADWORD	STPQ	RXY-a		N	A ⁹	A SP		ST	B ₂	7-393
E38F	LOAD PAIR FROM QUADWORD (64&64←128)	LPQ	RXY-a		N	A ⁹	A SP			B ₂	7-285
E390	LOAD LOGICAL CHARACTER (64←8)	LLGC	RXY-a		N	A				B ₂	7-278
E391	LOAD LOGICAL HALFWORD (64←16)	LLGH	RXY-a		N	A				B ₂	7-279
E394	LOAD LOGICAL CHARACTER (32←8)	LLC	RXY-a		EI	A				B ₂	7-278
E395	LOAD LOGICAL HALFWORD (32←16)	LLH	RXY-a		EI	A				B ₂	7-279
E396	MULTIPLY LOGICAL (64←32)	ML	RXY-a		N3	A	SP			B ₂	7-306
E397	DIVIDE LOGICAL (32←64)	DL	RXY-a		N3	A ⁹	A SP	IK		B ₂	7-252
E398	ADD LOGICAL WITH CARRY (32)	ALC	RXY-a	C	N3	A				B ₂	7-30
E399	SUBTRACT LOGICAL WITH BORROW (32)	SLB	RXY-a	C	N3	A				B ₂	7-398
E39C	LOAD LOGICAL THIRTY ONE BITS AND TRAP (64←31)	LLGTAT	RXY-a		LT	A		Dc		B ₂	7-281
E39D	LOAD LOGICAL AND TRAP (64←32)	LLGFAT	RXY-a		LT	A		Dc		B ₂	7-278
E39F	LOAD AND TRAP (32L←32)	LAT	RXY-a		LT	A		Dc		B ₂	7-270
E3C0	LOAD BYTE HIGH (32←8)	LBH	RXY-a		HW	A				B ₂	7-271
E3C2	LOAD LOGICAL CHARACTER HIGH (32←8)	LLCH	RXY-a		HW	A				B ₂	7-279
E3C3	STORE CHARACTER HIGH (8)	STCH	RXY-a		HW	A			ST	B ₂	7-385
E3C4	LOAD HALFWORD HIGH (32←16)	LHH	RXY-a		HW	A				B ₂	7-276
E3C6	LOAD LOGICAL HALFWORD HIGH (32←16)	LLHH	RXY-a		HW	A				B ₂	7-280
E3C7	STORE HALFWORD HIGH (16)	STHH	RXY-a		HW	A			ST	B ₂	7-391
E3C8	LOAD HIGH AND TRAP (32H←32)	LFHAT	RXY-a		LT	A		Dc		B ₂	7-277
E3CA	LOAD HIGH (32)	LFH	RXY-a		HW	A				B ₂	7-277
E3CB	STORE HIGH (32)	STFH	RXY-a		HW	A			ST	B ₂	7-391
E3CD	COMPARE HIGH (32)	CHF	RXY-a	C	HW	A				B ₂	7-150
E3CF	COMPARE LOGICAL HIGH (32)	CLHF	RXY-a	C	HW	A				B ₂	7-156
E500	LOAD ADDRESS SPACE PARAMETERS	LASP	SSE	C		P	A ¹ SP	SO		B ₁	10-41
E501	TEST PROTECTION	TPROT	SSE	C		P	A ^{1*}			B ₁	10-173
E502	STORE REAL ADDRESS	STRAG	SSE		N	P	A ¹ SP		ST	B ₁ BP	10-142
E50A	MOVE RIGHT TO LEFT	MVCRL	SSE		MI3	A ⁹	A	GO	ST	B ₁ B ₂	7-300
E50E	MOVE WITH SOURCE KEY	MVCSK	SSE			Q	A	GM	ST	B ₁ B ₂	10-72
E50F	MOVE WITH DESTINATION KEY	MVCDK	SSE			Q	A	GM	ST	B ₁ B ₂	10-67
E544	MOVE (16←16)	MVHHI	SIL		GE	A			ST	B ₁	7-288
E548	MOVE (64←16)	MVGHI	SIL		GE	A			ST	B ₁	7-288
E54C	MOVE (32←16)	MVHI	SIL		GE	A			ST	B ₁	7-288
E554	COMPARE HALFWORD IMMEDIATE (16←16)	CHHSI	SIL	C	GE	A				B ₁	7-149
E555	COMPARE LOGICAL IMMEDIATE (16←16)	CLHHSI	SIL	C	GE	A				B ₁	7-151
E558	COMPARE HALFWORD IMMEDIATE (64←16)	CGHSI	SIL	C	GE	A				B ₁	7-149
E559	COMPARE LOGICAL IMMEDIATE (64←16)	CLGHSI	SIL	C	GE	A				B ₁	7-151
E55C	COMPARE HALFWORD IMMEDIATE (32←16)	CHSI	SIL	C	GE	A				B ₁	7-149
E55D	COMPARE LOGICAL IMMEDIATE (32←16)	CLFHSI	SIL	C	GE	A				B ₁	7-151
E560	TRANSACTION BEGIN (nonconstrained)	TBEGIN	SIL	C	TX	A ⁹	A SP	SO \$ EX	ST		7-401
E561	TRANSACTION BEGIN (constrained)	TBEGINC	SIL	C	CX	A ⁹	SP	SO \$ EX			7-406
E601	VECTOR LOAD BYTE REVERSED ELEMENT (16)	VLEBRH	VRX		V2	A ^{7,9}	A SP	Dv		B ₂	21-7

Figure B-3. Instructions Arranged by Opcode (Part 16 of 24)

Op-code	Name	Mnemonic	Characteristics						Page		
E602	VECTOR LOAD BYTE REVERSED ELEMENT (64)	VLEBRG	VRX	V2	$\alpha^{7,9}$	A	SP	Dv		B ₂	21-7
E603	VECTOR LOAD BYTE REVERSED ELEMENT (32)	VLEBRF	VRX	V2	$\alpha^{7,9}$	A	SP	Dv		B ₂	21-7
E604	VECTOR LOAD BYTE REVERSED ELEMENT AND ZERO	VLLEBRZ	VRX	V2	$\alpha^{7,9}$	A	SP	Dv		B ₂	21-8
E605	VECTOR LOAD BYTE REVERSED ELEMENT AND REPLICATE	VLBRREP	VRX	V2	$\alpha^{7,9}$	A	SP	Dv		B ₂	21-8
E606	VECTOR LOAD BYTE REVERSED ELEMENTS	VLBR	VRX	V2	$\alpha^{7,9}$	A	SP	Dv		B ₂	21-9
E607	VECTOR LOAD ELEMENTS REVERSED	VLER	VRX	V2	$\alpha^{7,9}$	A	SP	Dv		B ₂	21-10
E609	VECTOR STORE BYTE REVERSED ELEMENT (16)	VSTEBRH	VRX	V2	$\alpha^{7,9}$	A	SP	Dv	ST	B ₂	21-22
E60A	VECTOR STORE BYTE REVERSED ELEMENT (64)	VSTEBRG	VRX	V2	$\alpha^{7,9}$	A	SP	Dv	ST	B ₂	21-22
E60B	VECTOR STORE BYTE REVERSED ELEMENT (32)	VSTEBRF	VRX	V2	$\alpha^{7,9}$	A	SP	Dv	ST	B ₂	21-22
E60E	VECTOR STORE BYTE REVERSED ELEMENTS	VSTBR	VRX	V2	$\alpha^{7,9}$	A	SP	Dv	ST	B ₂	21-22
E60F	VECTOR STORE ELEMENTS REVERSED	VSTER	VRX	V2	$\alpha^{7,9}$	A	SP	Dv	ST	B ₂	21-22
E634	VECTOR PACK ZONED	VPKZ	VSI	VD	$\alpha^{7,9}$	A	SP	Dv		B ₂	25-13
E635	VECTOR LOAD RIGHTMOST WITH LENGTH	VLRL	VSI	VD	$\alpha^{7,9}$	A	SP	Dv		B ₂	21-13
E637	VECTOR LOAD RIGHTMOST WITH LENGTH	VLRLR	VRS-d	VD	$\alpha^{7,9}$	A		Dv		B ₂	21-13
E63C	VECTOR UNPACK ZONED	VUPKZ	VSI	VD	$\alpha^{7,9}$	A	SP	Dv	ST	B ₂	25-22
E63D	VECTOR STORE RIGHTMOST WITH LENGTH	VSTRL	VSI	VD	$\alpha^{7,9}$	A	SP	Dv	ST	B ₂	21-25
E63F	VECTOR STORE RIGHTMOST WITH LENGTH	VSTRLR	VRS-d	VD	$\alpha^{7,9}$	A		Dv	ST	B ₂	21-25
E649	VECTOR LOAD IMMEDIATE DECIMAL	VLIP	VRI-h	VD	$\alpha^{7,9}$			Dv Dg			25-10
E650	VECTOR CONVERT TO BINARY	VCVB	VRR-i	C* VD	$\alpha^{7,9}$			Dv Dg IF*			25-5
E652	VECTOR CONVERT TO BINARY	VCVBG	VRR-i	C* VD	$\alpha^{7,9}$			Dv Dg IF*			25-5
E658	VECTOR CONVERT TO DECIMAL	VCVD	VRI-i	C* VD	$\alpha^{7,9}$		SP	Dv DF*			25-7
E659	VECTOR SHIFT AND ROUND DECIMAL	VSRP	VRI-g	C* VD	$\alpha^{7,9}$		SP	Dv Dg DF*			25-19
E65A	VECTOR CONVERT TO DECIMAL	VCVDG	VRI-i	C* VD	$\alpha^{7,9}$		SP	Dv DF*			25-7
E65B	VECTOR PERFORM SIGN OPERATION DECIMAL	VPSOP	VRI-g	C* VD	$\alpha^{7,9}$		SP	Dv Dg DF*			25-14
E65F	VECTOR TEST DECIMAL	VTP	VRR-g	C VD	$\alpha^{7,9}$			Dv			25-22
E671	VECTOR ADD DECIMAL	VAP	VRI-f	C* VD	$\alpha^{7,9}$		SP	Dv Dg DF*			25-3
E673	VECTOR SUBTRACT DECIMAL	VSP	VRI-f	C* VD	$\alpha^{7,9}$		SP	Dv Dg DF*			25-21
E677	VECTOR COMPARE DECIMAL	VCP	VRR-h	C VD	$\alpha^{7,9}$			Dv Dg			25-5
E678	VECTOR MULTIPLY DECIMAL	VMP	VRI-f	C* VD	$\alpha^{7,9}$		SP	Dv Dg DF*			25-10
E679	VECTOR MULTIPLY AND SHIFT DECIMAL	VMSP	VRI-f	C* VD	$\alpha^{7,9}$		SP	Dv Dg DF*			25-12
E67A	VECTOR DIVIDE DECIMAL	VDP	VRI-f	C* VD	$\alpha^{7,9}$		SP	Dv Dg DF* DK			25-8
E67B	VECTOR REMAINDER DECIMAL	VRP	VRI-f	C* VD	$\alpha^{7,9}$		SP	Dv Dg DF* DK			25-16
E67E	VECTOR SHIFT AND DIVIDE DECIMAL	VSDP	VRI-f	C* VD	$\alpha^{7,9}$		SP	Dv Dg DF* DK			25-18
E700	VECTOR LOAD ELEMENT (8)	VLEB	VRX	VF	$\alpha^{7,9}$	A	SP	Dv		B ₂	21-9
E701	VECTOR LOAD ELEMENT (16)	VLEH	VRX	VF	$\alpha^{7,9}$	A	SP	Dv		B ₂	21-9
E702	VECTOR LOAD ELEMENT (64)	VLEG	VRX	VF	$\alpha^{7,9}$	A	SP	Dv		B ₂	21-9
E703	VECTOR LOAD ELEMENT (32)	VLEF	VRX	VF	$\alpha^{7,9}$	A	SP	Dv		B ₂	21-9
E704	VECTOR LOAD LOGICAL ELEMENT AND ZERO	VLLEZ	VRX	VF	$\alpha^{7,9}$	A	SP	Dv		B ₂	21-12
E705	VECTOR LOAD AND REPLICATE	VLREP	VRX	VF	$\alpha^{7,9}$	A	SP	Dv		B ₂	21-7
E706	VECTOR LOAD	VL	VRX	VF	$\alpha^{7,9}$	A		Dv		B ₂	21-6
E707	VECTOR LOAD TO BLOCK BOUNDARY	VLBB	VRX	VF	$\alpha^{7,9}$	A	SP	Dv		B ₂	21-14
E708	VECTOR STORE ELEMENT (8)	VSTEB	VRX	VF	$\alpha^{7,9}$	A	SP	Dv	ST	B ₂	21-23
E709	VECTOR STORE ELEMENT (16)	VSTEH	VRX	VF	$\alpha^{7,9}$	A	SP	Dv	ST	B ₂	21-23
E70A	VECTOR STORE ELEMENT (64)	VSTEG	VRX	VF	$\alpha^{7,9}$	A	SP	Dv	ST	B ₂	21-23
E70B	VECTOR STORE ELEMENT (32)	VSTEF	VRX	VF	$\alpha^{7,9}$	A	SP	Dv	ST	B ₂	21-23
E70E	VECTOR STORE	VST	VRX	VF	$\alpha^{7,9}$	A		Dv	ST	B ₂	21-21
E712	VECTOR GATHER ELEMENT (64)	VGEG	VRV	VF	$\alpha^{7,9}$	A	SP	Dv		B ₂	21-5
E713	VECTOR GATHER ELEMENT (32)	VGEF	VRV	VF	$\alpha^{7,9}$	A	SP	Dv		B ₂	21-5
E71A	VECTOR SCATTER ELEMENT (64)	VSCEG	VRV	VF	$\alpha^{7,9}$	A	SP	Dv	ST	B ₂	21-20
E71B	VECTOR SCATTER ELEMENT (32)	VSCEF	VRV	VF	$\alpha^{7,9}$	A	SP	Dv	ST	B ₂	21-20
E721	VECTOR LOAD GR FROM VR ELEMENT	VLGV	VRS-c	VF	$\alpha^{7,9}$		SP	Dv			21-11

Figure B-3. Instructions Arranged by Opcode (Part 17 of 24)

Op-code	Name	Mnemonic	Characteristics						Page
E722	VECTOR LOAD VR ELEMENT FROM GR	VLVG	VRS-b	VF	$\alpha^{7,9}$	SP	Dv		21-14
E727	LOAD COUNT TO BLOCK BOUNDARY	LCBB	RXE C	VF			SP		7-272
E730	VECTOR ELEMENT SHIFT LEFT	VESL	VRS-a	VF	$\alpha^{7,9}$	SP	Dv		22-23
E733	VECTOR ELEMENT ROTATE LEFT LOGICAL	VERLL	VRS-a	VF	$\alpha^{7,9}$		SP		22-21
E736	VECTOR LOAD MULTIPLE	VLM	VRS-a	VF	$\alpha^{7,9}$	A	SP	Dv	B ₂ 21-12
E737	VECTOR LOAD WITH LENGTH	VLL	VRS-b	VF	$\alpha^{7,9}$	A		Dv	B ₂ 21-15
E738	VECTOR ELEMENT SHIFT RIGHT LOGICAL	VESRL	VRS-a	VF	$\alpha^{7,9}$		SP	Dv	22-24
E73A	VECTOR ELEMENT SHIFT RIGHT ARITHMETIC	VESRA	VRS-a	VF	$\alpha^{7,9}$		SP	Dv	22-23
E73E	VECTOR STORE MULTIPLE	VSTM	VRS-a	VF	$\alpha^{7,9}$	A	SP	Dv	ST B ₂ 21-24
E73F	VECTOR STORE WITH LENGTH	VSTL	VRS-b	VF	$\alpha^{7,9}$	A		Dv	ST B ₂ 21-26
E740	VECTOR LOAD ELEMENT IMMEDIATE (8)	VLEIB	VRI-a	VF	$\alpha^{7,9}$		SP	Dv	21-10
E741	VECTOR LOAD ELEMENT IMMEDIATE (16)	VLEIH	VRI-a	VF	$\alpha^{7,9}$		SP	Dv	21-10
E742	VECTOR LOAD ELEMENT IMMEDIATE (64)	VLEIG	VRI-a	VF	$\alpha^{7,9}$		SP	Dv	21-10
E743	VECTOR LOAD ELEMENT IMMEDIATE (32)	VLEIF	VRI-a	VF	$\alpha^{7,9}$		SP	Dv	21-10
E744	VECTOR GENERATE BYTE MASK	VGBM	VRI-a	VF	$\alpha^{7,9}$			Dv	21-5
E745	VECTOR REPLICATE IMMEDIATE	VREPI	VRI-a	VF	$\alpha^{7,9}$		SP	Dv	21-20
E746	VECTOR GENERATE MASK	VGM	VRI-b	VF	$\alpha^{7,9}$		SP	Dv	21-6
E74A	VECTOR FP TEST DATA CLASS IMMEDIATE	VFTCI	VRI-e C	VF	$\alpha^{7,9}$		SP	Dv	24-47
E74D	VECTOR REPLICATE	VREP	VRI-c	VF	$\alpha^{7,9}$		SP	Dv	21-19
E750	VECTOR POPULATION COUNT	VPOPCT	VRR-a	VF	$\alpha^{7,9}$		SP	Dv	22-21
E752	VECTOR COUNT TRAILING ZEROS	VCTZ	VRR-a	VF	$\alpha^{7,9}$		SP	Dv	22-10
E753	VECTOR COUNT LEADING ZEROS	VCLZ	VRR-a	VF	$\alpha^{7,9}$		SP	Dv	22-10
E756	VECTOR LOAD	VLR	VRR-a	VF	$\alpha^{7,9}$			Dv	21-6
E75C	VECTOR ISOLATE STRING	VISTR	VRR-a C*	VF	$\alpha^{7,9}$		SP	Dv	23-5
E75F	VECTOR SIGN EXTEND TO DOUBLEWORD	VSEG	VRR-a	VF	$\alpha^{7,9}$		SP	Dv	21-21
E760	VECTOR MERGE LOW	VMRL	VRR-c	VF	$\alpha^{7,9}$		SP	Dv	21-16
E761	VECTOR MERGE HIGH	VMRH	VRR-c	VF	$\alpha^{7,9}$		SP	Dv	21-15
E762	VECTOR LOAD VR FROM GRS DISJOINT	VLVGP	VRR-f	VF	$\alpha^{7,9}$			Dv	21-15
E764	VECTOR SUM ACROSS WORD	VSUM	VRR-c	VF	$\alpha^{7,9}$		SP	Dv	22-30
E765	VECTOR SUM ACROSS DOUBLEWORD	VSUMG	VRR-c	VF	$\alpha^{7,9}$		SP	Dv	22-29
E766	VECTOR CHECKSUM	VCKSM	VRR-c	VF	$\alpha^{7,9}$			Dv	22-6
E767	VECTOR SUM ACROSS QUADWORD	VSUMQ	VRR-c	VF	$\alpha^{7,9}$		SP	Dv	22-30
E768	VECTOR AND	VN	VRR-c	VF	$\alpha^{7,9}$			Dv	22-5
E769	VECTOR AND WITH COMPLEMENT	VNC	VRR-c	VF	$\alpha^{7,9}$			Dv	22-5
E76A	VECTOR OR	VO	VRR-c	VF	$\alpha^{7,9}$			Dv	22-20
E76B	VECTOR NOR	VNO	VRR-c	VF	$\alpha^{7,9}$			Dv	22-20
E76C	VECTOR NOT EXCLUSIVE OR	VNX	VRR-c	V1	$\alpha^{7,9}$			Dv	22-20
E76D	VECTOR EXCLUSIVE OR	VX	VRR-c	VF	$\alpha^{7,9}$			Dv	22-11
E76E	VECTOR NAND	VNN	VRR-c	V1	$\alpha^{7,9}$			Dv	22-20
E76F	VECTOR OR WITH COMPLEMENT	VOC	VRR-c	V1	$\alpha^{7,9}$			Dv	22-21
E770	VECTOR ELEMENT SHIFT LEFT	VESLV	VRR-c	VF	$\alpha^{7,9}$		SP	Dv	22-23
E772	VECTOR ELEMENT ROTATE AND INSERT UNDER MASK	VERIM	VRI-d	VF	$\alpha^{7,9}$		SP	Dv	22-22
E773	VECTOR ELEMENT ROTATE LEFT LOGICAL	VERLLV	VRR-c	VF	$\alpha^{7,9}$		SP	Dv	22-21
E774	VECTOR SHIFT LEFT	VSL	VRR-c	VF	$\alpha^{7,9}$			Dv	22-25
E775	VECTOR SHIFT LEFT BY BYTE	VSLB	VRR-c	VF	$\alpha^{7,9}$			Dv	22-25
E777	VECTOR SHIFT LEFT DOUBLE BY BYTE	VSLDB	VRI-d	VF	$\alpha^{7,9}$			Dv	22-26
E778	VECTOR ELEMENT SHIFT RIGHT LOGICAL	VESRLV	VRR-c	VF	$\alpha^{7,9}$		SP	Dv	22-24
E77A	VECTOR ELEMENT SHIFT RIGHT ARITHMETIC	VESRAV	VRR-c	VF	$\alpha^{7,9}$		SP	Dv	22-23
E77C	VECTOR SHIFT RIGHT LOGICAL	VSRL	VRR-c	VF	$\alpha^{7,9}$			Dv	22-27
E77D	VECTOR SHIFT RIGHT LOGICAL BY BYTE	VSRLB	VRR-c	VF	$\alpha^{7,9}$			Dv	22-27
E77E	VECTOR SHIFT RIGHT ARITHMETIC	VSRA	VRR-c	VF	$\alpha^{7,9}$			Dv	22-26
E77F	VECTOR SHIFT RIGHT ARITHMETIC BY BYTE	VSRAB	VRR-c	VF	$\alpha^{7,9}$			Dv	22-26
E780	VECTOR FIND ELEMENT EQUAL	VFEE	VRR-b C*	VF	$\alpha^{7,9}$		SP	Dv	23-3
E781	VECTOR FIND ELEMENT NOT EQUAL	VFENE	VRR-b C*	VF	$\alpha^{7,9}$		SP	Dv	23-4

Figure B-3. Instructions Arranged by Opcode (Part 18 of 24)

Op-code	Name	Mnemonic	Characteristics						Page		
E782	VECTOR FIND ANY ELEMENT EQUAL	VFAE	VRR-b	C*	VF	$\alpha^{7,9}$	SP	Dv			23-2
E784	VECTOR PERMUTE DOUBLEWORD IMMEDIATE	VPDI	VRR-c		VF	$\alpha^{7,9}$		Dv			21-19
E785	VECTOR BIT PERMUTE	VBPERM	VRR-c		V1	$\alpha^{7,9}$		Dv			21-4
E786	VECTOR SHIFT LEFT DOUBLE BY BIT	VSLD	VRI-d		V2	$\alpha^{7,9}$	SP	Dv			22-25
E787	VECTOR SHIFT RIGHT DOUBLE BY BIT	VSRD	VRI-d		V2	$\alpha^{7,9}$	SP	Dv			22-26
E78A	VECTOR STRING RANGE COMPARE	VSTRC	VRR-d	C*	VF	$\alpha^{7,9}$	SP	Dv			23-6
E78B	VECTOR STRING SEARCH	VSTRS	VRR-d	C	V2	$\alpha^{7,9}$	SP	Dv			23-8
E78C	VECTOR PERMUTE	VPERM	VRR-e		VF	$\alpha^{7,9}$		Dv			21-18
E78D	VECTOR SELECT	VSEL	VRR-e		VF	$\alpha^{7,9}$		Dv			21-21
E78E	VECTOR FP MULTIPLY AND SUBTRACT	VFMS	VRR-e		VF	$\alpha^{7,9}$	SP	Dv	Xi	Xo Xu Xx	24-42
E78F	VECTOR FP MULTIPLY AND ADD	VFMA	VRR-e		VF	$\alpha^{7,9}$	SP	Dv	Xi	Xo Xu Xx	24-42
E794	VECTOR PACK	VPK	VRR-c		VF	$\alpha^{7,9}$	SP	Dv			21-16
E795	VECTOR PACK LOGICAL SATURATE	VPKLS	VRR-b	C*	VF	$\alpha^{7,9}$	SP	Dv			21-18
E797	VECTOR PACK SATURATE	VPKS	VRR-b	C*	VF	$\alpha^{7,9}$	SP	Dv			21-17
E79E	VECTOR FP NEGATIVE MULTIPLY AND SUBTRACT	VFNMS	VRR-e		V1	$\alpha^{7,9}$	SP	Dv	Xi	Xo Xu Xx	24-42
E79F	VECTOR FP NEGATIVE MULTIPLY AND ADD	VFNMA	VRR-e		V1	$\alpha^{7,9}$	SP	Dv	Xi	Xo Xu Xx	24-42
E7A1	VECTOR MULTIPLY LOGICAL HIGH	VMLH	VRR-c		VF	$\alpha^{7,9}$	SP	Dv			22-17
E7A2	VECTOR MULTIPLY LOW	VML	VRR-c		VF	$\alpha^{7,9}$	SP	Dv			22-17
E7A3	VECTOR MULTIPLY HIGH	VMH	VRR-c		VF	$\alpha^{7,9}$	SP	Dv			22-16
E7A4	VECTOR MULTIPLY LOGICAL EVEN	VMLE	VRR-c		VF	$\alpha^{7,9}$	SP	Dv			22-18
E7A5	VECTOR MULTIPLY LOGICAL ODD	VMLO	VRR-c		VF	$\alpha^{7,9}$	SP	Dv			22-18
E7A6	VECTOR MULTIPLY EVEN	VME	VRR-c		VF	$\alpha^{7,9}$	SP	Dv			22-18
E7A7	VECTOR MULTIPLY ODD	VMO	VRR-c		VF	$\alpha^{7,9}$	SP	Dv			22-18
E7A9	VECTOR MULTIPLY AND ADD LOGICAL HIGH	VMALH	VRR-d		VF	$\alpha^{7,9}$	SP	Dv			22-15
E7AA	VECTOR MULTIPLY AND ADD LOW	VMAL	VRR-d		VF	$\alpha^{7,9}$	SP	Dv			22-14
E7AB	VECTOR MULTIPLY AND ADD HIGH	VMAH	VRR-d		VF	$\alpha^{7,9}$	SP	Dv			22-15
E7AC	VECTOR MULTIPLY AND ADD LOGICAL EVEN	VMALE	VRR-d		VF	$\alpha^{7,9}$	SP	Dv			22-15
E7AD	VECTOR MULTIPLY AND ADD LOGICAL ODD	VMALO	VRR-d		VF	$\alpha^{7,9}$	SP	Dv			22-16
E7AE	VECTOR MULTIPLY AND ADD EVEN	VMAE	VRR-d		VF	$\alpha^{7,9}$	SP	Dv			22-15
E7AF	VECTOR MULTIPLY AND ADD ODD	VMAO	VRR-d		VF	$\alpha^{7,9}$	SP	Dv			22-16
E7B4	VECTOR GALOIS FIELD MULTIPLY SUM	VGFM	VRR-c		VF	$\alpha^{7,9}$	SP	Dv			22-11
E7B8	VECTOR MULTIPLY SUM LOGICAL	VMSL	VRR-d		V1	$\alpha^{7,9}$	SP	Dv			22-19
E7B9	VECTOR ADD WITH CARRY COMPUTE CARRY	VACCC	VRR-d		VF	$\alpha^{7,9}$	SP	Dv			22-5
E7BB	VECTOR ADD WITH CARRY	VAC	VRR-d		VF	$\alpha^{7,9}$	SP	Dv			22-4
E7BC	VECTOR GALOIS FIELD MULTIPLY SUM AND ACCUMULATE	VGFMA	VRR-d		VF	$\alpha^{7,9}$	SP	Dv			22-12
E7BD	VECTOR SUBTRACT WITH BORROW COMPUTE BORROW INDICATION	VSBCBI	VRR-d		VF	$\alpha^{7,9}$	SP	Dv			22-29
E7BF	VECTOR SUBTRACT WITH BORROW INDICATION	VSBI	VRR-d		VF	$\alpha^{7,9}$	SP	Dv			22-28
E7C0	VECTOR FP CONVERT TO LOGICAL	VCLFP	VRR-a		V2	$\alpha^{7,9}$	SP	Dv	Xi	Xx	24-20
E7C0	VECTOR FP CONVERT TO LOGICAL 64-BIT	VCLGD	VRR-a		VF	$\alpha^{7,9}$	SP	Dv	Xi	Xx	24-20
E7C1	VECTOR FP CONVERT FROM LOGICAL	VCFPL	VRR-a		V2	$\alpha^{7,9}$	SP	Dv		Xx	24-17
E7C1	VECTOR FP CONVERT FROM LOGICAL 64-BIT	VCDLG	VRR-a		VF	$\alpha^{7,9}$	SP	Dv		Xx	24-17
E7C2	VECTOR FP CONVERT TO FIXED	VCSFP	VRR-a		V2	$\alpha^{7,9}$	SP	Dv	Xi	Xx	24-18
E7C2	VECTOR FP CONVERT TO FIXED 64-BIT	VCGD	VRR-a		VF	$\alpha^{7,9}$	SP	Dv	Xi	Xx	24-18
E7C3	VECTOR FP CONVERT FROM FIXED	VCFPS	VRR-a		V2	$\alpha^{7,9}$	SP	Dv		Xx	24-15
E7C3	VECTOR FP CONVERT FROM FIXED 64-BIT	VCDG	VRR-a		VF	$\alpha^{7,9}$	SP	Dv		Xx	24-15
E7C4	VECTOR FP LOAD LENGTHENED	VFLL	VRR-a		VF	$\alpha^{7,9}$	SP	Dv	Xi		24-26
E7C5	VECTOR FP LOAD ROUNDED	VFLR	VRR-a		VF	$\alpha^{7,9}$	SP	Dv	Xi	Xo Xu Xx	24-27
E7C7	VECTOR LOAD FP INTEGER	VFI	VRR-a		VF	$\alpha^{7,9}$	SP	Dv	Xi	Xx	24-24
E7CA	VECTOR FP COMPARE AND SIGNAL SCALAR	WFK	VRR-a	C	VF	$\alpha^{7,9}$	SP	Dv	Xi		24-8
E7CB	VECTOR FP COMPARE SCALAR	WFC	VRR-a	C	VF	$\alpha^{7,9}$	SP	Dv	Xi		24-7
E7CC	VECTOR FP PERFORM SIGN OPERATION	VFPSO	VRR-a		VF	$\alpha^{7,9}$	SP	Dv			24-44
E7CE	VECTOR FP SQUARE ROOT	VFSQ	VRR-a		VF	$\alpha^{7,9}$	SP	Dv	Xi	Xx	24-45

Figure B-3. Instructions Arranged by Opcode (Part 19 of 24)

Op-code	Name	Mnemonic	Characteristics							Page	
E7D4	VECTOR UNPACK LOGICAL LOW	VUPLL	VRR-a	VF	$\alpha^{7,9}$	SP	Dv			21-27	
E7D5	VECTOR UNPACK LOGICAL HIGH	VUPLH	VRR-a	VF	$\alpha^{7,9}$	SP	Dv			21-26	
E7D6	VECTOR UNPACK LOW	VUPL	VRR-a	VF	$\alpha^{7,9}$	SP	Dv			21-27	
E7D7	VECTOR UNPACK HIGH	VUPH	VRR-a	VF	$\alpha^{7,9}$	SP	Dv			21-26	
E7D8	VECTOR TEST UNDER MASK	VTM	VRR-a C	VF	$\alpha^{7,9}$		Dv			22-31	
E7D9	VECTOR ELEMENT COMPARE LOGICAL	VECL	VRR-a C	VF	$\alpha^{7,9}$	SP	Dv			22-7	
E7DB	VECTOR ELEMENT COMPARE	VEC	VRR-a C	VF	$\alpha^{7,9}$	SP	Dv			22-7	
E7DE	VECTOR LOAD COMPLEMENT	VLC	VRR-a	VF	$\alpha^{7,9}$	SP	Dv			22-12	
E7DF	VECTOR LOAD POSITIVE	VLP	VRR-a	VF	$\alpha^{7,9}$	SP	Dv			22-12	
E7E2	VECTOR FP SUBTRACT	VFS	VRR-c	VF	$\alpha^{7,9}$	SP	Dv Xi	Xo Xu Xx		24-46	
E7E3	VECTOR FP ADD	VFA	VRR-c	VF	$\alpha^{7,9}$	SP	Dv Xi	Xo Xu Xx		24-4	
E7E5	VECTOR FP DIVIDE	VFD	VRR-c	VF	$\alpha^{7,9}$	SP	Dv Xi Xz	Xo Xu Xx		24-22	
E7E7	VECTOR FP MULTIPLY	VFM	VRR-c	VF	$\alpha^{7,9}$	SP	Dv Xi	Xo Xu Xx		24-40	
E7E8	VECTOR FP COMPARE EQUAL	VFCE	VRR-c C*	VF	$\alpha^{7,9}$	SP	Dv Xi			24-9	
E7EA	VECTOR FP COMPARE HIGH OR EQUAL	VFCHE	VRR-c C*	VF	$\alpha^{7,9}$	SP	Dv Xi			24-13	
E7EB	VECTOR FP COMPARE HIGH	VFCH	VRR-c C*	VF	$\alpha^{7,9}$	SP	Dv Xi			24-11	
E7EE	VECTOR FP MINIMUM	VFMIN	VRR-c	V1	$\alpha^{7,9}$	SP	Dv Xi			24-34	
E7EF	VECTOR FP MAXIMUM	VFMAX	VRR-c	V1	$\alpha^{7,9}$	SP	Dv Xi			24-28	
E7F0	VECTOR AVERAGE LOGICAL	VAVGL	VRR-c	VF	$\alpha^{7,9}$	SP	Dv			22-6	
E7F1	VECTOR ADD COMPUTE CARRY	VACC	VRR-c	VF	$\alpha^{7,9}$	SP	Dv			22-4	
E7F2	VECTOR AVERAGE	VAVG	VRR-c	VF	$\alpha^{7,9}$	SP	Dv			22-6	
E7F3	VECTOR ADD	VA	VRR-c	VF	$\alpha^{7,9}$	SP	Dv			22-3	
E7F5	VECTOR SUBTRACT COMPUTE BORROW INDICATION	VSCBI	VRR-c	VF	$\alpha^{7,9}$	SP	Dv			22-28	
E7F7	VECTOR SUBTRACT	VS	VRR-c	VF	$\alpha^{7,9}$	SP	Dv			22-27	
E7F8	VECTOR COMPARE EQUAL	VCEQ	VRR-b C*	VF	$\alpha^{7,9}$	SP	Dv			22-7	
E7F9	VECTOR COMPARE HIGH LOGICAL	VCHL	VRR-b C*	VF	$\alpha^{7,9}$	SP	Dv			22-9	
E7FB	VECTOR COMPARE HIGH	VCH	VRR-b C*	VF	$\alpha^{7,9}$	SP	Dv			22-8	
E7FC	VECTOR MINIMUM LOGICAL	VMNL	VRR-c	VF	$\alpha^{7,9}$	SP	Dv			22-14	
E7FD	VECTOR MAXIMUM LOGICAL	VMXL	VRR-c	VF	$\alpha^{7,9}$	SP	Dv			22-13	
E7FE	VECTOR MINIMUM	VMN	VRR-c	VF	$\alpha^{7,9}$	SP	Dv			22-13	
E7FF	VECTOR MAXIMUM	VMX	VRR-c	VF	$\alpha^{7,9}$	SP	Dv			22-13	
E8	MOVE INVERSE	MVCIN	SS-a		α^9	A			ST	B ₁ B ₂	7-289
E9	PACK ASCII	PKA	SS-f	E2	α^9	A	SP		ST	B ₁ B ₂	7-315
EA	UNPACK ASCII	UNPKA	SS-a C	E2	α^9	A	SP		ST	B ₁ B ₂	7-423
EB04	LOAD MULTIPLE (64)	LMG	RSY-a	N		A				B ₂	7-281
EB0A	SHIFT RIGHT SINGLE (64)	SRAG	RSY-a C	N							7-382
EB0B	SHIFT LEFT SINGLE (64)	SLAG	RSY-a C	N				IF			7-379
EB0C	SHIFT RIGHT SINGLE LOGICAL (64)	SRLG	RSY-a	N							7-383
EB0D	SHIFT LEFT SINGLE LOGICAL (64)	SLLG	RSY-a	N							7-380
EB0F	TRACE (64)	TRACG	RSY-a	N	P	A	SP	T ¢		B ₂	10-176
EB14	COMPARE AND SWAP (32)	CSY	RSY-a C	LD	α^9	A	SP	\$	ST	B ₂	7-143
EB1C	ROTATE LEFT SINGLE LOGICAL (64)	RLLG	RSY-a	N		A					7-367
EB1D	ROTATE LEFT SINGLE LOGICAL (32)	RLL	RSY-a	N3							7-367
EB20	COMPARE LOGICAL CHAR. UNDER MASK (high)	CLMH	RSY-b C	N		A				B ₂	7-156
EB21	COMPARE LOGICAL CHAR. UNDER MASK (low)	CLMY	RSY-b C	LD		A				B ₂	7-156
EB23	COMPARE LOGICAL AND TRAP (32)	CLT	RSY-b	MI1		A		Dc		B ₂	7-154
EB24	STORE MULTIPLE (64)	STMG	RSY-a	N		A			ST	B ₂	7-392
EB25	STORE CONTROL (64)	STCTG	RSY-a	N	P	A	SP		ST	B ₂	10-138
EB26	STORE MULTIPLE HIGH (32)	STMH	RSY-a	N		A			ST	B ₂	7-392
EB2B	COMPARE LOGICAL AND TRAP (64)	CLGT	RSY-b	MI1		A		Dc		B ₂	7-154
EB2C	STORE CHARACTERS UNDER MASK (high)	STCMH	RSY-b	N	$\alpha^{9,11}$	A			ST	B ₂	7-385
EB2D	STORE CHARACTERS UNDER MASK (low)	STCMY	RSY-b	LD		A			ST	B ₂	7-385
EB2F	LOAD CONTROL (64)	LCTLG	RSY-a	N	P	A	SP			B ₂	10-50
EB30	COMPARE AND SWAP (64)	CSG	RSY-a C	N	α^9	A	SP	\$	ST	B ₂	7-143

Figure B-3. Instructions Arranged by Opcode (Part 20 of 24)

Op-code	Name	Mnemonic	Characteristics							Page			
			RSY-a	C	LD	α^9	A	SP			ST	B_2	
EB31	COMPARE DOUBLE AND SWAP (32)	CDSY	RSY-a	C	LD	α^9	A	SP	\$		ST	B_2	7-143
EB3E	COMPARE DOUBLE AND SWAP (64)	CDSG	RSY-a	C	N	α^9	A	SP	\$		ST	B_2	7-143
EB44	BRANCH ON INDEX HIGH (64)	BXHG	RSY-a		N	α^9					B		7-41
EB45	BRANCH ON INDEX LOW OR EQUAL (64)	BXLEG	RSY-a		N	α^9					B		7-41
EB4C	EXTRACT CPU ATTRIBUTE	ECAG	RSY-a		GE	α^9							7-256
EB51	TEST UNDER MASK	TMY	SIY	C	LD		A					B_1	7-400
EB52	MOVE (immediate)	MVIY	SIY		LD		A				ST	B_1	7-288
EB54	AND (immediate)	NIY	SIY	C	LD		A		ξ^2		ST	B_1	7-33
EB55	COMPARE LOGICAL (immediate)	CLiy	SIY	C	LD		A					B_1	7-151
EB56	OR (immediate)	Oiy	SIY	C	LD		A				ST	B_1	7-312
EB57	EXCLUSIVE OR (immediate)	Xiy	SIY	C	LD		A				ST	B_1	7-254
EB6A	ADD IMMEDIATE (32←8)	ASI	SIY	C	GE		A		IF ξ^1		ST	B_1	7-26
EB6E	ADD LOGICAL WITH SIGNED IMMEDIATE (32←8)	ALSI	SIY	C	GE		A		ξ^1		ST	B_1	7-31
EB7A	ADD IMMEDIATE (64←8)	AGSI	SIY	C	GE		A		IF ξ^1		ST	B_1	7-26
EB7E	ADD LOGICAL WITH SIGNED IMMEDIATE (64←8)	ALGSI	SIY	C	GE		A		ξ^1		ST	B_1	7-31
EB80	INSERT CHARACTERS UNDER MASK (high)	ICMH	RSY-b	C	N		A					B_2	7-261
EB81	INSERT CHARACTERS UNDER MASK (low)	ICMY	RSY-b	C	LD		A					B_2	7-261
EB8E	MOVE LONG UNICODE	MVCLU	RSY-a	C	E2	α^9	A	SP	IC		ST	R_1 R_3	7-296
EB8F	COMPARE LOGICAL LONG UNICODE	CLCLU	RSY-a	C	E2	α^9	A	SP	IC			R_1 R_2	7-162
EB90	STORE MULTIPLE (32)	STMY	RSY-a		LD		A				ST	B_2	7-392
EB96	LOAD MULTIPLE HIGH (32)	LMH	RSY-a		N		A					B_2	7-282
EB98	LOAD MULTIPLE (32)	LMY	RSY-a		LD		A					B_2	7-281
EB9A	LOAD ACCESS MULTIPLE	LAMY	RSY-a		LD	α^9	A	SP				UB	7-264
EB9B	STORE ACCESS MULTIPLE	STAMY	RSY-a		LD		A	SP			ST	UB	7-384
EBC0	TEST DECIMAL	TP	RSL-a	C	E2	α^9	A					B_1 B_2	8-14
EBDC	SHIFT RIGHT SINGLE (32)	SRAK	RSY-a	C	DO								7-382
EBDD	SHIFT LEFT SINGLE (32)	SLAK	RSY-a	C	DO				IF				7-379
EBDE	SHIFT RIGHT SINGLE LOGICAL (32)	SRLK	RSY-a		DO								7-383
EBDF	SHIFT LEFT SINGLE LOGICAL (32)	SLLK	RSY-a		DO								7-380
EBE0	LOAD HIGH ON CONDITION (32)	LOCFH	RSY-b		L2		A					B_2	7-283
EBE1	STORE HIGH ON CONDITION	STOCFH	RSY-b		L2		A				ST	B_2	7-393
EBE2	LOAD ON CONDITION (64)	LOCG	RSY-b		L1		A					B_2	7-283
EBE3	STORE ON CONDITION (64)	STOCG	RSY-b		L1		A				ST	B_2	7-392
EBE4	LOAD AND AND (64)	LANG	RSY-a	C	IA	α^9	A	SP	ξ		ST	B_2	7-268
EBE6	LOAD AND OR (64)	LAOG	RSY-a	C	IA	α^9	A	SP	ξ		ST	B_2	7-269
EBE7	LOAD AND EXCLUSIVE OR (64)	LAXG	RSY-a	C	IA	α^9	A	SP	ξ		ST	B_2	7-268
EBE8	LOAD AND ADD (64)	LAAG	RSY-a	C	IA	α^9	A	SP	IF ξ		ST	B_2	7-267
EBEA	LOAD AND ADD LOGICAL (64)	LAALG	RSY-a	C	IA	α^9	A	SP	ξ		ST	B_2	7-267
EBF2	LOAD ON CONDITION (32)	LOC	RSY-b		L1		A					B_2	7-283
EBF3	STORE ON CONDITION (32)	STOC	RSY-b		L1		A				ST	B_2	7-392
EBF4	LOAD AND AND (32)	LAN	RSY-a	C	IA	α^9	A	SP	ξ		ST	B_2	7-268
EBF6	LOAD AND OR (32)	LAO	RSY-a	C	IA	α^9	A	SP	ξ		ST	B_2	7-269
EBF7	LOAD AND EXCLUSIVE OR (32)	LAX	RSY-a	C	IA	α^9	A	SP	ξ		ST	B_2	7-268
EBF8	LOAD AND ADD (32)	LAA	RSY-a	C	IA	α^9	A	SP	IF ξ		ST	B_2	7-267
EBFA	LOAD AND ADD LOGICAL (32)	LAAL	RSY-a	C	IA	α^9	A	SP	ξ		ST	B_2	7-267
EC42	LOAD HALFWORD IMMEDIATE ON CONDITION (32←16)	LOCHI	RIE-g		L2								7-276
EC44	BRANCH RELATIVE ON INDEX HIGH (64)	BRXHG	RIE-e		N	α^9					B		7-47
EC45	BRANCH RELATIVE ON INDEX LOW OR EQ. (64)	BRXLG	RIE-e		N	α^9					B		7-48
EC46	LOAD HALFWORD IMMEDIATE ON CONDITION (64←16)	LOGGHI	RIE-g		L2								7-276
EC4E	LOAD HALFWORD HIGH IMMEDIATE ON CONDITION (32←16)	LOCHHI	RIE-g		L2								7-276
EC51	ROTATE THEN INSERT SELECTED BITS LOW (64)	RISBLG	RIE-f		HW								7-371
EC54	ROTATE THEN AND SELECTED BITS (64)	RNSBG	RIE-f	C	GE								7-368

Figure B-3. Instructions Arranged by Opcode (Part 21 of 24)

Op-code	Name	Mnemonic	Characteristics						Page
EC55	ROTATE THEN INSERT SELECTED BITS (64)	RISBG	RIE-f	C	GE				7-369
EC56	ROTATE THEN OR SELECTED BITS (64)	ROSBG	RIE-f	C	GE				7-368
EC57	ROTATE THEN EXCLUSIVE OR SELECT. BITS (64)	RXSBG	RIE-f	C	GE				7-368
EC59	ROTATE THEN INSERT SELECTED BITS (64)	RISBGN	RIE-f		MI1				7-369
EC5D	ROTATE THEN INSERT SELECTED BITS HIGH (64)	RISBHG	RIE-f		HW				7-371
EC64	COMPARE AND BRANCH RELATIVE (64)	CGRJ	RIE-b		GE	α^{10}		B	7-135
EC65	COMPARE LOGICAL AND BRANCH RELATIVE (64)	CLGRJ	RIE-b		GE	α^{10}		B	7-153
EC70	COMPARE IMMEDIATE AND TRAP (64←16)	CGIT	RIE-a		GE		Dc		7-148
EC71	COMPARE LOGICAL IMMEDIATE AND TRAP (64←16)	CLGIT	RIE-a		GE		Dc		7-155
EC72	COMPARE IMMEDIATE AND TRAP (32←16)	CIT	RIE-a		GE		Dc		7-148
EC73	COMPARE LOGICAL IMMEDIATE AND TRAP (32←16)	CLFIT	RIE-a		GE		Dc		7-155
EC76	COMPARE AND BRANCH RELATIVE (32)	CRJ	RIE-b		GE	α^{10}		B	7-134
EC77	COMPARE LOGICAL AND BRANCH RELATIVE (32)	CLRJ	RIE-b		GE	α^{10}		B	7-153
EC7C	COMPARE IMMEDIATE AND BRANCH RELATIVE (64←8)	CGIJ	RIE-c		GE	α^{10}		B	7-135
EC7D	COMPARE LOGICAL IMMEDIATE AND BRANCH RELATIVE (64←8)	CLGIJ	RIE-c		GE	α^{10}		B	7-153
EC7E	COMPARE IMMEDIATE AND BRANCH RELATIVE (32←8)	CIJ	RIE-c		GE	α^{10}		B	7-135
EC7F	COMPARE LOGICAL IMMEDIATE AND BRANCH RELATIVE (32←8)	CLIJ	RIE-c		GE	α^{10}		B	7-153
ECD8	ADD IMMEDIATE (32←16)	AHIK	RIE-d	C	DO		IF		7-26
ECD9	ADD IMMEDIATE (64←16)	AGHIK	RIE-d	C	DO		IF		7-26
ECDA	ADD LOGICAL WITH SIGNED IMMEDIATE (32←16)	ALHSIK	RIE-d	C	DO				7-31
ECDB	ADD LOGICAL WITH SIGNED IMMEDIATE (64←16)	ALGHSIK	RIE-d	C	DO				7-31
ECE4	COMPARE AND BRANCH (64)	CGRB	RRS		GE	α^9		B	7-134
ECE5	COMPARE LOGICAL AND BRANCH (64)	CLGRB	RRS		GE	α^9		B	7-153
ECF6	COMPARE AND BRANCH (32)	CRB	RRS		GE	α^9		B	7-134
ECF7	COMPARE LOGICAL AND BRANCH (32)	CLRB	RRS		GE	α^9		B	7-153
ECFC	COMPARE IMMEDIATE AND BRANCH (64←8)	CGIB	RIS		GE	α^9		B	7-135
ECFD	COMPARE LOGICAL IMMEDIATE AND BRANCH (64←8)	CLGIB	RIS		GE	α^9		B	7-153
ECFE	COMPARE IMMEDIATE AND BRANCH (32←8)	CIB	RIS		GE	α^9		B	7-135
ECFF	COMPARE LOGICAL IMMEDIATE AND BRANCH (32←8)	CLIB	RIS		GE	α^9		B	7-153
ED04	LOAD LENGTHENED (short to long BFP)	LDEB	RXE			$\alpha^{7,9}$ A	Db Xi		B ₂ 19-34
ED05	LOAD LENGTHENED (long to extended BFP)	LXDB	RXE			$\alpha^{7,9}$ A SP	Db Xi		B ₂ 19-34
ED06	LOAD LENGTHENED (short to extended BFP)	LXEB	RXE			$\alpha^{7,9}$ A SP	Db Xi		B ₂ 19-34
ED07	MULTIPLY (long to extended BFP)	MXDB	RXE			$\alpha^{7,9}$ A SP	Db Xi		B ₂ 19-37
ED08	COMPARE AND SIGNAL (short BFP)	KEB	RXE	C		$\alpha^{7,9}$ A	Db Xi		B ₂ 19-18
ED09	COMPARE (short BFP)	CEB	RXE	C		$\alpha^{7,9}$ A	Db Xi		B ₂ 19-17
ED0A	ADD (short BFP)	AEB	RXE	C		$\alpha^{7,9}$ A	Db Xi Xo Xu Xx		B ₂ 19-15
ED0B	SUBTRACT (short BFP)	SEB	RXE	C		$\alpha^{7,9}$ A	Db Xi Xo Xu Xx		B ₂ 19-40
ED0C	MULTIPLY (short to long BFP)	MDEB	RXE			$\alpha^{7,9}$ A	Db Xi		B ₂ 19-37
ED0D	DIVIDE (short BFP)	DEB	RXE			$\alpha^{7,9}$ A	Db Xi Xz Xo Xu Xx		B ₂ 19-27
ED0E	MULTIPLY AND ADD (short BFP)	MAEB	RXF			$\alpha^{7,9}$ A	Db Xi Xo Xu Xx		B ₂ 19-38
ED0F	MULTIPLY AND SUBTRACT (short BFP)	MSEB	RXF			$\alpha^{7,9}$ A	Db Xi Xo Xu Xx		B ₂ 19-38
ED10	TEST DATA CLASS (short BFP)	TCEB	RXE	C		$\alpha^{7,9}$	Db		19-41
ED11	TEST DATA CLASS (long BFP)	TCDB	RXE	C		$\alpha^{7,9}$	Db		19-41

Figure B-3. Instructions Arranged by Opcode (Part 22 of 24)

Op-code	Name	Mne-monic	Characteristics						Page						
ED12	TEST DATA CLASS (extended BFP)	TCXB	RXE	C	$\alpha^{7,9}$	A	SP	Db				19-41			
ED14	SQUARE ROOT (short BFP)	SQEB	RXE		$\alpha^{7,9}$	A		Db	Xi		Xx	B ₂	19-40		
ED15	SQUARE ROOT (long BFP)	SQDB	RXE		$\alpha^{7,9}$	A		Db	Xi		Xx	B ₂	19-40		
ED17	MULTIPLY (short BFP)	MEEB	RXE		$\alpha^{7,9}$	A		Db	Xi	Xo	Xu	Xx	B ₂	19-37	
ED18	COMPARE AND SIGNAL (long BFP)	KDB	RXE	C	$\alpha^{7,9}$	A		Db	Xi				B ₂	19-18	
ED19	COMPARE (long BFP)	CDB	RXE	C	$\alpha^{7,9}$	A		Db	Xi				B ₂	19-17	
ED1A	ADD (long BFP)	ADB	RXE	C	$\alpha^{7,9}$	A		Db	Xi	Xo	Xu	Xx	B ₂	19-15	
ED1B	SUBTRACT (long BFP)	SDB	RXE	C	$\alpha^{7,9}$	A		Db	Xi	Xo	Xu	Xx	B ₂	19-40	
ED1C	MULTIPLY (long BFP)	MDB	RXE		$\alpha^{7,9}$	A		Db	Xi	Xo	Xu	Xx	B ₂	19-37	
ED1D	DIVIDE (long BFP)	DDB	RXE		$\alpha^{7,9}$	A		Db	Xi	Xz	Xo	Xu	Xx	B ₂	19-27
ED1E	MULTIPLY AND ADD (long BFP)	MADB	RXF		$\alpha^{7,9}$	A		Db	Xi	Xo	Xu	Xx	B ₂	19-38	
ED1F	MULTIPLY AND SUBTRACT (long BFP)	MSDB	RXF		$\alpha^{7,9}$	A		Db	Xi	Xo	Xu	Xx	B ₂	19-38	
ED24	LOAD LENGTHENED (short to long HFP)	LDE	RXE		$\alpha^{7,9}$	A		Da					B ₂	18-15	
ED25	LOAD LENGTHENED (long to extended HFP)	LXD	RXE		$\alpha^{7,9}$	A	SP	Da					B ₂	18-15	
ED26	LOAD LENGTHENED (short to extended HFP)	LXE	RXE		$\alpha^{7,9}$	A	SP	Da					B ₂	18-15	
ED2E	MULTIPLY AND ADD (short HFP)	MAE	RXF	HM	$\alpha^{7,9}$	A		Da	EU	EO			B ₂	18-19	
ED2F	MULTIPLY AND SUBTRACT (short HFP)	MSE	RXF	HM	$\alpha^{7,9}$	A		Da	EU	EO			B ₂	18-19	
ED34	SQUARE ROOT (short HFP)	SQE	RXE		$\alpha^{7,9}$	A		Da		SQ			B ₂	18-23	
ED35	SQUARE ROOT (long HFP)	SQD	RXE		$\alpha^{7,9}$	A		Da		SQ			B ₂	18-23	
ED37	MULTIPLY (short HFP)	MEE	RXE		$\alpha^{7,9}$	A		Da	EU	EO			B ₂	18-18	
ED38	MULTIPLY AND ADD UNNRM. (long to ext. low HFP)	MAYL	RXF	UE	$\alpha^{7,9}$	A		Da					B ₂	18-20	
ED39	MULTIPLY UNNORM. (long to ext. low HFP)	MYL	RXF	UE	$\alpha^{7,9}$	A		Da					B ₂	18-22	
ED3A	MULTIPLY & ADD UNNORMALIZED (long to ext. HFP)	MAY	RXF	UE	$\alpha^{7,9}$	A		Da					B ₂	18-20	
ED3B	MULTIPLY UNNORMALIZED (long to ext. HFP)	MY	RXF	UE	$\alpha^{7,9}$	A	SP	Da					B ₂	18-22	
ED3C	MULTIPLY AND ADD UNNRM. (long to ext. high HFP)	MAYH	RXF	UE	$\alpha^{7,9}$	A		Da					B ₂	18-20	
ED3D	MULTIPLY UNNORM. (long to ext. high HFP)	MYH	RXF	UE	$\alpha^{7,9}$	A		Da					B ₂	18-22	
ED3E	MULTIPLY AND ADD (long HFP)	MAD	RXF	HM	$\alpha^{7,9}$	A		Da	EU	EO			B ₂	18-19	
ED3F	MULTIPLY AND SUBTRACT (long HFP)	MSD	RXF	HM	$\alpha^{7,9}$	A		Da	EU	EO			B ₂	18-19	
ED40	SHIFT SIGNIFICAND LEFT (long DFP)	SLDT	RXF	TF	$\alpha^{7,9}$			Dt						20-54	
ED41	SHIFT SIGNIFICAND RIGHT (long DFP)	SRDT	RXF	TF	$\alpha^{7,9}$			Dt						20-54	
ED48	SHIFT SIGNIFICAND LEFT (extended DFP)	SLXT	RXF	TF	$\alpha^{7,9}$		SP	Dt						20-54	
ED49	SHIFT SIGNIFICAND RIGHT (extended DFP)	SRXT	RXF	TF	$\alpha^{7,9}$		SP	Dt						20-54	
ED50	TEST DATA CLASS (short DFP)	TDCET	RXE	C	TF	$\alpha^{7,9}$		Dt						20-56	
ED51	TEST DATA GROUP (short DFP)	TDGET	RXE	C	TF	$\alpha^{7,9}$		Dt						20-57	
ED54	TEST DATA CLASS (long DFP)	TDCDT	RXE	C	TF	$\alpha^{7,9}$		Dt						20-56	
ED55	TEST DATA GROUP (long DFP)	TDGDT	RXE	C	TF	$\alpha^{7,9}$		Dt						20-57	
ED58	TEST DATA CLASS (extended DFP)	TDCXT	RXE	C	TF	$\alpha^{7,9}$		Dt						20-56	
ED59	TEST DATA GROUP (extended DFP)	TDGXT	RXE	C	TF	$\alpha^{7,9}$		Dt						20-57	
ED64	LOAD (short)	LEY	RXY-a	LD	$\alpha^{7,9}$	A		Da					B ₂	9-31	
ED65	LOAD (long)	LDY	RXY-a	LD	$\alpha^{7,9}$	A		Da					B ₂	9-31	
ED66	STORE (short)	STEY	RXY-a	LD	$\alpha^{7,9}$	A		Da				ST	B ₂	9-49	
ED67	STORE (long)	STDY	RXY-a	LD	$\alpha^{7,9}$	A		Da				ST	B ₂	9-49	
EDA8	CONVERT TO ZONED (from long DFP)	CZDT	RSL-b	C	ZF	$\alpha^{7,9}$	A	SP				ST	B ₂	20-36	
EDA9	CONVERT TO ZONED (from extended DFP)	CZXT	RSL-b	C	ZF	$\alpha^{7,9}$	A	SP				ST	B ₂	20-36	
EDAA	CONVERT FROM ZONED (to long DFP)	CDZT	RSL-b	ZF	$\alpha^{7,9}$	A	SP	Dt	Dg				B ₂	20-29	
EDAB	CONVERT FROM ZONED (to extended DFP)	CXZT	RSL-b	ZF	$\alpha^{7,9}$	A	SP	Dt	Dg				B ₂	20-29	
EDAC	CONVERT TO PACKED (from long DFP)	CPDT	RSL-b	C	PC	$\alpha^{7,9}$	A	SP	Dt	DF		ST	B ₂	20-33	
EDAD	CONVERT TO PACKED (from extended DFP)	CPXT	RSL-b	C	PC	$\alpha^{7,9}$	A	SP	Dt	DF		ST	B ₂	20-33	
EDAE	CONVERT FROM PACKED (to long DFP)	CDPT	RSL-b	PC	$\alpha^{7,9}$	A	SP	Dt	Dg				B ₂	20-26	
EDAF	CONVERT FROM PACKED (to extended DFP)	CXPT	RSL-b	PC	$\alpha^{7,9}$	A	SP	Dt	Dg				B ₂	20-26	
EE	PERFORM LOCKED OPERATION	PLO	SS-e	C	α^1	A	SP		\$	GM		ST	FC	7-337	
EF	LOAD MULTIPLE DISJOINT (64←32&32)	LMD	SS-e	N	α^9	A							B ₂ B ₄	7-282	

Figure B-3. Instructions Arranged by Opcode (Part 23 of 24)

Op-code	Name	Mnemonic	Characteristics						Page			
F0	SHIFT AND ROUND DECIMAL	SRP	SS-c	C	α^9	A	Dg	DF	ST	B ₁	B ₂	8-12
F1	MOVE WITH OFFSET	MVO	SS-b		α^9	A			ST	B ₁	B ₂	7-302
F2	PACK	PACK	SS-b		α^9	A			ST	B ₁	B ₂	7-314
F3	UNPACK	UNPK	SS-b		α^9	A			ST	B ₁	B ₂	7-423
F8	ZERO AND ADD	ZAP	SS-b	C	α^9	A	Dg	DF	ST	B ₁	B ₂	8-14
F9	COMPARE DECIMAL	CP	SS-b	C	α^9	A	Dg			B ₁	B ₂	8-7
FA	ADD DECIMAL	AP	SS-b	C	α^9	A	Dg	DF	ST	B ₁	B ₂	8-6
FB	SUBTRACT DECIMAL	SP	SS-b	C	α^9	A	Dg	DF	ST	B ₁	B ₂	8-13
FC	MULTIPLY DECIMAL	MP	SS-b		α^9	A	SP	Dg	ST	B ₁	B ₂	8-12
FD	DIVIDE DECIMAL	DP	SS-b		α^9	A	SP	Dg	ST	B ₁	B ₂	8-7

Figure B-3. Instructions Arranged by Opcode (Part 24 of 24)

Appendix C. Condition-Code Settings

This appendix lists the condition-code setting for instructions in z/Architecture which set the condition code. In addition to those instructions listed which set the condition code, the condition code may be changed by DIAGNOSE and the target of EXECUTE. The condition code is loaded by LOAD PSW, LOAD PSW EXTENDED, PROGRAM RETURN, RESUME PROGRAM, and SET PROGRAM MASK and by an

interruption. The condition code is set to zero by initial CPU reset and is loaded by the successful conclusion of the initial-program-loading sequence.

Some models may offer instructions which set the condition code and do not appear in this document, such as those provided for assists or as part of special or custom features.

Instruction	Condition Code			
	0	1	2	3
ADD (BFP, DFP)	Zero	< zero	> zero	NaN
ADD (general)	Zero	< zero	> zero	Overflow
ADD DECIMAL	Zero	< zero	> zero	Overflow
ADD HALFWORD	Zero	< zero	> zero	Overflow
ADD HALFWORD IMMEDIATE	Zero	< zero	> zero	Overflow
ADD HIGH	Zero	< zero	> zero	Overflow
ADD IMMEDIATE	Zero	< zero	> zero	Overflow
ADD IMMEDIATE HIGH	Zero	< zero	> zero	Overflow
ADD LOGICAL	Zero, no carry	Not zero, no carry	Zero, carry	Not zero, carry
ADD LOGICAL HIGH	Zero, no carry	Not zero, no carry	Zero, carry	Not zero, carry
ADD LOGICAL IMMEDIATE	Zero, no carry	Not zero, no carry	Zero, carry	Not zero, carry
ADD LOGICAL WITH CARRY	Zero, no carry	Not zero, no carry	Zero, carry	Not zero, carry
ADD LOGICAL WITH SIGNED IMMEDIATE	Zero, no carry	Not zero, no carry	Zero, carry	Not zero, carry
ADD LOGICAL WITH SIGNED IMMEDIATE HIGH	Zero, no carry	Not zero, no carry	Zero, carry	Not zero, carry
ADD NORMALIZED	Zero	< zero	> zero	—
ADD UNNORMALIZED	Zero	< zero	> zero	—
AND	Zero	Not zero	—	—
AND IMMEDIATE	Zero	Not zero	—	—
AND WITH COMPLEMENT	Zero	Not zero	—	—
CANCEL SUBCHANNEL	Function initiated	—	—	Not operational
CHECKSUM	Checksum complete	—	—	CPU-determined completion
CIPHER MESSAGE	Normal completion	Verification mismatch	—	Partial completion
CIPHER MESSAGE WITH AUTHENTICATION	Normal completion	Verification mismatch	Partial completion (LAAD or LPC zero)	Partial completion (time out)
CIPHER MESSAGE WITH CHAINING	Normal completion	Verification mismatch	—	Partial completion
CIPHER MESSAGE WITH CIPHER FEEDBACK	Normal completion	Verification mismatch	—	Partial completion
CIPHER MESSAGE WITH COUNTER	Normal completion	Verification mismatch	—	Partial completion
CIPHER MESSAGE WITH OUTPUT FEEDBACK	Normal completion	Verification mismatch	—	Partial completion
CLEAR SUBCHANNEL	Function initiated	—	—	Not operational
COMPARE (BFP, DFP)	Equal	Low	High	Unordered
COMPARE (general, HFP)	Equal	Low	High	—
COMPARE AND FORM CODEWORD	Equal	OCB=0: low OCB=1: high	OCB=0: high OCB=1: low	—
COMPARE AND REPLACE DAT TABLE ENTRY	Equal	Not equal	—	—

Figure C-1. Summary of Condition-Code Settings (Part 1 of 7)

Instruction	Condition Code			
	0	1	2	3
COMPARE AND SIGNAL	Equal	Low	High	Unordered
COMPARE AND SWAP	Equal	Not equal	—	—
COMPARE AND SWAP AND PURGE	Equal	Not equal	—	—
COMPARE AND SWAP AND STORE	Equal	Not equal	—	—
COMPARE BIASED EXPONENT	Equal	Low	High	Unordered
COMPARE DECIMAL	Equal	Low	High	—
COMPARE DOUBLE AND SWAP	Equal	Not equal	—	—
COMPARE HALFWORD	Equal	Low	High	—
COMPARE HALFWORD IMMEDIATE	Equal	Low	High	—
COMPARE HALFWORD RELATIVE LONG	Equal	Low	High	—
COMPARE HIGH	Equal	Low	High	—
COMPARE IMMEDIATE	Equal	Low	High	—
COMPARE IMMEDIATE HIGH	Equal	Low	High	—
COMPARE LOGICAL	Equal	Low	High	—
COMPARE LOGICAL CHARACTERS UNDER MASK	Equal	Low	High	—
COMPARE LOGICAL HIGH	Equal	Low	High	—
COMPARE LOGICAL IMMEDIATE	Equal	Low	High	—
COMPARE LOGICAL IMMEDIATE HIGH	Equal	Low	High	—
COMPARE LOGICAL LONG	Equal	Low	High	—
COMPARE LOGICAL LONG EXTENDED	Equal	Low	High	CPU-determined completion
COMPARE LOGICAL LONG UNICODE	Equal	Low	High	CPU-determined completion
COMPARE LOGICAL RELATIVE LONG	Equal	Low	High	—
COMPARE LOGICAL STRING	Equal	Low	High	CPU-determined completion
COMPARE RELATIVE LONG	Equal	Low	High	—
COMPARE UNTIL SUBSTRING EQUAL	Equal substrings	Last bytes equal	Last bytes unequal	CPU-determined completion
COMPRESSION CALL	Op2 processed	Op1 full and op2 not processed	—	CPU-determined completion
COMPUTE DIGITAL SIGNATURE AUTHENTICATION	Verify: Signature verified; Sign: Normal Completion	Verify: public key not on curve; Sign: key verification-pattern mismatch; Sign & Verify: reserved area	Verify: signature is incorrect or invalid; Sign: random number is not invertible if deterministic	Partial completion
COMPUTE INTERMEDIATE MESSAGE DIGEST	Normal completion	—	—	Partial completion
COMPUTE LAST MESSAGE DIGEST	Normal completion	—	—	Partial completion
COMPUTE MESSAGE AUTHENTICATION CODE	Normal completion	Verification mismatch	—	Partial completion
CONVERT BFP TO HFP	Zero	< zero	> zero	Special case
CONVERT HFP TO BFP	Zero	< zero	> zero	Special case
CONVERT TO FIXED	Zero	< zero	> zero	Special case
CONVERT TO LOGICAL	Zero	< zero	> zero	Special case
CONVERT TO PACKED	Source is zero	Source is less than zero	Source is greater than zero	Infinity, QNaN, SNaN, Partial result
CONVERT TO ZONED	Source is zero	Source is less than zero	Source is greater than zero	Infinity, QNaN, SNaN, Partial result

Figure C-1. Summary of Condition-Code Settings (Part 2 of 7)

Instruction	Condition Code			
	0	1	2	3
CONVERT UTF-16 TO UTF-32	Data processed	Op1 full	Invalid low surrogate	CPU-determined completion
CONVERT UTF-16 TO UTF-8	Data processed	Op1 full	Invalid low surrogate	CPU-determined completion
CONVERT UTF-32 TO UTF-16	Data processed	Op1 full	Invalid UTF-32 character	CPU-determined completion
CONVERT UTF-32 TO UTF-8	Data processed	Op1 full	Invalid UTF-32 character	CPU-determined completion
CONVERT UTF-8 TO UTF-16	Data processed	Op1 full	Invalid UTF-8 character	CPU-determined completion
CONVERT UTF-8 TO UTF-32	Data processed	Op1 full	Invalid UTF-8 character	CPU-determined completion
DEFLATE CONVERSION CALL	Normal Completion	op1 length insufficient	op2 length insufficient (DFLTCC-XPND) or invalid input	CPU-determined completion
DIAGNOSE ¹	See note	See note	See note	See note
DIVIDE TO INTEGER	Remainder complete; normal quotient	Remainder complete; quotient overflow or NaN	Remainder incomplete; normal quotient	Remainder incomplete; quotient overflow or NaN
EDIT	Zero	< zero	> zero	—
EDIT AND MARK	Zero	< zero	> zero	—
EXCLUSIVE OR	Zero	Not zero	—	—
EXCLUSIVE OR IMMEDIATE	Zero	Not zero	—	—
EXTRACT STACKED STATE	Branch state entry	Program-call state entry	—	—
FIND LEFTMOST ONE	No one bit found	—	One bit found	—
HALT SUBCHANNEL	Function initiated	Status-pending with other than intermediate status	Busy	Not operational
INSERT ADDRESS SPACE CONTROL	Primary-space mode	Secondary-space mode	Access-register mode	Home-space mode
INSERT CHARACTERS UNDER MASK	All zeros	First bit one	First bit zero	—
LOAD ADDRESS SPACE PARAMETERS	Parameters loaded	Primary ASN not available	Secondary ASN not available or not authorized	Space-switch event
LOAD AND TEST (BFP, DFP)	Zero	< zero	> zero	NaN
LOAD AND TEST (general, HFP)	Zero	< zero	> zero	—
LOAD COMPLEMENT (BFP)	Zero	< zero	> zero	NaN
LOAD COMPLEMENT (gen)	Zero	< zero	> zero	Overflow
LOAD COMPLEMENT (HFP)	Zero	< zero	> zero	—
LOAD COUNT TO BLOCK BOUNDARY	Operand 1 = 16	—	—	Operand 1 < 16
LOAD NEGATIVE (BFP)	Zero	< zero	—	NaN
LOAD NEGATIVE (gen, HFP)	Zero	< zero	—	—
LOAD PAGE TABLE ENTRY ADDRESS	Translation, STE.P = 0	Translation, STE.P = 1	1 bit on in RTE or STE, or enhanced-DAT applies and STE.FC=1	Exception condition exists
LOAD POSITIVE (BFP)	Zero	—	> zero	NaN
LOAD POSITIVE (gen)	Zero	—	> zero	Overflow

Figure C-1. Summary of Condition-Code Settings (Part 3 of 7)

Instruction	Condition Code			
	0	1	2	3
LOAD POSITIVE (HFP)	Zero	—	> zero	—
LOAD PSW ³ / LOAD PSW EXTENDED ³	See note	See note	See note	See note
LOAD REAL ADDRESS ²	Translation available	ST entry invalid	PT entry invalid	ASCE or entry not available or length violation
MODIFY SUBCHANNEL	SCHIB information placed in subchannel	Status-pending	Busy	Not operational
MOVE LONG	Length equal	Length low	Length high	Destructive overlap
MOVE LONG EXTENDED	Length equal	Length low	Length high	CPU-determined completion
MOVE LONG UNICODE	Length equal	Length low	Length high	CPU-determined completion
MOVE PAGE	Data moved	Operand 1 invalid, both valid in ES, locked, or ES error	Operand 2 invalid	—
MOVE STRING	—	Data moved	—	CPU-determined completion
MOVE TO PRIMARY	Length ≤ 256	—	—	Length > 256
MOVE TO SECONDARY	Length ≤ 256	—	—	Length > 256
MOVE WITH KEY	Length ≤ 256	—	—	Length > 256
MOVE WITH OPTIONAL SPECIFICATIONS	Length ≤ 4,096	—	—	Length > 4,096
NAND	Zero	Not zero	—	—
NOR	Zero	Not zero	—	—
NOT EXCLUSIVE OR	Zero	Not zero	—	—
OR	Zero	Not zero	—	—
OR IMMEDIATE	Zero	Not zero	—	—
OR WITH COMPLEMENT	Zero	Not zero	—	—
PAGE IN	Page-in operation completed	Expanded-storage data error	—	Expanded-storage block not available
PAGE OUT	Page-out operation completed	Expanded-storage data error	—	Expanded-storage block not available
PERFORM CRYPTOGRAPHIC COMPUTATION	Normal completion	Verification mismatch; Scalar-Multiply: source not on curve or out of range, d out of range	Invalid index or length; Scalar-Multiply: d is zero which yields result of infinity	Partial completion
PERFORM FLOATING-POINT OPERATION (test bit one)	Function code valid	—	—	Function code invalid
PERFORM FLOATING-POINT OPERATION (test bit zero)	Normal result	Nontrap exception	Trap exception with alternate action	—
PERFORM LOCKED OPERATION (test bit one)	Function code valid	—	—	Function code invalid
PERFORM LOCKED OPERATION (test bit zero)	Equal	Op1 not equal	Op1 equal, op3 not equal (dcs only)	—
PERFORM RANDOM NUMBER OPERATION	Normal completion	—	—	Partial completion
PERFORM TIMING FACILITY FUNCTION	Function performed	—	—	Function not available
PERFORM TOPOLOGY FUNCTION (FC 0 or 1)	Change initiated	—	Request rejected	—
PERFORM TOPOLOGY FUNCTION (FC 2)	Report not pending	Report pending	—	—
POPULATION COUNT	Zero	Not zero	—	—
PROGRAM RETURN	See note	See note	See note	See note
RESET CHANNEL PATH	Function initiated	—	Busy	Not operational

Figure C-1. Summary of Condition-Code Settings (Part 4 of 7)

Instruction	Condition Code			
	0	1	2	3
RESET REFERENCE BIT EXTENDED	R bit zero, C bit zero	R bit zero, C bit one	R bit one, C bit zero	R bit one, C bit one
RESUME PROGRAM ³	See note	See note	See note	See note
RESUME SUBCHANNEL	Function initiated	Status pending	Function not applicable	Not operational
ROTATE THEN AND SELECTED BITS	Zero	Not zero	—	—
ROTATE THEN EXCLUSIVE OR SELECTED BITS	Zero	Not zero	—	—
ROTATE THEN INSERT SELECTED BITS	Zero	< zero	> zero	—
ROTATE THEN OR SELECTED BITS	Zero	Not zero	—	—
SEARCH STRING	—	Found	Not found	CPU-determined completion
SEARCH STRING UNICODE	—	Found	Not found	CPU-determined completion
SET CLOCK	Set	Secure	—	Not operational
SET PROGRAM MASK ⁴	See note	See note	See note	See note
SET STORAGE KEY EXTENDED	Storage key not set	Entire storage key set	Partial storage key set	Entire storage key set; bits 48-55 of GR R ₁ unpredictable
SHIFT AND ROUND DECIMAL	Zero	< zero	> zero	Overflow
SHIFT LEFT (DOUBLE/SINGLE)	Zero	< zero	> zero	Overflow
SHIFT RIGHT (DOUBLE/SINGLE)	Zero	< zero	> zero	—
SIGNAL PROCESSOR	Order accepted	Status stored	Busy	Not operational
START SUBCHANNEL	Function initiated	Status-pending	Busy	Not operational
STORE CHANNEL REPORT WORD	CRW stored	Zeros stored	—	—
STORE CLOCK	Set	Not set	Error	Stopped or not operational
STORE CLOCK EXTENDED	Set	Not set	Error	Stopped or not operational
STORE CLOCK FAST	Set	Not set	Error	Stopped or not operational
STORE FACILITY LIST EXTENDED	Complete facility list stored	—	—	Incomplete facility list stored
STORE SUBCHANNEL	SCHIB stored	—	—	Not operational
STORE SYSTEM INFORMATION	Information provided	—	—	Information not available
SUBTRACT (BFP, DFP)	Zero	< zero	> zero	NaN
SUBTRACT (general)	Zero	< zero	> zero	Overflow
SUBTRACT DECIMAL	Zero	< zero	> zero	Overflow
SUBTRACT HALFWORD	Zero	< zero	> zero	Overflow
SUBTRACT HIGH	Zero	< zero	> zero	Overflow
SUBTRACT LOGICAL	—	Not zero, borrow	Zero, no borrow	Not zero, no borrow
SUBTRACT LOGICAL HIGH	—	Not zero, borrow	Zero, no borrow	Not zero, no borrow
SUBTRACT LOGICAL IMMEDIATE	—	Not zero, borrow	Zero, no borrow	Not zero, no borrow
SUBTRACT LOGICAL WITH BORROW	Zero, borrow	Not zero, borrow	Zero, no borrow	Not zero, no borrow
SUBTRACT NORMALIZED (HFP)	Zero	< zero	> zero	—
SUBTRACT UNNORMALIZED (HFP)	Zero	< zero	> zero	—

Figure C-1. Summary of Condition-Code Settings (Part 5 of 7)

Instruction	Condition Code			
	0	1	2	3
TEST ACCESS	ALET 0	DU access list, no exceptions	PS access list, no exceptions	ALET 1 or exceptions
TEST ADDRESSING MODE	Twenty-four bit mode	Thirty-one bit mode	—	Sixty-four bit mode
TEST AND SET	Left bit zero	Left bit one	—	—
TEST BLOCK	Usable	Not usable	—	—
TEST DATA CLASS	Zero (no match)	One (match)	—	—
TEST DATA GROUP	Zero (no match)	One (match)	—	—
TEST DECIMAL	Digits and sign valid	Sign invalid	Digit invalid	Sign and digit invalid
TEST PENDING EXTERNAL INTERRUPTION	None pending	One or more pending	—	—
TEST PENDING INTERRUPTION	Interruption code not stored	Interruption code stored	—	—
TEST PROTECTION	Can fetch, can store	Can fetch, cannot store	Cannot fetch, cannot store	Translation not available
TEST SUBCHANNEL	IRB stored; subchannel status-pending	IRB stored; subchannel not status-pending	—	Not operational
TEST UNDER MASK	All zeros	Mixed	—	All ones
TEST UNDER MASK (HIGH/LOW)	All zeros	Mixed, left bit zero	Mixed, left bit one	All ones
TRANSACTION BEGIN	Initiated successfully	—	—	—
TRANSACTION END	CPU in transactional-execution mode at start of instruction	—	CPU not in trans.-execution mode at start of instruction	—
TRANSLATE AND TEST	All zeros	Incomplete	Complete	—
TRANSLATE AND TEST EXTENDED	All zeros	Nonzero code selected	—	CPU-determined completion
TRANSLATE AND TEST REVERSE	All zeros	Incomplete	Complete	—
TRANSLATE AND TEST REVERSE EXTENDED	All zeros	Nonzero code selected	—	CPU-determined completion
TRANSLATE EXTENDED	Data processed	Op1 byte equal test byte	—	CPU-determined completion
TRANSLATE ONE TO ONE, ONE TO TWO, TWO TO ONE, TWO TO TWO	Character equal test character not found	Character equal test character found	—	CPU-determined completion
UNPACK ASCII	Sign plus	Sign minus	—	Sign invalid
UNPACK UNICODE	Sign plus	Sign minus	—	Sign invalid
UPDATE TREE	Equal	Not equal or no comparison	—	GR5 nonzero, GR0 negative
VECTOR ADD DECIMAL ⁵	Zero	< zero	> zero	Overflow
VECTOR COMPARE DECIMAL	Equal	Low	High	—
VECTOR COMPARE EQUAL ⁵	All elements equal	Some elements equal	—	No element equal
VECTOR COMPARE HIGH LOGICAL ⁵	All elements high	Some elements high	—	No element high
VECTOR COMPARE HIGH ⁵	All elements high	Some elements high	—	No element high
VECTOR CONVERT TO BINARY ⁵	No overflow	—	—	Overflow
VECTOR CONVERT TO DECIMAL ⁵	No overflow	—	—	Overflow
VECTOR DIVIDE DECIMAL ⁵	Zero	< zero	> zero	Overflow
VECTOR ELEMENT COMPARE	Equal	Low	High	—
VECTOR ELEMENT COMPARE LOGICAL	Equal	Low	High	—
VECTOR FIND ANY ELEMENT EQUAL ⁵	None equal, zero found	Equal element found, no zeros if ZS=1	Equal element found and zero found	No equal elements, no zeros

Figure C-1. Summary of Condition-Code Settings (Part 6 of 7)

Instruction	Condition Code			
	0	1	2	3
VECTOR FIND ELEMENT EQUAL ⁵	Zero found	Equal element found, no zeros	Equal element found, and zero	Not equal, no zeros
VECTOR FIND ELEMENT NOT EQUAL ⁵	Zero found	Not equal element found, less than	Not equal found, greater than	Equal, no zero
VECTOR FP COMPARE AND SIGNAL SCALAR	Elements equal	First element low	First element high	Elements unordered
VECTOR FP COMPARE EQUAL ⁵	All elements equal	Mix of equal and unequal (or unordered) elements	—	All elements not equal (or unordered)
VECTOR FP COMPARE HIGH OR EQUAL ⁵	All elements \geq	Mix of \geq and $<$	—	All elements $<$ (or unordered)
VECTOR FP COMPARE HIGH ⁵	All elements $>$	Mix of $>$ and \leq	—	All elements \leq (or unordered)
VECTOR FP COMPARE SCALAR	Elements equal	First element low	First element high	Elements unordered
VECTOR FP TEST DATA CLASS IMMEDIATE	Match	Selected bit 1 for some (but not all) elements	—	No match
VECTOR ISOLATE STRING ⁵	Zero element found	—	—	All elements nonzero
VECTOR MULTIPLY AND SHIFT DECIMAL ⁵	Zero	$<$ zero	$>$ zero	Overflow
VECTOR MULTIPLY DECIMAL ⁵	Zero	$<$ zero	$>$ zero	Overflow
VECTOR PACK LOGICAL SATURATE ⁵	No saturation	Some saturated		All saturated
VECTOR PACK SATURATE ⁵	No saturation	Some saturated		All saturated
VECTOR PERFORM SIGN OPERATION DECIMAL ⁵	Zero	$<$ zero	$>$ zero	Overflow
VECTOR REMAINDER DECIMAL ⁵	Zero	$<$ zero	$>$ zero	Overflow
VECTOR SHIFT AND DIVIDE DECIMAL ⁵	Zero	$<$ zero	$>$ zero	Overflow
VECTOR SHIFT AND ROUND DECIMAL ⁵	Zero	$<$ zero	$>$ zero	Overflow
VECTOR STRING RANGE COMPARE ⁵	Zero found	At least one in ranges, no zero	At least one in ranges, zero found	No ranges match, no zeros
VECTOR STRING SEARCH	no match found ⁶	no match found ⁶	full match found	partial match found
VECTOR SUBTRACT DECIMAL ⁵	Zero	$<$ zero	$>$ zero	Overflow
VECTOR TEST DECIMAL	Digits and sign valid	Sign invalid	Digit invalid	Sign and digit invalid
VECTOR TEST UNDER MASK	All zeros or mask zero	Mixed	—	All ones
ZERO AND ADD	Zero	$<$ zero	$>$ zero	Overflow
Explanation and Notes:				
—	Code is not set by the instruction.			
¹	For DIAGNOSE, the resulting condition code is model-dependent.			
²	For LOAD REAL ADDRESS, the following applies: Condition code 1 is set if segment-table entry is invalid for LRAG, or for LRA and LRAY in 64-bit addressing mode, or for LRA and LRAY in 24-bit or 31-bit addressing mode and bits 0-32 of the entry address are all zeros. Condition code 2 is set if page-table entry is invalid for LRAG, or for LRA and LRAY in 64-bit addressing mode, or for LRA and LRAY in 24-bit or 31-bit addressing mode and bits 0-32 of the entry address are all zeros. Condition code 3 is set if address-space-control element not available, region-table entry outside table or invalid, segment-table entry outside table, or, for LRA in 24- or 31-bit mode when bits 0-32 of entry address not all zeros, segment- or page-table entry invalid.			
³	For LOAD PSW, LOAD PSW EXTENDED, and RESUME PROGRAM, the condition code is loaded from the condition-code field of the second operand.			
⁴	For SET PROGRAM MASK, the condition code is loaded from bit positions 2 and 3 of the first operand.			
⁵	For various vector-facility instructions, the condition code is optionally set based on the CS control (in a mask field of the instruction)			
⁶	For VECTOR STRING SEARCH, refer to the instruction description for the distinction between condition codes 0 and 1.			

Figure C-1. Summary of Condition-Code Settings (Part 7 of 7)

Appendix D. Compression Call Facility

Introduction to Compression Call Facility	D-1	Order Preservation	D-8
Compression and Expansion Dictionaries	D-1	Entropy Encoding	D-9
Compression-Dictionary Entries	D-1	Results of Dictionary Errors	D-10
Compression Process	D-2	Dictionary Formats	D-10
Child and Sibling Characters	D-2	Notation	D-10
Child and Extension-Character Combinations	D-3	Compression Dictionary	D-11
Restriction on Identical Child and Sibling		Format-0 Sibling Descriptor	D-11
Characters	D-3	Format-1 Sibling Descriptor	D-12
Expansion-Dictionary Entries	D-6	Expansion Dictionary	D-12
Expansion Process	D-6	Character Entry	D-12
Compressed-Data Symbol Size	D-7	Format-1 Sibling Descriptor	D-13
Symbol Translation	D-8		

Introduction to Compression Call Facility

The compression call facility consists of the COMPRESSION CALL (CMPSC) instruction, which compresses or expands data as specified by a bit in general register 0. COMPRESSION CALL is primarily intended to operate on randomly accessed DB2* data, typically 80-byte records, so that the data can be kept on DASD in compressed form, thus saving DASD space. However, COMPRESSION CALL can also be used to compress any randomly or sequentially accessed data, provided that there is some degree of repetition of character strings (which may be actual characters or bytes of numeric or graphic data) in the data. COMPRESSION CALL also has an option, named the symbol-translation option and the order-preservation option, that allows the instruction to be used to compress VTAM* network data and DB2 keys, respectively.

In the following material, COMPRESSION CALL is first described for the case in which the symbol translation and order preservation options are not used, and then the differences due to the options are described.

Compression and Expansion Dictionaries

COMPRESSION CALL uses two static dictionaries that must be prepared by the program, before the

compression operation, by scanning data that is typical of that to be compressed. One of these dictionaries is named the compression dictionary and is used only during compression. The other dictionary is named the expansion dictionary, is used during expansion, and may, depending on an option, be used slightly during compression. During expansion, the beginning of the expansion dictionary is designated by an address in general register 1. During compression, this same address designates the beginning of the compression dictionary, and the expansion dictionary, if used, immediately follows the compression dictionary.

Each of the compression and expansion dictionaries contains 512, 1K, 2K, 4K, or 8K doubleword entries, as determined by bits in general register 0. An entry in either of the dictionaries is identified or designated by means of the *index* to its position in that dictionary. That is, the first entry in a dictionary is identified or designated by index 0, the next by index 1, and so forth. The two entries at the same index position in each of the two dictionaries correspond to each other in that they both represent the same character string, which string is called a *symbol*.

Compression-Dictionary Entries

The entries in the compression dictionary correspond approximately to a Ziv-Lempel tree. There are 256 *alphabet* entries corresponding to the 256 possible values of a single-byte character, and these are the topmost entries in the tree (which is upside down). The alphabet entries may be *parent* entries that point to *child* entries. The child entries may in turn be par-

ent entries that point to their child entries. Each of the alphabet entries and the child entries is called a *character entry*. A character entry represents one or more *extension characters*. An alphabet entry represents one extension character. (The character represented by an alphabet entry is the *first* character of a character symbol, which term is defined in the next paragraph. The character is an extension to a null character represented by a physically non-existing null root entry that conceptually is the parent of the 256 alphabet entries.) A lower-level character entry represents from one to five extension characters. (In a pure Ziv-Lempel tree, each node represents only one extension character.)

In addition to representing one or more extension characters, a compression-dictionary entry represents a *character symbol* that is the extension characters of the entry preceded by the extension characters of all of the entry's ancestor entries, up to an alphabet entry.

The alphabet entries are the first entries in a dictionary and have the indexes 0-255. If an entry is a parent, it contains the index, called a *child pointer*, of its first child. Its other children, if any, follow the first child contiguously in the dictionary (and thus in storage).

Compression Process

Compression occurs as follows. The first character of the string to be compressed is used as an index to locate the alphabet entry that represents the first character. If the alphabet entry has children, the children are processed in the left-to-right order of the children, and the extension characters represented by each child are compared to the next characters of the string until a match is found or all children have been examined. If a match is found, the process is repeated using the children of that child and the next characters of the string. When the last match has been found, which might be just the match on the alphabet entry, the index of the last matching entry is output as the compressed data. This index is called an *index symbol*. The length in bits of an index symbol is the power of 2 that defines the number of entries in the dictionary. Thus, the length is nine, 10, 11, 12, or 13 bits depending on whether the number of entries is 512, 1K, 2K, 4K, or 8K, respectively.

There is an exception to the above that is described below in the section "Restriction on Identical Child and Sibling Characters."

The unqualified term "symbol" can mean either a character symbol or an index symbol. The first meaning applies when discussing the uncompressed data or the dictionary entries. The second meaning applies when discussing the compressed data.

Child and Sibling Characters

It is a fundamental goal of the compression call facility to minimize the number of storage references required when processing dictionary entries to find matches. To this end, a character entry never contains its own first extension character and always contains the first extension characters of some number of its children, if any. These first extension characters of the children are named *child characters*. The positional number of a child character in a parent along with the pointer to the first child locates the child. If an entry represents more than one extension character, the characters after the first are in the entry and are called *additional extension characters*.

If a parent has more children than the number of bytes available in the parent to contain child characters, the first extension characters of the additional children are in a *sibling-descriptor* dictionary entry that follows the last child entry able to be represented by means of its child character in the parent. These first extension characters in a sibling descriptor are named *sibling characters*. COMPRESSION CALL provides the option of having either format-0 or format-1 sibling descriptors. A format-0 sibling descriptor is one doubleword, contains up to seven sibling characters, and resides entirely within the compression dictionary. It resides at an index position that would otherwise be used by a character entry. A format-1 sibling descriptor is two doublewords, contains up to 14 sibling characters, and has its first doubleword at an index position in the compression dictionary and its second doubleword at the same index position in the expansion dictionary. This position in the expansion dictionary would otherwise be wasted. This partial residence of sibling descriptors in the expansion dictionary is the only way the expansion dictionary is used during compression.

A sibling descriptor contains from one to seven or 14 sibling characters that correspond to the additional children of the parent. The additional child entries follow the sibling descriptor in the dictionary. If there are more than seven or 14 additional children, another sibling descriptor follows the seventh or fourteenth additional child. This following of seven or 14 children

by another sibling descriptor can be repeated again and again. However, a parent must have no more than 260 children; otherwise, a data exception may be recognized when an attempt is made to find a match on a child after the 260th child.

Child and Extension-Character Combinations

The compression dictionary contains only two types of entries: character entries and sibling descriptors. However, the character entries have different formats depending on how many additional extension characters an entry represents and on whether an entry has zero, one, or more than one children. Only the following combinations are allowed:

- If an entry has zero children, it can have from zero to four additional extension characters.
- If an entry has one child, it can have from zero to four additional extension characters.
- If an entry has more than one child it can have only zero or one additional extension character.

Character entries and sibling descriptors contain count fields whose contents specify the numbers of additional extension characters, child characters, or sibling characters in the entries and also whether a sibling descriptor follows a child. Character entries and sibling descriptors also contain *examine-child* bits that specify whether child entries, whether designated from a parent or a sibling descriptor, need to be examined. A child entry need not be examined if the entry represents only one extension character and has no children. Conversely, if the entry represents (contains) one or more additional extension characters or has children, the entry must be examined in order to continue the matching process.

Restriction on Identical Child and Sibling Characters

The compression process is described above with some lack of detail, which detail is provided here. However, this section, including its programming notes, does not apply if the order-preservation option is used.

After a match has been found on a parent entry, and if the parent has children, the next character of the

string is compared against the child characters in the parent and the sibling characters in the sibling descriptors that are among the children of the parent until a match is found or all child and sibling characters have been processed. If a match is found, the next characters of the string are compared against the additional extension characters, if any, in the child designated by means of the matched child or sibling character. If the additional extension characters match, or if there are no additional extension characters, the matching process is repeated using the matched child as the next parent. If there are additional extension characters that do not match the next characters of the string, then, except in one case, it is model-dependent whether the matching process is ended, with the match on the current parent being the last match, or whether the matching process is continued by attempting to match on a remaining child of the current parent. The one exceptional case is when the designated child and also the next child are in a set of children designated by means of consecutive identical child characters (not sibling characters) beginning with the first child character in the parent. In this case, an attempt is made to match on the following children in the set until either a match is found or all such children have been processed.

The effect of the detailed operation just described is that it is assured that it is useful for two or more identical characters to appear as child characters in a parent or sibling characters in a sibling descriptor under a parent only when the characters are all consecutive child characters beginning with the first child character in the parent. In any case where the identical characters are not consecutive child characters beginning with the first child character in the parent, the second character and any subsequent identical child or sibling character may be wasted since, depending on the model, they may never be compared against a string character equal to them.

Programming Notes:

1. When an *examine-child* bit indicates that the corresponding child need not be examined, it does not necessarily cause the child not to be examined. Therefore, the count fields in the child must contain all zeros as they correctly should; otherwise, there may be a match on one or more false additional extension characters or a false child character in the child. Since the expansion dictionary will not have been built to recreate the falsely matched character or characters, the

expanded data will not be equal to the original uncompressed data.

- The restriction against identical child or sibling characters may improve performance because it generally allows the matching process to be ended immediately after a match on a child or sibling character followed by a failure to match on additional extension characters in the designated child. On the other hand, the provision that attempted matching continues in the case of identical consecutive leading child characters improves performance in the case of compressing strings, of many different lengths, of the same repeated character. For example, consider the following two different sets of compression-dictionary entries that might be used for compressing strings, of lengths 1-15, of the character A. (Strings of binary zeros or of blanks are a more important case, but those two characters are unprintable and, therefore, cannot be shown in this example.)

In the first set of entries (Set 1), each parent has only one child, and there are no additional extension characters -- each child represents only one more character than its parent. Set 1 is shown abstractly as follows:

Set 1

Entry Number	Character Symbol Represented by Entry
1	A
2	AA
3	AAA
4	AAAA
5	AAAAA
6	AAAAAA
7	AAAAAAA
8	AAAAAAA
9	AAAAAAA
10	AAAAAAA
11	AAAAAAA
12	AAAAAAA
13	AAAAAAA
14	AAAAAAA
15	AAAAAAA

The entries in Set 1 are shown with the first and only child of a parent immediately beneath the parent except indented one character position to the right. Part of the abstraction is that the

entries are numbered 1-15 even though, in an actual dictionary, entries 0-255 must be alphabet entries. Note that the number of A's represented by an entry is equal to the number of the entry.

The number of storage references made to the dictionary during compression may be an important determinant of performance, depending on the model. Using Set 1, the number of dictionary storage references needed to compress a string of 1-15 A's is equal to the number of A's in the string.

In the second set of entries (Set 2), each parent has two children, the first child has one additional extension character, and the second child has no additional extension character -- the first child represents two more characters than its parent, and the second child represents one more character than its parent. Set 2 is shown abstractly as follows. The following also explicitly shows the number of A's represented by each entry and the number of storage references needed to match on each entry.:

Set 2

Entry Number	Character Symbol Represented by Entry	Stg. A's	Refs
1	A	1	1
2	AAA	3	2
4	AAAA	5	3
6	AAAAAA	7	4
8	AAAAAAA	9	5
10	AAAAAAA	11	6
12	AAAAAAA	13	7
14	AAAAAAA	15	8
15	AAAAAAA	14	9
13	AAAAAAA	12	8
11	AAAAAAA	10	7
9	AAAAAAA	8	6
7	AAAAAA	6	5
5	AAAA	4	4
3	AA	2	3

The entries in Set 2 are shown with the first child of a parent immediately beneath the parent, except indented one character position to the right, and with the other child of the same parent aligned vertically with the first child. For example, entry 1 (A) has the children 2 (AAA) and 3 (AA), and entry 2 (AAA) has the children 4 (AAAA) and 5 (AAAA). Entries 3 (AA) and 5 (AAAA) do

not have a child. The entries are numbered as they are because the children of a parent must be numbered consecutively.

It can be seen that except for entries 5 and 3 of Set 2, the number of storage references needed to match on a Set-2 entry is always less than the number of storage references needed to match on the Set-1 entry representing the same number of A's.

A dictionary might contain entries in the style of either Set 1 or Set 2 that would allow compression of a string of up to 260 repeated characters as a single index symbol. Using entries in the style of Set 2, instead of the style of Set 1, reduces the number of required storage references by approximately 50%. (Matching a string of 101 A's would require 101 references using the Set-1 style but only 51 references using the Set-2 style.)

- Long strings of a repeated character can be compressed with even fewer storage references if entries in the style of Set 3, shown below, are used. Using entries in the style of Set 3, instead of the style of Set 1, reduces the number of required storage references by approximately 67%.

Set 3		Character Symbol Represented by Entry	Stg. A's	Refs
1	A		1	1
2	AAAAAA		6	2
7	AAAAAAA		7	3
8	AAAAAAAAAAAA		12	4
13	AAAAAAAAAAAAA		13	5
14	AAAAAAAAAAAAAAAA		18	6
15	AAAAAAAAAAAAAAAAA		17	7
16	AAAAAAAAAAAAAAAAA		16	8
17	AAAAAAAAAAAAAAAAA		15	9
18	AAAAAAAAAAAAAAAAA		14	10
9	AAAAAAAAAAAA		11	5
10	AAAAAAAAAAAA		10	6
11	AAAAAAAAAAAA		9	7
12	AAAAAAAAAAAA		8	8
3	AAAAA		5	3
4	AAAA		4	4
5	AAA		3	5
6	AA		2	6

In Set 3, an odd-level parent has no additional extension character and five children, and the children, in order, have four, three, two, one, and zero additional extension characters -- the children represent from five to one more characters than their parent. An even-level parent, which is the first child of an odd-level parent, has four additional extension characters and one child, which is the next odd-level parent. The second through fifth children of an oddlevel parent do not have a child. Specifically in Set 3, entry 1 (A) has the children 2 (AAAAAA), 3 (AAAAA), 4 (AAAA), 5 (AAA), and 6 (AA); entry 2 (AAAAAA) has the child 7 (AAAAAAA); entry 7 has the children 8-12; entry 8 has the child 13, and entry 13 has the children 14-18. Entries 3-6, 9-12, and 15-18 do not have a child. Entry 14 might have a child to continue the pattern.

Matching a string of 18 A's requires six storage references, which is 33% of the number required when using the Set-1 style.

Entries should not be arranged as in the following examples.

Set 4 (Erroneous)

Entry Number	Character Symbol Represented by Entry
1	A
2	AA
3	AAA

Entry 3 in Set 4 is useless because if the string to be matched is AAA, a match of the AA at the beginning of the string will be found on entry 2, and entry 3 will not be examined. (This would be true also if the string to be matched were AAB and entry 3 represented AAB.)

Set 5 (Erroneous)

Entry Number	Character Symbol Represented by Entry
1	A
2	AAA
3	AB
4	AA

Entry 4 in Set 5 may be useless because if the string to be matched is AAX, the matching process may end, depending on the model, after the failure to match the AAX to entry 2. (Entries 2 and 4 are designated by identical child charac-

ters in entry 1, and the first of these child characters is the first child character in entry A, but the two child characters are not consecutive.)

Set 5 (Erroneous)

Entry Number	Character Symbol Represented by Entry
1	A
2	AB
3	AAA
4	AA

Entry 4 in Set 6 may be useless because if the string to be matched is AAX, the matching process may end, depending on the model, after the failure to match the AAX to entry 3. (Entries 3 and 4 are designated by identical consecutive child characters in entry 1, but the first of these child characters is not the first child character in entry A.)

Expansion-Dictionary Entries

The expansion dictionary contains three types of entries: *unpreceded character entries*, *preceded character entries*, and the second halves of the format-1 sibling descriptors that begin in the compression dictionary. An unpreceded character entry represents a character symbol by containing all of the characters of the symbol -- these are the extension characters represented by the corresponding entry in the compression dictionary and the extension characters represented by all the ancestors of that compression-dictionary entry. An unpreceded character entry can contain from one to seven characters. A preceded character entry represents a character symbol by containing from one to five of the rightmost characters of the symbol and also a pointer, called a *predecessor pointer*, to another expansion-dictionary character entry that contains some or all of the next lefthand characters of the character symbol. That is, the predecessor pointer in a preceded character entry can point to either an unpreceded or a preceded character entry.

A predecessor pointer is not necessarily a parent pointer, which term has no role in this definition. That is, a predecessor pointer may designate a higher-level entry that is more remote than simply a parent.

An unpreceded character entry contains a complete-symbol-length field whose contents specify the num-

ber of characters in the entry. A preceded character entry contains a partial-symbol-length field whose contents specify the number of characters in the entry, and it also contains an offset that may be used to position the leftmost character of the entry in the expanded-data operand.

Expansion Process

Expansion of an index symbol occurs in a way that depends on whether the value of the symbol is in the range 0-255 or is 256 or larger. If the value of the index symbol is in the range 0-255, a byte containing the value of the symbol is simply stored as the next byte of expanded data, and no reference is made to the expansion dictionary. That is, the index symbol is assumed to designate an expansion-dictionary entry that represents the same character symbol as does the alphabet entry that is designated by the index symbol in the compression dictionary -- the index symbol can be said to designate an alphabet entry in the expansion dictionary. If the value of the index symbol is 256 or larger, expansion occurs by using the value as an index to locate the corresponding expansion-dictionary character entry and then (1) outputting the characters in the entry, and (2) if the entry is a preceded entry, proceeding up the chain of preceded entries and outputting the characters in each of them on the left of the characters already output, until finally an unpreceded entry has been encountered. Following is a more detailed description of the case when the value of the index symbol is 256 or larger.

1. The rightmost byte of the first preceded character entry obtained during the expansion of an index symbol contains the byte offset from the current location in the expanded-data operand to where the first extension character represented by the character entry is to be placed. (All preceded character entries contain an offset since any entry can be the first one obtained during an expansion.) The address of the current location is named the current origin address. At the end of the operation, the current origin address is updated in accordance with one of two methods, and which method is used is unpredictable. When the first method is used, the current origin address is updated by adding to it the sum of the partial symbol length and the offset in the first-obtained preceded entry. When the second method is used, the current origin address is updated by adding to it the number of characters

placed in the first operand location due to the expansion of the index symbol. If the expansion-dictionary entries processed specify a logically correct operation, the results are the same regardless of which method is used. The entries are considered to specify a logically correct operation if they together contain n characters and cause placement of those n characters, without overlaps or spaces, in the n character positions beginning at the original current origin address and ending at the address that is one less than the updated current origin address. The machine does not check in any way that the operation is logically correct.

2. If the first character entry obtained during expansion of an index symbol is an unpreceded entry, the characters in the entry are placed at the current origin address, and then the current origin address is updated by adding to it the complete symbol length in the unpreceded entry.
3. When the first character entry obtained during expansion of an index symbol is a preceded entry, the processing of the preceding entries, which may include additional preceded entries, is in accordance with one of two methods, and which method is used is unpredictable. When the first method is used, the processing is the same as in items 1 and 2; that is, the characters in a preceded entry are placed as determined by the offset in the entry, and the characters in an unpreceded entry are placed at the current origin address. When the second method is used, the characters in each preceding entry are placed immediately to the left of the characters resulting from the previously processed preceded entry. Either the same or different methods may be used for each of preceded and unpreceded entries and for each of multiple preceded entries. If the entries processed specify a logically correct operation, the results are the same regardless of which method is used. The updated current origin address is determined as specified in item 1. If the operation is logically incorrect and leaves spaces in the n character positions beginning at the original current origin address, the contents of those spaces are unpredictable.

When method 1 is used, storing may be specified to occur at or to the right of the updated current origin address because either the offset in a subsequent preceded entry is larger than the offset

in the first one or because the offset in the first one is too small, considering the complete symbol length in the unpreceded entry. (The preceding is incomplete because it does not deal with partial symbol lengths, but the point should be clear.) When method 2 is used, storing may be specified to occur to the left of the original current origin address because the offset in the first preceded entry is too small. In the method-1 or method-2 case, such storing may be within or outside the first-operand location. It may cause a data exception to be recognized, or it may be attempted. If it is attempted, it may cause an access exception to be recognized and the operation to be nullified or suppressed, depending on the exception. If an access exception is recognized, the results may not be true nullification or suppression because storing may have occurred in a location for which no access exception was recognized. Recognition of an access exception may cause condition code 3 to be set instead of being treated as a program-interruption condition.

4. When entropy-encoding is not enabled and the value of a predecessor pointer is in the range 0-255, either the pointer may be used to reference a dictionary entry as already described, or the value may simply be stored as the next byte of expanded data. When entropy-encoding is enabled and the value of a predecessor pointer is in the range 0-255 the pointer is always used to reference a dictionary entry as already described.

Programming Note: If no predecessor pointer designates one of the entries 0-255 in the expansion dictionary, those entries need not actually be provided, and the storage that would be occupied by the entries can be used for other purposes. However, the storage must exist and have the correct storage key since the CPU may pretest the entire expansion dictionary, including entries 0-255, for access exceptions.

Compressed-Data Symbol Size

The bits in general register 0 that specify the number of bits in an index symbol and the size in entries and bytes of a dictionary are named the compressed-data symbol size (CDSS).

Symbol Translation

During compression, symbol translation can be specified by means of a bit in general register 0; this bit is ignored during expansion. When symbol translation is specified, the index symbols generated by the compression process are used to locate two-byte entries in a symbol-translation table (STT), and *interchange symbols* are taken from the STT entries and placed in the compressed-data operand. The beginning of the STT is designated by the address and an offset in general register 1.

When symbol-translation is specified, the CDSS does not specify either the number of bits in an index symbol or the size of the compression dictionary; the CDSS specifies the number of bits in an interchange symbol, the compression dictionary is considered to extend to the beginning of the STT, and the size of the STT in bytes is considered to be one fourth that of the compression dictionary.

Symbol translation is not performed during (before) expansion because the expansion dictionary can be formed to directly expand interchange symbols, that is, during expansion, interchange symbols and index symbols are considered to be identical, and only the term index symbol is used.

Symbol translation and format-1 sibling descriptors must not both be specified; otherwise, the results are unpredictable.

Programming Note: Symbol translation is for use by VTAM. During compression, VTAM will form an adaptive dictionary until compression becomes good, and VTAM will then freeze its dictionary and transform it to the architected form used by COMPRESSION CALL. VTAM will also signal the other end of the session to freeze its dictionary also, but the other end will then continue to use its frozen adaptive dictionary. Since the architected dictionary must contain some entries that are sibling-descriptor entries while the adaptive dictionary has no similar requirement (all of its entries are character entries), most of the entries in the architected dictionary cannot have the same indexes as the logically corresponding entries in the adaptive dictionary, and symbol translation must be used to generate the correct interchange symbols.

Order Preservation

During compression, order preservation can be specified by means of a bit in general register 0. When order preservation is specified, the symbol-translation bit in the register is ignored, but a modified form of symbol translation occurs.

When an appropriate compression dictionary and symbol-translation table are used, order preservation causes, for successive units of uncompressed data that are in collating-sequence order, production of corresponding successive units of compressed data that also are in collating-sequence order.

The compression process used in the basic compression operation uses what is referred to here as the *unordered* comparison algorithm: the children of a parent are not considered to be in any particular order, and the next characters from the string being compressed are compared against the extension characters represented by the children in the left-to-right order of the children until either a match is found or all of the children have been processed. The result of the compression process is the index symbol that designates the last matched entry, which is the parent entry if no match was found on any child or there are no children.

The order-preservation option causes the compression process to use an *ordered* comparison algorithm: the children of a parent are considered to be ordered such that the string of one or more extension characters represented by any child is always earlier in the collating sequence than the string of one or more extension characters represented by the next child of the same parent, that is, the children are considered to be in collating-sequence order. The next characters from the string being compressed are compared against the extension characters represented by the children in the left-to-right order of the children until any of the following is true: (1) a match is found on an entry without children, or a match is found on an entry with children but there is not another character in the string; (2) the next characters from the string have a collating-sequence value less than that of the extension characters represented by a child of the last matched parent; or (3) the next characters from the string have a collating-sequence value greater than that of the extension characters represented by the last child of the last matched parent. The result of the compression process in each of the three cases is as follows:

1. If the process ends because of a match on an entry without children or because of a match on an entry when there is not another character in the string, the result is the index symbol that designates the entry.
2. If the process ends because the next characters of the string have a value less than that of the characters represented by a child, the result is the index symbol that designates the child.
3. If the process ends because the next characters of the string have a value greater than that of the characters represented by the last child, the result is the index symbol that designates the last child.

Note that Case 2 includes the case when the next character of the string match the leftmost extension characters represented by a child but there are not as many next characters remaining in the string as there are additional extension characters represented in the child.

The index symbol produced by the compression process is used to locate a symbol-translation-table entry containing an interchange symbol just as when the symbol-translation option is specified. The resulting interchange symbol that is placed in the compressed-data operand is then as follows:

1. In Case 1, the interchange symbol in the entry.
2. In Case 2, the interchange symbol in the entry, minus one; that is, one is subtracted from the value of the interchange symbol that is in the entry to form the interchange symbol that is stored.
3. In Case 3, the interchange symbol in the entry, plus one; that is, one is added to the value of the interchange symbol that is in the entry to form the interchange symbol that is stored.

Although the order-preservation option does not affect the expansion process, the expansion dictionary must be formed so that the interchange symbols produced by compression are properly expanded when they are treated as index symbols during expansion. During expansion, an index symbol equal to an interchange symbol produced during compression must designate a dictionary entry that represents the same character symbol as did the last entry that was matched during the compression. In Case 2 or 3, the last matched entry is the parent of

the entry that caused the Case 2 or Case 3 condition to be satisfied.

Programming Note: The assumption that an index symbol in the range 0-255 designates an alphabet entry in the expansion dictionary requires that interchange symbols be assigned as follows when the order-preservation option is used. If n is the number of the lowest-numbered alphabet entry in the compression dictionary having a child, then the interchange symbols 0- n must be assigned to alphabet entries 0- n , the interchange symbol 256 must be assigned to the first epsilon entry or child under entry n , and the interchange symbols $(n+1)$ -255 must not be assigned.

Entropy Encoding

Entropy encoding can be specified by means of a bit in general register 0. When entropy encoding is specified, a higher degree of compression may be obtained due to using shorter codewords for more frequent symbols.

The compressed operand does not contain index symbols, instead it contains codewords. The codewords may vary from 1-16 bits in length. Each codeword represents an index symbol. The most frequent index symbols will have codewords with fewer bits, and less frequent index symbols will have codewords with more bits.

The mapping of index symbols to codewords is handled differently for compression and expansion. However, the entropy descriptor is common. The entropy descriptor describes the valid codewords from most frequent to least frequent. The entropy descriptor consists of sixteen halfword entries each of which contain a count of the number of entries of the corresponding bit length from one to sixteen.

The mapping of index symbols to codewords is done by generating a prefix tree for all index symbols. The prefix tree is formed using the frequency that each index symbol is seen when compressing data. The codewords are grouped by their information content and enumerated in descending order. This is sometimes called a canonical Huffman code or an Shannon-Fano code. Since all of the codewords are ordered, it is possible to describe the tree by enumerating the number of entries of each codeword length. The maximum codeword size supported is 16-bits. The entropy descriptor must fully represent a valid

tree. The sum of all of the entries in the entropy descriptor must add up to the number of dictionary entries plus one; otherwise, a general-operand data exception is recognized. Also there cannot be any underflow or overflow when computing the lower and upper bound codewords for each bit length otherwise a general-operand data exception is recognized.

The entropy descriptor is located immediately after the compression or expansion dictionary and is pointed to by the offset field in general register 1. During compression a symbol translation table is located immediately after the entropy descriptor. The symbol translation table is one fourth the size of the compression dictionary.

During compression index symbols which are formed during compression are used to index into the symbol translation table. Each halfword in the symbol translation table contains the codeword which maps to the index symbol left aligned in the halfword. Any unused bits in the symbol translation table entry must contain zeros; otherwise, a general-operand data exception is recognized. The number of bits from the symbol translation table entry to be copied to the first operand location is computed for each symbol translation table entry.

During expansion the bits of the second operand are broken into codewords using the information in the entropy description. The codewords are converted to sequence numbers and used to index directly into the expansion dictionary. Indices 0-255 have no special meaning in the expansion dictionary when the entropy encoding option is specified. Since the entries in the expansion dictionary are indexed by sequence numbers they must be ordered by likelihood. The sequence number is the number of codewords with a higher probability than the current input codeword.

Results of Dictionary Errors

The following may be truncated on the left to eliminate bits not needed because of the dictionary size,

or they may always be treated as 13 bits regardless of the dictionary size: child pointers, predecessor pointers, and index symbols that are used to locate entries in a symbol-translation table. If the pointers or symbols are not truncated and a child pointer specifies an entry beyond the end of the compression dictionary, a predecessor pointer specifies an entry beyond the end of the expansion dictionary, or an index symbol specifies an entry beyond the end of the symbol-translation table, any of the following may occur: in the case of a child pointer and a zero examine-child bit, an index symbol containing too many bits may be generated and stored in the first-operand location (possibly overlaying a rightmost bit or bits of the previous index symbol); the contents at the improper location may be used in the normal way as a dictionary or table entry; or a data exception may be recognized. If the contents are to be used in the normal way, an access exception can be recognized for the improper location even after a store has occurred in the first-operand location. Such an access exception does not result in true nullification or suppression, except that the instruction address in the PSW is correct for the type of exception recognized. When order-preservation is specified, the results when dictionary entries are not in collating-sequence order are unpredictable and may include recognition of a data exception.

Dictionary Formats

Notation

(m-n) Value allowed in the field

[EC] Extension character may be present

Three periods (...) means the preceding field may be repeated.

Compression Dictionary

Character Entry

When CCT = 0

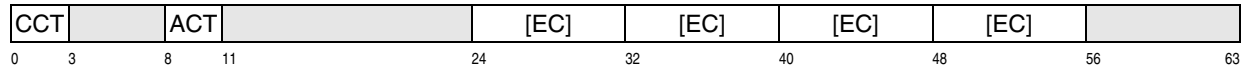

ACT Additional-extension-character count (0-4); number of ECs in entry. if ACT is 5, 6, or 7, it may be treated as 4, may cause data exception, or may cause comparison to mod(ACT,4) additional entries that are obtained from unpredictable locations in the current entry or from storage locations immediately following the current entry; see Note 1

EC Additional extension character

When CCT = 1

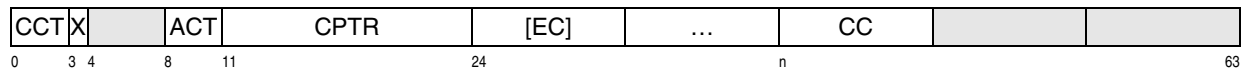

X examine-child bit; child has one or more additional extension characters or has children; see Note 2

ACT Additional-extension-character count (0-4). if ACT is 5, 6, or 7, it may be treated as 4, may cause data exception, or may cause comparison to mod(ACT,4) additional entries that are obtained from unpredictable locations in the current entry or from storage locations immediately following the current entry.

CPTR Index of first child

EC Additional extension character(s)

CC Child character

When CCT >1

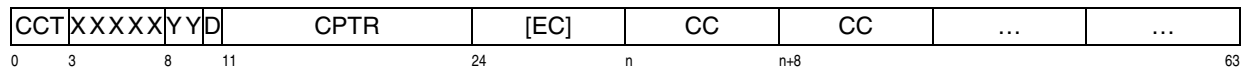

CCT Child count (2-6 if D=0, 2-5 if D=1). If D=0 and CCT=6, sibling descriptor follows 5th child (CCT = 7 may be treated as 6 or it may cause a data exception). If D=1 and CCT=5, sibling descriptor follows 4th child ACT (CCT = 6 or 7 may be treated as 5 or it may cause a data exception)

XXXXX Examine-child bits for children 1-5 (D=0) or 1-4 (D=1). Bit(s) ignored if respective child does not exist.

YY Examine child bits for 6th & 7th siblings designated by first format-0 sibling descriptor for children of this entry; or examine-child-bits for 13th and 14th siblings designated by first format-1 sibling descriptor for children of this entry. Bit(s) ignored if sibling does not exist.

EC Additional extension character(s)

CC Child character

Format-0 Sibling Descriptor

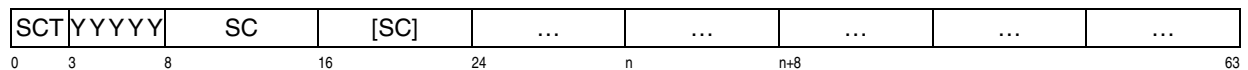

SCT Sibling Count (0-7); zero is treated as 7 and indicates another SD follows 7th sibling

YYY... Examine-child bits for siblings 1-5; bit is ignored if sibling does not exist; if this is the first sibling descriptor under parent, bits for siblings 6 and 7 are in parent — otherwise, 6th and 7th siblings must be examined since bits for them are not provided.

SC Sibling character

Format-1 Sibling Descriptor

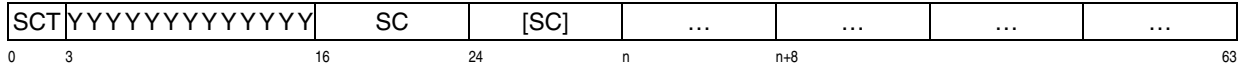

SCT Sibling Count (1-15); 15 is treated as 14 and indicates another SD follows 14th sibling. 0 may be treated as 15 or cause a data exception)

YYY... Examine-child bits for siblings 1-12; bit is ignored if sibling does not exist; if this is the first sibling descriptor under parent, bits for siblings 13 and 14 are in parent — otherwise, 13th and 14th siblings must be examined since bits for them are not provided.

SC Sibling character

Notes:

- If ACT or D is nonzero in alphabet entry, any of the following may result:
 - ACT or D is treated as zero.
 - ACT or D does not cause comparison to additional extension characters but does determine the position of the first child character.
 - ACT or D is treated the same as in a non-alphabet entry except that, if this causes a mismatch on the next characters to be compressed, a data exception is recognized.
- A child may be examined even if its examine-child bit (X or Y) is zero. If an examine-child bit (X or Y) is one and the corresponding child or sibling exists, but it is not true that the child or sibling either has one or more additional extension characters or has children, a data exception may be recognized.

Expansion Dictionary

Character Entry

Generic Form

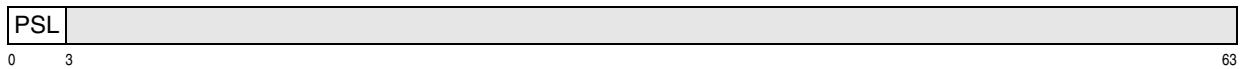

PSL Partial-symbol length (0-5); number of ECs in entry; 0 indicates an unpreceded entry; 6 and 7 may be treated as 5, may cause a data exception, or may cause movement to the first operand location of one or two, respectively, additional ECs that are obtained from unpredictable locations in the current entry or from the storage locations immediately following the current entry.

If PSL=0 (Unpreceded Entry)

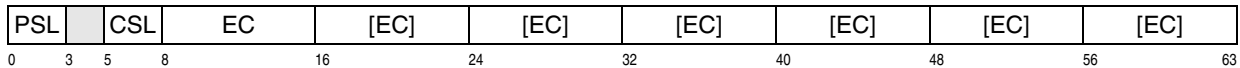

CSL Complete-symbol length (1-7); number of ECs in the entry; 0 may cause a data exception or may cause movement to the first operand location of up to 256 ECs that are obtained from unpredictable locations in the current entry or from storage locations immediately following the current entry

EC Extension character

Bits 3 and 4 of the entry should be zeros; otherwise, any of the following may occur: the bits may be ignored, they may cause a data exception, or they may cause movement to the first operand location of up to 24 additional ECs that are obtained from unpredictable locations in the current entry or from the storage locations immediately following the current entry.

If PSL>0 (Preceded Entry)

PSL	PPTR	EC	[EC]	[EC]	[EC]	[EC]	OFST	
0	3	16	24	32	40	48	56	63

PSL Partial-symbol length (1-5); number of ECs in the entry; 0 indicates an unpreceded entry; 6 and 7 may be treated as 5, may cause a data exception, or may cause movement to the first operand location of one or two, respectively, additional ECs that are obtained from unpredictable locations in the current entry or from the storage locations immediately following the current entry.

PPTR Predecessor pointer; index of preceding entry that should contain the next left-hand characters of the character symbol represented by this entry

OFST Offset (0-255) from the current position in the output area to where first EC in this entry is placed; however, for preceded entries after the first one, either method 1 or method 2 may be used -- see the text

When expansion is completed, the output pointer is advanced either by the sum of the PSL and OFST in the first-encountered preceded entry or by the number of characters placed in the first-operand location due to expansion of the index symbol. If the first method is used and PSL is 6 or 7, either 5 or the actual value of PSL may be used.

There is no checking for logical correctness of the operation.

Format-1 Sibling Descriptor

The expansion dictionary contains bits 64-127 of the format-1 sibling descriptors that begin in the compression dictionary.

Appendix G. Table of Powers of 2

Plus	Minus
1	0 1.
2	1 0.5
4	2 0.25
8	3 0.125
16	4 0.0625
32	5 0.03125
64	6 0.01562 5
128	7 0.00781 25
256	8 0.00390 625
512	9 0.00195 3125
1,024	10 0.00097 65625
2,048	11 0.00048 82812 5
4,096	12 0.00024 41406 25
8,192	13 0.00012 20703 125
16,384	14 0.00006 10351 5625
32,768	15 0.00003 05175 78125
65,536	16 0.00001 52587 89062 5
131,072	17 0.00000 76293 94531 25
262,144	18 0.00000 38146 97265 625
524,288	19 0.00000 19073 48632 8125
1,048,576	20 0.00000 09536 74316 40625
2,097,152	21 0.00000 04768 37158 20312 5
4,194,304	22 0.00000 02384 18579 10156 25
8,388,608	23 0.00000 01192 09289 55078 125
16,777,216	24 0.00000 00596 04644 77539 0625
33,554,432	25 0.00000 00298 02322 38769 53125
67,108,864	26 0.00000 00149 01161 19384 76562 5
134,217,728	27 0.00000 00074 50580 59692 38281 25
268,435,456	28 0.00000 00037 25290 29846 19140 625
536,870,912	29 0.00000 00018 62645 14923 09570 3125
1,073,741,824	30 0.00000 00009 31322 57461 54785 15625
2,147,483,648	31 0.00000 00004 65661 28730 77392 57812 5
4,294,967,296	32 0.00000 00002 32830 64365 38696 28906 25
8,589,934,592	33 0.00000 00001 16415 32182 69348 14453 125
17,179,869,184	34 0.00000 00000 58207 66091 34674 07226 5625
34,359,738,368	35 0.00000 00000 29103 83045 67337 03613 28125
68,719,476,736	36 0.00000 00000 14551 91522 83668 51806 64062 5
137,438,953,472	37 0.00000 00000 07275 95761 41834 25903 32031 25
274,877,906,944	38 0.00000 00000 03637 97880 70917 12951 66015 625
549,755,813,888	39 0.00000 00000 01818 98940 35458 56475 83007 8125
1,099,511,627,776	40 0.00000 00000 00909 49470 17729 28237 91503 90625
2,199,023,255,552	41 0.00000 00000 00454 74735 08864 64118 95751 95312 5
4,398,046,511,104	42 0.00000 00000 00227 37367 54432 32059 47875 97656 25
8,796,093,022,208	43 0.00000 00000 00113 68683 77216 16029 73937 98828 125
17,592,186,044,416	44 0.00000 00000 00056 84341 88608 08014 86968 99414 0625
35,184,372,088,832	45 0.00000 00000 00028 42170 94304 04007 43484 49707 03125
70,368,744,177,664	46 0.00000 00000 00014 21085 47152 02003 71742 24853 51562 5
140,737,488,355,328	47 0.00000 00000 00007 10542 73576 01001 85871 12426 75781 25
281,474,976,710,656	48 0.00000 00000 00003 55271 36788 00500 92935 56213 37890 625
562,949,953,421,312	49 0.00000 00000 00001 77635 68394 00250 46467 78106 68945 3125
1,125,899,906,842,624	50 0.00000 00000 00000 88817 84197 00125 23233 89053 34472 65625
2,251,799,813,685,248	51 0.00000 00000 00000 44408 92098 50062 61616 94526 67236 32812 5
4,503,599,627,370,496	52 0.00000 00000 00000 22204 46049 25031 30808 47263 33618 16406 25
9,007,199,254,740,992	53 0.00000 00000 00000 11102 23024 62515 65404 23631 66809 08203 125
18,014,398,509,481,984	54 0.00000 00000 00000 05551 11512 31257 82702 11815 83404 54101 5625
36,028,797,018,963,968	55 0.00000 00000 00000 02775 55756 15628 91351 05907 91702 27050 78125
72,057,594,037,927,936	56 0.00000 00000 00000 01387 77878 07814 45675 52953 95851 13525 39062 5
144,115,188,075,855,872	57 0.00000 00000 00000 00693 88939 03907 22837 76476 97925 56762 69531 25
288,230,376,151,711,744	58 0.00000 00000 00000 00346 94469 51953 61418 88238 48962 78381 34765 625
576,460,752,303,423,488	59 0.00000 00000 00000 00173 47234 75976 80709 44119 24481 39190 67382 8125
1,152,921,504,606,846,976	60 0.00000 00000 00000 00086 73617 37988 40354 72059 62240 69595 33691 40625
2,305,843,009,213,693,952	61 0.00000 00000 00000 00043 36808 68994 20177 36029 81120 34797 66845 70312 5
4,611,686,018,427,387,904	62 0.00000 00000 00000 00021 68404 34497 10088 68014 90560 17398 83422 85156 25
9,223,372,036,854,775,808	63 0.00000 00000 00000 00010 84202 17248 55044 34007 45280 08699 41711 42578 125

Figure G-1. Powers of 2

Plus		Minus	
18,446,744,073,709,551,616	64	0.00000 00000 00000 00005 42101 08624 27522 17003 72640 04349 70855 71289 0625	
36,893,488,147,419,103,232	65		
73,786,976,294,838,206,464	66		
147,573,952,589,676,412,928	67		
295,147,905,179,352,825,856	68		
590,295,810,358,705,651,712	69		
1,180,591,620,717,411,303,424	70		
2,361,183,241,434,822,606,848	71		
4,722,366,482,869,645,213,696	72		
9,444,732,965,739,290,427,392	73		
18,889,465,931,478,580,854,784	74		
37,778,931,862,957,161,709,568	75		
75,557,863,725,914,323,419,136	76		
151,115,727,451,828,646,838,272	77		
302,231,454,903,657,293,676,544	78		
604,462,909,807,314,587,353,088	79		
1,208,925,819,614,629,174,706,176	80		
2,417,851,639,229,258,349,412,352	81		
4,835,703,278,458,516,698,824,704	82		
9,671,406,556,917,033,397,649,408	83		
19,342,813,113,834,066,795,298,816	84		
38,685,626,227,668,133,590,597,632	85		
77,371,252,455,336,267,181,195,264	86		
154,742,504,910,672,534,362,390,528	87		
309,485,009,821,345,068,724,781,056	88		
618,970,019,642,690,137,449,562,112	89		
1,237,940,039,285,380,274,899,124,224	90		
2,475,880,078,570,760,549,798,248,448	91		
4,951,760,157,141,521,099,596,496,896	92		
9,903,520,314,283,042,199,192,993,792	93		
19,807,040,628,566,084,398,385,987,584	94		
39,614,081,257,132,168,796,771,975,168	95		
79,228,162,514,264,337,593,543,950,336	96		
158,456,325,028,528,675,187,087,900,672	97		
316,912,650,057,057,350,374,175,801,344	98		
633,825,300,114,114,700,748,351,602,688	99		
1,267,650,600,228,229,401,496,703,205,376	100		
2,535,301,200,456,458,802,993,406,410,752	101		
5,070,602,400,912,917,605,986,812,821,504	102		
10,141,204,801,825,835,211,973,625,643,008	103		
20,282,409,603,651,670,423,947,251,286,016	104		
40,564,819,207,303,340,847,894,502,572,032	105		
81,129,638,414,606,681,695,789,005,144,064	106		
162,259,276,829,213,363,391,578,010,288,128	107		
324,518,553,658,426,726,783,156,020,576,256	108		
649,037,107,316,853,453,566,312,041,152,512	109		
1,298,074,214,633,706,907,132,624,082,305,024	110		
2,596,148,429,267,413,814,265,248,164,610,048	111		
5,192,296,858,534,827,628,530,496,329,220,096	112		
10,384,593,717,069,655,257,060,992,658,440,192	113		
20,769,187,434,139,310,514,121,985,316,880,384	114		
41,538,374,868,278,621,028,243,970,633,760,768	115		
83,076,749,736,557,242,056,487,941,267,521,536	116		
166,153,499,473,114,484,112,975,882,535,043,072	117		
332,306,998,946,228,968,225,951,765,070,086,144	118		
664,613,997,892,457,936,451,903,530,140,172,288	119		
1,329,227,995,784,915,872,903,807,060,280,344,576	120		
2,658,455,991,569,831,745,807,614,120,560,689,152	121		
5,316,911,983,139,663,491,615,228,241,121,378,304	122		
10,633,823,966,279,326,983,230,456,482,242,756,608	123		
21,267,647,932,558,653,966,460,912,964,485,513,216	124		
42,535,295,865,117,307,932,921,825,928,971,026,432	125		
85,070,591,730,234,615,865,843,651,857,942,052,864	126		
170,141,183,460,469,231,731,687,303,715,884,105,728	127		
340,282,366,920,938,463,463,374,607,431,768,211,456	128		

Figure G-1. Powers of 2

Appendix H. Hexadecimal Tables

The following tables aid in converting hexadecimal values to decimal values, or the reverse.

Hexadecimal
000 to FFF

Decimal
0000 to 4095

Direct Conversion Table

This table provides direct conversion of decimal and hexadecimal numbers in these ranges:

To convert numbers outside these ranges, and to convert fractions, use the hexadecimal and decimal conversion tables that follow the direct conversion table in this appendix.

	0	1	2	3	4	5	6	7	8	9	A	B	C	D	E	F
00_	0000	0001	0002	0003	0004	0005	0006	0007	0008	0009	0010	0011	0012	0013	0014	0015
01_	0016	0017	0018	0019	0020	0021	0022	0023	0024	0025	0026	0027	0028	0029	0030	0031
02_	0032	0033	0034	0035	0036	0037	0038	0039	0040	0041	0042	0043	0044	0045	0046	0047
03_	0048	0049	0050	0051	0052	0053	0054	0055	0056	0057	0058	0059	0060	0061	0062	0063
04_	0064	0065	0066	0067	0068	0069	0070	0071	0072	0073	0074	0075	0076	0077	0078	0079
05_	0080	0081	0082	0083	0084	0085	0086	0087	0088	0089	0090	0091	0092	0093	0094	0095
06_	0096	0097	0098	0099	0100	0101	0102	0103	0104	0105	0106	0107	0108	0109	0110	0111
07_	0112	0113	0114	0115	0116	0117	0118	0119	0120	0121	0122	0123	0124	0125	0126	0127
08_	0128	0129	0130	0131	0132	0133	0134	0135	0136	0137	0138	0139	0140	0141	0142	0143
09_	0144	0145	0146	0147	0148	0149	0150	0151	0152	0153	0154	0155	0156	0157	0158	0159
0A_	0160	0161	0162	0163	0164	0165	0166	0167	0168	0169	0170	0171	0172	0173	0174	0175
0B_	0176	0177	0178	0179	0180	0181	0182	0183	0184	0185	0186	0187	0188	0189	0190	0191
0C_	0192	0193	0194	0195	0196	0197	0198	0199	0200	0201	0202	0203	0204	0205	0206	0207
0D_	0208	0209	0210	0211	0212	0213	0214	0215	0216	0217	0218	0219	0220	0221	0222	0223
0E_	0224	0225	0226	0227	0228	0229	0230	0231	0232	0233	0234	0235	0236	0237	0238	0239
0F_	0240	0241	0242	0243	0244	0245	0246	0247	0248	0249	0250	0251	0252	0253	0254	0255
10_	0256	0257	0258	0259	0260	0261	0262	0263	0264	0265	0266	0267	0268	0269	0270	0271
11_	0272	0273	0274	0275	0276	0277	0278	0279	0280	0281	0282	0283	0284	0285	0286	0287
12_	0288	0289	0290	0291	0292	0293	0294	0295	0296	0297	0298	0299	0300	0301	0302	0303
13_	0304	0305	0306	0307	0308	0309	0310	0311	0312	0313	0314	0315	0316	0317	0318	0319
14_	0320	0321	0322	0323	0324	0325	0326	0327	0328	0329	0330	0331	0332	0333	0334	0335
15_	0336	0337	0338	0339	0340	0341	0342	0343	0344	0345	0346	0347	0348	0349	0350	0351
16_	0352	0353	0354	0355	0356	0357	0358	0359	0360	0361	0362	0363	0364	0365	0366	0367
17_	0368	0369	0370	0371	0372	0373	0374	0375	0376	0377	0378	0379	0380	0381	0382	0383
18_	0384	0385	0386	0387	0388	0389	0390	0391	0392	0393	0394	0395	0396	0397	0398	0399
19_	0400	0401	0402	0403	0404	0405	0406	0407	0408	0409	0410	0411	0412	0413	0414	0415
1A_	0416	0417	0418	0419	0420	0421	0422	0423	0424	0425	0426	0427	0428	0429	0430	0431
1B_	0432	0433	0434	0435	0436	0437	0438	0439	0440	0441	0442	0443	0444	0445	0446	0447
1C_	0448	0449	0450	0451	0452	0453	0454	0455	0456	0457	0458	0459	0460	0461	0462	0463
1D_	0464	0465	0466	0467	0468	0469	0470	0471	0472	0473	0474	0475	0476	0477	0478	0479
1E_	0480	0481	0482	0483	0484	0485	0486	0487	0488	0489	0490	0491	0492	0493	0494	0495
1F_	0496	0497	0498	0499	0500	0501	0502	0503	0504	0505	0506	0507	0508	0509	0510	0511
20_	0512	0513	0514	0515	0516	0517	0518	0519	0520	0521	0522	0523	0524	0525	0526	0527
21_	0528	0529	0530	0531	0532	0533	0534	0535	0536	0537	0538	0539	0540	0541	0542	0543
22_	0544	0545	0546	0547	0548	0549	0550	0551	0552	0553	0554	0555	0556	0557	0558	0559
23_	0560	0561	0562	0563	0564	0565	0566	0567	0568	0569	0570	0571	0572	0573	0574	0575
24_	0576	0577	0578	0579	0580	0581	0582	0583	0584	0585	0586	0587	0588	0589	0590	0591
25_	0592	0593	0594	0595	0596	0597	0598	0599	0600	0601	0602	0603	0604	0605	0606	0607
26_	0608	0609	0610	0611	0612	0613	0614	0615	0616	0617	0618	0619	0620	0621	0622	0623
27_	0624	0625	0626	0627	0628	0629	0630	0631	0632	0633	0634	0635	0636	0637	0638	0639
28_	0640	0641	0642	0643	0644	0645	0646	0647	0648	0649	0650	0651	0652	0653	0654	0655
29_	0656	0657	0658	0659	0660	0661	0662	0663	0664	0665	0666	0667	0668	0669	0670	0671
2A_	0672	0673	0674	0675	0676	0677	0678	0679	0680	0681	0682	0683	0684	0685	0686	0687
2B_	0688	0689	0690	0691	0692	0693	0694	0695	0696	0697	0698	0699	0700	0701	0702	0703
2C_	0704	0705	0706	0707	0708	0709	0710	0711	0712	0713	0714	0715	0716	0717	0718	0719
2D_	0720	0721	0722	0723	0724	0725	0726	0727	0728	0729	0730	0731	0732	0733	0734	0735
2E_	0736	0737	0738	0739	0740	0741	0742	0743	0744	0745	0746	0747	0748	0749	0750	0751
2F_	0752	0753	0754	0755	0756	0757	0758	0759	0760	0761	0762	0763	0764	0765	0766	0767
30_	0768	0769	0770	0771	0772	0773	0774	0775	0776	0777	0778	0779	0780	0781	0782	0783
31_	0784	0785	0786	0787	0788	0789	0790	0791	0792	0793	0794	0795	0796	0797	0798	0799
32_	0800	0801	0802	0803	0804	0805	0806	0807	0808	0809	0810	0811	0812	0813	0814	0815
33_	0816	0817	0818	0819	0820	0821	0822	0823	0824	0825	0826	0827	0828	0829	0830	0831
34_	0832	0833	0834	0835	0836	0837	0838	0839	0840	0841	0842	0843	0844	0845	0846	0847
35_	0848	0849	0850	0851	0852	0853	0854	0855	0856	0857	0858	0859	0860	0861	0862	0863
36_	0864	0865	0866	0867	0868	0869	0870	0871	0872	0873	0874	0875	0876	0877	0878	0879
37_	0880	0881	0882	0883	0884	0885	0886	0887	0888	0889	0890	0891	0892	0893	0894	0895
38_	0896	0897	0898	0899	0900	0901	0902	0903	0904	0905	0906	0907	0908	0909	0910	0911
39_	0912	0913	0914	0915	0916	0917	0918	0919	0920	0921	0922	0923	0924	0925	0926	0927
3A_	0928	0929	0930	0931	0932	0933	0934	0935	0936	0937	0938	0939	0940	0941	0942	0943
3B_	0944	0945	0946	0947	0948	0949	0950	0951	0952	0953	0954	0955	0956	0957	0958	0959
3C_	0960	0961	0962	0963	0964	0965	0966	0967	0968	0969	0970	0971	0972	0973	0974	0975
3D_	0976	0977	0978	0979	0980	0981	0982	0983	0984	0985	0986	0987	0988	0989	0990	0991
3E_	0992	0993	0994	0995	0996	0997	0998	0999	1000	1001	1002	1003	1004	1005	1006	1007
3F_	1008	1009	1010	1011	1012	1013	1014	1015	1016	1017	1018	1019	1020	1021	1022	1023

	0	1	2	3	4	5	6	7	8	9	A	B	C	D	E	F
40_	1024	1025	1026	1027	1028	1029	1030	1031	1032	1033	1034	1035	1036	1037	1038	1039
41_	1040	1041	1042	1043	1044	1045	1046	1047	1048	1049	1050	1051	1052	1053	1054	1055
42_	1056	1057	1058	1059	1060	1061	1062	1063	1064	1065	1066	1067	1068	1069	1070	1071
43_	1072	1073	1074	1075	1076	1077	1078	1079	1080	1081	1082	1083	1084	1085	1086	1087
44_	1088	1089	1090	1091	1092	1093	1094	1095	1096	1097	1098	1099	1100	1101	1102	1103
45_	1104	1105	1106	1107	1108	1109	1110	1111	1112	1113	1114	1115	1116	1117	1118	1119
46_	1120	1121	1122	1123	1124	1125	1126	1127	1128	1129	1130	1131	1132	1133	1134	1135
47_	1136	1137	1138	1139	1140	1141	1142	1143	1144	1145	1146	1147	1148	1149	1150	1151
48_	1152	1153	1154	1155	1156	1157	1158	1159	1160	1161	1162	1163	1164	1165	1166	1167
49_	1168	1169	1170	1171	1172	1173	1174	1175	1176	1177	1178	1179	1180	1181	1182	1183
4A_	1184	1185	1186	1187	1188	1189	1190	1191	1192	1193	1194	1195	1196	1197	1198	1199
4B_	1200	1201	1202	1203	1204	1205	1206	1207	1208	1209	1210	1211	1212	1213	1214	1215
4C_	1216	1217	1218	1219	1220	1221	1222	1223	1224	1225	1226	1227	1228	1229	1230	1231
4D_	1232	1233	1234	1235	1236	1237	1238	1239	1240	1241	1242	1243	1244	1245	1246	1247
4E_	1248	1249	1250	1251	1252	1253	1254	1255	1256	1257	1258	1259	1260	1261	1262	1263
4F_	1264	1265	1266	1267	1268	1269	1270	1271	1272	1273	1274	1275	1276	1277	1278	1279
50_	1280	1281	1282	1283	1284	1285	1286	1287	1288	1289	1290	1291	1292	1293	1294	1295
51_	1296	1297	1298	1299	1300	1301	1302	1303	1304	1305	1306	1307	1308	1309	1310	1311
52_	1312	1313	1314	1315	1316	1317	1318	1319	1320	1321	1322	1323	1324	1325	1326	1327
53_	1328	1329	1330	1331	1332	1333	1334	1335	1336	1337	1338	1339	1340	1341	1342	1343
54_	1344	1345	1346	1347	1348	1349	1350	1351	1352	1353	1354	1355	1356	1357	1358	1359
55_	1360	1361	1362	1363	1364	1365	1366	1367	1368	1369	1370	1371	1372	1373	1374	1375
56_	1376	1377	1378	1379	1380	1381	1382	1383	1384	1385	1386	1387	1388	1389	1390	1391
57_	1392	1393	1394	1395	1396	1397	1398	1399	1400	1401	1402	1403	1404	1405	1406	1407
58_	1408	1409	1410	1411	1412	1413	1414	1415	1416	1417	1418	1419	1420	1421	1422	1423
59_	1424	1425	1426	1427	1428	1429	1430	1431	1432	1433	1434	1435	1436	1437	1438	1439
5A_	1440	1441	1442	1443	1444	1445	1446	1447	1448	1449	1450	1451	1452	1453	1454	1455
5B_	1456	1457	1458	1459	1460	1461	1462	1463	1464	1465	1466	1467	1468	1469	1470	1471
5C_	1472	1473	1474	1475	1476	1477	1478	1479	1480	1481	1482	1483	1484	1485	1486	1487
5D_	1488	1489	1490	1491	1492	1493	1494	1495	1496	1497	1498	1499	1500	1501	1502	1503
5E_	1504	1505	1506	1507	1508	1509	1510	1511	1512	1513	1514	1515	1516	1517	1518	1519
5F_	1520	1521	1522	1523	1524	1525	1526	1527	1528	1529	1530	1531	1532	1533	1534	1535
60_	1536	1537	1538	1539	1540	1541	1542	1543	1544	1545	1546	1547	1548	1549	1550	1551
61_	1552	1553	1554	1555	1556	1557	1558	1559	1560	1561	1562	1563	1564	1565	1566	1567
62_	1568	1569	1570	1571	1572	1573	1574	1575	1576	1577	1578	1579	1580	1581	1582	1583
63_	1584	1585	1586	1587	1588	1589	1590	1591	1592	1593	1594	1595	1596	1597	1598	1599
64_	1600	1601	1602	1603	1604	1605	1606	1607	1608	1609	1610	1611	1612	1613	1614	1615
65_	1616	1617	1618	1619	1620	1621	1622	1623	1624	1625	1626	1627	1628	1629	1630	1631
66_	1632	1633	1634	1635	1636	1637	1638	1639	1640	1641	1642	1643	1644	1645	1646	1647
67_	1648	1649	1650	1651	1652	1653	1654	1655	1656	1657	1658	1659	1660	1661	1662	1663
68_	1664	1665	1666	1667	1668	1669	1670	1671	1672	1673	1674	1675	1676	1677	1678	1679
69_	1680	1681	1682	1683	1684	1685	1686	1687	1688	1689	1690	1691	1692	1693	1694	1695
6A_	1696	1697	1698	1699	1700	1701	1702	1703	1704	1705	1706	1707	1708	1709	1710	1711
6B_	1712	1713	1714	1715	1716	1717	1718	1719	1720	1721	1722	1723	1724	1725	1726	1727
6C_	1728	1729	1730	1731	1732	1733	1734	1735	1736	1737	1738	1739	1740	1741	1742	1743
6D_	1744	1745	1746	1747	1748	1749	1750	1751	1752	1753	1754	1755	1756	1757	1758	1759
6E_	1760	1761	1762	1763	1764	1765	1766	1767	1768	1769	1770	1771	1772	1773	1774	1775
6F_	1776	1777	1778	1779	1780	1781	1782	1783	1784	1785	1786	1787	1788	1789	1790	1791
70_	1792	1793	1794	1795	1796	1797	1798	1799	1800	1801	1802	1803	1804	1805	1806	1807
71_	1808	1809	1810	1811	1812	1813	1814	1815	1816	1817	1818	1819	1820	1821	1822	1823
72_	1824	1825	1826	1827	1828	1829	1830	1831	1832	1833	1834	1835	1836	1837	1838	1839
73_	1840	1841	1842	1843	1844	1845	1846	1847	1848	1849	1850	1851	1852	1853	1854	1855
74_	1856	1857	1858	1859	1860	1861	1862	1863	1864	1865	1866	1867	1868	1869	1870	1871
75_	1872	1873	1874	1875	1876	1877	1878	1879	1880	1881	1882	1883	1884	1885	1886	1887
76_	1888	1889	1890	1891	1892	1893	1894	1895	1896	1897	1898	1899	1900	1901	1902	1903
77_	1904	1905	1906	1907	1908	1909	1910	1911	1912	1913	1914	1915	1916	1917	1918	1919
78_	1920	1921	1922	1923	1924	1925	1926	1927	1928	1929	1930	1931	1932	1933	1934	1935
79_	1936	1937	1938	1939	1940	1941	1942	1943	1944	1945	1946	1947	1948	1949	1950	1951
7A_	1952	1953	1954	1955	1956	1957	1958	1959	1960	1961	1962	1963	1964	1965	1966	1967
7B_	1968	1969	1970	1971	1972	1973	1974	1975	1976	1977	1978	1979	1980	1981	1982	1983
7C_	1984	1985	1986	1987	1988	1989	1990	1991	1992	1993	1994	1995	1996	1997	1998	1999
7D_	2000	2001	2002	2003	2004	2005	2006	2007	2008	2009	2010	2011	2012	2013	2014	2015
7E_	2016	2017	2018	2019	2020	2021	2022	2023	2024	2025	2026	2027	2028	2029	2030	2031
7F_	2032	2033	2034	2035	2036	2037	2038	2039	2040	2041	2042	2043	2044	2045	2046	2047

	0	1	2	3	4	5	6	7	8	9	A	B	C	D	E	F
80_	2048	2049	2050	2051	2052	2053	2054	2055	2056	2057	2058	2059	2060	2061	2062	2063
81_	2064	2065	2066	2067	2068	2069	2070	2071	2072	2073	2074	2075	2076	2077	2078	2079
82_	2080	2081	2082	2083	2084	2085	2086	2087	2088	2089	2090	2091	2092	2093	2094	2095
83_	2096	2097	2098	2099	2100	2101	2102	2103	2104	2105	2106	2107	2108	2109	2110	2111
84_	2112	2113	2114	2115	2116	2117	2118	2119	2120	2121	2122	2123	2124	2125	2126	2127
85_	2128	2129	2130	2131	2132	2133	2134	2135	2136	2137	2138	2139	2140	2141	2142	2143
86_	2144	2145	2146	2147	2148	2149	2150	2151	2152	2153	2154	2155	2156	2157	2158	2159
87_	2160	2161	2162	2163	2164	2165	2166	2167	2168	2169	2170	2171	2172	2173	2174	2175
88_	2176	2177	2178	2179	2180	2181	2182	2183	2184	2185	2186	2187	2188	2189	2190	2191
89_	2192	2193	2194	2195	2196	2197	2198	2199	2200	2201	2202	2203	2204	2205	2206	2207
8A_	2208	2209	2210	2211	2212	2213	2214	2215	2216	2217	2218	2219	2220	2221	2222	2223
8B_	2224	2225	2226	2227	2228	2229	2230	2231	2232	2233	2234	2235	2236	2237	2238	2239
8C_	2240	2241	2242	2243	2244	2245	2246	2247	2248	2249	2250	2251	2252	2253	2254	2255
8D_	2256	2257	2258	2259	2260	2261	2262	2263	2264	2265	2266	2267	2268	2269	2270	2271
8E_	2272	2273	2274	2275	2276	2277	2278	2279	2280	2281	2282	2283	2284	2285	2286	2287
8F_	2288	2289	2290	2291	2292	2293	2294	2295	2296	2297	2298	2299	2300	2301	2302	2303
90_	2304	2305	2306	2307	2308	2309	2310	2311	2312	2313	2314	2315	2316	2317	2318	2319
91_	2320	2321	2322	2323	2324	2325	2326	2327	2328	2329	2330	2331	2332	2333	2334	2335
92_	2336	2337	2338	2339	2340	2341	2342	2343	2344	2345	2346	2347	2348	2349	2350	2351
93_	2352	2353	2354	2355	2356	2357	2358	2359	2360	2361	2362	2363	2364	2365	2366	2367
94_	2368	2369	2370	2371	2372	2373	2374	2375	2376	2377	2378	2379	2380	2381	2382	2383
95_	2384	2385	2386	2387	2388	2389	2390	2391	2392	2393	2394	2395	2396	2397	2398	2399
96_	2400	2401	2402	2403	2404	2405	2406	2407	2408	2409	2410	2411	2412	2413	2414	2415
97_	2416	2417	2418	2419	2420	2421	2422	2423	2424	2425	2426	2427	2428	2429	2430	2431
98_	2432	2433	2434	2435	2436	2437	2438	2439	2440	2441	2442	2443	2444	2445	2446	2447
99_	2448	2449	2450	2451	2452	2453	2454	2455	2456	2457	2458	2459	2460	2461	2462	2463
9A_	2464	2465	2466	2467	2468	2469	2470	2471	2472	2473	2474	2475	2476	2477	2478	2479
9B_	2480	2481	2482	2483	2484	2485	2486	2487	2488	2489	2490	2491	2492	2493	2494	2495
9C_	2496	2497	2498	2499	2500	2501	2502	2503	2504	2505	2506	2507	2508	2509	2510	2511
9D_	2512	2513	2514	2515	2516	2517	2518	2519	2520	2521	2522	2523	2524	2525	2526	2527
9E_	2528	2529	2530	2531	2532	2533	2534	2535	2536	2537	2538	2539	2540	2541	2542	2543
9F_	2544	2545	2546	2547	2548	2549	2550	2551	2552	2553	2554	2555	2556	2557	2558	2559
A0_	2560	2561	2562	2563	2564	2565	2566	2567	2568	2569	2570	2571	2572	2573	2574	2575
A1_	2576	2577	2578	2579	2580	2581	2582	2583	2584	2585	2586	2587	2588	2589	2590	2591
A2_	2592	2593	2594	2595	2596	2597	2598	2599	2600	2601	2602	2603	2604	2605	2606	2607
A3_	2608	2609	2610	2611	2612	2613	2614	2615	2616	2617	2618	2619	2620	2621	2622	2623
A4_	2624	2625	2626	2627	2628	2629	2630	2631	2632	2633	2634	2635	2636	2637	2638	2639
A5_	2640	2641	2642	2643	2644	2645	2646	2647	2648	2649	2650	2651	2652	2653	2654	2655
A6_	2656	2657	2658	2659	2660	2661	2662	2663	2664	2665	2666	2667	2668	2669	2670	2671
A7_	2672	2673	2674	2675	2676	2677	2678	2679	2680	2681	2682	2683	2684	2685	2686	2687
A8_	2688	2689	2690	2691	2692	2693	2694	2695	2696	2697	2698	2699	2700	2701	2702	2703
A9_	2704	2705	2706	2707	2708	2709	2710	2711	2712	2713	2714	2715	2716	2717	2718	2719
AA_	2720	2721	2722	2723	2724	2725	2726	2727	2728	2729	2730	2731	2732	2733	2734	2735
AB_	2736	2737	2738	2739	2740	2741	2742	2743	2744	2745	2746	2747	2748	2749	2750	2751
AC_	2752	2753	2754	2755	2756	2757	2758	2759	2760	2761	2762	2763	2764	2765	2766	2767
AD_	2768	2769	2770	2771	2772	2773	2774	2775	2776	2777	2778	2779	2780	2781	2782	2783
AE_	2784	2785	2786	2787	2788	2789	2790	2791	2792	2793	2794	2795	2796	2797	2798	2799
AF_	2800	2801	2802	2803	2804	2805	2806	2807	2808	2809	2810	2811	2812	2813	2814	2815
B0_	2816	2817	2818	2819	2820	2821	2822	2823	2824	2825	2826	2827	2828	2829	2830	2831
B1_	2832	2833	2834	2835	2836	2837	2838	2839	2840	2841	2842	2843	2844	2845	2846	2847
B2_	2848	2849	2850	2851	2852	2853	2854	2855	2856	2857	2858	2859	2860	2861	2862	2863
B3_	2864	2865	2866	2867	2868	2869	2870	2871	2872	2873	2874	2875	2876	2877	2878	2879
B4_	2880	2881	2882	2883	2884	2885	2886	2887	2888	2889	2890	2891	2892	2893	2894	2895
B5_	2896	2897	2898	2899	2900	2901	2902	2903	2904	2905	2906	2907	2908	2909	2910	2911
B6_	2912	2913	2914	2915	2916	2917	2918	2919	2920	2921	2922	2923	2924	2925	2926	2927
B7_	2928	2929	2930	2931	2932	2933	2934	2935	2936	2937	2938	2939	2940	2941	2942	2943
B8_	2944	2945	2946	2947	2948	2949	2950	2951	2952	2953	2954	2955	2956	2957	2958	2959
B9_	2960	2961	2962	2963	2964	2965	2966	2967	2968	2969	2970	2971	2972	2973	2974	2975
BA_	2976	2977	2978	2979	2980	2981	2982	2983	2984	2985	2986	2987	2988	2989	2990	2991
BB_	2992	2993	2994	2995	2996	2997	2998	2999	3000	3001	3002	3003	3004	3005	3006	3007
BC_	3008	3009	3010	3011	3012	3013	3014	3015	3016	3017	3018	3019	3020	3021	3022	3023
BD_	3024	3025	3026	3027	3028	3029	3030	3031	3032	3033	3034	3035	3036	3037	3038	3039
BE_	3040	3041	3042	3043	3044	3045	3046	3047	3048	3049	3050	3051	3052	3053	3054	3055
BF_	3056	3057	3058	3059	3060	3061	3062	3063	3064	3065	3066	3067	3068	3069	3070	3071

	0	1	2	3	4	5	6	7	8	9	A	B	C	D	E	F
C0_	3072	3073	3074	3075	3076	3077	3078	3079	3080	3081	3082	3083	3084	3085	3086	3087
C1_	3088	3089	3090	3091	3092	3093	3094	3095	3096	3097	3098	3099	3100	3101	3102	3103
C2_	3104	3105	3106	3107	3108	3109	3110	3111	3112	3113	3114	3115	3116	3117	3118	3119
C3_	3120	3121	3122	3123	3124	3125	3126	3127	3128	3129	3130	3131	3132	3133	3134	3135
C4_	3136	3137	3138	3139	3140	3141	3142	3143	3144	3145	3146	3147	3148	3149	3150	3151
C5_	3152	3153	3154	3155	3156	3157	3158	3159	3160	3161	3162	3163	3164	3165	3166	3167
C6_	3168	3169	3170	3171	3172	3173	3174	3175	3176	3177	3178	3179	3180	3181	3182	3183
C7_	3184	3185	3186	3187	3188	3189	3190	3191	3192	3193	3194	3195	3196	3197	3198	3199
C8_	3200	3201	3202	3203	3204	3205	3206	3207	3208	3209	3210	3211	3212	3213	3214	3215
C9_	3216	3217	3218	3219	3220	3221	3222	3223	3224	3225	3226	3227	3228	3229	3230	3231
CA_	3232	3233	3234	3235	3236	3237	3238	3239	3240	3241	3242	3243	3244	3245	3246	3247
CB_	3248	3249	3250	3251	3252	3253	3254	3255	3256	3257	3258	3259	3260	3261	3262	3263
CC_	3264	3265	3266	3267	3268	3269	3270	3271	3272	3273	3274	3275	3276	3277	3278	3279
CD_	3280	3281	3282	3283	3284	3285	3286	3287	3288	3289	3290	3291	3292	3293	3294	3295
CE_	3296	3297	3298	3299	3300	3301	3302	3303	3304	3305	3306	3307	3308	3309	3310	3311
CF_	3312	3313	3314	3315	3316	3317	3318	3319	3320	3321	3322	3323	3324	3325	3326	3327
D0_	3328	3329	3330	3331	3332	3333	3334	3335	3336	3337	3338	3339	3340	3341	3342	3343
D1_	3344	3345	3346	3347	3348	3349	3350	3351	3352	3353	3354	3355	3356	3357	3358	3359
D2_	3360	3361	3362	3363	3364	3365	3366	3367	3368	3369	3370	3371	3372	3373	3374	3375
D3_	3376	3377	3378	3379	3380	3381	3382	3383	3384	3385	3386	3387	3388	3389	3390	3391
D4_	3392	3393	3394	3395	3396	3397	3398	3399	3400	3401	3402	3403	3404	3405	3406	3407
D5_	3408	3409	3410	3411	3412	3413	3414	3415	3416	3417	3418	3419	3420	3421	3422	3423
D6_	3424	3425	3426	3427	3428	3429	3430	3431	3432	3433	3434	3435	3436	3437	3438	3439
D7_	3440	3441	3442	3443	3444	3445	3446	3447	3448	3449	3450	3451	3452	3453	3454	3455
D8_	3456	3457	3458	3459	3460	3461	3462	3463	3464	3465	3466	3467	3468	3469	3470	3471
D9_	3472	3473	3474	3475	3476	3477	3478	3479	3480	3481	3482	3483	3484	3485	3486	3487
DA_	3488	3489	3490	3491	3492	3493	3494	3495	3496	3497	3498	3499	3500	3501	3502	3503
DB_	3504	3505	3506	3507	3508	3509	3510	3511	3512	3513	3514	3515	3516	3517	3518	3519
DC_	3520	3521	3522	3523	3524	3525	3526	3527	3528	3529	3530	3531	3532	3533	3534	3535
DD_	3536	3537	3538	3539	3540	3541	3542	3543	3544	3545	3546	3547	3548	3549	3550	3551
DE_	3552	3553	3554	3555	3556	3557	3558	3559	3560	3561	3562	3563	3564	3565	3566	3567
DF_	3568	3569	3570	3571	3572	3573	3574	3575	3576	3577	3578	3579	3580	3581	3582	3583
E0_	3584	3585	3586	3587	3588	3589	3590	3591	3592	3593	3594	3595	3596	3597	3598	3599
E1_	3600	3601	3602	3603	3604	3605	3606	3607	3608	3609	3610	3611	3612	3613	3614	3615
E2_	3616	3617	3618	3619	3620	3621	3622	3623	3624	3625	3626	3627	3628	3629	3630	3631
E3_	3632	3633	3634	3635	3636	3637	3638	3639	3640	3641	3642	3643	3644	3645	3646	3647
E4_	3648	3649	3650	3651	3652	3653	3654	3655	3656	3657	3658	3659	3660	3661	3662	3663
E5_	3664	3665	3666	3667	3668	3669	3670	3671	3672	3673	3674	3675	3676	3677	3678	3679
E6_	3680	3681	3682	3683	3684	3685	3686	3687	3688	3689	3690	3691	3692	3693	3694	3695
E7_	3696	3697	3698	3699	3700	3701	3702	3703	3704	3705	3706	3707	3708	3709	3710	3711
E8_	3712	3713	3714	3715	3716	3717	3718	3719	3720	3721	3722	3723	3724	3725	3726	3727
E9_	3728	3729	3730	3731	3732	3733	3734	3735	3736	3737	3738	3739	3740	3741	3742	3743
EA_	3744	3745	3746	3747	3748	3749	3750	3751	3752	3753	3754	3755	3756	3757	3758	3759
EB_	3760	3761	3762	3763	3764	3765	3766	3767	3768	3769	3770	3771	3772	3773	3774	3775
EC_	3776	3777	3778	3779	3780	3781	3782	3783	3784	3785	3786	3787	3788	3789	3790	3791
ED_	3792	3793	3794	3795	3796	3797	3798	3799	3800	3801	3802	3803	3804	3805	3806	3807
EE_	3808	3809	3810	3811	3812	3813	3814	3815	3816	3817	3818	3819	3820	3821	3822	3823
EF_	3824	3825	3826	3827	3828	3829	3830	3831	3832	3833	3834	3835	3836	3837	3838	3839
F0_	3840	3841	3842	3843	3844	3845	3846	3847	3848	3849	3850	3851	3852	3853	3854	3855
F1_	3856	3857	3858	3859	3860	3861	3862	3863	3864	3865	3866	3867	3868	3869	3870	3871
F2_	3872	3873	3874	3875	3876	3877	3878	3879	3880	3881	3882	3883	3884	3885	3886	3887
F3_	3888	3889	3890	3891	3892	3893	3894	3895	3896	3897	3898	3899	3900	3901	3902	3903
F4_	3904	3905	3906	3907	3908	3909	3910	3911	3912	3913	3914	3915	3916	3917	3918	3919
F5_	3920	3921	3922	3923	3924	3925	3926	3927	3928	3929	3930	3931	3932	3933	3934	3935
F6_	3936	3937	3938	3939	3940	3941	3942	3943	3944	3945	3946	3947	3948	3949	3950	3951
F7_	3952	3953	3954	3955	3956	3957	3958	3959	3960	3961	3962	3963	3964	3965	3966	3967
F8_	3968	3969	3970	3971	3972	3973	3974	3975	3976	3977	3978	3979	3980	3981	3982	3983
F9_	3984	3985	3986	3987	3988	3989	3990	3991	3992	3993	3994	3995	3996	3997	3998	3999
FA_	4000	4001	4002	4003	4004	4005	4006	4007	4008	4009	4010	4011	4012	4013	4014	4015
FB_	4016	4017	4018	4019	4020	4021	4022	4023	4024	4025	4026	4027	4028	4029	4030	4031
FC_	4032	4033	4034	4035	4036	4037	4038	4039	4040	4041	4042	4043	4044	4045	4046	4047
FD_	4048	4049	4050	4051	4052	4053	4054	4055	4056	4057	4058	4059	4060	4061	4062	4063
FE_	4064	4065	4066	4067	4068	4069	4070	4071	4072	4073	4074	4075	4076	4077	4078	4079
FF_	4080	4081	4082	4083	4084	4085	4086	4087	4088	4089	4090	4091	4092	4093	4094	4095

Conversion Table: Hexadecimal and Decimal Integers

Hex	Decimal	Hex	Decimal	Hex	Decimal	Hex	Decimal	Hex	Decimal	Hex	Decimal	Hex	Decimal	Hex	Decimal
0	0	0	0	0	0	0	0	0	0	0	0	0	0	0	0
1	268,435,456	1	16,777,216	1	1,048,576	1	65,536	1	4,096	1	256	1	16	1	1
2	536,870,912	2	33,554,432	2	2,097,152	2	131,072	2	8,192	2	512	2	32	2	2
3	805,306,368	3	50,331,648	3	3,145,728	3	196,608	3	12,288	3	768	3	48	3	3
4	1,073,741,824	4	67,108,864	4	4,194,304	4	262,144	4	16,384	4	1,024	4	64	4	4
5	1,342,177,280	5	83,886,080	5	5,242,880	5	327,680	5	20,480	5	1,280	5	80	5	5
6	1,610,612,736	6	100,663,296	6	6,291,456	6	393,216	6	24,576	6	1,536	6	96	6	6
7	1,879,048,192	7	117,440,512	7	7,340,032	7	458,752	7	28,672	7	1,792	7	112	7	7
8	2,147,483,648	8	134,217,728	8	8,388,608	8	524,288	8	32,768	8	2,048	8	128	8	8
9	2,415,919,104	9	150,994,944	9	9,437,184	9	589,824	9	36,864	9	2,304	9	144	9	9
A	2,684,354,560	A	167,772,160	A	10,485,760	A	655,360	A	40,960	A	2,560	A	160	A	10
B	2,952,790,016	B	184,549,376	B	11,534,336	B	720,896	B	45,056	B	2,816	B	176	B	11
C	3,221,225,472	C	201,326,592	C	12,582,912	C	786,432	C	49,152	C	3,072	C	192	C	12
D	3,489,660,928	D	218,103,808	D	13,631,488	D	851,968	D	53,248	D	3,328	D	208	D	13
E	3,758,096,384	E	234,881,024	E	14,680,064	E	917,504	E	57,344	E	3,584	E	224	E	14
F	4,026,531,840	F	251,658,240	F	15,728,640	F	983,040	F	61,440	F	3,840	F	240	F	15
8		7		6		5		4		3		2		1	

TO CONVERT HEXADECIMAL TO DECIMAL

1. Locate the column of the decimal numbers corresponding to the leftmost digit or letter of the hexadecimal; select from this column and record the number that corresponds to the position of the hexadecimal digit or letter.
2. Repeat step 1 for the next (second from the left) position.
3. Repeat step 1 for the units (third from the left) position.
4. Add the numbers selected from the table to form the decimal number.

EXAMPLE

Conversion of Hexadecimal Value	D34
1. D	3328
2. 3	48
3. 4	+ 4
4. Decimal	3380

To convert integer numbers greater than the capacity of the table, use the techniques below:

HEXADECIMAL TO DECIMAL

Successive cumulative multiplication from left to right, adding units position.

Example: $D34_{16} = 3380_{10}$

$$\begin{array}{r}
 D = 13 \\
 \times 16 \\
 \hline
 208 \\
 3 = + 3 \\
 \hline
 211 \\
 \times 16 \\
 \hline
 3376 \\
 4 = + 4 \\
 \hline
 3380
 \end{array}$$

TO CONVERT DECIMAL TO HEXADECIMAL

1. (a) Select from the table the highest decimal number that is equal to or less than the number to be converted.
(b) Record the hexadecimal of the column containing the selected number.
(c) Subtract the selected decimal from the number to be converted.
2. Using the remainder from step 1(c), repeat all of step 1 to develop the second position of the hexadecimal (and a remainder)
3. Using the remainder from step 2, repeat all of step 1 to develop the units position of the hexadecimal.
4. Combine the terms to form the hexadecimal number.

EXAMPLE

Conversion of Decimal Value	3380
1. D	-3328
	52
2. 3	- 48
	4
3. 4	- 4
4. Hexadecimal	D34

DECIMAL TO HEXADECIMAL

Divide and collect the remainder in reverse order

Example: $3380_{10} = X_{16}$

16 3380	→ 4	↑ Remainder
16 211	→ 3	
16 13	→ D	

$3380_{10} = D34_{16}$

POWERS OF 16 TABLE

Example: $268,435,456_{10} = (2.68435456 \times 10^8)_{10} = 1000\ 0000_{16} = (10^7)_{16}$

16^n	n
1	0
16	1
256	2
4 096	3
65 536	4
1 048 576	5
16 777 216	6
268 435 456	7

16^n	n
4 294 967 296	8
68 719 476 736	9
1 099 511 627 776	10 = A
17 592 186 044 416	11 = B
281 474 976 710 656	12 = C
4 503 599 627 370 496	13 = D
72 057 594 037 927 936	14 = E
1 152 921 504 606 846 976	15 = F
← Decimal Values	→

Conversion Table: Hexadecimal and Decimal Fractions

HALFWORD														
BYTE						BYTE								
Bits 0123		4567				0123				4567				
Hex	Decimal	Hex	Decimal			Hex	Decimal			Hex	Decimal Equivalent			
.0	.0000	.00	.0000	0000	0000	.000	.0000	0000	0000	.0000	.0000	0000	0000	0000
.1	.0625	.01	.0039	0625	0000	.001	.0002	4414	0625	.0001	.0000	1525	8789	0625
.2	.1250	.02	.0078	1250	0000	.002	.0004	8828	1250	.0002	.0000	3051	7578	1250
.3	.1875	.03	.0117	1875	0000	.003	.0007	3242	1875	.0003	.0000	4577	6367	1875
.4	.2500	.04	.0156	2500	0000	.004	.0009	7656	2500	.0004	.0000	6103	5156	2500
.5	.3125	.05	.0195	3125	0000	.005	.0012	2070	3125	.0005	.0000	7629	3945	3125
.6	.3750	.06	.0234	3750	0000	.006	.0014	6484	3750	.0006	.0000	9155	2734	3750
.7	.4375	.07	.0273	4375	0000	.007	.0017	0898	4375	.0007	.0001	0681	1523	4375
.8	.5000	.08	.0312	5000	0000	.008	.0019	5312	5000	.0008	.0001	2207	0312	5000
.9	.5625	.09	.0351	5625	0000	.009	.0021	9726	5625	.0009	.0001	3732	9101	5625
.A	.6250	.0A	.0390	6250	0000	.00A	.0024	4140	6250	.000A	.0001	5258	7890	6250
.B	.6875	.0B	.0429	6875	0000	.00B	.0026	8554	6875	.000B	.0001	6784	6679	6875
.C	.7500	.0C	.0468	7500	0000	.00C	.0029	2968	7500	.000C	.0001	8310	5468	7500
.D	.8125	.0D	.0507	8125	0000	.00D	.0031	7382	8125	.000D	.0001	9836	4257	8125
.E	.8750	.0E	.0546	8750	0000	.00E	.0034	1796	8750	.000E	.0002	1362	3046	8750
.F	.9375	.0F	.0585	9375	0000	.00F	.0036	6210	9375	.000F	.0002	2888	1835	9375
1		2				3				4				

TO CONVERT .ABC HEXADECIMAL TO DECIMAL

Find .A in position 1 .6250
 Find .0B in position 2 .0429 6825
 Find .00C in position 3 + .0029 2968 7500
 .ABC is equal to .6708 9843 7500

TO CONVERT .13 DECIMAL TO HEXADECIMAL

- Find .1250 next lowest to subtract

$$\begin{array}{r} .1300 \\ - .1250 \\ \hline \end{array} = .2 \text{ Hex}$$
- Find .0039 0625 next lowest to subtract

$$\begin{array}{r} .0050 \ 0000 \\ - .0039 \ 0625 \\ \hline \end{array} = .01$$
- Find .0009 7656 2500

$$\begin{array}{r} .0010 \ 9375 \ 0000 \\ - .0009 \ 7656 \ 2500 \\ \hline \end{array} = .004$$
- Find .0001 0681 1523 4375

$$\begin{array}{r} .0001 \ 1718 \ 7500 \ 0000 \\ - .0001 \ 0681 \ 1523 \ 4375 \\ \hline \end{array} = .0007$$

$$\begin{array}{r} .0000 \ 1037 \ 5976 \ 5625 \\ \hline \end{array} = .2147 \text{ Hex}$$
- .13 Decimal is approximately equal to _____ ↑

To convert fractions beyond the capacity of the table, use techniques below:

HEXADECIMAL TO FRACTION DECIMAL

Convert the hexadecimal fraction to its decimal equivalent using the same technique as for integer numbers. Divide the results by 16^n (n is the number of fraction positions).

Example: $.8A7_{16} = .540771_{10}$
 $8A7_{16} = 2215_{10}$
 $16^3 = 4096$

$$\begin{array}{r} 2215.000000 \\ 4096 \overline{) 2215.000000} \\ \underline{4096} \\ 8054 \\ \underline{8192} \\ 162 \\ \underline{1624} \\ 80 \\ \underline{819} \\ 81 \\ \underline{819} \\ 0 \\ \underline{0} \\ 0 \\ \underline{0} \\ 0 \\ \underline{0} \\ 0 \end{array}$$

DECIMAL FRACTION TO HEXADECIMAL

Collect integer parts of product in the order of calculation.

Example: $.5408_{10} = .8A7_{16}$

$$\begin{array}{r} .5408 \\ \times 16 \\ \hline 8 \leftarrow 8 \ 6528 \\ \times 16 \\ \hline A \leftarrow 10 \ 4448 \\ \times 16 \\ \hline 7 \leftarrow 7 \ 1168 \end{array}$$

Hexadecimal Addition and Subtraction Table

Example: $6 + 2 = 8$, $8 - 2 = 6$, and $8 - 6 = 2$

	1	2	3	4	5	6	7	8	9	A	B	C	D	E	F
1	02	03	04	05	06	07	08	09	0A	0B	0C	0D	0E	0F	10
2	03	04	05	06	07	08	09	0A	0B	0C	0D	0E	0F	10	11
3	04	05	06	07	08	09	0A	0B	0C	0D	0E	0F	10	11	12
4	05	06	07	08	09	0A	0B	0C	0D	0E	0F	10	11	12	13
5	06	07	08	09	0A	0B	0C	0D	0E	0F	10	11	12	13	14
6	07	08	09	0A	0B	0C	0D	0E	0F	10	11	12	13	14	15
7	08	09	0A	0B	0C	0D	0E	0F	10	11	12	13	14	15	16
8	09	0A	0B	0C	0D	0E	0F	10	11	12	13	14	15	16	17
9	0A	0B	0C	0D	0E	0F	10	11	12	13	14	15	16	17	18
A	0B	0C	0D	0E	0F	10	11	12	13	14	15	16	17	18	19
B	0C	0D	0E	0F	10	11	12	13	14	15	16	17	18	19	1A
C	0D	0E	0F	10	11	12	13	14	15	16	17	18	19	1A	1B
D	0E	0F	10	11	12	13	14	15	16	17	18	19	1A	1B	1C
E	0F	10	11	12	13	14	15	16	17	18	19	1A	1B	1C	1D
F	10	11	12	13	14	15	16	17	18	19	1A	1B	1C	1D	1E

Hexadecimal Multiplication Table

Example: $2 \times 4 = 08$, $F \times 2 = 1E$

	1	2	3	4	5	6	7	8	9	A	B	C	D	E	F
1	01	02	03	04	05	06	07	08	09	0A	0B	0C	0D	0E	0F
2	02	04	06	08	0A	0C	0E	10	12	14	16	18	1A	1C	1E
3	03	06	09	0C	0F	12	15	18	1B	1E	21	24	27	2A	2D
4	04	08	0C	10	14	18	1C	20	24	28	2C	30	34	38	3C
5	05	0A	0F	14	19	1E	23	28	2D	32	37	3C	41	46	4B
6	06	0C	12	18	1E	24	2A	30	36	3C	42	48	4E	54	5A
7	07	0E	15	1C	23	2A	31	38	3F	46	4D	54	5B	62	69
8	08	10	18	20	28	30	38	40	48	50	58	60	68	70	78
9	09	12	1B	24	2D	36	3F	48	51	5A	63	6C	75	7E	87
A	0A	14	1E	28	32	3C	46	50	5A	64	6E	78	82	8C	96
B	0B	16	21	2C	37	42	4D	58	63	6E	79	84	8F	9A	A5
C	0C	18	24	30	3C	48	54	60	6C	78	84	90	9C	A8	B4
D	0D	1A	27	34	41	4E	5B	68	75	82	8F	9C	A9	B6	C3
E	0E	1C	2A	38	46	54	62	70	7E	8C	9A	A8	B6	C4	D2
F	0F	1E	2D	3C	4B	5A	69	78	87	96	A5	B4	C3	D2	E1

Appendix I. EBCDIC and ISO-8 Codes

Dec	Hex	EBCDIC-037	ISO-8
0	00	NUL	NUL
1	01	SOH	SOH
2	02	STX	STX
3	03	ETX	ETX
4	04	SEL	EOT
5	05	HT	ENQ
6	06	RNL	ACK
7	07	DEL	BEL
8	08	GE	BS
9	09	SPS	HT
10	0A	RPT	LF
11	0B	VT	VT
12	0C	FF	FF
13	0D	CR	CR
14	0E	SO	SO
15	0F	SI	SI
16	10	DLE	DLE
17	11	DC1	DC1
18	12	DC2	DC2
19	13	DC3	DC3
20	14	RES/ENP	DC4
21	15	NL	NAK
22	16	BS	SYN
23	17	POC	ETB
24	18	CAN	CAN
25	19	EM	EM
26	1A	UBS	SUB
27	1B	CU1	ESC
28	1C	IFS	IFS
29	1D	IGS	IGS
30	1E	IRS	IRS
31	1F	ITB/IUS	IUS
32	20	DS	SP
33	21	SOS	!
34	22	FS	"
35	23	WUS	#
36	24	BYP/INP	\$
37	25	LF	%
38	26	ETB	&
39	27	ESC	'
40	28	SA	(
41	29	SFE)
42	2A	SM/SW	*
43	2B	CSP	+
44	2C	MFA	,
45	2D	ENQ	.
46	2E	ACK	.
47	2F	BEL	/
48	30		0
49	31		1
50	32	SYN	2
51	33	IR	3
52	34	PP	4
53	35	TRN	5
54	36	NBS	6
55	37	EOT	7
56	38	SBS	8
57	39	IT	9
58	3A	RFF	:
59	3B	CU3	:
60	3C	DC4	<
61	3D	NAK	=
62	3E		>
63	3F	SUB	?

Dec	Hex	EBCDIC-037	ISO-8
64	40	SP	@
65	41	RSP	A
66	42	à	B
67	43	â	C
68	44	ä	D
69	45	á	E
70	46	ã	F
71	47	å	G
72	48	ç	H
73	49	ñ	I
74	4A	ç	J
75	4B	.	K
76	4C	<	L
77	4D	(M
78	4E	+	N
79	4F		O
80	50	&	P
81	51	é	Q
82	52	ê	R
83	53	ë	S
84	54	è	T
85	55	í	U
86	56	î	V
87	57	ï	W
88	58	ì	X
89	59	β	Y
90	5A	!	Z
91	5B	\$	[
92	5C	*	\
93	5D)]
94	5E	;	^
95	5F	¬	_
96	60	-	`
97	61	/	a
98	62	À	b
99	63	Ã	c
100	64	Ä	d
101	65	Å	e
102	66	Ä	f
103	67	Ä	g
104	68	Ç	h
105	69	Ñ	i
106	6A	!	j
107	6B	.	k
108	6C	%	l
109	6D	_	m
110	6E	>	n
111	6F	?	o
112	70	ø	p
113	71	É	q
114	72	Ê	r
115	73	Ë	s
116	74	Ë	t
117	75	Í	u
118	76	Î	v
119	77	Ï	w
120	78	Ì	x
121	79	'	y
122	7A	:	z
123	7B	#	{
124	7C	@	
125	7D	'	}
126	7E	=	~
127	7F	"	∏

Dec	Hex	EBCDIC-037	ISO-8
128	80	Ø	
129	81	a	
130	82	b	BPH
131	83	c	NBH
132	84	d	IND
133	85	e	NEL
134	86	f	SSA
135	87	g	ESA
136	88	h	HTS
137	89	i	HTJ
138	8A	«	VTS
139	8B	»	PLD
140	8C	ð	PLU
141	8D	ý	RI
142	8E	þ	SS2
143	8F	±	SS3
144	90	°	DCS
145	91	j	PU1
146	92	k	PU2
147	93	l	STS
148	94	m	CCH
149	95	n	MW
150	96	o	SPA
151	97	p	EPA
152	98	q	SOS
153	99	r	
154	9A	ª	SCI
155	9B	º	CSI
156	9C	æ	ST
157	9D	.	OSC
158	9E	Æ	PM
159	9F	□	APC
160	A0	μ	RSP
161	A1	~	ì
162	A2	s	ç
163	A3	t	£
164	A4	u	□
165	A5	v	¥
166	A6	w	!
167	A7	x	§
168	A8	y	~
169	A9	z	©
170	AA	¡	ª
171	AB	¿	«
172	AC	Ð	¬
173	AD	Ý	SHY
174	AE	þ	©
175	AF	®	~
176	B0	^	°
177	B1	£	±
178	B2	¥	²
179	B3	.	³
180	B4	©	~
181	B5	§	μ
182	B6	¶	¶
183	B7	¼	.
184	B8	½	.
185	B9	¾	.
186	BA	[º
187	BB]	»
188	BC	~	¼
189	BD	~	½
190	BE	'	¾
191	BF	x	¿

Dec	Hex	EBCDIC-037	ISO-8
192	C0	{	À
193	C1	A	Á
194	C2	B	Â
195	C3	C	Ã
196	C4	D	Ä
197	C5	E	Å
198	C6	F	Æ
199	C7	G	Ç
200	C8	H	È
201	C9	I	É
202	CA	SHY	Ê
203	CB	ð	Ë
204	CC	ð	Ì
205	CD	ð	Í
206	CE	ó	Î
207	CF	ð	Ï
208	D0	}	Ð
209	D1	J	Ñ
210	D2	K	Ò
211	D3	L	Ó
212	D4	M	Ô
213	D5	N	Õ
214	D6	O	Ö
215	D7	P	×
216	D8	Q	Ø
217	D9	R	Ù
218	DA	'	Ú
219	DB	ù	Û
220	DC	ü	Ü
221	DD	ù	Ý
222	DE	ú	Þ
223	DF	ÿ	ß
224	E0	\	à
225	E1	÷/NSP	á
226	E2	S	â
227	E3	T	ã
228	E4	U	ä
229	E5	V	å
230	E6	W	æ
231	E7	X	ç
232	E8	Y	è
233	E9	Z	é
234	EA	²	ê
235	EB	Ó	ë
236	EC	Ô	ì
237	ED	Õ	í
238	EE	Ö	î
239	EF	Õ	ï
240	F0	0	ð
241	F1	1	ñ
242	F2	2	ò
243	F3	3	ó
244	F4	4	ô
245	F5	5	õ
246	F6	6	ö
247	F7	7	÷
248	F8	8	ø
249	F9	9	ù
250	FA	ª	ú
251	FB	Û	û
252	FC	Ü	ü
253	FD	Ù	ý
254	FE	Ú	þ
255	FF	EO	ÿ

Control Character Representations

ACK	Acknowledge	ENQ	Enquiry	ITB	Intermediate Transmission Block	SEL	Select
BEL	Bell	EO	Eight Ones	IUS	International Unit Separator	SFE	Start Field Extended
BS	Backspace	EOT	End of Transmission	LF	Line Feed	SI	Shift In
BYP	Bypass	ESC	Escape	MFA	Modify Field Attribute	SM	Set Mode
CAN	Cancel	ETB	End of Transmission Block	NAK	Negative Acknowledge	SO	Shift Out
CR	Carriage Return	ETX	End of Text	NBS	Numeric Backspace	SOH	Start of Heading
CSP	Control Sequence Prefix	FF	Form Feed	NL	New Line	SOS	Start of Significance
CU1	Customer Use 1	FS	Field Separator	NUL	Null	SPS	Superscript
CU3	Customer Use 3	GE	Graphic Escape	POC	Program-Operator Communication	STX	Start of Text
DC1	Device Control 1	HTB	Horizontal Tab	PP	Presentation Position	SUB	Substitute
DC2	Device Control 2	IFS	Interchange File Separator	RES	Restore	SW	Switch
DC3	Device Control 3	IGS	Interchange Group Separator	RFF	Required Form Feed	SYN	Synchronous Idle
DC4	Device Control 4	INP	Inhibit Presentation	RNL	Required New Line	TRN	Transparent
DEL	Delete	IR	Index Return	RPT	Repeat	UBS	Unit Backspace
DLE	Data Link Escape	IRS	Interchange Record Separator	SA	Set Attribute	VT	Vertical Tab
DS	Digit Select	IT	Indent Tab	SBS	Subscript	WUS	Word Underscore
EM	End of Medium						
ENP	Enable Presentation						

Formatting Character Representations

NSP	Numeric Space	RSP	Required Space	SP	Space	SHY	Syllable Hyphen
-----	---------------	-----	----------------	----	-------	-----	-----------------

Additional ISO-8 Control Character Representations

APC	Application Program Command	HTJ	Character Tabulation with Justification	OSC	Operating System Command	SPA	Start of Guarded Area
BPH	Break Permitted Here	HTS	Character Tabulation Set	PLD	Partial Line Down	SSA	Start of Selected Area
CCH	Cancel Character	IFS	Information Separator Four	PLU	Partial Line Up	SS2	Single Shift Two
CSI	Control Sequence Introducer	IGS	Information Separator Three	PM	Privacy Message	SS3	Single Shift Three
DCS	Device Control String	IND	Index	PU1	Private Use One	ST	String Terminator
EPA	End of Guarded Area	IRS	Information Separator Two	PU2	Private Use Two	STS	Set Transmit State
ESA	End of Selected Area	MW	Message Waiting	RI	Reverse linefeed (or index)	US	Information Separator One
		NBH	No Break Here	SCI	Single Character Introducer	VTS	Line Tabulation Set
		NEL	Next Line	SOS	Start of String		

Note: The ISO-8 controls are from ISO 6429, and the graphics are from ISO 8859-1. The ISO-8 graphics are code page 00819, named ISO/ANSI Multilingual.

Index

Numerics

2K-IDAW control 15-28
370-XA architecture 1-34

A

A (ADD) binary instruction 7-26
abort
 transactional execution 5-89
aborted-transaction-instruction-address
 in the transaction diagnostic block 5-95
absolute address 3-4
absolute storage 3-4
access-control bits
 in segment-table entry 3-46, 3-49
access-control bits in storage key 3-9
access-exception-fetch/store-indication facility
 facility indication 4-101
access exceptions 6-47, 6-53
 priority of 6-53
 recognition of 6-47
access key 3-11
 for channel-program execution 3-11, 15-25,
 15-30
 for channel-subsystem monitoring 3-11
 for CPU 3-11
access list 5-56
 See also access-list entry
 accessing capability, revocation of 5-51
 allocation and invalidation of entries in 5-49
 authorizing the use of entries in 5-49
 concepts 5-47
 designation (ALD) 5-56
 length (ALL) 5-56
 origin (ALO) 5-56
access-list-controlled protection 3-13
 exception for 6-34
access-list designation 5-56
access-list entry (ALE) 5-56
 authorization index (ALEAX) 5-57
 number
 See ALEN
 sequence exception 6-22
 as an access exception 6-47
 sequence number (ALESN)
 in ALE 5-56
 in ALET 5-54
 token
 See ALET
access-register mode 3-40
access-register translation (ART) 5-53
 as part of LOAD REAL ADDRESS, STORE REAL
 ADDRESS, TEST ACCESS, and TEST
 PROTECTION 5-59
 introduction to 5-47
 lookaside buffer
 See ALB
 sequence of table fetches 5-119
access-register-translation (ART) tables 5-55
access registers 2-6
 designation of 5-46
 functions of 5-46
 instructions for use of 5-52
 machine-check save area for 3-87
 save areas for 3-83
 store-status save area for 3-87
 validity bit for 11-21
access to storage 5-113
 See also reference
active
 device 16-16, 16-36
 subchannel 16-16, 16-36
active allegiance 15-13
active communication 15-13
activity-control field (SCSW) 16-14, 16-36
 following TEST SUBCHANNEL 14-21
AD (ADD NORMALIZED) HFP instruction 18-8
 example A-41
adaptive dictionary 7-179
ADB (ADD) BFP instruction 19-15
ADBR (ADD) BFP instruction 19-15
ADD BFP instructions 19-15
ADD binary instructions 7-25
ADD DECIMAL instruction 8-6
 example A-36
ADD DFP instructions 20-19
ADD HALFWORD IMMEDIATE instruction 7-28
ADD HALFWORD instruction 7-27
 example A-8
ADD HIGH binary instructions 7-28
ADD IMMEDIATE binary instructions 7-26
ADD IMMEDIATE HIGH binary instructions 7-29
ADD LOGICAL HIGH binary instructions 7-30
ADD LOGICAL IMMEDIATE instructions 7-29
ADD LOGICAL instructions 7-29
ADD LOGICAL WITH CARRY instructions 7-30
ADD LOGICAL WITH SIGNED IMMEDIATE HIGH
 binary instructions 7-32
ADD LOGICAL WITH SIGNED IMMEDIATE
 instructions 7-31

- ADD NORMALIZED HFP instructions 18-8
 - example A-41
- ADD UNNORMALIZED HFP instructions 18-9
 - example A-42
- additional floating-point (AFP) registers 9-9
- address 3-2
 - 24-bit, 31-bit, and 64-bit 3-6
 - in branch-address generation 5-13
 - in operand address generation 5-12
 - absolute 3-4
 - AR-specified virtual
 - See AR-specified
 - arithmetic 3-5, 5-11
 - unsigned binary 7-6
 - backward stack-entry 5-80
 - base
 - See base address
 - branch
 - See branch address
 - channel-program
 - See channel-program address
 - comparison 12-1
 - controls for 12-1
 - effect on CPU state 4-2
 - CPU
 - See CPU address
 - data (I/O)
 - See data address
 - effective
 - See effective address
 - failing-storage
 - See failing-storage address
 - format 3-3
 - forward-section header 5-81
 - generation 5-10
 - for storage addressing 3-7
 - home virtual
 - See home virtual address
 - I/O 13-5
 - instruction
 - See instruction address
 - invalid 6-20
 - logical
 - See logical address
 - numbering of for byte locations 3-2
 - PER
 - See PER address
 - prefixing
 - See prefix
 - primary virtual
 - See primary virtual address
 - real 3-4
 - secondary virtual
 - See secondary virtual address
 - size of
 - controlled by addressing mode 5-10
 - storage 3-2
 - summary information 3-70
 - translation
 - See dynamic address translation, prefix
 - types 3-4
 - virtual 3-5
 - wraparound
 - See wraparound
- address-limit checking (I/O)
 - effect of I/O-system reset on 17-15
 - limit mode (bits in PMCW) 15-3
- address-limit-checking control (I/O) 15-27, 16-12
 - used for IPL 17-17
- address of] 15-35
- address space 3-23
 - AR-specified 5-46
 - changing of 3-23
 - control bits
 - control bit 5-76
 - in the PSW 4-7
 - use in address translation 3-40
 - created by DAT 3-38
 - number
 - See ASN
- address-space-control element (ASCE) 3-42
 - effective 3-52
 - home 3-45
 - in AST entry 3-32
 - used for access-register translation 5-58
 - used for subspace groups 5-69
 - primary 3-42
 - secondary 3-44
 - type exception 6-22
- addressing
 - trimodal 7-8
- address-and-translation-mode identification (ATMID) 4-31
- addressing exception 6-20
 - as an access exception 6-47, 6-53
- addressing mode 5-10
 - bit in linkage-stack state entry 5-83
 - bit in the PSW 4-7
 - effect on address size 3-6
 - effect on operand-address generation 5-12
 - effect on sequential instruction-address generation 5-10
 - effect on wraparound 3-7
 - in branch-address generation 5-13
 - in examples A-7
 - in operand address generation 5-12
 - set by BRANCH AND SAVE AND SET MODE instruction 7-36

set by BRANCH AND SET MODE instruction 7-37
 set by SET ADDRESSING MODE instruction 7-377
 use of 5-18
 ADR (ADD NORMALIZED) HFP instruction 18-8
 ADTR (ADD) DFP instruction 20-19
 AE (ADD NORMALIZED) HFP instruction 18-8
 example A-41
 AEB (ADD) BFP instruction 19-15
 AEBR (ADD) BFP instruction 19-15
 AER (ADD NORMALIZED) HFP instruction 18-8
 AFI (ADD IMMEDIATE) instruction 7-26, 7-29
 AFP (additional floating-point) registers 9-9
 AFP-register data exception 6-25
 AFT (ASN first table) 3-31
 AFTE (ASN-first-table entry) 3-31
 AFTO (ASN-first-table origin) 3-31
 AFX (ASN-first-table index) 3-30
 invalid bit 3-31
 translation exception 6-22
 AG (ADD) binary instruction 7-26
 AGF (ADD) binary instruction 7-26
 AGFI (ADD IMMEDIATE) instruction 7-26
 AGFR (ADD) binary instruction 7-25
 AGH (ADD HALFWORD) instruction 7-28
 AGHI (ADD HALFWORD IMMEDIATE) instruction 7-28
 AGHIK (ADD IMMEDIATE) instruction 7-26
 AGR (ADD) binary instruction 7-25
 AGRK (ADD) binary instruction 7-26
 AGSI (ADD IMMEDIATE) instruction 7-26
 AH (ADD HALFWORD) instruction 7-27
 example A-8
 AHHHR (ADD HIGH) binary instruction 7-28
 AHI (ADD HALFWORD IMMEDIATE) instruction 7-28
 AHIK (ADD IMMEDIATE) instruction 7-26
 AHY (ADD HALFWORD) instruction 7-27
 AIH (ADD IMMEDIATE HIGH) binary instruction 7-29
 AKM (authorization key mask) 5-38
 AL (ADD LOGICAL) instruction 7-29
 ALB (ART-lookaside buffer) 5-64
 entry
 clearing of 5-66
 effect of translation changes on 5-66
 usable state 5-65
 ALC (ADD LOGICAL WITH CARRY) instruction 7-30
 ALCG (ADD LOGICAL WITH CARRY) instruction 7-30
 ALCGR (ADD LOGICAL WITH CARRY) instruction 7-30
 ALCR (ADD LOGICAL WITH CARRY) instruction 7-30
 ALD (access-list designation) 5-56
 ALE
 See access-list entry
 ALEAX (access-list-entry authorization index) 5-57
 ALEN (access-list-entry number) 5-54
 invalid bit 5-56
 translation exception 6-22
 as an access exception 6-47
 alert (class of machine-check condition) 11-10
 alert interruption condition (I/O) 16-5
 alert-status bit (I/O) 16-17
 ALESN (access-list-entry sequence number)
 in ALE 5-56
 in ALET 5-54
 ALET (access-list-entry token) 5-48, 5-54
 specification exception 6-22
 as an access exception 6-47
 ALFI (ADD LOGICAL IMMEDIATE) instruction 7-29
 ALG (ADD LOGICAL) instruction 7-29
 ALGF (ADD LOGICAL) instruction 7-29
 ALGFI (ADD LOGICAL IMMEDIATE) instruction 7-29
 ALGFR (ADD LOGICAL) instruction 7-29
 ALGHSIK (ADD LOGICAL WITH SIGNED IMMEDIATE) instruction 7-31
 ALGR (ADD LOGICAL) instruction 7-29
 ALGRK (ADD) binary instruction 7-29
 ALGSI (ADD LOGICAL WITH SIGNED IMMEDIATE) instruction 7-31
 ALHHHR (ADD LOGICAL HIGH) binary instruction 7-30
 ALHSIK (ADD LOGICAL WITH SIGNED IMMEDIATE) instruction 7-31
 alignment 3-3
 ALL (access-list length) 5-56
 allegiance
 active 15-13
 channel-path 15-12
 dedicated 15-13
 effect on CLEAR SUBCHANNEL of 15-12
 working 15-12
 allowed interruptions 6-6
 ALO (access-list origin) 5-56
 ALR (ADD LOGICAL) instruction 7-29
 ALRK (ADD) binary instruction 7-29
 ALSI (ADD LOGICAL WITH SIGNED IMMEDIATE) instruction 7-31
 ALSIH (ADD LOGICAL WITH SIGNED IMMEDIATE HIGH) instruction 7-32
 ALSIHN (ADD LOGICAL WITH SIGNED IMMEDIATE HIGH) binary instruction 7-32
 alter-and-display controls 12-2
 alteration
 storage (PER event) 4-37

ALY (ADD LOGICAL) instruction 7-29
 ancillary-report bit
 in channel-report word 17-30
 in machine-check-interruption code 11-18
 in subchannel logout 16-49
 AND IMMEDIATE instructions 7-34
 AND instructions 7-32
 examples A-8
 AND WITH COMPLEMENT instructions 7-34
 AP (ADD DECIMAL) instruction 8-6
 example A-36
 AR (ADD) binary instruction 7-25
 AR-specified (access-register-specified) 3-5, 3-23
 address space 3-23, 5-46
 virtual address 3-5
 AR-specified (access-register-specified) virtual
 address
 effective address-space-control element for 3-52
 architected register context
 See CPU
 architectural mode
 identification 3-76, 3-85
 indication of 12-2, 12-3
 selection of by IML controls 12-3
 selection of by manual controls 12-3
 selection of by signal-processor order 4-89
 architecture
 compatibility 1-36
 arithmetic
 address
 See address arithmetic
 binary 7-5
 examples A-2
 decimal 8-3
 examples A-4, A-36
 floating-point 9-1
 examples A-5, A-41
 logical (unsigned binary) 7-6
 examples A-3
 ARK (ADD) binary instruction 7-25
 ART
 See access-register translation
 ART-lookaside buffer
 See ALB
 ASCE
 See address-space-control element
 ASCE (address-space-control element)
 type exception 6-22
 ASCII character code
 handled by architecture 0-xxix
 ASI (ADD IMMEDIATE) instruction 7-26
 ASN (address-space number) 3-23
 AST (ASN second table) 3-31
 authorization 3-35
 first table (AFT) 3-31
 first-table index
 See AFX
 first-table origin (AFTO) 3-31
 in entry-table entry 5-38
 second-table (AST) 3-31
 second-table address in ETE 5-38
 second-table entry (ASTE)
 for subspace groups 5-68
 instance exception 6-23
 instance number (ASTEIN), used in ASN reuse
 3-26
 origin, in ALE 5-57
 primary (PASTE) 5-35
 pseudo 3-24
 sequence exception 6-23
 sequence exception as an access exception
 6-47
 sequence number (ASTESN), in ALE 5-57
 sequence number (ASTESN), in ASTE 5-58
 validity exception 6-24
 validity exception as an access exception 6-47
 second-table index
 See ASX
 second-table origin (ASTO) 3-31
 trace-control bit 4-15
 translation 3-30
 exceptions 6-55
 translation-control bit 3-30, 5-29
 ASN-and-LX-reuse-control bit 3-25
 ASN-and-LX-reuse facility 1-7, 3-25
 facility indication 4-99
 assembler language A-7
 instruction formats in
 See instruction lists and page numbers in
 Appendix B
 assigned storage locations 3-73
 AST (ASN second table) 3-31
 AST entry 5-57
 See also ASN-second-table entry
 ASTE
 See ASN-second-table entry
 ASTESN (AST-entry sequence number)
 in ALE 5-57
 in ASTE 5-58
 ASTO (ASN-second-table origin) 3-31
 ASX (ASN-second-table index) 3-30
 invalid bit 3-31
 use in ART 5-58
 translation exception 6-24
 AT
 See authority table
 ATL (authority-table length) 3-32
 use in ART 5-58

AT MID (addressing-and-translation-mode identification) 4-31
 ATO (authority-table origin) 3-32
 use in ART 5-58
 attached ART-table entry 5-65
 attached region-table, segment-table, or page-table entry 3-63
 attachment of I/O devices 13-3
 attribute-set indication
 CPU attribute
 CPU speed 7-257
 AU (ADD UNNORMALIZED) HFP instruction 18-9
 example A-42
 AUR (ADD UNNORMALIZED) HFP instruction 18-9
 authority table (AT) 5-30
 designation 3-32, 5-58
 length 3-32, 5-58
 origin 3-32, 5-58
 authorization
 ASN 3-35
 index (AX) 3-35, 5-29
 key mask (AKM) 5-38
 mechanisms 5-27
 summary of 5-32
 testing of 5-74
 authorization check 16-52
 indicator for (in ERW) 16-52
 automatic reconfiguration 1-34
 auxiliary storage 3-2, 3-38
 availability (characteristic of a system) 1-37
 AW (ADD UNNORMALIZED) HFP instruction 18-9
 AWR (ADD UNNORMALIZED) HFP instruction 18-9
 AX (authorization index) 3-35, 5-29
 AXBR (ADD) BFP instruction 19-15
 AXR (ADD NORMALIZED) HFP instruction 18-8
 AY (ADD) binary instruction 7-26

B
 B field of instruction 5-11
 backed-up bit (machine-check condition) 11-17
 backup
 processing (synchronous machine-check condition) 11-18
 backward stack-entry address 5-80
 backward stack-entry validity bit 5-80
 BAKR (BRANCH AND STACK) instruction 10-11
 examples A-10
 BAL (BRANCH AND LINK) instruction 7-35
 examples A-8
 BALR (BRANCH AND LINK) instruction 7-35
 examples A-8
 BAS (BRANCH AND SAVE) instruction 7-36
 example A-8

base address 5-11
 register for 2-4
 base-AST-entry origin (BASTEO) 5-67
 base-authority state 10-8
 base space 5-18
 base-space bit 5-68
 basic addressing mode
 bit in entry-table entry 5-38
 basic I/O functions 15-1
 basic PROGRAM CALL 5-72, 10-96
 BASR (BRANCH AND SAVE) instruction 7-36
 example A-8
 BASSM (BRANCH AND SAVE AND SET MODE) instruction 7-36
 example A-8
 BASTEO (base-AST-entry origin) 5-67
 BC (BRANCH ON CONDITION) instruction 7-39
 example A-12
 BCR (BRANCH ON CONDITION) instruction 7-39
 BCT (BRANCH ON COUNT) instruction 7-40
 example A-12
 BCTG (BRANCH ON COUNT) instruction 7-40
 BCTGR (BRANCH ON COUNT) instruction 7-40
 BCTR (BRANCH ON COUNT) instruction 7-40
 example A-12
 BFP
 data class
 testing of 19-41
 BFP (binary floating point) 9-4
 BFP data 19-2
 conversion of 9-27
 BFP facility 19-1
 BFP-instruction data exception 6-25
 bias for exponent 9-2, 19-2, 20-3
 function of view 9-2
 summary for BFP 19-2, 19-3
 summary for DFP 20-3, 20-6
 biased exponent 9-2, 19-2, 20-3
 BIC (BRANCH INDIRECT ON CONDITION) instruction 7-38
 big endian 7-287, 7-394
 bimodal addressing
 See addressing mode
 binary
 See also fixed point
 arithmetic 7-5
 examples A-2
 negative zero 7-4
 number representation 7-4
 examples A-2
 overflow 7-5
 example A-2
 See also fixed point
 sign bit 7-4

- binary floating point (BFP) 9-4
- binary integer
 - conversion from floating point 18-11, 19-22, 19-25, 20-29, 20-32
 - conversion to floating point 18-11, 19-19, 20-24, 20-25
- binary-to-decimal conversion 7-230, 25-7
 - example A-19
- bit 3-2
 - numbering of within a group of bytes 3-3
- bits to left of compressed data 7-174
- bits to right of compressed data 7-174
- block-concurrent storage references 5-127
- block number
 - expanded storage 2-2
- block of I/O data 15-24
- block of storage 3-4
 - See also* page
 - testing for usability of 10-170
- borrow 7-397
- boundary alignment 3-3
 - for instructions 5-3
- BPP (BRANCH PREDICTION PRELOAD) instruction 7-42
- BPRP (BRANCH PREDICTION RELATIVE PRELOAD) instruction 7-42
- branch address 5-12
 - control bit 4-28
 - in linkage-stack state entry 5-83
 - in trace entry 4-22
- BRANCH AND LINK instructions 7-35
 - examples A-8
- BRANCH AND SAVE AND SET MODE instruction 7-36
 - examples A-8
- BRANCH AND SAVE instructions 7-36
 - examples A-8
- BRANCH AND SET AUTHORITY instruction 10-7
- BRANCH AND SET MODE instruction 7-37
 - examples A-8
- BRANCH AND STACK instruction 10-11
 - examples A-10
- BRANCH IN SUBSPACE GROUP instruction 10-13
- BRANCH INDIRECT ON CONDITION instruction 7-38
- BRANCH ON CONDITION instructions 7-39
 - example A-12
- BRANCH ON COUNT instructions 7-40
 - example A-12
- BRANCH ON INDEX HIGH instruction 7-41
 - examples A-12
- BRANCH ON INDEX LOW OR EQUAL instruction 7-41
 - examples A-13
- BRANCH RELATIVE AND SAVE instruction 7-45
- BRANCH RELATIVE AND SAVE LONG instruction 7-45
- BRANCH RELATIVE ON CONDITION instruction 7-46
- BRANCH RELATIVE ON CONDITION LONG instruction 7-46
- BRANCH RELATIVE ON COUNT HIGH instruction 7-47
- BRANCH RELATIVE ON COUNT instruction 7-47
- BRANCH RELATIVE ON INDEX HIGH instruction 7-47
- BRANCH RELATIVE ON INDEX LOW OR EQUAL instruction 7-47
- branch state entry 5-81, 10-11
- branch-trace-control bit 4-15
- branching
 - branch-address generation 5-12
 - in a channel program 15-76
 - relative 5-13
 - to perform decision making, loop control, and subroutine linkage 5-14
 - using the linkage stack 5-73
- BRAS (BRANCH RELATIVE AND SAVE) instruction 7-45
- BRASL (BRANCH RELATIVE AND SAVE LONG) instruction 7-45
- BRC (BRANCH RELATIVE ON CONDITION) instruction 7-46
- BRCL (BRANCH RELATIVE ON CONDITION LONG) instruction 7-46
- BRCT (BRANCH RELATIVE ON COUNT) instruction 7-47
- BRCTG (BRANCH RELATIVE ON COUNT) instruction 7-47
- BRCTH (BRANCH RELATIVE ON COUNT HIGH) instruction 7-47
- breaking-event address
 - in the transaction diagnostic block 5-96
 - assigned storage locations for 3-80
- breaking-event-address register 4-46
- broadcasted-purging facility 1-30
- BRXH (BRANCH RELATIVE ON INDEX HIGH) instruction 7-47
- BRXHG (BRANCH RELATIVE ON INDEX HIGH) instruction 7-47
- BRXLE (BRANCH RELATIVE ON INDEX LOW OR EQUAL) instruction 7-47
- BRXLG (BRANCH RELATIVE ON INDEX LOW OR EQUAL) instruction 7-48
- BSA (BRANCH AND SET AUTHORITY) instruction 10-7
- BSG (BRANCH IN SUBSPACE GROUP) instruction 10-13

BSM (BRANCH AND SET MODE) instruction 7-37
 example A-8
 buffer storage (cache) 3-2
 burst mode (channel-path operation) 13-3
 busy
 in I/O operations 13-10
 in SIGNAL PROCESSOR 4-95
 BX (byte index) 3-39
 BXH (BRANCH ON INDEX HIGH) instruction 7-41
 examples A-12
 BXHG (BRANCH ON INDEX HIGH) instruction 7-41
 BXLE (BRANCH ON INDEX LOW OR EQUAL)
 instruction 7-41
 examples A-13
 BXLEG (BRANCH ON INDEX LOW OR EQUAL)
 instruction 7-41
 byte 3-2
 numbering of in storage 3-2
 byte index (BX) 3-39
 byte-multiplex mode (channel-path operation) 13-3

C

C (COMPARE) binary instruction 7-133
 cache 3-2
 called-space identification 5-83
 cancel-I/O facility 1-30
 CANCEL SUBCHANNEL instruction 14-3
 candidates
 selection of 9-13
 canonical
 declefs 20-6
 canonicalization
 of DFP data 20-7
 capability list 5-51
 carry 7-5
 CBC (checking-block code) 11-2
 invalid 11-2
 in registers 11-9
 in storage 11-7
 in storage keys 11-7
 near-valid 11-2
 valid 11-2
 CBN (compressed-data bit number) 7-172
 example of 7-178
 CCC (channel-control check) 16-29
 CCW (channel-command word) 15-31
 2K-IDAW control
 used for IPL 17-17
 address of 16-19
 byte count in 15-33
 channel-program-type control
 used for IPL 17-17
 check (in subchannel logout) 16-48

command codes
 See commands
 contents of 15-31
 current 15-31
 designation of storage area in 15-32
 format-0 and format-1 15-31
 format control 16-11, 16-12, 16-35, 16-36
 used for IPL 17-17
 IDA flag in 15-32
 IDAW control
 used for IPL 17-17
 incorrect-length-suppression-mode control
 used for IPL 17-17
 indirect data addressing used in 13-9, 15-66
 invalid format of 16-27
 invalid specification of 16-25, 16-40
 MIDA flag in 15-33
 modification control
 used for IPL 17-17
 modified indirect data addressing used in 15-68
 modified-CCW-IDA control
 used for IPL 17-17
 ORB-extension control
 used for IPL 17-17
 PCI flag in 15-32
 prefetch control in 16-11
 used for IPL 17-17
 prefetching 15-62
 retry of
 See command retry
 skip flag in 15-32
 streaming-mode control
 used for IPL 17-17
 suspend flag in 15-32
 CCW channel program 13-7
 CCW-format control 15-27
 CCW-type IPL (CCW-type initial program loading)
 17-17
 CD (COMPARE) HFP instruction 18-10
 CDB (COMPARE) BFP instruction 19-17
 CDBR (COMPARE) BFP instruction 19-17
 CDFBR (CONVERT FROM FIXED) BFP instruction
 19-19, 19-21
 CDFBRA (CONVERT FROM FIXED) BFP instruction
 19-19
 CDFR (CONVERT FROM FIXED) HFP instruction
 18-11
 CDFTR (CONVERT FROM FIXED) DFP instruction
 20-24
 CDGBR (CONVERT FROM FIXED) BFP instruction
 19-19, 19-21
 CDGBRA (CONVERT FROM FIXED) BFP instruction
 19-19

CDGR (CONVERT FROM FIXED) HFP instruction 18-11
 CDGTR (CONVERT FROM FIXED) DFP instruction 20-24
 CDGTRA (CONVERT FROM FIXED) DFP instruction 20-24
 CDLFBR (CONVERT FROM LOGICAL) BFP instruction 19-21
 CDLFTR (CONVERT FROM LOGICAL) DFP instruction 20-25
 CDLGBR (CONVERT FROM LOGICAL) BFP instruction 19-21
 CDLGTR (CONVERT FROM LOGICAL) DFP instruction 20-25
 CDPT (CONVERT FROM PACKED) instruction 20-26
 CDR (COMPARE) HFP instruction 18-10
 examples A-42
 CDS (COMPARE DOUBLE AND SWAP) instruction 7-143
 examples A-46
 CDSG (COMPARE DOUBLE AND SWAP) instruction 7-143
 CDSS (compressed-data symbol size) 7-173
 CDSTR (CONVERT FROM SIGNED PACKED) DFP instruction 20-28
 CDSY (COMPARE DOUBLE AND SWAP) instruction 7-143
 CDTR (COMPARE) DFP instruction 20-22
 CDUTR (CONVERT FROM UNSIGNED PACKED) DFP instruction 20-28
 CDZT '????' Zoned-decimal source, long DFP result 20-29, 20-36
 CE (COMPARE) HFP instruction 18-10
 CEB (COMPARE) BFP instruction 19-17
 CEBR (COMPARE) BFP instruction 19-17
 CEDTR (COMPARE BIASED EXPONENT) DFP instruction 20-23
 CEFBR (CONVERT FROM FIXED) BFP instruction 19-19, 19-21
 CEFBRA (CONVERT FROM FIXED) BFP instruction 19-19
 CEFR (CONVERT FROM FIXED) HFP instruction 18-11
 CEGBR (CONVERT FROM FIXED) BFP instruction 19-19, 19-21
 CEGBRA (CONVERT FROM FIXED) BFP instruction 19-19
 CEGR (CONVERT FROM FIXED) HFP instruction 18-11
 CELFBR (CONVERT FROM LOGICAL) BFP instruction 19-21
 CELGBR (CONVERT FROM LOGICAL) BFP instruction 19-21
 central processing unit
 See CPU
 CER (COMPARE) HFP instruction 18-10
 CEXTR (COMPARE BIASED EXPONENT) DFP instruction 20-23
 CFC (COMPARE AND FORM CODEWORD) instruction 7-136
 example A-53
 CFDBR (CONVERT TO FIXED) BFP instruction 19-22
 CFDBRA (CONVERT TO FIXED) BFP instruction 19-22
 CFDR (CONVERT TO FIXED) HFP instruction 18-11
 CFEBR (CONVERT TO FIXED) BFP instruction 19-22
 CFEBRA (CONVERT TO FIXED) BFP instruction 19-22
 CFER (CONVERT TO FIXED) HFP instruction 18-11
 CFI (COMPARE IMMEDIATE) instruction 7-133
 CFXBR (CONVERT TO FIXED) BFP instruction 19-22
 CFXBRA (CONVERT TO FIXED) BFP instruction 19-22
 CFXR (CONVERT TO FIXED) HFP instruction 18-11
 CG (COMPARE) binary instruction 7-133
 CGDBR (CONVERT TO FIXED) BFP instruction 19-22
 CGDBRA (CONVERT TO FIXED) BFP instruction 19-22
 CGDR (CONVERT TO FIXED) HFP instruction 18-11
 CGDTR (CONVERT TO FIXED) DFP instruction 20-29, 20-30
 CGEBR (CONVERT TO FIXED) BFP instruction 19-22
 CGEBRA (CONVERT TO FIXED) BFP instruction 19-22
 CGER (CONVERT TO FIXED) HFP instruction 18-11
 CGF (COMPARE) binary instruction 7-133
 CGFI (COMPARE IMMEDIATE) instruction 7-134
 CGFR (COMPARE) binary instruction 7-133
 CGFRL (COMPARE RELATIVE LONG) instruction 7-134
 CGH (COMPARE HALFWORD) binary instruction 7-149
 CGHI (COMPARE HALFWORD IMMEDIATE) instruction 7-149
 CGHRL (COMPARE HALFWORD RELATIVE LONG) binary instruction 7-149
 CGHSI (COMPARE HALFWORD IMMEDIATE) instruction 7-149
 CGIB (COMPARE IMMEDIATE AND BRANCH) instruction 7-135

CGIJ (COMPARE IMMEDIATE AND BRANCH RELATIVE) instruction 7-135

CGIT (COMPARE IMMEDIATE AND TRAP) instruction 7-148

CGR (COMPARE) binary instruction 7-133

CGRB (COMPARE AND BRANCH) instruction 7-134

CGRJ (COMPARE AND BRANCH RELATIVE) instruction 7-135

CGRL (COMPARE RELATIVE LONG) binary instruction 7-134

CGRT (COMPARE AND TRAP) instruction 7-148

CGXBR (CONVERT TO FIXED) BFP instruction 19-22

CGXBRA (CONVERT TO FIXED) BFP instruction 19-22

CGXR (CONVERT TO FIXED) HFP instruction 18-11

CGXTR (CONVERT TO FIXED) DFP instruction 20-29, 20-30, 20-32

CH (COMPARE HALFWORD) instruction 7-149
example A-14

chaining check (subchannel status) 16-30

chaining of CCWs 15-63
command
 See command chaining of CCWs
data
 See data chaining of CCWs

chaining of CRWs 17-29, 17-30

change bit in storage key 3-9

change recording 3-20

channel-command word
 See CCW

channel commands
 See commands (I/O)

channel-control check (subchannel status) 16-29

channel-data check (subchannel status) 16-28, 16-35, 16-44

channel path 13-3
 active allegiance for 15-13
 available for selection 15-13
 dedicated allegiance for 15-13
 effect of I/O-system reset on 17-14
 masks in SCHIB
 See LPM, LPUM, PAM, PIM, PNOM, POM
 multipath mode of 15-4, 15-23
 not operational 16-13
 parallel-I/O-interface type 13-3
 serial-I/O-interface type 13-3
 storing of status for 14-16
 type of 13-3, 13-6
 working allegiance for 15-12

channel-path identifier
 See CHPID

channel-path reset 17-13
 effect of I/O-system reset on 17-15

channel-path-reset function 15-80
 completion of 15-81
 initiation by RESET CHANNEL PATH 14-9
 reset signal issued as part of 17-12
 signaling for 15-81

channel-path-status word 14-16

channel-path timeout
 indicator for (in ERW) 16-52

channel program 15-31
 2K-IDAW control for 15-28
 branching in
 See TIC
 CCW channel program 13-7
 execution of 13-11, 15-23
 resumption of 14-11
 suspension of 13-11, 15-73
 format-2-IDAW control for 15-27
 modification control for 15-26
 serialization 5-133
 streaming-mode control for 15-25
 suspend control for 15-25
 synchronization control for 15-26
 TCW channel program 13-7

channel-program address 16-19
 field-validity flag for in IRB 16-49
 used for IPL 17-17

channel-program type
 CCW channel program 13-7
 TCW channel program 13-7

channel-program-type control 15-27

channel report 17-28
 generated as a result of RCHP 14-9

channel report pending 11-17, 17-28
 effect of I/O-system reset on 17-15
 subclass-mask bit for 11-26

channel-report word
 See CRW

channel subsystem 2-7, 13-1
 addressing used in 13-5
 damage 11-17
 effect of I/O-system reset on 17-13
 effect of power-on reset on 4-81
 isolated state of 16-52

channel-subsystem-call facility 1-33

channel-subsystem monitoring 17-1
 effect of I/O-system reset on 17-15

channel-subsystem recovery 11-5, 17-27

channel-subsystem timer 17-2
 effect of I/O-system reset on 17-15

channel-subsystem timing 17-2

channel-subsystem timing-facility bit (in PMCW) 15-4

characteristic (of HFP number) 18-1
 See also exponent

- characters
 - represented by eight-bit code 0-xxix
- check bits 3-3, 11-2
- check stop 4-3, 11-9
 - as signal-processor status 4-98
 - during manual operation 12-1
 - effect on CPU timer 4-64
 - entering of 11-13
 - indicator 12-3
 - malfunction alert for 6-13
 - system 11-10
- checking block 11-2
- checking-block code
 - See* CBC
- checkpoint 11-2
- checkpoint synchronization 11-3
 - action 11-4
 - operations 11-4
- CHECKSUM instruction 7-49
- CHH (COMPARE HIGH) instruction 7-150
- CHHR (COMPARE HIGH) instruction 7-150
- CHHSI (COMPARE HALFWORD IMMEDIATE) instruction 7-149
- CHI (COMPARE HALFWORD IMMEDIATE) instruction 7-149
- CHLR (COMPARE HIGH) instruction 7-150
- CHPID (channel-path identifier) 13-5
 - in PMCW 15-8
 - used in RESET CHANNEL PATH 14-9
- CHRL (COMPARE HALFWORD RELATIVE LONG) binary instruction 7-149
- CHSI (COMPARE HALFWORD IMMEDIATE) instruction 7-149
- CHY (COMPARE HALFWORD) instruction 7-149
- CIB (COMPARE IMMEDIATE AND BRANCH) instruction 7-135
- CIH (COMPARE IMMEDIATE HIGH) instruction 7-150
- CIJ (COMPARE IMMEDIATE AND BRANCH RELATIVE) instruction 7-135
- CIPHER MESSAGE instruction 7-52
- CIPHER MESSAGE WITH AUTHENTICATION instruction 7-77
- CIPHER MESSAGE WITH CHAINING instruction 7-52
- CIPHER MESSAGE WITH CIPHER FEEDBACK instruction 7-91
- CIPHER MESSAGE WITH COUNTER instruction 7-106
- CIPHER MESSAGE WITH OUTPUT FEEDBACK instruction 7-119
- CIT (COMPARE IMMEDIATE AND TRAP) instruction 7-148
- CKSM (CHECKSUM) instruction 7-49
- CL (COMPARE LOGICAL) instruction 7-151
- class
 - of BFP data 19-4
 - testing of 19-41
 - of DFP data
 - testing of 20-56
- CLC (COMPARE LOGICAL) instruction 7-151
 - example A-15
- CLCL (COMPARE LOGICAL LONG) instruction 7-157
 - example A-16
- CLCLE (COMPARE LOGICAL LONG EXTENDED) instruction 7-159
- CLCLU (COMPARE LOGICAL LONG UNICODE) instruction 7-162
- clear function 15-14, 15-22
 - bit in SCSW for 16-14
 - completion of 15-15
 - initiated by CLEAR SUBCHANNEL 14-5
 - path management for 15-14, 15-22
 - pending 16-16
 - signaling for 15-15
 - subchannel modification by 15-15
- clear reset 4-80
- clear signal 17-12
 - issued as part of clear function 15-15
- CLEAR SUBCHANNEL instruction 14-5
 - See also* clear function
 - effect on device status of 15-16
 - function initiated by 15-14, 15-22
 - use of after RESET CHANNEL PATH 14-10
- clearing operation
 - by clear-reset function 4-80
 - by load-clear key 12-4
 - by load-clear-list-directed key 12-4
 - by system-reset-clear key 12-6
 - by TEST BLOCK instruction 10-170
- CLFDBR (CONVERT TO FIXED) BFP instruction 19-25
- CLFDTR (CONVERT TO LOGICAL) DFP instruction 20-32
- CLFEFR (CONVERT TO FIXED) BFP instruction 19-25
- CLFHSI (COMPARE LOGICAL IMMEDIATE) instruction 7-151
- CLFI (COMPARE LOGICAL IMMEDIATE) instruction 7-151
- CLFIT (COMPARE LOGICAL IMMEDIATE AND TRAP) instruction 7-155
- CLFT (COMPARE LOGICAL AND TRAP) instruction 7-154
- CLFXBR (CONVERT TO FIXED) BFP instruction 19-25
- CLG (COMPARE LOGICAL) binary instruction 7-151

CLGDBR (CONVERT TO FIXED) BFP instruction 19-25
 CLGDTR (CONVERT TO LOGICAL) DFP instruction 20-32
 CLGEBR (CONVERT TO FIXED) BFP instruction 19-25
 CLGF (COMPARE LOGICAL) binary instruction 7-151
 CLGFI (COMPARE LOGICAL IMMEDIATE) instruction 7-151
 CLGFR (COMPARE LOGICAL) binary instruction 7-151
 CLGFRL (COMPARE LOGICAL RELATIVE LONG) binary instruction 7-152
 CLGHRL (COMPARE LOGICAL RELATIVE LONG) binary instruction 7-152
 CLGHSI (COMPARE LOGICAL IMMEDIATE) instruction 7-151
 CLGIB (COMPARE LOGICAL IMMEDIATE AND BRANCH) instruction 7-153
 CLGIJ (COMPARE LOGICAL IMMEDIATE AND BRANCH RELATIVE) instruction 7-153
 CLGIT (COMPARE LOGICAL IMMEDIATE AND TRAP) instruction 7-155
 CLGR (COMPARE LOGICAL) binary instruction 7-151
 CLGRB (COMPARE LOGICAL AND BRANCH) instruction 7-153
 CLGRJ (COMPARE LOGICAL AND BRANCH RELATIVE) instruction 7-153
 CLGRL (COMPARE LOGICAL RELATIVE LONG) binary instruction 7-152
 CLGRT (COMPARE LOGICAL AND TRAP) instruction 7-154
 CLGT (COMPARE LOGICAL AND TRAP) instruction 7-154
 CLGXBR (CONVERT TO FIXED) BFP instruction 19-25
 CLGXTR (CONVERT TO LOGICAL) DFP instruction 20-32
 CLHH (COMPARE LOGICAL HIGH) instruction 7-156
 CLHHR (COMPARE LOGICAL HIGH) instruction 7-156
 CLHHSI (COMPARE LOGICAL IMMEDIATE) instruction 7-151
 CLHLR (COMPARE LOGICAL HIGH) instruction 7-156
 CLHRL (COMPARE LOGICAL RELATIVE LONG) binary instruction 7-152
 CLI (COMPARE LOGICAL) instruction 7-151
 example A-15
 CLIB (COMPARE LOGICAL IMMEDIATE AND BRANCH) instruction 7-153
 CLIH (COMPARE LOGICAL IMMEDIATE HIGH) instruction 7-157
 CLIJ (COMPARE LOGICAL IMMEDIATE AND BRANCH RELATIVE) instruction 7-153
 CLIY (COMPARE LOGICAL) instruction 7-151
 CLM (COMPARE LOGICAL CHARACTERS UNDER MASK) instruction 7-156
 example A-16
 CLMH (COMPARE LOGICAL CHARACTERS UNDER MASK) instruction 7-156
 CLMY (COMPARE LOGICAL CHARACTERS UNDER MASK) instruction 7-156
 clock
 See TOD clock
 clock comparator 4-60
 external interruption 6-12
 machine-check save area for 3-86
 save areas for 3-82
 store-status save area for 3-86
 validity bit for 11-22
 clock unit 4-47, 7-389
 CLR (COMPARE LOGICAL) instruction 7-151
 example A-16
 CLRB (COMPARE LOGICAL AND BRANCH) instruction 7-153
 CLRJ (COMPARE LOGICAL AND BRANCH RELATIVE) instruction 7-153
 CLRL (COMPARE LOGICAL RELATIVE LONG) binary instruction 7-152
 CLRT (COMPARE LOGICAL AND TRAP) instruction 7-154
 CLST (COMPARE LOGICAL STRING) instruction 7-165
 examples A-18
 CLY (COMPARE LOGICAL) instruction 7-151
 CMPSC (COMPRESSION CALL) instruction 7-169
 CMPSC-enhancement facility 1-7
 facility indication CMPSC enhancement facility
 facility indication] 4-100
 code
 ASCII
 handled by architecture 0-xxix
 checking-block
 See CBC
 command (in CCW)
 See command code in CCW
 condition
 See condition code
 data-exception (DXC) 6-17, 20-15
 decimal digit and sign 8-2
 deferred condition (I/O) 16-9
 EBCDIC
 handled by architecture 0-xxix
 table for 1-2

- eight-bit
 - handled by architecture 0-xxix
- error-recovery (I/O) 17-30
- external-damage 11-23
 - validity bit for 11-21
- I/O-interruption subclass 15-2
- instruction-length
 - See ILC
- interruption
 - See interruption code
- linkage-stack-entry type 5-79
- monitor
 - See monitor code
- operation 5-3
- PER
 - See PER code
- reporting-source (I/O) 17-30
- storage-access (in subchannel logout) 16-50
- vector-exception (VXC) 6-20
- codeword (for sorting operations) 7-136
 - example A-54
- cohort 20-2
- combination field
 - in DFP data format 20-4
- command chaining of CCWs 15-63
 - effect of status modifier on 15-63
 - flag in CCW for 15-32
 - overview of 13-11
- command chaining of TCWs
 - overview of 13-11
- command code in CCW 15-57
 - See also commands
 - See also common I/O-device commands
 - invalid 16-25
- command codes
 - See command code in CCW
- command mode 13-9
- command retry 15-77
 - effect on PCI of 15-65
- commands (I/O) 15-57
 - See also common I/O-device commands
 - transfer in channel 15-77
- commit
 - transactional execution 5-90
- common I/O-device commands
 - publication referenced 0-xxix
- common-region bit 3-47
- common-segment bit 3-50
- common-rounding-point view 9-13
- COMPARE AND BRANCH instructions 7-134
- COMPARE AND BRANCH RELATIVE instructions 7-134
- COMPARE AND FORM CODEWORD instruction 7-136
 - example A-53
- COMPARE AND REPLACE DAT TABLE ENTRY instruction 10-17
- COMPARE AND SIGNAL BFP instructions 19-18
- COMPARE AND SIGNAL DFP instructions 20-23
- COMPARE AND SWAP AND PURGE instruction 10-21
- compare-and-swap-and-store facility 1-8
 - facility indication 4-100
- compare-and-swap-and-store facility 2 1-8
 - facility indication 4-100
- COMPARE AND SWAP AND STORE instruction 7-145
- COMPARE AND SWAP instruction 7-143
 - examples A-46
- compare-and-trap-instruction data exception 6-25
- COMPARE AND TRAP instructions 7-148
- COMPARE BFP instructions 19-17
- COMPARE BIASED EXPONENT DFP instructions 20-23
- COMPARE binary instructions 7-133
- COMPARE DECIMAL instruction 8-7
 - example A-36
- COMPARE DFP instructions 20-22
- COMPARE DOUBLE AND SWAP instruction 7-143
 - examples A-46
- COMPARE HALFWORD IMMEDIATE instructions 7-149
- COMPARE HALFWORD instruction 7-149
 - example A-14
- COMPARE HFP instructions 18-10
 - examples A-42
- COMPARE HIGH instructions 7-150
- COMPARE IMMEDIATE AND BRANCH instructions 7-135
- COMPARE IMMEDIATE AND BRANCH RELATIVE instructions 7-135
- COMPARE IMMEDIATE AND TRAP instructions 7-148
- COMPARE IMMEDIATE binary instructions 7-133
- COMPARE IMMEDIATE HIGH instruction 7-150
- COMPARE LOGICAL AND BRANCH instructions 7-153
- COMPARE LOGICAL AND BRANCH RELATIVE instructions 7-153
- COMPARE LOGICAL AND TRAP instructions 7-154
- COMPARE LOGICAL CHARACTERS UNDER MASK instruction 7-156
 - example A-16
- COMPARE LOGICAL HIGH instruction 7-156
- COMPARE LOGICAL IMMEDIATE AND BRANCH instructions 7-153
- COMPARE LOGICAL IMMEDIATE AND BRANCH RELATIVE instructions 7-153

COMPARE LOGICAL IMMEDIATE AND TRAP instructions 7-155
 COMPARE LOGICAL IMMEDIATE HIGH instruction 7-157
 COMPARE LOGICAL IMMEDIATE instructions 7-151
 COMPARE LOGICAL instructions 7-151
 examples A-15
 COMPARE LOGICAL LONG EXTENDED instruction 7-159
 COMPARE LOGICAL LONG instruction 7-157
 example A-16
 COMPARE LOGICAL LONG UNICODE instruction 7-162
 COMPARE LOGICAL STRING instruction 7-165
 examples A-18
 COMPARE RELATIVE LONG instructions 7-134
 COMPARE UNTIL SUBSTRING EQUAL instruction 7-166
 comparison
 address
 See address comparison
 decimal 8-7
 example A-36
 hexadecimal-floating-point
 examples A-42
 logical 7-7
 examples A-15
 of IEEE data 9-24
 signed-binary 7-7
 TOD-clock 4-60
 compatibility 1-36
 among systems implementing different architectures 1-37
 among systems implementing same architecture 1-36
 control-program 1-37
 problem-state 1-37
 completion of I/O functions
 by channel-path-reset function 15-81
 by clear function 15-15
 by halt function 15-17
 during initiation 15-78
 completion of instruction execution 5-22
 completion of unit of operation 5-24
 compressed-data bit number (CBN) 7-172
 example of 7-178
 compressed-data symbol size (CDSS) 7-173
 COMPRESSION CALL instruction 7-169
 restriction related to
 on leftmost bits in symbol-translation-table entry 7-175
 on length of chain of compression-dictionary entries 7-177
 on length of chain of expansion-dictionary entries 7-177
 on length of character symbol during compression 7-177
 on length of character symbol during expansion 7-177
 on number of children 7-177, 7-179
 on offset to symbol-translation table 7-173
 on symbol translation with format-1 sibling descriptors 7-173
 compression dictionary
 size of with symbol translation 7-173
 compression facility
 publication referenced 0-xxx
 COMPUTE DIGITAL SIGNATURE AUTHENTICATION 26-2
 COMPUTE INTERMEDIATE MESSAGE DIGEST instruction 7-187
 COMPUTE LAST MESSAGE DIGEST instruction 7-200
 COMPUTE MESSAGE AUTHENTICATION CODE instruction 7-218
 conceptual sequence 5-113
 as related to storage-operand accesses 5-129
 conclusion of I/O operations 13-10, 16-1
 during initiation 15-78
 conclusion of instruction execution 5-22
 concurrency of access for storage references 5-127
 concurrent sense
 in ECW 16-56
 indicator for (in ERW) 16-52
 concurrent-sense count (in ERW) 16-52
 concurrent-sense facility 17-27
 condition code 4-7
 deferred 16-9
 for IEEE instructions 9-24
 in the PSW 4-7
 inserted by INSERT PROGRAM MASK 7-263
 preserved by BRANCH AND LINK 5-15, 7-35
 set by SET PROGRAM MASK 7-378
 summary C-1
 tested by BRANCH ON CONDITION instruction 7-39
 used for decision making 5-14
 validity bit for 11-21
 conditional emergency signal (external interruption) signal-processor order 4-91
 conditional-SSKE facility 1-8
 and invalid CBC in storage key 11-8
 conditional-swapping instructions
 See COMPARE AND SWAP instruction, COMPARE DOUBLE AND SWAP instruction
 conditional-SSKE facility
 facility indication 4-100

- conditions for interruption
 - See interruption conditions
- configuration 2-1
 - of storage 3-4
- configuration-alert facility (I/O) 17-27
- configuration identification (in STORE CPU ID result) 10-139, 10-140
- configuration-topology facility 1-8
 - facility indication 4-100
- configuration-z/Architecture-architectural-mode facility 1-8
- conflict
 - transactional execution 5-90
- conflict token
 - in the transaction diagnostic block 5-95
- connective
 - See logical connective
- consistency (storage operand) 5-125
 - examples A-49, A-51
- console device 12-1
- console integration 1-34
- constrained transaction
 - transactional execution 5-90
- constrained transactional-execution facility
 - facility indication 4-100
- constrained-transactional-execution facility 1-8
- constrained transaction-execution mode
 - transactional execution 5-90
- contraction 4-85
- control 4-1
 - instructions 10-1
 - manual
 - See manual operation
- control-program compatibility 1-37
- control register 2-6, 4-8
 - save areas for 3-83
 - validity bit 11-21
- control-register assignment 4-10
 - (CRx.y indicates control register x, bit position y)
- CR0.15:
 - See (SA23-2260)
- CR0.43:
 - instruction-fetch-suppression-enablement-control bit 3-42
- CR0.33:
 - SSM-suppression-control bit 6-38, 10-136
- CR0.34:
 - TOD-clock-sync-control bit 4-49, 4-54
- CR0.35:
 - low-address-protection-control bit 3-14
- CR0.36:
 - extraction-authority-control bit 5-28
- CR0.37:
 - secondary-space-control bit 3-41, 5-29
- CR0.38:
 - fetch-protection-override-control bit 3-13
- CR0.39:
 - storage-protection-override-control bit 3-12
- CR0.40:
 - enhanced-DAT-enablement-control bit 3-41
- CR0.44:
 - ASN-and-LX-reuse-control bit 3-25
- CR0.45:
 - AFP-register-control bit 9-11
- CR0.48:
 - malfunction-alert subclass-mask bit 6-13
- CR0.49:
 - emergency-signal subclass-mask bit 6-13
- CR0.50:
 - external-call subclass-mask bit 6-13
- CR0.52:
 - clock-comparator subclass-mask bit 6-12
- CR0.53:
 - CPU-timer subclass-mask bit 6-13
- CR0.54:
 - service-signal subclass-mask bit 6-14
- CR0.57:
 - interrupt-key subclass-mask bit 6-13
- CR0.58:
 - See (SA23-2260)
- CR0.59:
 - timing-alert subclass-mask bit 6-14
- CR0.61:
 - crypto-control bit 6-24
- CR0.8:
 - transactional-execution control 5-92
- CR0.9:
 - transactional-execution program-interruption-filtering override 5-92
- CR1:
 - primary address-space-control element (PASCE) 3-42
- CR1.0-51:
 - primary real-space token origin (PRSTKO) 3-44
 - primary region-table origin (PRT0) 3-42
 - primary segment-table origin (PSTO) 3-42
- CR1.54:
 - primary subspace-group-control bit 3-43
- CR1.55:
 - primary private-space-control bit 3-43
- CR1.56:
 - primary storage-alteration-event-control bit 3-43
- CR1.57:
 - primary space-switch-event-control bit 3-43, 6-37
- CR1.58:

primary real-space-control bit 3-43
 CR1.60-61:
 primary designation-type-control bits 3-44
 CR1.62-63:
 primary region-table length (PRTL) 3-44
 primary segment-table length (PSTL) 3-44
 CR2.33-57:
 dispatchable-unit-control-table origin (DUCTO)
 5-53
 CR2.61:
 transaction-diagnostic-scope control 5-92
 CR2.62-63:
 transaction-diagnostic control 5-92
 CR3.0-31:
 secondary ASTEIN (SASTEIN) 3-26
 CR3.32-47:
 PSW-key mask (PKM) 5-28
 CR3.48-63:
 secondary ASN (SASN) 3-24
 CR4.0-31:
 primary ASTEIN (PASTEIN) 3-26
 CR4.32-47:
 authorization index (AX) 3-35, 5-29
 CR4.48-63:
 primary ASN (PASN) 3-24
 CR5.33-57:
 primary-AST-entry origin (PASTEO) 5-35,
 5-54
 CR6.32-39:
 I/O-interruption subclass mask 6-16
 CR7:
 secondary address-space-control element
 (SASCE) 3-44
 CR7.0-51:
 secondary real-space token origin (SRSTKO)
 3-44
 secondary region-table origin (SRTO) 3-44
 secondary segment-table origin (SSTO) 3-44
 CR7.54:
 secondary subspace-group-control bit 3-44
 CR7.55:
 secondary private-space-control bit 3-44
 CR7.56:
 secondary storage-alteration-event-control bit
 3-44
 CR7.58:
 secondary real-space-control bit 3-44
 CR7.60-61:
 secondary designation-type-control bits 3-44
 CR7.62-63:
 secondary region-table length (SRTL) 3-44
 secondary segment-table length (SSTL) 3-44
 CR8.16-31:
 enhanced-monitor-mask bits 6-30, 7-287
 CR8.32-47:
 extended authorization index (EAX) 5-54
 CR8.48-63:
 monitor-mask bits 6-30, 7-287
 CR9.32:
 PER successful-branching-event-mask bit
 4-27
 CR9.33:
 PER instruction-fetching-event-mask bit 4-27
 CR9.34:
 PER storage-alteration-event-mask bit 4-27
 CR9.36:
 PER store-using-real-address-event-mask bit
 4-27
 CR9.37:
 PER zero-address-detection-event-mask bit
 4-27
 CR9.38:
 PER transaction-end-event-mask bit 4-27
 CR9.39:
 PER instruction-fetching-nullification-event-
 mask bit 4-27
 CR9.40:
 PER branch-address-control bit 4-28
 CR9.41:
 PER event-suppression-control bit 4-28
 CR9.42:
 PER storage-alteration-space-control bit 4-28
 CR10.0-63:
 PER starting address 4-27
 CR11.0-63:
 PER ending address 4-27
 CR12.0:
 branch-trace-control bit 4-15
 CR12.1:
 mode-trace-control bit 4-15
 CR12.2-61:
 trace-entry address 4-15
 CR12.62:
 ASN-trace-control bit 4-15
 CR12.63:
 explicit-trace-control bit 4-15
 CR13:
 home address-space-control element
 (HASCE) 3-45
 CR13.0-51:
 home real-space token origin (HRSTKO) 3-45
 home region-table origin (HRTO) 3-45
 home segment-table origin (HSTO) 3-45
 CR13.55:
 home private-space-control bit 3-45
 CR13.56:
 home storage-alteration-event-control bit 3-45
 CR13.57:

- home space-switch-event-control bit 3-45, 6-37
- CR13.58:
 - home real-space-control bit 3-45
- CR13.60-61:
 - home designation-type-control bits 3-45
- CR13.62-63:
 - home region-table length (HRTL) 3-45
 - home segment-table length (HSTL) 3-45
- CR14.35:
 - channel-report-pending subclass-mask bit 11-26
- CR14.36:
 - recovery subclass-mask bit 11-26
- CR14.37:
 - degradation subclass-mask bit 11-27
- CR14.38:
 - external-damage subclass-mask bit 11-27
- CR14.39:
 - warning subclass-mask bit 11-27
- CR14.42:
 - TOD-clock-control-override control 4-49
- CR14.44:
 - ASN-translation-control bit 3-30, 5-29
- CR14.45-63:
 - ASN-first-table origin (AFTO) 3-31
- CR15.0-60:
 - linkage-stack-entry address 5-78
- control registers
 - machine-check save area for 3-87
 - store-status save area for 3-87
- control unit 2-8, 13-4
 - effect of I/O-system reset on 17-14
 - sharing of 13-4
 - type of 15-14
- control-unit-defer time (I/O) 17-9
- control unit defer time interval (in measurement block) 17-6
- control-unit-queuing measurement (I/O) 17-9
- control-unit-queuing-time interval (in measurement block) 17-5
- controlled-ASN bit 3-25
- conversion
 - between HFP and BFP data 9-27
 - binary-to-decimal 7-230, 25-7
 - example A-19
 - decimal-to-binary 7-229, 25-5
 - example A-18
 - hexadecimal-floating-point-number
 - basic example A-6
 - examples with instructions A-44
 - of floating-point format 9-23, 19-5
- CONVERT BFP TO HFP floating-point-support instructions 9-27
- CONVERT FROM FIXED BFP instructions 19-19, 19-22, 19-33
- CONVERT FROM FIXED DFP instructions 20-24
- CONVERT FROM FIXED HFP instructions 18-11
- CONVERT FROM LOGICAL DFP instructions 20-25
- CONVERT FROM SIGNED PACKED DFP instructions 20-28
- CONVERT FROM UNSIGNED PACKED DFP instructions 20-28
- CONVERT FROM ZONED DFP instruction 20-26, 20-29, 20-33, 20-36
- CONVERT HFP TO BFP floating-point-support instructions 9-28
- CONVERT TO BINARY instruction
 - example A-18
- CONVERT TO BINARY instructions 7-229
- CONVERT TO DECIMAL instruction
 - example A-19
- CONVERT TO DECIMAL instructions 7-230
- CONVERT TO FIXED BFP instructions 19-22, 19-25
- CONVERT TO FIXED DFP instructions 20-29
- CONVERT TO FIXED HFP instructions 18-11
- CONVERT TO LOGICAL DFP instructions 20-32
- CONVERT TO SIGNED PACKED DFP instructions 20-35
- CONVERT TO UNSIGNED PACKED DFP instructions 20-35
- CONVERT UNICODE TO UTF-8 instruction 7-233
- CONVERT UTF-16 TO UTF-32 instruction 7-230
- CONVERT UTF-16 TO UTF-8 instruction 7-233
- CONVERT UTF-32 TO UTF-16 instruction 7-237
- CONVERT UTF-32 TO UTF-8 instruction 7-240
- CONVERT UTF-8 TO UNICODE instruction 7-243
- CONVERT UTF-8 TO UTF-16 instruction 7-243
- CONVERT UTF-8 TO UTF-32 instruction 7-247
- Coordinated Universal Time (UTC) used in TOD epoch 4-52
- COPY ACCESS instruction 7-251
- COPY SIGN floating-point-support instruction 9-30
- core
 - identification (ID) 2-3, 4-84, 12-3, 12-7
 - multithreading 2-3
- count field
 - in CCW 15-33
 - invalid 16-25
 - in SCSW 16-31, 16-44
- counter updating (example) A-47
- counting operations 7-40
- coupling facility 1-34
- CP (COMPARE DECIMAL) instruction 8-7
 - example A-36
- CPA
 - See channel-program address

CPDT (CONVERT TO PACKED) instruction 20-33
 CPSDR (COPY SIGN) floating-point-support instruction 9-30
 CPU (central processing unit) 2-2
 address 4-84, 4-85
 assigned storage locations for 3-74, 3-84
 when stored during external interruptions 6-11
 architected register context 2-3, 4-93
 checkpoint 11-2
 configuration identification 10-139, 10-140
 effect of power-on reset on 4-81
 environment 10-139
 format indication 10-139, 10-140
 hangup due to string of interruptions 4-3
 machine-type number 10-139, 10-140
 registers 2-3
 save areas for 3-82
 reset 4-78
 signal-processor order 4-86
 retry 11-2
 serialization 5-130
 effects of transactional execution 5-131
 signaling 4-85
 state 4-2
 check-stop 4-3
 load 4-3
 no effect on TOD clock 4-48
 operating 4-3
 stopped 4-2
 types 2-3
 primary 2-3, 4-82, 12-7
 secondary 2-3
 CPU-measurement-counter facility
 facility indication 4-101
 CPU-measurement-sampling facility
 facility indication 4-101
 CPU state 4-2
 CPU timer 4-63
 external interruption 6-12
 machine-check save area for 3-86
 save areas for 3-82
 store-status save area for 3-86
 validity bit for 11-22
 CPUs-per-core
 operator indicator 12-3
 CPXT (CONVERT TO PACKED) instruction 20-33
 CPYA (COPY ACCESS) instruction 7-251
 CR
 See control register
 CR (COMPARE) binary instruction 7-133
 CRB (COMPARE AND BRANCH) instruction 7-134
 CRDTE (COMPARE AND REPLACE DAT TABLE ENTRY) instruction 10-17
 CRJ (COMPARE AND BRANCH RELATIVE) instruction 7-134
 CRL (COMPARE RELATIVE LONG) binary instruction 7-134
 CRT (COMPARE AND TRAP) instruction 7-148
 CRW (channel-report word)
 chaining of 17-29, 17-30
 error-recovery code (ERC) in 17-30
 overflow in 17-29
 reporting-source code (RSC) in 17-30
 reporting-source ID (RSID) in 17-31
 solicited 17-29
 storing of 14-17
 crypto-operation exception 6-24
 cryptographic facility 1-33, 2-7
 CS (COMPARE AND SWAP) instruction 7-143
 examples A-46
 CSCH (CLEAR SUBCHANNEL) instruction 14-5
 CSDTR (CONVERT TO SIGNED PACKED) DFP instruction 20-35
 CSG (COMPARE AND SWAP) instruction 7-143
 CSP (COMPARE AND SWAP AND PURGE) instruction 10-21
 CSPG (COMPARE AND SWAP AND PURGE) instruction 10-21
 CSS priority 15-29
 CSST (COMPARE AND SWAP AND STORE) instruction 7-145
 CSXTR (CONVERT TO SIGNED PACKED) DFP instruction 20-35
 CSY (COMPARE AND SWAP) instruction 7-143
 CTN configuration change (machine-check condition) 11-24
 CU12 (CONVERT UTF-8 TO UTF-16) instruction 7-243
 CU14 (CONVERT UTF-8 TO UTF-32) instruction 7-247
 CU21 (CONVERT UTF-16 TO UTF-8) instruction 7-233
 CU24 (CONVERT UTF-16 TO UTF-32) instruction 7-230
 CU41 (CONVERT UTF-32 TO UTF-8) instruction 7-240
 CU42 (CONVERT UTF-32 TO UTF-16) instruction 7-237
 CUDTR (CONVERT TO UNSIGNED PACKED) DFP instruction 20-35
 current CCW 15-31
 See also CCW
 current PSW 4-4, 5-14
 See also PSW
 stored during interruption 6-2
 CUSE (COMPARE UNTIL SUBSTRING EQUAL) instruction 7-166

CUTFU (CONVERT UTF-8 TO UNICODE) instruction 7-243
 CUUTF (CONVERT UNICODE TO UTF-8) instruction 7-233
 CUXTR (CONVERT TO UNSIGNED PACKED) DFP instruction 20-35
 CVB (CONVERT TO BINARY) instruction 7-229
 example A-18
 CVBG (CONVERT TO BINARY) instruction 7-229
 CVBY (CONVERT TO BINARY) instruction 7-229
 CVD (CONVERT TO DECIMAL) instruction 7-230
 example A-19
 CVDG (CONVERT TO DECIMAL) instruction 7-230
 CVDY (CONVERT TO DECIMAL) instruction 7-230
 CXBR (COMPARE) BFP instruction 19-17
 CXFBR (CONVERT FROM FIXED) BFP instruction 19-19, 19-21
 CXFBRA (CONVERT FROM FIXED) BFP instruction 19-19
 CXFR (CONVERT FROM FIXED) HFP instruction 18-11
 CXFTR (CONVERT FROM FIXED) DFP instruction 20-24
 CXGBR (CONVERT FROM FIXED) BFP instruction 19-19, 19-21
 CXGBRA (CONVERT FROM FIXED) BFP instruction 19-19
 CXGR (CONVERT FROM FIXED) HFP instruction 18-11
 CXGTR (CONVERT FROM FIXED) DFP instruction 20-24
 CXGTRA (CONVERT FROM FIXED) DFP instruction 20-24
 CXLFB (CONVERT FROM LOGICAL) BFP instruction 19-21
 CXLFBTR (CONVERT FROM LOGICAL) DFP instruction 20-25
 CXLGBR (CONVERT FROM LOGICAL) BFP instruction 19-21
 CXLGTR (CONVERT FROM LOGICAL) DFP instruction 20-25
 CXPT (CONVERT FROM PACKED) instruction 20-26
 CXR (COMPARE) HFP instruction 18-10
 CXSTR (CONVERT FROM SIGNED PACKED) DFP instruction 20-28
 CXTR (COMPARE) DFP instruction 20-22
 CXUTR (CONVERT FROM UNSIGNED PACKED) DFP instruction 20-28
 CY (COMPARE) binary instruction 7-133

D

D (DIVIDE) binary instruction 7-251

 example A-19
 D field of instruction 5-11
 damage
 channel-subsystem 11-17
 code (external) 11-23
 validity bit for 11-21
 external 11-16
 subclass-mask bit for 11-27
 instruction-processing 11-15
 processing 11-19
 service-processor 11-17
 system 11-15
 timing-facility 11-16
 DAT
 leaf-table entry 3-42, 3-53, 3-54, 3-65
 See dynamic address translation
 leaf-table entry 3-46
 DAT-enhancement facility
 facility indication 4-99
 DAT-enhancement facility 1 1-8
 DAT-enhancement facility 2 1-9
 DAT mode (bit in PSW)
 use in address translation 3-40
 DAT mode (bit in the PSW) 4-6
 DAT protection 3-13
 bit for in page-table entry 3-51
 bit for in region-table entry 3-46
 bit for in segment-table entry 3-50
 DAT-table format error 6-47
 data
 blocking of (I/O) 15-24
 format for
 binary-floating-point instructions 19-2
 decimal instructions 8-1
 decimal-floating-point instructions 20-3
 general instructions 7-4
 hexadecimal-floating-point instructions 18-2
 indirect addressing of (I/O) 13-9, 15-66
 measurement (I/O)
 See measurement data
 modified indirect addressing of (I/O) 15-68
 prefetching of for I/O operation 15-59
 transport indirect addressing of (I/O) 15-70
 data address (I/O)
 invalid 16-26
 invalid specification of 16-26
 data chaining of CCWs 15-61
 flag in CCW for 15-32
 overview of 13-11
 data check
 measurement-block 16-48
 data exception 6-25
 AFP-register 6-25
 BFP-instruction 6-25

- compare-and-trap-instruction 6-25
- DFP-instruction 6-25
- general-operand 6-25, 8-5
- IEEE-exception 6-25, 9-18
- priority of program interruptions for 6-17
- simulated IEEE exception 6-26
- data exception code
 - in the transaction diagnostic block 5-96
- data-exception code (DXC) 6-17, 20-15
- data signaling and quiet NaNs
 - classes of BFP data 19-4
 - classes of DFP data 20-7
- data streaming (I/O) 13-4
 - effect of CCW count on 15-63
- DCTI (device-connect-time interval)
 - in ESW 16-54
 - in extended-measurement word 16-57
 - in measurement block 17-4
- DCW (device-command word)
 - contents of 15-38
 - current 15-38
- DD (DIVIDE) HFP instruction 18-12
- DDB (DIVIDE) BFP instruction 19-27
- DDBR (DIVIDE) BFP instruction 19-27
- DDR (DIVIDE) HFP instruction 18-12
- DDTR (DIVIDE) DFP instruction 20-37
- DDTRA (DIVIDE) DFP instruction 20-37
- DE (DIVIDE) HFP instruction 18-12
- DEB (DIVIDE) BFP instruction 19-27
- DEBR (DIVIDE) BFP instruction 19-27
- decimal
 - arithmetic 8-3
 - comparison 8-7
 - digit codes 8-2
 - divide exception 6-26
 - instructions 8-1
 - examples A-36
 - number representation 8-1
 - examples A-4
 - operand overlap 8-3
 - overflow
 - exception 6-26
 - mask in PSW 4-7
 - sign codes 8-2
- decimal (DFP)
 - data formats 20-3
- decimal-floating-point
 - packed-conversion facility 1-9
 - zoned-conversion facility 1-9
- decimal floating point (DFP) 9-4
 - See also* DFP
- decimal-floating-point (DFP)
 - facility 20-1
- decimal-floating-point (DFP) facility
 - facility indication 4-100
- decimal-floating-point facility 1-9
- decimal floating point packed conversion facility
 - facility indication 4-101
- decimal-floating-point packed-conversion facility 1-9
- decimal-floating-point-rounding facility 1-9
- decimal-floating-point zoned-conversion facility 1-9
 - facility indication 4-100
- decimal-to-binary conversion 7-229, 25-5
 - example A-18
- decimal-floating-point (DFP)
 - facility 1-9
 - rounding facility 1-9
- dedicated allegiance 15-13
- default QNaN 9-3, 19-4, 20-7
- deferred condition code 16-9
- DEFLATE CONVERSION CALL 26-16
- DEFLATE-conversion facility 1-9
 - facility indication 4-101
- degradation (machine-check condition) 11-16
 - subclass-mask bit for 11-27
- degradation, storage (machine-check condition) 11-19
- delay in storing 5-123
- delayed access exception (machine-check condition) 11-17
- deletion of malfunctioning unit 11-5
- denormalization rounding 9-12
- denormalized value 9-12
- DER (DIVIDE) HFP instruction 18-12
 - examples A-42
- derived quantum 20-3
- designation
 - authority-table 3-32
 - entry-table 5-36, 5-37
 - home real-space (HRSD) 3-45
 - home region-table 3-45
 - home segment-table 3-45
 - linkage-first-table 5-36
 - linkage-table 5-35
 - primary real-space 3-42
 - primary region-table 3-42
 - primary segment-table 3-42
 - real-space 3-42
 - in AST entry 3-32
 - used for access-register translation 5-58
 - used for subspace groups 5-69
 - region-table 3-42
 - in AST entry 3-32
 - used for access-register translation 5-58
 - used for subspace groups 5-69
 - secondary real-space 3-44
 - secondary region-table 3-44
 - secondary segment-table 3-44

- segment-table 3-42
 - in AST entry 3-32
 - used for access-register translation 5-58
 - used for subspace groups 5-69
- designation (origin and length)
 - access-list 5-55
- designation-type-control bits
 - home 3-45
 - primary 3-44
 - secondary 3-44
- destructive overlap 5-128, 7-290, 7-295, 7-298
 - in the access-register mode 5-116
- device 2-8, 13-5
 - console 12-1
 - effect of I/O-system reset on 17-14
- device-active bit 16-16, 16-36
- device-active-only measurement (I/O) 17-9
- device-active-only-time interval (in measurement block) 17-6
- device address 13-6
- device-busy time (in extended measurement word) 16-58
- device-busy time (in measurement block) 17-6
- device-command word
 - See* DCW
- device-connect-time interval
 - See* DCTI
- device-connect-time measurement 17-10
 - effect of suspension on 15-75
 - enable 15-4
- device-disconnect-time interval (in measurement block) 17-5
- device identifier 13-6
- device number 13-6
 - assignment of 13-6
 - in PMCW 15-5
- device-number valid (bit in PMCW) 15-4
- device status 16-24
 - field-validity flag for (in subchannel logout) 16-29, 16-49
 - with inappropriate bit combination 16-50
- device status check 16-50
- DFLTCC (DEFLATE CONVERSION CALL) 26-16
- DFP
 - canonical data 20-6
 - canonical declats 20-6
 - classes of DFP data 20-6
 - data signaling and quiet NaNs 20-7
 - infinities 20-7
 - normal numbers 20-7
 - subnormal numbers 20-6
 - zero 20-6
 - cohort 20-2
 - data class
 - testing of 20-56
 - data formats 20-3
 - combination field 20-4
 - encoded trailing significand field 20-5
 - values of finite numbers 20-5
 - derived quantum 20-3
 - format conversion 20-7
 - formatting instructions 20-8
 - signed-packed-decimal format 20-28, 20-35
 - unsigned-packed-decimal format 20-28, 20-35
 - of DFP data
 - canonicalization 20-7
 - preferred quantum 20-2, 20-10
 - quantum 20-2
 - scaled preferred quantum 20-3
 - significand 20-5
 - significant digits 20-5
 - special quantum-handling operations 20-3
- DFP (decimal floating point) 9-4
- DFP-instruction data exception 6-25
- DIAGNOSE instruction 10-23
- dictionary
 - adaptive 7-179
- DIDBR (DIVIDE TO INTEGER) BFP instruction 19-28
- DIEBR (DIVIDE TO INTEGER) BFP instruction 19-28
- digit codes (decimal) 8-2
- digit selector (in EDIT) 8-8
- direct-access storage 3-2
- disabling for interruptions 6-6
- disallowed interruptions 6-6
- dispatchable unit (DU) 5-48
 - access-list designation (DUALD) 5-55
 - control table (DUCT) 5-55
 - origin (DUCTO) 5-53
 - when subspace-group facility installed 5-66
 - when trap facility installed 10-178
- displacement (in relative addressing) 5-11
- display (manual controls) 12-2
- distinct-operands facility 1-9
 - facility indication 4-100
- DIVIDE BFP instructions 19-27
- DIVIDE binary instructions 7-251
 - example A-19
- DIVIDE DECIMAL instruction 8-7
 - example A-37
- DIVIDE DFP instructions 20-37
- divide exception
 - decimal 6-26
 - fixed-point 6-27
 - HFP 6-28
- DIVIDE HFP instructions 18-12

- examples A-42
- DIVIDE LOGICAL instructions 7-252
- DIVIDE SINGLE binary instructions 7-253
- DIVIDE TO INTEGER BFP instructions 19-28
 - remainder result of 19-5
- divisible instruction execution 5-115
- DL (DIVIDE LOGICAL) instruction 7-252
- DLG (DIVIDE LOGICAL) binary instruction 7-252
- DLGR (DIVIDE LOGICAL) binary instruction 7-252
- DLR (DIVIDE LOGICAL) instruction 7-252
- doubleword 3-3
- doubleword-concurrent storage references 5-127
- DP (DIVIDE DECIMAL) instruction 8-7
 - example A-37
- DR (DIVIDE) binary instruction 7-251
- DSG (DIVIDE SINGLE) binary instruction 7-253
- DSGF (DIVIDE SINGLE) binary instruction 7-253
- DSGFR (DIVIDE SINGLE) binary instruction 7-253
- DSGR (DIVIDE SINGLE) binary instruction 7-253
- DU (dispatchable unit) 5-48
- DUALD (dispatchable-unit access-list designation) 5-55
- DUCT (dispatchable-unit control table) 5-55, 5-66
- DUCTO (dispatchable-unit-control-table origin) 5-53
- dump (standalone) 12-5
- DXBR (DIVIDE) BFP instruction 19-27
- DXC (data-exception code) 6-17, 19-10, 20-15
 - summary figures 6-17, 6-18
- DXR (DIVIDE) HFP instruction 18-12
- DXTRA (DIVIDE) DFP instruction 20-37
- dynamic address translation (DAT) 3-38
 - by LOAD REAL ADDRESS instruction 10-56
 - by STORE REAL ADDRESS instruction 10-142
 - control of 3-40
 - explicit and implicit 3-52
 - mode bit in PSW
 - use in address translation 3-40
 - mode bit in the PSW 4-6
 - sequence of table fetches 5-119
- dynamic-reconnection feature 13-3

E

- E (exa) 0-xxviii
- E instruction format 5-6
- EAR (EXTRACT ACCESS) instruction 7-256
- early exception recognition 6-9
- EAX
 - See extended authorization index
- EBCDIC (Extended Binary-Coded-Decimal Interchange Code)
 - architecture designed for 0-xxix
 - character code
 - table for 1-2
- ECAG (EXTRACT CPU ATTRIBUTE) instruction 7-256
- ECC (error checking and correction) 11-2
- ECTG (EXTRACT CPU TIME) instruction 7-259
- ECW (extended-control word) 16-56
 - indication in SCSW 16-12
- ED (EDIT) instruction 8-8
 - examples A-37
- EDIT AND MARK instruction 8-11
 - example A-38
- EDIT instruction 8-8
 - examples A-37
- editing instructions 8-4
 - See also ED instruction, EDMK instruction
- EDMK (EDIT AND MARK) instruction 8-11
 - example A-38
- EEDTR (EXTRACT BIASED EXPONENT) DFP instruction 20-39
- EEXTR (EXTRACT BIASED EXPONENT) DFP instruction 20-39
- effective access-list designation 5-55
- effective address 3-5
 - controlled by addressing mode 5-10
 - generation 5-10
 - used for storage interlocks 5-115
- effective address-space-control element 3-52
- EFPC (EXTRACT FPC) floating-point-support instruction 9-30
- EKM (entry key mask) 5-38
- emergency signal (external interruption) 6-13
 - signal-processor order 4-86
- EMIF (ESCON-multiple-image facility) 1-34
- EMW (extended-measurement word) 16-56
 - in IRB 16-56
- enabled (bit for TRAP) 10-178
- enabled (bit in PMCW) 15-3
- enabling for interruptions 6-6
 - subchannel 16-6
- enabling of subchannel 15-3, 16-6
- encoded trailing significand field
 - in DFP data format 20-5
- endian 7-287, 7-394
- ending of instruction execution 5-22
- enhanced-DAT facility 1-10
 - and change-bit override 3-10
 - and DAT protection 3-14
 - and format-control in R3TE 3-19
 - and format-control in STE 3-10, 3-19
- enhanced-DAT facility 1 1-10
 - facility indication 4-99
- enhanced-DAT facility1
 - facility indication 4-101, 7-175, 7-176
- enhanced-monitor facility 1-11
 - counter-array origin 5-110

- counter-array size 5-110
- exception count 5-110
- facility indication 4-100
- monitor masks 5-109
- enhanced-monitor masks 4-11
- enhanced-DAT-enablement control
 - and enhanced-DAT applicability 3-42
 - and the P bit in RTEs 3-47
 - definition 3-41
 - in control register 0 4-10
- Enterprise Systems Connection Architecture (ESCON) I/O interface
 - publication referenced 0-xxix
- entropy-encoding compression facility 1-11
 - facility indication 4-100
- entry
 - extended authorization index 5-76
 - key 5-76
- entry (for tracing) 4-15
- entry descriptor 5-79
- entry index (EX) 5-33
- entry key mask (EKM) 5-38
- entry table (ET)
 - designation 5-36, 5-37
 - length (ETL) 5-36, 5-37
 - origin (ETO) 5-36, 5-37
- entry-table entry (ETE) 5-37, 5-75
- entry-type code 5-79
- environment (in STORE CPU ID result) 10-139
- EPAIR (EXTRACT PRIMARY ASN AND INSTANCE) instruction 10-24
- EPAR (EXTRACT PRIMARY ASN) instruction 10-24
- epoch (for TOD clock) 4-52
 - definition 4-47
- epoch index 4-48
- epoch index (for TOD clock)
 - definition 4-47
- EPSW (EXTRACT PSW) instruction 7-260
- equipment check
 - in signal-processor status 4-97
- ERC (error-recovery code) 17-30
 - See also* CRW
- EREG (EXTRACT STACKED REGISTERS) instruction 10-25
- EREGG (EXTRACT STACKED REGISTERS) instruction 10-25
- error
 - checking and correction 11-2
 - from DIAGNOSE instruction 10-23
 - I/O-error alert 16-50
 - indirect storage 11-20
 - intermittent 11-6
 - PSW-format 6-9
 - secondary (I/O) 16-50
 - solid 11-6
 - state of TOD clock 4-49
 - storage 11-19
 - storage-key 11-19
- error-recovery code (ERC) 17-30
 - See also* CRW
- ERW (extended-report word) 16-47, 16-51
 - as result of channel-control check 16-29, 16-43
 - as result of channel-data check 16-28, 16-42, 16-43
- ESA/370 architecture 1-34
- ESA/390
 - compatibility with z/Architecture 1-37
- ESA/390 architecture
 - architectural-mode controls 12-3
- ESA/390-compatibility-mode facility 1-11, 5-111
 - facility indication 4-101
- ESAIR (EXTRACT SECONDARY ASN AND INSTANCE) instruction 10-25
- ESAR (EXTRACT SECONDARY ASN) instruction 10-24
- ESCON (Enterprise Systems Connection Architecture) 13-3
- ESCON (Enterprise Systems Connection Architecture) I/O interface
 - publication referenced 0-xxix
- ESCON channel-to-channel adapter
 - publication referenced 0-xxix
- ESCON-multiple-image facility (EMIF) 1-34
- ESDTR (EXTRACT SIGNIFICANCE) DFP instruction 20-39
- ESEA (EXTRACT AND SET EXTENDED AUTHORITY) instruction 10-24
- ESTA (EXTRACT STACKED STATE) instruction 10-26
- ESW (extended-status word) 16-47
 - See also* extended status
- ESW format bit (in SCSW) 16-9
- ESXTR (EXTRACT SIGNIFICANCE) DFP instruction 20-39
- ET
 - See* entry table
- ETE
 - See* entry-table entry
- ETF2-enhancement facility 1-11
 - facility indication 4-100
- ETF3-enhancement facility 1-11
 - facility indication 4-100
- ETL (entry-table length) 5-36, 5-37
- ETND (EXTRACT TRANSACTION NESTING DEPTH) instruction 7-260
- ETO (entry-table origin) 5-36, 5-37
- ETR (external time reference) 2-7
- ETR (external time reference) facility 1-33

- ETR sync check (machine-check condition) 11-23
- ETR-timing-alert condition
 - See timing alert
- event 6-16
 - monitor 7-287
 - PER 4-26
 - space-switch 6-37
 - transactional-execution aborted 6-46
- EX (entry index) 5-33
 - translation exception 6-26
- EX (EXECUTE)
 - See EXECUTE instruction
- EX-translation exception 6-26
- exception access identification 3-74
 - in the transaction diagnostic block 5-96
- exceptions 6-16
 - access (collective program-interruption name) 6-47, 6-53
 - addressing 6-20
 - AFX-translation 6-22
 - ALE-sequence 6-22
 - ALEN-translation 6-22
 - ALET-specification 6-22
 - ASCE-type 6-22
 - ASN-translation (collective program-interruption name) 6-55
 - associated with
 - ART 5-64
 - stacking process 5-86
 - unstacking process 5-89
 - ASTE-instance 6-23
 - ASTE-sequence 6-23
 - ASTE-validity 6-24
 - ASX-translation 6-24
 - crypto-operation 6-24
 - data 6-25
 - decimal-divide 6-26
 - decimal-overflow 6-26
 - delayed access (machine-check condition) 11-17
 - during translation 3-62
 - EX-translation 6-26
 - extended-authority 6-27
 - fixed-point-divide 6-27
 - fixed-point-overflow 6-27
 - HFP-divide 6-28
 - HFP-exponent-overflow 6-28
 - HFP-exponent-underflow 6-28
 - HFP-significance 6-28
 - HFP-square-root 6-29
 - IEEE 9-18
 - LFX-translation 6-29
 - LSTE-sequence 6-29
 - LSX-translation 6-29
 - LX-translation 6-30
 - operand (of I/O instruction) 6-31
 - operation 6-31
 - page-translation 6-32
 - PC-translation-specification 6-32
 - primary-authority 6-33
 - privileged-operation 6-33
 - protection 6-34
 - PSW-related 6-9
 - recognition of
 - early and late 6-9
 - region-first-translation 6-35
 - region-second-translation 6-36
 - region-third-translation 6-36
 - region translation 6-35
 - secondary-authority 6-37
 - segment-translation 6-37
 - special-operation 6-38
 - specification 6-40
 - stack-empty 6-44
 - stack-full 6-45
 - stack-operation 6-45
 - stack-specification 6-45
 - stack-type 6-45
 - subspace-replacement (collective program-interruption name) 6-56
 - trace (collective program-interruption name) 6-56
 - trace-table 6-45
 - transaction constraint 6-46
 - translation-specification 6-46
- EXCLUSIVE OR IMMEDIATE instructions 7-255
- EXCLUSIVE OR instructions 7-253
 - examples A-20
- execute-extensions facility 1-12
 - facility indication 4-100
- EXECUTE instruction 7-255
 - effect of address comparison on 12-1
 - example A-21
 - exceptions while fetching target of 6-8
 - PER event for target of 4-37
- EXECUTE RELATIVE LONG instruction 7-255
- execution-hint facility 1-12
 - facility indication 4-100
- exigent machine-check conditions 11-10
- expanded storage 2-2
 - block number 2-2
- expansion 4-84
- expansion dictionary
 - location of during compression 7-173
- expansion-operation bit 7-172
- expansion process
 - flowchart of 7-185
- explicit address translation 3-52
- explicit-trace-control bit 4-15
- exponent 18-1

- See also* characteristic, floating point
- overflow
 - HFP 18-1
- signed value 9-2
- underflow
 - HFP 18-1
 - mask in PSW 4-7
- exponent bias 9-2, 19-2, 20-3
 - summary for BFP 19-3
 - summary for DFP 20-6
- extended addressing mode
 - bit in entry-table entry 5-38
 - bit in trace entry 4-23
- extended-authority exception 6-27
 - as an access exception 6-47
- extended authorization 5-63
- extended authorization index (EAX) 5-54
 - control bit 5-76
 - in entry-table entry 5-76
 - in linkage-stack state entry 5-82
- extended binary-floating-point number 19-2
- extended control (bit in SCSW) 16-12
- extended-control word 16-56
 - See also* ECW
- extended decimal-floating-point number 20-4
- extended hexadecimal-floating-point number 18-2
- extended-I/O-measurement-block facility 1-12
- extended-I/O-measurement-word facility 1-12
- extended-immediate facility 1-12
 - facility indication 4-100
- extended-measurement-word 17-11
- extended-measurement-word enable (I/O)
 - update enable 15-8
- extended measurement word mode enable (I/O) 15-8
- extended-report word
 - See* ERW
- extended-save-area address
 - machine-check save area for 3-86
 - store-status save area for 3-86
- extended-sorting facility 1-33
- extended status
 - See also* ESW
 - flags in subchannel logout for 16-47
 - format-0 16-47
 - format-1 16-53
 - format-2 16-54
 - format-3 16-55
 - secondary-CCW address 16-53
- extended-status word 16-47
 - See also* extended status
- extended-status-word-format bit 16-9
- extended-subchannel-logout descriptor (in ERW) 16-53
 - in ESW 16-53
- extended-subchannel-logout pending 16-52
 - indicator for (in ERW) 16-52
- extended-translation facility 2 1-13
 - facility indication 4-100
- extended-translation facility 3 1-13
 - facility indication 4-100
- external call
 - external interruption 6-13
 - pending (signal-processor status) 4-97
 - signal-processor order 4-85
- external damage 11-16
 - subclass-mask bit for 11-27
- external-damage code 11-23
 - assigned storage locations for 3-80, 3-86
 - validity bit for 11-21
- external interruption 6-11
 - clock-comparator 6-12, 4-60
 - CPU-timer 4-63, 6-12
 - direct conditions 6-11
 - emergency-signal 6-13
 - external-call 6-13
 - interrupt-key 6-13
 - malfunction-alert 6-13
 - mask in the PSW 4-6
 - measurement-alert 6-14
 - parameter 6-11
 - assigned storage locations for 3-74, 3-84
 - pending conditions 6-11
 - priority of conditions 6-11
 - service-signal 6-14
 - timing-alert 6-14
- external time reference (ETR) 2-7
- external-time-reference (ETR) facility 1-33
- externally initiated functions 4-74
 - I/O 17-16
- EXTRACT ACCESS instruction 7-256
- EXTRACT AND SET EXTENDED AUTHORITY instruction 10-24
- EXTRACT BIASED EXPONENT DFP instructions 20-39
- extract-CPU-time facility 1-13, 7-260
 - facility indication 4-100
- EXTRACT CPU TIME instruction 7-259
- EXTRACT FPC floating-point-support instruction 9-30
- EXTRACT PRIMARY ASN AND INSTANCE instruction 10-24
- EXTRACT PRIMARY ASN instruction 10-24
- EXTRACT PSW instruction 7-260
- EXTRACT SECONDARY ASN AND INSTANCE instruction 10-25
- EXTRACT SECONDARY ASN instruction 10-24
- EXTRACT SIGNIFICANCE DFP instructions 20-39

EXTRACT STACKED REGISTERS instruction 10-25
EXTRACT STACKED STATE instruction 10-26
EXTRACT TRANSACTION NESTING DEPTH
instruction 7-260
extraction-authority-control bit 5-28

F

facility indication

access-exception-fetch/store-indication facility 4-101
ASN-and-LX-reuse facility 4-99
CMPSC-enhancement facility 4-100
compare-and-swap-and-store facility 4-100
compare-and-swap-and-store facility 2 4-100
conditional-SSKE facility 4-100
configuration-topology facility 4-100
configuration-z/architecture-architectural-mode facility 4-101
constrained transactional-execution facility 4-100
CPU-measurement-counter facility 4-101
CPU-measurement-sampling facility 4-101
DAT-enhancement facility 4-99
decimal-floating-point facility 4-100
decimal-floating-point high-performance 4-100
decimal-floating-point packed-conversion facility 4-101
decimal-floating-point zoned-conversion facility 4-100
DEFLATE-conversion facility 4-101
distinct-operands facility 4-100
enhanced-DAT facility 1 4-99, 4-101, 7-175, 7-176
enhanced-monitor facility 4-100
entropy-encoding compression facility 4-100
ESA/390-compatibility-mode facility 4-101
ETF2-enhancement facility 4-100
ETF3-enhancement facility 4-100
execute-extensions facility 4-100
execution-hint facility 4-100
extended-immediate facility 4-100
extended-translation facility 2 4-100
extended-translation facility 3 4-100
extract-CPU-time facility 4-100
fast-BCR-serialization facility 4-100
floating-point-extension facility 4-100
floating-point-support-enhancement facilities 4-100
general-instructions-extension facility 4-100
guarded-storage facility 4-101
HFP-multiply-and-add/subtract facility 4-100
HFP-unnormalized-extension facility 4-100
high-word facility 4-100
insert-reference-bits-multiple facility 4-101

instruction-execution-protection facility 4-101
interlocked-access facility 1 4-100
interlocked-access facility 2 4-100
IPTE-range facility 4-100
load-and-trap facility 4-100
load-and-zero-rightmost-byte facility 4-100
load/store-on-condition facility 1 4-100
local-TLB-clearing facility 4-100
long-displacement facility 4-100
long-displacement-facility high-performance 4-100
message-security-assist extension 3 4-101
message-security-assist extension 4 4-101
message-security-assist extension 5 4-100
message-security-assist extension 8 4-101
message-security-assist extension 9 4-101
message-security assist 4-100
miscellaneous-instruction-extensions facility 1 4-100
miscellaneous-instruction-extensions facility 2 4-100
miscellaneous-instruction-extensions facility 3 4-101
move-with-optional-specifications facility 4-100
move-page-and-set-key facility 4-101
nonquiescing key-setting facility 4-100
order-preserving-compression facility 4-100
parsing-enhancement facility 4-100
PFPO facility 4-100
population-count facility 4-100
PPA-in-order facility 4-101
processor-assist facility 4-100
reset-reference-bits-multiple facility 4-101
sense-running-status facility 4-99
set-program-parameters facility 4-100
side-effect-access facility 4-101
store-clock-fast facility 4-100
store-CPU-counter-multiple facility 4-101
store-facility-list-extended facility 4-99
store-hypervisor-information facility 4-101
test-pending-external-interruption 4-101
TOD-clock epoch-extension facility 4-101
TOD-clock-steering facility 4-100
transactional-execution facility 4-101
vector-enhancements facility 1 4-101
vector-enhancements facility 2 4-101
vector facility for z/Architecture 4-101
vector-packed-decimal-enhancement facility 4-101
vector-packed-decimal facility 4-101
z/architecture active 4-99
z/architecture installed 4-99
z/architecture instructions in ESA/390 mode 4-99
facility indications 4-99

- assigned storage locations for 3-80, 3-86
 - in ESW 16-47, 16-53
 - as result of channel-control check 16-29, 16-43
 - as result of channel-data check 16-28, 16-42, 16-43
 - validity bit for 11-21
 - validity flag for (in ERW) 16-52
- indicator for (in ERW) 16-53
- fast-BCR-serialization facility 1-13
 - facility indication 4-100
- FCX-bidirectional-data-transfer facility 1-14
- FCX facility 1-13
- fetch-only bit 5-56
- fetch protection 3-11
 - bit in segment-table entry 3-46, 3-49
 - bit in storage key 3-9
 - override-control bit 3-13
- fetch reference 5-123
 - access exceptions for 6-50
- fetching
 - handling of invalid CBC in storage during 11-8
 - of ART-table and DAT-table entries 5-119
 - of instructions 5-118
 - of PSWs during interruptions 5-130
 - of storage operands 5-123
- Fibre-Channel Extensions 13-6
- fibre-channel-extensions facility 1-13
- Fibre-Channel Extensions 13-6
- FICON I/O interface
 - publication referenced 0-xxix
- FIDBR (LOAD FP INTEGER) BFP instruction 19-32
- FIDBRA (LOAD FP INTEGER) BFP instruction 19-32
- FIDR (LOAD FP INTEGER) HFP instruction 18-15
- FIDTR (LOAD FP INTEGER) DFP instruction 20-42
- FIEBR (LOAD FP INTEGER) BFP instruction 19-32
- FIEBRA (LOAD FP INTEGER) BFP instruction 19-32
- field 3-3
- field separator (in EDIT) 8-8
- field-validity flags (in subchannel logout) 16-49
 - relation to channel-control check of 16-29
- FIER (LOAD FP INTEGER) HFP instruction 18-15
- FIFO (first in first out) queuing
 - example for lock and unlock A-49
- fill byte (in EDIT) 8-8
- filtering
 - of program interruptions 5-104
- FIND LEFTMOST ONE instruction 7-261
 - example A-22
- FIXBR (LOAD FP INTEGER) BFP instruction 19-32
- FIXBRA (LOAD FP INTEGER) BFP instruction 19-32
- fixed-length field 3-3
- fixed logout
 - assigned storage locations for 3-82
 - machine-check 11-27
- fixed point
 - See also* binary
 - divide exception 6-27
 - overflow exception 6-27
 - mask in PSW 4-7
 - See also* binary
- FIXR (LOAD FP INTEGER) HFP instruction 18-15
- FIXTR (LOAD FP INTEGER) DFP instruction 20-42
- flags
 - for IEEE exceptions 9-10
 - in the transaction diagnostic block 5-95
- floating interruption conditions 6-6, 11-25
 - clearing of 4-80
- floating point
 - See also* exponent
 - binary (BFP) 9-4
 - binary data format 19-2
 - conversion
 - between formats 9-23, 19-5
 - conversion from binary integer 18-11, 19-19, 20-24
 - conversion from unsigned binary integer 19-21, 20-25
 - conversion to binary integer 18-11, 19-22, 20-29
 - conversion to unsigned binary integer 19-25, 20-32
 - data
 - lengthening format of 18-15, 19-33, 20-45
 - shortening format of 18-17, 19-35, 20-46
 - data class 19-4
 - decimal (DFP) 9-4
 - hexadecimal (HFP) 9-3
 - hexadecimal data formats 18-2
 - instructions 9-1
 - numbers 19-2
 - registers 2-4, 9-8
 - clearing of 9-35
 - save areas for 3-82
 - validity bit for 11-21
 - shifting
 - See* normalization
- floating-point
 - registers
 - machine-check save area for 3-87
 - store-status save area for 3-87
- floating-point-control (FPC) register 9-9
 - save area for 3-82
 - validity bit for 11-22
- floating-point extension facility 1-14
- floating-point-extension facility
 - facility indication 4-100

- floating-point-support-enhancement facilities
 - facility indication 4-100
- floating-point-support-sign-handling facility 1-15
- FLOGR (FIND LEFTMOST ONE) instruction 7-261
 - example A-22
- format
 - address 3-3
 - binary-floating-point data 19-2
 - CCW
 - See CCW format control
 - decimal data 8-1
 - error
 - in DAT-table entry 6-47
 - in PSW 6-9
 - general data 7-4
 - in the transaction diagnostic block 5-94
 - information 3-3
 - instruction 5-3
 - PSW 4-5
- format-0 and format-1 CCWs 15-31
- format-2-IDAW control 15-27
- format indication (in STORE CPU ID result) 10-139, 10-140
- format-1-sibling-descriptor bit 7-173
- formats
 - hexadecimal-floating-point data 18-2
- forward section header address 5-81
- forward-section validity bit 5-81
- FPC
 - See floating-point-control (FPC) register
- FPC (floating-point-control) register 9-9
- FPR-GR-transfer facility 1-15
- fraction 18-1
- fraction view of floating-point numbers 9-2
- free-pool manipulation
 - programming example A-50
- freeze 7-179
- fullword
 - See word
- function control (I/O) 16-13
- function-pending time 17-2
 - in extended-measurement word 16-57
- functionally-constrained rounding 9-12
- functionally-rounded value 9-12
- function-pending time
 - in measurement block 17-5

G

- G (giga) 0-xxviii
- general instructions 7-4
 - examples A-7
- general-instructions-extension facility 1-15
 - facility indication 4-100

- general-operand data exception 6-25, 8-5
- general register
 - save areas 3-82
- general registers 2-4
 - machine-check save area for 3-87
 - store-status save area for 3-87
 - validity bit for 11-21
- glue module 5-21
- GMT (Greenwich Mean Time) obsolete term for UTC 4-52
- Greenwich Mean Time (GMT) obsolete term for Coordinated Universal Time 4-52
- guard digit 18-4
- guarded-storage facility 1-16, 4-65
 - facility indication 4-101
 - guarded-storage-event parameter list 4-67
 - guarded-storage-facility registers 4-65
 - guarded-storage-designation register 4-66
 - guarded-storage-event-parameter-list register 4-67
 - guarded-storage-facility-enablement control 4-65
 - guarded-storage-section-mask register 4-66
 - operation 4-70
 - event detection 4-70
 - event processing 4-71

H

- halfword 3-3
- halfword-concurrent storage references 5-127
- halt function 15-16
 - bit in SCSW for 16-13
 - completion of 15-17
 - initiated by HALT SUBCHANNEL 14-6
 - path management for 15-16
 - pending 16-16
 - signaling for 15-17
- halt signal 17-12
 - issued as part of halt function 15-17
- HALT SUBCHANNEL instruction 14-6
 - See also halt function
 - effect on SCSW count field 15-19
 - function initiated by 15-16
 - use of after RESET CHANNEL PATH 14-10
- HALVE HFP instructions 18-13
 - example A-43
- HASCE (home address-space-control element) 3-45
- HDR (HALVE) HFP instruction 18-13
 - example A-43
- HER (HALVE) HFP instruction 18-13
- hex
 - See hexadecimal
- hexadecimal (hex) representation 5-7

- hexadecimal floating point
 - conversion
 - examples with instructions A-44
 - instructions
 - examples A-41
- hexadecimal floating point (HFP) 9-3
 - conversion
 - basic example A-6
- hexadecimal-floating-point number
 - examples A-5
- HFP (hexadecimal floating point) 9-3
- HFP data 18-2
 - conversion of 9-27
- HFP exponent
 - overflow
 - exception 6-28
 - underflow
 - exception 6-28
- HFP-multiply-and-add/subtract facility 1-16
 - facility indication 4-100
- HFP significance
 - exception 6-28
- HFP square root
 - exception 6-29
- HFP-unnormalized-extension facility 1-16
 - facility indication 4-100
- HFP-unnormalized-extensions facility 1-16
- high-speed data transfer (I/O) 13-4
- high-word facility 1-16
 - facility indication 4-100
- home address space 3-23, 5-44
 - facilities 5-44
- home designation-type-control bits 3-45
- home private-space-control bit 3-45
- home real-space-control bit 3-45
- home real-space token origin (HRSTKO) 3-45
- home region table
 - designation (HRTD) 3-45
 - length (HRTL) 3-45
 - origin (HRTO) 3-45
- home segment table
 - designation (HSTD) 3-45
 - length (HSTL) 3-45
 - origin (HSTO) 3-45
- home-space mode 3-40
- home space-switch-event-control bit 3-45
- home storage-alteration-event-control bit 3-45
- home virtual address 3-5
 - effective address-space-control element for 3-52
- HRSD (home real-space designation) 3-45
- HRTD (home region-table designation) 3-45
- HRTL (home region-table length) 3-45
- HRTO (home region-table origin) 3-45
- HSCH (HALT SUBCHANNEL) instruction 14-6

- HSTD (home segment-table designation) 3-45
- HSTL (home segment-table length) 3-45
- HSTO (home segment-table origin) 3-45

I

- I field of instruction 5-8
- I instruction format 5-6
- I/O (input/output) 2-7
 - basic functions of 15-1
 - blocking of data for 15-24
 - effect on CPU timer 4-63
 - sense data
 - See* sense data
 - support functions of 17-1
- I/O addressing 13-5
- I/O-command words
 - CCW 13-7
 - DCW 13-7
- I/O commands
 - See also* commands
 - publication referenced 0-xxix
- I/O device
 - See* device
- I/O-error alert (in subchannel logout) 16-50
- I/O instructions 14-2
 - deferred condition code for 16-9
 - operand access by 14-2
 - role of in I/O operations 13-8
- I/O interface
 - ESCON publication referenced 0-xxix
 - OEMI publication referenced 0-xxix
- I/O interruption 6-15, 16-1
 - See also* interruption
 - action for 16-6
 - mask in the PSW 4-6
 - masking of 13-12
 - priority of 16-5
 - program-controlled interrupton
 - See* PCI)
- I/O-interruption code 6-15
 - interruption-identification word in 14-20
 - stored by TPI 14-20
- I/O-interruption condition 13-12, 16-2
 - alert 16-5
 - intermediate 16-4
 - primary 13-10, 16-4
 - secondary 13-10, 16-5
 - solicited 16-3
 - unsolicited 16-3
- I/O-interruption-identification word 14-20
 - assigned storage locations for 3-79, 3-85
- I/O-interruption parameter
 - assigned storage locations for 3-79, 3-85

- in I/O-interruption code 14-20
- in ORB 15-25
- in PMCW 15-2
- used for IPL 17-17
- I/O-interruption request
 - clearing of 13-12
 - from subchannels 16-6
- I/O-interruption subclass 13-12
- I/O-interruption subclass code
 - See ISC
- I/O-interruption subclass mask 6-16, 16-6
 - relation to priority 16-5
- I/O operations 13-8
 - conclusion of
 - See conclusion of I/O operations
 - initiated indication for 16-12
 - termination of
 - See conclusion of I/O operations
- I/O-system reset 17-13
 - as part of subsystem reset 4-80
- IAC (INSERT ADDRESS SPACE CONTROL) instruction 10-29
- IC (INSERT CHARACTER) instruction 7-261
- IC (instruction counter)
 - See instruction address
- ICM (INSERT CHARACTERS UNDER MASK) instruction 7-261
 - examples A-23
- ICMH (INSERT CHARACTERS UNDER MASK) instruction 7-261
- ICMY (INSERT CHARACTERS UNDER MASK) instruction 7-261
- ICY (INSERT CHARACTER) instruction 7-261
- IDA (indirect-data address) 15-66
 - flag in CCW 15-32
- IDAW (indirect-data-address word) 15-66
 - check (in subchannel logout) 16-48
 - invalid address of 16-25
 - invalid address specification in 16-25
 - invalid address specification of 16-26
- idle state for subchannel 16-14
- IDTE (INVALIDATE DAT TABLE ENTRY) instruction 10-32
- IEDTR (INSERT BIASED EXPONENT) DFP instruction 20-40
- IEEE exception conditions
 - summary figure 19-10, 24-2
- IEEE-exception data exception 6-25, 9-18
- IEEE-exception-simulation facility 1-17
- IEEE rounding 9-13
- IEEE standard 1-32
- IEEE trap action and nontrap action 9-18
- IEEE-exception data exception 19-10, 24-2
- IEXTR (INSERT BIASED EXPONENT) DFP instruction 20-40
- IFCC (interface-control check) 16-29
- IIHF (INSERT IMMEDIATE) instruction 7-262
- IIHH (INSERT IMMEDIATE) instruction 7-262
- IIHL (INSERT IMMEDIATE) instruction 7-262
- IILF (INSERT IMMEDIATE) instruction 7-262
- IILH (INSERT IMMEDIATE) instruction 7-262
- IILL (INSERT IMMEDIATE) instruction 7-262
- ILC (instruction-length code) 6-7
 - assigned storage locations for 3-74, 3-84
 - for program interruptions 6-16
- IML (initial machine loading) controls 12-3
- immediate operand 5-8
- immediate operation
 - SLI flag in CCW for 15-60
- implicit address translation 3-52
- in DFP data 20-5
- incorrect length (subchannel status) 16-24, 16-39
 - for immediate operations 15-60
- incorrect-length-indication mode 15-28
- incorrect-length-indication-suppression facility 17-27
 - effect on immediate operation 15-60
- incorrect-length-suppression mode 15-28
- incorrect state (signal-processor status) 4-97
- index
 - for address generation 5-11
 - instructions for branching on 7-41
 - into access list 5-54
 - into ASN first and second tables 3-30
 - into authority table 5-29
 - into entry and linkage tables 5-33
 - register for 2-4
- indicator
 - check-stop 12-3
 - CPUs-per-core 12-3
 - load 12-3
 - manual 12-4
 - mode 12-2, 12-3
 - test 12-6
 - wait 12-6
- indirect-data address
 - See IDA
- indirect-data-address word
 - See IDAW
- indirect storage error 11-20
- infinities 9-2, 19-4
 - classes of DFP data 20-7
- information format 3-3
- initial-command-response measurement (I/O) 17-9
- initial-command-response time (in measurement block) 17-6
- initial CPU reset 4-79
 - signal-processor order 4-86

- initial-machine-loading (IML) controls 12-3
- initial program loading
 - See IPL
- initial-program-loading CCW1 (assigned storage locations) 3-73, 3-83
- initial-program-loading CCW2 (assigned storage locations) 3-74, 3-83
- initial-program-loading PSW (assigned storage locations) 3-73, 3-83
- initial-status-interruption control 15-27, 16-12
 - relation to Z bit 16-12
 - used for IPL 17-17
- inoperative (signal-processor status) 4-98
- input/output
 - See I/O
- INSERT ADDRESS SPACE CONTROL instruction 10-29
- INSERT BIASED EXPONENT DFP instructions 20-40
- INSERT CHARACTER instructions 7-261
- INSERT CHARACTERS UNDER MASK instruction 7-261
 - examples A-23
- INSERT IMMEDIATE instructions 7-262
- INSERT PROGRAM MASK instruction 7-263
- INSERT PSW KEY instruction 10-30
- INSERT REFERENCE BIT MULTIPLE instruction 10-30
- insert-reference-bits-multiple facility 1-17
 - facility indication 4-101
- INSERT STORAGE KEY EXTENDED instruction 10-30
- INSERT VIRTUAL STORAGE KEY instruction 10-31
- installation 2-1
- instruction address
 - as a type of address 3-5
 - handling by DAT 3-40
 - in entry-table entry 5-38
 - in the PSW 4-7
 - validity bit for 11-21
- instruction-execution protection 3-10
- instruction-execution-protection facility 1-17, 3-14
 - facility indication 4-101
- instruction-fetching-nullification-event mask 4-27
- instruction format 5-6
- instruction-length code
 - preserved by BRANCH AND LINK 5-15, 7-35
 - See ILC
- instruction-processing damage 11-15
 - resulting in processing backup 11-18
 - resulting in processing damage 11-19
- instructions
 - See also instruction lists and page numbers in Appendix B
- backing up of 11-18
- classes of 2-2
- control 10-1
- damage to 11-15, 11-19
- decimal 8-1
 - examples A-36
- divisible execution of 5-115
- ending of 5-22
- examples of use A-7
- execution of 5-14
- fetching of 5-118
 - access exception for 6-47
 - PER event for 4-37
 - PER-event mask for 4-27
- floating-point 9-1
- format of 5-3
- general 7-4
 - examples A-7
- hexadecimal-floating-point
 - examples A-41
- I/O
 - See I/O Instructions 13-1
- interruptible
 - See interruptible instructions
- length of 5-7
- list of B-1
- modification by execute-type instruction 7-255
- prefetching of 5-118
- privileged 4-6
 - for control 10-1
- See instruction lists and page numbers in Appendix B
- semiprivileged 4-6, 10-2
- sequence of execution of 5-3
- stepping of (rate control) 12-5
 - effect on CPU state 4-2
 - effect on CPU timer 4-64
- unprivileged 4-6, 7-4
- integer
 - binary 7-4
 - address as 5-11
 - conversion from floating point 18-11, 19-22, 19-25, 20-29, 20-32
 - conversion to floating point 18-11, 19-19, 20-24, 20-25
 - examples A-2
 - decimal 8-3
 - unsigned binary
 - conversion to floating point 19-21
- integer quotient 19-28
- integral boundary 3-3
 - octoword 3-3
- interface
 - ESCON I/O

- publication referenced 0-xxix
- parallel-I/O
 - OEMI publication referenced 0-xxix
- serial-I/O
 - publication referenced 0-xxix
- interface-control check (subchannel status) 16-29
- interlocked-access facility 1 1-17
 - facility indication 4-100
- interlocked-access facility 2 1-17
 - facility indication 4-100
- interlocked-update storage reference 5-123, 5-124
- interlocks for virtual storage references 5-115
- intermediate interruption condition (I/O) 16-4
- intermediate-status bit (I/O) 16-18, 16-36
- intermediate values 9-12
- intermittent errors 11-6
- International Atomic Time (TAI) related to
 - Coordinated Universal Time 4-52
- interpretive execution
 - publication referenced 0-xxx
- interpretive-execution facility 1-35
- interrogate TCW
 - address of 15-36
- interrupt-delay time (in measurement block) 17-6
- interrupt key 12-3
 - external interruption 6-13
- interruptible instructions 5-24
 - COMPARE AND FORM CODEWORD 7-136
 - COMPARE LOGICAL LONG 7-158
 - COMPARE UNTIL SUBSTRING EQUAL 7-168
 - MOVE LONG 7-291
 - PER event affecting the ending of 4-34
 - stopping of 4-2
 - TEST BLOCK 10-171
 - UPDATE TREE 7-426
- interruption 6-2
 - See also* masks
 - action 6-2
 - I/O 16-6
 - machine-check 11-11
 - classes of 6-5
 - effect on instruction sequence 5-22
 - external
 - See* external interruption
 - I/O
 - See* I/O interruption
 - machine-check
 - See* machine-check interruption
 - masking of 6-6
 - pending 6-6
 - external 6-11
 - machine-check 11-13
 - relation to CPU state 4-2
 - priority of
 - See* priority
 - program
 - See* program interruption
 - program-controlled (I/O)
 - See* PCI
 - restart 6-56
 - string
 - See* string of interruptions
 - supervisor-call 6-57
- interruption code 6-5
 - external 6-11
 - I/O
 - See* I/O-interruption code
 - machine-check (MCIC) 3-80, 3-86, 11-14
 - program 6-16
 - summary of 6-2
- interruption conditions 6-2
 - clearing of 4-78
 - floating 6-6, 11-25
 - I/O
 - See* I/O-interruption condition
- interruption parameter
 - external (assigned storage locations) 3-74, 3-84
 - I/O
 - See* I/O-interruption parameter
- interruption-response block
 - See* IRB
- interruption subclass
 - See* I/O-interruption subclass
- invalid
 - access-list entry 5-56
 - address 6-20
 - bit in ASN-first-table entry 3-31
 - bit in ASN-second-table entry 3-31
 - bit in linkage-first-table entry 5-36
 - bit in linkage-second-table entry 5-37
 - bit in linkage-table entry 5-36
 - bit in page-table entry 3-51
 - bit in region-table entry 3-47
 - bit in segment-table entry 3-50
 - CBC 11-2
 - in registers 11-9
 - in storage 11-7
 - in storage keys 11-7
 - operation code 6-31
 - order (signal-processor status) 4-98
 - parameter (signal-processor status) 4-97
 - translation address 3-62
 - translation format
 - exception recognition 3-62
- invalid address specification
 - in channel-program address 16-25, 16-40
 - in IDAW 16-26
 - in MIDAW 16-26

- of data in CCW 16-26
- of IDAW 16-25
- of TIC CCW 16-25, 16-40
- invalid CCW field
 - command code 16-25
 - count 16-25
 - data address 16-26
 - MIDA flag 16-27
 - suspend flag 16-27
- invalid format
 - of CCW 16-27
 - of ORB 16-27
- invalid sequence of CCWs 16-27
- INVALIDATE DAT TABLE ENTRY instruction 10-32
- INVALIDATE PAGE TABLE ENTRY instruction 10-37
 - effect of when CPU is stopped 4-3
- inverse move
 - See* MOVE INVERSE instruction, move-inverse facility
- IPK (INSERT PSW KEY) instruction 10-30
- IPL (initial program loading) 4-81, 17-16
- IPM (INSERT PROGRAM MASK) instruction 7-263
- IPTE (INVALIDATE PAGE TABLE ENTRY) instruction 10-37
 - IPTE-range facility 1-17
 - facility indication 4-100
- IRB (interruption-response block) 16-6
 - See also* ECW, ERW, ESW, SCSW
 - storage requirements for 16-13
- IRBM (INSERT REFERENCE BIT MULTIPLE) instruction 10-30
- ISC (I/O-interruption-subclass code) 15-2
 - enhanced 14-20
- ISKE (INSERT STORAGE KEY EXTENDED) instruction 10-30
- isolated state 16-52
- IVSK (INSERT VIRTUAL STORAGE KEY) instruction 10-31

K

- K (kilo) 0-xxviii
- KDB (COMPARE AND SIGNAL) BFP instruction 19-18
- KDBR (COMPARE AND SIGNAL) BFP instruction 19-18
- KDSA (COMPUTE DIGITAL SIGNATURE AUTHENTICATION) 26-2
- KDTR (COMPARE AND SIGNAL) DFP instruction 20-23
- KEB (COMPARE AND SIGNAL) BFP instruction 19-18

- KEBR (COMPARE AND SIGNAL) BFP instruction 19-18
- key
 - access
 - See* access key
 - manual
 - See* manual operation
 - PSW
 - See* PSW key
 - storage
 - See* storage key
 - subchannel
 - See* subchannel key
- key check (in subchannel logout) 16-47
- key-controlled protection 3-11
 - exception for 6-34
- key mask
 - authorization 5-38
 - entry 5-38
 - PSW (PKM) 5-28
- KIMD (COMPUTE INTERMEDIATE MESSAGE DIGEST) instruction 7-187
- KLMD (COMPUTE LAST MESSAGE DIGEST) instruction 7-200
- KM (CIPHER MESSAGE) instruction 7-52
- KMA (CIPHER MESSAGE WITH AUTHENTICATION) instruction 7-77
- KMAC (COMPUTE MESSAGE AUTHENTICATION CODE) instruction 7-218
- KMC (CIPHER MESSAGE WITH CHAINING) instruction 7-52
- KMCTR (CIPHER MESSAGE WITH COUNTER) instruction 7-106
- KMF (CIPHER MESSAGE WITH CIPHER FEEDBACK) instruction 7-91
- KMO (CIPHER MESSAGE WITH OUTPUT FEEDBACK) instruction 7-119
- KXBR (COMPARE AND SIGNAL) BFP instruction 19-18
- KXTR (COMPARE AND SIGNAL) DFP instruction 20-23

L

- L (LOAD) binary instruction 7-263
 - example A-23
- L fields of instruction 5-9
- LA (LOAD ADDRESS) instruction 7-265
 - examples A-23
- LAA (LOAD AND ADD) instruction 7-267
- LAAG (LOAD AND ADD) instruction 7-267
- LAAL (LOAD AND ADD LOGICAL) instruction 7-267
- LAALG (LOAD AND ADD LOGICAL) instruction 7-267

LAE (LOAD ADDRESS EXTENDED) instruction 7-265
 LAEY (LOAD ADDRESS EXTENDED) instruction 7-265
 LAM (LOAD ACCESS MULTIPLE) instruction 7-264
 LAMY (LOAD ACCESS MULTIPLE) instruction 7-264
 LAN (LOAD AND AND) instruction 7-268
 LANG (LOAD AND AND) instruction 7-268
 LAO (LOAD AND OR) instruction 7-269
 LAOG (LOAD AND OR) instruction 7-269
 LARL (LOAD ADDRESS RELATIVE LONG) instruction 7-266
 LASP (LOAD ADDRESS SPACE PARAMETERS) instruction 10-41
 last-path-used mask
 See LPUM
 LAT (LOAD AND TRAP) instruction 7-270
 late exception recognition 6-10
 LATG (LOAD LOGICAL AND TRAP) instruction 7-270
 LATH (LOAD HIGH AND TRAP) instruction 7-277
 LAX (LOAD AND EXCLUSIVE OR) instruction 7-268
 LAXG (LOAD AND EXCLUSIVE OR) instruction 7-268
 LAY (LOAD ADDRESS) instruction 7-265
 LB (LOAD BYTE) instruction 7-271
 LBH (LOAD BYTE HIGH) instruction 7-271
 LBR (LOAD BYTE) binary instruction 7-271
 LCCB (LOAD COUNT TO BLOCK BOUNDARY) binary instruction 7-272
 LCDBR (LOAD COMPLEMENT) BFP instruction 19-31
 LCDFR (LOAD COMPLEMENT) floating-point-support instruction 9-31
 LCDR (LOAD COMPLEMENT) HFP instruction 18-14
 LCEBR (LOAD COMPLEMENT) BFP instruction 19-31
 LCER (LOAD COMPLEMENT) HFP instruction 18-14
 LCGFR (LOAD COMPLEMENT) binary instruction 7-272
 LCGR (LOAD COMPLEMENT) binary instruction 7-272
 LCR (LOAD COMPLEMENT) binary instruction 7-271
 LCTL (LOAD CONTROL) instruction 10-50
 LCTLG (LOAD CONTROL) instruction 10-50
 LCXBR (LOAD COMPLEMENT) BFP instruction 19-31
 LCXR (LOAD COMPLEMENT) HFP instruction 18-14
 LD (LOAD) floating-point-support instruction 9-31
 LDE (LOAD LENGTHENED) HFP instruction 18-15
 LDEB (LOAD LENGTHENED) BFP instruction 19-34
 LDEBR (LOAD LENGTHENED) BFP instruction 19-33
 LDER (LOAD LENGTHENED) HFP instruction 18-15
 LDETR (LOAD LENGTHENED) DFP instruction 20-45
 LDGR (LOAD FPR FROM GR) floating-point-support instruction 9-34
 LDR (LOAD) floating-point-support instruction 9-31
 LDXB (LOAD ROUNDED) BFP instruction 19-35
 LDXBRA (LOAD ROUNDED) BFP instruction 19-35
 LDXR (LOAD ROUNDED) HFP instruction 18-17
 LDXTR (LOAD ROUNDED) DFP instruction 20-46
 LDY (LOAD) floating-point-support instruction 9-31
 LE (LOAD) floating-point-support instruction 9-31
 leaf
 DAT-table entry 3-42, 3-53, 3-54, 3-65, 3-46
 LEDBR (LOAD ROUNDED) BFP instruction 19-35
 LEDBRA (LOAD ROUNDED) BFP instruction 19-35
 LEDR (LOAD ROUNDED) HFP instruction 18-17
 LEDTR (LOAD ROUNDED) DFP instruction 20-46
 left-to-right addressing 3-2
 left-units view (LUV) of floating-point numbers 9-2
 length
 field 3-3
 instruction 5-7
 of BFP data
 decreasing 19-35
 increasing 19-33
 of DFP data
 decreasing 20-46
 increasing 20-45
 of HFP data
 decreasing 18-17
 increasing 18-15
 register-operand 5-8
 second operand same as first 5-8
 variable (storage operand) 5-9
 LER (LOAD) floating-point-support instruction 9-31
 LEXBR (LOAD ROUNDED) BFP instruction 19-35
 LEXBRA (LOAD ROUNDED) BFP instruction 19-35
 LEXR (LOAD ROUNDED) HFP instruction 18-17
 LEY (LOAD) floating-point-support instruction 9-31
 LFAS (LOAD FPC AND SIGNAL) floating-point-support instruction 9-32
 LFH (LOAD HIGH) instruction 7-277
 LFPC (LOAD FPC) floating-point-support instruction 9-31
 LFT (linkage first table) 5-36
 LFTD (linkage-first-table designation) 5-36
 LFTL (linkage-first-table length) 5-36
 LFTO (linkage-first-table origin) 5-36
 LFX (linkage first index)

LLH (LOAD LOGICAL HALFWORD) instruction 7-279
 LLHH (LOAD LOGICAL HALFWORD HIGH) instruction 7-280
 LLHR (LOAD LOGICAL HALFWORD) binary instruction 7-279
 LLHRL (LOAD LOGICAL RELATIVE LONG) binary instruction 7-279
 LLIHF (LOAD LOGICAL IMMEDIATE) instruction 7-280
 LLIHH (LOAD LOGICAL IMMEDIATE) instruction 7-280
 LLIHL (LOAD LOGICAL IMMEDIATE) instruction 7-280
 LLILF (LOAD LOGICAL IMMEDIATE) instruction 7-280
 LLILH (LOAD LOGICAL IMMEDIATE) instruction 7-280
 LLILL (LOAD LOGICAL IMMEDIATE) instruction 7-280
 LLTG (LOAD AND TRAP) instruction 7-270
 LLTGF (LOAD LOGICAL AND TRAP) instruction 7-278
 LLTGT (LOAD LOGICAL THIRTY ONE BITS AND TRAP) instruction 7-281
 LLZRGF (LOAD LOGICAL AND ZERO RIGHTMOST BYTE) binary instruction 7-278
 LM (LOAD MULTIPLE) instruction 7-281
 LMD (LOAD MULTIPLE DISJOINT) instruction 7-282
 LMG (LOAD MULTIPLE) instruction 7-281
 LMH (LOAD MULTIPLE HIGH) instruction 7-282
 LMY (LOAD MULTIPLE) instruction 7-281
 LNDBR (LOAD NEGATIVE) BFP instruction 19-34
 LNDFR (LOAD NEGATIVE) floating-point-support instruction 9-34
 LNDR (LOAD NEGATIVE) HFP instruction 18-16
 LNEBR (LOAD NEGATIVE) BFP instruction 19-34
 LNER (LOAD NEGATIVE) HFP instruction 18-16
 LNGFR (LOAD NEGATIVE) binary instruction 7-283
 LNGR (LOAD NEGATIVE) binary instruction 7-282
 LNR (LOAD NEGATIVE) binary instruction 7-282
 LNXBR (LOAD NEGATIVE) BFP instruction 19-34
 LNXR (LOAD NEGATIVE) HFP instruction 18-16
 LOAD ACCESS MULTIPLE instructions 7-264
 LOAD ADDRESS EXTENDED instruction 7-265
 LOAD ADDRESS instructions 7-265
 examples A-23
 LOAD ADDRESS RELATIVE LONG instruction 7-266
 LOAD ADDRESS SPACE PARAMETERS instruction 10-41
 LOAD AND ADD instructions 7-267
 LOAD AND ADD LOGICAL instructions 7-267
 LOAD AND AND instructions 7-268
 LOAD AND EXCLUSIVE OR instructions 7-268
 LOAD AND OR instructions 7-269
 LOAD AND TEST BFP instructions 19-31
 LOAD AND TEST binary instruction 7-269
 LOAD AND TEST DFP instructions 20-41
 LOAD AND TEST HFP instructions 18-13
 LOAD AND TRAP binary instructions 7-270
 load-and-trap facility 1-18
 facility indication 4-100
 LOAD AND ZERO RIGHTMOST BYTE binary instructions 7-270
 load-and-zero-rightmost-byte facility 1-18
 facility indication 4-100
 LOAD binary instructions 7-263
 example A-23
 LOAD BYTE HIGH instruction 7-271
 LOAD BYTE instructions 7-271
 load-clear key 12-4
 load-clear-list-directed key 12-4
 LOAD COMPLEMENT BFP instructions 19-31
 LOAD COMPLEMENT binary instruction 7-271
 LOAD COMPLEMENT floating-point-support instruction 9-31
 LOAD COMPLEMENT HFP instructions 18-14
 LOAD CONTROL instructions 10-50
 LOAD COUNT TO BLOCK BOUNDARY binary instruction 7-272
 LOAD floating-point-support instructions 9-31
 LOAD FP INTEGER BFP instructions 19-32
 LOAD FP INTEGER DFP instructions 20-42
 LOAD FP INTEGER HFP instructions 18-15
 LOAD FPC AND SIGNAL floating-point-support instruction 9-32
 LOAD FPC floating-point-support instruction 9-31
 LOAD FPR FROM GR floating-point-support instruction 9-34
 LOAD GR FROM FPR floating-point-support instruction 9-34
 LOAD GUARDED instruction 7-273
 LOAD GUARDED STORAGE CONTROLS instruction 7-274
 LOAD HALFWORD binary 7-275
 LOAD HALFWORD HIGH IMMEDIATE ON CONDITION binary instruction 7-276
 LOAD HALFWORD HIGH instruction 7-276
 LOAD HALFWORD IMMEDIATE instruction 7-275
 LOAD HALFWORD IMMEDIATE ON CONDITION binary instruction 7-276
 LOAD HALFWORD instruction
 examples A-24
 LOAD HALFWORD RELATIVE LONG instructions 7-275
 LOAD HIGH AND TRAP instruction 7-277
 LOAD HIGH instruction 7-277

LOAD HIGH ON CONDITION instructions 7-283
 LOAD IMMEDIATE instruction 7-263
 load indicator 12-3
 LOAD LENGTHENED BFP instructions 19-33
 LOAD LENGTHENED DFP instructions 20-45
 LOAD LENGTHENED HFP instructions 18-15
 LOAD LOGICAL AND SHIFT GUARDED instruction 7-273
 LOAD LOGICAL AND TRAP instruction 7-278
 LOAD LOGICAL AND ZERO RIGHTMOST BYTE binary instruction 7-278
 LOAD LOGICAL CHARACTER HIGH instruction 7-279
 LOAD LOGICAL CHARACTER instructions 7-278
 LOAD LOGICAL HALFWORD HIGH instruction 7-280
 LOAD LOGICAL HALFWORD instructions 7-279
 LOAD LOGICAL HALFWORD RELATIVE LONG instructions 7-279
 LOAD LOGICAL IMMEDIATE instructions 7-280
 LOAD LOGICAL instructions 7-277
 LOAD LOGICAL RELATIVE LONG binary instruction 7-277
 LOAD LOGICAL THIRTY ONE BITS AND TRAP instruction 7-281
 LOAD LOGICAL THIRTY ONE BITS instructions 7-280
 LOAD MULTIPLE DISJOINT instruction 7-282
 LOAD MULTIPLE HIGH instruction 7-282
 LOAD MULTIPLE instructions 7-281
 LOAD NEGATIVE BFP instructions 19-34
 LOAD NEGATIVE binary instruction 7-282
 LOAD NEGATIVE floating-point-support instruction 9-34
 LOAD NEGATIVE HFP instructions 18-16
 load-normal key 12-4
 LOAD ON CONDITION instructions 7-283
 LOAD PAGE-TABLE-ENTRY ADDRESS instruction 10-50
 LOAD PAIR DISJOINT instructions 7-284
 LOAD PAIR FROM QUADWORD instruction 7-285
 LOAD POSITIVE BFP instructions 19-35
 LOAD POSITIVE binary instruction 7-286
 LOAD POSITIVE floating-point-support instruction 9-34
 LOAD POSITIVE HFP instructions 18-16
 LOAD PSW EXTENDED instruction 10-55
 LOAD PSW instruction 10-54
 LOAD REAL ADDRESS instructions 10-56
 LOAD RELATIVE LONG instruction 7-263
 LOAD REVERSED instructions 7-286
 LOAD ROUNDED BFP instructions 19-35
 LOAD ROUNDED DFP instructions 20-46
 LOAD ROUNDED HFP instructions 18-17
 load state 4-2, 4-3
 during CCW-type IPL 4-82
 load/store-on-condition facility 1 1-18
 facility indication 4-100
 load-unit-address controls 12-4
 LOAD USING REAL ADDRESS instruction 10-60
 load-with-dump key 12-4
 LOAD ZERO floating-point-support instructions 9-35
 load/store-on-condition facility 2 1-18
 loading, initial
 See IML, IPL
 LOC (LOAD ON CONDITION) instruction 7-283
 local-TLB-clearing facility 1-18
 facility indication 4-100
 location 3-2
 not available in configuration 6-20
 See also address
 LOCFH (LOAD HIGH ON CONDITION) binary instruction 7-283
 LOCFHR (LOAD HIGH ON CONDITION) binary instruction 7-283
 LOCG (LOAD ON CONDITION) instruction 7-283
 LOCGHI (LOAD HALFWORD HIGH IMMEDIATE ON CONDITION) binary instruction 7-276
 LOCGR (LOAD ON CONDITION) instruction 7-283
 LOCHHI (LOAD HALFWORD HIGH IMMEDIATE ON CONDITION) binary instruction 7-276
 LOCHI (LOAD HALFWORD IMMEDIATE ON CONDITION) binary instruction 7-276
 lock A-47
 example with FIFO queuing A-49
 example with LIFO queuing A-48
 lock used by PERFORM LOCKED OPERATION instruction 7-347
 LOCR (LOAD ON CONDITION) instruction 7-283
 logical
 arithmetic (unsigned binary) 7-6
 comparison 7-7
 connective
 AND 7-33, 7-34
 EXCLUSIVE OR 7-254, 7-255
 OR 7-312, 7-313
 data 7-4
 logical address 3-5
 handling by DAT 3-40
 logical-path mask
 See LPM
 I/O-interruption
 See I/O-interruption subclass mask
 logical string assist 1-30
 logically partitioned (LPAR) mode 1-34, 1-36
 logout
 fixed
 assigned storage locations for 3-82

- machine-check 11-27
- subchannel (I/O) 16-47
- long binary-floating-point number 19-2
- long decimal-floating-point number 20-3
- long-displacement facility 1-18
 - facility indication 4-100
- long hexadecimal-floating-point number 18-2
- long I/O block 16-24, 16-39
- loop control 5-14
- loop of interruptions
 - See string of interruptions
- low-address protection 3-14
 - control bit 3-14
 - exception for 6-34
- LPAR (logically partitioned) mode 1-34, 1-36
- LPD (LOAD PAIR DISJOINT instructions 7-284
- LPDBR (LOAD POSITIVE) BFP instruction 19-35
- LPDFR (LOAD POSITIVE) floating-point-support instruction 9-34
- LPDG (LOAD PAIR DISJOINT instructions 7-284
- LPDR (LOAD POSITIVE) HFP instruction 18-16
- LPEBR (LOAD POSITIVE) BFP instruction 19-35
- LPER (LOAD POSITIVE) HFP instruction 18-16
- LPGFR (LOAD POSITIVE) binary instruction 7-286
- LPGR (LOAD POSITIVE) binary instruction 7-286
- LPM (logical-path mask) 15-5, 15-28, 15-30
 - effect on system performance of 15-11
 - used for IPL 17-17
- LPQ (LOAD PAIR FROM QUADWORD) instruction 7-285
- LPR (LOAD POSITIVE) binary instruction 7-286
- LPSW (LOAD PSW) instruction 10-54
- LPSWE (LOAD PSW EXTENDED) instruction 10-55
- LPTEA (LOAD PAGE-TABLE-ENTRY ADDRESS) instruction 10-50
- LPUM (last-path-used mask) 15-6
 - in ESW 16-49
 - field-validity flag for (in subchannel logout) 16-49
- LPXBR (LOAD POSITIVE) BFP instruction 19-35
- LPXR (LOAD POSITIVE) HFP instruction 18-16
- LR (LOAD) binary instruction 7-263
- LRA (LOAD REAL ADDRESS) instruction 10-56
- LRAG (LOAD REAL ADDRESS) instruction 10-56
- LRAY (LOAD REAL ADDRESS) instruction 10-56
- LRDR (LOAD ROUNDED) HFP instruction 18-17
- LRER (LOAD ROUNDED) HFP instruction 18-17
- LRL (LOAD RELATIVE LONG) binary instruction 7-263
- LRV (LOAD REVERSED) instruction 7-286
- LRVG (LOAD REVERSED) instruction 7-286
- LRVGR (LOAD REVERSED) instruction 7-286
- LRVH (LOAD REVERSED) instruction 7-286
- LRVR (LOAD REVERSED) instruction 7-286
- LST (linkage second table) 5-37
- LSTO (linkage-second-table origin) 5-36
- LSX (linkage first index)
 - translation exception 6-29
- LSX (linkage second index)
 - invalid bit 5-37
- LT (linkage table) 5-36
- LT (LOAD AND TEST) instruction 7-270
- LTD (linkage-table designation) 5-35
- LTDBR (LOAD AND TEST) BFP instruction 19-31
- LTDR (LOAD AND TEST) HFP instruction 18-13
- LTDR (LOAD AND TEST) DFP instruction 20-41
- LTEBR (LOAD AND TEST) BFP instruction 19-31
- LTER (LOAD AND TEST) HFP instruction 18-13
- LTG (LOAD AND TEST) instruction 7-270
- LTGF (LOAD AND TEST) binary instruction 7-270
- LTGFR (LOAD AND TEST) binary instruction 7-269
- LTGR (LOAD AND TEST) binary instruction 7-269
- LTL (linkage-table length) 5-35
- LTO (linkage-table origin) 5-35
- LTR (LOAD AND TEST) binary instruction 7-269
- LTXBR (LOAD AND TEST) BFP instruction 19-31
- LTXR (LOAD AND TEST) HFP instruction 18-14
- LTXTR (LOAD AND TEST) DFP instruction 20-41
- LURA (LOAD USING REAL ADDRESS) instruction 10-60
- LURAG (LOAD USING REAL ADDRESS) instruction 10-60
- LUV (left-units view) of floating-point numbers 9-2
- LX (linkage index) 5-33
 - invalid bit 5-36
 - translation exception 6-30
- LXD (LOAD LENGTHENED) HFP instruction 18-15
- LXDB (LOAD LENGTHENED) BFP instruction 19-34
- LXDBR (LOAD LENGTHENED) BFP instruction 19-33
- LXDR (LOAD LENGTHENED) HFP instruction 18-15
- LXDTR (LOAD LENGTHENED) DFP instruction 20-45
- LXE (LOAD LENGTHENED) HFP instruction 18-15
- LXEB (LOAD LENGTHENED) BFP instruction 19-34
- LXEBR (LOAD LENGTHENED) BFP instruction 19-33
- LXER (LOAD LENGTHENED) HFP instruction 18-15
- LXR (LOAD) floating-point-support instruction 9-31
- LY (LOAD) binary instruction 7-263
- LZDR (LOAD ZERO) floating-point-support instruction 9-35
- LZER (LOAD ZERO) floating-point-support instruction 9-35
- LZRF (LOAD AND ZERO RIGHTMOST BYTE) binary instruction 7-270
- LZRG (LOAD AND ZERO RIGHTMOST BYTE) binary instruction 7-270

LZXR (LOAD ZERO) floating-point-support instruction 9-35

M

M (mega) 0-xxviii

M (MULTIPLY) binary instruction 7-304, 7-305
example A-28

machine check

See also malfunction

handling of malfunction detected as part of I/O 11-5

interruption 6-16, 11-10

action 11-11

code (MCIC) 3-80, 3-86, 11-14

floating conditions 11-26

machine check interruption 11-26

mask in the PSW 4-6

subclass masks in control register 11-26

logout 11-27

mask

in the PSW 4-6

machine-check architectural-mode identification 3-76, 3-85

machine-check extended save area 11-24

machine-type number (in STORE CPU ID result) 10-139, 10-140

MAD (MULTIPLY AND ADD) HFP instruction 18-19

MADB (MULTIPLY AND ADD) BFP instruction 19-38

MADBR (MULTIPLY AND ADD) BFP instruction 19-38

MADR (MULTIPLY AND ADD) HFP instruction 18-19

MAE (MULTIPLY AND ADD) HFP instruction 18-19

MAEB (MULTIPLY AND ADD) BFP instruction 19-38

MAEBR (MULTIPLY AND ADD) BFP instruction 19-38

MAER (MULTIPLY AND ADD) HFP instruction 18-19

main storage 3-2

See also storage

effect of power-on reset on 4-81

See also storage

shared (in multiprocessing) 4-84

malfunction 11-2

at channel subsystem 16-29

at I/O device 16-29

correction of 11-2

effect on manual operation 12-1

from DIAGNOSE instruction 10-23

indication of 11-5

machine-check handling for when detected as part of I/O 11-5

malfunction alert (external interruption) 6-13

when entering check-stop state 11-10

manual indicator 12-4

See also stopped state

manual operation 12-1

controls

address-compare 12-1

alter-and-display 12-2

IML 12-3

load-unit-address 12-4

power 12-4

rate 12-5

TOD-clock 12-6

effect on CPU signaling 4-95

keys

interrupt 12-3

load-clear 12-4

load-clear-list-directed 12-4

load-normal 12-4

load-with-dump 12-4

restart 12-5

start 12-5

stop 12-5

store-status 12-5

system-reset-clear 12-6

system-reset-normal 12-6

masks 6-6

See also I/O interruption, interruption for IEEE exceptions 9-10

in BRANCH INDIRECT ON CONDITION instruction 7-39

in BRANCH ON CONDITION instruction 7-40

in BRANCH RELATIVE ON CONDITION instruction 7-46

in COMPARE LOGICAL CHARACTERS UNDER MASK instruction 7-156

in INSERT CHARACTERS UNDER MASK instruction 7-262

in PSW 4-5

in STORE CHARACTERS UNDER MASK instruction 7-385

in TEST UNDER MASK instruction 7-400

monitor 6-30

path-management 15-2, 15-28, 15-30

PER-event 4-27

program-interruption 6-17

subclass

See subclass-mask bits

maximum negative number 7-4

MBA (measurement-block address) 15-9

MC (MONITOR CALL) instruction 7-287

MCIC (machine-check-interruption code) 3-80, 3-86, 11-14

MD (MULTIPLY) HFP instruction 18-18

MDB (MULTIPLY) BFP instruction 19-37

MDBR (MULTIPLY) BFP instruction 19-37

MDE (MULTIPLY) HFP instruction 18-18

MDEB (MULTIPLY) BFP instruction 19-37
MDEBR (MULTIPLY) BFP instruction 19-37
MDER (MULTIPLY) HFP instruction 18-17
MDR (MULTIPLY) HFP instruction 18-17
 example A-43
MDTR (MULTIPLY) DFP instruction 20-47
MDTRA (MULTIPLY) DFP instruction 20-48
ME (MULTIPLY) HFP instruction 18-18
measurement
 block (I/O)
 address 17-7
 format 17-7
 origin 17-7
 device-connect-time 17-10
 extended-measurement-word 17-11
 measurement-block update (I/O) 17-2
measurement-alert external interruption 6-14
measurement block (I/O) 17-3
 data check 16-48
 index 15-7
 key (MBK)
 used as access key 3-11
 multiple use of 15-11
 program check 16-48
 protection check 16-48
 update enable 15-3
measurement-block-format control (I/O) 15-8
measurement data (I/O)
 accumulated 17-3
 effect of CSCH on 14-5
 effect of HSCH on 14-7
measurement-mode control (I/O) 15-3
MEE (MULTIPLY) HFP instruction 18-18
MEEB (MULTIPLY) BFP instruction 19-37
MEEBR (MULTIPLY) BFP instruction 19-37
MEER (MULTIPLY) HFP instruction 18-17
MER (MULTIPLY) HFP instruction 18-18
message byte (in EDIT) 8-8
message-security assist 1-19
 facility indication 4-100
message-security-assist extension 1 1-19
message-security-assist extension 2 1-19
message-security-assist extension 3 1-19
 facility indication 4-101
message-security-assist extension 4 1-20
 facility indication 4-101
message-security-assist extension 5 1-21
 facility indication 4-100
message-security-assist extension 6 1-21
message-security-assist extension 7 1-22
message-security-assist extension 8 1-22
 facility indication 4-101
message-security-assist extension 9 1-22
 facility indication 4-101
MFY (MULTIPLY) binary instruction 7-304
MG (MULTIPLY) binary instruction 7-304
MGH (MULTIPLY HALFWORD) binary instruction
 7-305
MGHI (MULTIPLY HALFWORD IMMEDIATE)
 instruction 7-305
MGRK (MULTIPLY) binary instruction 7-304
MH (MULTIPLY HALFWORD) instruction 7-305
 example A-29
MHI (MULTIPLY HALFWORD IMMEDIATE)
 instruction 7-305
MHY (MULTIPLY HALFWORD) binary instruction
 7-305
MIDA (modified-indirect-data addressing) 15-68
MIDA flag in CCW 15-33
 invalid 16-27
MIDAW (modified indirect-data-address word)
 invalid address specification of 16-26
MIDAW (modified-indirect-data-address word) 15-68
 check (in subchannel logout) 16-48
MIDAW (modified indirect-data-address word)
 invalid address of 16-25
MIDAW control 15-28
miscellaneous-instruction-extensions facility 1 1-23
 facility indication 4-100
miscellaneous-instruction-extensions facility 2 1-23
 facility indication 4-100
miscellaneous-instruction-extensions facility 3 1-23
 facility indication 4-101
ML (MULTIPLY LOGICAL) instruction 7-306
MLG (MULTIPLY LOGICAL) instruction 7-306
MLGR (MULTIPLY LOGICAL) instruction 7-306
MLR (MULTIPLY LOGICAL) instruction 7-306
modal instructions 1-5, 7-8
mode
 access-register 3-40
 addressing
 See addressing mode
 architectural
 See architectural mode
 burst (channel-path operation) 13-3
 byte-multiplex mode (channel-path operation)
 13-3
 home-space 3-40
 incorrect-length-indication 15-28
 incorrect-length-suppression 15-28
 indicator
 architectural 12-2, 12-3
 multipath
 See multipath mode
 primary-space 3-40
 real 3-40
 requirements for semiprivileged instructions 5-28
 secondary-space 3-40

- single-path 15-4, 15-23
- translation 3-40
- mode-trace-control bit 4-15
- modifiable area (in linkage-stack state entry) 5-83
- modification control 15-26
- modified-CCW-indirect-data-addressing control 15-28
- modified-CCW-indirect-data-addressing facility 1-23
- MODIFY STACKED STATE instruction 10-61
- MODIFY SUBCHANNEL instruction 14-7
- MONITOR CALL instruction 7-287
- monitor-class number 6-30, 7-287
 - assigned storage locations for 3-74, 3-85
- monitor code 6-31, 7-287
 - assigned storage locations for 3-79, 3-85
- monitor event 6-30, 7-287
 - counting operation 7-287
 - program interruption 7-287
- monitor-event
 - counting operation 5-110
- monitor masks 6-30, 7-287
- monitoring
 - See also* measurement
 - channel-subsystem 17-1
 - for PER events
 - See* PER
 - with MONITOR CALL 6-30, 7-287
- MOVE instructions 7-288
 - examples A-21, A-24
- move-inverse facility 7-289
- MOVE INVERSE instruction 7-289
 - example A-25
- MOVE LONG EXTENDED instruction 7-293
- MOVE LONG instruction 7-289
 - examples A-26
- MOVE LONG UNICODE instruction 7-296
- MOVE NUMERICS instruction 7-300
 - example A-26
- MOVE PAGE instruction 10-62, 10-80
- MOVE RIGHT TO LEFT instruction 7-300
- MOVE STRING instruction 7-301
 - example A-27
- MOVE TO PRIMARY instruction 10-65
- MOVE TO SECONDARY instruction 10-65
- MOVE WITH DESTINATION KEY instruction 10-67
- MOVE WITH KEY instruction 10-67
- MOVE WITH OFFSET instruction 7-302
 - example A-27
- move-with-optional-specifications facility 1-24
 - facility indication 4-100
- MOVE WITH OPTIONAL SPECIFICATIONS instruction 10-69
- MOVE WITH SOURCE KEY instruction 10-72
- MOVE ZONES instruction 7-303
 - example A-28
- move-page-and-set-key facility 1-24
 - facility indication 4-101
- MP (MULTIPLY DECIMAL) instruction 8-12
 - example A-39
- MR (MULTIPLY) binary instruction 7-304
 - example A-28
- MS (MULTIPLY SINGLE) instruction 7-307
- MSC (MULTIPLY SINGLE) instruction 7-307
- MSCH (MODIFY SUBCHANNEL) instruction 14-7
- MSD (MULTIPLY AND SUBTRACT) HFP instruction 18-19
- MSDB (MULTIPLY AND SUBTRACT) BFP instruction 19-38
- MSDBR (MULTIPLY AND SUBTRACT) BFP instruction 19-38
- MSDR (MULTIPLY AND SUBTRACT) HFP instruction 18-19
- MSE (MULTIPLY AND SUBTRACT) HFP instruction 18-19
- MSEB (MULTIPLY AND SUBTRACT) BFP instruction 19-38
- MSEBR (MULTIPLY AND SUBTRACT) BFP instruction 19-38
- MSER (MULTIPLY AND SUBTRACT) HFP instruction 18-19
- MSFI (MULTIPLY SINGLE IMMEDIATE) instruction 7-307
- MSG (MULTIPLY SINGLE) instruction 7-307
- MSGC (MULTIPLY SINGLE) instruction 7-307
- MSGF (MULTIPLY SINGLE) instruction 7-307
- MSGFI (MULTIPLY SINGLE IMMEDIATE) instruction 7-307
- MSGFR (MULTIPLY SINGLE) instruction 7-307
- MSGR (MULTIPLY SINGLE) instruction 7-307
- MSGRKC (MULTIPLY SINGLE) instruction 7-307
- MSR (MULTIPLY SINGLE) instruction 7-307
- MSRKC (MULTIPLY SINGLE) instruction 7-307
- MSS (multiple subchannel set facility) 17-33
- MSS (multiple-subchannel-set) facility 1-24
- MSTA (MODIFY STACKED STATE) instruction 10-61
- MSY (MULTIPLY SINGLE) instruction 7-307
- multipath mode 15-4
 - entering 15-23
- multiple-access storage references 5-125
- multiple-epoch facility 1-24
- multiple-subchannel-set facility 1-24
- multiple subchannel set facility (MSS) 17-33
- MULTIPLY AND ADD BFP instructions 19-38
- MULTIPLY AND ADD HFP instructions 18-19
- MULTIPLY AND SUBTRACT BFP instructions 19-38
- MULTIPLY AND SUBTRACT HFP instructions 18-19
- MULTIPLY BFP instructions 19-37

MULTIPLY binary instructions 7-304
 examples A-28

MULTIPLY DECIMAL instruction 8-12
 example A-39

MULTIPLY DFP instructions 20-47

MULTIPLY HALFWORD IMMEDIATE instruction 7-305

MULTIPLY HALFWORD instruction 7-305
 example A-29

MULTIPLY HFP instructions 18-17
 example A-43

MULTIPLY LOGICAL instructions 7-306

MULTIPLY SINGLE IMMEDIATE instructions 7-307

MULTIPLY SINGLE instructions 7-307

multiprocessing 4-83
 manual operations for 12-6
 programming considerations for 8-4, A-45
 programming examples A-45
 timing-facility interruptions for 4-53
 TOD clock for 4-47

multiprogramming examples A-45

multithreading
 core 2-3
 disablement of 4-78, 4-79, 4-80
 enablement of 4-92
 facility description 1-25
 operator considerations 12-7
 terminology 2-3
 thread 2-3

MVC (MOVE) instruction 7-288
 examples A-21, A-24

MVCDK (MOVE WITH DESTINATION KEY) instruction 10-67

MVCIN (MOVE INVERSE) instruction 7-289
 example A-25

MVCK (MOVE WITH KEY) instruction 10-67

MVCL (MOVE LONG) instruction 7-289
 examples A-26

MVCLE (MOVE LONG EXTENDED) instruction 7-293

MVCLU (MOVE LONG UNICODE) instruction 7-296

MVCOS (MOVE WITH OPTIONAL SPECIFICATIONS) instruction 10-69

MVCP (MOVE TO PRIMARY) instruction 10-65

MVCL (MOVE RIGHT TO LEFT) instruction 7-300

MVCS (MOVE TO SECONDARY) instruction 10-65

MVCSK (MOVE WITH SOURCE KEY) instruction 10-72

MVGHI (MOVE) instruction 7-288

MVHHI (MOVE) instruction 7-288

MVHI (MOVE) instruction 7-288

MVI (MOVE) instruction 7-288
 example A-25

MVIY (MOVE) instruction 7-288

MVN (MOVE NUMERICS) instruction 7-300
 example A-26

MVO (MOVE WITH OFFSET) instruction 7-302
 example A-27

MVPG (MOVE PAGE) instruction 10-62, 10-80

MVST (MOVE STRING) instruction 7-301
 example A-27

MVZ (MOVE ZONES) instruction 7-303
 example A-28

MXBR (MULTIPLY) BFP instruction 19-37

MXD (MULTIPLY) HFP instruction 18-18

MXDB (MULTIPLY) BFP instruction 19-37

MXDBR (MULTIPLY) BFP instruction 19-37

MXDR (MULTIPLY) HFP instruction 18-17

MXR (MULTIPLY) HFP instruction 18-17

MXTR (MULTIPLY) DFP instruction 20-47

MXTRA (MULTIPLY) DFP instruction 20-48

N

N (AND) instruction 7-32

N condition (I/O) 16-13

NaN (not-a-number) 9-2, 19-4, 20-7

NAND instructions 7-308

NC (AND) instruction 7-33

NCGRK (AND WITH COMPLEMENT) instruction 7-34

NCRK (AND WITH COMPLEMENT) instruction 7-34

NDNR (AND) binary instruction 7-32

NDXGR (EXCLUSIVE OR) binary instruction 7-253

near-valid CBC 11-2
 in storage 11-6

negative zero
 binary 7-4
 decimal 8-3
 example A-5

nested transaction
 transactional execution 5-90, 5-91

nesting 5-90, 5-91

new PSW 4-4
 assigned storage locations for 3-81
 assigned storage locations for (in the z/Architecture architectural mode) 3-83
 fetched during interruption 6-2

next-entry size (in linkage stack) 5-80

NG (AND) instruction 7-33

NGR (AND) instruction 7-32

NGRK (AND) binary instruction 7-32

NI (AND) instruction 7-33
 example A-8

NIHF (AND IMMEDIATE) instruction 7-34

NIHH (AND IMMEDIATE) instruction 7-34

NIHL (AND IMMEDIATE) instruction 7-34

NILF (AND IMMEDIATE) instruction 7-34

- NILH (AND IMMEDIATE) instruction 7-34
- NILL (AND IMMEDIATE) instruction 7-34
- NIY (AND) instruction 7-33
- NNGRK (NAND) instruction 7-308
- NNRK (NAND) instruction 7-308
- no-operation
 - instruction (BRANCH ON CONDITION) 7-40
 - instruction (BRANCH RELATIVE ON CONDITION) 7-46
- node (of tree structure) 7-425
- NOGRK (NOR) instruction 7-311
- nonconstrained transaction
 - transactional execution 5-91
- nonconstrained transaction-execution mode
 - transactional execution 5-91
- noninterlocked-update storage reference 5-124
- nonnumeric entities
 - decimal 20-7
 - IEEE 9-2
- nonquiescing key-setting facility
 - facility indication 4-100
 - NQ control
 - in SET STORAGE KEY EXTENDED 10-133
 - storage-key accesses 5-120
- 1-25
- NONTRANSACTION STORE instruction 7-310
- nontrap action
 - IEEE 9-18
- nonvolatile storage 3-2
- NOR instructions 7-311
- NORK (NOR) instruction 7-311
- normal numbers
 - class of BFP data 19-4
 - class of DFP data 20-7
- normalization
 - of HFP numbers 18-2
- not-a-number (NaN) 9-2, 19-4, 20-7
- NOT EXCLUSIVE OR instructions 7-311
- not operational
 - as channel-path state 16-13
 - See path-not-operational bit
 - as CPU state 4-95
 - as TOD-clock state 4-49
- not set (TOD-clock state) 4-48
- NR (AND) instruction 7-32
- NTSTG (NONTRANSACTION STORE) instruction 7-310
- nullification
 - exceptions to 5-26
 - for exigent machine-check conditions 11-10
 - of instruction execution 5-23
 - of unit of operation 5-25
- numbering
 - of addresses (byte locations) 3-2

- of bits 3-3
- numbers
 - binary 7-4
 - examples A-2
 - binary-floating-point 19-2
 - configuration identification (in STORE CPU ID result) 10-139, 10-140
 - decimal 8-1
 - examples A-4
 - device 13-6
 - hexadecimal 5-7
 - hexadecimal-floating-point 18-2
 - examples A-5
 - machine-type number (in STORE CPU ID result) 10-139, 10-140
- numeric bits 8-1
 - moving of 7-300
- Numeric part of PC number 5-83
- NXGRK (NOT EXCLUSIVE OR) instruction 7-311
- NXRK (NOT EXCLUSIVE OR) instruction 7-311
- NY (AND) instruction 7-33

O

- O (OR) instruction 7-312
- OC (OR) instruction 7-312
- OCGRK (OR WITH COMPLEMENT) instruction 7-314
- OCRK (OR WITH COMPLEMENT) instruction 7-314
- octoword 3-3
- OEMI (original equipment manufacturers information) for I/O interface
 - publication referenced 0-xxix
- offset of symbol-translation table 7-172
- OG (OR) instruction 7-312
- OGR (OR) instruction 7-312
- OGRK (OR) binary instruction 7-312
- OI (OR) instruction 7-312
 - example A-29
 - example of problem with A-45
- OIHF (OR IMMEDIATE) instruction 7-313
- OIHH (OR IMMEDIATE) instruction 7-313
- OIHL (OR IMMEDIATE) instruction 7-313
- OILF (OR IMMEDIATE) instruction 7-313
- OILH (OR IMMEDIATE) instruction 7-313
- OILL (OR IMMEDIATE) instruction 7-313
- OIY (OR) instruction 7-312
- old PSW 6-2
 - assigned storage locations for 3-80
 - assigned storage locations for (in the ESA/390-compatibility mode) 3-83
 - assigned storage locations for (in the z/Architecture architectural mode) 3-83
- one's complement binary notation 7-4

- used for SUBTRACT LOGICAL instruction 7-397
- used for SUBTRACT LOGICAL WITH BORROW instruction 7-398
- op code
 - See operation code
- operand 5-3
 - access identification 3-75
 - access of 5-123
 - for I/O instructions 14-2
 - address generation for 5-11
 - exception 6-31
 - immediate 5-8
 - length of 5-3
 - overlap of
 - for decimal instructions 8-3
 - for general instructions 7-4
 - register for 5-7
 - sequence of references for 5-123
 - storage 5-9
 - types of (fetch, store, update) 5-123
 - used for result 5-3
- operating state 4-2, 4-3
- operation
 - I/O
 - See I/O operations
 - unit of 5-24
- operation code (op code) 5-3
 - invalid 6-31
- operation exception 6-31
- operation-request block
 - See ORB
- operator facilities 2-8, 12-1
 - basic 12-1
- operator intervening (signal-processor status) 4-97
- OR (OR) instruction 7-312
- OR IMMEDIATE instructions 7-313
- OR instructions 7-312
 - example of problem with OR immediate A-45
 - examples A-29
- OR WITH COMPLEMENT instructions 7-314
- ORB (operation-request block) 15-24
 - channel-program-type control 15-27
 - CSS priority 15-29
 - designating a CCW channel program 15-25
 - extension control in 15-28, 15-30
 - interruption parameter in 15-25
 - invalid 16-27
 - logical-path mask (LPM) in 15-28, 15-30
- order-preserving-compression facility 1-25
 - facility indication 4-100
- orders (I/O) 13-8
- orders (signal-processor) 4-85
 - conditional emergency signal 4-91
 - conditions precluding response to 4-95

- CPU reset 4-86
- emergency signal 4-86
- emergency signal, conditional 4-91
- external call 4-85
- initial CPU reset 4-86
- restart 4-86
- sense 4-85
- set architecture 4-89, 4-93
- set prefix 4-86
- start 4-86
- stop 4-86
- stop and store status 4-86
- store status at address 4-87
 - set multithreading 4-92
- ORK (OR) binary instruction 7-312
- outer transaction 5-91
- outermost transaction 5-91
- overflow
 - binary 7-5
 - example A-2
 - decimal 6-26
 - exponent
 - See exponent overflow
 - fixed-point 6-27, 7-5
 - in CRW 17-29
- overlap
 - destructive 7-290, 7-295, 7-298
 - operand 5-116
 - for decimal instructions 8-3
 - for general instructions 7-4
 - operation 5-114
- OY (OR) instruction 7-312

P

- P (peta) 0-xxviii
- PACK ASCII instruction 7-315
- PACK instruction 7-314
 - example A-29
- PACK UNICODE instruction 7-316
- packed decimal numbers 8-1
 - conversion of to zoned format 7-423
 - conversion to from zoned format 7-314
- padding byte
 - for COMPARE LOGICAL LONG EXTENDED instruction 7-160
 - for COMPARE LOGICAL LONG instruction 7-157
 - for MOVE LONG EXTENDED instruction 7-293
 - for MOVE LONG instruction 7-289
- page 3-39
- page-frame real address (PFRA) 3-51
- PAGE IN instruction 10-73
- page index (PX) 3-39
- page-invalid bit (in page-table entry) 3-51

PAGE OUT instruction 10-74
 page protection
 exception for 6-34
 page swapping 3-38
 page table 3-51
 lookup 3-61
 origin (PTO) 3-49
 page-translation exception 6-32
 as an access exception 6-47, 6-53
 PALB (PURGE ALB) instruction 10-119
 PAM (path-available mask) 15-7
 effect of reconfiguration on 15-11
 effect of resetting on 15-11
 effect on allegiance of 15-12
 parallel-I/O channel-to-channel adapter
 publication referenced 0-xxix
 parallel-I/O interface 13-3
 OEMI publication referenced 0-xxix
 parameter
 external-interruption 6-11
 assigned storage locations for 3-74, 3-84
 I/O-interruption
 See I/O-interruption parameter
 register for SIGNAL PROCESSOR 4-86, 10-137
 translation 3-40
 parity bit 11-2
 parsing-enhancement facility 1-25
 facility indication 4-100
 partial completion of instruction execution 5-24
 PASCE (primary address-space-control element)
 3-42
 PASN (primary address-space number) 3-24
 in trace entry 4-23
 PASTE (primary AST entry) 5-35
 PASTEIN (primary-AST-entry instance number) 3-26
 PASTEO (primary-AST-entry origin) 5-35, 5-54
 path
 See channel path
 path available for selection 15-13
 path management 13-9
 for clear function 15-14, 15-22
 for halt function 15-16
 for start function and resume function 15-20
 path-management-control word
 See PMCW
 path-management masks
 last-path-used mask
 See LPUM
 logical-path mask
 See LPM
 path-available mask
 See PAM
 path-installed mask
 See PIM
 path-not-operational mask
 See PNOM
 path-operational mask
 See POM
 path-not-operational bit (N) in SCSW 16-13
 path-not-operational condition 15-5
 path verification required
 indicator for (in ERW) 16-52
 pattern (in EDIT) 8-8
 PC-cp (PROGRAM CALL instruction, to current
 primary) 10-98
 PC number 10-95
 in linkage-stack state entry 5-83
 in trace entry 4-23
 translation 5-33
 PC-ss (PROGRAM CALL instruction, with space
 switching) 10-98
 PC-translation-specification exception 6-32
 PC-type bit 5-38
 PCC (PERFORM CRYPTOGRAPHIC
 COMPUTATION) instruction 7-316
 PCI (program-controlled interruption) 15-64
 as flag in CCW 15-32
 intermediate interruption condition for 16-18
 subchannel status for 16-24
 PCKMO (PERFORM CRYPTOGRAPHIC KEY
 MANAGEMENT OPERATION) instruction 10-75
 pending channel reports
 effect of I/O-system reset on 17-15
 pending interruption
 See interruption pending
 PER (program-event recording)
 access identification 3-75, 3-85, 4-32
 address 4-32
 assigned storage locations for 3-74, 3-85
 address-space-control element (ASCE)
 identification 4-31
 ASCE (address-space-control element)
 identification 4-31
 ATMID (addressing-and-translation-mode
 identification) 4-31
 code 4-30
 assigned storage locations for 3-74, 3-85
 events 4-26
 extensions 1-33
 instruction-fetching event 4-37
 masks
 bit in the PSW 4-5
 PER-event 4-27
 priority of indication 4-33
 program-interruption condition 6-32
 storage-alteration event 4-37
 storage-area designation 4-35
 ending address 4-28

- starting address 4-28
- wraparound 4-35
- store-using-real-address event 4-38
- successful-branching event 4-36
- PER zero-address-detection facility 1-26
- PER-3 facility 1-25
 - breaking-event-address recording 4-45
 - PER instruction-fetching nullification 4-26
- PERFORM CRYPTOGRAPHIC COMPUTATION instruction 7-316
- PERFORM CRYPTOGRAPHIC KEY MANAGEMENT OPERATION instruction 10-75
- PERFORM FLOATING-POINT OPERATION floating-point-support instruction 9-35
- PERFORM FRAME MANAGEMENT FUNCTION instruction 10-80
- PERFORM LOCKED OPERATION instruction 7-337
 - example A-51
- PERFORM PROCESSOR ASSIST instruction 7-351
- PERFORM RANDOM NUMBER OPERATION instruction 7-352
- PERFORM TIMING FACILITY FUNCTION instruction 10-83
- PERFORM TOPOLOGY FUNCTION instruction 10-92
- permissible set 9-13
- PER-storage-key-alteration facility 1-26
- PFD (PREFETCH DATA) instruction 7-365
- PFDRL (PREFETCH DATA RELATIVE LONG) instruction 7-366
- PFPO (PERFORM FLOATING-POINT OPERATION) floating-point-support instruction 9-35
- PFPO facility 1-26
 - facility indication 4-100
- PFRA (page-frame real address) 3-51
- PGIN (PAGE IN) instruction 10-73
- PGOUT (PAGE OUT) instruction 10-74
- piecemeal steps of instruction execution 5-115
- PIM (path-installed mask) 15-6
- PKA (PACK ASCII) instruction 7-315
- PKM (PSW-key mask) 5-28
- PKU (PACK UNICODE) instruction 7-316
- PLO (PERFORM LOCKED OPERATION) instruction 7-337
 - example A-51
- PMCW (path-management-control word) 15-2
 - channel-path identifiers (CHPID) 15-8
- PNOM (path-not-operational mask) 15-5
 - effect on PNOM of 15-11
 - indicated in SCSW 16-13
- point of damage 11-14
- point of interruption 5-24
 - for machine check 11-14
- POM (path-operational mask) 15-7
 - effect on PNOM of 15-11
- POPCNT (POPULATION COUNT) instruction 7-365
- population-count facility 1-26
 - facility indication 4-100
- POPULATION COUNT instruction 7-365
- postnormalization 18-2
- power controls 12-4
- power-on reset 4-81
- powers of 2
 - table of G-1
- PPA (PERFORM PROCESSOR ASSIST) instruction 7-351
- PPA-in-order facility
 - facility indication 4-101
- PPNO. *See* PRNO
- PR (PROGRAM CALL) instruction 10-93
- PR (PROGRAM RETURN) instruction 10-106
- PR-cp (PROGRAM RETURN instruction, to current primary) 10-107
- PR-ss (PROGRAM RETURN instruction, with space switching) 10-107
- PR/SM (Processor Resource/Systems Manager) 1-34, 1-36
- precise intermediate value 9-12
- precision (floating-point) 9-1
- precision-rounded value 9-12
- preferred quantum 20-2
- preferred sign codes 8-2
- prefetch control 15-27
- PREFETCH DATA instruction 7-365
- PREFETCH DATA RELATIVE LONG instruction 7-366
- prefetching
 - access exceptions not recognized for 6-47
 - channel-control check during 16-29, 16-43
 - channel-data check during 16-28, 16-42, 16-43
 - handling of invalid CBC in storage during 11-8
 - of ART-table and DAT-table entries 5-119
 - of data for I/O 15-59
 - of instructions 5-118
 - of operands 5-123
 - See* CCW prefetch control
- prefix 3-21
 - set by signal-processor order 4-86
 - store-status save area for 3-82, 3-86
- prefix area 3-21
- prefix register 3-21
- prenormalization 18-2
- primary address space 3-23
- primary ASN (PASN) 3-24
 - in linkage-stack state entry 5-82
- primary-AST entry (PASTE) 5-35
 - origin (PASTEO) 5-35, 5-54
- primary ASTEIN (PASTEIN)

- in linkage-stack state entry 5-84
- primary authority 3-36
 - exception 6-33
- primary CPU 2-3, 4-82, 12-7
- primary designation-type-control bits 3-44
- primary interruption condition (I/O) 16-4
- primary-list bit 5-54
- primary private-space-control bit 3-43
- primary real-space-control bit 3-43
- primary real-space token origin (PRSTKO) 3-44
- primary region table
 - designation (PRTD) 3-42
 - length (PRTL) 3-44
 - origin (PRTO) 3-42
- primary segment table
 - designation (PSTD) 3-42
 - length (PSTL) 3-44
 - origin (PSTO) 3-42
- primary-space access-list designation (PSALD) 5-56
- primary-space mode 3-40
- primary space-switch-event-control bit 3-43
- primary-status bit (I/O) 16-19
- primary storage-alteration-event-control bit 3-43
- primary subspace-group-control bit 3-43
- primary virtual address 3-5
 - effective address-space-control element for 3-52
- priority
 - of access exceptions 6-53
 - of ASN-translation exceptions 6-55
 - of data exceptions 6-17
 - of external-interruption conditions 6-11
 - of I/O interruptions 16-5
 - of interruptions (CPU) 6-57
 - of PER events 4-33
 - of program-interruption conditions 6-51
 - of subspace-replacement exceptions 6-56
 - of trace exceptions 6-56
- private bit 5-56
- private-space control
 - effect on
 - fetch-protection override 3-13
 - low-address protection 3-14
 - use of common regions 3-47
 - use of common segments 3-50
- private-space-control bit 3-43
 - home 3-45
 - primary 3-43
 - secondary 3-44
- privileged instructions 4-6
 - control 10-1
- privileged-operation exception 6-33
- PRNO (PERFORM RANDOM NUMBER GENERATION) instruction 7-352
- problem state 4-6
 - bit in entry-table entry 5-38
 - bit in the PSW 4-6
 - compatibility 1-37
- processing backup (synchronous machine-check condition) 11-18
- processing damage (synchronous machine-check condition) 11-19
- processor
 - See CPU 2-2
- processor-assist facility 1-26
 - facility indication 4-100
- processor-availability facility 1-34
- Processor Resource/Systems Manager (PR/SM) 1-34, 1-36
- program 5-48
 - channel
 - See channel program
 - exceptions 6-16
 - execution of 5-1
 - fields of SCHIB modifiable by 15-10
 - initial loading by CCW-type IPL 17-17
 - initial loading by list-directed IPL 17-19
 - initial loading of 4-81, 17-16
 - interruption 6-16
 - priority of 6-17, 6-51
- PROGRAM CALL instruction 10-93
 - trace entry for 4-23
 - type of 5-38
- program-call state entry 5-81, 10-97
- program check
 - as subchannel status 16-25, 16-40
 - measurement-block 16-48
- program-controlled interruption (I/O)
 - See PCI
- program-event recording
 - See PER
- program events
 - See PER events
- program interruption
 - filtering 5-104
 - transaction diagnostic block 3-83
- program-interruption filtering
 - in transactional execution 5-91
- program interruption identification
 - in the transaction diagnostic block 5-96
- program mask
 - in the PSW 4-7, 6-17
 - inserted by INSERT PROGRAM MASK 7-263
 - preserved by BRANCH AND LINK 5-15, 7-35
 - set by SET PROGRAM MASK 7-378
 - validity bit for 11-21
- PROGRAM RETURN instruction 10-106
- program-status word
 - See PSW

- PROGRAM TRANSFER instruction 10-110
 - trace entry for 4-23
- PROGRAM TRANSFER WITH INSTANCE instruction 10-110
- programmable field of TOD clock 4-52
- protection (storage) 3-10
 - access-list-controlled
 - See access-list-controlled protection
 - DAT
 - See DAT protection
 - during tracing 4-25
 - fetch
 - See fetch protection
 - key-controlled
 - See key-controlled protection
 - low-address
 - See low-address protection
 - page
 - See page protection
- protection check
 - as subchannel status 16-28, 16-42
 - measurement-block 16-48
- protection exception 6-34
 - as an access exception 6-47, 6-53
- PRSD (primary real-space designation) 3-42
- PRSTKO (primary real-space token origin) 3-44
- PRTD (primary region-table designation) 3-42
- PRTL (primary region-table length) 3-44
- PRTO (primary region-table origin) 3-42
- PSALD (primary-space access-list designation) 5-56
- pseudo AST entry 3-24
- PSMF(PERFORM FRAME MANAGEMENT FUNCTION) instruction 10-80
- PSTD (primary segment-table designation) 3-42
- PSTL (primary segment-table length) 3-44
- PSTO (primary segment-table origin) 3-42
- PSW (program-status word) 2-4, 4-4
 - current 4-4, 5-14
 - stored during interruption 6-2
 - exceptions associated with 6-9
 - format error 6-9
 - in linkage-stack state entry 5-82
 - in program execution 5-14
 - saved 4-78
 - store-status save area for 3-82, 3-86
 - validity bits for 11-20
- PSW key 4-6
 - control bit 5-75
 - in entry-table entry 5-76
 - in trace entry 4-23
 - used as access key 3-11
 - validity bit for 11-20
- PSW-key mask (PKM) 5-28
 - control bit 5-75

- in linkage-stack state entry 5-82
- PT (PROGRAM TRANSFER) instruction 10-110
- PT-cp (PROGRAM TRANSFER instruction, to current primary) 10-111
- PT-ss or PTI-ss (PROGRAM TRANSFER (WITH INSTANCE) instruction, with space switching) 10-111
- PTF (PERFORM TOPOLOGY FUNCTION) instruction 10-92
- PTFF (PERFORM TIMING FACILITY FUNCTION) instruction 10-83
- PTI (PROGRAM TRANSFER WITH INSTANCE) instruction 10-110
- PTLB (PURGE TLB) instruction 10-119
- PTO (page-table origin) 3-49
- publications
 - other related documents 0-xxix
- PURGE ALB instruction 10-119
- PURGE TLB instruction 10-119
- PX (page index) 3-39

Q

- QADTR (QUANTIZE) DFP instruction 20-49
- QAXTR (QUANTIZE) DFP instruction 20-49
- QNaN (quiet NaN) 9-2, 19-4, 20-7
- quadword 3-3
- quadword-concurrent storage references 5-127
- QUANTIZE DFP instructions 20-49
- quantum 20-2
- quantum exception 9-21
 - nontrap action 9-22
 - trap action 9-22
- queuing
 - FIFO
 - example for lock and unlock A-49
 - LIFO
 - example for lock and unlock A-48
- quiescing 5-133
- quiet NaN (QNaN) 9-2, 19-4, 20-7

R

- R field of instruction 5-7
- radix
 - binary 9-4
 - decimal 9-4
 - hexadecimal 9-3
- rate control 12-5
- RCHP (RESET CHANNEL PATH) instruction 14-9
- real address 3-4
- real mode 3-40
- real space
 - token origin (RSTKO) 3-42
- real-space-control bit

- home 3-45
- primary 3-43
- secondary 3-44
- real-space designation (RSD)
 - home 3-45
 - primary 3-42
 - secondary 3-44
- real storage 3-5
- receiver check (signal-processor status) 4-98
- reconfiguration of I/O system 17-25
- recovery
 - as class of machine-check condition 11-10
 - channel-subsystem 17-27
 - system 11-15
 - subclass-mask bit for 11-26
- reduced-authority state 10-8
- redundancy 11-2
- reference
 - bit in storage key 3-9
 - multiple-access 5-125
 - recording 3-19
 - sequence for storage 5-113
 - See also* sequence
 - single-access 5-125
- region 3-39
- region first index (RFX) 3-39
- region-first-translation exception 6-35
 - as an access exception 6-53
- region index (RX)
 - in virtual address 3-39
- region-invalid bit (in region-table entry) 3-47
- region second index (RSX) 3-39
- region-second-translation exception 6-36
 - as an access exception 6-53
- region table
 - origin (RTO) 3-42
- region-table designation (RTD) 3-42
 - home 3-45
 - primary 3-42
 - secondary 3-44
- region-table entry (RTE) 3-46
- region third index (RTX) 3-39
- region-third-translation exception 6-36
 - as an access exception 6-53
- region-translation exception 6-35
- register
 - access 2-6
 - base-address 2-4
 - control 2-6
 - designation of 5-7
 - floating-point 2-4, 9-8
 - floating-point-control 9-9
 - general 2-4
 - index 2-4
 - prefix 3-21
 - save areas for 3-82, 11-23
 - validation of 11-9
 - validity bits for 11-21, 11-22
 - vector 2-5
- relative branching 5-13
- remainder 19-5
 - result of DIVIDE TO INTEGER 19-28
- remaining free space (in linkage stack) 5-79
- remote operating stations 12-1
- reporting-source code (RSC) 17-30
- reporting-source ID (RSID) 17-31
- repressible machine-check conditions 11-10
- request-logging-only 16-52
 - indicator for (in ERW) 16-52
- REROUND DFP instructions 20-52
- reset 17-13
 - channel-path 17-13
 - clear 4-80
 - CPU 4-78
 - effect on CPU state 4-2
 - effect on TOD clock 4-48
 - I/O-system 17-13
 - as part of subsystem reset 4-80
 - initial CPU 4-79
 - power on 4-81
 - subsystem 4-80
 - summary of functions 4-76
 - summary of functions performed by manual initiation of 4-75
 - system-reset-clear key 12-6
 - system-reset-normal key 12-6
- RESET CHANNEL PATH instruction 14-9
 - function initiated by 15-80
 - See* channel-path-reset function
- RESET REFERENCE BIT EXTENDED instruction 10-119
- RESET REFERENCE BIT MULTIPLE instruction 10-120
- reset-reference-bits-multiple facility 1-26
 - facility indication 4-101
- reset signal (I/O) 17-12
 - in I/O-system reset 17-14
 - issued as part of RCHP 15-81
 - in channel-path reset 17-13
- resolution
 - of clock comparator 4-60
 - of CPU timer 4-63
 - of TOD clock 4-47
- restart
 - interruption 6-56
 - key 12-5
 - signal-processor order 4-86
- result operand 5-3

- resume function 13-11, 15-20
 - initiated by RESUME SUBCHANNEL 14-10
 - path management for 15-20
 - pending 16-14, 16-36
 - See also* start function
- RESUME PROGRAM instruction 10-120
- RESUME SUBCHANNEL instruction 14-10
 - channel-program requirements for 14-11
 - count of in measurement block 17-4
 - function initiated by 15-20
 - See* resume function
- retry
 - CPU 11-2
 - I/O command
 - See* command retry
- reusable-ASN bit 3-25
- RFX (region first index) 3-39
- RI instruction format 5-6
- RIE instruction format 5-6
- right-units view (RUV) of floating-point numbers 9-2
- RIL instruction format 5-6
- RIS instruction format 5-6
- RISBG (ROTATE THEN INSERT SELECTED BITS) instruction 7-369
- RISBG N(ROTATE THEN INSERT SELECTED BITS) instruction 7-369
- RISBHG (ROTATE THEN INSERT SELECTED BITS HIGH) instruction 7-371
- RISBLG (ROTATE THEN INSERT SELECTED BITS LOW) instruction 7-371
- RLL (ROTATE LEFT SINGLE LOGICAL) instruction 7-367
- RLLG (ROTATE LEFT SINGLE LOGICAL) instruction 7-367
- RNSBG (ROTATE THEN AND SELECTED BITS) instruction 7-368
- ROTATE LEFT SINGLE LOGICAL instruction 7-367
- ROTATE THEN AND SELECTED BITS instruction 7-368
- ROTATE THEN EXCLUSIVE OR SELECTED BITS instruction 7-368
 - example A-30
- ROTATE THEN INSERT SELECTED BITS HIGH instruction 7-371
- ROTATE THEN INSERT SELECTED BITS instruction 7-369
 - example A-30
- ROTATE THEN INSERT SELECTED BITS LOW instruction 7-371
- ROTATE THEN OR SELECTED BITS instruction 7-368
 - example A-30
- rounded intermediate value 9-12
- rounding (decimal) 8-12
 - example A-40
- rounding (floating-point)
 - IEEE 9-13
- rounding action
 - summary of 9-17
- rounding methods 9-14
- RP (RESUME PROGRAM) instruction 10-120
- RR instruction format 5-6
- RRBE (RESET REFERENCE BIT EXTENDED) instruction 10-119
- RRBM (RESET REFERENCE BIT MULTIPLE) instruction 10-120
- RRD instruction format 5-6
- RRDTR (REROUND) DFP instruction 20-52
- RRE instruction format 5-6
- RRF instruction format 5-6
- RRS instruction format 5-6
- RRXTR (REROUND) DFP instruction 20-52
- RS instruction format 5-6
- RSC (reporting-source code) 17-30
- RSCH (RESUME SUBCHANNEL) instruction 14-10
- RSI instruction format 5-6
- RSID (reporting-source ID) 17-31
- RSL instruction format 5-6
- RSTKO (real-space token origin) 3-42
- RSX (region second index) 3-39
- RSY instruction format 5-6
- RTE (region-table entry) 3-46
- RTO (region-table origin) 3-42
- RTX (region third index) 3-39
- running (state of TOD clock) 4-48
- RUV (right-units view) of floating-point numbers 9-2
- RX (region index) 3-39
- RX instruction format 5-6
- RXE instruction format 5-6, 5-7
- RXF instruction format 5-6, 5-7
- RXSBG (ROTATE THEN EXCLUSIVE OR SELECTED BITS) instruction 7-368
- RXY instruction format 5-6, 5-7

S

- S (SUBTRACT) binary instruction 7-395
- S instruction format 5-6, 5-7
- SAC (SET ADDRESS SPACE CONTROL) instruction 10-123
- SACF (SET ADDRESS SPACE CONTROL FAST) instruction 10-123
- SAL (SET ADDRESS LIMIT) instruction 14-12
- SAM24 (SET ADDRESSING MODE) instruction 7-377
- SAM31 (SET ADDRESSING MODE) instruction 7-377

SAM64 (SET ADDRESSING MODE) instruction 7-377

sample count (in ESW) 17-4

SAR (SET ACCESS) instruction 7-377

SASCE (secondary address-space-control element) 3-44

SASN (secondary address-space number) 3-24
in trace entry 4-24

SASTEIN (secondary-AST-entry instance number) 3-26

save areas for registers 3-82, 11-23

saved PSW 4-78

scale factor (Ψ) 9-12

scaled preferred quantum 20-3

scaled value 9-12

scaling exponent
signed (Ω) 9-13
unsigned (α) 9-12

SCHIB (subchannel-information block) 15-2
as operand of
 MODIFY SUBCHANNEL 14-7
 STORE SUBCHANNEL 14-18
Measurement-Block Address (MBA) 15-9
model-dependent area in 15-9
path-management-control word (PMCW) in 15-2
subchannel-status word (SCSW) in 15-9
summary of modifiable fields in 15-10

SCHM (SET CHANNEL MONITOR) instruction 14-13

SCK (SET CLOCK) instruction 10-124

SCKC (SET CLOCK COMPARATOR) instruction 10-125

SCKPF (SET CLOCK PROGRAMMABLE FIELD) instruction 10-126

SCP-initiated reset 1-34

SCSW (subchannel-status word) 16-7
activity-control field in 16-14, 16-36
CCW address in 16-19
count in 16-31, 16-44
device-status field in 16-24
function-control field in 16-13
in IRB 16-7
in SCHIB 15-9
status-control field in 16-17
subchannel-control field in 16-12, 16-35
subchannel-status field in 16-24, 16-39

SD (SUBTRACT NORMALIZED) HFP instruction 18-24

SDB (SUBTRACT) BFP instruction 19-40

SDBR (SUBTRACT) BFP instruction 19-40

SDR (SUBTRACT NORMALIZED) HFP instruction 18-24

SDTR (SUBTRACT) DFP instruction 20-55

SDTRA (SUBTRACT) DFP instruction 20-55

SE (SUBTRACT NORMALIZED) HFP instruction 18-24

SEARCH STRING instruction 7-372
examples A-31

SEARCH STRING UNICODE instruction 7-374

SEB (SUBTRACT) BFP instruction 19-40

SEBR (SUBTRACT) BFP instruction 19-40

secondary address space 3-23

secondary ASN (SASN) 3-24
control bit 5-76
in linkage-stack state entry 5-82

secondary ASTEIN (SASTEIN)
in linkage-stack state entry 5-83

secondary authority 3-36
exception 6-37

secondary-CCW address validity (in ERW) 16-52

secondary CPU 2-3

secondary designation-type-control bits 3-44

secondary error (in subchannel logout) 16-50

secondary interruption condition (I/O) 16-5

secondary private-space-control bit 3-44

secondary real-space-control bit 3-44

secondary real-space token origin (SRSTKO) 3-44

secondary region table
designiation (SRTD) 3-44
length (SRTL) 3-44
origin (SRTO) 3-44

secondary segment table
designiation (SSTD) 3-44
length (SSTL) 3-44
origin (SSTO) 3-44

secondary-space-control bit 3-41, 5-29

secondary-space mode 3-40

secondary-status bit (I/O) 16-19

secondary storage-alteration-event-control bit 3-44

secondary subspace-group-control bit 3-44

secondary virtual address 3-5
effective address-space-control element for 3-52

segment 3-39
segment-frame absolute address 3-49
segment index (SX) 3-39
segment-invalid bit (in segment-table entry) 3-50
segment table 3-49
length (STL) 3-42
origin (STO) 3-42
segment-table designation (STD)
home 3-45
obtaining of in access-register translation 5-47
primary 3-42
secondary 3-44
segment-translation exception 6-37
as an access exception 6-47, 6-53

SELECT HIGH instruction 7-376

SELECT instructions 7-376

- self-describing block of I/O data 15-62
- SELFHR (SELECT HIGH) instruction 7-376
- SELGR (SELECT) instruction 7-376
- SELR (SELECT) instruction 7-376
- semiprivileged
 - instructions 4-6
 - descriptions of 10-2
 - program authorization 5-27
 - summary of 5-32
 - programs 4-6, 5-27
- sense
 - as signal-processor order 4-85
- sense-running-status facility
 - facility indication 4-99
- sequence
 - conceptual 5-113
 - instruction-execution 5-3
 - of CCWs that is invalid 16-27
 - of storage references 5-113
 - ART-table and DAT-table entries 5-119
 - for floating-point data 9-8
 - instructions 5-118
 - operands 5-123
 - storage keys 5-120
- sequence code (in subchannel logout) 16-50
 - field-validity flag 16-49
- SER (SUBTRACT NORMALIZED) HFP instruction 18-24
- serial-I/O channel-to-channel adapter
 - publication referenced 0-xxix
- serial-I/O interface 13-3
 - publication referenced 0-xxix
- serialization 5-130
 - caused by I/O Instructions 14-2
 - channel-program 5-133
 - CPU 5-130
 - effects of transactional execution 5-131
 - in completion of store operations 5-124
 - quiescing 5-133
 - specific operand 5-132
- server-time-protocol facility 1-26
- service-call-logical-processor (SCLP) facility 1-35
- service-processor damage 11-17
- service processor inoperative (signal-processor status) 4-98
- service-signal external interruption 6-14
 - subclass-mask bit for 6-14
- SET ACCESS instruction 7-377
- SET ADDRESS LIMIT instruction 14-12
- SET ADDRESS SPACE CONTROL FAST instruction 10-123
- SET ADDRESS SPACE CONTROL instruction 10-123
- SET ADDRESSING MODE instruction 7-377
- SET ADDRESSING MODE instructions 7-377
- set architecture
 - signal-processor order 4-89, 4-93
- SET BFP ROUNDING MODE floating-point-support instructions 9-47
- SET CHANNEL MONITOR instruction 14-13
 - effect on measurement modes of 17-1
- SET CLOCK COMPARATOR instruction 10-125
- SET CLOCK instruction 10-124
- SET CLOCK PROGRAMMABLE FIELD instruction 10-126
- SET CPU TIMER instruction 10-126
- SET DFP ROUNDING MODE (SRNMT) floating-point-support instruction 9-47
- SET FPC AND SIGNAL floating-point-support instruction 9-48
- SET FPC floating-point-support instruction 9-47
- set multithreading
 - signal-processor order 4-92
- set prefix (signal-processor order) 4-86
- SET PREFIX instruction 10-126
- SET PROGRAM MASK instruction 7-378
- set-program-parameters facility
 - facility indication 4-100
- SET PSW KEY FROM ADDRESS instruction 10-127
- SET SECONDARY ASN instruction 10-128
 - access registers 5-51
- SET SECONDARY ASN WITH INSTANCE instruction 10-128
- set state (of TOD clock) 4-49
- SET STORAGE KEY EXTENDED instruction 10-133
- SET SYSTEM MASK instruction 10-136
- SFAA (segment-frame absolute address) 3-49
- SFASR (SET FPC AND SIGNAL) floating-point-support instruction 9-48
- SFPC (SET FPC) floating-point-support instruction 9-47
- SG (SUBTRACT) binary instruction 7-395
- SGF (SUBTRACT) binary instruction 7-395
- SGFR (SUBTRACT) binary instruction 7-394
- SGH (SUBTRACT HALFWORD) instruction 7-395
- SGR (SUBTRACT) binary instruction 7-394
- SGRK (SUBTRACT) binary instruction 7-394
- SH (SUBTRACT HALFWORD) instruction 7-395
- shared storage
 - See storage sharing
- shared TOD clock 4-47
- SHHHR (SUBTRACT HIGH) instruction 7-396
- SHHLR (SUBTRACT HIGH) instruction 7-396
- SHIFT AND ROUND DECIMAL instruction 8-12
 - examples A-39
- SHIFT LEFT DOUBLE instruction 7-378
 - example A-31
- SHIFT LEFT DOUBLE LOGICAL instruction 7-379

- SHIFT LEFT SINGLE instruction 7-379
 - example A-32
- SHIFT LEFT SINGLE LOGICAL instruction 7-380
- SHIFT RIGHT DOUBLE instruction 7-381
- SHIFT RIGHT DOUBLE LOGICAL instruction 7-381
- SHIFT RIGHT SINGLE instruction 7-382
- SHIFT RIGHT SINGLE LOGICAL instruction 7-383
- SHIFT SIGNIFICAND LEFT DFP instructions 20-54
- SHIFT SIGNIFICAND RIGHT DFP instructions 20-54
- shifting
 - floating-point
 - See normalization
- short binary-floating-point number 19-2
- short decimal-floating-point number 20-3
- short hexadecimal-floating-point number 18-2
- short I/O block 16-24, 16-39
- SHY (SUBTRACT HALFWORD) instruction 7-395
- SI instruction format 5-6, 5-7
- SID
 - See subsystem-identification word
- side-effect-access facility 1-27
 - facility indication 4-101
- sign bit
 - binary 7-4
 - floating point 9-2
- sign codes (decimal) 8-2
- signal (I/O) 17-11
 - clear
 - See clear signal
 - halt
 - See halt signal
 - reset
 - See reset signal
- SIGNAL PROCESSOR instruction 10-136
 - orders 4-85
 - status 4-96
- signaling NaN (SNaN) 9-2, 19-4, 20-7
- signed binary
 - arithmetic 7-5
 - comparison 7-7
 - integer 7-4
 - examples A-2
- signed exponent 9-2
- signed-packed-decimal format 8-2
 - used in DFP formatting instructions 20-8
- signed-packed-decimal numbers
 - examples A-4
- signed scaling exponent (Ω) 9-13
- significance
 - loss 18-2
 - in HFP addition 18-9
 - mask (in PSW) 4-7
 - requested in REROUND 20-52
 - See also significant digits
 - starter (in EDIT) 8-8
- significantand
 - in BFP data 19-3
 - in DFP data 20-5
- significant digits 20-5
- SIGP
 - See SIGNAL PROCESSOR instruction
- SIGP (SIGNAL PROCESSOR) instruction 10-136
- SIL instruction format 5-7
- simulated IEEE-exception data exception 6-26
- single-access reference 5-125
- single-path mode 15-4, 15-23
- SIY instruction format 5-6, 5-7
- size notation 0-xxviii
- size of address
 - controlled by addressing mode 5-10
 - in CCW 15-32
- skip flag in CCW 15-32
 - effect on data transfer of 15-64
- SL (SUBTRACT LOGICAL) instruction 7-396
- SLA (SHIFT LEFT SINGLE) instruction 7-379
 - example A-32
- SLAG (SHIFT LEFT SINGLE) instruction 7-379
- SLAK (SHIFT LEFT SINGLE) instruction 7-379
- SLB (SUBTRACT LOGICAL WITH BORROW)
 - instruction 7-398
- SLBG (SUBTRACT LOGICAL WITH BORROW)
 - instruction 7-398
- SLBGR (SUBTRACT LOGICAL WITH BORROW)
 - instruction 7-398
- SLBR (SUBTRACT LOGICAL WITH BORROW)
 - instruction 7-398
- SLDA (SHIFT LEFT DOUBLE) instruction 7-378
 - example A-31
- SLDL (SHIFT LEFT DOUBLE LOGICAL) instruction 7-379
- SLDT (SHIFT SIGNIFICAND LEFT) DFP instruction 20-54
- SLFI (SUBTRACT LOGICAL IMMEDIATE)
 - instruction 7-397
- SLGFI (SUBTRACT LOGICAL IMMEDIATE)
 - instruction 7-397
- SLGFR (SUBTRACT LOGICAL) instruction 7-396
- SLGR (SUBTRACT LOGICAL) instruction 7-396, 7-397
- SLGRK (SUBTRACT LOGICAL) binary instruction 7-396
- SLHHHR (SUBTRACT LOGICAL HIGH) instruction 7-397
- SLHHLR (SUBTRACT LOGICAL HIGH) instruction 7-397
- SLI (suppress-length-indication) flag in CCW 15-32, 15-39
 - for immediate operations 15-60

SLL (SHIFT LEFT SINGLE LOGICAL) instruction 7-380

SLLG (SHIFT LEFT SINGLE LOGICAL) instruction 7-380

SLLK (SHIFT LEFT SINGLE LOGICAL) instruction 7-380

SLR (SUBTRACT LOGICAL) instruction 7-396

SLRK (SUBTRACT LOGICAL) binary instruction 7-396

SLXT (SHIFT SIGNIFICAND LEFT) DFP instruction 20-54

Sly (SUBTRACT LOGICAL) instruction 7-396

SNaN (signaling NaN) 9-2, 19-4, 20-7

solicited interruption condition (I/O) 16-3

solid errors 11-6

sorting

- extended 1-33

sorting instructions

- example A-53
- See also* COMPARE AND FORM CODEWORD instruction, UPDATE TREE instruction

source of interruption

- identified by interruption code 6-5

SP (SUBTRACT DECIMAL) instruction 8-13

space-switch event 6-37

- control bit
 - in ASTE 3-32

space-switch-event-control bit

- home 3-45
- primary 3-43

special-operation exception 6-38

special QNaN 9-3, 19-4, 20-7

special quantum-handling operations 20-3

specific-operand serialization 5-132

specification exception 6-40

SPKA (SET PSW KEY FROM ADDRESS) instruction 10-127

SPM (SET PROGRAM MASK) instruction 7-378

SPT (SET CPU TIMER) instruction 10-126

SPX (SET PREFIX) instruction 10-126

SQD (SQUARE ROOT) HFP instruction 18-23

SQDB (SQUARE ROOT) BFP instruction 19-40

SQDBR (SQUARE ROOT) BFP instruction 19-40

SQDR (SQUARE ROOT) HFP instruction 18-23

SQE (SQUARE ROOT) HFP instruction 18-23

SQEB (SQUARE ROOT) BFP instruction 19-40

SQEBR (SQUARE ROOT) BFP instruction 19-40

SQER (SQUARE ROOT) HFP instruction 18-23

SQUARE ROOT BFP instructions 19-40

SQUARE ROOT HFP instructions 18-20

SQXBR (SQUARE ROOT) BFP instruction 19-40

SQXR (SQUARE ROOT) HFP instruction 18-23

SR (SUBTRACT) binary instruction 7-394

SRA (SHIFT RIGHT SINGLE) instruction 7-382

SRAG (SHIFT RIGHT SINGLE) instruction 7-382

SRAK (SHIFT RIGHT SINGLE) instruction 7-382

SRDA (SHIFT RIGHT DOUBLE) instruction 7-381

SRDL (SHIFT RIGHT DOUBLE LOGICAL) instruction 7-381

SRDT (SHIFT SIGNIFICAND RIGHT) DFP instruction 20-54

SRK (SUBTRACT) binary instruction 7-394

SRL (SHIFT RIGHT SINGLE LOGICAL) instruction 7-383

SRLG (SHIFT RIGHT SINGLE LOGICAL) instruction 7-383

SRLK (SHIFT RIGHT SINGLE LOGICAL) instruction 7-383

SRNM (SET BFP ROUNDING MODE) floating-point-support instruction 9-47

SRNMB (SET BFP ROUNDING MODE) floating-point-support instruction 9-47

SRNMT (SET DFP ROUNDING MODE) floating-point-support instruction 9-47

SRP (SHIFT AND ROUND DECIMAL) instruction 8-12

- examples A-39

SRSD (secondary real-space designation) 3-44

SRST (SEARCH STRING) instruction 7-372

- examples A-31

SRSTKO (secondary real-space token origin) 3-44

SRSTU (SEARCH STRING UNICODE) instruction 7-374

SRTD (secondary region-table designation) 3-44

SRTL (secondary region-table length) 3-44

SRTO (secondary region-table origin) 3-44

SRXT (SHIFT SIGNIFICAND RIGHT) DFP instruction 20-54

SS instruction format 5-6, 5-7

SSAIR (SET SECONDARY ASN WITH INSTANCE) instruction 10-128

SSAR (SET SECONDARY ASN) instruction 10-128

- access registers 5-51

SSAR-cp or SSAIR-cp (SET SECONDARY ASN (WITH INSTANCE) instruction, to current primary) 10-128

SSAR-ss or SSAIR-ss (SET SECONDARY ASN (WITH INSTANCE) instruction, with space switching) 10-128

SSASTEO (subspace-AST-entry origin) 5-67

SSASTESN (subspace-AST-entry sequence number) 5-67

SSCH (START SUBCHANNEL) instruction 14-15

SSE instruction format 5-6, 5-7

SSF instruction format 5-7

SSID (subchannel-set identifier) 13-5

SSKE (SET STORAGE KEY EXTENDED) instruction 10-133

- SSM (SET SYSTEM MASK) instruction 10-136
- SSM-suppression-control bit 6-38, 10-136
- SSTD (secondary segment-table designation) 3-44
- SSTL (secondary segment-table length) 3-44
- SSTO (secondary segment-table origin) 3-44
- ST (STORE) binary instruction 7-383
- stack-empty exception 6-44
- stack-full exception 6-45
- stack-operation exception 6-45
- stack-specification exception 6-45
- stack-type exception 6-45
- stacking process 5-84
- stacking PROGRAM CALL 5-72
- STAM (STORE ACCESS MULTIPLE) instruction 7-384
- STAMY (STORE ACCESS MULTIPLE) instruction 7-384
- standalone dump 12-5
- standard epoch (for TOD clock) 4-52
- STAP (STORE CPU ADDRESS) instruction 10-139
- start (CPU)
 - function 4-3
 - key 12-5
 - signal-processor order 4-86
- start function (I/O) 13-8, 15-20
 - bit in SCSW for 16-13
 - initiated by START SUBCHANNEL 14-15
 - path management for 15-20
 - pending 16-15, 16-36
- START SUBCHANNEL instruction 14-15
 - See also* start function for I/O
 - count of in measurement block 17-4
 - deferred condition code for (in SCSW) 16-9
 - function initiated by 15-20
 - operation-request block (ORB) used by 15-24
- state
 - CPU
 - See* CPU state
 - TOD-clock 4-48
- state entry 5-81
- status
 - alert 16-17
 - device 16-24
 - effect of clear function on 15-16
 - field-validity flag for (in subchannel logout) 16-49
 - with inappropriate bit combination 16-50
 - device-status check 16-50
 - for SIGNAL PROCESSOR 4-85, 10-137
 - initial-status interruption
 - See* initial-status-interruption control
 - intermediate 16-18, 16-36
 - primary 16-19
 - program
 - See* PSW
 - resulting from signal-processor orders 4-96
 - secondary 16-19
 - storing of 4-82
 - manual key for 12-5
 - subchannel 16-24
 - status-control field (in SCSW) 16-17
 - status modifier (device status)
 - effect of in command chaining 15-63
 - status pending 16-19
 - status-verification facility 17-26
- STC (STORE CHARACTER) instruction 7-385
- STCH (STORE CHARACTER HIGH) instruction 7-385
- STCK (STORE CLOCK) instruction 7-386
- STCKC (STORE CLOCK COMPARATOR) instruction 10-138
- STCKE (STORE CLOCK EXTENDED) instruction 7-387
- STCKF (STORE CLOCK FAST) instruction 7-386
- STCM (STORE CHARACTERS UNDER MASK) instruction 7-385
 - examples A-32
- STCMH (STORE CHARACTERS UNDER MASK) instruction 7-385
- STCMY (STORE CHARACTERS UNDER MASK) instruction 7-385
- STCPS (STORE CHANNEL PATH STATUS) instruction 14-16
- STCRW (STORE CHANNEL REPORT WORD) instruction 14-17
- STCTG (STORE CONTROL) instruction 10-138
- STCTL (STORE CONTROL) instruction 10-138
- STCY (STORE CHARACTER) instruction 7-385
- STD
 - See* segment-table designation
- STD (STORE) floating-point-support instruction 9-48
- STDY (STORE) floating-point-support instruction 9-49
- STE (STORE) floating-point-support instruction 9-48
- STEY (STORE) floating-point-support instruction 9-49
- STFH (STORE HIGH) instruction 7-391
- STFL (STORE FACILITY LIST) instruction 10-141
- STFL facility list 3-79, 3-85
- STFLE (STORE FACILITY LIST EXTENDED) instruction 7-389
- STFPC (STORE FPC) floating-point-support instruction 9-49
- STG (STORE) binary instruction 7-384
- STGRL (STORE RELATIVE LONG) instruction 7-384
- STGSC (STORE GUARDED STORAGE CONTROLS) instruction 7-390

STH (STORE HALFWORD) instruction 7-390
 STHH (STORE HALFWORD HIGH) instruction 7-391
 STHRL (STORE HALFWORD RELATIVE LONG) instruction 7-391
 STHY (STORE HALFWORD) instruction 7-391
 STIDP (STORE CPU ID) instruction 10-139
 configuration identification 10-140
 environment 10-139
 format indication 10-139, 10-140
 machine-type number 10-139, 10-140
 STL (segment-table length) 3-42
 STM (STORE MULTIPLE) instruction 7-392
 example A-32
 STMG (STORE MULTIPLE) instruction 7-392
 STMH (STORE MULTIPLE HIGH) instruction 7-392
 STMY (STORE MULTIPLE) instruction 7-392
 STNSM (STORE THEN AND SYSTEM MASK) instruction 10-167
 STO (segment-table origin) 3-42
 STOC (STORE ON CONDITION) instruction 7-392
 STOCFH (STORE HIGH ON CONDITION) binary instruction 7-393
 STOCG (STORE ON CONDITION) instruction 7-392
 stop
 function 4-2
 key 12-5
 signal-processor order 4-86
 stop and store status (signal-processor order) 4-86
 stopped (signal-processor status) 4-97
 stopped state
 of CPU 4-2
 effect on completion of store operations 5-124
 of TOD clock 4-49
 storage 3-1, 3-43
 absolute 3-4
 address wraparound
 See wraparound
 addressing 3-2
 See also address
 alteration
 space-control bit 4-28
 alteration manual controls 12-2
 alteration PER event 4-37
 bits for 3-43
 mask for 4-27
 assigned locations in 3-73
 auxiliary 3-2, 3-38
 block 3-4
 testing for usability of 10-170
 buffer (cache) 3-2
 clearing of
 See clearing operation
 concurrency of access for references to 5-127
 configuration of 3-4
 direct-access 3-2
 display 12-2
 error 11-19
 indirect 11-20
 expanded 2-2
 failing address in
 See failing-storage address
 interlocked update 5-123, 5-124
 interlocks for virtual references 5-115
 main 3-2
 noninterlocked update of 5-124
 nonvolatile 3-2
 operand 5-9
 reference to (fetch, store, update) 5-123
 update reference 5-124
 operand consistency 5-125
 examples A-49, A-51
 prefixing for 3-21
 real 3-5
 sequence of references to 5-113
 for floating-point data 9-8
 size
 notation for 0-xxviii
 validation of 11-7
 virtual 3-38
 volatile 3-2
 effect of power-on reset on 4-81
 storage-access code (in subchannel logout) 16-50
 storage-alteration-event bit 4-28
 storage-alteration-event-control bit 3-43
 home 3-45
 primary 3-43
 secondary 3-44
 storage-area designation
 for PER events 4-35
 storage degradation (machine-check condition) 11-19
 storage key 3-9
 error in 11-19
 sequence of references to 5-120
 testing for usability of 10-170
 validation of 11-7
 storage-key function 1-34
 storage-logical-validity bit 11-21
 storage protection 3-10
 during tracing 4-25
 storage-protection-override-control bit 3-12
 storage reconfiguration 1-34
 storage sharing
 by address spaces 3-38
 by CPUs and the channel subsystem 3-4
 examples A-45
 in multiprocessing 4-84

STORE ACCESS MULTIPLE instructions 7-384
 STORE binary instructions 7-383
 STORE CHANNEL PATH STATUS instruction 14-16
 STORE CHANNEL REPORT WORD instruction 14-17
 channel-report word (CRW) stored by 17-29
 STORE CHARACTER HIGH instruction 7-385, 7-391
 STORE CHARACTER instructions 7-385
 STORE CHARACTERS UNDER MASK instruction 7-385
 examples A-32
 STORE CLOCK COMPARATOR instruction 10-138
 STORE CLOCK EXTENDED instruction 7-387
 store-clock-fast facility 1-27, 4-24
 facility indication 4-100
 STORE CLOCK FAST instruction 7-386
 STORE CLOCK instruction 7-386
 STORE CONTROL instruction 10-138
 STORE CPU ADDRESS instruction 10-139
 store-CPU-counter-multiple facility
 facility indication 4-101
 STORE CPU ID instruction 10-139
 configuration identification 10-139, 10-140
 environment 10-139
 format indication 10-139, 10-140
 machine-type number 10-139, 10-140
 STORE CPU TIMER instruction 10-141
 store-facility-list-extended facility 1-27
 facility indication 4-99
 STORE FACILITY LIST EXTENDED instruction 7-389
 STORE FACILITY LIST instruction 10-141
 STORE floating-point-support instructions 9-48
 STORE FPC floating-point-support instruction 9-49
 STORE GUARDED STORAGE CONTROLS instruction 7-390
 STORE HALFWORD HIGH instruction 7-391
 STORE HALFWORD instructions 7-390
 STORE HALFWORD RELATIVE LONG instruction 7-391
 STORE HIGH instruction 7-391
 STORE HIGH ON CONDITION instructions 7-393
 store-hypervisor-information facility
 facility indication 4-101
 STORE MULTIPLE HIGH instruction 7-392
 STORE MULTIPLE instruction
 example A-32
 STORE MULTIPLE instructions 7-392
 STORE ON CONDITION instructions 7-392
 STORE PAIR TO QUADWORD instruction 7-393
 STORE PREFIX instruction 10-142
 STORE REAL ADDRESS instruction 10-142
 store reference 5-123
 access exceptions for 6-50
 STORE RELATIVE LONG instructions 7-384
 STORE REVERSED instructions 7-394
 store status 4-82
 key 12-5
 signal-processor order for 4-86
 store-status architectural-mode identification 3-76, 3-85
 store status at address (signal-processor order) 4-87
 STORE SUBCHANNEL instruction 14-18
 STORE SYSTEM INFORMATION instruction 10-143
 STORE THEN AND SYSTEM MASK instruction 10-167
 STORE THEN OR SYSTEM MASK instruction 10-167
 store using real address (PER event) 4-38
 store-using-real-address-event mask 4-27
 STORE USING REAL ADDRESS instruction 10-168
 STOSM (STORE THEN OR SYSTEM MASK) instruction 10-167
 STP clock source error (machine-check condition) 11-24
 STP sync check (machine-check condition) 11-23
 STP-timing-alert condition
 See timing alert
 STPQ (STORE PAIR TO QUADWORD) instruction 7-393
 STPT (STORE CPU TIMER) instruction 10-141
 STPX (STORE PREFIX) instruction 10-142
 STRAG (STORE REAL ADDRESS) instruction 10-142
 streaming-mode control 15-25
 string of interruptions 4-3, 6-57
 caused by clock comparator 4-61
 caused by CPU timer 4-64
 STRV (STORE REVERSED) instruction 7-394
 STRVG (STORE REVERSED) instruction 7-394
 STRVH (STORE REVERSED) instruction 7-394
 STSCH (STORE SUBCHANNEL) instruction 14-18
 STSI (STORE SYSTEM INFORMATION) instruction 10-143
 STURA (STORE USING REAL ADDRESS) instruction 10-168
 STURG (STORE USING REAL ADDRESS) instruction 10-168
 STY (STORE) binary instruction 7-384
 SU (SUBTRACT UNNORMALIZED) HFP instruction 18-25
 subchannel
 active allegiance for 15-13
 dedicated allegiance for 15-13
 effect of I/O-system reset on 17-15
 idle 16-14
 working allegiance for 15-12

- subchannel-active bit 16-16, 16-36
- subchannel addressing 13-5
- subchannel control information in SCSW 16-12, 16-35
- subchannel enabled bit in PMCW 15-3
- subchannel-information block
 - See SCHIB
- subchannel key 15-25, 15-30, 16-9
 - used as access key 3-11
 - used for IPL 17-17
- subchannel key check (in subchannel logout) 16-47
- subchannel logout 16-47
- subchannel number 13-5
- subchannel operation mode
 - command mode 13-9
 - transport mode 13-9
- subchannel-set identifier
 - See SSID
- Subchannel sets 13-2
- subchannel status 16-24, 16-39
- subchannel-status word
 - See SCSW
- subchannels 13-2
- subclass-mask bits
 - I/O-interruption
 - See I/O-interruption subclass mask
 - external-interruption 6-11
 - machine-check 11-26
- subnormal numbers
 - class of DFP data 20-6
- subroutine linkage 5-14
- subspace-active bit 5-67
- subspace-AST-entry origin (SSASTE0) 5-67
- subspace-AST-entry sequence number (SSASTESN) 5-67
- subspace-group control 3-43
- subspace-group-control bit
 - primary 3-43
 - secondary 3-44
- subspace groups
 - introduction to 5-18
- subspace-replacement
 - exceptions 6-56
 - operations 5-70
- subsystem-identification word 14-1
- subsystem-identification word (SID)
 - assigned storage locations for 3-79, 3-85
- subsystem-linkage-control bit 5-29, 5-35, 5-36
- subsystem reset 4-80
- SUBTRACT BFP instructions 19-40
- SUBTRACT binary instructions 7-394
- SUBTRACT DECIMAL instruction 8-13
- SUBTRACT DFP instructions 20-55
- SUBTRACT HALFWORD instructions 7-395
- SUBTRACT HIGH instruction 7-396
- SUBTRACT LOGICAL HIGH instructions 7-397
- SUBTRACT LOGICAL IMMEDIATE instructions 7-397
- SUBTRACT LOGICAL instructions 7-396
- SUBTRACT LOGICAL WITH BORROW instructions 7-398
- SUBTRACT NORMALIZED
 - See SUBTRACT BFP instructions
- SUBTRACT NORMALIZED HFP instructions 18-24
- SUBTRACT UNNORMALIZED HFP instructions 18-25
- successful-branching PER event 4-36
 - mask for 4-27
- SUPERVISOR CALL instruction 7-398
- supervisor-call interruption 6-57
- supervisor state 4-6
- support functions (I/O) 17-1
- suppress-length-indication flag in CCW
 - See SLI
- suppress-suspended-interruption control (I/O) 15-27, 16-12
 - used for IPL 17-17
- suppression
 - exceptions to 5-26
 - of instruction execution 5-22
 - of unit of operation 5-25
- SUR (SUBTRACT UNNORMALIZED) HFP instruction 18-25
- suspend control 15-25
- suspend-control bit 16-9
 - used for IPL 17-17
- suspend flag in CCW 15-32
 - invalid 16-27
- suspend function 13-11
- suspended bit (in SCSW) 16-17, 16-36
- suspension of channel-program execution 15-73
 - effect on DCTI of 15-75
 - intermediate interruption condition for 16-18
- SVC (SUPERVISOR CALL) instruction 7-398
- SW (SUBTRACT UNNORMALIZED) HFP instruction 18-25
- swapping
 - by COMPARE (DOUBLE) AND SWAP instructions 7-143
 - by EXCLUSIVE OR instruction 7-254
- SWR (SUBTRACT UNNORMALIZED) HFP instruction 18-25
- SX (segment index) 3-39
- SXBR (SUBTRACT) BFP instruction 19-40
- SXR (SUBTRACT NORMALIZED) HFP instruction 18-24
- SXTR (SUBTRACT) DFP instruction 20-55
- SXTRA (SUBTRACT) DFP instruction 20-55

- SY (SUBTRACT) binary instruction 7-395
- symbol translation
 - use by VTAM 7-179
- symbol-translation-option bit 7-172
- synchronization
 - checkpoint 11-3
 - of CPU timer with TOD clock 4-63
 - of TOD clocks 4-49, 4-54
- synchronization control 15-26
- synchronous machine-check-interruption conditions 11-18
- system
 - manual control of 12-1
 - organization of 2-1
- system check stop 11-10
- system damage 11-15
- system mask (in PSW) 4-5
 - validity bit for 11-20
- system recovery 11-15
- system reset
 - I/O
 - See* I/O-system reset
 - See* reset
- system-reset-clear key 12-6
- system-reset-normal key 12-6
- System/360 and System/370 I/O interface
 - See* parallel-I/O interface

T

- T (tera) 0-xxviii
- table of powers of 2 G-1
- table-type bits 3-48, 3-50
 - in region-table entry 3-48
 - in segment-table entry 3-50
- tables
 - ASN
 - See* ASN first table, ASN second table
 - authority
 - See* authority table
 - DAT
 - See* page table, segment table, region table
 - entry
 - See* entry table
 - linkage
 - See* linkage tables
 - page
 - See* page table
 - region
 - See* region table
 - segment
 - See* segment table
 - translation 3-45

- TABORT (TRANSACTION ABORT) instruction 7-401
- TAI (International Atomic Time) related to UTC 4-52
- TAM (TEST ADDRESSING MODE) instruction 7-399
- TAR (TEST ACCESS) instruction 10-168
- target instruction 7-255
- target-precision-constrained rounding 9-12
- TB (TEST BLOCK) instruction 10-170
- TBDR (CONVERT HFP TO BFP) floating-point-support instruction 9-28
- TBDER (CONVERT HFP TO BFP) floating-point-support instruction 9-28
- TBEGIN (TRANSACTION BEGIN) instruction 7-401
- TBEGINC (TRANSACTION BEGIN CONSTRAINED) instruction 7-406
- TCCB (transport-command-control block)
 - address of 15-35
 - contents of 15-37
- TCDB (TEST DATA CLASS) BFP instruction 19-41
- TCEB (TEST DATA CLASS) BFP instruction 19-41
- DCW (device-command word) 15-38
- TCW (transport-command word) 15-33
 - contents of 15-33
- TCW channel program 13-7
- TCW (transport-command word)
 - chaining 15-63
- TCXB (TEST DATA CLASS) BFP instruction 19-41
- TDCDT (TEST DATA CLASS) DFP instruction 20-56
- TDCET (TEST DATA CLASS) DFP instruction 20-56
- TDCXT (TEST DATA CLASS) DFP instruction 20-56
- TDGDT (TEST DATA GROUP) DFP instruction 20-57
- TDGET (TEST DATA GROUP) DFP instruction 20-57
- TDGXT (TEST DATA GROUP) DFP instruction 20-57
- TEND (TRANSACTION END) instruction 7-408
- termination
 - of I/O operations
 - See* conclusion of I/O operations
 - of instruction execution 5-23
 - for exigent machine-check conditions 11-10
 - of unit of operation 5-25
 - for exigent machine-check conditions 11-10
- termination code (in subchannel logout) 16-50
 - field-validity flag for 16-49
- TEST ACCESS instruction 10-168
- TEST ADDRESSING MODE instruction 7-399
- TEST AND SET instruction 7-399
- TEST BLOCK instruction 10-170
- TEST DATA CLASS BFP instructions 19-41
- TEST DATA CLASS DFP instructions 20-56
- TEST DATA GROUP DFP instructions 20-57
- TEST DECIMAL instruction 8-14

- test indicator 12-6
- test-pending-external-interruption facility 1-27
 - facility indication 4-101
- TEST PENDING EXTERNAL INTERRUPTION instruction 10-172
- TEST PENDING INTERRUPTION instruction 14-19
 - interruption code stored by 14-20
- TEST PROTECTION instruction 10-173
- TEST SUBCHANNEL instruction 14-21
 - interruption-response block (IRB)used by 16-6
- TEST UNDER MASK HIGH instruction 7-400
- TEST UNDER MASK instruction 7-400
 - examples A-33
- TEST UNDER MASK LOW instruction 7-400
- testing for storage-block and storage-key usability 10-170
- THDER (CONVERT BFP TO HFP) floating-point-support instruction 9-27
- THDR (CONVERT BFP TO HFP) floating-point-support instruction 9-27
- thread
 - identification (ID) 2-3, 4-84, 4-85, 4-93, 12-3, 12-7
 - program-specified maximum 2-3, 4-84, 4-92, 4-93, 12-3
 - width 4-84
 - multithreading 2-3
- TIC (transfer in channel) 15-77
 - invalid sequence of 16-27
- TID
 - See* thread identification
- TID width
 - See* thread identification width
- ties 9-13
- time-of-day clock
 - See* TOD clock
- timer
 - See* CPU timer
- timing
 - channel-subsystem 17-2
- timing alert
 - external interruption 6-14
- timing facilities 4-47
- timing-facility bit (in PMCW) 15-4
- timing-facility damage 11-16
 - for TOD clock 4-49
- timing-alert condition
 - ETR-timing-alert condition 6-14
 - STP-timing-alert condition 6-14
- TLB (translation-lookaside buffer) 3-62
 - entries 3-63
 - attachment of 3-63
 - clearing of 3-67
 - effect of translation changes on 3-67
 - usable state 3-65
- TM (TEST UNDER MASK) instruction 7-400
 - examples A-33
- TMH (TEST UNDER MASK HIGH) instruction 7-400
- TMHH (TEST UNDER MASK) instruction 7-400
- TMHL (TEST UNDER MASK) instruction 7-400
- TML (TEST UNDER MASK LOW) instruction 7-400
- TMLH (TEST UNDER MASK) instruction 7-400
- TMLL (TEST UNDER MASK) instruction 7-400
- TMY (TEST UNDER MASK) instruction 7-400
- TOD clock 4-47
 - effect of power-on reset on 4-81
 - effect on clock-comparator interruption 6-12
 - effect on CPU-timer decrementing 4-64
 - effect on CPU-timer interruption 6-12
 - manual control of 4-49, 12-6
 - offset-based steering
 - overview 4-57
 - steering 4-55
 - episodes 4-57
 - facility indication 4-100
 - hardware based 4-55
 - overview 4-56
 - offset based 4-55
 - overview 4-56
 - offset update events 4-57
 - registers 4-57
 - UTC information block (UIB) 4-58
 - unique values of 4-50
 - validation of 11-9
 - value in trace entry 4-24
- TOD-clock-control-override control 4-49
- TOD-clock epoch-extension facility
 - facility indication 4-101
- TOD-clock programmable field 4-52
- TOD-clock programmable register 4-52
 - save areas for 3-82
 - validity bit for 11-22
- TOD-clock-steering facility 1-27
- TOD-clock-sync-control bit 4-49, 4-54
- TOD-clock-synchronization facility 4-54
- TP (TEST DECIMAL) instruction 8-14
- TPEI (TEST PENDING EXTERNAL INTERRUPTION) instruction 10-172
- TPI (TEST PENDING INTERRUPTION) instruction 14-19
 - interruption code stored by 14-20
- TPROT (TEST PROTECTION) instruction 10-173
- TR (TRANSLATE) instruction 7-408
 - example A-33
- trace 4-12
 - entries 4-15
 - entry address 4-15
 - exceptions 6-56

- table exception 6-45
- TRACE instruction 10-176
 - trace entry for 4-24
- TRACG (TRACE) instruction 10-176
- transaction
 - definition of 5-91
- transaction abort code
 - in the transaction diagnostic block 5-95
- TRANSACTION ABORT instruction 7-401
- transaction-abort PSW 5-93
- TRANSACTION BEGIN CONSTRAINED instruction 7-406
- TRANSACTION BEGIN instruction 7-401, 7-406
 - processing of 7-403, 7-406
- transaction constraint exception 6-46
- transaction diagnostic block
 - aborted-transaction-instruction-address field 5-95
 - breaking-event-address field 5-96
 - conflict-token field 5-95
 - data-exception-code field 5-96
 - exception-access-identification field 5-96
 - flags field 5-95
 - for a program interruption 3-83
 - format field 5-94
 - program-interruption-identification field 5-96
 - transaction-abort-code field 5-95
 - transaction-nesting-depth field 5-95
 - translation-exception-identification field 5-96
- transaction-diagnostic-block address 5-93
- transaction diagnostic control
 - in control register 2 5-92
- transaction diagnostic scope
 - in control register 2 5-92
- TRANSACTION END instruction 7-408
- transaction-end PER event
 - mask for 4-27
- transaction initiation 5-99
- transaction nesting depth 5-93
 - in the transaction diagnostic block 5-95
- transactional access 5-91
- transactional execution
 - abort 5-89
 - and breaking events 4-46
 - and PER events 4-29, 4-41
 - commit 5-90
 - conflict 5-90
 - constrained transaction 5-90
 - constrained transaction-execution mode 5-90
 - controls 5-92
 - effects on CPU serialization 5-131
 - nested transaction 5-90, 5-91
 - nonconstrained transaction 5-91
 - nonconstrained transaction-execution mode 5-91
 - outer transaction 5-91
 - outermost transaction 5-91
 - program-interruption filtering 5-91
 - restricted instruction
 - tracing 4-25
 - transaction
 - definition of 5-91
 - transactional access 5-91
 - transactional-execution mode 5-91
 - transactional-execution-aborted event 6-46
 - transactional-execution control
 - in control register 0 4-10, 5-92
 - transactional-execution facility 1-27, 5-89
 - facility indication 4-101
 - instructions 5-97
 - restricted 5-97
 - operation 5-99
 - execution in the transactional-execution mode 5-99
 - normal transaction ending 5-99
 - program-interruption filtering 5-104
 - transaction abort conditions 5-100
 - transaction abort processing 5-102
 - transaction initiation 5-99
 - terminology 5-89
- transactional-execution program-interruption filtering
 - override
 - in control register 0 5-92, 4-10
- transfer in channel
 - See TIC
- transferring program control 5-71
- TRANSLATE AND TEST instruction 7-409
 - example A-34
- TRANSLATE AND TEST REVERSE instruction 7-415
- TRANSLATE EXTENDED instruction 7-415
- TRANSLATE instruction 7-408
 - example A-33
- TRANSLATE ONE TO ONE instruction 7-418
- TRANSLATE ONE TO TWO instruction 7-418
- TRANSLATE TWO TO ONE instruction 7-418
- TRANSLATE TWO TO TWO instruction 7-418
- translation
 - address 3-38
 - See dynamic address translation
 - exception identification 3-76, 3-77
 - lookaside buffer
 - See TLB
 - PC-number 5-33
 - specification exception 6-46
 - tables for 3-45
- translation exception identification
 - in the transaction diagnostic block 5-96
- translation modes 3-40
- translation parameters 3-40

- translation path 3-64
- TCCB (transport-command-control block) 15-36
- transport-command-control block
 - See TCCB
- transport-command word
 - See TCW
- transport-status block
 - See TSB
- trap action
 - IEEE 9-18
- trap control block 10-178
- TRAP instruction 10-177
- trap save area 10-179
- TRAP2 (TRAP) instruction 10-177
- TRAP4 (TRAP) instruction 10-177
- TRE (TRANSLATE EXTENDED) instruction 7-415
- tree structure for sorting 7-425
 - example A-53
- trial execution
 - for editing instructions and TRANSLATE instruction 5-27
 - for PER 4-30
- trimodal addressing 5-10, 7-8
- TROO (TRANSLATE ONE TO ONE) instruction 7-418
- TROT (TRANSLATE ONE TO TWO) instruction 7-418
- TRT (TRANSLATE AND TEST) instruction 7-409
 - example A-34
- TRTO (TRANSLATE TWO TO ONE) instruction 7-418
- TRTR (TRANSLATE AND TEST REVERSE) instruction 7-415
- TRTT (TRANSLATE TWO TO TWO) instruction 7-418
- true zero (HFP number) 18-1
- TS (TEST AND SET) instruction 7-399
- TSB (transport-status block) 15-48
 - address of 15-35
 - contents of 15-49, 15-56
- TSCH (TEST SUBCHANNEL) instruction 14-21
- two's complement binary notation 7-4
 - examples A-2
- type of PROGRAM CALL 5-38

U

- UIB
 - See UTC information block 4-58
- ulp (unit in the last place) 9-7, 9-8, 19-3
- underflow
 - See exponent underflow
- unit check (device status)
 - in establishing dedicated allegiance 15-13

- unit of operation 5-24
- unlock A-47
 - example with FIFO queuing A-50
 - example with LIFO queuing A-49
- unnormalized floating-point number 18-2
 - HFP data only 9-3
- unordered (comparison to a NaN) 9-24
- UNPACK ASCII instruction 7-423
- UNPACK instruction 7-423
 - example A-35
- UNPACK UNICODE instruction 7-424
- UNPK (UNPACK) instruction 7-423
 - example A-35
- UNPKA (PACK ASCII) instruction 7-423
- UNPKU (PACK UNICODE) instruction 7-424
- unprivileged instructions 4-6, 7-4
- unsigned binary
 - arithmetic 7-6
 - integer 7-4
 - examples A-3
 - in address generation 5-11
- unsigned binary integer
 - conversion to floating point 19-21
- unsigned-packed-decimal format 8-2
 - used in DFP formatting instructions 20-8
- unsigned scaling exponent (α) 9-12
- unsolicited interruption condition (I/O) 16-3
- unstack-suppression bit 5-79
- unstacking process 5-86
- update reference 5-124
- UPDATE TREE instruction 7-425
 - example A-53
- UPT (UPDATE TREE) instruction 7-425
 - example A-53
- usable ALB entry 5-65
- UTC (Coordinated Universal Time) used in TOD epoch 4-52
- UTC information block (UIB) 4-58

V

- VA (VECTOR ADD) vector instruction 22-3
- VAC (VECTOR ADD WITH CARRY) vector instruction 22-4
- VACC (VECTOR ADD COMPUTE CARRY) vector instruction 22-4
- VACCC (VECTOR ADD WITH CARRY COMPUTE CARRY) vector instruction 22-5
- valid ART-table entry 5-65
- valid CBC 11-2
- valid floating-point-register numbers 9-9
- valid region-table, segment-table, or page-table entry 3-63
- validation 11-6

- of registers 11-9
- of storage 11-7
- of storage key 11-7
- of TOD clock 11-9
- validity bit for backward stack-entry address 5-80
- validity bit for forward-section-header address 5-81
- validity bits
 - in machine-check-interruption code 11-20
 - in subchannel logout 16-49
- VAP (VECTOR ADD DECIMAL) instruction 25-3
- variable-length field 3-3
- VAVG (VECTOR AVERAGE) vector instruction 22-6
- VAVGL (VECTOR AVERAGE LOGICAL) vector instruction 22-6
- VBPERM (VECTOR BIT PERMUTE) vector instruction 21-4
- VCDG (VECTOR FP CONVERT FROM FIXED 64-BIT) vector instruction 24-15
- VCDLG (VECTOR FP CONVERT FROM LOGICAL 64-BIT) vector instruction 24-17
- VCEQ (VECTOR COMPARE EQUAL) vector instruction 22-7
- VCFPS (VECTOR FP CONVERT FROM FIXED) vector instruction 24-15
- VCGD (VECTOR FP CONVERT TO FIXED 64-BIT) vector instruction 24-18
- VCH (VECTOR COMPARE HIGH) vector instruction 22-8
- VCHL (VECTOR COMPARE HIGH LOGICAL) vector instruction 22-9
- VCKSM (VECTOR CHECKSUM) vector instruction 22-6
- VCLFP (VECTOR FP CONVERT TO LOGICAL) vector instruction 24-20
- VCLGD (VECTOR FP CONVERT TO LOGICAL 64-BIT) vector instruction 24-20
- VCLZ (VECTOR COUNT LEADING ZEROS) vector instruction 22-10
- VCP (VECTOR COMPARE DECIMAL) instruction 25-5
- VCSFP (VECTOR FP CONVERT TO FIXED) vector instruction 24-18
- VCTZ (VECTOR COUNT TRAILING ZEROS) vector instruction 22-10
- VCVB (VECTOR CONVERT TO BINARY) instruction 25-5
- VCVBG (VECTOR CONVERT TO BINARY) instruction 25-5
- VCVD (VECTOR CONVERT TO DECIMAL) instruction 25-7
- VCVDG (VECTOR CONVERT TO DECIMAL) instruction 25-7
- VDP (VECTOR DIVIDE DECIMAL) instruction 25-8
- VEC (VECTOR ELEMENT COMPARE) vector instruction 22-7
- VECL (VECTOR ELEMENT COMPARE LOGICAL) vector instruction 22-7
- vector
 - registers 2-5
 - validity bit for 11-21, 11-22
- VECTOR ADD COMPUTE CARRY vector instruction 22-4
- VECTOR ADD DECIMAL instruction 25-3
- VECTOR ADD vector instruction 22-3
- VECTOR ADD WITH CARRY COMPUTE CARRY vector instruction 22-5
- VECTOR ADD WITH CARRY vector instruction 22-4
- VECTOR AND vector instruction 22-5
- VECTOR AND WITH COMPLEMENT vector instruction 22-5
- VECTOR AVERAGE LOGICAL vector instruction 22-6
- VECTOR AVERAGE vector instruction 22-6
- VECTOR BIT PERMUTE vector instruction 21-4
- VECTOR CHECKSUM vector instruction 22-6
- VECTOR COMPARE DECIMAL instruction 25-5
- VECTOR COMPARE EQUAL vector instruction 22-7
- VECTOR COMPARE HIGH LOGICAL vector instruction 22-9
- VECTOR COMPARE HIGH vector instruction 22-8
- VECTOR CONVERT TO BINARY instructions 25-5
- VECTOR CONVERT TO DECIMAL instructions 25-7
- VECTOR COUNT LEADING ZEROS vector instruction 22-10
- VECTOR COUNT TRAILING ZEROS vector instruction 22-10
- VECTOR DIVIDE DECIMAL instruction 25-8
- VECTOR ELEMENT COMPARE LOGICAL vector instruction 22-7
- VECTOR ELEMENT COMPARE vector instruction 22-7
- VECTOR ELEMENT ROTATE AND INSERT UNDER MASK vector instruction 22-22
- VECTOR ELEMENT ROTATE LEFT LOGICAL vector instruction 22-21
- VECTOR ELEMENT SHIFT LEFT vector instruction 22-23
- VECTOR ELEMENT SHIFT RIGHT ARITHMETIC vector instruction 22-23
- VECTOR ELEMENT SHIFT RIGHT LOGICAL vector instruction 22-24
- vector-enhancements facility 1
 - facility indication 4-101
- vector-enhancements facility 2 1-28
 - facility indication 4-101
- vector-exception code (VXC) 6-20
- VECTOR EXCLUSIVE OR vector instruction 22-11

vector facility for z/Architecture
 facility indication 4-101

vector facility for z/architecture 1-28

VECTOR FIND ANY ELEMENT EQUAL vector
 instruction 23-2

VECTOR FIND ELEMENT EQUAL vector instruction
 23-3

VECTOR FIND ELEMENT NOT EQUAL vector
 instruction 23-4

VECTOR FP ADD vector instruction 24-4

VECTOR FP COMPARE AND SIGNAL SCALAR
 vector instruction 24-8

VECTOR FP COMPARE EQUAL vector instruction
 24-9

VECTOR FP COMPARE HIGH OR EQUAL vector
 instruction 24-13

VECTOR FP COMPARE HIGH vector instruction
 24-11

VECTOR FP COMPARE SCALAR vector instruction
 24-7

VECTOR FP CONVERT FROM FIXED 64-BIT vector
 instruction 24-15

VECTOR FP CONVERT FROM LOGICAL 64-BIT
 vector instruction 24-17

VECTOR FP CONVERT TO FIXED 64-BIT vector
 instruction 24-18

VECTOR FP CONVERT TO LOGICAL 64-BIT vector
 instruction 24-20

VECTOR FP DIVIDE vector instruction 24-22

VECTOR FP LOAD LENGTHENED vector instruction
 24-26

VECTOR FP LOAD ROUNDED vector instruction
 24-27

VECTOR FP MAXIMUM vector instruction 24-28

VECTOR FP MINIMUM vector instruction 24-34

VECTOR FP MULTIPLY AND ADD vector instruction
 24-42

VECTOR FP MULTIPLY AND SUBTRACT vector
 instruction 24-42

VECTOR FP MULTIPLY vector instruction 24-40

VECTOR FP NEGATIVE MULTIPLY AND ADD
 vector instruction 24-42

VECTOR FP NEGATIVE MULTIPLY AND
 SUBTRACT vector instruction 24-42

VECTOR FP PERFORM SIGN OPERATION vector
 instruction 24-44

VECTOR FP SQUARE ROOT vector instruction
 24-45

VECTOR FP SUBTRACT vector instruction 24-46

VECTOR FP TEST DATA CLASS IMMEDIATE
 vector instruction 24-47

VECTOR GALOIS FIELD MULTIPLY SUM AND
 ACCUMULATE vector instruction 22-12

VECTOR GALOIS FIELD MULTIPLY SUM vector
 instruction 22-11

VECTOR GATHER ELEMENT vector instruction
 21-5

VECTOR GENERATE BYTE MASK vector
 instruction 21-5

VECTOR GENERATE MASK vector instruction 21-6

VECTOR ISOLATE STRING vector instruction 23-5

VECTOR LOAD AND REPLICATE vector instruction
 21-7

VECTOR LOAD COMPLEMENT vector instruction
 22-12

VECTOR LOAD ELEMENT IMMEDIATE vector
 instruction 21-10

VECTOR LOAD ELEMENT vector instruction 21-9

VECTOR LOAD FP INTEGER vector instruction
 24-24

VECTOR LOAD GR FROM VR ELEMENT vector
 instruction 21-11

VECTOR LOAD IMMEDIATE DECIMAL instruction
 25-10

VECTOR LOAD LOGICAL ELEMENT AND ZERO
 vector instruction 21-12

VECTOR LOAD MULTIPLE vector instruction 21-12

VECTOR LOAD POSITIVE vector instruction 22-12

VECTOR LOAD RIGHTMOST WITH LENGTH
 instruction 21-13

VECTOR LOAD TO BLOCK BOUNDARY vector
 instruction 21-14

VECTOR LOAD vector instruction 21-6

VECTOR LOAD VR ELEMENT FROM GR vector
 instruction 21-14

VECTOR LOAD VR FROM GRS DISJOINT vector
 instruction 21-15

VECTOR LOAD WITH LENGTH vector instruction
 21-15

VECTOR MAXIMUM LOGICAL vector instruction
 22-13

VECTOR MAXIMUM vector instruction 22-13

VECTOR MERGE HIGH vector instruction 21-15

VECTOR MERGE LOW vector instruction 21-16

VECTOR MINIMUM LOGICAL vector instruction
 22-14

VECTOR MINIMUM vector instruction 22-13

VECTOR MULTIPLY AND ADD EVEN vector
 instruction 22-15

VECTOR MULTIPLY AND ADD HIGH vector
 instruction 22-15

VECTOR MULTIPLY AND ADD LOGICAL EVEN
 vector instruction 22-15

VECTOR MULTIPLY AND ADD LOGICAL HIGH
 vector instruction 22-15

VECTOR MULTIPLY AND ADD LOGICAL ODD
 vector instruction 22-16

VECTOR MULTIPLY AND ADD LOW vector instruction 22-14
 VECTOR MULTIPLY AND ADD ODD vector instruction 22-16
 VECTOR MULTIPLY AND SHIFT DECIMAL instruction 25-11
 VECTOR MULTIPLY DECIMAL instruction 25-10
 VECTOR MULTIPLY EVEN vector instruction 22-18
 VECTOR MULTIPLY HIGH vector instruction 22-16
 VECTOR MULTIPLY LOGICAL EVEN vector instruction 22-18
 VECTOR MULTIPLY LOGICAL HIGH vector instruction 22-17
 VECTOR MULTIPLY LOGICAL ODD vector instruction 22-18
 VECTOR MULTIPLY LOW vector instruction 22-17
 VECTOR MULTIPLY ODD vector instruction 22-18
 VECTOR NAND vector instruction 22-20
 VECTOR NOR vector instruction 22-19
 VECTOR NOT EXCLUSIVE OR vector instruction 22-20
 VECTOR OR vector instruction 22-20
 VECTOR OR WITH COMPLEMENT vector instruction 22-21
 VECTOR PACK LOGICAL SATURATE vector instruction 21-18
 VECTOR PACK SATURATE vector instruction 21-17
 VECTOR PACK vector instruction 21-16
 VECTOR PACK ZONED instruction 25-13
 vector-packed-decimal facility 1-27, 1-28
 facility indication 4-101
 VECTOR PERFORM SIGN OPERATION DECIMAL instruction 25-14
 VECTOR PERMUTE DOUBLEWORD IMMEDIATE vector instruction 21-19
 VECTOR PERMUTE vector instruction 21-18
 VECTOR POPULATION COUNT vector instruction 22-21
 VECTOR REMAINDER DECIMAL instruction 25-16
 VECTOR REPLICATE IMMEDIATE vector instruction 21-20
 VECTOR REPLICATE vector instruction 21-19
 VECTOR SCATTER ELEMENT vector instruction 21-20
 VECTOR SELECT vector instruction 21-21
 VECTOR SHIFT AND DIVIDE DECIMAL instruction 25-18
 VECTOR SHIFT AND ROUND DECIMAL instruction 25-19
 VECTOR SHIFT LEFT BY BYTE vector instruction 22-25
 VECTOR SHIFT LEFT DOUBLE BY BYTE vector instruction 22-26
 VECTOR SHIFT LEFT vector instruction 22-25
 VECTOR SHIFT RIGHT ARITHMETIC BY BYTE vector instruction 22-26
 VECTOR SHIFT RIGHT ARITHMETIC vector instruction 22-26
 VECTOR SHIFT RIGHT LOGICAL BY BYTE vector instruction 22-27
 VECTOR SHIFT RIGHT LOGICAL vector instruction 22-27
 VECTOR SIGN EXTEND TO DOUBLEWORD vector instruction 21-21
 VECTOR STORE ELEMENT vector instruction 21-23, 21-24
 VECTOR STORE MULTIPLE vector instruction 21-24
 VECTOR STORE RIGHTMOST WITH LENGTH instruction 21-25
 VECTOR STORE vector instruction 21-21
 VECTOR STORE WITH LENGTH vector instruction 21-26
 VECTOR STRING RANGE COMPARE vector instruction 23-6
 VECTOR SUBTRACT COMPUTE BORROW INDICATION vector instruction 22-28
 VECTOR SUBTRACT DECIMAL instruction 25-21
 VECTOR SUBTRACT vector instruction 22-27
 VECTOR SUBTRACT WITH BORROW COMPUTE BORROW INDICATION vector instruction 22-29
 VECTOR SUBTRACT WITH BORROW INDICATION vector instruction 22-28
 VECTOR SUM ACROSS DOUBLEWORD vector instruction 22-29
 VECTOR SUM ACROSS QUADWORD vector instruction 22-30
 VECTOR SUM ACROSS WORD vector instruction 22-30
 VECTOR TEST DECIMAL instruction 25-22
 VECTOR TEST UNDER MASK vector instruction 22-31
 VECTOR UNPACK HIGH vector instruction 21-26
 VECTOR UNPACK LOGICAL HIGH vector instruction 21-26
 VECTOR UNPACK LOGICAL LOW vector instruction 21-27
 VECTOR UNPACK LOW vector instruction 21-27
 VECTOR UNPACK ZONED instruction 25-22
 vector-packed-decimal-enhancement facility 1-29
 facility indication 4-101
 VERIM (VECTOR ELEMENT ROTATE AND INSERT UNDER MASK) vector instruction 22-22
 VERLL (VECTOR ELEMENT ROTATE LEFT LOGICAL) vector instruction 22-21
 VERLLV (VECTOR ELEMENT ROTATE LEFT LOGICAL) vector instruction 22-21

VESL (VECTOR ELEMENT SHIFT LEFT) vector instruction 22-23

VESLV (VECTOR ELEMENT SHIFT LEFT) vector instruction 22-23

VESRA (VECTOR ELEMENT SHIFT RIGHT ARITHMETIC) vector instruction 22-23

VESRAV (VECTOR ELEMENT SHIFT RIGHT ARITHMETIC) vector instruction 22-23

VESRL (VECTOR ELEMENT SHIFT RIGHT LOGICAL) vector instruction 22-24

VESRLV (VECTOR ELEMENT SHIFT RIGHT LOGICAL) vector instruction 22-24

VFA (VECTOR FP ADD) vector instruction 24-4

VFAE (VECTOR FIND ANY ELEMENT EQUAL) vector instruction 23-2

VFCE (VECTOR FP COMPARE EQUAL) vector instruction 24-9

VFCH (VECTOR FP COMPARE HIGH) vector instruction 24-11

VFCHE (VECTOR FP COMPARE HIGH OR EQUAL) vector instruction 24-13

VFD (VECTOR FP DIVIDE) vector instruction 24-22

VFEE (VECTOR FIND ELEMENT EQUAL) vector instruction 23-3

VFENE (VECTOR FIND ELEMENT NOT EQUAL) vector instruction 23-4

VFI (VECTOR LOAD FP INTEGER) vector instruction 24-24

VFLL (VECTOR FP LOAD LENGTHENED) vector instruction 24-26

VFLR (VECTOR FP LOAD ROUNDED) vector instruction 24-27

VFM (VECTOR FP MULTIPLY) vector instruction 24-40

VFMA (VECTOR FP MULTIPLY AND ADD) vector instruction 24-42

VFMAX (VECTOR FP MAXIMUM) vector instruction 24-28

VFMIN (VECTOR FP MINIMUM) vector instruction 24-34

VFMS (VECTOR FP MULTIPLY AND SUBTRACT) vector instruction 24-42

VFNMA (VECTOR FP NEGATIVE MULTIPLY AND ADD) vector instruction 24-42

VFNMS (VECTOR FP NEGATIVE MULTIPLY AND SUBTRACT) vector instruction 24-42

VFPSO (VECTOR FP PERFORM SIGN OPERATION) vector instruction 24-44

VFS (VECTOR FP SUBTRACT) vector instruction 24-46

VFSQ (VECTOR FP SQUARE ROOT) vector instruction 24-45

VFTCI (VECTOR FP TEST DATA CLASS IMMEDIATE) vector instruction 24-47

VGBM (VECTOR GENERATE BYTE MASK) vector instruction 21-5

VGEF (VECTOR GATHER ELEMENT) vector instruction 21-5

VGEG (VECTOR GATHER ELEMENT) vector instruction 21-5

VGFM (VECTOR GALOIS FIELD MULTIPLY SUM) vector instruction 22-11

VGFMA (VECTOR GALOIS FIELD MULTIPLY SUM AND ACCUMULATE) vector instruction 22-12

VGM (VECTOR GENERATE MASK) vector instruction 21-6

view (of floating-point numbers) 9-2

- common-rounding-point 9-13
- fraction 9-2
- left-units view 9-2
- right-units view 9-2

virtual address 3-5

virtual machine

- extensions for 1-34

virtual storage 3-38

VISTR (VECTOR ISOLATE STRING) vector instruction 23-5

VL (VECTOR LOAD) vector instruction 21-6

VLBB (VECTOR LOAD TO BLOCK BOUNDARY) vector instruction 21-14

VLBR (VECTOR LOAD BYTE REVERSED ELEMENTS) vector instruction 21-9

VLBRREP (VECTOR LOAD BYTE REVERSED ELEMENT AND REPLICATE) vector instruction 21-8

VLC (VECTOR LOAD COMPLEMENT) vector instruction 22-12

VLEB (VECTOR LOAD ELEMENT) vector instruction 21-9

VLEBRF (VECTOR LOAD BYTE REVERSED ELEMENT) vector instruction 21-7

VLEBRG (VECTOR LOAD BYTE REVERSED ELEMENT) vector instruction 21-7

VLEBRH (VECTOR LOAD BYTE REVERSED ELEMENT) vector instruction 21-7

VLEF (VECTOR LOAD ELEMENT) vector instruction 21-9

VLEG (VECTOR LOAD ELEMENT) vector instruction 21-9

VLEH (VECTOR LOAD ELEMENT) vector instruction 21-9

VLEIB (VECTOR LOAD ELEMENT IMMEDIATE) vector instruction 21-10

VLEIF (VECTOR LOAD ELEMENT IMMEDIATE) vector instruction 21-10

VLEIG (VECTOR LOAD ELEMENT IMMEDIATE) vector instruction 21-10

VLEIH (VECTOR LOAD ELEMENT IMMEDIATE) vector instruction 21-10

VLER (VECTOR LOAD ELEMENTS REVERSED) vector instruction 21-10

VLGV (VECTOR LOAD GR FROM VR ELEMENT) vector instruction 21-11

VLIP (VECTOR LOAD IMMEDIATE DECIMAL) instruction 25-10

VLL (VECTOR LOAD WITH LENGTH) vector instruction 21-15

VLEBRZ (VECTOR LOAD BYTE REVERSED ELEMENT AND ZERO) vector instruction 21-8

VLEZ (VECTOR LOAD LOGICAL ELEMENT AND ZERO) vector instruction 21-12

VLM (VECTOR LOAD MULTIPLE) vector instruction 21-12

VLP (VECTOR LOAD POSITIVE) vector instruction 22-12

VLR (VECTOR LOAD) vector instruction 21-6

VLREP (VECTOR LOAD AND REPLICATE) vector instruction 21-7

VLRL (VECTOR LOAD RIGHTMOST WITH LENGTH) vector instruction 21-13

VLRLR (VECTOR LOAD RIGHTMOST WITH LENGTH) vector instruction 21-13

VLVG (VECTOR LOAD VR ELEMENT FROM GR) vector instruction 21-14

VLVGP (VECTOR LOAD VR FROM GRS DISJOINT) vector instruction 21-15

VM-data-space facility 1-34

VMAE (VECTOR MULTIPLY AND ADD EVEN) vector instruction 22-15

VMAH (VECTOR MULTIPLY AND ADD HIGH) vector instruction 22-15

VMAL (VECTOR MULTIPLY AND ADD LOW) vector instruction 22-14

VMALE (VECTOR MULTIPLY AND ADD LOGICAL EVEN) vector instruction 22-15

VMALH (VECTOR MULTIPLY AND ADD LOGICAL HIGH) vector instruction 22-15

VMALO (VECTOR MULTIPLY AND ADD LOGICAL ODD) vector instruction 22-16

VMAO *VECTOR MULTIPLY AND ADD ODD) vector instruction 22-16

VME (VECTOR MULTIPLY EVEN) vector instruction 22-18

VMH (VECTOR MULTIPLY HIGH) vector instruction 22-16

VML (VECTOR MULTIPLY LOW) vector instruction 22-17

VMLE (VECTOR MULTIPLY LOGICAL EVEN) vector instruction 22-18

VMLH (VECTOR MULTIPLY LOGICAL HIGH) vector instruction 22-17

VMLO (VECTOR MULTIPLY LOGICAL ODD) vector instruction 22-18

VMN (VECTOR MINIMUM) vector instruction 22-13

VMNL (VECTOR MINIMUM LOGICAL) vector instruction 22-14

VMO (VECTOR MULTIPLY ODD) vector instruction 22-18

VMP (VECTOR MULTIPLY DECIMAL) instruction 25-10

VMRH (VECTOR MERGE HIGH) vector instruction 21-15

VMRL (VECTOR MERGE LOW) vector instruction 21-16

VMSL (VECTOR MULTIPLY SUM LOGICAL) vector instruction 22-19

VMSP (VECTOR MULTIPLY AND SHIFT DECIMAL) instruction 25-12

VMX (VECTOR MAXIMUM) vector instruction 22-13

VMXL (VECTOR MAXIMUM LOGICAL) vector instruction 22-13

VN (VECTOR AND) vector instruction 22-5

VNC (VECTOR AND WITH COMPLEMENT) vector instruction 22-5

VNN (VECTOR NAND) vector instruction 22-20

VNO (VECTOR NOR) vector instruction 22-20

VNX (VECTOR NOT EXCLUSIVE OR) vector instruction 22-20

VO (VECTOR OR) vector instruction 22-20

VOC (VECTOR OR WITH COMPLEMENT) vector instruction 22-21

volatile storage 3-2
effect of power-on reset on 4-81

voting digit 9-13

VPDI (VECTOR PERMUTE DOUBLEWORD IMMEDIATE) vector instruction 21-19

VPERM (VECTOR PERMUTE) vector instruction 21-18

VPK (VECTOR PACK) vector instruction 21-16

VPKLS (VECTOR PACK LOGICAL SATURATE) vector instruction 21-18

VPKS (VECTOR PACK SATURATE) vector instruction 21-17

VPKZ (VECTOR PACK ZONED) instruction 25-13

VPOPCT (VECTOR POPULATION COUNT) vector instruction 22-21

VPSOP (VECTOR PERFORM SIGN OPERATION DECIMAL) instruction 25-14

VREP (VECTOR REPLICATE) vector instruction 21-19

VREPI (VECTOR REPLICATE IMMEDIATE) vector instruction 21-20

VRP (VECTOR REMAINDER DECIMAL) instruction 25-16

VS (VECTOR SUBTRACT) vector instruction 22-27

VSBCBI (VECTOR SUBTRACT WITH BORROW COMPUTE BORROW INDICATION) vector instruction 22-29
 VSBI (VECTOR SUBTRACT WITH BORROW INDICATION) vector instruction 22-28
 VSCBI (VECTOR SUBTRACT COMPUTE BORROW INDICATION) vector instruction 22-28
 VSCEF (VECTOR SCATTER ELEMENT) vector instruction 21-20
 VSCEG (VECTOR SCATTER ELEMENT) vector instruction 21-20
 VSDP (VECTOR SHIFT AND DIVIDE DECIMAL) instruction 25-18
 VSEG (VECTOR SIGN EXTEND TO DOUBLEWORD) vector instruction 21-21
 VSEL (VECTOR SELECT) vector instruction 21-21
 VSL (VECTOR SHIFT LEFT) vector instruction 22-25
 VSLB (VECTOR SHIFT LEFT BY BYTE) vector instruction 22-25
 VSLD (VECTOR SHIFT LEFT DOUBLE BY BIT) vector instruction 22-25
 VSLDB (VECTOR SHIFT LEFT DOUBLE BY BYTE) vector instruction 22-26
 VSP (VECTOR SUBTRACT DECIMAL) instruction 25-21
 VSRA (VECTOR SHIFT RIGHT ARITHMETIC) vector instruction 22-26
 VSRAB (VECTOR SHIFT RIGHT ARITHMETIC BY BYTE) vector instruction 22-26
 VSRD (VECTOR SHIFT RIGHT DOUBLE BY BIT) vector instruction 22-26
 VSRL (VECTOR SHIFT RIGHT LOGICAL) vector instruction 22-27
 VSRLB (VECTOR SHIFT RIGHT LOGICAL) vector instruction 22-27
 VSRP (VECTOR SHIFT AND ROUND DECIMAL) instruction 25-19
 VST (VECTOR STORE) vector instruction 21-21
 VSTBR (VECTOR STORE BYTE REVERSED ELEMENTS) vector instruction 21-22
 VSTEB (VECTOR STORE ELEMENT) vector instruction 21-22, 21-23
 VSTEBRF (VECTOR STORE BYTE REVERSED ELEMENT) vector instruction 21-22
 VSTEBRG (VECTOR STORE BYTE REVERSED ELEMENT) vector instruction 21-22
 VSTEBRH (VECTOR STORE BYTE REVERSED ELEMENT) vector instruction 21-22
 VSTEF (VECTOR STORE ELEMENT) vector instruction 21-23
 VSTEG (VECTOR STORE ELEMENT) vector instruction 21-23
 VSTEH (VECTOR STORE ELEMENT) vector instruction 21-22, 21-23, 21-24
 VSTER (VECTOR STORE ELEMENTS REVERSED) vector instruction 21-24
 VSTL (VECTOR STORE WITH LENGTH) vector instruction 21-26
 VSTM (VECTOR STORE MULTIPLE) vector instruction 21-24
 VSTRC (VECTOR STRING RANGE COMPARE) vector instruction 23-6
 VSTRLR (VECTOR LOAD RIGHTMOST WITH LENGTH) vector instruction 21-25
 VSTRLR (VECTOR STORE RIGHTMOST WITH LENGTH) vector instruction 21-25
 VSTRS (VECTOR STRING SEARCH) vector instruction 23-8
 VSUM (VECTOR SUM ACROSS WORD) vector instruction 22-30
 VSUMG (VECTOR SUM ACROSS DOUBLEWORD) vector instruction 22-29
 VSUMQ (VECTOR SUM ACROSS QUADWORD) vector instruction 22-30
 VTAM use of symbol translation 7-179
 VTM (VECTOR TEST UNDER MASK) vector instruction 22-31
 VTP (VECTOR TEST DECIMAL) instruction 25-22
 VUPH (VECTOR UNPACK HIGH) vector instruction 21-26
 VUPKZ (VECTOR UNPACK ZONED) instruction 25-22
 VUPL (VECTOR UNPACK LOW) vector instruction 21-27
 VUPLH (VECTOR UNPACK LOGICAL) vector instruction 21-26
 VUPLL (VECTOR UNPACK LOGICAL LOW) vector instruction 21-27
 VX (VECTOR EXCLUSIVE OR) vector instruction 22-11
 VXC (vector-exception code) 6-20

W

wait indicator 12-6
 wait-state bit
 in the PSW 4-6
 warning (machine-check condition) 11-17
 subclass-mask bit for 11-27
 warning-track-interruption facility 1-29
 WFC (VECTOR FP COMPARE SCALAR) vector instruction 24-7
 WFK (VECTOR FP COMPARE AND SIGNAL SCALAR) vector instruction 24-8
 word 3-3
 word-concurrent storage references 5-127

- working allegiance (I/O) 15-12
- wraparound
 - of instruction addresses 5-10
 - of PER addresses 4-35
 - of register numbers
 - for LOAD MULTIPLE instruction 7-281
 - for STORE MULTIPLE instruction 7-392
 - of storage addresses 3-7
 - controlled by addressing mode 3-7
 - for MOVE INVERSE instruction 7-289
 - for MOVE LONG EXTENDED instruction 7-295
 - for MOVE LONG instruction 7-291
 - for MOVE LONG UNICODE instruction 7-298
 - for MOVE WITH OPTIONAL SPECIFICATIONS instruction 10-70
 - of TOD clock 4-48

X

- X (EXCLUSIVE OR) instruction 7-253
- X field of instruction 5-11
- XA (extended architecture)
 - See* 370-XA architecture
- XC (EXCLUSIVE OR) instruction 7-254
 - examples A-20
- XG (EXCLUSIVE OR) instruction 7-253
- XGR (EXCLUSIVE OR) instruction 7-253
- XI (EXCLUSIVE OR) instruction 7-254
 - example A-21
- XIHF (EXCLUSIVE OR IMMEDIATE) instruction 7-255
- XILF (EXCLUSIVE OR IMMEDIATE) instruction 7-255

- XIY (EXCLUSIVE OR) instruction 7-254
- XR (EXCLUSIVE OR) instruction 7-253
- XRK (EXCLUSIVE OR) binary instruction 7-253
- XSCH (CANCEL SUBCHANNEL) instruction 14-3
- XY (EXCLUSIVE OR) instruction 7-253

Z

- Z bit (zero condition-code bit) 16-12
 - as cause of intermediate interruption condition 16-18
- z/Architecture architecture
 - additions to 1-2, 1-7
 - original highlights of 1-2
- ZAP (ZERO AND ADD) instruction 8-14
 - example A-41
- zero
 - instruction-length code 6-7
 - negative
 - See* negative zero
 - normal meaning for byte value 0-xxix
 - setting floating-point register to 9-35
 - true (HFP number) 18-1
- zero-address-detection PER event
 - mask for 4-27
- ZERO AND ADD instruction 8-14
 - example A-41
- zero condition code (Z bit in SCSW) 16-12
- zero-padding control 7-172
- zone bits 8-1
 - moving of 7-303
- zoned decimal numbers 8-1
- zoned-decimal numbers
 - examples A-4

Communicating Your Comments to IBM

Title: z/Architecture Principles of Operation

Publication No: SA22-7832-12

If you especially like or dislike anything about this book, please direct your comments to:

Internet e-mail: mhvrcfs@us.ibm.com

Be sure to send your name, address, and telephone number if you would like a reply.

Feel free to comment on specific errors or omissions, accuracy, organization, subject matter, or completeness of this book. However, the comments you send should pertain to only the information in this manual and the way in which the information is presented. To request additional publications, or to ask questions or make comments about the functions of IBM products or systems, you should talk to your IBM representative or to your IBM authorized remarketer.

When you send comments to IBM, you grant IBM a nonexclusive right to use or distribute your comments in any way it believes appropriate without incurring any obligation to you.

Make sure to include the following in your note:

- Title and publication number of this book
- Page number or topic to which your comment applies

Optionally, if you include your telephone number, we will be able to respond to your comments by phone.



SA22-7832-12

