

[MS-PPT]:

PowerPoint (.ppt) Binary File Format

Intellectual Property Rights Notice for Open Specifications Documentation

- **Technical Documentation.** Microsoft publishes Open Specifications documentation (“this documentation”) for protocols, file formats, data portability, computer languages, and standards support. Additionally, overview documents cover inter-protocol relationships and interactions.
- **Copyrights.** This documentation is covered by Microsoft copyrights. Regardless of any other terms that are contained in the terms of use for the Microsoft website that hosts this documentation, you can make copies of it in order to develop implementations of the technologies that are described in this documentation and can distribute portions of it in your implementations that use these technologies or in your documentation as necessary to properly document the implementation. You can also distribute in your implementation, with or without modification, any schemas, IDLs, or code samples that are included in the documentation. This permission also applies to any documents that are referenced in the Open Specifications documentation.
- **No Trade Secrets.** Microsoft does not claim any trade secret rights in this documentation.
- **Patents.** Microsoft has patents that might cover your implementations of the technologies described in the Open Specifications documentation. Neither this notice nor Microsoft's delivery of this documentation grants any licenses under those patents or any other Microsoft patents. However, a given Open Specifications document might be covered by the Microsoft [Open Specifications Promise](#) or the [Microsoft Community Promise](#). If you would prefer a written license, or if the technologies described in this documentation are not covered by the Open Specifications Promise or Community Promise, as applicable, patent licenses are available by contacting iplg@microsoft.com.
- **License Programs.** To see all of the protocols in scope under a specific license program and the associated patents, visit the [Patent Map](#).
- **Trademarks.** The names of companies and products contained in this documentation might be covered by trademarks or similar intellectual property rights. This notice does not grant any licenses under those rights. For a list of Microsoft trademarks, visit www.microsoft.com/trademarks.
- **Fictitious Names.** The example companies, organizations, products, domain names, email addresses, logos, people, places, and events that are depicted in this documentation are fictitious. No association with any real company, organization, product, domain name, email address, logo, person, place, or event is intended or should be inferred.

Reservation of Rights. All other rights are reserved, and this notice does not grant any rights other than as specifically described above, whether by implication, estoppel, or otherwise.

Tools. The Open Specifications documentation does not require the use of Microsoft programming tools or programming environments in order for you to develop an implementation. If you have access to Microsoft programming tools and environments, you are free to take advantage of them. Certain Open Specifications documents are intended for use in conjunction with publicly available standards specifications and network programming art and, as such, assume that the reader either is familiar with the aforementioned material or has immediate access to it.

Support. For questions and support, please contact dochelp@microsoft.com.

Revision Summary

Date	Revision History	Revision Class	Comments
6/27/2008	1.0	New	First release
8/15/2008	1.01	Minor	Revised and edited the technical content
1/16/2009	1.02	Minor	Updated the Intellectual Property Rights Notice
7/13/2009	1.03	Major	Changes made for template compliance
8/28/2009	1.04	Editorial	Revised and edited the technical content
11/6/2009	1.05	Editorial	Revised and edited the technical content
2/19/2010	2.0	Minor	Updated the technical content
3/31/2010	2.01	Editorial	Revised and edited the technical content
4/30/2010	2.02	Editorial	Revised and edited the technical content
6/7/2010	2.03	Editorial	Revised and edited the technical content
6/29/2010	2.04	Editorial	Changed language and formatting in the technical content.
7/23/2010	2.05	Major	Significantly changed the technical content.
9/27/2010	2.05	None	No changes to the meaning, language, or formatting of the technical content.
11/15/2010	2.05	None	No changes to the meaning, language, or formatting of the technical content.
12/17/2010	2.05	None	No changes to the meaning, language, or formatting of the technical content.
3/18/2011	2.05	None	No changes to the meaning, language, or formatting of the technical content.
6/10/2011	2.05	None	No changes to the meaning, language, or formatting of the technical content.
1/20/2012	3.0	Major	Significantly changed the technical content.
4/11/2012	3.0	None	No changes to the meaning, language, or formatting of the technical content.
7/16/2012	3.0	None	No changes to the meaning, language, or formatting of the technical content.
10/8/2012	3.0	None	No changes to the meaning, language, or formatting of the technical content.
2/11/2013	3.0	None	No changes to the meaning, language, or formatting of the technical content.
7/30/2013	3.0	None	No changes to the meaning, language, or formatting of the technical content.
11/18/2013	3.1	Minor	Clarified the meaning of the technical content.
2/10/2014	3.1	None	No changes to the meaning, language, or formatting of the technical content.

Date	Revision History	Revision Class	Comments
4/30/2014	3.1	None	No changes to the meaning, language, or formatting of the technical content.
7/31/2014	3.1	None	No changes to the meaning, language, or formatting of the technical content.
10/30/2014	3.1	None	No changes to the meaning, language, or formatting of the technical content.
3/16/2015	4.0	Major	Significantly changed the technical content.
9/4/2015	4.0	None	No changes to the meaning, language, or formatting of the technical content.
7/15/2016	4.0	None	No changes to the meaning, language, or formatting of the technical content.
9/22/2016	4.0	None	No changes to the meaning, language, or formatting of the technical content.
6/20/2017	4.1	Minor	Clarified the meaning of the technical content.
9/19/2017	4.2	Minor	Clarified the meaning of the technical content.

Table of Contents

1	Introduction	15
1.1	Glossary	15
1.2	References	20
1.2.1	Normative References	20
1.2.2	Informative References	21
1.3	Overview	22
1.3.1	Presentation Document	22
1.3.2	Slides.....	22
1.3.3	Shapes.....	22
1.3.4	Placeholders Shapes	22
1.3.5	External Objects.....	22
1.3.6	Animation.....	23
1.3.6.1	Timeline.....	23
1.3.6.2	Conditional Properties.....	23
1.3.6.3	Behaviors.....	23
1.3.6.4	Builds	24
1.3.7	Slide show	25
1.3.7.1	Named Show	25
1.3.7.2	Slide Transitions	25
1.3.8	Byte Ordering	26
1.4	Relationship to Protocols and Other Structures	26
1.5	Applicability Statement	27
1.6	Versioning and Localization	27
1.7	Vendor-Extensible Fields	27
2	Structures	28
2.1	File Streams and Storages.....	28
2.1.1	Current User Stream	28
2.1.2	PowerPoint Document Stream	28
2.1.3	Pictures Stream.....	32
2.1.4	Summary Information Stream.....	32
2.1.5	Document Summary Information Stream.....	32
2.1.6	Encrypted Summary Information Stream.....	32
2.1.7	Digital Signature Storage.....	32
2.1.8	Custom XML Data Storage	32
2.1.9	Signatures Stream.....	33
2.2	Basic Types	33
2.2.1	BlipRef	33
2.2.2	bool1	33
2.2.3	BulletSize	33
2.2.4	char2	33
2.2.5	ExHyperlinkId	33
2.2.6	ExHyperlinkIdRef	34
2.2.7	ExObjId.....	34
2.2.8	ExObjIdRef	34
2.2.9	FileOrDirNameFragment	34
2.2.10	FontIndexRef	34
2.2.11	FontIndexRef10.....	34
2.2.12	HttpUrl	34
2.2.13	IndentLevel.....	34
2.2.14	MachineName	35
2.2.15	MarginOrIndent	35
2.2.16	MasterId.....	35
2.2.17	MasterIdRef	35
2.2.18	NotesId	35

2.2.19	NotesIdRef.....	35
2.2.20	ParaSpacing.....	35
2.2.21	PersistIdRef.....	36
2.2.22	PrintableAnsiString.....	36
2.2.23	PrintableUnicodeString.....	36
2.2.24	SlideId.....	36
2.2.25	SlideIdRef.....	37
2.2.26	SmartTagIndex.....	37
2.2.27	SoundIdRef.....	37
2.2.28	TabCrLfPrintableUnicodeString.....	37
2.2.29	TabSize.....	37
2.2.30	TextPosition.....	37
2.2.31	TxLCID.....	38
2.2.32	UncOrLocalPath.....	38
2.2.33	UncPath.....	38
2.2.34	UncPathOrHttpUrl.....	38
2.2.35	UnicodeString.....	38
2.2.36	Utf8UnicodeString.....	38
2.3	File Structure Types.....	39
2.3.1	RecordHeader.....	39
2.3.2	CurrentUserAtom.....	39
2.3.3	UserEditAtom.....	41
2.3.4	PersistDirectoryAtom.....	42
2.3.5	PersistDirectoryEntry.....	43
2.3.6	PersistOffsetEntry.....	43
2.3.7	CryptSession10Container.....	44
2.4	Document Types.....	45
2.4.1	DocumentContainer.....	45
2.4.2	DocumentAtom.....	48
2.4.3	DrawingGroupContainer.....	50
2.4.4	DocInfoListContainer.....	51
2.4.5	DocInfoListSubContainerOrAtom.....	51
2.4.6	PresAdvisorFlags9Atom.....	52
2.4.7	ModifyPasswordAtom.....	53
2.4.8	FilterPrivacyFlags10Atom.....	54
2.4.9	PhotoAlbumInfo10Atom.....	54
2.4.10	VBAInfoContainer.....	55
2.4.11	VBAInfoAtom.....	56
2.4.12	PrintOptionsAtom.....	57
2.4.13	EndDocumentAtom.....	57
2.4.14	Slide List Types.....	58
2.4.14.1	MasterListWithTextContainer.....	58
2.4.14.2	MasterPersistAtom.....	59
2.4.14.3	SlideListWithTextContainer.....	59
2.4.14.4	SlideListWithTextSubContainerOrAtom.....	60
2.4.14.5	SlidePersistAtom.....	61
2.4.14.6	NotesListWithTextContainer.....	62
2.4.14.7	NotesPersistAtom.....	63
2.4.15	Header/Footer Types.....	64
2.4.15.1	SlideHeadersFootersContainer.....	64
2.4.15.2	HeadersFootersAtom.....	65
2.4.15.3	UserDateAtom.....	65
2.4.15.4	HeaderAtom.....	66
2.4.15.5	FooterAtom.....	67
2.4.15.6	NotesHeadersFootersContainer.....	67
2.4.16	Sound Types.....	68
2.4.16.1	SoundCollectionContainer.....	68
2.4.16.2	SoundCollectionAtom.....	69

2.4.16.3	SoundContainer	70
2.4.16.4	SoundNameAtom	71
2.4.16.5	SoundExtensionAtom.....	71
2.4.16.6	SoundIdAtom	72
2.4.16.7	SoundBuiltinIdAtom	73
2.4.17	Broadcast Types	74
2.4.17.1	BroadcastDocInfo9Container	74
2.4.17.2	BCTitleAtom	77
2.4.17.3	BCDescriptionAtom	78
2.4.17.4	BCSpeakerAtom.....	78
2.4.17.5	BCContactAtom	79
2.4.17.6	BCRexServerNameAtom.....	80
2.4.17.7	BCEmailAddressAtom	80
2.4.17.8	BCEmailNameAtom	81
2.4.17.9	BCChatUrlAtom.....	82
2.4.17.10	BCArchiveDirAtom.....	82
2.4.17.11	BCNetShowFilesBaseDirAtom.....	83
2.4.17.12	BCNetShowFilesDirAtom	84
2.4.17.13	BCNetShowServerNameAtom	84
2.4.17.14	BCPptFilesBaseDirAtom.....	85
2.4.17.15	BCPptFilesDirAtom	86
2.4.17.16	BCPptFilesBaseUrlAtom.....	86
2.4.17.17	BCUserNameAtom.....	87
2.4.17.18	BCBroadcastDateTimeAtom	88
2.4.17.19	BCPresentationNameAtom.....	88
2.4.17.20	BCAsdFileNameAtom	89
2.4.17.21	BCEntryIDAtom	90
2.4.17.22	BroadcastDocInfoAtom	90
2.4.18	HTML Publish Types	92
2.4.18.1	HTMLDocInfo9Atom.....	92
2.4.18.2	HTMLPublishInfo9Container.....	93
2.4.18.3	FileNameAtom	94
2.4.18.4	NamedShowAtom	95
2.4.18.5	HTMLPublishInfoAtom.....	95
2.4.19	Comment Author Types	96
2.4.19.1	CommentIndex10Container.....	96
2.4.19.2	AuthorNameAtom	97
2.4.19.3	CommentIndex10Atom	98
2.4.20	Document Comparison Types	98
2.4.20.1	DocToolbarStates10Atom.....	98
2.4.20.2	SlideListTable10Container	99
2.4.20.3	SlideListTableSize10Atom	100
2.4.20.4	SlideListEntry10Atom	100
2.4.20.5	DiffTree10Container	101
2.4.20.6	ReviewerNameAtom	102
2.4.20.7	DiffRecordHeaders	103
2.4.20.8	DocDiff10Container	104
2.4.20.9	HeaderFooterDiffContainer	106
2.4.20.10	NamedShowListDiffContainer.....	106
2.4.20.11	NamedShowDiffContainer	107
2.4.20.12	SlideListDiffContainer	108
2.4.20.13	MasterListDiffContainer.....	109
2.4.20.14	MasterListDiff10ChildContainer	110
2.4.20.15	MainMasterDiffContainer	110
2.4.20.16	SlideDiffContainer	111
2.4.20.17	ShapeListDiffContainer	114
2.4.20.18	ShapeDiffContainer	114
2.4.20.19	TextDiffContainer	117

2.4.20.20	RecolorInfoDiffContainer	118
2.4.20.21	ExternalObjectDiffContainer	119
2.4.20.22	InteractiveInfoDiffContainer	120
2.4.20.23	TableListDiffContainer.....	120
2.4.20.24	TableDiffContainer	121
2.4.20.25	SlideShowDiffContainer.....	122
2.4.20.26	NotesDiffContainer	123
2.4.21	View Info Types.....	124
2.4.21.1	GridSpacing10Atom.....	124
2.4.21.2	NormalViewSetInfoContainer	124
2.4.21.3	NormalViewSetInfoAtom	125
2.4.21.4	NotesTextViewInfoContainer.....	127
2.4.21.5	ZoomViewInfoAtom.....	127
2.4.21.6	OutlineViewInfoContainer.....	129
2.4.21.7	NoZoomViewInfoAtom	129
2.4.21.8	SlideViewInfoInstance	131
2.4.21.9	SlideViewInfoContainer	131
2.4.21.10	SlideViewInfoAtom	132
2.4.21.11	GuideAtom.....	132
2.4.21.12	NotesViewInfoContainer.....	133
2.4.21.13	SorterViewInfoContainer	134
2.4.22	Summary Info Types.....	135
2.4.22.1	CopyrightAtom	135
2.4.22.2	KeywordsAtom	135
2.4.22.3	SummaryContainer	136
2.4.22.4	BookmarkCollectionContainer	137
2.4.22.5	BookmarkSeedAtom.....	137
2.4.22.6	BookmarkEntityAtomContainer	138
2.4.22.7	BookmarkEntityAtom.....	139
2.4.22.8	BookmarkValueAtom	140
2.4.23	Document Tag Info Types	140
2.4.23.1	DocProgTagsContainer.....	140
2.4.23.2	DocProgTagsSubContainerOrAtom.....	141
2.4.23.3	DocProgBinaryTagContainer	141
2.4.23.4	DocProgBinaryTagSubContainerOrAtom	142
2.4.23.5	PP9DocBinaryTagExtension	142
2.4.23.6	PP10DocBinaryTagExtension.....	145
2.4.23.7	PP11DocBinaryTagExtension.....	148
2.4.23.8	PP12DocBinaryTagExtension.....	149
2.5	Slide Types	150
2.5.1	SlideContainer.....	150
2.5.2	RoundTripSlideRecord	152
2.5.3	MainMasterContainer.....	152
2.5.4	RoundTripMainMasterRecord	155
2.5.5	MasterOrSlideContainer	155
2.5.6	NotesContainer	156
2.5.7	NotesRoundTripAtom	157
2.5.8	HandoutContainer.....	157
2.5.9	HandoutRoundTripAtom.....	158
2.5.10	SlideAtom	159
2.5.11	SlideFlags	164
2.5.12	NotesAtom.....	164
2.5.13	DrawingContainer	165
2.5.14	SlideSchemeColorSchemeAtom	166
2.5.15	SchemeListElementColorSchemeAtom	166
2.5.16	PerSlideHeadersFootersContainer	167
2.5.17	SlideNameAtom.....	168
2.5.18	TemplateNameAtom	168

2.5.19	SlideProgTagsContainer	169
2.5.20	SlideProgTagsSubContainerOrAtom	170
2.5.21	SlideProgBinaryTagContainer	170
2.5.22	SlideProgBinaryTagSubContainerOrAtom	170
2.5.23	PP9SlideBinaryTagExtension	171
2.5.24	PP10SlideBinaryTagExtension	172
2.5.25	Comment10Container	174
2.5.26	Comment10AuthorAtom	175
2.5.27	Comment10TextAtom	176
2.5.28	Comment10AuthorInitialAtom	176
2.5.29	Comment10Atom	177
2.5.30	SlideFlags10Atom	178
2.5.31	SlideTime10Atom	178
2.5.32	LinkedSlide10Atom	179
2.5.33	LinkedShape10Atom	181
2.5.34	PP12SlideBinaryTagExtension	182
2.6	Slide Show Types	183
2.6.1	SlideShowDocInfoAtom	183
2.6.2	NamedShowsContainer	184
2.6.3	NamedShowContainer	185
2.6.4	NamedShowNameAtom	185
2.6.5	NamedShowSlidesAtom	186
2.6.6	SlideShowSlideInfoAtom	187
2.6.7	InteractiveInfoInstance	194
2.6.8	MouseClickedInteractiveInfoContainer	194
2.6.9	MouseOverInteractiveInfoContainer	195
2.6.10	InteractiveInfoAtom	195
2.6.11	MacroNameAtom	196
2.7	Shape Types	197
2.7.1	OfficeArtClientAnchor	197
2.7.2	OfficeArtClientAnchorData	198
2.7.3	OfficeArtClientData	198
2.7.4	ShapeClientRoundtripDataSubContainerOrAtom	200
2.7.5	ShapeFlagsAtom	200
2.7.6	ShapeFlags10Atom	201
2.7.7	ExObjRefAtom	201
2.7.8	PlaceholderAtom	202
2.7.9	RecolorInfoAtom	204
2.7.10	RecolorEntry	206
2.7.11	RecolorEntryVariant	207
2.7.12	RecolorEntryColor	207
2.7.13	RecolorEntryBrush	207
2.7.14	ShapeProgTagsContainer	209
2.7.15	ShapeProgTagsSubContainerOrAtom	209
2.7.16	ShapeProgBinaryTagContainer	209
2.7.17	ShapeProgBinaryTagSubContainerOrAtom	210
2.7.18	PP9ShapeBinaryTagExtension	210
2.7.19	PP10ShapeBinaryTagExtension	211
2.7.20	PP11ShapeBinaryTagExtension	212
2.8	Animation Types	213
2.8.1	AnimationInfoContainer	213
2.8.2	AnimationInfoAtom	214
2.8.3	HashCode10Atom	223
2.8.4	BuildListContainer	225
2.8.5	BuildListSubContainer	225
2.8.6	ParaBuildContainer	226
2.8.7	BuildAtom	227
2.8.8	ParaBuildAtom	227

2.8.9	ParaBuildLevel.....	229
2.8.10	LevelInfoAtom.....	229
2.8.11	ChartBuildContainer.....	230
2.8.12	ChartBuildAtom.....	231
2.8.13	DiagramBuildContainer.....	232
2.8.14	DiagramBuildAtom.....	232
2.8.15	ExtTimeNodeContainer.....	233
2.8.16	SubEffectContainer.....	237
2.8.17	TimeNodeAtom.....	239
2.8.18	TimePropertyList4TimeNodeContainer.....	240
2.8.19	TimeVariant4TimeNode.....	241
2.8.20	TimeDisplayType.....	242
2.8.21	TimeMasterRelType.....	243
2.8.22	TimeSubType.....	244
2.8.23	TimeEffectID.....	245
2.8.24	TimeEffectType.....	258
2.8.25	TimeNodeTimeFilter.....	259
2.8.26	TimeEventFilter.....	260
2.8.27	TimeGroupID.....	260
2.8.28	TimeEffectNodeType.....	261
2.8.29	TimeAnimateBehaviorContainer.....	262
2.8.30	TimeAnimateBehaviorAtom.....	264
2.8.31	TimeAnimationValueListContainer.....	266
2.8.32	TimeAnimationValueListEntry.....	266
2.8.33	TimeAnimationValueAtom.....	269
2.8.34	TimeBehaviorContainer.....	270
2.8.35	TimeBehaviorAtom.....	271
2.8.36	TimeStringListContainer.....	272
2.8.37	TimePropertyList4TimeBehavior.....	273
2.8.38	TimeVariant4Behavior.....	274
2.8.39	TimeColorModel.....	275
2.8.40	TimeColorDirection.....	276
2.8.41	TimeOverride.....	276
2.8.42	TimeRuntimeContext.....	277
2.8.43	TimePointsTypes.....	278
2.8.44	ClientVisualElementContainer.....	279
2.8.45	VisualElementAtom.....	280
2.8.46	VisualPageAtom.....	280
2.8.47	VisualShapeOrSoundAtom.....	281
2.8.48	VisualSoundAtom.....	281
2.8.49	VisualShapeAtom.....	282
2.8.50	VisualShapeChartElementAtom.....	282
2.8.51	VisualShapeGeneralAtom.....	283
2.8.52	TimeColorBehaviorContainer.....	284
2.8.53	TimeColorBehaviorAtom.....	285
2.8.54	TimeColorBehaviorPropertyUsedFlag.....	286
2.8.55	TimeAnimateColorBy.....	286
2.8.56	RGBColorBy.....	287
2.8.57	HSLColorBy.....	287
2.8.58	TimeAnimateColor.....	288
2.8.59	RGBColor.....	288
2.8.60	IndexSchemeColor.....	289
2.8.61	TimeEffectBehaviorContainer.....	289
2.8.62	TimeEffectBehaviorAtom.....	294
2.8.63	TimeMotionBehaviorContainer.....	295
2.8.64	TimeMotionBehaviorAtom.....	297
2.8.65	TimeRotationBehaviorContainer.....	299
2.8.66	TimeRotationBehaviorAtom.....	299

2.8.67	TimeScaleBehaviorContainer	301
2.8.68	TimeScaleBehaviorAtom	301
2.8.69	TimeSetBehaviorContainer	303
2.8.70	TimeSetBehaviorAtom	326
2.8.71	TimeCommandBehaviorContainer	327
2.8.72	TimeCommandBehaviorAtom	329
2.8.73	TimeIterateDataAtom	329
2.8.74	TimeSequenceDataAtom	331
2.8.75	TimeConditionContainer	333
2.8.76	TimeConditionAtom	333
2.8.77	TimeModifierAtom	335
2.8.78	TimeVariant	335
2.8.79	TimeVariantBool	336
2.8.80	TimeVariantInt	336
2.8.81	TimeVariantFloat	337
2.8.82	TimeVariantString	338
2.9	Text Types	338
2.9.1	DocumentTextInfoContainer	338
2.9.2	KinsokuContainer	340
2.9.3	KinsokuAtom	341
2.9.4	KinsokuLeadingAtom	341
2.9.5	KinsokuFollowingAtom	342
2.9.6	Kinsoku9Container	342
2.9.7	Kinsoku9Atom	343
2.9.8	FontCollectionContainer	345
2.9.9	FontCollectionEntry	345
2.9.10	FontEntityAtom	346
2.9.11	FontCollection10Container	347
2.9.12	FontEmbedFlags10Atom	348
2.9.13	TextCFExceptionAtom	348
2.9.14	TextCFException	349
2.9.15	CFMasks	350
2.9.16	CFStyle	351
2.9.17	TextCFException9	352
2.9.18	TextCFException10	353
2.9.19	TextPFExceptionAtom	354
2.9.20	TextPFException	354
2.9.21	PFMasks	356
2.9.22	BulletFlags	357
2.9.23	TabStops	358
2.9.24	TabStop	358
2.9.25	PFWrapFlags	359
2.9.26	TextPFException9	359
2.9.27	TextAutoNumberScheme	360
2.9.28	DefaultRulerAtom	361
2.9.29	TextRulerAtom	361
2.9.30	TextRuler	362
2.9.31	TextSIExceptionAtom	364
2.9.32	TextSIException	364
2.9.33	SpellingFlags	366
2.9.34	SmartTags	366
2.9.35	TextMasterStyleAtom	366
2.9.36	TextMasterStyleLevel	368
2.9.37	TextMasterStyle9Atom	368
2.9.38	TextMasterStyle9Level	369
2.9.39	TextMasterStyle10Atom	370
2.9.40	TextMasterStyle10Level	371
2.9.41	TextHeaderAtom	371

2.9.42	TextCharsAtom	373
2.9.43	TextBytesAtom	373
2.9.44	StyleTextPropAtom	374
2.9.45	TextPFRun	375
2.9.46	TextCFRun	376
2.9.47	SlideNumberMCAtom	376
2.9.48	HeaderMCAtom	377
2.9.49	FooterMCAtom	377
2.9.50	DateTimeMCAtom	378
2.9.51	GenericDateMCAtom	385
2.9.52	RTFDateTimeMCAtom	385
2.9.53	TextBookmarkAtom	386
2.9.54	TextSpecialInfoAtom	387
2.9.55	TextSIRun	387
2.9.56	TextInteractiveInfoInstance	388
2.9.57	MouseClickedTextInteractiveInfoAtom	388
2.9.58	MouseOverTextInteractiveInfoAtom	389
2.9.59	TextRange	389
2.9.60	OutlineTextProps9Container	390
2.9.61	OutlineTextProps9Entry	391
2.9.62	OutlineTextPropsHeaderExAtom	391
2.9.63	OutlineTextProps10Container	392
2.9.64	OutlineTextProps10Entry	392
2.9.65	OutlineTextProps11Container	393
2.9.66	OutlineTextProps11Entry	393
2.9.67	StyleTextProp9Atom	394
2.9.68	StyleTextProp9	395
2.9.69	StyleTextProp10Atom	396
2.9.70	StyleTextProp11Atom	396
2.9.71	StyleTextProp11	397
2.9.72	BlipCollection9Container	398
2.9.73	BlipEntityAtom	398
2.9.74	TextDefaults9Atom	399
2.9.75	TextDefaults10Atom	400
2.9.76	OfficeArtClientTextbox	400
2.9.77	TextClientDataSubContainerOrAtom	401
2.9.78	OutlineTextRefAtom	402
2.9.79	MasterTextPropAtom	403
2.9.80	MasterTextPropRun	403
2.10	External Object Types	404
2.10.1	ExObjListContainer	404
2.10.2	ExObjListSubContainer	405
2.10.3	ExObjListAtom	405
2.10.4	ExAviMovieContainer	406
2.10.5	ExVideoContainer	406
2.10.6	ExMediaAtom	407
2.10.7	UncOrLocalPathAtom	408
2.10.8	ExCDAudioContainer	408
2.10.9	ExCDAudioAtom	409
2.10.10	ExControlContainer	410
2.10.11	ExControlAtom	411
2.10.12	ExOleObjAtom	412
2.10.13	MenuNameAtom	413
2.10.14	ProgIDAtom	413
2.10.15	ClipboardNameAtom	414
2.10.16	ExHyperlinkContainer	414
2.10.17	ExHyperlinkAtom	415
2.10.18	FriendlyNameAtom	416

2.10.19	TargetAtom.....	417
2.10.20	LocationAtom	417
2.10.21	ExHyperlink9Container	418
2.10.22	ExHyperlinkRefAtom	419
2.10.23	ScreenTipAtom	419
2.10.24	ExHyperlinkFlagsAtom.....	420
2.10.25	ExMCIMovieContainer.....	420
2.10.26	ExMIDIAudioContainer	421
2.10.27	ExOleEmbedContainer	422
2.10.28	ExOleEmbedAtom	423
2.10.29	ExOleLinkContainer	424
2.10.30	ExOleLinkAtom	425
2.10.31	ExWAVAudioEmbeddedContainer	426
2.10.32	ExWAVAudioEmbeddedAtom	427
2.10.33	ExWAVAudioLinkContainer.....	427
2.10.34	ExOleObjStg	428
2.10.35	ExOleObjStgUncompressedAtom.....	428
2.10.36	ExOleObjStgCompressedAtom	429
2.10.37	ExControlStg.....	430
2.10.38	ExControlStgUncompressedAtom	430
2.10.39	ExControlStgCompressedAtom	430
2.10.40	VbaProjectStg	431
2.10.41	VbaProjectStgUncompressedAtom	431
2.10.42	VbaProjectStgCompressedAtom.....	432
2.11	Other Types	433
2.11.1	DocRoutingSlipAtom	433
2.11.2	DocRoutingSlipString	435
2.11.3	EnvelopeFlags9Atom	436
2.11.4	EnvelopeData9Atom.....	436
2.11.5	FontEmbedDataBlob.....	437
2.11.6	MetafileBlob	437
2.11.7	RoundTripAnimationAtom	438
2.11.8	RoundTripAnimationHashAtom	439
2.11.9	RoundTripColorMappingAtom	440
2.11.10	RoundTripCompositeMasterId12Atom	440
2.11.11	RoundTripContentMasterId12Atom.....	441
2.11.12	RoundTripContentMasterInfo12Atom	442
2.11.13	RoundTripCustomTableStyles12Atom	442
2.11.14	RoundTripDocFlags12Atom	443
2.11.15	RoundTripHeaderFooterDefaults12Atom	443
2.11.16	RoundTripHFPlaceholder12Atom	444
2.11.17	RoundTripNewPlaceholderId12Atom	445
2.11.18	RoundTripNotesMasterTextStyles12Atom.....	445
2.11.19	RoundTripOArtTextStyles12Atom	446
2.11.20	RoundTripOriginalMainMasterId12Atom	446
2.11.21	RoundTripShapeChecksumForCustomLayouts12Atom	447
2.11.22	RoundTripShapeId12Atom	448
2.11.23	RoundTripSlideSyncInfo12Container.....	448
2.11.24	ServerIdAtom	449
2.11.25	SlideLibUrlAtom.....	450
2.11.26	SlideSyncInfoAtom12	450
2.11.27	RoundTripThemeAtom	451
2.11.28	SmartTagStore11Container.....	452
2.11.29	SoundDataBlob	452
2.11.30	ProgStringTagContainer.....	453
2.11.31	TagNameAtom	454
2.11.32	TagValueAtom.....	454
2.11.33	UnknownBinaryTag	455

2.11.34	BinaryTagDataBlob	455
2.12	Common Structures	456
2.12.1	ColorStruct	456
2.12.2	ColorIndexStruct	456
2.12.3	WideColorStruct	457
2.12.4	DateTimeStruct	457
2.12.5	PointStruct.....	458
2.12.6	RatioStruct	458
2.12.7	RectStruct	458
2.12.8	SmallRectStruct.....	459
2.12.9	ScalingStruct	459
2.12.10	TmsfTimeStruct.....	459
2.13	Enumerations	460
2.13.1	AnimAfterEffectEnum	460
2.13.2	AnimBuildTypeEnum	460
2.13.3	BuildTypeEnum	461
2.13.4	ChartBuildEnum	462
2.13.5	ColorModeEnum	463
2.13.6	ConditionEnum	463
2.13.7	DiagramBuildEnum	463
2.13.8	DiffTypeEnum	464
2.13.9	ElementTypeEnum	465
2.13.10	ExColorFollowEnum.....	465
2.13.11	ExOleObjSubTypeEnum	465
2.13.12	ExOleObjTypeEnum	466
2.13.13	InteractiveInfoActionEnum.....	466
2.13.14	InteractiveInfoJumpEnum	467
2.13.15	LinkToEnum	467
2.13.16	NormalViewSetBarStates	468
2.13.17	OLEVerbEnum	468
2.13.18	ParaBuildEnum	468
2.13.19	PhotoAlbumFrameShapeEnum.....	469
2.13.20	PhotoAlbumLayoutEnum	469
2.13.21	PlaceholderEnum	470
2.13.22	PlaceholderSize	471
2.13.23	PrintWhatEnum	471
2.13.24	RecordType.....	471
2.13.25	SlideLayoutType	481
2.13.26	SlideSizeEnum	482
2.13.27	TextAlignmentEnum	482
2.13.28	TextAutoNumberSchemeEnum	483
2.13.29	TextBuildSubEffectEnum	485
2.13.30	TextDirectionEnum	485
2.13.31	TextFontAlignmentEnum.....	485
2.13.32	TextTabTypeEnum	485
2.13.33	TextTypeEnum	486
2.13.34	TimeAnimateBehaviorValueTypeEnum	486
2.13.35	TimeCommandBehaviorTypeEnum	486
2.13.36	TimeNodeTypeEnum	487
2.13.37	TimePropertyID4TimeBehavior	487
2.13.38	TimePropertyID4TimeNode	487
2.13.39	TimeVariantTypeEnum	488
2.13.40	TimeVisualElementEnum	488
2.13.41	TriggerObjectEnum	489
2.13.42	ViewTypeEnum.....	489
2.13.43	WebFrameColorsEnum	490
2.13.44	WebOutputEnum	490

3	Structure Examples	491
3.1	Introduction	491
3.2	File Structure.....	502
3.3	Persist Objects.....	508
3.4	Outline Text	510
3.5	Slides	517
3.5.1	Master Slides	517
3.5.2	Presentation Slides	519
3.5.3	Notes Slides.....	530
3.6	Programmable Tags.....	537
3.6.1	Document Programmable Tags	537
3.6.2	Slide Programmable Tags	540
3.7	Animation	541
3.7.1	Text Animation.....	541
3.7.2	Shape Animation	555
3.8	Shape Client Data	594
3.8.1	Shape Anchor.....	594
3.8.2	Shape Placeholder	596
3.8.3	Shape Text	597
3.8.4	OLE Object	599
3.8.5	External Video.....	603
3.9	Text	605
3.9.1	Paragraph Formatting	605
3.9.2	Character Formatting	611
3.9.3	TextInteractiveInfo	618
3.9.4	Metacharacter	621
4	Security Considerations.....	625
5	Appendix A: Product Behavior	626
6	Change Tracking.....	633
7	Index.....	634

1 Introduction

This document specifies the binary file format for a PowerPoint (PPT) file (.ppt) used by Microsoft PowerPoint 97, Microsoft PowerPoint 2000, Microsoft PowerPoint 2002, and Microsoft Office PowerPoint 2003. A PPT file is a collection of records and structures that specify **slides**, **shapes**, pictures, audio, video, text, and other **presentation** content. This content can then be delivered to an audience by means of a **slide show**.

Each record has a common header that specifies the record type and any additional data that follows. This file format provides an efficient way to parse only records that contain content of interest to a particular implementation and to skip any other records.

Sections 1.7 and 2 of this specification are normative. All other sections and examples in this specification are informative.

1.1 Glossary

This document uses the following terms:

ActiveX control: A reusable software control, such as a check box or button, that uses ActiveX technology and provides options to users or runs macros or scripts that automate a task. See also ActiveX object.

add-in: Supplemental functionality that is provided by an external application or macro to extend the capabilities of an application.

atom record: A record that contains presentation data. Analogous to a file system, atom records are similar to files that contain data and container records are similar to directories that provide structure and hierarchy for atom records.

Audio Interchange File Format (AIFF): A sound file format that was originally used on Macintosh and Silicon Graphics (SGI) computers. AIFF stores waveform files in an 8-bit monaural format. See also **waveform (WAV)**.

Audio Video Interleaved (AVI): A multimedia file format for sound and video that uses the Microsoft Resource Interchange File Format (RIFF).

Augmented Backus-Naur Form (ABNF): A modified version of Backus-Naur Form (BNF), commonly used by Internet specifications. ABNF notation balances compactness and simplicity with reasonable representational power. ABNF differs from standard BNF in its definitions and uses of naming rules, repetition, alternatives, order-independence, and value ranges. For more information, see [\[RFC5234\]](#).

big-endian: Multiple-byte values that are byte-ordered with the most significant byte stored in the memory location with the lowest address.

bookmark: An entity that is used in a document to denote the beginning and ending character positions of specific text in the document, and optionally, metadata about that text or its relationship to other referenced parts of the document.

Boolean: An operation or expression that can be evaluated only as either true or false.

build: An animation effect that is applied to content on a **presentation slide**. The complete animation for a given piece of content is specified as a sequence of builds, where each build causes parts of the content to appear, disappear, move, or be emphasized in some manner.

build identifier: An integer that identifies a **build**.

code page: An ordered set of characters of a specific script in which a numerical index (code-point value) is associated with each character. Code pages are a means of providing support for character sets and keyboard layouts used in different countries. Devices such as the display and keyboard can be configured to use a specific code page and to switch from one code page (such as the United States) to another (such as Portugal) at the user's request.

color scheme: A table of color values that enables colors to be referenced by an index value in the table instead of a color value. See also color palette.

color space: A system that describes color numerically by mapping color components to a multidimensional coordinate system. The number of dimensions is typically two, three, or four. For example, if colors are expressed as a combination of the three components red, green, and blue, a three-dimensional space can describe all possible colors. Grayscale colors can be mapped to a two-dimensional color space. If transparency is considered a component, four dimensions are appropriate. Also referred to as color model.

computer name: The DNS or NetBIOS name.

container record: A record that defines the structure and hierarchy of **atom records** and other container records.

cyclic redundancy check (CRC): An algorithm used to produce a checksum (a small, fixed number of bits) against a block of data, such as a packet of network traffic or a block of a computer file. The CRC is a broad class of functions used to detect errors after transmission or storage. A CRC is designed to catch random errors, as opposed to intentional errors. If errors might be introduced by a motivated and intelligent adversary, a cryptographic hash function should be used instead.

encrypted document: A document that was converted from plaintext into cipher text to disguise the content of the document when it is stored or sent.

envelope: A container that stores the information that is used to send a document, workbook, or presentation in an email message. The information includes the intended recipients, the subject of the email message, and any attachments to be included.

external object: An object such as a movie file, audio file, OLE object, or hyperlink that can be associated with a presentation or document.

floating-point number: A number that is represented by a mantissa and an exponent according to a given base. The mantissa is typically a value between "0" and "1". To find the value of a floating-point number, the base is raised to the power of the exponent, and the mantissa is multiplied by the result.

footer: One or more lines of text in the bottom margin area of a page in a document or a slide in a presentation. A footer typically contains elements such as the page number and the name of the file.

grid unit: A unit of linear measurement that is equal to 1/1024 master unit or 1/589824 inch.

guide: A vertical or a horizontal line that can be set as part of the user interface to position and align content on a slide.

handout master slide: A slide that defines layout and positioning information for handout pages, which are pages that are optimized for printing a presentation.

handout slide: A slide that is taken from a presentation and then printed and distributed to the audience of the presentation. Users can select the number of slides to be printed on each page in a handout.

header: A line, or lines, of content in the top margin area of a page in a document or a slide in a presentation. A header typically contains elements such as the title of the chapter, the title of the document, a page number, or the name of the author.

hue-saturation-luminance (HSL): A color model that defines a color by using three dimensions: hue, the color itself; saturation, the purity of the color; and luminance, the amount of light that is either reflected or absorbed by the color. See also **color scheme** and **color space**.

hyperlink: A relationship between two anchors, as described in [\[RFC1866\]](#).

kiosk mode: A display mode in which a single window expands to fill the whole screen. In kiosk mode, the toolbar and menu bar are not displayed, and the desktop is inaccessible.

little-endian: Multiple-byte values that are byte-ordered with the least significant byte stored in the memory location with the lowest address.

macro: A set of instructions that are recorded or written, and then typically saved to a file. When a macro is run, all of the instructions are performed automatically.

main master slide: A slide that defines the formatting and content that can be used by presentation slides. If a slide uses formatting and content from a main master slide, it is referred to as following a main master slide.

master unit: A unit of linear measurement that is equal to 1/576 inch.

Media Control Interface (MCI): A part of the Windows API that enables an application to control multimedia devices. The term is also used to generically describe any media object that can be played through the interface.

metafile: A file that stores an image as graphical objects, such as lines, circles, and polygons, instead of pixels. A metafile preserves an image more accurately than pixels when an image is resized.

Musical Instrument Digital Interface (MIDI): A specification of the MIDI Manufacturers Association (MMA). The specification for Musical Instrument Digital Interface (MIDI) defines a protocol for describing music data, such as note on and note off messages; a file format for storing music data, called Standard MIDI; and a standard hardware interface.

named show: A named sequence of slides that can be displayed as a slide show.

notes master slide: A slide that defines the formatting and content that can be used by notes slides for a presentation. If a notes slide uses formatting and content from a notes master slide, it is referred to as following a notes master slide.

notes slide: A slide that contains presentation notes or other information that is not displayed during a slide show. The formatting and content of a notes slide can derive from a notes master slide.

Object Linking and Embedding (OLE): A technology for transferring and sharing information between applications by inserting a file or part of a file into a compound document. The inserted file can be either embedded or linked. See also embedded object and linked object.

OLE compound file: A form of structured storage, as described in [\[MS-CFB\]](#). A compound file allows independent storages and streams to exist within a single file.

OLE object: An object that supports the **Object Linking and Embedding (OLE)** protocol.

OLE verb: An action defined by an OLE-linked object that specifies what behaviors can be applied to it.

persist object: A top-level object that can be independently persisted and that forms the basis of an incremental save model. A persist object is one of the following: presentation document, main master slide, title master slide, handout master slide, notes master slide, presentation slide, notes slide, OLE object storage, or Microsoft Visual Basic for Applications (VBA) project storage.

persist object directory: A table of persist object identifiers and stream offsets to where persist objects can be found. Each user edit stores a persist object directory that identifies where any new and modified persist objects can be found.

persist object identifier: A unique identifier that is associated with a persist object and is stored in a persist object directory.

placeholder: A character or symbol that is used in place of an actual value, text, or object. The actual value that the placeholder represents is unknown or unavailable at the current time, or is not displayed for security reasons.

placeholder shape: A special type of shape in a presentation that usually includes common visual properties. These are used to effect a uniform look among different slides, or to uniformly represent meta-information about each slide.

point: A unit of measurement for fonts and spacing. A point is equal to 1/72 of an inch.

Portable Network Graphics (PNG): A bitmap graphics file format that uses lossless data compression and supports variable transparency of images (alpha channels) and control of image brightness on different computers (gamma correction). PNG-format files have a .png file name extension.

presentation: A collection of slides that are intended to be viewed by an audience.

presentation broadcast: A feature that enables users to run a presentation over the web. The presentation is saved in HTML format and can contain audio and video. It can also be recorded and saved for viewing later.

presentation comment: A text note that is attached to a slide to enable readers of a presentation to provide feedback to the presentation author.

presentation slide: A slide that contains the content that can be displayed during a slide show. A presentation slide can derive formatting and content from a main master slide or a title master slide.

programmable tag: A name/value pair. The value can be either a Unicode string or binary data.

red-green-blue (RGB): A color model that describes color information in terms of the red (R), green (G), and blue (B) intensities in a color.

routing slip: Information that specifies how a document is to be distributed from a document originator and processed by one or more recipients. It also specifies subject and message body text that is associated with the document routing process and routing status or workflow information.

seed: A value that is greater than or equal to all other values in a set of values and is used to create the next value in the set.

shape: A collection of qualifiers, such as names, and quantifiers, such as coordinates, that is used to represent a geometric object. A shape can be contained in a document, file structure, run-time structure, or other medium.

shape identifier: An integer that corresponds to a shape object or an instantiation of a shape object.

slide: A frame that contains text, shapes, pictures, or other content. A slide is a digital equivalent to a traditional film slide.

slide layout: An organizational scheme, such as Title Only or Comparison, for content on a presentation slide.

slide show: A delivery of a sequence of presentation slides, typically to an audience.

smart tag: A feature that adds the ability to recognize and label specific data types, such as people's names, within a document and displays an action button that enables users to perform common tasks for that data type.

sound identifier: A unique identifier for an embedded or linked sound.

table object: A group of shapes that are arranged in rows and columns to form a table.

text ruler: A collection of settings for tabs, margins, and indentation of text. See also ruler.

time condition: A logical condition that can be evaluated, or an event that can be triggered, to determine whether timed object behavior starts or ends. Conditions include items such as the start or end of time nodes, keyboard presses, mouse clicks, or delegate events. See also **time node**.

time node: A record or parent node that stores the information that is necessary to cause a time- or action-based effect to occur. Each time node has a corresponding object to which an effect is applied. It can be used randomly, simultaneously, or sequentially, and it can be used to specify certain time-based effects between objects that are being animated. Effects include visual and media behaviors.

title master slide: A slide that defines the formatting and content that can be used by presentation slides that have a title slide layout. If a slide uses formatting and content from a title master slide, it is referred to as following a title master slide.

Unicode: A character encoding standard developed by the Unicode Consortium that represents almost all of the written languages of the world. The **Unicode** standard [\[UNICODE5.0.0/2007\]](#) provides three forms (UTF-8, UTF-16, and UTF-32) and seven schemes (UTF-8, UTF-16, UTF-16 BE, UTF-16 LE, UTF-32, UTF-32 LE, and UTF-32 BE).

Uniform Resource Locator (URL): A string of characters in a standardized format that identifies a document or resource on the World Wide Web. The format is as specified in [\[RFC1738\]](#).

Universal Naming Convention (UNC): A string format that specifies the location of a resource. For more information, see [\[MS-DTYP\]](#) section 2.2.57.

user edit: A set of persist objects and a persist object directory that represent changes made by a user. Each time a file is written, a user edit that contains only those persist objects that are new or modified from the previous user edit can be appended to the pre-existing record stream. The persist objects and the persist object directory in a later user edit supersede those in a previous user edit.

VBA project: A collection of the modules, class modules, and user forms that are needed to create an application. Modules, class modules, and user forms can be imported into and exported from a project.

Vector Markup Language (VML): A system of marking up or tagging two-dimensional vector graphics for publication on the World Wide Web. VML graphics are scalable and editable, and typically require less disk space and less time to download.

Visual Basic for Applications (VBA): A macro-based programming language that derives from Microsoft Visual Basic and can be used to customize and extend an application. Unlike Visual Basic, VBA code and macros can be run only from within a host application that supports VBA.

waveform (WAV): A file format in which Windows stores sounds as waveforms. Depending on the sampling frequency, whether the sound is monaural or stereo, and whether 8 or 16 bits are used for each sample, one minute of sound can occupy as little as 644 kilobytes or as much as 27 megabytes of storage. Waveform files have a .wav file name extension.

MAY, SHOULD, MUST, SHOULD NOT, MUST NOT: These terms (in all caps) are used as defined in [\[RFC2119\]](#). All statements of optional behavior use either MAY, SHOULD, or SHOULD NOT.

1.2 References

Links to a document in the Microsoft Open Specifications library point to the correct section in the most recently published version of the referenced document. However, because individual documents in the library are not updated at the same time, the section numbers in the documents may not match. You can confirm the correct section numbering by checking the [Errata](#).

1.2.1 Normative References

We conduct frequent surveys of the normative references to assure their continued availability. If you have any issue with finding a normative reference, please contact dochelp@microsoft.com. We will assist you in finding the relevant information.

[ECMA-376] ECMA International, "Office Open XML File Formats", 1st Edition, ECMA-376, December 2006, <http://www.ecma-international.org/publications/standards/Ecma-376.htm>

[Embed-Open-Type-Format] Nelson, P., "Embedded OpenType (EOT) File Format", W3C Member Submission, March 2008, <http://www.w3.org/Submission/2008/SUBM-EOT-20080305/>

[IEC-RGB] International Electrotechnical Commission, "Colour Measurement and Management in Multimedia Systems and Equipment - Part 2-1: Default RGB Colour Space - sRGB", May 1998, <http://webstore.iec.ch/webstore/webstore.nsf/artnum/025408>

[JFIF] Hamilton, E., "JPEG File Interchange Format, Version 1.02", September 1992, <http://www.w3.org/Graphics/JPEG/jfif.txt>

[MC-LOGFONT] Microsoft Corporation, "Windows GDI LOGFONT", <http://msdn.microsoft.com/en-us/library/dd145037.aspx>

[MS-CFB] Microsoft Corporation, "[Compound File Binary File Format](#)".

[MS-DTYP] Microsoft Corporation, "[Windows Data Types](#)".

[MS-EMF] Microsoft Corporation, "[Enhanced Metafile Format](#)".

[MS-LCID] Microsoft Corporation, "[Windows Language Code Identifier \(LCID\) Reference](#)".

[MS-ODRAW] Microsoft Corporation, "[Office Drawing Binary File Format](#)".

[MS-OFFCRYPTO] Microsoft Corporation, "[Office Document Cryptography Structure](#)".

[MS-OFORMS] Microsoft Corporation, "[Office Forms Binary File Formats](#)".

[MS-OLEPS] Microsoft Corporation, "[Object Linking and Embedding \(OLE\) Property Set Data Structures](#)".

[MS-OSHARED] Microsoft Corporation, "[Office Common Data Types and Objects Structures](#)".

[MS-OVBA] Microsoft Corporation, "[Office VBA File Format Structure](#)".

[MS-WMF] Microsoft Corporation, "[Windows Metafile Format](#)".

- [MSFT-RTF] Microsoft Corporation, "Rich Text Format (RTF) Specification", version 1.9.1, March 2008, <http://www.microsoft.com/en-us/download/details.aspx?id=10725>
- [RFC1950] Deutsch, P., and Gailly, J-L., "ZLIB Compressed Data Format Specification version 3.3", RFC 1950, May 1996, <http://www.ietf.org/rfc/rfc1950.txt>
- [RFC1951] Deutsch, P., "DEFLATE Compressed Data Format Specification version 1.3", RFC 1951, May 1996, <http://www.ietf.org/rfc/rfc1951.txt>
- [RFC2083] Boutell, T., et al., "PNG (Portable Network Graphics) Specification Version 1.0", RFC 2083, March 1997, <http://www.ietf.org/rfc/rfc2083.txt>
- [RFC2119] Bradner, S., "Key words for use in RFCs to Indicate Requirement Levels", BCP 14, RFC 2119, March 1997, <http://www.rfc-editor.org/rfc/rfc2119.txt>
- [RFC2781] Hoffman, P., and Yergeau, F., "UTF-16, an encoding of ISO 10646", RFC 2781, February 2000, <http://www.rfc-editor.org/rfc/rfc2781.txt>
- [RFC3629] Yergeau, F., "UTF-8, A Transformation Format of ISO 10646", STD 63, RFC 3629, November 2003, <http://www.ietf.org/rfc/rfc3629.txt>
- [RFC3986] Berners-Lee, T., Fielding, R., and Masinter, L., "Uniform Resource Identifier (URI): Generic Syntax", STD 66, RFC 3986, January 2005, <http://www.rfc-editor.org/rfc/rfc3986.txt>
- [RFC5234] Crocker, D., Ed., and Overell, P., "Augmented BNF for Syntax Specifications: ABNF", STD 68, RFC 5234, January 2008, <http://www.rfc-editor.org/rfc/rfc5234.txt>
- [XML] World Wide Web Consortium, "Extensible Markup Language (XML) 1.0 (Fourth Edition)", W3C Recommendation 16 August 2006, edited in place 29 September 2006, <http://www.w3.org/TR/2006/REC-xml-20060816/>

1.2.2 Informative References

- [ASF] Microsoft Corporation, "Advanced Systems Format Specification", December 2004, http://download.microsoft.com/download/7/9/0/790feca-f64a-4a5e-a430-0bccdab3f1b4/ASF_Specification.doc
- [ISO/IEC29500-1:2012] ISO/IEC, "Information Technology -- Document description and processing languages -- Office Open XML File Formats -- Part 1: Fundamentals and Markup Language Reference", ISO/IEC 29500-1:2012, http://www.iso.org/iso/home/store/catalogue_ics/catalogue_detail_ics.htm?csnumber=61750
- [MS-OLEDS] Microsoft Corporation, "[Object Linking and Embedding \(OLE\) Data Structures](#)".
- [MSDN-COM] Microsoft Corporation, "Component Object Model", <http://msdn.microsoft.com/en-us/library/aa286559.aspx>
- [MSDN-CP] Microsoft Corporation, "Code Page Identifiers", [http://msdn.microsoft.com/en-us/library/dd317756\(VS.85\).aspx](http://msdn.microsoft.com/en-us/library/dd317756(VS.85).aspx)
- [MSDN-FILE] Microsoft Corporation, "Naming Files, Paths, and Namespaces", <http://msdn.microsoft.com/en-us/library/aa365247.aspx>
- [MSFT-UMWNSNS] Microsoft Corporation, "Using MS Windows NT Server NetShow Services", <http://technet.microsoft.com/en-us/library/bb676131.aspx>

1.3 Overview

1.3.1 Presentation Document

A **presentation** is a collection of **presentation slides** intended to be viewed by an audience during a **slide show**. In addition to presentation slides and slide show settings, it stores **notes slides** containing speaker notes and a **handout master slide** that determines how to print presentation handouts.

The following sections elaborate on the various types of **slides**, their contents, and slide show behaviors.

See the Document Types (section [2.4](#)) for records pertaining to the document as a whole.

1.3.2 Slides

Slides are the basic building blocks of a **presentation**. Each slide contains user data such as **shapes**, text, animations, and media. A **slide show** sequentially displays each **presentation slide** within the presentation to an audience.

The **main master slides** and **title master slides** are special types of slides that define common visual properties such as content and formatting for a group of presentation slides. A presentation slide inherits visual properties defined in a main master slide or title master slide. Inheritance of visual properties is referred to as following that main master slide or title master slide. Likewise, the **notes master slide** and the **handout master slide** serve a similar purpose and provide common visual properties for all **notes slides** and all printed handouts respectively.

See the Slide Types (section [2.5](#)) for records pertaining to slides. Also see the Slides Example (section [3.5](#)) for examples about slides.

1.3.3 Shapes

Shapes are the primary way to represent data on a **slide**. Different types of shapes such as **placeholder shapes**, pictures, and graphs allow users to add a variety of content to a slide. Shapes on a master slide define common data for groups of shapes.

See the Shape Types (section [2.7](#)) for records pertaining to shapes. Also see Office Drawing Binary File Format Structure Specification, [\[MS-ODRAW\]](#), for more information about shapes.

1.3.4 Placeholder Shapes

Placeholder shapes are specialized **shapes** that serve as containers for a variety of objects. Title and body placeholder shapes can be used to extract an outline text representation of the document. Header, footer, date, and slide-number placeholder shapes can be used to uniformly present meta-information on each **slide**. Various object placeholder shapes can be used to provide clues to insert specific types of shapes, such as tables or charts.

When contained within **presentation slides** or **notes slides**, a placeholder shape inherits its visual properties from a corresponding placeholder shape on a **main master slide**, **title master slide**, or **notes master slide**.

1.3.5 External Objects

Slides can contain objects that link to resources external to the presentation document. Presenters can activate linked objects to access external resources during a **slide show**. Examples of **external objects** are embedded and linked audio, linked video, embedded and linked **OLE objects**, and hyperlinks.

See the External Object Types (section [2.10](#)) for records pertaining to external objects.

1.3.6 Animation

One or more animation effects can be applied to a **shape** or the text in a shape. Animation effects vary one or more of the shape's properties over a defined period of time during a **slide show**. Each **slide** has a timeline that stores timing and sequencing information for all animations on that slide. Animations are displayed according to the timeline during a slide show.

1.3.6.1 Timeline

A **slide** timeline defines the order, duration, start conditions, and exit conditions for all animations on a slide. Each slide has exactly one timeline.

Time nodes are the basic building blocks for timelines. Each time node stores the order, duration, start conditions, and exit conditions for an animation effect. A timeline can contain an unlimited number of time nodes organized in a tree structure.

There are two main types of time nodes, as described in the following table:

Time node	Description
Parallel	A time node whose child nodes are executed in parallel.
Sequence	A time node whose child nodes are executed only after the previous sibling has started to be executed.

1.3.6.2 Conditional Properties

Conditional properties allow more granular control and choreography between **time nodes** in a timeline. These properties specify conditions that need to be met before a time node starts or finishes executing. For example, it allows an animation to be started when a **slide** is first displayed or when triggered by a user action.

There are four such conditional properties, as described in the following table:

Time node	Description
Start Condition	Conditions that control when a time node starts.
Previous Condition	Conditions that control when the timeline goes back to the previous time node.
Next Conditions	Conditions that control when the timeline advances to next time node.
End Conditions	Conditions that need to be met for a time node to end.

1.3.6.3 Behaviors

Animation effects vary one or more properties of a **shape**. Variation of a property over time is called a behavior. Available behaviors are dependent on the type of shape being animated. For example, a geometric shape supports behaviors that change its color and size while a video shape supports behaviors that define its playback.

Behaviors belong to the basic types described in the following table:

Behavior type	Description
Animate	Animates any property of an object that is either a numerical or a string value.
Animate Color	Animates the color values of an object.
Animate Effect	Allows image transformations and filter animations on an object.
Animate Motion	Animates position properties of an object by using either key-frame data or detailed path descriptions that include Bezier curves or lines.
Animate Rotation	Animates the orientation of an object.
Animate Scale	Animates the width and height of an object over time.

A **time node** can combine multiple animations to create complex effects. For example, the "flash bulb" animation, which scales a shape larger while simultaneously fading it, uses two animation behavior elements. An example is shown in the following figure:



Figure 1: Simultaneous color and scale animations

1.3.6.4 Builds

Some **shapes**, such as text, diagrams, and graphs, have component objects. A text **placeholder shape**, for example, can contain multiple lines of text. A pie chart can contain multiple slices. Build order allows for the animation of component objects within a shape.

An example of animating a pie chart by category is shown in the following figure:



Figure 2: A chart-build animation

See the Animation Types (section [2.8](#)) for records pertaining to animation.

1.3.7 Slide show

A **slide show** delivers **presentation slides** to an audience. During a slide show, each presentation slide is displayed sequentially in the order it is stored. Users can add animation effects between **slides**, and they can create a custom sequence of slides by using a **named show**.

1.3.7.1 Named Show

By default, a **slide show** sequentially displays all **presentation slides**. A **named show** specifies a sequence of presentation slides during a slide show that is different from the order in which the presentation slides themselves are stored. Named shows can contain a subset of all presentation slides in a document.

1.3.7.2 Slide Transitions

Slide transitions are the animation effects displayed between **presentation slides**. An example of a **slide** that has a "push" slide transition is shown in the following figure:

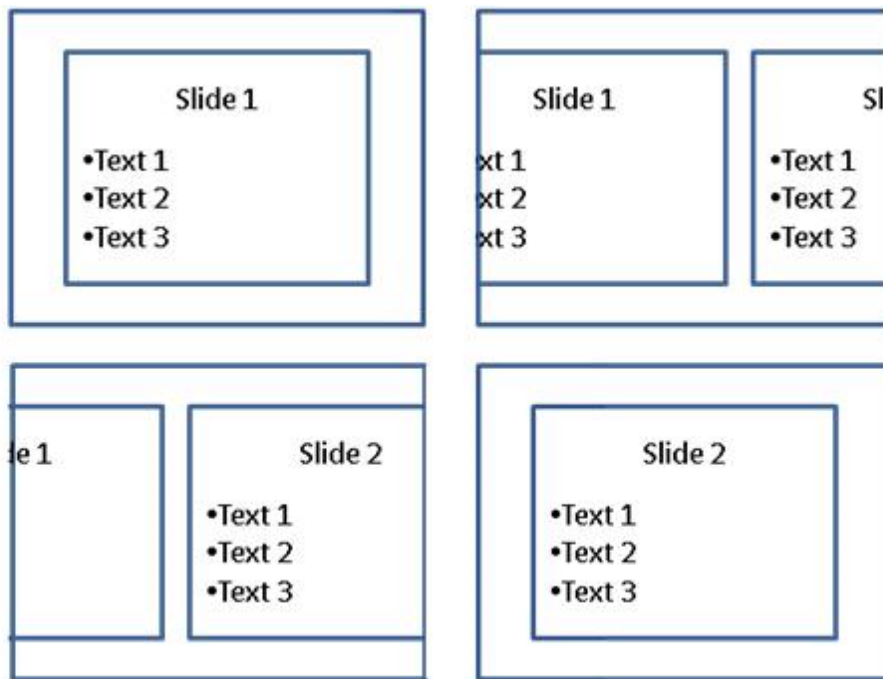

Figure 3: A "push" slide transition

See the Slide Show Types (section [1.3.7](#)) for records pertaining to **slide show**.

1.3.8 Byte Ordering

Some computer architectures number bytes in a binary word from left to right, a format that is referred to as **big-endian**. The packet diagrams for this documentation are big-endian. Other architectures number the bytes in a binary word from right to left, a format that is referred to as **little-endian**. The underlying file format enumerations, objects, and records are little-endian.

Using big-endian and little-endian methods, the number 0x12345678 is stored as shown in the following table:

Byte order	Byte 0	Byte 1	Byte 2	Byte 3
Big-endian	0x12	0x34	0x56	0x78
Little-endian	0x78	0x56	0x34	0x12

Unless otherwise specified, all data in the PowerPoint Binary File Format is stored in little-endian format.

1.4 Relationship to Protocols and Other Structures

This file format is an **OLE compound file** as described in [\[MS-CFB\]](#). It is dependent on the structures described in the following references:

- [\[MS-ODRAW\]](#) for the persistence format for **shapes**.
- [\[MS-OVBA\]](#) for the persistence format for a **VBA project**.
- [\[MS-OFFCRYPTO\]](#) for the persistence format for document signing, information rights management, document encryption and obfuscation.
- [\[MS-OSHARED\]](#) for the persistence format for additional common structures.

This file format has been superseded by [\[ECMA-376\]](#) in Microsoft Office PowerPoint 2007 and by [\[ISO/IEC29500-1:2012\]](#) in Microsoft PowerPoint 2010 and Microsoft PowerPoint 2013.

1.5 Applicability Statement

This document specifies a persistence format for **presentation** content and templates, which can include slides, drawing objects, text, images, transitions, and animations. This persistence format is applicable when the primary presentation format for the contained information is electronic.

This persistence format is applicable for use as a stand-alone document, and for containment within other documents as an embedded object as described in [\[MS-OLEDS\]](#).

This persistence format provides interoperability with applications that create or read documents conforming to this structure, including PowerPoint 97, PowerPoint 2000, PowerPoint 2002, and Office PowerPoint 2003. This persistence format can also be used for interoperability with Office PowerPoint 2007, PowerPoint 2010, and PowerPoint 2013 when compatibility with PowerPoint 97, PowerPoint 2000, PowerPoint 2002, and Office PowerPoint 2003 is a primary concern.

1.6 Versioning and Localization

None.

1.7 Vendor-Extensible Fields

This persistence format can be extended by storing information in streams and storages that are not described in section [2](#). Implementations are not required to preserve or remove additional streams or storages when modifying an existing document.

2 Structures

2.1 File Streams and Storages

As an **OLE compound file**, this file format specification is organized as a hierarchy of storages and streams as specified in [MS-CFB]. The following sections list the top-level storages and streams found in a file.

2.1.1 Current User Stream

A required stream whose name MUST be "Current User".

The contents of this stream are specified by the **CurrentUserAtom** record (section 2.3.2).

2.1.2 PowerPoint Document Stream

A required stream whose name MUST be "PowerPoint Document".

Let a *top-level record* be specified as any one of the following: **DocumentContainer** (section 2.4.1), **MasterOrSlideContainer** (section 2.5.5), **HandoutContainer** (section 2.5.8), **SlideContainer** (section 2.5.1), **NotesContainer** (section 2.5.6), **ExOleObjStg** (section 2.10.34), **ExControlStg** (section 2.10.37), **VbaProjectStg** (section 2.10.40), **PersistDirectoryAtom** (section 2.3.4), or **UserEditAtom** (section 2.3.3) record.

The contents of this stream are specified by a sequence of *top-level records*. Partial ordering restrictions on the record sequence are specified in the **PersistDirectoryAtom** and **UserEditAtom** records.

As **container records**, the **DocumentContainer**, **MainMasterContainer** (section 2.5.3), **HandoutContainer** (section 2.5.8), **SlideContainer** (section 2.5.1), and **NotesContainer** (section 2.5.6) records are each the root of a tree of container records and **atom records**. Inside any container record, other records can exist that are not explicitly listed as child records. Unknown records are identified when the **recType** field of the **RecordHeader** structure (section 2.3.1) contains a value not specified by the **RecordType** enumeration (section 2.13.24). These unknown records, if encountered, MUST be ignored, and MAY<1> be preserved. Unknown records can be ignored by seeking forward **recLen** bytes from the end of the **RecordHeader** structure.

Each time this stream is written, new *top-level records*, a **user edit**, can be appended to the existing stream, or the entire stream contents can be replaced with an updated sequence of *top-level records*. If the entire stream is not replaced, any previously existing *top-level records* that comprised any previous user edit, can be made obsolete by the subsequently appended *top-level records* that comprise the current user edit.

Let a *live record* be specified as any *top-level record* in this stream, or any descendant of a *top-level record* in this stream, identified by the following process:

Part 1: Construct the **persist object directory**.

1. Read the **CurrentUserAtom** record (section 2.3.2) from the **Current User Stream** (section 2.1.1). All seek operations in the steps that follow this step are in the **PowerPoint Document Stream**.
2. Seek, in the **PowerPoint Document Stream**, to the offset specified by the **offsetToCurrentEdit** field of the **CurrentUserAtom** record identified in step 1.
3. Read the **UserEditAtom** record at the current offset. Let this record be a *live record*.

4. Seek to the offset specified by the **offsetPersistDirectory** field of the **UserEditAtom** record identified in step 3.
5. Read the **PersistDirectoryAtom** record at the current offset. Let this record be a *live record*.
6. Seek to the offset specified by the **offsetLastEdit** field in the **UserEditAtom** record identified in step 3.
7. Repeat steps 3 through 6 until **offsetLastEdit** is 0x00000000.
8. Construct the complete persist object directory for this file as follows:
 1. For each **PersistDirectoryAtom** record previously identified in step 5, add the **persist object identifier** and **persist object** stream offset pairs to the persist object directory starting with the **PersistDirectoryAtom** record last identified, that is, the one closest to the beginning of the stream.
 2. Continue adding these pairs to the persist object directory for each **PersistDirectoryAtom** record in the reverse order that they were identified in step 5; that is, the pairs from the **PersistDirectoryAtom** record closest to the end of the stream are added last.
 3. When adding a new pair to the persist object directory, if the persist object identifier already exists in the persist object directory, the persist object stream offset from the new pair replaces the existing persist object stream offset for that persist object identifier.

Part 2: Identify the document persist object.

1. Read the **docPersistIdRef** field of the **UserEditAtom** record first identified in step 3 of Part 1, that is, the **UserEditAtom** record closest to the end of the stream.
2. Lookup the value of the **docPersistIdRef** field in the persist object directory constructed in step 8 of Part 1 to find the stream offset of a persist object.
3. Seek to the stream offset specified in step 2.
4. Read the **DocumentContainer** record at the current offset. Let this record be a *live record*.

Part 3: Identify the **notes master slide** persist object.

1. Read the **documentAtom.notesMasterPersistIdRef** field of the **DocumentContainer** record identified in step 4 of Part 2. If the value of the field is zero, skip to step 1 of Part 4.
2. Lookup the value of the **documentAtom.notesMasterPersistIdRef** field in the persist object directory constructed in step 8 of Part 1 to find the stream offset of a persist object.
3. Seek to the stream offset specified in step 2.
4. Read the **NotesContainer** record at the current offset. Let this record be a *live record*.

Part 4: Identify the **handout master slide** persist object.

1. Read the **documentAtom.handoutMasterPersistIdRef** field of the **DocumentContainer** record identified in step 4 of Part 2. If the value of the field is zero, skip to step 1 of Part 5.
2. Lookup the value of the **documentAtom.handoutMasterPersistIdRef** field in the persist object directory constructed in step 8 of Part 1 to find the stream offset of a persist object.
3. Seek to the stream offset specified in step 2.
4. Read the **HandoutContainer** record at the current offset. Let this record be a *live record*.

Part 5: Identify the **main master slide** and **title master slide** persist objects.

1. Read the **MasterListWithTextContainer** record specified by the **masterList** field of the **DocumentContainer** record identified in step 4 of Part 2.
2. Read the first **MasterPersistAtom** (section [2.4.14.2](#)) child record of the **MasterListWithTextContainer** record identified in step 1.
3. Lookup the value of the **persistIdRef** field of the **MasterPersistAtom** record previously identified in the persist object directory constructed in step 8 of Part 1 to find the stream offset of a persist object.
4. Seek to the stream offset specified in step 3.
5. Read the **MasterOrSlideContainer** record at the current offset. Let this record be a *live record*.
6. Repeat steps 3 through 5 for each **MasterPersistAtom** child record of the **MasterListWithTextContainer** record identified in step 1.

Part 6: Identify the **presentation slide** persist objects.

1. Read the **SlideListWithTextContainer** record (section [2.4.14.3](#)), if present, specified by the **slideList** field of the **DocumentContainer** record identified in step 4 of Part 2. If not present, skip to step 1 of Part 7.
2. Read the first **SlidePersistAtom** (section [2.4.14.5](#)) child record of the **SlideListWithTextContainer** record identified in step 1.
3. Lookup the value of the **persistIdRef** field of the **SlidePersistAtom** record (section 2.4.14.5) previously identified in the persist object directory constructed in step 8 of Part 1 to find the stream offset of a persist object.
4. Seek to the stream offset specified in step 3.
5. Read the **SlideContainer** record at the current offset. Let this record be a *live record*.
6. Repeat steps 3 through 5 for each **SlidePersistAtom** child record (section 2.4.14.5) of the **SlideListWithTextContainer** record identified in step 1.

Part 7: Identify the **notes slide** persist objects.

1. Read the **NotesListWithTextContainer** record (section [2.4.14.6](#)), if present, specified by the **notesList** field of the **DocumentContainer** record identified in step 4 of Part 2. If not present, skip to step 1 of Part 8.
2. Read the first **NotesPersistAtom** (section [2.4.14.7](#)) child record of the **NotesListWithTextContainer** record identified in step 1.
3. Lookup the value of the **persistIdRef** field of the **NotesPersistAtom** record previously identified in the persist object directory constructed in step 8 of Part 1 to find the stream offset of a persist object.
4. Seek to the stream offset specified in step 3.
5. Read the **NotesContainer** record at the current offset. Let this record be a *live record*.
6. Repeat steps 3 through 5 for each **NotesPersistAtom** child record of the **NotesListWithTextContainer** record identified in step 1.

Part 8: Identify the **ActiveX control** persist objects.

1. Read the **ExObjListContainer** record (section [2.10.1](#)), if present, specified by the **exObjList** field of the **DocumentContainer** record identified in step 4 of Part 2. If not present, skip to step 1 of Part 11.
2. Read the first, if any, **ExControlContainer** child record (section [2.10.10](#)) of the **ExObjListContainer** record identified in step 1. If no such child record exists, skip to step 1 of Part 9.
3. Lookup the value of the **exOleObjAtom.persistIdRef** field of the **ExControlContainer** record previously identified in the persist object directory constructed in step 8 of Part 1 to find the stream offset of a persist object.
4. Seek to the stream offset specified in step 3.
5. Read the **ExControlStg** record at the current offset. Let this record be a *live record*.
6. Repeat steps 3 through 5 for each **ExControlContainer** child record of the **ExObjListContainer** record identified in step 1.

Part 9: Identify the embedded **OLE object** persist objects.

1. Read the first, if any, **ExOleEmbedContainer** child record (section [2.10.27](#)) of the **ExObjListContainer** record identified in step 1 of Part 8. If no such child record exists, skip to step 1 of Part 10.
2. Lookup the value of the **exOleObjAtom.persistIdRef** field of the **ExOleEmbedContainer** record previously identified in the persist object directory constructed in step 8 of Part 1 to find the stream offset of a persist object.
3. Seek to the stream offset specified in step 2.
4. Read the **ExOleObjStg** record at the current offset. Let this record be a *live record*.
5. Repeat steps 2 through 4 for each **ExOleEmbedContainer** child record of the **ExObjListContainer** record identified in step 1 of Part 8.

Part 10: Identify the linked OLE object persist objects.

1. Read the first, if any, **ExOleLinkContainer** child record (section [2.10.29](#)) of the **ExObjListContainer** record identified in step 1 of Part 8. If no such child record exists, skip to step 1 of Part 11.
2. Lookup the value of the **exOleObjAtom.persistIdRef** field of the **ExOleLinkContainer** record previously identified in the persist object directory constructed in step 8 of Part 1 to find the stream offset of a persist object.
3. Seek to the stream offset specified in step 2.
4. Read the **ExOleObjStg** record at the current offset. Let this record be a *live record*.
5. Repeat steps 2 through 4 for each **ExOleLinkContainer** child record of the **ExObjListContainer** record identified in step 1 of Part 8.

Part 11: Identify the **VBA project** persist object.

1. Read the **DocInfoListContainer** record (section [2.4.4](#)), if present, specified by the **docInfoList** field of the **DocumentContainer** record identified in step 4 of Part 2. If not present, skip to step 6.
2. Read the **VBAInfoContainer** (section [2.4.10](#)) child record, if present, of the **DocInfoListContainer** record identified in step 1. If no such child record exists, skip to step 6.

3. Lookup the value of the **vbaInfoAtom.persistIdRef** field of the **VBAInfoContainer** record identified in step 2 in the persist object directory constructed in step 8 of Part 1 to find the stream offset of a persist object.
4. Seek to the stream offset specified in step 3.
5. Read the **VbaProjectStg** record at the current offset. Let this record be a *live record*.
6. End of process. All *live records* have been identified.

Let a *dead record* be specified as any *top-level record* in this stream, or any descendant of a *top-level record* in this stream, that is not a *live record*.

All uses of prescriptive terminology (MAY, SHOULD, MUST, SHOULD NOT, MUST NOT) in the specification of records in the following sections apply only to *live records*. The contents of all *dead records* are undefined and MUST be ignored.

2.1.3 Pictures Stream

An optional stream whose name MUST be "Pictures".

The contents of this stream are specified by the **OfficeArtBStoreDelay** record as specified in [\[MS-ODRAW\]](#) section 2.2.21.

2.1.4 Summary Information Stream

An optional stream whose name MUST be "\005SummaryInformation", where \005 is the character with value 0x0005, not the string literal "\005". This stream SHOULD be omitted for **encrypted documents**.

The contents of this stream are specified in [\[MS-OSHARED\]](#) section 2.3.3.2.1.

2.1.5 Document Summary Information Stream

An optional stream whose name MUST be "\005DocumentSummaryInformation", where \005 is the character with value 0x0005, not the string literal "\005". This stream MAY [<2>](#) be omitted for **encrypted documents**.

The contents of this stream are specified in [\[MS-OSHARED\]](#) section 2.3.3.2.2.

2.1.6 Encrypted Summary Information Stream

An optional stream whose name MUST be "EncryptedSummary". This stream exists only in an **encrypted document**.

The contents of this stream are specified in [\[MS-OFFCRYPTO\]](#) section 2.3.5.4.

2.1.7 Digital Signature Storage

An optional storage whose name MUST be "_xmldsignatures". It MAY [<3>](#) be omitted and MAY be ignored.

The contents of this storage are specified in [\[MS-OFFCRYPTO\]](#) section 2.5.2.

2.1.8 Custom XML Data Storage

An optional storage whose name MUST be "MsoDataStore".

The contents of the storage are specified in [\[MS-OSHARED\]](#) section 2.3.6.

2.1.9 Signatures Stream

An optional stream whose name MUST be "_signatures". It SHOULD [<4>](#) be omitted and MAY be ignored.

The contents of this stream are specified in [\[MS-OFFCRYPTO\]](#) section 2.5.1.

2.2 Basic Types

2.2.1 BlipRef

Referenced by: [TextPFException9](#)

A 2-byte signed integer that specifies a zero-based index of a picture bullet within the collection of picture bullets specified by the **BlipCollection9Container** record (section [2.9.72](#)). The value 0xFFFF specifies a **null** reference.

2.2.2 bool1

Referenced by: [BuildAtom](#), [ChartBuildAtom](#), [DiffRecordHeaders](#), [DocumentAtom](#), [ExOleEmbedAtom](#), [NormalViewSetInfoAtom](#), [NoZoomViewInfoAtom](#), [ParaBuildAtom](#), [PhotoAlbumInfo10Atom](#), [PrintOptionsAtom](#), [SlideViewInfoAtom](#), [TimeScaleBehaviorAtom](#), [TimeVariantBool](#), [ZoomViewInfoAtom](#)

A 1-byte unsigned integer that specifies a Boolean value. It SHOULD be 0x00 or 0x01. A value of 0x00 specifies **FALSE** and all other values specify **TRUE**.

2.2.3 BulletSize

Referenced by: [TextPFException](#)

A 2-byte signed integer that specifies the bullet font size. It MUST [<5>](#) be a value from the following table:

Range	Meaning
25 to 400, inclusive.	The value specifies bullet font size as a percentage of the font size of the first text run in the paragraph.
-4000 to -1, inclusive.	The absolute value specifies the bullet font size in points .

2.2.4 char2

Referenced by: [BookmarkEntityAtom](#), [FontEntityAtom](#), [RTFDateTimeMCAtom](#), [SlideShowDocInfoAtom](#)

An array of bytes that specifies a UTF-16 Unicode [\[RFC2781\]](#) string. The Unicode **NULL** character (0x0000), if present, terminates the string.

2.2.5 ExHyperlinkId

Referenced by: [ExHyperlinkAtom](#)

A 4-byte unsigned integer that specifies an identifier for a **hyperlink**. It MUST be greater than 0x00000000. The combined set of **ExObjId** (section [2.2.7](#)) and **ExHyperlinkId** values in the file MUST NOT contain duplicates.

2.2.6 ExHyperlinkIdRef

Referenced by: [ExHyperlinkRefAtom](#), [InteractiveInfoAtom](#)

A 4-byte unsigned integer that specifies a reference to a **hyperlink**. It MUST be 0x00000000 or equal to the value of the **exHyperlinkId** field of an **ExHyperlinkAtom** record (section [2.10.17](#)). The value 0x00000000 specifies a **null** reference.

2.2.7 ExObjId

Referenced by: [ExMediaAtom](#), [ExOleObjAtom](#)

A 4-byte unsigned integer that specifies an identifier for an **external object**. It MUST be greater than 0x00000000. The combined set of **ExObjId** and **ExHyperlinkId** (section [2.2.5](#)) values in the file MUST NOT contain duplicates.

2.2.8 ExObjIdRef

Referenced by: [ExObjRefAtom](#)

A 4-byte unsigned integer that specifies a reference to an **external object**. It MUST be equal to the value of the **exObjId** field of an **ExMediaAtom** record (section [2.10.6](#)) or the value of the **exObjId** field of an **ExOleObjAtom** record (section [2.10.12](#)).

2.2.9 FileOrDirNameFragment

Referenced by: [BCBroadcastDateTimeAtom](#), [BCPresentationNameAtom](#), [BCUserNameAtom](#)

An array of bytes that specifies a UTF-16 Unicode [\[RFC2781\]](#) string that specifies a valid file name or directory name. See [\[MSDN-FILE\]](#) for more information about file naming.

2.2.10 FontIndexRef

Referenced by: [TextCFException](#), [TextPFException](#)

A 2-byte unsigned integer that specifies a zero-based index of a font within the collection of fonts specified by the **FontCollectionContainer** record (section [2.9.8](#)).

2.2.11 FontIndexRef10

Referenced by: [TextCFException10](#)

A 2-byte unsigned integer that specifies a zero-based index of a font within the collection of fonts specified by the **FontCollection10Container** record (section [2.9.11](#)).

2.2.12 HttpUrl

Referenced by: [BCChatUrlAtom](#), [SlideLibUrlAtom](#)

An array of bytes that specifies a UTF-16 Unicode [\[RFC2781\]](#) string. It MUST be a valid URI [\[RFC3986\]](#) with the HTTP scheme.

2.2.13 IndentLevel

Referenced by: [MasterTextPropRun](#), [TextPFRun](#)

A 2-byte unsigned integer that specifies a text paragraph indent level. It MUST be less than or equal to 0x0004.

2.2.14 MachineName

Referenced by: [BCNetShowServerNameAtom](#), [BCRexServerNameAtom](#)

An array of bytes that specifies a UTF-16 Unicode [\[RFC2781\]](#) string that specifies a **computer name**. See [\[MSDN-FILE\]](#) for more information about computer naming.

2.2.15 MarginOrIndent

Referenced by: [TextPFException](#), [TextRuler](#)

A 2-byte signed integer that specifies an offset in **master units**. The origin of the offset is specified at each use of this **MarginOrIndent** type.

2.2.16 MasterId

Referenced by: [MasterPersistAtom](#)

A 4-byte unsigned integer that specifies an identifier for a **main master slide** or **title master slide**. It MUST be greater than or equal to 0x80000000. The set of **MasterId** values in the file MUST NOT contain duplicates.

2.2.17 MasterIdRef

Referenced by: [SlideAtom](#)

A 4-byte unsigned integer that specifies a reference to a **main master slide** or **title master slide**. It MUST be 0x00000000 or equal to the value of the **masterId** field of a **MasterPersistAtom** record (section [2.4.14.2](#)). The value 0x00000000 specifies a **null** reference.

2.2.18 NotesId

Referenced by: [NotesPersistAtom](#)

A 4-byte unsigned integer that specifies an identifier for a **notes slide**. It MUST be greater than or equal to 0x00000100 and MUST be less than or equal to 0x7FFFFFFF. The set of **NotesId** values in the file MUST NOT contain duplicates.

2.2.19 NotesIdRef

Referenced by: [SlideAtom](#)

A 4-byte unsigned integer that specifies a reference to a **notes slide**. It MUST be 0x00000000 or equal to the value of the **notesId** field of a **NotesPersistAtom** record (section [2.4.14.7](#)). The value 0x00000000 specifies a **null** reference.

2.2.20 ParaSpacing

Referenced by: [TextPFException](#)

A 2-byte signed integer that specifies text paragraph spacing. It MUST be a value from the following table:

Range	Meaning
0 to 13200, inclusive.	The value specifies spacing as a percentage of the text line height.
Less than 0.	The absolute value specifies spacing in master units .

2.2.21 PersistIdRef

Referenced by: [DocumentAtom](#), [ExOleObjAtom](#), [MasterPersistAtom](#), [NotesPersistAtom](#), [SlidePersistAtom](#), [UserEditAtom](#), [VBAInfoAtom](#)

A 4-byte unsigned integer that specifies a reference to a **persist object**. It MUST be 0x00000000 or equal to a **persist object identifier** specified by a **PersistDirectoryAtom** record (section [2.3.4](#)). The value 0x00000000 specifies a **null** reference.

2.2.22 PrintableAnsiString

Referenced by: [CurrentUserAtom](#), [DocRoutingSlipString](#)

An array of bytes that specifies an ANSI string. It MUST NOT contain the following characters:

0x00 - 0x1F

0x7F - 0x9F

The ANSI **NULL** character (0x00), if present, terminates the string.

2.2.23 PrintableUnicodeString

Referenced by: [AuthorNameAtom](#), [BCContactAtom](#), [BCEmailAddressAtom](#), [BCEmailNameAtom](#), [BCSpeakerAtom](#), [BookmarkValueAtom](#), [ClipboardNameAtom](#), [Comment10AuthorAtom](#), [Comment10AuthorInitialAtom](#), [CopyrightAtom](#), [CurrentUserAtom](#), [FileNameAtom](#), [FooterAtom](#), [HeaderAtom](#), [KeywordsAtom](#), [MacroNameAtom](#), [ModifyPasswordAtom](#), [NamedShowAtom](#), [NamedShowNameAtom](#), [PP10DocBinaryTagExtension](#), [PP10ShapeBinaryTagExtension](#), [PP10SlideBinaryTagExtension](#), [PP11DocBinaryTagExtension](#), [PP11ShapeBinaryTagExtension](#), [PP12DocBinaryTagExtension](#), [PP12SlideBinaryTagExtension](#), [PP9DocBinaryTagExtension](#), [PP9ShapeBinaryTagExtension](#), [PP9SlideBinaryTagExtension](#), [ProgIDAtom](#), [ReviewerNameAtom](#), [ServerIdAtom](#), [SoundNameAtom](#), [TagNameAtom](#), [UserDataAtom](#)

An array of bytes that specifies a UTF-16 Unicode [\[RFC2781\]](#) string. It MUST NOT contain the following characters:

- 0x0000 - 0x001F
- 0x007F - 0x009F

The Unicode **NULL** character (0x0000), if present, terminates the string.

2.2.24 SlideId

Referenced by: [SlidePersistAtom](#)

A 4-byte unsigned integer that specifies an identifier for a **presentation slide**. It MUST be greater than or equal to 0x00000100 and MUST be less than or equal to 0x7FFFFFFF. The set of **SlideId** values in the file MUST NOT contain duplicates.

2.2.25 SlideIdRef

Referenced by: [ExControlAtom](#), [ExOleLinkAtom](#), [LinkedSlide10Atom](#), [NamedShowSlidesAtom](#), [NotesAtom](#), [OutlineTextPropsHeaderExAtom](#), [SlideListEntry10Atom](#), [UserEditAtom](#)

A 4-byte unsigned integer that specifies a reference to a **presentation slide**. It MUST be 0x00000000 or equal to the value of the **slideId** field of a **SlidePersistAtom** record (section [2.4.14.5](#)). The value 0x00000000 specifies a **null** reference.

2.2.26 SmartTagIndex

Referenced by: [SmartTags](#)

A 4-byte unsigned integer that specifies a zero-based index of a **smart tag** within the collection of smart tags specified by the **SmartTagStore11Container** record (section [2.11.28](#)).

2.2.27 SoundIdRef

Referenced by: [AnimationInfoAtom](#), [ExWAVAudioEmbeddedAtom](#), [InteractiveInfoAtom](#), [SlideShowSlideInfoAtom](#), [VisualSoundAtom](#)

A 4-byte unsigned integer that specifies a reference to a sound. It MUST be 0x00000000 or equal to the integer value of the **soundIdAtom** field of a **SoundContainer** record (section [2.4.16.3](#)). The value 0x00000000 specifies a **null** reference.

2.2.28 TabCrLfPrintableUnicodeString

Referenced by: [Comment10TextAtom](#)

An array of bytes that specifies a UTF-16 Unicode [\[RFC2781\]](#) string. It MUST NOT contain the following characters:

- 0x0000 - 0x0008
- 0x000B
- 0x000C
- 0x000E - 0x001F
- 0x007F - 0x009F

The Unicode **NULL** character (0x0000), if present, terminates the string.

2.2.29 TabSize

Referenced by: [TextPFException](#), [TextRuler](#)

A 2-byte signed integer that specifies the size, in **master units**, of a tab.

2.2.30 TextPosition

Referenced by: [DateTimeMCAAtom](#), [FooterMCAAtom](#), [GenericDateMCAAtom](#), [HeaderMCAAtom](#), [RTFDateTimeMCAAtom](#), [SlideNumberMCAAtom](#), [TextBookmarkAtom](#), [TextRange](#)

A 4-byte signed integer that specifies a zero-based character position in a range of text. It MUST be greater than or equal to 0x00000000, and MUST be less than the character length of the *corresponding text*.

Let the *corresponding text* be as specified at each use of this **TextPosition** type.

2.2.31 TxLCID

Referenced by: [TextSIException](#)

A 2-byte unsigned integer that specifies a language identifier. It MUST be a value from the following table.

Value	Meaning
0x0000	No language.
0x0013	Any Dutch language is preferred over non-Dutch languages when proofing the text.
0x0400	No proofing is performed on the text.
Greater than 0x0400	A valid LCID as specified by [MS-LCID] .

2.2.32 UncOrLocalPath

Referenced by: [BCArchiveDirAtom](#), [UncOrLocalPathAtom](#)

An array of bytes that specifies a UTF-16 Unicode [\[RFC2781\]](#) string that specifies a **UNC** or local file system path. See [\[MSDN-FILE\]](#) for more information about file naming.

2.2.33 UncPath

Referenced by: [BCAsdFileNameAtom](#), [BCNetShowFilesBaseDirAtom](#), [BCNetShowFilesDirAtom](#), [BCPptFilesBaseDirAtom](#), [BCPptFilesDirAtom](#)

An array of bytes that specifies a UTF-16 Unicode [\[RFC2781\]](#) string that specifies a **UNC** path. See [\[MSDN-FILE\]](#) for more information about file naming.

2.2.34 UncPathOrHttpUri

Referenced by: [BCPptFilesBaseUrlAtom](#)

An array of bytes that specifies a UTF-16 Unicode [\[RFC2781\]](#) string that specifies a **UNC** path or a valid URI [\[RFC3986\]](#) with the HTTP scheme. See [\[MSDN-FILE\]](#) for more information about file naming.

2.2.35 UnicodeString

Referenced by: [BCDescriptionAtom](#), [BCEntryIDAtom](#), [BCTitleAtom](#), [FriendlyNameAtom](#), [LocationAtom](#), [MenuNameAtom](#), [ScreenTipAtom](#), [SlideNameAtom](#), [TagValueAtom](#), [TargetAtom](#), [TemplateNameAtom](#), [TimeEventFilter](#), [TimeNodeTimeFilter](#), [TimePointsTypes](#), [TimeRuntimeContext](#), [TimeVariantString](#)

An array of bytes that specifies a UTF-16 Unicode [\[RFC2781\]](#) string. The Unicode **NULL** character (0x0000), if present, terminates the string.

2.2.36 Utf8UnicodeString

Referenced by: [RoundTripColorMappingAtom](#)

An array of bytes that specifies a UTF-8 Unicode [\[RFC3629\]](#) string. It MUST be valid XML as defined in [\[XML\]](#).

2.3 File Structure Types

2.3.1 RecordHeader

A structure at the beginning of each **container record** and each **atom record** in the file. The values in the record header and the context of the record are used to identify and interpret the record data that follows.

0	1	2	3	4	5	6	7	8	9	10	11	12	13	14	15	16	17	18	19	20	21	22	23	24	25	26	27	28	29	30	31
recVer				recInstance												recType															
recLen																															

recVer (4 bits): An unsigned integer that specifies the version of the record data that follows the record header. A value of 0xF specifies that the record is a container record.

recInstance (12 bits): An unsigned integer that specifies the record instance data. Interpretation of the value is dependent on the particular record type.

recType (2 bytes): A **RecordType** enumeration (section [2.13.24](#)) that specifies the type of the record data that follows the record header.

recLen (4 bytes): An unsigned integer that specifies the length, in bytes, of the record data that follows the record header.

2.3.2 CurrentUserAtom

An **atom record** that specifies information about the last user to modify the file and where the most recent **user edit** is located. This is the only record in the **Current User Stream** (section [2.1.1](#)).

0	1	2	3	4	5	6	7	8	9	10	11	12	13	14	15	16	17	18	19	20	21	22	23	24	25	26	27	28	29	30	31
rh																															
...																															
size																															
headerToken																															
offsetToCurrentEdit																															
lenUserName																docFileVersion															
majorVersion								minorVersion								unused															
ansiUserName (variable)																															
...																															

relVersion
unicodeUserName (variable)
...

rh (8 bytes): A **RecordHeader** structure (section [2.3.1](#)) that specifies the header for this record. Sub-fields are further specified in the following table.

Field	Meaning
rh.recVer	MUST be 0x0.
rh.recInstance	MUST be 0x000.
rh.recType	MUST be RT_CurrentUserAtom (section 2.13.24).

size (4 bytes): An unsigned integer that specifies the length, in bytes, of the fixed-length portion of the record, which begins after the **rh** field and ends before the **ansiUserName** field. It MUST be 0x00000014.

headerToken (4 bytes): An unsigned integer that specifies a token used to identify whether the file is encrypted. It MUST be a value from the following table.

Value	Meaning
0xE391C05F	The file SHOULD NOT <6> be an encrypted document .
0xF3D1C4DF	The file MUST be an encrypted document.

offsetToCurrentEdit (4 bytes): An unsigned integer that specifies an offset, in bytes, from the beginning of the **PowerPoint Document Stream** (section [2.1.2](#)) to the **UserEditAtom** record (section [2.3.3](#)) for the most recent user edit.

lenUserName (2 bytes): An unsigned integer that specifies the length, in bytes, of the **ansiUserName** field. It MUST be less than or equal to 255.

docFileVersion (2 bytes): An unsigned integer that specifies the document file version of the file. It MUST be 0x03F4.

majorVersion (1 byte): An unsigned integer that specifies the major version of the storage format. It MUST be 0x03.

minorVersion (1 byte): An unsigned integer that specifies the minor version of the storage format. It MUST be 0x00.

unused (2 bytes): Undefined and MUST be ignored.

ansiUserName (variable): A **PrintableAnsiString** (section [2.2.22](#)) that specifies the user name of the last user to modify the file. The length, in bytes, of the field is specified by the **lenUserName** field.

relVersion (4 bytes): An unsigned integer that specifies the release version of the file format. It MUST be a value from the following table.

Value	Meaning
0x00000008	The file contains one or more main master slide .

Value	Meaning
0x00000009	The file contains more than one main master slide. It SHOULD NOT <7> be used.

unicodeUserName (variable): An optional **PrintableUnicodeString** (section [2.2.23](#)) that specifies the user name of the last user to modify the file. The length, in bytes, of the field is specified by 2 * **lenUserName**. This user name supersedes that specified by the **ansiUserName** field. It MAY [<8>](#) be omitted.

2.3.3 UserEditAtom

An **atom record** that specifies information about a **user edit**.

0	1	2	3	4	5	6	7	8	9	10	11	12	13	14	15	16	17	18	19	20	21	22	23	24	25	26	27	28	29	30	31
rh																															
...																															
lastSlideIdRef																															
version																minorVersion								majorVersion							
offsetLastEdit																															
offsetPersistDirectory																															
docPersistIdRef																															
persistIdSeed																															
lastView																unused															
encryptSessionPersistIdRef (optional)																															

rh (8 bytes): A **RecordHeader** structure (section [2.3.1](#)) that specifies the header for this record. Sub-fields are further specified in the following table.

Field	Meaning
rh.recVer	MUST be 0x0.
rh.recInstance	MUST be 0x000.
rh.recType	MUST be RT_UserEditAtom (section 2.13.24).
rh.recLen	MUST be 0x0000001C or 0x00000020.

lastSlideIdRef (4 bytes): A **SlideIdRef** (section [2.2.25](#)) that specifies the last slide viewed, if this is the last **UserEditAtom** record in the **PowerPoint Document Stream** (section [2.1.2](#)). In all other cases the value of this field is undefined and MUST be ignored.

version (16 bits): An unsigned integer that specifies a build version of the executable that wrote the file. It SHOULD [<9>](#) be 0x0000 and MUST be ignored.

minorVersion (8 bits): An unsigned integer that specifies the minor version of the storage format. It MUST be 0x00.

majorVersion (8 bits): An unsigned integer that specifies the major version of the storage format. It MUST be 0x03.

offsetLastEdit (4 bytes): An unsigned integer that specifies an offset, in bytes, from the beginning of the **PowerPoint Document Stream** to a **UserEditAtom** record for the previous user edit. It MUST be less than the offset, in bytes, of this **UserEditAtom** record. The value 0x00000000 specifies that no previous user edit exists.

offsetPersistDirectory (4 bytes): An unsigned integer that specifies an offset, in bytes, from the beginning of the **PowerPoint Document Stream** to the **PersistDirectoryAtom** record (section [2.3.4](#)) for this user edit. It MUST be greater than **offsetLastEdit** and less than the offset, in bytes, of this **UserEditAtom** record.

docPersistIdRef (4 bytes): A **PersistIdRef** (section [2.2.21](#)) that specifies the value to look up in the **persist object directory** to find the offset of the **DocumentContainer** record (section [2.4.1](#)). It MUST be 0x00000001.

persistIdSeed (4 bytes): An unsigned integer that specifies a **seed** for creating a new **persist object identifier**. It MUST be greater than or equal to all persist object identifiers in the file as specified by the **PersistDirectoryAtom** records.

lastView (2 bytes): A **ViewTypeEnum** enumeration (section [2.13.42](#)) that specifies the last view used to display the file.

unused (2 bytes): Undefined and MUST be ignored.

encryptSessionPersistIdRef (4 bytes): An optional **PersistIdRef** that specifies the value to look up in the persist object directory to find the offset of the **CryptSession10Container** record (section [2.3.7](#)). It MAY [<10>](#) be omitted. It MUST exist if the document is an **encrypted document**.

2.3.4 PersistDirectoryAtom

An **atom record** that specifies a **persist object directory**. Each **persist object identifier** specified MUST be unique in that persist object directory.

0	1	2	3	4	5	6	7	8	9	10	1	2	3	4	5	6	7	8	9	20	1	2	3	4	5	6	7	8	9	30	1
rh																															
...																															
rgPersistDirEntry (variable)																															
...																															

rh (8 bytes): A **RecordHeader** structure (section [2.3.1](#)) that specifies the header for this record. Sub-fields are further specified in the following table.

Field	Meaning
rh.recVer	MUST be 0x0.
rh.recInstance	MUST be 0x000.
rh.recType	MUST be RT_PersistDirectoryAtom (section 2.13.24).

rgPersistDirEntry (variable): An array of **PersistDirectoryEntry** structures (section [2.3.5](#)) that specifies persist object identifiers and stream offsets to **persist objects**. The size, in bytes, of the array is specified by **rh.recLen**.

2.3.5 PersistDirectoryEntry

Referenced by: [PersistDirectoryAtom](#)

A structure that specifies a compressed table of sequential **persist object identifiers** and stream offsets to associated **persist objects**.

Let the *corresponding user edit* be specified by the **UserEditAtom** record (section [2.3.3](#)) that most closely follows the **PersistDirectoryAtom** record (section 2.3.4) that contains this structure.

Let the *corresponding persist object directory* be specified by the **PersistDirectoryAtom** record that contains this structure.

0	1	2	3	4	5	6	7	8	9	10	11	12	13	14	15	16	17	18	19	20	1	2	3	4	5	6	7	8	9	30	1
persistId																				cPersist											
rgPersistOffset (variable)																															
...																															

persistId (20 bits): An unsigned integer that specifies a starting persist object identifier. It MUST be less than or equal to 0xFFFFE. The first entry in **rgPersistOffset** is associated with **persistId**. The next entry, if present, is associated with **persistId** plus 1. Each entry in **rgPersistOffset** is associated with a persist object identifier in this manner, with the final entry associated with **persistId + cPersist - 1**.

cPersist (12 bits): An unsigned integer that specifies the count of items in **rgPersistOffset**. It MUST be greater than or equal to 0x001.

rgPersistOffset (variable): An array of **PersistOffsetEntry** (section [2.3.6](#)) that specifies stream offsets to persist objects. The count of items in the array is specified by **cPersist**. The value of each item MUST be greater than or equal to **offsetLastEdit** in the *corresponding user edit* and MUST be less than the offset, in bytes, of the *corresponding persist object directory*.

2.3.6 PersistOffsetEntry

Referenced by: [PersistDirectoryEntry](#)

An unsigned 4-byte integer that specifies an offset, in bytes, from the beginning of the **PowerPoint Document Stream** (section [2.1.2](#)) to a **persist object**.

2.3.7 CryptSession10Container

A **container record** that specifies encryption properties for the file.

Only the Office Binary Document RC4 CryptoAPI encryption method as specified in [\[MS-OFFCRYPTO\]](#) section 2.3.5 is supported.

The following conditions MUST apply for the **Current User Stream** (section [2.1.1](#)) of an encrypted file:

- The stream MUST NOT be encrypted.
- The **headerToken** field of the **CurrentUserAtom** record (section [2.3.2](#)) SHOULD [<11>](#) be equal to 0xF3D1C4DF.

The following conditions MUST apply for the **PowerPoint Document Stream** (section [2.1.2](#)) of an encrypted file:

- The **UserEditAtom** record (section [2.3.3](#)) and the **PersistDirectoryAtom** record (section [2.3.4](#)) MUST NOT be encrypted.
- The **rh** field of this **CryptSession10Container** record MUST NOT be encrypted.
- The **data** field of this **CryptSession10Container** record MUST be encrypted as specified in [\[MS-OFFCRYPTO\]](#) section 2.3.5.1.
- All other parts of the stream MUST be encrypted.
- The stream MUST contain exactly one **UserEditAtom** record.
- The **encryptSessionPersistIdRef** field of the **UserEditAtom** record MUST exist. It MUST refer to a valid **persist object**, which MUST contain this **CryptSession10Container** record.

The **Pictures Stream** (section [2.1.3](#)) MUST be encrypted.

The following conditions MUST apply for the **Summary Info Stream** (section [2.1.4](#)) and **Document Summary Info Stream** (section [2.1.5](#)) of an encrypted file if the **fDocProps** bit is not set in the **data.EncryptionHeader.Flags** field:

- The **Summary Info Stream** MUST NOT exist.
- The **Encrypted Summary Info Stream** (section [2.1.6](#)) MUST exist.
- The **Document Summary Info Stream** SHOULD exist but MUST be empty.

If the **fDocProps** bit is set in the **data.EncryptionHeader.Flags** field, the **Summary Info Stream** and **Document Summary Info Stream** MUST NOT be encrypted and MUST contain the same content as the unencrypted file.

Encrypted parts of an **encrypted document** MUST be decrypted according to the following rules:

- A password hash MUST be generated from a password and the **data.EncryptionVerifier.Salt** field as specified in [\[MS-OFFCRYPTO\]](#) section 2.3.5.5.
- The password MUST be the same as the password which was used to encrypt the file.
- For each block number the derived encryption key MUST be generated from the password hash and the block number as specified in [\[MS-OFFCRYPTO\]](#) section 2.3.5.2.
- The corresponding derived encryption key MUST be used to decrypt the data.

A persist object in the **PowerPoint Document Stream** is decrypted as follows:

- For a persist object, the block number for the derived encryption key is the **persist object identifier**.
- The derived encryption key for a persist object MUST be generated from the password hash and the persist object identifier.
- The range of bytes of the persist object that MUST be decrypted using the derived encryption key is specified by:
 - The file offset of the persist object as specified in the **PowerPoint Document Stream** section.
 - The length in bytes which is 8 + the **recLen** field of the **RecordHeader** structure (section [2.3.1](#)) at the file offset.
- After decrypting, the range of bytes conforms to the content as specified by this document.

A picture in the **Pictures Stream** is decrypted as follows:

For each field of an **OfficeArtBStoreContainerFileBlock** record as specified in [\[MS-ODRAW\]](#) section 2.2.22 the following decryption steps apply:

- The derived encryption key MUST be generated from the password hash and a block number equal to zero.
- The size of each field in bytes MUST be decrypted with the derived encryption key.

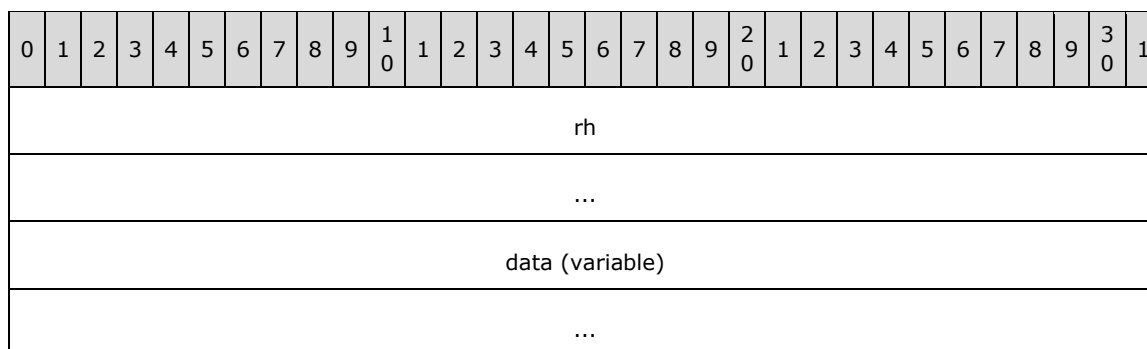

rh (8 bytes): A **RecordHeader** structure that specifies the header for this record. Sub-fields are further specified in the following table:

Field	Meaning
rh.recVer	MUST be 0xF.
rh.recInstance	MUST be 0x000.
rh.recType	MUST be RT_CryptSession10Container (section 2.13.24).

data (variable): An **EncryptionHeader** record as specified in [\[MS-OFFCRYPTO\]](#) section 2.3.5.1. The length, in bytes, of the field is specified by **rh.recLen**.

2.4 Document Types

2.4.1 DocumentContainer

A **container record** that specifies information about the document.

0	1	2	3	4	5	6	7	8	9	10	11	12	13	14	15	16	17	18	19	20	21	22	23	24	25	26	27	28	29	30	31
rh																															
...																															
documentAtom (48 bytes)																															
...																															
...																															
exObjList (variable)																															
...																															
documentTextInfo (variable)																															
...																															
soundCollection (variable)																															
...																															
drawingGroup (variable)																															
...																															
masterList (variable)																															
...																															
docInfoList (variable)																															
...																															
slideHF (variable)																															
...																															
notesHF (variable)																															
...																															
slideList (variable)																															
...																															
notesList (variable)																															

...	
slideShowDocInfoAtom (88 bytes, optional)	
...	
...	
namedShows (variable)	
...	
summary (variable)	
...	
docRoutingSlipAtom (variable)	
...	
printOptionsAtom (13 bytes, optional)	
...	
...	
...	rtCustomTableStylesAtom1 (variable)
...	
endDocumentAtom	
...	
rtCustomTableStylesAtom2 (variable)	
...	

rh (8 bytes): A **RecordHeader** structure (section [2.3.1](#)) that specifies the header for this record. Sub-fields are further specified in the following table:

Field	Meaning
rh.recVer	MUST be 0xF.
rh.recInstance	MUST be 0x000.
rh.recType	MUST be RT_Document (section 2.13.24)

documentAtom (48 bytes): A **DocumentAtom** record (section [2.4.2](#)) that specifies size information for **presentation slides** and **notes slides**.

exObjList (variable): An optional **ExObjListContainer** record (section [2.10.1](#)) that specifies the list of **external objects** in the document.

documentTextInfo (variable): A **DocumentTextInfoContainer** record (section [2.9.1](#)) that specifies the default text styles for the document.

soundCollection (variable): An optional **SoundCollectionContainer** record (section [2.4.16.1](#)) that specifies the list of sounds in the file.

drawingGroup (variable): A **DrawingGroupContainer** record (section [2.4.3](#)) that specifies drawing information for the document.

masterList (variable): A **MasterListWithTextContainer** record (section [2.4.14.1](#)) that specifies the list of **main master slides** and **title master slides**.

docInfoList (variable): An optional **DocInfoListContainer** record (section [2.4.4](#)) that specifies additional document information.

slideHF (variable): An optional **SlideHeadersFootersContainer** record (section [2.4.15.1](#)) that specifies the default **header** and **footer** information for presentation slides.

notesHF (variable): An optional **NotesHeadersFootersContainer** record (section [2.4.15.6](#)) that specifies the default header and footer information for notes slides.

slideList (variable): An optional **SlideListWithTextContainer** record (section [2.4.14.3](#)) that specifies the list of presentation slides.

notesList (variable): An optional **NotesListWithTextContainer** record (section [2.4.14.6](#)) that specifies the list of notes slides.

slideShowDocInfoAtom (88 bytes): An optional **SlideShowDocInfoAtom** record (section [2.6.1](#)) that specifies **slide show** information for the document.

namedShows (variable): An optional **NamedShowsContainer** record (section [2.6.2](#)) that specifies named shows in the document.

summary (variable): An optional **SummaryContainer** record (section [2.4.22.3](#)) that specifies **bookmarks** for the document.

docRoutingSlipAtom (variable): An optional **DocRoutingSlipAtom** record (section [2.11.1](#)) that specifies document routing information.

printOptionsAtom (13 bytes): An optional **PrintOptionsAtom** record (section [2.4.12](#)) that specifies default print options.

rtCustomTableStylesAtom1 (variable): An optional **RoundTripCustomTableStyles12Atom** record (section [2.11.13](#)) that specifies round-trip information for custom table styles.

endDocumentAtom (8 bytes): An **EndDocumentAtom** record (section [2.4.13](#)) that specifies the end of the information for the document.

rtCustomTableStylesAtom2 (variable): An optional **RoundTripCustomTableStyles12Atom** record that specifies round-trip information for custom table styles. It MUST NOT exist if **rtCustomTableStylesAtom1** exists.

2.4.2 DocumentAtom

Referenced by: [DocumentContainer](#)

An **atom record** that specifies information about the entire document.

0	1	2	3	4	5	6	7	8	9	10	11	12	13	14	15	16	17	18	19	20	21	22	23	24	25	26	27	28	29	30	31
rh																															
...																															
slideSize																															
...																															
notesSize																															
...																															
serverZoom																															
...																															
notesMasterPersistIdRef																															
handoutMasterPersistIdRef																															
firstSlideNumber																slideSizeType															
fSaveWithFonts								fOmitTitlePlace								fRightToLeft								fShowComments							

rh (8 bytes): A **RecordHeader** structure (section [2.3.1](#)) that specifies the header for this record. Sub-fields are further specified in the following table.

Field	Meaning
rh.recVer	MUST be 0x1.
rh.recInstance	MUST be 0x000.
rh.recType	MUST be RT_DocumentAtom (section 2.13.24).
rh.recLen	MUST be 0x00000028.

slideSize (8 bytes): A **PointStruct** structure (section [2.12.5](#)) that specifies the dimensions of the **presentation slides** in **master units**. Sub-fields are further specified in the following table.

Field	Meaning
slideSize.x	Specifies the width. It MUST be greater than or equal to 0x00000240 and less than or equal to 0x00007E00.
slideSize.y	Specifies the height. It MUST be greater than or equal to 0x00000240 and less than or equal to 0x00007E00.

notesSize (8 bytes): A **PointStruct** structure that specifies the dimensions of the **notes slides** and **handout slides** in master units. Sub-fields are further specified in the following table.

Field	Meaning
notesSize.x	Specifies the width. It MUST be greater than or equal to 0x00000240 and less than or equal to 0x00007E00.
notesSize.y	Specifies the height. It MUST be greater than or equal to 0x00000240 and less than or equal to 0x00007E00.

serverZoom (8 bytes): A **RatioStruct** structure (section [2.12.6](#)) that specifies a zoom level for visual representations of the document in **Object Linking and Embedding (OLE)** scenarios. The ratio specified by this field MUST be greater than zero.

notesMasterPersistIdRef (4 bytes): A **PersistIdRef** (section [2.2.21](#)) that specifies the value to look up in the **persist object directory** to find the offset of a **NotesContainer** record (section [2.5.6](#)) that specifies the **notes master slide**.

handoutMasterPersistIdRef (4 bytes): A **PersistIdRef** that specifies the value to look up in the persist object directory to find the offset of a **HandoutContainer** record (section [2.5.8](#)) that specifies the **handout master slide**.

firstSlideNumber (2 bytes): An **unsigned integer** that specifies the starting number for numbering slides. It MUST be less than 10000.

slideSizeType (2 bytes): A **SlideSizeEnum** enumeration (section [2.13.26](#)) that specifies the type of a presentation slide size.

fSaveWithFonts (1 byte): A **bool1** (section [2.2.2](#)) that specifies whether fonts are embedded in the document.

fOmitTitlePlace (1 byte): A **bool1** that specifies whether **placeholder shapes** on the title slide are not displayed.

fRightToLeft (1 byte): A **bool1** that specifies whether the user interface displays the document optimized for right-to-left languages.

fShowComments (1 byte): A **bool1** that specifies whether **presentation comments** are displayed.

2.4.3 DrawingGroupContainer

Referenced by: [DocumentContainer](#)

A **container record** that specifies drawing information for the document.

0	1	2	3	4	5	6	7	8	9	10	11	12	13	14	15	16	17	18	19	20	21	22	23	24	25	26	27	28	29	30	31
rh																															
...																															
OfficeArtDgg (variable)																															
...																															

rh (8 bytes): A **RecordHeader** structure (section [2.3.1](#)) that specifies the header for this record. Sub-fields are further specified in the following table:

Field	Meaning
rh.recVer	MUST be 0xF.
rh.recInstance	MUST be 0x000.
rh.recType	MUST be RT_DrawingGroup (section 2.13.24).

OfficeArtDgg (variable): An **OfficeArtDggContainer** ([\[MS-ODRAW\]](#) section 2.2.12) that specifies drawing information for the document.

2.4.4 DocInfoListContainer

Referenced by: [DocumentContainer](#)

A **container record** that specifies information about the document and document display settings.

0	1	2	3	4	5	6	7	8	9	10	11	12	13	14	15	16	17	18	19	20	21	22	23	24	25	26	27	28	29	30	31
rh																															
...																															
rgChildRec (variable)																															
...																															

rh (8 bytes): A **RecordHeader** structure (section [2.3.1](#)) that specifies the header for this record. Sub-fields are further specified in the following table.

Field	Meaning
rh.recVer	MUST be 0xF.
rh.recInstance	MUST be 0x000.
rh.recType	MUST be RT_List (section 2.13.24).

rgChildRec (variable): An array of **DocInfoListSubContainerOrAtom** records (section [2.4.5](#)) that specifies information about the document or how the document is displayed. The size, in bytes, of the array is specified by **rh.recLen**. The **rh.recType** of the **DocInfoListSubContainerOrAtom** items MUST be one of the following record types: **RT_ProgTags** (section 2.13.24), **RT_NormalViewSetInfo9** (section 2.13.24), **RT_NotesTextViewInfo9** (section 2.13.24), **RT_OutlineViewInfo** (section 2.13.24), **RT_SlideViewInfo** (section 2.13.24), **RT_SorterViewInfo** (section 2.13.24), or **RT_VbaInfo** (section 2.13.24). Each record type MUST NOT occur more than once, except for the **RT_SlideViewInfo** record type, which MUST NOT occur more than twice. If the **RT_SlideViewInfo** record type occurs twice, one occurrence MUST refer to a **SlideViewInfoContainer** record (section [2.4.21.9](#)) and the other occurrence MUST refer to a **NotesViewInfoContainer** record (section [2.4.21.12](#)).

2.4.5 DocInfoListSubContainerOrAtom

Referenced by: [DocInfoListContainer](#)

A variable type record whose type and meaning are dictated by the value of **rh.recType**, as specified in the following table.

Value	Meaning
RT_ProgTags (section 2.13.24)	A DocProgTagsContainer record (section 2.4.23.1) that specifies programmable tags containing additional document data.
RT_NormalViewSetInfo9 (section 2.13.24)	A NormalViewSetInfoContainer record (section 2.4.21.2) that specifies display preferences for a view optimized for the simultaneous display of all presentation slides , a specific presentation slide, and the text of the notes slide associated with that specific presentation slide.
RT_NotesTextViewInfo9 (section 2.13.24)	A NotesTextViewInfoContainer record (section 2.4.21.4) that specifies display preferences for a view optimized for the display of the text on the notes slides.
RT_OutlineViewInfo (section 2.13.24)	A OutlineViewInfoContainer record (section 2.4.21.6) that specifies display preferences for a view optimized for the display of the text on the presentation slides.
RT_SlideViewInfo (section 2.13.24)	A SlideViewInfoInstance record (section 2.4.21.8) that specifies display preferences for a view optimized for the display of presentation slides or notes slides.
RT_SorterViewInfo (section 2.13.24)	A SorterViewInfoContainer record (section 2.4.21.13) that specifies display preferences for a view optimized for the simultaneous display of multiple presentation slides.
RT_VbaInfo (section 2.13.24)	A VBAInfoContainer record (section 2.4.10) that specifies VBA info for the document.

2.4.6 PresAdvisorFlags9Atom

Referenced by: [PP9DocBinaryTagExtension](#)

An **atom record** that specifies which rules to ignore when warning the user about aspects of the document that do not conform to a particular style.

0	1	2	3	4	5	6	7	8	9	10	11	12	13	14	15	16	17	18	19	20	21	22	23	24	25	26	27	28	29	30	31
rh																															
...																															
A	B	C	D	E	F	G	H	I	J	K	reserved																				

rh (8 bytes): A **RecordHeader** structure (section [2.3.1](#)) that specifies the header for this record. Sub-fields are further specified in the following table:

Field	Meaning
rh.recVer	MUST be 0x0.
rh.recInstance	MUST be 0x000.
rh.recType	MUST be RT_PresentationAdvisorFlags9Atom (section 2.13.24).
rh.recLen	MUST be 0x00000004.

- A - fDisableCaseStyleTitleRule (1 bit):** A bit that specifies not to warn the user when the letter casing of text in a title **placeholder shape** does not follow a certain rule.
 - B - fDisableCaseStyleBodyRule (1 bit):** A bit that specifies not to warn the user when the letter casing of text in a body placeholder shape does not follow a certain rule.
 - C - fDisableEndPunctuationTitleRule (1 bit):** A bit that specifies not to warn the user when the ending punctuation of text in a title placeholder shape does not follow a certain rule.
 - D - fDisableEndPunctuationBodyRule (1 bit):** A bit that specifies not to warn the user when the ending punctuation of text in a body placeholder shape does not follow a certain rule.
 - E - fDisableTooManyBulletsRule (1 bit):** A bit that specifies not to warn the user when too many bullets are used.
 - F - fDisableFontSizeTitleRule (1 bit):** A bit that specifies not to warn the user when the font size in a title placeholder shape exceeds a certain size.
 - G - fDisableFontSizeBodyRule (1 bit):** A bit that specifies not to warn the user when the font size in a body placeholder shape exceeds a certain size.
 - H - fDisableNumberOfLinesTitleRule (1 bit):** A bit that specifies not to warn the user when the number of lines of text in a title placeholder shape exceeds a certain quantity.
 - I - fDisableNumberOfLinesBodyRule (1 bit):** A bit that specifies not to warn the user when the number of lines of a paragraph in a body placeholder shape exceeds a certain quantity.
 - J - fDisableTooManyFontsRule (1 bit):** A bit that specifies not to warn the user when the number of different fonts used exceeds a certain quantity.
 - K - fDisablePrintTip (1 bit):** A bit that specifies not to advise the user about printing when they first print the document.
- reserved (21 bits):** MUST be zero and MUST be ignored.

2.4.7 ModifyPasswordAtom

Referenced by: [PP10DocBinaryTagExtension](#)

An **atom record** that specifies a password used to modify the document.

Files with a modify password MUST be encrypted as specified in [\[MS-OFFCRYPTO\]](#) section 2.4.2.3. An application only grants modify access to the presentation if a user provided password matches the **modifyPassword** field.

0	1	2	3	4	5	6	7	8	9	10	11	12	13	14	15	16	17	18	19	20	21	22	23	24	25	26	27	28	29	30	31
rh																															
...																															
modifyPassword (variable)																															
...																															

rh (8 bytes): A **RecordHeader** structure (section [2.3.1](#)) that specifies the header for this record. Sub-fields are further specified in the following table.

Field	Meaning
rh.recVer	MUST be 0x0.
rh.recInstance	MUST be 0x003.
rh.recType	MUST be RT_CString (section 2.13.24).
rh.recLen	MUST be an even number. It MUST be less than or equal to 510.

modifyPassword (variable): A **PrintableUnicodeString** (section [2.2.23](#)) that specifies a password used to modify the document. The length, in bytes, of the field is specified by **rh.recLen**.

2.4.8 FilterPrivacyFlags10Atom

Referenced by: [PP10DocBinaryTagExtension](#)

An **atom record** that specifies privacy settings.

0	1	2	3	4	5	6	7	8	9	10	11	12	13	14	15	16	17	18	19	20	21	22	23	24	25	26	27	28	29	30	31
rh																															
...																															
A	reserved																														

rh (8 bytes): A **RecordHeader** structure (section [2.3.1](#)) that specifies the header for this record. Sub-fields are further specified in the following table.

Field	Meaning
rh.recVer	MUST be 0x0.
rh.recInstance	MUST be 0x000.
rh.recType	MUST be RT_FilterPrivacyFlags10Atom (section 2.13.24).
rh.recLen	MUST be 0x00000004.

A - fRemovePII (1 bit): A bit that specifies whether personally identifiable information is removed when saving the document.

reserved (31 bits): MUST be zero and MUST be ignored.

2.4.9 PhotoAlbumInfo10Atom

Referenced by: [PP10DocBinaryTagExtension](#)

An **atom record** that specifies information about how to display a presentation as a photo album.

0	1	2	3	4	5	6	7	8	9	10	11	12	13	14	15	16	17	18	19	20	21	22	23	24	25	26	27	28	29	30	31
rh																															
...																															
fUseBlackWhite								fHasCaption								layout								unused							
frameShape																															

rh (8 bytes): A **RecordHeader** structure (section [2.3.1](#)) that specifies the header for this record. Sub-fields are further specified in the following table.

Field	Meaning
rh.recVer	MUST be 0x0.
rh.recInstance	MUST be 0x000.
rh.recType	MUST be RT_PhotoAlbumInfo10Atom (section 2.13.24).
rh.recLen	MUST be 0x00000006.

fUseBlackWhite (1 byte): A **bool1** (section [2.2.2](#)) that specifies a user preference for whether to display all pictures in grayscale graphics.

fHasCaption (1 byte): A **bool1** that specifies a user preference for whether a text caption exists beneath each picture in the album.

layout (1 byte): A **PhotoAlbumLayoutEnum** enumeration (section [2.13.20](#)) that specifies a user preference for the layout of the photos in this presentation.

unused (1 byte): Undefined and MUST be ignored.

frameShape (2 bytes): A [PhotoAlbumFrameShapeEnum](#) enumeration that specifies a user preference for the shape of the frame around each photo.

2.4.10 VBAInfoContainer

Referenced by: [DocInfoListSubContainerOrAtom](#)

A **container record** that specifies **VBA** information for the document.

0	1	2	3	4	5	6	7	8	9	10	11	12	13	14	15	16	17	18	19	20	21	22	23	24	25	26	27	28	29	30	31
rh																															
...																															
vbaInfoAtom (20 bytes)																															
...																															

...

rh (8 bytes): A **RecordHeader** structure (section [2.3.1](#)) that specifies the header for this record. Sub-fields are further specified in the following table.

Field	Meaning
rh.recVer	MUST be 0xF.
rh.recInstance	MUST be 0x001.
rh.recType	MUST be RT_VbaInfo (section 2.13.24).
rh.recLen	MUST be 0x00000014.

vbaInfoAtom (20 bytes): A [VBAInfoAtom](#) record that specifies VBA information for this document.

2.4.11 VBAInfoAtom

Referenced by: [VBAInfoContainer](#)

An **atom record** that specifies a reference to the **VBA** project storage.

0	1	2	3	4	5	6	7	8	9	10	11	12	13	14	15	16	17	18	19	20	21	22	23	24	25	26	27	28	29	30	31
rh																															
...																															
persistIdRef																															
fHasMacros																															
version																															

rh (8 bytes): A **RecordHeader** structure (section [2.3.1](#)) that specifies the header for this record. Sub-fields are further specified in the following table.

Field	Meaning
rh.recVer	MUST be 0x2.
rh.recInstance	MUST be 0x000.
rh.recType	MUST be RT_VbaInfoAtom .
rh.recLen	MUST be 0x0000000C.

persistIdRef (4 bytes): A **PersistIdRef** (section [2.2.21](#)) that specifies the value to look up in the **persist object directory** to find the offset of a **VbaProjectStg** record (section [2.10.40](#)).

fHasMacros (4 bytes): An **unsigned integer** that specifies whether the VBA project storage contains data. It MUST be a value from the following table.

Value	Meaning
0x00000000	The VBA storage is empty.

Value	Meaning
0x00000001	The VBA storage contains data.

version (4 bytes): An unsigned integer that specifies the VBA runtime version that generated the VBA project storage. It MUST be 0x00000002.

2.4.12 PrintOptionsAtom

Referenced by: [DocumentContainer](#)

An **atom record** that specifies user preferences for printing the document.

0	1	2	3	4	5	6	7	8	9	10	11	12	13	14	15	16	17	18	19	20	21	22	23	24	25	26	27	28	29	30	31
rh																															
...																															
printWhat								colorMode								fPrintHidden								fScaleToFitPaper							
fFrameSlides																															

rh (8 bytes): A **RecordHeader** structure (section [2.3.1](#)) that specifies the header for this record. Sub-fields are further specified in the following table.

Field	Meaning
rh.recVer	MUST be 0x0.
rh.recInstance	MUST be 0x000.
rh.recType	MUST be RT_PrintOptionsAtom .
rh.recLen	MUST be 0x00000005.

printWhat (1 byte): A [PrintWhatEnum](#) enumeration that specifies what is printed.

colorMode (1 byte): A [ColorModeEnum](#) enumeration that specifies how colors are printed.

fPrintHidden (1 byte): A **bool1** (section [2.2.2](#)) that specifies whether hidden slides are printed.

fScaleToFitPaper (1 byte): A **bool1** that specifies whether the **slide** is scaled as large as possible to fit the printable area of the page and maintain its aspect ratio.

fFrameSlides (1 byte): A **bool1** that specifies whether a border is drawn around each slide.

2.4.13 EndDocumentAtom

Referenced by: [DocumentContainer](#)

An **atom record** that specifies the end of information for the document inside a **DocumentContainer** record (section 2.4.1).

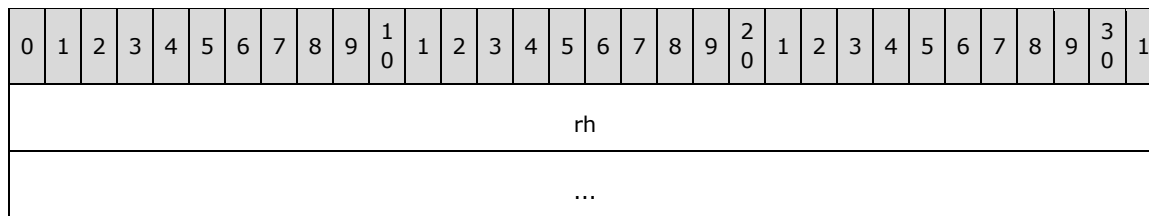

rh (8 bytes): A **RecordHeader** structure (section [2.3.1](#)) that specifies the header for this record. Sub-fields are further specified in the following table.

Field	Meaning
rh.recVer	MUST be 0x0.
rh.recInstance	MUST be 0x000.
rh.recType	MUST be RT_EndDocumentAtom .
rh.recLen	MUST be 0x00000000.

2.4.14 Slide List Types

2.4.14.1 MasterListWithTextContainer

Referenced by: [DocumentContainer](#)

A **container record** that specifies a list of references to **main master slides** and **title master slides**.

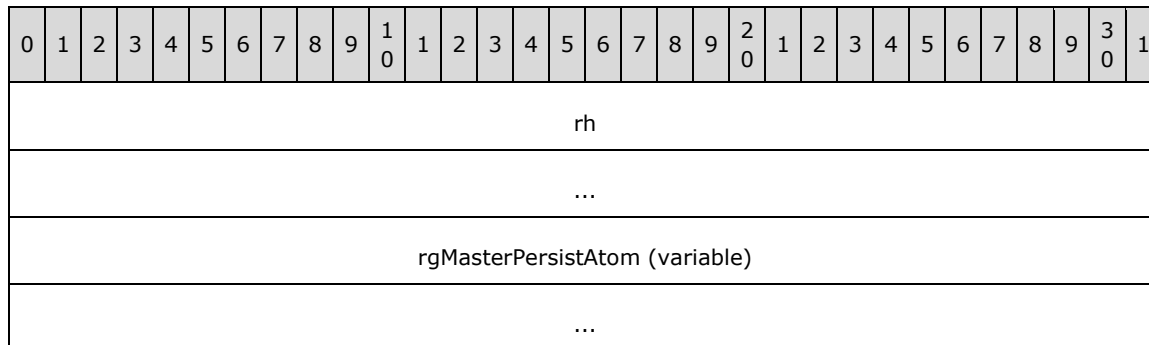

rh (8 bytes): A **RecordHeader** structure (section [2.3.1](#)) that specifies the header for this record. Sub-fields are further specified in the following table.

Field	Meaning
rh.recVer	MUST be 0xF.
rh.recInstance	MUST be 0x001.
rh.recType	MUST be RT_SlideListWithText .

rgMasterPersistAtom (variable): An array of **MasterPersistAtom** records (section [2.4.14.2](#)) that specifies references to the main master slides and title master slides. The length, in bytes, of the array is specified by **rh.recLen**.

2.4.14.2 MasterPersistAtom

Referenced by: [MasterListWithTextContainer](#)

An **atom record** that specifies a reference to a **main master slide** or **title master slide**.

0	1	2	3	4	5	6	7	8	9	10	11	12	13	14	15	16	17	18	19	20	21	22	23	24	25	26	27	28	29	30	31
rh																															
...																															
persistIdRef																															
A		B		reserved2																											
reserved3																															
masterId																															
reserved4																															

rh (8 bytes): A **RecordHeader** structure (section [2.3.1](#)) that specifies the header for this record. Sub-fields are further specified in the following table.

Field	Meaning
rh.recVer	MUST be 0x0.
rh.recInstance	MUST be 0x000.
rh.recType	MUST be RT_SlidePersistAtom .
rh.recLen	MUST be 0x00000014.

persistIdRef (4 bytes): A **PersistIdRef** (section [2.2.21](#)) that specifies the value to look up in the **persist object directory** to find the offset of the **MainMasterContainer** record (section [2.5.3](#)) for a main master slide or a **SlideContainer** record (section [2.5.1](#)) for a title master slide.

A - reserved1 (2 bits): MUST be zero and MUST be ignored.

B - fNonOutlineData (1 bit): A bit that specifies whether the main master slide or title master slide specified by the **persistIdRef** field contains data other than text in a **placeholder shape**.

reserved2 (29 bits): MUST be zero and MUST be ignored.

reserved3 (4 bytes): MUST be zero and MUST be ignored.

masterId (4 bytes): A [MasterId](#) that specifies the identifier for the main master slide or title master slide specified by the **persistIdRef** field.

reserved4 (4 bytes): MUST be zero and MUST be ignored.

2.4.14.3 SlideListWithTextContainer

Referenced by: [DocumentContainer](#)

A **container record** that specifies a list of references to **presentation slides** and text-related records for text contained within those presentation slides.

Each **SlidePersistAtom** record (section 2.4.14.5) in this list references a **SlideContainer** record (section 2.5.1) as specified by the **persistIdRef** field of the **SlidePersistAtom** record. Let the *corresponding slide* be the **SlideContainer** record so specified.

Let the *corresponding text placeholder list* be specified by the sequence of items in the **slideAtom.rgPlaceholderTypes** array of the *corresponding slide* with one of the following values: [PT_MasterTitle](#), [PT_MasterBody](#), [PT_MasterCenterTitle](#), [PT_MasterSubTitle](#), [PT_Title](#), [PT_Body](#), [PT_CenterTitle](#), [PT_SubTitle](#), [PT_VerticalTitle](#), or [PT_VerticalBody](#).

The i^{th} [TextHeaderAtom](#) record that follows a **SlidePersistAtom** record specifies the text of a **shape** that corresponds to the i^{th} item in the *corresponding text placeholder list*.

0	1	2	3	4	5	6	7	8	9	1	0	1	2	3	4	5	6	7	8	9	2	0	1	2	3	4	5	6	7	8	9	3	0	1	
rh																																			
...																																			
rgChildRec (variable)																																			
...																																			

rh (8 bytes): A **RecordHeader** structure (section 2.3.1) that specifies the header for this record. Sub-fields are further specified in the following table.

Field	Meaning
rh.recVer	MUST be 0xF.
rh.recInstance	MUST be 0x000.
rh.recType	MUST be RT_SlideListWithText .

rgChildRec (variable): An array of [SlideListWithTextSubContainerOrAtom](#) records that specifies the references to presentation slides and text contained within those presentation slides. The sequence of the **rh.recType** fields of array items MUST be a valid **SlideListWithTextRecordList** as specified in the following ABNF (specified in [RFC5234](#)) grammar:

```

SlideListWithTextRecordList = 1*SlideRecordList
SlideRecordList              = RT_SlidePersistAtom *8(RT_TextHeaderAtom TextCharsOrBytesRecord
StyleTextPropRecord MetaCharRecordList TextBookmarkRecordList TextSpecialInfoRecord
InteractiveRecordList)
TextCharsOrBytesRecord       = *1(RT_TextCharsAtom / RT_TextBytesAtom)
StyleTextPropRecord          = *1RT_StyleTextPropAtom
MetaCharRecordList           = *(RT_SlideNumberMetaCharAtom / RT_DateTimeMetaCharAtom /
RT_GenericDateMetaCharAtom / RT_HeaderMetaCharAtom / RT_FooterMetaCharAtom /
RT_RtfDateTimeMetaCharAtom)
TextBookmarkRecordList       = *RT_TextBookmarkAtom
TextSpecialInfoRecord        = *1RT_TextSpecialInfoAtom
InteractiveRecordList         = *(RT_InteractiveInfo RT_TextInteractiveInfoAtom)

```

2.4.14.4 SlideListWithTextSubContainerOrAtom

Referenced by: [SlideListWithTextContainer](#)

A variable type record whose type and meaning are dictated by the value of **rh.recType**, as specified in the following table.

Value	Meaning
RT_SlidePersistAtom	A SlidePersistAtom record (section 2.4.14.5) that specifies a reference to a presentation slide .
RT_TextHeaderAtom	A TextHeaderAtom record that specifies the type of a body of text.
RT_TextCharsAtom	A TextCharsAtom record that specifies text characters.
RT_TextBytesAtom	A TextBytesAtom record that specifies text characters.
RT_StyleTextPropAtom	A StyleTextPropAtom record that specifies text character and paragraph properties.
RT_SlideNumberMetaCharAtom	A SlideNumberMCAtom record that specifies a slide number metacharacter.
RT_DateTimeMetaCharAtom	A DateTimeMCAtom record that specifies a datetime metacharacter.
RT_GenericDateMetaCharAtom	A GenericDateMCAtom record that specifies a datetime metacharacter.
RT_HeaderMetaCharAtom	A HeaderMCAtom record that specifies a header metacharacter.
RT_FooterMetaCharAtom	A FooterMCAtom record that specifies a footer metacharacter.
RT_RtfDateTimeMetaCharAtom	A RtfDateTimeMCAtom record that specifies an RTF datetime metacharacter.
RT_TextBookmarkAtom	A TextBookmarkAtom record that specifies a text bookmark .
RT_TextSpecialInfoAtom	A TextSpecialInfoAtom record that specifies additional text properties.
RT_InteractiveInfo	An InteractiveInfoInstance record that specifies text interactive information.
RT_TextInteractiveInfoAtom	A TextInteractiveInfoInstance record that specifies the anchor for text interactive information.

2.4.14.5 SlidePersistAtom

Referenced by: [SlideListWithTextSubContainerOrAtom](#)

An **atom record** that specifies a reference to a **presentation slide**.

Let the *corresponding slide* be as specified by the **persistIdRef** field.

0	1	2	3	4	5	6	7	8	9	10	1	2	3	4	5	6	7	8	9	20	1	2	3	4	5	6	7	8	9	30	1	
rh																																
...																																
persistIdRef																																
A	B	C	reserved2																													
cTexts																																

slideId
reserved3

rh (8 bytes): A **RecordHeader** structure (section [2.3.1](#)) that specifies the header for this record. Sub-fields are further specified in the following table.

Field	Meaning
rh.recVer	MUST be 0x0.
rh.recInstance	MUST be 0x000.
rh.recType	MUST be RT_SlidePersistAtom .
rh.recLen	MUST be 0x00000014.

persistIdRef (4 bytes): A **PersistIdRef** (section [2.2.21](#)) that specifies the value to look up in the **persist object directory** to find the offset of the **SlideContainer** record (section [2.5.1](#)) for a presentation slide.

A - reserved1 (1 bit): MUST be zero and MUST be ignored.

B - fShouldCollapse (1 bit): A **bit** that specifies whether the *corresponding slide* is collapsed.

C - fNonOutlineData (1 bit): A **bit** that specifies whether the *corresponding slide* contains data other than text in a **placeholder shape**.

reserved2 (29 bits): MUST be zero and MUST be ignored.

cTexts (4 bytes): A **signed integer** that specifies the number of text placeholder shapes on the *corresponding slide*. It MUST be greater than or equal to 0x00000000. It SHOULD be less than or equal to 0x00000005 and MUST be less than or equal to 0x00000008.

slideId (4 bytes): A [SlideId](#) that specifies the identifier for the *corresponding slide*.

reserved3 (4 bytes): MUST be zero and MUST be ignored.

2.4.14.6 NotesListWithTextContainer

Referenced by: [DocumentContainer](#)

A **container record** that specifies a list of references to **notes slides**.

0	1	2	3	4	5	6	7	8	9	10	11	12	13	14	15	16	17	18	19	20	21	22	23	24	25	26	27	28	29	30	31
rh																															
...																															
rgNotesPersistAtom (variable)																															
...																															

rh (8 bytes): A **RecordHeader** structure (section [2.3.1](#)) that specifies the header for this record. Sub-fields are further specified in the following table.

Field	Meaning
rh.recVer	MUST be 0xF.
rh.recInstance	MUST be 0x002.
rh.recType	MUST be RT_SlideListWithText .

rgNotesPersistAtom (variable): An array of **NotesPersistAtom** records (section [2.4.14.7](#)) that specifies references to notes slides. The length, in bytes, of the array is specified by **rh.recLen**.

2.4.14.7 NotesPersistAtom

Referenced by: [NotesListWithTextContainer](#)

An **atom record** that specifies a reference to a **notes slide**.

0	1	2	3	4	5	6	7	8	9	10	11	12	13	14	15	16	17	18	19	20	21	22	23	24	25	26	27	28	29	30	31
rh																															
...																															
persistIdRef																															
A		B		reserved2																											
reserved3																															
notesId																															
reserved4																															

rh (8 bytes): A **RecordHeader** structure (section [2.3.1](#)) that specifies the header for this record. Sub-fields are further specified in the following table.

Field	Meaning
rh.recVer	MUST be 0x0.
rh.recInstance	MUST be 0x000.
rh.recType	MUST be RT_SlidePersistAtom .
rh.recLen	MUST be 0x00000014.

persistIdRef (4 bytes): A **PersistIdRef** (section [2.2.21](#)) that specifies the value to look up in the **persist object directory** to find the offset of the **NotesContainer** record (section [2.5.6](#)) for a notes slide.

A - reserved1 (2 bits): MUST be zero and MUST be ignored.

B - fNonOutlineData (1 bit): A bit that specifies whether the notes slide specified by the **persistIdRef** field contains data other than text in a **placeholder shape**.

reserved2 (29 bits): MUST be zero and MUST be ignored.

reserved3 (4 bytes): MUST be zero and MUST be ignored.

notesId (4 bytes): A [NotesId](#) that specifies the identifier for the notes slide specified by the **persistIdRef** field.

reserved4 (4 bytes): MUST be zero and MUST be ignored.

2.4.15 Header/Footer Types

2.4.15.1 SlideHeadersFootersContainer

Referenced by: [DocumentContainer](#)

A **container record** that specifies information about the **footers** on a **presentation slide**.

0	1	2	3	4	5	6	7	8	9	10	11	12	13	14	15	16	17	18	19	20	21	22	23	24	25	26	27	28	29	30	31
rh																															
...																															
hfAtom																															
...																															
...																															
userDateAtom (variable)																															
...																															
footerAtom (variable)																															
...																															

rh (8 bytes): A **RecordHeader** structure (section [2.3.1](#)) that specifies the header for this record. Sub-fields are further specified in the following table.

Field	Meaning
rh.recVer	MUST be 0xF.
rh.recInstance	MUST be 0x003.
rh.recType	MUST be RT_HeadersFooters .

hfAtom (12 bytes): A [HeadersFootersAtom](#) record that specifies the options for displaying the footers. The **hfAtom.fHasHeader** sub-field MUST be ignored.

userDateAtom (variable): An optional [UserDateAtom](#) record that specifies the custom date to be used in the date field.

footerAtom (variable): An optional [FooterAtom](#) record that specifies the content of the footer.

2.4.15.2 HeadersFootersAtom

Referenced by: [NotesHeadersFootersContainer](#), [PerSlideHeadersFootersContainer](#), [SlideHeadersFootersContainer](#)

An **atom record** that specifies options for displaying **headers** and **footers** on a **presentation slide** or **notes slide**.

0	1	2	3	4	5	6	7	8	9	10	11	12	13	14	15	16	17	18	19	20	21	22	23	24	25	26	27	28	29	30	31						
rh																																					
...																																					
formatId																A	B	C	D	E	F	reserved															

rh (8 bytes): A **RecordHeader** structure (section [2.3.1](#)) that specifies the header for this record. Sub-fields are further specified in the following table.

Field	Meaning
rh.recVer	MUST be 0x0.
rh.recInstance	MUST be 0x000.
rh.recType	MUST be RT_HeadersFootersAtom .
rh.recLen	MUST be 0x00000004.

formatId (2 bytes): A signed integer that specifies the format identifier to be used to style the date and time. It MUST be greater than or equal to 0x0000 and less than or equal to 0x000D. It SHOULD [<12>](#) be less than or equal to 0x000C. This value is converted into a string as specified by the **index** field of the [DateTimeMCAtom](#) record. It MUST be ignored unless **fHasTodayDate** is **TRUE**.

A - fHasDate (1 bit): A bit that specifies whether the date is displayed in the footer.

B - fHasTodayDate (1 bit): A bit that specifies whether the current **datetime** is used for displaying the **datetime**.

C - fHasUserData (1 bit): A bit that specifies whether the date specified in [UserDataAtom](#) record is used for displaying the **datetime**.

D - fHasSlideNumber (1 bit): A bit that specifies whether the slide number is displayed in the footer.

E - fHasHeader (1 bit): A bit that specifies whether the header text specified by [HeaderAtom](#) record is displayed.

F - fHasFooter (1 bit): A bit that specifies whether the footer text specified by [FooterAtom](#) record is displayed.

reserved (10 bits): MUST be zero and MUST be ignored.

2.4.15.3 UserDataAtom

Referenced by: [NotesHeadersFootersContainer](#), [PerSlideHeadersFootersContainer](#), [SlideHeadersFootersContainer](#)

An **atom record** that specifies the custom date for use in **headers** and **footers**.

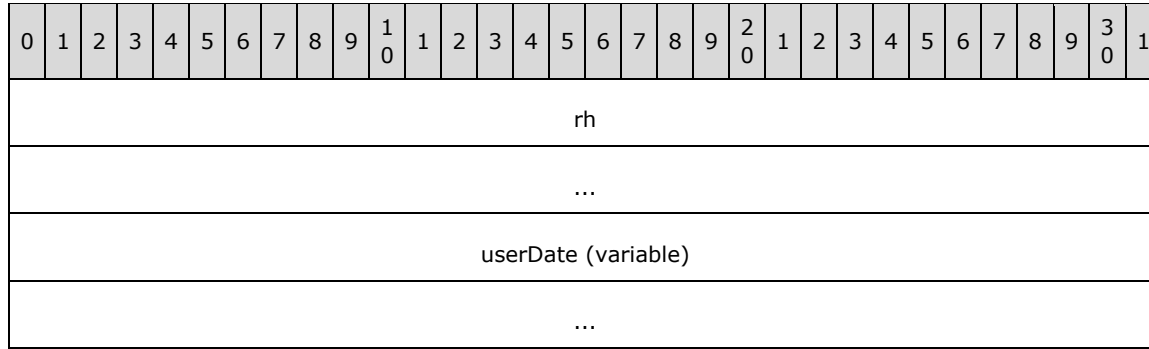

rh (8 bytes): A **RecordHeader** structure (section [2.3.1](#)) that specifies the header for this record. Sub-fields are further specified in the following table.

Field	Meaning
rh.recVer	MUST be 0x0.
rh.recInstance	MUST be 0x000.
rh.recType	MUST be RT_CString (section 2.13.24).
rh.recLen	MUST be an even number. It MUST be less than or equal to 510.

userDate (variable): A **PrintableUnicodeString** (section [2.2.23](#)) that specifies the custom date. The length, in bytes, of the field is specified by **rh.recLen**.

2.4.15.4 HeaderAtom

Referenced by: [NotesHeadersFootersContainer](#)

An **atom record** that specifies text to be used in a **header** on a **handout slide** or **notes slide**.

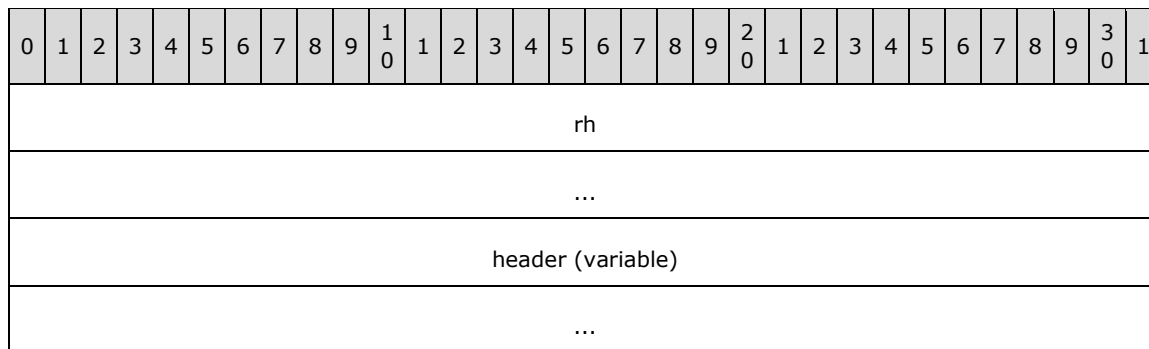

rh (8 bytes): A **RecordHeader** structure (section [2.3.1](#)) that specifies the header for this record. Sub-fields are further specified in the following table.

Field	Meaning
rh.recVer	MUST be 0x0.
rh.recInstance	MUST be 0x001.
rh.recType	MUST be RT_CString (section 2.13.24).
rh.recLen	MUST be an even number.

header (variable): A **PrintableUnicodeString** (section [2.2.23](#)) that specifies the text for the header. The length, in bytes, of the field is specified by **rh.recLen**.

2.4.15.5 FooterAtom

Referenced by: [NotesHeadersFootersContainer](#), [PerSlideHeadersFootersContainer](#), [SlideHeadersFootersContainer](#)

An **atom record** that specifies text to be used in a **footer** on a **presentation slide**, **handout slide** or **notes slide**.

0	1	2	3	4	5	6	7	8	9	10	11	12	13	14	15	16	17	18	19	20	21	22	23	24	25	26	27	28	29	30	31
rh																															
...																															
footer (variable)																															
...																															

rh (8 bytes): A **RecordHeader** structure (section [2.3.1](#)) that specifies the header for this record. Sub-fields are further specified in the following table.

Field	Meaning
rh.recVer	MUST be 0x0.
rh.recInstance	MUST be 0x002.
rh.recType	MUST be RT_CString (section 2.13.24).
rh.recLen	MUST be an even number.

footer (variable): A **PrintableUnicodeString** (section [2.2.23](#)) that specifies the text for the footer. The length, in bytes, of the field is specified by **rh.recLen**.

2.4.15.6 NotesHeadersFootersContainer

Referenced by: [DocumentContainer](#)

A **container record** that specifies information about the **headers** and **footers** on a **notes slide**.

0	1	2	3	4	5	6	7	8	9	10	11	12	13	14	15	16	17	18	19	20	21	22	23	24	25	26	27	28	29	30	31
rh																															
...																															
hfAtom																															
...																															

...
userDateAtom (variable)
...
headerAtom (variable)
...
footerAtom (variable)
...

rh (8 bytes): A **RecordHeader** structure (section [2.3.1](#)) that specifies the header for this record. Sub-fields are further specified in the following table.

Field	Meaning
rh.recVer	MUST be 0xF.
rh.recInstance	MUST be 0x004.
rh.recType	MUST be RT_HeadersFooters .

hfAtom (12 bytes): A [HeadersFootersAtom](#) record that specifies the options for displaying the headers and footers.

userDateAtom (variable): An optional [UserDateAtom](#) record that specifies the custom date to be used in a HeadersFootersAtom record.

headerAtom (variable): An optional [HeaderAtom](#) record that specifies the content of the header.

footerAtom (variable): An optional [FooterAtom](#) record that specifies the content of the footer.

2.4.16 Sound Types

2.4.16.1 SoundCollectionContainer

Referenced by: [DocumentContainer](#)

A **container record** that specifies all embedded sounds in the document.

0	1	2	3	4	5	6	7	8	9	10	11	12	13	14	15	16	17	18	19	20	21	22	23	24	25	26	27	28	29	30	31
rh																															
...																															
soundCollectionAtom																															
...																															

...
rgSoundContainer (variable)
...

rh (8 bytes): A **RecordHeader** structure (section [2.3.1](#)) that specifies the header for this record. Sub-fields are further specified in the following table.

Field	Meaning
rh.recVer	MUST be 0xF.
rh.recInstance	MUST be 0x005.
rh.recType	MUST be RT_SoundCollection .

soundCollectionAtom (12 bytes): A [SoundCollectionAtom](#) record that specifies the **seed** for creating new **sound identifiers** for sounds in this collection.

rgSoundContainer (variable): An array of **SoundContainer** records (section [2.4.16.3](#)) that specifies the embedded sounds. The length, in bytes, of the array is specified by the following formula:

`rh.recLen - 12.`

2.4.16.2 SoundCollectionAtom

Referenced by: [SoundCollectionContainer](#)

An **atom record** that specifies the **seed** for creating new **sound identifiers** for sounds in the **SoundCollectionContainer** record (section 2.4.16.1).

0	1	2	3	4	5	6	7	8	9	10	11	12	13	14	15	16	17	18	19	20	21	22	23	24	25	26	27	28	29	30	31
rh																															
...																															
soundIdSeed																															

rh (8 bytes): A **RecordHeader** structure (section [2.3.1](#)) that specifies the header for this record. Sub-fields are further specified in the following table.

Field	Meaning
rh.recVer	MUST be 0x0.
rh.recInstance	MUST be 0x000.
rh.recType	MUST be RT_SoundCollectionAtom .
rh.recLen	MUST be 0x00000004.

soundIdSeed (4 bytes): A signed integer that specifies the seed for creating a new sound identifier. It MUST be greater than 0x00000000 and greater than or equal to all sound identifiers specified by the [SoundIdAtom](#) records.

2.4.16.3 SoundContainer

Referenced by: [AnimationInfoContainer](#), [SoundCollectionContainer](#)

A **container record** that specifies information about an embedded sound.

0	1	2	3	4	5	6	7	8	9	10	11	12	13	14	15	16	17	18	19	20	21	22	23	24	25	26	27	28	29	30	31
rh																															
...																															
soundNameAtom (variable)																															
...																															
soundExtensionAtom (16 bytes, optional)																															
...																															
...																															
soundIdAtom (variable)																															
...																															
builtinIdAtom (variable)																															
...																															
soundDataBlob (variable)																															
...																															

rh (8 bytes): A **RecordHeader** structure (section [2.3.1](#)) that specifies the header for this record. Sub-fields are further specified in the following table.

Field	Meaning
rh.recVer	MUST be 0xF.
rh.recInstance	MUST be 0x000.
rh.recType	MUST be RT_Sound .

soundNameAtom (variable): A [SoundNameAtom](#) record that specifies the name of the sound.

soundExtensionAtom (16 bytes): An optional [SoundExtensionAtom](#) record that specifies the format of the audio data.

soundIdAtom (variable): A [SoundIdAtom](#) record that specifies the **sound identifier** for the sound.

builtinIdAtom (variable): An optional [SoundBuiltinIdAtom](#) record that specifies an identifier that describes the sound.

soundDataBlob (variable): A [SoundDataBlob](#) record that specifies the audio data for the sound.

2.4.16.4 SoundNameAtom

Referenced by: [SoundContainer](#)

An **atom record** that specifies the name of a sound.

0	1	2	3	4	5	6	7	8	9	10	1	2	3	4	5	6	7	8	9	20	1	2	3	4	5	6	7	8	9	30	1
rh																															
...																															
soundName (variable)																															
...																															

rh (8 bytes): A **RecordHeader** structure (section [2.3.1](#)) that specifies the header for this record. Sub-fields are further specified in the following table.

Field	Meaning
rh.recVer	MUST be 0x0.
rh.recInstance	MUST be 0x000.
rh.recType	MUST be RT_CString (section 2.13.24).
rh.recLen	MUST be an even number.

soundName (variable): A **PrintableUnicodeString** (section [2.2.23](#)) that specifies the name of a sound. The length, in bytes, of the field is specified by **rh.recLen**.

2.4.16.5 SoundExtensionAtom

Referenced by: [SoundContainer](#)

An **atom record** that specifies the format of the audio data for a sound.

0	1	2	3	4	5	6	7	8	9	10	1	2	3	4	5	6	7	8	9	20	1	2	3	4	5	6	7	8	9	30	1
rh																															
...																															
soundExtension																															
...																															

rh (8 bytes): A **RecordHeader** structure (section [2.3.1](#)) that specifies the header for this record. Sub-fields are further specified in the following table.

Field	Meaning
rh.recVer	MUST be 0x0.
rh.recInstance	MUST be 0x001.
rh.recType	MUST be RT_CString (section 2.13.24).
rh.recLen	MUST be 0x00000008.

soundExtension (8 bytes): A **UTF-16 Unicode** [\[RFC2781\]](#) **string** that specifies the format of the audio data for a sound. It SHOULD [<13>](#) be a value from the following table.

Value (case-insensitive)	Meaning
.wav	The format is WAV .
wave	The format is WAV.
.aif	The format is Audio Interchange File Format (AIFF) .
aiff	The format is AIFF.

2.4.16.6 SoundIdAtom

Referenced by: [SoundContainer](#)

An **atom record** that specifies the **sound identifier** for a sound.

0	1	2	3	4	5	6	7	8	9	10	11	12	13	14	15	16	17	18	19	20	21	22	23	24	25	26	27	28	29	30	31
rh																															
...																															
soundId (variable)																															
...																															

rh (8 bytes): A **RecordHeader** structure (section [2.3.1](#)) that specifies the header for this record. Sub-fields are further specified in the following table.

Field	Meaning
rh.recVer	MUST be 0x0.
rh.recInstance	MUST be 0x002.
rh.recType	MUST be RT_CString (section 2.13.24).
rh.recLen	MUST be an even number.

soundId (variable): A UTF-16 Unicode [\[RFC2781\]](#) string representation of the base-10 form of an integer value that specifies the sound identifier for a sound. The integer value MUST be greater than zero, less than or equal to the **seed** specified by the [SoundCollectionAtom](#) record and unique

within the **SoundCollectionContainer** record (section [2.4.16.1](#)). The length, in bytes, of the field is specified by **rh.recLen**.

2.4.16.7 SoundBuiltinIdAtom

Referenced by: [SoundContainer](#)

An **atom record** that specifies a description of a sound.

0	1	2	3	4	5	6	7	8	9	10	11	12	13	14	15	16	17	18	19	20	21	22	23	24	25	26	27	28	29	30	31
rh																...															
soundBuiltinId (variable)																															
...																															

rh (8 bytes): A RecordHeader structure (section [2.3.1](#)) that specifies the header for this record. Sub-fields are further specified in the following table.

Field	Meaning
rh.recVer	MUST be 0x0.
rh.recInstance	MUST be 0x003.
rh.recType	MUST be RT_CString (section 2.13.24).
rh.recLen	MUST be an even number.

soundBuiltinId (variable): A UTF-16 Unicode [RFC2781](#) string representation of the base-10 form of an integer value that specifies a description of a sound. It MUST be a value from the following table.

Value	Meaning
100	Cash Register
101	Typewriter
102	Screeching Brakes
103	Whoosh
104	Laser
105	Camera
106	Chime
107	Clapping
108	Applause
109	Drive By
110	Drum Roll
111	Explosion
112	Breaking Glass
113	Gunshot
114	Slide Projector
115	Ricochet

Value	Meaning
116	Arrow
117	Bomb
118	Breeze
119	Click
120	Coin
121	Hammer
122	Push
123	Suction
124	Voltage
125	Wind

The length, in bytes, of the field is specified by **rh.recLen**.

2.4.17 Broadcast Types

2.4.17.1 BroadcastDocInfo9Container

Referenced by: [PP9DocBinaryTagExtension](#)

A **container record** that specifies settings for a **presentation broadcast**. It SHOULD<14> be ignored. Some settings refer to NetShow; see [MSFT-UMWNSNS](#) for more information.

0	1	2	3	4	5	6	7	8	9	10	11	12	13	14	15	16	17	18	19	20	21	22	23	24	25	26	27	28	29	30	31
rh																															
...																															
bcTitleAtom (variable)																															
...																															
bcDescrAtom (variable)																															
...																															
bcSpeakerAtom (variable)																															
...																															
bcContactAtom (variable)																															
...																															
bcRexServerNameAtom (variable)																															
...																															

bcEmailAddressAtom (variable)
...
bcEmailNameAtom (variable)
...
bcChatUrlAtom (variable)
...
bcArchiveDirAtom (variable)
...
bcNSFilesBaseDirAtom (variable)
...
bcNSFilesDirAtom (variable)
...
bcNSServerNameAtom (variable)
...
bcPptFilesBaseDirAtom (variable)
...
bcPptFilesDirAtom (variable)
...
bcPptFilesBaseUrlAtom (variable)
...
bcUserNameAtom (variable)
...
bcBroadcastDateTimeAtom (variable)
...
bcPresentationNameAtom (variable)

...
bcAsdFileNameAtom (variable)
...
bcEntryIdAtom (variable)
...
bcDocInfoAtom (42 bytes)
...
...
...

rh (8 bytes): A **RecordHeader** structure (section 2.3.1) that specifies the header for this record. Sub-fields are further specified in the following table:

Field	Meaning
rh.recVer	MUST be 0xF.
rh.recInstance	MUST be 0x000.
rh.recType	MUST be RT_BroadcastDocInfo9 .

bcTitleAtom (variable): An optional [BCTitleAtom](#) record that specifies the title.

bcDescrAtom (variable): An optional [BCDescriptionAtom](#) record that specifies the description.

bcSpeakerAtom (variable): An optional [BCSpeakerAtom](#) record that specifies the name of the speaker.

bcContactAtom (variable): An optional [BCContactAtom](#) record that specifies the name of the contact person.

bcRexServerNameAtom (variable): An optional [BCRexServerNameAtom](#) record that specifies the name of the remote computer to which a camera or microphone is connected to record the video or audio. It MUST exist if the **fCameraRemote** field of the [BroadcastDocInfoAtom](#) record is set to **TRUE**.

bcEmailAddressAtom (variable): An optional [BCEmailAddressAtom](#) record that specifies the e-mail address for audience feedback.

bcEmailNameAtom (variable): An optional [BCEmailNameAtom](#) record that specifies the e-mail name for audience feedback. It MUST exist if **bcDocInfoAtom.fCanEmail** is **TRUE**.

bcChatUrlAtom (variable): An optional [BCChatUrlAtom](#) record that specifies the URL of a chat server.

bcArchiveDirAtom (variable): An optional [BCArchiveDirAtom](#) record that specifies the directory location to archive this presentation broadcast.

bcNSFilesBaseDirAtom (variable): An optional [BCNetShowFilesBaseDirAtom](#) record that specifies the UNC base directory to store presentation broadcast files for NetShow.

bcNSFilesDirAtom (variable): An optional [BCNetShowFilesDirAtom](#) record that specifies the UNC directory location to store presentation broadcast files for NetShow. It MUST exist if **bcDocInfoAtom.fUseNetShow** is **TRUE**.

bcNSServerNameAtom (variable): An optional [BCNetShowServerNameAtom](#) record that specifies the name of the NetShow server. It MUST exist if **bcDocInfoAtom.fUseNetShow** is **TRUE**.

bcPptFilesBaseDirAtom (variable): A [BCPptFilesBaseDirAtom](#) record that specifies the path to the UNC base directory to store presentation broadcast files.

bcPptFilesDirAtom (variable): A [BCPptFilesDirAtom](#) record that specifies the path to the UNC directory to store presentation broadcast files.

bcPptFilesBaseUrlAtom (variable): A [BCPptFilesBaseUrlAtom](#) record that specifies the UNC or HTTP location of the directory specified in **bcPptFilesDirAtom**.

bcUserNameAtom (variable): A [BCUserNameAtom](#) record that specifies the name of the user who scheduled the presentation broadcast.

bcBroadcastDateTimeAtom (variable): A [BCBroadcastDateTimeAtom](#) record that specifies the directory name to create under the base directory specified in **bcPptFilesBaseDirAtom**.

bcPresentationNameAtom (variable): A [BCPresentationNameAtom](#) record that specifies the name of the presentation.

bcAsdFileNameAtom (variable): A [BCAsdFileNameAtom](#) record that specifies the location of an ASD file. The ASD file is the description file for an Advanced Systems Format (ASF) file, described in [\[ASF\]](#), used to stream audio and video content.

bcEntryIdAtom (variable): An optional [BCEntryIDAtom](#) record that specifies the identifier for a calendar item to associate with this presentation broadcast.

bcDocInfoAtom (42 bytes): A BroadcastDocInfoAtom record that specifies properties of a presentation broadcast.

2.4.17.2 BCTitleAtom

Referenced by: [BroadcastDocInfo9Container](#)

An **atom record** that specifies the title of a **presentation broadcast**.

Let the *corresponding presentation broadcast* be specified by the BroadcastDocInfo9Container record that contains this **BCTitleAtom** record.

0	1	2	3	4	5	6	7	8	9	10	11	12	13	14	15	16	17	18	19	20	21	22	23	24	25	26	27	28	29	30	31
rh																															
...																															
title (variable)																															
...																															

rh (8 bytes): A **RecordHeader** structure (section [2.3.1](#)) that specifies the header for this record. Sub-fields are further specified in the following table.

Field	Meaning
rh.recVer	MUST be 0x0.
rh.recInstance	MUST be 0x001.
rh.recType	MUST be RT_CString (section 2.13.24).
rh.recLen	MUST be an even number. It MUST be less than or equal to 510.

title (variable): A [UnicodeString](#) that specifies the title of the *corresponding presentation broadcast*. The length, in bytes, of the field is specified by **rh.recLen**.

2.4.17.3 BCDescriptionAtom

Referenced by: [BroadcastDocInfo9Container](#)

An **atom record** that specifies the description of a **presentation broadcast**.

Let the *corresponding presentation broadcast* be specified by the BroadcastDocInfo9Container record that contains this **BCDescriptionAtom** record.

0	1	2	3	4	5	6	7	8	9	10	11	12	13	14	15	16	17	18	19	20	21	22	23	24	25	26	27	28	29	30	31
rh																															
...																															
description (variable)																															
...																															

rh (8 bytes): A **RecordHeader** structure (section [2.3.1](#)) that specifies the header for this record. Sub-fields are further specified in the following table.

Field	Meaning
rh.recVer	MUST be 0x0.
rh.recInstance	MUST be 0x002.
rh.recType	MUST be RT_CString (section 2.13.24).
rh.recLen	MUST be an even number. It MUST be less than or equal to 2040.

description (variable): A [UnicodeString](#) that specifies the description of the corresponding presentation broadcast. The length, in bytes, of the field is specified by **rh.recLen**.

2.4.17.4 BCSpkerAtom

Referenced by: [BroadcastDocInfo9Container](#)

An **atom record** that specifies the name of the speaker for a **presentation broadcast**.

Let the *corresponding presentation broadcast* be specified by the BroadcastDocInfo9Container record that contains this **BCSpeakerAtom** record.

0	1	2	3	4	5	6	7	8	9	10	1	2	3	4	5	6	7	8	9	20	1	2	3	4	5	6	7	8	9	30	1
rh																															
...																															
speaker (variable)																															
...																															

rh (8 bytes): A **RecordHeader** structure (section [2.3.1](#)) that specifies the header for this record. Sub-fields are further specified in the following table.

Field	Meaning
rh.recVer	MUST be 0x0.
rh.recInstance	MUST be 0x003.
rh.recType	MUST be RT_CString (section 2.13.24).
rh.recLen	MUST be an even number. It MUST be less than or equal to 510.

speaker (variable): A **PrintableUnicodeString** (section [2.2.23](#)) that specifies the name of the speaker for the *corresponding presentation broadcast*. The length, in bytes, of the field is specified by **rh.recLen**.

2.4.17.5 BCContactAtom

Referenced by: [BroadcastDocInfo9Container](#)

An **atom record** that specifies the name of the contact person for a **presentation broadcast**.

Let the *corresponding presentation broadcast* be specified by the BroadcastDocInfo9Container record that contains this **BCContactAtom** record.

0	1	2	3	4	5	6	7	8	9	10	1	2	3	4	5	6	7	8	9	20	1	2	3	4	5	6	7	8	9	30	1
rh																															
...																															
contact (variable)																															
...																															

rh (8 bytes): A **RecordHeader** structure (section [2.3.1](#)) that specifies the header for this record. Sub-fields are further specified in the following table.

Field	Meaning
rh.recVer	MUST be 0x0.
rh.recInstance	MUST be 0x004.
rh.recType	MUST be RT_CString (section 2.13.24).
rh.recLen	MUST be an even number. It MUST be less than or equal to 510.

contact (variable): A **PrintableUnicodeString** (section [2.2.23](#)) that specifies the name of the contact person for the *corresponding presentation broadcast*. The length, in bytes, of the field is specified by **rh.recLen**.

2.4.17.6 BCRexServerNameAtom

Referenced by: [BroadcastDocInfo9Container](#)

An **atom record** that specifies the name of the remote computer to which a camera or microphone is connected to record the video or audio of a **presentation broadcast**.

Let the *corresponding presentation broadcast* be specified by the [BroadcastDocInfo9Container](#) record that contains this **BCRexServerNameAtom** record.

0	1	2	3	4	5	6	7	8	9	10	11	12	13	14	15	16	17	18	19	20	21	22	23	24	25	26	27	28	29	30	31
rh																															
...																															
rexServerName (variable)																															
...																															

rh (8 bytes): A **RecordHeader** structure (section [2.3.1](#)) that specifies the header for this record. Sub-fields are further specified in the following table.

Field	Meaning
rh.recVer	MUST be 0x0.
rh.recInstance	MUST be 0x005.
rh.recType	MUST be RT_CString (section 2.13.24).
rh.recLen	MUST be an even number. It MUST be less than or equal to 510.

rexServerName (variable): A [MachineName](#) that specifies the name of the remote computer to which a camera or microphone is connected to record the video or audio of the corresponding presentation broadcast. The length, in bytes, of the field is specified by **rh.recLen**.

2.4.17.7 BCEmailAddressAtom

Referenced by: [BroadcastDocInfo9Container](#)

An **atom record** that specifies the e-mail address for audience feedback during a **presentation broadcast**.

Let the *corresponding presentation broadcast* be specified by the BroadcastDocInfo9Container record that contains this **BCEmailAddressAtom** record.

0	1	2	3	4	5	6	7	8	9	10	11	12	13	14	15	16	17	18	19	20	21	22	23	24	25	26	27	28	29	30	31
rh																															
...																															
emailAddress (variable)																															
...																															

rh (8 bytes): A **RecordHeader** structure (section [2.3.1](#)) that specifies the header for this record. Sub-fields are further specified in the following table.

Field	Meaning
rh.recVer	MUST be 0x0.
rh.recInstance	MUST be 0x006.
rh.recType	MUST be RT_CString (section 2.13.24).
rh.recLen	MUST be an even number. It MUST be less than or equal to 510.

emailAddress (variable): A **PrintableUnicodeString** (section [2.2.23](#)) that specifies the e-mail address for audience feedback for the *corresponding presentation broadcast*. The length, in bytes, of the field is specified by **rh.recLen**.

2.4.17.8 BCEmailNameAtom

Referenced by: [BroadcastDocInfo9Container](#)

An **atom record** that specifies the email name for audience feedback for a **presentation broadcast**.

Let the *corresponding presentation broadcast* be specified by the BroadcastDocInfo9Container record that contains this **BCEmailNameAtom** record.

0	1	2	3	4	5	6	7	8	9	10	11	12	13	14	15	16	17	18	19	20	21	22	23	24	25	26	27	28	29	30	31
rh																															
...																															
emailName (variable)																															
...																															

rh (8 bytes): A **RecordHeader** structure (section [2.3.1](#)) that specifies the header for this record. Sub-fields are further specified in the following table.

Field	Meaning
rh.recVer	MUST be 0x0.
rh.recInstance	MUST be 0x007.
rh.recType	MUST be RT_CString (section 2.13.24).
rh.recLen	MUST be an even number. It MUST be less than or equal to 510.

emailName (variable): A **PrintableUnicodeString** (section [2.2.23](#)) that specifies the e-mail name for audience feedback for the *corresponding presentation broadcast*. The length, in bytes, of the field is specified by **rh.recLen**.

2.4.17.9 BCChatUriAtom

Referenced by: [BroadcastDocInfo9Container](#)

An **atom record** that specifies the URL of a chat server for a **presentation broadcast**.

Let the *corresponding presentation broadcast* be specified by the BroadcastDocInfo9Container record that contains this **BCChatUriAtom** record.

0	1	2	3	4	5	6	7	8	9	10	11	12	13	14	15	16	17	18	19	20	21	22	23	24	25	26	27	28	29	30	31
rh																															
...																															
chatUrl (variable)																															
...																															

rh (8 bytes): A **RecordHeader** structure (section [2.3.1](#)) that specifies the header for this record. Sub-fields are further specified in the following table.

Field	Meaning
rh.recVer	MUST be 0x0.
rh.recInstance	MUST be 0x008.
rh.recType	MUST be RT_CString (section 2.13.24).
rh.recLen	MUST be an even number. It MUST be less than 4166.

chatUrl (variable): An [HttpUrl](#) that specifies the URL of a chat server for the corresponding presentation broadcast. The length, in bytes, of the field is specified by **rh.recLen**.

2.4.17.10 BCArchiveDirAtom

Referenced by: [BroadcastDocInfo9Container](#)

An **atom record** that specifies the directory location for archival storage of the **presentation broadcast**.

Let the *corresponding presentation broadcast* be specified by the BroadcastDocInfo9Container record that contains this **BCArchiveDirAtom** record.

0	1	2	3	4	5	6	7	8	9	10	1	2	3	4	5	6	7	8	9	20	1	2	3	4	5	6	7	8	9	30	1
rh																															
...																															
archiveDir (variable)																															
...																															

rh (8 bytes): A **RecordHeader** structure (section [2.3.1](#)) that specifies the header for this record. Sub-fields are further specified in the following table.

Field	Meaning
rh.recVer	MUST be 0x0.
rh.recInstance	MUST be 0x009.
rh.recType	MUST be RT_CString (section 2.13.24).
rh.recLen	MUST be an even number. It MUST be less than 510.

archiveDir (variable): A [UncOrLocalPath](#) that specifies the UNC directory location for archival storage of the *corresponding presentation broadcast*. The length, in bytes, of the field is specified by **rh.recLen**.

2.4.17.11 BCNetShowFilesBaseDirAtom

Referenced by: [BroadcastDocInfo9Container](#)

An **atom record** that specifies the UNC base directory to store **presentation broadcast** files for NetShow. For more information about NetShow, see [\[MSFT-UMWNSNS\]](#).

Let the *corresponding presentation broadcast* be specified by the BroadcastDocInfo9Container record that contains this **BCNetShowFilesBaseDirAtom** record.

0	1	2	3	4	5	6	7	8	9	10	1	2	3	4	5	6	7	8	9	20	1	2	3	4	5	6	7	8	9	30	1
rh																															
...																															
netShowFilesBaseDir (variable)																															
...																															

rh (8 bytes): A **RecordHeader** structure (section [2.3.1](#)) that specifies the header for this record. Sub-fields are further specified in the following table:

Field	Meaning
rh.recVer	MUST be 0x0.
rh.recInstance	MUST be 0x00A.
rh.recType	MUST be RT_CString (section 2.13.24).
rh.recLen	MUST be an even number. It MUST be less than 510.

netShowFilesBaseDir (variable): A [UncPath](#) that specifies the UNC base directory to store files for NetShow for the *corresponding presentation broadcast*. The length, in bytes, of the field is specified by **rh.recLen**.

2.4.17.12 BCNetShowFilesDirAtom

Referenced by: [BroadcastDocInfo9Container](#)

An **atom record** that specifies the UNC directory to store **presentation broadcast** files for NetShow. For more information about NetShow, see [\[MSFT-UMWNSNS\]](#).

Let the *corresponding presentation broadcast* be specified by the BroadcastDocInfo9Container record that contains this **BCNetShowFilesDirAtom** record.

0	1	2	3	4	5	6	7	8	9	10	11	12	13	14	15	16	17	18	19	20	21	22	23	24	25	26	27	28	29	30	31
rh																															
...																															
netShowFilesDir (variable)																															
...																															

rh (8 bytes): A **RecordHeader** structure (section [2.3.1](#)) that specifies the header for this record. Sub-fields are further specified in the following table.

Field	Meaning
rh.recVer	MUST be 0x0.
rh.recInstance	MUST be 0x00B.
rh.recType	MUST be RT_CString (section 2.13.24).
rh.recLen	MUST be an even number. It MUST be less than 494.

netShowFilesDir (variable): A [UncPath](#) that specifies the UNC directory to store files for NetShow for the *corresponding presentation broadcast*. The length, in bytes, of the field is specified by **rh.recLen**.

2.4.17.13 BCNetShowServerNameAtom

Referenced by: [BroadcastDocInfo9Container](#)

An **atom record** that specifies the name of the NetShow server to use for the **presentation broadcast**. For more information about NetShow, see [\[MSFT-UMWNSNS\]](#).

Let the *corresponding presentation broadcast* be specified by the BroadcastDocInfo9Container record that contains this **BCNetShowServerNameAtom** record.

0	1	2	3	4	5	6	7	8	9	10	11	12	13	14	15	16	17	18	19	20	21	22	23	24	25	26	27	28	29	30	31
rh																															
...																															
netShowServerName (variable)																															
...																															

rh (8 bytes): A **RecordHeader** structure (section [2.3.1](#)) that specifies the header for this record. Sub-fields are further specified in the following table.

Field	Meaning
rh.recVer	MUST be 0x0.
rh.recInstance	MUST be 0x00C.
rh.recType	MUST be RT_CString (section 2.13.24).
rh.recLen	MUST be an even number. It MUST be less than or equal to 510.

netShowServerName (variable): A [MachineName](#) that specifies the name of the NetShow server for the *corresponding presentation broadcast*. The length, in bytes, of the field is specified by **rh.recLen**.

2.4.17.14 BCPptFilesBaseDirAtom

Referenced by: [BroadcastDocInfo9Container](#)

An **atom record** that specifies the path to the UNC base directory to store **presentation broadcast** files.

Let the *corresponding presentation broadcast* be specified by the BroadcastDocInfo9Container record that contains this **BCPptFilesBaseDirAtom** record.

0	1	2	3	4	5	6	7	8	9	10	11	12	13	14	15	16	17	18	19	20	21	22	23	24	25	26	27	28	29	30	31
rh																															
...																															
pptFilesBaseDir (variable)																															
...																															

rh (8 bytes): A **RecordHeader** structure (section [2.3.1](#)) that specifies the header for this record. Sub-fields are further specified in the following table.

Field	Meaning
rh.recVer	MUST be 0x0.
rh.recInstance	MUST be 0x00D.
rh.recType	MUST be RT_CString (section 2.13.24).
rh.recLen	MUST be an even number. It MUST be less than 510.

pptFilesBaseDir (variable): A [UncPath](#) that specifies the path to the UNC base directory to store files for the *corresponding presentation broadcast*. The length, in bytes, of the field is specified by **rh.recLen**.

2.4.17.15 BCPptFilesDirAtom

Referenced by: [BroadcastDocInfo9Container](#)

An **atom record** that specifies the path to the UNC directory to store **presentation broadcast** files.

Let the *corresponding presentation broadcast* be specified by the BroadcastDocInfo9Container record that contains this **BCPptFilesDirAtom** record.

0	1	2	3	4	5	6	7	8	9	10	11	12	13	14	15	16	17	18	19	20	21	22	23	24	25	26	27	28	29	30	31
rh																															
...																															
pptFilesDir (variable)																															
...																															

rh (8 bytes): A **RecordHeader** structure (section [2.3.1](#)) that specifies the header for this record. Sub-fields are further specified in the following table.

Field	Meaning
rh.recVer	MUST be 0x0.
rh.recInstance	MUST be 0x00E.
rh.recType	MUST be RT_CString (section 2.13.24).
rh.recLen	MUST be an even number. It MUST be less than 494.

pptFilesDir (variable): A [UncPath](#) that specifies the path to the UNC directory to store files for the *corresponding presentation broadcast*. The length, in bytes, of the field is specified by **rh.recLen**.

2.4.17.16 BCPptFilesBaseUrlAtom

Referenced by: [BroadcastDocInfo9Container](#)

An **atom record** that specifies the location of the **presentation broadcast** files.

Let the *corresponding presentation broadcast* be specified by the BroadcastDocInfo9Container record that contains this **BCPptFilesBaseUrlAtom** record.

0	1	2	3	4	5	6	7	8	9	10	11	12	13	14	15	16	17	18	19	20	21	22	23	24	25	26	27	28	29	30	31
rh																															
...																															
pptFilesBaseUrl (variable)																															
...																															

rh (8 bytes): A RecordHeader structure (section [2.3.1](#)) that specifies the header for this record. Sub-fields are further specified in the following table.

Field	Meaning
rh.recVer	MUST be 0x0.
rh.recInstance	MUST be 0x00F.
rh.recType	MUST be RT_CString (section 2.13.24).
rh.recLen	MUST be an even number. It MUST be less than 4118.

pptFilesBaseUrl (variable): A UncPathOrHttpUrl that specifies the location of the files for the *corresponding presentation broadcast*. The length, in bytes, of the field is specified by **rh.recLen**.

2.4.17.17 BCUserNameAtom

Referenced by: [BroadcastDocInfo9Container](#)

An **atom record** that specifies the name of the user who scheduled the **presentation broadcast**.

Let the *corresponding presentation broadcast* be specified by the BroadcastDocInfo9Container record that contains this **BCUserNameAtom** record.

0	1	2	3	4	5	6	7	8	9	10	11	12	13	14	15	16	17	18	19	20	21	22	23	24	25	26	27	28	29	30	31
rh																															
...																															
userName (variable)																															
...																															

rh (8 bytes): A RecordHeader structure (section [2.3.1](#)) that specifies the header for this record. Sub-fields are further specified in the following table.

Field	Meaning
rh.recVer	MUST be 0x0.
rh.recInstance	MUST be 0x010.
rh.recType	MUST be RT_CString (section 2.13.24).
rh.recLen	MUST be an even number. It MUST be less than 510.

userName (variable): A [FileOrDirNameFragment](#) that specifies the name of the user who scheduled the *corresponding presentation broadcast*. The length, in bytes, of the field is specified by **rh.recLen**.

2.4.17.18 BCBroadcastDateTimeAtom

Referenced by: [BroadcastDocInfo9Container](#)

An **atom record** that specifies the directory name to create under the base directory of a **presentation broadcast**.

Let the *corresponding presentation broadcast* be specified by the BroadcastDocInfo9Container record that contains this **BCBroadcastDateTimeAtom** record.

0	1	2	3	4	5	6	7	8	9	10	11	12	13	14	15	16	17	18	19	20	21	22	23	24	25	26	27	28	29	30	31
rh																															
...																															
broadcastDateTime (variable)																															
...																															

rh (8 bytes): A **RecordHeader** structure (section [2.3.1](#)) that specifies the header for this record. Sub-fields are further specified in the following table.

Field	Meaning
rh.recVer	MUST be 0x0.
rh.recInstance	MUST be 0x011.
rh.recType	MUST be RT_CString (section 2.13.24).
rh.recLen	MUST be an even number. It MUST be less than 520.

broadcastDateTime (variable): A [FileOrDirNameFragment](#) that specifies the directory name to create under the base directory specified in the **bcPptFilesBaseDirAtom** field of the *corresponding presentation broadcast*. The length, in bytes, of the field is specified by **rh.recLen**.

2.4.17.19 BCPresentationNameAtom

Referenced by: [BroadcastDocInfo9Container](#)

An **atom record** that specifies the name of the presentation in a **presentation broadcast**.

Let the *corresponding presentation broadcast* be specified by the BroadcastDocInfo9Container record that contains this **BCPresentationNameAtom** record.

0	1	2	3	4	5	6	7	8	9	10	1	2	3	4	5	6	7	8	9	20	1	2	3	4	5	6	7	8	9	30	1
rh																															
...																															
presentationName (variable)																															
...																															

rh (8 bytes): A **RecordHeader** structure (section [2.3.1](#)) that specifies the header for this record. Sub-fields are further specified in the following table.

Field	Meaning
rh.recVer	MUST be 0x0.
rh.recInstance	MUST be 0x012.
rh.recType	MUST be RT_CString (section 2.13.24).
rh.recLen	MUST be an even number. It MUST be less than 510.

presentationName (variable): A [FileOrDirNameFragment](#) that specifies the name of the *corresponding presentation broadcast*. The length, in bytes, of the field is specified by **rh.recLen**.

2.4.17.20 BCAsdFileNameAtom

Referenced by: [BroadcastDocInfo9Container](#)

An **atom record** that specifies the location of an ASD file for a **presentation broadcast**. The ASD file is the description file for an Advanced Systems Format (ASF) file, described in [\[ASF\]](#), used to stream audio and video content.

Let the *corresponding presentation broadcast* be specified by the BroadcastDocInfo9Container record that contains this **BCAsdFileNameAtom** record.

0	1	2	3	4	5	6	7	8	9	10	1	2	3	4	5	6	7	8	9	20	1	2	3	4	5	6	7	8	9	30	1
rh																															
...																															
asdFileName (variable)																															
...																															

rh (8 bytes): A **RecordHeader** structure (section [2.3.1](#)) that specifies the header for this record. Sub-fields are further specified in the following table.

Field	Meaning
rh.recVer	MUST be 0x0.
rh.recInstance	MUST be 0x013.
rh.recType	MUST be RT_CString (section 2.13.24).
rh.recLen	MUST be an even number. It MUST be less than 520.

asdFileName (variable): A [UncPath](#) that specifies the location of an ASD file for the corresponding presentation broadcast. The length, in bytes, of the field is specified by **rh.recLen**.

2.4.17.21 BEntryIDAtom

Referenced by: [BroadcastDocInfo9Container](#)

An **atom record** that specifies the identifier for a calendar item to associate with this **presentation broadcast**.

Let the *corresponding presentation broadcast* be specified by the BroadcastDocInfo9Container record that contains this **BEntryIDAtom** record.

0	1	2	3	4	5	6	7	8	9	10	11	12	13	14	15	16	17	18	19	20	21	22	23	24	25	26	27	28	29	30	31
rh																															
...																															
entryId (variable)																															
...																															

rh (8 bytes): A **RecordHeader** structure (section [2.3.1](#)) that specifies the header for this record. Sub-fields are further specified in the following table.

Field	Meaning
rh.recVer	MUST be 0x0.
rh.recInstance	MUST be 0x014.
rh.recType	MUST be RT_CString (section 2.13.24).
rh.recLen	MUST be an even number.

entryId (variable): A [UnicodeString](#) that specifies the calendar item identifier for the *corresponding presentation broadcast*. The length, in bytes, of the field is specified by **rh.recLen**.

2.4.17.22 BroadcastDocInfoAtom

Referenced by: [BroadcastDocInfo9Container](#)

An **atom record** that specifies properties of a **presentation broadcast**.

Let the *corresponding presentation broadcast* be specified by the BroadcastDocInfo9Container record that contains this **BroadcastDocInfoAtom** record.

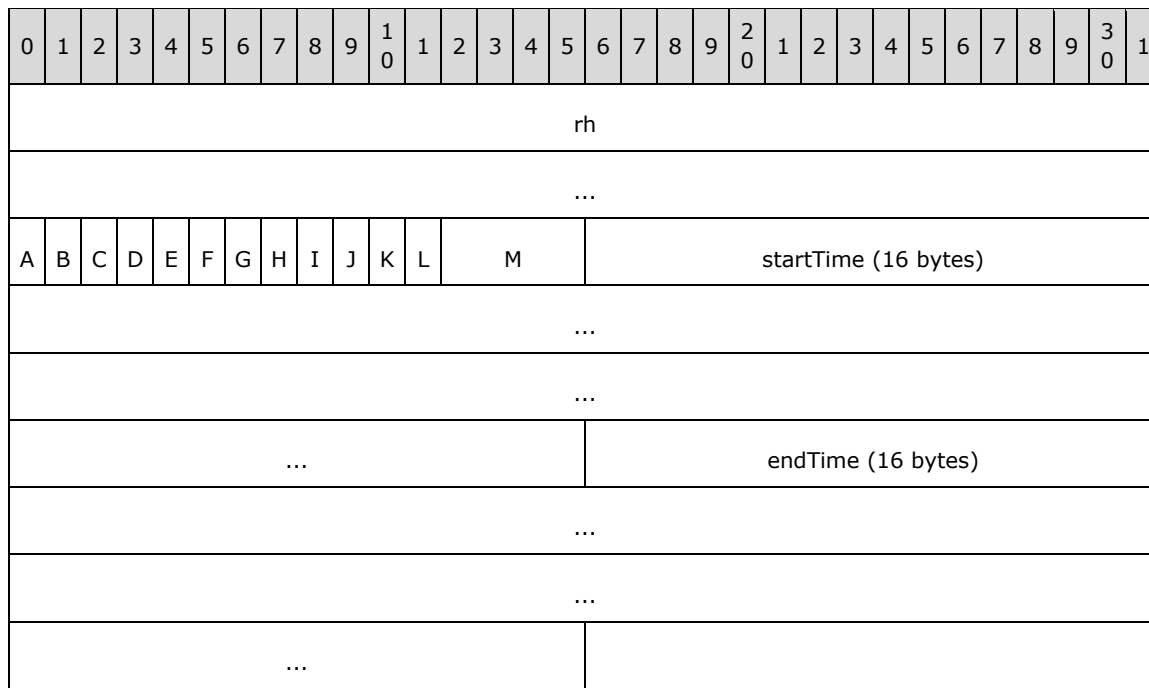

rh (8 bytes): A **RecordHeader** structure (section [2.3.1](#)) that specifies the header for this record. Sub-fields are further specified in the following table.

Field	Meaning
rh.recVer	MUST be 0x0.
rh.recInstance	MUST be 0x000.
rh.recType	MUST be RT_BroadcastDocInfo9Atom .
rh.recLen	MUST be 0x00000022.

A - fSendAudio (1 bit): A bit that specifies whether to include an audio stream.

B - fSendVideo (1 bit): A bit that specifies whether to include a video stream.

C - fCameraRemote (1 bit): A bit that specifies whether the camera is located on a computer other than the computer giving the *corresponding presentation broadcast*.

D - fUseNetShow (1 bit): A bit that specifies whether to use NetShow server technology described in [\[MSFT-UMWNSNS\]](#).

E - fUseOtherServer (1 bit): A bit that specifies whether to use a third-party server for the *corresponding presentation broadcast*.

F - fCanEmail (1 bit): A bit that specifies whether an e-mail address is provided to the audience.

G - fCanChat (1 bit): A bit that specifies whether a chat URL is provided to the audience.

H - fDoArchive (1 bit): A bit that specifies whether the *corresponding presentation broadcast* is archived.

I - fSpeakerNotes (1 bit): A bit that specifies whether the audience can see the speaker notes.

J - fQuarterScreen (1 bit): A bit that specifies whether the **slide show** is displayed to the presenter in a resizable window.

K - fShowTools (1 bit): A **bit** that specifies whether to show speaker notes to the presenter.

L - fRecordOnly (1 bit): A bit that specifies whether the *corresponding presentation broadcast* is for recording only.

M - reserved (4 bits): MUST be zero and MUST be ignored.

startTime (16 bytes): A [DateTimeStruct](#) structure that specifies the time the corresponding presentation broadcast is scheduled to begin.

endTime (16 bytes): A [DateTimeStruct](#) structure that specifies the time the corresponding presentation broadcast is scheduled to end.

2.4.18 HTML Publish Types

2.4.18.1 HTMLDocInfo9Atom

Referenced by: [PP9DocBinaryTagExtension](#)

An **atom record** that specifies settings for how to publish a document as a Web page.

0	1	2	3	4	5	6	7	8	9	10	11	12	13	14	15	16	17	18	19	20	21	22	23	24	25	26	27	28	29	30	31								
rh																																							
...																																							
unused1																																							
encoding																																							
frameColorType																screenSize								unused2															
outputType								A	B	C	D	E	F	G	H	unused3																							

rh (8 bytes): A **RecordHeader** structure (section [2.3.1](#)) that specifies the header for this record. Sub-fields are further specified in the following table.

Field	Meaning
rh.recVer	MUST be 0x0.
rh.recInstance	MUST be 0x000.
rh.recType	MUST be RT_HTMLDocInfo9Atom .
rh.recLen	MUST be 0x00000010.

unused1 (4 bytes): Undefined and MUST be ignored.

encoding (4 bytes): An unsigned integer that specifies the **code page** for character encoding used by the Web page. See [\[MSDN-CP\]](#) for a list of possible code pages.

frameColorType (2 bytes): A [WebFrameColorsEnum](#) enumeration that specifies color options for displaying the text and background for the Web page notes pane and outline pane.

screenSize (1 byte): A **WebScreenSizeEnum** as specified in [\[MS-OSHARED\]](#) section 2.2.1.4 that specifies the document window size for the monitor on which the Web page is displayed.

unused2 (1 byte): Undefined and MUST be ignored.

outputType (1 byte): A **WebOutputEnum** enumeration that specifies the Web browser support that this publication ought to be optimized for.

A - fShowFrame (1 bit): A bit that specifies whether to include the notes pane and outline pane representation in the Web page.

B - fResizeGraphics (1 bit): A bit that specifies whether the graphics in the Web page are resizable.

C - fOrganizeInFolder (1 bit): A bit that specifies whether any additional files created to represent Web page content in a Web browser are stored in a separate folder.

D - fUseLongFileNames (1 bit): A bit that specifies whether a file name longer than eight characters is valid.

E - fRelyOnVML (1 bit): A bit that specifies whether the Web page requires **Vector Markup Language (VML)** to display in a Web browser.

F - fAllowPNG (1 bit): A bit that specifies whether to save pictures supporting the Web page using **Portable Network Graphics (PNG)** format.

G - fShowSlideAnimation (1 bit): A bit that specifies whether the Web page contains object animation and slide transition effect information.

H - reserved (1 bit): MUST be zero and MUST be ignored.

unused3 (2 bytes): Undefined and MUST be ignored.

2.4.18.2 HTMLPublishInfo9Container

Referenced by: [PP9DocBinaryTagExtension](#)

A **container record** that specifies additional information for how to publish a document as a Web page.

0	1	2	3	4	5	6	7	8	9	10	11	12	13	14	15	16	17	18	19	20	21	22	23	24	25	26	27	28	29	30	31
rh																															
...																															
fileNameAtom (variable)																															
...																															
namedShowAtom (variable)																															
...																															
htmlPublishInfoAtom (20 bytes)																															
...																															

...

rh (8 bytes): A **RecordHeader** structure (section [2.3.1](#)) that specifies the header for this record. Sub-fields are further specified in the following table.

Field	Meaning
rh.recVer	MUST be 0xF.
rh.recInstance	MUST be 0x000.
rh.recType	MUST be RT_HTMLPublishInfo9 .

fileNameAtom (variable): A [FileNameAtom](#) record that specifies the file name.

namedShowAtom (variable): An optional [NamedShowAtom](#) record that specifies the **named show** being published. It MUST exist if the **htmlPublishInfoAtom.fUseNamedShowX** field is set to **TRUE**.

htmlPublishInfoAtom (20 bytes): A [HTMLPublishInfoAtom](#) record that specifies the settings for publishing the document.

2.4.18.3 FileNameAtom

Referenced by: [HTMLPublishInfo9Container](#)

An **atom record** that specifies the file name of the Web page being published.

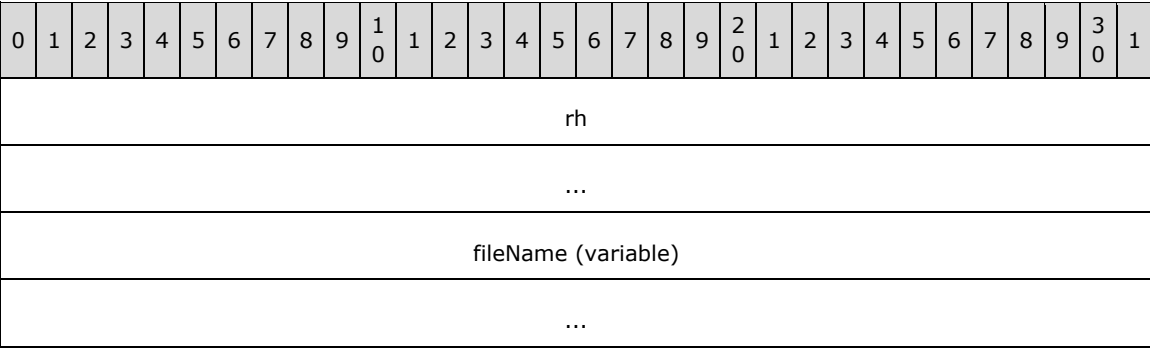

rh (8 bytes): A **RecordHeader** structure (section [2.3.1](#)) that specifies the header for this record. Sub-fields are further specified in the following table.

Field	Meaning
rh.recVer	MUST be 0x0.
rh.recInstance	MUST be 0x000.
rh.recType	MUST be RT_CString (section 2.13.24).
rh.recLen	MUST be an even number. It MUST be less than or equal to 510.

fileName (variable): A **PrintableUnicodeString** (section [2.2.23](#)) that specifies a local path, a **UNC** path, or a URI (specified in [RFC3986](#)) with the HTTP or FTP scheme. The length, in bytes, of the field is specified by **rh.recLen**. See [MSDN-FILE](#) for more information about file naming.

2.4.18.4 NamedShowAtom

Referenced by: [HTMLPublishInfo9Container](#)

An **atom record** that specifies the name of a **named show** that is published to a Web page.

0	1	2	3	4	5	6	7	8	9	10	11	12	13	14	15	16	17	18	19	20	21	22	23	24	25	26	27	28	29	30	31
rh																															
...																															
namedShow (variable)																															
...																															

rh (8 bytes): A **RecordHeader** structure (section [2.3.1](#)) that specifies the header for this record. Sub-fields are further specified in the following table.

Field	Meaning
rh.recVer	MUST be 0x0.
rh.recInstance	MUST be 0x001.
rh.recType	MUST be RT_CString (section 2.13.24).
rh.recLen	MUST be an even number. It MUST be less than or equal to 62.

namedShow (variable): A **PrintableUnicodeString** (section [2.2.23](#)) that specifies the named show to publish. It MUST be the same as the value of the **namedShowName** field of a [NamedShowNameAtom](#) record. The length, in bytes, of the field is specified by **rh.recLen**.

2.4.18.5 HTMLPublishInfoAtom

Referenced by: [HTMLPublishInfo9Container](#)

An **atom record** that specifies the settings to publish the document to a Web page.

0	1	2	3	4	5	6	7	8	9	10	11	12	13	14	15	16	17	18	19	20	21	22	23	24	25	26	27	28	29	30	31				
rh																																			
...																																			
startSlide																																			
endSlide																																			
outputType								A	B	C	D	E								unused															

rh (8 bytes): A **RecordHeader** structure (section [2.3.1](#)) that specifies the header for this record. Sub-fields are further specified in the following table.

Field	Meaning
rh.recVer	MUST be 0x0.
rh.recInstance	MUST be 0x000.
rh.recType	MUST be RT_HTMLPublishInfoAtom .
rh.recLen	MUST be 0x0000000C.

startSlide (4 bytes): A signed integer that specifies the first slide in the range of slides to publish. It MUST be greater than or equal to zero.

endSlide (4 bytes): A signed integer that specifies the last slide in the range of slides to publish. It MUST be greater than or equal to zero.

outputType (1 byte): A [WebOutputEnum](#) enumeration that specifies the Web browser support that this publication ought to be optimized for.

A - fUseSlideRangeX (1 bit): A bit that specifies whether to publish the range of slides defined by **startSlide** and **endSlide**.

B - fUseNamedShowX (1 bit): A bit that specifies whether to publish the slides defined by the **namedShowAtom** field of the [HTMLPublishInfo9Container](#) record that contains this [HTMLPublishInfoAtom](#) record.

C - fLoadInBrowserX (1 bit): A bit that specifies whether to automatically display the Web page in the Web browser.

D - fShowSpeakerNote (1 bit): A bit that specifies whether to display the notes pane when viewing the Web page in a Web browser.

E - reserved (4 bits): MUST be zero and MUST be ignored.

unused (2 bytes): Undefined and MUST be ignored.

2.4.19 Comment Author Types

2.4.19.1 CommentIndex10Container

Referenced by: [PP10DocBinaryTagExtension](#)

A **container record** that specifies information for an author who creates a **presentation comment**.

0	1	2	3	4	5	6	7	8	9	10	11	12	13	14	15	16	17	18	19	20	21	22	23	24	25	26	27	28	29	30	31
rh																															
...																															
authorNameAtom (variable)																															
...																															
authorIndexAtom (16 bytes, optional)																															

...
...

rh (8 bytes): A **RecordHeader** structure (section [2.3.1](#)) that specifies the header for this record. Sub-fields are further specified in the following table.

Field	Meaning
rh.recVer	MUST be 0xF.
rh.recInstance	MUST be 0x000.
rh.recType	MUST be RT_CommentIndex10 .

authorNameAtom (variable): An optional [AuthorNameAtom](#) record that specifies the name of the author.

authorIndexAtom (16 bytes): An optional [CommentIndex10Atom](#) record that specifies an index for deriving a color for the author's presentation comments and an index for the last presentation comment created by the author.

2.4.19.2 AuthorNameAtom

Referenced by: [CommentIndex10Container](#)

An **atom record** that specifies the name of the author who created a **presentation comment**.

0	1	2	3	4	5	6	7	8	9	10	11	12	13	14	15	16	17	18	19	20	21	22	23	24	25	26	27	28	29	30	31
rh																															
...																															
authorName (variable)																															
...																															

rh (8 bytes): A **RecordHeader** structure (section [2.3.1](#)) that specifies the header for this record. Sub-fields are further specified in the following table.

Field	Meaning
rh.recVer	MUST be 0x0.
rh.recInstance	MUST be 0x000.
rh.recType	MUST be RT_CString .
rh.recLen	MUST be an even number. It MUST be less than or equal to 104.

authorName (variable): A **PrintableUnicodeString** (section [2.2.23](#)) that specifies the name of the author. The length, in bytes, of the field is specified by **rh.recLen**.

2.4.19.3 CommentIndex10Atom

Referenced by: [CommentIndex10Container](#)

An **atom record** that specifies an index for deriving a color used to display the author's **presentation comments** and an index for the last presentation comment created by the author.

0	1	2	3	4	5	6	7	8	9	10	1	2	3	4	5	6	7	8	9	20	1	2	3	4	5	6	7	8	9	30	1
rh																															
...																															
colorIndex																															
commentIndexSeed																															

rh (8 bytes): A **RecordHeader** structure (section [2.3.1](#)) that specifies the header for this record. Sub-fields are further specified in the following table.

Field	Meaning
rh.recVer	MUST be 0x0.
rh.recInstance	MUST be 0x000.
rh.recType	MUST be RT_CommentIndex10Atom .
rh.recLen	MUST be 0x00000008.

colorIndex (4 bytes): A signed integer that specifies a zero-based index into the list of colors defined by the rendering application used for displaying the presentation comments created by the author. It MUST be greater than or equal to 0x00000000.

commentIndexSeed (4 bytes): A signed integer that specifies a **seed** for creating a new index for a presentation comment created by the author. It MUST be greater than or equal to 0x00000000 and MUST be greater than or equal to the value of the **commentAtom.index** field of all [Comment10Container](#) records, where the author name specified by the **commentAuthorAtom** field of the Comment10Container record matches the author name specified by the **authorNameAtom** field of the CommentIndex10Container record that contains this **CommentIndex10Atom** record.

2.4.20 Document Comparison Types

2.4.20.1 DocToolbarStates10Atom

Referenced by: [PP10DocBinaryTagExtension](#)

An **atom record** that specifies the display options for a reviewing toolbar that has controls that manage **presentation comments** and the information contained by the [DiffTree10Container](#) records and a reviewing gallery that displays the information contained by the DiffTree10Container records.

0	1	2	3	4	5	6	7	8	9	10	1	2	3	4	5	6	7	8	9	20	1	2	3	4	5	6	7	8	9	30	1
rh																															

...		
A	B	reserved

rh (8 bytes): A **RecordHeader** structure (section [2.3.1](#)) that specifies the header for this record. Sub-fields are further specified in the following table.

Field	Meaning
rh.recVer	MUST be 0x0.
rh.recInstance	MUST be 0x000.
rh.recType	MUST be RT_DocToolBarStates10Atom .
rh.recLen	MUST be 0x00000001.

A - fShowReviewingToolBar (1 bit): A bit that specifies whether to display the reviewing toolbar.

B - fShowReviewingGallery (1 bit): A bit that specifies whether to display the reviewing gallery.

reserved (6 bits): MUST be zero and MUST be ignored.

2.4.20.2 SlideListTable10Container

Referenced by: [PP10DocBinaryTagExtension](#)

A **container record** that specifies information about **presentation slides** contained in the document that also contains this **SlideListTable10Container** record.

0	1	2	3	4	5	6	7	8	9	10	11	12	13	14	15	16	17	18	19	20	21	22	23	24	25	26	27	28	29	30	31
rh																															
...																															
slideListTableSizeAtom																															
...																															
...																															
rgSlideListEntryAtom (variable)																															
...																															

rh (8 bytes): A **RecordHeader** structure (section [2.3.1](#)) that specifies the header for this record. Sub-fields are further specified in the following table.

Field	Meaning
rh.recVer	MUST be 0xF.
rh.recInstance	MUST be 0x000.
rh.recType	MUST be RT_SlideListTable10 .

slideListTableSizeAtom (12 bytes): A [SlideListTableSize10Atom](#) record that specifies the number of [SlideListEntry10Atom](#) records in the **rgSlideListEntryAtom** field.

rgSlideListEntryAtom (variable): An array of [SlideListEntry10Atom](#) records that specifies the creation time of the presentation slides in the document. The count of items in the array is specified by the **slideListTableSizeAtom.count** field.

2.4.20.3 SlideListTableSize10Atom

Referenced by: [SlideListTable10Container](#)

An **atom record** that specifies the count of the [SlideListEntry10Atom](#) records that are contained within the [SlideListTable10Container](#) record that contains this **SlideListTableSize10Atom** record.

0	1	2	3	4	5	6	7	8	9	10	11	12	13	14	15	16	17	18	19	20	21	22	23	24	25	26	27	28	29	30	31
rh																															
...																															
count																															

rh (8 bytes): A **RecordHeader** structure (section [2.3.1](#)) that specifies the header for this record. Sub-fields are further specified in the following table.

Field	Meaning
rh.recVer	MUST be 0x0.
rh.recInstance	MUST be 0x000.
rh.recType	MUST be RT_SlideListTableSize10Atom .
rh.recLen	MUST be 0x00000004.

count (4 bytes): A signed integer that specifies the count of the **rgSlideListEntryAtom** field of the [SlideListTable10Container](#) record that contains this **SlideListTableSize10Atom** record. It MUST be greater than or equal to 0x00000000 and MUST be less than or equal to 0x000F4240.

2.4.20.4 SlideListEntry10Atom

Referenced by: [SlideListTable10Container](#)

An **atom record** that specifies the creation time of a **presentation slide** in the document that contains this **SlideListEntry10Atom** record.

0	1	2	3	4	5	6	7	8	9	10	11	12	13	14	15	16	17	18	19	20	21	22	23	24	25	26	27	28	29	30	31
rh																															
...																															
slideIdRef																															

dwHighDateTime
dwLowDateTime

rh (8 bytes): A **RecordHeader** structure (section [2.3.1](#)) that specifies the header for this record. Sub-fields are further specified in the following table.

Field	Meaning
rh.recVer	MUST be 0x0.
rh.recInstance	MUST be 0x000.
rh.recType	MUST be RT_SlideListEntry10Atom .
rh.recLen	MUST be 0x0000000C.

slideIdRef (4 bytes): A **SlideIdRef** (section [2.2.25](#)) that specifies the presentation slide. Its creation time is specified by the **dwHighDateTime** and **dwLowDateTime** fields of this SlideListEntry10Atom record.

dwHighDateTime (4 bytes): An unsigned integer that specifies the high-order part of the file time, as specified in [\[MS-DTYP\]](#) section [2.3.3](#).

dwLowDateTime (4 bytes): An unsigned integer that specifies the low-order part of the file time, as specified in [\[MS-DTYP\]](#) section [2.3.3](#).

2.4.20.5 DiffTree10Container

Referenced by: [PP10DocBinaryTagExtension](#)

A **container record** that specifies the name of a reviewer and how to display the changes to the document made by that reviewer.

Let the *corresponding main master slide* be specified by the **MainMasterContainer** record (section [2.5.3](#)) that is specified by the first **MasterPersistAtom** record (section [2.4.14.2](#)) in the **MasterListWithTextContainer** record (section [2.4.14.1](#)).

Let the *corresponding shape* be specified by the **OfficeArtSpContainer** record ([\[MS-ODRAW\]](#) section 2.2.14) such that the **wzName_complex** property ([\[MS-ODRAW\]](#) section 2.3.4.2) matches the string "Reviewer". The *corresponding shape* is contained by the **drawing** field of the *corresponding main master slide*.

Let the *corresponding OLE object* be specified by the **ExOleEmbedContainer** record (section [2.10.27](#)) whose **exOleObjAtom.exObjId** field matches the **exObjIdRef** field of the [ExObjRefAtom](#) record that is contained by the *corresponding shape*.

Let the *corresponding reviewer document* be specified by the *corresponding OLE object*.

0	1	2	3	4	5	6	7	8	9	10	1	2	3	4	5	6	7	8	9	20	1	2	3	4	5	6	7	8	9	30	1		
rh																																	
...																																	
reviewerNameAtom (variable)																																	

...
docDiff (variable)
...

rh (8 bytes): A **RecordHeader** structure (section [2.3.1](#)) that specifies the header for this record. Sub-fields are further specified in the following table.

Field	Meaning
rh.recVer	MUST be 0xF.
rh.recInstance	MUST be 0x000.
rh.recType	MUST be RT_DiffTree10 .

reviewerNameAtom (variable): A [ReviewerNameAtom](#) record that specifies the name of the reviewer who made the changes to the *corresponding reviewer document*.

docDiff (variable): A [DocDiff10Container](#) record that specifies how to display the changes made by the reviewer to the *corresponding reviewer document*.

2.4.20.6 ReviewerNameAtom

Referenced by: [DiffTree10Container](#)

An **atom record** that specifies the name of the reviewer who made changes to a copy of the document that was later merged into this document.

The name of the reviewer MUST be the value of the **GKPIDSI_AUTHOR** property ([\[MS-OSHARED\]](#) section 2.3.3.2.1.1) of the **Summary Info Stream** (section [2.1.4](#)) specified in the *corresponding reviewer document*.

Let the *corresponding reviewer document* be as specified in the [DiffTree10Container](#) record that contains this **ReviewerNameAtom** record.

0	1	2	3	4	5	6	7	8	9	10	1	2	3	4	5	6	7	8	9	20	1	2	3	4	5	6	7	8	9	30	1
rh																															
...																															
reviewerName (variable)																															
...																															

rh (8 bytes): A **RecordHeader** structure (section [2.3.1](#)) that specifies the header for this record. Sub-fields are further specified in the following table.

Field	Meaning
rh.recVer	MUST be 0x0.
rh.recInstance	MUST be 0x000.
rh.recType	MUST be RT_CString (section 2.13.24).

Field	Meaning
rh.recLen	MUST be an even number. It MUST be less than or equal to 104.

reviewerName (variable): A **PrintableUnicodeString** (section [2.2.23](#)) that specifies the name of the reviewer. The length, in bytes, of the field is specified by **rh.recLen**.

2.4.20.7 DiffRecordHeaders

Referenced by: [DocDiff10Container](#), [ExternalObjectDiffContainer](#), [HeaderFooterDiffContainer](#), [InteractiveInfoDiffContainer](#), [MainMasterDiffContainer](#), [MasterListDiffContainer](#), [NamedShowDiffContainer](#), [NamedShowListDiffContainer](#), [NotesDiffContainer](#), [RecolorInfoDiffContainer](#), [ShapeDiffContainer](#), [ShapeListDiffContainer](#), [SlideDiffContainer](#), [SlideListDiffContainer](#), [SlideShowDiffContainer](#), [TableDiffContainer](#), [TableListDiffContainer](#), [TextDiffContainer](#)

A structure at the beginning of each **container record**, when that container record is used to specify how to display the changes to a document made by a reviewer.

Let the *corresponding reviewer document* be as specified in the [DiffTree10Container](#) record that contains this **DiffRecordHeaders** record.

0	1	2	3	4	5	6	7	8	9	10	11	12	13	14	15	16	17	18	19	20	21	22	23	24	25	26	27	28	29	30	31
rh																															
...																															
rhAtom																															
...																															
fIndex								unused1								unused2								unused3							
gmiTag																															
unused4																															

rh (8 bytes): A **RecordHeader** structure (section [2.3.1](#)) that specifies the header for the container record. Sub-fields are further specified in the following table.

Field	Meaning
rh.recVer	MUST be 0xF.
rh.recInstance	MUST be 0x000.
rh.recType	MUST be RT_Diff10 .

rhAtom (8 bytes): A **RecordHeader** structure (section [2.3.1](#)) that specifies a header for the **atom record** that specifies how the changes made by the reviewer are displayed. Sub-fields are further specified in the following table.

Field	Meaning
rhAtom.recVer	MUST be 0x0.
rhAtom.recInstance	MUST be 0x000.
rhAtom.recType	MUST be RT_Diff10Atom.
rhAtom.recLen	MUST be 0x0000000C.

fIndex (1 byte): A **bool1** (section [2.2.2](#)) that specifies instance data. Interpretation of the value is dependent on **gmiTag**.

unused1 (1 byte): Undefined and MUST be ignored.

unused2 (1 byte): Undefined and MUST be ignored.

unused3 (1 byte): Undefined and MUST be ignored.

gmiTag (4 bytes): A **DiffTypeEnum** enumeration that identifies the type of changes made by the reviewer.

unused4 (4 bytes): Undefined and MUST be ignored.

2.4.20.8 DocDiff10Container

Referenced by: [DiffTree10Container](#)

A **container record** that specifies how to display document-level changes made by the reviewer.

Let the *corresponding reviewer document* be as specified in the DiffTree10Container record that contains this **DocDiff10Container** record.

0	1	2	3	4	5	6	7	8	9	10	11	12	13	14	15	16	17	18	19	20	21	22	23	24	25	26	27	28	29	30	31
rhs (28 bytes)																															
...																															
...																															
A	B	C	D	E	F	reserved2																									
slideHFDiff (32 bytes, optional)																															
...																															
...																															
notesHFDiff (32 bytes, optional)																															
...																															
...																															

namedShowListDiff (variable)
...
masterListDiff (variable)
...
slideListDiff (variable)
...

rhs (28 bytes): A [DiffRecordHeaders](#) structure that specifies the header for the container record. Sub-fields are further specified in the following table.

Field	Meaning
rhs.fIndex	MUST be 0x00.
rhs.gmiTag	MUST be Diff_DocDiff .

A - reserved1 (2 bits): MUST be zero and MUST be ignored.

B - slideSize (1 bit): A bit that specifies whether the change made by the reviewer in the *corresponding reviewer document* to the **slideSize** field of the **DocumentAtom** record (section [2.4.2](#)) is not displayed.

C - omitTitlePlace (1 bit): A bit that specifies whether the change made by the reviewer in the *corresponding reviewer document* to the **fOmitTitlePlace** field of the **DocumentAtom** record is not displayed.

D - namedShowList (1 bit): A bit that specifies whether the changes made by the reviewer in the *corresponding reviewer document* to any [NamedShowContainer](#) record in the **NamedShowsContainer** record (section [2.6.2](#)) are not displayed.

E - slideHeaderFooter (1 bit): A bit that specifies whether the changes made by the reviewer in the *corresponding reviewer document* to the **SlideHeadersFootersContainer** record (section [2.4.15.1](#)) are not displayed.

F - notesHeaderFooter (1 bit): A bit that specifies whether the changes made by the reviewer in the *corresponding reviewer document* to the **NotesHeadersFootersContainer** record (section [2.4.15.6](#)) are not displayed.

reserved2 (25 bits): MUST be zero and MUST be ignored.

slideHFDiff (32 bytes): An optional [HeaderFooterDiffContainer](#) record that specifies how to display the changes made by the reviewer in the *corresponding reviewer document* to the **SlideHeadersFootersContainer** record.

notesHFDiff (32 bytes): An optional [HeaderFooterDiffContainer](#) record that specifies how to display the changes made by the reviewer in the *corresponding reviewer document* to the **NotesHeadersFootersContainer** record.

namedShowListDiff (variable): An optional [NamedShowListDiffContainer](#) record that specifies how to display the changes made by the reviewer in the *corresponding reviewer document* to each **NamedShowContainer** record in the **NamedShowsContainer** record.

masterListDiff (variable): An optional [MasterListDiffContainer](#) record that specifies how to display the changes made by the reviewer in the *corresponding reviewer document* to each **MasterPersistAtom** record (section [2.4.14.2](#)) in the **MasterListWithTextContainer** record (section [2.4.14.1](#)).

slideListDiff (variable): An optional [SlideListDiffContainer](#) record that contains records that specify how to display the changes made by the reviewer in the *corresponding reviewer document* to each **SlidePersistAtom** record (section [2.4.14.5](#)) in the **SlideListWithTextContainer** record (section [2.4.14.3](#)).

2.4.20.9 HeaderFooterDiffContainer

Referenced by: [DocDiff10Container](#), [SlideDiffContainer](#)

A **container record** that specifies how to display the changes made by the reviewer to the **SlideHeadersFootersContainer** (section [2.4.15.1](#)), **NotesHeadersFootersContainer** (section [2.4.15.6](#)), or [PerSlideHeadersFootersContainer](#) record.

Let the *corresponding reviewer document* be as specified in the [DiffTree10Container](#) record that contains this **HeaderFooterDiffContainer** record.

Let the *corresponding slide* be as specified in the [SlideDiffContainer](#) record that contains this **HeaderFooterDiffContainer** record.

0	1	2	3	4	5	6	7	8	9	10	11	12	13	14	15	16	17	18	19	20	21	22	23	24	25	26	27	28	29	30	31
rhs (28 bytes)																															
...																															
...																															
reserved																															

rhs (28 bytes): A [DiffRecordHeaders](#) structure that specifies the header for the container record. Sub-fields are further specified in the following table.

Field	Meaning
rhs.fIndex	The value 0x00 specifies display information for the changes made in the <i>corresponding reviewer document</i> to the NotesHeadersFootersContainer record (section 2.4.15.6). The value 0x01 specifies display information for the changes made in the <i>corresponding reviewer document</i> to the SlideHeadersFootersContainer record or to the PerSlideHeadersFootersContainer record in the <i>corresponding slide</i> .
rhs.gmiTag	MUST be Diff_HeaderFooterDiff .

reserved (32 bits): MUST be zero and MUST be ignored.

2.4.20.10 NamedShowListDiffContainer

Referenced by: [DocDiff10Container](#)

A **container record** that specifies how to display the changes made by the reviewer to the **NamedShowsContainer** record (section [2.6.2](#)).

Let the *corresponding reviewer document* be as specified in the [DiffTree10Container](#) record that contains this **NamedShowListDiffContainer** record.

0	1	2	3	4	5	6	7	8	9	10	11	12	13	14	15	16	17	18	19	20	21	22	23	24	25	26	27	28	29	30	31
rhs (28 bytes)																															
...																															
...																															
reserved																															
rgNamedShowDiff (variable)																															
...																															

rhs (28 bytes): A [DiffRecordHeaders](#) structure that specifies the header for the container record. Sub-fields are further specified in the following table.

Field	Meaning
rhs.fIndex	MUST be 0x00.
rhs.gmiTag	MUST be Diff_NamedShowListDiff .

reserved (32 bits): MUST be zero and MUST be ignored.

rgNamedShowDiff (variable): An array of [NamedShowDiffContainer](#) records that specifies how to display changes made by the reviewer in the *corresponding reviewer document* to the **named shows**. The size, in bytes, of the array is specified by the following formula:

$$\text{rhs.rh.recLen} - \text{rhs.rhAtom.recLen} - 8$$

2.4.20.11 NamedShowDiffContainer

Referenced by: [NamedShowListDiffContainer](#)

A **container record** that specifies how to display the changes made by the reviewer to a [NamedShowContainer](#) record.

Let the *corresponding reviewer document* be as specified in the [DiffTree10Container](#) record that contains this **NamedShowDiffContainer** record.

The i^{th} **NamedShowDiffContainer** record in its parent **NamedShowListDiffContainer** record specifies how to display changes made to the i^{th} **NamedShowContainer** record in its parent **NamedShowsContainer** record (section [2.6.2](#)) in the *corresponding reviewer document*.

0	1	2	3	4	5	6	7	8	9	10	11	12	13	14	15	16	17	18	19	20	21	22	23	24	25	26	27	28	29	30	31
rhs (28 bytes)																															
...																															
...																															
reserved																															

rhs (28 bytes): A [DiffRecordHeaders](#) structure that specifies the header for the container record. Sub-fields are further specified in the following table.

Field	Meaning
rhs.fIndex	MUST be 0x00.
rhs.gmiTag	MUST be Diff_NamedShowDiff .

reserved (32 bits): MUST be zero and MUST be ignored.

2.4.20.12 SlideListDiffContainer

Referenced by: [DocDiff10Container](#)

A **container record** that specifies how to display the changes made by the reviewer to the **SlideListWithTextContainer** record (section [2.4.14.3](#)).

Let the *corresponding reviewer document* be as specified in the [DiffTree10Container](#) record that contains this **SlideListDiffContainer** record.

0	1	2	3	4	5	6	7	8	9	10	11	12	13	14	15	16	17	18	19	20	21	22	23	24	25	26	27	28	29	30	31
rhs (28 bytes)																															
...																															
...																															
reserved																															
rgSlideDiff (variable)																															
...																															

rhs (28 bytes): A [DiffRecordHeaders](#) structure that specifies the header for the container record. Sub-fields are further specified in the following table.

Field	Meaning
rhs.fIndex	MUST be 0x00.
rhs.gmiTag	MUST be Diff_SlideListDiff .

reserved (32 bits): MUST be zero and MUST be ignored.

rgSlideDiff (variable): An array of [SlideDiffContainer](#) records that specifies how to display changes made by the reviewer in the *corresponding reviewer document* to the **SlideListWithTextContainer** record (section 2.4.14.3). The size, in bytes, of the array is specified by the following formula:

$$\text{rhs.rh.recLen} - \text{rhs.rhAtom.recLen} - 8$$

2.4.20.13 MasterListDiffContainer

Referenced by: [DocDiff10Container](#)

A **container record** that specifies how to display the changes made by the reviewer to the **MasterListWithTextContainer** record (section [2.4.14.1](#)).

Let the *corresponding reviewer document* be as specified in the [DiffTree10Container](#) record that contains this **MasterListDiffContainer** record.

0	1	2	3	4	5	6	7	8	9	10	1	2	3	4	5	6	7	8	9	20	1	2	3	4	5	6	7	8	9	30	1
rhs (28 bytes)																															
...																															
...																															
reserved																															
rgChildRec (variable)																															
...																															

rhs (28 bytes): A [DiffRecordHeaders](#) structure that specifies the header for the container record. Sub-fields are further specified in the following table.

Field	Meaning
rhs.fIndex	MUST be 0x00.
rhs.gmiTag	MUST be Diff MasterListDiff .

reserved (32 bits): MUST be zero and MUST be ignored.

rgChildRec (variable): An array of [MasterListDiff10ChildContainer](#) records that specifies how to display changes made by the reviewer in the *corresponding reviewer document* to the **MasterListWithTextContainer** record (section 2.4.14.1). The size, in bytes, of the array is specified by the following formula:

$$\text{rhs.rh.recLen} - \text{rhs.rhAtom.recLen} - 8$$

2.4.20.14 MasterListDiff10ChildContainer

Referenced by: [MasterListDiffContainer](#)

A variable type record whose type and meaning are dictated by the value of **rhs.gmiTag** as specified in the following table.

Value	Meaning
Diff_SlideDiff	A SlideDiffContainer record that specifies how to display the changes to a title master slide .
Diff_MainMasterDiff	A MainMasterDiffContainer record that specifies how to display the changes to a main master slide .

2.4.20.15 MainMasterDiffContainer

Referenced by: [MasterListDiff10ChildContainer](#)

A **container record** that specifies how to display the changes made by the reviewer to a **main master slide**.

Let the *corresponding reviewer document* be as specified in the [DiffTree10Container](#) record that contains this **MainMasterDiffContainer** record.

The *i*th **MainMasterDiffContainer** record in its parent [MasterListDiffContainer](#) record specifies how to display changes made to the **MainMasterContainer** record in the *corresponding reviewer document* that is referenced by the *i*th **MasterPersistAtom** record (section [2.4.14.2](#)) in its parent **MasterListWithTextContainer** record (section [2.4.14.1](#)) in the *corresponding reviewer document*. Let the *corresponding main master slide* be the **MainMasterContainer** record so specified.

0	1	2	3	4	5	6	7	8	9	10	1	2	3	4	5	6	7	8	9	20	1	2	3	4	5	6	7	8	9	30	1
rhs (28 bytes)																															
...																															
...																															
A	B	reserved1										C	D	E	F	reserved2															
shapeListDiff (variable)																															
...																															
tableListDiff (variable)																															
...																															
notesDiff (32 bytes, optional)																															
...																															

...

rhs (28 bytes): A [DiffRecordHeaders](#) structure that specifies the header for the container record. Sub-fields are further specified in the following table.

Field	Meaning
rhs.fIndex	MUST be 0x00.
rhs.gmiTag	MUST be Diff_MainMasterDiff .

A - scheme (1 bit): A bit that specifies whether the change made by the reviewer to the **slideFlags.fMasterScheme** field of the [SlideAtom](#) record contained within the corresponding main master slide is not displayed.

B - background (1 bit): A bit that specifies whether the change made by the reviewer to the **slideFlags.fMasterBackground** field of the [SlideAtom](#) record contained within the corresponding main master slide is not displayed.

reserved1 (10 bits): MUST be zero and MUST be ignored.

C - timeNode (1 bit): A bit that specifies whether the change made by the reviewer to the **ExtTimeNodeContainer** record (section [2.8.15](#)) contained within the *corresponding main master slide* is not displayed.

D - addMainMaster (1 bit): A bit that specifies whether the addition of the *corresponding main master slide* made by the reviewer in the *corresponding reviewer document* is not displayed.

E - deleteMainMaster (1 bit): A bit that specifies whether the deletion of the *corresponding main master slide* made by the reviewer in the *corresponding reviewer document* is not displayed.

F - locked (1 bit): A bit that specifies whether the change made by the reviewer to the **slideFlagsAtom.fPreserveMaster** field of the [PP10SlideBinaryTagExtension](#) record contained within the *corresponding main master slide* is not displayed.

reserved2 (16 bits): MUST be zero and MUST be ignored.

shapeListDiff (variable): An optional [ShapeListDiffContainer](#) record that specifies how to display the changes made by the reviewer to the **shapes** contained within the *corresponding main master slide*.

tableListDiff (variable): An optional [TableListDiffContainer](#) record that specifies how to display the changes made by the reviewer to the **table objects** contained within the *corresponding main master slide*.

notesDiff (32 bytes): An optional [NotesDiffContainer](#) record that specifies how to display the changes made by the reviewer in the *corresponding reviewer document* to the **notes master slide**.

2.4.20.16 SlideDiffContainer

Referenced by: [MasterListDiff10ChildContainer](#), [SlideListDiffContainer](#)

A **container record** that specifies how to display the changes made by the reviewer to a **title master slide** or to a **presentation slide**.

Let the *corresponding reviewer document* be as specified in the [DiffTree10Container](#) record that contains this **SlideDiffContainer** record.

When this **SlideDiffContainer** record is contained within a [MasterListDiffContainer](#) record, the i^{th} **SlideDiffContainer** record in its parent MasterListDiffContainer record specifies how to display changes made to the **SlideContainer** record (section [2.5.1](#)) in the *corresponding reviewer document* that is referenced by the i^{th} **MasterPersistAtom** record (section [2.4.14.2](#)) in its parent **MasterListWithTextContainer** record (section [2.4.14.1](#)) in the *corresponding reviewer document*. Let the *corresponding slide* be the **SlideContainer** record (section 2.5.1) so specified.

When this **SlideDiffContainer** record is contained within a SlideListDiffContainer, the i^{th} **SlideDiffContainer** record in its parent SlideListDiffContainer record specifies how to display changes made to the **SlideContainer** record in the *corresponding reviewer document* that is specified by the i^{th} **SlidePersistAtom** record (section [2.4.14.5](#)) in its parent **SlideListWithTextContainer** record (section [2.4.14.3](#)) in the *corresponding reviewer document*. Let the *corresponding slide* be the **SlideContainer** record so specified.

0	1	2	3	4	5	6	7	8	9	10	11	12	13	14	15	16	17	18	19	20	21	22	23	24	25	26	27	28	29	30	31
rhs (28 bytes)																															
...																															
...																															
A	B	C	D	E	F	G	H	I	J	K	L	reserved3																			
shapeListDiff (variable)																															
...																															
tableListDiff (variable)																															
...																															
slideShowDiff (32 bytes, optional)																															
...																															
...																															
hfDiff (32 bytes, optional)																															
...																															
...																															
notesDiff (32 bytes, optional)																															
...																															
...																															

rhs (28 bytes): A [DiffRecordHeaders](#) structure that specifies the header for the container record. Sub-fields are further specified in the following table.

Field	Meaning
rhs.fIndex	MUST be 0x00.
rhs.gmiTag	MUST be Diff_SlideDiff .

- A - scheme (1 bit):** A bit that specifies whether the change made by the reviewer to the **slideFlags.fMasterScheme** field of the [SlideAtom](#) record contained within the *corresponding slide* is not displayed.
- B - background (1 bit):** A bit that specifies whether the change made by the reviewer to the **slideFlags.fMasterBackground** field of the [SlideAtom](#) record contained within the *corresponding slide* is not displayed.
- C - reserved1 (2 bits):** MUST be zero and MUST be ignored.
- D - addSlide (1 bit):** A bit that specifies whether the addition of the *corresponding slide* made by the reviewer in the *corresponding reviewer document* is not displayed.
- E - deleteSlide (1 bit):** A bit that specifies whether the deletion of the *corresponding slide* made by the reviewer in the *corresponding reviewer document* is not displayed.
- F - layout (1 bit):** A bit that specifies whether the change made by the reviewer to the **geom** field of the [SlideAtom](#) record contained within the *corresponding slide* is not displayed.
- G - slideShow (1 bit):** A bit that specifies whether the changes made by the reviewer to the [SlideShowSlideInfoAtom](#) record contained within the *corresponding slide* are not displayed.
- H - headerFooter (1 bit):** A bit that specifies whether the changes made by the reviewer in the *corresponding reviewer document* to the [PerSlideHeadersFootersContainer](#) record in the *corresponding slide* are not displayed.
- I - reserved2 (1 bit):** MUST be zero and MUST be ignored.
- J - master (1 bit):** A bit that specifies whether the change made by the reviewer to the **masterIdRef** field of the [SlideAtom](#) record contained within the *corresponding slide* is not displayed.
- K - position (1 bit):** A bit that specifies whether the change made by the reviewer to the position of the *corresponding slide* in the **SlideListWithTextContainer** record (section 2.4.14.3) in the *corresponding reviewer document* is not displayed.
- L - timeNode (1 bit):** A bit that specifies whether the change made by the reviewer to the **ExtTimeNodeContainer** record (section 2.8.15) contained within the *corresponding slide* is not displayed.
- reserved3 (19 bits):** MUST be zero and MUST be ignored.
- shapeListDiff (variable):** An optional [ShapeListDiffContainer](#) record that specifies how to display the changes made by the reviewer to the **shapes** contained within the *corresponding slide*.
- tableListDiff (variable):** An optional [TableListDiffContainer](#) record that specifies how to display the changes made by the reviewer to the **table objects** contained within the *corresponding slide*.
- slideShowDiff (32 bytes):** An optional [SlideShowDiffContainer](#) record that specifies how to display the changes made by the reviewer to the [SlideShowSlideInfoAtom](#) record contained within the *corresponding slide*.

hfDiff (32 bytes): An optional [HeaderFooterDiffContainer](#) record that specifies how to display the changes made by the reviewer to the PerSlideHeadersFootersContainer record contained within the *corresponding slide*.

notesDiff (32 bytes): An optional [NotesDiffContainer](#) record that specifies how to display the changes made by the reviewer to the **notes slide** for the *corresponding slide*.

2.4.20.17 ShapeListDiffContainer

Referenced by: [MainMasterDiffContainer](#), [SlideDiffContainer](#)

A **container record** that specifies how to display the changes made by the reviewer to **shapes**.

Let the *corresponding slide* or *corresponding main master slide* be as specified in the SlideDiffContainer or MainMasterDiffContainer record that contains this **ShapeListDiffContainer** record.

0	1	2	3	4	5	6	7	8	9	10	11	12	13	14	15	16	17	18	19	20	21	22	23	24	25	26	27	28	29	30	31
rhs (28 bytes)																															
...																															
...																															
reserved																															
rgShapeDiff (variable)																															
...																															

rhs (28 bytes): A [DiffRecordHeaders](#) structure that specifies the header for the container record. Sub-fields are further specified in the following table.

Field	Meaning
rhs.fIndex	MUST be 0x00.
rhs.gmiTag	MUST be Diff_ShapeListDiff .

reserved (32 bits): MUST be zero and MUST be ignored.

rgShapeDiff (variable): An array of [ShapeDiffContainer](#) records that specifies how to display changes made by the reviewer to the shapes contained within the *corresponding slide* or *corresponding main master slide*. The size, in bytes, of the array is specified by the following formula:

$$\text{rhs.rh.recLen} - \text{rhs.rhAtom.recLen} - 8$$

2.4.20.18 ShapeDiffContainer

Referenced by: [ShapeListDiffContainer](#)

A **container record** that specifies how to display the changes made by the reviewer to a **shape**.

Let the *corresponding slide* or *corresponding main master slide* be as specified in the ShapeListDiffContainer record that contains this **ShapeDiffContainer** record.

The i^{th} **ShapeDiffContainer** record in its parent ShapeListDiffContainer specifies how to display changes made to the i^{th} **OfficeArtSpContainer** record ([MS-ODRAW] section 2.2.14) contained within the *corresponding slide* or *corresponding main master slide*. Let the **OfficeArtSpContainer** record so specified be the *corresponding shape*.

0	1	2	3	4	5	6	7	8	9	10	11	12	13	14	15	16	17	18	19	20	21	22	23	24	25	26	27	28	29	30	31	
rhs (28 bytes)																																
...																																
...																																
A	B	C	D	E	F	G	H	I	J	K	L	M	N	O	P	Q	R	S	T	U	V	W	reserved4									
textDiff (32 bytes, optional)																																
...																																
...																																
recolorInfoDiff (32 bytes, optional)																																
...																																
...																																
externalObjDiff (32 bytes, optional)																																
...																																
...																																
clickInteractiveInfoDiff (32 bytes, optional)																																
...																																
...																																
overInteractiveInfoDiff (32 bytes, optional)																																
...																																
...																																

rhs (28 bytes): A [DiffRecordHeaders](#) structure that specifies the header for the container record. Sub-fields are further specified in the following table.

Field	Meaning
rhs.fIndex	MUST be 0x00.
rhs.gmiTag	MUST be Diff_ShapeDiff .

A - addShape (1 bit): A bit that specifies whether the addition of the *corresponding shape* made by the reviewer in the *corresponding slide* or *corresponding main master slide* is not displayed.

B - deleteShape (1 bit): A bit that specifies whether the deletion of the *corresponding shape* made by the reviewer in the *corresponding slide* or *corresponding main master slide* is not displayed.

C - child (1 bit): A bit that specifies whether the change made by the reviewer to the set of child shapes of the *corresponding shape* is not displayed.

MUST be ignored if the **shapeProp.fGroup** field of the **OfficeArtSpContainer** record ([MS-ODRAW] section 2.2.14) is **FALSE**.

D - position (1 bit): A bit that specifies whether the change made by the reviewer to the position of the *corresponding shape* in the **OfficeArtDgContainer** record ([MS-ODRAW] section 2.2.13) is not displayed.

E - recolorInfo (1 bit): A bit that specifies whether the changes made by the reviewer to the [RecolorInfoAtom](#) record contained within the *corresponding shape* are not displayed.

F - externalObject (1 bit): A bit that specifies whether the changes made by the reviewer to the *corresponding external object* referenced from within the *corresponding shape* is not displayed.

Let the *corresponding external object* be an **external object** that is specified by either the **ExMediaAtom** record (section [2.10.6](#)) or the **ExOleObjAtom** record (section [2.10.12](#)) whose **exObjId** field equals the **exObjIdRef** field of [ExObjRefAtom](#) record contained within the *corresponding shape*.

G - interactiveInfoOnOver (1 bit): A bit that specifies whether the changes made by the reviewer to the [MouseOverInteractiveInfoContainer](#) record contained within the *corresponding shape* are not displayed.

H - interactiveInfoOnClick (1 bit): A bit that specifies whether the changes made by the reviewer to the [MouseClickedInteractiveInfoContainer](#) record contained within the *corresponding shape* are not displayed.

I - reserved1 (1 bit): MUST be zero and MUST be ignored.

J - msopsid3DSettings (1 bit): A bit that specifies whether the changes made by the reviewer to the 3D object ([MS-ODRAW] section 2.3.15), 3D Style ([MS-ODRAW] section 2.3.16), and perspective style ([MS-ODRAW] section 2.3.14) properties of the *corresponding shape* are not displayed.

K - msopsidBWSettings (1 bit): A bit that specifies whether the changes made by the reviewer to the **bWMode** ([MS-ODRAW] section 2.3.2.3), **bWModePureBW** ([MS-ODRAW] section 2.3.2.4), and **bWModeBW** ([MS-ODRAW] section 2.3.2.5) properties of the *corresponding shape* are not displayed.

L - msopsidAutoShape (1 bit): A bit that specifies whether the changes made by the reviewer to the shape type in the **OfficeArtFSP** record ([MS-ODRAW] section 2.2.40) and the callout ([MS-ODRAW] section 2.3.3) properties of the *corresponding shape* are not displayed.

M - msopsidLineStyle (1 bit): A bit that specifies whether the changes made by the reviewer to the line style properties ([MS-ODRAW] section 2.3.8) of the *corresponding shape* are not displayed.

- N - msopsidFillStyle (1 bit):** A bit that specifies whether the changes made by the reviewer to the fill style properties ([MS-ODRAW] section 2.3.7) of the *corresponding shape* are not displayed.
- O - msopsidShadowStyle (1 bit):** A bit that specifies whether the changes made by the reviewer to the shadow style properties ([MS-ODRAW] section 2.3.13) of the *corresponding shape* are not displayed.
- P - msopsidWordArt (1 bit):** A bit that specifies whether the changes made by the reviewer to the geometry text properties ([MS-ODRAW] section 2.3.22) of the *corresponding shape* are not displayed.
- Q - msopsidPicture (1 bit):** A bit that specifies whether the changes made by the reviewer to the blip properties ([MS-ODRAW] section 2.3.23) of the *corresponding shape* are not displayed.
- R - msopsidOrientation (1 bit):** A bit that specifies whether the changes made by the reviewer to the transform properties ([MS-ODRAW] section 2.3.18 and [MS-ODRAW] section 2.3.19) of the *corresponding shape* are not displayed.
- S - msopsidTextSetting (1 bit):** A bit that specifies whether the changes made by the reviewer to the text properties ([MS-ODRAW] section 2.3.21) of the *corresponding shape* are not displayed.
- T - reserved2 (1 bit):** MUST be zero and MUST be ignored.
- U - msopsidSize (1 bit):** A bit that specifies whether the changes made by the reviewer to the [OfficeArtClientAnchor](#) record contained within the *corresponding shape* are not displayed.
- V - reserved3 (1 bit):** MUST be zero and MUST be ignored.
- W - ruler (1 bit):** A bit that specifies whether the changes made by the reviewer to the [TextRulerAtom](#) record of the [OfficeArtClientTextbox](#) record contained within the corresponding shape are not displayed.
- reserved4 (9 bits):** MUST be zero and MUST be ignored.
- textDiff (32 bytes):** An optional [TextDiffContainer](#) record that specifies how to display the changes made by the reviewer to the OfficeArtClientTextbox record contained within the corresponding shape.
- recolorInfoDiff (32 bytes):** An optional [RecolorInfoDiffContainer](#) record that specifies how to display the changes made by the reviewer to the RecolorInfoAtom record contained within the *corresponding shape*.
- externalObjDiff (32 bytes):** An optional [ExternalObjectDiffContainer](#) record that specifies how to display the changes made by the reviewer to the external object referenced from within the *corresponding shape*.
- clickInteractiveInfoDiff (32 bytes):** An optional [InteractiveInfoDiffContainer](#) record that specifies how to display the changes made by the reviewer to the MouseClickInteractiveInfoContainer record contained within the *corresponding shape*.
- overInteractiveInfoDiff (32 bytes):** An optional InteractiveInfoDiffContainer record that specifies how to display the changes made by the reviewer to the MouseOverInteractiveInfoContainer record contained within the *corresponding shape*.

2.4.20.19 TextDiffContainer

Referenced by: [ShapeDiffContainer](#)

A **container record** that specifies how to display the changes made by the reviewer to the text of a **shape**.

Let the *corresponding shape* be as specified in the ShapeDiffContainer record that contains this **TextDiffContainer** record.

Let the *corresponding text* be as specified in the [OfficeArtClientTextbox](#) record contained within the *corresponding shape*.

0	1	2	3	4	5	6	7	8	9	10	11	12	13	14	15	16	17	18	19	20	21	22	23	24	25	26	27	28	29	30	31
rhs (28 bytes)																															
...																															
...																															
A B		reserved2																													

rhs (28 bytes): A [DiffRecordHeaders](#) structure that specifies the header for the container record. Sub-fields are further specified in the following table.

Field	Meaning
rhs.fIndex	MUST be 0x00.
rhs.gmiTag	MUST be Diff_TextDiff .

A - reserved1 (2 bits): MUST be zero and MUST be ignored.

B - wordList (1 bit): A **bit** that specifies whether the changes made by the reviewer to the *corresponding text* are not displayed.

reserved2 (29 bits): MUST be zero and MUST be ignored.

2.4.20.20 RecolorInfoDiffContainer

Referenced by: [ShapeDiffContainer](#)

A **container record** that specifies how to display the changes made by the reviewer to the [RecolorInfoAtom](#) record contained within the *corresponding shape*.

Let the *corresponding shape* be as specified in the ShapeDiffContainer record that contains this **RecolorDiffContainer** record.

0	1	2	3	4	5	6	7	8	9	10	11	12	13	14	15	16	17	18	19	20	21	22	23	24	25	26	27	28	29	30	31
rhs (28 bytes)																															
...																															
...																															
reserved																															

rhs (28 bytes): A [DiffRecordHeaders](#) structure that specifies the header for the container record. Sub-fields are further specified in the following table.

Field	Meaning
rhs.fIndex	MUST be 0x00.
rhs.gmiTag	MUST be Diff_RecolorInfoDiff .

reserved (32 bits): MUST be zero and MUST be ignored.

2.4.20.21 ExternalObjectDiffContainer

Referenced by: [ShapeDiffContainer](#)

A **container record** that specifies how to display the changes made by the reviewer to an **external object**.

Let the *corresponding shape* be as specified in the ShapeDiffContainer record that contains this **ExternalObjectDiffContainer** record.

Let the *corresponding external object* be specified by one of the container records listed in the following table that contains a field, also listed in the table, that matches the **exObjIdRef** field of the [ExObjRefAtom](#) record contained within the *corresponding shape*.

External object container	Field
ExAviMovieContainer	exVideo.exMediaAtom.exObjId
ExMCIMovieContainer	exVideo.exMediaAtom.exObjId
ExCDAudioContainer	exMediaAtom.exObjId
ExMIDIAudioContainer	exMediaAtom.exObjId
ExWAVAudioEmbeddedContainer	exMedia.exObjId
ExWAVAudioLinkContainer	exMedia.exObjId
ExControlContainer (section 2.10.10)	exOleObjAtom.exObjId
ExOleEmbedContainer (section 2.10.27)	exOleObjAtom.exObjId
ExOleLinkContainer (section 2.10.29)	exOleObjAtom.exObjId

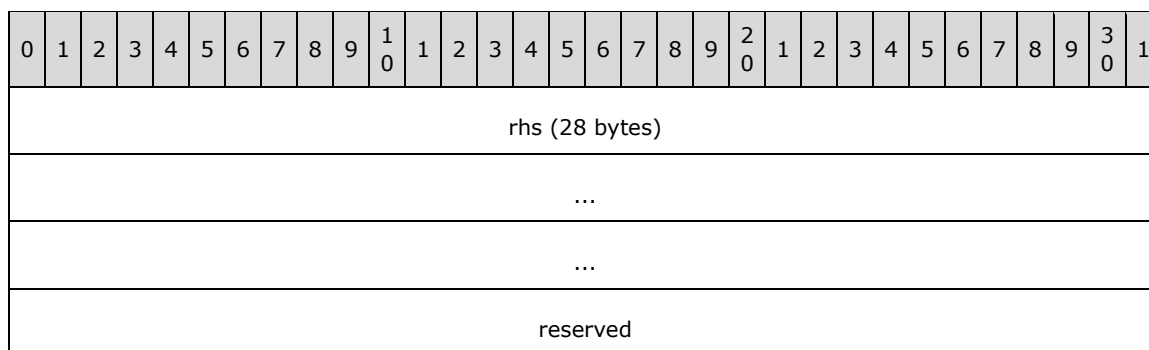

rhs (28 bytes): A [DiffRecordHeaders](#) structure that specifies the header for the container record. Sub-fields are further specified in the following table.

Field	Meaning
rhs.fIndex	MUST be 0.

Field	Meaning
rhs.gmiTag	MUST be Diff_ExternalObjectDiff .

reserved (32 bits): MUST be zero and MUST be ignored.

2.4.20.22 InteractiveInfoDiffContainer

Referenced by: [ShapeDiffContainer](#)

A **container record** that specifies how to display the changes made by the reviewer to the [MouseClickedInteractiveInfoContainer](#) or [MouseOverInteractiveInfoContainer](#) record contained within the *corresponding shape*.

Let the *corresponding shape* be as specified in the ShapeDiffContainer record that contains this **InteractiveInfoDiffContainer** record.

0	1	2	3	4	5	6	7	8	9	10	11	12	13	14	15	16	17	18	19	20	21	22	23	24	25	26	27	28	29	30	31
rhs (28 bytes)																															
...																															
...																															
reserved																															

rhs (28 bytes): A [DiffRecordHeaders](#) structure that specifies the header for the container record. Sub-fields are further specified in the following table.

Field	Meaning
rhs.fIndex	The value 0x00 specifies display information for the changes to the MouseOverInteractiveInfoContainer record contained within the <i>corresponding shape</i> . The value 0x01 specifies display information for the changes to the MouseClickedInteractiveInfoContainer record contained within the <i>corresponding shape</i> .
rhs.gmiTag	MUST be Diff_InteractiveInfoDiff .

reserved (32 bits): MUST be zero and MUST be ignored.

2.4.20.23 TableListDiffContainer

Referenced by: [MainMasterDiffContainer](#), [SlideDiffContainer](#)

A **container record** that specifies how to display the changes made by the reviewer to **table objects**.

Let the *corresponding slide* or *corresponding main master slide* be as specified in the SlideDiffContainer or MainMasterDiffContainer record that contains this **TableListDiffContainer** record.

0	1	2	3	4	5	6	7	8	9	10	11	12	13	14	15	16	17	18	19	20	21	22	23	24	25	26	27	28	29	30	31
rhs (28 bytes)																															
...																															
...																															
reserved																															
rgTableDiff (variable)																															
...																															

rhs (28 bytes): A [DiffRecordHeaders](#) structure that specifies the header for the container record. Sub-fields are further specified in the following table.

Field	Meaning
rhs.fIndex	MUST be 0x00.
rhs.gmiTag	MUST be Diff_TableListDiff .

reserved (32 bits): MUST be zero and MUST be ignored.

rgTableDiff (variable): An array of [TableDiffContainer](#) records that specifies how to display changes made by the reviewer to the table objects in the *corresponding slide* or *corresponding main master slide*. The size, in bytes, of the array is specified by the following formula:

$$\text{rhs.rh.recLen} - \text{rhs.rhAtom.recLen} - 8$$

2.4.20.24 TableDiffContainer

Referenced by: [TableListDiffContainer](#)

A **container record** that specifies how to display the changes made by the reviewer to a **table object**.

Let the *corresponding slide* or *corresponding main master slide* be as specified in the TableListDiffContainer record that contains this **TableDiffContainer** record.

The *i*th **TableDiffContainer** record in its parent TableListDiffContainer record specifies how to display changes made to the *i*th *corresponding table object* contained within the *corresponding slide* or *corresponding main master slide*.

Let the *corresponding table object* be specified by the **OfficeArtSpContainer** record ([\[MS-ODRAW\]](#) section 2.2.14) such that the **tableProperties.fIsTable** field of the **tableProperties** property ([\[MS-ODRAW\]](#) section 2.3.4.36) MUST be **TRUE**.

0	1	2	3	4	5	6	7	8	9	10	11	12	13	14	15	16	17	18	19	20	21	22	23	24	25	26	27	28	29	30	31
rhs (28 bytes)																															

				...
				...
A	B	C	D	reserved

rhs (28 bytes): A [DiffRecordHeaders](#) structure that specifies the header for the container record. Sub-fields are further specified in the following table:

Field	Meaning
rhs.fIndex	MUST be 0x00.
rhs.gmiTag	MUST be Diff_TableDiff .

A - addTable (1 bit): A **bit** that specifies whether the addition of the *corresponding table object* made by the reviewer in the *corresponding slide* or *corresponding main master slide* is not displayed.

B - deleteTable (1 bit): A **bit** that specifies whether the deletion of the *corresponding table object* made by the reviewer in the *corresponding slide* or *corresponding main master slide* is not displayed.

C - modifiedTable (1 bit): A **bit** that specifies whether the changes made by the reviewer to the *corresponding table object* are not displayed.

D - position (1 bit): A **bit** that specifies whether the change made by the reviewer to the z-order of the *corresponding table object* is not displayed.

reserved (28 bits): MUST be zero and MUST be ignored.

2.4.20.25 SlideShowDiffContainer

Referenced by: [SlideDiffContainer](#)

A **container record** that specifies how to display changes made by the reviewer to the [SlideShowSlideInfoAtom](#) record contained within the *corresponding slide*.

Let the *corresponding slide* be as specified in the SlideDiffContainer record that contains this **SlideShowDiffContainer** record.

0	1	2	3	4	5	6	7	8	9	10	11	12	13	14	15	16	17	18	19	20	21	22	23	24	25	26	27	28	29	30	31
rhs (28 bytes)																															
...																															
...																															
reserved																															

rhs (28 bytes): A [DiffRecordHeaders](#) structure that specifies the header for the container record. Sub-fields are further specified in the following table.

Field	Meaning
rhs.fIndex	MUST be 0x00.
rhs.gmiTag	MUST be Diff_SlideShowDiff .

reserved (32 bits): MUST be zero and MUST be ignored.

2.4.20.26 NotesDiffContainer

Referenced by: [MainMasterDiffContainer](#), [SlideDiffContainer](#)

A **container record** that specifies how to display the changes made by the reviewer to the **notes master slide** or to a **notes slide**.

Let the *corresponding reviewer document* be as specified in the [DiffTree10Container](#) record that contains this **NotesDiffContainer** record.

Let the *corresponding slide* be as specified in the SlideDiffContainer record that contains this **NotesDiffContainer** record or let the *corresponding main master slide* be as specified in the MainMasterDiffContainer record that contains this **NotesDiffContainer** record.

Let the *corresponding notes slide* be the **NotesContainer** record (section [2.5.6](#)) as specified by the **slideAtom.notesIdRef** field of the *corresponding slide* or let the *corresponding notes master slide* be as specified by the **notesMasterPersistIdRef** field of the **DocumentAtom** record (section [2.4.2](#)) in the corresponding reviewer document.

Let the *corresponding notes shape* be specified by the **OfficeArtSpContainer** record ([\[MS-ODRAW\]](#) section 2.2.14) contained in the *corresponding notes slide* or *corresponding notes master slide* such that the **placementId** field of the [PlaceholderAtom](#) record contained within the **OfficeArtSpContainer** record has the value of [PT_NotesBody](#).

Let the *corresponding notes text* be as specified in the [OfficeArtClientTextbox](#) record contained within the *corresponding notes shape*.

0	1	2	3	4	5	6	7	8	9	10	11	12	13	14	15	16	17	18	19	20	21	22	23	24	25	26	27	28	29	30	31
rhs (28 bytes)																															
...																															
...																															
A	B	reserved2																													

rhs (28 bytes): A [DiffRecordHeaders](#) structure that specifies the header for the container record. Sub-fields are further specified in the following table:

Field	Meaning
rhs.fIndex	MUST be 0x00.
rhs.gmiTag	MUST be Diff_NotesDiff .

A - reserved1 (2 bits): MUST be zero and MUST be ignored.

B - wordList (1 bit): A **bit** that specifies whether the change made by the reviewer to the *corresponding notes text* is not displayed. It MUST be **FALSE** if the *corresponding notes text* is contained within the *corresponding notes master slide*.

reserved2 (29 bits): MUST be zero and MUST be ignored.

2.4.21 View Info Types

2.4.21.1 GridSpacing10Atom

Referenced by: [PP10DocBinaryTagExtension](#)

An **atom record** that specifies spacing for a grid that can be used to align objects on a **slide** and to display positioning cues. Only square grids are allowed.

0	1	2	3	4	5	6	7	8	9	1	0	1	2	3	4	5	6	7	8	9	2	0	1	2	3	4	5	6	7	8	9	3	0	1
rh																																		
...																																		
x																																		
y																																		

rh (8 bytes): A **RecordHeader** structure (section [2.3.1](#)) that specifies the header for this record. Sub-fields are further specified in the following table.

Field	Meaning
rh.recVer	MUST be 0x0.
rh.recInstance	MUST be 0x000.
rh.recType	MUST be RT_GridSpacing10Atom .
rh.recLen	MUST be 0x00000008.

x (4 bytes): A signed integer that specifies horizontal grid spacing in **grid units**. It MUST be greater than or equal to 0x00005AB8 or 1 mm and less than or equal to 0x00120000 or 2 inches. It MUST be equal to **y**.

y (4 bytes): A signed integer that specifies vertical grid spacing in grid units. It MUST be greater than or equal to 0x00005AB8 or 1 mm and less than or equal to 0x00120000 or 2 inches. It MUST be equal to **x**.

2.4.21.2 NormalViewSetInfoContainer

Referenced by: [DocInfoListSubContainerOrAtom](#)

A **container record** that specifies display preferences for when a user interface shows the **presentation** in a manner optimized for the simultaneous display of all **presentation slides**, a specific presentation slide, and the text of the **notes slide** associated with that specific presentation slide.

0	1	2	3	4	5	6	7	8	9	10	11	12	13	14	15	16	17	18	19	20	21	22	23	24	25	26	27	28	29	30	31
rh																															
...																															
normalViewSetInfoAtom (28 bytes)																															
...																															
...																															

rh (8 bytes): A **RecordHeader** structure (section [2.3.1](#)) that specifies the header for this record. Sub-fields are further specified in the following table.

Field	Meaning
rh.recVer	MUST be 0xF.
rh.recInstance	MUST be 0x001.
rh.recType	MUST be RT_NormalViewSetInfo9 (section 2.13.24).
rh.Len	MUST be 0x0000001C.

normalViewSetInfoAtom (28 bytes): A [NormalViewSetInfoAtom](#) record that specifies the display preferences.

2.4.21.3 NormalViewSetInfoAtom

Referenced by: [NormalViewSetInfoContainer](#)

An **atom record** that specifies the appearance of different regions in a user interface view that consists of three content panes: a side content pane, a slide pane, and a notes text pane.

The side content pane can contain either thumbnail images of **presentation slides** in the presentation or a text outline of the **presentation**. It occupies the full height of the view and is separated from the slide pane and notes text pane by a vertical bar. It occupies the left edge of the view if the **fRightToLeft** field of the **DocumentAtom** record (section [2.4.2](#)) is **FALSE** and the right edge of the view if the **fRightToLeft** field of the **DocumentAtom** record is **TRUE**.

The remainder of the view not occupied by the side content region is divided vertically by a horizontal bar. The slide pane displays a single presentation slide and is located above the horizontal bar. The notes text pane displays the text of the **notes slide** associated with the presentation slide and is located beneath the horizontal bar.

0	1	2	3	4	5	6	7	8	9	10	11	12	13	14	15	16	17	18	19	20	21	22	23	24	25	26	27	28	29	30	31
rh																															
...																															
leftPortion																															

...				
topPortion				
...				
vertBarState	horizBarState	fPreferSingleSet	A	B reserved

rh (8 bytes): A **RecordHeader** structure (section [2.3.1](#)) that specifies the header for this record. Sub-fields are further specified in the following table.

Field	Meaning
rh.recVer	MUST be 0x0.
rh.recInstance	MUST be 0x000.
rh.recType	MUST be RT_NormalViewSetInfo9Atom .
rh.recLen	MUST be 0x00000014

leftPortion (8 bytes): A **RatioStruct** structure (section [2.12.6](#)) that specifies the width of the side content pane as a percentage of the view's width. The value of **leftPortion.numer** / **leftPortion.denom** MUST be greater than or equal to 0 and less than or equal to 1.

topPortion (8 bytes): A **RatioStruct** structure that specifies the height of the slide pane as a percentage of the view's height. The value of **topPortion.numer** / **topPortion.denom** MUST be greater than or equal to 0 and less than or equal to 1.

vertBarState (1 byte): A [NormalViewSetBarStates](#) enumeration that specifies the state of the vertical bar that separates the side content pane from the slide pane and notes text pane. If the value is BS_Minimized or BS_Maximized, the value of **leftPortion** MUST be ignored.

horizBarState (1 byte): A [NormalViewSetBarStates](#) enumeration that specifies the state of the horizontal bar that separates the slide pane from the notes text pane. If the value is BS_Minimized or BS_Maximized, the value of **topPortion** MUST be ignored.

fPreferSingleSet (1 byte): A **bool1** (section [2.2.2](#)) that specifies whether the view consists of only the slide pane or all three panes. It MUST be a value from the following table:

Value	Meaning
0x01	The slide pane occupies the entire view.
0x00	All three panes exist in the view.

A - fHideThumbnails (1 bit): A bit that specifies the content of the side content pane. It MUST be a value from the following table.

Value	Meaning
0x1	The side content pane contains a text outline of the presentation.
0x0	The side content pane contains thumbnail images of the presentation slides.

B - fBarSnapped (1 bit): A bit that specifies whether the vertical bar is snapped to specific positions when resized.

reserved (6 bits): MUST be zero and MUST be ignored.

2.4.21.4 NotesTextViewInfoContainer

Referenced by: [DocInfoListSubContainerOrAtom](#)

A **container record** that specifies display preferences for when a user interface shows the **presentation** in a manner optimized for the display of the text on the **notes slides**.

0	1	2	3	4	5	6	7	8	9	10	11	12	13	14	15	16	17	18	19	20	21	22	23	24	25	26	27	28	29	30	31
rh																															
...																															
zoomViewInfo (60 bytes, optional)																															
...																															
...																															

rh (8 bytes): A **RecordHeader** structure (section [2.3.1](#)) that specifies the header for this record. Sub-fields are further specified in the following table.

Field	Meaning
rh.recVer	MUST be 0xF.
rh.recInstance	MUST be 0x001.
rh.recType	MUST be RT_NotesTextViewInfo9 (section 2.13.24).

zoomViewInfo (60 bytes): An optional [ZoomViewInfoAtom](#) record that specifies origin and scaling information.

2.4.21.5 ZoomViewInfoAtom

Referenced by: [NotesTextViewInfoContainer](#), [NotesViewInfoContainer](#), [SlideViewInfoContainer](#)

An **atom record** that specifies origin and scaling information for a view that can be zoomed beyond 100 percent.

0	1	2	3	4	5	6	7	8	9	10	11	12	13	14	15	16	17	18	19	20	21	22	23	24	25	26	27	28	29	30	31
rh																															
...																															
curScale (16 bytes)																															

...		
...		
unused1 (24 bytes)		
...		
...		
origin		
...		
fUseVarScale	fDraftMode	unused2

rh (8 bytes): A **RecordHeader** structure (section [2.3.1](#)) that specifies the header for this record. Sub-fields are further specified in the following table.

Field	Meaning
rh.recVer	MUST be 0x0.
rh.recInstance	MUST be 0x000.
rh.recType	MUST be RT_ViewInfoAtom .
rh.recLen	MUST be 0x00000034.

curScale (16 bytes): A [ScalingStruct](#) structure that specifies the scaling of content in the view. Sub fields are further specified in the following table.

Field	Meaning
curScale.x	Specifies scaling of the x-axis. The value of curScale.x.numer / curScale.x.denom MUST be greater than or equal to 0.10 and less than or equal to 4.0.
curScale.y	Specifies the scaling of the y-axis. The value of curScale.y.numer / curScale.y.denom MUST be equal to curScale.x.numer / curScale.x.denom .

unused1 (24 bytes): Undefined and MUST be ignored.

origin (8 bytes): A **PointStruct** structure (section [2.12.5](#)) that specifies a position in **master units**, relative to the top-left corner of the full view, that is displayed in the top-left corner of the displayable view area.

fUseVarScale (1 byte): A **bool1** (section [2.2.2](#)) that specifies how content is scaled. It MUST be a value from the following table.

Value	Meaning
0x00	Content is scaled as specified by curScale .
0x01	The scale varies with the size of the view such that

Value	Meaning
	the complete slide always occupies the entire view.

fDraftMode (1 byte): A **bool1** that specifies whether the view is displayed with less formatting.

unused2 (2 bytes): Undefined and MUST be ignored.

2.4.21.6 OutlineViewInfoContainer

Referenced by: [DocInfoListSubContainerOrAtom](#)

A **container record** that specifies display preferences for when a user interface shows the **presentation** in a manner optimized for the display of the text on the **presentation slides**.

0	1	2	3	4	5	6	7	8	9	10	11	12	13	14	15	16	17	18	19	20	21	22	23	24	25	26	27	28	29	30	31
rh																															
...																															
noZoomViewInfo (60 bytes, optional)																															
...																															
...																															

rh (8 bytes): A **RecordHeader** structure (section [2.3.1](#)) that specifies the header for this record. Sub-fields are further specified in the following table.

Field	Meaning
rh.recVer	MUST be 0xF.
rh.recInstance	MUST be 0x001.
rh.recType	MUST be RT_OutlineViewInfo (section 2.13.24).

noZoomViewInfo (60 bytes): An optional [NoZoomViewInfoAtom](#) record that specifies origin and scaling information.

2.4.21.7 NoZoomViewInfoAtom

Referenced by: [OutlineViewInfoContainer](#), [SorterViewInfoContainer](#)

An **atom record** that specifies origin and scaling information for a view that cannot be zoomed beyond 100 percent.

0	1	2	3	4	5	6	7	8	9	10	11	12	13	14	15	16	17	18	19	20	21	22	23	24	25	26	27	28	29	30	31
rh																															

...		
curScale (16 bytes)		
...		
...		
unused1 (24 bytes)		
...		
...		
origin		
...		
unused2	fDraftMode	unused3

rh (8 bytes): A **RecordHeader** structure (section [2.3.1](#)) that specifies the header for this record. Sub-fields are further specified in the following table.

Field	Meaning
rh.recVer	MUST be 0x0.
rh.recInstance	MUST be 0x000.
rh.recType	MUST be RT_ViewInfoAtom .
rh.recLen	MUST be 0x00000034.

curScale (16 bytes): A [ScalingStruct](#) structure that specifies the scaling of content in the view. Sub-fields are further specified in the following table.

Field	Meaning
curScale.x	Specifies scaling of the x-axis. The value of curScale.x.numer / curScale.x.denom MUST be greater than or equal to 0.20 and less than or equal to 1.0.
curScale.y	Specifies scaling of the y-axis. The value of curScale.y.numer / curScale.y.denom MUST be equal to curScale.x.numer / curScale.x.denom .

unused1 (24 bytes): Undefined and MUST be ignored.

origin (8 bytes): A **PointStruct** structure (section [2.12.5](#)) that specifies a position in **master units**, relative to the top-left corner of the full view, that is displayed in the top-left corner of the displayable view area.

unused2 (1 byte): Undefined and MUST be ignored.

fDraftMode (1 byte): A **bool1** (section [2.2.2](#)) that specifies whether the view is displayed with less formatting.

unused3 (2 bytes): Undefined and MUST be ignored.

2.4.21.8 SlideViewInfoInstance

Referenced by: [DocInfoListSubContainerOrAtom](#)

A variable type record whose type and meaning are dictated by the value of **rh.recInstance**, as specified in the following table.

Value	Meaning
0x000	A SlideViewInfoContainer record (section 2.4.21.9) that specifies display preferences for when a user interface shows the presentation in a manner optimized for the display of presentation slides .
0x001	A NotesViewInfoContainer record (section 2.4.21.12) that specifies display preferences for when a user interface shows the presentation in a manner optimized for the display of notes slides .

2.4.21.9 SlideViewInfoContainer

Referenced by: [SlideViewInfoInstance](#)

A **container record** that specifies display preferences for when a user interface shows the **presentation** in a manner optimized for the display of **presentation slides**.

0	1	2	3	4	5	6	7	8	9	10	11	12	13	14	15	16	17	18	19	20	21	22	23	24	25	26	27	28	29	30	31
rh																															
...																															
slideViewInfoAtom																															
...																															
...																								zoomViewInfoAtom (60 bytes optional)							
...																															
...																															
...																								rgGuideAtom (variable)							
...																															

rh (8 bytes): A **RecordHeader** structure (section [2.3.1](#)) that specifies the header for this record. Sub-fields are further specified in the following table.

Field	Meaning
rh.recVer	MUST be 0xF.
rh.recInstance	MUST be 0x000.

Field	Meaning
rh.recType	MUST be RT_SlideViewInfo (section 2.13.24).

slideViewInfoAtom (11 bytes): A [SlideViewInfoAtom](#) record that specifies editing preferences for content positioning.

zoomViewInfoAtom (60 bytes): An optional [ZoomViewInfoAtom](#) record that specifies origin and scaling information.

rgGuideAtom (variable): An array of [GuideAtom](#) records that specifies **guides** for the slide view. It MUST NOT contain more than eight [GuideAtom](#) records with **type** equal to 0x00000000 (horizontal) and MUST NOT contain more than eight [GuideAtom](#) records with **type** equal to 0x00000001 (vertical). The array continues while **rh.recType** of the [GuideAtom](#) record is equal to RT_GuideAtom.

2.4.21.10 SlideViewInfoAtom

Referenced by: [NotesViewInfoContainer](#), [SlideViewInfoContainer](#)

An **atom record** that specifies editing preferences for content positioning.

0	1	2	3	4	5	6	7	8	9	10	11	12	13	14	15	16	17	18	19	20	21	22	23	24	25	26	27	28	29	30	31
rh																															
...																															
unused								fSnapToGrid								fSnapToShape															

rh (8 bytes): A **RecordHeader** structure (section [2.3.1](#)) that specifies the header for this record. Sub-fields are further specified in the following table.

Field	Meaning
rh.recVer	MUST be 0x0.
rh.recInstance	MUST be 0x000.
rh.recType	MUST be RT_SlideViewInfoAtom .
rh.recLen	MUST be 0x00000003.

unused (1 byte): Undefined and MUST be ignored.

fSnapToGrid (1 byte): A **bool1** (section [2.2.2](#)) that specifies an editing preference that the position of a **shape** aligns to the grid specified by the [GridSpacing10Atom](#) record.

fSnapToShape (1 byte): A **bool1** that specifies an editing preference that the position of a shape aligns to the position of other shapes.

2.4.21.11 GuideAtom

Referenced by: [NotesViewInfoContainer](#), [SlideViewInfoContainer](#)

An **atom record** that specifies a **guide**. A guide can be used to align objects on a **slide** and to display visual positioning cues.

0	1	2	3	4	5	6	7	8	9	10	1	2	3	4	5	6	7	8	9	20	1	2	3	4	5	6	7	8	9	30	1
rh																															
...																															
type																															
pos																															

rh (8 bytes): A **RecordHeader** structure (section [2.3.1](#)) that specifies the header for this record. Sub-fields are further specified in the following table.

Field	Meaning
rh.recVer	MUST be 0x0.
rh.recInstance	MUST be 0x007.
rh.recType	MUST be RT_GuideAtom .
rh.recLen	MUST be 0x00000008.

type (4 bytes): An **unsigned integer** that specifies whether the guide is horizontal or vertical. It MUST be a value from the following table.

Value	Meaning
0x00000000	The guide is horizontal.
0x00000001	The guide is vertical.

pos (4 bytes): A **signed integer** that specifies the position of the guide in **master units** relative to the top-left corner of the slide. It MUST be greater than or equal to -15840 or -27.5 inches and less than or equal to 32255 or 56 inches. Typical values range from zero to slide height for a horizontal guide and from zero to slide width for a vertical guide.

2.4.21.12 NotesViewInfoContainer

Referenced by: [SlideViewInfoInstance](#)

A **container record** that specifies display preferences for when a user interface shows the **presentation** in a manner optimized for the display of **notes slides**.

0	1	2	3	4	5	6	7	8	9	10	1	2	3	4	5	6	7	8	9	20	1	2	3	4	5	6	7	8	9	30	1
rh																															
...																															
slideViewInfoAtom																															

...	
...	zoomViewInfoAtom (60 bytes, optional)
...	
...	
...	rgGuideAtom (variable)
...	

rh (8 bytes): A **RecordHeader** structure (section 2.3.1) that specifies the header for this record. Sub-fields are further specified in the following table.

Field	Meaning
rh.recVer	MUST be 0xF.
rh.recInstance	MUST be 0x001.
rh.recType	MUST be RT_SlideViewInfo (section 2.13.24).

slideViewInfoAtom (11 bytes): A [SlideViewInfoAtom](#) record that specifies editing preferences for content positioning.

zoomViewInfoAtom (60 bytes): An optional [ZoomViewInfoAtom](#) record that specifies origin and scaling information.

rgGuideAtom (variable): An array of [GuideAtom](#) records that specifies **guides** for the notes view. It MUST NOT contain more than eight [GuideAtom](#) records with **type** equal to 0x00000000 (horizontal) and MUST NOT contain more than eight [GuideAtom](#) records with **type** equal to 0x00000001 (vertical). The array continues while **rh.recType** of the [GuideAtom](#) record is equal to RT_GuideAtom.

2.4.21.13 SorterViewInfoContainer

Referenced by: [DocInfoListSubContainerOrAtom](#)

A **container record** that specifies display preferences for when a user interface shows the **presentation** in a manner optimized for the simultaneous display of multiple **presentation slides**.

0	1	2	3	4	5	6	7	8	9	10	11	12	13	14	15	16	17	18	19	20	21	22	23	24	25	26	27	28	29	30	31
rh																															
...																															
viewInfo (60 bytes, optional)																															
...																															
...																															

rh (8 bytes): A **RecordHeader** structure (section [2.3.1](#)) that specifies the header for this record. Sub-fields are further specified in the following table.

Field	Meaning
rh.recVer	MUST be 0xF.
rh.recInstance	MUST be 0x001.
rh.recType	MUST be RT_SorterViewInfo (section 2.13.24).

viewInfo (60 bytes): An optional [NoZoomViewInfoAtom](#) record that specifies origin and scaling information.

2.4.22 Summary Info Types

2.4.22.1 CopyrightAtom

Referenced by: [PP10DocBinaryTagExtension](#)

An **atom record** that specifies copyright information.

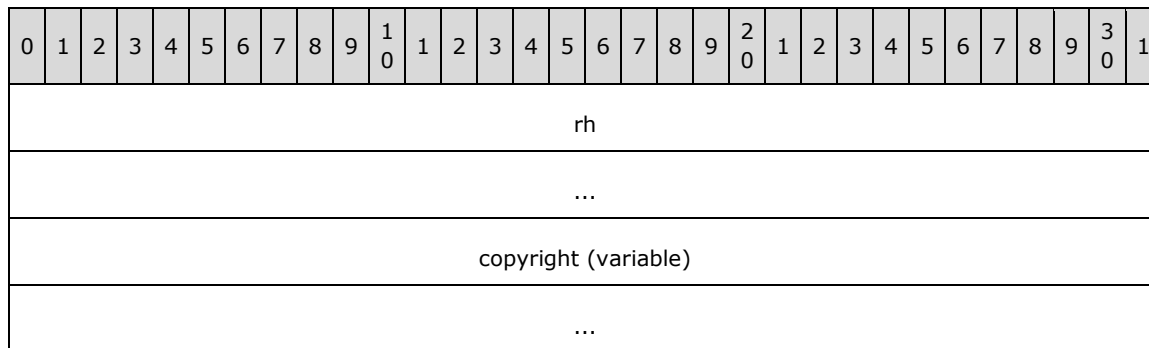

rh (8 bytes): A **RecordHeader** structure (section [2.3.1](#)) that specifies the header for this record. Sub-fields are further specified in the following table.

Field	Meaning
rh.recVer	MUST be 0x0.
rh.recInstance	MUST be 0x001.
rh.recType	MUST be RT_CString (section 2.13.24).
rh.recLen	MUST be an even number. It MUST be less than or equal to 510.

copyright (variable): A **PrintableUnicodeString** (section [2.2.23](#)) that specifies copyright information. The length, in bytes, of the field is specified by **rh.recLen**.

2.4.22.2 KeywordsAtom

Referenced by: [PP10DocBinaryTagExtension](#)

An **atom record** that specifies keyword information.

0	1	2	3	4	5	6	7	8	9	10	11	12	13	14	15	16	17	18	19	20	21	22	23	24	25	26	27	28	29	30	31
rh																															
...																															
keywords (variable)																															
...																															

rh (8 bytes): A **RecordHeader** structure (section [2.3.1](#)) that specifies the header for this record. Sub-fields are further specified in the following table.

Field	Meaning
rh.recVer	MUST be 0x0.
rh.recInstance	MUST be 0x002.
rh.recType	MUST be RT_CString (section 2.13.24).
rh.recLen	MUST be an even number. It MUST be less than or equal to 510.

keywords (variable): A **PrintableUnicodeString** (section [2.2.23](#)) that specifies keyword information. The length, in bytes, of the field is specified by **rh.recLen**.

2.4.22.3 SummaryContainer

Referenced by: [DocumentContainer](#)

A **container record** that specifies **bookmark** information.

0	1	2	3	4	5	6	7	8	9	10	11	12	13	14	15	16	17	18	19	20	21	22	23	24	25	26	27	28	29	30	31
rh																															
...																															
bookmarkCollection (variable)																															
...																															

rh (8 bytes): A **RecordHeader** structure (section [2.3.1](#)) that specifies the header for this record. Sub-fields are further specified in the following table.

Field	Meaning
rh.recVer	MUST be 0xF.
rh.recInstance	MUST be 0x000.
rh.recType	MUST be RT_Summary .

bookmarkCollection (variable): A [BookmarkCollectionContainer](#) record that specifies the bookmarks.

2.4.22.4 BookmarkCollectionContainer

Referenced by: [SummaryContainer](#)

A **container record** that specifies a collection of **bookmarks**.

0	1	2	3	4	5	6	7	8	9	10	11	12	13	14	15	16	17	18	19	20	21	22	23	24	25	26	27	28	29	30	31
rh																															
...																															
bookmarkSeedAtom																															
...																															
...																															
rgBookmarkEntity (variable)																															
...																															

rh (8 bytes): A **RecordHeader** structure (section [2.3.1](#)) that specifies the header for this record. Sub-fields are further specified in the following table.

Field	Meaning
rh.recVer	MUST be 0xF.
rh.recInstance	MUST be 0x000.
rh.recType	MUST be RT_BookmarkCollection .

bookmarkSeedAtom (12 bytes): A [BookmarkSeedAtom](#) record that specifies the identifier to use when creating a new bookmark.

rgBookmarkEntity (variable): An array of [BookmarkEntityAtomContainer](#) records that specifies the bookmarks. The size, in bytes, of the array is specified by the following formula:

$$rh.recLen - 12$$

2.4.22.5 BookmarkSeedAtom

Referenced by: [BookmarkCollectionContainer](#)

An **atom record** that specifies the **seed** value to use when creating new **bookmark** identifiers.

0	1	2	3	4	5	6	7	8	9	10	11	12	13	14	15	16	17	18	19	20	21	22	23	24	25	26	27	28	29	30	31
rh																															
...																															
bookmarkIdSeed																															

rh (8 bytes): A **RecordHeader** structure (section [2.3.1](#)) that specifies the header for this record. Sub-fields are further specified in the following table.

Field	Meaning
rh.recVer	MUST be 0x0.
rh.recInstance	MUST be 0x002.
rh.recType	MUST be RT_BookmarkSeedAtom .
rh.recLen	MUST be 0x00000004.

bookmarkIdSeed (4 bytes): An unsigned integer that specifies a seed for creating a new bookmark identifier. It MUST be greater than all existing bookmark identifier values specified by the **bookmarkID** field of the [BookmarkEntityAtom](#) records and the **bookmarkID** field of the [TextBookMarkAtom](#) records.

2.4.22.6 BookmarkEntityAtomContainer

Referenced by: [BookmarkCollectionContainer](#)

A **container record** that specifies information about a **bookmark**.

0	1	2	3	4	5	6	7	8	9	10	11	12	13	14	15	16	17	18	19	20	21	22	23	24	25	26	27	28	29	30	31
rh																															
...																															
bookmarkEntityAtom (76 bytes)																															
...																															
...																															
bookmarkValueAtom (variable)																															
...																															

rh (8 bytes): A **RecordHeader** structure (section [2.3.1](#)) that specifies the header for this record. Sub-fields are further specified in the following table.

Field	Meaning
rh.recVer	MUST be 0xF.

Field	Meaning
rh.recType	MUST be RT_BookmarkEntityAtom .

bookmarkEntityAtom (76 bytes): A [BookMarkEntityAtom](#) record that specifies how to link text to a bookmark.

bookmarkValueAtom (variable): A [BookmarkValueAtom](#) record that specifies the text value of the bookmark. This field MUST be the same as the text referred to by the associated [TextBookMarkAtom](#) record referred to by the **bookmarkId** field of the **bookmarkEntityAtom** in this record.

2.4.22.7 BookmarkEntityAtom

Referenced by: [BookmarkEntityAtomContainer](#)

An **atom record** that specifies information used to link the **bookmark** records in the text itself to the bookmarks in the [Summary Information Stream](#).

0	1	2	3	4	5	6	7	8	9	10	11	12	13	14	15	16	17	18	19	20	21	22	23	24	25	26	27	28	29	30	31
rh																															
...																															
bookmarkId																															
bookmarkName (64 bytes)																															
...																															
...																															

rh (8 bytes): A **RecordHeader** structure (section [2.3.1](#)) that specifies the header for this record. Sub-fields are further specified in the following table.

Field	Meaning
rh.recVer	MUST be 0x0.
rh.recInstance	MUST be 0x000.
rh.recType	MUST be RT_BookmarkEntityAtom .
rh.recLen	MUST be 0x00000044.

bookmarkId (4 bytes): An unsigned integer that specifies this bookmark identifier. It MUST be the same as the **bookmarkID** field of a [TextBookMarkAtom](#) record.

bookmarkName (64 bytes): A [char2](#) that specifies the name of a bookmark. The name MUST NOT be empty. The name SHOULD be the same as one of the **PropertyIdentifierAndOffset.PropertyIdentifier** fields, as specified in [\[MS-OLEPS\]](#) section [2.19](#), in the Summary Information Stream.

2.4.22.8 BookmarkValueAtom

Referenced by: [BookmarkEntityAtomContainer](#)

An **atom record** that specifies the value of a **bookmark**.

0	1	2	3	4	5	6	7	8	9	10	11	12	13	14	15	16	17	18	19	20	21	22	23	24	25	26	27	28	29	30	31
rh																															
...																															
bookmarkValue (variable)																															
...																															

rh (8 bytes): A **RecordHeader** structure (section [2.3.1](#)) that specifies the header for this record. Sub-fields are further specified in the following table.

Field	Meaning
rh.recVer	MUST be 0x0.
rh.recInstance	MUST be 0x001.
rh.recType	MUST be RT_CString (section 2.13.24).
rh.recLen	MUST be an even number. It MUST be greater than zero and less than or equal to 510.

bookmarkValue (variable): A **PrintableUnicodeString** (section [2.2.23](#)) that specifies the value of this bookmark. The length, in bytes, of the field is specified by **rh.recLen**.

2.4.23 Document Tag Info Types

2.4.23.1 DocProgTagsContainer

Referenced by: [DocInfoListSubContainerOrAtom](#)

A **container record** that specifies **programmable tags** with additional document data.

0	1	2	3	4	5	6	7	8	9	10	11	12	13	14	15	16	17	18	19	20	21	22	23	24	25	26	27	28	29	30	31
rh																															
...																															
rgChildRec (variable)																															
...																															

rh (8 bytes): A **RecordHeader** structure (section [2.3.1](#)) that specifies the header for this record. Sub-fields are further specified in the following table.

Field	Meaning
rh.recVer	MUST be 0xF.
rh.recInstance	SHOULD <15> be 0x000.
rh.recType	MUST be RT_ProgTags (section 2.13.24).

rgChildRec (variable): An array of [DocProgTagsSubContainerOrAtom](#) records that specifies the programmable tags. The size, in bytes, of the array is specified by **rh.recLen**. The array MUST NOT contain more than one of each of the following records: [PP9DocBinaryTagExtension](#), [PP10DocBinaryTagExtension](#), [PP11DocBinaryTagExtension](#), [PP12DocBinaryTagExtension](#).

2.4.23.2 DocProgTagsSubContainerOrAtom

Referenced by: [DocProgTagsContainer](#)

A variable type record whose type and meaning are dictated by the value of **rh.recType**, as specified in the following table.

Value	Meaning
RT_ProgStringTag	A ProgStringTagContainer record that specifies additional document data.
RT_ProgBinaryTag	A DocProgBinaryTagContainer record that specifies additional document data.

2.4.23.3 DocProgBinaryTagContainer

Referenced by: [DocProgTagsSubContainerOrAtom](#)

A **container record** that specifies **programmable tags** with additional binary document data.

0	1	2	3	4	5	6	7	8	9	10	11	12	13	14	15	16	17	18	19	20	21	22	23	24	25	26	27	28	29	30	31
rh																															
...																															
rec (variable)																															
...																															

rh (8 bytes): A **RecordHeader** structure (section [2.3.1](#)) that specifies the header for this record. Sub-fields are further specified in the following table.

Field	Meaning
rh.recVer	MUST be 0xF.
rh.recInstance	MUST be 0x000.
rh.recType	MUST be RT_ProgBinaryTag .

rec (variable): A [DocProgBinaryTagSubContainerOrAtom](#) record that specifies additional document data.

2.4.23.4 DocProgBinaryTagSubContainerOrAtom

Referenced by: [DocProgBinaryTagContainer](#)

A variable type record whose type and meaning are dictated by the value of **tagNameAtom.tagName** for [UnknownBinaryTag](#) or by the value of **tagName** for [PP9DocBinaryTagExtension](#), [PP10DocBinaryTagExtension](#), [PP11DocBinaryTagExtension](#), [PP12DocBinaryTagExtension](#), as specified in the following table.

Value	Meaning
"__PPT9"	A PP9DocBinaryTagExtension record pair that specifies additional document data. It MAY <16> be ignored and MUST be preserved.
"__PPT10"	A PP10DocBinaryTagExtension record pair that specifies additional document data. It MAY <17> be ignored and MUST be preserved.
"__PPT11"	A PP11DocBinaryTagExtension record pair that specifies additional document data. It MAY <18> be ignored and MUST be preserved.
"__PPT12"	A PP12DocBinaryTagExtension record pair that specifies additional document data. It MAY <19> be ignored and MUST be preserved.
Any other value	An UnknownBinaryTag record pair that specifies additional document data. It MUST be ignored and MUST be preserved.

2.4.23.5 PP9DocBinaryTagExtension

Referenced by: [DocProgBinaryTagSubContainerOrAtom](#)

A pair of **atom records** that specifies a **programmable tag** with additional document data.

0	1	2	3	4	5	6	7	8	9	10	11	12	13	14	15	16	17	18	19	20	21	22	23	24	25	26	27	28	29	30	31
rh																															
...																															
tagName (14 bytes)																															
...																															
...																															
...																rhData															
...																															
...																rgTextMasterStyle9 (variable)															
...																															
blipCollectionContainer (variable)																															

...
textDefaultsAtom (variable)
...
kinsokuContainer (variable)
...
rgExternalHyperlink9 (variable)
...
presAdvisorFlagsAtom (optional)
...
...
envelopeDataAtom (variable)
...
envelopeFlagsAtom (optional)
...
...
htmlDocInfoAtom (24 bytes, optional)
...
...
htmlPublishInfoAtom (variable)
...
rgBroadcastDocInfo9 (variable)
...
outlineTextPropsContainer (variable)
...

rh (8 bytes): A **RecordHeader** structure (section [2.3.1](#)) that specifies the header for the first record. Sub-fields are further specified in the following table.

Field	Meaning
rh.recVer	MUST be 0x0.
rh.recInstance	MUST be 0x000.
rh.recType	MUST be RT_CString (section 2.13.24).
rh.recLen	MUST be 0x0000000E.

tagName (14 bytes): A **PrintableUnicodeString** (section [2.2.23](#)) that specifies the programmable tag name. It MUST be "___PPT9".

rhData (8 bytes): A **RecordHeader** structure (section 2.3.1) that specifies the header for the second record. Sub-fields are further specified in the following table:

Field	Meaning
rhData.recVer	MUST be 0x0.
rhData.recInstance	MUST be 0x000.
rhData.recType	MUST be RT_BinaryTagDataBlob.

rgTextMasterStyle9 (variable): An array of [TextMasterStyle9Atom](#) records that specifies additional character-level and paragraph-level formatting of **main master slides**. The array continues while **rh.recType** of the [TextMasterStyle9Atom](#) is equal to RT_TextMasterStyle9Atom.

blipCollectionContainer (variable): An optional **BlipCollection9Container** record (section [2.9.72](#)) that specifies information about picture bullet points.

textDefaultsAtom (variable): An optional [TextDefaults9Atom](#) record that specifies additional default character-level and paragraph-level formatting.

kinsokuContainer (variable): An optional **Kinsoku9Container** (section [2.9.6](#)) that specifies the user preferences for East Asian text line break settings.

rgExternalHyperlink9 (variable): An array of [ExHyperlink9Container](#) records that specifies additional information about **hyperlinks**. The array continues while **rh.recType** of the [ExHyperlink9Container](#) record is equal to RT_ExternalHyperlink9.

presAdvisorFlagsAtom (12 bytes): An optional [PresAdvisorFlags9Atom](#) record that specifies Presentation Assistant settings. It SHOULD [<20>](#) be ignored.

envelopeDataAtom (variable): An optional [EnvelopeData9Atom](#) record that specifies data for an **envelope**. It SHOULD [<21>](#) be ignored.

envelopeFlagsAtom (12 bytes): An optional [EnvelopeFlags9Atom](#) record that specifies information about an envelope. It SHOULD [<22>](#) be ignored.

htmlDocInfoAtom (24 bytes): An optional [HTMLDocInfo9Atom](#) record that specifies settings how to publish a document as a Web page.

htmlPublishInfoAtom (variable): An optional [HTMLPublishInfo9Container](#) record that contains additional information specifying how to publish a document as a Web page.

rgBroadcastDocInfo9 (variable): An array of [BroadcastDocInfo9Container](#) records that specifies settings for a **presentation broadcast**. The array continues while **rh.recType** of the [BroadcastDocInfo9Container](#) is equal to RT_BroadcastDocInfo9. It SHOULD [<23>](#) be ignored.

outlineTextPropsContainer (variable): An optional [OutlineTextProps9Container](#) record that specifies additional text properties for outline text.

2.4.23.6 PP10DocBinaryTagExtension

Referenced by: [DocProgBinaryTagSubContainerOrAtom](#)

A pair of **atom records** that specifies a **programmable tag** with additional document data.

0	1	2	3	4	5	6	7	8	9	10	11	12	13	14	15	16	17	18	19	20	21	22	23	24	25	26	27	28	29	30	31
rh																															
...																															
tagName (16 bytes)																															
...																															
...																															
rhData																															
...																															
fontCollectionContainer (variable)																															
...																															
rgTextMasterStyle10 (variable)																															
...																															
textDefaultsAtom (variable)																															
...																															
gridSpacingAtom (16 bytes, optional)																															
...																															
...																															
rgCommentIndex10 (variable)																															
...																															
fontEmbedFlagsAtom (optional)																															
...																															
...																															

copyrightAtom (variable)	
...	
keywordsAtom (variable)	
...	
filterPrivacyFlagsAtom (optional)	
...	
...	
outlineTextPropsContainer (variable)	
...	
docToolbarStatesAtom (optional)	
...	
...	slideListTableContainer (variable)
...	
rgDiffTree10Container (variable)	
...	
modifyPasswordAtom (variable)	
...	
photoAlbumInfoAtom (14 bytes, optional)	
...	
...	
...	

rh (8 bytes): A **RecordHeader** structure (section [2.3.1](#)) that specifies the header for the first record. Sub-fields are further specified in the following table.

Field	Meaning
rh.recVer	MUST be 0x0.
rh.recInstance	MUST be 0x000.
rh.recType	MUST be RT_CString (section 2.13.24).
rh.recLen	MUST be 0x00000010.

tagName (16 bytes): A **PrintableUnicodeString** (section [2.2.23](#)) that specifies the programmable tag name. It MUST be "___PPT10".

rhData (8 bytes): A **RecordHeader** structure (section 2.3.1) that specifies the header for the second record. Sub-fields are further specified in the following table.

Field	Meaning
rhData.recVer	MUST be 0x0.
rhData.recInstance	MUST be 0x000.
rhData.recType	MUST be RT_BinaryTagDataBlob.

fontCollectionContainer (variable): An optional **FontCollection10Container** record (section [2.9.11](#)) that specifies information about additional fonts in the presentation.

rgTextMasterStyle10 (variable): An array of [TextMasterStyle10Atom](#) records that specifies additional character-level and paragraph-level formatting of **main master slides**. The array continues while **rh.recType** of the [TextMasterStyle10Atom](#) record is equal to RT_TextMasterStyle10Atom.

textDefaultsAtom (variable): An optional [TextDefaults10Atom](#) record that specifies additional default character-level formatting.

gridSpacingAtom (16 bytes): A [GridSpacing10Atom](#) record that specifies spacing for a grid that can be used to align objects on a **slide** and to display positioning cues.

rgCommentIndex10 (variable): An array of [CommentIndex10Container](#) records that specifies information for **presentation comments** in the document. The array continues while **rh.recType** of the [CommentIndex10Container](#) item is equal to RT_CommentIndex10.

fontEmbedFlagsAtom (12 bytes): An optional [FontEmbedFlags10Atom](#) record that specifies how font data is embedded.

copyrightAtom (variable): An optional [CopyrightAtom](#) record that specifies copyright information.

keywordsAtom (variable): An optional [KeywordsAtom](#) record that specifies keyword information.

filterPrivacyFlagsAtom (12 bytes): An optional [FilterPrivacyFlags10Atom](#) record that specifies privacy settings.

outlineTextPropsContainer (variable): An optional [OutlineTextProps10Container](#) record that specifies additional text properties for outline text.

docToolbarStatesAtom (9 bytes): An optional [DocToolbarStates10Atom](#) record that specifies display options for toolbars. It SHOULD [<24>](#) be ignored and SHOULD [<25>](#) be omitted.

slideListTableContainer (variable): An optional [SlideListTable10Container](#) record that specifies additional data about slides in the document. It SHOULD [<26>](#) be ignored and SHOULD [<27>](#) be omitted.

rgDiffTree10Container (variable): An optional array of [DiffTree10Container](#). The array continues while **rh.recType** of the [DiffTree10Container](#) item is equal to RT_DiffTree10. The array specifies the names of reviewers and how to display the changes of the document made by those reviewers. It SHOULD [<28>](#) be ignored and SHOULD [<29>](#) be omitted.

modifyPasswordAtom (variable): An optional [ModifyPasswordAtom](#) record that specifies a password used to modify the document.

photoAlbumInfoAtom (14 bytes): An optional [PhotoAlbumInfo10Atom](#) record that specifies user preferences for how to display a presentation as a photo album.

2.4.23.7 PP11DocBinaryTagExtension

Referenced by: [DocProgBinaryTagSubContainerOrAtom](#)

A pair of **atom records** that specifies a **programmable tag** with additional document data.

0	1	2	3	4	5	6	7	8	9	10	11	12	13	14	15	16	17	18	19	20	21	22	23	24	25	26	27	28	29	30	31
rh																															
...																															
tagName (16 bytes)																															
...																															
...																															
rhData																															
...																															
smartTagStore11 (variable)																															
...																															
outlineTextProps (variable)																															
...																															

rh (8 bytes): A **RecordHeader** structure (section [2.3.1](#)) that specifies the header for the first record. Sub-fields are further specified in the following table.

Field	Meaning
rh.recVer	MUST be 0x0.
rh.recInstance	MUST be 0x000.
rh.recType	MUST be RT_CString (section 2.13.24).
rh.recLen	MUST be 0x00000010.

tagName (16 bytes): A **PrintableUnicodeString** (section [2.2.23](#)) that specifies the programmable tag name. It MUST be "___PPT11".

rhData (8 bytes): A **RecordHeader** structure (section [2.3.1](#)) that specifies the header for the second record. Sub-fields are further specified in the following table.

Field	Meaning
rhData.recVer	MUST be 0x0.

Field	Meaning
rhData.recInstance	MUST be 0x000.
rhData.recType	MUST be RT_BinaryTagDataBlob.

smartTagStore11 (variable): An optional **SmartTagStore11Container** record (section [2.11.28](#)) that specifies smart tag data.

outlineTextProps (variable): An optional [OutlineTextProps11Container](#) record that specifies outline text data.

2.4.23.8 PP12DocBinaryTagExtension

Referenced by: [DocProgBinaryTagSubContainerOrAtom](#)

A pair of **atom records** that specifies a **programmable tag** with additional document data.

0	1	2	3	4	5	6	7	8	9	10	11	12	13	14	15	16	17	18	19	20	21	22	23	24	25	26	27	28	29	30	31
rh																															
...																															
tagName (16 bytes)																															
...																															
...																															
rhData																															
...																															
rtDocFlagsAtom																															
...																															
...																															

rh (8 bytes): A **RecordHeader** structure (section [2.3.1](#)) that specifies the header for the first record. Sub-fields are further specified in the following table.

Field	Meaning
rh.recVer	MUST be 0x0.
rh.recInstance	MUST be 0x000.
rh.recType	MUST be RT_CString (section 2.13.24).
rh.recLen	MUST be 0x00000010.

tagName (16 bytes): A **PrintableUnicodeString** (section [2.2.23](#)) that specifies the programmable tag name. It MUST be "__PPT12".

rhData (8 bytes): A **RecordHeader** structure (section 2.3.1) that specifies the header for the second record. Sub-fields are further specified in the following table.

Field	Meaning
rhData.recVer	MUST be 0x0.
rhData.recInstance	MUST be 0x000.
rhData.recType	MUST be RT_BinaryTagDataBlob.

rtDocFlagsAtom (9 bytes): An optional [RoundTripDocFlags12Atom](#) record that specifies document level flags. It SHOULD <30> be omitted.

2.5 Slide Types

2.5.1 SlideContainer

Referenced by: [MasterOrSlideContainer](#)

A **container record** that specifies a **presentation slide** or **title master slide**.

Let the *corresponding master slide* be the **MainMasterContainer** record (section [2.5.3](#)) or **SlideContainer** record specified by **slideAtom.masterIdRef**.

Let the *corresponding notes slide* be the **NotesContainer** record (section [2.5.6](#)) specified by **slideAtom.notesIdRef**.

0	1	2	3	4	5	6	7	8	9	10	11	12	13	14	15	16	17	18	19	20	21	22	23	24	25	26	27	28	29	30	31
rh																															
...																															
slideAtom (32 bytes)																															
...																															
...																															
slideShowSlideInfoAtom (24 bytes, optional)																															
...																															
...																															
perSlideHFContainer (variable)																															
...																															
rtSlideSyncInfo12 (variable)																															
...																															

drawing (variable)
...
slideSchemeColorSchemeAtom (40 bytes)
...
...
slideNameAtom (variable)
...
slideProgTagsContainer (variable)
...
rgRoundTripSlide (variable)
...

rh (8 bytes): A **RecordHeader** structure (section [2.3.1](#)) that specifies the header for this record. Sub-fields are further specified in the following table.

Field	Meaning
rh.recVer	MUST be 0xF.
rh.recInstance	MUST be 0x000.
rh.recType	MUST be RT_Slide .

slideAtom (32 bytes): A [SlideAtom](#) record that specifies information specific to this slide.

slideShowSlideInfoAtom (24 bytes): An optional [SlideShowSlideInfoAtom](#) record that specifies **slide** transition information.

perSlideHFContainer (variable): An optional [PerSlideHeadersFootersContainer](#) record that specifies **header** and **footer** information for this slide. It SHOULD<31> be preserved.

rtSlideSyncInfo12 (variable): An optional [RoundTripSlideSyncInfo12Container](#) record that specifies round-trip information. It SHOULD<32> be ignored and SHOULD<33> be preserved.

drawing (variable): A **DrawingContainer** (section [2.5.13](#)) that specifies drawing information for this slide.

slideSchemeColorSchemeAtom (40 bytes): A [SlideSchemeColorSchemeAtom](#) record that specifies the **color scheme** for this slide. If **slideAtom.slideFlags.fMasterScheme** is set, then the [SlideSchemeColorSchemeAtom](#) record contained by the *corresponding master slide* is used instead.

slideNameAtom (variable): An optional [SlideNameAtom](#) record that specifies the name of this slide. It SHOULD<34> be preserved.

slideProgTagsContainer (variable): An optional [SlideProgTagsContainer](#) record that specifies a list of **programmable tags**.

rgRoundTripSlide (variable): An array of [RoundTripSlideRecord](#) records that specifies round-trip information. The array continues while **rh.recType** of the RoundTripSlideRecord item is equal to one of the following record types: RT_RoundTripTheme12Atom, RT_RoundTripColorMapping12Atom, RT_RoundTripCompositeMasterId12Atom, RT_RoundTripSlideSyncInfo12, RT_RoundTripAnimationHashAtom12Atom, RT_RoundTripAnimationAtom12Atom, or RT_RoundTripContentMasterId12Atom. Each record type MUST NOT appear more than once.

2.5.2 RoundTripSlideRecord

Referenced by: [SlideContainer](#)

A variable type record whose type and meaning are dictated by the value of **rh.recType**, as specified in the following table.

Value	Meaning
RT_RoundTripTheme12Atom	A RoundTripThemeAtom record that specifies round-trip information. It SHOULD<35> be ignored and SHOULD<36> be preserved.
RT_RoundTripColorMapping12Atom	A RoundTripColorMappingAtom record that specifies round-trip information. It SHOULD<37> be ignored and SHOULD<38> be preserved.
RT_RoundTripCompositeMasterId12Atom	A RoundTripCompositeMasterId12Atom record that specifies round-trip information. It SHOULD<39> be ignored and SHOULD<40> be preserved.
RT_RoundTripSlideSyncInfo12	A RoundTripSlideSyncInfo12Container record that specifies round-trip information. It SHOULD<41> be ignored and SHOULD<42> be preserved.
RT_RoundTripAnimationHashAtom12Atom	A RoundTripAnimationHashAtom record that specifies round-trip information. It SHOULD<43> be ignored and SHOULD<44> be preserved.
RT_RoundTripAnimationAtom12Atom	A RoundTripAnimationAtom record that specifies round-trip information. It SHOULD<45> be ignored and SHOULD<46> be preserved.
RT_RoundTripContentMasterId12Atom	A RoundTripContentMasterId12Atom record that specifies round-trip information. It SHOULD<47> be ignored and SHOULD<48> be preserved.

2.5.3 MainMasterContainer

Referenced by: [MasterOrSlideContainer](#)

A **container record** that specifies a **main master slide**.

0	1	2	3	4	5	6	7	8	9	10	11	12	13	14	15	16	17	18	19	20	21	22	23	24	25	26	27	28	29	30	31
rh																															
...																															

slideAtom (32 bytes)
...
...
rgSchemeListElementColorScheme (variable)
...
rgTextMasterStyle (variable)
...
roundTripOArtTextStyles12Atom (variable)
...
slideShowSlideInfoAtom (24 bytes, optional)
...
...
perSlideHeadersFootersContainer (variable)
...
drawing (variable)
...
slideSchemeColorSchemeAtom (40 bytes)
...
...
slideNameAtom (variable)
...
slideProgTagsContainer (variable)
...
rgRoundTripMainMaster (variable)
...

templateNameAtom (variable)
...

rh (8 bytes): A **RecordHeader** structure (section [2.3.1](#)) that specifies the header for this record. Sub-fields are further specified in the following table.

Field	Meaning
rh.recVer	MUST be 0xF.
rh.recInstance	MUST be 0x000.
rh.recType	MUST be RT_MainMaster .

slideAtom (32 bytes): A [SlideAtom](#) record that specifies slide-specific information.

rgSchemeListElementColorScheme (variable): An array of [SchemeListElementColorSchemeAtom](#) record that specifies a list of **color schemes**. The array continues while the **rh.recType** field of each SchemeListElementColorSchemeAtom item is equal to RT_ColorSchemeAtom.

rgTextMasterStyle (variable): An array of [TextMasterStyleAtom](#) record that specifies text formatting for this main master slide. It MUST contain at least one item with **rh.recInstance** equal to 0x000 (title placeholder) and at least one item with **rh.recInstance** equal to 0x001 (body placeholder). If this **MainMasterContainer** record is referenced by the first **MasterPersistAtom** record (section [2.4.14.2](#)) contained within the **MasterListWithTextContainer** record (section [2.4.14.1](#)), this array MUST also contain at least one item with **rh.recInstance** equal to 0x002 (notes placeholder). The array continues while the **rh.recType** field of each TextMasterStyleAtom item is equal to RT_TextMasterStyleAtom.

roundTripOArtTextStyles12Atom (variable): An optional [RoundTripOArtTextStyles12Atom](#) record that specifies round-trip information. It SHOULD [<49>](#) be ignored and SHOULD [<50>](#) be preserved.

slideShowSlideInfoAtom (24 bytes): An optional [SlideShowSlideInfoAtom](#) record that specifies **slide show** information for this main master slide.

perSlideHeadersFootersContainer (variable): An optional [PerSlideHeadersFootersContainer](#) record that specifies **header** and **footer** information for this main master slide. It SHOULD [<51>](#) be preserved.

drawing (variable): A **DrawingContainer** record (section [2.5.13](#)) that specifies drawing information for this main master slide.

slideSchemeColorSchemeAtom (40 bytes): A [SlideSchemeColorSchemeAtom](#) record that specifies the color scheme for this main master slide.

slideNameAtom (variable): An optional [SlideNameAtom](#) record that specifies the name of this main master slide. It SHOULD [<52>](#) be preserved.

slideProgTagsContainer (variable): An optional [SlideProgTagsContainer](#) record that specifies a list of **programmable tags**.

rgRoundTripMainMaster (variable): An array of [RoundTripMainMasterRecord](#) records that specifies additional data for this main master slide. The array continues while **rh.recType** of the RoundTripMainMasterRecord item is equal to one of the following record types: RT_RoundTripOriginalMainMasterId12Atom, RT_RoundTripTheme12Atom, RT_RoundTripColorMapping12Atom, RT_RoundTripContentMasterInfo12Atom, RT_RoundTripOArtTextStyles12Atom, RT_RoundTripAnimationHashAtom12Atom,

RT_RoundTripAnimationAtom12Atom, or RT_RoundTripCompositeMasterId12Atom. Each record type MUST NOT appear more than once, except for the RT_RoundTripContentMasterInfo12Atom record type.

templateNameAtom (variable): An optional [TemplateNameAtom](#) record that specifies the design name of this main master slide.

2.5.4 RoundTripMainMasterRecord

Referenced by: [MainMasterContainer](#)

A variable type record whose type and meaning is dictated by the value of **rh.recType**, as specified in the following table.

Value	Meaning
RT_RoundTripOriginalMainMasterId12Atom	A RoundTripOriginalMainMasterId12Atom record that specifies round-trip information. It SHOULD<53> be ignored and SHOULD<54> be preserved.
RT_RoundTripTheme12Atom	A RoundTripThemeAtom record that specifies round-trip information. It SHOULD<55> be ignored and SHOULD<56> be preserved.
RT_RoundTripColorMapping12Atom	A RoundTripColorMappingAtom record that specifies round-trip information. It SHOULD<57> be ignored and SHOULD<58> be preserved.
RT_RoundTripContentMasterInfo12Atom	A RoundTripContentMasterInfo12Atom record that specifies round-trip information. It SHOULD<59> be ignored and SHOULD<60> be preserved.
RT_RoundTripOArtTextStyles12Atom	A RoundTripOArtTextStyles12Atom record that specifies round-trip information. It SHOULD<61> be ignored and SHOULD<62> be preserved.
RT_RoundTripAnimationHashAtom12Atom	A RoundTripAnimationHashAtom record that specifies round-trip information. It SHOULD<63> be ignored and SHOULD<64> be preserved.
RT_RoundTripAnimationAtom12Atom	A RoundTripAnimationAtom record that specifies round-trip information. It SHOULD<65> be ignored and SHOULD<66> be preserved.
RT_RoundTripCompositeMasterId12Atom	A RoundTripCompositeMasterId12Atom record that specifies round-trip information. It SHOULD<67> be ignored and SHOULD<68> be preserved.

2.5.5 MasterOrSlideContainer

A variable type record whose type and meaning is dictated by the value of **rh.recType**, as specified in the following table.

Value	Meaning
RT_Slide	A SlideContainer record (section 2.5.1) that specifies a title master slide .
RT_MainMaster	A MainMasterContainer record (section 2.5.3) that specifies a main master slide .

2.5.6 NotesContainer

A **container record** that specifies a **notes slide** or a **notes master slide**.

Let the *corresponding notes master* be specified by the **NotesContainer** record specified by the **notesMasterPersistIdRef** field of the **DocumentAtom** record (section [2.4.2](#)).

0	1	2	3	4	5	6	7	8	9	10	11	12	13	14	15	16	17	18	19	20	21	22	23	24	25	26	27	28	29	30	31
rh																															
...																															
notesAtom (16 bytes)																															
...																															
...																															
drawing (variable)																															
...																															
slideSchemeColorSchemeAtom (40 bytes)																															
...																															
...																															
slideNameAtom (variable)																															
...																															
slideProgTagsContainer (variable)																															
...																															
rgNotesRoundTripAtom (variable)																															
...																															

rh (8 bytes): A **RecordHeader** structure (section [2.3.1](#)) that specifies the header for this record. Sub-fields are further specified in the following table.

Field	Meaning
rh.recVer	MUST be 0xF.
rh.recInstance	MUST be 0x000.
rh.recType	MUST be RT_Notes .

notesAtom (16 bytes): A [NotesAtom](#) record that specifies data for this notes slide or notes master slide.

drawing (variable): A **DrawingContainer** record (section [2.5.13](#)) that specifies the arrangement of content on this notes slide or notes master slide.

slideSchemeColorSchemeAtom (40 bytes): A [SlideSchemeColorSchemeAtom](#) record that specifies a **color scheme** for this notes slide or notes master slide. If **notesAtom.slideFlags.fMasterScheme** is set, the SlideSchemeColorSchemeAtom record contained by the *corresponding notes master* is used instead.

slideNameAtom (variable): An optional [SlideNameAtom](#) record that specifies a name for this notes slide or notes master slide. It SHOULD [<69>](#) be preserved.

slideProgTagsContainer (variable): An optional [SlideProgTagsContainer](#) record that specifies a list of **programmable tags**.

rgNotesRoundTripAtom (variable): An array of [NotesRoundTripAtom](#) records that specifies additional data for this notes slide or notes master slide. The array continues while **rh.recType** of the NotesRoundTripAtom item is equal to one of the following record types: RT_RoundTripTheme12Atom, RT_RoundTripColorMapping12Atom, or RT_RoundTripNotesMasterTextStyles12Atom. Each record type MUST NOT appear more than once.

2.5.7 NotesRoundTripAtom

Referenced by: [NotesContainer](#)

A variable type record whose type and meaning is dictated by the value of **rh.recType**, as specified in the following table.

Value	Meaning
RT_RoundTripTheme12Atom	A RoundTripThemeAtom record that specifies round-trip information. It SHOULD <70> be ignored and SHOULD <71> be preserved.
RT_RoundTripColorMapping12Atom	A RoundTripColorMappingAtom record that specifies round-trip information. It SHOULD <72> be ignored and SHOULD <73> be preserved.
RT_RoundTripNotesMasterTextStyles12Atom	A RoundTripNotesMasterTextStyles12Atom record that specifies round-trip information. It SHOULD <74> be ignored and SHOULD <75> be preserved.

2.5.8 HandoutContainer

A **container record** that specifies the **handout master slide**.

0	1	2	3	4	5	6	7	8	9	10	1	2	3	4	5	6	7	8	9	20	1	2	3	4	5	6	7	8	9	30	1		
rh																																	
...																																	
drawing (variable)																																	

...
slideSchemeColorSchemeAtom (40 bytes)
...
...
slideNameAtom (variable)
...
slideProgTagsContainer (variable)
...
rgHandoutRoundTripAtom (variable)
...

rh (8 bytes): A **RecordHeader** structure (section [2.3.1](#)) that specifies the header for this record. Sub-fields are further specified in the following table.

Field	Meaning
rh.recVer	MUST be 0xF.
rh.recInstance	MUST be 0x000.
rh.recType	MUST be RT_Handout .

drawing (variable): A **DrawingContainer** record (section [2.5.13](#)) that specifies the arrangement of content on the handout master slide.

slideSchemeColorSchemeAtom (40 bytes): A [SlideSchemeColorSchemeAtom](#) record that specifies the **color scheme** for the handout master slide.

slideNameAtom (variable): An optional [SlideNameAtom](#) record that specifies the name for the handout master slide. It SHOULD [<76>](#) be preserved.

slideProgTagsContainer (variable): An optional [SlideProgTagsContainer](#) record that specifies a list of **programmable tags**.

rgHandoutRoundTripAtom (variable): An array of [HandoutRoundTripAtom](#) records that specifies round-trip information. The array continues while **rh.recType** of the HandoutRoundTripAtom item is equal to one of the following record types: RT_RoundTripTheme12Atom or RT_RoundTripColorMapping12Atom. Each record type MUST NOT appear more than once.

2.5.9 HandoutRoundTripAtom

Referenced by: [HandoutContainer](#)

A variable type record whose type and meaning are dictated by the value of **rh.recType**, as specified in the following table.

Value	Meaning
RT_RoundTripTheme12Atom	A RoundTripThemeAtom record that specifies round-trip information. It SHOULD<77> be ignored and SHOULD<78> be preserved.
RT_RoundTripColorMapping12Atom	A RoundTripColorMappingAtom record that specifies round-trip information. It SHOULD<79> be ignored and SHOULD<80> be preserved.

2.5.10 SlideAtom

Referenced by: [MainMasterContainer](#), [SlideContainer](#)

An **atom record** that specifies information about a **slide**.

Let the *corresponding slide* be specified by the **SlideContainer** record (section 2.5.1) or **MainMasterContainer** record (section 2.5.3) that contains this **SlideAtom** record.

0	1	2	3	4	5	6	7	8	9	10	11	12	13	14	15	16	17	18	19	20	21	22	23	24	25	26	27	28	29	30	31
rh																															
...																															
geom																															
rgPlaceholderTypes																															
...																															
masterIdRef																															
notesIdRef																															
slideFlags																unused															

rh (8 bytes): A **RecordHeader** structure (section 2.3.1) that specifies the header for this record. Sub-fields are further specified in the following table.

Field	Meaning
rh.recVer	MUST be 0x2.
rh.recInstance	MUST be 0x000.
rh.recType	MUST be RT_SlideAtom .
rh.recLen	MUST be 0x00000018.

geom (4 bytes): A [SlideLayoutType](#) enumeration that specifies a hint to the user interface which **slide layout** exists on the *corresponding slide*.

A slide layout specifies the type and number of **placeholder shapes** on a slide. A placeholder shape is specified as an **OfficeArtSpContainer** ([\[MS-ODRAW\]](#) section 2.2.14) that contains a [PlaceholderAtom](#) record with a **pos** field not equal to 0xFFFFFFFF. The **placementId** field of the **PlaceholderAtom** record specifies the placeholder shape type. Additional constraints on the type and number of placeholder shapes are specified in the following table.

Value	Placeholder shapes
SL_TitleSlide	The <i>corresponding slide</i> MUST be a presentation slide and MUST contain at most one PlaceholderAtom record with a placementId equal to PT_CenterTitle , and at most one PlaceholderAtom record with a placementId equal to PT_SubTitle, and MUST NOT contain any other PlaceholderAtom record with a placementId unequal to 0xFFFFFFFF.
SL_TitleBody	<p>If the <i>corresponding slide</i> is a main master slide it MUST contain one PlaceholderAtom record with a placementId equal to PT_MasterTitle, one PlaceholderAtom record with a placementId equal to PT_MasterBody, one PlaceholderAtom record with a placementId equal to PT_MasterDate, one PlaceholderAtom record with a placementId equal to PT_MasterFooter, and one PlaceholderAtom record with a placementId equal to PT_MasterSlideNumber, and MUST NOT contain any other PlaceholderAtom record with a placementId unequal to 0xFFFFFFFF.</p> <p>If the <i>corresponding slide</i> is a presentation slide it MUST contain at most one PlaceholderAtom record with placementId equal to PT_Title and at most one PlaceholderAtom record with placementId equal to PT_Body, PT_Table, PT_OrgChart, PT_Graph, PT_Object or PT_VerticalBody, and MUST NOT contain any other PlaceholderAtom record with a placementId unequal to 0xFFFFFFFF.</p>
SL_MasterTitle	The <i>corresponding slide</i> MUST be a title master slide and MUST contain one PlaceholderAtom record with a placementId equal to PT_MasterCenterTitle, one PlaceholderAtom record with a placementId equal to PT_MasterSubTitle, at most one PlaceholderAtom record with a placementId equal to PT_MasterDate, at most one PlaceholderAtom record with a placementId equal to PT_MasterFooter and at most one PlaceholderAtom record with a placementId equal to PT_MasterSlideNumber, and MUST NOT contain any other PlaceholderAtom record with a placementId unequal to 0xFFFFFFFF.
SL_TitleOnly	The <i>corresponding slide</i> MUST be a presentation slide and MUST contain at most one PlaceholderAtom record with a placementId equal to PT_Title, and MUST NOT contain any other PlaceholderAtom record with a placementId unequal 0xFFFFFFFF.
SL_TwoColumns	<p>The <i>corresponding slide</i> MUST be a presentation slide and MUST contain at most one PlaceholderAtom record with a placementId equal to PT_Title, and any combination of zero, one, or two PlaceholderAtom records with placementId fields. The following list shows the possible combinations:</p> <ul style="list-style-type: none"> ▪ PT_Body and PT_Body ▪ PT_Body and PT_Graph ▪ PT_Graph and PT_Body ▪ PT_Body and PT_ClipArt ▪ PT_ClipArt and PT_Body ▪ PT_Body and PT_Object ▪ PT_Object and PT_Body ▪ PT_Body and PT_Media ▪ PT_Media and PT_Body ▪ PT_ClipArt and PT_VerticalBody ▪ PT_Object and PT_Object ▪ PT_Body ▪ PT_Graph ▪ PT_ClipArt ▪ PT_Object ▪ PT_Media ▪ PT_VerticalBody <p>It MUST NOT contain any other PlaceholderAtom record with a placementId unequal to 0xFFFFFFFF.</p>
SL_TwoRows	The <i>corresponding slide</i> MUST be a presentation slide and MUST contain at most

Value	Placeholder shapes
	one PlaceholderAtom record with a placementId equal to PT_Title, at most one PlaceholderAtom record with a placementId equal to PT_Body, at most one PlaceholderAtom record with a placementId equal to PT_Object, and MUST NOT contain any other PlaceholderAtom record with a placementId unequal to 0xFFFFFFFF.
SL_ColumnTwoRows	The <i>corresponding slide</i> MUST be a presentation slide and MUST contain at most one PlaceholderAtom record with a placementId equal to PT_Title, at most one PlaceholderAtom record with a placementId equal to PT_Body or PT_Object, at most two additional PlaceholderAtom records with placementId fields equal to PT_Object, and MUST NOT contain any other PlaceholderAtom record with a placementId unequal to 0xFFFFFFFF.
SL_TwoRowsColumn	The <i>corresponding slide</i> MUST be a presentation slide and MUST contain at most one PlaceholderAtom record with a placementId equal to PT_Title, at most two PlaceholderAtom records with placementId fields equal to PT_Object, at most one additional PlaceholderAtom record with a placementId equal to PT_Body or PT_Object, and MUST NOT contain any other PlaceholderAtom record with a placementId unequal to 0xFFFFFFFF.
SL_TwoColumnsRow	The <i>corresponding slide</i> MUST be a presentation slide and MUST contain at most one PlaceholderAtom record with a placementId equal to PT_Title, at most two PlaceholderAtom records with placementId fields equal to PT_Object, at most one PlaceholderAtom record with a placementId equal to PT_Body, and MUST NOT contain any other PlaceholderAtom record with a placementId unequal to 0xFFFFFFFF.
SL_FourObjects	The <i>corresponding slide</i> MUST be a presentation slide and MUST contain at most one PlaceholderAtom record with a placementId equal to PT_Title, at most four PlaceholderAtom records with placementId fields equal to PT_Object, and MUST NOT contain any other PlaceholderAtom record with a placementId unequal to 0xFFFFFFFF.
SL_BigObject	The <i>corresponding slide</i> MUST be a presentation slide and MUST contain at most one PlaceholderAtom record with a placementId equal to PT_Object, and MUST NOT contain any other PlaceholderAtom record with a placementId unequal to 0xFFFFFFFF.
SL_Blank	<p>The <i>corresponding slide</i> MUST be a presentation slide. There are five layouts supported with this value:</p> <p>Layout 1: The <i>corresponding slide</i> MUST NOT contain any PlaceholderAtom records with a placementId unequal to 0xFFFFFFFF.</p> <p>Layout 2: The <i>corresponding slide</i> MUST contain at most one PlaceholderAtom record with a placementId equal to PT_Title, at most one PlaceholderAtom record with a placementId equal to PT_Body, and MUST NOT contain any other PlaceholderAtom record with a placementId unequal to 0xFFFFFFFF.</p> <p>Layout 3: The <i>corresponding slide</i> MUST contain at most one PlaceholderAtom record with a placementId equal to PT_Title, at most two PlaceholderAtom records with a placementId equal to PT_Body, at most one PlaceholderAtom record with a placementId equal to PT_Object, and MUST NOT contain any other PlaceholderAtom record with a placementId unequal to 0xFFFFFFFF.</p> <p>Layout 4: The <i>corresponding slide</i> MUST contain at most one PlaceholderAtom record with a placementId equal to PT_Title, at most one PlaceholderAtom record with a placementId equal to PT_Object, at most one PlaceholderAtom record with a placementId equal to PT_Body, and MUST NOT contain any other PlaceholderAtom record with a placementId unequal to 0xFFFFFFFF.</p> <p>Layout 5: The <i>corresponding slide</i> MUST contain at most one PlaceholderAtom</p>

Value	Placeholder shapes
	record with a placementId equal to PT_Title, at most one PlaceholderAtom record with a placementId equal to PT_Picture, at most one PlaceholderAtom record with a placementId equal to PT_Body, and MUST NOT contain any other PlaceholderAtom record with a placementId unequal to 0xFFFFFFFF.
SL_VerticalTitleBody	The <i>corresponding slide</i> MUST be a presentation slide and MUST contain at most one PlaceholderAtom record with placementId equal to PT_VerticalTitle, at most one PlaceholderAtom record with placementId equal to PT_VerticalBody, and MUST NOT contain any other PlaceholderAtom record with a placementId unequal to 0xFFFFFFFF.
SL_VerticalTwoRows	The <i>corresponding slide</i> MUST be a presentation slide and MUST contain at most one PlaceholderAtom record with placementId equal to PT_VerticalTitle, at most one PlaceholderAtom record with placementId equal to PT_VerticalBody, at most one PlaceholderAtom record with placementId equal to PT_Graph, and MUST NOT contain any other PlaceholderAtom record with a placementId unequal to 0xFFFFFFFF.

rgPlaceholderTypes (8 bytes): An array of **PlaceholderEnum** (section 2.13.21) enumeration values that specifies a hint to the user interface which placeholder shapes exist on the *corresponding slide*. The count of items in the array MUST be 8. The sequence of array items MUST be a valid **PlaceholderList** as specified by the ABNF (specified in [\[RFC5234\]](#)) grammars in the following table.

Value of geom.	Value of rgPlaceholderTypes
SL_TitleSlide	<pre>PlaceholderList = (Variant1 / Variant2)6PT_None Variant1 = PT_CenterTitle PT_SubTitle Variant2 = PT_Title PT_Body</pre> <p>The Variant2 rule SHOULD NOT be used.</p>
SL_TitleBody	<pre>PlaceholderList = MasterVariant / SlideVariant MasterVariant = PT_MasterTitle PT_MasterBody PT_MasterDate PT_MasterFooter PT_MasterSlideNumber 3PT_None SlideVariant = PT_Title (PT_Body / PT_Table / PT_OrgChart / PT_Graph / PT_Object / PT_VerticalBody)6PT_None</pre>
SL_MasterTitle	<pre>PlaceholderList = PT_MasterCenterTitle PT_MasterSubTitle (Variant1 / Variant2) Variant1 = PT_MasterDate PT_MasterFooter PT_MasterSlideNumber 3PT_None Variant2 = 6PT_None</pre> <p>The Variant2 rule SHOULD NOT be used.</p>
SL_TitleOnly	<pre>PlaceholderList = PT_Title 7PT_None</pre>
SL_TwoColumns	<pre>PlaceholderList = PT_Title (BodyBody / BodyGraph / GraphBody / BodyClipart / ClipartBody / BodyObject / ObjectBody / BodyMedia / MediaBody / ClipartVBody / ObjectObject) 5PT_None</pre>

Value of geom.	Value of rgPlaceholderTypes
	BodyBody = PT_Body PT_Body BodyGraph = PT_Body PT_Graph GraphBody = PT_Graph PT_Body BodyClipart = PT_Body PT_ClipArt ClipartBody = PT_ClipArt PT_Body BodyObject = PT_Body PT_Object ObjectBody = PT_Object PT_Body BodyMedia = PT_Body PT_Media MediaBody = PT_Media PT_Body ClipartVBody = PT_ClipArt PT_VerticalBody ObjectObject = PT_Object PT_Object
SL_TwoRows	PlaceholderList = PT_Title (BodyObject / ObjectBody) 5PT_None BodyObject = PT_Body PT_Object ObjectBody = PT_Object PT_Body
SL_ColumnTwoRows	PlaceholderList = PT_Title (PT_Body / PT_Object) 2PT_Object 4PT_None
SL_TwoRowsColumn	PlaceholderList = PT_Title 2PT_Object (PT_Body / PT_Object) 4PT_None
SL_TwoColumnsRow	PlaceholderList = PT_Title 2PT_Object PT_Body 4PT_None
SL_FourObjects	PlaceholderList = PT_Title 4PT_Object 3PT_None
SL_BigObject	PlaceholderList = PT_Object 7PT_None
SL_Blank	PlaceholderList = AllBlank / BlankVariants AllBlank = 8PT_None BlankVariants = PT_Title (Variant1 / Variant2 / Variant3 / Variant4) 3PT_None Variant1 = PT_Body 3PT_None Variant2 = PT_Body PT_Object PT_Body PT_Object Variant3 = PT_Object PT_Body 2PT_None Variant4 = PT_Picture PT_Body 2PT_None The BlankVariants, Variant1, Variant2, Variant3, and Variant4 rules SHOULD NOT be used.
SL_VerticalTitleBody	PlaceholderList = PT_VerticalTitle PT_VerticalBody 6PT_None
SL_VerticalTwoRows	PlaceholderList = PT_VerticalTitle PT_VerticalBody PT_Graph

Value of geom.	Value of rgPlaceholderTypes
	5PT_None

masterIdRef (4 bytes): A [MasterIdRef](#) that specifies the identifier for the main master slide or title master slide that the *corresponding slide* follows. The value 0x00000000 specifies that the *corresponding slide* does not follow a main master slide or a title master slide. It MUST NOT be 0x00000000 if the record that contains this **SlideAtom** record is a **SlideContainer** section. It MUST be 0x00000000 if the record that contains this **SlideAtom** record is a **MainMasterContainer** record.

notesIdRef (4 bytes): A [NotesIdRef](#) that specifies the identifier for the **notes slide** of the *corresponding slide*. The value 0x00000000 specifies that no notes slide exists. It MUST be 0x00000000 if the record that contains this **SlideAtom** record is a **MainMasterContainer** record.

slideFlags (2 bytes): A [SlideFlags](#) structure that specifies which content the *corresponding slide* follows from its main master slide.

unused (2 bytes): Undefined and MUST be ignored.

2.5.11 SlideFlags

Referenced by: [NotesAtom](#), [SlideAtom](#)

A structure that specifies information about a **presentation slide** and its relationship with its **main master slide** or **title master slide**; or about a **notes slide** and its relationship with its **notes master slide**.

Let the *corresponding slide* be specified by the **SlideContainer** record (section [2.5.1](#)), **MainMasterContainer** record (section [2.5.3](#)), or **NotesContainer** record (section [2.5.6](#)) that contains this SlideFlags structure.

0	1	2	3	4	5	6	7	8	9	10	11	12	13	14	15	16	17	18	19	20	21	22	23	24	25	26	27	28	29	30	31
A	B	C	reserved																												

A - fMasterObjects (1 bit): A bit that specifies whether the *corresponding slide* inherits objects from its main master slide, title master slide, or notes master slide.

B - fMasterScheme (1 bit): A bit that specifies whether the *corresponding slide* inherits the **color scheme** from its main master slide, title master slide, or notes master slide.

C - fMasterBackground (1 bit): A bit that specifies whether the *corresponding slide* inherits the background from its main master slide, title master slide, or notes master slide.

reserved (13 bits): MUST be zero, and MUST be ignored.

2.5.12 NotesAtom

Referenced by: [NotesContainer](#)

An **atom record** that specifies information about a **notes slide** or **notes master slide**.

0	1	2	3	4	5	6	7	8	9	10	11	12	13	14	15	16	17	18	19	20	21	22	23	24	25	26	27	28	29	30	31
rh																															
...																															
slideIdRef																															
slideFlags																unused															

rh (8 bytes): A **RecordHeader** structure (section [2.3.1](#)) that specifies the header for this record. Sub-fields are further specified in the following table.

Field	Meaning
rh.recVer	MUST be 0x1.
rh.recInstance	MUST be 0x000.
rh.recType	MUST be RT_NotesAtom .
rh.recLen	MUST be 0x00000008.

slideIdRef (4 bytes): A **SlideIdRef** (section [2.2.25](#)) that specifies the **presentation slide** associated with the notes slide. It MUST be 0x00000000 if the **NotesContainer** record (section 2.5.6) that contains this **NotesAtom** record represents the notes master slide. It MUST NOT be 0x00000000 if the **NotesContainer** record that contains this **NotesAtom** record represents a notes slide.

slideFlags (2 bytes): A [SlideFlags](#) structure that specifies which content on the notes slide follows content on the notes master slide. It MUST be 0x0000 if **slideIdRef** is 0x00000000.

unused (2 bytes): Undefined and MUST be ignored.

2.5.13 DrawingContainer

Referenced by: [HandoutContainer](#), [MainMasterContainer](#), [NotesContainer](#), [SlideContainer](#)

A **container record** that specifies drawing information for a **slide**.

0	1	2	3	4	5	6	7	8	9	10	11	12	13	14	15	16	17	18	19	20	21	22	23	24	25	26	27	28	29	30	31
rh																															
...																															
OfficeArtDg (variable)																															
...																															

rh (8 bytes): A **RecordHeader** structure (section [2.3.1](#)) that specifies the header for this record. Sub-fields are further specified in the following table.

Field	Meaning
rh.recVer	MUST be 0xF.
rh.recInstance	MUST be 0x000.
rh.recType	MUST be RT_Drawing .

OfficeArtDg (variable): An **OfficeArtDgContainer** ([\[MS-ODRAW\]](#) section 2.2.13) that specifies drawing information for a slide.

2.5.14 SlideSchemeColorSchemeAtom

Referenced by: [HandoutContainer](#), [MainMasterContainer](#), [NotesContainer](#), [SlideContainer](#)

A **container record** that specifies the **color scheme** used by a **slide**.

0	1	2	3	4	5	6	7	8	9	10	11	12	13	14	15	16	17	18	19	20	21	22	23	24	25	26	27	28	29	30	31
rh																															
...																															
rgSchemeColor (32 bytes)																															
...																															
...																															

rh (8 bytes): A **RecordHeader** structure (section [2.3.1](#)) that specifies the header for this record. Sub-fields are further specified in the following table.

Field	Meaning
rh.recVer	MUST be 0x0.
rh.recInstance	MUST be 0x001.
rh.recType	MUST be RT_ColorSchemeAtom .
rh.recLen	MUST be 0x00000020.

rgSchemeColor (32 bytes): An array of [ColorStruct](#) structures that specifies a list of colors in the color scheme. The count of items in this array MUST be 8.

2.5.15 SchemeListElementColorSchemeAtom

Referenced by: [MainMasterContainer](#)

A **container record** that specifies a **color scheme** in a list of available color schemes.

0	1	2	3	4	5	6	7	8	9	10	11	12	13	14	15	16	17	18	19	20	21	22	23	24	25	26	27	28	29	30	31
rh																															

...
rgSchemeColor (32 bytes)
...
...

rh (8 bytes): A **RecordHeader** structure (section [2.3.1](#)) that specifies the header for this record. Sub-fields are further specified in the following table.

Field	Meaning
rh.recVer	MUST be 0x0.
rh.recInstance	MUST be 0x006.
rh.recType	MUST be RT_ColorSchemeAtom .
rh.recLen	MUST be 0x00000020.

rgSchemeColor (32 bytes): An array of [ColorStruct](#) structures that specifies a list of colors in the color scheme. The count of items in this array MUST be 8.

2.5.16 PerSlideHeadersFootersContainer

Referenced by: [MainMasterContainer](#), [SlideContainer](#)

A **container record** that specifies information about the **headers** and **footers** within a **slide**.

0	1	2	3	4	5	6	7	8	9	10	11	12	13	14	15	16	17	18	19	20	21	22	23	24	25	26	27	28	29	30	31
rh																															
...																															
hfAtom																															
...																															
...																															
userDateAtom (variable)																															
...																															
footerAtom (variable)																															
...																															

rh (8 bytes): A **RecordHeader** structure (section [2.3.1](#)) that specifies the header for this record. Sub-fields are further specified in the following table.

Field	Meaning
rh.recVer	MUST be 0xF.
rh.recInstance	MUST be 0x000.
rh.recType	MUST be RT-HeadersFooters .

hfAtom (12 bytes): A [HeadersFootersAtom](#) record that specifies the options for displaying headers and footers.

userDataAtom (variable): An optional [UserDataAtom](#) record that specifies the custom date to be used in the date field.

footerAtom (variable): An optional [FooterAtom](#) record that specifies the text that is used in the footer.

2.5.17 SlideNameAtom

Referenced by: [HandoutContainer](#), [MainMasterContainer](#), [NotesContainer](#), [SlideContainer](#)

An **atom record** that specifies the name of a **slide**.

0	1	2	3	4	5	6	7	8	9	10	1	2	3	4	5	6	7	8	9	20	1	2	3	4	5	6	7	8	9	30	1
rh																															
...																															
slideName (variable)																															
...																															

rh (8 bytes): A **RecordHeader** structure (section [2.3.1](#)) that specifies the header for this record. Sub-fields are further specified in the following table.

Field	Meaning
rh.recVer	MUST be 0x0.
rh.recInstance	MUST be 0x003.
rh.recType	MUST be RT_CString (section 2.13.24).
rh.recLen	MUST be an even number.

slideName (variable): A [UnicodeString](#) that specifies the name of a slide. The length, in bytes, of the field is specified by **rh.recLen**.

2.5.18 TemplateNameAtom

Referenced by: [MainMasterContainer](#)

An **atom record** that specifies the name of a **main master slide** design.

0	1	2	3	4	5	6	7	8	9	10	11	12	13	14	15	16	17	18	19	20	21	22	23	24	25	26	27	28	29	30	31
rh																															
...																															
templateName (variable)																															
...																															

rh (8 bytes): A **RecordHeader** structure (section [2.3.1](#)) that specifies the header for this record. Sub-fields are further specified in the following table.

Field	Meaning
rh.recVer	MUST be 0x0.
rh.recInstance	MUST be 0x002.
rh.recType	MUST be RT_CString (section 2.13.24).
rh.recLen	MUST be an even number. It MUST be less than or equal to 4168.

templateName (variable): A [UnicodeString](#) that specifies the name of a main master slide design. The length, in bytes, of the field is specified by **rh.recLen**.

2.5.19 SlideProgTagsContainer

Referenced by: [HandoutContainer](#), [MainMasterContainer](#), [NotesContainer](#), [SlideContainer](#)

A **container record** that specifies **programmable tags** with additional slide data.

0	1	2	3	4	5	6	7	8	9	10	11	12	13	14	15	16	17	18	19	20	21	22	23	24	25	26	27	28	29	30	31
rh																															
...																															
rgChildRec (variable)																															
...																															

rh (8 bytes): **rh (8 bytes):** A **RecordHeader** structure (section [2.3.1](#)) that specifies the header for this record. Sub-fields are further specified in the following table.

Field	Meaning
rh.recVer	MUST be 0xF.
rh.recInstance	MUST be 0x000.
rh.recType	MUST be RT_ProgTags (section 2.13.24).

rgChildRec (variable): An array of [SlideProgTagsSubContainerOrAtom](#) records that specifies additional slide data. The size, in bytes, of the array is specified by **rh.recLen**. The array MUST NOT contain more than one of each of the following records: [PP9SlideBinaryTagExtension](#), [PP10SlideBinaryTagExtension](#), or [PP12SlideBinaryTagExtension](#).

2.5.20 SlideProgTagsSubContainerOrAtom

Referenced by: [SlideProgTagsContainer](#)

A variable type record whose type and meaning are dictated by the value of **rh.recType**, as specified in the following table.

Value	Meaning
RT_ProgStringTag	A ProgStringTagContainer record that specifies additional slide data.
RT_ProgBinaryTag	A SlideProgBinaryTagContainer record that specifies additional slide data.

2.5.21 SlideProgBinaryTagContainer

Referenced by: [SlideProgTagsSubContainerOrAtom](#)

A **container record** that specifies **programmable tags** with additional binary slide data.

0	1	2	3	4	5	6	7	8	9	10	11	12	13	14	15	16	17	18	19	20	21	22	23	24	25	26	27	28	29	30	31
rh																															
...																															
rec (variable)																															
...																															

rh (8 bytes): A **RecordHeader** structure (section [2.3.1](#)) that specifies the header for this record. Sub-fields are further specified in the following table.

Field	Meaning
rh.recVer	MUST be 0xF.
rh.recInstance	MUST be 0x000.
rh.recType	MUST be RT_ProgBinaryTag .

rec (variable): A [SlideProgBinaryTagSubContainerOrAtom](#) record that specifies additional slide data.

2.5.22 SlideProgBinaryTagSubContainerOrAtom

Referenced by: [SlideProgBinaryTagContainer](#)

A variable type record whose type and meaning are dictated by the value of **tagNameAtom.tagName** for [UnknownBinaryTag](#) or by the value of **tagName** for [PP9SlideBinaryTagExtension](#), [PP10SlideBinaryTagExtension](#), [PP12SlideBinaryTagExtension](#), as specified in the following table.

Value	Meaning
"__PPT9"	A PP9SlideBinaryTagExtension record pair that specifies additional slide data. It MAY <81> be ignored and MUST be preserved.
"__PPT10"	A PP10SlideBinaryTagExtension record pair that specifies additional slide data. It MAY <82> be ignored and MUST be preserved.
"__PPT12"	A PP12SlideBinaryTagExtension record pair that specifies additional slide data. It MAY <83> be ignored and MUST be preserved.
Any other value	An UnknownBinaryTag record pair that specifies additional slide data. It MUST be ignored and MUST be preserved.

2.5.23 PP9SlideBinaryTagExtension

Referenced by: [SlideProgBinaryTagSubContainerOrAtom](#)

A pair of **atom records** that specifies a **programmable tag** with additional slide data.

0	1	2	3	4	5	6	7	8	9	10	11	12	13	14	15	16	17	18	19	20	21	22	23	24	25	26	27	28	29	30	31
rh																															
...																															
tagName (14 bytes)																															
...																															
...																															
...																rhData															
...																															
...																rgTextMasterStyleAtom (variable)															
...																															

rh (8 bytes): A **RecordHeader** structure (section [2.3.1](#)) that specifies the header for the first record. Sub-fields are further specified in the following table.

Field	Meaning
rh.recVer	MUST be 0x0.
rh.recInstance	MUST be 0x000.
rh.recType	MUST be RT_CString (section 2.13.24).
rh.recLen	MUST be 0x0000000E.

tagName (14 bytes): A **PrintableUnicodeString** string (section [2.2.23](#)) that specifies the programmable tag name. It MUST be "__PPT9".

rhData (8 bytes): A **RecordHeader** structure (section 2.3.1) that specifies the header for the second record. Sub-fields are further specified in the following table.

Field	Meaning
rhData.recVer	MUST be 0x0.
rhData.recInstance	MUST be 0x000.
rhData.recType	MUST be RT_BinaryTagDataBlob.

rgTextMasterStyleAtom (variable): An array of [TextMasterStyle9Atom](#) records that specifies additional character-level and paragraph-level formatting of master slides. The size, in bytes, of the array is specified by **rhData.recLen**.

2.5.24 PP10SlideBinaryTagExtension

Referenced by: [SlideProgBinaryTagSubContainerOrAtom](#)

A pair of **atom records** that specifies a **programmable tag** with additional slide data.

0	1	2	3	4	5	6	7	8	9	10	11	12	13	14	15	16	17	18	19	20	21	22	23	24	25	26	27	28	29	30	31
rh																															
...																															
tagName (16 bytes)																															
...																															
...																															
rhData																															
...																															
rgTextMasterStyleAtom (variable)																															
...																															
rgComment10Container (variable)																															
...																															
linkedSlideAtom (16 bytes, optional)																															
...																															
...																															
rgLinkedShape10Atom (variable)																															

...
slideFlagsAtom (optional)
...
...
slideTimeAtom (16 bytes, optional)
...
...
hashCodeAtom (optional)
...
...
extTimeNodeContainer (variable)
...
buildListContainer (variable)
...

rh (8 bytes): A **RecordHeader** structure (section [2.3.1](#)) that specifies the header for the first record. Sub-fields are further specified in the following table.

Field	Meaning
rh.recVer	MUST be 0x0.
rh.recInstance	MUST be 0x000.
rh.recType	MUST be RT_CString (section 2.13.24).
rh.recLen	MUST be 0x00000010.

tagName (16 bytes): A **PrintableUnicodeString** string (section [2.2.23](#)) that specifies the programmable tag name. It MUST be "___PPT10".

rhData (8 bytes): A **RecordHeader** structure (section [2.3.1](#)) that specifies the header for the second record. Sub-fields are further specified in the following table.

Field	Meaning
rhData.recVer	MUST be 0x0.
rhData.recInstance	MUST be 0x000.
rhData.recType	MUST be RT_BinaryTagDataBlob.

rgTextMasterStyleAtom (variable): An array of [TextMasterStyle10Atom](#) records that specifies additional character-level and paragraph-level formatting of master slides. The array continues while **rh.recType** of the TextMasterStyle10Atom item is equal to RT_TextMasterStyle10Atom.

rgComment10Container (variable): An array of [Comment10Container](#) records that specifies **presentation comments**. The array continues while **rh.recType** of the Comment10Container item is equal to RT_Comment10.

linkedSlideAtom (16 bytes): An optional [LinkedSlide10Atom](#) record that specifies a link to a slide used to display the changes to the slide made by a reviewer. It SHOULD [<84>](#) be ignored and SHOULD [<85>](#) be omitted.

rgLinkedShape10Atom (variable): An optional array of [LinkedShape10Atom](#) records. The count of items in the array is specified by **linkedSlideAtom.cLinkedShapes**. The array specifies links to shapes used to display the changes of the slide made by a reviewer. It SHOULD [<86>](#) be ignored and SHOULD [<87>](#) be omitted.

slideFlagsAtom (12 bytes): An optional [SlideFlags10Atom](#) record that specifies slide-level flags.

slideTimeAtom (16 bytes): An optional [SlideTime10Atom](#) record that specifies the slide creation timestamp.

hashCodeAtom (12 bytes): An optional [HashCode10Atom](#) record that specifies a hash code for the animations on the slide.

extTimeNodeContainer (variable): An optional **ExtTimeNodeContainer** record (section [2.8.15](#)) that specifies slide animation timing data.

buildListContainer (variable): An optional [BuildListContainer](#) record that specifies slide animation **build** data.

2.5.25 Comment10Container

Referenced by: [PP10SlideBinaryTagExtension](#)

A **container record** that specifies a **presentation comment**.

0	1	2	3	4	5	6	7	8	9	10	11	12	13	14	15	16	17	18	19	20	21	22	23	24	25	26	27	28	29	30	31
rh																															
...																															
commentAuthorAtom (variable)																															
...																															
commentTextAtom (variable)																															
...																															
commentAuthorInitialsAtom (variable)																															
...																															

commentAtom (36 bytes)
...
...

rh (8 bytes): A **RecordHeader** structure (section [2.3.1](#)) that specifies the header for this record. Sub-fields are further specified in the following table.

Field	Meaning
rh.recVer	MUST be 0xF.
rh.recInstance	MUST be 0x000.
rh.recType	MUST be RT_Comment10 .

commentAuthorAtom (variable): An optional [Comment10AuthorAtom](#) record that specifies the name of the author of the presentation comment.

commentTextAtom (variable): An optional [Comment10TextAtom](#) record that specifies the text of the presentation comment.

commentAuthorInitialsAtom (variable): An optional [Comment10AuthorInitialAtom](#) record that specifies the initials of the author of the presentation comment.

commentAtom (36 bytes): A [Comment10Atom](#) record that specifies the settings for displaying the presentation comment.

2.5.26 Comment10AuthorAtom

Referenced by: [Comment10Container](#)

An **atom record** that specifies the name of the author of the **presentation comment**. The presentation comment is specified by the [Comment10Container](#) record that contains this **Comment10AuthorAtom** record.

0	1	2	3	4	5	6	7	8	9	10	11	12	13	14	15	16	17	18	19	20	21	22	23	24	25	26	27	28	29	30	31
rh																															
...																															
commentAuthor (variable)																															
...																															

rh (8 bytes): A **RecordHeader** structure (section [2.3.1](#)) that specifies the header for this record. Sub-fields are further specified in the following table.

Field	Meaning
rh.recVer	MUST be 0x0.
rh.recInstance	MUST be 0x000.
rh.recType	MUST be an RT_CString (section 2.13.24).

Field	Meaning
rh.recLen	MUST be an even number. It MUST be less than or equal to 104.

commentAuthor (variable): A **PrintableUnicodeString** (section [2.2.23](#)) that specifies the name of the author. The length, in bytes, of the field is specified by **rh.recLen**.

2.5.27 Comment10TextAtom

Referenced by: [Comment10Container](#)

An **atom record** that specifies the text of the **presentation comment**. The presentation comment is specified by the Comment10Container record that contains this **Comment10TextAtom** record.

0	1	2	3	4	5	6	7	8	9	10	11	12	13	14	15	16	17	18	19	20	21	22	23	24	25	26	27	28	29	30	31
rh																															
...																															
commentText (variable)																															
...																															

rh (8 bytes): A **RecordHeader** structure (section [2.3.1](#)) that specifies the header for this record. Sub-fields are further specified in the following table.

Field	Meaning
rh.recVer	MUST be 0x0.
rh.recInstance	MUST be 0x001.
rh.recType	MUST be an RT_CString (section 2.13.24).
rh.recLen	MUST be an even number. It MUST be less than or equal to 64000.

commentText (variable): A [TabCrLfPrintableUnicodeString](#) that specifies the text for the presentation comment. The length, in bytes, of the field is specified by **rh.recLen**.

2.5.28 Comment10AuthorInitialAtom

Referenced by: [Comment10Container](#)

An **atom record** that specifies the initials of the author of the **presentation comment**. The presentation comment is specified by the Comment10Container record that contains this **Comment10AuthorInitialAtom** record.

0	1	2	3	4	5	6	7	8	9	10	11	12	13	14	15	16	17	18	19	20	21	22	23	24	25	26	27	28	29	30	31
rh																															

...
commentAuthorInitials (variable)
...

rh (8 bytes): A **RecordHeader** structure (section [2.3.1](#)) that specifies the header for this record. Sub-fields are further specified in the following table.

Field	Meaning
rh.recVer	MUST be 0x0.
rh.recInstance	MUST be 0x002.
rh.recType	MUST be an RT_CString (section 2.13.24).
rh.recLen	MUST be an even number. It MUST be less than or equal to 104.

commentAuthorInitials (variable): A **PrintableUnicodeString** (section [2.2.23](#)) that specifies the initials of the author of the presentation comment. The length, in bytes, of the field is specified by **rh.recLen**.

2.5.29 Comment10Atom

Referenced by: [Comment10Container](#)

An **atom record** that specifies the settings for displaying a **presentation comment**. The presentation comment is specified by the **Comment10Container** record that contains this **Comment10Atom** record.

0	1	2	3	4	5	6	7	8	9	10	11	12	13	14	15	16	17	18	19	20	21	22	23	24	25	26	27	28	29	30	31
rh																															
...																															
index																															
datetime (16 bytes)																															
...																															
...																															
anchor																															
...																															

rh (8 bytes): A **RecordHeader** structure (section [2.3.1](#)) that specifies the header for this record. Sub-fields are further specified in the following table.

Field	Meaning
rh.recVer	MUST be 0x0.
rh.recInstance	MUST be 0x000.
rh.recType	MUST be an RT_Comment10Atom .
rh.recLen	MUST be 0x0000001C.

index (4 bytes): A signed integer that specifies the index of the presentation comment. The index is part of the presentation comment label. It MUST be greater than or equal to zero.

datetime (16 bytes): A [DateTimeStruct](#) structure that specifies the creation time of the presentation comment.

anchor (8 bytes): A **PointStruct** structure (section [2.12.5](#)) that specifies the location of the presentation comment label in **master units**, relative to the top-left corner of the **slide**.

2.5.30 SlideFlags10Atom

Referenced by: [PP10SlideBinaryTagExtension](#)

An **atom record** that specifies slide-level flags.

0	1	2	3	4	5	6	7	8	9	10	11	12	13	14	15	16	17	18	19	20	21	22	23	24	25	26	27	28	29	30	31
rh																															
...																															
A	B	unused																													

rh (8 bytes): A **RecordHeader** structure (section [2.3.1](#)) that specifies the header for this record. Sub-fields are further specified in the following table.

Field	Meaning
rh.recVer	MUST be 0x0.
rh.recInstance	MUST be 0x000.
rh.recType	MUST be an RT_SlideFlags10Atom .
rh.recLen	MUST be 0x00000004.

A - fPreserveMaster (1 bit): A bit that specifies whether to preserve the **main master slide** or **title master slide** when there is no slide that follows it. It MUST be ignored if the slide is not a main master slide or title master slide.

B - fOverrideMasterAnimation (1 bit): A bit that specifies whether the slide does not follow the animations on the main master slide or title master slide.

unused (30 bits): Undefined and MUST be ignored.

2.5.31 SlideTime10Atom

Referenced by: [PP10SlideBinaryTagExtension](#)

An **atom record** that specifies the slide creation time stamp.

0	1	2	3	4	5	6	7	8	9	10	11	12	13	14	15	16	17	18	19	20	21	22	23	24	25	26	27	28	29	30	31
rh																															
...																															
fileTime																															
...																															

rh (8 bytes): A **RecordHeader** structure (section [2.3.1](#)) that specifies the header for this record. Sub-fields are further specified in the following table.

Field	Meaning
rh.recVer	MUST be 0x0.
rh.recInstance	MUST be 0x000.
rh.recType	MUST be RT_SlideTime10Atom .
rh.recLen	MUST be 0x00000008.

fileTime (8 bytes): A **FILETIME** structure, as specified in [\[MS-DTYP\]](#) section [2.3.3](#), that specifies the time of slide creation.

2.5.32 LinkedSlide10Atom

Referenced by: [PP10SlideBinaryTagExtension](#)

An **atom record** that specifies a reference to a **presentation slide** and a count of [LinkedShape10Atom](#) records.

Let the *corresponding main document* be specified by the document that contains both the *corresponding linked document* and the *corresponding reviewer document*.

Let the *corresponding linked document* be specified as follows:

- Let the *corresponding main master slide* be specified by the **MainMasterContainer** record (section [2.5.3](#)) that is specified by the first **MasterPersistAtom** record (section [2.4.14.2](#)) in the **MasterListWithTextContainer** record (section [2.4.14.1](#)) in the *corresponding main document*.
- Let the *corresponding shape* be specified by the **OfficeArtSpContainer** record ([\[MS-ODRAW\]](#) section 2.2.14) such that the **wzName_complex** property ([\[MS-ODRAW\]](#) section 2.3.4.2) matches the string "Linked". The *corresponding shape* is contained by the **drawing** field of the *corresponding main master slide*.
- Let the *corresponding OLE object* be specified by the **ExOleEmbedContainer** record (section [2.10.27](#)) whose **exOleObjAtom.exObjId** field matches the **exObjIdRef** field of the [ExObjRefAtom](#) record that is contained within the *corresponding shape*. Let the *corresponding linked document* be the *corresponding OLE object* so specified.

Let the *corresponding reviewer document* be specified as follows:

- Let the *corresponding main master slide* be specified by the **MainMasterContainer** record that is specified by the first **MasterPersistAtom** record (section 2.4.14.2) in the **MasterListWithTextContainer** record (section 2.4.14.1) in the *corresponding main document*.
- Let the *corresponding shape* be specified by the **OfficeArtSpContainer** record ([MS-ODRAW] section 2.2.14) such that the **wzName_complex** property ([MS-ODRAW] section 2.3.4.2) matches the string "Reviewer". The *corresponding shape* is contained by the **drawing** field of the *corresponding main master slide*.
- Let the *corresponding OLE object* be specified by the **ExOleEmbedContainer** record whose **exOleObjAtom.exObjId** field matches the **exObjIdRef** field of the ExObjRefAtom record that is contained within the *corresponding shape*. Let the *corresponding reviewer document* be the *corresponding OLE object* so specified.

Let the *corresponding base document* be specified as follows:

- Let the *corresponding main master slide* be specified by the **MainMasterContainer** record that is specified by the first **MasterPersistAtom** record (section 2.4.14.2) in the **MasterListWithTextContainer** record (section 2.4.14.1) in the *corresponding reviewer document*.
- Let the *corresponding shape* be specified by the **OfficeArtSpContainer** record ([MS-ODRAW] section 2.2.14) such that the **wzName_complex** property ([MS-ODRAW] section 2.3.4.2) matches the string "Base". The *corresponding shape* is contained by the **drawing** field of the *corresponding main master slide*.
- Let the *corresponding OLE object* be specified by the **ExOleEmbedContainer** record whose **exOleObjAtom.exObjId** field matches the **exObjIdRef** field of the ExObjRefAtom record that is contained within the *corresponding shape*. Let the *corresponding base document* be the *corresponding OLE object* so specified.

If this **LinkedSlide10Atom** record is contained within the *corresponding main document*, let the *associated document* be specified by the *corresponding linked document*; or if this **LinkedSlide10Atom** record is contained within the *corresponding reviewer document*, let the *associated document* be specified by the *corresponding main document*; or if this **LinkedSlide10Atom** record is contained within the *corresponding base document*, let the *associated document* be specified by the *corresponding linked document*.

0	1	2	3	4	5	6	7	8	9	10	1	2	3	4	5	6	7	8	9	20	1	2	3	4	5	6	7	8	9	30	1
rh																															
...																															
linkedSlideIdRef																															
cLinkedShapes																															

rh (8 bytes): A **RecordHeader** structure (section 2.3.1) that specifies the header for this record. Sub-fields are further specified in the following table.

Field	Meaning
rh.recVer	MUST be 0x0.
rh.recInstance	MUST be 0x000.
rh.recType	MUST be RT_LinkedSlide10Atom .
rh.recLen	MUST be 0x00000008.

linkedSlideIdRef (4 bytes): A **SlideIdRef** (section [2.2.25](#)) that specifies a reference to a presentation slide in the *associated document*.

cLinkedShapes (4 bytes): A **signed integer** that specifies the count of **LinkedShape10Atom** records in the **rgLinkedShape10Atom** field of the **PP10SlideBinaryTagExtension** record that contains this **LinkedSlide10Atom** record.

2.5.33 LinkedShape10Atom

Referenced by: [PP10SlideBinaryTagExtension](#)

An **atom record** that specifies a **shape** in a **presentation slide** that contains this **LinkedShape10Atom** record and its *associated shape* from the *associated presentation slide* that is contained within the *associated document*.

Let the *corresponding slide* be specified by the **SlideContainer** record (section [2.5.1](#)) that contains this **LinkedShape10Atom** record.

Let the *associated document* be as specified by the [LinkedSlide10Atom](#) record contained within the **PP10SlideBinaryTagExtension** record pair that contains this **LinkedShape10Atom** record.

Let the *associated presentation slide* contained within the *associated document* be specified by the **linkedSlideIdRef** field of the **LinkedSlide10Atom** record in the **PP10SlideBinaryTagExtension** record pair that contains this **LinkedShape10Atom** record.

Let the *associated shape* contained within the *associated presentation slide* be specified by the **linkedShapeIdRef** field of this **LinkedShape10Atom**.

0	1	2	3	4	5	6	7	8	9	10	11	12	13	14	15	16	17	18	19	20	21	22	23	24	25	26	27	28	29	30	31
rh																															
...																															
shapeIdRef																															
linkedShapeIdRef																															

rh (8 bytes): A **RecordHeader** structure (section [2.3.1](#)) that specifies the header for this record. Sub-fields are further specified in the following table.

Field	Meaning
rh.recVer	MUST be 0x0.
rh.recInstance	MUST be 0x000.
rh.recType	MUST be RT_LinkedShape10Atom .
rh.recLen	MUST be 0x00000008.

shapeIdRef (4 bytes): An **unsigned integer** that specifies a reference to the **OfficeArtSpContainer** ([\[MS-ODRAW\]](#) section 2.2.14) contained within the *corresponding slide* such that the **shapeProp.spid** field matches the value of this field.

linkedShapeIdRef (4 bytes): An **unsigned integer** that specifies a reference to the **OfficeArtSpContainer** ([MS-ODRAW] section 2.2.14) contained within the *associated presentation slide* such that the **shapeProp.spid** field matches the value of this field.

2.5.34 PP12SlideBinaryTagExtension

Referenced by: [SlideProgBinaryTagSubContainerOrAtom](#)

A pair of **atom records** that specifies a **programmable tag** with additional slide data.

0	1	2	3	4	5	6	7	8	9	10	11	12	13	14	15	16	17	18	19	20	21	22	23	24	25	26	27	28	29	30	31
rh																															
...																															
tagName (16 bytes)																															
...																															
...																															
rhData																															
...																															
roundTripHeaderFooterDefaultsAtom (optional)																															
...																															
...																															

rh (8 bytes): A **RecordHeader** structure (section 2.3.1) that specifies the header for the first record. Sub-fields are further specified in the following table.

Field	Meaning
rh.recVer	MUST be 0x0.
rh.recInstance	MUST be 0x000.
rh.recType	MUST be RT_CString (section 2.13.24).
rh.recLen	MUST be 0x00000010.

tagName (16 bytes): A **PrintableUnicodeString** string (section 2.2.23) that specifies the programmable tag name. It MUST be "___PPT12".

rhData (8 bytes): A **RecordHeader** structure (section 2.3.1) that specifies the header for the second record. Sub-fields are further specified in the following table.

Field	Meaning
rhData.recVer	MUST be 0x0.
rhData.recInstance	MUST be 0x000.

Field	Meaning
rhData.recType	MUST be RT_BinaryTagDataBlob.

roundTripHeaderFooterDefaultsAtom (9 bytes): An optional [RoundTripHeaderFooterDefaults12Atom](#) record that specifies **headers** and **footers** data for a **main master slide**, **title master slide**, **handout master slide**, or **notes master slide**.

2.6 Slide Show Types

2.6.1 SlideShowDocInfoAtom

Referenced by: [DocumentContainer](#)

An **atom record** that specifies how a **slide show** is displayed.

0	1	2	3	4	5	6	7	8	9	10	11	12	13	14	15	16	17	18	19	20	21	22	23	24	25	26	27	28	29	30	31
rh																															
...																															
penColor																															
restartTime																															
startSlide																endSlide															
namedShow (64 bytes)																															
...																															
...																															
A	B	C	D	E	F	G	H	I	reserved											unused											

rh (8 bytes): A **RecordHeader** structure (section [2.3.1](#)) that specifies the header for this record. Sub-fields are further specified in the following table.

Field	Meaning
rh.recVer	MUST be 0x1.
rh.recInstance	MUST be 0x000.
rh.recType	MUST be RT_SlideShowDocInfoAtom .
rh.recLen	MUST be 0x00000050.

penColor (4 bytes): A [ColorIndexStruct](#) structure that specifies a color used to annotate **presentation slides** during a slide show.

restartTime (4 bytes): A **signed integer** that specifies an amount of time, in milliseconds, to wait during a period of inactivity before restarting a slide show in **kiosk mode**.

startSlide (2 bytes): A **signed integer** that specifies the one-based index of the slide with which the slide show starts. It MUST be greater than or equal to 0x0000. If **fUseSlideRange** is **TRUE**, it MUST NOT be set to 0x0000.

endSlide (2 bytes): A **signed integer** that specifies the one-based index of the slide with which the slide show ends. It MUST be greater than or equal to 0x0000. If **fUseSlideRange** is **TRUE**, it MUST NOT be set to 0x0000.

namedShow (64 bytes): A [char2](#) that specifies the name of a **named show** to use when running the slide show.

A - fAutoAdvance (1 bit): A bit that specifies whether to automatically advance to the next slide during a slide show based on timing information on the slide.

B - fWillSkipBuilds (1 bit): A bit that specifies whether to display animations during a slide show.

C - fUseSlideRange (1 bit): A bit that specifies whether to display only the slide range specified by the **startSlide** and **endSlide** fields during a slide show.

D - fDocUseNamedShow (1 bit): A bit that specifies whether the slides shown during a slide show are from the named show identified by **namedShow**. It MUST be ignored if **fUseSlideRange** is **TRUE**.

E - fBrowseMode (1 bit): A bit that specifies whether the slide show is presented in a way optimized for browsing. If **fBrowseMode** is **TRUE**, **fKioskMode** MUST be **FALSE**.

F - fKioskMode (1 bit): A bit that specifies whether the slide show is presented in a way optimized to run at a kiosk. If **fKioskMode** is **TRUE**, **fBrowseMode** MUST be **FALSE**.

G - fWillSkipNarration (1 bit): A bit that specifies whether to play slide audio narrations during a slide show.

H - fLoopContinuously (1 bit): A bit that specifies whether to restart the slide show at the beginning after advancing from the last slide.

I - fHideScrollBar (1 bit): A bit that specifies whether to display the navigational scroll bar during a slide show.

reserved (7 bits): MUST be zero and MUST be ignored.

unused (2 bytes): Undefined and MUST be ignored.

2.6.2 NamedShowsContainer

Referenced by: [DocumentContainer](#)

A **container record** that specifies the **named shows**.

0	1	2	3	4	5	6	7	8	9	10	11	12	13	14	15	16	17	18	19	20	21	22	23	24	25	26	27	28	29	30	31
rh																															
...																															
rgNamedShow (variable)																															
...																															

rh (8 bytes): A **RecordHeader** structure (section [2.3.1](#)) that specifies the header for this record. Sub-fields are further specified in the following table.

Field	Meaning
rh.recVer	MUST be 0xF.
rh.recInstance	MUST be 0x000.
rh.recType	MUST be RT_NamedShows .

rgNamedShow (variable): An array of [NamedShowContainer](#) records that specifies the named shows.

2.6.3 NamedShowContainer

Referenced by: [NamedShowsContainer](#)

A **container record** that specifies a **named show**.

0	1	2	3	4	5	6	7	8	9	10	11	12	13	14	15	16	17	18	19	20	21	22	23	24	25	26	27	28	29	30	31
rh																															
...																															
namedShowNameAtom (variable)																															
...																															
namedShowSlidesAtom (variable)																															
...																															

rh (8 bytes): A **RecordHeader** structure (section [2.3.1](#)) that specifies the header for this record. Sub-fields are further specified in the following table.

Field	Meaning
rh.recVer	MUST be 0xF.
rh.recInstance	MUST be 0x000.
rh.recType	MUST be RT_NamedShow .

namedShowNameAtom (variable): A [NamedShowNameAtom](#) record that specifies the name of this named show.

namedShowSlidesAtom (variable): An optional [NamedShowSlidesAtom](#) record that specifies the slides in this named show.

2.6.4 NamedShowNameAtom

Referenced by: [NamedShowContainer](#)

An **atom record** that specifies the name of a **named show**.

0	1	2	3	4	5	6	7	8	9	1	0	1	2	3	4	5	6	7	8	9	2	0	1	2	3	4	5	6	7	8	9	3	0	1
rh																																		
...																																		
namedShowName (variable)																																		
...																																		

rh (8 bytes): A **RecordHeader** structure (section [2.3.1](#)) that specifies the header for this record. Sub-fields are further specified in the following table.

Field	Meaning
rh.recVer	MUST be 0x0.
rh.recInstance	MUST be 0x000.
rh.recType	MUST be RT_CString (section 2.13.24).
rh.recLen	MUST be an even number.

namedShowName (variable): A **PrintableUnicodeString** (section [2.2.23](#)) that specifies the name of a named show that can be used when running the **slide show**.

2.6.5 NamedShowSlidesAtom

Referenced by: [NamedShowContainer](#)

An **atom record** that specifies the slide identifiers of **presentation slides** in a **named show**.

0	1	2	3	4	5	6	7	8	9	1	0	1	2	3	4	5	6	7	8	9	2	0	1	2	3	4	5	6	7	8	9	3	0	1
rh																																		
...																																		
rgSlideIdRef (variable)																																		
...																																		

rh (8 bytes): A **RecordHeader** structure (section [2.3.1](#)) that specifies the header for this record. Sub-fields are further specified in the following table.

Field	Meaning
rh.recVer	MUST be 0x0.
rh.recInstance	MUST be 0x000.
rh.recType	MUST be RT_NamedShowSlidesAtom .

rgSlideIdRef (variable): An array of **SlideIdRef** (section [2.2.25](#)) that specifies the slides that are in this named show. The order of the slides in this array is also the order for the slides in the named show. Any slides referenced here that do not exist in the presentation itself **MUST** be ignored.

2.6.6 SlideShowSlideInfoAtom

Referenced by: [MainMasterContainer](#), [SlideContainer](#)

An **atom record** that specifies what transition effect to perform during a **slide show**, and how to advance to the next **presentation slide**.

Let the *corresponding slide* be specified by the **SlideContainer** record (section 2.5.1) that contains this **SlideShowSlideInfoAtom** record.

0	1	2	3	4	5	6	7	8	9	10	1	2	3	4	5	6	7	8	9	20	1	2	3	4	5	6	7	8	9	30	1		
rh																																	
...																																	
slideTime																																	
soundIdRef																																	
effectDirection										effectType										A	B	C	D	E	F	G	H	I	J	K	L	M	N
speed										unused																							

rh (8 bytes): A **RecordHeader** structure (section [2.3.1](#)) that specifies the header for this record. Sub-fields are further specified in the following table:

Field	Meaning
rh.recVer	MUST be 0x0.
rh.recInstance	MUST be 0x000.
rh.recType	MUST be RT_SlideShowSlideInfoAtom .
rh.recLen	MUST be 0x00000010.



slideTime (4 bytes): A signed integer that specifies an amount of time, in milliseconds, to wait before advancing to the next presentation slide. It **MUST** be greater than or equal to 0 and less than or equal to 86399000. It **MUST** be ignored unless **fAutoAdvance** is **TRUE**.

soundIdRef (4 bytes): A [SoundIdRef](#) that specifies which sound to play when the transition starts.

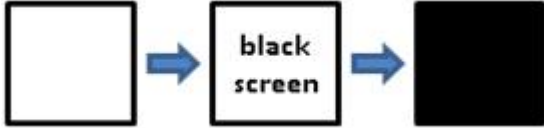
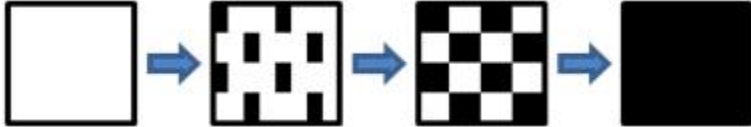

effectDirection (1 byte): A byte that specifies the variant of **effectType**. See the **effectType** field for further restriction and specification of this field.

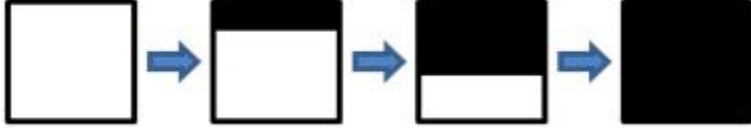
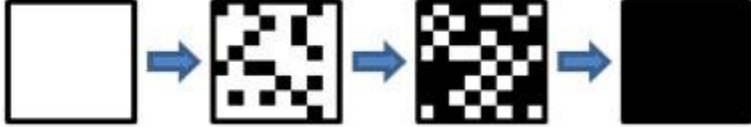

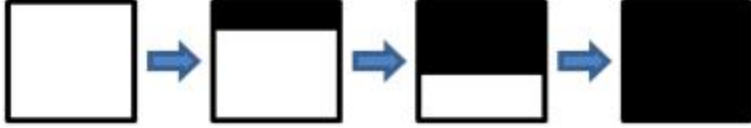
effectType (1 byte): A byte that specifies which transition is used when transitioning to the next presentation slide during a slide show. Any of the following samples are for sample purposes only. Exact rendering of any transition is determined by the rendering application. As such, the same transition can have many variations depending on the implementation.

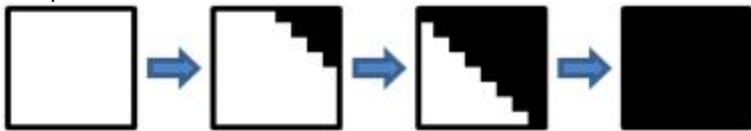
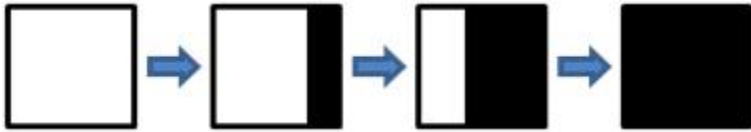
Value	Meaning
0	<p>Cut</p> <p>The following specifies the possible effectDirection values and their meanings:</p> <ul style="list-style-type: none"> ▪ 0x00: The transition is not made through black. (The effect is the same as no transition at all.) ▪ 0x01: The transition is made through black. <p>Sample of through black:</p> 
1	<p>Random effectDirection MUST be ignored.</p>
2	<p>Blinds</p> <p>The following specifies the possible effectDirection values and their meanings:</p> <ul style="list-style-type: none"> ▪ 0x00: Vertical ▪ 0x01: Horizontal
3	<p>Checker</p> <p>The following specifies the possible effectDirection values and their meanings:</p> <ul style="list-style-type: none"> ▪ 0x00: Horizontal ▪ 0x01: Vertical <p>Sample of Horizontal:</p> 
4	<p>Cover</p> <p>The following specifies the possible effectDirection values and their meanings:</p> <ul style="list-style-type: none"> ▪ 0x00: Left ▪ 0x01: Up ▪ 0x02: Right ▪ 0x03: Down ▪ 0x04: Left Up ▪ 0x05: Right Up ▪ 0x06: Left Down

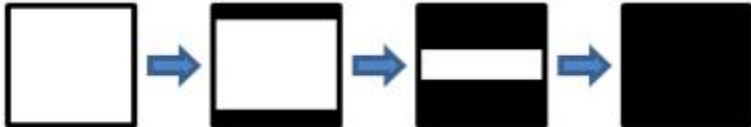
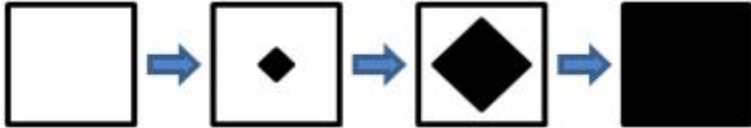
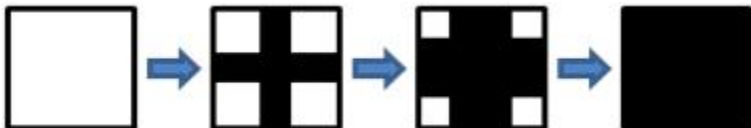
Value	Meaning
	<ul style="list-style-type: none"> ▪ 0x07: Right Down <p>Sample of Down:</p> 
5	<p>Dissolve</p>  <p>effectDirection MUST be 0x00.</p>
6	<p>Fade</p>  <p>effectDirection MUST be 0x00.</p>
7	<p>Uncover</p> <p>The following specifies the possible effectDirection values and their meanings:</p> <ul style="list-style-type: none"> ▪ 0x00: Left ▪ 0x01: Up ▪ 0x02: Right ▪ 0x03: Down ▪ 0x04: Left Up ▪ 0x05: Right Up ▪ 0x06: Left Down ▪ 0x07: Right Down <p>Sample of Down:</p> 
8	<p>Random Bars</p> <p>The following specifies the possible effectDirection values and their meanings:</p>

Value	Meaning
	<ul style="list-style-type: none"> ▪ 0x00: Horizontal ▪ 0x01: Vertical <p>Sample of Horizontal:</p> 
9	<p>Strips</p> <p>The following specifies the possible effectDirection values and their meanings:</p> <ul style="list-style-type: none"> ▪ 0x04: Left Up ▪ 0x05: Right Up ▪ 0x06: Left Down ▪ 0x07: Right Down <p>Sample of Left Down:</p> 
10	<p>Wipe</p> <p>The following specifies the possible effectDirection values and their meanings:</p> <ul style="list-style-type: none"> ▪ 0x00: Left ▪ 0x01: Up ▪ 0x02: Right ▪ 0x03: Down <p>Sample of Left:</p> 
11	<p>Box In/Out</p> <p>The following specifies the possible effectDirection values and their meanings:</p> <ul style="list-style-type: none"> ▪ 0x00: Out ▪ 0x01: In <p>Sample of In:</p>

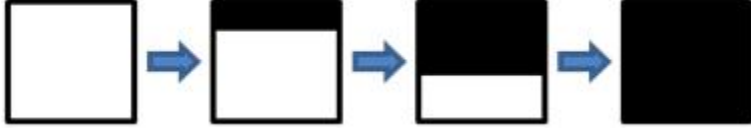
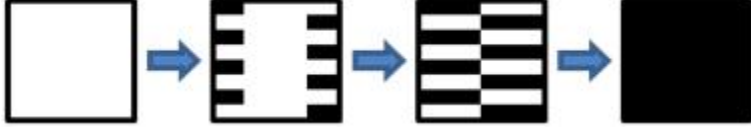
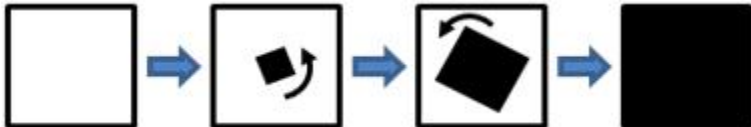
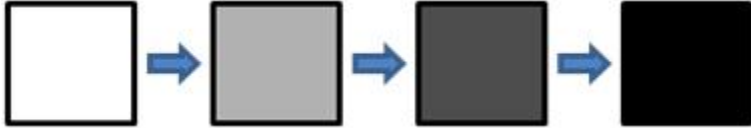
Value	Meaning
	
13	<p>Split</p> <p>The following specifies the possible effectDirection values and their meanings:</p> <ul style="list-style-type: none"> ▪ 0x00: Horizontally out ▪ 0x01: Horizontally in ▪ 0x02: Vertically out ▪ 0x03: Vertically in <p>Sample of Horizontally In:</p> 
17	<p>Diamond</p>  <p>effectDirection MUST be 0x00.</p>
18	<p>Plus</p>  <p>effectDirection MUST be 0x00.</p>
19	<p>Wedge</p>  <p>effectDirection MUST be 0x00.</p>
20	<p>Push</p> <p>The following specifies the possible effectDirection values and their meanings:</p> <ul style="list-style-type: none"> ▪ 0x00: Left

Value	Meaning
	<ul style="list-style-type: none"> ▪ 0x01: Up ▪ 0x02: Right ▪ 0x03: Down <p>Sample of Down:</p> 
21	<p>Comb</p> <p>The following specifies the possible effectDirection values and their meanings:</p> <ul style="list-style-type: none"> ▪ 0x00: Horizontal ▪ 0x01: Vertical <p>Sample of Horizontal:</p> 
22	<p>Newsflash</p>  <p>effectDirection MUST be 0x00.</p>
23	<p>AlphaFade</p>  <p>effectDirection MUST be 0x00.</p>
26	<p>Wheel</p> <p>Sample of 3:</p>  <p>effectDirection values refer to the number of radial divisions used in the effect. The value MUST be one of 0x01, 0x02, 0x03, 0x04, or 0x08.</p>

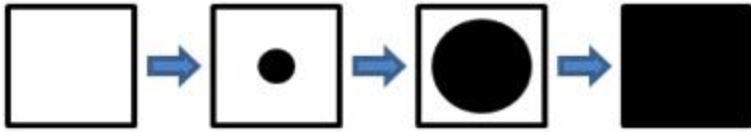
Value	Meaning
27	Circle  effectDirection MUST be 0x00.
255	Undefined and MUST be ignored.

A - fManualAdvance (1 bit): A bit that specifies whether the presentation slide can be manually advanced by the user during the slide show.

B - reserved1 (1 bit): MUST be zero and MUST be ignored.

C - fHidden (1 bit): A bit that specifies whether the *corresponding slide* is hidden and is not displayed during the slide show.

D - reserved2 (1 bit): MUST be zero and MUST be ignored.

E - fSound (1 bit): A bit that specifies whether to play the sound specified by **soundIfRef**.

F - reserved3 (1 bit): MUST be zero and MUST be ignored.

G - fLoopSound (1 bit): A bit that specifies whether the sound specified by **soundIdRef** is looped continuously when playing until the next sound plays.

H - reserved4 (1 bit): MUST be zero and MUST be ignored.

I - fStopSound (1 bit): A bit that specifies whether to stop any currently playing sound when the transition starts.

J - reserved5 (1 bit): MUST be zero and MUST be ignored.

K - fAutoAdvance (1 bit): A bit that specifies whether the slide will automatically advance after **slideTime** milliseconds during the slide show.

L - reserved6 (1 bit): MUST be zero and MUST be ignored.

M - fCursorVisible (1 bit): A bit that specifies whether to display the cursor during the slide show.

N - reserved7 (3 bits): MUST be zero and MUST be ignored.

speed (1 byte): A byte value that specifies how long the transition takes to run.

Value	Meaning
0x00	0.75 seconds
0x01	0.5 seconds
0x02	0.25 seconds

unused (3 bytes): Undefined and MUST be ignored.

2.6.7 InteractiveInfoInstance

Referenced by: [SlideListWithTextSubContainerOrAtom](#), [TextClientDataSubContainerOrAtom](#)

A variable type record whose type and meaning are dictated by the value of **rh.recInstance** as specified in the following table.

Value	Meaning
0x000	A MouseClickedInteractiveInfoContainer record that specifies actions to perform when the mouse is clicked on an object.
0x001	A MouseOverInteractiveInfoContainer record that specifies actions to perform when the mouse is moved over an object.

2.6.8 MouseClickInteractiveInfoContainer

Referenced by: [InteractiveInfoInstance](#), [OfficeArtClientData](#)

A **container record** that specifies what actions to perform when interacting with an object by means of a mouse click.

0	1	2	3	4	5	6	7	8	9	10	11	12	13	14	15	16	17	18	19	20	21	22	23	24	25	26	27	28	29	30	31
rh																															
...																															
interactiveInfoAtom (24 bytes)																															
...																															
...																															
macroNameAtom (variable)																															
...																															

rh (8 bytes): A **RecordHeader** structure (section [2.3.1](#)) that specifies the header for this record. Sub-fields are further specified in the following table.

Field	Meaning
rh.recVer	MUST be 0xF.
rh.recInstance	MUST be 0x000.
rh.recType	MUST be RT_InteractiveInfo .

interactiveInfoAtom (24 bytes): An [InteractiveInfoAtom](#) record that specifies the type of action to be performed.

macroNameAtom (variable): An optional [MacroNameAtom](#) record that specifies the name of a **macro**, a file name, or a **named show**. It MUST be ignored unless **interactiveInfoAtom.action** is equal to "II_MacroAction", "II_RunProgramAction", or "II_CustomShowAction".

2.6.9 MouseOverInteractiveInfoContainer

Referenced by: [InteractiveInfoInstance](#), [OfficeArtClientData](#)

A **container record** that specifies what actions to perform when interacting with an object by moving the mouse cursor over it.

0	1	2	3	4	5	6	7	8	9	10	11	12	13	14	15	16	17	18	19	20	21	22	23	24	25	26	27	28	29	30	31
rh																															
...																															
interactiveInfoAtom (24 bytes)																															
...																															
...																															
macroNameAtom (variable)																															
...																															

rh (8 bytes): A RecordHeader structure (section [2.3.1](#)) that specifies the header for this record. Sub-fields are further specified in the following table.

Field	Meaning
rh.recVer	MUST be 0xF.
rh.recInstance	MUST be 0x001.
rh.recType	MUST be RT_InteractiveInfo .

interactiveInfoAtom (24 bytes): An [InteractiveInfoAtom](#) record that specifies the type of action to be performed.

macroNameAtom (variable): An optional [MacroNameAtom](#) record that specifies the name of a **macro**, a file name, or a **named show**. It MUST be ignored unless **interactiveInfoAtom.action** is equal to "II_MacroAction", "II_RunProgramAction", or "II_CustomShowAction".

2.6.10 InteractiveInfoAtom

Referenced by: [MouseClickedInteractiveInfoContainer](#), [MouseOverInteractiveInfoContainer](#)

An **atom record** that specifies a type of action to be performed.

0	1	2	3	4	5	6	7	8	9	10	11	12	13	14	15	16	17	18	19	20	21	22	23	24	25	26	27	28	29	30	31
rh																															
...																															

soundIdRef							
exHyperlinkIdRef							
action	oleVerb	jump	A	B	C	D	E
hyperlinkType	unused						

rh (8 bytes): A **RecordHeader** structure (section [2.3.1](#)) that specifies the header for this record. Sub-fields are further specified in the following table.

Field	Meaning
rh.recVer	MUST be 0x0.
rh.recInstance	MUST be 0x000.
rh.recType	MUST be RT_InteractiveInfoAtom .
rh.recLen	MUST be 0x00000010.

soundIdRef (4 bytes): A [SoundIdRef](#) that specifies the sound to play when this action executes.

exHyperlinkIdRef (4 bytes): An [ExHyperlinkIdRef](#) that specifies the hyperlink to follow when this action executes. It MUST be ignored unless **action** is equal to "II_JumpAction", "II_HyperlinkAction", or "II_CustomShowAction".

action (1 byte): An [InteractiveInfoActionEnum](#) enumeration that specifies the action to perform when this action executes.

oleVerb (1 byte): An [OLEVerbEnum](#) enumeration that specifies the OLE verb to run when this action executes. It MUST be ignored unless **action** is equal to "II_OLEAction".

jump (1 byte): An [InteractiveInfoJumpEnum](#) enumeration that specifies the slide to jump to. It MUST be ignored unless **action** is equal to "II_JumpAction".

A - fAnimated (1 bit): A bit that specifies whether to animate the object this action applies to when the action is performed.

B - fStopSound (1 bit): A bit that specifies whether to stop currently playing sounds. It MUST be ignored if the **soundIdRef** field specifies a sound to play.

C - fCustomShowReturn (1 bit): A bit that specifies to return to the previous set of displayed slides at the end of the **named show**. It MUST be ignored unless **action** is equal to [II_CustomShowAction](#).

D - fVisited (1 bit): A bit that specifies whether this action was executed since the file was last loaded.

E - reserved (4 bits): MUST be zero and MUST be ignored.

hyperlinkType (1 byte): A [LinkToEnum](#) enumeration that specifies how to interpret the hyperlink referred to by **exHyperlinkIdRef**.

unused (3 bytes): Undefined and MUST be ignored.

2.6.11 MacroNameAtom

Referenced by: [MouseClickInteractiveInfoContainer](#), [MouseOverInteractiveInfoContainer](#)

An **atom record** that specifies the name of a **macro**, a file name, or a **named show**.

0	1	2	3	4	5	6	7	8	9	10	1	2	3	4	5	6	7	8	9	20	1	2	3	4	5	6	7	8	9	30	1
rh																															
...																															
macroName (variable)																															
...																															

rh (8 bytes): A **RecordHeader** structure (section [2.3.1](#)) that specifies the header for this record. Sub-fields are further specified in the following table.

Field	Meaning
rh.recVer	MUST be 0x0.
rh.recInstance	MUST be 0x002.
rh.recType	MUST be RT_CString (section 2.13.24).
rh.recLen	MUST be an even number.

macroName (variable): A **PrintableUnicodeString** (section [2.2.23](#)) that specifies the name of a macro, a file name, or a named show. If this field specifies a macro and it is not the same as a subroutine present in the **VBA project**, it MUST be ignored. The length, in bytes, of the field is specified by **rh.recLen**.

2.7 Shape Types

2.7.1 OfficeArtClientAnchor

An **atom record** that specifies the location of a **shape**.

0	1	2	3	4	5	6	7	8	9	10	1	2	3	4	5	6	7	8	9	20	1	2	3	4	5	6	7	8	9	30	1
rh																															
...																															
clientAnchorData (variable)																															
...																															

rh (8 bytes): An **OfficeArtRecordHeader** ([\[MS-ODRAW\]](#) section 2.2.1) that specifies the header for this record. Sub-fields are further specified in the following table.

Field	Meaning
rh.recVer	MUST be 0x0.
rh.recInstance	MUST be 0x000.
rh.recType	MUST be 0xF010.

Field	Meaning
rh.recLen	MUST be 0x00000008 or 0x00000010.

clientAnchorData (variable): An [OfficeArtClientAnchorData](#) structure that specifies the location.

2.7.2 OfficeArtClientAnchorData

Referenced by: [OfficeArtClientAnchor](#)

A variable type structure whose type and meaning are dictated by the value of **rh.recLen** of the [OfficeArtClientAnchor](#) record that contains this **OfficeArtClientAnchorData** structure, as specified in the following table.

Value	Meaning
0x00000008	A SmallRectStruct structure that specifies the location of the shape.
0x00000010	A RectStruct structure that specifies the location of the shape.

2.7.3 OfficeArtClientData

A **container record** that specifies information about a **shape**.

0	1	2	3	4	5	6	7	8	9	10	11	12	13	14	15	16	17	18	19	20	21	22	23	24	25	26	27	28	29	30	31
rh																															
...																															
shapeFlagsAtom (optional)																															
...																															
...																shapeFlags10Atom (optional)															
...																															
...																exObjRefAtom (optional)															
...																															
...																															
...																animationInfo (variable)															
...																															
mouseClickInteractiveInfo (variable)																															
...																															

mouseOverInteractiveInfo (variable)
...
placeholderAtom (16 bytes, optional)
...
...
recolorInfoAtom (variable)
...
rgShapeClientRoundtripData (variable)
...

rh (8 bytes): An **OfficeArtRecordHeader** ([\[MS-ODRAW\]](#) section 2.2.1) that specifies the header for this record. Sub-fields are further specified in the following table.

Field	Meaning
rh.recVer	MUST be 0xF.
rh.recInstance	MUST be 0x000.
rh.recType	MUST be 0xF011.

shapeFlagsAtom (9 bytes): An optional [ShapeFlagsAtom](#) record that specifies flags for the shape.

shapeFlags10Atom (9 bytes): An optional [ShapeFlags10Atom](#) record that specifies flags for the shape.

exObjRefAtom (12 bytes): An optional [ExObjRefAtom](#) record that specifies a reference to an **external object**.

animationInfo (variable): An optional [AnimationInfoContainer](#) record that specifies animation information for the shape.

mouseClickInteractiveInfo (variable): An optional [MouseClickedInteractiveInfoContainer](#) record that specifies information about interacting with the shape by clicking the mouse on the shape.

mouseOverInteractiveInfo (variable): An optional [MouseOverInteractiveInfoContainer](#) record that specifies information about interacting with the shape by moving the mouse over the shape.

placeholderAtom (16 bytes): An optional [PlaceholderAtom](#) record that specifies whether the shape is a **placeholder shape**.

recolorInfoAtom (variable): An optional [RecolorInfoAtom](#) record that specifies a collection of re-color mappings for the shape.

rgShapeClientRoundtripData (variable): An array of [ShapeClientRoundtripDataSubContainerOrAtom](#) records that specifies additional information about a shape. The array continues while **rh.recType** of the [ShapeClientRoundtripDataSubContainerOrAtom](#) item is equal to one of the following record types:

[RT_ProgTags](#), [RT_RoundTripNewPlaceholderId12Atom](#), [RT_RoundTripShapeId12Atom](#), [RT_RoundTripHFPlaceholder12Atom](#), or [RT_RoundTripShapeChecksumForCL12Atom](#). Each record type MUST NOT appear more than once.

2.7.4 ShapeClientRoundtripDataSubContainerOrAtom

Referenced by: [OfficeArtClientData](#)

A variable type record whose type and meaning are dictated by the value of **rh.recType**, as specified by the following table.

Value	Meaning
RT_ProgTags (section 2.13.24)	A ShapeProgTagsContainer record that specifies programmable tags for the shape .
RT_RoundTripNewPlaceholderId12Atom	A RoundTripNewPlaceholderId12Atom record that specifies a placeholder shape identifier. It SHOULD<88> be ignored and SHOULD<89> be preserved.
RT_RoundTripShapeId12Atom	A RoundTripShapeId12Atom record that specifies a shape identifier. It SHOULD<90> be ignored and SHOULD<91> be preserved.
RT_RoundTripHFPlaceholder12Atom	A RoundTripHFPlaceholder12Atom record that specifies whether a shape is a header or footer placeholder shape. It SHOULD<92> be ignored and SHOULD<93> be preserved.
RT_RoundTripShapeChecksumForCL12Atom	A RoundTripShapeChecksumForCustomLayouts12Atom record that specifies checksum values for a shape. It SHOULD<94> be ignored and SHOULD<95> be preserved.

2.7.5 ShapeFlagsAtom

Referenced by: [OfficeArtClientData](#)

An **atom record** that specifies shape-level **Boolean** flags. More flags are specified in the [ShapeFlags10Atom](#) record.

0	1	2	3	4	5	6	7	8	9	10	11	12	13	14	15	16	17	18	19	20	21	22	23	24	25	26	27	28	29	30	31
rh																															
...																															
A	reserved																														

rh (8 bytes): A **RecordHeader** structure (section [2.3.1](#)) that specifies the header for this record. Sub-fields are further specified in the following table.

Field	Meaning
rh.recVer	MUST be 0x0.
rh.recInstance	MUST be 0x000.
rh.recType	MUST be RT_ShapeAtom .
rh.recLen	MUST be 0x00000001.

A - fAlwaysOnTop (1 bit): A bit that specifies whether a **shape** is rendered on top of other shapes.
reserved (7 bits): MUST be zero and MUST be ignored.

2.7.6 ShapeFlags10Atom

Referenced by: [OfficeArtClientData](#)

An **atom record** that specifies shape-level **Boolean** flags. More flags are specified in the [ShapeFlagsAtom](#) record.

0	1	2	3	4	5	6	7	8	9	10	11	12	13	14	15	16	17	18	19	20	21	22	23	24	25	26	27	28	29	30	31
rh																															
...																															
A		B		reserved2																											

rh (8 bytes): A **RecordHeader** structure (section [2.3.1](#)) that specifies the header for this record. Sub-fields are further specified in the following table.

Field	Meaning
rh.recVer	MUST be 0x0.
rh.recInstance	MUST be 0x000.
rh.recType	MUST be RT_ShapeFlags10Atom .
rh.recLen	MUST be 0x00000001.

A - reserved1 (2 bits): MUST be zero and MUST be ignored.

B - fIsPhotoAlbumPicture (1 bit): A bit that specifies whether a **shape** is a picture in a photo album specified by the [PhotoAlbumInfo10Atom](#) record. It MAY [<96>](#) be ignored.

reserved2 (5 bits): MUST be zero and MUST be ignored.

2.7.7 ExObjRefAtom

Referenced by: [OfficeArtClientData](#)

An **atom record** that specifies a reference to an **external object**.

0	1	2	3	4	5	6	7	8	9	10	11	12	13	14	15	16	17	18	19	20	21	22	23	24	25	26	27	28	29	30	31
rh																															
...																															
exObjIdRef																															

rh (8 bytes): A **RecordHeader** structure (section [2.3.1](#)) that specifies the header for this record. Sub-fields are further specified in the following table.

Field	Meaning
rh.recVer	MUST be 0x0.
rh.recInstance	MUST be 0x000.
rh.recType	MUST be RT_ExternalObjectRefAtom .
rh.recLen	MUST be 0x00000004.

exObjIdRef (4 bytes): An [ExObjIdRef](#) that specifies an identifier that references an external object.

2.7.8 PlaceholderAtom

Referenced by: [OfficeArtClientData](#)

An **atom record** that specifies whether a **shape** is a **placeholder shape**. The number, position, and type of placeholder shapes are determined by the **slide layout** as specified in the [SlideAtom](#) record.

Let the *corresponding shape* be specified by the **OfficeArtSpContainer** record ([\[MS-ODRAW\]](#) section 2.2.14) that contains this **PlaceholderAtom** record.

Let the *corresponding slide* be specified by the **MainMasterContainer** record (section [2.5.3](#)), **HandoutContainer** record (section [2.5.8](#)), **SlideContainer** record (section [2.5.1](#)), or **NotesContainer** record (section [2.5.6](#)) that contains this **PlaceholderAtom** record.

0	1	2	3	4	5	6	7	8	9	10	11	12	13	14	15	16	17	18	19	20	21	22	23	24	25	26	27	28	29	30	31
rh																															
...																															
position																															
placementId								size																unused							

rh (8 bytes): A **RecordHeader** structure (section [2.3.1](#)) that specifies the header for this record. Sub-fields are further specified in the following table.

Field	Meaning
rh.recVer	MUST be 0x0.
rh.recInstance	MUST be 0x000.
rh.recType	MUST be RT_PlaceholderAtom .
rh.recLen	MUST be 0x00000008.

position (4 bytes): A **signed integer** that specifies an identifier for the placeholder shape. It SHOULD be unique among all **PlaceholderAtom** records contained in the *corresponding slide*. The value 0xFFFFFFFF specifies that the *corresponding shape* is not a placeholder shape.

placementId (1 byte): A [PlaceholderEnum](#) enumeration that specifies the type of the placeholder shape. The value MUST conform to the constraints as specified in the following table.

Value	Meaning
PT_None	MUST NOT be used for this field.
PT_MasterTitle	The <i>corresponding shape</i> contains the master title text. The <i>corresponding slide</i> MUST be a main master slide .
PT_MasterBody	The <i>corresponding shape</i> contains the master body text. The <i>corresponding slide</i> MUST be a main master slide.
PT_MasterCenterTitle	The <i>corresponding shape</i> contains the master center title text. The <i>corresponding slide</i> MUST be a title master slide .
PT_MasterSubTitle	The <i>corresponding shape</i> contains the master sub-title text. The <i>corresponding slide</i> MUST be a title master slide.
PT_MasterNotesSlideImage	The <i>corresponding shape</i> contains the shared properties for slide image shapes. The <i>corresponding slide</i> MUST be a notes master slide .
PT_MasterNotesBody	The <i>corresponding shape</i> contains the master body text. The <i>corresponding slide</i> MUST be a notes master slide.
PT_MasterDate	The <i>corresponding shape</i> contains the date text field. The <i>corresponding slide</i> MUST be a main master slide, title master slide, notes master slide, or handout master slide .
PT_MasterSlideNumber	The <i>corresponding shape</i> contains a slide number text field. The <i>corresponding slide</i> MUST be a main master slide, title master slide, notes master slide, or handout master slide.
PT_MasterFooter	The <i>corresponding shape</i> contains a footer text field. The <i>corresponding slide</i> MUST be a main master slide, title master slide, notes master slide, or handout master slide.
PT_MasterHeader	The <i>corresponding shape</i> contains a header text field. The <i>corresponding slide</i> MUST be a notes master slide or handout master slide.
PT_NotesSlideImage	The <i>corresponding shape</i> contains a presentation slide image. The <i>corresponding slide</i> MUST be a notes slide .
PT_NotesBody	The <i>corresponding shape</i> contains the notes text. The <i>corresponding slide</i> MUST be a notes slide.
PT_Title	The <i>corresponding shape</i> contains the title text. The <i>corresponding slide</i> MUST be a presentation slide.
PT_Body	The <i>corresponding shape</i> contains the body text. The <i>corresponding slide</i> MUST be a presentation slide.
PT_CenterTitle	The <i>corresponding shape</i> contains the center title text. The <i>corresponding slide</i> MUST be a presentation slide.
PT_SubTitle	The <i>corresponding shape</i> contains the sub-title text. The <i>corresponding slide</i> MUST be a presentation slide.
PT_VerticalTitle	The <i>corresponding shape</i> contains the title text with vertical text flow. The corresponding slide MUST be a presentation slide.
PT_VerticalBody	The <i>corresponding shape</i> contains the body text with vertical text flow. The corresponding slide

Value	Meaning
	MUST be a presentation slide.
PT_Object	The <i>corresponding shape</i> contains a generic object. The <i>corresponding slide</i> MUST be a presentation slide.
PT_Graph	The <i>corresponding shape</i> contains a chart object. The <i>corresponding slide</i> MUST be a presentation slide.
PT_Table	The <i>corresponding shape</i> contains a table object. The <i>corresponding slide</i> MUST be a presentation slide.
PT_ClipArt	The <i>corresponding shape</i> contains a clipart object. The <i>corresponding slide</i> MUST be a presentation slide.
PT_OrgChart	The <i>corresponding shape</i> contains an organization chart object. The corresponding slide MUST be a presentation slide.
PT_Media	The <i>corresponding shape</i> contains a media object. The <i>corresponding slide</i> MUST be a presentation slide.
PT_VerticalObject	The <i>corresponding shape</i> contains a generic object with vertical text flow. The <i>corresponding slide</i> MUST be a presentation slide.
PT_Picture	The <i>corresponding shape</i> contains a picture object. The <i>corresponding slide</i> MUST be a presentation slide.

size (1 byte): A [PlaceholderSize](#) enumeration that specifies the preferred size of the placeholder shape.

unused (2 bytes): Undefined and MUST be ignored.

2.7.9 RecolorInfoAtom

Referenced by: [OfficeArtClientData](#)

An **atom record** that specifies a collection of re-color mappings for a **metafile** ([\[MS-WMF\]](#)).

The *corresponding metafile* is specified by the **Blip** properties ([\[MS-ODRAW\]](#) section 2.3.23) of the **OfficeArtSpContainer** ([\[MS-ODRAW\]](#) section 2.2.14) that contains this **RecolorInfoAtom** record.

0	1	2	3	4	5	6	7	8	9	10	11	12	13	14	15	16	17	18	19	20	21	22	23	24	25	26	27	28	29	30	31
rh																															
...																															
A	B	C	D	E	unused2																cColors										
cFills																monoColor															
...																															

rgRecolorEntry (variable)
...
unused3 (variable)
...

rh (8 bytes): A **RecordHeader** structure (section [2.3.1](#)) that specifies the header for this record. Sub-fields are further specified in the following table.

Field	Meaning
rh.recVer	MUST be 0x0.
rh.recInstance	MUST be 0x000.
rh.recType	MUST be RT_RecolorInfoAtom .

A - fShouldRecolor (1 bit): A bit that specifies whether the re-color mappings are applied.

B - fMissingColors (1 bit): A bit that specifies whether **rgRecolorEntry** has more than 64 items with a [RecolorEntryColor](#) variant. It SHOULD [<97>](#) be ignored.

C - fMissingFills (1 bit): A bit that specifies whether **rgRecolorEntry** has more than 64 items with a [RecolorEntryBrush](#) variant. It SHOULD [<98>](#) be ignored.

D - unused1 (1 bit): Undefined and MUST be ignored.

E - fMonoRecolor (1 bit): A bit that specifies whether **monoColor** is used as the destination color instead of the destination colors specified by the [RecolorEntry](#) structures in the **rgRecolorEntry** array.

unused2 (11 bits): Undefined and MUST be ignored.

cColors (2 bytes): An unsigned integer that specifies the count of items in the **rgRecolorEntry** array with a [RecolorEntryColor](#) variant.

cFills (2 bytes): An unsigned integer that specifies the count of items in the **rgRecolorEntry** array with a [RecolorEntryBrush](#) variant.

monoColor (6 bytes): A [WideColorStruct](#) structure that specifies the destination color if the **fMonoRecolor** bit is set.

rgRecolorEntry (variable): An array of [RecolorEntry](#) structures that specifies color mappings. The count of items in the array is specified by **cColors** + **cFills**. It MUST contain **cColor** items with a [RecolorEntryColor](#) variant. It MUST contain **cFills** items with a [RecolorEntryBrush](#) variant.

unused3 (variable): Undefined and MUST be ignored. The size, in bytes, is specified by the following formula:

$$\text{rh.recLen} - (12 + 44 * (\text{cColors} + \text{cFills}))$$

2.7.10 RecolorEntry

Referenced by: [RecolorInfoAtom](#)

A structure that specifies a color mapping for **metafile** records. A color mapping has a source color description and a destination color description. Applying a color mapping to a metafile means to be the same as the source color description with the corresponding fields of the listed metafile records that follow and replace them with metafile records which represent the mapped destination color.

The following metafile ([\[MS-WMF\]](#)) records are the targets for possible color replacement.

Metafile record	Specified in
META_SETTEXTCOLOR	[MS-WMF] section 2.3.5.26
META_SETBKCOLOR	[MS-WMF] section 2.3.5.14
META_CREATEPENINDIRECT	[MS-WMF] section 2.3.4.5
META_CREATEBRUSHINDIRECT	[MS-WMF] section 2.3.4.1
META_CREATEPATTERNBRUSH	[MS-WMF] section 2.3.4.4
META_DIBCREATEPATTERNBRUSH	[MS-WMF] section 2.3.4.8
META_DIBSTRETCHBLT	[MS-WMF] section 2.3.1.3
META_STRETCHDIB	[MS-WMF] section 2.3.1.6

Let the *corresponding color scheme* be as specified by the **MainMasterContainer** record (section [2.5.3](#)), **HandoutContainer** record (section [2.5.8](#)), **SlideContainer** record (section [2.5.1](#)), or **NotesContainer** record (section [2.5.6](#)) that contains this **RecolorEntry** structure.

0	1	2	3	4	5	6	7	8	9	10	1	2	3	4	5	6	7	8	9	20	1	2	3	4	5	6	7	8	9	30	1						
A											reserved1																toColor										
...																																					
toIndex											unused											colorOrBrush (34 bytes)															
...																																					
...																																					
...																																					

A - fDoRecolor (1 bit): A bit that specifies whether the color mapping is performed.

reserved1 (15 bits): MUST be zero and MUST be ignored.

toColor (6 bytes): A [WideColorStruct](#) structure that specifies the destination color of the mapping when **toIndex** is greater than or equal to 8. It MUST be ignored if **toIndex** is less than 8.

toIndex (1 byte): An unsigned integer that specifies the destination color of the mapping. If the value is less than 8, it is a 0-based index into the *corresponding color scheme*. If the value is greater than or equal to 8, **toColor** is used for the destination color.

unused (1 byte): Undefined and MUST be ignored.

colorOrBrush (34 bytes): A [RecolorEntryVariant](#) structure that specifies the source color of the color mapping.

2.7.11 RecolorEntryVariant

Referenced by: [RecolorEntry](#)

A variant structure whose type and meaning are dictated by the value of the **type** field of either of these two structures, as specified in the following table.

Type	Meaning
0x0000	A RecolorEntryColor structure that specifies a source color.
0x0001	A RecolorEntryBrush structure that specifies a source brush.

2.7.12 RecolorEntryColor

Referenced by: [RecolorEntryVariant](#)

A structure that specifies a source color for a [RecolorEntry](#) structure.

0	1	2	3	4	5	6	7	8	9	10	11	12	13	14	15	16	17	18	19	20	21	22	23	24	25	26	27	28	29	30	31
type											fromColor																				
...																															
unused (26 bytes)																															
...																															
...																															
...																															

type (2 bytes): An **unsigned integer** that specifies the variant of the containing RecolorEntryVariant structure. It MUST be 0x0000.

fromColor (6 bytes): A [WideColorStruct](#) structure that specifies a source color.

unused (26 bytes): Undefined and MUST be ignored.

2.7.13 RecolorEntryBrush

Referenced by: [RecolorEntryVariant](#)

A structure that specifies a source color for a [RecolorEntry](#) that corresponds to a **LogBrush** Object as specified in [\[MS-WMF\]](#) section [2.2.2.10](#). The meaning of the fields corresponds to the meaning of the fields of a **LogBrush** Object.

0	1	2	3	4	5	6	7	8	9	10	11	12	13	14	15	16	17	18	19	20	21	22	23	24	25	26	27	28	29	30	31
type											lbStyle																				
lbColor																															

...	lbHatch
fgColor	
...	bgColor
...	
bitmapType	pattern
...	
...	

type (2 bytes): An unsigned integer that specifies the variant of the containing RecolorEntryVariant structure. It MUST be 0x0001.

lbStyle (2 bytes): An unsigned integer that specifies a brush type. It MUST be a **BrushStyle Enumeration** as specified in [MS-WMF] section [2.1.1.4](#).

lbColor (6 bytes): A [WideColorStruct](#) structure that specifies the color of the **LogBrush** Object. Its interpretation depends on the value of **lbStyle** and is specified in [MS-WMF] section 2.2.2.10.

lbHatch (2 bytes): An unsigned integer that specifies a brush hatch type. Its interpretation depends on the value of **lbStyle** and is specified in [MS-WMF] section [2.1.1.12](#).

fgColor (6 bytes): A [WideColorStruct](#) structure that specifies a foreground color. Only used for metafile records of type META_DIBCREATEPATTERNBRUSH, specified in [MS-WMF] section [2.3.4.8](#). This field represents the color of the first entry of the **DIB** color table, specified in [MS-WMF] section [2.2.2.3](#). Undefined and MUST be ignored if **lbStyle** is not equal to 0x0003.

bgColor (6 bytes): A [WideColorStruct](#) structure that specifies a background color. Only used for metafile records of type META_DIBCREATEPATTERNBRUSH, as specified in [MS-WMF] section 2.3.4.8. This field represents the color of the second entry of the **DIB** color table, as specified in [MS-WMF] section 2.2.2.3. Undefined and MUST be ignored if **lbStyle** is not equal to 0x0003.

bitmapType (2 bytes): An unsigned integer that specifies the type of the bitmap if **lbStyle** is equal to 0x0003. It MUST also be a value from the following table.

Value	Meaning
0x0000	Color mapping is used for META_CREATEPATTERNBRUSH records with a monochrome pattern bitmap.
0x0001	Color mapping is used for META_DIBCREATEPATTERNBRUSH records.
0x0003	Color mapping is used for META_CREATEBRUSHINDIRECT records and META_CREATEPATTERNBRUSH records with a non-monochrome pattern bitmap.

MUST be ignored if **lbStyle** is not equal to 0x0003.

pattern (8 bytes): An array of bytes that specifies the bit pattern for a monochrome 8x8 pixel brush. Undefined and MUST be ignored if **lbStyle** is not equal to 0x0003 or if **bitmapType** is equal to 0x0003. If **bitmapType** is equal to 0x0000 it specifies the **Bits** field for a META_CREATEPATTERNBRUSH record as specified in [MS-WMF] section [2.3.4.4](#). If **bitmapType** is equal to 0x0001 it specifies the **Bits** field of a DeviceIndependentBitmap (DIB) Object ([MS-WMF] section 2.2.2.3) for a META_DIBCREATEPATTERNBRUSH record as specified in [MS-WMF] sections 2.3.4.8.

2.7.14 ShapeProgTagsContainer

Referenced by: [ShapeClientRoundtripDataSubContainerOrAtom](#)

A **container record** that specifies **programmable tags** with additional shape data.

0	1	2	3	4	5	6	7	8	9	10	11	12	13	14	15	16	17	18	19	20	21	22	23	24	25	26	27	28	29	30	31
rh																															
...																															
rgChildRec (variable)																															
...																															

rh (8 bytes): A **RecordHeader** structure (section [2.3.1](#)) that specifies the header for this record. Sub-fields are further specified in the following table.

Field	Meaning
rh.recVer	MUST be 0xF.
rh.recInstance	SHOULD <99> be 0x000.
rh.recType	MUST be RT_ProgTags (section 2.13.24).

rgChildRec (variable): An array of [ShapeProgTagsSubContainerOrAtom](#) records that specifies the programmable tags. The size, in bytes, of the array is specified by **rh.recLen**. The array MUST NOT contain more than one of each of the following records: [PP9ShapeBinaryTagExtension](#), [PP10ShapeBinaryTagExtension](#), or [PP11ShapeBinaryTagExtension](#).

2.7.15 ShapeProgTagsSubContainerOrAtom

Referenced by: [ShapeProgTagsContainer](#)

A variable type record whose type and meaning are dictated by the value of **rh.recType**, as specified in the following table.

Value	Meaning
RT_ProgStringTag	A ProgStringTagContainer record that specifies additional shape data.
RT_ProgBinaryTag	A ShapeProgBinaryTagContainer record that specifies additional shape data.

2.7.16 ShapeProgBinaryTagContainer

Referenced by: [ShapeProgTagsSubContainerOrAtom](#)

A **container record** that specifies **programmable tags** with additional binary shape data.

0	1	2	3	4	5	6	7	8	9	10	11	12	13	14	15	16	17	18	19	20	21	22	23	24	25	26	27	28	29	30	31
rh																															

...
rec (variable)
...

rh (8 bytes): A **RecordHeader** structure (section [2.3.1](#)) that specifies the header for this record. Sub-fields are further specified in the following table.

Field	Meaning
rh.recVer	MUST be 0xF.
rh.recInstance	MUST be 0x000.
rh.recType	MUST be RT_ProgBinaryTag .

rec (variable): A [ShapeProgBinaryTagSubContainerOrAtom](#) record that specifies additional shape data.

2.7.17 ShapeProgBinaryTagSubContainerOrAtom

Referenced by: [ShapeProgBinaryTagContainer](#)

A variable type record whose type and meaning are dictated by the value of **tagNameAtom.tagName** for [UnknownBinaryTag](#) or by the value of **tagName** for [PP9ShapeBinaryTagExtension](#), [PP10ShapeBinaryTagExtension](#), [PP11ShapeBinaryTagExtension](#), as specified in the following table.

Value	Meaning
"__PPT9"	A PP9ShapeBinaryTagExtension record pair that specifies additional shape data. It MAY <100> be ignored and MUST be preserved.
"__PPT10"	A PP10ShapeBinaryTagExtension record pair that specifies additional shape data. It MAY <101> be ignored and MUST be preserved.
"__PPT11"	A PP11ShapeBinaryTagExtension record pair that specifies additional shape data. It MAY <102> be ignored and MUST be preserved.
Any other value	An UnknownBinaryTag record pair that specifies additional shape data. It MUST be ignored and MUST be preserved.

2.7.18 PP9ShapeBinaryTagExtension

Referenced by: [ShapeProgBinaryTagSubContainerOrAtom](#)

A pair of **atom records** that specifies a **programmable tag** with additional shape data.

0	1	2	3	4	5	6	7	8	9	10	1	2	3	4	5	6	7	8	9	20	1	2	3	4	5	6	7	8	9	30	1		
rh																																	
...																																	

tagName (14 bytes)	
...	
...	
...	rhData
...	
...	styleTextPropAtom (variable)
...	

rh (8 bytes): A **RecordHeader** structure (section [2.3.1](#)) that specifies the header for the first record. Sub-fields are further specified in the following table.

Field	Meaning
rh.recVer	MUST be 0x0.
rh.recInstance	MUST be 0x000.
rh.recType	MUST be RT_CString (section 2.13.24).
rh.recLen	MUST be 0x0000000E.

tagName (14 bytes): A **PrintableUnicodeString** (section [2.2.23](#)) that specifies the programmable tag name. It MUST be "___PPT9".

rhData (8 bytes): A **RecordHeader** structure (section [2.3.1](#)) that specifies the header for the second record. Sub-fields are further specified in the following table:

Field	Meaning
rhData.recVer	MUST be 0x0.
rhData.recInstance	MUST be 0x000.
rhData.recType	MUST be RT_BinaryTagDataBlob.

styleTextPropAtom (variable): A [StyleTextProp9Atom](#) record that specifies additional text style properties.

2.7.19 PP10ShapeBinaryTagExtension

Referenced by: [ShapeProgBinaryTagSubContainerOrAtom](#)

A pair of **atom records** that specifies a **programmable tag** with additional shape data.

0	1	2	3	4	5	6	7	8	9	10	1	2	3	4	5	6	7	8	9	20	1	2	3	4	5	6	7	8	9	30	1		
rh																																	
...																																	

tagName (16 bytes)
...
...
rhData
...
styleTextPropAtom (variable)
...

rh (8 bytes): A **RecordHeader** structure (section [2.3.1](#)) that specifies the header for the first record. Sub-fields are further specified in the following table.

Field	Meaning
rh.recVer	MUST be 0x0.
rh.recInstance	MUST be 0x000.
rh.recType	MUST be RT_CString (section 2.13.24).
rh.recLen	MUST be 0x00000010.

tagName (16 bytes): A **PrintableUnicodeString** (section [2.2.23](#)) that specifies the programmable tag name. It MUST be "___PPT10".

rhData (8 bytes): A **RecordHeader** structure (section [2.3.1](#)) that specifies the header for the second record. Sub-fields are further specified in the following table.

Field	Meaning
rhData.recVer	MUST be 0x0.
rhData.recInstance	MUST be 0x000.
rhData.recType	MUST be RT_BinaryTagDataBlob.

styleTextPropAtom (variable): A [StyleTextProp10Atom](#) record that specifies additional text style properties.

2.7.20 PP11ShapeBinaryTagExtension

Referenced by: [ShapeProgBinaryTagSubContainerOrAtom](#)

A pair of **atom records** that specifies a **programmable tag** with additional shape data.

0	1	2	3	4	5	6	7	8	9	10	1	2	3	4	5	6	7	8	9	20	1	2	3	4	5	6	7	8	9	30	1		
rh																																	
...																																	

tagName (16 bytes)
...
...
rhData
...
styleTextPropAtom (variable)
...

rh (8 bytes): A **RecordHeader** structure (section [2.3.1](#)) that specifies the header for this record. Sub-fields are further specified in the following table.

Field	Meaning
rh.recVer	MUST be 0x0.
rh.recInstance	MUST be 0x000.
rh.recType	MUST be RT_CString (section 2.13.24).
rh.recLen	MUST be 0x00000010.

tagName (16 bytes): A **PrintableUnicodeString** (section [2.2.23](#)) that specifies the programmable tag name. It MUST be "___PPT11".

rhData (8 bytes): A **RecordHeader** structure (section [2.3.1](#)) that specifies the header for the second record. Sub-fields are further specified in the following table.

Field	Meaning
rhData.recVer	MUST be 0x0.
rhData.recInstance	MUST be 0x000.
rhData.recType	MUST be RT_BinaryTagDataBlob.

styleTextPropAtom (variable): A [StyleTextProp11Atom](#) record that specifies additional text style properties.

2.8 Animation Types

2.8.1 AnimationInfoContainer

Referenced by: [OfficeArtClientData](#)

A **container record** that specifies the animation and sound information for a **shape**.

0	1	2	3	4	5	6	7	8	9	10	1	2	3	4	5	6	7	8	9	20	1	2	3	4	5	6	7	8	9	30	1		
rh																																	

...
animationAtom (36 bytes)
...
...
animationSound (variable)
...

rh (8 bytes): A **RecordHeader** structure (section [2.3.1](#)) that specifies the header for this record. Sub-fields are further specified in the following table.

Field	Meaning
rh.recVer	MUST be 0xF.
rh.recInstance	MUST be 0x000.
rh.recType	MUST be RT_AnimationInfo .

animationAtom (36 bytes): An [AnimationInfoAtom](#) record that specifies the animation effect information for the shape. It SHOULD [<103>](#) be ignored.

animationSound (variable): An optional **SoundContainer** record (section [2.4.16.3](#)) that specifies the sound for the animation specified by the **animationAtom**. If this field exists, it overrides the **animationAtom.soundIdRef**.

2.8.2 AnimationInfoAtom

Referenced by: [AnimationInfoContainer](#)

An **atom record** that specifies the animation information for a shape or text.

0	1	2	3	4	5	6	7	8	9	10	1	2	3	4	5	6	7	8	9	20	1	2	3	4	5	6	7	8	9	30	1
rh																															
...																															
dimColor																															
A	B	C	D	E	F	G	H	reserved																							
soundIdRef																															
delayTime																															
orderID																slideCount															

animBuildType	animEffect	animEffectDirection	animAfterEffect
textBuildSubEffect	oleVerb	unused	

rh (8 bytes): A **RecordHeader** structure (section [2.3.1](#)) that specifies the header for this record. Sub-fields are further specified in the following table.

Field	Meaning
rh.recVer	MUST be 0x1.
rh.recInstance	MUST be 0x000.
rh.recType	MUST be RT_AnimationInfoAtom .
rh.recLen	MUST be 0x0000001C.

dimColor (4 bytes): A [ColorIndexStruct](#) structure that specifies a color for the dim effect after the animation is complete.

A - fReverse (2 bits): An **unsigned integer** that specifies whether the animation plays in the reverse direction. It MUST be a value from the following table.

Value	Meaning
0x0	Do not play in the reverse direction.
0x1	Play in the reverse direction.

B - fAutomatic (2 bits): An **unsigned integer** that specifies whether the animation starts automatically. It MUST be a value from the following table.

Value	Meaning
0x0	Start manually by click.
0x1	Start automatically.

C - fSound (2 bits): An **unsigned integer** that specifies whether the animation has an associated sound. It MUST be a value from the following table.

Value	Meaning
0x0	Has no associated sound.
0x1	Has associated sound.

D - fStopSound (2 bits): An **unsigned integer** that specifies whether all playing sounds are stopped when this animation begins. It MUST be a value from the following table.

Value	Meaning
0x0	All playing sounds are not stopped.
0x1	All playing sounds are stopped.

E - fPlay (2 bits): An unsigned integer that specifies whether an associated sound, media or action verb is activated when the **shape** is clicked. It MUST be a value from the following table.

Value	Meaning
0x0	No behavior happens when the shape is clicked.
0x1	The associated sound, media or action verb plays when the shape is clicked.

F - fSynchronous (2 bits): An unsigned integer that specifies that the animation, while playing, stops other **slide show** actions. If the shape is a media or **OLE object**, this field is valid; otherwise, it MUST be ignored. It MUST be a value from the following table.

Value	Meaning
0x0	Do not stop other slide show actions.
0x1	Stop other slide show actions.

G - fHide (2 bits): An unsigned integer that specifies whether the shape is hidden while the animation is not playing. If the shape is a media or OLE object, this field is valid; otherwise, it MUST be ignored. It MUST be a value from the following table.

Value	Meaning
0x0	Do not hide the shape while the animation is not playing.
0x1	Hide the shape while the animation is not playing.

H - fAnimateBg (2 bits): An unsigned integer that specifies whether the background of the shape is animated. It MUST be a value from the following table.

Value	Meaning
0x0	Do not animate the background.
0x1	Animate the background.

reserved (16 bits): MUST be zero, and MUST be ignored.

soundIdRef (4 bytes): A [SoundIdRef](#) that specifies the value to refer to in the **SoundCollectionContainer** record (section [2.4.16.1](#)) to locate the embedded audio.



delayTime (4 bytes): A **signed integer** that specifies the delay time, in milliseconds, before the animation starts to play. If **fAutomatic** is 0x1, this value MUST be greater than or equal to 0; otherwise, this field MUST be ignored.



orderID (2 bytes): A signed integer that specifies the order of the animation in the slide. It MUST be greater than or equal to -2. The value -2 specifies that this animation follows the order of the corresponding **placeholder shape** on the **main master slide** or **title master slide**. The value -1 SHOULD NOT [<104>](#) be used.

slideCount (2 bytes): An unsigned integer that specifies the number of slides that this animation continues playing. This field is utilized only in conjunction with media. The value 0xFFFFFFFF specifies that the animation plays for one slide.

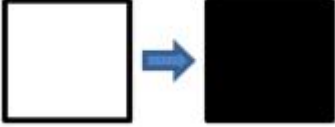
animBuildType (1 byte): An [AnimBuildTypeEnum](#) enumeration that specifies the animation build type for the animation effect.

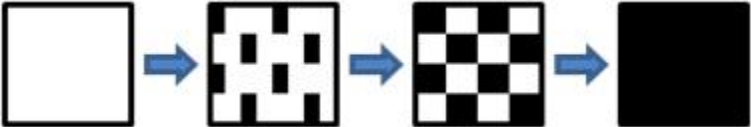

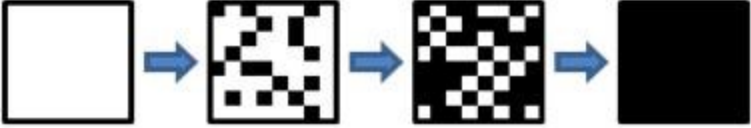
animEffect (1 byte): An unsigned integer that specifies the animation effect type for the shape. The following diagrams are for example purposes only. Exact rendering of any animation effect is determined by the rendering application. As such, the same animation effect can have many variations depending on the implementation. It MUST be a value from the following table:

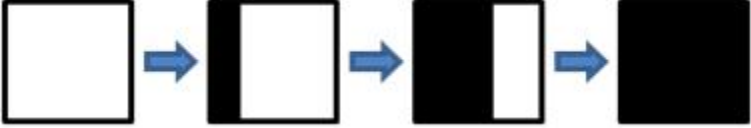

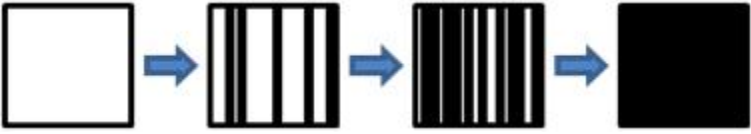
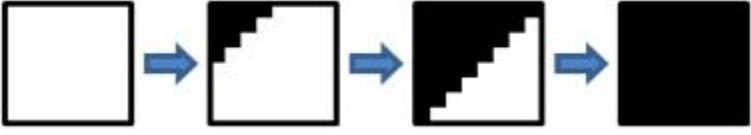
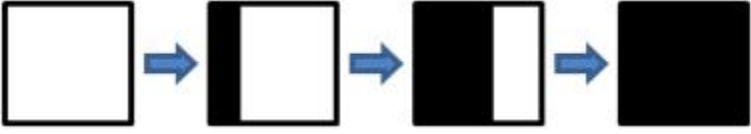
Value	Description
0x00	<p>Cut animation effect that replaces the previous object instance with the new object instance instantaneously, as illustrated in the following example:</p>  <p>The animEffectDirection value MUST be one of the following:</p> <ul style="list-style-type: none"> ▪ 0x00: Not through black ▪ 0x01: Through black ▪ 0x02: The same as 0x00
0x01	<p>Random animation effect that chooses a random effect with a random applicable direction from the set available. This effect can be different each time it is used. animEffectDirection MUST be ignored.</p>
0x02	<p>Blinds animation effect that uses a set of horizontal or vertical bars and wipes them either left-to-right or top-to-bottom, respectively, until the new object instance is fully shown, as illustrated in the following example:</p>  <p>The animEffectDirection value MUST be one of the following:</p> <ul style="list-style-type: none"> ▪ 0x00: Vertical direction ▪ 0x01: Horizontal direction
0x03	<p>Checker animation effect that uses a set of horizontal or vertical checkerboard squares and wipes them either left-to-right or top-to-bottom, respectively, until the new object instance is fully shown, as illustrated in the following example:</p>  <p>The animEffectDirection value MUST be one of the following:</p> <ul style="list-style-type: none"> ▪ 0x00: Horizontal direction ▪ 0x01: Vertical direction
0x04	<p>Cover animation effect that moves the new object instance in from the specified direction, continually covering more of the previous object instance until the new object instance is fully shown, as illustrated in the following example:</p>

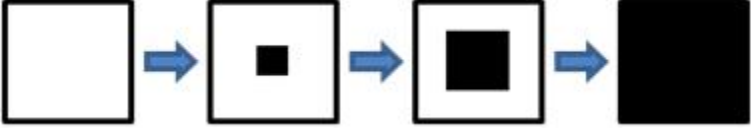
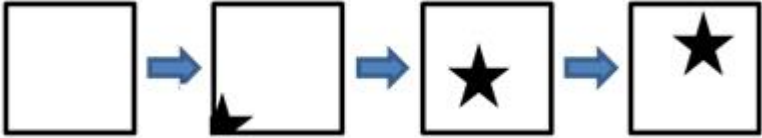
Value	Description
	 <p>The animEffectDirection value MUST be one of the following:</p> <ul style="list-style-type: none"> ▪ 0x00: Cover from the right to the left side of the object. ▪ 0x01: Cover from the bottom to the top side of the object. ▪ 0x02: Cover from the left to the right side of the object. ▪ 0x03: Cover from the top to the bottom side of the object. ▪ 0x04: Cover from the bottom-right to the top-left corner of the object. ▪ 0x05: Cover from the bottom-left to the top-right corner of the object. ▪ 0x06: Cover from the top-right to the bottom-left corner of the object. ▪ 0x07: Cover from the top-left to the bottom-right corner of the object.
0x05	<p>Dissolve animation effect that uses a set of randomly placed squares on the object instance that continue to be added to until the new object instance is fully shown, as illustrated in the following example:</p>  <p>animEffectDirection MUST be 0x00.</p>
0x06	<p>Fade animation effect that smoothly fades the previous object instance either directly to the new object instance or first to a black screen and then to the new object instance, as illustrated in the following example:</p>  <p>animEffectDirection MUST be 0x00.</p>
0x07	 <p>The animEffectDirection value MUST be one of the following:</p> <ul style="list-style-type: none"> ▪ 0x00: Reveal from the right to the left side of the object. ▪ 0x01: Reveal from the bottom to the top side of the object. ▪ 0x02: Reveal from the left to the right side of the object. ▪ 0x03: Reveal from the top to the bottom side of the object.

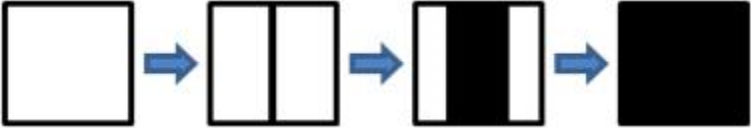
Value	Description
	<ul style="list-style-type: none"> ▪ 0x04: Reveal from the bottom-right to the top-left corner of the object. ▪ 0x05: Reveal from the bottom-left to the top-right corner of the object. ▪ 0x06: Reveal from the top-right to the bottom-left corner of the object. ▪ 0x07: Reveal from the top-left to the bottom-right corner of the object.
0x08	<p>Random bar animation effect that uses a set of randomly placed horizontal or vertical bars on the object instance that continue to be added to until the new object instance is fully shown, as illustrated in the following example:</p>  <p>The animEffectDirection value MUST be one of the following:</p> <ul style="list-style-type: none"> ▪ 0x00: Horizontal direction ▪ 0x01: Vertical direction
0x09	<p>Strips animation effect that uses a set of bars that are arranged in a staggered fashion and wipes them across the screen until the new object instance is fully shown, as illustrated in the following example:</p>  <p>The animEffectDirection value MUST be one of the following:</p> <ul style="list-style-type: none"> ▪ 0x04: Strips move from the bottom-right to the top-left corner of the object. ▪ 0x05: Strips move from the bottom-left to the top-right corner of the object. ▪ 0x06: Strips move from the top-right to the bottom-left corner of the object. ▪ 0x07: Strips move from the top-left to the bottom-right corner of the object.
0x0A	<p>Wipe animation effect that wipes the new object instance over the previous object instance from one edge of the screen to the opposite until the new object instance is fully shown, as illustrated in the following example:</p>  <p>The animEffectDirection value MUST be one of the following:</p> <ul style="list-style-type: none"> ▪ 0x00: Wipe effect is from the right to the left side of the object. ▪ 0x01: Wipe effect is from the bottom to the top side of the object. ▪ 0x02: Wipe effect is from the left to the right side of the object. ▪ 0x03: Wipe effect is from the top to the bottom side of the object.

Value	Description
0x0B	<p>Zoom animation effect that uses a box pattern centered on the object instance that increases or decreases in size until the new object instance is fully shown, as illustrated in the following example:</p>  <p>The animEffectDirection value MUST be one of the following:</p> <ul style="list-style-type: none"> ▪ 0x00: Outward direction ▪ 0x01: Inward direction
0x0C	<p>Fly animation effect that moves the new object instance in from the specified direction to the object's on-screen location, as illustrated in the following example:</p>  <p>The animEffectDirection value MUST be one of the following:</p> <ul style="list-style-type: none"> ▪ 0x00: Fly from the left side of the presentation slide. ▪ 0x01: Fly from the top side of the presentation slide. ▪ 0x02: Fly from the right side of the presentation slide. ▪ 0x03: Fly from the bottom side of the presentation slide. ▪ 0x04: Fly from the top-left corner of the presentation slide. ▪ 0x05: Fly from the top-right corner of the presentation slide. ▪ 0x06: Fly from the bottom-left corner of the presentation slide. ▪ 0x07: Fly from the bottom-right corner of the presentation slide. ▪ 0x08: Fly from the left edge of the shape or text. ▪ 0x09: Fly from the bottom edge of the shape or text. ▪ 0x0A: Fly from the right edge of the shape or text. ▪ 0x0B: Fly from the top edge of the shape or text. ▪ 0x0C: Crawl from the left side of the presentation slide. ▪ 0x0D: Crawl from the top side of the presentation slide. ▪ 0x0E: Crawl from the right side of the presentation slide. ▪ 0x0F: Crawl from the bottom side of the presentation slide. ▪ 0x10: The shape or text zooms in from zero size to its full size, and its center keeps unchanged. ▪ 0x11: The shape or text zooms in from half of its size to its full size, and its center remains unchanged.

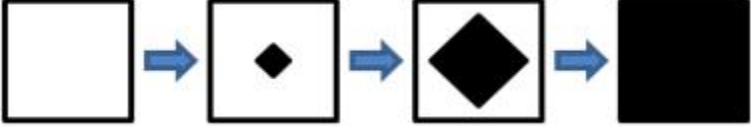
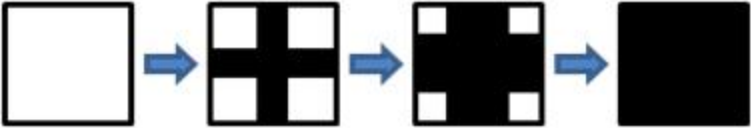
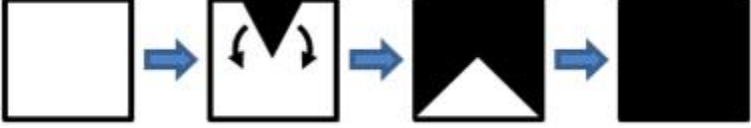
Value	Description
	<ul style="list-style-type: none"> ▪ 0x12: The shape or text zooms out from 4 times its size to its full size, and its center remains unchanged. ▪ 0x13: The shape or text zooms out from 1.5 times its size to its full size, and its center remains unchanged. ▪ 0x14: The shape or text zooms in from zero size to its full size, and its center moves from the screen center to its actual center. ▪ 0x15: The shape or text zooms out from 4 times its size to its full size, and it moves from the bottom side of the screen to its actual position. ▪ 0x16: The shape or text stretches from its center to both left and right. ▪ 0x17: The shape or text stretches from its left side to its right side. ▪ 0x18: The shape or text stretches from its top side to its bottom side. ▪ 0x19: The shape or text stretches from its right side to its left side. ▪ 0x1A: The shape or text stretches from its bottom side to its top side. ▪ 0x1B: The shape or text rotates around the vertical axis that passes through its center. ▪ 0x1C: The shape or text flies in a spiral.
0x0D	<p>Split animation that reveals the new object instance directly on top of the previous one by wiping either horizontally or vertically from the outside in, or from the inside out, until the new object instance is fully shown, as illustrated in the following example:</p>  <p>The animEffectDirection value MUST be one of the following:</p> <ul style="list-style-type: none"> ▪ 0x00: The split animation plays horizontally from the middle to both the top and bottom of the shape or text. ▪ 0x01: The split animation plays horizontally from the top and bottom to the middle of the shape or text. ▪ 0x02: The split animation plays vertically from the middle to both the left and right of the shape or text. ▪ 0x03: The split animation plays vertically from the left and right to the middle of the shape or text.
0x0E	<p>Flash animation effect that displays the new object instance for a period of time and then hides the object from view, as illustrated in the following example:</p>  <p>animEffectDirection specifies the time when the flash takes place. The following table is for description purposes only. Exact time when the flash takes place is</p>

Value	Description
	<p>determined by the application.</p> <p>The animEffectDirection value MUST be one of the following:</p> <ul style="list-style-type: none"> ▪ 0x00: Flash takes place after a short time. ▪ 0x01: Flash takes place after a medium time. ▪ 0x02: Flash takes place after a long time.
0x11	<p>Diamond animation effect that uses a diamond pattern centered on the object instance that increases in size until the new object instance is fully shown, as illustrated in the following example:</p>  <p>animEffectDirection MUST be 0x00.</p>
0x12	<p>Plus animation effect that uses a plus pattern centered on the object instance that increases in size until the new object instance is fully shown, as illustrated in the following example:</p>  <p>animEffectDirection MUST be 0x00.</p>
0x13	<p>Wedge animation effect that uses two radial edges that wipe from top to bottom in opposite directions until the new object instance is fully shown, as illustrated in the following example:</p>  <p>animEffectDirection MUST be 0x00.</p>
0x1A	<p>Wheel animation effect that uses a set of radial edges and wipes them in the clockwise direction until the new object instance is fully shown, as illustrated in the following example:</p>  <p>The animEffectDirection value MUST be one of the following:</p> <ul style="list-style-type: none"> ▪ 0x01: Use 1 spoke. ▪ 0x02: Use 2 spokes. ▪ 0x03: Use 3 spokes. ▪ 0x04: Use 4 spokes. ▪ 0x08: Use 8 spokes.
0x1B	<p>Circle animation effect that uses a circle pattern centered on the object instance that</p>

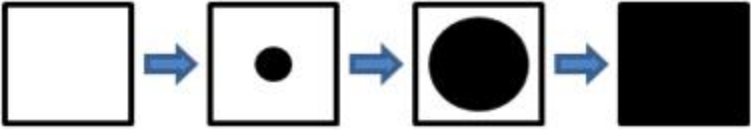
Value	Description
	<p>increases in size until the new object instance is fully shown, as illustrated in the following example:</p>  <p>animEffectDirection MUST be 0x00.</p>

animEffectDirection (1 byte): An **unsigned integer** that specifies the direction of the animation effect. It MUST be a value as specified by the **animEffect** field.

animAfterEffect (1 byte): An [AnimAfterEffectEnum](#) enumeration that specifies the behavior of the shape or text after the animation effect is finished.

textBuildSubEffect (1 byte): A [TextBuildSubEffectEnum](#) enumeration that specifies the behavior of text in the animation effect.

oleVerb (1 byte): An [OLEVerbEnum](#) enumeration that SHOULD<105> specify the OLE verb associated with this shape.

unused (2 bytes): Undefined and MUST be ignored.

2.8.3 HashCode10Atom

Referenced by: [PP10SlideBinaryTagExtension](#)

An **atom record** that specifies the hash code for the animation information for a **slide**.

0	1	2	3	4	5	6	7	8	9	10	1	2	3	4	5	6	7	8	9	20	1	2	3	4	5	6	7	8	9	30	1
rh																															
...																															
hash																															

rh (8 bytes): A **RecordHeader** structure (section [2.3.1](#)) that specifies the header for this record. Sub-fields are further specified in the following table.

Field	Meaning
rh.recVer	MUST be 0x0.
rh.recInstance	MUST be 0x000.
rh.recType	MUST be RT_HashCodeAtom .
rh.recLen	MUST be 0x00000004.

hash (4 bytes): An **unsigned integer** that specifies a hash value for the animation information of all shapes in a slide. To calculate the hash value, a random array MUST be initialized first, as specified in the following pseudocode:

- Define **randomArray** as an array of 256 rows and 256 columns
- Initialize all elements of randomArray with 0x00000000
- Set **randomSeed** to 0x00000001
 - FOR each row of **randomArray**
 - FOR each column of **randomArray**
 - Set r0 to **randomSeed**
 - Set r1 to ((r0 * 0x000343FD + 0x00269EC3) >> 16) & 0x00007FFF
 - Set r2 to ((r1 * 0x000343FD + 0x00269EC3) >> 16) & 0x00007FFF
 - Set r3 to ((r2 * 0x000343FD + 0x00269EC3) >> 16) & 0x00007FFF
 - Set r4 to ((r3 * 0x000343FD + 0x00269EC3) >> 16) & 0x00007FFF
 - Set **randomSeed** to r4
 - Set r1 to (r1 % 0x00000100)
 - Set r2 to (r2 % 0x00000100) << 8
 - Set r3 to (r3 % 0x00000100) << 16
 - Set r4 to (r4 % 0x00000100) << 24
 - Set **randomArray** position (row, column) to r4 | r3 | r2 | r1
 - END FOR
 - END FOR
 - END FOR

Then, the random array can be used to calculate hash values for all slides, as specified in the following pseudocode:

- Set hash to 0x00000000
 - FOR each shape in the slide
 - Define **animInfoAtom** as **AnimationInfoAtom**
 - Initialize all bytes of **animInfoAtom** with zero
 - IF **AnimationInfoAtom** exists in the shape THEN
 - Read the animation information into **animInfoAtom**
 - END IF
 - Set **shapeId** to identifier of the shape
 - FOR each byte in **animInfoAtom**
 - Set **byteIndex** to the index of the byte in **animInfoAtom**
 - Set **rowIndex** to (shapeId * (**byteIndex** + 1)) % 256
 - Set **hash** to **hash** ^ **randomArray**[**rowIndex**][**byte**]

- END FOR
- END FOR

2.8.4 BuildListContainer

Referenced by: [PP10SlideBinaryTagExtension](#)

A **container record** that specifies all animation **builds** for a **slide**.

0	1	2	3	4	5	6	7	8	9	10	11	12	13	14	15	16	17	18	19	20	21	22	23	24	25	26	27	28	29	30	31
rh																															
...																															
rgChildRec (variable)																															
...																															

rh (8 bytes): A **RecordHeader** structure (section [2.3.1](#)) that specifies the header for this record. Sub-fields are further specified in the following table.

Field	Meaning
rh.recVer	MUST be 0xF.
rh.recInstance	MUST be 0x000.
rh.recType	MUST be RT_BuildList .

rgChildRec (variable): An array of [BuildListSubContainer](#) records that specifies all builds for a slide. Each item specifies build information for a **shape**.

2.8.5 BuildListSubContainer

Referenced by: [BuildListContainer](#)

A variable type record whose type and meaning are dictated by the value of **rh.recType**, as specified in the following table.

Value	Meaning
RT_ParaBuild	A ParaBuildContainer record that specifies text build information.
RT_ChartBuild	A ChartBuildContainer record that specifies chart build information.
RT_DiagramBuild	A DiagramBuildContainer record that specifies diagram build information.

2.8.6 ParaBuildContainer

Referenced by: [BuildListSubContainer](#)

A **container record** that specifies the **build** information for text paragraphs in a **shape**.

0	1	2	3	4	5	6	7	8	9	10	11	12	13	14	15	16	17	18	19	20	21	22	23	24	25	26	27	28	29	30	31
rh																															
...																															
buildAtom (24 bytes)																															
...																															
...																															
paraBuildAtom (24 bytes)																															
...																															
...																															
rgParaBuildLevel (variable)																															
...																															

rh (8 bytes): A **RecordHeader** structure (section [2.3.1](#)) that specifies the header for this record. Sub-fields are further specified in the following table.

Field	Meaning
rh.recVer	MUST be 0xF.
rh.recInstance	MUST be 0x000.
rh.recType	MUST be RT_ParaBuild .

buildAtom (24 bytes): A [BuildAtom](#) record that specifies the information for the build.

paraBuildAtom (24 bytes): A [ParaBuildAtom](#) record that specifies the information for the paragraph build.

rgParaBuildLevel (variable): An array of [ParaBuildLevel](#) that specifies the template effects for the text. If **paraBuildAtom.paraBuild** is [TLPB_AsAWhole](#), **rgParaBuildLevel** MUST contain one and only one [ParaBuildLevel](#) that specifies the template effects for the text. Otherwise, **rgParaBuildLevel** MUST contain the same number of [ParaBuildLevel](#) items as the number of paragraph levels in the shape, ordered from level 1 to the biggest level. Each [ParaBuildLevel](#) item in the array specifies the template effects for a paragraph level in the text.

2.8.7 BuildAtom

Referenced by: [ChartBuildContainer](#), [DiagramBuildContainer](#), [ParaBuildContainer](#)

An **atom record** that specifies the **build** information for a chart, diagram or text.

0	1	2	3	4	5	6	7	8	9	10	11	12	13	14	15	16	17	18	19	20	21	22	23	24	25	26	27	28	29	30	31
rh																															
...																															
buildType																															
buildId																															
shapeIdRef																															
fExpanded								fUIExpanded								unused															

rh (8 bytes): A **RecordHeader** structure (section [2.3.1](#)) that specifies the header for this record. Sub-fields are further specified in the following table.

Field	Meaning
rh.recVer	MUST be 0x0.
rh.recInstance	MUST be 0x000.
rh.recType	MUST be an RT_BuildAtom .
rh.recLen	MUST be 0x00000010.

buildType (4 bytes): A [BuildTypeEnum](#) enumeration that specifies the build type.

buildId (4 bytes): An unsigned integer that specifies the **build identifier**. The combination of **buildId** and **shapeIdRef** MUST be unique for all builds in the slide.

shapeIdRef (4 bytes): An unsigned integer that specifies the target **shape** that this build is applied to.

fExpanded (1 byte): A **bool1** (section [2.2.2](#)) that specifies whether this build has been expanded into **time nodes**.

fUIExpanded (1 byte): A **bool1** that specifies whether this build is shown as expanded in the user interface.

unused (2 bytes): Undefined and MUST be ignored.

2.8.8 ParaBuildAtom

Referenced by: [ParaBuildContainer](#)

An **atom record** that specifies the information for a paragraph **build**.

0	1	2	3	4	5	6	7	8	9	10	11	12	13	14	15	16	17	18	19	20	21	22	23	24	25	26	27	28	29	30	31
rh																															
...																															

paraBuild			
buildLevel			
fAnimBackground	fReverse	fUserSetAnimBackground	fAutomatic
delayTime			

rh (8 bytes): A **RecordHeader** structure (section [2.3.1](#)) that specifies the header for this record. Sub-fields are further specified in the following table.

Field	Meaning
rh.recVer	MUST be 0x1.
rh.recInstance	MUST be 0x000.
rh.recType	MUST be RT_ParaBuildAtom .
rh.recLen	MUST be 0x00000010.

paraBuild (4 bytes): A [ParaBuildEnum](#) enumeration that specifies the paragraph build type for text in the **shape**.

buildLevel (4 bytes): An unsigned integer that specifies which paragraph level the paragraph build applies to. Paragraphs in level 1 to level **buildLevel** expand individually, and paragraphs in other levels animate at the same time as level **buildLevel**. If **paraBuild** is not TLPB_BuildByNthLevel, **buildLevel** MUST be ignored.

fAnimBackground (1 byte): A **bool1** (section [2.2.2](#)) that specifies whether the background animates. If there is an attached shape or a background on the text box or text **placeholder shape**, **fAnimBackground** is valid; otherwise, it MUST be ignored. It MUST be a value from the following table.

Value	Meaning
0x00	The background is not animated.
0x01	The background is animated.

fReverse (1 byte): A **bool1** that specifies whether the animation plays in reverse order. It MUST be a value from the following table:

Value	Meaning
0x00	The animation does not play in reverse order.
0x01	The animation plays in reverse order.

fUserSetAnimBackground (1 byte): A **bool1** that specifies whether **fAnimBackground** has been toggled by any users. It MUST be a value from the following table.

Value	Meaning
0x00	fAnimBackground has never been toggled.
0x01	fAnimBackground has been toggled.

fAutomatic (1 byte): A **bool1** that specifies whether to automatically proceed to the next build step after the current build step is finished. It MUST be a value from the following table.

Value	Meaning
0x00	Do not automatically proceed to the next build step.
0x01	Automatically proceed to the next build step.

delayTime (4 bytes): An unsigned integer that specifies the waiting time, in milliseconds, from the time when the current build step is finished to the time when the next build step starts. It MUST be ignored if **fAutomatic** is 0x00.

2.8.9 ParaBuildLevel

Referenced by: [ParaBuildContainer](#)

A structure that specifies information about the **build** step for a specific paragraph level.

0	1	2	3	4	5	6	7	8	9	10	11	12	13	14	15	16	17	18	19	20	21	22	23	24	25	26	27	28	29	30	31
levelInfoAtom																															
...																															
...																															
timeNode (variable)																															
...																															

levelInfoAtom (12 bytes): A [LevelInfoAtom](#) record that specifies the paragraph level.

timeNode (variable): An **ExtTimeNodeContainer** record (section [2.8.15](#)) that specifies all time nodes for the paragraph level specified by the **levelInfoAtom**.

2.8.10 LevelInfoAtom

Referenced by: [ParaBuildLevel](#)

An **atom record** that specifies the level for a paragraph.

0	1	2	3	4	5	6	7	8	9	10	11	12	13	14	15	16	17	18	19	20	21	22	23	24	25	26	27	28	29	30	31
rh																															
...																															
level																															

rh (8 bytes): A **RecordHeader** structure (section [2.3.1](#)) that specifies the header for this record. Sub-fields are further specified in the following table.

Field	Meaning
rh.recVer	MUST be 0x0.
rh.recInstance	MUST be 0x000.
rh.recType	MUST be RT_LevelInfoAtom .
rh.recLen	MUST be 0x00000004

level (4 bytes): An **unsigned integer** that specifies the paragraph level. It MUST be less than or equal to 0x00000009. It SHOULD [<106>](#) be less than or equal to 0x00000005.

2.8.11 ChartBuildContainer

Referenced by: [BuildListSubContainer](#)

A **container record** that specifies the **build** information for a chart.

0	1	2	3	4	5	6	7	8	9	10	11	12	13	14	15	16	17	18	19	20	21	22	23	24	25	26	27	28	29	30	31
rh																															
...																															
buildAtom (24 bytes)																															
...																															
...																															
chartBuildAtom (16 bytes)																															
...																															
...																															

rh (8 bytes): A **RecordHeader** structure (section [2.3.1](#)) that specifies the header for this record. Sub-fields are further specified in the following table.

Field	Meaning
rh.recVer	MUST be 0xF.
rh.recInstance	MUST be 0x000.
rh.recType	MUST be an RT_ChartBuild .
rh.recLen	MUST be 0x00000028.

buildAtom (24 bytes): A [BuildAtom](#) record that specifies the information for the build.

chartBuildAtom (16 bytes): A [ChartBuildAtom](#) record that specifies the information for the chart build.

2.8.12 ChartBuildAtom

Referenced by: [ChartBuildContainer](#)

An **atom record** that specifies the information for a chart **build**.

0	1	2	3	4	5	6	7	8	9	10	11	12	13	14	15	16	17	18	19	20	21	22	23	24	25	26	27	28	29	30	31
rh																															
...																															
chartBuild																															
fAnimBackground										unused																					

rh (8 bytes): A **RecordHeader** structure (section [2.3.1](#)) that specifies the header for this record. Sub-fields are further specified in the following table.

Field	Meaning
rh.recVer	MUST be 0x0.
rh.recInstance	MUST be 0x000.
rh.recType	MUST be an RT_ChartBuildAtom .
rh.recLen	MUST be 0x00000008.

chartBuild (4 bytes): A [ChartBuildEnum](#) enumeration that specifies the chart build type.

fAnimBackground (1 byte): A **bool1** (section [2.2.2](#)) that specifies whether the background of the chart animates separately. If **chartBuild** is `TLCB_AsOneObject`, **fAnimBackground** MUST be ignored. It MUST be a value from the following table.

Value	Meaning
0x00	Do not animate the background.
0x01	Animate the background.

unused (3 bytes): Undefined and MUST be ignored.

2.8.13 DiagramBuildContainer

Referenced by: [BuildListSubContainer](#)

A **container record** that specifies the **build** information for a diagram.

0	1	2	3	4	5	6	7	8	9	10	11	12	13	14	15	16	17	18	19	20	21	22	23	24	25	26	27	28	29	30	31
rh																															
...																															

buildAtom (24 bytes)
...
...
diagramBuildAtom
...
...

rh (8 bytes): A **RecordHeader** structure (section [2.3.1](#)) that specifies the header for this record. Sub-fields are further specified in the following table.

Field	Meaning
rh.recVer	MUST be 0xF.
rh.recInstance	MUST be 0x000.
rh.recType	MUST be an RT_DiagramBuild .
rh.recLen	MUST be 0x00000024.

buildAtom (24 bytes): A [BuildAtom](#) record that specifies the information for the build.

diagramBuildAtom (12 bytes): A [DiagramBuildAtom](#) record that specifies the information for the diagram build.

2.8.14 DiagramBuildAtom

Referenced by: [DiagramBuildContainer](#)

An **atom record** that specifies the information for a diagram **build**.

0	1	2	3	4	5	6	7	8	9	10	11	12	13	14	15	16	17	18	19	20	21	22	23	24	25	26	27	28	29	30	31
rh																															
...																															
diagramBuild																															

rh (8 bytes): A **RecordHeader** structure (section [2.3.1](#)) that specifies the header for this record. Sub-fields are further specified in the following table.

Field	Meaning
rh.recVer	MUST be 0x0.
rh.recInstance	MUST be 0x000.
rh.recType	MUST be an RT_DiagramBuildAtom .
rh.recLen	MUST be 0x00000004.

diagramBuild (4 bytes): A [DiagramBuildEnum](#) enumeration that specifies the diagram build type.

2.8.15 ExtTimeNodeContainer

Referenced by: [ParaBuildLevel](#), [PP10SlideBinaryTagExtension](#)

A **container record** that specifies a **time node**. This time node is used to store all information necessary to cause a time-based or an action-based effect to occur during a **slide show**. Each time node effect has a corresponding object to which the effect applies.

At most one of the following fields MUST exist: **timeAnimateBehavior**, **timeColorBehavior**, **timeEffectBehavior**, **timeMotionBehavior**, **timeRotationBehavior**, **timeScaleBehavior**, **timeSetBehavior**, or **timeCommandBehavior**.

0	1	2	3	4	5	6	7	8	9	10	11	12	13	14	15	16	17	18	19	20	21	22	23	24	25	26	27	28	29	30	31
rh																															
...																															
timeNodeAtom (40 bytes)																															
...																															
...																															
timePropertyList (variable)																															
...																															
timeAnimateBehavior (variable)																															
...																															
timeColorBehavior (variable)																															
...																															
timeEffectBehavior (variable)																															
...																															
timeMotionBehavior (variable)																															
...																															
timeRotationBehavior (variable)																															
...																															
timeScaleBehavior (variable)																															

...
timeSetBehavior (variable)
...
timeCommandBehavior (variable)
...
clientVisualElement (variable)
...
timeIterateDataAtom (28 bytes, optional)
...
...
timeSequenceDataAtom (28 bytes, optional)
...
...
rgBeginTimeCondition (variable)
...
rgEndTimeCondition (variable)
...
timeEndSyncTimeCondition (variable)
...
rgTimeModifierAtom (variable)
...
rgSubEffect (variable)
...
rgExtTimeNodeChildren (variable)
...

rh (8 bytes): A **RecordHeader** structure (section [2.3.1](#)) that specifies the header for this record. Subfields are further specified in the following table.

Field	Meaning
rh.recVer	MUST be 0xF.
rh.recInstance	MUST be 0x001.
rh.recType	MUST be an RT_TimeExtTimeNodeContainer .

timeNodeAtom (40 bytes): A [TimeNodeAtom](#) record that specifies time-based attributes of this time node.

timePropertyList (variable): An optional **TimePropertyList4TimeNodeContainer** record (section [2.8.18](#)) that specifies a list of attributes of the time node.

timeAnimateBehavior (variable): An optional **TimeAnimateBehaviorContainer** record (section [2.8.29](#)) that specifies a generic animation behavior that can animate any property of an object. It MUST exist only if **timeNodeAtom.type** is [TL_TNT_Behavior](#).

timeColorBehavior (variable): An optional **TimeColorBehaviorContainer** record (section [2.8.52](#)) that specifies a color animation behavior that changes the color of an object. It MUST only if **timeNodeAtom.type** is [TL_TNT_Behavior](#).

timeEffectBehavior (variable): An optional **TimeEffectBehaviorContainer** record (section [2.8.61](#)) that specifies an effect-animation behavior that transforms the image of an object. It MUST exist only if **timeNodeAtom.type** is [TL_TNT_Behavior](#).

timeMotionBehavior (variable): An optional **TimeMotionBehaviorContainer** record (section [2.8.63](#)) that specifies a motion-animation behavior that moves a positioned object along a path. It MUST exist only if **timeNodeAtom.type** is [TL_TNT_Behavior](#).

timeRotationBehavior (variable): An optional **TimeRotationBehaviorContainer** record (section [2.8.65](#)) that specifies a rotation animation behavior that rotates an object. It MUST exist only if **timeNodeAtom.type** is [TL_TNT_Behavior](#).

timeScaleBehavior (variable): An optional **TimeScaleBehaviorContainer** record (section [2.8.67](#)) that specifies a scale-animation behavior that changes the size of an object. It MUST exist only if **timeNodeAtom.type** is [TL_TNT_Behavior](#).

timeSetBehavior (variable): An optional **TimeSetBehaviorContainer** record (section [2.8.69](#)) that specifies a set-animation behavior that assigns a value to a property of an object. It MUST exist if **timeNodeAtom.type** is [TL_TNT_Behavior](#).

timeCommandBehavior (variable): An optional **TimeCommandBehaviorContainer** record (section [2.8.71](#)) that specifies a command-animation behavior that performs a command as an animation. It MUST exist only if **timeNodeAtom.type** field is [TL_TNT_Behavior](#).

clientVisualElement (variable): An optional **ClientVisualElementContainer** record (section [2.8.44](#)) that specifies a media file to be played. It MUST exist only if **timeNodeAtom.type** is [TL_TNT_Media](#).

timeIterateDataAtom (28 bytes): An optional [TimeIterateDataAtom](#) record that specifies how an animation is applied to the subelements of a target object for a repeated effect.

timeSequenceDataAtom (28 bytes): An optional [TimeSequenceDataAtom](#) record that specifies sequencing information for the child nodes of this time node. It MUST exist only if **timeNodeAtom.type** is [TL_TNT_Sequential](#).

rgBeginTimeCondition (variable): An optional array of **TimeConditionContainer** record (section [2.8.75](#)) that specifies the **time conditions** that MUST be used in one of the following situations:

- When the **rh.recInstance** field of a **TimeConditionContainer** record is [TL_CT_Begin](#), any of these time conditions determines when this time node will be activated.
- When the **rh.recInstance** field of a **TimeConditionContainer** record is [TL_CT_Next](#) and the **timeNodeAtom.type** field is [TL_TNT_Sequential](#), any of these time conditions determines when the next child time node will be activated.

The array continues while the **rh.recType** field of the **TimeConditionContainer** record is equal to [RT_TimeConditionContainer](#) and one of the two aforementioned situations applies.

rgEndTimeCondition (variable): An optional array of **TimeConditionContainer** records (section [2.8.75](#)) that specifies the time conditions that MUST be utilized in one of the following situations:

- When the **rh.recInstance** field of a **TimeConditionContainer** record is [TL_CT_End](#), any of these time conditions determines when this time node will be deactivated.
- When the **rh.recInstance** field of a **TimeConditionContainer** record is [TL_CT_Previous](#) and the **timeNodeAtom.type** field is [TL_TNT_Sequential](#), any of these time conditions determines when the next child time node will be deactivated.

The array continues while the **rh.recType** field of the **TimeConditionContainer** record is equal to [RT_TimeConditionContainer](#) and one of the two aforementioned situations is applies.

timeEndSyncTimeCondition (variable): An optional **TimeConditionContainer** record (section [2.8.75](#)) that specifies how to synchronize the stopping of the child nodes of this time node. The **timeEndSyncTimeCondition.rh.recInstance** sub-field MUST be [TL_CT_EndSync](#).

rgTimeModifierAtom (variable): An optional array of [TimeModifierAtom](#) records that specifies the modification records that store the type of data to be modified and the new data value. The array continues while the **rh.recType** field of the [TimeModifierAtom](#) record is equal to [RT_TimeModifier](#).

rgSubEffect (variable): An optional array of [SubEffectContainer](#) that specifies the subordinate time nodes whose start time depends on the relation to this time node. The relationship is specified in the [TimeMasterRelType](#) record contained in the **timePropertyList** field of the [SubEffectContainer](#) record. The array continues while the **rh.recType** field of the [SubEffectContainer](#) record is equal to [RT_TimeSubEffectContainer](#).

rgExtTimeNodeChildren (variable): An array of **ExtTimeNodeContainer** that specifies the child time nodes of this time node.

2.8.16 SubEffectContainer

A **container record** that specifies a subordinate **time node** whose start time depends on the relation to its master time node.

At most one of the following fields MUST exist: **timeColorBehavior**, **timeSetBehavior**, or **timeCommandBehavior**.

0	1	2	3	4	5	6	7	8	9	10	1	2	3	4	5	6	7	8	9	20	1	2	3	4	5	6	7	8	9	30	1	
rh																																
...																																

timeNodeAtom (40 bytes)
...
...
timePropertyList (variable)
...
timeColorBehavior (variable)
...
timeSetBehavior (variable)
...
timeCommandBehavior (variable)
...
clientVisualElement (variable)
...
rgBeginTimeCondition (variable)
...
rgEndTimeCondition (variable)
...
rgTimeModifierAtom (variable)
...

rh (8 bytes): A **RecordHeader** structure (section [2.3.1](#)) that specifies the header for this record. Subfields are further specified in the following table.

Field	Meaning
rh.recVer	MUST be 0xF.
rh.recInstance	MUST be 0x001.
rh.recType	MUST be an RT_TimeSubEffectContainer .

timeNodeAtom (40 bytes): A [TimeNodeAtom](#) record that specifies some attributes of this subordinate time node. The **timeNodeAtom.type** subfield MUST be [TL_TNT_Behavior](#) or [TL_TNT_Media](#).

timePropertyList (variable): An optional **TimePropertyList4TimeNodeContainer** record (section [2.8.18](#)) that specifies a list of attributes of the subordinate time node.

timeColorBehavior (variable): An optional **TimeColorBehaviorContainer** record (section [2.8.52](#)) that specifies a color animation behavior that changes the color of an object. It MUST exist only if **timeNodeAtom.type** is TL_TNT_Behavior.

timeSetBehavior (variable): An optional **TimeSetBehaviorContainer** record (section [2.8.69](#)) that specifies a set animation behavior that assigns a value to a property of an object. It MUST exist only if **timeNodeAtom.type** is TL_TNT_Behavior.

timeCommandBehavior (variable): An optional **TimeCommandBehaviorContainer** record (section [2.8.71](#)) that specifies a command-animation behavior that performs a command as an animation. It MUST exist if and only if the **timeCommandBehavior.rh.recType** field is RT_TimeCommandBehaviorContainer and the **timeNodeAtom.type** field is TL_TNT_Behavior.

clientVisualElement (variable): An optional **ClientVisualElementContainer** record (section [2.8.44](#)) that specifies a media to be played. It MUST exist only if **timeNodeAtom.type** is TL_TNT_Media.

rgBeginTimeCondition (variable): An optional array of **TimeConditionContainer** records (section [2.8.75](#)) that specifies the **time conditions**. It MUST be used when the **rh.recInstance** field of a **TimeConditionContainer** record is [TL_CT_Begin](#). Any of these time conditions determine when this subordinate time node will be activated.

The array continues while the **rh.recType** field of the **TimeConditionContainer** record is equal to RT_TimeConditionContainer and the situation in the previous paragraph applies.

rgEndTimeCondition (variable): An optional array of **TimeConditionContainer** records that specifies the time conditions. It MUST be used when the **rh.recInstance** field of a **TimeConditionContainer** item is [TL_CT_End](#). Any of these time conditions determines when this subordinate time node will be deactivated.

The array continues while the **rh.recType** field of the **TimeConditionContainer** record is equal to RT_TimeConditionContainer and the previous situation applies.

rgTimeModifierAtom (variable): An optional array of [TimeModifierAtom](#) records that specifies the modification records that store the type of data to be modified and the new data value. The array continues while the **rh.recType** field of the TimeModifierAtom record is equal to RT_TimeModifier.

2.8.17 TimeNodeAtom

Referenced by: [ExtTimeNodeContainer](#), [SubEffectContainer](#)

An **atom record** that specifies the attributes of a **time node**.

Let the *corresponding time node* be specified by the **ExtTimeNodeContainer** record (section 2.8.15) or the **SubEffectContainer** record that contains this **TimeNodeAtom** record.

0	1	2	3	4	5	6	7	8	9	1	0	1	2	3	4	5	6	7	8	9	2	0	1	2	3	4	5	6	7	8	9	3	0	1
rh																																		
...																																		
reserved1																																		

restart					
type					
fill					
reserved2					
reserved3			unused		
duration					
A	B	C	D	E	reserved5

rh (8 bytes): A **RecordHeader** structure (section [2.3.1](#)) that specifies the header for this record. Sub-fields are further specified in the following table.

Field	Meaning
rh.recVer	MUST be 0x0.
rh.recInstance	MUST be 0x000.
rh.recType	MUST be an RT_TimeNode .
rh.recLen	MUST be 0x00000020.

reserved1 (4 bytes): MUST be zero, and MUST be ignored.

restart (4 bytes): An **unsigned integer** that specifies how the *corresponding time node* restarts when it completes its action. It MUST be ignored if **fRestartProperty** is **FALSE** and a value of 0x00000000 MUST be used instead. It MUST be a value from the following table:

Value	Meaning
0x00000000	Does not restart.
0x00000001	Can restart at any time.
0x00000002	Can restart when the <i>corresponding time node</i> is not active.
0x00000003	Same as 0x00000000.

type (4 bytes): A [TimeNodeTypeEnum](#) enumeration that specifies the type of the *corresponding time node*. It MUST be ignored if **fGroupingTypeProperty** is **FALSE** and a value of TL_TNT_Parallel MUST be used instead.

fill (4 bytes): An **unsigned integer** that specifies the state of the target object's properties when the animation ends. It MUST be ignored if **fFillProperty** is **FALSE** and a value of 0x00000000 MUST be used instead. It MUST be a value from the following table.

Value	Meaning
0x00000000	The properties remain at their ending values while the parent time node is still running or holding. After which, the properties reset to their original values.
0x00000001	The properties reset to their original values after

Value	Meaning
	the time node becomes inactive.
0x00000002	The properties remain at their ending values while the parent time node is still running or holding, or until another sibling time node is started under a sequential time node as specified in the type field. After which, the properties reset to their original values.
0x00000003	Same as 0x00000000.
0x00000004	Same as 0x00000001.

reserved2 (4 bytes): MUST be zero, and MUST be ignored.

reserved3 (1 byte): MUST be zero, and MUST be ignored.

unused (3 bytes): Undefined and MUST be ignored.

duration (4 bytes): A signed integer that specifies the duration of the *corresponding time node* in milliseconds. It MUST be ignored if **fDurationProperty** is **FALSE** and a value of 0x00000000 MUST be used instead.

A - fFillProperty (1 bit): A bit that specifies whether **fill** was explicitly set by a user interface action.

B - fRestartProperty (1 bit): A bit that specifies whether **restart** was explicitly set by a user interface action.

C - reserved4 (1 bit): MUST be zero, and MUST be ignored.

D - fGroupingTypeProperty (1 bit): A bit that specifies whether **type** was explicitly set by a user interface action.

E - fDurationProperty (1 bit): A bit that specifies whether **duration** was explicitly set by a user interface action.

reserved5 (27 bits): MUST be zero, and MUST be ignored.

2.8.18 TimePropertyList4TimeNodeContainer

Referenced by: [ExtTimeNodeContainer](#), [SubEffectContainer](#)

A **container record** that specifies a list of attributes for a **time node**.

Let the *corresponding time node* be specified by the **ExtTimeNodeContainer** record (section 2.8.15) or the **SubEffectContainer** record (section 2.8.16) that contains this **TimePropertyList4TimeNodeContainer** record.

0	1	2	3	4	5	6	7	8	9	10	11	12	13	14	15	16	17	18	19	20	21	22	23	24	25	26	27	28	29	30	31
rh																															
...																															
rgTimeVariant (variable)																															
...																															

rh (8 bytes): A **RecordHeader** structure (section [2.3.1](#)) that specifies the header for this record. Subfields are further specified in the following table.

Field	Meaning
rh.recVer	MUST be 0xF.
rh.recInstance	MUST be 0x000.
rh.recType	MUST be RT_TimePropertyList .

rgTimeVariant (variable): An array of [TimeVariant4TimeNode](#) records that specifies the list of attributes for the *corresponding time node*. The size, in bytes, of the array is specified by **rh.recLen**. Each [TimePropertyID4TimeNode](#) enumeration value MUST NOT occur more than once as a value of the **rh.recInstance** field in the array.

If the TL_TPID_AfterEffect value does not occur, a [TimeVariantBool](#) record in which the **boolValue** field is set to 0x00 SHOULD be used.

If the TL_TPID_Display value does not occur, a [TimeDisplayType](#) record in which the **displayType** field is set to 0x00000000 SHOULD be used.

If the *corresponding time node* is an **ExtTimeNodeContainer** record (section 2.8.15), the following values MUST NOT occur: TL_TPID_MasterPos and [TimeSubType](#).

If the *corresponding time node* is a **SubEffectContainer** record, the following values MUST NOT occur: TL_TPID_EffectID, TL_TPID_EffectDir, TL_TPID_EffectType, TL_TPID_SlideCount, TL_TPID_TimeFilter, TL_TPID_EventFilter, TL_TPID_HideWhenStopped, TL_TPID_GroupID, TL_TPID_EffectNodeType, and TL_TPID_ZoomToFullScreen.

2.8.19 TimeVariant4TimeNode

Referenced by: [TimePropertyList4TimeNodeContainer](#)

A variable type record that specifies an attribute of a **time node** and whose type and meaning are specified by the value of the **rh.recInstance** field, as specified in the following table.

Value	Meaning
TL_TPID_Display	A TimeDisplayType record that specifies the visibility of the time node in the user interface.
TL_TPID_MasterPos	A TimeMasterRelType record that specifies the relationship of a subordinate time node to its master time node.
TL_TPID_SubType	A TimeSubType record that specifies the type of subordinate time node.
TL_TPID_EffectID	A TimeEffectID record that specifies an identifier of an animation effect.
TL_TPID_EffectDir	A TimeVariantInt record that specifies the direction or other attributes of an animation effect. The values for each animation effect are specified in the TimeEffectID record.
TL_TPID_EffectType	A TimeEffectType record that specifies the type of animation effect.
TL_TPID_AfterEffect	A TimeVariantBool record that specifies whether the time node is an after effect.
TL_TPID_SlideCount	A TimeVariantInt record that specifies the number of slides that a media will play across.
TL_TPID_TimeFilter	A TimeNodeTimeFilter record that specifies a time filter that transforms a given

Value	Meaning
	time to the local time of a time node.
TL_TPID_EventFilter	A TimeEventFilter structure that specifies an event filter for a time node.
TL_TPID_HideWhenStopped	A TimeVariantBool structure that specifies whether to display the media when it is stopped.
TL_TPID_GroupID	A TimeGroupID structure that specifies a reference to a build identifier of an animation effect.
TL_TPID_EffectNodeType	A TimeEffectNodeType structure that specifies the role of a time node in the timing structure.
TL_TPID_PlaceholderNode	A TimeVariantBool structure that specifies whether the time node is a placeholder node that is not played during a slide show .
TL_TPID_MediaVolume	A TimeVariantFloat structure that specifies the volume of a media. The floatValue sub-field MUST be greater than or equal to 0 and less than or equal to 100000.
TL_TPID_MediaMute	A TimeVariantBool structure that specifies whether a media is muted.
TL_TPID_ZoomToFullScreen	A TimeVariantBool structure that specifies whether to zoom a media to full screen when it plays.

2.8.20 TimeDisplayType

Referenced by: [TimeVariant4TimeNode](#)

An **atom record** that specifies whether a **time node** is visible in the user interface.

Let the *corresponding time node* be as specified in the **TimePropertyList4TimeNodeContainer** record (section [2.8.18](#)) that contains this **TimeDisplayType** record.

0	1	2	3	4	5	6	7	8	9	10	1	2	3	4	5	6	7	8	9	20	1	2	3	4	5	6	7	8	9	30	1
rh																															
...																															
type																displayType															
...																															

rh (8 bytes): A **RecordHeader** structure (section [2.3.1](#)) that specifies the header for this record. Sub-fields are further specified in the following table.

Field	Meaning
rh.recVer	MUST be 0x0.
rh.recType	MUST be an RT_TimeVariant .
rh.recLen	MUST be 0x00000005.

type (1 byte): A [TimeVariantTypeEnum](#) enumeration that specifies the data type of this record. It MUST be TL_TVT_Int.

displayType (4 bytes): A signed integer that specifies whether the *corresponding time node* is displayed in the user interface. It MUST be a value from the following table:

Value	Meaning
0x00000000	The <i>corresponding time node</i> is visible.
0x00000001	The <i>corresponding time node</i> is hidden.

2.8.21 TimeMasterRelType

Referenced by: [TimeVariant4TimeNode](#)

An **atom record** that specifies how a subordinate **time node** plays back relative to its master time node.

Let the *corresponding subordinate time node* be specified by the **SubEffectContainer** record (section [2.8.16](#)) that contains this **TimeMasterRelType** record.

Let the *corresponding master time node* be specified by the **ExtTimeNodeContainer** record (section [2.8.15](#)) that contains the *corresponding subordinate time node*.

0	1	2	3	4	5	6	7	8	9	10	11	12	13	14	15	16	17	18	19	20	21	22	23	24	25	26	27	28	29	30	31
rh																															
...																															
type																masterRel															
...																															

rh (8 bytes): A **RecordHeader** structure (section [2.3.1](#)) that specifies the header for this record. Sub-fields are further specified in the following table.

Field	Meaning
rh.recVer	MUST be 0x0.
rh.recType	MUST be RT TimeVariant .
rh.recLen	MUST be 0x00000005.

type (1 byte): A [TimeVariantTypeEnum](#) enumeration that specifies the data type of this record. It MUST be TL_TVT_Int.

masterRel (4 bytes): A **signed integer** that specifies how the *corresponding subordinate time node* plays back relative to the *corresponding master time node*. It MUST be a value from the following table.

Value	Meaning
0x00000000	Do not start the <i>corresponding subordinate time node</i> .
0x00000002	Start the <i>corresponding subordinate time node</i> when the <i>corresponding master time node</i> starts.

2.8.22 TimeSubType

Referenced by: [TimeVariant4TimeNode](#)

An **atom record** that specifies the type of subordinate **time node**.

Let the *corresponding subordinate time node* be specified by the **SubEffectContainer** record (section [2.8.16](#)) that contains this **TimeSubType** record.

Let the *corresponding master time node* be specified by the **ExtTimeNodeContainer** record (section [2.8.15](#)) that contains the *corresponding subordinate time node*.

0	1	2	3	4	5	6	7	8	9	10	11	12	13	14	15	16	17	18	19	20	21	22	23	24	25	26	27	28	29	30	31
rh																															
...																															
type																subType															
...																															

rh (8 bytes): A **RecordHeader** structure (section [2.3.1](#)) that specifies the header for this record. Subfields are further specified in the following table.

Field	Meaning
rh.recVer	MUST be 0x0.
rh.recType	MUST be an RT_TimeVariant .
rh.recLen	MUST be 0x00000005.

type (1 byte): A [TimeVariantTypeEnum](#) enumeration that specifies the data type of this record. It MUST be TL_TVT_Int.

subType (4 bytes): A signed integer that specifies the type of the *corresponding subordinate time node*. It MUST be 0x00000001, specifying that the corresponding *subordinate time node* position is relative to the *corresponding master time node*.

2.8.23 TimeEffectID

Referenced by: [TimeVariant4TimeNode](#)

An **atom record** that specifies the identifier of an animation effect.

Let the *corresponding time node* be as specified in the **TimePropertyList4TimeNodeContainer** record (section [2.8.18](#)) that contains this **TimeEffectID** record.

Let the *corresponding effect type* be specified by the [TimeEffectType](#) record contained in the **TimePropertyList4TimeNodeContainer** record that contains this **TimeEffectID** record.

Let the *corresponding effect direction* be specified by the **intValue** field of the [TimeVariantInt](#) record contained in the **TimePropertyList4TimeNodeContainer** record such that the **rh.recInstance** field of the [TimeVariantInt](#) record is equal to [TL_TPID_EffectDir](#).

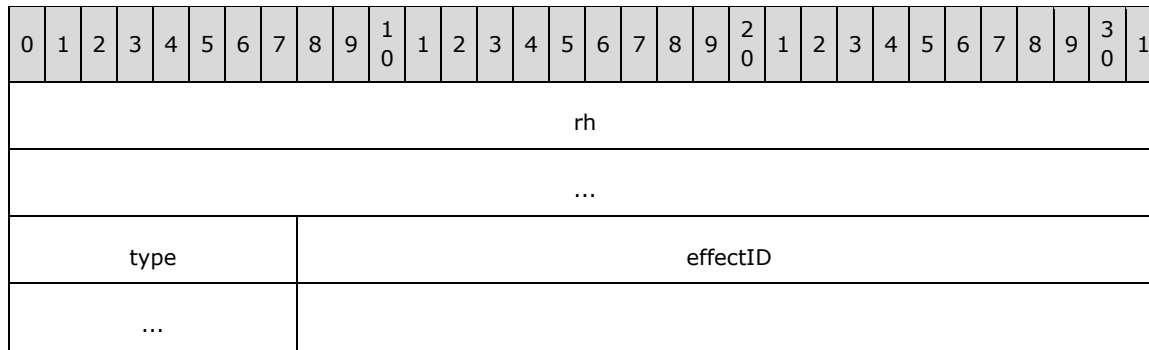

rh (8 bytes): A **RecordHeader** structure (section [2.3.1](#)) that specifies the header for this record. Sub-fields are further specified in the following table.

Field	Meaning
rh.recVer	MUST be 0x0.
rh.recType	MUST be RT_TimeVariant .
rh.recLen	MUST be 0x00000005.

type (1 byte): A [TimeVariantTypeEnum](#) enumeration that specifies the data type of this record. It MUST be TL_TVT_Int.

effectID (4 bytes): A signed integer that specifies the identifier of the animation effect of the *corresponding time node*. When the *corresponding effect type* is an entrance or an exit effect, this field MUST be a value from the following table:

Value	Meaning
0x00000000	Custom. The <i>corresponding effect direction</i> MUST be ignored.
0x00000001	Appear. The <i>corresponding effect direction</i> MUST be ignored.
0x00000002	Fly in. The <i>corresponding effect direction</i> MUST be one of the following values: <ul style="list-style-type: none"> ▪ 0x00000002: Right ▪ 0x00000008: Left ▪ 0x00000001: Top ▪ 0x00000004: Bottom ▪ 0x00000009: Top left ▪ 0x00000003: Top right ▪ 0x00000006: Bottom right ▪ 0x0000000C: Bottom left

Value	Meaning
0x00000003	Blinds. The <i>corresponding effect direction</i> MUST be one of the following values: <ul style="list-style-type: none"> ▪ 0x0000000A: Horizontal ▪ 0x00000005: Vertical
0x00000004	Box. The <i>corresponding effect direction</i> MUST be one of the following values: <ul style="list-style-type: none"> ▪ 0x00000010: In ▪ 0x00000020: Out
0x00000005	Check board. The <i>corresponding effect direction</i> MUST be one of the following values: <ul style="list-style-type: none"> ▪ 0x00000005: Vertical ▪ 0x0000000A: Across
0x00000006	Circle. The <i>corresponding effect direction</i> MUST be one of the following values: <ul style="list-style-type: none"> ▪ 0x00000010: In ▪ 0x00000020: Out
0x00000007	Crawl. The <i>corresponding effect direction</i> MUST be one of the following values: <ul style="list-style-type: none"> ▪ 0x00000002: Right ▪ 0x00000008: Left ▪ 0x00000001: Top ▪ 0x00000004: Bottom ▪ 0x00000009: Top left ▪ 0x00000003: Top right ▪ 0x00000006: Bottom right

Value	Meaning
	<ul style="list-style-type: none"> 0x0000000C: Bottom left
0x00000008	<p>Diamond.</p> <p>The <i>corresponding effect direction</i> MUST be one of the following values:</p> <ul style="list-style-type: none"> 0x00000010: In 0x00000020: Out
0x00000009	<p>Dissolve.</p> <p>The <i>corresponding effect direction</i> MUST be ignored.</p>
0x0000000A	<p>Fade.</p> <p>The <i>corresponding effect direction</i> MUST be ignored.</p>
0x0000000B	<p>Flash once.</p> <p>The <i>corresponding effect direction</i> MUST be ignored.</p>
0x0000000C	<p>Peek.</p> <p>The <i>corresponding effect direction</i> MUST be one of the following values:</p> <ul style="list-style-type: none"> 0x00000002: Right 0x00000008: Left 0x00000001: Top 0x00000004: Bottom
0x0000000D	<p>Plus.</p> <p>The <i>corresponding effect direction</i> MUST be one of the following values:</p> <ul style="list-style-type: none"> 0x00000010: In 0x00000020: Out
0x0000000E	<p>Random bars.</p> <p>The <i>corresponding effect direction</i> MUST be one of the following values:</p> <ul style="list-style-type: none"> 0x0000000A: Horizontal 0x00000005: Vertical
0x0000000F	<p>Spiral.</p>

Value	Meaning
	The <i>corresponding effect direction</i> MUST be ignored.
0x00000010	Split. The <i>corresponding effect direction</i> MUST be one of the following values: <ul style="list-style-type: none"> ▪ 0x0000001A: Horizontal in ▪ 0x0000002A: Horizontal out ▪ 0x00000015: Vertical in ▪ 0x00000025: Vertical out
0x00000011	Stretch. The <i>corresponding effect direction</i> MUST be one of the following values: <ul style="list-style-type: none"> ▪ 0x00000002: Right ▪ 0x00000008: Left ▪ 0x00000001: Top ▪ 0x00000004: Bottom ▪ 0x0000000A: Across
0x00000012	Strips. The <i>corresponding effect direction</i> MUST be one of the following values: <ul style="list-style-type: none"> ▪ 0x00000009: Up left ▪ 0x00000003: Up right ▪ 0x00000006: Down right ▪ 0x0000000C: Down left
0x00000013	Swivel. The <i>corresponding effect direction</i> MUST be one of the following values: <ul style="list-style-type: none"> ▪ 0x0000000A: Horizontal ▪ 0x00000005: Vertical
0x00000014	Wedge.

Value	Meaning
	The <i>corresponding effect direction</i> MUST be ignored.
0x00000015	Wheel. The <i>corresponding effect direction</i> MUST be one of the following values: <ul style="list-style-type: none"> ▪ 0x00000001: Wheel(1) ▪ 0x00000002: Wheel(2) ▪ 0x00000003: Wheel(3) ▪ 0x00000004: Wheel(4) ▪ 0x00000008: Wheel(8)
0x00000016	Wipe. The <i>corresponding effect direction</i> MUST be one of the following values: <ul style="list-style-type: none"> ▪ 0x00000001: Up ▪ 0x00000002: Right ▪ 0x00000004: Down ▪ 0x00000008: Left
0x00000017	Zoom. The <i>corresponding effect direction</i> MUST be one of the following values: <ul style="list-style-type: none"> ▪ 0x00000010: In ▪ 0x00000020: Out ▪ 0x00000210: In center ▪ 0x00000024: Out bottom ▪ 0x00000120: Out slightly ▪ 0x00000110: In slightly
0x00000018	Random effects. The <i>corresponding effect direction</i> MUST be ignored.
0x00000019	Boomerang. The <i>corresponding effect direction</i> MUST be ignored.
0x0000001A	Bounce.

Value	Meaning
	The <i>corresponding effect direction</i> MUST be ignored.
0x0000001B	Color reveal. The <i>corresponding effect direction</i> MUST be ignored.
0x0000001C	Credits. The <i>corresponding effect direction</i> MUST be ignored.
0x0000001D	Ease in. The <i>corresponding effect direction</i> MUST be ignored.
0x0000001E	Float. The <i>corresponding effect direction</i> MUST be ignored.
0x0000001F	Grow and turn. The <i>corresponding effect direction</i> MUST be ignored.
0x00000020	Reserved.
0x00000021	Reserved.
0x00000022	Light speed. The <i>corresponding effect direction</i> MUST be ignored.
0x00000023	Pin wheel. The <i>corresponding effect direction</i> MUST be ignored.
0x00000024	Reserved.
0x00000025	Rise up. The <i>corresponding effect direction</i> MUST be ignored.
0x00000026	Swish. The <i>corresponding effect direction</i> MUST be ignored.
0x00000027	Thin line. The <i>corresponding effect direction</i> MUST be ignored.
0x00000028	Unfold. The <i>corresponding effect direction</i> MUST be ignored.
0x00000029	Whip. The <i>corresponding effect direction</i> MUST be ignored.

Value	Meaning
0x0000002A	Ascend. The <i>corresponding effect direction</i> MUST be ignored.
0x0000002B	Center revolve. The <i>corresponding effect direction</i> MUST be ignored.
0x0000002C	Reserved.
0x0000002D	Faded swivel. The <i>corresponding effect direction</i> MUST be ignored.
0x0000002E	Reserved.
0x0000002F	Descend. The <i>corresponding effect direction</i> MUST be ignored.
0x00000030	Sling. The <i>corresponding effect direction</i> MUST be ignored.
0x00000031	Spinner. The <i>corresponding effect direction</i> MUST be ignored.
0x00000032	Compress. The <i>corresponding effect direction</i> MUST be ignored.
0x00000033	Zip. The <i>corresponding effect direction</i> MUST be ignored.
0x00000034	Arc up. The <i>corresponding effect direction</i> MUST be ignored.
0x00000035	Faded zoom. The <i>corresponding effect direction</i> MUST be ignored.
0x00000036	Glide. The <i>corresponding effect direction</i> MUST be ignored.
0x00000037	Expand. The <i>corresponding effect direction</i> MUST be ignored.
0x00000038	Flip.

Value	Meaning
	The <i>corresponding effect direction</i> MUST be ignored.
0x00000039	Reserved.
0x0000003A	Fold. The <i>corresponding effect direction</i> MUST be ignored.

When the *corresponding effect type* is an emphasis effect, this field MUST be a value from the following table:

Value	Meaning
0x00000000	Custom. The <i>corresponding effect direction</i> MUST be ignored.
0x00000001	Change fill color. The <i>corresponding effect direction</i> MUST be one of the following values: <ul style="list-style-type: none"> ▪ 0x00000001: Instant ▪ 0x00000002: Gradual ▪ 0x00000006: Gradual and cycle clockwise ▪ 0x0000000A: Gradual and cycle counterclockwise
0x00000002	Change font. The <i>corresponding effect direction</i> MUST be ignored.
0x00000003	Change font color. The <i>corresponding effect direction</i> MUST be one of the following values: <ul style="list-style-type: none"> ▪ 0x00000001: Instant ▪ 0x00000001: Gradual ▪ 0x00000006: Gradual and cycle clockwise ▪ 0x0000000A: Gradual and cycle counterclockwise
0x00000004	Change font size. The <i>corresponding effect direction</i> MUST be one of the following values: <ul style="list-style-type: none"> ▪ 0x00000001: Instant ▪ 0x00000002: Gradual

Value	Meaning
0x00000005	Change font style. The <i>corresponding effect direction</i> MUST be a value of any combination of the following values: <ul style="list-style-type: none"> ▪ 0x00000001: Font bold ▪ 0x00000002: Font italic ▪ 0x00000004: Font underline
0x00000006	Grow and shrink. The <i>corresponding effect direction</i> MUST be ignored.
0x00000007	Change line color. The <i>corresponding effect direction</i> MUST be one of the following values: <ul style="list-style-type: none"> ▪ 0x00000001: Instant ▪ 0x00000002: Gradual ▪ 0x00000006: Gradual and cycle clockwise ▪ 0x0000000A: Gradual and cycle counterclockwise
0x00000008	Spin. The <i>corresponding effect direction</i> MUST be ignored.
0x00000009	Transparency. The <i>corresponding effect direction</i> MUST be ignored.
0x0000000A	Bold flash. The <i>corresponding effect direction</i> MUST be ignored.
0x0000000B	Reserved.
0x0000000C	Reserved.
0x0000000D	Reserved.
0x0000000E	Blast. The <i>corresponding effect direction</i> MUST be ignored.
0x0000000F	Bold reveal. The <i>corresponding effect direction</i> MUST be ignored.
0x00000010	Brush on color.

Value	Meaning
	The <i>corresponding effect direction</i> MUST be ignored.
0x00000011	Reserved.
0x00000012	Brush on underline. The <i>corresponding effect direction</i> MUST be ignored.
0x00000013	Color blend. The <i>corresponding effect direction</i> MUST be ignored.
0x00000014	Color wave. The <i>corresponding effect direction</i> MUST be ignored.
0x00000015	Complementary color. The <i>corresponding effect direction</i> MUST be ignored.
0x00000016	Complementary color 2. The <i>corresponding effect direction</i> MUST be ignored.
0x00000017	Contrasting color. The <i>corresponding effect direction</i> MUST be ignored.
0x00000018	Darken. The <i>corresponding effect direction</i> MUST be ignored.
0x00000019	Desaturate. The <i>corresponding effect direction</i> MUST be ignored.
0x0000001A	Flash bulb. The <i>corresponding effect direction</i> MUST be ignored.
0x0000001B	Flicker. The <i>corresponding effect direction</i> MUST be ignored.
0x0000001C	Grow with color. The <i>corresponding effect direction</i> MUST be ignored.
0x0000001D	Reserved.
0x0000001E	Lighten. The <i>corresponding effect direction</i> MUST be ignored.
0x0000001F	Style emphasis.

Value	Meaning
	The <i>corresponding effect direction</i> MUST be ignored.
0x00000020	Teeter. The <i>corresponding effect direction</i> MUST be ignored.
0x00000021	Vertical grow. The <i>corresponding effect direction</i> MUST be ignored.
0x00000022	Wave. The <i>corresponding effect direction</i> MUST be ignored.
0x00000023	Blink. The <i>corresponding effect direction</i> MUST be ignored.
0x00000024	Shimmer. The <i>corresponding effect direction</i> MUST be ignored.

When the *corresponding effect type* is a motion path effect, the *corresponding effect direction* MUST be ignored and this field MUST be a value from the following table:

Value	Meaning
0x00000000	Custom.
0x00000001	Circle.
0x00000002	Right triangle.
0x00000003	Diamond.
0x00000004	Hexagon.
0x00000005	5-point star.
0x00000006	Crescent moon.
0x00000007	Square.
0x00000008	Trapezoid.
0x00000009	Heart.
0x0000000A	Octagon.
0x0000000B	6-point star.
0x0000000C	Football.
0x0000000D	Equal triangle.
0x0000000E	Parallelogram.
0x0000000F	Pentagon.

Value	Meaning
0x00000010	4-point star.
0x00000011	8-point star.
0x00000012	Teardrop.
0x00000013	Pointy star.
0x00000014	Curved square.
0x00000015	Curved X.
0x00000016	Vertical figure 8.
0x00000017	Curvy star.
0x00000018	Loop de loop.
0x00000019	Buzz saw.
0x0000001A	Horizontal figure 8.
0x0000001B	Peanut.
0x0000001C	Figure 8 four.
0x0000001D	Neutron.
0x0000001E	Swoosh.
0x0000001F	Bean.
0x00000020	Plus.
0x00000021	Inverted triangle.
0x00000022	Inverted square.
0x00000023	Left.
0x00000024	Turn right.
0x00000025	Arc down.
0x00000026	Zigzag.
0x00000027	S curve 2.
0x00000028	Sine wave.
0x00000029	Bounce left.
0x0000002A	Down.
0x0000002B	Turn up.
0x0000002C	Arc up.
0x0000002D	Heartbeat.
0x0000002E	Spiral right.
0x0000002F	Wave.

Value	Meaning
0x00000030	Curvy left.
0x00000031	Diagonal down right.
0x00000032	Turn down.
0x00000033	Arc left.
0x00000034	Funnel.
0x00000035	Spring.
0x00000036	Bounce right.
0x00000037	Spiral left.
0x00000038	Diagonal up right.
0x00000039	Turn up right.
0x0000003A	Arc right.
0x0000003B	S curve 1.
0x0000003C	Decaying wave.
0x0000003D	Curvy right.
0x0000003E	Stairs down.
0x0000003F	Right.
0x00000040	Up.

When the *corresponding effect type* is a media effect, the *corresponding effect direction* MUST be ignored and this field MUST be a value from the following table:

Value	Meaning
0x00000000	Custom.
0x00000001	Play.
0x00000002	Pause.
0x00000003	Stop.

2.8.24 TimeEffectType

Referenced by: [TimeVariant4TimeNode](#)

An **atom record** that specifies the type of animation effect.

Let the *corresponding time node* be as specified in the **TimePropertyList4TimeNodeContainer** record (section [2.8.18](#)) that contains this **TimeEffectType** record.

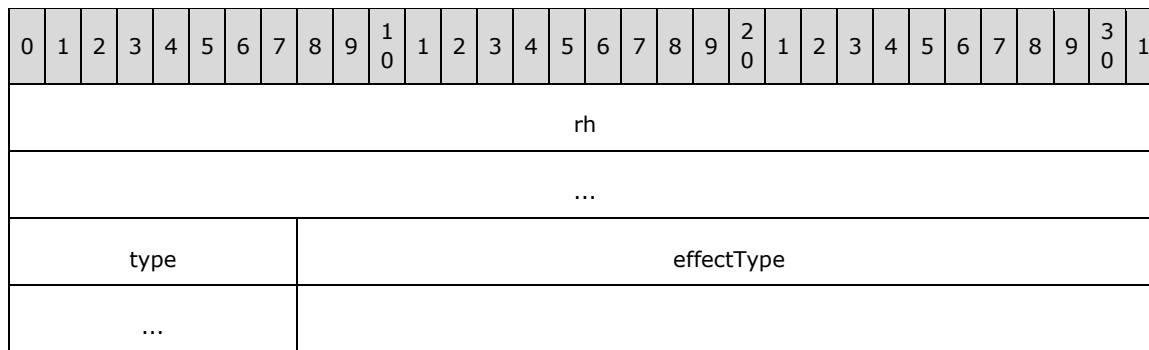

rh (8 bytes): A **RecordHeader** structure (section [2.3.1](#)) that specifies the header for this record. Sub-fields are further specified in the following table.

Field	Meaning
rh.recVer	MUST be 0x0.
rh.recType	MUST be an RT_TimeVariant .
rh.recLen	MUST be 0x00000005.

type (1 byte): A [TimeVariantTypeEnum](#) enumeration that specifies the data type of this record. It MUST be TL_TVT_Int.

effectType (4 bytes): A **signed integer** that specifies the type of animation effect of the *corresponding time node*. It MUST be a value from the following table.

Value	Meaning
0x00000001	Entrance.
0x00000002	Exit.
0x00000003	Emphasis.
0x00000004	Motion path.
0x00000005	Action verb.
0x00000006	Media command.

2.8.25 TimeNodeTimeFilter

Referenced by: [TimeVariant4TimeNode](#)

An **atom record** that specifies a time filter that transforms a given time to the local time of a **time node**.

Let the *corresponding time node* be as specified in the **TimePropertyList4TimeNodeContainer** record (section [2.8.18](#)) that contains this **TimeNodeTimeFilter** record.

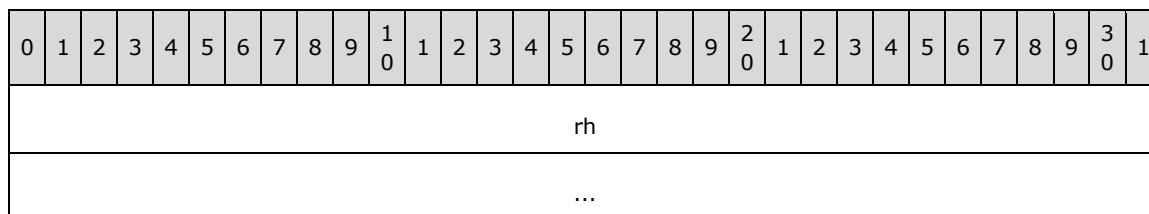

type	timeFilter (variable)
...	

rh (8 bytes): A **RecordHeader** structure (section [2.3.1](#)) that specifies the header for this record. Sub-fields are further specified in the following table.

Field	Meaning
rh.recVer	MUST be 0x0.
rh.recType	MUST be an RT_TimeVariant .
rh.recLen	MUST be an odd number.

type (1 byte): A [TimeVariantTypeEnum](#) enumeration that specifies the data type of this record. It MUST be TL_TVT_String.

timeFilter (variable): A [UnicodeString](#) that specifies the time filter that transforms a given time value into the local time of the *corresponding time node*. It MUST be a valid TIMESEQUENCE as specified in the following ABNF (specified in [\[RFC5234\]](#)) grammar:

```
TIMESEQUENCE = TIME "," TRANSTIME *("," TIMESEQUENCE)
TIME = "0" "." 1*DIGIT / "1" "." "0"
TRANSTIME = "0" "." 1*DIGIT / "1" "." "0"
```

Each TIME is the normalized local time for the time node whose value ranges from 0.0 to 1.0, and TRANSTIME is the transformed local time for the time node. The length, in bytes, of the field is specified by the following formula:

$$\text{rh.recLen} - 1$$

2.8.26 TimeEventFilter

Referenced by: [TimeVariant4TimeNode](#)

An **atom record** that specifies an event filter for a **time node**.

Let the *corresponding time node* be as specified in the **TimePropertyList4TimeNodeContainer** record (section [2.8.18](#)) that contains this **TimeEventFilter** record.

0	1	2	3	4	5	6	7	8	9	10	11	12	13	14	15	16	17	18	19	20	21	22	23	24	25	26	27	28	29	30	31
rh																															
...																															
type																				timeEventFilter (variable)											
...																															

rh (8 bytes): A **RecordHeader** structure (section [2.3.1](#)) that specifies the header for this record. Sub-fields are further specified in the following table.

Field	Meaning
rh.recVer	MUST be 0x0.
rh.recType	MUST be an RT_TimeVariant .
rh.recLen	MUST be an odd number.

type (1 byte): A [TimeVariantTypeEnum](#) enumeration that specifies the data type of this record. It MUST be TL_TVT_String.

timeEventFilter (variable): A [UnicodeString](#) that specifies the event filter for the *corresponding time node*. It MUST be "cancelBubble" and the **TimePropertyList4TimeNodeContainer** record that contains this **TimeEventFilter** record MUST contain a [TimeEffectNodeType](#) record with **effectNodeType** equal to 0x000000005. The length, in bytes, of the field is specified by the following formula:

$$\text{rh.recLen} - 1$$

2.8.27 TimeGroupID

Referenced by: [TimeVariant4TimeNode](#)

An **atom record** that specifies a reference to a **build identifier** of an animation effect.

Let the *corresponding time node* be as specified in the **TimePropertyList4TimeNodeContainer** record (section [2.8.18](#)) that contains this **TimeGroupID** record.

0	1	2	3	4	5	6	7	8	9	10	11	12	13	14	15	16	17	18	19	20	21	22	23	24	25	26	27	28	29	30	31
rh																															
...																															
type																groupID															
...																															

rh (8 bytes): A **RecordHeader** structure (section [2.3.1](#)) that specifies the header for this record. Sub-fields are further specified in the following table.

Field	Meaning
rh.recVer	MUST be 0x0.
rh.recType	MUST be an RT_TimeVariant .
rh.recLen	MUST be 0x00000005.

type (1 byte): A [TimeVariantTypeEnum](#) enumeration that specifies the data type of this record. It MUST be TL_TVT_Int.

groupID (4 bytes): A **signed integer** that specifies a reference to a build identifier of the animation as specified in the [BuildAtom](#) record. There is a **shapeIdRef** field specified in either the [VisualShapeChartElementAtom](#) record or the [VisualShapeGeneralAtom](#) record; it is used with this field to form a unique pair for the animation effect that will be applied to the specified object.

2.8.28 TimeEffectNodeType

Referenced by: [TimeVariant4TimeNode](#)

An **atom record** that specifies the role of a **time node** in the timing structure.

Let the *corresponding time node* be as specified in the **TimePropertyList4TimeNodeContainer** record (section [2.8.18](#)) that contains this **TimeEffectNodeType** record.

0	1	2	3	4	5	6	7	8	9	10	11	12	13	14	15	16	17	18	19	20	21	22	23	24	25	26	27	28	29	30	31
rh																															
...																															
type																effectNodeType															
...																															

rh (8 bytes): A **RecordHeader** structure (section [2.3.1](#)) that specifies the header for this record. Sub-fields are further specified in the following table.

Field	Meaning
rh.recVer	MUST be 0x0.
rh.recType	MUST be an RT_TimeVariant .
rh.recLen	MUST be 0x00000005.

type (1 byte): A [TimeVariantTypeEnum](#) enumeration that specifies the data type of this record. It MUST be TL_TVT_Int.

effectNodeType (4 bytes): A **signed integer** that specifies the role of the *corresponding time node*. It MUST be a value from the following table.

Value	Meaning
0x00000001	Click effect node.
0x00000002	With previous node.
0x00000003	After previous node.
0x00000004	Main sequence node.
0x00000005	Interactive sequence node.
0x00000006	Click parallel node.
0x00000007	With group node.
0x00000008	After group node.
0x00000009	Timing root node.

2.8.29 TimeAnimateBehaviorContainer

Referenced by: [ExtTimeNodeContainer](#)

A **container record** that specifies a generic animation behavior. This animation behavior is applied to the object specified by the **behavior.clientVisualElement** field and used to animate

one property specified by the **behavior.stringList** field. The property MUST be one from the list that is specified in the **TimeStringListContainer** record (section [2.8.36](#)).

0	1	2	3	4	5	6	7	8	9	10	11	12	13	14	15	16	17	18	19	20	21	22	23	24	25	26	27	28	29	30	31
rh																															
...																															
animateBehaviorAtom (20 bytes)																															
...																															
...																															
animateValueList (variable)																															
...																															
varBy (variable)																															
...																															
varFrom (variable)																															
...																															
varTo (variable)																															
...																															
behavior (variable)																															
...																															

rh (8 bytes): A **RecordHeader** structure (section [2.3.1](#)) that specifies the header for this record. Sub-fields are further specified in the following table.

Field	Meaning
rh.recVer	MUST be 0xF.
rh.recInstance	MUST be 0x000.
rh.recType	MUST be an RT_TimeAnimateBehaviorContainer .

animateBehaviorAtom (20 bytes): A [TimeAnimateBehaviorAtom](#) record that specifies the value type of the animated property as specified in the **behavior.stringList** field, how to interpolate the value, and which attributes of this field and this **TimeAnimateBehaviorContainer** record are valid.

animateValueList (variable): An optional **TimeAnimationValueListContainer** record (section [2.8.31](#)) that specifies the list of key points that consists of a time and the value at that time. The **animateBehaviorAtom.calcMode** field specifies how to calculate interpolated values between

these key points. It MUST be ignored if **animateBehaviorAtom.fAnimationValuesPropertyUsed** is **FALSE**.

varBy (variable): An optional [TimeVariantString](#) record that specifies the offset value of the animated property. The sub-field **varBy.rh.recInstance** MUST be 0x001. It MUST be in a format dictated by the value of **animateBehaviorAtom.valueType** as specified in the following table.

Value	Meaning
TL_TABVT_String	An arbitrary Unicode string.
TL_TABVT_Number	A preset string value as specified in the varTo field of the TimeSetBehaviorContainer record (section 2.8.69); or a string that specifies a real number, whose format is specified by the varTo field of the TimeSetBehaviorContainer record.
TL_TABVT_Color	A string that specifies a color value, whose format is specified by the varTo field of the TimeSetBehaviorContainer record.

MUST be ignored if **varTo** exists. It MUST be ignored if **animateValueList** exists. It MUST be ignored if **animateBehaviorAtom.fByPropertyUsed** is **FALSE**.

varFrom (variable): An optional [TimeVariantString](#) record that specifies the starting value of the animated property. The sub-field **varFrom.rh.recInstance** MUST be 0x002. It MUST be in a format dictated by the value of **animateBehaviorAtom.valueType** as specified in the following table.

Value	Meaning
TL_TABVT_String	An arbitrary Unicode string.
TL_TABVT_Number	A preset string value as specified in the varTo field of the TimeSetBehaviorContainer record; or a string that specifies a real number, whose format is specified by the varTo field of the TimeSetBehaviorContainer record.
TL_TABVT_Color	A string that specifies a color value, whose format is specified by the varTo field of the TimeSetBehaviorContainer record.

If **varFrom** exists, **varTo** or **varBy** MUST also exist. It MUST be ignored if **animateValueList** exists. It MUST be ignored if **animateBehaviorAtom.fFromPropertyUsed** is **FALSE**.

varTo (variable): An optional [TimeVariantString](#) record that specifies the end value of the animated property. The sub-field **varTo.rh.recInstance** MUST be 0x003. It MUST be in a format dictated by the value of **animateBehaviorAtom.valueType** as specified in the following table.

Value	Meaning
TL_TABVT_String	An arbitrary Unicode string.
TL_TABVT_Number	A preset string value as specified in the varTo field of the TimeSetBehaviorContainer record; or a string that specifies a real number, whose format is specified by the varTo field of the TimeSetBehaviorContainer record.
TL_TABVT_Color	A string that specifies a color value, whose format is specified by the varTo field of the TimeSetBehaviorContainer record.

MUST be ignored if **animateValueList** exists. It MUST be ignored if **animateBehaviorAtom.fToPropertyUsed** is **FALSE**.

behavior (variable): A **TimeBehaviorContainer** record (section [2.8.34](#)) that specifies the common animation behavior information.

2.8.30 TimeAnimateBehaviorAtom

Referenced by: [TimeAnimateBehaviorContainer](#)

An **atom record** that specifies the information of a generic animation that can animate any property.

0	1	2	3	4	5	6	7	8	9	10	11	12	13	14	15	16	17	18	19	20	21	22	23	24	25	26	27	28	29	30	31
rh																															
...																															
calcMode																															
A	B	C	D	E	F	reserved																									
valueType																															

rh (8 bytes): A **RecordHeader** structure (section [2.3.1](#)) that specifies the header for this record. Sub-fields are further specified in the following table.

Field	Meaning
rh.recVer	MUST be 0x0.
rh.recInstance	MUST be 0x000.
rh.recType	MUST be an RT_TimeAnimateBehavior .
rh.recLen	MUST be 0x0000000C.

calcMode (4 bytes): An **unsigned integer** that specifies how the property value is calculated. It MUST be ignored if **fCalcModePropertyUsed** is **FALSE** and a value of 0x00000001 MUST be used instead. It MUST be a value from the following table:

Value	Meaning
0x00000000	Discrete mode, which specifies that the value will jump from one to another without any interpolation.
0x00000001	Linear mode, which specifies that the values are linearly interpolated.
0x00000002	Formula mode, which specifies that a formula specified by the animateValueList field of the TimeAnimateBehaviorContainer record (section 2.8.29) that contains this TimeAnimateBehaviorAtom record is used in the interpolation.

- A - fByPropertyUsed (1 bit):** A bit that specifies whether the **varBy** field of the **TimeAnimateBehaviorContainer** record (section 2.8.29) that contains this **TimeAnimateBehaviorAtom** record is valid.
- B - fFromPropertyUsed (1 bit):** A bit that specifies whether the **varFrom** field of the **TimeAnimateBehaviorContainer** record (section 2.8.29) that contains this **TimeAnimateBehaviorAtom** record is valid.
- C - fToPropertyUsed (1 bit):** A bit that specifies whether the **varTo** field of the **TimeAnimateBehaviorContainer** record (section 2.8.29) that contains this **TimeAnimateBehaviorAtom** record is valid.
- D - fCalcModePropertyUsed (1 bit):** A bit that specifies whether **calcMode** was explicitly set by a user interface action.
- E - fAnimationValuesPropertyUsed (1 bit):** A bit that specifies whether the **animateValueList** field of the **TimeAnimateBehaviorContainer** record (section 2.8.29) that contains this **TimeAnimateBehaviorAtom** record is valid.
- F - fValueTypePropertyUsed (1 bit):** A bit that specifies whether **valueType** was explicitly set by a user interface action.

reserved (26 bits): MUST be zero, and MUST be ignored.

valueType (4 bytes): A [TimeAnimateBehaviorValueTypeEnum](#) enumeration that specifies the value type of the property to be animated. It MUST be ignored if **fValueTypePropertyUsed** is **FALSE** and a value of **TL_TABVT_Number** MUST be used instead.

2.8.31 TimeAnimationValueListContainer

Referenced by: [TimeAnimateBehaviorContainer](#)

A **container record** that specifies the list of key points that are used during a property animation to set a property to a value at a point within the timeline as specified in the **TimeAnimateBehaviorContainer** record (section 2.8.29).

0	1	2	3	4	5	6	7	8	9	10	1	2	3	4	5	6	7	8	9	20	1	2	3	4	5	6	7	8	9	30	1		
rh																																	
...																																	
rgTimeAnimValueList (variable)																																	
...																																	

rh (8 bytes): A **RecordHeader** structure (section [2.3.1](#)) that specifies the header for this record. Sub-fields are further specified in the following table.

Field	Meaning
rh.recVer	MUST be 0xF.
rh.recInstance	MUST be 0x000.
rh.recType	MUST be an RT_TimeAnimationValueList .

rgTimeAnimValueList (variable): An array of [TimeAnimationValueListEntry](#) structures that specifies the key points that are used during the animation. The length, in bytes, of the array is specified by **rh.recLen**.

If the value of the **timeAnimationValueAtom.time** field in any [TimeAnimationValueListEntry](#) record in this array is -1000, the time for the key points is evenly partitioned between 0 and 1.

2.8.32 TimeAnimationValueListEntry

Referenced by: [TimeAnimationValueListContainer](#)

A structure that specifies a key point in a property animation.

0	1	2	3	4	5	6	7	8	9	10	11	12	13	14	15	16	17	18	19	20	21	22	23	24	25	26	27	28	29	30	31
timeAnimationValueAtom																															
...																															
...																															
varValue (variable)																															
...																															
varFormula (variable)																															
...																															

timeAnimationValueAtom (12 bytes): A [TimeAnimationValueAtom](#) record that specifies the time, as a percentage of the animation time, at which the property takes on the value specified by the **varValue** and **varFormula** fields.

varValue (variable): An optional [TimeVariant](#) record that specifies a value that corresponds to the time as specified in the **timeAnimationValueAtom.time** field. The sub-field **varValue.rh.recInstance** MUST be 0x000. If the **varFormula** field exists, the property takes on the value specified by the formula; otherwise, the property takes on this value.

varFormula (variable): An optional [TimeVariantString](#) record that specifies a formula to be used to specify a complex animation for an object. The sub-field **varFormula.rh.recInstance** MUST be 0x001.

The formula manipulates a property value of the object, over a specified period of time. Each formula has zero or more inputs specified by the (\$) symbol, zero or more variables specified by the (#) symbol, and a target variable. In each instance, the special symbols are pre-pended to the variable name. The target variable is specified by the **behavior.stringList.rgChildRec** field of the **TimeAnimateBehaviorContainer** record (section 2.8.29) that also contains the **TimeAnimationValueListContainer** record (section 2.8.31) that contains this **TimeAnimationValueListEntry** record. The formula can contain one or more of any of the following constants, operators or functions. In addition, the formula can also contain **floating-point numbers** and parentheses.

The **varFormula.stringValue** MUST be a valid FORMULA as specified in the following ABNF (specified in [RFC5234](#)) grammar:

```

FORMULA = TERM * ( ( "+" / "-" ) TERM)
TERM = POWER * ( ( "*" / "/" / "%" ) POWER)
POWER = UNARY * ( "^" UNARY)
UNARY = [ "+" / "-" ] FACTOR
FACTOR = VARIABLE / CONSTANT / FUNCTION / PARENS
PARENS = "(" FORMULA ")" CHAR = "." / " " / ALPHA / DIGIT
NUMBER = 1 * DIGIT
EXPONENT = ( "e" / "E" ) [ "-" ] NUMBER
VALUE = NUMBER [ "." NUMBER ] [ EXPONENT ]
VARIABLE = "$" / ATTRIBUTE
ATTRIBUTE = [ "#" ] ATTRNAME
ATTRNAME = OFFICEART_CLIENT_ATTRNAME / OFFICEART_FOFT_ATTRNAME
OFFICEART_CLIENT_ATTRNAME = "ppt_x" / "ppt_y" / "ppt_w" / "ppt_h" / "ScaleX" / "ScaleY"
OFFICEART_FOFT_ATTRNAME = "style.rotation" / "style.opacity" / "style.visibility" / "ppt_r" /
"r" / "style.fontSize" / "style.fontWeight" / "style.fontStyle" / "style.fontFamily" /
"style.textEffectEmboss" / "style.textShadow" / "style.textTransform" /
"style.textDecorationUnderline" / "style.textEffectOutline" /
"style.textDecorationLineThrough" / "style.sRotation" / "imageData.cropTop" /
"imageData.cropBottom" / "imageData.cropLeft" / "imageData.cropRight" / "imageData.gain" /
"imageData.blackLevel" / "imageData.gamma" / "imageData.grayscale" / "fill.on" / "fill.type" /
"fill.opacity" / "fill.method" / "fill.opacity2" / "fill.angle" / "fill.focus" /
"fill.focusposition.x" / "fill.focusposition.y" / "fill.focussize.x" / "fill.focussize.y" /
"stroke.on" / "stroke.weight" / "stroke.opacity" / "stroke.linestyle" / "stroke.dashstyle" /
"stroke.filltype" / "stroke.imagesize.x" / "stroke.imagesize.y" / "stroke.startArrow" /
"stroke.endArrow" / "stroke.startArrowWidth" / "stroke.startArrowLength" /
"stroke.endArrowWidth" / "stroke.endArrowLength" / "shadow.on" / "shadow.type" /
"shadow.opacity" / "shadow.offset.x" / "shadow.offset.y" / "shadow.offset2.x" /
"shadow.offset2.y" / "shadow.origin.x" / "shadow.origin.y" / "shadow.matrix.xtox" /
"shadow.matrix.ytox" / "shadow.matrix.xtoy" / "shadow.matrix.ytoy" /
"shadow.matrix.perspectiveX" / "shadow.matrix.perspectiveY" / "skew.on" / "skew.offset.x" /
"skew.offset.y" / "skew.origin.x" / "skew.origin.y" / "skew.matrix.xtox" / "skew.matrix.ytox" /
"skew.matrix.xtoy" / "skew.matrix.ytoy" / "skew.matrix.perspectiveX" /
"skew.matrix.perspectiveY" / "extrusion.on" / "extrusion.type" / "extrusion.render" /
"extrusion.viewpointorigin.x" / "extrusion.viewpointorigin.y" / "extrusion.viewpoint.x" /
"extrusion.viewpoint.y" / "extrusion.viewpoint.z" / "extrusion.plane" / "extrusion.skewangle" /
"extrusion.skewamt" / "extrusion.backdepth" / "extrusion.foredepth" /
"extrusion.orientation.x" / "extrusion.orientation.y" / "extrusion.orientation.z" /
"extrusion.orientationangle" / "extrusion.rotationangle.x" / "extrusion.rotationangle.y" /
"extrusion.lockrotationcenter" / "extrusion.autorotationcenter" /
"extrusion.rotationcenter.x" / "extrusion.rotationcenter.y" / "extrusion.rotationcenter.z" /
"extrusion.colormode"
CONSTANT = VALUE / "pi" / "e"
IDENT = "abs" / "acos" / "asin" / "atan" / "ceil" / "cos" / "cosh" / "deg" / "exp" / "floor" /
"ln" / "max" / "min" / "rad" / "rand" / "sin" / "sinh" / "sqrt" / "tan" / "tanh"
FUNCTION = IDENT "(" FORMULA [ "," FORMULA ] ")"

```

Components of the preceding formula are further specified as follows.

Operator precedence

Mathematical operations have the following order of precedence, listed from lowest to highest. Operators listed on the same line have equal precedence.

1. "+" (Addition), "-" (Subtraction)
2. "*" (Multiplication), "/" (Division), "%" (Modulo)
3. "^" (Exponentiation)
4. "-" (Unary minus), "+" (Unary plus)
5. Variables, Constants (including numbers) and Functions

Variables

The symbol '\$' represents the value of **varValue**.

Attributes

ATTRNAME MUST be one from the following two lists:

- OFFICEART_CLIENT_ATTRNAME specifies the list of attributes that are translated from the [OfficeArtClientAnchor](#) record.
- OFFICEART_FOFT_ATTRNAME specifies the list of attributes that are translated from the OfficeArtFOFT record ([\[MS-ODRAW\]](#) section 2.2.9).

Constants

Name	Description
pi	Mathematical constant pi
e	Mathematical constant e

Operators

Name	Description	Usage
+	Addition	"x+y", adds x to the value y
-	Subtraction	"x-y", subtracts y from the value x
*	Multiplication	"x*y", multiplies x by the value y
/	Division	"x/y", divides x by the value y
%	Modulus	"x%y", the remainder of x/y
^	Power	"x^y", x raised to the power y

Functions

Name	Description	Usage
abs	Absolute value	"abs(x)", absolute value of x
acos	Arc Cosine	"acos(x)", arc cosine of the value x
asin	Arc Sine	"asin(x)", arc sine of the value x
atan	Arc Tangent	"atan(x)", arc tangent of the value x
ceil	Ceil value	"ceil(x)", value of x rounded up
cos	Cosine	"cos(x)", cosine of the value of x
cosh	Hyperbolic Cosine	"cosh(x)", hyperbolic cosine of the value x
deg	Radian to Degree convert	"deg(x)", the degree value of radiant value x
exp	Exponent	"exp(x)", value of constant e raised to the power of x
floor	Floor value	"floor(x)", value of x rounded down
ln	Natural logarithm	"ln(x)", natural logarithm of x
max	Maximum of two values	"max(x,y)", returns x if (x > y) or returns y if (y > x)
min	Minimum of two values	"min(x,y)", returns x if (x < y) or returns y if (y < x)
rad	Degree to Radian convert	"rad(x)", the radian value of degree value x
rand	Random value	"rand(x)", returns a random floating point value between 0 and x
sin	Sine	"sin(x)", sine of the value x
sinh	Hyperbolic Sine	"sinh(x)", hyperbolic sine of the value x
sqrt	Square root	"sqrt(x)", square root of the value x
tan	Tangent	"tan(x)", tangent of the value x
tanh	Hyperbolic Tangent	"tanh(x)", hyperbolic tangent of the value x

2.8.33 TimeAnimationValueAtom

Referenced by: [TimeAnimationValueListEntry](#)

An **atom record** that specifies a value of time that is used in the TimeAnimationValueListEntry structure to determine the overall timeline for the corresponding animation.

0	1	2	3	4	5	6	7	8	9	10	11	12	13	14	15	16	17	18	19	20	21	22	23	24	25	26	27	28	29	30	31
rh																															
...																															
time																															

rh (8 bytes): A **RecordHeader** structure (section [2.3.1](#)) that specifies the header for this record. Sub-fields are further specified in the following table.

Field	Meaning
rh.recVer	MUST be 0x0.
rh.recInstance	MUST be 0x000.
rh.recType	MUST be an RT TimeAnimationValue .
rh.recLen	MUST be 0x00000004.

time (4 bytes): A **signed integer** that specifies a percentage value of time in 1000ths that is utilized in the TimeAnimationValueListEntry record. For example, 1000 means 100% of time of an animation. This field MUST be either equal to -1000, or greater than or equal to 0 and less than or equal to 1000.

2.8.34 TimeBehaviorContainer

Referenced by: [TimeAnimateBehaviorContainer](#), [TimeColorBehaviorContainer](#), [TimeCommandBehaviorContainer](#), [TimeEffectBehaviorContainer](#), [TimeMotionBehaviorContainer](#), [TimeRotationBehaviorContainer](#), [TimeScaleBehaviorContainer](#), [TimeSetBehaviorContainer](#)

A **container record** that specifies the common information of an animation behavior.

0	1	2	3	4	5	6	7	8	9	10	11	12	13	14	15	16	17	18	19	20	21	22	23	24	25	26	27	28	29	30	31
rh																															
...																															
behaviorAtom (24 bytes)																															
...																															
...																															

stringList (variable)
...
propertyList (variable)
...
clientVisualElement (variable)
...

rh (8 bytes): A **RecordHeader** structure (section [2.3.1](#)) that specifies the header for this record. Sub-fields are further specified in the following table.

Field	Meaning
rh.recVer	MUST be 0xF.
rh.recInstance	MUST be 0x000.
rh.recType	MUST be RT_TimeBehaviorContainer .

behaviorAtom (24 bytes): A [TimeBehaviorAtom](#) record that specifies the type of transform used in the animation, how to compose animated values, and which attributes of this field and this **TimeBehaviorContainer** record are valid.

stringList (variable): An optional **TimeStringListContainer** record (section [2.8.36](#)) that specifies the list of the names of properties to be animated. It MUST be ignored if **behaviorAtom.fAttributeNamesPropertyUsed** is **FALSE**.

propertyList (variable): An optional [TimePropertyList4TimeBehavior](#) record that specifies a list of animation attributes that are used in the animation behavior.

clientVisualElement (variable): A **ClientVisualElementContainer** record (section [2.8.44](#)) that specifies the target object that is animated.

2.8.35 TimeBehaviorAtom

Referenced by: [TimeBehaviorContainer](#)

An **atom record** that specifies the common information of an animation behavior.

0	1	2	3	4	5	6	7	8	9	10	1	2	3	4	5	6	7	8	9	20	1	2	3	4	5	6	7	8	9	30	1
rh																															
...																															
A	B	C	D	reserved3																											
behaviorAdditive																															

behaviorAccumulate
behaviorTransform

rh (8 bytes): A **RecordHeader** structure (section [2.3.1](#)) that specifies the header for this record. Sub-fields are further specified in the following table.

Field	Meaning
rh.recVer	MUST be 0x0.
rh.recInstance	MUST be 0x000.
rh.recType	MUST be an RT TimeBehavior .
rh.recLen	MUST be 0x00000010.

A - fAdditivePropertyUsed (1 bit): A bit that specifies whether the **behaviorAdditive** field was explicitly set by a user interface action.

B - reserved1 (1 bit): MUST be zero, and MUST be ignored.

C - fAttributeNamesPropertyUsed (1 bit): A bit that specifies whether the **stringList** field of the **TimeBehaviorContainer** record (section 2.8.34) that contains this TimeBehaviorAtom record is valid.

D - reserved2 (1 bit): MUST be zero, and MUST be ignored.

reserved3 (28 bits): MUST be zero, and MUST be ignored.

behaviorAdditive (4 bytes): An unsigned integer that specifies how to compose the animated value with the original value of the property that is animated. It MUST be ignored if **fAdditivePropertyUsed** is **FALSE** and a value of 0x00000000 MUST be used instead. It MUST be a value from the following table.

Value	Meaning
0x00000000	Override the original value with the animated value.
0x00000001	Add the animated value to the original value.

behaviorAccumulate (4 bytes): An unsigned integer that specifies how to compose the animated values of the property in repeating animations. It MUST be 0x00000000 that specifies that no accumulation is used.

behaviorTransform (4 bytes): An unsigned integer that specifies the type of animation transform to use. It MUST be 0x00000000 that specifies that the animation animates properties of the target object.

2.8.36 TimeStringListContainer

Referenced by: [TimeBehaviorContainer](#)

A **container record** that specifies a list of names of properties that are animated by an animation behavior.

0	1	2	3	4	5	6	7	8	9	10	11	12	13	14	15	16	17	18	19	20	21	22	23	24	25	26	27	28	29	30	31
rh																															
...																															
rgChildRec (variable)																															
...																															

rh (8 bytes): A **RecordHeader** structure (section [2.3.1](#)) that specifies the header for this record. Sub-fields are further specified in the following table.

Field	Meaning
rh.recVer	MUST be 0xF.
rh.recInstance	MUST be 0x001.
rh.recType	MUST be an RT_TimeVariantList .

rgChildRec (variable): An array of [TimeVariantString](#) record that specifies the list of names. The length, in bytes, of the array is specified by **rh.recLen**. The property names SHOULD be from the following list of possible names:

ppt_x, ppt_y, ppt_w, ppt_h, ppt_c, ppt_r, xshear, yshear, image, ScaleX, ScaleY, r, fillcolor, style.opacity, style.rotation, style.visibility, style.color, style.fontSize, style.fontWeight, style.fontStyle, style.fontFamily, style.textEffectEmboss, style.textShadow, style.textTransform, style.textDecorationUnderline, style.textEffectOutline, style.textDecorationLineThrough, style.sRotation, imageData.cropTop, imageData.cropBottom, imageData.cropLeft, imageData.cropRight, imageData.gain, imageData.blacklevel, imageData.gamma, imageData.grayscale, imageData.chromakey, fill.on, fill.type, fill.color, fill.opacity, fill.color2, fill.method, fill.opacity2, fill.angle, fill.focus, fill.focusposition.x, fill.focusposition.y, fill.focussize.x, fill.focussize.y, stroke.on, stroke.color, stroke.weight, stroke.opacity, stroke.linestyle, stroke.dashstyle, stroke.filltype, stroke.src, stroke.color2, stroke.imagesize.x, stroke.imagesize.y, stroke.startArrow, stroke.endArrow, stroke.startArrowWidth, stroke.startArrowLength, stroke.endArrowWidth, stroke.endArrowLength, shadow.on, shadow.type, shadow.color, shadow.color2, shadow.opacity, shadow.offset.x, shadow.offset.y, shadow.offset2.x, shadow.offset2.y, shadow.origin.x, shadow.origin.y, shadow.matrix.xtox, shadow.matrix.ytox, shadow.matrix.xtoy, shadow.matrix.ytoy, shadow.matrix.perspectiveX, shadow.matrix.perspectiveY, skew.on, skew.offset.x, skew.offset.y, skew.origin.x, skew.origin.y, skew.matrix.xtox, skew.matrix.ytox, skew.matrix.xtoy, skew.matrix.ytoy, skew.matrix.perspectiveX, skew.matrix.perspectiveY, extrusion.on, extrusion.type, extrusion.render, extrusion.viewpointorigin.x, extrusion.viewpointorigin.y, extrusion.viewpoint.x, extrusion.viewpoint.y, extrusion.viewpoint.z, extrusion.plane, extrusion.skewangle, extrusion.skewamt, extrusion.backdepth, extrusion.foredepth, extrusion.orientation.x, extrusion.orientation.y, extrusion.orientation.z, extrusion.orientationangle, extrusion.color, extrusion.rotationangle.x, extrusion.rotationangle.y, extrusion.lockrotationcenter, extrusion.autorotationcenter, extrusion.rotationcenter.x, extrusion.rotationcenter.y, extrusion.rotationcenter.z, and extrusion.colormode

2.8.37 TimePropertyList4TimeBehavior

Referenced by: [TimeBehaviorContainer](#)

A **container record** that specifies a list of animation attributes that is used in an animation behavior.

Let the *corresponding time node* be specified by the **ExtTimeNodeContainer** record (section [2.8.15](#)) or the **SubEffectContainer** record (section [2.8.16](#)) that contains this **TimePropertyList4TimeBehavior** record.

0	1	2	3	4	5	6	7	8	9	10	11	12	13	14	15	16	17	18	19	20	21	22	23	24	25	26	27	28	29	30	31
rh																															
...																															
rgChildRec (variable)																															
...																															

rh (8 bytes): A **RecordHeader** structure (section [2.3.1](#)) that specifies the header for this record. Sub-fields are further specified in the following table.

Field	Meaning
rh.recVer	MUST be 0xF.
rh.recInstance	MUST be 0x000.
rh.recType	MUST be an RT_TimePropertyList .

rgChildRec (variable): An array of [TimeVariant4Behavior](#) records that specifies the list of animation attributes. The length, in bytes, of the array is specified by **rh.recLen**. Each [TimePropertyID4TimeBehavior](#) enumeration value MUST NOT occur more than once as a value of the **rh.recInstance** field in the array.

If the TL_TBPID_MotionPathEditRelative value does not occur, a [TimeVariantBool](#) structure in which the **boolValue** field is 0x01 SHOULD be used.

If the TL_TBPID_PathEditRotationAngle value does not occur, a [TimeVariantFloat](#) structure in which the **floatValue** field is 0 SHOULD be used.

If the TL_TBPID_PathEditRotationX value does not occur, a [TimeVariantFloat](#) structure in which the **floatValue** field is 0 SHOULD be used.

If the TL_TBPID_PathEditRotationY value does not occur, a [TimeVariantFloat](#) structure in which the **floatValue** field is 0 SHOULD be used.

If the **colorBehaviorAtom.flags.fColorSpacePropertyUsed** field of the **TimeColorBehaviorContainer** record (section [2.8.52](#)) is **FALSE**, any item with the TL_TBPID_ColorColorModel value MUST be ignored and a [TimeColorModel](#) record with a **colorModel** field equal to 0x00000000 MUST be used instead.

If the **colorBehaviorAtom.flags.fDirectionPropertyUsed** field of the **TimeColorBehaviorContainer** record is **FALSE**, any item with the TL_TBPID_ColorDirection value MUST be ignored and a [TimeColorDirection](#) record with a **colorDirection** field equal to 0x00000000 MUST be used instead.

2.8.38 TimeVariant4Behavior

Referenced by: [TimePropertyList4TimeBehavior](#)

A variable type record that specifies an attribute of an animation behavior and whose type and meaning are dictated by the value of the **rh.recInstance** field of any of these attributes, as specified in the following table.

Value	Meaning
TL_TBPID_UnknownPropertyList	A TimeVariantString record that specifies unknown attributes.
TL_TBPID_RuntimeContext	A TimeRuntimeContext record that specifies which versions of the hosting applications can run this behavior.
TL_TBPID_MotionPathEditRelative	A TimeVariantBool record that specifies whether a motion path moves along with the object that it applies to during editing. This record is only used by the TimeMotionBehaviorContainer record (section 2.8.63).
TL_TBPID_ColorColorModel	A TimeColorModel record that specifies the color model. This record is only used by the TimeColorBehaviorContainer record (section 2.8.52).
TL_TBPID_ColorDirection	A TimeColorDirection record that specifies the interpolation direction in the HSL color space . This record is only used by the TimeColorBehaviorContainer record.
TL_TBPID_Override	A TimeOverride record that specifies how to override animated values.
TL_TBPID_PathEditRotationAngle	A TimeVariantFloat record that specifies the rotation angle of a motion path. This record is only used by the TimeMotionBehaviorContainer record.
TL_TBPID_PathEditRotationX	A TimeVariantFloat record that specifies the horizontal position of the rotation center of a motion path. This record is only used by the TimeMotionBehaviorContainer record.
TL_TBPID_PathEditRotationY	A TimeVariantFloat record that specifies the vertical position of the rotation center of a motion path. This record is only used by the TimeMotionBehaviorContainer record.
TL_TBPID_PointsTypes	A TimePointsTypes record that specifies the type of points in a motion path. This record is only used by the TimeMotionBehaviorContainer record.

2.8.39 TimeColorModel

Referenced by: [TimeVariant4Behavior](#)

An **atom record** that specifies the color model used by a color animation.

Let the *corresponding time node* be as specified in the [TimePropertyList4TimeBehavior](#) record that contains this **TimeColorModel** record.

0	1	2	3	4	5	6	7	8	9	10	11	12	13	14	15	16	17	18	19	20	21	22	23	24	25	26	27	28	29	30	31
rh																															
...																															
type																colorModel															
...																															

rh (8 bytes): A **RecordHeader** structure (section [2.3.1](#)) that specifies the header for this record. Sub-fields are further specified in the following table.

Field	Meaning
rh.recVer	MUST be 0x0.
rh.recType	MUST be RT_TimeVariant .
rh.recLen	MUST be 0x00000005.

type (1 byte): A [TimeVariantTypeEnum](#) enumeration that specifies the data type of this record. It MUST be TL_TVT_Int.

colorModel (4 bytes): A signed integer that specifies the color model used by the color animation of the *corresponding time node*. It MUST be a value from the following table.

Value	Meaning
0x00000000	Use red, green, and blue color components in red-green-blue (RGB) color space .
0x00000001	Use hue, saturation, and luminance color components in HSL color space.
0x00000002	Use index to color scheme .

2.8.40 TimeColorDirection

Referenced by: [TimeVariant4Behavior](#)

An **atom record** that specifies the interpolation direction of a color animation.

Let the *corresponding time node* be as specified in the [TimePropertyList4TimeBehavior](#) record that contains this **TimeColorDirection** record.

0	1	2	3	4	5	6	7	8	9	10	11	12	13	14	15	16	17	18	19	20	21	22	23	24	25	26	27	28	29	30	31
rh																															
...																															
type																colorDirection															
...																															

rh (8 bytes): A **RecordHeader** structure (section [2.3.1](#)) that specifies the header for this record. Sub-fields are further specified in the following table.

Field	Meaning
rh.recVer	MUST be 0x0.
rh.recType	MUST be an RT_TimeVariant .
rh.recLen	MUST be 0x00000005.

type (1 byte): A [TimeVariantTypeEnum](#) enumeration that specifies the data type of this record. It MUST be TL_TVT_Int.

colorDirection (4 bytes): A **signed integer** that specifies the interpolation direction of the color animation of the *corresponding time node*. It MUST be a value from the following table.

Value	Meaning
0x00000000	Use clockwise direction for the hue component in HSL color space .
0x00000001	Use counterclockwise direction for the hue component in HSL color space.

2.8.41 TimeOverride

Referenced by: [TimeVariant4Behavior](#)

An **atom record** that specifies how an animation behavior overrides the values of the properties being animated on an object.

Let the *corresponding time node* be as specified in the [TimePropertyList4TimeBehavior](#) record that contains this **TimeOverride** record.

0	1	2	3	4	5	6	7	8	9	10	11	12	13	14	15	16	17	18	19	20	21	22	23	24	25	26	27	28	29	30	31
rh																															
...																															
type																override															
...																															

rh (8 bytes): A **RecordHeader** structure (section [2.3.1](#)) that specifies the header for this record. Sub-fields are further specified in the following table.

Field	Meaning
rh.recVer	MUST be 0x0.
rh.recType	MUST be an RT_TimeVariant .
rh.recLen	MUST be 0x00000005.

type (1 byte): A [TimeVariantTypeEnum](#) enumeration that specifies the data type of this record. It MUST be TL_TVT_Int.

override (4 bytes): A [TimeVariantInt](#) record that specifies how to override the values of the properties of the target object being animated by the animation behavior of the *corresponding time node*. It MUST be 0x00000001 that specifies the animated properties of the sub-elements contained inside the target object are cleared and inherited from the target object before the animation.

2.8.42 TimeRuntimeContext

Referenced by: [TimeVariant4Behavior](#)

An **atom record** that specifies the runtime context of an animation behavior.

Let the *corresponding time node* be as specified in the [TimePropertyList4TimeBehavior](#) record that contains this **TimeRuntimeContext** record.

0	1	2	3	4	5	6	7	8	9	10	11	12	13	14	15	16	17	18	19	20	21	22	23	24	25	26	27	28	29	30	31
rh																															
...																															
type										timeRuntimeContext (variable)																					
...																															

rh (8 bytes): A **RecordHeader** structure (section [2.3.1](#)) that specifies the header for this record. Sub-fields are further specified in the following table.

Field	Meaning
rh.recVer	MUST be 0x0.
rh.recType	MUST be an RT_TimeVariant .
rh.recLen	MUST be an odd number.

type (1 byte): A [TimeVariantTypeEnum](#) enumeration that specifies the data type of this record. It MUST be TL_TVT_String.

timeRuntimeContext (variable): A [UnicodeString](#) that specifies the runtime context of the animation behavior of the *corresponding time node*. It MUST be a valid RUNTIME_CONTEXT as specified in the following ABNF (specified in [\[RFC5234\]](#)) grammar:

```

RUNTIME_CONTEXT = CONTEXT_ATOM *(";" CONTEXT_ATOM) [";"]
CONTEXT_ATOM = [RELATION_OPERATOR SPACE] APP_ABBREV [SPACE VERSION]
RELATION_OPERATOR = GTE / GT / LTE / LT / NOT
APP_ABBREV = ("p" / "P") ("p" / "P") ("t" / "T")
VERSION = DEC_NUMBER [ "." DEC_NUMBER ]
DEC_NUMBER = 1 * DIGIT
GTE = "g" "t" "e"
GT = "g" "t"
LTE = "l" "t" "e"
LT = "l" "t"
NOT = "!"
SPACE = 1 * " "

```

The length, in bytes, of the field is specified by the following formula:

```
rh.recLen - 1
```

2.8.43 TimePointsTypes

Referenced by: [TimeVariant4Behavior](#)

An **atom record** that specifies the type of points in a motion path.

Let the *corresponding time node* be as specified in the [TimePropertyList4TimeBehavior](#) record that contains this **TimePointsTypes** record.

0	1	2	3	4	5	6	7	8	9	10	11	12	13	14	15	16	17	18	19	20	21	22	23	24	25	26	27	28	29	30	31
rh																															
...																															
type										timePointsTypes (variable)																					
...																															

rh (8 bytes): A **RecordHeader** structure (section [2.3.1](#)) that specifies the header for this record. Sub-fields are further specified in the following table.

Field	Meaning
rh.recVer	MUST be 0x0.
rh.recType	MUST be an RT_TimeVariant .
rh.recLen	MUST be an odd number.

type (1 byte): A [TimeVariantTypeEnum](#) enumeration that specifies the data type of this record. It MUST be TL_TVT_String.

timePointsTypes (variable): A [UnicodeString](#) that specifies the type of points in the path attribute and the description of the motion path near the current point. The length, in bytes, of the field is specified by the following formula:

$$\text{rh.recLen} - 1$$

This field has no effect on the playing of the animation. It is only used when the motion path is edited in a user interface.

Each character in this string sequentially maps to a point defined in the path string as specified in the **varPath** field of the **TimeMotionBehaviorContainer** record (section [2.8.63](#)). It MUST be a sequence formed with characters from the following table.

Character	Meaning
A	Auto line point.
a	Auto curve point.
F	Corner line point.
f	Corner curve point.
T	Straight line point.
t	Straight curve point.
S	Smooth line point.

Character	Meaning
s	Smooth curve point.

2.8.44 ClientVisualElementContainer

Referenced by: [ExtTimeNodeContainer](#), [SubEffectContainer](#), [TimeBehaviorContainer](#), [TimeConditionContainer](#)

A **container record** that specifies the target for an animation effect.

0	1	2	3	4	5	6	7	8	9	10	11	12	13	14	15	16	17	18	19	20	21	22	23	24	25	26	27	28	29	30	31
rh																															
...																															
visualElementAtom (variable)																															
...																															

rh (8 bytes): A **RecordHeader** structure (section [2.3.1](#)) that specifies the header for this record. Subfields are further specified in the following table.

Field	Meaning
rh.recVer	MUST be 0xF.
rh.recInstance	MUST be 0x000.
rh.recType	MUST be an RT_TimeClientVisualElement .

visualElementAtom (variable): A [VisualElementAtom](#) record that specifies the target to which the animation effect applies.

2.8.45 VisualElementAtom

Referenced by: [ClientVisualElementContainer](#)

A variable type record whose type and meaning are dictated by the value of **rh.recType**, as specified in the following table.

Value	Meaning
RT_VisualPageAtom	A VisualPageAtom record that specifies the slide as the target for a time condition .
RT_VisualShapeAtom	A VisualShapeOrSoundAtom record that specifies the shape or sound information for an animation target.

2.8.46 VisualPageAtom

Referenced by: [VisualElementAtom](#)

An **atom record** that specifies the **slide** as the target for a **time condition**.

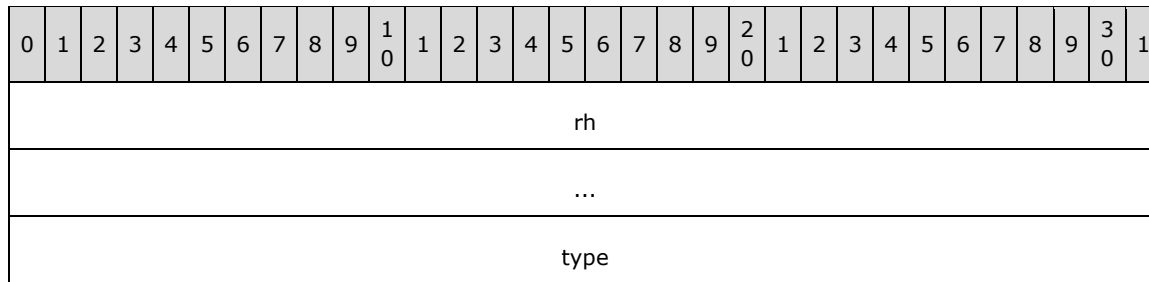

rh (8 bytes): A **RecordHeader** structure (section [2.3.1](#)) that specifies the header for this record. Sub-fields are further specified in the following table.

Field	Meaning
rh.recVer	MUST be 0x0.
rh.recInstance	MUST be 0x000.
rh.recType	MUST be an RT_VisualPageAtom .
rh.recLen	MUST be 0x00000004.

type (4 bytes): A [TimeVisualElementEnum](#) enumeration that specifies the target element type. It MUST be TL_TVET_Page.

2.8.47 VisualShapeOrSoundAtom

Referenced by: [VisualElementAtom](#)

A variable type record whose type and meaning are dictated by the value of **refType**, as specified in the following table.

Value	Meaning
TL_ET_SoundType	A VisualSoundAtom record that specifies the sound information for an animation target.
TL_ET_ShapeType	A VisualShapeAtom record that specifies the shape information for an animation target.

2.8.48 VisualSoundAtom

Referenced by: [VisualShapeOrSoundAtom](#)

An **atom record** that specifies the sound information for an animation target.

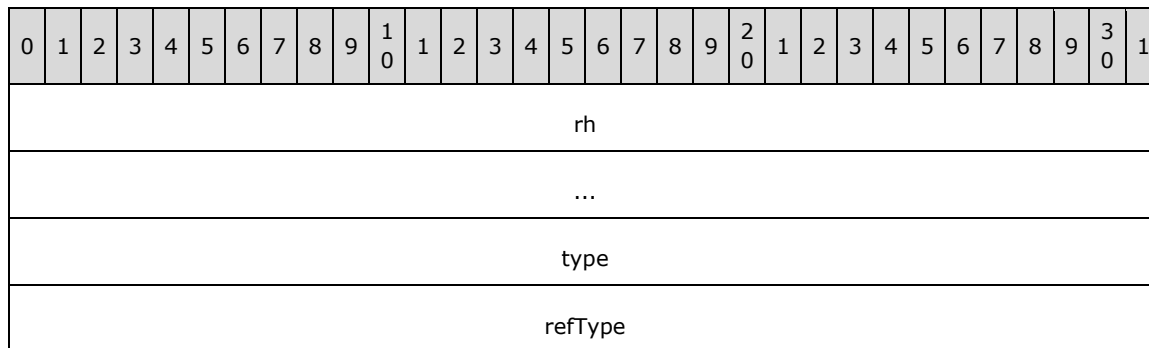

soundIdRef
data1
data2

rh (8 bytes): A **RecordHeader** structure (section [2.3.1](#)) that specifies the header for this record. Sub-fields are further specified in the following table.

Field	Meaning
rh.recVer	MUST be 0x0.
rh.recInstance	MUST be 0x000.
rh.recType	MUST be an RT_VisualShapeAtom .
rh.recLen	MUST be 0x00000014.

type (4 bytes): A [TimeVisualElementEnum](#) enumeration that specifies the target element type for the shape that the animation is applied to. It MUST NOT be TL_TVET_Page.

refType (4 bytes): An [ElementTypeEnum](#) enumeration that specifies the target element type of the animation. It MUST be TL_ET_SoundType.

soundIdRef (4 bytes): A [SoundIdRef](#) that specifies the value to look up in the **SoundCollectionContainer** record (section [2.4.16.1](#)) to find the embedded audio.

data1 (4 bytes): MUST be 0xFFFFFFFF, and MUST be ignored.

data2 (4 bytes): MUST be 0xFFFFFFFF, and MUST be ignored.

2.8.49 VisualShapeAtom

Referenced by: [VisualShapeOrSoundAtom](#)

A variable type record whose type and meaning are dictated by the value of **type**, as specified in the following table.

Value	Meaning
TL_TVET_ChartElement	A VisualShapeChartElementAtom record that specifies the embedded chart shape for an animation target.
All other values	A VisualShapeGeneralAtom record that specifies the shape for an animation target. The shape MUST NOT be an embedded chart.

2.8.50 VisualShapeChartElementAtom

Referenced by: [VisualShapeAtom](#)

An **atom record** that specifies an embedded chart or its sub-elements to animate.

0	1	2	3	4	5	6	7	8	9	10	11	12	13	14	15	16	17	18	19	20	21	22	23	24	25	26	27	28	29	30	31
rh																															

...
type
refType
shapeIdRef
data1
data2

rh (8 bytes): A **RecordHeader** structure (section [2.3.1](#)) that specifies the header for this record. Sub-fields are further specified in the following table.

Field	Meaning
rh.recVer	MUST be 0x0.
rh.recInstance	MUST be 0x000.
rh.recType	MUST be an RT_VisualShapeAtom .
rh.recLen	MUST be 0x00000014.

type (4 bytes): A [TimeVisualElementEnum](#) enumeration that specifies the target element type in the shape to which the animation is applied. It MUST be TL_TVET_ChartElement.

refType (4 bytes): An [ElementTypeEnum](#) enumeration that specifies the target element type of the animation. It MUST be TL_ET_ShapeType.

shapeIdRef (4 bytes): An unsigned integer that specifies the target shape on the slide to animate.

data1 (4 bytes): An **unsigned integer** that specifies how the chart is built during its animation. It MUST be a value from the following table.

Value	Meaning
0x00000000	The entire chart.
0x00000001	By series.
0x00000002	By category.
0x00000003	By series element.
0x00000004	By category element.
0x00000005	Custom chart element.

data2 (4 bytes): A **signed integer** that specifies a chart element to animate. It MUST be greater than or equal to 0xFFFFFFFF (-1). The value 0xFFFFFFFF specifies that this record is invalid and SHOULD be ignored. The value 0x00000000 specifies the chart background. Values greater than 0x00000000 specify a one-based index in the list of chart elements specified by **data1**.

2.8.51 VisualShapeGeneralAtom

Referenced by: [VisualShapeAtom](#)

An **atom record** that specifies a shape or one of its parts as a target to animate.

0	1	2	3	4	5	6	7	8	9	10	11	12	13	14	15	16	17	18	19	20	21	22	23	24	25	26	27	28	29	30	31
rh																															
...																															
type																															
refType																															
shapeIdRef																															
data1																															
data2																															

rh (8 bytes): A **RecordHeader** structure (section [2.3.1](#)) that specifies the header for this record. Sub-fields are further specified in the following table.

Field	Meaning
rh.recVer	MUST be 0x0.
rh.recInstance	MUST be 0x000.
rh.recType	MUST be an RT_VisualShapeAtom .
rh.recLen	MUST be 0x00000014.

type (4 bytes): A [TimeVisualElementEnum](#) enumeration that specifies the target element type in the shape to which the animation is applied. It MUST NOT be TL_TVET_Page.

refType (4 bytes): An [ElementTypeEnum](#) enumeration that specifies the target element type of the animation. It MUST be TL_ET_ShapeType.

shapeIdRef (4 bytes): An unsigned integer that specifies the target **shape** on the **slide** to animate.

data1 (4 bytes): A signed integer that specifies the zero-based character index of the beginning of a text range. It MUST be ignored unless **type** is TL_TVET_TextRange.

data2 (4 bytes): A signed integer that specifies the zero-based character index of the end of a text range. It MUST be ignored unless **type** is TL_TVET_TextRange.

2.8.52 TimeColorBehaviorContainer

Referenced by: [ExtTimeNodeContainer](#), [SubEffectContainer](#)

A **container record** that specifies a behavior that changes the color of an object. This animation behavior is applied to the object specified by the **behavior.clientVisualElement** field and used to animate one property specified by the **behavior.stringList** field. The property MUST be one from the following list that is a subset of the properties specified in the **TimeStringListContainer** record (section [2.8.36](#)): "ppt_c", "style.color", "imageData.chromakey", "fill.color", "fill.color2", "stroke.color", "stroke.color2", "shadow.color", "shadow.color2", "extrusion.color", and "fillcolor".

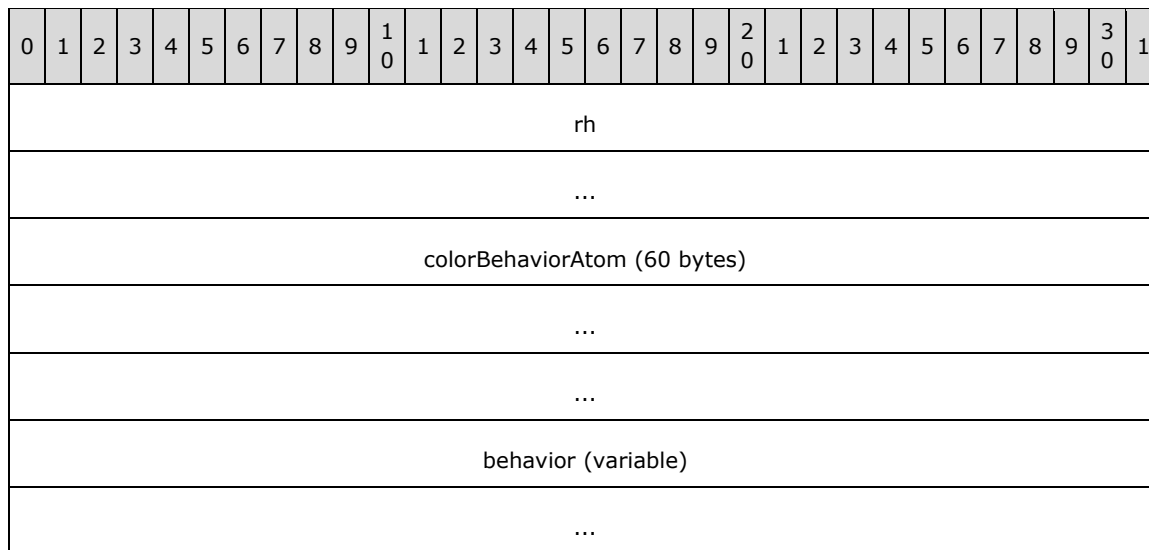

rh (8 bytes): A **RecordHeader** structure (section [2.3.1](#)) that specifies the header for this record. Subfields are further specified in the following table.

Field	Meaning
rh.recVer	MUST be 0xF.
rh.recInstance	MUST be 0x000.
rh.recType	MUST be an RT_TimeColorBehaviorContainer .

colorBehaviorAtom (60 bytes): A [TimeColorBehaviorAtom](#) record that specifies how to change the color of the object and which attributes within this field are valid.

behavior (variable): A **TimeBehaviorContainer** record (section [2.8.34](#)) that specifies the common behavior information.

2.8.53 TimeColorBehaviorAtom

Referenced by: [TimeColorBehaviorContainer](#)

An **atom record** that specifies the information for an animation that changes the color of an object.

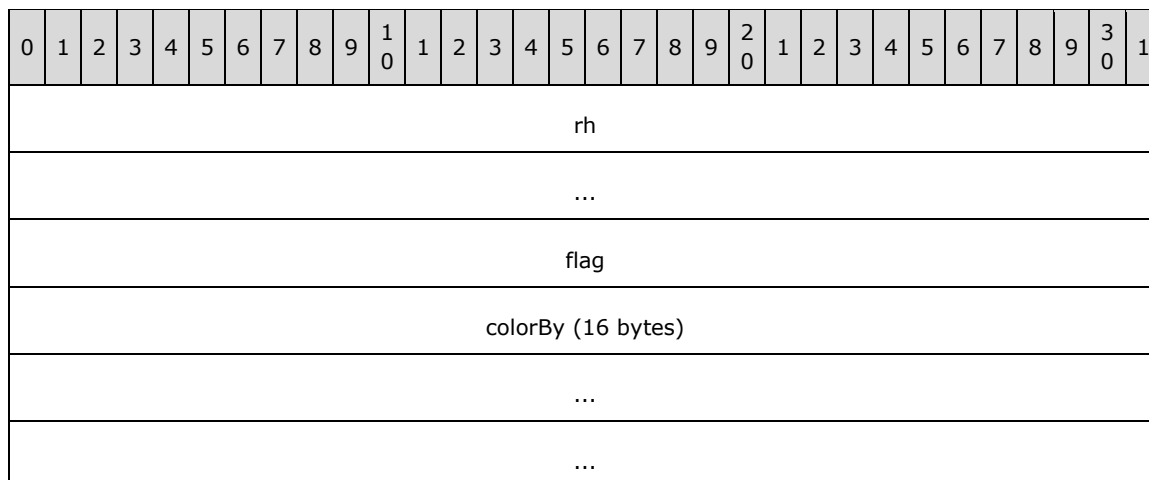

colorFrom (16 bytes)
...
...
colorTo (16 bytes)
...
...

rh (8 bytes): A **RecordHeader** structure (section [2.3.1](#)) that specifies the header for this record. Sub-fields are further specified in the following table.

Field	Meaning
rh.recVer	MUST be 0x0.
rh.recInstance	MUST be 0x000.
rh.recType	MUST be an RT_TimeColorBehavior .
rh.recLen	MUST be 0x00000034.

flag (4 bytes): A [TimeColorBehaviorPropertyUsedFlag](#) structure that specifies which fields are valid.

colorBy (16 bytes): A [TimeAnimateColorBy](#) structure that specifies the offset color value.

MUST be ignored if **colorTo** exists. It MUST be ignored if **flag.fByPropertyUsed** is **FALSE**.

colorFrom (16 bytes): A [TimeAnimateColor](#) structure that specifies the starting color value.

If **colorFrom** exists, **colorBy** or **colorTo** MUST also exist. It MUST be ignored if **flag.fFromPropertyUsed** is **FALSE**.

colorTo (16 bytes): A [TimeAnimateColor](#) structure that specifies the end color value.

MUST be ignored if **flag.fToPropertyUsed** is **FALSE**.

2.8.54 TimeColorBehaviorPropertyUsedFlag

Referenced by: [TimeColorBehaviorAtom](#)

A structure that specifies which attributes of a color animation are valid.

Let the *corresponding* **TimeColorBehaviorAtom** be specified by the [TimeColorBehaviorAtom](#) record that contains this **TimeColorBehaviorPropertyUsedFlag** record.

Let the *corresponding* **TimeColorBehaviorContainer** be specified by the **TimeColorBehaviorContainer** record (section [2.8.52](#)) that contains the *corresponding* **TimeColorBehaviorAtom**.

0	1	2	3	4	5	6	7	8	9	10	11	12	13	14	15	16	17	18	19	20	21	22	23	24	25	26	27	28	29	30	31
A	B	C	D	E	reserved																										

- A - fByPropertyUsed (1 bit):** A bit that specifies whether the **colorBy** field of the corresponding **TimeColorBehaviorAtom** is valid.
 - B - fFromPropertyUsed (1 bit):** A bit that specifies whether the **colorFrom** field of the corresponding **TimeColorBehaviorAtom** is valid.
 - C - fToPropertyUsed (1 bit):** A bit that specifies whether the **colorTo** field of the corresponding **TimeColorBehaviorAtom** is valid.
 - D - fColorSpacePropertyUsed (1 bit):** A bit that specifies whether the **behavior.propertyList.rec** field of the corresponding **TimeColorBehaviorContainer** which has **behavior.propertyList.rec.rh.recInstance** equal to [TL_TBPID_ColorColorModel](#) was explicitly set by a user interface action.
 - E - fDirectionPropertyUsed (1 bit):** A bit that specifies whether the **behavior.propertyList.rec** field of the corresponding **TimeColorBehaviorContainer** which has **behavior.propertyList.rec.rh.recInstance** equal to [TL_TBPID_ColorDirection](#) was explicitly set by a user interface action.
- reserved (27 bits):** MUST be zero, and MUST be ignored.

2.8.55 TimeAnimateColorBy

Referenced by: [TimeColorBehaviorAtom](#)

A variable type structure whose type and meaning are dictated by the value of the **model** field within these three structures, as specified by the following table.

Value	Meaning
0x00000000	An RGBColorBy structure that specifies an RGB color offset.
0x00000001	An HSLColorBy structure that specifies an HSL color offset.
0x00000002	An IndexSchemeColor structure that specifies a color scheme color.

2.8.56 RGBColorBy

Referenced by: [TimeAnimateColorBy](#)

A structure that specifies the offset values during an animation of the red, green, and blue color components in **RGB color space**. These offset values are added to the starting value for each color component at specified time intervals until the animation is complete.

0	1	2	3	4	5	6	7	8	9	10	11	12	13	14	15	16	17	18	19	20	21	22	23	24	25	26	27	28	29	30	31
model																															
red																															
green																															
blue																															

model (4 bytes): An unsigned integer that specifies this color is defined within the RGB color space. It MUST be 0x00000000.

red (4 bytes): A signed integer that specifies the offset value of the red color component. It MUST be greater than or equal to -255 and less than or equal to 255.

green (4 bytes): A signed integer that specifies the offset value of the green color component. It MUST be greater than or equal to -255 and less than or equal to 255.

blue (4 bytes): A signed integer that specifies the offset value of the blue color component. It MUST be greater than or equal to -255 and less than or equal to 255.

2.8.57 HSLColorBy

Referenced by: [TimeAnimateColorBy](#)

A structure that specifies the offset values during an animation of the hue, saturation, and luminance color components in **HSL color space**. These offset values are added to the starting value for each color component at specified time intervals until the animation is complete.

0	1	2	3	4	5	6	7	8	9	10	11	12	13	14	15	16	17	18	19	20	21	22	23	24	25	26	27	28	29	30	31
model																															
hue																															
saturation																															
luminance																															

model (4 bytes): An unsigned integer that specifies that this color is defined within the HSL color space. It MUST be 0x00000001.

hue (4 bytes): A signed integer that specifies the offset value of the hue color component. It MUST be greater than or equal to -255 and less than or equal to 255.

saturation (4 bytes): A signed integer that specifies the offset value of the saturation color component. It MUST be greater than or equal to -255 and less than or equal to 255.

luminance (4 bytes): A signed integer that specifies the offset value of the luminance color component. It MUST be greater than or equal to -255 and less than or equal to 255.

2.8.58 TimeAnimateColor

Referenced by: [TimeColorBehaviorAtom](#)

A variable type structure whose type and meaning are dictated by the value of the **model** field within these two structures, as specified by the following table.

Value	Meaning
0x00000000	An RGBColor structure that specifies an RGB color.
0x00000002	An IndexSchemeColor structure that specifies a color scheme color.

2.8.59 RGBColor

Referenced by: [TimeAnimateColor](#)

A structure that specifies the values of the red, green, and blue components of a color in the **RGB color space**.

0	1	2	3	4	5	6	7	8	9	10	11	12	13	14	15	16	17	18	19	20	21	22	23	24	25	26	27	28	29	30	31
model																															
red																															
green																															
blue																															

model (4 bytes): An **unsigned integer** that specifies this color is defined within the RGB color space. It MUST be 0x00000000.

red (4 bytes): An **unsigned integer** that specifies the value of the red color component. It MUST be less than or equal to 255.

green (4 bytes): An **unsigned integer** that specifies the value of the green color component. It MUST be less than or equal to 255.

blue (4 bytes): An **unsigned integer** that specifies the value of the blue color component. It MUST be less than or equal to 255.

2.8.60 IndexSchemeColor

Referenced by: [TimeAnimateColor](#), [TimeAnimateColorBy](#)

A structure that specifies a color from a **color scheme**.

0	1	2	3	4	5	6	7	8	9	10	11	12	13	14	15	16	17	18	19	20	21	22	23	24	25	26	27	28	29	30	31
model																															
index																															
reserved1																															
reserved2																															

model (4 bytes): An unsigned integer that specifies this color is from a color scheme. It MUST be 0x00000002.

index (4 bytes): An unsigned integer that specifies the index to the color scheme. It MUST be less than or equal to 7.

reserved1 (4 bytes): MUST be zero, and MUST be ignored.

reserved2 (4 bytes): MUST be zero, and MUST be ignored.

2.8.61 TimeEffectBehaviorContainer

Referenced by: [ExtTimeNodeContainer](#)

A **container record** that specifies an effect behavior that transforms the image of an object. The transformation provides the ability to perform transitions on objects. There is no property to be animated in this behavior. The **behavior.stringList** field is ignored.

0	1	2	3	4	5	6	7	8	9	10	11	12	13	14	15	16	17	18	19	20	21	22	23	24	25	26	27	28	29	30	31
rh																															
...																															
effectBehaviorAtom (16 bytes)																															
...																															
...																															
varType (variable)																															
...																															
varProgress (13 bytes, optional)																															
...																															
...																															
...																varRuntimeContext (variable)															
...																															
behavior (variable)																															
...																															

rh (8 bytes): A **RecordHeader** structure (section [2.3.1](#)) that specifies the header for this record. Sub-fields are further specified in the following table:





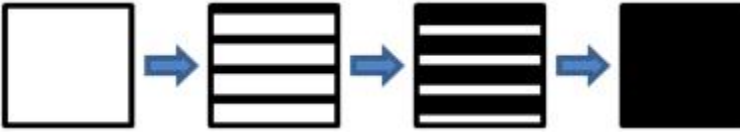
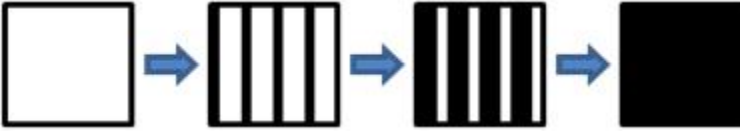
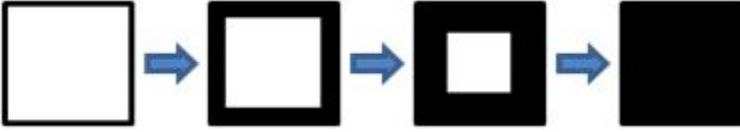
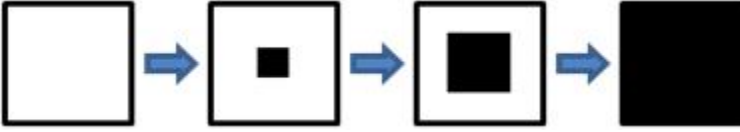
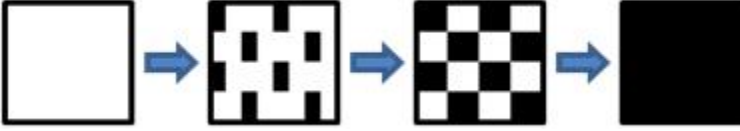
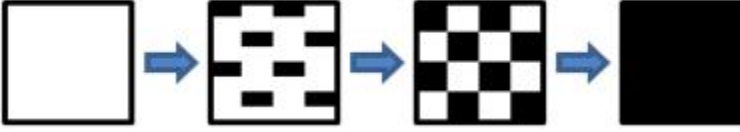
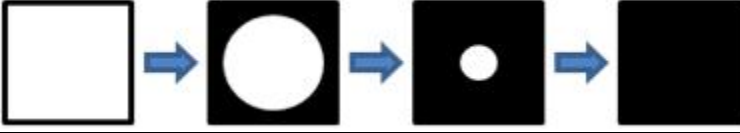
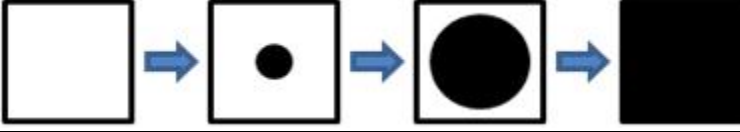
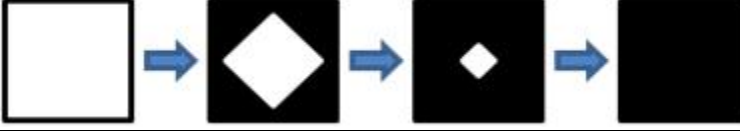
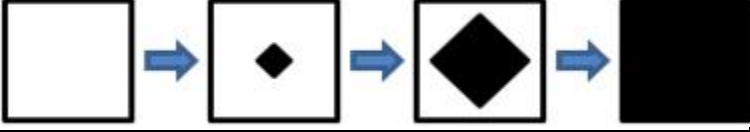

Field	Meaning
rh.recVer	MUST be 0xF.
rh.recInstance	MUST be 0x000.
rh.recType	MUST be an RT_TimeEffectBehaviorContainer .

effectBehaviorAtom (16 bytes): A [TimeEffectBehaviorAtom](#) record that specifies which attributes of this field and this **TimeEffectBehaviorContainer** are valid, and the transformation style of the object.

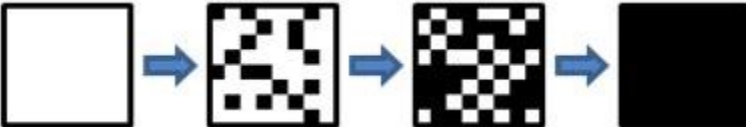
varType (variable): A [TimeVariantString](#) record that specifies the object transitions for the effect. The **varType.rh.recInstance** sub-field MUST be 0x001. It MUST be ignored if **effectBehaviorAtom.fTypePropertyUsed** is **FALSE**.

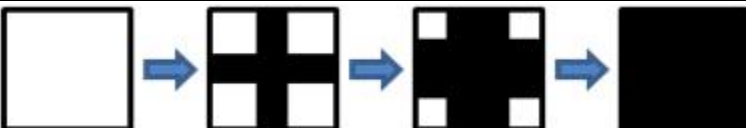
The **varType.stringValue** sub-field MUST be a value specified in the following table:

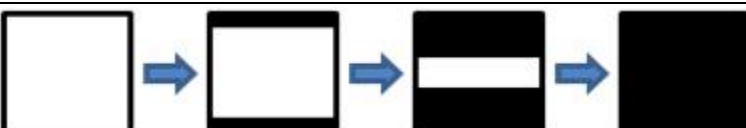
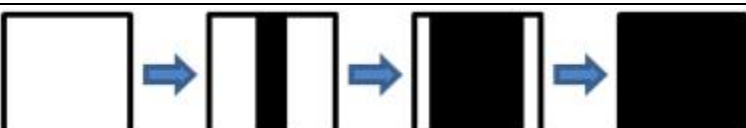
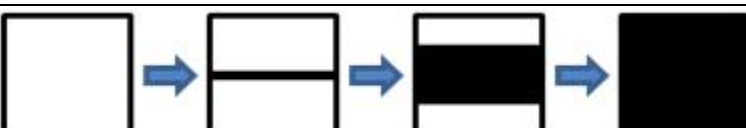
Value	Description
blinds(horizontal)	
blinds(vertical)	
box(in)	
box(out)	
checkerboard(across)	
checkerboard(down)	
circle(in)	
circle(out)	
diamond(in)	
diamond(out)	

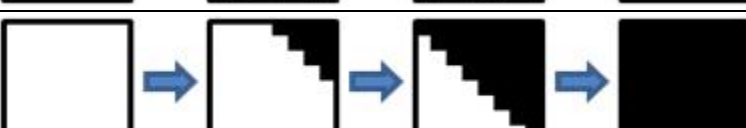
Value	Description
dissolve	
fade	
plus(in)	
plus(out)	
barn(inVertical)	
barn(inHorizontal)	
barn(outVertical)	
barn(outHorizontal)	
randombar(horizontal)	
randombar(vertical)	
strips(downLeft)	

Value	Description
strips(upLeft)	
strips(downRight)	
strips(upRight)	
wedge	
wheel(1)	
wheel(2)	
wheel(3)	
wheel(4)	
wheel(8)	
wipe(right)	
wipe(left)	

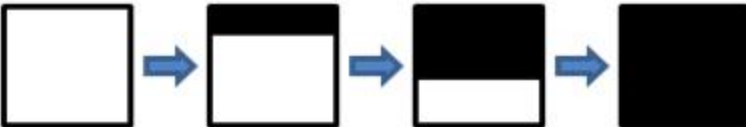
Value	Description
wipe(up)	
wipe(down)	

varProgress (13 bytes): An optional [TimeVariantFloat](#) record that specifies the normalized time for which the state of the animation is displayed until the end time. It MUST be ignored if **effectBehaviorAtom.fProgressPropertyUsed** is **FALSE**. Sub-fields are further specified in the following table.

Field	Meaning
varProgress.rh.recInstance	MUST be 0x002.
varProgress.floatValue	MUST be greater than or equal to 0, the normalized start time of the animation, and less than or equal to 1, the normalized end time of the animation.

varRuntimeContext (variable): An optional [TimeVariantString](#) record that specifies the runtime context. It MUST be ignored if **effectBehaviorAtom.fRuntimeContextObsolete** is **FALSE**. Sub-fields are further specified in the following table.

Field	Meaning
varRuntimeContext.rh.recInstance	MUST be 0x003.
varRuntimeContext.stringValue	MUST have a format as specified by the timeRuntimeContext field of the TimeRuntimeContext record

behavior (variable): A [TimeBehaviorContainer](#) record (section [2.8.34](#)) that specifies the common behavior information.

2.8.62 TimeEffectBehaviorAtom

Referenced by: [TimeEffectBehaviorContainer](#)

An **atom record** that specifies the information of an animation that transforms the image of an object.

0	1	2	3	4	5	6	7	8	9	1	0	1	2	3	4	5	6	7	8	9	2	0	1	2	3	4	5	6	7	8	9	3	0	1
rh																																		
...																																		
A	B	C	D	reserved																														

effectTransition

rh (8 bytes): A **RecordHeader** structure (section [2.3.1](#)) that specifies the header for this record. Sub-fields are further specified in the following table.

Field	Meaning
rh.recVer	MUST be 0x0.
rh.recInstance	MUST be 0x000.
rh.recType	MUST be an RT_TimeEffectBehavior .
rh.recLen	MUST be 0x00000008.

A - fTransitionPropertyUsed (1 bit): A **bit** that specifies whether **effectTransition** was explicitly set by a user interface action.

B - fTypePropertyUsed (1 bit): A bit that specifies whether the **varType** of the **TimeEffectBehaviorContainer** record (section 2.8.61) that contains this **TimeEffectBehaviorAtom** is valid.

C - fProgressPropertyUsed (1 bit): A bit that specifies whether the **varProgress** of the **TimeEffectBehaviorContainer** record that contains this **TimeEffectBehaviorAtom** is valid.

D - fRuntimeContextObsolete (1 bit): A bit that specifies whether the **varRuntimeContext** of the **TimeEffectBehaviorContainer** record that contains this **TimeEffectBehaviorAtom** is valid.

reserved (28 bits): MUST be zero, and MUST be ignored.

effectTransition (4 bytes): An unsigned integer that specifies how the image of the object is transformed. It MUST be ignored if **fTransitionPropertyUsed** is **FALSE** and a value of 0x00000000 MUST be used instead. It MUST be a value from the following table.

Value	Meaning
0x00000000	Transition in: the object is completely invisible at the beginning of the transformation and becomes completely visible at the end of the transformation.
0x00000001	Transition out: the object is completely visible at the beginning of the transformation and becomes completely invisible at the end of the transformation.

2.8.63 TimeMotionBehaviorContainer

Referenced by: [ExtTimeNodeContainer](#)

A **container record** that specifies a motion behavior that moves an object along a path. This animation behavior is applied to the object specified by the **timeBehavior.clientVisualElement** field and used to animate two properties specified by the **timeBehavior.stringList** field. The properties MUST be ones from the list that is specified in the **TimeStringListContainer** record (section [2.8.36](#)). If no properties are specified, "ppt_x" and "ppt_y" will be used. If only one property is specified, "ppt_y" will be used as the second property.

0	1	2	3	4	5	6	7	8	9	10	11	12	13	14	15	16	17	18	19	20	21	22	23	24	25	26	27	28	29	30	31
rh																															
...																															
motionBehaviorAtom (40 bytes)																															
...																															
...																															
varPath (variable)																															
...																															
reserved (13 bytes, optional)																															
...																															
...																															
...																timeBehavior (variable)															
...																															

rh (8 bytes): A **RecordHeader** structure (section [2.3.1](#)) that specifies the header for this record. Sub-fields are further specified in the following table.

Field	Meaning
rh.recVer	MUST be 0xF.
rh.recInstance	MUST be 0x000.
rh.recType	MUST be an RT_TimeMotionBehaviorContainer .

motionBehaviorAtom (40 bytes): A [TimeMotionBehaviorAtom](#) record that specifies the origin of the path, which attributes of this field and this **TimeMotionBehaviorContainer** record are valid, and a path specified by a starting point, an endpoint, and an offset value.

varPath (variable): An optional [TimeVariantString](#) record that specifies the path for the animation motion. The **varPath.rh.recInstance** sub-field MUST be 0x001. It MUST be a valid MOTION_PATH as specified in the following ABNF (specified in [RFC5234](#)) grammar:

```

MOTION_PATH = 1*PATH_COMMAND
PATH_COMMAND = MOVE_COMMAND / LINE_COMMAND / CURVE_COMMAND / CLOSE_COMMAND
MOVE_COMMAND = ("m" / "M") SPACE COORD_NUMBER SPACE COORD_NUMBER
LINE_COMMAND = ("l" / "L") SPACE COORD_NUMBER SPACE COORD_NUMBER
CURVE_COMMAND = ("c" / "C") SPACE COORD_NUMBER SPACE COORD_NUMBER SPACE COORD_NUMBER SPACE
COORD_NUMBER SPACE COORD_NUMBER SPACE COORD_NUMBER
CLOSE_COMMAND = ("z" / "Z")
COORD_NUMBER = (DEC_NUMBER [ "." DEC_NUMBER ] ) / ( "(" FORMULA ")" )
DEC_NUMBER = 1*DIGIT

```

SPACE = 1*" "

The FORMULA rule is specified by the **varFormula** field of the [TimeAnimationValueListEntry](#) record.

The path is specified by defining an action and coordinates that go along with the action. The allowed action types that are understood within a path are listed in the following table. If the action is expressed in uppercase, the following point(s) are to be interpreted as absolute coordinates, or a point on the slide. If the action is expressed in lowercase, the point(s) are to be interpreted as relative coordinates, or an offset from the current position.

Action	Meaning
M = move to	This action requires a point specified by two coordinates. Move to will move the object to the specified point. It does not animate the object to that point; rather, the object will snap to the given point.
L = line to	This action requires a point specified by two coordinates. Line to will move the object to the specified point along the shortest line between the current point and the specified point.
C = curve to	This action requires three points specified by six coordinates. Curve to will move the object along a cubic Bezier curve specified by the current point and the three provided points.
Z =close loop	This action requires no points. Close loop will move the object back to where it was before the path began along the shortest line between the current point and the starting point. The relative and absolute versions of this action are identical.
E =end	This action requires no points. End will terminate the motion path. Any action specified in the string after the End action is ignored. If this action is not present at the end of a string and the string ends, this action will be implied. The relative and absolute versions of this action are identical.

Thus the total allowed set is {M,L,C,Z,E,m,l,c,z,e}.

Points are expressed as normalized values of the slide size, for example, 1,1 means the lower-right corner of the slide in absolute coordinates, or the slide width and height in relative coordinates. Expressing a coordinate less than 1 but greater than 0 MUST be prefixed with 0 before the decimal point.

Formulas can also be used for any coordinate. To use a formula, the entire formula MUST be inside parentheses. Formula syntax is specified in the **varFormula** field of the TimeAnimationValueListEntry record.

reserved (13 bytes): An optional [TimeVariantInt](#) record that MUST be ignored.

timeBehavior (variable): A **TimeBehaviorContainer** record (section [2.8.34](#)) that specifies the common behavior information.

2.8.64 TimeMotionBehaviorAtom

Referenced by: [TimeMotionBehaviorContainer](#)

An **atom record** that specifies the information of an animation that moves an object along a path.

0	1	2	3	4	5	6	7	8	9	1	0	1	2	3	4	5	6	7	8	9	2	0	1	2	3	4	5	6	7	8	9	3	0	1
rh																																		

...								
A	B	C	D	E	F	G	H	reserved2
fXBy								
fYBy								
fXFrom								
fYFrom								
fXTo								
fYTo								
behaviorOrigin								

rh (8 bytes): A **RecordHeader** structure (section [2.3.1](#)) that specifies the header for this record. Sub-fields are further specified in the following table.

Field	Meaning
rh.recVer	MUST be 0x0.
rh.recInstance	MUST be 0x000.
rh.recType	MUST be an RT_TimeMotionBehavior .
rh.recLen	MUST be 0x00000020.

- A - fByPropertyUsed (1 bit):** A bit that specifies whether **fXBy** and **fYBy** were explicitly set by a user interface action.
- B - fFromPropertyUsed (1 bit):** A bit that specifies whether **fXFrom** and **fYFrom** were explicitly set by a user interface action. If **fFromPropertyUsed** is **TRUE**, **fByPropertyUsed** or **fToPropertyUsed** MUST also be **TRUE**.
- C - fToPropertyUsed (1 bit):** A bit that specifies whether **fXTo** and **fYTo** were explicitly set by a user interface action.
- D - fOriginPropertyUsed (1 bit):** A bit that specifies whether **behaviorOrigin** was explicitly set by a user interface action.
- E - fPathPropertyUsed (1 bit):** A bit that specifies whether the **varPath** of the **TimeMotionBehaviorContainer** record (section 2.8.63) that contains this **TimeMotionBehaviorAtom** is valid.
- F - reserved1 (1 bit):** MUST be 0x0.
- G - fEditRotationPropertyUsed (1 bit):** A bit that specifies whether the **timeContainer.propertyList** of the **TimeMotionBehaviorContainer** record that contains this **TimeMotionBehaviorAtom** has items of types [TL_TBPID_PathEditRotationAngle](#), [TL_TBPID_PathEditRotationX](#), and [TL_TBPID_PathEditRotationY](#) as specified in the **TimePropertyID4TimeBehavior** enumeration.

H - fPointsTypesPropertyUsed (1 bit): A bit that specifies whether the **timeContainer.propertyList** of the **TimeMotionBehaviorContainer** record that contains this **TimeMotionBehaviorAtom** has items of type **TL_TBPID_PointsTypes** as specified in the **TimePropertyID4TimeBehavior** enumeration.

reserved2 (24 bits): MUST be 0x000000.

fXBy (4 bytes): A **floating-point number** that specifies the offset value of the object position in the horizontal axis. It MUST be ignored if **fByPropertyUsed** is **FALSE** or if **fToPropertyUsed** is **TRUE**.

fYBy (4 bytes): A floating-point number that specifies the offset value of the object position in the vertical axis. It MUST be ignored if **fByPropertyUsed** is **FALSE** or if **fToPropertyUsed** is **TRUE**.

fXFrom (4 bytes): A floating-point number that specifies the starting position of the object in the horizontal axis. It MUST be ignored if **fFromPropertyUsed** is **FALSE** and a value of 0x00000000 MUST be used instead.

fYFrom (4 bytes): A floating-point number that specifies the starting position of the object in the vertical axis. It MUST be ignored if **fFromPropertyUsed** is **FALSE** and a value of 0x00000000 MUST be used instead.

fXTo (4 bytes): A floating-point number that specifies the end position of the object in the horizontal axis. It MUST be ignored if **fToPropertyUsed** is **FALSE**.

fYTo (4 bytes): A floating-point number that specifies the end position of the object in the vertical axis. It MUST be ignored if **fToPropertyUsed** is **FALSE**.

behaviorOrigin (4 bytes): An **unsigned integer** that specifies the origin of the motion path. It MUST be ignored if **fOriginPropertyUsed** is **FALSE** and a value of 0x00000002 MUST be used instead. It MUST be a value from the following table.

Value	Meaning
0x00000000	The origin is at the upper left corner of the slide that contains the object.
0x00000001	Same as 0x00000000.
0x00000002	The origin is at the center of the object.

2.8.65 TimeRotationBehaviorContainer

Referenced by: [ExtTimeNodeContainer](#)

A **container record** that specifies a rotation behavior that rotates an object. This animation behavior is applied to the object specified by the **behavior.clientVisualElement** field and used to animate one property specified by the **behavior.stringList** field. The property MUST be "r" or "ppt_r" from the list that is specified in the **TimeStringListContainer** record (section [2.8.36](#)).

0	1	2	3	4	5	6	7	8	9	10	11	12	13	14	15	16	17	18	19	20	21	22	23	24	25	26	27	28	29	30	31
rh																															
...																															
rotationBehaviorAtom (28 bytes)																															

...
...
behavior (variable)
...

rh (8 bytes): A **RecordHeader** structure (section [2.3.1](#)) that specifies the header for this record. Sub-fields are further specified in the following table.

Field	Meaning
rh.recVer	MUST be 0xF.
rh.recInstance	MUST be 0x000.
rh.recType	MUST be an RT_TimeRotationBehaviorContainer .

rotationBehaviorAtom (28 bytes): A [TimeRotationBehaviorAtom](#) record that specifies how to rotate the object and which attributes within this field are valid.

behavior (variable): A **TimeBehaviorContainer** record (section [2.8.34](#)) that specifies the common behavior information.

2.8.66 TimeRotationBehaviorAtom

Referenced by: [TimeRotationBehaviorContainer](#)

An **atom record** that specifies animation information for object rotation.

0	1	2	3	4	5	6	7	8	9	10	11	12	13	14	15	16	17	18	19	20	21	22	23	24	25	26	27	28	29	30	31
rh																															
...																															
A	B	C	D	reserved																											
fBy																															
fFrom																															
fTo																															
rotationDirection																															

rh (8 bytes): A **RecordHeader** structure (section [2.3.1](#)) that specifies the header for this record. Sub-fields are further specified in the following table.

Field	Meaning
rh.recVer	MUST be 0x0.

Field	Meaning
rh.recInstance	MUST be 0x000.
rh.recType	MUST be an RT_TimeRotationBehavior .
rh.recLen	MUST be 0x00000014.

- A - fByPropertyUsed (1 bit):** A bit that specifies whether **fBy** was explicitly set by a user interface action.
- B - fFromPropertyUsed (1 bit):** A bit that specifies whether **fFrom** was explicitly set by a user interface action. If **fFromPropertyUsed** is **TRUE**, **fByPropertyUsed** or **fToPropertyUsed** MUST also be **TRUE**.
- C - fToPropertyUsed (1 bit):** A bit that specifies whether **fTo** was explicitly set by a user interface action.
- D - fDirectionPropertyUsed (1 bit):** A **bit** that specifies whether **rotationDirection** was explicitly set by a user interface action.

reserved (28 bits): MUST be zero, and MUST be ignored.

fBy (4 bytes): A **floating-point number** that specifies the offset degree of rotation. It MUST be ignored if **fByPropertyUsed** is **FALSE** or if **fToPropertyUsed** is **TRUE**.

fFrom (4 bytes): A floating-point number that specifies the starting degree of rotation. It MUST be ignored if **fFromPropertyUsed** is **FALSE** and a value of 0 MUST be used instead.

fTo (4 bytes): A floating-point number that specifies the end degree of rotation. It MUST be ignored if **fToPropertyUsed** is **FALSE** and a value of 360 MUST be used instead.

rotationDirection (4 bytes): An **unsigned integer** that specifies the rotation direction. It MUST be ignored if **fDirectionPropertyUsed** is **FALSE** and a value of 0x00000000 MUST be used instead. It MUST be a value from the following table.

Value	Meaning
0x00000000	Rotate clockwise.
0x00000001	Rotate counter clockwise.

2.8.67 TimeScaleBehaviorContainer

Referenced by: [ExtTimeNodeContainer](#)

A **container record** that specifies a scale behavior that animates the size of an object. This animation behavior is applied to the object specified by the **behavior.clientVisualElement** field and used to animate two properties including "ScaleX" and "ScaleY" from the list that is specified in the **TimeStringListContainer** record (section [2.8.36](#)). The **behavior.stringList** field is ignored.

0	1	2	3	4	5	6	7	8	9	1	0	1	2	3	4	5	6	7	8	9	2	0	1	2	3	4	5	6	7	8	9	3	0	1
rh																																		
...																																		

scaleBehaviorAtom (40 bytes)
...
...
behavior (variable)
...

rh (8 bytes): A **RecordHeader** structure (section [2.3.1](#)) that specifies the header for this record. Sub-fields are further specified in the following table.

Field	Meaning
rh.recVer	MUST be 0xF.
rh.recInstance	MUST be 0x000.
rh.recType	MUST be an RT_TimeScaleBehaviorContainer .

scaleBehaviorAtom (40 bytes): A [TimeScaleBehaviorAtom](#) record that specifies how to scale the size of an object and which attributes within this field are valid.

behavior (variable): A **TimeBehaviorContainer** record (section [2.8.34](#)) that specifies the common behavior information.

2.8.68 TimeScaleBehaviorAtom

Referenced by: [TimeScaleBehaviorContainer](#)

An **atom record** that specifies animation information for scaling the size of an object.

0	1	2	3	4	5	6	7	8	9	10	11	12	13	14	15	16	17	18	19	20	21	22	23	24	25	26	27	28	29	30	31
rh																															
...																															
A	B	C	D	reserved																											
fXBy																															
fYBy																															
fXFrom																															
fYFrom																															
fXTo																															
fYTo																															

fZoomContents	unused
---------------	--------

rh (8 bytes): A **RecordHeader** structure (section [2.3.1](#)) that specifies the header for this record. Sub-fields are further specified in the following table.

Field	Meaning
rh.recVer	MUST be 0x0.
rh.recInstance	MUST be 0x000.
rh.recType	MUST be an RT_TimeScaleBehavior .
rh.recLen	MUST be 0x00000020.

A - fByPropertyUsed (1 bit): A bit that specifies whether **fXBy** and **fYBy** were explicitly set by a user interface action.

B - fFromPropertyUsed (1 bit): A bit that specifies whether **fXFrom** and **fYFrom** were explicitly set by a user interface action. If **fFromPropertyUsed** is **TRUE**, **fByPropertyUsed** or **fToPropertyUsed** MUST also be **TRUE**.

C - fToPropertyUsed (1 bit): A bit that specifies whether **fXTo** and **fYTo** were explicitly set by a user interface action.

D - fZoomContentsUsed (1 bit): A bit that specifies whether **fZoomContents** was explicitly set by a user interface action.

reserved (28 bits): MUST be zero, and MUST be ignored.

fXBy (4 bytes): A **floating-point number** that specifies the offset value of the width of the object that is animated. It MUST be ignored if **fByPropertyUsed** is **FALSE** or if **fToPropertyUsed** is **TRUE**.

fYBy (4 bytes): A floating-point number that specifies the offset value of the height of the object that is animated. It MUST be ignored if **fByPropertyUsed** is **FALSE** or if **fToPropertyUsed** is **TRUE**.

fXFrom (4 bytes): A floating-point number that specifies the starting value of the width of the object that is animated. It MUST be ignored if **fFromPropertyUsed** is **FALSE** and a value of 0 MUST be used instead.

fYFrom (4 bytes): A floating-point number that specifies the starting value of the height of the object that is animated. It MUST be ignored if **fFromPropertyUsed** is **FALSE** and a value of 0 MUST be used instead.

fXTo (4 bytes): A floating-point number that specifies the end value of the width of the object that is animated. It MUST be ignored if **fToPropertyUsed** is **FALSE** and a value of 100 MUST be used instead.

fYTo (4 bytes): A floating-point number that specifies the end value of the height of the object that is animated. It MUST be ignored if **fToPropertyUsed** is **FALSE** and a value of 100 MUST be used instead.

fZoomContents (1 byte): A **bool1** (section [2.2.2](#)) that specifies whether the content contained by the scaling object is also scaled. It MUST be ignored if **fZoomContentsUsed** is **FALSE** and a value of 0x01 MUST be used instead.

unused (3 bytes): Undefined and MUST be ignored.

2.8.69 TimeSetBehaviorContainer

Referenced by: [ExtTimeNodeContainer](#), [SubEffectContainer](#)

A **container record** that specifies a set behavior that assigns a value to a property. This animation behavior is applied to the object specified by the **behavior.clientVisualElement** field and used to animate one property specified by the **behavior.stringList** field. The property MUST be from the list that is specified in the **TimeStringListContainer** record (section [2.8.36](#)).

0	1	2	3	4	5	6	7	8	9	10	11	12	13	14	15	16	17	18	19	20	21	22	23	24	25	26	27	28	29	30	31
rh																															
...																															
setBehaviorAtom (16 bytes)																															
...																															
...																															
varTo (variable)																															
...																															
behavior (variable)																															
...																															

rh (8 bytes): A RecordHeader structure (section [2.3.1](#)) that specifies the header for this record. Subfields are further specified in the following table.

Field	Meaning
rh.recVer	MUST be 0xF.
rh.recInstance	MUST be 0x000.
rh.recType	MUST be an RT_TimeSetBehaviorContainer .

setBehaviorAtom (16 bytes): A [TimeSetBehaviorAtom](#) record that specifies the type of the value to be set and which attributes of this field and this **TimeSetBehaviorContainer** are valid.

varTo (variable): A [TimeVariantString](#) record that specifies the value that to be set to the property. The **varTo.rh.recInstance** subfield MUST be 0x001. It MUST be ignored if **setBehaviorAtom.fToPropertyUsed** is FALSE.

The allowed set of strings depends on the specific attribute names used in the **behavior.stringList** field. The supported attribute names are specified by the **TimeStringListContainer** record. The **varTo.stringValue** MUST be a value as specified in the following tables.

When using attribute names in the following table, the **setBehaviorAtom.valueType** field MUST be [TL_TABVT Number](#).

Attribute Name	varTo.stringValue Preset
style.visibility	"hidden", "visible"
style.fontWeight	"none", "normal", "bold"
style.fontStyle	"none", "normal", "italic"
style.textEffectEmboss	"none", "normal", "emboss"
style.textShadow	"none", "normal", "auto"
style.textTransform	"none", "normal", "sub", "super"
style.textDecorationUnderline	"false", "true"
style.textEffectOutline	"false", "true"
style.textDecorationLineThrough	"false", "true"
imageData.grayscale	"false", "true"
fill.on	"false", "f", "t", "true"
fill.type	"solid", "pattern", "tile", "frame", "gradientUnscaled", "gradient", "gradientCenter", "gradientRadial", "gradientTile", "background"
fill.method	"none", "linear", "sigma", "any"
stroke.on	"false", "f", "t", "true"
stroke.linestyle	"single", "thinThin", "thinThick", "thickThin", "thickBetweenThin"
stroke.dashstyle	"solid", "dot", "dash", "dashDot", "longDash", "longDashDot", "longDashDotDot"
stroke.filltype	"solid", "tile", "pattern", "frame"
stroke.startArrow	"none", "block", "classic", "diamond", "oval", "open", "chevron", "doublechevron"
stroke.endArrow	"none", "block", "classic", "diamond", "oval", "open", "chevron", "doublechevron"
stroke.startArrowWidth	"narrow", "medium", "wide"
stroke.startArrowLength	"short", "medium", "long"
stroke.endArrowWidth	"narrow", "medium", "wide"
stroke.endArrowLength	"short", "medium", "long"
shadow.on	"false", "f", "t", "true"
shadow.type	"single", "double", "emboss", "perspective"
skew.on	"false", "f", "t", "true"
extrusion.on	"false", "f", "t", "true"
extrusion.type	"parallel", "perspective"
extrusion.render	"solid", "wireframe", "boundingcube"
extrusion.plane	"xy", "zx", "yz"
extrusion.lockrotationcenter	"false", "true"
extrusion.autorotationcenter	"false", "true"
extrusion.colormode	"false", "true"

When using attribute names in the following table, the **setBehaviorAtom.valueType** field MUST be TL_TABVT_Number.

Attribute Name	varTo.stringValue
ppt_x	MUST be a valid FORMULA_OR_NUMBER as specified in the following ABNF (specified in RFC52341) grammar: FORMULA_OR_NUMBER = SETFORMULA / REAL_NUMBER

Attribute Name	varTo.stringValue
	<pre> SETFORMULA = "(" FORMULA ")" REAL_NUMBER = DEC_REGULAR_VALUE / DEC_PURE_FLOATING DEC_REGULAR_VALUE = ["-"] DEC_NUMBER ["."] [DEC_NUMBER] [DEC_EXPONENT] DEC_PURE_FLOATING = ["-"] "." DEC_NUMBER [DEC_EXPONENT] DEC_NUMBER = 1 * DIGIT DEC_EXPONENT = ["-"] ("e" / "E") DEC_NUMBER </pre> <p>The FORMULA rule is specified by the varFormula field of the TimeAnimationValueListEntry record.</p>
ppt_y	<p>MUST be a valid FORMULA_OR_NUMBER as specified in the following ABNF (specified in [RFC5234]) grammar:</p> <pre> FORMULA_OR_NUMBER = SETFORMULA / REAL_NUMBER SETFORMULA = "(" FORMULA ")" REAL_NUMBER = DEC_REGULAR_VALUE / DEC_PURE_FLOATING DEC_REGULAR_VALUE = ["-"] DEC_NUMBER ["."] [DEC_NUMBER] [DEC_EXPONENT] DEC_PURE_FLOATING = ["-"] "." DEC_NUMBER [DEC_EXPONENT] DEC_NUMBER = 1 * DIGIT DEC_EXPONENT = ["-"] ("e" / "E") DEC_NUMBER </pre> <p>The FORMULA rule is specified by the varFormula field of the TimeAnimationValueListEntry record.</p>
ppt_w	<p>MUST be a valid FORMULA_OR_NUMBER as specified in the following ABNF (specified in [RFC5234]) grammar:</p> <pre> FORMULA_OR_NUMBER = SETFORMULA / REAL_NUMBER SETFORMULA = "(" FORMULA ")" REAL_NUMBER = DEC_REGULAR_VALUE / DEC_PURE_FLOATING DEC_REGULAR_VALUE = ["-"] DEC_NUMBER ["."] [DEC_NUMBER] [DEC_EXPONENT] DEC_PURE_FLOATING = ["-"] "." DEC_NUMBER [DEC_EXPONENT] DEC_NUMBER = 1 * DIGIT DEC_EXPONENT = ["-"] ("e" / "E") DEC_NUMBER </pre> <p>The FORMULA rule is specified by the varFormula field of the TimeAnimationValueListEntry record.</p>
ppt_h	<p>MUST be a valid FORMULA_OR_NUMBER as specified in the following ABNF (specified in [RFC5234]) grammar:</p> <pre> FORMULA_OR_NUMBER = SETFORMULA / REAL_NUMBER SETFORMULA = "(" FORMULA ")" REAL_NUMBER = DEC_REGULAR_VALUE / DEC_PURE_FLOATING DEC_REGULAR_VALUE = ["-"] DEC_NUMBER ["."] [DEC_NUMBER] [DEC_EXPONENT] DEC_PURE_FLOATING = ["-"] "." DEC_NUMBER [DEC_EXPONENT] DEC_NUMBER = 1 * DIGIT DEC_EXPONENT = ["-"] ("e" / "E") DEC_NUMBER </pre> <p>The FORMULA rule is specified by the varFormula field of the TimeAnimationValueListEntry record.</p>
ppt_r	<p>MUST be a valid FORMULA_OR_NUMBER as specified in the following</p>

Attribute Name	varTo.stringValue
	<p>ABNF (specified in [RFC5234]) grammar:</p> <pre> FORMULA_OR_NUMBER = SETFORMULA / REAL_NUMBER SETFORMULA = "(" FORMULA ")" REAL_NUMBER = DEC_REGULAR_VALUE / DEC_PURE_FLOATING DEC_REGULAR_VALUE = ["-"] DEC_NUMBER ["."] [DEC_NUMBER] [DEC_EXPONENT] DEC_PURE_FLOATING = ["-"] "." DEC_NUMBER [DEC_EXPONENT] DEC_NUMBER = 1*DIGIT DEC_EXPONENT = ["-"] ("e" / "E") DEC_NUMBER </pre> <p>The FORMULA rule is specified by the varFormula field of the TimeAnimationValueListEntry record.</p>
xshear	<p>MUST be a valid FORMULA_OR_NUMBER as specified in the following ABNF (specified in [RFC5234]) grammar:</p> <pre> FORMULA_OR_NUMBER = SETFORMULA / REAL_NUMBER SETFORMULA = "(" FORMULA ")" REAL_NUMBER = DEC_REGULAR_VALUE / DEC_PURE_FLOATING DEC_REGULAR_VALUE = ["-"] DEC_NUMBER ["."] [DEC_NUMBER] [DEC_EXPONENT] DEC_PURE_FLOATING = ["-"] "." DEC_NUMBER [DEC_EXPONENT] DEC_NUMBER = 1*DIGIT DEC_EXPONENT = ["-"] ("e" / "E") DEC_NUMBER </pre> <p>The FORMULA rule is specified by the varFormula field of the TimeAnimationValueListEntry record.</p>
yshear	<p>MUST be a valid FORMULA_OR_NUMBER as specified in the following ABNF (specified in [RFC5234]) grammar:</p> <pre> FORMULA_OR_NUMBER = SETFORMULA / REAL_NUMBER SETFORMULA = "(" FORMULA ")" REAL_NUMBER = DEC_REGULAR_VALUE / DEC_PURE_FLOATING DEC_REGULAR_VALUE = ["-"] DEC_NUMBER ["."] [DEC_NUMBER] [DEC_EXPONENT] DEC_PURE_FLOATING = ["-"] "." DEC_NUMBER [DEC_EXPONENT] DEC_NUMBER = 1*DIGIT DEC_EXPONENT = ["-"] ("e" / "E") DEC_NUMBER </pre> <p>The FORMULA rule is specified by the varFormula field of the TimeAnimationValueListEntry record.</p>
ScaleX	<p>MUST be a valid FORMULA_OR_NUMBER as specified in the following ABNF (specified in [RFC5234]) grammar:</p> <pre> FORMULA_OR_NUMBER = SETFORMULA / REAL_NUMBER SETFORMULA = "(" FORMULA ")" REAL_NUMBER = DEC_REGULAR_VALUE / DEC_PURE_FLOATING DEC_REGULAR_VALUE = ["-"] DEC_NUMBER ["."] [DEC_NUMBER] [DEC_EXPONENT] DEC_PURE_FLOATING = ["-"] "." DEC_NUMBER [DEC_EXPONENT] DEC_NUMBER = 1*DIGIT </pre>

Attribute Name	varTo.stringValue
	<pre>DEC_EXPONENT = ["-"] ("e" / "E") DEC_NUMBER</pre> <p>The FORMULA rule is specified by the varFormula field of the TimeAnimationValueListEntry record.</p>
ScaleY	<p>MUST be a valid FORMULA_OR_NUMBER as specified in the following ABNF (specified in [RFC5234]) grammar:</p> <pre>FORMULA_OR_NUMBER = SETFORMULA / REAL_NUMBER SETFORMULA = "(" FORMULA ")" REAL_NUMBER = DEC_REGULAR_VALUE / DEC_PURE_FLOATING DEC_REGULAR_VALUE = ["-"] DEC_NUMBER ["."] [DEC_NUMBER] [DEC_EXPONENT] DEC_PURE_FLOATING = ["-"] "." DEC_NUMBER [DEC_EXPONENT] DEC_NUMBER = 1 * DIGIT DEC_EXPONENT = ["-"] ("e" / "E") DEC_NUMBER</pre> <p>The FORMULA rule is specified by the varFormula field of the TimeAnimationValueListEntry record.</p>
r	<p>MUST be a valid FORMULA_OR_NUMBER as specified in the following ABNF (specified in [RFC5234]) grammar:</p> <pre>FORMULA_OR_NUMBER = SETFORMULA / REAL_NUMBER SETFORMULA = "(" FORMULA ")" REAL_NUMBER = DEC_REGULAR_VALUE / DEC_PURE_FLOATING DEC_REGULAR_VALUE = ["-"] DEC_NUMBER ["."] [DEC_NUMBER] [DEC_EXPONENT] DEC_PURE_FLOATING = ["-"] "." DEC_NUMBER [DEC_EXPONENT] DEC_NUMBER = 1 * DIGIT DEC_EXPONENT = ["-"] ("e" / "E") DEC_NUMBER</pre> <p>The FORMULA rule is specified by the varFormula field of the TimeAnimationValueListEntry record.</p>
style.opacity	<p>MUST be a valid FORMULA_OR_NUMBER as specified in the following ABNF (specified in [RFC5234]) grammar:</p> <pre>FORMULA_OR_NUMBER = SETFORMULA / REAL_NUMBER SETFORMULA = "(" FORMULA ")" REAL_NUMBER = DEC_REGULAR_VALUE / DEC_PURE_FLOATING DEC_REGULAR_VALUE = ["-"] DEC_NUMBER ["."] [DEC_NUMBER] [DEC_EXPONENT] DEC_PURE_FLOATING = ["-"] "." DEC_NUMBER [DEC_EXPONENT] DEC_NUMBER = 1 * DIGIT DEC_EXPONENT = ["-"] ("e" / "E") DEC_NUMBER</pre> <p>The FORMULA rule is specified by the varFormula field of the TimeAnimationValueListEntry record.</p>
style.rotation	<p>MUST be a valid FORMULA_OR_NUMBER as specified in the following ABNF (specified in [RFC5234]) grammar:</p> <pre>FORMULA_OR_NUMBER = SETFORMULA / REAL_NUMBER SETFORMULA = "(" FORMULA ")" REAL_NUMBER = DEC_REGULAR_VALUE / DEC_PURE_FLOATING DEC_REGULAR_VALUE = ["-"] DEC_NUMBER ["."]</pre>

Attribute Name	varTo.stringValue
	<pre>[DEC NUMBER] [DEC EXPONENT] DEC_PURE_FLOATING = ["-"] "." DEC_NUMBER [DEC EXPONENT] DEC_NUMBER = 1*DIGIT DEC_EXPONENT = ["-"] ("e" / "E") DEC_NUMBER</pre> <p>The FORMULA rule is specified by the varFormula field of the TimeAnimationValueListEntry record.</p>
style.fontSize	<p>MUST be a valid FORMULA_OR_NUMBER as specified in the following ABNF (specified in [RFC5234]) grammar:</p> <pre>FORMULA_OR_NUMBER = SETFORMULA / REAL_NUMBER SETFORMULA = "(" FORMULA ")" REAL_NUMBER = DEC_REGULAR_VALUE / DEC_PURE_FLOATING DEC_REGULAR_VALUE = ["-"] DEC_NUMBER ["."] [DEC NUMBER] [DEC EXPONENT] DEC_PURE_FLOATING = ["-"] "." DEC_NUMBER [DEC EXPONENT] DEC_NUMBER = 1*DIGIT DEC_EXPONENT = ["-"] ("e" / "E") DEC_NUMBER</pre> <p>The FORMULA rule is specified by the varFormula field of the TimeAnimationValueListEntry record.</p>
style.sRotation	<p>MUST be a valid FORMULA_OR_NUMBER as specified in the following ABNF (specified in [RFC5234]) grammar:</p> <pre>FORMULA_OR_NUMBER = SETFORMULA / REAL_NUMBER SETFORMULA = "(" FORMULA ")" REAL_NUMBER = DEC_REGULAR_VALUE / DEC_PURE_FLOATING DEC_REGULAR_VALUE = ["-"] DEC_NUMBER ["."] [DEC NUMBER] [DEC EXPONENT] DEC_PURE_FLOATING = ["-"] "." DEC_NUMBER [DEC EXPONENT] DEC_NUMBER = 1*DIGIT DEC_EXPONENT = ["-"] ("e" / "E") DEC_NUMBER</pre> <p>The FORMULA rule is specified by the varFormula field of the TimeAnimationValueListEntry record.</p>
imageData.cropTop	<p>MUST be a valid FORMULA_OR_NUMBER as specified in the following ABNF (specified in [RFC5234]) grammar:</p> <pre>FORMULA_OR_NUMBER = SETFORMULA / REAL_NUMBER SETFORMULA = "(" FORMULA ")" REAL_NUMBER = DEC_REGULAR_VALUE / DEC_PURE_FLOATING DEC_REGULAR_VALUE = ["-"] DEC_NUMBER ["."] [DEC NUMBER] [DEC EXPONENT] DEC_PURE_FLOATING = ["-"] "." DEC_NUMBER [DEC EXPONENT] DEC_NUMBER = 1*DIGIT DEC_EXPONENT = ["-"] ("e" / "E") DEC_NUMBER</pre> <p>The FORMULA rule is specified by the varFormula field of the TimeAnimationValueListEntry record.</p>
imageData.cropBottom	<p>MUST be a valid FORMULA_OR_NUMBER as specified in the following ABNF (specified in [RFC5234]) grammar:</p>

Attribute Name	varTo.stringValue
	<pre> FORMULA_OR_NUMBER = SETFORMULA / REAL_NUMBER SETFORMULA = "(" FORMULA ")" REAL_NUMBER = DEC_REGULAR_VALUE / DEC_PURE_FLOATING DEC_REGULAR_VALUE = ["-"] DEC_NUMBER ["."] [DEC_NUMBER] [DEC_EXPONENT] DEC_PURE_FLOATING = ["-"] "." DEC_NUMBER [DEC_EXPONENT] DEC_NUMBER = 1*DIGIT DEC_EXPONENT = ["-"] ("e" / "E") DEC_NUMBER </pre> <p>The FORMULA rule is specified by the varFormula field of the TimeAnimationValueListEntry record.</p>
imageData.cropLeft	<p>MUST be a valid FORMULA_OR_NUMBER as specified in the following ABNF (specified in [RFC5234]) grammar:</p> <pre> FORMULA_OR_NUMBER = SETFORMULA / REAL_NUMBER SETFORMULA = "(" FORMULA ")" REAL_NUMBER = DEC_REGULAR_VALUE / DEC_PURE_FLOATING DEC_REGULAR_VALUE = ["-"] DEC_NUMBER ["."] [DEC_NUMBER] [DEC_EXPONENT] DEC_PURE_FLOATING = ["-"] "." DEC_NUMBER [DEC_EXPONENT] DEC_NUMBER = 1*DIGIT DEC_EXPONENT = ["-"] ("e" / "E") DEC_NUMBER </pre> <p>The FORMULA rule is specified by the varFormula field of the TimeAnimationValueListEntry record.</p>
imageData.cropRight	<p>MUST be a valid FORMULA_OR_NUMBER as specified in the following ABNF (specified in [RFC5234]) grammar:</p> <pre> FORMULA OR NUMBER = SETFORMULA / REAL NUMBER SETFORMULA = "(" FORMULA ")" REAL NUMBER = DEC_REGULAR_VALUE / DEC_PURE_FLOATING DEC_REGULAR_VALUE = ["-"] DEC_NUMBER ["."] [DEC_NUMBER] [DEC_EXPONENT] DEC_PURE_FLOATING = ["-"] "." DEC NUMBER [DEC_EXPONENT] DEC_NUMBER = 1*DIGIT DEC_EXPONENT = ["-"] ("e" / "E") DEC_NUMBER </pre> <p>The FORMULA rule is specified by the varFormula field of the TimeAnimationValueListEntry record.</p>
imageData.gain	<p>MUST be a valid FORMULA_OR_NUMBER as specified in the following ABNF (specified in [RFC5234]) grammar:</p> <pre> FORMULA OR NUMBER = SETFORMULA / REAL NUMBER SETFORMULA = "(" FORMULA ")" REAL_NUMBER = DEC_REGULAR_VALUE / DEC_PURE_FLOATING DEC_REGULAR_VALUE = ["-"] DEC_NUMBER ["."] [DEC_NUMBER] [DEC_EXPONENT] DEC_PURE_FLOATING = ["-"] "." DEC NUMBER [DEC_EXPONENT] DEC_NUMBER = 1*DIGIT DEC_EXPONENT = ["-"] ("e" / "E") DEC_NUMBER </pre> <p>The FORMULA rule is specified by the varFormula field of the</p>

Attribute Name	varTo.stringValue
	TimeAnimationValueListEntry record.
imageData.blacklevel	<p>MUST be a valid FORMULA_OR_NUMBER as specified in the following ABNF (specified in [RFC5234]) grammar:</p> <pre> FORMULA_OR_NUMBER = SETFORMULA / REAL_NUMBER SETFORMULA = "(" FORMULA ")" REAL_NUMBER = DEC_REGULAR_VALUE / DEC_PURE_FLOATING DEC_REGULAR_VALUE = ["-"] DEC_NUMBER ["."] [DEC_NUMBER] [DEC_EXPONENT] DEC_PURE_FLOATING = ["-"] "." DEC_NUMBER [DEC_EXPONENT] DEC_NUMBER = 1 * DIGIT DEC_EXPONENT = ["-"] ("e" / "E") DEC_NUMBER </pre> <p>The FORMULA rule is specified by the varFormula field of the TimeAnimationValueListEntry record.</p>
imageData.gamma	<p>MUST be a valid FORMULA_OR_NUMBER as specified in the following ABNF (specified in [RFC5234]) grammar:</p> <pre> FORMULA_OR_NUMBER = SETFORMULA / REAL_NUMBER SETFORMULA = "(" FORMULA ")" REAL_NUMBER = DEC_REGULAR_VALUE / DEC_PURE_FLOATING DEC_REGULAR_VALUE = ["-"] DEC_NUMBER ["."] [DEC_NUMBER] [DEC_EXPONENT] DEC_PURE_FLOATING = ["-"] "." DEC_NUMBER [DEC_EXPONENT] DEC_NUMBER = 1 * DIGIT DEC_EXPONENT = ["-"] ("e" / "E") DEC_NUMBER </pre> <p>The FORMULA rule is specified by the varFormula field of the TimeAnimationValueListEntry record.</p>
fill.opacity	<p>MUST be a valid FORMULA_OR_NUMBER as specified in the following ABNF (specified in [RFC5234]) grammar:</p> <pre> FORMULA_OR_NUMBER = SETFORMULA / REAL_NUMBER SETFORMULA = "(" FORMULA ")" REAL_NUMBER = DEC_REGULAR_VALUE / DEC_PURE_FLOATING DEC_REGULAR_VALUE = ["-"] DEC_NUMBER ["."] [DEC_NUMBER] [DEC_EXPONENT] DEC_PURE_FLOATING = ["-"] "." DEC_NUMBER [DEC_EXPONENT] DEC_NUMBER = 1 * DIGIT DEC_EXPONENT = ["-"] ("e" / "E") DEC_NUMBER </pre> <p>The FORMULA rule is specified by the varFormula field of the TimeAnimationValueListEntry record.</p>
fill.opacity2	<p>MUST be a valid FORMULA_OR_NUMBER as specified in the following ABNF (specified in [RFC5234]) grammar:</p> <pre> FORMULA_OR_NUMBER = SETFORMULA / REAL_NUMBER SETFORMULA = "(" FORMULA ")" REAL_NUMBER = DEC_REGULAR_VALUE / DEC_PURE_FLOATING DEC_REGULAR_VALUE = ["-"] DEC_NUMBER ["."] [DEC_NUMBER] [DEC_EXPONENT] DEC_PURE_FLOATING = ["-"] "." DEC_NUMBER [DEC_EXPONENT] DEC_NUMBER = 1 * DIGIT </pre>

Attribute Name	varTo.stringValue
	<pre>DEC_EXPONENT = ["-"] ("e" / "E") DEC_NUMBER</pre> <p>The FORMULA rule is specified by the varFormula field of the TimeAnimationValueListEntry record.</p>
fill.angle	<p>MUST be a valid FORMULA_OR_NUMBER as specified in the following ABNF (specified in [RFC5234]) grammar:</p> <pre>FORMULA_OR_NUMBER = SETFORMULA / REAL_NUMBER SETFORMULA = "(" FORMULA ")" REAL_NUMBER = DEC_REGULAR_VALUE / DEC_PURE_FLOATING DEC_REGULAR_VALUE = ["-"] DEC_NUMBER ["."] [DEC_NUMBER] [DEC_EXPONENT] DEC_PURE_FLOATING = ["-"] "." DEC_NUMBER [DEC_EXPONENT] DEC_NUMBER = 1 * DIGIT DEC_EXPONENT = ["-"] ("e" / "E") DEC_NUMBER</pre> <p>The FORMULA rule is specified by the varFormula field of the TimeAnimationValueListEntry record.</p>
fill.focus	<p>MUST be a valid FORMULA_OR_NUMBER as specified in the following ABNF (specified in [RFC5234]) grammar:</p> <pre>FORMULA_OR_NUMBER = SETFORMULA / REAL_NUMBER SETFORMULA = "(" FORMULA ")" REAL_NUMBER = DEC_REGULAR_VALUE / DEC_PURE_FLOATING DEC_REGULAR_VALUE = ["-"] DEC_NUMBER ["."] [DEC_NUMBER] [DEC_EXPONENT] DEC_PURE_FLOATING = ["-"] "." DEC_NUMBER [DEC_EXPONENT] DEC_NUMBER = 1 * DIGIT DEC_EXPONENT = ["-"] ("e" / "E") DEC_NUMBER</pre> <p>The FORMULA rule is specified by the varFormula field of the TimeAnimationValueListEntry record.</p>
fill.focusposition.x	<p>MUST be a valid FORMULA_OR_NUMBER as specified in the following ABNF (specified in [RFC5234]) grammar:</p> <pre>FORMULA_OR_NUMBER = SETFORMULA / REAL_NUMBER SETFORMULA = "(" FORMULA ")" REAL_NUMBER = DEC_REGULAR_VALUE / DEC_PURE_FLOATING DEC_REGULAR_VALUE = ["-"] DEC_NUMBER ["."] [DEC_NUMBER] [DEC_EXPONENT] DEC_PURE_FLOATING = ["-"] "." DEC_NUMBER [DEC_EXPONENT] DEC_NUMBER = 1 * DIGIT DEC_EXPONENT = ["-"] ("e" / "E") DEC_NUMBER</pre> <p>The FORMULA rule is specified by the varFormula field of the TimeAnimationValueListEntry record.</p>
fill.focusposition.y	<p>MUST be a valid FORMULA_OR_NUMBER as specified in the following ABNF (specified in [RFC5234]) grammar:</p> <pre>FORMULA_OR_NUMBER = SETFORMULA / REAL_NUMBER SETFORMULA = "(" FORMULA ")" REAL_NUMBER = DEC_REGULAR_VALUE / DEC_PURE_FLOATING DEC_REGULAR_VALUE = ["-"] DEC_NUMBER ["."]</pre>

Attribute Name	varTo.stringValue
	<pre>[DEC NUMBER] [DEC EXPONENT] DEC_PURE_FLOATING = ["-"] "." DEC_NUMBER [DEC EXPONENT] DEC_NUMBER = 1*DIGIT DEC_EXPONENT = ["-"] ("e" / "E") DEC_NUMBER</pre> <p>The FORMULA rule is specified by the varFormula field of the TimeAnimationValueListEntry record.</p>
fill.focussize.x	<p>MUST be a valid FORMULA_OR_NUMBER as specified in the following ABNF (specified in [RFC5234]) grammar:</p> <pre>FORMULA_OR_NUMBER = SETFORMULA / REAL_NUMBER SETFORMULA = "(" FORMULA ")" REAL_NUMBER = DEC_REGULAR_VALUE / DEC_PURE_FLOATING DEC_REGULAR_VALUE = ["-"] DEC_NUMBER ["."] [DEC NUMBER] [DEC EXPONENT] DEC_PURE_FLOATING = ["-"] "." DEC_NUMBER [DEC EXPONENT] DEC_NUMBER = 1*DIGIT DEC_EXPONENT = ["-"] ("e" / "E") DEC_NUMBER</pre> <p>The FORMULA rule is specified by the varFormula field of the TimeAnimationValueListEntry record.</p>
fill.focussize.y	<p>MUST be a valid FORMULA_OR_NUMBER as specified in the following ABNF (specified in [RFC5234]) grammar:</p> <pre>FORMULA_OR_NUMBER = SETFORMULA / REAL_NUMBER SETFORMULA = "(" FORMULA ")" REAL_NUMBER = DEC_REGULAR_VALUE / DEC_PURE_FLOATING DEC_REGULAR_VALUE = ["-"] DEC_NUMBER ["."] [DEC NUMBER] [DEC EXPONENT] DEC_PURE_FLOATING = ["-"] "." DEC_NUMBER [DEC EXPONENT] DEC_NUMBER = 1*DIGIT DEC_EXPONENT = ["-"] ("e" / "E") DEC_NUMBER</pre> <p>The FORMULA rule is specified by the varFormula field of the TimeAnimationValueListEntry record.</p>
stroke.weight	<p>MUST be a valid FORMULA_OR_NUMBER as specified in the following ABNF (specified in [RFC5234]) grammar:</p> <pre>FORMULA_OR_NUMBER = SETFORMULA / REAL_NUMBER SETFORMULA = "(" FORMULA ")" REAL_NUMBER = DEC_REGULAR_VALUE / DEC_PURE_FLOATING DEC_REGULAR_VALUE = ["-"] DEC_NUMBER ["."] [DEC NUMBER] [DEC EXPONENT] DEC_PURE_FLOATING = ["-"] "." DEC_NUMBER [DEC EXPONENT] DEC_NUMBER = 1*DIGIT DEC_EXPONENT = ["-"] ("e" / "E") DEC_NUMBER</pre> <p>The FORMULA rule is specified by the varFormula field of the TimeAnimationValueListEntry record.</p>
stroke.opacity	<p>MUST be a valid FORMULA_OR_NUMBER as specified in the following ABNF (specified in [RFC5234]) grammar:</p>

Attribute Name	varTo.stringValue
	<pre> FORMULA_OR_NUMBER = SETFORMULA / REAL_NUMBER SETFORMULA = "(" FORMULA ")" REAL_NUMBER = DEC_REGULAR_VALUE / DEC_PURE_FLOATING DEC_REGULAR_VALUE = ["-"] DEC_NUMBER ["."] [DEC_NUMBER] [DEC_EXPONENT] DEC_PURE_FLOATING = ["-"] "." DEC_NUMBER [DEC_EXPONENT] DEC_NUMBER = 1*DIGIT DEC_EXPONENT = ["-"] ("e" / "E") DEC_NUMBER </pre> <p>The FORMULA rule is specified by the varFormula field of the TimeAnimationValueListEntry record.</p>
stroke.imagesize.x	<p>MUST be a valid FORMULA_OR_NUMBER as specified in the following ABNF (specified in [RFC5234]) grammar:</p> <pre> FORMULA_OR_NUMBER = SETFORMULA / REAL_NUMBER SETFORMULA = "(" FORMULA ")" REAL_NUMBER = DEC_REGULAR_VALUE / DEC_PURE_FLOATING DEC_REGULAR_VALUE = ["-"] DEC_NUMBER ["."] [DEC_NUMBER] [DEC_EXPONENT] DEC_PURE_FLOATING = ["-"] "." DEC_NUMBER [DEC_EXPONENT] DEC_NUMBER = 1*DIGIT DEC_EXPONENT = ["-"] ("e" / "E") DEC_NUMBER </pre> <p>The FORMULA rule is specified by the varFormula field of the TimeAnimationValueListEntry record.</p>
stroke.imagesize.y	<p>MUST be a valid FORMULA_OR_NUMBER as specified in the following ABNF (specified in [RFC5234]) grammar:</p> <pre> FORMULA OR NUMBER = SETFORMULA / REAL NUMBER SETFORMULA = "(" FORMULA ")" REAL_NUMBER = DEC_REGULAR_VALUE / DEC_PURE_FLOATING DEC_REGULAR_VALUE = ["-"] DEC_NUMBER ["."] [DEC_NUMBER] [DEC_EXPONENT] DEC_PURE_FLOATING = ["-"] "." DEC NUMBER [DEC_EXPONENT] DEC_NUMBER = 1*DIGIT DEC_EXPONENT = ["-"] ("e" / "E") DEC_NUMBER </pre> <p>The FORMULA rule is specified by the varFormula field of the TimeAnimationValueListEntry record.</p>
shadow.opacity	<p>MUST be a valid FORMULA_OR_NUMBER as specified in the following ABNF (specified in [RFC5234]) grammar:</p> <pre> FORMULA OR NUMBER = SETFORMULA / REAL NUMBER SETFORMULA = "(" FORMULA ")" REAL_NUMBER = DEC_REGULAR_VALUE / DEC_PURE_FLOATING DEC_REGULAR_VALUE = ["-"] DEC NUMBER ["."] [DEC_NUMBER] [DEC_EXPONENT] DEC_PURE_FLOATING = ["-"] "." DEC NUMBER [DEC_EXPONENT] DEC_NUMBER = 1*DIGIT DEC_EXPONENT = ["-"] ("e" / "E") DEC_NUMBER </pre> <p>The FORMULA rule is specified by the varFormula field of the</p>

Attribute Name	varTo.stringValue
	TimeAnimationValueListEntry record.
shadow.offset.x	<p>MUST be a valid FORMULA_OR_NUMBER as specified in the following ABNF (specified in [RFC5234]) grammar:</p> <pre> FORMULA_OR_NUMBER = SETFORMULA / REAL_NUMBER SETFORMULA = "(" FORMULA ")" REAL_NUMBER = DEC_REGULAR_VALUE / DEC_PURE_FLOATING DEC_REGULAR_VALUE = ["-"] DEC_NUMBER ["."] [DEC_NUMBER] [DEC_EXPONENT] DEC_PURE_FLOATING = ["-"] "." DEC_NUMBER [DEC_EXPONENT] DEC_NUMBER = 1 * DIGIT DEC_EXPONENT = ["-"] ("e" / "E") DEC_NUMBER </pre> <p>The FORMULA rule is specified by the varFormula field of the TimeAnimationValueListEntry record.</p>
shadow.offset.y	<p>MUST be a valid FORMULA_OR_NUMBER as specified in the following ABNF (specified in [RFC5234]) grammar:</p> <pre> FORMULA_OR_NUMBER = SETFORMULA / REAL_NUMBER SETFORMULA = "(" FORMULA ")" REAL_NUMBER = DEC_REGULAR_VALUE / DEC_PURE_FLOATING DEC_REGULAR_VALUE = ["-"] DEC_NUMBER ["."] [DEC_NUMBER] [DEC_EXPONENT] DEC_PURE_FLOATING = ["-"] "." DEC_NUMBER [DEC_EXPONENT] DEC_NUMBER = 1 * DIGIT DEC_EXPONENT = ["-"] ("e" / "E") DEC_NUMBER </pre> <p>The FORMULA rule is specified by the varFormula field of the TimeAnimationValueListEntry record.</p>
shadow.offset2.x	<p>MUST be a valid FORMULA_OR_NUMBER as specified in the following ABNF (specified in [RFC5234]) grammar:</p> <pre> FORMULA_OR_NUMBER = SETFORMULA / REAL_NUMBER SETFORMULA = "(" FORMULA ")" REAL_NUMBER = DEC_REGULAR_VALUE / DEC_PURE_FLOATING DEC_REGULAR_VALUE = ["-"] DEC_NUMBER ["."] [DEC_NUMBER] [DEC_EXPONENT] DEC_PURE_FLOATING = ["-"] "." DEC_NUMBER [DEC_EXPONENT] DEC_NUMBER = 1 * DIGIT DEC_EXPONENT = ["-"] ("e" / "E") DEC_NUMBER </pre> <p>The FORMULA rule is specified by the varFormula field of the TimeAnimationValueListEntry record.</p>
shadow.offset2.y	<p>MUST be a valid FORMULA_OR_NUMBER as specified in the following ABNF (specified in [RFC5234]) grammar:</p> <pre> FORMULA_OR_NUMBER = SETFORMULA / REAL_NUMBER SETFORMULA = "(" FORMULA ")" REAL_NUMBER = DEC_REGULAR_VALUE / DEC_PURE_FLOATING DEC_REGULAR_VALUE = ["-"] DEC_NUMBER ["."] [DEC_NUMBER] [DEC_EXPONENT] DEC_PURE_FLOATING = ["-"] "." DEC_NUMBER [DEC_EXPONENT] DEC_NUMBER = 1 * DIGIT </pre>

Attribute Name	varTo.stringValue
	<pre>DEC_EXPONENT = ["-"] ("e" / "E") DEC_NUMBER</pre> <p>The FORMULA rule is specified by the varFormula field of the TimeAnimationValueListEntry record.</p>
shadow.origin.x	<p>MUST be a valid FORMULA_OR_NUMBER as specified in the following ABNF (specified in [RFC5234]) grammar:</p> <pre>FORMULA_OR_NUMBER = SETFORMULA / REAL_NUMBER SETFORMULA = "(" FORMULA ")" REAL_NUMBER = DEC_REGULAR_VALUE / DEC_PURE_FLOATING DEC_REGULAR_VALUE = ["-"] DEC_NUMBER ["."] [DEC_NUMBER] [DEC_EXPONENT] DEC_PURE_FLOATING = ["-"] "." DEC_NUMBER [DEC_EXPONENT] DEC_NUMBER = 1 * DIGIT DEC_EXPONENT = ["-"] ("e" / "E") DEC_NUMBER</pre> <p>The FORMULA rule is specified by the varFormula field of the TimeAnimationValueListEntry record.</p>
shadow.origin.y	<p>MUST be a valid FORMULA_OR_NUMBER as specified in the following ABNF (specified in [RFC5234]) grammar:</p> <pre>FORMULA_OR_NUMBER = SETFORMULA / REAL_NUMBER SETFORMULA = "(" FORMULA ")" REAL_NUMBER = DEC_REGULAR_VALUE / DEC_PURE_FLOATING DEC_REGULAR_VALUE = ["-"] DEC_NUMBER ["."] [DEC_NUMBER] [DEC_EXPONENT] DEC_PURE_FLOATING = ["-"] "." DEC_NUMBER [DEC_EXPONENT] DEC_NUMBER = 1 * DIGIT DEC_EXPONENT = ["-"] ("e" / "E") DEC_NUMBER</pre> <p>The FORMULA rule is specified by the varFormula field of the TimeAnimationValueListEntry record.</p>
shadow.matrix.xtox	<p>MUST be a valid FORMULA_OR_NUMBER as specified in the following ABNF (specified in [RFC5234]) grammar:</p> <pre>FORMULA_OR_NUMBER = SETFORMULA / REAL_NUMBER SETFORMULA = "(" FORMULA ")" REAL_NUMBER = DEC_REGULAR_VALUE / DEC_PURE_FLOATING DEC_REGULAR_VALUE = ["-"] DEC_NUMBER ["."] [DEC_NUMBER] [DEC_EXPONENT] DEC_PURE_FLOATING = ["-"] "." DEC_NUMBER [DEC_EXPONENT] DEC_NUMBER = 1 * DIGIT DEC_EXPONENT = ["-"] ("e" / "E") DEC_NUMBER</pre> <p>The FORMULA rule is specified by the varFormula field of the TimeAnimationValueListEntry record.</p>
shadow.matrix.ytox	<p>MUST be a valid FORMULA_OR_NUMBER as specified in the following ABNF (specified in [RFC5234]) grammar:</p> <pre>FORMULA_OR_NUMBER = SETFORMULA / REAL_NUMBER SETFORMULA = "(" FORMULA ")" REAL_NUMBER = DEC_REGULAR_VALUE / DEC_PURE_FLOATING DEC_REGULAR_VALUE = ["-"] DEC_NUMBER ["."]</pre>

Attribute Name	varTo.stringValue
	<pre>[DEC NUMBER] [DEC EXPONENT] DEC_PURE_FLOATING = ["-"] "." DEC_NUMBER [DEC EXPONENT] DEC_NUMBER = 1*DIGIT DEC_EXPONENT = ["-"] ("e" / "E") DEC_NUMBER</pre> <p>The FORMULA rule is specified by the varFormula field of the TimeAnimationValueListEntry record.</p>
shadow.matrix.ytoy	<p>MUST be a valid FORMULA_OR_NUMBER as specified in the following ABNF (specified in [RFC5234]) grammar:</p> <pre>FORMULA_OR_NUMBER = SETFORMULA / REAL_NUMBER SETFORMULA = "(" FORMULA ")" REAL_NUMBER = DEC_REGULAR_VALUE / DEC_PURE_FLOATING DEC_REGULAR_VALUE = ["-"] DEC_NUMBER ["."] [DEC NUMBER] [DEC EXPONENT] DEC_PURE_FLOATING = ["-"] "." DEC_NUMBER [DEC EXPONENT] DEC_NUMBER = 1*DIGIT DEC_EXPONENT = ["-"] ("e" / "E") DEC_NUMBER</pre> <p>The FORMULA rule is specified by the varFormula field of the TimeAnimationValueListEntry record.</p>
shadow.matrix.perspectiveX	<p>MUST be a valid FORMULA_OR_NUMBER as specified in the following ABNF (specified in [RFC5234]) grammar:</p> <pre>FORMULA_OR_NUMBER = SETFORMULA / REAL_NUMBER SETFORMULA = "(" FORMULA ")" REAL_NUMBER = DEC_REGULAR_VALUE / DEC_PURE_FLOATING DEC_REGULAR_VALUE = ["-"] DEC_NUMBER ["."] [DEC NUMBER] [DEC EXPONENT] DEC_PURE_FLOATING = ["-"] "." DEC_NUMBER [DEC EXPONENT] DEC_NUMBER = 1*DIGIT DEC_EXPONENT = ["-"] ("e" / "E") DEC_NUMBER</pre> <p>The FORMULA rule is specified by the varFormula field of the TimeAnimationValueListEntry record.</p>
shadow.matrix.perspectiveY	<p>MUST be a valid FORMULA_OR_NUMBER as specified in the following ABNF (specified in [RFC5234]) grammar:</p> <pre>FORMULA_OR_NUMBER = SETFORMULA / REAL_NUMBER SETFORMULA = "(" FORMULA ")" REAL_NUMBER = DEC_REGULAR_VALUE / DEC_PURE_FLOATING DEC_REGULAR_VALUE = ["-"] DEC_NUMBER ["."] [DEC NUMBER] [DEC EXPONENT] DEC_PURE_FLOATING = ["-"] "." DEC_NUMBER [DEC EXPONENT] DEC_NUMBER = 1*DIGIT DEC_EXPONENT = ["-"] ("e" / "E") DEC_NUMBER</pre> <p>The FORMULA rule is specified by the varFormula field of the TimeAnimationValueListEntry record.</p>
skew.offset.x	<p>MUST be a valid FORMULA_OR_NUMBER as specified in the following ABNF (specified in [RFC5234]) grammar:</p>

Attribute Name	varTo.stringValue
	<pre> FORMULA_OR_NUMBER = SETFORMULA / REAL_NUMBER SETFORMULA = "(" FORMULA ")" REAL_NUMBER = DEC_REGULAR_VALUE / DEC_PURE_FLOATING DEC_REGULAR_VALUE = ["-"] DEC_NUMBER ["."] [DEC_NUMBER] [DEC_EXPONENT] DEC_PURE_FLOATING = ["-"] "." DEC_NUMBER [DEC_EXPONENT] DEC_NUMBER = 1*DIGIT DEC_EXPONENT = ["-"] ("e" / "E") DEC_NUMBER </pre> <p>The FORMULA rule is specified by the varFormula field of the TimeAnimationValueListEntry record.</p>
skew.offset.y	<p>MUST be a valid FORMULA_OR_NUMBER as specified in the following ABNF (specified in [RFC5234]) grammar:</p> <pre> FORMULA_OR_NUMBER = SETFORMULA / REAL_NUMBER SETFORMULA = "(" FORMULA ")" REAL_NUMBER = DEC_REGULAR_VALUE / DEC_PURE_FLOATING DEC_REGULAR_VALUE = ["-"] DEC_NUMBER ["."] [DEC_NUMBER] [DEC_EXPONENT] DEC_PURE_FLOATING = ["-"] "." DEC_NUMBER [DEC_EXPONENT] DEC_NUMBER = 1*DIGIT DEC_EXPONENT = ["-"] ("e" / "E") DEC_NUMBER </pre> <p>The FORMULA rule is specified by the varFormula field of the TimeAnimationValueListEntry record.</p>
skew.origin.x	<p>MUST be a valid FORMULA_OR_NUMBER as specified in the following ABNF (specified in [RFC5234]) grammar:</p> <pre> FORMULA OR NUMBER = SETFORMULA / REAL NUMBER SETFORMULA = "(" FORMULA ")" REAL_NUMBER = DEC_REGULAR_VALUE / DEC_PURE_FLOATING DEC_REGULAR_VALUE = ["-"] DEC_NUMBER ["."] [DEC_NUMBER] [DEC_EXPONENT] DEC_PURE_FLOATING = ["-"] "." DEC NUMBER [DEC_EXPONENT] DEC_NUMBER = 1*DIGIT DEC_EXPONENT = ["-"] ("e" / "E") DEC_NUMBER </pre> <p>The FORMULA rule is specified by the varFormula field of the TimeAnimationValueListEntry record.</p>
skew.origin.y	<p>MUST be a valid FORMULA_OR_NUMBER as specified in the following ABNF (specified in [RFC5234]) grammar:</p> <pre> FORMULA OR NUMBER = SETFORMULA / REAL NUMBER SETFORMULA = "(" FORMULA ")" REAL_NUMBER = DEC_REGULAR_VALUE / DEC_PURE_FLOATING DEC_REGULAR_VALUE = ["-"] DEC NUMBER ["."] [DEC_NUMBER] [DEC_EXPONENT] DEC_PURE_FLOATING = ["-"] "." DEC NUMBER [DEC_EXPONENT] DEC_NUMBER = 1*DIGIT DEC_EXPONENT = ["-"] ("e" / "E") DEC_NUMBER </pre> <p>The FORMULA rule is specified by the varFormula field of the</p>

Attribute Name	varTo.stringValue
	TimeAnimationValueListEntry record.
skew.matrix.xtox	<p>MUST be a valid FORMULA_OR_NUMBER as specified in the following ABNF (specified in [RFC5234]) grammar:</p> <pre> FORMULA_OR_NUMBER = SETFORMULA / REAL_NUMBER SETFORMULA = "(" FORMULA ")" REAL_NUMBER = DEC_REGULAR_VALUE / DEC_PURE_FLOATING DEC_REGULAR_VALUE = ["-"] DEC_NUMBER ["."] [DEC_NUMBER] [DEC_EXPONENT] DEC_PURE_FLOATING = ["-"] "." DEC_NUMBER [DEC_EXPONENT] DEC_NUMBER = 1 * DIGIT DEC_EXPONENT = ["-"] ("e" / "E") DEC_NUMBER </pre> <p>The FORMULA rule is specified by the varFormula field of the TimeAnimationValueListEntry record.</p>
skew.matrix.ytox	<p>MUST be a valid FORMULA_OR_NUMBER as specified in the following ABNF (specified in [RFC5234]) grammar:</p> <pre> FORMULA_OR_NUMBER = SETFORMULA / REAL_NUMBER SETFORMULA = "(" FORMULA ")" REAL_NUMBER = DEC_REGULAR_VALUE / DEC_PURE_FLOATING DEC_REGULAR_VALUE = ["-"] DEC_NUMBER ["."] [DEC_NUMBER] [DEC_EXPONENT] DEC_PURE_FLOATING = ["-"] "." DEC_NUMBER [DEC_EXPONENT] DEC_NUMBER = 1 * DIGIT DEC_EXPONENT = ["-"] ("e" / "E") DEC_NUMBER </pre> <p>The FORMULA rule is specified by the varFormula field of the TimeAnimationValueListEntry record.</p>
skew.matrix.ytoy	<p>MUST be a valid FORMULA_OR_NUMBER as specified in the following ABNF (specified in [RFC5234]) grammar:</p> <pre> FORMULA_OR_NUMBER = SETFORMULA / REAL_NUMBER SETFORMULA = "(" FORMULA ")" REAL_NUMBER = DEC_REGULAR_VALUE / DEC_PURE_FLOATING DEC_REGULAR_VALUE = ["-"] DEC_NUMBER ["."] [DEC_NUMBER] [DEC_EXPONENT] DEC_PURE_FLOATING = ["-"] "." DEC_NUMBER [DEC_EXPONENT] DEC_NUMBER = 1 * DIGIT DEC_EXPONENT = ["-"] ("e" / "E") DEC_NUMBER </pre> <p>The FORMULA rule is specified by the varFormula field of the TimeAnimationValueListEntry record.</p>
skew.matrix.perspectiveX	<p>MUST be a valid FORMULA_OR_NUMBER as specified in the following ABNF (specified in [RFC5234]) grammar:</p> <pre> FORMULA OR NUMBER = SETFORMULA / REAL_NUMBER SETFORMULA = "(" FORMULA ")" REAL_NUMBER = DEC_REGULAR_VALUE / DEC_PURE_FLOATING DEC_REGULAR_VALUE = ["-"] DEC_NUMBER ["."] [DEC_NUMBER] [DEC_EXPONENT] DEC_PURE_FLOATING = ["-"] "." DEC_NUMBER [DEC_EXPONENT] DEC_NUMBER = 1 * DIGIT </pre>

Attribute Name	varTo.stringValue
	<p>DEC_EXPONENT = ["-"] ("e" / "E") DEC_NUMBER</p> <p>The FORMULA rule is specified by the varFormula field of the TimeAnimationValueListEntry record.</p>
skew.matrix.perspectiveY	<p>MUST be a valid FORMULA_OR_NUMBER as specified in the following ABNF (specified in [RFC5234]) grammar:</p> <pre> FORMULA_OR_NUMBER = SETFORMULA / REAL_NUMBER SETFORMULA = "(" FORMULA ")" REAL_NUMBER = DEC_REGULAR_VALUE / DEC_PURE_FLOATING DEC_REGULAR_VALUE = ["-"] DEC_NUMBER ["."] [DEC_NUMBER] [DEC_EXPONENT] DEC_PURE_FLOATING = ["-"] "." DEC_NUMBER [DEC_EXPONENT] DEC_NUMBER = 1 * DIGIT DEC_EXPONENT = ["-"] ("e" / "E") DEC_NUMBER </pre> <p>The FORMULA rule is specified by the varFormula field of the TimeAnimationValueListEntry record.</p>
extrusion.viewpointorigin.x	<p>MUST be a valid FORMULA_OR_NUMBER as specified in the following ABNF (specified in [RFC5234]) grammar:</p> <pre> FORMULA_OR_NUMBER = SETFORMULA / REAL_NUMBER SETFORMULA = "(" FORMULA ")" REAL_NUMBER = DEC_REGULAR_VALUE / DEC_PURE_FLOATING DEC_REGULAR_VALUE = ["-"] DEC_NUMBER ["."] [DEC_NUMBER] [DEC_EXPONENT] DEC_PURE_FLOATING = ["-"] "." DEC_NUMBER [DEC_EXPONENT] DEC_NUMBER = 1 * DIGIT DEC_EXPONENT = ["-"] ("e" / "E") DEC_NUMBER </pre> <p>The FORMULA rule is specified by the varFormula field of the TimeAnimationValueListEntry record.</p>
extrusion.viewpointorigin.y	<p>MUST be a valid FORMULA_OR_NUMBER as specified in the following ABNF (specified in [RFC5234]) grammar:</p> <pre> FORMULA_OR_NUMBER = SETFORMULA / REAL_NUMBER SETFORMULA = "(" FORMULA ")" REAL_NUMBER = DEC_REGULAR_VALUE / DEC_PURE_FLOATING DEC_REGULAR_VALUE = ["-"] DEC_NUMBER ["."] [DEC_NUMBER] [DEC_EXPONENT] DEC_PURE_FLOATING = ["-"] "." DEC_NUMBER [DEC_EXPONENT] DEC_NUMBER = 1 * DIGIT DEC_EXPONENT = ["-"] ("e" / "E") DEC_NUMBER </pre> <p>The FORMULA rule is specified by the varFormula field of the TimeAnimationValueListEntry record.</p>
extrusion.viewpoint.x	<p>MUST be a valid FORMULA_OR_NUMBER as specified in the following ABNF (specified in [RFC5234]) grammar:</p> <pre> FORMULA_OR_NUMBER = SETFORMULA / REAL_NUMBER SETFORMULA = "(" FORMULA ")" REAL_NUMBER = DEC_REGULAR_VALUE / DEC_PURE_FLOATING DEC_REGULAR_VALUE = ["-"] DEC_NUMBER ["."] </pre>

Attribute Name	varTo.stringValue
	<pre>[DEC NUMBER] [DEC EXPONENT] DEC_PURE_FLOATING = ["-"] "." DEC_NUMBER [DEC EXPONENT] DEC_NUMBER = 1*DIGIT DEC_EXPONENT = ["-"] ("e" / "E") DEC_NUMBER</pre> <p>The FORMULA rule is specified by the varFormula field of the TimeAnimationValueListEntry record.</p>
extrusion.viewpoint.y	<p>MUST be a valid FORMULA_OR_NUMBER as specified in the following ABNF (specified in [RFC5234]) grammar:</p> <pre>FORMULA_OR_NUMBER = SETFORMULA / REAL_NUMBER SETFORMULA = "(" FORMULA ")" REAL_NUMBER = DEC_REGULAR_VALUE / DEC_PURE_FLOATING DEC_REGULAR_VALUE = ["-"] DEC_NUMBER ["."] [DEC NUMBER] [DEC EXPONENT] DEC_PURE_FLOATING = ["-"] "." DEC_NUMBER [DEC EXPONENT] DEC_NUMBER = 1*DIGIT DEC_EXPONENT = ["-"] ("e" / "E") DEC_NUMBER</pre> <p>The FORMULA rule is specified by the varFormula field of the TimeAnimationValueListEntry record.</p>
extrusion.viewpoint.z	<p>MUST be a valid FORMULA_OR_NUMBER as specified in the following ABNF (specified in [RFC5234]) grammar:</p> <pre>FORMULA_OR_NUMBER = SETFORMULA / REAL_NUMBER SETFORMULA = "(" FORMULA ")" REAL_NUMBER = DEC_REGULAR_VALUE / DEC_PURE_FLOATING DEC_REGULAR_VALUE = ["-"] DEC_NUMBER ["."] [DEC NUMBER] [DEC EXPONENT] DEC_PURE_FLOATING = ["-"] "." DEC_NUMBER [DEC EXPONENT] DEC_NUMBER = 1*DIGIT DEC_EXPONENT = ["-"] ("e" / "E") DEC_NUMBER</pre> <p>The FORMULA rule is specified by the varFormula field of the TimeAnimationValueListEntry record.</p>
extrusion.skewangle	<p>MUST be a valid FORMULA_OR_NUMBER as specified in the following ABNF (specified in [RFC5234]) grammar:</p> <pre>FORMULA_OR_NUMBER = SETFORMULA / REAL_NUMBER SETFORMULA = "(" FORMULA ")" REAL_NUMBER = DEC_REGULAR_VALUE / DEC_PURE_FLOATING DEC_REGULAR_VALUE = ["-"] DEC_NUMBER ["."] [DEC NUMBER] [DEC EXPONENT] DEC_PURE_FLOATING = ["-"] "." DEC_NUMBER [DEC EXPONENT] DEC_NUMBER = 1*DIGIT DEC_EXPONENT = ["-"] ("e" / "E") DEC_NUMBER</pre> <p>The FORMULA rule is specified by the varFormula field of the TimeAnimationValueListEntry record.</p>
extrusion.skewamt	<p>MUST be a valid FORMULA_OR_NUMBER as specified in the following ABNF (specified in [RFC5234]) grammar:</p>

Attribute Name	varTo.stringValue
	<pre> FORMULA_OR_NUMBER = SETFORMULA / REAL_NUMBER SETFORMULA = "(" FORMULA ")" REAL_NUMBER = DEC_REGULAR_VALUE / DEC_PURE_FLOATING DEC_REGULAR_VALUE = ["-"] DEC_NUMBER ["."] [DEC_NUMBER] [DEC_EXPONENT] DEC_PURE_FLOATING = ["-"] "." DEC_NUMBER [DEC_EXPONENT] DEC_NUMBER = 1*DIGIT DEC_EXPONENT = ["-"] ("e" / "E") DEC_NUMBER </pre> <p>The FORMULA rule is specified by the varFormula field of the TimeAnimationValueListEntry record.</p>
extrusion.backdepth	<p>MUST be a valid FORMULA_OR_NUMBER as specified in the following ABNF (specified in [RFC5234]) grammar:</p> <pre> FORMULA_OR_NUMBER = SETFORMULA / REAL_NUMBER SETFORMULA = "(" FORMULA ")" REAL_NUMBER = DEC_REGULAR_VALUE / DEC_PURE_FLOATING DEC_REGULAR_VALUE = ["-"] DEC_NUMBER ["."] [DEC_NUMBER] [DEC_EXPONENT] DEC_PURE_FLOATING = ["-"] "." DEC_NUMBER [DEC_EXPONENT] DEC_NUMBER = 1*DIGIT DEC_EXPONENT = ["-"] ("e" / "E") DEC_NUMBER </pre> <p>The FORMULA rule is specified by the varFormula field of the TimeAnimationValueListEntry record.</p>
extrusion.foredepth	<p>MUST be a valid FORMULA_OR_NUMBER as specified in the following ABNF (specified in [RFC5234]) grammar:</p> <pre> FORMULA OR NUMBER = SETFORMULA / REAL NUMBER SETFORMULA = "(" FORMULA ")" REAL_NUMBER = DEC_REGULAR_VALUE / DEC_PURE_FLOATING DEC_REGULAR_VALUE = ["-"] DEC_NUMBER ["."] [DEC_NUMBER] [DEC_EXPONENT] DEC_PURE_FLOATING = ["-"] "." DEC NUMBER [DEC_EXPONENT] DEC_NUMBER = 1*DIGIT DEC_EXPONENT = ["-"] ("e" / "E") DEC_NUMBER </pre> <p>The FORMULA rule is specified by the varFormula field of the TimeAnimationValueListEntry record.</p>
extrusion.orientation.x	<p>MUST be a valid FORMULA_OR_NUMBER as specified in the following ABNF (specified in [RFC5234]) grammar:</p> <pre> FORMULA OR NUMBER = SETFORMULA / REAL NUMBER SETFORMULA = "(" FORMULA ")" REAL_NUMBER = DEC_REGULAR_VALUE / DEC_PURE_FLOATING DEC_REGULAR_VALUE = ["-"] DEC NUMBER ["."] [DEC_NUMBER] [DEC_EXPONENT] DEC_PURE_FLOATING = ["-"] "." DEC NUMBER [DEC_EXPONENT] DEC_NUMBER = 1*DIGIT DEC_EXPONENT = ["-"] ("e" / "E") DEC_NUMBER </pre> <p>The FORMULA rule is specified by the varFormula field of the</p>

Attribute Name	varTo.stringValue
	TimeAnimationValueListEntry record.
extrusion.orientation.y	<p>MUST be a valid FORMULA_OR_NUMBER as specified in the following ABNF (specified in [RFC5234]) grammar:</p> <pre> FORMULA_OR_NUMBER = SETFORMULA / REAL_NUMBER SETFORMULA = "(" FORMULA ")" REAL_NUMBER = DEC_REGULAR_VALUE / DEC_PURE_FLOATING DEC_REGULAR_VALUE = ["-"] DEC_NUMBER ["."] [DEC_NUMBER] [DEC_EXPONENT] DEC_PURE_FLOATING = ["-"] "." DEC_NUMBER [DEC_EXPONENT] DEC_NUMBER = 1 * DIGIT DEC_EXPONENT = ["-"] ("e" / "E") DEC_NUMBER </pre> <p>The FORMULA rule is specified by the varFormula field of the TimeAnimationValueListEntry record.</p>
extrusion.orientation.z	<p>MUST be a valid FORMULA_OR_NUMBER as specified in the following ABNF (specified in [RFC5234]) grammar:</p> <pre> FORMULA_OR_NUMBER = SETFORMULA / REAL_NUMBER SETFORMULA = "(" FORMULA ")" REAL_NUMBER = DEC_REGULAR_VALUE / DEC_PURE_FLOATING DEC_REGULAR_VALUE = ["-"] DEC_NUMBER ["."] [DEC_NUMBER] [DEC_EXPONENT] DEC_PURE_FLOATING = ["-"] "." DEC_NUMBER [DEC_EXPONENT] DEC_NUMBER = 1 * DIGIT DEC_EXPONENT = ["-"] ("e" / "E") DEC_NUMBER </pre> <p>The FORMULA rule is specified by the varFormula field of the TimeAnimationValueListEntry record.</p>
extrusion.orientationangle	<p>MUST be a valid FORMULA_OR_NUMBER as specified in the following ABNF (specified in [RFC5234]) grammar:</p> <pre> FORMULA_OR_NUMBER = SETFORMULA / REAL_NUMBER SETFORMULA = "(" FORMULA ")" REAL_NUMBER = DEC_REGULAR_VALUE / DEC_PURE_FLOATING DEC_REGULAR_VALUE = ["-"] DEC_NUMBER ["."] [DEC_NUMBER] [DEC_EXPONENT] DEC_PURE_FLOATING = ["-"] "." DEC_NUMBER [DEC_EXPONENT] DEC_NUMBER = 1 * DIGIT DEC_EXPONENT = ["-"] ("e" / "E") DEC_NUMBER </pre> <p>The FORMULA rule is specified by the varFormula field of the TimeAnimationValueListEntry record.</p>
extrusion.rotationangle.x	<p>MUST be a valid FORMULA_OR_NUMBER as specified in the following ABNF (specified in [RFC5234]) grammar:</p> <pre> FORMULA_OR_NUMBER = SETFORMULA / REAL_NUMBER SETFORMULA = "(" FORMULA ")" REAL_NUMBER = DEC_REGULAR_VALUE / DEC_PURE_FLOATING DEC_REGULAR_VALUE = ["-"] DEC_NUMBER ["."] [DEC_NUMBER] [DEC_EXPONENT] DEC_PURE_FLOATING = ["-"] "." DEC_NUMBER [DEC_EXPONENT] DEC_NUMBER = 1 * DIGIT </pre>

Attribute Name	varTo.stringValue
	<p>DEC_EXPONENT = ["-"] ("e" / "E") DEC_NUMBER</p> <p>The FORMULA rule is specified by the varFormula field of the TimeAnimationValueListEntry record.</p>
extrusion.rotationangle.y	<p>MUST be a valid FORMULA_OR_NUMBER as specified in the following ABNF (specified in [RFC5234]) grammar:</p> <pre> FORMULA_OR_NUMBER = SETFORMULA / REAL_NUMBER SETFORMULA = "(" FORMULA ")" REAL_NUMBER = DEC_REGULAR_VALUE / DEC_PURE_FLOATING DEC_REGULAR_VALUE = ["-"] DEC_NUMBER ["."] [DEC_NUMBER] [DEC_EXPONENT] DEC_PURE_FLOATING = ["-"] "." DEC_NUMBER [DEC_EXPONENT] DEC_NUMBER = 1 *DIGIT DEC_EXPONENT = ["-"] ("e" / "E") DEC_NUMBER </pre> <p>The FORMULA rule is specified by the varFormula field of the TimeAnimationValueListEntry record.</p>
extrusion.rotationcenter.x	<p>MUST be a valid FORMULA_OR_NUMBER as specified in the following ABNF (specified in [RFC5234]) grammar:</p> <pre> FORMULA_OR_NUMBER = SETFORMULA / REAL_NUMBER SETFORMULA = "(" FORMULA ")" REAL_NUMBER = DEC_REGULAR_VALUE / DEC_PURE_FLOATING DEC_REGULAR_VALUE = ["-"] DEC_NUMBER ["."] [DEC_NUMBER] [DEC_EXPONENT] DEC_PURE_FLOATING = ["-"] "." DEC_NUMBER [DEC_EXPONENT] DEC_NUMBER = 1 *DIGIT DEC_EXPONENT = ["-"] ("e" / "E") DEC_NUMBER </pre> <p>The FORMULA rule is specified by the varFormula field of the TimeAnimationValueListEntry record.</p>
extrusion.rotationcenter.y	<p>MUST be a valid FORMULA_OR_NUMBER as specified in the following ABNF (specified in [RFC5234]) grammar:</p> <pre> FORMULA_OR_NUMBER = SETFORMULA / REAL_NUMBER SETFORMULA = "(" FORMULA ")" REAL_NUMBER = DEC_REGULAR_VALUE / DEC_PURE_FLOATING DEC_REGULAR_VALUE = ["-"] DEC_NUMBER ["."] [DEC_NUMBER] [DEC_EXPONENT] DEC_PURE_FLOATING = ["-"] "." DEC_NUMBER [DEC_EXPONENT] DEC_NUMBER = 1 *DIGIT DEC_EXPONENT = ["-"] ("e" / "E") DEC_NUMBER </pre> <p>The FORMULA rule is specified by the varFormula field of the TimeAnimationValueListEntry record.</p>
extrusion.rotationcenter.z	<p>MUST be a valid FORMULA_OR_NUMBER as specified in the following ABNF (specified in [RFC5234]) grammar:</p> <pre> FORMULA_OR_NUMBER = SETFORMULA / REAL_NUMBER SETFORMULA = "(" FORMULA ")" REAL_NUMBER = DEC_REGULAR_VALUE / DEC_PURE_FLOATING DEC_REGULAR_VALUE = ["-"] DEC_NUMBER ["."] </pre>

Attribute Name	varTo.stringValue
	<pre data-bbox="711 184 1295 304"> [DEC NUMBER] [DEC EXPONENT] DEC_PURE_FLOATING = ["-"] "." DEC_NUMBER [DEC EXPONENT] DEC_NUMBER = 1*DIGIT DEC_EXPONENT = ["-"] ("e" / "E") DEC_NUMBER </pre> <p data-bbox="662 357 1328 405">The FORMULA rule is specified by the varFormula field of the TimeAnimationValueListEntry record.</p>

When using attribute names in the following table, the **setBehaviorAtom.valueType** field MUST be TL_TABVT_Color.

Attribute Name	varTo.stringValue
ppt_c	<p data-bbox="565 615 1369 667">MUST be a valid SETCOLOR as specified in the following ABNF (specified in [RFC5234]) grammar:</p> <pre data-bbox="613 720 987 814"> SETCOLOR = "#" RED GREEN BLUE RED = 2HEXDIG GREEN = 2HEXDIG BLUE = 2HEXDIG </pre>
fillcolor	<p data-bbox="565 873 1369 926">MUST be a valid SETCOLOR as specified in the following ABNF (specified in [RFC5234]) grammar:</p> <pre data-bbox="613 978 987 1073"> SETCOLOR = "#" RED GREEN BLUE RED = 2HEXDIG GREEN = 2HEXDIG BLUE = 2HEXDIG </pre>
style.color	<p data-bbox="565 1131 1369 1184">MUST be a valid SETCOLOR as specified in the following ABNF (specified in [RFC5234]) grammar:</p> <pre data-bbox="613 1236 987 1331"> SETCOLOR = "#" RED GREEN BLUE RED = 2HEXDIG GREEN = 2HEXDIG BLUE = 2HEXDIG </pre>
imageData.chromaKey	<p data-bbox="565 1390 1369 1442">MUST be a valid SETCOLOR as specified in the following ABNF (specified in [RFC5234]) grammar:</p> <pre data-bbox="613 1495 987 1589"> SETCOLOR = "#" RED GREEN BLUE RED = 2HEXDIG GREEN = 2HEXDIG BLUE = 2HEXDIG </pre>
fill.color	<p data-bbox="565 1648 1369 1701">MUST be a valid SETCOLOR as specified in the following ABNF (specified in [RFC5234]) grammar:</p> <pre data-bbox="613 1753 987 1806"> SETCOLOR = "#" RED GREEN BLUE RED = 2HEXDIG </pre>

Attribute Name	varTo.stringValue
	<pre>GREEN = 2HEXDIG BLUE = 2HEXDIG</pre>
fill.color2	<p>MUST be a valid SETCOLOR as specified in the following ABNF (specified in [RFC5234]) grammar:</p> <pre>SETCOLOR = "#" RED GREEN BLUE RED = 2HEXDIG GREEN = 2HEXDIG BLUE = 2HEXDIG</pre>
stroke.color	<p>MUST be a valid SETCOLOR as specified in the following ABNF (specified in [RFC5234]) grammar:</p> <pre>SETCOLOR = "#" RED GREEN BLUE RED = 2HEXDIG GREEN = 2HEXDIG BLUE = 2HEXDIG</pre>
stroke.color2	<p>MUST be a valid SETCOLOR as specified in the following ABNF (specified in [RFC5234]) grammar:</p> <pre>SETCOLOR = "#" RED GREEN BLUE RED = 2HEXDIG GREEN = 2HEXDIG BLUE = 2HEXDIG</pre>
shadow.color	<p>MUST be a valid SETCOLOR as specified in the following ABNF (specified in [RFC5234]) grammar:</p> <pre>SETCOLOR = "#" RED GREEN BLUE RED = 2HEXDIG GREEN = 2HEXDIG BLUE = 2HEXDIG</pre>
shadow.color2	<p>MUST be a valid SETCOLOR as specified in the following ABNF (specified in [RFC5234]) grammar:</p> <pre>SETCOLOR = "#" RED GREEN BLUE RED = 2HEXDIG GREEN = 2HEXDIG BLUE = 2HEXDIG</pre>
extrusion.color	<p>MUST be a valid SETCOLOR as specified in the following ABNF (specified in [RFC5234]) grammar:</p> <pre>SETCOLOR = "#" RED GREEN BLUE RED = 2HEXDIG GREEN = 2HEXDIG</pre>

Attribute Name	varTo.stringValue
	BLUE = 2HEXDIG

behavior (variable): A **TimeBehaviorContainer** record (section [2.8.34](#)) that specifies the common behavior information.

2.8.70 TimeSetBehaviorAtom

Referenced by: [TimeSetBehaviorContainer](#)

An **atom record** that specifies animation information for an object or object property.

[TimeAnimateBehaviorValueTypeEnum](#) enumeration specifies the object or object property that will be animated.

0	1	2	3	4	5	6	7	8	9	10	11	12	13	14	15	16	17	18	19	20	21	22	23	24	25	26	27	28	29	30	31
rh																															
...																															
A	B	reserved																													
valueType																															

rh (8 bytes): A **RecordHeader** structure (section [2.3.1](#)) that specifies the header for this record. Sub-fields are further specified in the following table.

Field	Meaning
rh.recVer	MUST be 0x0.
rh.recInstance	MUST be 0x000.
rh.recType	MUST be an RT_TimeSetBehavior .
rh.recLen	MUST be 0x00000008.

A - fToPropertyUsed (1 bit): A bit that specifies whether the **varTo** of the **TimeSetBehaviorContainer** record (section 2.8.69) that contains this **TimeSetBehaviorAtom** is valid.

B - fValueTypePropertyUsed (1 bit): A bit that specifies whether **valueType** was explicitly set by a user interface action.

reserved (30 bits): MUST be zero, and MUST be ignored.

valueType (4 bytes): A **TimeAnimateBehaviorValueTypeEnum** enumeration that specifies the type of object or object property to which to apply an animation. It MUST be ignored if **fValueTypePropertyUsed** is **FALSE** and a value of **TL_TABVT_Number** MUST be used instead.

2.8.71 TimeCommandBehaviorContainer

Referenced by: [ExtTimeNodeContainer](#), [SubEffectContainer](#)

A **container record** that specifies a command behavior that performs a command as an animation. There is no property to be animated in this behavior. The **behavior.stringList** field is ignored.

0	1	2	3	4	5	6	7	8	9	10	11	12	13	14	15	16	17	18	19	20	21	22	23	24	25	26	27	28	29	30	31
rh																															
...																															
commandBehaviorAtom (16 bytes)																															
...																															
...																															
varCommand (variable)																															
...																															
behavior (variable)																															
...																															

rh (8 bytes): A **RecordHeader** structure (section [2.3.1](#)) that specifies the header for this record. Subfields are further specified in the following table.

Field	Meaning
rh.recVer	MUST be 0xF.
rh.recInstance	MUST be 0x000.
rh.recType	MUST be an RT_TimeCommandBehaviorContainer .

commandBehaviorAtom (16 bytes): A [TimeCommandBehaviorAtom](#) record that specifies the property usage flag of the command behavior and the type of the command behavior.

varCommand (variable): An optional [TimeVariantString](#) record that specifies the command to be performed. It MUST be ignored if **commandBehaviorAtom.fCommandPropertyUsed** is FALSE. The **varCommand.rh.recInstance** sub-field MUST be 0x001.

When **commandBehaviorAtom.commandBehaviorType** is [TL_TCBT_Event](#), the command MUST be "onstopaudio" that specifies to stop playing of all audio.

When **commandBehaviorAtom.commandBehaviorType** is [TL_TCBT_Call](#), the command MUST be one from the following table.

Command	Meaning
play	Play corresponding media.
playFrom(s)	Play corresponding media starting from s, where s is the number of seconds from the beginning of the clip.

Command	Meaning
pause	Pause corresponding media.
resume	Resume playing of corresponding media.
stop	Stop playing of corresponding media.
togglePause	Play corresponding media if media is paused, or pause corresponding media if media is playing. If the corresponding media is not active, this command will restart the media and play from its beginning.

When **commandBehaviorAtom.commandBehaviorType** is TL_TCBT_OleVerb, the command MUST be the string representation of an integer that specifies the embedded object verb number that determines the action.

behavior (variable): A **TimeBehaviorContainer** record (section [2.8.34](#)) that specifies the common behavior information.

2.8.72 TimeCommandBehaviorAtom

Referenced by: [TimeCommandBehaviorContainer](#)

An **atom record** that specifies the information of a command that is performed as an animation.

0	1	2	3	4	5	6	7	8	9	10	11	12	13	14	15	16	17	18	19	20	21	22	23	24	25	26	27	28	29	30	31
rh																															
...																															
A	B	reserved																													
commandBehaviorType																															

rh (8 bytes): A **RecordHeader** structure (section [2.3.1](#)) that specifies the header for this record. Sub-fields are further specified in the following table.

Field	Meaning
rh.recVer	MUST be 0x0.
rh.recInstance	MUST be 0x000.
rh.recType	MUST be an RT_TimeCommandBehavior .
rh.recLen	MUST be 0x00000008.

A - fTypePropertyUsed (1 bit): A bit that specifies whether **commandBehaviorType** was explicitly set by a user interface action.

B - fCommandPropertyUsed (1 bit): A bit that specifies whether **varCommand** of the **TimeCommandBehaviorContainer** record (section 2.8.71) that contains this **TimeCommandBehaviorAtom** is valid.

reserved (30 bits): MUST be zero, and MUST be ignored.

commandBehaviorType (4 bytes): A [TimeCommandBehaviorTypeEnum](#) enumeration that specifies the type of the command. It MUST be ignored if **fTypePropertyUsed** is **FALSE** and a value of TL_TCBT_Call MUST be used instead.

2.8.73 TimeIterateDataAtom

Referenced by: [ExtTimeNodeContainer](#)

An **atom record** that specifies how an animation is applied to sub-elements of the target object for a repeated effect. It can be applied to the letters, words, or **shapes** within a target object.

0	1	2	3	4	5	6	7	8	9	10	11	12	13	14	15	16	17	18	19	20	21	22	23	24	25	26	27	28	29	30	31
rh																															
...																															
iterateInterval																															
iterateType																															
iterateDirection																															
iterateIntervalType																															
A	B	C	D	reserved																											

rh (8 bytes): A **RecordHeader** structure (section [2.3.1](#)) that specifies the header for this record. Sub-fields are further specified in the following table.

Field	Meaning
rh.recVer	MUST be 0x0.
rh.recInstance	MUST be 0x000.
rh.recType	MUST be an RT_TimeIterateData .
rh.recLen	MUST be 0x00000014.

iterateInterval (4 bytes): An unsigned integer that specifies the interval time of iterations, which can be either absolute time or a percentage as specified in **iterateIntervalType**. It MUST be ignored if **fIterateIntervalPropertyUsed** is **FALSE** and a value of 0x00000000 MUST be used instead.

iterateType (4 bytes): An unsigned integer that specifies the type of iteration behavior. It MUST be ignored if **fIterateTypePropertyUsed** is **FALSE** and a value of 0x00000000 MUST be used instead. It MUST be a value from the following table.

Value	Meaning
0x00000000	All at once: all sub-elements animate together with no interval time.
0x00000001	By word: sub-elements are words.
0x00000002	By letter: sub-elements are letters.

iterateDirection (4 bytes): An unsigned integer that specifies the direction of the iteration behavior. It MUST be ignored if **fIterateDirectionPropertyUsed** is **FALSE** and a value of 0x00000001 MUST be used instead. It MUST be a value from the following table.

Value	Meaning
0x00000000	Backwards: from the last sub-element to the first sub-element.
0x00000001	Forwards: from the first sub-element to the last sub-element.

iterateIntervalType (4 bytes): An unsigned integer that specifies the type of interval time as specified in **iterateInterval**. It MUST be ignored if **fIterateIntervalTypePropertyUsed** is **FALSE** and a value of 0x00000000 MUST be used instead. It MUST be a value from the following table.

Value	Meaning
0x00000000	Seconds: iterateInterval is absolute time in milliseconds.
0x00000001	Percentage: iterateInterval is a percentage of animation duration, in tenths of a percent.

A - fIterateDirectionPropertyUsed (1 bit): A bit that specifies whether **iterateDirection** was explicitly set by a user interface action.

B - fIterateTypePropertyUsed (1 bit): A bit that specifies whether **iterateType** was explicitly set by a user interface action.

C - fIterateIntervalPropertyUsed (1 bit): A bit that specifies whether **iterateInterval** was explicitly set by a user interface action.

D - fIterateIntervalTypePropertyUsed (1 bit): A bit that specifies whether **iterateIntervalType** was explicitly set by a user interface action.

reserved (28 bits): MUST be zero, and MUST be ignored.

2.8.74 TimeSequenceDataAtom

Referenced by: [ExtTimeNodeContainer](#)

An **atom record** that specifies sequencing information for the child nodes of a **time node**. Each child can only be activated after its prior sibling has been activated.

Let the *corresponding time node* be specified by the **ExtTimeNodeContainer** record (section 2.8.15) that contains this **TimeSequenceDataAtom** record.

Let the *corresponding next time condition list* be specified by the **rgBeginTimeCondition** field in *corresponding time node*, which specifies the **time conditions** to activate the next child time node.

0	1	2	3	4	5	6	7	8	9	10	1	2	3	4	5	6	7	8	9	20	1	2	3	4	5	6	7	8	9	30	1
rh																															
...																															
concurrency																															

nextAction			
previousAction			
reserved1			
A	B	C	reserved2

rh (8 bytes): A **RecordHeader** structure (section [2.3.1](#)) that specifies the header for this record. Sub-fields are further specified in the following table.

Field	Meaning
rh.recVer	MUST be 0x0.
rh.recInstance	MUST be 0x000.
rh.recType	MUST be an RT TimeSequenceData .
rh.recLen	MUST be 0x00000014.

concurrency (4 bytes): An **unsigned integer** that specifies the concurrency behavior of the child nodes of the *corresponding time node*. It MUST be ignored if **fConcurrencyPropertyUsed** is **FALSE** and a value of 0x00000000 MUST be used instead. It MUST be a value from the following table.

Value	Meaning
0x00000000	No concurrency: the next child is activated only after the current child ends and conditions in the <i>corresponding next time condition list</i> are met.
0x00000001	Concurrency enabled: the next child can be activated after the current child is activated and conditions in the <i>corresponding next time condition list</i> are met.

nextAction (4 bytes): An **unsigned integer** that specifies actions when traversing forward in the sequence of child nodes of the *corresponding time node*. It MUST be ignored if **fNextActionPropertyUsed** is **FALSE** and a value of 0x00000000 MUST be used instead. It MUST be a value from the following table.

Value	Meaning
0x00000000	Take no action.
0x00000001	<p>Traverse forward the current child node along the timeline to a natural end time.</p> <p>The natural end time of a child node is the time when the child node will end without interventions. If the end time is infinite, the child node will never stop. The natural end time of the child node is specified as the latest non-infinite end time of its child nodes.</p>

previousAction (4 bytes): An **unsigned integer** that specifies actions when traversing backward in the sequence of child nodes of the *corresponding time node*. It MUST be ignored if

fPreviousActionPropertyUsed is **FALSE** and a value of 0x00000000 MUST be used instead. It MUST be a value from the following table.

Value	Meaning
0x00000000	Take no action.
0x00000001	Continue backwards in the sequence until reaching a child that starts only on the next time condition as specified in the <i>corresponding next time condition list</i> .

reserved1 (4 bytes): MUST be zero, and MUST be ignored.

A - fConcurrencyPropertyUsed (1 bit): A bit that specifies whether **concurrency** was explicitly set by a user interface action.

B - fNextActionPropertyUsed (1 bit): A bit that specifies whether **nextAction** was explicitly set by a user interface action.

C - fPreviousActionPropertyUsed (1 bit): A **bit** that specifies whether **previousAction** was explicitly set by a user interface action.

reserved2 (29 bits): MUST be zero, and MUST be ignored.

2.8.75 TimeConditionContainer

Referenced by: [ExtTimeNodeContainer](#), [SubEffectContainer](#)

A **container record** that specifies a **time condition** of a **time node**.

0	1	2	3	4	5	6	7	8	9	10	11	12	13	14	15	16	17	18	19	20	21	22	23	24	25	26	27	28	29	30	31
rh																															
...																															
conditionAtom (24 bytes)																															
...																															
...																															
visualElement (variable)																															
...																															

rh (8 bytes): A **RecordHeader** structure (section [2.3.1](#)) that specifies the header for this record. Subfields are further specified in the following table.

Field	Meaning
rh.recVer	MUST be 0xF.
rh.recInstance	MUST be greater than or equal to 0x000 and less than or equal to 0x005.
rh.recType	MUST be an RT_TimeConditionContainer .

conditionAtom (24 bytes): A [TimeConditionAtom](#) record that specifies the information that is used to evaluate the time condition.

visualElement (variable): An optional **ClientVisualElementContainer** record (section [2.8.44](#)) that specifies the target object that participates in the evaluation of the time condition. It **MUST** exist if and only if **conditionAtom.triggerObject** is [TL_TOT_VisualElement](#).

2.8.76 TimeConditionAtom

Referenced by: [TimeConditionContainer](#)

An **atom record** that specifies the information used to evaluate when a condition will be true.

0	1	2	3	4	5	6	7	8	9	10	11	12	13	14	15	16	17	18	19	20	21	22	23	24	25	26	27	28	29	30	31
rh																															
...																															
triggerObject																															
triggerEvent																															
id																															
delay																															

rh (8 bytes): A **RecordHeader** structure (section [2.3.1](#)) that specifies the header for this record. Sub-fields are further specified in the following table.

Field	Meaning
rh.recVer	MUST be 0x0.
rh.recInstance	MUST be 0x000.
rh.recType	MUST be an RT_TimeCondition .
rh.recLen	MUST be 0x00000010.

triggerObject (4 bytes): A [TriggerObjectEnum](#) enumeration that specifies the type of target that participates in the evaluation of the condition.

triggerEvent (4 bytes): An unsigned integer that specifies the event that causes the condition to be **TRUE**. It **MUST** be a value from the following table.

Value	Meaning
0x00000000	None.
0x00000001	OnBegin event that occurs on the specified target.
0x00000003	Start of the time node that is specified by id .
0x00000004	End of the time node that is specified by id .
0x00000005	Mouse click.
0x00000007	Mouse over.

Value	Meaning
0x00000009	OnNext event that occurs on the specified target.
0x0000000A	OnPrev event that occurs on the specified target.
0x0000000B	Stop audio event that occurs when an "onstopaudio" command is fired.

id (4 bytes): An unsigned integer that specifies the target that participates in the evaluation of the condition.

When **triggerObject** is TL_TOT_TimeNode, this field specifies the time node identifier.

When **triggerObject** is TL_TOT_RuntimeNodeRef, this field MUST be 0x00000002 that specifies that all child time node of the **ExtTimeNodeContainer** record (section [2.8.15](#)) or **SubEffectContainer** record (section [2.8.16](#)) that contains this record are the target.

delay (4 bytes): A signed integer that specifies the offset time, in milliseconds, that sets when the condition will become **TRUE**.

2.8.77 TimeModifierAtom

Referenced by: [ExtTimeNodeContainer](#), [SubEffectContainer](#)

An **atom record** that specifies the type of data to be modified and the new data value.

0	1	2	3	4	5	6	7	8	9	10	11	12	13	14	15	16	17	18	19	20	21	22	23	24	25	26	27	28	29	30	31
rh																															
...																															
type																															
value																															

rh (8 bytes): A **RecordHeader** structure (section [2.3.1](#)) that specifies the header for this record. Sub-fields are further specified in the following table.

Field	Meaning
rh.recVer	MUST be 0x0.
rh.recType	MUST be RT_TimeModifier .
rh.recLen	MUST be 0x00000008.

type (4 bytes): An **unsigned integer** that specifies the type of data to be modified. It MUST be a value from the following table.

Value	Meaning
0x00000000	Repeat count.
0x00000001	Repeat duration.
0x00000002	Speed.
0x00000003	Accelerate.

Value	Meaning
0x00000004	Decelerate.
0x00000005	Automatic reverse.

value (4 bytes): An **unsigned integer** that specifies the new value.

2.8.78 TimeVariant

Referenced by: [TimeAnimationValueListEntry](#)

A variable type record whose type and meaning are dictated by the value of the **type** field of any of these four structures, as specified by the following table.

Value	Meaning
TL_TVT_Bool	A TimeVariantBool record that specifies a Boolean value.
TL_TVT_Int	A TimeVariantInt that specifies an integer value.
TL_TVT_Float	A TimeVariantFloat record that specifies a floating-point number .
TL_TVT_String	A TimeVariantString record that specifies a string.

2.8.79 TimeVariantBool

Referenced by: [TimeVariant](#), [TimeVariant4Behavior](#), [TimeVariant4TimeNode](#)

An **atom record** that specifies a Boolean value.

0	1	2	3	4	5	6	7	8	9	10	11	12	13	14	15	16	17	18	19	20	21	22	23	24	25	26	27	28	29	30	31
rh																															
...																															
type																boolValue															

rh (8 bytes): A **RecordHeader** structure (section [2.3.1](#)) that specifies the header for this record. Sub-fields are further specified in the following table.

Field	Meaning
rh.recVer	MUST be 0x0.
rh.recType	MUST be an RT_TimeVariant .
rh.recLen	MUST be 0x00000002.

type (1 byte): A [TimeVariantTypeEnum](#) enumeration that specifies the data type of this record. It MUST be TL_TVT_Bool.

boolValue (1 byte): A **bool1** (section [2.2.2](#)) that specifies the value.

2.8.80 TimeVariantInt

Referenced by: [TimeMotionBehaviorContainer](#), [TimeVariant](#), [TimeVariant4TimeNode](#)

An **atom record** that specifies a signed integer value.

0	1	2	3	4	5	6	7	8	9	10	11	12	13	14	15	16	17	18	19	20	21	22	23	24	25	26	27	28	29	30	31
rh																															
...																															
type																intValue															
...																															

rh (8 bytes): A **RecordHeader** structure (section [2.3.1](#)) that specifies the header for this record. Sub-fields are further specified in the following table.

Field	Meaning
rh.recVer	MUST be 0x0.
rh.recType	MUST be an RT_TimeVariant .
rh.recLen	MUST be 0x00000005.

type (1 byte): A [TimeVariantTypeEnum](#) enumeration that specifies the data type of this record. It MUST be TL_TVT_Int.

intValue (4 bytes): A signed integer that specifies the value.

2.8.81 TimeVariantFloat

Referenced by: [TimeEffectBehaviorContainer](#), [TimeVariant](#), [TimeVariant4Behavior](#), [TimeVariant4TimeNode](#)

An **atom record** that specifies a **floating-point number**.

0	1	2	3	4	5	6	7	8	9	10	11	12	13	14	15	16	17	18	19	20	21	22	23	24	25	26	27	28	29	30	31
rh																															
...																															
type																floatValue															
...																															

rh (8 bytes): A **RecordHeader** structure (section [2.3.1](#)) that specifies the header for this record. Sub-fields are further specified in the following table.

Field	Meaning
rh.recVer	MUST be 0x0.
rh.recType	MUST be an RT_TimeVariant .
rh.recLen	MUST be 0x00000005.

type (1 byte): A [TimeVariantTypeEnum](#) enumeration that specifies the data type of this record. It MUST be TL_TVT_Float.

floatValue (4 bytes): A floating-point number that specifies the value.

2.8.82 TimeVariantString

Referenced by: [TimeAnimateBehaviorContainer](#), [TimeAnimationValueListEntry](#), [TimeCommandBehaviorContainer](#), [TimeEffectBehaviorContainer](#), [TimeMotionBehaviorContainer](#), [TimeSetBehaviorContainer](#), [TimeStringListContainer](#), [TimeVariant](#), [TimeVariant4Behavior](#)

An **atom record** that specifies a Unicode string.

0	1	2	3	4	5	6	7	8	9	10	11	12	13	14	15	16	17	18	19	20	21	22	23	24	25	26	27	28	29	30	31
rh																															
...																															
type																stringValue (variable)															
...																															

rh (8 bytes): A [RecordHeader](#) structure that specifies the header for this record. Sub-fields are further specified in the following table.

Field	Meaning
rh.recVer	MUST be 0x0.
rh.recType	MUST be an RT_TimeVariant .
rh.recLen	MUST be an odd number.

type (1 byte): A [TimeVariantTypeEnum](#) enumeration that specifies the data type of this record. It MUST be TL_TVT_String.

stringValue (variable): A [UnicodeString](#) that specifies the value. The length, in bytes, of the field is specified by the following formula:

$$\text{rh.recLen} - 1.$$

2.9 Text Types

2.9.1 DocumentTextInfoContainer

Referenced by: [DocumentContainer](#)

A **container record** that specifies default settings and user preferences for text.

0	1	2	3	4	5	6	7	8	9	10	1	2	3	4	5	6	7	8	9	20	1	2	3	4	5	6	7	8	9	30	1
rh																															
...																															
kinsoku (variable)																															
...																															
fontCollection (variable)																															
...																															
textCFDefaultsAtom (variable)																															
...																															
textPFDefaultsAtom (variable)																															
...																															
defaultRulerAtom (variable)																															
...																															
textSIDefaultsAtom (variable)																															
...																															
textMasterStyleAtom (variable)																															
...																															

rh (8 bytes): A **RecordHeader** structure (section [2.3.1](#)) that specifies the header for this record. Sub-fields are further specified in the following table.

Field	Meaning
rh.recVer	MUST be 0xF.
rh.recInstance	MUST be 0x000.
rh.recType	MUST be an RT Environment .

kinsoku (variable): An optional **KinsokuContainer** record (section [2.9.2](#)) that specifies the user preferences for East Asian text line breaking settings.

fontCollection (variable): An optional **FontCollectionContainer** record (section [2.9.8](#)) that specifies the collection of fonts used.

textCFDefaultsAtom (variable): An optional [TextCFExceptionAtom](#) record that specifies default settings for character-level style and formatting.

textPFDefaultsAtom (variable): An optional [TextPFExceptionAtom](#) record that specifies default settings for paragraph-level style and formatting.

defaultRulerAtom (variable): An optional [DefaultRulerAtom](#) record that specifies the default ruler and corresponding options.

textSISDefaultsAtom (variable): A [TextSIExceptionAtom](#) record that specifies default settings for language and spelling information.

textMasterStyleAtom (variable): A [TextMasterStyleAtom](#) record that specifies the character-level and paragraph-level formatting of a **main master slide**.

2.9.2 KinsokuContainer

Referenced by: [DocumentTextInfoContainer](#)

A **container record** that specifies user preferences for East Asian text line breaking settings.

0	1	2	3	4	5	6	7	8	9	10	1	2	3	4	5	6	7	8	9	20	1	2	3	4	5	6	7	8	9	30	1
rh																															
...																															
kinsokuAtom																															
...																															
...																															
kinsokuLeadingAtom (variable)																															
...																															
kinsokuFollowingAtom (variable)																															
...																															

rh (8 bytes): A **RecordHeader** structure (section [2.3.1](#)) that specifies the header for this record. Sub-fields are further specified in the following table.

Field	Meaning
rh.recVer	MUST be 0xF.
rh.recInstance	MUST be 0x002.
rh.recType	MUST be an RT_Kinsoku .

kinsokuAtom (12 bytes): A [KinsokuAtom](#) record that specifies the type of East Asian text line breaking settings.

kinsokuLeadingAtom (variable): An optional [KinsokuLeadingAtom](#) record that specifies a list of characters that cannot appear immediately after a line break of East Asian text. It MUST exist if and only if **kinsokuAtom.level** is 0x00000002. If this field exists and the document contains a **Kinsoku9Container** record (section [2.9.6](#)), the **Kinsoku9Container** record MUST NOT contain a **kinsokuLeadingAtom** field.

kinsokuFollowingAtom (variable): An optional [KinsokuFollowingAtom](#) record that specifies a list of characters that cannot appear immediately before a line break of East Asian text. It MUST exist if and only if **kinsokuAtom.level** is 0x00000002. If this field exists and the document contains a **Kinsoku9Container** record, the **Kinsoku9Container** record MUST NOT contain a **kinsokuFollowingAtom** field.

2.9.3 KinsokuAtom

Referenced by: [KinsokuContainer](#)

An **atom record** that specifies the type of East Asian text line breaking.

0	1	2	3	4	5	6	7	8	9	10	11	12	13	14	15	16	17	18	19	20	21	22	23	24	25	26	27	28	29	30	31
rh																															
...																															
level																															

rh (8 bytes): A **RecordHeader** structure (section [2.3.1](#)) that specifies the header for this record. Sub-fields are further specified in the following table.

Field	Meaning
rh.recVer	MUST be 0x0.
rh.recInstance	MUST be 0x003.
rh.recType	MUST be an RT_KinsokuAtom .
rh.recLen	MUST be 0x00000004.

level (4 bytes): A signed integer that specifies the type of East Asian text line breaking. It MUST be a value from the following table.

Value	Meaning
0x00000000	Use standard line breaking settings.
0x00000001	Use strict line breaking settings for Japanese text.
0x00000002	Use the customized line breaking settings specified by the kinsokuLeadingAtom and kinsokuFollowingAtom fields of the KinsokuContainer (section 2.9.2) that contains this KinsokuAtom .

2.9.4 KinsokuLeadingAtom

Referenced by: [Kinsoku9Container](#), [KinsokuContainer](#)

An **atom record** that specifies a list of characters that cannot appear immediately after a line break of East Asian text.

0	1	2	3	4	5	6	7	8	9	10	11	12	13	14	15	16	17	18	19	20	21	22	23	24	25	26	27	28	29	30	31
rh																															
...																															
kinsokuLeading (variable)																															
...																															

rh (8 bytes): A **RecordHeader** structure (section [2.3.1](#)) that specifies the header for this record. Sub-fields are further specified in the following table.

Field	Meaning
rh.recVer	MUST be 0x0.
rh.recInstance	MUST be 0x000.
rh.recType	MUST be an RT_CString (section 2.13.24).
rh.recLen	MUST be an even number

kinsokuLeading (variable): An array of **UTF-16 Unicode** [\[RFC2781\]](#) characters that specifies the list of characters.

2.9.5 KinsokuFollowingAtom

Referenced by: [Kinsoku9Container](#), [KinsokuContainer](#)

An **atom record** that specifies a list of characters that cannot appear immediately before a line break of East Asian text.

0	1	2	3	4	5	6	7	8	9	10	11	12	13	14	15	16	17	18	19	20	21	22	23	24	25	26	27	28	29	30	31
rh																															
...																															
kinsokuFollowing (variable)																															
...																															

rh (8 bytes): A **RecordHeader** structure (section [2.3.1](#)) that specifies the header for this record. Sub-fields are further specified in the following table.

Field	Meaning
rh.recVer	MUST be 0x0.
rh.recInstance	MUST be 0x001.
rh.recType	MUST be an RT_CString (section 2.13.24).
rh.recLen	MUST be an even number

kinsokuFollowing (variable): An array of **UTF-16 Unicode** [\[RFC2781\]](#) characters that specifies the list of characters.

2.9.6 Kinsoku9Container

Referenced by: [PP9DocBinaryTagExtension](#)

A **container record** that specifies the user preferences for East Asian text line break settings for the following languages: Japanese, Korean, Simplified Chinese and Traditional Chinese.

0	1	2	3	4	5	6	7	8	9	10	11	12	13	14	15	16	17	18	19	20	21	22	23	24	25	26	27	28	29	30	31
rh																															
...																															
kinsoku9Atom																															
...																															
...																															
kinsokuLeadingAtom (variable)																															
...																															
kinsokuFollowingAtom (variable)																															
...																															

rh (8 bytes): A **RecordHeader** structure (section [2.3.1](#)) that specifies the header for this record. Sub-fields are further specified in the following table.

Field	Meaning
rh.recVer	MUST be 0xF.
rh.recInstance	MUST be 0x002.
rh.recType	MUST be an RT_Kinsoku .

kinsoku9Atom (12 bytes): A [Kinsoku9Atom](#) record that specifies the types of East Asian text line breaking for the following languages: Japanese, Korean, Simplified Chinese and Traditional Chinese. This field takes precedence over the settings specified by the **kinsokuAtom** field of the **KinsokuContainer** record (section [2.9.2](#)) in the document. At most one of the following sub-fields MUST be set to 0x00000002: **kinsoku9Atom.korLevel**, **kinsoku9Atom.scLevel**, **kinsoku9Atom.tcLevel**, or **kinsoku9Atom.jpnLevel**.

kinsokuLeadingAtom (variable): An optional [KinsokuLeadingAtom](#) record that specifies a list of characters that cannot appear immediately after a line break of East Asian text. It MUST exist if and only if the **kinsokuLeadingAtom** field of the **KinsokuContainer** record does not exist and one of **kinsoku9Atom.korLevel**, **kinsoku9Atom.scLevel**, **kinsoku9Atom.tcLevel**, or **kinsoku9Atom.jpnLevel** is 0x00000002.

kinsokuFollowingAtom (variable): An optional [KinsokuFollowingAtom](#) record that specifies a list of characters that cannot appear immediately before a line break of East Asian text. It MUST exist if and only if the **kinsokuFollowingAtom** field of the **KinsokuContainer** record does not exist and one of **kinsoku9Atom.korLevel**, **kinsoku9Atom.scLevel**, **kinsoku9Atom.tcLevel**, or **kinsoku9Atom.jpnLevel** is 0x00000002.

2.9.7 Kinsoku9Atom

Referenced by: [Kinsoku9Container](#)

An **atom record** that specifies information about the types of East Asian text line breaking for the following languages: Japanese, Korean, Simplified Chinese and Traditional Chinese.

0	1	2	3	4	5	6	7	8	9	10	11	12	13	14	15	16	17	18	19	20	21	22	23	24	25	26	27	28	29	30	31
rh																															
...																															
A	B	C	D	reserved																											

rh (8 bytes): A **RecordHeader** structure (section [2.3.1](#)) that specifies the header for this record. Sub-fields are further specified in the following table.

Field	Meaning
rh.recVer	MUST be 0x0.
rh.recInstance	MUST be 0x003.
rh.recType	MUST be an RT_KinsokuAtom .
rh.recLen	MUST be 0x00000004.

A - korLevel (2 bits): An **unsigned integer** that specifies the type of East Asian text line breaking applied to Korean text. It MUST be a value from the following table:

Value	Meaning
0x00000000	Use standard line breaking settings.
0x00000002	Use the customized line breaking settings specified by the KinsokuLeadingAtom and KinsokuFollowingAtom records contained in either the KinsokuContainer (section 2.9.2) or Kinsoku9Container record (section 2.9.6).

B - scLevel (2 bits): An **unsigned integer** that specifies the type of East Asian text line breaking applied to Simplified Chinese text. It MUST be a value from the following table.

Value	Meaning
0x00000000	Use standard line breaking settings.
0x00000002	Use the customized line breaking settings specified by the KinsokuLeadingAtom and KinsokuFollowingAtom records contained in either the KinsokuContainer or Kinsoku9Container record.

C - tcLevel (2 bits): An **unsigned integer** that specifies the type of East Asian text line breaking applied to Traditional Chinese text. It **MUST** be a value from the following table.

Value	Meaning
0x00000000	Use standard line breaking settings.
0x00000002	Use the customized line breaking settings specified by the KinsokuLeadingAtom and KinsokuFollowingAtom records contained in either the KinsokuContainer or Kinsoku9Container record.

D - jpnLevel (2 bits): An **unsigned integer** that specifies the type of East Asian text line breaking applied to Japanese text. It **MUST** be a value from the following table.

Value	Meaning
0x00000000	Use standard line breaking settings.
0x00000001	Use strict line breaking settings.
0x00000002	Use the customized line breaking settings specified by the KinsokuLeadingAtom and KinsokuFollowingAtom records contained in either the KinsokuContainer or Kinsoku9Container record.

reserved (24 bits): **MUST** be zero and **MUST** be ignored.

2.9.8 FontCollectionContainer

Referenced by: [DocumentTextInfoContainer](#)

A **container record** that specifies information about fonts in the **presentation**.

0	1	2	3	4	5	6	7	8	9	10	11	12	13	14	15	16	17	18	19	20	21	22	23	24	25	26	27	28	29	30	31
rh																															
...																															
rgFontCollectionEntry (variable)																															
...																															

rh (8 bytes): A **RecordHeader** structure (section [2.3.1](#)) that specifies the header for this record. Sub-fields are further specified in the following table.

Field	Meaning
rh.recVer	MUST be 0xF.
rh.recInstance	MUST be 0x000.
rh.recType	MUST be an RT_FontCollection .

rgFontCollectionEntry (variable): An array of [FontCollectionEntry](#) structures that specifies information about the fonts. The size, in bytes, of the array is specified by **rh.recLen**.

2.9.9 FontCollectionEntry

Referenced by: [FontCollection10Container](#), [FontCollectionContainer](#)

A structure that specifies information about a font contained in the **presentation**.

0	1	2	3	4	5	6	7	8	9	10	11	12	13	14	15	16	17	18	19	20	21	22	23	24	25	26	27	28	29	30	31
fontEntityAtom (76 bytes)																															
...																															
...																															
fontEmbedData1 (variable)																															
...																															
fontEmbedData2 (variable)																															
...																															
fontEmbedData3 (variable)																															
...																															
fontEmbedData4 (variable)																															
...																															

fontEntityAtom (76 bytes): A [FontEntityAtom](#) record that specifies the required attributes of the font.

fontEmbedData1 (variable): An optional [FontEmbedDataBlob](#) record that specifies the plain style data of an embedded font.

fontEmbedData2 (variable): An optional FontEmbedDataBlob record that specifies the bold style data of an embedded font.

fontEmbedData3 (variable): An optional FontEmbedDataBlob record that specifies the italic style data of an embedded font.

fontEmbedData4 (variable): An optional FontEmbedDataBlob record that specifies the bold and italic style data of an embedded font.

2.9.10 FontEntityAtom

Referenced by: [FontCollectionEntry](#)

An **atom record** that specifies the information needed to define the attributes of a font, such as typeface name, character set, and so on, and corresponds in part to a Windows Logical Font (**LOGFONT**) structure [\[MC-LOGFONT\]](#).

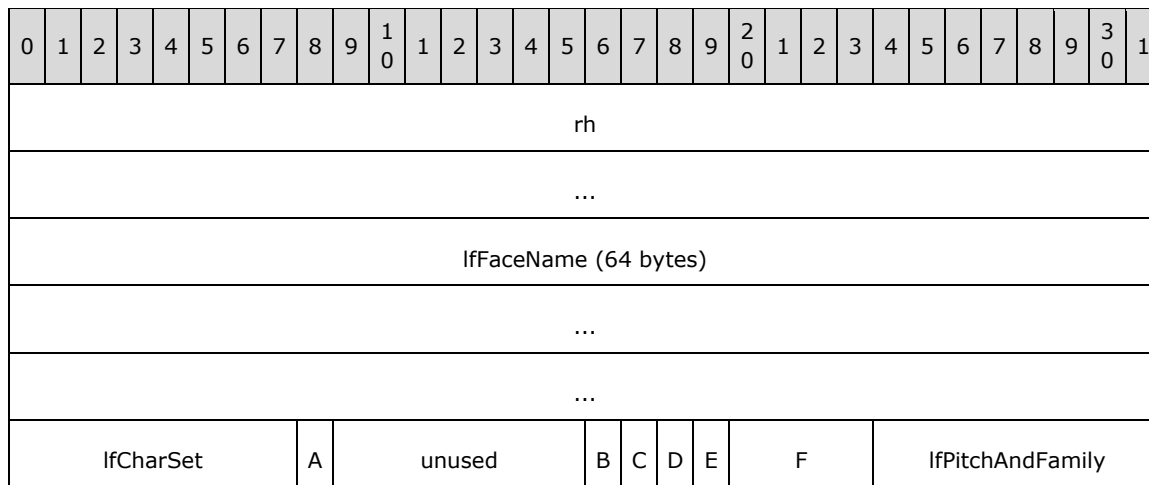

rh (8 bytes): A **RecordHeader** structure (section [2.3.1](#)) that specifies the header for this record. Sub-fields are further specified in the following table.

Field	Meaning
rh.recVer	MUST be 0x0.
rh.recInstance	MUST be greater than or equal to 0 and less than or equal to 128.
rh.recType	MUST be an RT_FontEntityAtom .
rh.recLen	MUST be equal to 0x00000044.

IfFaceName (64 bytes): A [char2](#) that specifies the typeface name of the font. It corresponds to the **IfFaceName** field of the **LOGFONT** structure. The length of this string MUST NOT exceed 32 characters, including the terminating **null** character.

IfCharSet (1 byte): An unsigned byte that specifies the character set. It corresponds to the **IfCharSet** field of the **LOGFONT** structure.

A - fEmbedSubsetting (1 bit): A bit that specifies whether a subset of this font is embedded.

unused (7 bits): Undefined and MUST be ignored.

B - rasterFontType (1 bit): A bit that specifies whether the font is a raster font.

C - deviceFontType (1 bit): A bit that specifies whether the font is a device font.

D - truetypeFontType (1 bit): A bit that specifies whether the font is a TrueType font.

E - fNoFontSubstitution (1 bit): A bit that specifies whether font substitution logic is not applied for this font.

F - reserved (4 bits): MUST be zero and MUST be ignored.

IfPitchAndFamily (1 byte): An unsigned byte that specifies the pitch and family of the font. It corresponds to the **IfPitchAndFamily** field of the **LOGFONT** structure.

2.9.11 FontCollection10Container

Referenced by: [PP10DocBinaryTagExtension](#)

A **container record** that specifies information about fonts in the presentation for international support.

0	1	2	3	4	5	6	7	8	9	10	11	12	13	14	15	16	17	18	19	20	21	22	23	24	25	26	27	28	29	30	31
rh																															
...																															
rgFontCollectionEntry (variable)																															
...																															

rh (8 bytes): A **RecordHeader** structure (section [2.3.1](#)) that specifies the header for this record. Sub-fields are further specified in the following table.

Field	Meaning
rh.recVer	MUST be 0xF.
rh.recInstance	MUST be 0x000.
rh.recType	MUST be RT_FontCollection10 .

rgFontCollectionEntry (variable): An array of [FontCollectionEntry](#) structures that specifies information about the fonts. The size, in bytes, of the array is specified by **rh.recLen**.

2.9.12 FontEmbedFlags10Atom

Referenced by: [PP10DocBinaryTagExtension](#)

An **atom record** that specifies information about how font data is embedded.

0	1	2	3	4	5	6	7	8	9	10	11	12	13	14	15	16	17	18	19	20	21	22	23	24	25	26	27	28	29	30	31
rh																															
...																															
A	B	unused																													

rh (8 bytes): A **RecordHeader** structure (section [2.3.1](#)) that specifies the header for this record. Sub-fields are further specified in the following table.

Field	Meaning
rh.recVer	MUST be 0x0.
rh.recInstance	MUST be 0x000.
rh.recType	MUST be an RT_FontEmbedFlags10Atom .
rh.recLen	MUST be 0x00000004.

A - fSubset (1 bit): A bit that specifies whether embedded fonts contain data for only those characters in use.

B - fSubsetOptionConfirmed (1 bit): A bit that specifies whether the user has confirmed the choice of **fSubset** in the user interface.

unused (30 bits): Undefined and MUST be ignored.

2.9.13 TextCFExceptionAtom

Referenced by: [DocumentTextInfoContainer](#)

An **atom record** that specifies character-level style and formatting.

0	1	2	3	4	5	6	7	8	9	10	11	12	13	14	15	16	17	18	19	20	21	22	23	24	25	26	27	28	29	30	31
rh																															
...																															
cf (variable)																															
...																															

rh (8 bytes): A **RecordHeader** structure (section [2.3.1](#)) that specifies the header for this record. Sub-fields are further specified in the following table.

Field	Meaning
rh.recVer	MUST be 0x0.
rh.recInstance	MUST be 0x000.
rh.recType	MUST be an RT_TextCharFormatExceptionAtom .

cf (variable): A [TextCFException](#) structure that specifies character-level style and formatting.

2.9.14 TextCFException

Referenced by: [TextCFExceptionAtom](#), [TextCFRun](#), [TextMasterStyleLevel](#)

A structure that specifies character-level style and formatting, font information, coloring and positioning.

0	1	2	3	4	5	6	7	8	9	10	11	12	13	14	15	16	17	18	19	20	21	22	23	24	25	26	27	28	29	30	31
masks																															
fontStyle (optional)																fontRef (optional)															
oldEAFontRef (optional)																ansiFontRef (optional)															
symbolFontRef (optional)																fontSize (optional)															

color (optional)	
position (optional)	

masks (4 bytes): A [CFMasks](#) structure that specifies whether certain fields in this **TextCFException** record exist and are valid. Sub-fields are further specified in the following table.

Field	Meaning
masks.pp10ext	MUST be zero.
masks.newEATypeface	MUST be zero.
masks.csTypeface	MUST be zero.
masks.pp11ext	MUST be zero.

fontStyle (2 bytes): A [CFStyle](#) structure that specifies the character-level style. It MUST exist if and only if one or more of the following fields are **TRUE**: **masks.bold**, **masks.italic**, **masks.underline**, **masks.shadow**, **masks.fehint**, **masks.kumi**, **masks.emboss**, or **masks.fHasStyle**.

fontRef (2 bytes): An optional [FontIndexRef](#) that specifies the font. It MUST exist if and only if **masks.typeface** is **TRUE**.

oldEAFontRef (2 bytes): An optional [FontIndexRef](#) that specifies an East Asian font. It MUST exist if and only if **masks.oldEATypeface** is **TRUE**.

ansiFontRef (2 bytes): An optional [FontIndexRef](#) that specifies an ANSI font. It MUST exist if and only if **masks.ansiTypeface** is **TRUE**.

symbolFontRef (2 bytes): An optional [FontIndexRef](#) that specifies a symbol font. It MUST exist if and only if **masks.symbolTypeface** is **TRUE**.

fontSize (2 bytes): An optional signed integer that specifies the size, in points, of the font. It MUST be greater than or equal to 1 and less than or equal to 4000. It MUST exist if and only if **masks.size** is **TRUE**.

color (4 bytes): An optional [ColorIndexStruct](#) structure that specifies the color of the text. It MUST exist if and only if **masks.color** is **TRUE**.

position (2 bytes): An optional **signed integer** that specifies the baseline position of a text run relative to the baseline of the text line as a percentage of line height. It MUST be greater than or equal to -100 and less than or equal to 100. It MUST exist if and only if **masks.position** is **TRUE**.

2.9.15 CFMasks

Referenced by: [TextCFException](#), [TextCFException10](#), [TextCFException9](#)

A structure that specifies character-level font, text-formatting, and extensibility options.

0	1	2	3	4	5	6	7	8	9	10	11	12	13	14	15	16	17	18	19	20	21	22	23	24	25	26	27	28	29	30	31
A	B	C	D	E	F	G	H	I	J	K			L	M	N	O	P	Q	R	S	T	U	V	W	reserved						

A - bold (1 bit): A bit that specifies whether the **fontStyle.bold** field of the **TextCFException** structure that contains this **CFMasks** is valid.

- B - italic (1 bit):** A bit that specifies whether the **fontStyle.italic** field of the TextCFException structure that contains this CFMasks is valid.
- C - underline (1 bit):** A bit that specifies whether the **fontStyle.underline** field of the TextCFException structure that contains this CFMasks is valid.
- D - unused1 (1 bit):** Undefined and MUST be ignored.
- E - shadow (1 bit):** A bit that specifies whether the **fontStyle.shadow** field of the TextCFException structure that contains this CFMasks is valid.
- F - fehint (1 bit):** A bit that specifies whether the **fontStyle.fehint** field of the TextCFException structure that contains this CFMasks is valid.
- G - unused2 (1 bit):** Undefined and MUST be ignored.
- H - kumi (1 bit):** A bit that specifies whether the **fontStyle.kumi** field of the TextCFException structure that contains this CFMasks is valid.
- I - unused3 (1 bit):** Undefined and MUST be ignored.
- J - emboss (1 bit):** A bit that specifies whether the **fontStyle.emboss** field of the TextCFException structure that contains this CFMasks is valid.
- K - fHasStyle (4 bits):** An unsigned integer that specifies whether the **fontStyle** field of the TextCFException structure that contains this CFMasks exists.
- L - unused4 (2 bits):** Undefined and MUST be ignored.
- M - typeface (1 bit):** A bit that specifies whether the **fontRef** field of the TextCFException structure that contains this CFMasks exists.
- N - size (1 bit):** A bit that specifies whether the **fontSize** field of the TextCFException structure that contains this CFMasks exists.
- O - color (1 bit):** A bit that specifies whether the **color** field of the TextCFException structure that contains this CFMasks exists.
- P - position (1 bit):** A bit that specifies whether the **position** field of the TextCFException structure that contains this CFMasks exists.
- Q - pp10ext (1 bit):** A bit that specifies whether the **pp10runid** and **unused** fields of the TextCFException9 structure that contains this CFMasks exist.
- R - oldEATypeface (1 bit):** A bit that specifies whether the **oldEAFontRef** field of the TextCFException structure that contains this CFMasks exists.
- S - ansiTypeface (1 bit):** A bit that specifies whether the **ansiFontRef** field of the TextCFException structure that contains this CFMasks exists.
- T - symbolTypeface (1 bit):** A bit that specifies whether the **symbolFontRef** field of the TextCFException structure that contains this CFMasks exists.
- U - newEATypeface (1 bit):** A bit that specifies whether the **newEAFontRef** field of the TextCFException10 structure that contains this CFMasks exists.
- V - csTypeface (1 bit):** A bit that specifies whether the **csFontRef** field of the TextCFException10 structure that contains this CFMasks exists.
- W - pp11ext (1 bit):** A bit that specifies whether the **pp11ext** field of the TextCFException10 structure that contains this CFMasks exists.

reserved (5 bits): MUST be zero and MUST be ignored.

2.9.16 CFStyle

Referenced by: [TextCFException](#)

A structure that specifies character-level text formatting.

0	1	2	3	4	5	6	7	8	9	10	11	12	13	14	15	16	17	18	19	20	21	22	23	24	25	26	27	28	29	30	31
A	B	C	D	E	F	G	H	I	J	pp9rt				K																	

A - bold (1 bit): A bit that specifies whether the characters are bold.

B - italic (1 bit): A bit that specifies whether the characters are italicized.

C - underline (1 bit): A bit that specifies whether the characters are underlined.

D - unused1 (1 bit): Undefined and MUST be ignored.

E - shadow (1 bit): A bit that specifies whether the characters have a shadow effect.

F - fehint (1 bit): A bit that specifies whether characters originated from double-byte input.

G - unused2 (1 bit): Undefined and MUST be ignored.

H - kumi (1 bit): A bit that specifies whether Kumimoji are used for vertical text.

I - unused3 (1 bit): Undefined and MUST be ignored.

J - emboss (1 bit): A bit that specifies whether the characters are embossed.

pp9rt (4 bits): An unsigned integer that specifies the run grouping of additional text properties in [StyleTextProp9Atom](#) record.

K - unused4 (2 bits): Undefined and MUST be ignored.

2.9.17 TextCFException9

Referenced by: [StyleTextProp9](#), [TextDefaults9Atom](#), [TextMasterStyle9Level](#)

A structure that specifies additional character-level formatting.

0	1	2	3	4	5	6	7	8	9	10	11	12	13	14	15	16	17	18	19	20	21	22	23	24	25	26	27	28	29	30	31
masks																															
A (optional)				unused (optional)																											

masks (4 bytes): A [CFMasks](#) structure that specifies which fields of this **TextCFException9** exist and are valid. Sub-fields are further specified in the following table.

Field	Meaning
masks.bold	MUST be zero.
masks.italic	MUST be zero.

Field	Meaning
masks.underline	MUST be zero.
masks.shadow	MUST be zero.
masks.fehint	MUST be zero.
masks.kumi	MUST be zero.
masks.emboss	MUST be zero.
masks.fHasStyle	MUST be zero.
masks.typeface	MUST be zero.
masks.size	MUST be zero.
masks.color	MUST be zero.
masks.position	MUST be zero.
masks.oldEATypeface	MUST be zero.
masks.ansiTypeface	MUST be zero.
masks.symbolTypeface	MUST be zero.
masks.newEATypeface	MUST be zero.
masks.csTypeface	MUST be zero.
masks.pp11ext	MUST be zero.

A - pp10runid (4 bits): An optional unsigned integer that specifies an identifier for a character run that contains [TextCFException10](#) data. It MUST exist if and only if **masks.pp10ext** is **TRUE**.

unused (28 bits): Undefined and MUST be ignored. It MUST exist if and only if **masks.pp10ext** is **TRUE**.

2.9.18 TextCFException10

Referenced by: [StyleTextProp10Atom](#), [TextDefaults10Atom](#), [TextMasterStyle10Level](#)

A structure that specifies additional character-level formatting information.

0	1	2	3	4	5	6	7	8	9	10	11	12	13	14	15	16	17	18	19	20	21	22	23	24	25	26	27	28	29	30	31
masks																															
newEAFontRef (optional)																csFontRef (optional)															
pp11ext (optional)																															

masks (4 bytes): A [CFMasks](#) structure that specifies which fields of this **TextCFException10** exist and are valid.

Field	Meaning
masks.bold	MUST be zero.
masks.italic	MUST be zero.
masks.underline	MUST be zero.
masks.shadow	MUST be zero.
masks.fehint	MUST be zero.
masks.kumi	MUST be zero.
masks.emboss	MUST be zero.

Field	Meaning
masks.fHasStyle	MUST be zero.
masks.typeface	MUST be zero.
masks.size	MUST be zero.
masks.color	MUST be zero.
masks.position	MUST be zero.
masks.pp10ext	MUST be zero.
masks.oldEATypeface	MUST be zero.
masks.ansiTypeface	MUST be zero.
masks.symbolTypeface	MUST be zero.

newEAFontRef (2 bytes): An optional [FontIndexRef10](#) that specifies a new East Asian font. It MUST exist if and only if **masks.newEATypeface** is **TRUE**.

csFontRef (2 bytes): An optional [FontIndexRef10](#) that specifies a complex script font. It MUST exist if and only if **masks.csTypeface** is **TRUE**.

pp11ext (4 bytes): Undefined and MUST be ignored. It MUST exist if and only if **masks.pp11ext** is **TRUE**.

2.9.19 TextPFExceptionAtom

Referenced by: [DocumentTextInfoContainer](#)

An **atom record** that specifies paragraph-level formatting.

0	1	2	3	4	5	6	7	8	9	10	11	12	13	14	15	16	17	18	19	20	21	22	23	24	25	26	27	28	29	30	31
rh																															
...																															
reserved																pf (variable)															
...																															

rh (8 bytes): A **RecordHeader** structure (section [2.3.1](#)) that specifies the header for this record. Sub-fields are further specified in the following table.

Field	Meaning
rh.recVer	MUST be 0x0.
rh.recInstance	MUST be 0x000.
rh.recType	MUST be an RT_TextParagraphFormatExceptionAtom .

reserved (2 bytes): MUST be zero and MUST be ignored.

pf (variable): A [TextPFException](#) structure that specifies paragraph-level formatting.

2.9.20 TextPFException

Referenced by: [TextMasterStyleLevel](#), [TextPFExceptionAtom](#), [TextPFRun](#)

A structure that specifies paragraph-level formatting.

0	1	2	3	4	5	6	7	8	9	10	11	12	13	14	15	16	17	18	19	20	21	22	23	24	25	26	27	28	29	30	31
masks																															
bulletFlags (optional)																bulletChar (optional)															
bulletFontRef (optional)																bulletSize (optional)															
bulletColor (optional)																															
textAlignment (optional)																lineSpacing (optional)															
spaceBefore (optional)																spaceAfter (optional)															
leftMargin (optional)																indent (optional)															
defaultTabSize (optional)																tabStops (variable)															
...																															
fontAlign (optional)																wrapFlags (optional)															
textDirection (optional)																															

masks (4 bytes): A [PFMasks](#) structure that specifies whether certain fields of this **TextPFException** record exist and are valid. Sub-fields are further specified in the following table.

Field	Meaning
masks.bulletBlip	MUST be zero.
masks.bulletHasScheme	MUST be zero.
masks.bulletScheme	MUST be zero.

bulletFlags (2 bytes): An optional [BulletFlags](#) structure that specifies whether certain bullet-related fields are valid. It MUST exist if and only if any of **masks.hasBullet**, **masks.bulletHasFont**, **masks.bulletHasColor**, or **masks.bulletHasSize** is **TRUE**.

bulletChar (2 bytes): An optional **signed integer** that specifies a **UTF-16 Unicode** [\[RFC2781\]](#) character to display as the bullet. The character MUST NOT be the NUL character 0x0000. It MUST exist if and only if **masks.bulletChar** is **TRUE**.

bulletFontRef (2 bytes): An optional [FontIndexRef](#) that specifies the font to use for the bullet. It MUST exist if and only if **masks.bulletFont** is **TRUE**. This field is valid if and only if **bulletFlags.fBulletHasFont** is **TRUE**.

bulletSize (2 bytes): An optional [BulletSize](#) that specifies the size of the bullet. It MUST exist if and only if **masks.bulletSize** is **TRUE**. This field is valid if and only if **bulletFlags.fBulletHasSize** is **TRUE**.

bulletColor (4 bytes): An optional [ColorIndexStruct](#) structure that specifies the color of a bullet. This field exists if and only if **masks.bulletColor** is **TRUE**. This field is valid if and only if **bulletFlags.fBulletHasColor** is **TRUE**.

textAlignment (2 bytes): An optional [TextAlignmentEnum](#) enumeration that specifies the alignment of the paragraph. It MUST exist if and only if **masks.align** is **TRUE**.

lineSpacing (2 bytes): An optional [ParaSpacing](#) that specifies the spacing between lines in the paragraph. It MUST exist if and only if **masks.lineSpacing** is **TRUE**.

spaceBefore (2 bytes): An optional [ParaSpacing](#) that specifies the size of the spacing before the paragraph. It MUST exist if and only if **masks.spaceBefore** is **TRUE**.

spaceAfter (2 bytes): An optional [ParaSpacing](#) that specifies the size of the spacing after the paragraph. It MUST exist if and only if **masks.spaceAfter** is **TRUE**.

leftMargin (2 bytes): An optional [MarginOrIndent](#) that specifies the left margin of the paragraph. It MUST exist if and only if **masks.leftMargin** is **TRUE**.

indent (2 bytes): An optional [MarginOrIndent](#) that specifies the indentation of the paragraph. It MUST exist if and only if **masks.indent** is **TRUE**.

defaultTabSize (2 bytes): An optional [TabSize](#) that specifies the default tab size of the paragraph. It MUST exist if and only if **masks.defaultTabSize** is **TRUE**.

tabStops (variable): An optional [TabStops](#) structure that specifies the tab stops for the paragraph. It MUST exist if and only if **masks.tabStops** is **TRUE**.

fontAlign (2 bytes): An optional [TextFontAlignmentEnum](#) enumeration that specifies the font alignment of the text in the paragraph. It MUST exist if and only if **masks.fontAlign** is **TRUE**.

wrapFlags (2 bytes): An optional [PFWrapFlags](#) structure that specifies text-wrapping options for the paragraph. It MUST exist if and only if any of **masks.charWrap**, **masks.wordWrap**, or **masks.overflow** is **TRUE**.

textDirection (2 bytes): An optional [TextDirectionEnum](#) enumeration that specifies the direction of the text in this paragraph. It MUST exist if and only if **masks.textDirection** is **TRUE**.

2.9.21 PFMasks

Referenced by: [TextPFException](#), [TextPFException9](#)

A structure that specifies which paragraph-level formatting fields are valid in the [TextPFException](#) or [TextPFException9](#) record that contains this **PFMasks** structure.

0	1	2	3	4	5	6	7	8	9	10	11	12	13	14	15	16	17	18	19	20	21	22	23	24	25	26	27	28	29	30	31				
A	B	C	D	E	F	G	H	I	J	K	L	M	N	O	P	Q	R	S	T	U	V	W	X	Y	Z	reserved2									

A - hasBullet (1 bit): A bit that specifies whether the **bulletFlags** field of the [TextPFException](#) structure that contains this **PFMasks** exists and whether **bulletFlags.fHasBullet** is valid.

B - bulletHasFont (1 bit): A bit that specifies whether the **bulletFlags** field of the [TextPFException](#) structure that contains this **PFMasks** exists and whether **bulletFlags.fBulletHasFont** is valid.

- C - bulletHasColor (1 bit):** A bit that specifies whether the **bulletFlags** field of the TextPFEException structure that contains this **PFMasks** exists and whether **bulletFlags.fBulletHasColor** is valid.
- D - bulletHasSize (1 bit):** A bit that specifies whether the **bulletFlags** field of the TextPFEException structure that contains this **PFMasks** exists and whether **bulletFlags.fBulletHasSize** is valid.
- E - bulletFont (1 bit):** A bit that specifies whether the **bulletFontRef** field of the TextPFEException structure that contains this **PFMasks** exists.
- F - bulletColor (1 bit):** A bit that specifies whether the **bulletColor** field of the TextPFEException structure that contains this **PFMasks** exists.
- G - bulletSize (1 bit):** A bit that specifies whether the **bulletSize** field of the TextPFEException structure that contains this **PFMasks** exists.
- H - bulletChar (1 bit):** A bit that specifies whether the **bulletChar** field of the TextPFEException structure that contains this **PFMasks** exists.
- I - leftMargin (1 bit):** A bit that specifies whether the **leftMargin** field of the TextPFEException structure that contains this **PFMasks** exists.
- J - unused (1 bit):** Undefined and MUST be ignored.
- K - indent (1 bit):** A bit that specifies whether the **indent** field of the TextPFEException structure that contains this **PFMasks** exists.
- L - align (1 bit):** A bit that specifies whether the **textAlignment** field of the TextPFEException structure that contains this **PFMasks** exists.
- M - lineSpacing (1 bit):** A bit that specifies whether the **lineSpacing** field of the TextPFEException structure that contains this **PFMasks** exists.
- N - spaceBefore (1 bit):** A bit that specifies whether the **spaceBefore** field of the TextPFEException structure that contains this **PFMasks** exists.
- O - spaceAfter (1 bit):** A bit that specifies whether the **spaceAfter** field of the TextPFEException structure that contains this **PFMasks** exists.
- P - defaultTabSize (1 bit):** A bit that specifies whether the **defaultTabSize** field of the TextPFEException structure that contains this **PFMasks** exists.
- Q - fontAlign (1 bit):** A bit that specifies whether the **fontAlign** field of the TextPFEException structure that contains this **PFMasks** exists.
- R - charWrap (1 bit):** A bit that specifies whether the **wrapFlags** field of the TextPFEException structure that contains this **PFMasks** exists and whether **wrapFlags.charWrap** is valid.
- S - wordWrap (1 bit):** A bit that specifies whether the **wrapFlags** field of the TextPFEException structure that contains this **PFMasks** exists and whether **wrapFlags.wordWrap** is valid.
- T - overflow (1 bit):** A bit that specifies whether the **wrapFlags** field of the TextPFEException structure that contains this **PFMasks** exists and whether **wrapFlags.overflow** is valid.
- U - tabStops (1 bit):** A bit that specifies whether the **tabStops** field of the TextPFEException structure that contains this **PFMasks** exists.
- V - textDirection (1 bit):** A bit that specifies whether the **textDirection** field of the TextPFEException structure that contains this **PFMasks** exists.
- W - reserved1 (1 bit):** MUST be zero and MUST be ignored.

X - bulletBlip (1 bit): A bit that specifies whether the **bulletBlipRef** field of the TextPFException9 structure that contains this **PFMasks** exists.

Y - bulletScheme (1 bit): A bit that specifies whether the **bulletAutoNumberScheme** field of the TextPFException9 structure that contains this **PFMasks** exists.

Z - bulletHasScheme (1 bit): A bit that specifies whether the **fBulletHasAutoNumber** field of the TextPFException9 structure that contains this **PFMasks** exists.

reserved2 (6 bits): MUST be zero and MUST be ignored.

2.9.22 BulletFlags

Referenced by: [TextPFException](#)

A structure that specifies bullet properties.

0	1	2	3	4	5	6	7	8	9	10	11	12	13	14	15	16	17	18	19	20	21	22	23	24	25	26	27	28	29	30	31
A	B	C	D	reserved																											

A - fHasBullet (1 bit): A bit that specifies whether a bullet exists.

B - fBulletHasFont (1 bit): A bit that specifies whether the bullet has a font.

C - fBulletHasColor (1 bit): A bit that specifies whether the bullet has a color.

D - fBulletHasSize (1 bit): A bit that specifies whether the bullet has a size.

reserved (12 bits): MUST be zero and MUST be ignored.

2.9.23 TabStops

Referenced by: [TextPFException](#), [TextRuler](#)

A structure that specifies tab stops.

0	1	2	3	4	5	6	7	8	9	10	11	12	13	14	15	16	17	18	19	20	21	22	23	24	25	26	27	28	29	30	31
count																rgTabStop (variable)															
...																															

count (2 bytes): An unsigned integer that specifies the count of tab stops in **rgTabStop**.

rgTabStop (variable): An array of [TabStop](#) that specifies the tab stops. The length, in bytes, of the array is specified by the following formula:

$$\text{count} * 4$$

2.9.24 TabStop

Referenced by: [TabStops](#)

A structure that specifies a tab stop.

0	1	2	3	4	5	6	7	8	9	10	11	12	13	14	15	16	17	18	19	20	21	22	23	24	25	26	27	28	29	30	31
position																type															

position (2 bytes): A **signed integer** that specifies an offset, in **master units**, of the tab stop.

If the [TextPFXException](#) record that contains this **TabStop** structure also contains a **leftMargin**, then the value of **position** is relative to the left margin of the paragraph; otherwise, the value is relative to the left side of the paragraph.

If a [TextRuler](#) record contains this **TabStop** structure, the value is relative to the left side of the text ruler.

type (2 bytes): A [TextTabTypeEnum](#) enumeration that specifies how text aligns at the tab stop.

2.9.25 PFWrapFlags

Referenced by: [TextPFXException](#)

A structure that specifies line breaking settings for a paragraph.

0	1	2	3	4	5	6	7	8	9	10	11	12	13	14	15	16	17	18	19	20	21	22	23	24	25	26	27	28	29	30	31
A	B	C	reserved																												

A - charWrap (1 bit): A bit that specifies whether the paragraph follows the East Asian text line breaking settings specified by the **KinsokuContainer** (section [2.9.2](#)) and **Kinsoku9Container** (section [2.9.6](#)) records.

B - wordWrap (1 bit): A bit that specifies whether text wraps from one line to the next only at word breaks, or in the middle of a word. It MUST be a value from the following table.

Value	Meaning
TRUE	Text wraps at word breaks. All of the characters of a word exist on the same line.
FALSE	Text wraps at character breaks. Characters of a word can be split across lines.

C - overflow (1 bit): A bit that specifies whether hanging punctuation is allowed for East Asian text.

reserved (13 bits): MUST be zero and MUST be ignored.

2.9.26 TextPFXException9

Referenced by: [StyleTextProp9](#), [TextDefaults9Atom](#), [TextMasterStyle9Level](#)

A structure that specifies additional paragraph-level formatting.

0	1	2	3	4	5	6	7	8	9	10	11	12	13	14	15	16	17	18	19	20	21	22	23	24	25	26	27	28	29	30	31
masks																															
bulletBlipRef (optional)																fBulletHasAutoNumber (optional)															
bulletAutoNumberScheme (optional)																															

masks (4 bytes): A [PFMasks](#) structure that specifies which fields in this **TextPFException9** exist. Sub-fields are further specified in the following table.

Field	Meaning
masks.hasBullet	MUST be zero.
masks.bulletHasFont	MUST be zero.
masks.bulletHasColor	MUST be zero.
masks.bulletHasSize	MUST be zero.
masks.bulletFont	MUST be zero.
masks.bulletColor	MUST be zero.
masks.bulletSize	MUST be zero.
masks.bulletChar	MUST be zero.
masks.leftMargin	MUST be zero.
masks.indent	MUST be zero.
masks.align	MUST be zero.
masks.lineSpacing	MUST be zero.
masks.spaceBefore	MUST be zero.
masks.spaceAfter	MUST be zero.
masks.defaultTabSize	MUST be zero.
masks.fontAlign	MUST be zero.
masks.charWrap	MUST be zero.
masks.wordWrap	MUST be zero.
masks.overflow	MUST be zero.
masks.tabStops	MUST be zero.
masks.textDirection	MUST be zero.

bulletBlipRef (2 bytes): An optional [BlipRef](#) that specifies a picture to use as a bullet for this paragraph. It MUST exist if and only if **masks.bulletBlip** is **TRUE**.

fBulletHasAutoNumber (2 bytes): An optional **signed integer** that specifies whether this paragraph has an automatic numbering scheme. It MUST exist if and only if **masks.bulletHasScheme** is **TRUE**. It MUST be a value from the following table.

Field	Meaning
0x0000	This paragraph does not have an automatic numbering scheme.
0x0001	This paragraph has an automatic numbering scheme.

bulletAutoNumberScheme (4 bytes): An optional [TextAutoNumberScheme](#) structure that specifies the automatic numbering scheme for this paragraph. It MUST exist if and only if **masks.bulletScheme** is **TRUE**.

2.9.27 TextAutoNumberScheme

Referenced by: [TextPFException9](#)

A structure that specifies the automatic numbering scheme for text paragraphs.

0	1	2	3	4	5	6	7	8	9	10	11	12	13	14	15	16	17	18	19	20	21	22	23	24	25	26	27	28	29	30	31
scheme																startNum															

scheme (2 bytes): A [TextAutoNumberSchemeEnum](#) enumeration that specifies the scheme. The scheme describes the style of the number bullets.

startNum (2 bytes): A **signed integer** that specifies the numeric value of the first number assigned. It MUST be greater than or equal to 0x0001.

2.9.28 DefaultRulerAtom

Referenced by: [DocumentTextInfoContainer](#)

An **atom record** that specifies the default ruler and corresponding options.

0	1	2	3	4	5	6	7	8	9	10	11	12	13	14	15	16	17	18	19	20	21	22	23	24	25	26	27	28	29	30	31
rh																...															
defaultTextRuler (variable)																															
...																															

rh (8 bytes): A **RecordHeader** structure (section [2.3.1](#)) that specifies the header for this record. Sub-fields are further specified in the following table.

Field	Meaning
rh.recVer	MUST be 0x0.
rh.recInstance	MUST be 0x000.
rh.recType	MUST be an RT_DefaultRulerAtom .

defaultTextRuler (variable): A [TextRuler](#) structure that specifies the default text ruler. Sub-fields are further specified in the following table.

Field	Meaning
defaultTextRuler.fDefaultTabSize	MUST be TRUE .
defaultTextRuler.fCLevels	MUST be TRUE .

Field	Meaning
defaultTextRuler.fTabStops	MUST be TRUE .
defaultTextRuler.fLeftMargin1	MUST be TRUE .
defaultTextRuler.fLeftMargin2	MUST be TRUE .
defaultTextRuler.fLeftMargin3	MUST be TRUE .
defaultTextRuler.fLeftMargin4	MUST be TRUE .
defaultTextRuler.fLeftMargin5	MUST be TRUE .
defaultTextRuler.fIndent1	MUST be TRUE .
defaultTextRuler.fIndent2	MUST be TRUE .
defaultTextRuler.fIndent3	MUST be TRUE .
defaultTextRuler.fIndent4	MUST be TRUE .
defaultTextRuler.fIndent5	MUST be TRUE .

2.9.29 TextRulerAtom

Referenced by: [TextClientDataSubContainerOrAtom](#)

An **atom record** that specifies a **text ruler**.

0	1	2	3	4	5	6	7	8	9	10	11	12	13	14	15	16	17	18	19	20	21	22	23	24	25	26	27	28	29	30	31
rh																															
...																															
textRuler (variable)																															
...																															

rh (8 bytes): A **RecordHeader** structure (section [2.3.1](#)) that specifies the header for this record. Sub-fields are further specified in the following table.

Field	Meaning
rh.recVer	MUST be 0x0.
rh.recInstance	MUST be 0x000.
rh.recType	MUST be an RT_TextRulerAtom .

textRuler (variable): A [TextRuler](#) structure that specifies a text ruler.

2.9.30 TextRuler

Referenced by: [DefaultRulerAtom](#), [TextRulerAtom](#)

A structure that specifies tabbing, margins, and indentation for text.

0	1	2	3	4	5	6	7	8	9	10	11	12	13	14	15	16	17	18	19	20	21	22	23	24	25	26	27	28	29	30	31
A	B	C	D	E	F	G	H	I	J	K	L	M	reserved																		
cLevels (optional)												defaultTabSize (optional)																			
tabs (variable)																															
...																															
leftMargin1 (optional)												indent1 (optional)																			
leftMargin2 (optional)												indent2 (optional)																			
leftMargin3 (optional)												indent3 (optional)																			
leftMargin4 (optional)												indent4 (optional)																			
leftMargin5 (optional)												indent5 (optional)																			

A - fDefaultTabSize (1 bit): A bit that specifies whether **defaultTabSize** exists.

B - fCLevels (1 bit): A bit that specifies whether **cLevels** exists.

C - fTabStops (1 bit): A bit that specifies whether **tabs** exists.

D - fLeftMargin1 (1 bit): A bit that specifies whether **leftMargin1** exists.

E - fLeftMargin2 (1 bit): A bit that specifies whether **leftMargin2** exists.

F - fLeftMargin3 (1 bit): A bit that specifies whether **leftMargin3** exists.

G - fLeftMargin4 (1 bit): A bit that specifies whether **leftMargin4** exists.

H - fLeftMargin5 (1 bit): A bit that specifies whether **leftMargin5** exists.

I - fIndent1 (1 bit): A bit that specifies whether **indent1** exists.

J - fIndent2 (1 bit): A bit that specifies whether **indent2** exists.

K - fIndent3 (1 bit): A bit that specifies whether **indent3** exists.

L - fIndent4 (1 bit): A bit that specifies whether **indent4** exists.

M - fIndent5 (1 bit): A bit that specifies whether **indent5** exists.

reserved (19 bits): MUST be zero and MUST be ignored.

cLevels (2 bytes): An optional signed integer that specifies the number of style levels in this **text ruler**. It MUST exist if and only if **fCLevels** is **TRUE**.

defaultTabSize (2 bytes): An optional [TabSize](#) that specifies the default tab size for this text ruler. It MUST exist if and only if **fDefaultTabSize** is **TRUE**.

tabs (variable): An optional [TabStops](#) structure that specifies the tab stops for this text ruler. It MUST exist if and only if **fTabStops** is **TRUE**.

leftMargin1 (2 bytes): An optional [MarginOrIndent](#) that specifies the left margin for text that has an [IndentLevel](#) equal to 0x0000. It MUST exist if and only if **fLeftMargin1** is **TRUE**.

indent1 (2 bytes): An optional [MarginOrIndent](#) that specifies the indentation for text that has an [IndentLevel](#) equal to 0x0000. It MUST exist if and only if **fIndent1** is **TRUE**.

leftMargin2 (2 bytes): An optional [MarginOrIndent](#) that specifies the left margin for text that has an [IndentLevel](#) equal to 0x0001. It MUST exist if and only if **fLeftMargin2** is **TRUE**.

indent2 (2 bytes): An optional [MarginOrIndent](#) that specifies the indentation for text that has an [IndentLevel](#) equal to 0x0001. It MUST exist if and only if **fIndent2** is **TRUE**.

leftMargin3 (2 bytes): An optional [MarginOrIndent](#) that specifies the left margin for text that has an [IndentLevel](#) equal to 0x0002. It MUST exist if and only if **fLeftMargin3** is **TRUE**.

indent3 (2 bytes): An optional [MarginOrIndent](#) that specifies the indentation for text that has an [IndentLevel](#) equal to 0x0002. It MUST exist if and only if **fIndent3** is **TRUE**.

leftMargin4 (2 bytes): An optional [MarginOrIndent](#) that specifies the left margin for text that has an [IndentLevel](#) equal to 0x0003. It MUST exist if and only if **fLeftMargin4** is **TRUE**.

indent4 (2 bytes): An optional [MarginOrIndent](#) that specifies the indentation for text that has an [IndentLevel](#) equal to 0x0003. It MUST exist if and only if **fIndent4** is **TRUE**.

leftMargin5 (2 bytes): An optional [MarginOrIndent](#) that specifies the left margin for text that has an [IndentLevel](#) equal to 0x0004. It MUST exist if and only if **fLeftMargin5** is **TRUE**.

indent5 (2 bytes): An optional [MarginOrIndent](#) that specifies the indentation for text that has an [IndentLevel](#) equal to 0x0004. It MUST exist if and only if **fIndent5** is **TRUE**.

2.9.31 TextSIExceptionAtom

Referenced by: [DocumentTextInfoContainer](#)

An **atom record** that specifies default settings for language and spelling information.

0	1	2	3	4	5	6	7	8	9	10	11	12	13	14	15	16	17	18	19	20	21	22	23	24	25	26	27	28	29	30	31
rh																															
...																															
textSIException (variable)																															
...																															

rh (8 bytes): A **RecordHeader** structure (section [2.3.1](#)) that specifies the header for this record. Sub-fields are further specified in the following table.

Field	Meaning
rh.recVer	MUST be 0x0.
rh.recInstance	MUST be 0x000.
rh.recType	MUST be an RT_TextSpecialInfoDefaultAtom .

textSIEException (variable): A [TextSIEException](#) structure that specifies default settings for language and spelling information. The length, in bytes, of the field is specified by **rh.recLen**. Sub-fields are further specified in the following table.

Field	Meaning
textSIEException.fPp10ext	MUST be zero.
textSIEException.fBidi	MUST be zero.
textSIEException.smartTag	MUST be zero.

2.9.32 TextSIEException

Referenced by: [StyleTextProp11](#), [StyleTextProp9](#), [TextSIEExceptionAtom](#), [TextSIRun](#)

A structure that specifies additional text properties.

0	1	2	3	4	5	6	7	8	9	10	11	12	13	14	15	16	17	18	19	20	21	22	23	24	25	26	27	28	29	30	31
A	B	C	D	E	F	G	H	I	J	reserved2																					
spellInfo (optional)											lid (optional)																				
altLid (optional)											bidi (optional)																				
K (optional)		reserved3 (optional)																								L					
smartTags (variable)																															
...																															

A - spell (1 bit): A bit that specifies whether the **spellInfo** field exists.

B - lang (1 bit): A bit that specifies whether the **lid** field exists.

C - altLang (1 bit): A bit that specifies whether the **altLid** field exists.

D - unused1 (1 bit): Undefined and MUST be ignored.

E - unused2 (1 bit): Undefined and MUST be ignored.

F - fPp10ext (1 bit): A bit that specifies whether the **pp10runid**, **reserved3**, and **grammarError** fields exist.

G - fBidi (1 bit): A bit that specifies whether the **bidi** field exists.

H - unused3 (1 bit): Undefined and MUST be ignored.

I - reserved1 (1 bit): MUST be zero and MUST be ignored.

J - smartTag (1 bit): A bit that specifies whether the **smartTags** field exists.

reserved2 (22 bits): MUST be zero and MUST be ignored.

spellInfo (2 bytes): An optional [SpellingFlags](#) structure that specifies the spelling status of this text. It MUST exist if and only if **spell** is **TRUE**. The **spellInfo.grammar** sub-field MUST be zero.

lid (2 bytes): An optional [TxLCID](#) that specifies the language identifier of this text. It MUST exist if and only if **lang** is **TRUE**.

altLid (2 bytes): An optional TxLCID that specifies the alternate language identifier of this text. It MUST exist if and only if **altLang** is **TRUE**.

bidi (2 bytes): An optional signed integer that specifies whether the text contains bidirectional characters. It MUST exist if and only if **fBidi** is **TRUE**. It MUST be a value from the following table:

Value	Meaning
0x0000	Contains no bidirectional characters.
0x0001	Contains bidirectional characters.

K - pp10runid (4 bits): An optional unsigned integer that specifies an identifier for a character run that contains StyleTextProp11 data. It MUST exist if and only if **fPp10ext** is **TRUE**.

reserved3 (27 bits): An optional unsigned integer that MUST be zero, and MUST be ignored. It MUST exist if and only if **fPp10ext** is **TRUE**.

L - grammarError (1 bit): An optional bit that specifies a grammar error. It MUST exist if and only if **fPp10ext** is **TRUE**.

smartTags (variable): An optional [SmartTags](#) structure that specifies **smart tags** applied to the text. It MUST exist if and only if **smartTag** is **TRUE**.

2.9.33 SpellingFlags

Referenced by: [TextSIFException](#)

A structure that specifies the spelling status of a run of text.

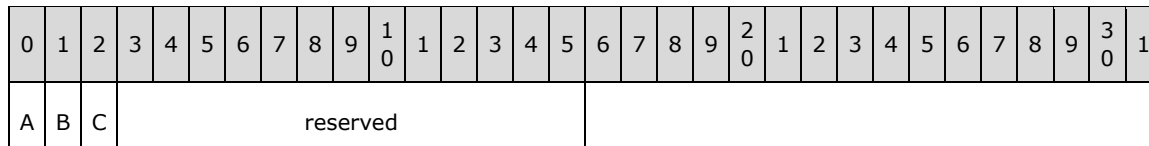

A - error (1 bit): A bit that specifies whether the text is spelled incorrectly.

B - clean (1 bit): A bit that specifies whether the text needs rechecking.

C - grammar (1 bit): A bit that specifies whether the text has a grammar error.

reserved (13 bits): MUST be zero and MUST be ignored.

2.9.34 SmartTags

Referenced by: [TextSIFException](#)

A structure that specifies the **smart tags** attached to a run of text.

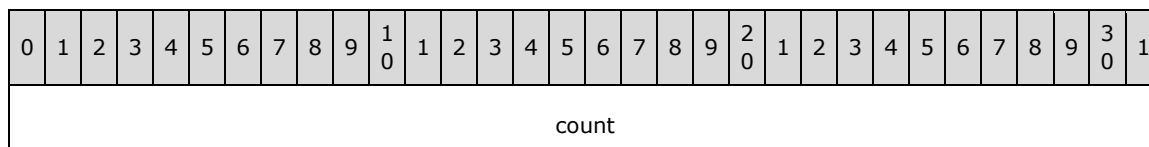

rgSmartTagIndex (variable)
...

count (4 bytes): An unsigned integer specifies the count of items in **rgSmartTagIndex**.

rgSmartTagIndex (variable): An array of [SmartTagIndex](#) that specifies the indices. The count of items in the array is specified by **count**.

2.9.35 TextMasterStyleAtom

Referenced by: [DocumentTextInfoContainer](#), [MainMasterContainer](#)

An **atom record** that specifies the character-level and paragraph-level formatting of a **main master slide**.

If this **TextMasterStyleAtom** is contained in a **MainMasterContainer** record (section 2.5.3), character-level and paragraph-level formatting not specified by this **TextMasterStyleAtom** record inherit from the **TextMasterStyleAtom** record contained in the **DocumentTextInfoContainer** record (section 2.9.1).

0	1	2	3	4	5	6	7	8	9	10	11	12	13	14	15	16	17	18	19	20	21	22	23	24	25	26	27	28	29	30	31
rh																															
...																															
cLevels																lstLvl1 (variable)															
...																															
lstLvl2 (variable)																															
...																															
lstLvl3 (variable)																															
...																															
lstLvl4 (variable)																															
...																															
lstLvl5 (variable)																															
...																															

rh (8 bytes): A **RecordHeader** structure (section [2.3.1](#)) that specifies the header for this record. Sub-fields are further specified in the following table.

Field	Meaning
rh.recVer	MUST be 0x0.
rh.recInstance	Specifies the type of text to which the formatting applies. It MUST be a TextTypeEnum enumeration value.
rh.recType	MUST be an RT_TextMasterStyleAtom .

cLevels (2 bytes): An **unsigned integer** that specifies the number of style levels. It MUST be less than or equal to 0x0005.

IstLvl1 (variable): An optional [TextMasterStyleLevel](#) structure that specifies the master formatting for text that has an [IndentLevel](#) equal to 0x0000. It MUST exist if and only if **cLevels** is greater than 0x0000.

IstLvl2 (variable): An optional [TextMasterStyleLevel](#) structure that specifies the master formatting for text that has an [IndentLevel](#) equal to 0x0001. It MUST exist if and only if **cLevels** is greater than 0x0001.

IstLvl3 (variable): An optional [TextMasterStyleLevel](#) structure that specifies the master formatting for text that has an [IndentLevel](#) equal to 0x0002. It MUST exist if and only if **cLevels** is greater than 0x0002.

IstLvl4 (variable): An optional [TextMasterStyleLevel](#) structure that specifies the master formatting for text that has an [IndentLevel](#) equal to 0x0003. It MUST exist if and only if **cLevels** is greater than 0x0003.

IstLvl5 (variable): An optional [TextMasterStyleLevel](#) structure that specifies the master formatting for text that has an [IndentLevel](#) equal to 0x0004. It MUST exist if and only if **cLevels** is greater than 0x0004.

2.9.36 TextMasterStyleLevel

Referenced by: [TextMasterStyleAtom](#)

A structure that specifies character-level and paragraph-level formatting for a style level.

0	1	2	3	4	5	6	7	8	9	10	11	12	13	14	15	16	17	18	19	20	21	22	23	24	25	26	27	28	29	30	31
level (optional)																pf (variable)															
...																															
cf (variable)																															
...																															

level (2 bytes): An optional **unsigned integer** that specifies to what style level this **TextMasterStyleLevel** applies. This field MUST exist if and only if the **rh.recInstance** field of the [TextMasterStyleAtom](#) record that contains this **TextMasterStyleLevel** structure is greater than or equal to 0x005. If the field exists, its value MUST be less than the **cLevels** field of the [TextMasterStyleAtom](#) record that contains this **TextMasterStyleLevel** structure.

pf (variable): A [TextPFException](#) structure that specifies paragraph-level formatting.

cf (variable): A [TextCFException](#) structure that specifies character-level formatting.

2.9.37 TextMasterStyle9Atom

Referenced by: [PP9DocBinaryTagExtension](#), [PP9SlideBinaryTagExtension](#)

An **atom record** that specifies additional character-level and paragraph-level formatting of a **main master slide**.

If this **TextMasterStyle9Atom** is contained in a **MainMasterContainer** record (section [2.5.3](#)), character-level and paragraph-level formatting not specified by this **TextMasterStyle9Atom** record inherit from the **TextMasterStyle9Atom** records contained in the [PP9DocBinaryTagExtension](#) record.

0	1	2	3	4	5	6	7	8	9	10	11	12	13	14	15	16	17	18	19	20	21	22	23	24	25	26	27	28	29	30	31
rh																															
...																															
cLevels																lStLvl1 (variable)															
...																															
lStLvl2 (variable)																															
...																															
lStLvl3 (variable)																															
...																															
lStLvl4 (variable)																															
...																															
lStLvl5 (variable)																															
...																															

rh (8 bytes): A **RecordHeader** structure (section [2.3.1](#)) that specifies the header for this record. Sub-fields are further specified in the following table.

Field	Meaning
rh.recVer	MUST be 0x0.
rh.recInstance	Specifies the type of text to which the formatting applies. It MUST be a TextTypeEnum enumeration value.
rh.recType	MUST be an RT_TextMasterStyle9Atom .

cLevels (2 bytes): An **unsigned integer** that specifies the number of style levels. It MUST be less than or equal to 0x0005.

IstLvl1 (variable): An optional [TextMasterStyle9Level](#) structure that specifies additional master formatting for text that has an [IndentLevel](#) equal to 0x0000. It MUST exist if and only if **cLevels** is greater than 0x0000.

IstLvl2 (variable): An optional [TextMasterStyle9Level](#) structure that specifies additional master formatting for text that has an [IndentLevel](#) equal to 0x0001. It MUST exist if and only if **cLevels** is greater than 0x0001.

IstLvl3 (variable): An optional [TextMasterStyle9Level](#) structure that specifies additional master formatting for text that has an [IndentLevel](#) equal to 0x0002. It MUST exist if and only if **cLevels** is greater than 0x0002.

IstLvl4 (variable): An optional [TextMasterStyle9Level](#) structure that specifies additional master formatting for text that has an [IndentLevel](#) equal to 0x0003. It MUST exist if and only if **cLevels** is greater than 0x0003.

IstLvl5 (variable): An optional [TextMasterStyle9Level](#) structure that specifies additional master formatting for text that has an [IndentLevel](#) equal to 0x0004. It MUST exist if and only if **cLevels** is greater than 0x0004.

2.9.38 TextMasterStyle9Level

Referenced by: [TextMasterStyle9Atom](#)

A structure that specifies additional character-level and paragraph level-formatting for a style level.

0	1	2	3	4	5	6	7	8	9	10	11	12	13	14	15	16	17	18	19	20	21	22	23	24	25	26	27	28	29	30	31
pf9 (variable)																															
...																															
cf9 (variable)																															
...																															

pf9 (variable): A [TextPFException9](#) structure that specifies paragraph-level formatting.

cf9 (variable): A [TextCFException9](#) structure that specifies character-level formatting.

2.9.39 TextMasterStyle10Atom

Referenced by: [PP10DocBinaryTagExtension](#), [PP10SlideBinaryTagExtension](#)

An **atom record** that specifies additional character-level formatting of a **main master slide**.

If this **TextMasterStyle10Atom** is contained in a **MainMasterContainer** record (section [2.5.3](#)), character-level formatting not specified by this **TextMasterStyle10Atom** record inherits from the **TextMasterStyle10Atom** records contained in the [PP10DocBinaryTagExtension](#) record.

0	1	2	3	4	5	6	7	8	9	10	11	12	13	14	15	16	17	18	19	20	21	22	23	24	25	26	27	28	29	30	31
rh																															

...	
cLevels	IstLvl1 (variable)
...	
IstLvl2 (variable)	
...	
IstLvl3 (variable)	
...	
IstLvl4 (variable)	
...	
IstLvl5 (variable)	
...	

rh (8 bytes): A **RecordHeader** structure (section [2.3.1](#)) that specifies the header for this record. Sub-fields are further specified in the following table.

Field	Meaning
rh.recVer	MUST be 0x0.
rh.recInstance	Specifies the type of text to which the formatting applies. It MUST be a TextTypeEnum enumeration value.
rh.recType	MUST be an RT_TextMasterStyle10Atom .

cLevels (2 bytes): An unsigned integer that specifies the number of style levels. It MUST be less than or equal to 0x0005.

IstLvl1 (variable): An optional [TextMasterStyle10Level](#) structure that specifies additional master formatting for text that has an [IndentLevel](#) equal to 0x0000. It MUST exist if and only if **cLevels** is greater than 0x0000.

IstLvl2 (variable): An optional [TextMasterStyle10Level](#) structure that specifies additional master formatting for text that has an [IndentLevel](#) equal to 0x0001. It MUST exist if and only if **cLevels** is greater than 0x0001.

IstLvl3 (variable): An optional [TextMasterStyle10Level](#) structure that specifies additional master formatting for text that has an [IndentLevel](#) equal to 0x0002. It MUST exist if and only if **cLevels** is greater than 0x0002.

IstLvl4 (variable): An optional [TextMasterStyle10Level](#) structure that specifies additional master formatting for text that has an [IndentLevel](#) equal to 0x0003. It MUST exist if and only if **cLevels** is greater than 0x0003.

IstLvl15 (variable): An optional TextMasterStyle10Level structure that specifies additional master formatting for text that has an IndentLevel equal to 0x0004. It MUST exist if and only if **cLevels** is greater than 0x0004.

2.9.40 TextMasterStyle10Level

Referenced by: [TextMasterStyle10Atom](#)

A structure that specifies additional character-level formatting for a style level.

0	1	2	3	4	5	6	7	8	9	10	11	12	13	14	15	16	17	18	19	20	21	22	23	24	25	26	27	28	29	30	31
cf10 (variable)																															
...																															

cf10 (variable): A [TextCFException10](#) structure that specifies additional character-level formatting.

2.9.41 TextHeaderAtom

Referenced by: [SlideListWithTextSubContainerOrAtom](#), [TextClientDataSubContainerOrAtom](#)

An **atom record** that specifies the type of a text body. The presence of this atom indicates a text body whose properties are specified by other atom and container records that follow. The records comprising this text body continue up until the next **SlidePersistAtom** record (section [2.4.14.5](#)) or the next **TextHeaderAtom** record that follows this **TextHeaderAtom** or the end of the **rgChildRec** array of the [OfficeArtClientTextBox](#) or **SlideListWithTextContainer** (section [2.4.14.3](#)) record that contains this **TextHeaderAtom**.

Let the *corresponding slide* be specified by one of the following:

- When this **TextHeaderAtom** is contained in a **SlideListWithTextContainer** record, let the *corresponding slide* be the **SlideContainer** record (section [2.5.1](#)) as specified by the **SlidePersistAtom** record that most closely precedes this **TextHeaderAtom** record.
- When this **TextHeaderAtom** is contained in a **SlideContainer** record, let the *corresponding slide* be specified by the **SlideContainer** record that contains this **TextHeaderAtom** record.
- When this **TextHeaderAtom** is contained in a **NotesContainer** record (section [2.5.6](#)), let the *corresponding slide* be specified by the **SlideContainer** record referred to by the **notesAtom.slideIdRef** field of the **NotesContainer** record that contains this **TextHeaderAtom** record.

Let the *corresponding main master* be specified by the **MainMasterContainer** record (section [2.5.3](#)) specified by the **slideAtom.masterIdRef** field of the *corresponding slide*.

Let the *corresponding shape* be specified by one of the following:

- When this **TextHeaderAtom** record is contained in a **OfficeArtSpContainer** record ([\[MS-ODRAW\]](#) section 2.2.14), let the *corresponding shape* be the **OfficeArtSpContainer** record that contains this **TextHeaderAtom** record.
- When this **TextHeaderAtom** record is contained in a **SlideListWithTextContainer** record, let the *corresponding shape* be specified by the **OfficeArtSpContainer** record ([\[MS-ODRAW\]](#) section 2.2.14) contained in the *corresponding slide* that contains an [OutlineTextRefAtom](#) record that refers to this **TextHeaderAtom** record.

The characters of the text body are specified by the [TextCharsAtom](#) record or the [TextBytesAtom](#) record, if any, that follows this **TextHeaderAtom** record. In addition, the text body contains a single terminating paragraph break character (0x000D) that is not included in the TextCharsAtom record or TextBytesAtom record.

Let the *corresponding text style*, if any, be specified by the [StyleTextPropAtom](#) record that follows this **TextHeaderAtom**.

The text body contains a sequence of character runs comprised of consecutive characters with identical [TextCFException](#) record data as specified by the [TextCfRun](#) structures in the **rgTextCfRun** array of the *corresponding text style*.

Let the *corresponding text placeholder list* be as specified in the **SlideListWithTextContainer** record that contains this **TextHeaderAtom** record.

0	1	2	3	4	5	6	7	8	9	10	11	12	13	14	15	16	17	18	19	20	21	22	23	24	25	26	27	28	29	30	31
rh																															
...																															
textType																															

rh (8 bytes): A **RecordHeader** structure (section [2.3.1](#)) that specifies the header for this record. Sub-fields are further specified in the following table.

Field	Meaning
rh.recVer	MUST be 0x0.
rh.recInstance	Specifies whether this TextHeaderAtom record specifies the text of a placeholder shape. It MUST be greater than or equal to 0x000 and less than or equal to 0x005. When this TextHeaderAtom record is contained in a SlideListWithTextContainer record, this field specifies the index of an item in the <i>corresponding text placeholder list</i> . When this TextHeaderAtom record is contained in an OfficeArtClientTextbox record, this field MUST be 0x000.
rh.recType	MUST be RT_TextHeaderAtom .
rh.recLen	MUST be 0x00000004.

textType (4 bytes): A [TextTypeEnum](#) enumeration that specifies the type of the text body.

2.9.42 TextCharsAtom

Referenced by: [SlideListWithTextSubContainerOrAtom](#), [TextClientDataSubContainerOrAtom](#)

An **atom record** that specifies Unicode characters.

Let the *corresponding text* be specified by the [TextHeaderAtom](#) record that most closely precedes this record.

0	1	2	3	4	5	6	7	8	9	10	11	12	13	14	15	16	17	18	19	20	21	22	23	24	25	26	27	28	29	30	31
rh																															
...																															
textChars (variable)																															
...																															

rh (8 bytes): A **RecordHeader** structure (section [2.3.1](#)) that specifies the header for this record. Sub-fields are further specified in the following table.

Field	Meaning
rh.recVer	MUST be 0x0.
rh.recInstance	MUST be 0x000.
rh.recType	MUST be an RT_TextCharsAtom .
rh.recLen	MUST be even.

textChars (variable): An array of UTF-16 Unicode [\[RFC2781\]](#) characters that specifies the characters of the *corresponding text*. The length, in bytes, of the array is specified by **rh.recLen**. The array MUST NOT contain the NUL character 0x0000.

2.9.43 TextBytesAtom

Referenced by: [SlideListWithTextSubContainerOrAtom](#), [TextClientDataSubContainerOrAtom](#)

An **atom record** that specifies Unicode characters.

Let the *corresponding text* be specified by the [TextHeaderAtom](#) record that most closely precedes this record.

0	1	2	3	4	5	6	7	8	9	10	11	12	13	14	15	16	17	18	19	20	21	22	23	24	25	26	27	28	29	30	31
rh																															
...																															
textBytes (variable)																															
...																															

rh (8 bytes): A **RecordHeader** structure (section [2.3.1](#)) that specifies the header for this record. Sub-fields are further specified in the following table.

Field	Meaning
rh.recVer	MUST be 0x0.
rh.recInstance	MUST be 0x000.
rh.recType	MUST be an RT_TextBytesAtom .

textBytes (variable): An array of bytes that specifies the characters of the *corresponding text*. Each item represents the low byte of a UTF-16 Unicode [\[RFC2781\]](#) character whose high byte is 0x00. The length, in bytes, of the array is specified by **rh.recLen**. The array MUST NOT contain a 0x00 byte.

2.9.44 StyleTextPropAtom

Referenced by: [SlideListWithTextSubContainerOrAtom](#), [TextClientDataSubContainerOrAtom](#)

An **atom record** that specifies character-level and paragraph-level formatting.

Let the *corresponding text* be specified by the [TextHeaderAtom](#) record that most closely precedes this record.

Let the *corresponding shape* be as specified in the *corresponding text*.

Let the *corresponding main master* be as specified in the *corresponding text*.

If the *corresponding shape* is a **placeholder shape**, character-level and paragraph-level formatting not specified by this StyleTextPropAtom record inherit from the [TextMasterStyleAtom](#) records contained in the *corresponding main master*.

0	1	2	3	4	5	6	7	8	9	10	11	12	13	14	15	16	17	18	19	20	21	22	23	24	25	26	27	28	29	30	31
rh																															
...																															
rgTextPFRun (variable)																															
...																															
rgTextCFRun (variable)																															
...																															

rh (8 bytes): A **RecordHeader** structure (section [2.3.1](#)) that specifies the header for this record. Sub-fields are further specified in the following table.

Field	Meaning
rh.recVer	MUST be 0x0.
rh.recInstance	MUST be 0x000.
rh.recType	MUST be an RT_StyleTextPropAtom .

rgTextPFRun (variable): An array of [TextPFRun](#) structures that specifies paragraph-level formatting for the *corresponding text*. The **count** field of each TextPFRun item specifies the number of characters to which the formatting applies, starting with the character at the zero-based index equal to the sum of the **count** fields of all previous TextPFRun records in the array.

The sum of the **count** fields of the TextPFRun items MUST be equal to the number of characters in the *corresponding text*.

rgTextCFRun (variable): An array of [TextCFRun](#) structures that specifies character-level formatting for the *corresponding text*. The **count** field of each TextCFRun specifies the number of characters to which the formatting applies, starting with the character at the zero-based index equal to the sum of the **count** fields of all previous TextCFRun records in the array.

The sum of the **count** fields of the TextCFRun items MUST be equal to the number of characters in the *corresponding text*.

2.9.45 TextPFRun

Referenced by: [StyleTextPropAtom](#)

A structure that specifies the paragraph-level formatting of a run of text.

Let the *corresponding text* be as specified in the StyleTextPropAtom record that contains this **TextPFRun** structure.

0	1	2	3	4	5	6	7	8	9	10	1	2	3	4	5	6	7	8	9	20	1	2	3	4	5	6	7	8	9	30	1
count																															
indentLevel																pf (variable)															
...																															

count (4 bytes): An unsigned integer that specifies the number of characters of the *corresponding text* to which this paragraph formatting applies.

indentLevel (2 bytes): An [IndentLevel](#) that specifies the indentation level of the paragraph.

pf (variable): A [TextPFException](#) structure that specifies paragraph-level formatting. Sub-fields are further specified in the following table.

Field	Meaning
masks.leftMargin	MUST be FALSE .
masks.indent	MUST be FALSE .
masks.defaultTabSize	MUST be FALSE .
masks.tabStops	MUST be FALSE .

2.9.46 TextCFRun

Referenced by: [StyleTextPropAtom](#)

A structure that specifies the character-level formatting of a run of text.

Let the *corresponding text* be as specified in the StyleTextPropAtom record that contains this **TextCFRun** structure.

0	1	2	3	4	5	6	7	8	9	10	1	2	3	4	5	6	7	8	9	20	1	2	3	4	5	6	7	8	9	30	1
count																															

cf (variable)
...

count (4 bytes): An unsigned integer that specifies the number of characters of the corresponding text to which this character formatting applies.

cf (variable): A [TextCFException](#) structure that specifies character-level formatting.

2.9.47 SlideNumberMCAtom

Referenced by: [SlideListWithTextSubContainerOrAtom](#), [TextClientDataSubContainerOrAtom](#)

An **atom record** that specifies a slide number metacharacter.

The metacharacter is replaced by the slide number on which the metacharacter is found.

Let the *corresponding text* be specified by the [TextHeaderAtom](#) record that most closely precedes this **SlideNumberMCAtom** record.

0	1	2	3	4	5	6	7	8	9	10	11	12	13	14	15	16	17	18	19	20	21	22	23	24	25	26	27	28	29	30	31
rh																															
...																															
position																															

rh (8 bytes): A **RecordHeader** structure (section [2.3.1](#)) that specifies the header for this record. Sub-fields are further specified in the following table.

Field	Meaning
rh.recVer	MUST be 0x0.
rh.recInstance	MUST be 0x000.
rh.recType	MUST be an RT_SlideNumberMetaCharAtom .
rh.recLen	MUST be 0x00000004.

position (4 bytes): A [TextPosition](#) that specifies the position of the metacharacter in the *corresponding text*.

2.9.48 HeaderMCAtom

Referenced by: [SlideListWithTextSubContainerOrAtom](#), [TextClientDataSubContainerOrAtom](#)

An **atom record** that specifies a header metacharacter.

The metacharacter is replaced by the text in the *corresponding header*.

Let the *corresponding header* be specified by the [HeaderAtom](#) record contained in the **NotesHeadersFootersContainer** record (section [2.4.15.6](#)) for the handout slide or the notes slide.

Let the *corresponding text* be specified by the [TextHeaderAtom](#) record that most closely precedes this **HeaderMCAtom** record.

0	1	2	3	4	5	6	7	8	9	10	1	2	3	4	5	6	7	8	9	20	1	2	3	4	5	6	7	8	9	30	1
rh																															
...																															
position																															

rh (8 bytes): A **RecordHeader** structure (section [2.3.1](#)) that specifies the header for this record. Sub-fields are further specified in the following table.

Field	Meaning
rh.recVer	MUST be 0x0.
rh.recInstance	MUST be 0x000.
rh.recType	MUST be an RT_HeaderMetaCharAtom .
rh.recLen	MUST be 0x00000004.

position (4 bytes): A [TextPosition](#) that specifies the position of the header metacharacter in the *corresponding text*.

2.9.49 FooterMCAtom

Referenced by: [SlideListWithTextSubContainerOrAtom](#), [TextClientDataSubContainerOrAtom](#)

An **atom record** that specifies a footer metacharacter.

The metacharacter is replaced by the text in the *corresponding footer*.

Let the *corresponding footer* be specified by the [FooterAtom](#) record contained in the **SlideHeadersFootersContainer** record (section [2.4.15.1](#)) for presentation slides, the **NotesHeadersFootersContainer** record (section [2.4.15.6](#)) for handout slides and notes slides, or in the [PerSlideHeadersFootersContainer](#) record for each slide.

Let the *corresponding text* be specified by the [TextHeaderAtom](#) record that most closely precedes this **FooterMCAtom** record.

0	1	2	3	4	5	6	7	8	9	10	1	2	3	4	5	6	7	8	9	20	1	2	3	4	5	6	7	8	9	30	1
rh																															
...																															
position																															

rh (8 bytes): A **RecordHeader** structure (section [2.3.1](#)) that specifies the header for this record. Sub-fields are further specified in the following table.

Field	Meaning
rh.recVer	MUST be 0x0.
rh.recInstance	MUST be 0x000.
rh.recType	MUST be an RT_FooterMetaCharAtom .
rh.recLen	MUST be 0x00000004.

position (4 bytes): A [TextPosition](#) that specifies the position of the metacharacter in the corresponding text.

2.9.50 DateTimeMCAtom

Referenced by: [SlideListWithTextSubContainerOrAtom](#), [TextClientDataSubContainerOrAtom](#)

An **atom record** that specifies a datetime metacharacter.

The metacharacter is replaced by the current datetime. Current datetime is formatted in the style that is specified by the **index** field.

Let the corresponding text be specified by the [TextHeaderAtom](#) record that most closely precedes this **DateTimeMCAtom** record.

0	1	2	3	4	5	6	7	8	9	10	11	12	13	14	15	16	17	18	19	20	21	22	23	24	25	26	27	28	29	30	31
rh																															
...																															
position																															
index																unused															

rh (8 bytes): A **RecordHeader** structure (section [2.3.1](#)) that specifies the header for this record. Sub-fields are further specified in the following table.

Field	Meaning
rh.recVer	MUST be 0x0.
rh.recInstance	MUST be 0x000.
rh.recType	MUST be an RT_DateTimeMetaCharAtom .
rh.recLen	MUST be 0x00000008.

position (4 bytes): A [TextPosition](#) that specifies the position of the metacharacter in the corresponding text.

index (1 byte): An unsigned byte that specifies the **Format ID** used to stylize datetime. The identifier specified by the **Format ID** is converted based on the LCID [\[MS-LCID\]](#) into a value or string as specified in the following tables. The LCID is specified in **TextSIException.lid**. If no valid LCID is found in **TextSIException.lid**, **TextSIException.altLid** (if it exists) is used. If, in the following tables, the converted **Format ID** is a value, it specifies the format index (specified in [\[MS-OSHARED\]](#) section 2.4.4.1) that is used to style the datetime. If, in the following tables, the

converted Format ID is a string, that string is used as the style to format the datetime. The value MUST be greater than or equal to 0x0 and MUST be less than or equal to 0xC.

LCID: American (0x0409)

Format ID	Converted value/string
0	0
1	1
2	8
3	2
4	5
5	9
6	10
7	11
8	12
9	15
10	16
11	13
12	14

LCID: British (0x0809) / Australian (0x0C09)

Format ID	Converted value/string
0	0
1	1
2	"d MMMM, yyy"
3	2
4	5
5	9
6	10
7	11
8	12
9	15
10	16
11	13
12	14

LCID: Japanese (0x0411)

Format ID	Converted value/string
0	4
1	8
2	7
3	3
4	0
5	9
6	5
7	11
8	12
9	"HH:mm"
10	"HH:mm:ss"
11	15
12	16

LCID: Taiwan (0x0404)

Format ID	Converted value/string
0	0
1	1
2	3
3	7
4	12
5	9
6	10
7	4
8	11
9	"HH:mm"
10	"HH:mm:ss"
11	"H:mm AMPM"
12	"H:mm:ss AMPM"

LCID: China (0x0804)

Format ID	Converted value/string
0	0
1	1
2	2
3	2
4	4
5	9
6	5
7	"\x79\x79\x79\x79\x5E74\x4D\x6708\x64\x65E5\x68\x65F6\x6D\x5206"
8	"\x79\x79\x79\x79\x5E74\x4D\x6708\x64\x65E5\x661F\x671f\x57\x68\x65F6\x6D\x5206\x73\x79D2"
9	"HH:mm"
10	"HH:mm:ss"
11	"\x41\x4D\x50\x4D\x68\x65F6\x6D\x5206"
12	"\x41\x4D\x50\x4D\x68\x65F6\x6D\x5206\x73\x79D2"

LCID: Korean (0x0412)

Format ID	Converted value/string
0	0
1	1
2	6
3	3
4	4
5	10
6	7
7	12
8	11
9	"HH:mm"
10	"HH:mm:ss"
11	13
12	14

LCID: Arabic (0x0401)

Format ID	Converted value/string
0	0
1	1
2	2
3	3
4	4
5	5
6	8
7	7
8	8
9	1
10	10
11	11
12	5

LCID: Hebrew (0x040D)

Format ID	Converted value/string
0	0
1	1
2	2
3	6
4	11
5	5
6	12
7	7
8	8
9	9
10	1
11	11
12	6

LCID: Swedish (0x041D)

Format ID	Converted value/string
0	0
1	1
2	3
3	2
4	7
5	9
6	10
7	11
8	12
9	15
10	16
11	13
12	14

LCID: Singapore (0x1004) / Macao SAR (0x1404) / Hong Kong SAR (0x0C04)

Format ID	Converted value/string
0	0
1	1
2	3
3	2
4	4
5	9
6	5
7	"\x79\x79\x79\x79\x5E74\x4D\x6708\x64\x65E5\x68\x65F6\x6D\x5206"
8	"\x79\x79\x79\x79\x5E74\x4D\x6708\x64\x65E5\x661F\x671f\x57\x68\x65F6\x6D\x5206\x73\x79D2"
9	"HH:mm"
10	"HH:mm:ss"
11	"\x41\x4D\x50\x4D\x68\x65F6\x6D\x5206"
12	"\x41\x4D\x50\x4D\x68\x65F6\x6D\x5206\x73\x79D2"

LCID: Thai (0x41E)

Format ID	Converted value/string
0	0
1	1
2	2
3	3
4	5
5	6
6	7
7	8
8	9
9	10
10	11
11	13
12	14

LCID: Vietnamese (0x042A)

Format ID	Converted value/string
0	0
1	1
2	2
3	3
4	5
5	6
6	10
7	11
8	12
9	13
10	14
11	15
12	16

LCID: Hindi (0x0439)

Format ID	Converted value/string
0	1
1	2
2	3
3	5
4	7
5	11
6	13
7	0
8	1
9	5
10	10
11	11
12	14

LCID: Syriac (0x045A)

Format ID	Converted value/string
0	0
1	1
2	2
3	3
4	4
5	5
6	6
7	7
8	8
9	9
10	10
11	11
2	12

unused (3 bytes): Undefined and MUST be ignored.

2.9.51 GenericDateMCAtom

Referenced by: [SlideListWithTextSubContainerOrAtom](#), [TextClientDataSubContainerOrAtom](#)

An **atom record** that specifies a datetime metacharacter.

The metacharacter is replaced by the datetime option specified in the [HeadersFootersAtom](#) record.

Let the *corresponding text* be specified by the [TextHeaderAtom](#) record that most closely precedes this **GenericDateMCAtom** record.

0	1	2	3	4	5	6	7	8	9	10	1	2	3	4	5	6	7	8	9	20	1	2	3	4	5	6	7	8	9	30	1
rh																															
...																															
position																															

rh (8 bytes): A **RecordHeader** structure (section [2.3.1](#)) that specifies the header for this record. Sub-fields are further specified in the following table.

Field	Meaning
rh.recVer	MUST be 0x0.
rh.recInstance	MUST be 0x000.
rh.recType	MUST be an RT_GenericDateMetaCharAtom .
rh.recLen	MUST be 0x00000004

position (4 bytes): A [TextPosition](#) that specifies the position of the metacharacter in the *corresponding text*.

2.9.52 RTFDateTimeMCAtom

Referenced by: [SlideListWithTextSubContainerOrAtom](#), [TextClientDataSubContainerOrAtom](#)

An **atom record** that specifies a Rich Text Format (RTF) datetime metacharacter. RTF format is specified by [\[MSFT-RTF\]](#).

The metacharacter is replaced by the datetime, using the format specified in the format string in this metacharacter.

Let the *corresponding text* be specified by the [TextHeaderAtom](#) record that most closely precedes this **RTFDateTimeMCAtom** record.

0	1	2	3	4	5	6	7	8	9	10	1	2	3	4	5	6	7	8	9	20	1	2	3	4	5	6	7	8	9	30	1
rh																															
...																															

position
format (128 bytes)
...
...

rh (8 bytes): A **RecordHeader** structure (section [2.3.1](#)) that specifies the header for this record. Sub-fields are further specified in the following table.

Field	Meaning
rh.recVer	MUST be 0x0.
rh.recInstance	MUST be 0x000.
rh.recType	MUST be an RT_RtfDateTimeMetaCharAtom .
rh.recLen	MUST be 0x00000084.

position (4 bytes): A [TextPosition](#) that specifies the position of the metacharacter in the corresponding text.

format (128 bytes): A [char2](#) that specifies the date and time format in RTF.

2.9.53 TextBookmarkAtom

Referenced by: [SlideListWithTextSubContainerOrAtom](#), [TextClientDataSubContainerOrAtom](#)

An **atom record** that specifies a range of text that has a **bookmark**. The length of the range of text is specified by the following formula:

end - begin

0	1	2	3	4	5	6	7	8	9	10	11	12	13	14	15	16	17	18	19	20	21	22	23	24	25	26	27	28	29	30	31
rh																															
...																															
begin																															
end																															
bookmarkID																															

rh (8 bytes): A **RecordHeader** structure (section [2.3.1](#)) that specifies the header for this record. Sub-fields are further specified in the following table.

Field	Meaning
rh.recVer	MUST be 0x0.
rh.recInstance	MUST be 0x000.

Field	Meaning
rh.recType	MUST be an RT_TextBookmarkAtom .
rh.recLen	MUST be 0x0000000C.

begin (4 bytes): A [TextPosition](#) that specifies the beginning of the bookmarked range.

end (4 bytes): A [TextPosition](#) that specifies the end of the bookmarked range. This field MUST be greater than **begin** and SHOULD [<107>](#) be less than or equal to **begin** plus 255.

bookmarkID (4 bytes): An unsigned integer that specifies a reference to a bookmark identifier. It MUST be the same as the **bookmarkID** field of a [BookmarkEntityAtom](#) record.

2.9.54 TextSpecialInfoAtom

Referenced by: [SlideListWithTextSubContainerOrAtom](#), [TextClientDataSubContainerOrAtom](#)

An **atom record** that specifies additional text properties.

Let the *corresponding text* be specified by the [TextHeaderAtom](#) record that most closely precedes this record.

0	1	2	3	4	5	6	7	8	9	10	1	2	3	4	5	6	7	8	9	20	1	2	3	4	5	6	7	8	9	30	1
rh																															
...																															
rgSIRun (variable)																															
...																															

rh (8 bytes): A **RecordHeader** structure (section [2.3.1](#)) that specifies the header for this record. Sub-fields are further specified in the following table.

Field	Meaning
rh.recVer	MUST be 0x0.
rh.recInstance	MUST be 0x000.
rh.recType	MUST be an RT_TextSpecialInfoAtom .

rgSIRun (variable): An array of [TextSIRun](#) structures that specifies additional text properties for the *corresponding text*. The **count** field of each [TextSIRun](#) specifies the number of characters to which the properties apply, starting with the character at the zero-based index equal to the sum of the **count** fields of all previous [TextSIRun](#) records in the array.

The sum of the **count** fields of the [TextSIRun](#) items MUST be equal to the number of characters in the *corresponding text*. The length, in bytes, of the array is specified by **rh.recLen**.

2.9.55 TextSIRun

Referenced by: [TextSpecialInfoAtom](#)

A structure that specifies language and spelling information for a run of text.

Let the *corresponding text* be as specified in the TextSpecialInfoAtom record that contains this **TextSIRun** structure.

0	1	2	3	4	5	6	7	8	9	10	11	12	13	14	15	16	17	18	19	20	21	22	23	24	25	26	27	28	29	30	31
count																															
si (variable)																															
...																															

count (4 bytes): An **unsigned integer** that specifies the number of characters of the corresponding text to which these additional text properties apply. It **MUST** be greater than or equal to 0x00000001.

si (variable): A [TextSIXception](#) structure that specifies language and spelling information.

2.9.56 TextInteractiveInfoInstance

Referenced by: [SlideListWithTextSubContainerOrAtom](#), [TextClientDataSubContainerOrAtom](#)

A variable type record whose type and meaning are dictated by the value of **rh.recInstance**, as specified in the following table.

Value	Meaning
0x000	A MouseClickedTextInteractiveInfoAtom record that specifies the corresponding text range of the preceding MouseClickedInteractiveInfoContainer record.
0x001	A MouseOverTextInteractiveInfoAtom record that specifies the corresponding text range of the preceding MouseOverInteractiveInfoContainer record.

2.9.57 MouseClickTextInteractiveInfoAtom

Referenced by: [TextInteractiveInfoInstance](#)

An **atom record** that specifies a text range that anchors the preceding [MouseClickedInteractiveInfoContainer](#) record in the containing [OfficeArtClientTextbox](#) record or **SlideListWithTextContainer** record (section [2.4.14.3](#)).

Let the *corresponding text* be specified by the [TextHeaderAtom](#) record that most closely precedes this **MouseClickedTextInteractiveInfoAtom** record.

0	1	2	3	4	5	6	7	8	9	10	11	12	13	14	15	16	17	18	19	20	21	22	23	24	25	26	27	28	29	30	31
rh																															
...																															
range																															

...

rh (8 bytes): A **RecordHeader** structure (section [2.3.1](#)) that specifies the header for this record. Sub-fields are further specified in the following table.

Field	Meaning
rh.recVer	MUST be 0x0.
rh.recInstance	MUST be 0x000.
rh.recType	MUST be an RT_TextInteractiveInfoAtom .
rh.recLen	MUST be 0x00000008.

range (8 bytes): A [TextRange](#) structure that specifies the anchor in the *corresponding text*.

2.9.58 MouseOverTextInteractiveInfoAtom

Referenced by: [TextInteractiveInfoInstance](#)

An **atom record** that specifies a text range that anchors the preceding [MouseOverInteractiveInfoContainer](#) record in the containing [OfficeArtClientTextbox](#) record or [SlideListWithTextContainer](#) record (section [2.4.14.3](#)).

Let the *corresponding text* be specified by the [TextHeaderAtom](#) record that most closely precedes this **MouseOverTextInteractiveInfoAtom** record.

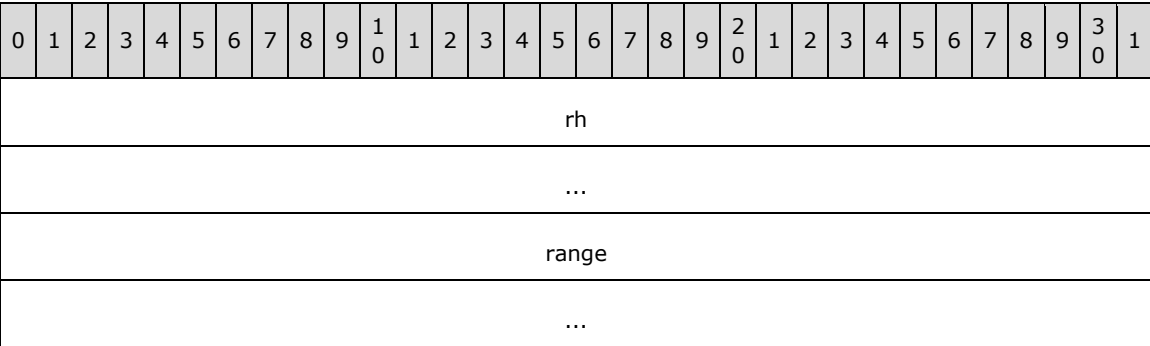

rh (8 bytes): A **RecordHeader** structure (section [2.3.1](#)) that specifies the header for this record. Sub-fields are further specified in the following table.

Field	Meaning
rh.recVer	MUST be 0x0.
rh.recInstance	MUST be 0x001.
rh.recType	MUST be an RT_TextInteractiveInfoAtom .
rh.recLen	MUST be 0x00000008.

range (8 bytes): A [TextRange](#) structure that specifies the anchor in the *corresponding text*.

2.9.59 TextRange

Referenced by: [MouseClickedTextInteractiveInfoAtom](#), [MouseOverTextInteractiveInfoAtom](#)

A structure that specifies a range of text.

Let the *corresponding text* be as specified in the `MouseClickedTextInteractiveInfoAtom` record or the `MouseOverTextInteractiveInfoAtom` record that contains this **TextRange** structure.

The range specified MUST be valid for the *corresponding text*. The length of the range of text is specified by the following formula:

$$\text{end} - \text{begin}$$

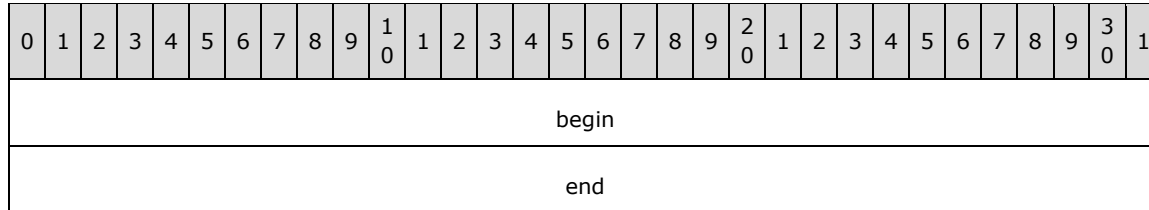

begin (4 bytes): A [TextPosition](#) that specifies the first position of the range. It MUST be greater than or equal to zero and MUST be less than or equal to the length of the *corresponding text*.

end (4 bytes): A [TextPosition](#) that specifies the cutoff position for the range. The character before this position is the last character in the range. It MUST be greater than **begin** and MUST be less than or equal to the length of the *corresponding text*.

2.9.60 OutlineTextProps9Container

Referenced by: [PP9DocBinaryTagExtension](#)

A **container record** that specifies additional text properties for outline text.

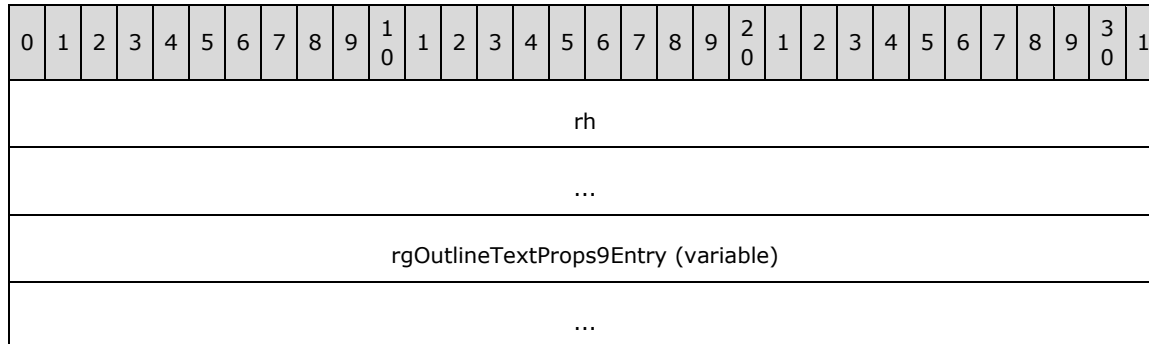

rh (8 bytes): A **RecordHeader** structure (section [2.3.1](#)) that specifies the header for this record. Sub-fields are further specified in the following table.

Field	Meaning
rh.recVer	MUST be 0xF.
rh.recInstance	MUST be 0x000.
rh.recType	MUST be an RT_OutlineTextProps9 .

rgOutlineTextProps9Entry (variable): An array of [OutlineTextProps9Entry](#) structures that specifies the text properties. The size, in bytes, of the array is specified by **rh.recLen**.

2.9.61 OutlineTextProps9Entry

Referenced by: [OutlineTextProps9Container](#)

A structure that specifies additional text properties for a single **placeholder shape** position on a slide.

0	1	2	3	4	5	6	7	8	9	10	11	12	13	14	15	16	17	18	19	20	21	22	23	24	25	26	27	28	29	30	31
outlineTextHeaderAtom (16 bytes)																															
...																															
...																															
styleTextProp9Atom (variable)																															
...																															

outlineTextHeaderAtom (16 bytes): An [OutlineTextPropsHeaderExAtom](#) record that specifies to which placeholder shape position and slide the **styleTextProp9Atom** field applies.

styleTextProp9Atom (variable): A [StyleTextProp9Atom](#) record that specifies additional text properties.

2.9.62 OutlineTextPropsHeaderExAtom

Referenced by: [OutlineTextProps10Entry](#), [OutlineTextProps11Entry](#), [OutlineTextProps9Entry](#)

An **atom record** that specifies a reference to text contained in the **SlideListWithTextContainer** record (section [2.4.14.3](#)).

Let the *corresponding slide persist* be specified by the **SlidePersistAtom** record (section [2.4.14.5](#)) contained in the **SlideListWithTextContainer** record whose **slideId** field is equal to **slideIdRef**.

Let the *corresponding text* be specified by the [TextHeaderAtom](#) record referenced by **rh.recInstance**.

0	1	2	3	4	5	6	7	8	9	10	11	12	13	14	15	16	17	18	19	20	21	22	23	24	25	26	27	28	29	30	31
rh																															
...																															
slideIdRef																															
txType																															

rh (8 bytes): A **RecordHeader** structure (section [2.3.1](#)) that specifies the header for this record. Sub-fields are further specified in the following table.

Field	Meaning
rh.recVer	MUST be 0x0.
rh.recInstance	Specifies a zero-based index into the sequence of TextHeaderAtom records that follows the

Field	Meaning
	<i>corresponding slide persist</i> . It MUST be greater than or equal to 0x000 and less than the number of TextHeaderAtom records that follow the <i>corresponding slide persist</i> . It MUST be less than or equal to 0x005.
rh.recType	MUST be RT_OutlineTextPropsHeader9Atom .

slideIdRef (4 bytes): A **SlideIdRef** (section [2.2.25](#)) that specifies the **presentation slide** that contains the *corresponding text*. If this field does not reference a valid presentation slide, the structure that contains this **OutlineTextPropsHeaderExAtom** MUST be ignored.

txType (4 bytes): A [TextTypeEnum](#) enumeration that specifies the type of text of the *corresponding text*.

2.9.63 OutlineTextProps10Container

Referenced by: [PP10DocBinaryTagExtension](#)

A **container record** that specifies additional text properties for outline text.

0	1	2	3	4	5	6	7	8	9	10	1	2	3	4	5	6	7	8	9	20	1	2	3	4	5	6	7	8	9	30	1
rh																															
...																															
rgOutlineTextProps10Entry (variable)																															
...																															

rh (8 bytes): A **RecordHeader** structure (section [2.3.1](#)) that specifies the header for this record. Sub-fields are further specified in the following table.

Field	Meaning
rh.recVer	MUST be 0xF.
rh.recInstance	MUST be 0x000.
rh.recType	MUST be an RT_OutlineTextProps10 .

rgOutlineTextProps10Entry (variable): An array of [OutlineTextProps10Entry](#) structures that specifies the text properties. The size, in bytes, of the array is specified by **rh.recLen**.

2.9.64 OutlineTextProps10Entry

Referenced by: [OutlineTextProps10Container](#)

A structure that specifies additional text properties for a single **placeholder shape** position on a slide.

0	1	2	3	4	5	6	7	8	9	10	11	12	13	14	15	16	17	18	19	20	21	22	23	24	25	26	27	28	29	30	31
outlineTextHeaderAtom (16 bytes)																															
...																															
...																															
styleTextProp10Atom (variable)																															
...																															

outlineTextHeaderAtom (16 bytes): An [OutlineTextPropsHeaderExAtom](#) record that specifies to which placeholder shape position and slide the **styleTextProp10Atom** field applies.

styleTextProp10Atom (variable): A [StyleTextProp10Atom](#) record that specifies additional text properties.

2.9.65 OutlineTextProps11Container

Referenced by: [PP11DocBinaryTagExtension](#)

A **container record** that specifies additional text properties for outline text.

0	1	2	3	4	5	6	7	8	9	10	11	12	13	14	15	16	17	18	19	20	21	22	23	24	25	26	27	28	29	30	31
rh																															
...																															
rgOutlineTextProps11Entry (variable)																															
...																															

rh (8 bytes): A **RecordHeader** structure (section [2.3.1](#)) that specifies the header for this record. Sub-fields are further specified in the following table.

Field	Meaning
rh.recVer	MUST be 0xF.
rh.recInstance	MUST be 0x000.
rh.recType	MUST be an RT_OutlineTextProps11 .

rgOutlineTextProps11Entry (variable): An array of [OutlineTextProps11Entry](#) structures that specifies the text properties. The size, in bytes, of the array is specified by **rh.recLen**.

2.9.66 OutlineTextProps11Entry

Referenced by: [OutlineTextProps11Container](#)

A structure that specifies additional text properties for a single **placeholder shape** position on a slide.

0	1	2	3	4	5	6	7	8	9	10	11	12	13	14	15	16	17	18	19	20	21	22	23	24	25	26	27	28	29	30	31
outlineTextHeaderAtom (16 bytes)																															
...																															
...																															
styleTextProp11Atom (variable)																															
...																															

outlineTextHeaderAtom (16 bytes): An [OutlineTextPropsHeaderExAtom](#) record that specifies to which placeholder shape position and slide the **styleTextProp11Atom** field applies

styleTextProp11Atom (variable): A [StyleTextProp11Atom](#) record that specifies additional text properties.

2.9.67 StyleTextProp9Atom

Referenced by: [OutlineTextProps9Entry](#), [PP9ShapeBinaryTagExtension](#)

An **atom record** that specifies additional text formatting.

When this record is contained in an OutlineTextProps9Entry structure, let the *corresponding text* be as specified in the [OutlineTextPropsHeaderExAtom](#) record contained in the OutlineTextProps9Entry structure that contains this **StyleTextProp9Atom** record.

When this record is contained in a PP9ShapeBinaryTagExtension record, let the *corresponding text* be specified by the [TextHeaderAtom](#) record contained in the **OfficeArtSpContainer** ([\[MS-ODRAW\]](#) section 2.2.14) that contains this **StyleTextProp9Atom** record.

Let the *corresponding shape* be as specified in the *corresponding text*.

Let the *corresponding main master* be as specified in the *corresponding text*.

If the *corresponding shape* is a **placeholder shape**, character-level and paragraph-level formatting not specified by this **StyleTextProp9Atom** record inherit from the [TextMasterStyle9Atom](#) records contained in the *corresponding main master*.

0	1	2	3	4	5	6	7	8	9	10	11	12	13	14	15	16	17	18	19	20	21	22	23	24	25	26	27	28	29	30	31
rh																															
...																															
rgStyleTextProp9 (variable)																															
...																															

rh (8 bytes): A **RecordHeader** structure (section [2.3.1](#)) that specifies the header for this record. Sub-fields are further specified in the following table.

Field	Meaning
rh.recVer	MUST be 0x0.
rh.recInstance	MUST be 0x000.
rh.recType	MUST be an RT_StyleTextProp9Atom .

rgStyleTextProp9 (variable): An array of [StyleTextProp9](#) structures that specifies additional formatting for the *corresponding text*. Each item in the array specifies formatting for a sequence of consecutive character runs of the *corresponding text* that share the same value of the **fontStyle.pp9rt** field of the [TextCFException](#) record. If a TextCFException record does not specify a **fontStyle.pp9rt** field, its value is assumed to be 0x0000. An item at index *i* MUST be ignored if $i \% 16$ is not equal to the value of the **fontstyle.pp9rt** field of the next such sequence. The length, in bytes, of the array is specified by **rh.recLen**.

2.9.68 StyleTextProp9

Referenced by: [StyleTextProp9Atom](#)

A structure that specifies additional paragraph-level formatting, character-level formatting, and text properties for a text run.

0	1	2	3	4	5	6	7	8	9	10	11	12	13	14	15	16	17	18	19	20	21	22	23	24	25	26	27	28	29	30	31
pf9 (variable)																															
...																															
cf9 (variable)																															
...																															
si (variable)																															
...																															

pf9 (variable): A [TextPFException9](#) structure that specifies additional paragraph-level formatting.

cf9 (variable): A [TextCFException9](#) structure that specifies additional character-level formatting.

si (variable): A [TextSIException](#) structure that specifies additional text properties. Sub-fields are further specified in the following table.

Field	Meaning
masks.spell	MUST be 0.
masks.lang	MUST be 0.
masks.altLang	MUST be 0.
masks.smartTag	MUST be 0.

2.9.69 StyleTextProp10Atom

Referenced by: [OutlineTextProps10Entry](#), [PP10ShapeBinaryTagExtension](#)

An **atom record** that specifies additional character-level formatting.

When this record is contained in an OutlineTextProps10Entry structure, let the *corresponding text* be as specified in the [OutlineTextPropsHeaderExAtom](#) record contained in the OutlineTextProps10Entry structure that contains this **StyleTextProp10Atom** record.

When this record is contained in a PP10ShapeBinaryTagExtension record, let the *corresponding text* be specified by the [TextHeaderAtom](#) record contained in the OfficeArtSpContainer ([\[MS-ODRAW\]](#) section 2.2.14) that contains this **StyleTextProp10Atom** record.

Let the *corresponding shape* be as specified in the *corresponding text*.

Let the *corresponding main master* be as specified in the *corresponding text*.

If the *corresponding shape* is a **placeholder shape**, character-level formatting not specified by this **StyleTextProp10Atom** record inherits from the [TextMasterStyle10Atom](#) records contained in the *corresponding main master*.

0	1	2	3	4	5	6	7	8	9	10	1	2	3	4	5	6	7	8	9	20	1	2	3	4	5	6	7	8	9	30	1
rh																															
...																															
rgStyleTextProp10 (variable)																															
...																															

rh (8 bytes): A **RecordHeader** structure (section [2.3.1](#)) that specifies the header for this record. Sub-fields are further specified in the following table.

Field	Meaning
rh.recVer	MUST be 0x0.
rh.recInstance	MUST be 0x000.
rh.recType	MUST be an RT_StyleTextProp10Atom .

rgStyleTextProp10 (variable): An array of [TextCFException10](#) structures that specifies additional character-level formatting for the *corresponding text*. Each item in the array specifies formatting for a sequence of consecutive character runs that share the same value of the **pp10runid** field of the [TextCFException9](#) structure, as specified by the [StyleTextProp9Atom](#) record that refers to the same *corresponding text*. If a TextCFException9 structure does not contain the **pp10runid** field, its value is assumed to be 0x0000. An item at index *i* MUST be ignored if $i \% 16$ is not equal to the value of the **pp10runid** field of the next such sequence. The length, in bytes, of the array is specified by **rh.recLen**.

2.9.70 StyleTextProp11Atom

Referenced by: [OutlineTextProps11Entry](#), [PP11ShapeBinaryTagExtension](#)

An **atom record** that specifies additional text properties.

When this record is contained in an OutlineTextProps11Entry structure, let the *corresponding text* be as specified in the [OutlineTextPropsHeaderExAtom](#) record contained in the OutlineTextProps11Entry structure that contains this **StyleTextProp11Atom** record.

When this record is contained in a PP11ShapeBinaryTagExtension record, let the *corresponding text* be specified by the [TextHeaderAtom](#) record contained in the OfficeArtSpContainer ([\[MS-ODRAW\]](#) section 2.2.14) that contains this **StyleTextProp11Atom** record.

0	1	2	3	4	5	6	7	8	9	10	11	12	13	14	15	16	17	18	19	20	21	22	23	24	25	26	27	28	29	30	31
rh																															
...																															
rgStyleTextProp11 (variable)																															
...																															

rh (8 bytes): A **RecordHeader** structure (section [2.3.1](#)) that specifies the header for this record. Sub-fields are further specified in the following table.

Field	Meaning
rh.recVer	MUST be 0x0.
rh.recInstance	MUST be 0x000.
rh.recType	MUST be an RT_StyleTextProp11Atom .

rgStyleTextProp11 (variable): An array of [StyleTextProp11](#) structures that specifies smart tags for the *corresponding text*. Each item specifies properties for a sequence of characters until the beginning or end of the next smart tag. An item at index *i* MUST be ignored if $i \% 16$ is not equal to the value of the **si.pp10runid** field of the [StyleTextProp9](#) record that refers to the same characters. If the StyleTextProp9 record does not contain a **si.pp10runid** field, its value is assumed to be 0x0000.

2.9.71 StyleTextProp11

Referenced by: [StyleTextProp11Atom](#)

A structure that specifies additional text properties.

0	1	2	3	4	5	6	7	8	9	10	11	12	13	14	15	16	17	18	19	20	21	22	23	24	25	26	27	28	29	30	31
info (variable)																															
...																															

info (variable): A [TextSIException](#) structure that specifies additional text properties for a text run. Sub-fields are further specified in the following table.

Field	Meaning
info.spell	MUST be zero.
info.lang	MUST be zero.
info.altLang	MUST be zero.
info.fPp10ext	MUST be zero.
info.fBidi	MUST be zero.

2.9.72 BlipCollection9Container

Referenced by: [PP9DocBinaryTagExtension](#)

A **container record** that specifies information about picture bullet points.

0	1	2	3	4	5	6	7	8	9	10	11	12	13	14	15	16	17	18	19	20	21	22	23	24	25	26	27	28	29	30	31
rh																															
...																															
rgBlipEntityAtom (variable)																															
...																															

rh (8 bytes): A **RecordHeader** structure (section [2.3.1](#)) that specifies the header for this record. Sub-fields are further specified in the following table.

Field	Meaning
rh.recVer	MUST be 0xF.
rh.recInstance	MUST be 0x000.
rh.recType	MUST be an RT_BlipCollection9 .

rgBlipEntityAtom (variable): An array of [BlipEntityAtom](#) record that specifies picture bullets. It MUST NOT contain more than one BlipEntityAtom record with the same value of **rh.recInstance**. The size, in bytes, of the array is specified by **rh.recLen**.

2.9.73 BlipEntityAtom

Referenced by: [BlipCollection9Container](#)

An **atom record** that specifies a picture bullet.

0	1	2	3	4	5	6	7	8	9	10	11	12	13	14	15	16	17	18	19	20	21	22	23	24	25	26	27	28	29	30	31
rh																															
...																															

winBlipType	unused	blip (variable)
...		

rh (8 bytes): A **RecordHeader** structure (section [2.3.1](#)) that specifies the header for this record. Sub-fields are further specified in the following table.

Field	Meaning
rh.recVer	MUST be 0x0.
rh.recInstance	An unsigned integer that specifies a zero-based index of a picture bullet within the collection of picture bullets specified by BlipCollection9Container (section 2.9.72). It MUST be greater than or equal to 0x000 and less than or equal to 0x080.
rh.recType	MUST be an RT_BlipEntity9Atom .

winBlipType (1 byte): An **unsigned integer** that specifies the preferred picture type. It MUST be one of the values in the following table.

Value	Meaning
0x02	Windows Enhanced Metafile [MS-EMF]
0x03	Windows Metafile [MS-WMF]
0x05	JPEG [JFIF]
0x06	PNG [RFC2083]

unused (1 byte): Undefined and MUST be ignored.

blip (variable): An **OfficeArtBStoreContainerFileBlock** ([\[MS-ODRAW\]](#) section 2.2.22) that specifies the picture data for the picture bullet.

2.9.74 TextDefaults9Atom

Referenced by: [PP9DocBinaryTagExtension](#)

An **atom record** that specifies additional default character-level and paragraph-level formatting.

0	1	2	3	4	5	6	7	8	9	10	11	12	13	14	15	16	17	18	19	20	21	22	23	24	25	26	27	28	29	30	31
rh																															
...																															
cf9 (variable)																															
...																															
pf9 (variable)																															

...

rh (8 bytes): A **RecordHeader** structure (section [2.3.1](#)) that specifies the header for this record. Sub-fields are further specified in the following table.

Field	Meaning
rh.recVer	MUST be 0x0.
rh.recInstance	MUST be 0x000.
rh.recType	MUST be an RT_TextDefaults9Atom .

cf9 (variable): A [TextCFException9](#) structure that specifies default character-level formatting.

pf9 (variable): A [TextPFException9](#) structure that specifies default paragraph-level formatting.

2.9.75 TextDefaults10Atom

Referenced by: [PP10DocBinaryTagExtension](#)

An **atom record** that specifies additional default character-level formatting.

0	1	2	3	4	5	6	7	8	9	10	1	2	3	4	5	6	7	8	9	20	1	2	3	4	5	6	7	8	9	30	1		
rh																																	
...																																	
cf10 (variable)																																	
...																																	

rh (8 bytes): A **RecordHeader** structure (section [2.3.1](#)) that specifies the header for this record. Sub-fields are further specified in the following table.

Field	Meaning
rh.recVer	MUST be 0x0.
rh.recInstance	MUST be 0x000.
rh.recType	MUST be an RT_TextDefaults10Atom .

cf10 (variable): A [TextCFException10](#) structure that specifies additional font information.

2.9.76 OfficeArtClientTextbox

A **container record** that specifies text related data for a **shape**.

0	1	2	3	4	5	6	7	8	9	10	1	2	3	4	5	6	7	8	9	20	1	2	3	4	5	6	7	8	9	30	1		
rh																																	

...
rgChildRec (variable)
...

rh (8 bytes): An **OfficeArtRecordHeader** ([\[MS-ODRAW\]](#) section 2.2.1) that specifies the header for this record. Sub-fields are further specified in the following table.

Field	Meaning
rh.recVer	MUST be 0x0.
rh.recInstance	MUST be 0x000.
rh.recType	MUST be 0xF00D.

rgChildRec (variable): An array of [TextClientDataSubContainerOrAtom](#) records that specifies text-related data. The size, in bytes, of the array is specified by **rh.recLen**. The sequence of the **rh.recType** fields of the array items MUST be a valid OfficeArtClientTextBoxAtoms as specified in the following ABNF (specified in [\[RFC5234\]](#)) grammar:

```
OfficeArtClientTextBoxAtoms = OutlineAtom / (RT_TextHeaderAtom [RT_TextCharsAtom /
RT_TextBytesAtom]TextStylePropAtom MetaCharAtom TextBookAtom TextSpecialInfoAtom
InteractiveAtom TextOrMaster)
OutlineAtom = RT_OutlineTextRefAtom [RT_TextRulerAtom]
TextStylePropAtom = *1(RT_StyleTextPropAtom / RT_MasterTextPropAtom)
MetaCharAtom = *(RT_SlideNumberMetaCharAtom / RT_DateTimeMetaCharAtom /
RT\_GenericDateMetaCharAtom / RT_HeaderMetaCharAtom / RT_FooterMetaCharAtom /
RT_RtfDateTimeMetaCharAtom)
TextBookAtom = *RT_TextBookmarkAtom
TextSpecialInfoAtom = *1RT_TextSpecialInfoAtom
InteractiveAtom = *(RT_InteractiveInfo RT_TextInteractiveInfoAtom)
TextOrMaster = *(RT_TextRulerAtom / RT_MasterTextPropAtom)
```

2.9.77 TextClientDataSubContainerOrAtom

Referenced by: [OfficeArtClientTextbox](#)

A variable type record whose type and meaning are dictated by the value of **rh.recType**, as specified in the following table.

Value	Meaning
RT_OutlineTextRefAtom	An OutlineTextRefAtom record that specifies a reference to a TextHeaderAtom record contained in the SlideListWithTextContainer record (section 2.4.14.3). The TextHeaderAtom record specifies the text for the shape that contains this record.
RT_TextHeaderAtom	A TextHeaderAtom record that specifies the type of a body of text.
RT_TextCharsAtom	A TextCharsAtom record that specifies text characters.

Value	Meaning
RT_TextBytesAtom	A TextBytesAtom record that specifies text characters.
RT_StyleTextPropAtom	A StyleTextPropAtom record that specifies text character and paragraph properties.
RT_SlideNumberMetaCharAtom	A SlideNumberMCAtom record that specifies a slide number metacharacter.
RT_DateTimeMetaCharAtom	A DateTimeMCAtom record that specifies a datetime metacharacter.
RT_GenericDateMetaCharAtom	A GenericDateMCAtom record that specifies a generic date metacharacter.
RT_HeaderMetaCharAtom	A HeaderMCAtom record that specifies a header metacharacter.
RT_FooterMetaCharAtom	A FooterMCAtom record that specifies a footer metacharacter.
RT_RtfDateTimeMetaCharAtom	A RTFDateTimeMCAtom record that specifies an RTF datetime metacharacter.
RT_TextBookmarkAtom	A TextBookmarkAtom record that specifies a text bookmark (1).
RT_TextSpecialInfoAtom	A TextSpecialInfoAtom record that specifies additional text properties.
RT_InteractiveInfo	An InteractiveInfoInstance record that specifies text interactive information.
RT_TextInteractiveInfoAtom	A TextInteractiveInfoInstance record that specifies the anchor for text interactive information.
RT_TextRulerAtom	A TextRulerAtom record that specifies a text ruler.
RT_MasterTextPropAtom	A MasterTextPropAtom record that specifies style properties for text on a master slide.

2.9.78 OutlineTextRefAtom

Referenced by: [TextClientDataSubContainerOrAtom](#)

An **atom record** that specifies a reference to text contained in the **SlideListWithTextContainer** record (section [2.4.14.3](#)). Let the *corresponding slide persist* be specified by the **SlidePersistAtom** record (section [2.4.14.5](#)) contained in the **SlideListWithTextContainer** record whose **persistIdRef** field refers to the **SlideContainer** record (section [2.5.1](#)) that contains this **OutlineTextRefAtom** record.

0	1	2	3	4	5	6	7	8	9	10	11	12	13	14	15	16	17	18	19	20	21	22	23	24	25	26	27	28	29	30	31
rh																															
...																															
index																															

rh (8 bytes): A **RecordHeader** structure (section [2.3.1](#)) that specifies the header for this record. Sub-fields are further specified in the following table.

Field	Meaning
rh.recVer	MUST be 0x0.
rh.recInstance	MUST be 0x000.
rh.recType	MUST be an RT_OutlineTextRefAtom .

Field	Meaning
rh.recLen	MUST be 0x00000004.

index (4 bytes): A **signed integer** that specifies a zero-based index into the sequence of [TextHeaderAtom](#) records that follows the *corresponding slide persist*. It MUST be greater than or equal to 0x00000000 and less than the number of TextHeaderAtom records that follow the *corresponding slide persist*.

2.9.79 MasterTextPropAtom

Referenced by: [TextClientDataSubContainerOrAtom](#)

An **atom record** that specifies the indent levels for the text.

Let the *corresponding text* be specified by the [TextHeaderAtom](#) record that most closely precedes this **MasterTextPropAtom** record.

0	1	2	3	4	5	6	7	8	9	10	11	12	13	14	15	16	17	18	19	20	21	22	23	24	25	26	27	28	29	30	31
rh																															
...																															
rgMasterTextPropRun (variable)																															
...																															

rh (8 bytes): A **RecordHeader** structure (section [2.3.1](#)) that specifies the header for this record. Sub-fields are further specified in the following table.

Field	Meaning
rh.recVer	MUST be 0x0.
rh.recInstance	MUST be 0x000.
rh.recType	MUST be an RT_MasterTextPropAtom .

rgMasterTextPropRun (variable): An array of [MasterTextPropRun](#) structures that specifies indent levels. The **count** field of each MasterTextPropRun specifies the number of characters to which the indent level applies, starting with the character at the zero-based index equal to the sum of the **count** fields of all previous MasterTextPropRun items in the array.

The sum of the **count** fields of the array items MUST be equal to the number of characters in the *corresponding text*. The length, in bytes, of the array is specified by **rh.recLen**.

2.9.80 MasterTextPropRun

Referenced by: [MasterTextPropAtom](#)

A structure that specifies the indent level for a text run.

Let the *corresponding text* be as specified in the MasterTextPropAtom record that contains this **MasterTextPropRun** structure.

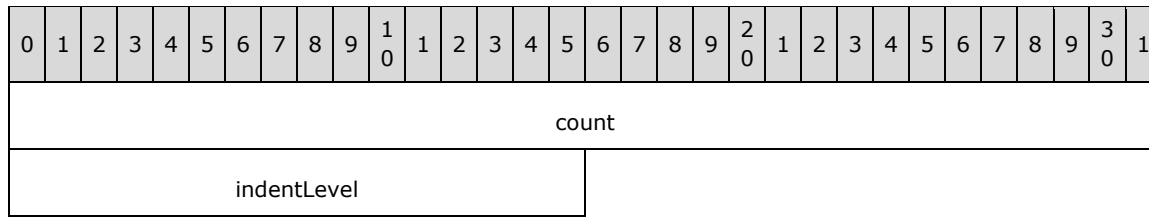

count (4 bytes): An unsigned integer that specifies the number of characters of the corresponding text to which **indentLevel** applies.

indentLevel (2 bytes): An [IndentLevel](#) that specifies the indent level of the characters.

2.10 External Object Types

2.10.1 ExObjListContainer

Referenced by: [DocumentContainer](#)

A **container record** that specifies a list of **external objects** in the document.

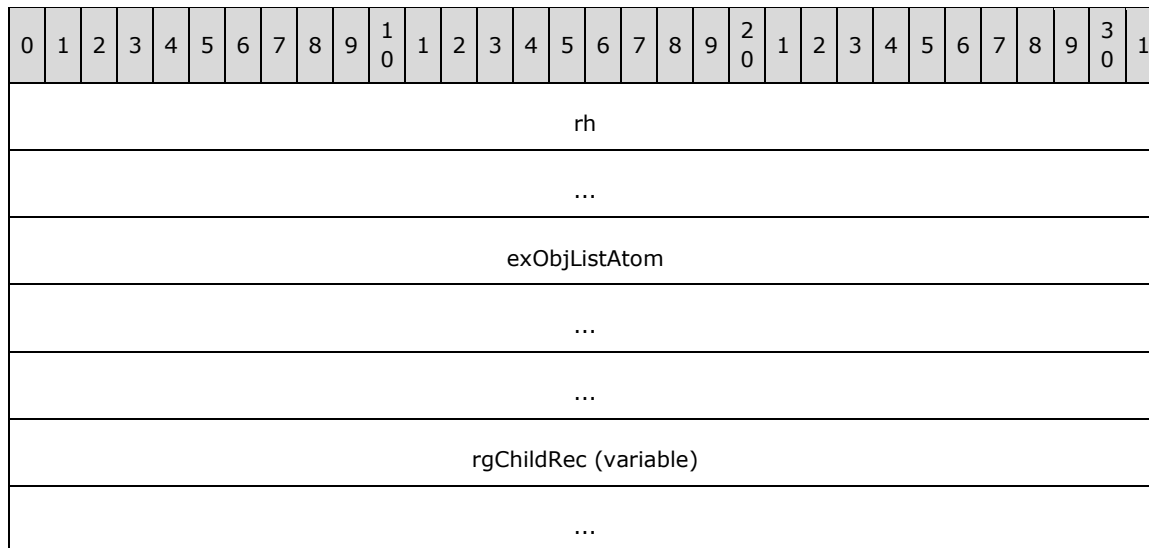

rh (8 bytes): A **RecordHeader** structure (section [2.3.1](#)) that specifies the header for this record. Sub-fields are further specified in the following table.

Field	Meaning
rh.recVer	MUST be 0xF.
rh.recInstance	MUST be 0x000.
rh.recType	MUST be an RT_ExternalObjectList .

exObjListAtom (12 bytes): An [ExObjListAtom](#) record that specifies list-specific properties.

rgChildRec (variable): An array of [ExObjListSubContainer](#) records that specifies the external objects. The length, in bytes, of the array is specified by the following formula:

$$rh.recLen - 12.$$

2.10.2 ExObjListSubContainer

Referenced by: [ExObjListContainer](#)

A variable type record whose type and meaning are dictated by the value of **rh.recType**, as specified in the following table.

Value	Meaning
RT_ExternalAviMovie	An ExAviMovieContainer record that specifies an Audio Video Interleaved (AVI) movie.
RT_ExternalCdAudio	An ExCDAudioContainer record that specifies information about CD audio.
RT_ExternalOleControl	An ExControlContainer record (section 2.10.10) that specifies an ActiveX control .
RT_ExternalHyperlink	An ExHyperlinkContainer record that specifies information about a hyperlink .
RT_ExternalMciMovie	An ExMCIMovieContainer record that specifies an MCI movie.
RT_ExternalMidiAudio	An ExMIDIAudioContainer record that specifies information about MIDI audio.
RT_ExternalOleEmbed	An ExOleEmbedContainer record (section 2.10.27) that specifies an embedded OLE object .
RT_ExternalOleLink	An ExOleLinkContainer record (section 2.10.29) that specifies a linked OLE object.
RT_ExternalWavAudioEmbedded	An ExWAVAudioEmbeddedContainer record that specifies an embedded WAV sound.
RT_ExternalWavAudioLink	An ExWAVAudioLinkContainer record that specifies a linked WAV sound.

2.10.3 ExObjListAtom

Referenced by: [ExObjListContainer](#)

An **atom record** that specifies properties for the containing **ExObjListContainer** record (section 2.10.1).

0	1	2	3	4	5	6	7	8	9	10	11	12	13	14	15	16	17	18	19	20	21	22	23	24	25	26	27	28	29	30	31
rh																															
...																															
exObjIdSeed																															

rh (8 bytes): A **RecordHeader** structure (section [2.3.1](#)) that specifies the header for this record. Sub-fields are further specified in the following table.

Field	Meaning
rh.recVer	MUST be 0x0.
rh.recInstance	MUST be 0x000.
rh.recType	MUST be an RT_ExternalObjectListAtom .
rh.recLen	MUST be 0x00000004.

exObjIdSeed (4 bytes): A signed integer that specifies a **seed** for creating a new **ExObjId** (section [2.2.7](#)) or **ExHyperlinkId** (section [2.2.5](#)) value. It MUST be greater than or equal to the largest **ExObjId** value in the file as specified by the **ExMediaAtom** record (section [2.10.6](#)) or **ExOleObjAtom** record (section [2.10.12](#)) and MUST be greater than or equal to the largest **ExHyperlinkId** value in the file as specified by the **ExHyperlinkAtom** record (section [2.10.17](#)). It MUST be greater than or equal to 0x00000001.

2.10.4 ExAviMovieContainer

Referenced by: [ExObjListSubContainer](#)

A **container record** that specifies information about an **AVI** movie.

0	1	2	3	4	5	6	7	8	9	10	11	12	13	14	15	16	17	18	19	20	21	22	23	24	25	26	27	28	29	30	31
rh																															
...																															
exVideo (variable)																															
...																															

rh (8 bytes): A **RecordHeader** structure (section [2.3.1](#)) that specifies the header for this record. Sub-fields are further specified in the following table.

Field	Meaning
rh.recVer	MUST be 0xF.
rh.recInstance	MUST be 0x000.
rh.recType	MUST be an RT_ExternalAviMovie .

exVideo (variable): An [ExVideoContainer](#) record that specifies information about the AVI movie.

2.10.5 ExVideoContainer

Referenced by: [ExAviMovieContainer](#), [ExMCIMovieContainer](#)

A **container record** that specifies information about external video data.

0	1	2	3	4	5	6	7	8	9	10	11	12	13	14	15	16	17	18	19	20	21	22	23	24	25	26	27	28	29	30	31
rh																															
...																															
exMediaAtom (16 bytes)																															
...																															

...
videoFilePathAtom (variable)
...

rh (8 bytes): A **RecordHeader** structure (section [2.3.1](#)) that specifies the header for this record. Sub-fields are further specified in the following table.

Field	Meaning
rh.recVer	MUST be 0xF.
rh.recInstance	MUST be 0x000.
rh.recType	MUST be an RT_ExternalVideo .

exMediaAtom (16 bytes): An **ExMediaAtom** record (section [2.10.6](#)) that specifies information about the external video.

videoFilePathAtom (variable): An optional [UncOrLocalPathAtom](#) record that specifies the UNC or local path to a video file. The length, in bytes, of the field is specified by the following formula:

$$rh.recLen - 16.$$

2.10.6 ExMediaAtom

Referenced by: [ExCDAudioContainer](#), [ExMIDIAudioContainer](#), [ExVideoContainer](#), [ExWAVAudioEmbeddedContainer](#), [ExWAVAudioLinkContainer](#)

An **atom record** that specifies information about external audio or video data.

0	1	2	3	4	5	6	7	8	9	10	11	12	13	14	15	16	17	18	19	20	21	22	23	24	25	26	27	28	29	30	31
rh																															
...																															
exObjId																															
A	B	C	reserved												unused																

rh (8 bytes): A **RecordHeader** structure (section [2.3.1](#)) that specifies the header for this record. Sub-fields are further specified in the following table.

Field	Meaning
rh.recVer	MUST be 0x0.
rh.recInstance	MUST be 0x000.
rh.recType	MUST be an RT_ExternalMediaAtom .
rh.recLen	MUST be 0x00000008.

exObjId (4 bytes): An **ExObjId** (section [2.2.7](#)) that specifies the identifier for the audio or video data.

A - fLoop (1 bit): A bit that specifies whether the audio or video data is repeated continuously during playback.

B - fRewind (1 bit): A bit that specifies whether the audio or video data is rewound after playing.

C - fNarration (1 bit): A bit that specifies whether the audio data is recorded narration for the **slide show**. It MUST be **FALSE** if this **ExMediaAtom** record is contained by an ExVideoContainer record.

reserved (13 bits): MUST be zero and MUST be ignored.

unused (2 bytes): Undefined and MUST be ignored.

2.10.7 UncOrLocalPathAtom

Referenced by: [ExMIDIContainer](#), [ExVideoContainer](#), [ExWAVAudioLinkContainer](#)

An **atom record** that specifies a UNC or local path to a file.

0	1	2	3	4	5	6	7	8	9	10	11	12	13	14	15	16	17	18	19	20	21	22	23	24	25	26	27	28	29	30	31
rh																															
...																															
path (variable)																															
...																															

rh (8 bytes): A **RecordHeader** structure (section [2.3.1](#)) that specifies the header for this record. Sub-fields are further specified in the following table.

Field	Meaning
rh.recVer	MUST be 0x0.
rh.recInstance	MUST be 0x000.
rh.recType	MUST be an RT_CString (section 2.13.24).
rh.recLen	MUST be an even number.

path (variable): A [UncOrLocalPath](#) that specifies the UNC or local path to a file. The length, in bytes, of the field is specified by **rh.recLen**.

2.10.8 ExCDAudioContainer

Referenced by: [ExObjListSubContainer](#)

A **container record** that specifies information about compact disc (CD) audio.

0	1	2	3	4	5	6	7	8	9	10	11	12	13	14	15	16	17	18	19	20	21	22	23	24	25	26	27	28	29	30	31
rh																															
...																															
exMediaAtom (16 bytes)																															
...																															
...																															
exCDAudioAtom (16 bytes)																															
...																															
...																															

rh (8 bytes): A **RecordHeader** structure (section [2.3.1](#)) that specifies the header for this record. Sub-fields are further specified in the following table.

Field	Meaning
rh.recVer	MUST be 0xF.
rh.recInstance	MUST be 0x000.
rh.recType	MUST be an RT_ExternalCdAudio .

exMediaAtom (16 bytes): An **ExMediaAtom** record (section [2.10.6](#)) that specifies information about the CD audio.

exCDAudioAtom (16 bytes): An [ExCDAudioAtom](#) record that specifies start and end information for the CD audio.

2.10.9 ExCDAudioAtom

Referenced by: [ExCDAudioContainer](#)

An **atom record** that specifies start and end information for a CD audio clip.

0	1	2	3	4	5	6	7	8	9	10	11	12	13	14	15	16	17	18	19	20	21	22	23	24	25	26	27	28	29	30	31
rh																															
...																															
start																															
end																															

rh (8 bytes): A **RecordHeader** structure (section [2.3.1](#)) that specifies the header for this record. Sub-fields are further specified in the following table.

Field	Meaning
rh.recVer	MUST be 0x0.
rh.recInstance	MUST be 0x000.
rh.recType	MUST be an RT_ExternalCdAudioAtom .
rh.recLen	MUST be 0x00000008.

start (4 bytes): A [TmsfTimeStruct](#) structure that specifies the beginning of the CD audio clip. It MUST be less than or equal to the value specified by **end**.

end (4 bytes): A [TmsfTimeStruct](#) structure that specifies the end of the CD audio clip. It MUST be greater than or equal to the value specified by **start**.

2.10.10 ExControlContainer

Referenced by: [ExObjListSubContainer](#)

A **container record** that specifies information about an **ActiveX control**.

0	1	2	3	4	5	6	7	8	9	10	11	12	13	14	15	16	17	18	19	20	21	22	23	24	25	26	27	28	29	30	31
rh																															
...																															
exControlAtom																															
...																															
...																															
exOleObjAtom (32 bytes)																															
...																															
...																															
menuNameAtom (variable)																															
...																															
progIdAtom (variable)																															
...																															
clipboardNameAtom (variable)																															

...
metafile (variable)
...

rh (8 bytes): A **RecordHeader** structure (section [2.3.1](#)) that specifies the header for this record. Sub-fields are further specified in the following table.

Field	Meaning
rh.recVer	MUST be 0xF.
rh.recInstance	MUST be 0x000.
rh.recType	MUST be an RT_ExternalOleControl .

exControlAtom (12 bytes): An [ExControlAtom](#) record that specifies the identifying information for this ActiveX control.

exOleObjAtom (32 bytes): An **ExOleObjAtom** record (section [2.10.12](#)) that specifies information about this ActiveX control as an **OLE object**.

menuNameAtom (variable): An optional [MenuNameAtom](#) record that specifies the name to use in the user interface.

progIdAtom (variable): An optional [ProgIDAtom](#) record that specifies the **ProgID** (described in [\[MSDN-COM\]](#)) of the ActiveX control.

clipboardNameAtom (variable): An optional [ClipboardNameAtom](#) record that specifies the name used by the user interface during copy and paste operations.

metafile (variable): An optional [MetafileBlob](#) record that specifies the icon for the ActiveX control.

2.10.11 ExControlAtom

Referenced by: [ExControlContainer](#)

An **atom record** that specifies an **ActiveX control**.

0	1	2	3	4	5	6	7	8	9	10	11	12	13	14	15	16	17	18	19	20	21	22	23	24	25	26	27	28	29	30	31
rh																															
...																															
slideIdRef																															

rh (8 bytes): A **RecordHeader** structure (section [2.3.1](#)) that specifies the header for this record. Sub-fields are further specified in the following table.

Field	Meaning
rh.recVer	MUST be 0x0.
rh.recInstance	MUST be 0x000.

Field	Meaning
rh.recType	MUST be an RT ExternalOleControlAtom .
rh.recLen	MUST be 0x00000004.

slideIdRef (4 bytes): A **SlideIdRef** (section [2.2.25](#)) that specifies which **presentation slide** is associated with the ActiveX control.

2.10.12 ExOleObjAtom

Referenced by: [ExControlContainer](#), [ExOleEmbedContainer](#), [ExOleLinkContainer](#)

An **atom record** that specifies information about **OLE objects**. Each **ExOleObjAtom** MUST be referred to by exactly one [ExObjRefAtom](#).

0	1	2	3	4	5	6	7	8	9	10	11	12	13	14	15	16	17	18	19	20	21	22	23	24	25	26	27	28	29	30	31
rh																															
...																															
drawAspect																															
type																															
exObjId																															
subType																															
persistIdRef																															
unused																															

rh (8 bytes): A **RecordHeader** structure (section [2.3.1](#)) that specifies the header for this record. Sub-fields are further specified in the following table.

Field	Meaning
rh.recVer	MUST be 0x1.
rh.recInstance	MUST be 0x000.
rh.recType	MUST be an RT ExternalOleObjectAtom .
rh.recLen	MUST be 0x00000018.

drawAspect (4 bytes): A **DataViewAspectEnum** ([\[MS-OSHARED\]](#) section 2.2.1.2) that specifies the view aspect used to display the OLE object.

type (4 bytes): An [ExOleObjTypeEnum](#) enumeration that specifies the type of OLE object.

exObjId (4 bytes): An **ExObjId** (section [2.2.7](#)) that specifies a unique identifier for the OLE object.

subType (4 bytes): An [ExOleObjSubTypeEnum](#) enumeration that specifies the sub-type of the OLE object.

persistIdRef (4 bytes): A **PersistIdRef** (section [2.2.21](#)) that specifies the value to look up in the **persist object directory** to find the offset of an **ExOleObjStg** (section [2.10.34](#)) or an **ExControlStg** (section [2.10.37](#)).

unused (4 bytes): Undefined and MUST be ignored.

2.10.13 MenuNameAtom

Referenced by: [ExControlContainer](#), [ExOleEmbedContainer](#), [ExOleLinkContainer](#)

An **atom record** that specifies the short name of an **OLE object** or an **ActiveX control**.

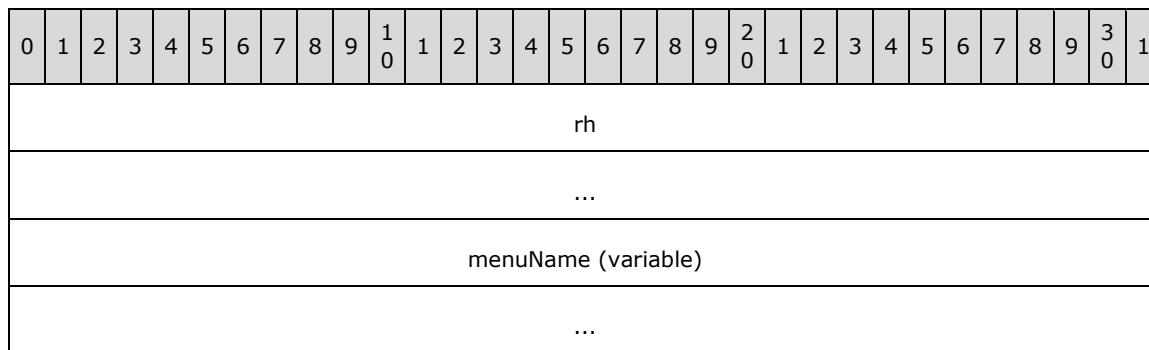

rh (8 bytes): A **RecordHeader** structure (section [2.3.1](#)) that specifies the header for this record. Sub-fields are further specified in the following table.

Field	Meaning
rh.recVer	MUST be 0x0.
rh.recInstance	MUST be 0x001.
rh.recType	MUST be an RT_CString (section 2.13.24).
rh.recLen	MUST be even.

menuName (variable): A [UnicodeString](#) that specifies the name. The length, in bytes, of the field is specified by **rh.recLen**.

2.10.14 ProgIDAtom

Referenced by: [ExControlContainer](#), [ExOleEmbedContainer](#), [ExOleLinkContainer](#)

An **atom record** that specifies the programmatic identifier of an **OLE object** or an **ActiveX control**. A **ProgID** (described in [\[MSDN-COM\]](#)), a programmatic identifier, is a string that uniquely identifies a class.

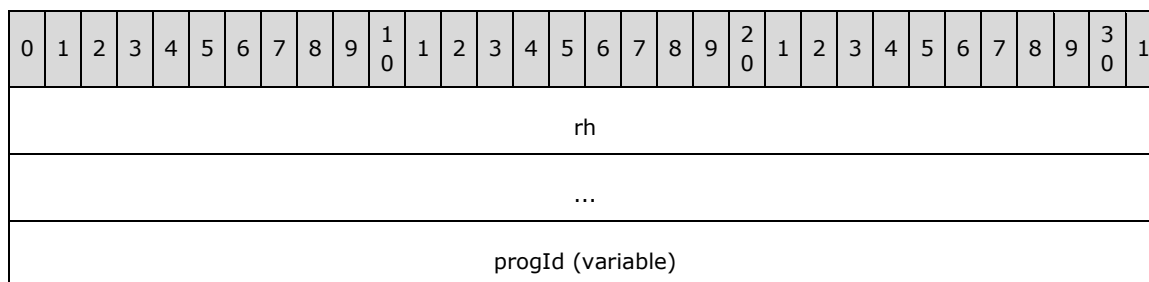

...

rh (8 bytes): A **RecordHeader** structure (section [2.3.1](#)) that specifies the header for this record. Sub-fields are further specified in the following table.

Field	Meaning
rh.recVer	MUST be 0x0.
rh.recInstance	MUST be 0x002.
rh.recType	MUST be an RT_CString (section 2.13.24).
rh.recLen	MUST be even.

progId (variable): A **PrintableUnicodeString** (section [2.2.23](#)) that specifies the **ProgID**. The length, in bytes, of the field is specified by **rh.recLen**.

2.10.15 ClipboardNameAtom

Referenced by: [ExControlContainer](#), [ExOleEmbedContainer](#), [ExOleLinkContainer](#)

An **atom record** that specifies the full descriptive class name of an **OLE object** or an **ActiveX control**.

0	1	2	3	4	5	6	7	8	9	10	11	12	13	14	15	16	17	18	19	20	21	22	23	24	25	26	27	28	29	30	31
rh																															
...																															
clipboardName (variable)																															
...																															

rh (8 bytes): A **RecordHeader** structure (section [2.3.1](#)) that specifies the header for this record. Sub-fields are further specified in the following table.

Field	Meaning
rh.recVer	MUST be 0x0.
rh.recInstance	MUST be 0x003.
rh.recType	MUST be an RT_CString (section 2.13.24).
rh.recLen	MUST be even.

clipboardName (variable): A **PrintableUnicodeString** (section [2.2.23](#)) that specifies the full descriptive class name. The length, in bytes, of the field is specified by **rh.recLen**.

2.10.16 ExHyperlinkContainer

Referenced by: [ExObjListSubContainer](#)

A **container record** that specifies information about a **hyperlink**.

0	1	2	3	4	5	6	7	8	9	10	11	12	13	14	15	16	17	18	19	20	21	22	23	24	25	26	27	28	29	30	31
rh																															
...																															
exHyperlinkAtom																															
...																															
...																															
friendlyNameAtom (variable)																															
...																															
targetAtom (variable)																															
...																															
locationAtom (variable)																															
...																															

rh (8 bytes): A **RecordHeader** structure (section [2.3.1](#)) that specifies the header for this record. Sub-fields are further specified in the following table.

Field	Meaning
rh.recVer	MUST be 0xF.
rh.recInstance	MUST be 0x000.
rh.recType	MUST be an RT_ExternalHyperlink .

exHyperlinkAtom (12 bytes): An **ExHyperlinkAtom** record (section [2.10.17](#)) that specifies information needed to identify this hyperlink.

friendlyNameAtom (variable): An optional [FriendlyNameAtom](#) record that specifies the user-readable name of this hyperlink.

targetAtom (variable): An optional [TargetAtom](#) record that specifies the full path of the destination file of this hyperlink.

locationAtom (variable): An optional [LocationAtom](#) record that specifies the location within the destination file of the hyperlink.

2.10.17 ExHyperlinkAtom

Referenced by: [ExHyperlinkContainer](#)

An **atom record** that specifies the value needed to look up a **hyperlink** within the collection of external objects as specified by the **ExObjListContainer** record (section [2.10.1](#)).

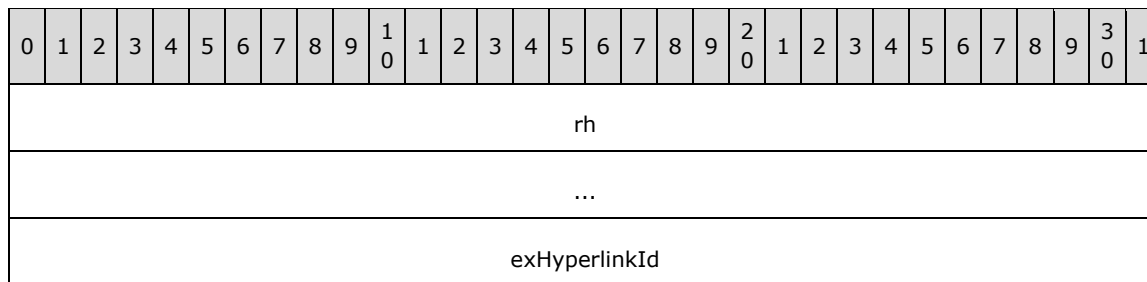

rh (8 bytes): A **RecordHeader** structure (section [2.3.1](#)) that specifies the header for this record. Sub-fields are further specified in the following table.

Field	Meaning
rh.recVer	MUST be 0x0.
rh.recInstance	MUST be 0x000.
rh.recType	MUST be an RT_ExternalHyperlinkAtom .
rh.recLen	MUST be 0x00000004.

exHyperlinkId (4 bytes): An **ExHyperlinkId** (section [2.2.5](#)) that specifies the identifier of this hyperlink.

2.10.18 FriendlyNameAtom

Referenced by: [ExHyperlinkContainer](#)

An **atom record** that specifies the user-readable name of a **hyperlink**.

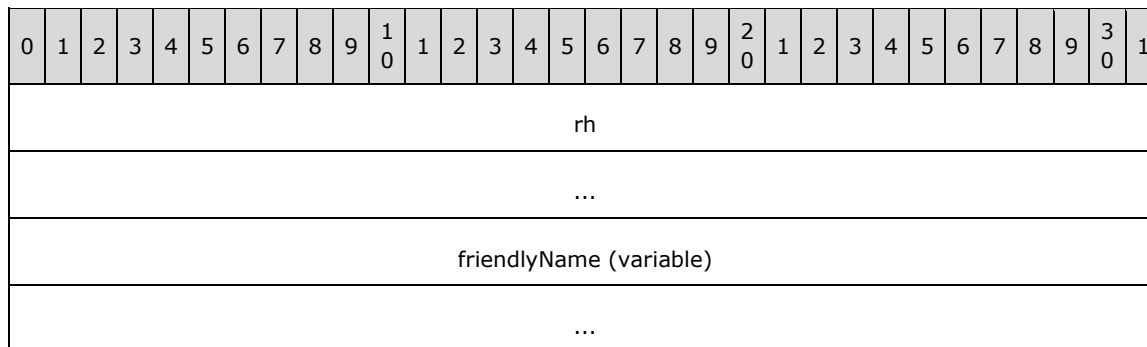

rh (8 bytes): A **RecordHeader** structure (section [2.3.1](#)) that specifies the header for this record. Sub-fields are further specified in the following table.

Field	Meaning
rh.recVer	MUST be 0x0.
rh.recInstance	MUST be 0x000.
rh.recType	MUST be an RT_CString (section 2.13.24).
rh.recLen	MUST be even.

friendlyName (variable): A [UnicodeString](#) that specifies the user-readable name. The length, in bytes, of the field is specified by **rh.recLen**.

2.10.19 TargetAtom

Referenced by: [ExHyperlinkContainer](#)

An **atom record** that specifies the full path of the **hyperlink** destination file.

0	1	2	3	4	5	6	7	8	9	10	11	12	13	14	15	16	17	18	19	20	21	22	23	24	25	26	27	28	29	30	31
rh																															
...																															
target (variable)																															
...																															

rh (8 bytes): A **RecordHeader** structure (section [2.3.1](#)) that specifies the header for this record. Sub-fields are further specified in the following table.

Field	Meaning
rh.recVer	MUST be 0x0.
rh.recInstance	MUST be 0x001.
rh.recType	MUST be an RT_CString (section 2.13.24).
rh.recLen	MUST be even.

target (variable): A [UnicodeString](#) that specifies the full path of the destination file. The length, in bytes, of the field is specified by **rh.recLen**.

2.10.20 LocationAtom

Referenced by: [ExHyperlinkContainer](#)

An **atom record** that specifies the location of the **hyperlink** within the destination file.

0	1	2	3	4	5	6	7	8	9	10	11	12	13	14	15	16	17	18	19	20	21	22	23	24	25	26	27	28	29	30	31
rh																															
...																															
location (variable)																															
...																															

rh (8 bytes): A **RecordHeader** structure (section [2.3.1](#)) that specifies the header for this record. Sub-fields are further specified in the following table.

Field	Meaning
rh.recVer	MUST be 0x0.
rh.recInstance	MUST be 0x003.

Field	Meaning
rh.recType	MUST be an RT_CString (section 2.13.24).
rh.recLen	MUST be even.

location (variable): A [UnicodeString](#) that specifies the location within the destination file. The length, in bytes, of the field is specified by **rh.recLen**.

2.10.21 ExHyperlink9Container

Referenced by: [PP9DocBinaryTagExtension](#)

A **container record** that specifies additional information about a **hyperlink**.

0	1	2	3	4	5	6	7	8	9	10	11	12	13	14	15	16	17	18	19	20	21	22	23	24	25	26	27	28	29	30	31
rh																															
...																															
exHyperlinkRefAtom																															
...																															
...																															
screenTipAtom (variable)																															
...																															
exHyperlinkFlagsAtom																															
...																															
...																															

rh (8 bytes): A **RecordHeader** structure (section [2.3.1](#)) that specifies the header for this record. Sub-fields are further specified in the following table.

Field	Meaning
rh.recVer	MUST be 0xF.
rh.recInstance	MUST be 0x000.
rh.recType	MUST be an RT_ExternalHyperlink9 .

exHyperlinkRefAtom (12 bytes): An [ExHyperlinkRefAtom](#) record that specifies a reference to the corresponding hyperlink.

screenTipAtom (variable): An optional [ScreenTipAtom](#) record that specifies the screen tip of the corresponding hyperlink.

exHyperlinkFlagsAtom (12 bytes): An [ExHyperlinkFlagsAtom](#) record that specifies additional information about the corresponding hyperlink.

2.10.22 ExHyperlinkRefAtom

Referenced by: [ExHyperlink9Container](#)

An atom record that specifies a reference to a **hyperlink**.

0	1	2	3	4	5	6	7	8	9	10	11	12	13	14	15	16	17	18	19	20	21	22	23	24	25	26	27	28	29	30	31
rh																															
...																															
exHyperlinkIdRef																															

rh (8 bytes): A **RecordHeader** structure (section [2.3.1](#)) that specifies the header for this record. Sub-fields are further specified in the following table.

Field	Meaning
rh.recVer	MUST be 0x0.
rh.recInstance	MUST be 0x000.
rh.recType	MUST be an RT_ExternalHyperlinkAtom .
rh.recLen	MUST be 0x00000004.

exHyperlinkIdRef (4 bytes): An [ExHyperlinkIdRef](#) that specifies an identifier that references the corresponding hyperlink.

2.10.23 ScreenTipAtom

Referenced by: [ExHyperlink9Container](#)

An **atom record** that specifies the screen tip of a **hyperlink**.

0	1	2	3	4	5	6	7	8	9	10	11	12	13	14	15	16	17	18	19	20	21	22	23	24	25	26	27	28	29	30	31
rh																															
...																															
screenTip (variable)																															
...																															

rh (8 bytes): A **RecordHeader** structure (section [2.3.1](#)) that specifies the header for this record. Sub-fields are further specified in the following table.

Field	Meaning
rh.recVer	MUST be 0x0.

Field	Meaning
rh.recInstance	MUST be 0x000.
rh.recType	MUST be an RT_CString (section 2.13.24).
rh.recLen	MUST be even.

screenTip (variable): A [UnicodeString](#) that specifies the screen tip. The length, in bytes, of the field is specified by **rh.recLen**.

2.10.24 ExHyperlinkFlagsAtom

Referenced by: [ExHyperlink9Container](#)

An **atom record** that specifies additional information about a **hyperlink**.

0	1	2	3	4	5	6	7	8	9	10	11	12	13	14	15	16	17	18	19	20	21	22	23	24	25	26	27	28	29	30	31
rh																															
...																															
A	B	C	reserved																												

rh (8 bytes): A **RecordHeader** structure (section [2.3.1](#)) that specifies the header for this record. Sub-fields are further specified in the following table.

Field	Meaning
rh.recVer	MUST be 0x0.
rh.recInstance	MUST be 0x000.
rh.recType	MUST be an RT_ExternalHyperlinkFlagsAtom .
rh.recLen	MUST be 0x00000004.

A - fInsertHyperlinkDialog (1 bit): A bit that specifies whether this hyperlink was created in the **Insert Hyperlink** dialog box.

B - fLocationIsNamedShow (1 bit): A bit that specifies whether the location of this hyperlink is a **named show**.

C - fNameShowReturnToSlide (1 bit): A bit that specifies whether this hyperlink to a named show was set to return to the slide.

reserved (29 bits): MUST be zero and MUST be ignored.

2.10.25 ExMCIMovieContainer

Referenced by: [ExObjListSubContainer](#)

A **container record** that specifies information about a movie stored externally as a **Media Control Interface (MCI)** file.

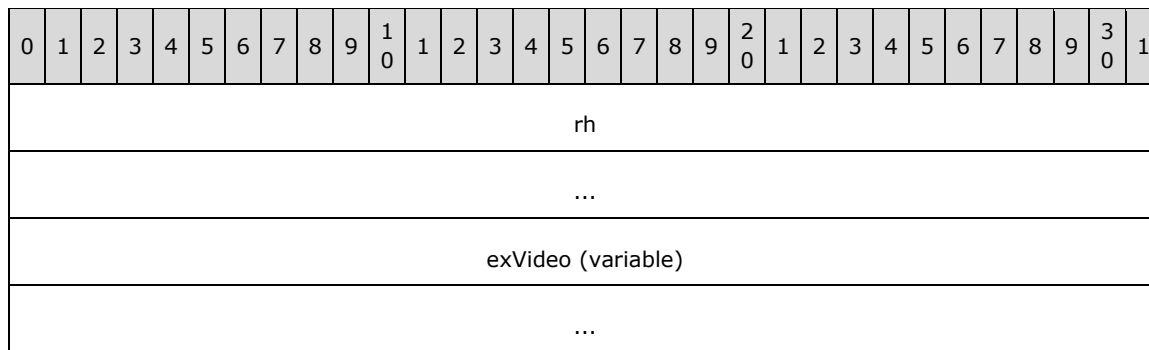

rh (8 bytes): A **RecordHeader** structure (section [2.3.1](#)) that specifies the header for this record. Sub-fields are further specified in the following table.

Field	Meaning
rh.recVer	MUST be 0xF.
rh.recInstance	MUST be 0x000.
rh.recType	MUST be an RT_ExternalMciMovie .

exVideo (variable): An [ExVideoContainer](#) record that specifies information about the MCI movie.

2.10.26 ExMIDIAudioContainer

Referenced by: [ExObjListSubContainer](#)

A **container record** that specifies information about audio stored externally as a **Musical Instrument Digital Interface (MIDI)** file.

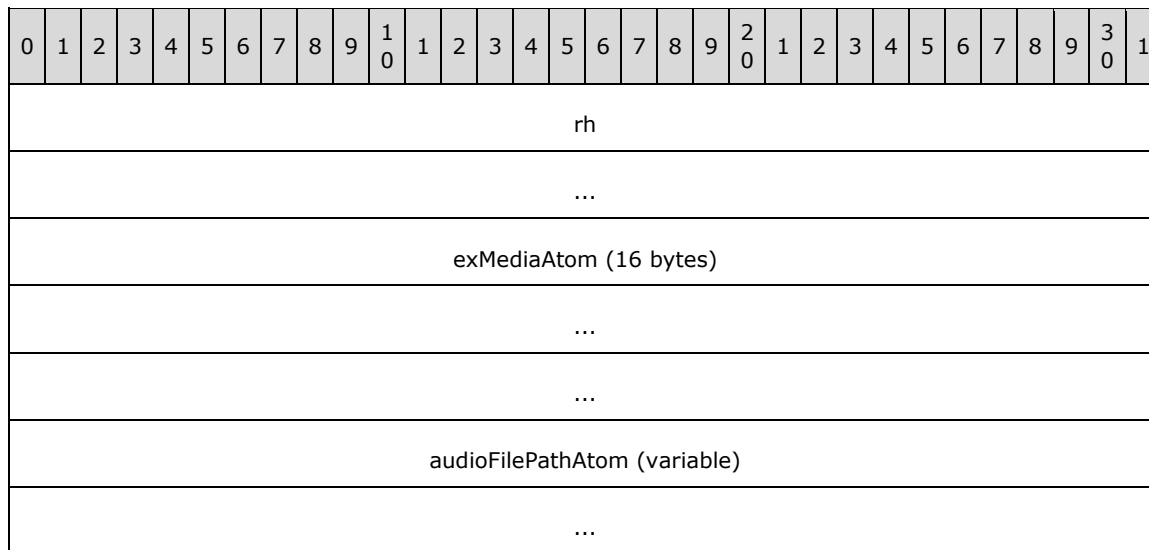

rh (8 bytes): A **RecordHeader** structure (section [2.3.1](#)) that specifies the header for this record. Sub-fields are further specified in the following table.

Field	Meaning
rh.recVer	MUST be 0xF.
rh.recInstance	MUST be 0x000.

Field	Meaning
rh.recType	MUST be an RT_ExternalMidiAudio .

exMediaAtom (16 bytes): An **ExMediaAtom** record (section [2.10.6](#)) that specifies information about the external MIDI audio.

audioFilePathAtom (variable): An optional [UncOrLocalPathAtom](#) record that specifies the UNC or local path to a MIDI audio file. The length, in bytes, of the field is specified by the following formula:

$$rh.recLen - 16.$$

2.10.27 ExOleEmbedContainer

Referenced by: [ExObjListSubContainer](#)

A **container record** that specifies information about an embedded **OLE object**.

0	1	2	3	4	5	6	7	8	9	10	11	12	13	14	15	16	17	18	19	20	21	22	23	24	25	26	27	28	29	30	31
rh																															
...																															
exOleEmbedAtom (16 bytes)																															
...																															
...																															
exOleObjAtom (32 bytes)																															
...																															
...																															
menuNameAtom (variable)																															
...																															
progIdAtom (variable)																															
...																															
clipboardNameAtom (variable)																															
...																															
metafile (variable)																															

...

rh (8 bytes): A **RecordHeader** structure (section [2.3.1](#)) that specifies the header for this record. Sub-fields are further specified in the following table.

Field	Meaning
rh.recVer	MUST be 0xF.
rh.recInstance	MUST be 0x000.
rh.recType	MUST be an RT_ExternalOleEmbed .

exOleEmbedAtom (16 bytes): An [ExOleEmbedAtom](#) record that specifies information about embedding an OLE object.

exOleObjAtom (32 bytes): An **ExOleObjAtom** record (section [2.10.12](#)) that specifies information about the OLE object.

menuNameAtom (variable): An optional [MenuNameAtom](#) record that specifies the name to use in the user interface.

progIdAtom (variable): An optional [ProgIDAtom](#) record that specifies the **ProgID** (described in [\[MSDN-COM\]](#)) of the OLE object.

clipboardNameAtom (variable): An optional [ClipboardNameAtom](#) record that specifies the name used by the user interface during copy and paste operations.

metafile (variable): An optional [MetafileBlob](#) record that specifies the icon for the OLE object.

2.10.28 ExOleEmbedAtom

Referenced by: [ExOleEmbedContainer](#)

An **atom record** that specifies preferences for embedding an **OLE object**.

0	1	2	3	4	5	6	7	8	9	10	11	12	13	14	15	16	17	18	19	20	21	22	23	24	25	26	27	28	29	30	31
rh																															
...																															
exColorFollow																															
fCantLockServer								fNoSizeToServer								fIsTable								unused							

rh (8 bytes): A **RecordHeader** structure (section [2.3.1](#)) that specifies the header for this record. Sub-fields are further specified in the following table.

Field	Meaning
rh.recVer	MUST be 0x0.
rh.recInstance	MUST be 0x000.
rh.recType	MUST be an RT_ExternalOleEmbedAtom .
rh.recLen	MUST be 0x00000008.

exColorFollow (4 bytes): An [ExColorFollowEnum](#) enumeration that specifies how the OLE object follows the color scheme of the containing document.

fCantLockServer (1 byte): A **bool1** (section [2.2.2](#)) that specifies whether the **OLE** server for the embedded OLE object cannot be locked.

fNoSizeToServer (1 byte): A byte that specifies whether sending the OLE object dimensions to the OLE server can be omitted. It SHOULD [<108>](#) be a value from the following table.

Value	Meaning
0x00	Do send the dimensions to the OLE server.
0x01	Do not send the dimension to the OLE server.

fIsTable (1 byte): A **bool1** that specifies whether the OLE object represents a table created by **ProgID** (described in [\[MSDN-COM\]](#)) **Word.Document**. It SHOULD [<109>](#) be ignored.

unused (1 byte): Undefined and MUST be ignored.

2.10.29 ExOleLinkContainer

Referenced by: [ExObjListSubContainer](#)

A **container record** that specifies information about a linked **OLE object**.

0	1	2	3	4	5	6	7	8	9	10	11	12	13	14	15	16	17	18	19	20	21	22	23	24	25	26	27	28	29	30	31
rh																															
...																															
exOleLinkAtom (20 bytes)																															
...																															
...																															
exOleObjAtom (32 bytes)																															
...																															
...																															
menuNameAtom (variable)																															
...																															
progIdAtom (variable)																															
...																															

clipboardNameAtom (variable)
...
metafile (variable)
...

rh (8 bytes): A **RecordHeader** structure (section [2.3.1](#)) that specifies the header for this record. Sub-fields are further specified in the following table.

Field	Meaning
rh.recVer	MUST be 0xF.
rh.recInstance	MUST be 0x000.
rh.recType	MUST be an RT_ExternalOleLink .

exOleLinkAtom (20 bytes): An [ExOleLinkAtom](#) record that specifies OLE object linking information.

exOleObjAtom (32 bytes): An **ExOleObjAtom** record (section [2.10.12](#)) that specifies information about the linked OLE object.

menuNameAtom (variable): An optional [MenuNameAtom](#) record that specifies the name to use in the user interface.

progIdAtom (variable): An optional [ProgIDAtom](#) record that specifies the **ProgID** (described in [\[MSDN-COM\]](#)) of the OLE object.

clipboardNameAtom (variable): An optional [ClipboardNameAtom](#) record that specifies the name used by the user interface during copy and paste operations.

metafile (variable): An optional [MetafileBlob](#) record that specifies the icon for the OLE object.

2.10.30 ExOleLinkAtom

Referenced by: [ExOleLinkContainer](#)

An **atom record** that specifies information about a linked **OLE object**.

0	1	2	3	4	5	6	7	8	9	10	11	12	13	14	15	16	17	18	19	20	21	22	23	24	25	26	27	28	29	30	31
rh																															
...																															
slideIdRef																															
oleUpdateMode																															
unused																															

rh (8 bytes): A **RecordHeader** structure (section [2.3.1](#)) that specifies the header for this record. Sub-fields are further specified in the following table.

Field	Meaning
rh.recVer	MUST be 0x0.
rh.recInstance	MUST be 0x000.
rh.recType	MUST be an RT_ExternalOleLinkAtom .
rh.recLen	MUST be 0x0000000C.

slideIdRef (4 bytes): A **SlideIdRef** (section [2.2.25](#)) that specifies the **presentation slide** associated with this OLE object.

oleUpdateMode (4 bytes): An **ObjectUpdateEnum** ([\[MS-OSHARED\]](#) section 2.2.1.1) that specifies how the OLE object is updated.

unused (4 bytes): Undefined and MUST be ignored.

2.10.31 ExWAVAudioEmbeddedContainer

Referenced by: [ExObjListSubContainer](#)

A **container record** that specifies information about embedded **WAV** audio.

0	1	2	3	4	5	6	7	8	9	10	11	12	13	14	15	16	17	18	19	20	21	22	23	24	25	26	27	28	29	30	31
rh																															
...																															
exMedia (16 bytes)																															
...																															
...																															
exWavAudioEmbedded (16 bytes)																															
...																															
...																															

rh (8 bytes): A **RecordHeader** structure (section [2.3.1](#)) that specifies the header for this record. Sub-fields are further specified in the following table.

Field	Meaning
rh.recVer	MUST be 0xF.
rh.recInstance	MUST be 0x000.
rh.recType	MUST be an RT_ExternalWavAudioEmbedded .
rh.recLen	MUST be 0x20.

exMedia (16 bytes): An **ExMediaAtom** record (section [2.10.6](#)) that specifies information about the WAV audio.

exWavAudioEmbedded (16 bytes): An [ExWAVAudioEmbeddedAtom](#) record that specifies information about an embedded WAV audio in the **SoundCollectionContainer** record (section [2.4.16.1](#)).

2.10.32 ExWAVAudioEmbeddedAtom

Referenced by: [ExWAVAudioEmbeddedContainer](#)

An **atom record** that specifies information about an embedded **WAV** audio.

0	1	2	3	4	5	6	7	8	9	10	1	2	3	4	5	6	7	8	9	20	1	2	3	4	5	6	7	8	9	30	1
rh																															
...																															
soundIdRef																															
soundLength																															

rh (8 bytes): A **RecordHeader** structure (section [2.3.1](#)) that specifies the header for this record. Sub-fields are further specified in the following table.

Field	Meaning
rh.recVer	MUST be 0x1.
rh.recInstance	MUST be 0x001.
rh.recType	MUST be an RT_ExternalWavAudioEmbeddedAtom .
rh.recLen	MUST be 0x00000008.

soundIdRef (4 bytes): A [SoundIdRef](#) that specifies the value to look up in the **SoundCollectionContainer** record (section [2.4.16.1](#)) to find the embedded audio.

soundLength (4 bytes): A signed integer that specifies the duration, in milliseconds, for which to play the audio. It MUST be greater than or equal to 0x00000000.

2.10.33 ExWAVAudioLinkContainer

Referenced by: [ExObjListSubContainer](#)

A **container record** that specifies information about external **WAV** audio.

0	1	2	3	4	5	6	7	8	9	10	1	2	3	4	5	6	7	8	9	20	1	2	3	4	5	6	7	8	9	30	1
rh																															
...																															

exMedia (16 bytes)
...
...
audioFilePathAtom (variable)
...

rh (8 bytes): A **RecordHeader** structure (section [2.3.1](#)) that specifies the header for this record. Sub-fields are further specified in the following table.

Field	Meaning
rh.recVer	MUST be 0xF.
rh.recInstance	MUST be 0x000.
rh.recType	MUST be an RT_ExternalWavAudioLink .

exMedia (16 bytes): An **ExMediaAtom** record (section [2.10.6](#)) that specifies information about the external WAV audio.

audioFilePathAtom (variable): An optional [UncOrLocalPathAtom](#) record that specifies the UNC or local path to a WAV audio file. The length, in bytes, of the field is specified by the following formula:

`rh.recLen - 16.`

2.10.34 ExOleObjStg

A variable type record whose type and meaning are specified by the value of the **rh.recInstance** field of the contained storage, as specified in the following table.

Value	Meaning
0x000	An ExOleObjStgUncompressedAtom record that specifies an uncompressed OLE object .
0x001	An ExOleObjStgCompressedAtom record that specifies a compressed OLE object.

2.10.35 ExOleObjStgUncompressedAtom

Referenced by: [ExOleObjStg](#)

An **atom record** that specifies an uncompressed storage of an **OLE object**.

0	1	2	3	4	5	6	7	8	9	10	11	12	13	14	15	16	17	18	19	20	21	22	23	24	25	26	27	28	29	30	31
rh																															
...																															

oleStgUncompressed (variable)
...

rh (8 bytes): A **RecordHeader** structure (section [2.3.1](#)) that specifies the header for this record. Sub-fields are further specified in the following table.

Field	Meaning
rh.recVer	MUST be 0x0.
rh.recInstance	MUST be 0x000.
rh.recType	MUST be an RT_ExternalOleObjectStg .

oleStgUncompressed (variable): An array of bytes that specifies a structured storage (described in [\[MSDN-COM\]](#)) for the OLE object. The length, in bytes, of the field is specified by **rh.recLen**.

2.10.36 ExOleObjStgCompressedAtom

Referenced by: [ExOleObjStg](#)

An **atom record** that specifies a compressed storage for an **OLE object**.

0	1	2	3	4	5	6	7	8	9	10	11	12	13	14	15	16	17	18	19	20	21	22	23	24	25	26	27	28	29	30	31
rh																															
...																															
decompressedSize																															
oleStgCompressed (variable)																															
...																															

rh (8 bytes): A **RecordHeader** structure (section [2.3.1](#)) that specifies the header for this record. Sub-fields are further specified in the following table.

Field	Meaning
rh.recVer	MUST be 0x0.
rh.recInstance	MUST be 0x001.
rh.recType	MUST be an RT_ExternalOleObjectStg .

decompressedSize (4 bytes): An **unsigned integer** that specifies the length, in bytes, of the storage after decompression.

oleStgCompressed (variable): An array of bytes that specifies a compressed structured storage (described in [\[MSDN-COM\]](#)) for the OLE object. The original bytes of the storage are compressed by the algorithm specified in [\[RFC1950\]](#) and are decompressed by the algorithm specified in [\[RFC1951\]](#). The length, in bytes, of the field is specified by the following formula:

2.10.37 ExControlStg

A variable type record whose type and meaning are specified by the value of the record header member **rh.recInstance** of the contained storage, as specified in the following table.

Value	Meaning
0x000	An ExControlStgUncompressedAtom record that specifies an uncompressed storage for an ActiveX control .
0x001	An ExControlStgCompressedAtom record that specifies a compressed storage for an ActiveX control.

2.10.38 ExControlStgUncompressedAtom

Referenced by: [ExControlStg](#)

An **atom record** that specifies information about the uncompressed storage of an **ActiveX control**.

0	1	2	3	4	5	6	7	8	9	10	11	12	13	14	15	16	17	18	19	20	21	22	23	24	25	26	27	28	29	30	31
rh																															
...																															
pptControlStgUncompressed (variable)																															
...																															

rh (8 bytes): A **RecordHeader** structure (section [2.3.1](#)) that specifies the header for this record. Sub-fields are further specified in the following table.

Field	Meaning
rh.recVer	MUST be 0x0.
rh.recInstance	MUST be 0x000.
rh.recType	MUST be an RT_ExternalOleObjectStg .

pptControlStgUncompressed (variable): An array of bytes that specifies a structured storage (described in [\[MSDN-COM\]](#)) for the ActiveX control. Office Forms ActiveX controls are specified in [\[MS-OFORMS\]](#). The length, in bytes, of the field is specified by **rh.recLen**.

2.10.39 ExControlStgCompressedAtom

Referenced by: [ExControlStg](#)

An **atom record** that specifies information about the compressed storage for an **ActiveX control**.

0	1	2	3	4	5	6	7	8	9	10	11	12	13	14	15	16	17	18	19	20	21	22	23	24	25	26	27	28	29	30	31
rh																															
...																															
decompressedSize																															
pptControlStgCompressed (variable)																															
...																															

rh (8 bytes): A **RecordHeader** structure (section [2.3.1](#)) that specifies the header for this record. Sub-fields are further specified in the following table.

Field	Meaning
rh.recVer	MUST be 0x0.
rh.recInstance	MUST be 0x001.
rh.recType	MUST be an RT_ExternalOleObjectStg .

decompressedSize (4 bytes): An unsigned integer that specifies the length, in bytes, of the storage after decompression.

pptControlStgCompressed (variable): An array of bytes that specifies a compressed structured storage (described in [\[MSDN-COM\]](#)) for the ActiveX control. Office Forms ActiveX controls are specified in [\[MS-OFORMS\]](#). The original bytes of the storage are compressed by the algorithm specified in [\[RFC1950\]](#) and are decompressed by the algorithm specified in [\[RFC1951\]](#). The length, in bytes, of the field is specified by the following formula:

`rh.recLen - 4.`

2.10.40 VbaProjectStg

A variable type record whose type and meaning are dictated by the value of the record header member **rh.recInstance** of the contained storage, as specified in the following table.

Value	Meaning
0x000	A VbaProjectStgUncompressedAtom record that specifies uncompressed storage for a VBA project .
0x001	A VbaProjectStgCompressedAtom record that specifies compressed storage for a VBA project.

2.10.41 VbaProjectStgUncompressedAtom

Referenced by: [VbaProjectStg](#)

An **atom record** that specifies information about the uncompressed structured storage (described in [\[MSDN-COM\]](#)) for a **VBA project**.

0	1	2	3	4	5	6	7	8	9	10	11	12	13	14	15	16	17	18	19	20	21	22	23	24	25	26	27	28	29	30	31
rh																															
...																															
pptVbaProjStgUncompressed (variable)																															
...																															

rh (8 bytes): A **RecordHeader** structure (section [2.3.1](#)) that specifies the header for this record. Sub-fields are further specified in the following table.

Field	Meaning
rh.recVer	MUST be 0x0.
rh.recInstance	MUST be 0x000.
rh.recType	MUST be an RT_ExternalOleObjectStg .

pptVbaProjStgUncompressed (variable): An array of bytes that specifies a structured storage (described in [MSDN-COM]) for the VBA project ([\[MS-OVBA\]](#) section 2.2.1). The length, in bytes, of the field is specified by **rh.recLen**.

2.10.42 VbaProjectStgCompressedAtom

Referenced by: [VbaProjectStg](#)

An **atom record** that specifies information about the compressed structured storage (described in [\[MSDN-COM\]](#)) for a **VBA project**.

0	1	2	3	4	5	6	7	8	9	10	11	12	13	14	15	16	17	18	19	20	21	22	23	24	25	26	27	28	29	30	31
rh																															
...																															
decompressedSize																															
pptVbaProjStgCompressed (variable)																															
...																															

rh (8 bytes): A **RecordHeader** structure (section [2.3.1](#)) that specifies the header for this record. Sub-fields are further specified in the following table.

Field	Meaning
rh.recVer	MUST be 0x0.
rh.recInstance	MUST be 0x001.
rh.recType	MUST be an RT_ExternalOleObjectStg .

decompressedSize (4 bytes): An unsigned integer that specifies the length of the storage after decompression.

pptVbaProjStgCompressed (variable): An array of bytes that specifies a compressed structured storage (described in [MSDN-COM]) for the VBA project as specified in [MS-OVBA] section 2.2.1. The original bytes of the storage are compressed by the algorithm specified in [RFC1950] and are decompressed by the algorithm specified in [RFC1951]. The length, in bytes, of the field is specified by the following formula:

$$rh.recLen - 4$$

2.11 Other Types

2.11.1 DocRoutingSlipAtom

Referenced by: [DocumentContainer](#)

An **atom record** that specifies information about a document **routing slip**.

0	1	2	3	4	5	6	7	8	9	10	11	12	13	14	15	16	17	18	19	20	21	22	23	24	25	26	27	28	29	30	31
rh																															
...																															
length																															
unused1																															
recipientCount																															
currentRecipient																															
A	B	C	D	E	F	reserved2																									
unused2																															
originatorString (variable)																															
...																															
rgRecipientRoutingSlipStrings (variable)																															
...																															
subjectString (variable)																															
...																															

messageString (variable)
...
unused3 (variable)
...

rh (8 bytes): A **RecordHeader** structure (section [2.3.1](#)) that specifies the header for this record. Sub-fields are further specified in the following table.

Field	Meaning
rh.recVer	MUST be 0x0.
rh.recInstance	MUST be 0x000.
rh.recType	MUST be an RT_DocRoutingSlipAtom .

length (4 bytes): An unsigned integer that specifies the length, in bytes, of the data contained in the document routing slip, including this field. It MUST be less than or equal to **rh.recLen**.

unused1 (4 bytes): Undefined and MUST be ignored.

recipientCount (4 bytes): An unsigned integer that specifies the count of strings in the collection of recipients specified by **rgRecipientRoutingSlipStrings**.

currentRecipient (4 bytes): An unsigned integer that specifies the addressee of the document routing slip. It MUST be less than or equal to **recipientCount**+1. A value of 0x00000000 or a value of **recipientCount**+1 specifies the originator identified by **originatorString**. A value greater than 0x00000000 and less than **recipientCount**+1 specifies a 1-based index into the collection of recipients specified by **rgRecipientRoutingSlipStrings**.

A - fOneAfterAnother (1 bit): A bit that specifies how a document is sent to recipients. It MUST be a value from the following table.

Value	Meaning
FALSE	The document is sent from the originator to all recipients simultaneously.
TRUE	The document is sent sequentially to one recipient after another. After a recipient is finished processing the document, the document is sent to the next recipient.

B - fReturnWhenDone (1 bit): A bit that specifies whether a document is sent back to the originator after all recipients have processed the document.

C - fTrackStatus (1 bit): A bit that specifies whether progress of a document routing slip is tracked. If progress is tracked, the originator is notified after a recipient finishes processing the document.

D - reserved1 (1 bit): MUST be zero, and MUST be ignored.

E - fDocumentRouted (1 bit): A bit that specifies whether the document-routing is in progress and the document is being processed by recipients.

F - fCycleCompleted (1 bit): A bit that specifies whether all recipients have finished processing the document.

reserved2 (26 bits): MUST be ignored and MUST be 0.

unused2 (4 bytes): Undefined and MUST be ignored.

originatorString (variable): A [DocRoutingSlipString](#) structure that specifies the originator of a document routing slip. The **originatorString.stringType** field MUST be 0x0001.

rgRecipientRoutingSlipStrings (variable): An array of DocRoutingSlipString structures that specifies recipients of a document routing slip. The count of items in the array is specified by **recipientCount**. The **stringType** field of each DocRoutingSlipString item MUST be 0x0002.

subjectString (variable): A DocRoutingSlipString structure that specifies the subject of a document routing slip. The **subjectString.stringType** field MUST be 0x0003.

messageString (variable): A DocRoutingSlipString structure that specifies the message of a document routing slip. The **messageString.stringType** field MUST be 0x0004.

unused3 (variable): Undefined and MUST be ignored. The length, in bytes, of the field is specified by the following formula:

$$8 + \text{rh.recLen} - \text{length}$$

2.11.2 DocRoutingSlipString

Referenced by: [DocRoutingSlipAtom](#)

A structure that specifies information about a string in a document **routing slip**.

0	1	2	3	4	5	6	7	8	9	10	11	12	13	14	15	16	17	18	19	20	21	22	23	24	25	26	27	28	29	30	31
stringType																stringLength															
string (variable)																															
...																															

stringType (2 bytes): An **unsigned integer** that specifies the type of a string. It MUST be a value from the following table.

Value	Meaning
0x0001	The originator of a document routing slip.
0x0002	A recipient of a document routing slip.
0x0003	The subject of a document routing slip.
0x0004	The message body of a document routing slip.

stringLength (2 bytes): An unsigned integer that specifies the number of bytes supplied for the string, minus 1. If **stringType** is equal to 0x0001 or 0x0002, this value MUST be greater than 0x0000.

string (variable): A **PrintableAnsiString** (section [2.2.22](#)) that specifies the characters of the string. The length, in bytes, of the string is specified by **stringLength** plus 1. If **stringType** is equal to 0x0001 or 0x0002, the byte at index **stringLength** minus 1 MUST be equal to 0x00 and the byte at index **stringLength** MUST be ignored. If **stringType** is equal to 0x0003 or 0x0004, the byte at index **stringLength** MUST be equal to 0x00.

2.11.3 EnvelopeFlags9Atom

Referenced by: [PP9DocBinaryTagExtension](#)

An **atom record** that specifies information about an **envelope**.

0	1	2	3	4	5	6	7	8	9	10	11	12	13	14	15	16	17	18	19	20	21	22	23	24	25	26	27	28	29	30	31
rh																															
...																															
A	B	C	D	reserved2																											

rh (8 bytes): A **RecordHeader** structure (section [2.3.1](#)) that specifies the header for this record. Sub-fields are further specified in the following table.

Field	Meaning
rh.recVer	MUST be 0x0.
rh.recInstance	MUST be 0x000.
rh.recType	MUST be an RT_EnvelopeFlags9Atom .
rh.recLen	MUST be 0x00000004.

A - fHasEnvelope (1 bit): A bit that specifies whether an [EnvelopeData9Atom](#) record exists in the file.

B - fEnvelopeVisible (1 bit): A bit that specifies whether the envelope is visible. If the value is **TRUE**, **fHasEnvelope** MUST also be **TRUE**.

C - reserved1 (2 bits): MUST be zero and MUST be ignored.

D - fEnvelopeDirty (1 bit): A bit that specifies whether the envelope has been modified since the last time it was sent to the mail client. If the value is **TRUE**, **fHasEnvelope** MUST also be **TRUE**.

reserved2 (27 bits): MUST be zero and MUST be ignored.

2.11.4 EnvelopeData9Atom

Referenced by: [PP9DocBinaryTagExtension](#)

An **atom record** that specifies data for an **envelope**.

0	1	2	3	4	5	6	7	8	9	10	11	12	13	14	15	16	17	18	19	20	21	22	23	24	25	26	27	28	29	30	31
rh																															

...
data (variable)
...

rh (8 bytes): A **RecordHeader** structure (section [2.3.1](#)) that specifies the header for this record. Sub-fields are further specified in the following table.

Field	Meaning
rh.recVer	MUST be 0x0.
rh.recInstance	MUST be 0x000.
rh.recType	MUST be an RT_EnvelopeData9Atom .

data (variable): An **MsoEnvelopeCLSID** ([\[MS-OSHARED\]](#) section 2.3.8.1) that specifies data for an envelope. The length, in bytes, of this field is specified by **rh.recLen**.

2.11.5 FontEmbedDataBlob

Referenced by: [FontCollectionEntry](#)

An **atom record** that specifies the font data of an embedded font.

0	1	2	3	4	5	6	7	8	9	10	11	12	13	14	15	16	17	18	19	20	21	22	23	24	25	26	27	28	29	30	31
rh																															
...																															
data (variable)																															
...																															

rh (8 bytes): A **RecordHeader** structure (section [2.3.1](#)) that specifies the header for this record. Sub-fields are further specified in the following table.

Field	Meaning
rh.recVer	MUST be 0x0.
rh.recInstance	MUST be greater than or equal to 0x000 and less than or equal to 0x003.
rh.recType	MUST be an RT_FontEmbedDataBlob .

data (variable): A structure that specifies the font data of an embedded font as specified in [\[Embed-Open-Type-Format\]](#). The length, in bytes, of this field is specified by **rh.recLen**.

2.11.6 MetafileBlob

Referenced by: [ExControlContainer](#), [ExOleEmbedContainer](#), [ExOleLinkContainer](#)

An **atom record** that specifies a **metafile** ([\[MS-WMF\]](#)).

0	1	2	3	4	5	6	7	8	9	10	11	12	13	14	15	16	17	18	19	20	21	22	23	24	25	26	27	28	29	30	31
rh																															
...																															
mm																xExt															
yExt																data (variable)															
...																															

rh (8 bytes): A **RecordHeader** structure (section [2.3.1](#)) that specifies the header for this record. Sub-fields are further specified in the following table.

Field	Meaning
rh.recVer	MUST be 0x0.
rh.recInstance	MUST be 0x000.
rh.recType	MUST be an RT_MetaFile .
rh.recLen	MUST be greater than 0x00000010.

mm (2 bytes): A signed integer that specifies the mapping mode of the metafile as specified in [MS-WMF] section [2.1.1.16](#).

xExt (2 bytes): A signed integer that specifies the width of the metafile in units that correspond to the mapping mode specified by the **mm** field as specified in [MS-WMF] section 2.1.1.16.

yExt (2 bytes): A signed integer that specifies the height of the metafile in units that correspond to the mapping mode specified by the **mm** field as specified in [MS-WMF] section 2.1.1.16.

data (variable): A metafile as specified in [MS-WMF]. The length, in bytes, of the field is specified by the following formula:

$$rh.recLen - 6.$$

2.11.7 RoundTripAnimationAtom

Referenced by: [RoundTripMainMasterRecord](#), [RoundTripSlideRecord](#)

An **atom record** that specifies animations for a **slide**.

0	1	2	3	4	5	6	7	8	9	10	11	12	13	14	15	16	17	18	19	20	21	22	23	24	25	26	27	28	29	30	31
rh																															
...																															

data (variable)
...

rh (8 bytes): A [RecordHeader](#) type that specifies the header for this record. Sub-fields are further specified in the following table.

Field	Meaning
rh.recVer	MUST be 0x0.
rh.recInstance	MUST be 0x000.
rh.recType	MUST be an RT_RoundTripAnimationAtom12Atom .

data (variable): An ECMA-376 document that specifies animations, along with embedded sounds if present. The package contains XML in the PresentationML Timing Info part containing a <timing> element that conforms to the schema specified by **CT_SlideTiming** as specified in [\[ECMA-376\]](#) Part 4: Markup Language Reference, section 4.4.1.44.

2.11.8 RoundTripAnimationHashAtom

Referenced by: [RoundTripMainMasterRecord](#), [RoundTripSlideRecord](#)

An **atom record** that specifies a checksum for animation data.

0	1	2	3	4	5	6	7	8	9	10	11	12	13	14	15	16	17	18	19	20	21	22	23	24	25	26	27	28	29	30	31
rh																															
...																															
animationChecksum																															

rh (8 bytes): A **RecordHeader** structure (section [2.3.1](#)) that specifies the header for this record. Sub-fields are further specified in the following table.

Field	Meaning
rh.recVer	MUST be 0x0.
rh.recInstance	MUST be 0x000.
rh.recType	MUST be an RT_RoundTripAnimationHashAtom12Atom .
rh.recLen	MUST be 0x00000004.

animationChecksum (4 bytes): An **unsigned integer** that specifies the checksum of the animation data.

Let *corresponding slide* be specified as the **SlideContainer** record (section [2.5.1](#)) that contains this **RoundTripAnimationHashAtom** record.

The data used to calculate the checksum is all fields in the [VisualSoundAtom](#) record contained within the *corresponding slide*, computed sequentially in 4-byte pieces. The other input to the checksum calculation is all of the bytes of the **spid** field of the **OfficeArtFSP** record ([\[MS-](#)

[ODRAW](#) section 2.2.40) that specify the **shape** identifier of each shape on the corresponding slide. The checksum value is a **cyclic redundancy check (CRC)** logical exclusive or (XOR) hash of each consecutive 4-byte sequence in the specified data.

2.11.9 RoundTripColorMappingAtom

Referenced by: [HandoutRoundTripAtom](#), [NotesRoundTripAtom](#), [RoundTripMainMasterRecord](#), [RoundTripSlideRecord](#)

An **atom record** that specifies the color mapping for a **slide**.

0	1	2	3	4	5	6	7	8	9	10	11	12	13	14	15	16	17	18	19	20	21	22	23	24	25	26	27	28	29	30	31
rh																															
...																															
colorMapping (variable)																															
...																															

rh (8 bytes): A **RecordHeader** structure (section [2.3.1](#)) that specifies the header for this record. Sub-fields are further specified in the following table.

Field	Meaning
rh.recVer	MUST be 0x0.
rh.recInstance	MUST be 0x000.
rh.recType	MUST be an RT_RoundTripColorMapping12Atom .

colorMapping (variable): A [Utf8UnicodeString](#) that specifies the color mapping. Either the XML in this string contains a **clrMap** element that conforms to the schema specified by **CT_ColorMapping** as specified in [\[ECMA-376\]](#) Part 4: Markup Language Reference, section 4.4.1.6, or the XML contains a **clrMapOverride** element that conforms to the schema specified by **CT_ColorMappingOverride** as specified in [\[ECMA-376\]](#) Part 4: Markup Language Reference, section 4.4.1.7.

2.11.10 RoundTripCompositeMasterId12Atom

Referenced by: [RoundTripMainMasterRecord](#), [RoundTripSlideRecord](#)

An **atom record** that specifies that a **slide** is a **slide layout** merged with its **main master slide**. The corresponding main master slide has a [RoundTripOriginalMainMasterId12Atom](#) record with the same identifier.

0	1	2	3	4	5	6	7	8	9	10	11	12	13	14	15	16	17	18	19	20	21	22	23	24	25	26	27	28	29	30	31
rh																															
...																															

compositeMasterId

rh (8 bytes): A **RecordHeader** structure (section [2.3.1](#)) that specifies the header for this record. Sub-fields are further specified in the following table.

Field	Meaning
rh.recVer	MUST be 0x0.
rh.recInstance	MUST be 0x000.
rh.recType	MUST be an RT_RoundTripCompositeMasterId12Atom .
rh.recLen	MUST be 0x00000004.

compositeMasterId (4 bytes): An **unsigned integer** that specifies the identifier for the main master slide this slide was merged with. This field is equivalent to the **ST_SlideMasterId** simple type as specified in [\[ECMA-376\]](#) Part 4: Markup Language Reference, section 4.8.20.

2.11.11 RoundTripContentMasterId12Atom

Referenced by: [RoundTripSlideRecord](#)

An **atom record** that specifies the relation between a **slide** and its **slide layout**.

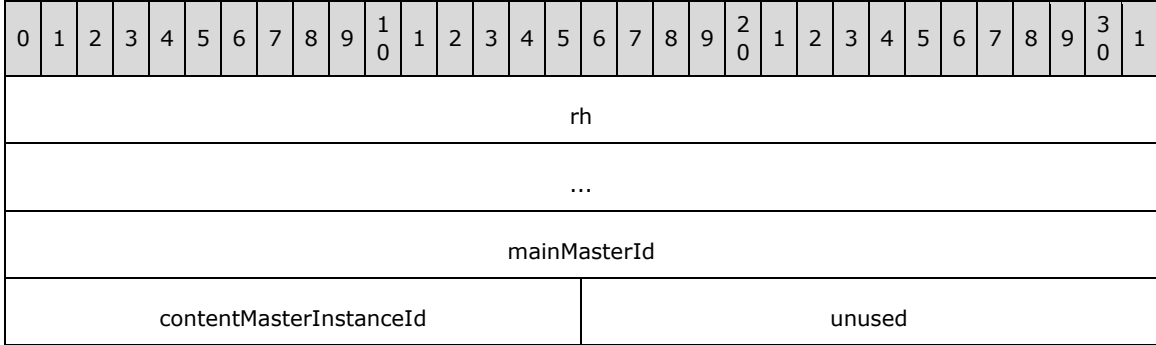

rh (8 bytes): A **RecordHeader** structure (section [2.3.1](#)) that specifies the header for this record. Sub-fields are further specified in the following table.

Field	Meaning
rh.recVer	MUST be 0x0.
rh.recType	MUST be an RT_RoundTripContentMasterId12Atom .
rh.recLen	MUST be 0x00000008.

mainMasterId (4 bytes): An **unsigned integer** that specifies the identifier of a **main master slide**. This field is equivalent to the **ST_SlideMasterId** simple type as specified in [\[ECMA-376\]](#) Part 4: Markup Language Reference, section 4.8.20.

contentMasterInstanceId (2 bytes): An **unsigned integer** that specifies the instance identifier of the slide layout. This field is equivalent to the **ST_SlideLayoutId** simple type as specified in [\[ECMA-376\]](#) Part 4: Markup Language Reference, section 4.8.18.

unused (2 bytes): Undefined and MUST be ignored.

2.11.12 RoundTripContentMasterInfo12Atom

Referenced by: [RoundTripMainMasterRecord](#)

An **atom record** that specifies a **slide layout**.

0	1	2	3	4	5	6	7	8	9	10	11	12	13	14	15	16	17	18	19	20	21	22	23	24	25	26	27	28	29	30	31
rh																															
...																															
data (variable)																															
...																															

rh (8 bytes): A **RecordHeader** structure (section [2.3.1](#)) that specifies the header for this record. Sub-fields are further specified in the following table.

Field	Meaning
rh.recVer	MUST be 0x0.
rh.recType	MUST be an RT_RoundTripContentMasterInfo12Atom .

data (variable): An ECMA-376 document that specifies a slide layout. The package contains XML in the PresentationML Content Master part containing a **sldLayout** element that conforms to the schema specified by **CT_SlideLayout** as specified in [\[ECMA-376\]](#) Part 4: Markup Language Reference, section 4.4.1.36.

2.11.13 RoundTripCustomTableStyles12Atom

Referenced by: [DocumentContainer](#)

An **atom record** that specifies table styles.

0	1	2	3	4	5	6	7	8	9	10	11	12	13	14	15	16	17	18	19	20	21	22	23	24	25	26	27	28	29	30	31
rh																															
...																															
data (variable)																															
...																															

rh (8 bytes): A **RecordHeader** structure (section [2.3.1](#)) that specifies the header for this record. Sub-fields are further specified in the following table.

Field	Meaning
rh.recVer	MUST <110> be 0x0.
rh.recInstance	MUST be 0x000.

Field	Meaning
rh.recType	MUST be an RT_RoundTripCustomTableStyles12Atom .

data (variable): An ECMA-376 document that specifies table styles. The package contains XML in the PresentationML Table Styles part containing a **tblStyle** element that conforms to the schema specified by **CT_TableStyleList** as specified in [\[ECMA-376\]](#) Part 4: Markup Language Reference, section 5.1.4.2.27.

2.11.14 RoundTripDocFlags12Atom

Referenced by: [PP12DocBinaryTagExtension](#)

An **atom record** that specifies document-level flags.

0	1	2	3	4	5	6	7	8	9	10	11	12	13	14	15	16	17	18	19	20	21	22	23	24	25	26	27	28	29	30	31	
rh																																
...																																
A	reserved																															

rh (8 bytes): A **RecordHeader** structure (section [2.3.1](#)) that specifies the header for this record. Sub-fields are further specified in the following table.

Field	Meaning
rh.recVer	MUST be 0x0.
rh.recInstance	MUST be 0x000.
rh.recType	MUST be an RT_RoundTripDocFlags12Atom .
rh.recLen	MUST be 0x00000001.

A - fCompressPicturesOnSave (1 bit): A bit that specifies whether pictures are automatically compressed when saving.

reserved (7 bits): MUST be zero and MUST be ignored.

2.11.15 RoundTripHeaderFooterDefaults12Atom

Referenced by: [PP12SlideBinaryTagExtension](#)

An **atom record** that specifies default **header** and **footer** flags.

0	1	2	3	4	5	6	7	8	9	10	11	12	13	14	15	16	17	18	19	20	21	22	23	24	25	26	27	28	29	30	31
rh																															
...																															

A	B	C	D	E
---	---	---	---	---

rh (8 bytes): A **RecordHeader** structure (section [2.3.1](#)) that specifies the header for this record. Sub-fields are further specified in the following table.

Field	Meaning
rh.recVer	MUST be 0x0.
rh.recInstance	MUST be 0x000.
rh.recType	MUST be an RT_RoundTripHeaderFooterDefaults12Atom .
rh.recLen	MUST be 0x00000001.

A - fIncludeDate (1 bit): A bit that specifies whether the date is included in the footer of new slides.

B - fIncludeFooter (1 bit): A bit that specifies whether the footer is included in new slides.

C - fIncludeHeader (1 bit): A bit that specifies whether the header is included in new slides.

D - fIncludeSlideNumber (1 bit): A bit that specifies whether the slide number or page number is included in the footer of new slides.

E - reserved (4 bits): MUST be zero and MUST be ignored.

2.11.16 RoundTripHFPlaceholder12Atom

Referenced by: [ShapeClientRoundtripDataSubContainerOrAtom](#)

An **atom record** that specifies that a **shape** is a **header** or **footer placeholder shape**.

0	1	2	3	4	5	6	7	8	9	10	11	12	13	14	15	16	17	18	19	20	21	22	23	24	25	26	27	28	29	30	31
rh																															
...																															
placeholderId																															

rh (8 bytes): A **RecordHeader** structure (section [2.3.1](#)) that specifies the header for this record. Sub-fields are further specified in the following table.

Field	Meaning
rh.recVer	MUST be 0x0.
rh.recInstance	MUST be 0x000.
rh.recType	MUST be an RT_RoundTripHFPlaceholder12Atom .
rh.recLen	MUST be 0x00000001.

placeholderId (1 byte): A [PlaceholderEnum](#) enumeration that specifies the placeholder shape identifier. It MUST be PT_MasterDate, PT_MasterSlideNumber, PT_MasterFooter, or PT_MasterHeader.

2.11.17 RoundTripNewPlaceholderId12Atom

Referenced by: [ShapeClientRoundtripDataSubContainerOrAtom](#)

An **atom record** that specifies a **placeholder** identifier.

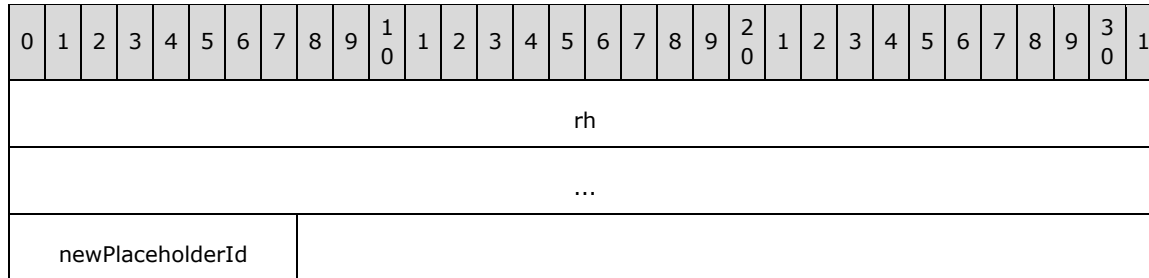

rh (8 bytes): A **RecordHeader** structure (section [2.3.1](#)) that specifies the header for this record. Sub-fields are further specified in the following table.

Field	Meaning
rh.recVer	MUST be 0x0.
rh.recInstance	MUST be 0x000.
rh.recType	MUST be an RT_RoundTripNewPlaceholderId12Atom .
rh.recLen	MUST be 0x00000001.

newPlaceholderId (1 byte): A **PlaceholderEnum** enumeration that specifies the **placeholder shape** identifier. It MUST be PT_VerticalObject or PT_Picture.

2.11.18 RoundTripNotesMasterTextStyles12Atom

Referenced by: [NotesRoundTripAtom](#)

An **atom record** that specifies text styles used by the **notes master slide**.

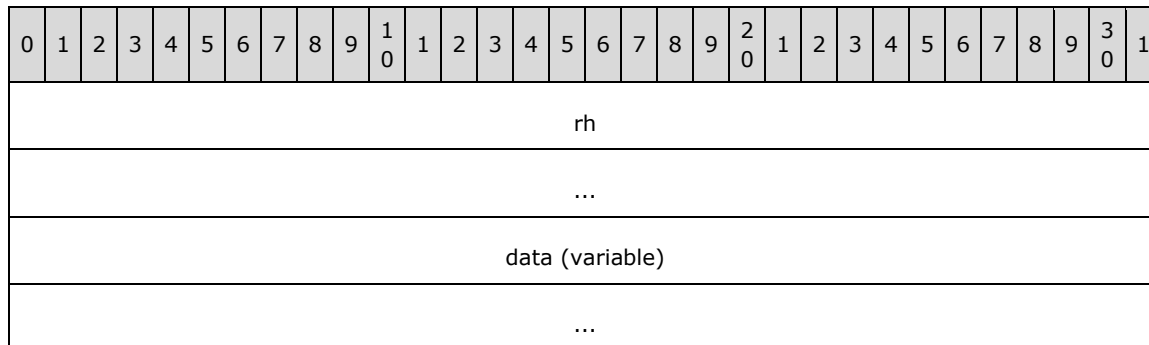

rh (8 bytes): A **RecordHeader** structure (section [2.3.1](#)) that specifies the header for this record. Sub-fields are further specified in the following table.

Field	Meaning
rh.recVer	MUST be 0x0.
rh.recInstance	MUST be 0x000.
rh.recType	MUST be an RT_RoundTripNotesMasterTextStyles12Atom .

data (variable): An ECMA-376 document that specifies text styles. The package contains XML in the PresentationML Main Master part containing a **txStyles** element that conforms to the schema specified by **CT_SlideMasterTextStyles** as specified in [\[ECMA-376\]](#) Part 4: Markup Language Reference, section 4.4.1.48.

2.11.19 RoundTripOArtTextStyles12Atom

Referenced by: [MainMasterContainer](#), [RoundTripMainMasterRecord](#)

An **atom record** that specifies text styles used by a **main master slide**.

0	1	2	3	4	5	6	7	8	9	10	1	2	3	4	5	6	7	8	9	20	1	2	3	4	5	6	7	8	9	30	1
rh																															
...																															
data (variable)																															
...																															

rh (8 bytes): A **RecordHeader** structure (section [2.3.1](#)) that specifies the header for this record. Sub-fields are further specified in the following table.

Field	Meaning
rh.recVer	MUST be 0x0.
rh.recInstance	MUST be 0x000.
rh.recType	MUST be an RT_RoundTripOArtTextStyles12Atom .

data (variable): An ECMA-376 document that specifies text styles. The package contains XML in the PresentationML Main Master part containing a **txStyles** element that conforms to the schema specified by **CT_SlideMasterTextStyles** as specified in [\[ECMA-376\]](#) Part 4: Markup Language Reference, section 4.4.1.48.

2.11.20 RoundTripOriginalMainMasterId12Atom

Referenced by: [RoundTripMainMasterRecord](#)

An **atom record** that specifies the original identifier of a <slidMaster> element in the Slide Master part that conforms to the schema specified by **CT_SlideMaster** as specified in [\[ECMA-376\]](#) Part 4: Markup Language Reference, section 4.4.1.39.

0	1	2	3	4	5	6	7	8	9	10	1	2	3	4	5	6	7	8	9	20	1	2	3	4	5	6	7	8	9	30	1
rh																															
...																															

mainMasterId

rh (8 bytes): A **RecordHeader** structure (section [2.3.1](#)) that specifies the header for this record. Sub-fields are further specified in the following table.

Field	Meaning
rh.recVer	MUST be 0x0.
rh.recInstance	MUST be 0x000.
rh.recType	MUST be an RT_RoundTripOriginalMainMasterId12Atom .
rh.recLen	MUST be 0x00000004.

mainMasterId (4 bytes): An **unsigned integer** that specifies the identifier of the **main master slide**. This field is equivalent to the **ST_SlideMasterId** simple type as specified in [ECMA-376] Part 4: Markup Language Reference, section 4.8.20.

2.11.21 RoundTripShapeChecksumForCustomLayouts12Atom

Referenced by: [ShapeClientRoundtripDataSubContainerOrAtom](#)

An **atom record** that specifies application-defined IDs for a **shape** and its text. To be interoperable this record SHOULD<111> be preserved if encountered but SHOULD<112> be omitted otherwise.

0	1	2	3	4	5	6	7	8	9	10	11	12	13	14	15	16	17	18	19	20	21	22	23	24	25	26	27	28	29	30	31
rh																															
...																															
shapeChecksum																															
textChecksum																															

rh (8 bytes): A **RecordHeader** structure (section [2.3.1](#)) that specifies the header for this record. Sub-fields are further specified in the following table.

Field	Meaning
rh.recVer	MUST be 0x0.
rh.recInstance	MUST be 0x000.
rh.recType	MUST be an RT_RoundTripShapeChecksumForCL12Atom .
rh.recLen	MUST be 0x00000008.

shapeChecksum (4 bytes): An unsigned integer that specifies an application-defined identifier for quickly determining whether the shape properties specified by the **OfficeArtSpContainer** record ([\[MS-ODRAW\]](#) section 2.2.14) that contains this **RoundTripShapeChecksumForCustomLayouts12Atom** have changed since they were last saved.

textChecksum (4 bytes): An unsigned integer that specifies an application-defined identifier for quickly determining whether the text body specified by the [OfficeArtClientTextbox](#) record

contained within the **OfficeArtSpContainer** record ([MS-ODRAW] section 2.2.14) that contains this **RoundTripShapeChecksumForCustomLayouts12Atom** has changed since it was last saved.

2.11.22 RoundTripShapeId12Atom

Referenced by: [ShapeClientRoundtripDataSubContainerOrAtom](#)

An **atom record** that specifies a **shape** identifier.

0	1	2	3	4	5	6	7	8	9	10	11	12	13	14	15	16	17	18	19	20	21	22	23	24	25	26	27	28	29	30	31
rh																															
...																															
shapeId																															

rh (8 bytes): A **RecordHeader** structure (section 2.3.1) that specifies the header for this record. Sub-fields are further specified in the following table.

Field	Meaning
rh.recVer	MUST be 0x0.
rh.recInstance	MUST be 0x000.
rh.recType	MUST be an RT_RoundTripShapeId12Atom .
rh.recLen	MUST be 0x00000004.

shapeId (4 bytes): An unsigned integer that specifies the shape identifier. This field is equivalent to the **ST_ShapeID** simple type as specified in [\[ECMA-376\]](#) Part 4: Markup Language Reference, section 5.1.12.55.

2.11.23 RoundTripSlideSyncInfo12Container

Referenced by: [RoundTripSlideRecord](#), [SlideContainer](#)

A **container record** that specifies information about a **slide** that synchronizes to a slide in a slide library. Slide synchronization data is fully specified in [\[ECMA-376\]](#) Part 4: Markup Language Reference, section 4.7.

0	1	2	3	4	5	6	7	8	9	10	11	12	13	14	15	16	17	18	19	20	21	22	23	24	25	26	27	28	29	30	31
rh																															
...																															
serverId (variable)																															
...																															
slideLibUrl (variable)																															

...
slideSyncInfoAtom12 (40 bytes)
...
...

rh (8 bytes): A **RecordHeader** structure (section [2.3.1](#)) that specifies the header for this record. Sub-fields are further specified in the following table.

Field	Meaning
rh.recVer	MUST be 0xF.
rh.recInstance	MUST be 0x000.
rh.recType	MUST be an RT_RoundTripSlideSyncInfo12 .

serverId (variable): A [ServerIdAtom](#) record that specifies a unique identifier for a slide in a slide library.

slideLibUrl (variable): A [SlideLibUrlAtom](#) record that specifies the URL of a slide library.

slideSyncInfoAtom12 (40 bytes): A [SlideSyncInfoAtom12](#) record that specifies timestamps for slides that synchronize with versions stored in a slide library.

2.11.24 ServerIdAtom

Referenced by: [RoundTripSlideSyncInfo12Container](#)

An **atom record** that specifies a unique identifier for a **slide** in a slide library.

0	1	2	3	4	5	6	7	8	9	10	1	2	3	4	5	6	7	8	9	20	1	2	3	4	5	6	7	8	9	30	1		
rh																																	
...																																	
serverId (variable)																																	
...																																	

rh (8 bytes): A **RecordHeader** structure (section [2.3.1](#)) that specifies the header for this record. Sub-fields are further specified in the following table.

Field	Meaning
rh.recVer	MUST be 0x0.
rh.recInstance	MUST be 0x000.
rh.recType	MUST be an RT_CString (section 2.13.24).
rh.recLen	MUST be even.

serverId (variable): A **PrintableUnicodeString** (section [2.2.23](#)) that specifies the unique identifier for the slide. This field is equivalent to the **serverSIdId** attribute specified in [\[ECMA-376\]](#) Part 4: Markup Language Reference, section 4.7.1.

2.11.25 SlideLibUrlAtom

Referenced by: [RoundTripSlideSyncInfo12Container](#)

An **atom record** that specifies the URL of a slide library.

0	1	2	3	4	5	6	7	8	9	10	11	12	13	14	15	16	17	18	19	20	21	22	23	24	25	26	27	28	29	30	31
rh																															
...																															
slideLibUrl (variable)																															
...																															

rh (8 bytes): A **RecordHeader** structure (section [2.3.1](#)) that specifies the header for this record. Sub-fields are further specified in the following table.

Field	Meaning
rh.recVer	MUST be 0x0.
rh.recInstance	MUST be 0x001.
rh.recType	MUST be an RT_CString (section 2.13.24).
rh.recLen	MUST be even.

slideLibUrl (variable): An [HttpUrl](#) that specifies the URL of the slide library.

2.11.26 SlideSyncInfoAtom12

Referenced by: [RoundTripSlideSyncInfo12Container](#)

An **atom record** that specifies timestamps for a **slide** that synchronizes with a version of the slide stored in a slide library.

0	1	2	3	4	5	6	7	8	9	10	11	12	13	14	15	16	17	18	19	20	21	22	23	24	25	26	27	28	29	30	31
rh																															
...																															
dateTimeModified (16 bytes)																															
...																															
...																															

dateTimeInserted (16 bytes)
...
...

rh (8 bytes): A **RecordHeader** structure (section [2.3.1](#)) that specifies the header for this record. Sub-fields are further specified in the following table.

Field	Meaning
rh.recVer	MUST be 0x0.
rh.recInstance	MUST be 0x000.
rh.recType	MUST be an RT_RoundTripSlideSyncInfoAtom12 .
rh.recLen	MUST be 0x00000020.

dateTimeModified (16 bytes): A [DateTimeStruct](#) structure that specifies the time stamp the slide was last modified on the server. This field is equivalent to the **serverSIdModified** attribute as specified in [\[ECMA-376\]](#) Part 4: Markup Language Reference, section 4.7.1.

dateTimeInserted (16 bytes): A [DateTimeStruct](#) structure that specifies the time stamp the slide was inserted in the document. This field is equivalent to the **clientInsertedTime** attribute as specified in [\[ECMA-376\]](#) Part 4: Markup Language Reference, section 4.7.1.

2.11.27 RoundTripThemeAtom

Referenced by: [HandoutRoundTripAtom](#), [NotesRoundTripAtom](#), [RoundTripMainMasterRecord](#), [RoundTripSlideRecord](#)

An **atom record** that specifies the theme of the **main master slide**.

0	1	2	3	4	5	6	7	8	9	10	11	12	13	14	15	16	17	18	19	20	21	22	23	24	25	26	27	28	29	30	31
rh																															
...																															
data (variable)																															
...																															

rh (8 bytes): A **RecordHeader** structure (section [2.3.1](#)) that specifies the header for this record. Sub-fields are further specified in the following table.

Field	Meaning
rh.recVer	MUST be 0x0.
rh.recInstance	MUST be 0x000.
rh.recType	MUST be an RT_RoundTripTheme12Atom .

data (variable): An ECMA-376 document that specifies theme information. The package contains XML in the DrawingML Theme part containing a **theme** element that conforms to the schema specified by **CT_OfficeStyleSheet** as specified in [ECMA-376] Part 4: Markup Language Reference, section 5.1.8.9, or XML in the DrawingML Theme Override part containing a **themeOverride** element that conforms to the schema specified by **CT_BaseStylesOverride** as specified in [ECMA-376] Part 4: Markup Language Reference, section 5.1.8.12.

2.11.28 SmartTagStore11Container

Referenced by: [PP11DocBinaryTagExtension](#)

A **container record** that specifies information about all smart tags within the corresponding presentation. A smart tag is additional information that is specified to correspond to a string of text.

0	1	2	3	4	5	6	7	8	9	10	11	12	13	14	15	16	17	18	19	20	21	22	23	24	25	26	27	28	29	30	31
rh																															
...																															
cBags																															
propBagStore (variable)																															
...																															
rgPpropBag (variable)																															
...																															

rh (8 bytes): A **RecordHeader** structure (section 2.3.1) that specifies the header for this record. Sub-fields are further specified in the following table.

Field	Meaning
rh.recVer	MUST be 0xF.
rh.recInstance	MUST be 0x000.
rh.recType	MUST be an RT_SmartTagStore11Container .

cBags (4 bytes): An unsigned integer that specifies the count of items in **rgPpropBag**.

propBagStore (variable): A **PropertyBagStore** that specifies a collection of smart tag types and their corresponding data as specified in [MS-OSHARED] section 2.3.4.1.

rgPpropBag (variable): An array of **PropertyBag** that specifies a set of properties with their corresponding key/value pairs as specified in [MS-OSHARED] section 2.3.4.4. These key/value pairs each represent a string of text and correspond to an entry within **propBagStore**.

2.11.29 SoundDataBlob

Referenced by: [SoundContainer](#)

An **atom record** that specifies audio data for a sound.

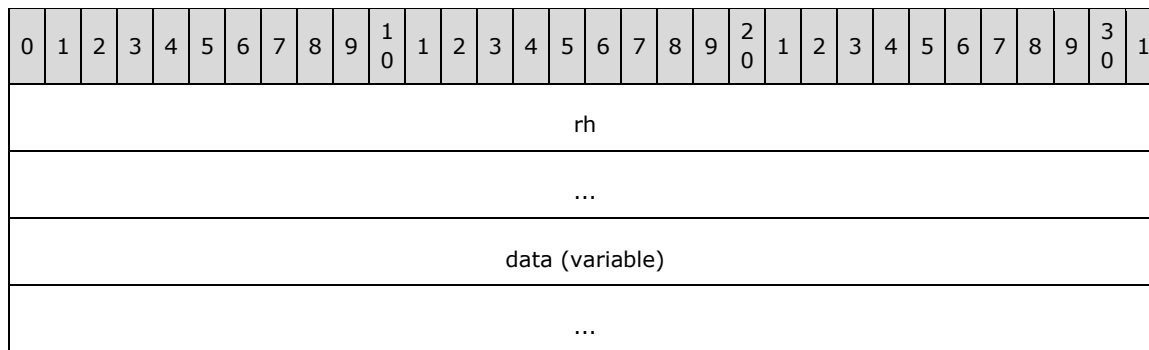

rh (8 bytes): A **RecordHeader** structure (section [2.3.1](#)) that specifies the header for this record. Sub-fields are further specified in the following table.

Field	Meaning
rh.recVer	MUST be 0x0.
rh.recInstance	MUST be 0x000.
rh.recType	MUST be an RT_SoundDataBlob .

data (variable): A structure that specifies **WAV** or **AIFF** audio data for a sound. The length, in bytes, of this field is specified by **rh.recLen**.

2.11.30 ProgStringTagContainer

Referenced by: [DocProgTagsSubContainerOrAtom](#), [ShapeProgTagsSubContainerOrAtom](#), [SlideProgTagsSubContainerOrAtom](#)

A **container record** that specifies a **programmable tag** that has a [UnicodeString](#) as its value.

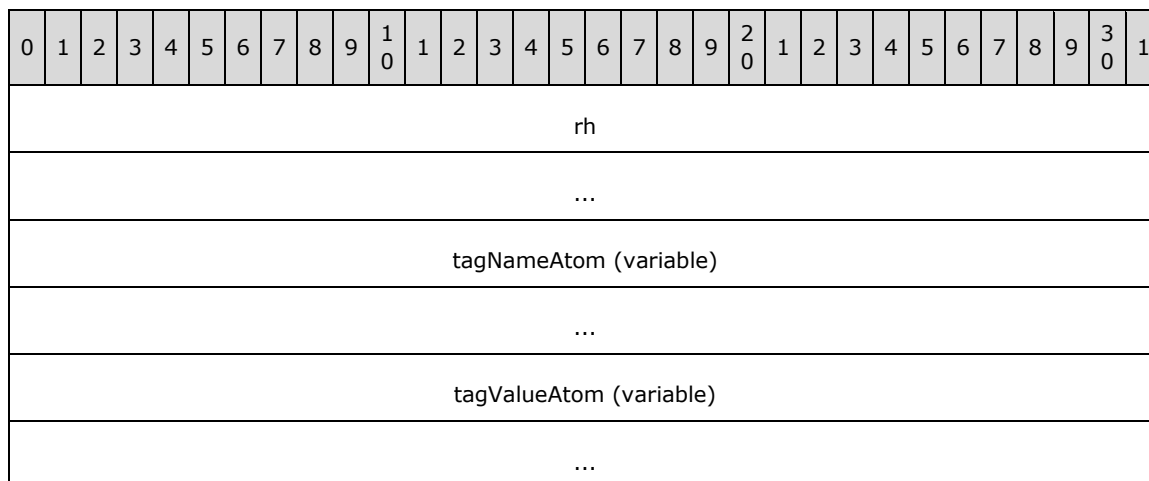

rh (8 bytes): A **RecordHeader** structure (section [2.3.1](#)) that specifies the header for this record. Sub-fields are further specified in the following table.

Field	Meaning
rh.recVer	MUST be 0xF.
rh.recInstance	MUST be 0x000.
rh.recType	MUST be an RT_ProgStringTag .

tagNameAtom (variable): A [TagNameAtom](#) record that specifies the name of the programmable tag.

tagValueAtom (variable): An optional [TagValueAtom](#) record that specifies the value of the programmable tag.

2.11.31 TagNameAtom

Referenced by: [ProgStringTagContainer](#), [UnknownBinaryTag](#)

An **atom record** that contains the name of the name-value pair in a **programmable tag**.

0	1	2	3	4	5	6	7	8	9	10	11	12	13	14	15	16	17	18	19	20	21	22	23	24	25	26	27	28	29	30	31
rh																															
...																															
tagName (variable)																															
...																															

rh (8 bytes): A **RecordHeader** structure (section [2.3.1](#)) that specifies the header for this record. Sub-fields are further specified in the following table.

Field	Meaning
rh.recVer	MUST be 0x0.
rh.recInstance	MUST be 0x000.
rh.recType	MUST be an RT_CString (section 2.13.24).
rh.recLen	MUST be an even number. It MUST be greater than zero.

tagName (variable): A **PrintableUnicodeString** string (section [2.2.23](#)) that specifies the name of the programmable tag. The length, in bytes, of the field is specified by **rh.recLen**.

2.11.32 TagValueAtom

Referenced by: [ProgStringTagContainer](#)

An **atom record** that contains the value of the name-value pair in a **programmable tag**.

0	1	2	3	4	5	6	7	8	9	10	11	12	13	14	15	16	17	18	19	20	21	22	23	24	25	26	27	28	29	30	31
rh																															
...																															
tagValue (variable)																															

...

rh (8 bytes): A **RecordHeader** structure (section [2.3.1](#)) that specifies the header for this record. Sub-fields are further specified in the following table.

Field	Meaning
rh.recVer	MUST be 0x0.
rh.recInstance	MUST be 0x001.
rh.recType	MUST be an RT_CString (section 2.13.24).
rh.recLen	MUST be an even number. It MUST be greater than zero.

tagValue (variable): A [UnicodeString](#) string that specifies the value of the programmable tag. The length, in bytes, of the field is specified by **rh.recLen**.

2.11.33 UnknownBinaryTag

Referenced by: [DocProgBinaryTagSubContainerOrAtom](#), [ShapeProgBinaryTagSubContainerOrAtom](#), [SlideProgBinaryTagSubContainerOrAtom](#)

A pair of **atom records** that specifies a **programmable tag** that has binary data as its value.

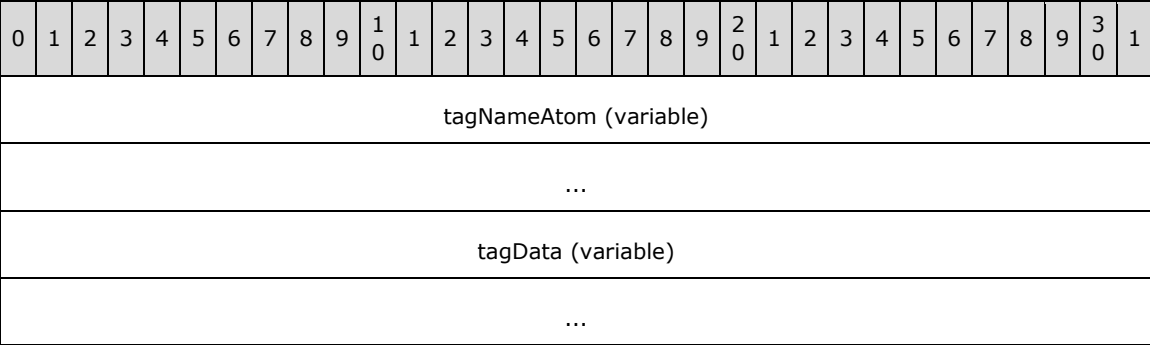

tagNameAtom (variable): A [TagNameAtom](#) record that specifies the name of the programmable tag.

tagData (variable): A [BinaryTagDataBlob](#) record that specifies the value of the programmable tag.

2.11.34 BinaryTagDataBlob

Referenced by: [UnknownBinaryTag](#)

An **atom record** that contains the value of the name-value pair in a **programmable tag**.

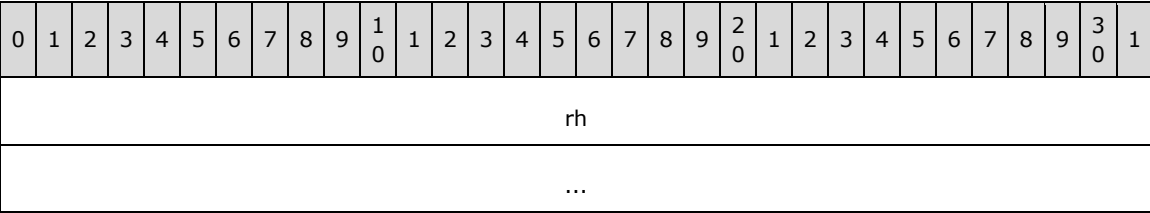

data (variable)
...

rh (8 bytes): A **RecordHeader** structure (section [2.3.1](#)) that specifies the header for this record. Sub-fields are further specified in the following table.

Field	Meaning
rh.recVer	MUST be 0x0.
rh.recInstance	MUST be 0x000.
rh.recType	MUST be an RT_BinaryTagDataBlob .

data (variable): An array of bytes that specifies the data of this item. The size, in bytes, of the data is specified by **rh.recLen**.

2.12 Common Structures

2.12.1 ColorStruct

Referenced by: [SchemeListElementColorSchemeAtom](#), [SlideSchemeColorSchemeAtom](#)

A structure that specifies a color in the sRGB color space as specified in [\[IEC-RGB\]](#).

0	1	2	3	4	5	6	7	8	9	10	11	12	13	14	15	16	17	18	19	20	21	22	23	24	25	26	27	28	29	30	31
red										green										blue						unused					

red (1 byte): An unsigned integer that specifies the red component of this color.

green (1 byte): An unsigned integer that specifies the green component of this color.

blue (1 byte): An unsigned integer that specifies the blue component of this color.

unused (1 byte): Undefined and MUST be ignored.

2.12.2 ColorIndexStruct

Referenced by: [AnimationInfoAtom](#), [SlideShowDocInfoAtom](#), [TextCFException](#), [TextPFException](#)

A structure that specifies an index in the color scheme, or a color in the sRGB color space as specified in [\[IEC-RGB\]](#). Color schemes are specified by the [SlideSchemeColorSchemeAtom](#) record.

0	1	2	3	4	5	6	7	8	9	10	11	12	13	14	15	16	17	18	19	20	21	22	23	24	25	26	27	28	29	30	31
red										green										blue						index					

red (1 byte): An unsigned integer that specifies the red component of this color.

green (1 byte): An unsigned integer that specifies the green component of this color.

blue (1 byte): An unsigned integer that specifies the blue component of this color.

index (1 byte): An unsigned integer that specifies the index in the color scheme. It MUST be a value from the following table.

Value	Description
0x00	Background color
0x01	Text color
0x02	Shadow color
0x03	Title text color
0x04	Fill color
0x05	Accent 1 color
0x06	Accent 2 color
0x07	Accent 3 color
0xFE	Color is an sRGB value specified by red , green , and blue fields.
0xFF	Color is undefined.

2.12.3 WideColorStruct

Referenced by: [RecolorEntry](#), [RecolorEntryBrush](#), [RecolorEntryColor](#), [RecolorInfoAtom](#)

A structure that specifies a color in the sRGB color space as specified in [\[IEC-RGB\]](#).

0	1	2	3	4	5	6	7	8	9	10	11	12	13	14	15	16	17	18	19	20	21	22	23	24	25	26	27	28	29	30	31
red																green															
blue																															

red (2 bytes): An unsigned integer that specifies the red component of this color.

green (2 bytes): An unsigned integer that specifies the green component of this color.

blue (2 bytes): An unsigned integer that specifies the blue component of this color.

2.12.4 DateTimeStruct

Referenced by: [BroadcastDocInfoAtom](#), [Comment10Atom](#), [SlideSyncInfoAtom12](#)

A structure that specifies the date and time.

0	1	2	3	4	5	6	7	8	9	10	11	12	13	14	15	16	17	18	19	20	21	22	23	24	25	26	27	28	29	30	31
datetime (16 bytes)																															
...																															
...																															

datetime (16 bytes): A **SYSTEMTIME** structure, as specified in [\[MS-DTYP\]](#) section [2.3.13](#), that specifies the date and time.

2.12.5 PointStruct

Referenced by: [Comment10Atom](#), [DocumentAtom](#), [NoZoomViewInfoAtom](#), [ZoomViewInfoAtom](#)

A structure that specifies a point in the x-y coordinate system.

0	1	2	3	4	5	6	7	8	9	10	11	12	13	14	15	16	17	18	19	20	21	22	23	24	25	26	27	28	29	30	31
																x															
																y															

x (4 bytes): A signed integer that specifies the x-coordinate. Positive x increases to the right.

y (4 bytes): A signed integer that specifies the y-coordinate. Positive y increases to the bottom.

2.12.6 RatioStruct

Referenced by: [DocumentAtom](#), [NormalViewSetInfoAtom](#), [ScalingStruct](#)

A structure that specifies a rational number.

0	1	2	3	4	5	6	7	8	9	10	11	12	13	14	15	16	17	18	19	20	21	22	23	24	25	26	27	28	29	30	31
																numer															
																denom															

numer (4 bytes): A signed integer that specifies the numerator portion of this ratio.

denom (4 bytes): A signed integer that specifies the denominator portion of this ratio. It MUST NOT be 0x00000000.

2.12.7 RectStruct

Referenced by: [OfficeArtClientAnchorData](#)

A structure that specifies a rectangle.

0	1	2	3	4	5	6	7	8	9	10	11	12	13	14	15	16	17	18	19	20	21	22	23	24	25	26	27	28	29	30	31
																top															
																left															
																right															
																bottom															

top (4 bytes): A signed integer that specifies the minimum y-value of the rectangle.

left (4 bytes): A signed integer that specifies the minimum x-value of the rectangle.

right (4 bytes): A signed integer that specifies the maximum x-value of the rectangle.

bottom (4 bytes): A signed integer that specifies the maximum y-value of the rectangle.

2.12.8 SmallRectStruct

Referenced by: [OfficeArtClientAnchorData](#)

A structure that specifies a small rectangle.

0	1	2	3	4	5	6	7	8	9	10	11	12	13	14	15	16	17	18	19	20	21	22	23	24	25	26	27	28	29	30	31
top																left															
right																bottom															

top (2 bytes): A signed integer that specifies the minimum y-value of the rectangle.

left (2 bytes): A signed integer that specifies the minimum x-value of the rectangle.

right (2 bytes): A signed integer that specifies the maximum x-value of the rectangle.

bottom (2 bytes): A signed integer that specifies the maximum y-value of the rectangle.

2.12.9 ScalingStruct

Referenced by: [NoZoomViewInfoAtom](#), [ZoomViewInfoAtom](#)

A structure that specifies two-dimensional scaling.

0	1	2	3	4	5	6	7	8	9	10	11	12	13	14	15	16	17	18	19	20	21	22	23	24	25	26	27	28	29	30	31
x																...															
y																...															

x (8 bytes): A **RatioStruct** structure (section [2.12.6](#)) that specifies the scale to apply along the x-axis.

y (8 bytes): A **RatioStruct** structure that specifies the scale to apply along the y-axis.

2.12.10 TmsfTimeStruct

Referenced by: [ExCDAudioAtom](#)

A structure that specifies CD (compact disc) audio time in terms of tracks, minutes, seconds, and frames.

0	1	2	3	4	5	6	7	8	9	10	11	12	13	14	15	16	17	18	19	20	21	22	23	24	25	26	27	28	29	30	31								
track										minute										second										frame									

track (1 byte): An unsigned integer that specifies the track number. It MUST be greater than 0x00 and less than or equal to 0x64.

minute (1 byte): An unsigned integer that specifies the number of minutes. It MUST be less than or equal to 0x3C.

second (1 byte): An unsigned integer that specifies the number of seconds. It MUST be less than 0x3C.

frame (1 byte): An unsigned integer that specifies the frame number. It MUST be less than 0x4A.

2.13 Enumerations

2.13.1 AnimAfterEffectEnum

Referenced by: [AnimationInfoAtom](#)

An enumeration that specifies behavior types of **shapes** or text after animation effects are complete.

Name	Value	Meaning
AI_NoAfterEffect	0x00	No further change to the animated object after the animation is complete.
AI_Dim	0x01	Change the animated object to a specified color after the animation is complete.
AI_Hide	0x02	Hide the animated object on the next mouse click.
AI_HideImmediately	0x03	Hide the animated object immediately after the animation is complete.

2.13.2 AnimBuildTypeEnum

Referenced by: [AnimationInfoAtom](#)

An enumeration that specifies animation **build** types.

Name	Value	Meaning
BT_FollowMaster	0xFE	The shape follows the build type of the placeholder shape on its main master slide or its title master slide .
BT_NoBuild	0x00	No build for the shape .
BT_OneBuild	0x01	The shape animates in its entirety.
BT_Level1Build	0x02	Each paragraph of level 1 animates separately, and paragraphs of all other levels animate at the same time as their level 1 paragraphs.
BT_Level2Build	0x03	Each paragraph from level 1 to level 2 animates separately, and paragraphs of all other levels animate at the same time as their level 2 paragraphs.

Name	Value	Meaning
BT_Level3Build	0x04	Each paragraph from level 1 to level 3 animates separately, and paragraphs of all other levels animate at the same time as their level 3 paragraphs.
BT_Level4Build	0x05	Each paragraph from level 1 to level 4 animates separately, and paragraphs of level 5 animate at the same time as their level 4 paragraphs.
BT_Level5Build	0x06	Each paragraph from level 1 to level 5 animates separately.
BT_GraphBySeries	0x07	Each series animates separately, and all elements in each series animate at the same time.
BT_GraphByCategory	0x08	Each category animates separately, and all elements in each category animate at the same time.
BT_GraphByElementInSeries	0x09	Elements in the chart animate in the following order: Element in series 1 and category 1 Element in series 1 and category 2 Element in series 1 and category 3 ... Element in series 2 and category 1 Element in series 2 and category 2 Element in series 2 and category 3 ... Element in series 3 and category 1 Element in series 3 and category 2 Element in series 3 and category 3 ...
BT_GraphByElementInCategory	0x0A	Elements in the chart animate in the following order: Element in category 1 and series 1 Element in category 1 and series 2 Element in category 1 and series 3 ... Element in category 2 and series 1 Element in category 2 and series 2 Element in category 2 and series 3 ... Element in category 3 and series 1 Element in category 3 and series 2 Element in category 3 and series 3 ...

2.13.3 BuildTypeEnum

Referenced by: [BuildAtom](#)

An enumeration that specifies different types of **builds**.

Name	Value	Meaning
TL_BuildParagraph	0x00000001	Paragraph build type.

Name	Value	Meaning
TL_BuildChart	0x00000002	Chart build type.
TL_BuildDiagram	0x00000003	Diagram build type.

2.13.4 ChartBuildEnum

Referenced by: [ChartBuildAtom](#)

An enumeration that specifies different types of chart **builds**.

Name	Value	Meaning
TLCB_AsOneObject	0x00000000	Chart animates in its entirety.
TLCB_BySeries	0x00000001	Each series animates separately, and all elements in each series animate at the same time.
TLCB_ByCategory	0x00000002	Each category animates separately, and all elements in each category animate at the same time.
TLCB_ByElementInSeries	0x00000003	Elements in the chart animate in the following order: Element in series 1 and category 1 Element in series 1 and category 2 Element in series 1 and category 3 ... Element in series 2 and category 1 Element in series 2 and category 2 Element in series 2 and category 3 ... Element in series 3 and category 1 Element in series 3 and category 2 Element in series 3 and category 3 ...
TLCB_ByElementInCategory	0x00000004	Elements in the chart animate in the following order: Element in category 1 and series 1 Element in category 1 and series 2 Element in category 1 and series 3 ... Element in category 2 and series 1 Element in category 2 and series 2 Element in category 2 and series 3 ... Element in category 3 and series 1 Element in category 3 and series 2 Element in category 3 and series 3 ...
TLCB_Custom	0x00000005	Custom chart build type.

2.13.5 ColorModeEnum

Referenced by: [PrintOptionsAtom](#)

An enumeration that specifies how colors are printed.

Name	Value	Meaning
CM_BlackAndWhite	0x00	Every color is represented as black only or white only.
CM_Grayscale	0x01	Every color is represented by its corresponding shade of gray.
CM_Color	0x02	No processing is done on the colors before sending them to the printer.

2.13.6 ConditionEnum

Referenced by: [TimeConditionContainer](#)

An enumeration that specifies the type of a **time condition**.

Name	Value	Meaning
TL_CT_None	0x00000001	None.
TL_CT_Begin	0x00000002	Begin condition that specifies when a time node will be activated.
TL_CT_End	0x00000003	End condition that specifies when a time node will be deactivated.
TL_CT_Next	0x00000004	Next condition that specifies when the next child time node of a sequential time node will be activated.
TL_CT_Previous	0x00000005	Previous condition that specifies when the previous child time node of a sequential time node will be activated.
TL_CT_EndSync	0x00000006	EndSync condition that specifies how to synchronize the stopping of the child nodes of a time node.

2.13.7 DiagramBuildEnum

Referenced by: [DiagramBuildAtom](#)

An enumeration that specifies the animation diagram **build** type to be applied to a diagram.

Name	Value	Meaning
TLDB_AsOneObject	0x00000000	The diagram and all corresponding parts animate as one graphical object.
TLDB_DepthByNode	0x00000001	The root shape of the diagram animates first, followed by its branches from left to right. For each branch, the root shape of the branch animates first, followed by the branches of this branch. This process is recursive for each shape in the diagram.
TLDB_DepthByBranch	0x00000002	The root shape of the diagram animates first, followed by its branches from left to right; and each of its branches animates as one graphical object.
TLDB_BreadthByNode	0x00000003	The root shape of the diagram animates first, followed by its levels from top to bottom. Shapes in each level animate separately from left to right.

Name	Value	Meaning
TLDB_BreadthByLevel	0x00000004	The root shape of the diagram animates first, followed by its levels from top to bottom. Each level animates as one graphical object.
TLDB_ClockWise	0x00000005	Shapes in the diagram animate in the clockwise direction.
TLDB_ClockWiseIn	0x00000006	Shapes in the diagram animate in the clockwise direction. Shapes animate inwardly starting from the outermost ring.
TLDB_ClockWiseOut	0x00000007	Shapes in the diagram animate in the clockwise direction. Shapes animate outwardly starting from the innermost ring.
TLDB_CounterClockWise	0x00000008	Shapes in the diagram animate in the counterclockwise direction.
TLDB_CounterClockWiseIn	0x00000009	Shapes in the diagram animate in the counterclockwise direction. Shapes animate inwardly starting from the outermost ring.
TLDB_CounterClockWiseOut	0x0000000A	Shapes in the diagram animate in the counterclockwise direction. Shapes animate outwardly starting from the innermost ring.
TLDB_InByRing	0x0000000B	Rings in the diagram animate from the outside to the inside. All shapes in each ring animate at the same time.
TLDB_OutByRing	0x0000000C	Rings in the diagram animate from the inside to the outside. All shapes in each ring animate at the same time.
TLDB_Up	0x0000000D	Shapes in the diagram animate from bottom to top.
TLDB_Down	0x0000000E	Shapes in the diagram animate from top to bottom.
TLDB_AllAtOnce	0x0000000F	All shapes in the diagram animate at the same time.
TLDB_Custom	0x00000010	Shapes in the diagram animate in a custom way not otherwise specified by one of the allowed diagram build types.

2.13.8 DiffTypeEnum

Referenced by: [DiffRecordHeaders](#)

An enumeration that specifies different types of document changes made by a reviewer.

Name	Value	Meaning
Diff_DocDiff	0x00000000	Document level change.
Diff_SlideDiff	0x00000002	Slide change.
Diff_MainMasterDiff	0x00000003	Main master change.
Diff_SlideListDiff	0x00000004	Slide list change.
Diff_MasterListDiff	0x00000005	Master list change.
Diff_ShapeListDiff	0x00000006	Shape list change.
Diff_ShapeDiff	0x00000007	Shape change.
Diff_TextDiff	0x00000009	Text change.

Name	Value	Meaning
Diff_NotesDiff	0x0000000A	Notes change.
Diff_SlideShowDiff	0x0000000B	Slide show change.
Diff_HeaderFooterDiff	0x0000000C	Header footer change.
Diff_NamedShowDiff	0x0000000E	Named show change.
Diff_NamedShowListDiff	0x0000000F	Named show list change.
Diff_RecolorInfoDiff	0x00000012	Recolor info change.
Diff_ExternalObjectDiff	0x00000013	External object change.
Diff_TableListDiff	0x00000015	Table list change.
Diff_TableDiff	0x00000016	Table change.
Diff_InteractiveInfoDiff	0x00000017	Interactive information change.

2.13.9 ElementTypeEnum

Referenced by: [VisualShapeChartElementAtom](#), [VisualShapeGeneralAtom](#), [VisualSoundAtom](#)

An enumeration that specifies the element type of an animation target.

Name	Value	Meaning
TL_ET_ShapeType	0x00000001	The animation targets a shape or some part of a shape.
TL_ET_SoundType	0x00000002	The animation targets a sound file that does not correspond to a shape.

2.13.10 ExColorFollowEnum

Referenced by: [ExOleEmbedAtom](#)

An enumeration that specifies how an **OLE object** follows the **color scheme**.

Name	Value	Meaning
ExColor_FollowNone	0x00000000	Does not follow the color scheme.
ExColor_FollowScheme	0x00000001	Follows the color scheme.
ExColor_FollowTextAndBackground	0x00000002	Follows only the text and background colors of the color scheme.

2.13.11 ExOleObjSubTypeEnum

Referenced by: [ExOleObjAtom](#)

An enumeration that specifies the subtype of an **OLE object** based on its **ProgID** (described in [\[MSDN-COM\]](#)).

Name	Value	Meaning
ExOleSub_Default	0x00000000	Used when none of the following apply.

Name	Value	Meaning
ExOleSub_Clipart	0x00000001	MS_ClipArt_Gallery
ExOleSub_WordDoc	0x00000002	Word.Document or Word.DocumentMacroEnabled
ExOleSub_Excel	0x00000003	Excel.Sheet, Excel.SheetMacroEnabled or Excel.SheetBinaryMacroEnabled
ExOleSub_Graph	0x00000004	MSGraph.Chart or MSGraph
ExOleSub_OrgChart	0x00000005	OrgChart, MSOrgChart or OrgPlusWOPX
ExOleSub_Equation	0x00000006	Equations or Equation
ExOleSub_WordArt	0x00000007	MSWordArt
ExOleSub_Sound	0x00000008	SoundRec
ExOleSub_Project	0x0000000C	MSProject
ExOleSub_NoteIt	0x0000000D	Note-It
ExOleSub_ExcelChart	0x0000000E	Excel.Chart
ExOleSub_MediaPlayer	0x0000000F	MPlayer, MIDFile or AVIFile
ExOleSub_WordPad	0x00000010	WordPad.Document
ExOleSub_Visio	0x00000011	Visio.Drawing< 113 >
ExOleSub_WordODF	0x00000012	Word.OpenDocumentText< 114 >
ExOleSub_ExcelODF	0x00000013	Excel.OpenDocumentSpreadsheet< 115 >
ExOleSub_PPTODF	0x00000014	PowerPoint.OpenDocumentPresentation< 116 >

2.13.12 ExOleObjTypeEnum

Referenced by: [ExOleObjAtom](#)

An enumeration that specifies the type of an **OLE object**.

Name	Value	Meaning
ExOle_Embedded	0x00000000	An embedded OLE object; the object is serialized and saved within the file.
ExOle_Link	0x00000001	A linked OLE object; the object is saved outside of the file.
ExOle_Control	0x00000002	The OLE object is an ActiveX control .

2.13.13 InteractiveInfoActionEnum

Referenced by: [InteractiveInfoAtom](#)

An enumeration that specifies an action that can be performed when interacting with an object during a **slide show**.

Name	Value	Meaning
II_NoAction	0x00	No effect.

Name	Value	Meaning
II_MacroAction	0x01	A macro is executed.
II_RunProgramAction	0x02	A program is run.
II_JumpAction	0x03	The current presentation slide of the slide show jumps to another presentation slide in the same presentation .
II_HyperlinkAction	0x04	A URL is executed.
II_OLEAction	0x05	An OLE action (only valid if the object this applies to is an OLE embedded object).
II_MediaAction	0x06	A media object is played.
II_CustomShowAction	0x07	A named show is displayed.

2.13.14 InteractiveInfoJumpEnum

Referenced by: [InteractiveInfoAtom](#)

An enumeration that specifies a location relative to the currently-displayed **presentation slide** in the **slide show**.

Name	Value	Meaning
II_NoJump	0x00	No change.
II_NextSlide	0x01	The next slide.
II_PreviousSlide	0x02	The previous slide.
II_FirstSlide	0x03	The first slide.
II_LastSlide	0x04	The last slide.
II_LastSlideViewed	0x05	The last viewed slide.
II_EndShow	0x06	The end of show slide (a virtual slide displayed after the last slide).

2.13.15 LinkToEnum

Referenced by: [InteractiveInfoAtom](#)

An enumeration that specifies how the action of a hyperlink is interpreted. All locations are relative to the currently-displayed **presentation slide** in the **slide show**.

Name	Value	Meaning
LT_NextSlide	0x00	The next slide.
LT_PreviousSlide	0x01	The previous slide.
LT_FirstSlide	0x02	The first slide.
LT_LastSlide	0x03	The last slide.
LT_CustomShow	0x06	A named show .
LT_SlideNumber	0x07	A specific slide number.

Name	Value	Meaning
LT_Url	0x08	A Uniform Resource Locator (URL) .
LT_OtherPresentation	0x09	Another presentation file.
LT_OtherFile	0x0A	Another file that is not necessarily a presentation.
LT_Nil	0xFF	The hyperlink is not valid.

2.13.16 NormalViewSetBarStates

Referenced by: [NormalViewSetInfoAtom](#)

An enumeration that specifies different states of a region of a view.

Name	Value	Meaning
BS_Minimized	0x00	The region occupies a minimal area of the view.
BS_Restored	0x01	The region has an intermediate size.
BS_Maximized	0x02	The region occupies a maximal area of the view.

2.13.17 OLEVerbEnum

Referenced by: [AnimationInfoAtom](#), [InteractiveInfoAtom](#)

An enumeration that specifies the identifier of an **OLE verb**. Because this enumeration refers to values defined by the OLE object that it is linked to, the sample values listed in the table are placeholders that specify which command to run. The actual number of verbs depends on the **OLE object** itself.

Name	Value	Meaning
OV_Primary	0x00	The primary verb is to be used.
OV_Secondary	0x01	The secondary verb is to be used.
OV_Tertiary	0x02	The tertiary verb is to be used.

2.13.18 ParaBuildEnum

Referenced by: [ParaBuildAtom](#)

An enumeration that specifies the animation paragraph **build** type that is to be applied to the paragraphs of the **shape**.

Name	Value	Meaning
TLPB_AllAtOnce	0x00000000	All paragraphs in the shape animate at the same time.
TLPB_BuildByNthLevel	0x00000001	Paragraph levels 1 to $n - 1$ in the shape animate separately. All paragraph levels n or greater animate at the same time.
TLPB_CustomBuild	0x00000002	Applies a custom animation paragraph build type to the paragraphs of the shape.

Name	Value	Meaning
TLPB_AsAWhole	0x00000003	The shape and all paragraphs within the shape animate as one graphical object.

2.13.19 PhotoAlbumFrameShapeEnum

Referenced by: [PhotoAlbumInfo10Atom](#)

An enumeration that specifies how the frames around the pictures in the photo album are drawn. Some frames are created by cropping the photos to a certain **shape**, and others involve putting a frame image on top of them without modifying them.

Name	Value	Meaning
PA_Rectangle	0x0000	The pictures are drawn normally.
PA_RoundedRectangle	0x0001	The pictures are drawn with their edges cropped such that the shape of the frame of the pictures is a rounded rectangle.
PA_Beveled	0x0002	The pictures are drawn to look like the frame has a beveled edge.
PA_Oval	0x0003	The pictures are drawn with their edges cropped such that the shape of the frame of the pictures is an oval.
PA_Octagon	0x0004	The pictures are drawn with triangular shapes covering the four corners of the frame.
PA_Cross	0x0005	The pictures are drawn with square shapes covering the four corners of the frame.
PA_Plaque	0x0006	The pictures are drawn with rounded shapes covering the four corners of the frame.

2.13.20 PhotoAlbumLayoutEnum

Referenced by: [PhotoAlbumInfo10Atom](#)

An enumeration that specifies how the pictures are arranged on each **presentation slide**.

Name	Value	Meaning
PA_FitToSlide	0x00	Each presentation slide contains one picture that is scaled as large as will fit within the bounds of the slides while still preserving the aspect ratio.
PA_OnePicture	0x01	Each presentation slide contains one picture.
PA_TwoPictures	0x02	Each presentation slide contains two pictures.
PA_FourPictures	0x03	Each presentation slide contains four pictures
PA_OnePictureAndTitle	0x04	Each presentation slide contains one picture and a title placeholder shape .
PA_TwoPicturesAndTitle	0x05	Each presentation slide contains two pictures and a title placeholder shape.
PA_FourPicturesAndTitle	0x06	Each presentation slide contains four pictures and a title placeholder shape.

2.13.21 PlaceholderEnum

Referenced by: [PlaceholderAtom](#), [RoundTripHFPlaceholder12Atom](#), [RoundTripNewPlaceholderId12Atom](#), [SlideAtom](#)

An enumeration that specifies the type of a **placeholder shape**. The meaning of each enumeration value is further specified in the PlaceholderAtom record. This enumeration is also used to define a **slide layout** as described in the SlideAtom record.

Name	Value	Meaning
PT_None	0x00	No placeholder shape.
PT_MasterTitle	0x01	Master title text placeholder shape.
PT_MasterBody	0x02	Master body text placeholder shape.
PT_MasterCenterTitle	0x03	Master center title text placeholder shape.
PT_MasterSubTitle	0x04	Master sub-title text placeholder shape.
PT_MasterNotesSlideImage	0x05	Master notes slide image placeholder shape.
PT_MasterNotesBody	0x06	Master notes body text placeholder shape.
PT_MasterDate	0x07	Master date placeholder shape.
PT_MasterSlideNumber	0x08	Master slide number placeholder shape.
PT_MasterFooter	0x09	Master footer placeholder shape.
PT_MasterHeader	0x0A	Master header placeholder shape.
PT_NotesSlideImage	0x0B	Notes slide image placeholder shape.
PT_NotesBody	0x0C	Notes body text placeholder shape.
PT_Title	0x0D	Title text placeholder shape.
PT_Body	0x0E	Body text placeholder shape.
PT_CenterTitle	0x0F	Center title text placeholder shape.
PT_SubTitle	0x10	Sub-title text placeholder shape.
PT_VerticalTitle	0x11	Vertical title text placeholder shape.
PT_VerticalBody	0x12	Vertical body text placeholder shape.
PT_Object	0x13	Object placeholder shape.
PT_Graph	0x14	Graph object placeholder shape.
PT_Table	0x15	Table object placeholder shape.
PT_ClipArt	0x16	Clipart object placeholder shape.
PT_OrgChart	0x17	Organization chart object placeholder shape.
PT_Media	0x18	Media object placeholder shape.
PT_VerticalObject	0x19	Vertical object placeholder shape.
PT_Picture	0x1A	Picture object placeholder shape.

2.13.22 PlaceholderSize

Referenced by: [PlaceholderAtom](#)

An enumeration that specifies the preferred size of a **placeholder shape**. The size is relative to the size of the master body text placeholder shape.

Name	Value	Meaning
PS_Full	0x00	The full size of the master body text placeholder shape.
PS_Half	0x01	Half of the size of the master body text placeholder shape.
PS_Quarter	0x02	A quarter of the size of the master body text placeholder shape.

2.13.23 PrintWhatEnum

Referenced by: [PrintOptionsAtom](#)

An enumeration that specifies which aspect of the presentation to print.

Name	Value	Meaning
PW_Slides	0x00	The presentation slides .
PW_BuildSlides	0x01	The presentation slides plus extra images showing the steps of animations.
PW_Handouts2	0x02	A layout optimized for handout slides where two slides are shown per page.
PW_Handouts3	0x03	A layout optimized for handout slides where three slides are shown per page.
PW_Handouts6	0x04	A layout optimized for handout slides where six slides are shown per page.
PW_Notes	0x05	The presentation slides plus the attached notes.
PW_Outline	0x06	The text outline of the presentation.
PW_Handouts4	0x07	A layout optimized for handout slides where four slides are shown per page.
PW_Handouts9	0x08	A layout optimized for handout slides where nine slides are shown per page.
PW_Handouts1	0x09	A layout optimized for handout slides where one slide is shown per page.

2.13.24 RecordType

Referenced by: [RecordHeader](#)

An enumeration that specifies the record type of an **atom record** or a **container record**.

Name	Value	Meaning
RT_Document	0x03E8	Specifies a DocumentContainer (section 2.4.1).
RT_DocumentAtom	0x03E9	Specifies a DocumentAtom (section 2.4.2).
RT_EndDocumentAtom	0x03EA	Specifies a EndDocumentAtom record (section 2.4.13).
RT_Slide	0x03EE	Specifies a SlideContainer (section 2.5.1).

Name	Value	Meaning
RT_SlideAtom	0x03EF	Specifies a SlideAtom .
RT_Notes	0x03F0	Specifies a NotesContainer (section 2.5.6).
RT_NotesAtom	0x03F1	Specifies a NotesAtom .
RT_Environment	0x03F2	Specifies a DocumentTextInfoContainer record (section 2.9.1).
RT_SlidePersistAtom	0x03F3	Specifies a MasterPersistAtom (section 2.4.14.2), SlidePersistAtom (section 2.4.14.5), or NotesPersistAtom (section 2.4.14.7).
RT_MainMaster	0x03F8	Specifies a MainMasterContainer (section 2.5.3).
RT_SlideShowSlideInfoAtom	0x03F9	Specifies a SlideShowSlideInfoAtom .
RT_SlideViewInfo	0x03FA	Specifies a SlideViewInfoContainer (section 2.4.21.9) or NotesViewInfoContainer (section 2.4.21.12).
RT_GuideAtom	0x03FB	Specifies a GuideAtom .
RT_ViewInfoAtom	0x03FD	Specifies a ZoomViewInfoAtom or NoZoomViewInfoAtom .
RT_SlideViewInfoAtom	0x03FE	Specifies a SlideViewInfoAtom .
RT_VbaInfo	0x03FF	Specifies a VBAInfoContainer (section 2.4.10).
RT_VbaInfoAtom	0x0400	Specifies a VBAInfoAtom .
RT_SlideShowDocInfoAtom	0x0401	Specifies a SlideShowDocInfoAtom record (section 2.6.1).
RT_Summary	0x0402	Specifies a SummaryContainer record (section 2.4.22.3).
RT_DocRoutingSlipAtom	0x0406	Specifies a DocRoutingSlipAtom record (section 2.11.1).
RT_OutlineViewInfo	0x0407	Specifies an OutlineViewInfoContainer (section 2.4.21.6).
RT_SorterViewInfo	0x0408	Specifies a SorterViewInfoContainer record (section 2.4.21.13).
RT_ExternalObjectList	0x0409	Specifies an ExObjListContainer (section 2.10.1).
RT_ExternalObjectListAtom	0x040A	Specifies an ExObjListAtom .
RT_DrawingGroup	0x040B	Specifies a DrawingGroupContainer (section 2.4.3).
RT_Drawing	0x040C	Specifies a DrawingContainer (section 2.5.13).
RT_GridSpacing10Atom	0x040D	Specifies a GridSpacing10Atom .
RT_RoundTripTheme12Atom	0x040E	Specifies a RoundTripThemeAtom .

Name	Value	Meaning
RT_RoundTripColorMapping12Atom	0x040F	Specifies a RoundTripColorMappingAtom .
RT_NamedShows	0x0410	Specifies a NamedShowsContainer (section 2.6.2).
RT_NamedShow	0x0411	Specifies a NamedShowContainer .
RT_NamedShowSlidesAtom	0x0412	Specifies a NamedShowSlidesAtom .
RT_NotesTextViewInfo9	0x0413	Specifies a NotesTextViewInfoContainer (section 2.4.21.4).
RT_NormalViewSetInfo9	0x0414	Specifies a NormalViewSetInfoContainer (section 2.4.21.2).
RT_NormalViewSetInfo9Atom	0x0415	Specifies a NormalViewSetInfoAtom .
RT_RoundTripOriginalMainMasterId12Atom	0x041C	Specifies a RoundTripOriginalMainMasterId12Atom .
RT_RoundTripCompositeMasterId12Atom	0x041D	Specifies a RoundTripCompositeMasterId12Atom .
RT_RoundTripContentMasterInfo12Atom	0x041E	Specifies a RoundTripContentMasterInfo12Atom .
RT_RoundTripShapeId12Atom	0x041F	Specifies a RoundTripShapeId12Atom .
RT_RoundTripHFPlaceholder12Atom	0x0420	Specifies a RoundTripHFPlaceholder12Atom .
RT_RoundTripContentMasterId12Atom	0x0422	Specifies a RoundTripContentMasterId12Atom .
RT_RoundTripOArtTextStyles12Atom	0x0423	Specifies a RoundTripOArtTextStyles12Atom .
RT_RoundTripHeaderFooterDefaults12Atom	0x0424	Specifies a RoundTripHeaderFooterDefaults12Atom .
RT_RoundTripDocFlags12Atom	0x0425	Specifies a RoundTripDocFlags12Atom .
RT_RoundTripShapeChecksumForCL12Atom	0x0426	Specifies a RoundTripShapeChecksumForCustomLayouts12AtomAtom .
RT_RoundTripNotesMasterTextStyles12Atom	0x0427	Specifies a RoundTripNotesMasterTextStyles12Atom .
RT_RoundTripCustomTableStyles12Atom	0x0428	Specifies a RoundTripCustomTableStyles12Atom record (section 2.11.13).
RT_List	0x07D0	Specifies a DocInfoListContainer (section 2.4.4).
RT_FontCollection	0x07D5	Specifies a FontCollectionContainer (section 2.9.8).
RT_FontCollection10	0x07D6	Specifies a FontCollection10Container (section 2.9.11).
RT_BookmarkCollection	0x07E3	Specifies a BookmarkCollectionContainer .
RT_SoundCollection	0x07E4	Specifies a SoundCollectionContainer record (section 2.4.16.1).
RT_SoundCollectionAtom	0x07E5	Specifies a SoundCollectionAtom .

Name	Value	Meaning
RT_Sound	0x07E6	Specifies a SoundContainer (section 2.4.16.3).
RT_SoundDataBlob	0x07E7	Specifies a SoundDataBlob .
RT_BookmarkSeedAtom	0x07E9	Specifies a BookmarkSeedAtom .
RT_ColorSchemeAtom	0x07F0	Specifies a SlideSchemeColorSchemeAtom or SchemeListElementColorSchemeAtom .
RT_BlipCollection9	0x07F8	Specifies a BlipCollection9Container (section 2.9.72).
RT_BlipEntity9Atom	0x07F9	Specifies a BlipEntityAtom .
RT_ExternalObjectRefAtom	0x0BC1	Specifies an ExObjRefAtom .
RT_PlaceholderAtom	0x0BC3	Specifies a PlaceholderAtom .
RT_ShapeAtom	0x0BD B	Specifies a ShapeFlagsAtom .
RT_ShapeFlags10Atom	0x0BD C	Specifies a ShapeFlags10Atom .
RT_RoundTripNewPlaceholderId12Atom	0x0BD D	Specifies a RoundTripNewPlaceholderId12Atom .
RT_OutlineTextRefAtom	0x0F9E	Specifies an OutlineTextRefAtom .
RT_TextHeaderAtom	0x0F9F	Specifies a TextHeaderAtom .
RT_TextCharsAtom	0x0FA0	Specifies a TextCharsAtom .
RT_StyleTextPropAtom	0x0FA1	Specifies a StyleTextPropAtom .
RT_MasterTextPropAtom	0x0FA2	Specifies a MasterTextPropAtom .
RT_TextMasterStyleAtom	0x0FA3	Specifies a TextMasterStyleAtom .
RT_TextCharFormatExceptionAtom	0x0FA4	Specifies a TextCFExceptionAtom .
RT_TextParagraphFormatExceptionAtom	0x0FA5	Specifies a TextPFExceptionAtom .
RT_TextRulerAtom	0x0FA6	Specifies a TextRulerAtom .
RT_TextBookmarkAtom	0x0FA7	Specifies a TextBookmarkAtom .
RT_TextBytesAtom	0x0FA8	Specifies a TextBytesAtom .
RT_TextSpecialInfoDefaultAtom	0x0FA9	Specifies a TextSIExceptionAtom .
RT_TextSpecialInfoAtom	0x0FA A	Specifies a TextSpecialInfoAtom .
RT_DefaultRulerAtom	0x0FA B	Specifies a DefaultRulerAtom .
RT_StyleTextProp9Atom	0x0FA C	Specifies a StyleTextProp9Atom .
RT_TextMasterStyle9Atom	0x0FA	Specifies a TextMasterStyle9Atom .

Name	Value	Meaning
	D	
RT_OutlineTextProps9	0x0FAE	Specifies an OutlineTextProps9Container .
RT_OutlineTextPropsHeader9Atom	0x0FAF	Specifies an OutlineTextPropsHeaderExAtom .
RT_TextDefaults9Atom	0x0FB0	Specifies a TextDefaults9Atom .
RT_StyleTextProp10Atom	0x0FB1	Specifies a StyleTextProp10Atom .
RT_TextMasterStyle10Atom	0x0FB2	Specifies a TextMasterStyle10Atom .
RT_OutlineTextProps10	0x0FB3	Specifies an OutlineTextProps10Container .
RT_TextDefaults10Atom	0x0FB4	Specifies a TextDefaults10Atom .
RT_OutlineTextProps11	0x0FB5	Specifies an OutlineTextProps11Container .
RT_StyleTextProp11Atom	0x0FB6	Specifies a StyleTextProp11Atom .
RT_FontEntityAtom	0x0FB7	Specifies a FontEntityAtom .
RT_FontEmbedDataBlob	0x0FB8	Specifies a FontEmbedDataBlob .
RT_CString	0x0FB A	Specifies a KinsokuLeadingAtom , KinsokuFollowingAtom , NamedShowNameAtom , MacroNameAtom , UncOrLocalPathAtom , MenuNameAtom , ProgIDAtom , ClipboardNameAtom , FriendlyNameAtom , TargetAtom , LocationAtom , ScreenTipAtom , PP9ShapeBinaryTagExtension , PP10ShapeBinaryTagExtension , PP11ShapeBinaryTagExtension , SlideNameAtom , TemplateNameAtom , PP9SlideBinaryTagExtension , PP10SlideBinaryTagExtension , Comment10AuthorAtom , Comment10TextAtom , Comment10AuthorInitialAtom , PP12SlideBinaryTagExtension , SoundNameAtom , PP9DocBinaryTagExtension , FileNameAtom , NamedShowAtom , BCTitleAtom , BCDescriptionAtom , BCSpeakerAtom , BCContactAtom , BCRexServerNameAtom , BCEmailAddressAtom , BCEmailNameAtom , BCChatUrlAtom , BCArchiveDirAtom , BCNetShowFilesBaseDirAtom , BCNetShowFilesDirAtom , BCNetShowServerNameAtom , BCPptFilesBaseDirAtom , BCPptFilesDirAtom , BCPptFilesBaseUrlAtom , BCBroadcastDateTimeAtom , BCPresentationNameAtom , BCAsdFileNameAtom , BCEntryIDAtom , PP10DocBinaryTagExtension , AuthorNameAtom , CopyrightAtom , KeywordsAtom , ModifyPasswordAtom , ReviewerNameAtom , PP11DocBinaryTagExtension , PP12DocBinaryTagExtension , UserDataAtom , HeaderAtom , FooterAtom , BookmarkValueAtom , TagNameAtom , TagValueAtom , SoundExtensionAtom , SoundIdAtom , SoundBuiltinIdAtom , BCUserNameAtom , ServerIdAtom , or SlideLibUrlAtom .
RT_MetaFile	0x0FC1	Specifies a MetafileBlob .
RT_ExternalOleObjectAtom	0x0FC3	Specifies an ExOleObjAtom section 2.10.12).
RT_Kinsoku	0x0FC8	Specifies a KinsokuContainer (section 2.9.2) or

Name	Value	Meaning
		Kinsoku9Container (section 2.9.6).
RT_Handout	0x0FC9	Specifies a HandoutContainer (section 2.5.8).
RT_ExternalOleEmbed	0x0FC C	Specifies an ExOleEmbedContainer (section 2.10.27).
RT_ExternalOleEmbedAtom	0x0FC D	Specifies an ExOleEmbedAtom .
RT_ExternalOleLink	0x0FCE	Specifies an ExOleLinkContainer (section 2.10.29).
RT_BookmarkEntityAtom	0x0FD 0	Specifies a BookmarkEntityAtom or BookmarkEntityAtomContainer .
RT_ExternalOleLinkAtom	0x0FD 1	Specifies a ExOleLinkAtom .
RT_KinsokuAtom	0x0FD 2	Specifies a KinsokuAtom or Kinsoku9Atom .
RT_ExternalHyperlinkAtom	0x0FD 3	Specifies an ExHyperlinkAtom (section 2.10.17) or ExHyperlinkRefAtom .
RT_ExternalHyperlink	0x0FD 7	Specifies an ExHyperlinkContainer .
RT_SlideNumberMetaCharAtom	0x0FD 8	Specifies a SlideNumberMCAtom .
RT_HeadersFooters	0x0FD 9	Specifies a SlideHeadersFootersContainer (section 2.4.15.1), NotesHeadersFootersContainer (section 2.4.15.6), or PerSlideHeadersFootersContainer .
RT_HeadersFootersAtom	0x0FD A	Specifies a HeadersFootersAtom .
RT_TextInteractiveInfoAtom	0x0FDF	Specifies a MouseClickedTextInteractiveInfoAtom or MouseOverTextInteractiveInfoAtom .
RT_ExternalHyperlink9	0x0FE4	Specifies an ExHyperlink9Container .
RT_RecolorInfoAtom	0x0FE7	Specifies a RecolorInfoAtom .
RT_ExternalOleControl	0x0FEE	Specifies an ExControlContainer (section 2.10.10).
RT_SlideListWithText	0x0FF0	Specifies a MasterListWithTextContainer (section 2.4.14.1), SlideListWithTextContainer (section 2.4.14.3), or NotesListWithTextContainer (section 2.4.14.6).
RT_AnimationInfoAtom	0x0FF1	Specifies an AnimationInfoAtom .
RT_InteractiveInfo	0x0FF2	Specifies a MouseClickedInteractiveInfoContainer or MouseOverInteractiveInfoContainer .
RT_InteractiveInfoAtom	0x0FF3	Specifies an InteractiveInfoAtom .
RT_UserEditAtom	0x0FF5	Specifies a UserEditAtom (section 2.3.3).
RT_CurrentUserAtom	0x0FF6	Specifies a CurrentUserAtom .
RT_DateTimeMetaCharAtom	0x0FF7	Specifies a DateTimeMCAtom .

Name	Value	Meaning
RT_GenericDateMetaCharAtom	0x0FF8	Specifies a GenericDateMCAtom .
RT_HeaderMetaCharAtom	0x0FF9	Specifies a HeaderMCAtom .
RT_FooterMetaCharAtom	0x0FFA	Specifies a FooterMCAtom .
RT_ExternalOleControlAtom	0x0FFB	Specifies an ExControlAtom .
RT_ExternalMediaAtom	0x1004	Specifies an ExMediaAtom (section 2.10.6).
RT_ExternalVideo	0x1005	Specifies an ExVideoContainer .
RT_ExternalAviMovie	0x1006	Specifies an ExAviMovieContainer .
RT_ExternalMciMovie	0x1007	Specifies an ExMCI MovieContainer .
RT_ExternalMidiAudio	0x100D	Specifies an ExMIDIAudioContainer .
RT_ExternalCdAudio	0x100E	Specifies an ExCDAudioContainer .
RT_ExternalWavAudioEmbedded	0x100F	Specifies an ExWAVAudioEmbeddedContainer .
RT_ExternalWavAudioLink	0x1010	Specifies an ExWAVAudioLinkContainer .
RT_ExternalOleObjectStg	0x1011	Specifies an ExOleObjStgCompressedAtom , ExOleObjStgUncompressedAtom , VbaProjectStgCompressedAtom , VbaProjectStgUncompressedAtom , ExControlStgUncompressedAtom , or ExControlStgCompressedAtom .
RT_ExternalCdAudioAtom	0x1012	Specifies an ExCDAudioAtom .
RT_ExternalWavAudioEmbeddedAtom	0x1013	Specifies an ExWAVAudioEmbeddedAtom .
RT_AnimationInfo	0x1014	Specifies an AnimationInfoContainer .
RT_RtfDateTimeMetaCharAtom	0x1015	Specifies a RTFDateTimeMCAtom .
RT_ExternalHyperlinkFlagsAtom	0x1018	Specifies an ExHyperlinkFlagsAtom .
RT_ProgTags	0x1388	Specifies a SlideProgTagsContainer , DocProgTagsContainer (section 2.4.23.1), or ShapeProgTagsContainer .
RT_ProgStringTag	0x1389	Specifies a ProgStringTagContainer .
RT_ProgBinaryTag	0x138A	Specifies a SlideProgBinaryTagContainer , DocProgBinaryTagContainer , or ShapeProgBinaryTagContainer .
RT_BinaryTagDataBlob	0x138B	Specifies a PP9ShapeBinaryTagExtension, PP10ShapeBinaryTagExtension, PP11ShapeBinaryTagExtension, PP9DocBinaryTagExtension, PP10DocBinaryTagExtension, PP11DocBinaryTagExtension, PP12DocBinaryTagExtension, PP9SlideBinaryTagExtension, PP10SlideBinaryTagExtension, PP12SlideBinaryTagExtension, or BinaryTagDataBlob .

Name	Value	Meaning
RT_PrintOptionsAtom	0x1770	Specifies a PrintOptionsAtom record (section 2.4.12).
RT_PersistDirectoryAtom	0x1772	Specifies a PersistDirectoryAtom (section 2.3.4).
RT_PresentationAdvisorFlags9Atom	0x177 A	Specifies a PresAdvisorFlags9Atom .
RT_HtmlDocInfo9Atom	0x177 B	Specifies an HTMLDocInfo9Atom .
RT_HtmlPublishInfoAtom	0x177 C	Specifies an HTMLPublishInfoAtom .
RT_HtmlPublishInfo9	0x177 D	Specifies an HTMLPublishInfo9Container .
RT_BroadcastDocInfo9	0x177E	Specifies a BroadcastDocInfo9Container .
RT_BroadcastDocInfo9Atom	0x177F	Specifies a BroadcastDocInfoAtom .
RT_EnvelopeFlags9Atom	0x1784	Specifies an EnvelopeFlags9Atom .
RT_EnvelopeData9Atom	0x1785	Specifies an EnvelopeData9Atom .
RT_VisualShapeAtom	0x2AF B	Specifies a VisualSoundAtom , VisualShapeChartElementAtom , or VisualShapeGeneralAtom .
RT_HashCodeAtom	0x2B0 0	Specifies a HashCode10Atom .
RT_VisualPageAtom	0x2B0 1	Specifies a VisualPageAtom .
RT_BuildList	0x2B0 2	Specifies a BuildListContainer .
RT_BuildAtom	0x2B0 3	Specifies a BuildAtom .
RT_ChartBuild	0x2B0 4	Specifies a ChartBuildContainer .
RT_ChartBuildAtom	0x2B0 5	Specifies a ChartBuildAtom .
RT_DiagramBuild	0x2B0 6	Specifies a DiagramBuildContainer .
RT_DiagramBuildAtom	0x2B0 7	Specifies a DiagramBuildAtom .
RT_ParaBuild	0x2B0 8	Specifies a ParaBuildContainer .
RT_ParaBuildAtom	0x2B0 9	Specifies a ParaBuildAtom .
RT_LevelInfoAtom	0x2B0 A	Specifies a LevelInfoAtom .
RT_RoundTripAnimationAtom12Atom	0x2B0	Specifies a RoundTripAnimationAtom .

Name	Value	Meaning
	B	
RT_RoundTripAnimationHashAtom	0x2B0D	Specifies a RoundTripAnimationHashAtom .
RT_Comment10	0x2EE0	Specifies a Comment10Container .
RT_Comment10Atom	0x2EE1	Specifies a Comment10Atom .
RT_CommentIndex10	0x2EE4	Specifies a CommentIndex10Container .
RT_CommentIndex10Atom	0x2EE5	Specifies a CommentIndex10Atom .
RT_LinkedShape10Atom	0x2EE6	Specifies a LinkedShape10Atom .
RT_LinkedSlide10Atom	0x2EE7	Specifies a LinkedSlide10Atom .
RT_SlideFlags10Atom	0x2EEA	Specifies a SlideFlags10Atom .
RT_SlideTime10Atom	0x2EEB	Specifies a SlideTime10Atom .
RT_DiffTree10	0x2EEC	Specifies a DiffTree10Container .
RT_Diff10	0x2EED	Specifies a DocDiff10Container , HeaderFooterDiffContainer , NamedShowListDiffContainer , NamedShowDiffContainer , SlideListDiffContainer , MasterListDiffContainer , MainMasterDiffContainer , SlideDiffContainer , ShapeListDiffContainer , ShapeDiffContainer , TextDiffContainer , RecolorInfoDiffContainer , ExternalObjectDiffContainer , InteractiveInfoDiffContainer , TableDiffContainer , SlideShowDiffContainer , NotesDiffContainer , or TableListDiffContainer .
RT_Diff10Atom	0x2EEE	Specifies a DocDiff10Container , HeaderFooterDiffContainer , NamedShowListDiffContainer , NamedShowDiffContainer , SlideListDiffContainer , MasterListDiffContainer , MainMasterDiffContainer , SlideDiffContainer , ShapeListDiffContainer , ShapeDiffContainer , TextDiffContainer , RecolorInfoDiffContainer , ExternalObjectDiffContainer , InteractiveInfoDiffContainer , TableDiffContainer , SlideShowDiffContainer , NotesDiffContainer , or TableListDiffContainer .
RT_SlideListTableSize10Atom	0x2EEF	Specifies a SlideListTableSize10Atom .
RT_SlideListEntry10Atom	0x2EF0	Specifies a SlideListEntry10Atom .
RT_SlideListTable10	0x2EF1	Specifies a SlideListTable10Container .
RT_CryptSession10Container	0x2F14	Specifies a CryptSession10Container (section 2.3.7).
RT_FontEmbedFlags10Atom	0x32C8	Specifies a FontEmbedFlags10Atom .
RT_FilterPrivacyFlags10Atom	0x36B	Specifies a FilterPrivacyFlags10Atom .

Name	Value	Meaning
	0	
RT_DocToolBarStates10Atom	0x36B1	Specifies a DocToolBarStates10Atom .
RT_PhotoAlbumInfo10Atom	0x36B2	Specifies a PhotoAlbumInfo2.4.9Atom .
RT_SmartTagStore11Container	0x36B3	Specifies a SmartTagStore11Container (section 2.11.28).
RT_RoundTripSlideSyncInfo12	0x3714	Specifies a RoundTripSlideSyncInfo12Container .
RT_RoundTripSlideSyncInfoAtom12	0x3715	Specifies a SlideSyncInfoAtom12 .
RT_TimeConditionContainer	0xF125	Specifies a TimeConditionContainer (section 2.8.75).
RT_TimeNode	0xF127	Specifies a TimeNodeAtom .
RT_TimeCondition	0xF128	Specifies a TimeConditionAtom .
RT_TimeModifier	0xF129	Specifies a TimeModifierAtom .
RT_TimeBehaviorContainer	0xF12A	Specifies a TimeBehaviorContainer (section 2.8.34).
RT_TimeAnimateBehaviorContainer	0xF12B	Specifies a TimeAnimateBehaviorContainer (section 2.8.29).
RT_TimeColorBehaviorContainer	0xF12C	Specifies a TimeColorBehaviorContainer (section 2.8.52).
RT_TimeEffectBehaviorContainer	0xF12D	Specifies a TimeEffectBehaviorContainer (section 2.8.61).
RT_TimeMotionBehaviorContainer	0xF12E	Specifies a TimeMotionBehaviorContainer (section 2.8.63).
RT_TimeRotationBehaviorContainer	0xF12F	Specifies a TimeRotationBehaviorContainer (section 2.8.65).
RT_TimeScaleBehaviorContainer	0xF130	Specifies a TimeScaleBehaviorContainer (section 2.8.67).
RT_TimeSetBehaviorContainer	0xF131	Specifies a TimeSetBehaviorContainer (section 2.8.69).
RT_TimeCommandBehaviorContainer	0xF132	Specifies a TimeCommandBehaviorContainer (section 2.8.71).
RT_TimeBehavior	0xF133	Specifies a TimeBehaviorAtom .
RT_TimeAnimateBehavior	0xF134	Specifies a TimeAnimateBehaviorAtom .
RT_TimeColorBehavior	0xF135	Specifies a TimeColorBehaviorAtom .
RT_TimeEffectBehavior	0xF136	Specifies a TimeEffectBehaviorAtom .
RT_TimeMotionBehavior	0xF137	Specifies a TimeMotionBehaviorAtom .
RT_TimeRotationBehavior	0xF138	Specifies a TimeRotationBehaviorAtom .

Name	Value	Meaning
RT_TimeScaleBehavior	0xF139	Specifies a TimeScaleBehaviorAtom .
RT_TimeSetBehavior	0xF13A	Specifies a TimeSetBehaviorAtom .
RT_TimeCommandBehavior	0xF13B	Specifies a TimeCommandBehaviorAtom .
RT_TimeClientVisualElement	0xF13C	Specifies a ClientVisualElementContainer (section 2.8.44).
RT_TimePropertyList	0xF13D	Specifies a TimePropertyList4TimeNodeContainer (section 2.8.18) or TimePropertyList4TimeBehavior .
RT_TimeVariantList	0xF13E	Specifies a TimeStringListContainer (section 2.8.36).
RT_TimeAnimationValueList	0xF13F	Specifies a TimeAnimationValueListContainer (section 2.8.31).
RT_TimeIterateData	0xF140	Specifies a TimeIterateDataAtom .
RT_TimeSequenceData	0xF141	Specifies a TimeSequenceDataAtom .
RT_TimeVariant	0xF142	Specifies a TimeVariantBool , TimeVariantInt , TimeVariantFloat , TimeVariantString , TimeDisplayType , TimeMasterRelType , TimeSubType , TimeEffectID , TimeEffectType , TimeNodeTimeFilter , TimeEventFilter , TimeGroupID , TimeEffectNodeType , TimeColorModel , TimeColorDirection , TimeOverride , TimeRuntimeContext , or TimePointsTypes .
RT_TimeAnimationValue	0xF143	Specifies a TimeAnimationValueAtom .
RT_TimeExtTimeNodeContainer	0xF144	Specifies an ExtTimeNodeContainer (section 2.8.15).
RT_TimeSubEffectContainer	0xF145	Specifies a SubEffectContainer .

2.13.25 SlideLayoutType

Referenced by: [SlideAtom](#)

An enumeration that specifies the **slide layout** of a **slide**.

Name	Value	Meaning
SL_TitleSlide	0x00000000	One title and one subtitle placeholder shapes .
SL_TitleBody	0x00000001	Presentation slide or main master slide layout with one title and one body placeholder shape.
SL_MasterTitle	0x00000002	Title master slide layout with one title and one subtitle placeholder shape.
SL_TitleOnly	0x00000007	Presentation slide layout with one title placeholder shape.
SL_TwoColumns	0x00000008	Presentation slide layout with one title and two body placeholder shapes stacked horizontally.
SL_TwoRows	0x00000009	Presentation slide layout with one title and two body placeholder shapes stacked vertically.

Name	Value	Meaning
SL_ColumnTwoRows	0x0000000A	Presentation slide layout with one title and three body placeholder shapes split into two columns. The right column has two rows.
SL_TwoRowsColumn	0x0000000B	Presentation slide layout with one title and three body placeholder shapes split into two columns. The left column has two rows.
SL_TwoColumnsRow	0x0000000D	Presentation slide layout with one title and three body placeholder shapes split into two rows. The top row has two columns.
SL_FourObjects	0x0000000E	Presentation slide layout with one title and four body placeholder shapes.
SL_BigObject	0x0000000F	Presentation slide layout with one body placeholder shape.
SL_Blank	0x00000010	Presentation slide layout with no placeholder shape.
SL_VerticalTitleBody	0x00000011	Presentation slide layout with a vertical title placeholder shape on the right and a body placeholder shape on the left.
SL_VerticalTwoRows	0x00000012	Presentation slide layout with a vertical title placeholder shape on the right and two body placeholder shapes in two columns on the left.

2.13.26 SlideSizeEnum

Referenced by: [DocumentAtom](#)

An enumeration that specifies types of slide sizes.

Name	Value	Meaning
SS_Screen	0x0000	Slide size ratio is consistent with a computer screen.
SS_LetterPaper	0x0001	Slide size ratio is consistent with letter paper.
SS_A4Paper	0x0002	Slide size ratio is consistent with A4 paper.
SS_35mm	0x0003	Slide size ratio is consistent with 35mm photo slides.
SS_Overhead	0x0004	Slide size ratio is consistent with overhead projector slides.
SS_Banner	0x0005	Slide size ratio is consistent with a banner.
SS_Custom	0x0006	Slide size ratio that is not consistent with any of the other specified slide sizes in this enumeration.

2.13.27 TextAlignmentEnum

Referenced by: [TextPFException](#)

An enumeration that specifies paragraph alignments.

Name	Value	Meaning
Tx_ALIGNLeft	0x0000	For horizontal text, left aligned. For vertical text, top aligned.
Tx_ALIGNCenter	0x0001	For horizontal text, centered. For vertical text, middle aligned.

Name	Value	Meaning
Tx_ALIGNRight	0x0002	For horizontal text, right aligned. For vertical text, bottom aligned.
Tx_ALIGNJustify	0x0003	For horizontal text, flush left and right. For vertical text, flush top and bottom.
Tx_ALIGNEDistributed	0x0004	Distribute space between characters.
Tx_ALIGNThaiDistributed	0x0005	Thai distribution justification.
Tx_ALIGNJustifyLow	0x0006	Kashida justify low.

2.13.28 TextAutoNumberSchemeEnum

Referenced by: [TextAutoNumberScheme](#)

An enumeration that specifies the character sequence and delimiters to use for automatic numbering.

Name	Value	Meaning
ANM_AlphaLcPeriod	0x0000	Lowercase Latin character followed by a period. Example: a., b., c., ...
ANM_AlphaUcPeriod	0x0001	Uppercase Latin character followed by a period. Example: A., B., C., ...
ANM_ArabicParenRight	0x0002	Arabic numeral followed by a closing parenthesis. Example: 1), 2), 3), ...
ANM_ArabicPeriod	0x0003	Arabic numeral followed by a period. Example: 1., 2., 3., ...
ANM_RomanLcParenBoth	0x0004	Lowercase Roman numeral enclosed in parentheses. Example: (i), (ii), (iii), ...
ANM_RomanLcParenRight	0x0005	Lowercase Roman numeral followed by a closing parenthesis. Example: i), ii), iii), ...
ANM_RomanLcPeriod	0x0006	Lowercase Roman numeral followed by a period. Example: i., ii., iii., ...
ANM_RomanUcPeriod	0x0007	Uppercase Roman numeral followed by a period. Example: I., II., III., ...
ANM_AlphaLcParenBoth	0x0008	Lowercase alphabetic character enclosed in parentheses. Example: (a), (b), (c), ...
ANM_AlphaLcParenRight	0x0009	Lowercase alphabetic character followed by a closing parenthesis. Example: a), b), c), ...
ANM_AlphaUcParenBoth	0x000A	Uppercase alphabetic character enclosed in parentheses. Example: (A), (B), (C), ...
ANM_AlphaUcParenRight	0x000B	Uppercase alphabetic character followed by a closing parenthesis.

Name	Value	Meaning
		Example: A), B), C), ...
ANM_ArabicParenBoth	0x000C	Arabic numeral enclosed in parentheses. Example: (1), (2), (3), ...
ANM_ArabicPlain	0x000D	Arabic numeral. Example: 1, 2, 3, ...
ANM_RomanUcParenBoth	0x000E	Uppercase Roman numeral enclosed in parentheses. Example: (I), (II), (III), ...
ANM_RomanUcParenRight	0x000F	Uppercase Roman numeral followed by a closing parenthesis. Example: I), II), III), ...
ANM_ChSPlain	0x0010	Simplified Chinese.
ANM_ChSPeriod	0x0011	Simplified Chinese with single-byte period.
ANM_CircleNumDBPlain	0x0012	Double byte circle numbers.
ANM_CircleNumWDBWhitePlain	0x0013	Wingdings white circle numbers.
ANM_CircleNumWDBBlackPlain	0x0014	Wingdings black circle numbers.
ANM_ChtPlain	0x0015	Traditional Chinese.
ANM_ChtPeriod	0x0016	Traditional Chinese with single-byte period.
ANM_Arabic1Minus	0x0017	Bidi Arabic 1 (AraAlpha) with ANSI minus symbol.
ANM_Arabic2Minus	0x0018	Bidi Arabic 2 (AraAbjad) with ANSI minus symbol.
ANM_Hebrew2Minus	0x0019	Bidi Hebrew 2 with ANSI minus symbol.
ANM_JpnKorPlain	0x001A	Japanese/Korean.
ANM_JpnKorPeriod	0x001B	Japanese/Korean with single-byte period.
ANM_ArabicDbPlain	0x001C	Double-byte Arabic numbers.
ANM_ArabicDbPeriod	0x001D	Double-byte Arabic numbers with double-byte period.
ANM_ThaiAlphaPeriod	0x001E	Thai alphabetic character followed by a period.
ANM_ThaiAlphaParenRight	0x001F	Thai alphabetic character followed by a closing parenthesis.
ANM_ThaiAlphaParenBoth	0x0020	Thai alphabetic character enclosed by parentheses.
ANM_ThaiNumPeriod	0x0021	Thai numeral followed by a period.
ANM_ThaiNumParenRight	0x0022	Thai numeral followed by a closing parenthesis.
ANM_ThaiNumParenBoth	0x0023	Thai numeral enclosed in parentheses.
ANM_HindiAlphaPeriod	0x0024	Hindi alphabetic character followed by a period.
ANM_HindiNumPeriod	0x0025	Hindi numeric character followed by a period.
ANM_JpnChsDBPeriod	0x0026	Japanese with double-byte period.
ANM_HindiNumParenRight	0x0027	Hindi numeric character followed by a closing parenthesis.

Name	Value	Meaning
ANM_HindiAlpha1Period	0x0028	Hindi alphabetic character followed by a period.

2.13.29 TextBuildSubEffectEnum

Referenced by: [AnimationInfoAtom](#)

An enumeration that specifies behavior types of text in animation effects.

Name	Value	Meaning
TXB_BuildByNone	0x00	Text is animated all at once.
TXB_BuildByWord	0x01	Text is animated word by word.
TXB_BuildByCharacter	0x02	Text is animated character by character.

2.13.30 TextDirectionEnum

Referenced by: [TextPFException](#)

An enumeration that specifies the direction of a paragraph of text.

Name	Value	Meaning
LeftToRight	0x0000	Left to right text flow.
RightToLeft	0x0001	Right to left text flow.

2.13.31 TextFontAlignmentEnum

Referenced by: [TextPFException](#)

An enumeration that specifies font alignment.

Name	Value	Meaning
Tx_ALIGNFONTRoman	0x0000	Place characters on font baseline.
Tx_ALIGNFONTHanging	0x0001	Characters hang from top of line height
Tx_ALIGNFONTCenter	0x0002	Characters centered within line height.
Tx_ALIGNFONTUpholdFixed	0x0003	Characters are anchored to the very bottom of a single line. This is different than Tx_ALIGNFONTRoman because of letters such as "g", "q", and "y".

2.13.32 TextTabTypeEnum

Referenced by: [TabStop](#)

An enumeration that specifies alignment types of tab stops.

Name	Value	Meaning
Tx_TABLeft	0x0000	Left-aligned tab stop.

Name	Value	Meaning
Tx_TABCenter	0x0001	Center-aligned tab stop.
Tx_TABRight	0x0002	Right-aligned tab stop.
Tx_TABDecimal	0x0003	Decimal point-aligned tab stop.

2.13.33 TextTypeEnum

Referenced by: [OutlineTextPropsHeaderExAtom](#), [TextHeaderAtom](#)

An enumeration that specifies the types of text.

Name	Value	Meaning
Tx_TYPE_TITLE	0x00000000	Title placeholder shape text.
Tx_TYPE_BODY	0x00000001	Body placeholder shape text.
Tx_TYPE_NOTES	0x00000002	Notes placeholder shape text.
Tx_TYPE_OTHER	0x00000004	Any other text.
Tx_TYPE_CENTERBODY	0x00000005	Center body placeholder shape text.
Tx_TYPE_CENTERTITLE	0x00000006	Center title placeholder shape text.
Tx_TYPE_HALFBODY	0x00000007	Half-sized body placeholder shape text.
Tx_TYPE_QUARTERBODY	0x00000008	Quarter-sized body placeholder shape text.

2.13.34 TimeAnimateBehaviorValueTypeEnum

Referenced by: [TimeAnimateBehaviorAtom](#), [TimeSetBehaviorAtom](#)

An enumeration that specifies the data type of a property to be animated.

Name	Value	Meaning
TL_TABVT_String	0x00000000	Animate text content.
TL_TABVT_Number	0x00000001	Animate a numeric property.
TL_TABVT_Color	0x00000002	Animate a color property.

2.13.35 TimeCommandBehaviorTypeEnum

Referenced by: [TimeCommandBehaviorAtom](#)

An enumeration that specifies the type of a command.

Name	Value	Meaning
TL_TCBT_Event	0x00000000	Send out an event to the target object.
TL_TCBT_Call	0x00000001	Call a method or function on the target object.
TL_TCBT_OleVerb	0x00000002	Send an OLE verb to the target object.

2.13.36 TimeNodeTypeEnum

Referenced by: [TimeNodeAtom](#)

An enumeration that specifies the type of a **time node**.

Name	Value	Meaning
TL_TNT_Parallel	0x00000000	Parallel time node whose child nodes can start simultaneously.
TL_TNT_Sequential	0x00000001	Sequential time node whose child nodes can only start sequentially and each child can only start after its previous sibling has started.
TL_TNT_Behavior	0x00000003	Behavior time node that contains a behavior.
TL_TNT_Media	0x00000004	Media time node that contains a media object.

2.13.37 TimePropertyID4TimeBehavior

Referenced by: [TimeVariant4Behavior](#)

An enumeration that specifies the type of attributes for an animation behavior.

Name	Value	Meaning
TL_TBPID_UnknownPropertyList	0x00000001	Unknown property list.
TL_TBPID_RuntimeContext	0x00000002	Runtime context that specifies which versions of the application can run the behavior.
TL_TBPID_MotionPathEditRelative	0x00000003	Whether a motion path moves with the object that it applies to during editing.
TL_TBPID_ColorColorModel	0x00000004	Color model of a color animation.
TL_TBPID_ColorDirection	0x00000005	Color direction of a color animation.
TL_TBPID_Override	0x00000006	How to override animated values.
TL_TBPID_PathEditRotationAngle	0x00000007	Rotation angle of a motion path.
TL_TBPID_PathEditRotationX	0x00000008	Horizontal position of the rotation center of the motion path.
TL_TBPID_PathEditRotationY	0x00000009	Vertical position of the rotation center of the motion path.
TL_TBPID_PointsTypes	0x0000000A	The type of points in the motion path.

2.13.38 TimePropertyID4TimeNode

Referenced by: [TimeVariant4TimeNode](#)

An enumeration that specifies the type of attributes for a **time node**.

Name	Value	Meaning
TL_TPID_Display	0x00000002	Display type in UI.
TL_TPID_MasterPos	0x00000005	Relationship to the master time node.

Name	Value	Meaning
TL_TPID_SubType	0x00000006	Type of the subordinate time node.
TL_TPID_EffectID	0x00000009	Identifier of an animation effect.
TL_TPID_EffectDir	0x0000000A	Direction of an animation effect.
TL_TPID_EffectType	0x0000000B	Type of an animation effect.
TL_TPID_AfterEffect	0x0000000D	Whether the time node is an after effect.
TL_TPID_SlideCount	0x0000000F	The number of slides that a media will play across.
TL_TPID_TimeFilter	0x00000010	Time filtering for the time node.
TL_TPID_EventFilter	0x00000011	Event filtering for the time node.
TL_TPID_HideWhenStopped	0x00000012	Whether to display the media when it is stopped.
TL_TPID_GroupID	0x00000013	Build identifier.
TL_TPID_EffectNodeType	0x00000014	The role of the time node in the timing structure.
TL_TPID_PlaceholderNode	0x00000015	Whether the time node is a placeholder.
TL_TPID_MediaVolume	0x00000016	The volume of a media.
TL_TPID_MediaMute	0x00000017	Whether a media object is mute.
TL_TPID_ZoomToFullScreen	0x0000001A	Whether to zoom a media object to full screen.

2.13.39 TimeVariantTypeEnum

Referenced by: [TimeColorDirection](#), [TimeColorModel](#), [TimeDisplayType](#), [TimeEffectID](#), [TimeEffectNodeType](#), [TimeEffectType](#), [TimeEventFilter](#), [TimeGroupID](#), [TimeMasterRelType](#), [TimeNodeTimeFilter](#), [TimeOverride](#), [TimePointsTypes](#), [TimeRuntimeContext](#), [TimeSubType](#), [TimeVariantBool](#), [TimeVariantFloat](#), [TimeVariantInt](#), [TimeVariantString](#)

An enumeration that specifies the data type of a value.

Name	Value	Meaning
TL_TVT_Bool	0x00	A Boolean value.
TL_TVT_Int	0x01	A signed integer .
TL_TVT_Float	0x02	A floating-point number .
TL_TVT_String	0x03	A Unicode string.

2.13.40 TimeVisualElementEnum

Referenced by: [VisualPageAtom](#), [VisualShapeChartElementAtom](#), [VisualShapeGeneralAtom](#), [VisualSoundAtom](#)

An enumeration that specifies the part of a **slide** or **shape** to which the animation is applied.

Name	Value	Meaning
TL_TVET_Shape	0x00000000	Applies to the shape and all its text.
TL_TVET_Page	0x00000001	Applies to the slide.
TL_TVET_TextRange	0x00000002	Applies to a specified range of text of the shape.
TL_TVET_Audio	0x00000003	Applies to the audio of the shape.
TL_TVET_Video	0x00000004	Applies to the video of the shape.
TL_TVET_ChartElement	0x00000005	Applies to the elements of the chart.
TL_TVET_ShapeOnly	0x00000006	Applies to the shape but not its text.
TL_TVET_AllTextRange	0x00000008	Applies to all text of the shape.

2.13.41 TriggerObjectEnum

Referenced by: [TimeConditionAtom](#)

An enumeration that specifies the type of a target that participates in the evaluation of a **time condition**.

Name	Value	Meaning
TL_TOT_None	0x00000000	None.
TL_TOT_VisualElement	0x00000001	An animatable object.
TL_TOT_TimeNode	0x00000002	A time node .
TL_TOT_RuntimeNodeRef	0x00000003	Runtime child time nodes.

2.13.42 ViewTypeEnum

Referenced by: [UserEditAtom](#)

An enumeration that specifies different viewing modes in which a **presentation** can be displayed in a user interface.

Name	Value	Meaning
V_Slide	0x0001	A view optimized for the display of a presentation slide .
V_SlideMaster	0x0002	A view optimized for the display of a main master slide .
V_Notes	0x0003	A view optimized for the display of a notes slide .
V_Handout	0x0004	A view optimized for the display of the handout master slide .
V_NotesMaster	0x0005	A view optimized for the display of the notes master slide .
V_OutlineMaster	0x0006	A view optimized for the display of the outline master slide.
V_Outline	0x0007	A view optimized for the display of the text on the presentation slides.
V_SlideSorter	0x0008	A view optimized for the simultaneous display of multiple presentation slides.

Name	Value	Meaning
V_VisualBasic	0x0009	A view optimized for the display of the VBA information.
V_TitleMaster	0x000A	A view optimized for the display of a title master slide .
V_SlideShow	0x000B	A view optimized for the display of a slide show .
V_SlideShowFullScreen	0x000C	A view optimized for the display of a slide show in full screen.
V_NotesText	0x000D	A view optimized for the display of the text of a notes slide.
V_PrintPreview	0x000E	A view optimized for the display of a print preview of the presentation slides.
V_Thumbnails	0x000F	A view optimized for the simultaneous display of multiple presentation slides in a single column.
V_MasterThumbnails	0x0010	A view optimized for the simultaneous display of multiple main master slides or title master slides in a single column.
V_PodiumSlideView	0x0011	A view optimized for the display of presentation slides while a slide show is also being displayed.
V_PodiumNotesView	0x0012	A view optimized for the display of the text of a notes slide while a slide show is also being displayed.

2.13.43 WebFrameColorsEnum

Referenced by: [HTMLDocInfo9Atom](#)

An enumeration that specifies the color options for displaying the text and background for the Web page notes pane and outline pane.

Name	Value	Meaning
MSOWOPTBrowserColors	0x0000	Browser colors.
MSOWOPTPresentationSchemeTextColor	0x0001	Presentation text colors.
MSOWOPTPresentationSchemeAccentColor	0x0002	Presentation accent colors.
MSOWOPTWhiteTextOnBlack	0x0003	White text on black background.
MSOWOPTBlackTextOnWhite	0x0004	Black text on white background.

2.13.44 WebOutputEnum

Referenced by: [HTMLDocInfo9Atom](#), [HTMLPublishInfoAtom](#)

An enumeration that specifies the target Web technology support for which a publishing is optimized.

Name	Value	Meaning
HTML_EXPORTVersion3	0x01	Web page is optimized for use with HTML, CSS, Javascript and frames.
HTML_EXPORTVersion4	0x02	Web page is optimized for use with HTML, MHTML, DHTML, CSS, JScript, frames, VML, and PNG graphics.
HTML_EXPORTDual	0x04	Web page contains optimized output for both technology formats and conditional statements to determine proper usage.

3 Structure Examples

3.1 Introduction

The following sections provide structure examples of different features of this file format. These examples are illustrative of the preceding specification and do not cover all possible structure usage scenarios. They are not intended to replace the preceding specification but rather to clarify and enhance it. All examples are derived from the same presentation, sample.ppt, which is represented visually in the following figures.



Figure 4: Outline text

a sample

presentation

Figure 5: Presentation slide 1

the weather

- + a sunny day
- + the blue sky
- + some green grass

Figure 6: Presentation slide 2

a green square

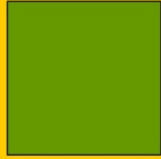

Figure 7: Presentation slide 3

a hungry bear



Figure 8: Presentation slide 4

a fruit pie chart

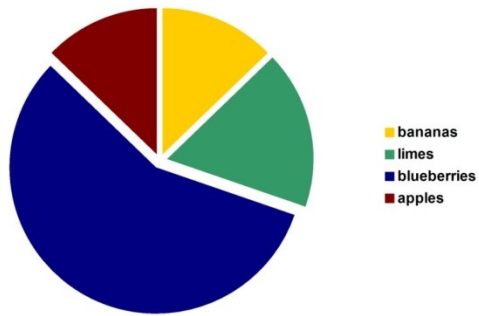

Figure 9: Presentation slide 5

shapes with text

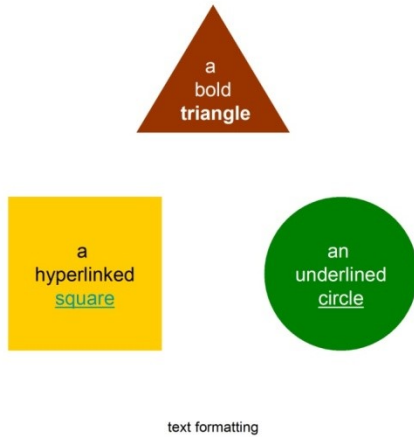
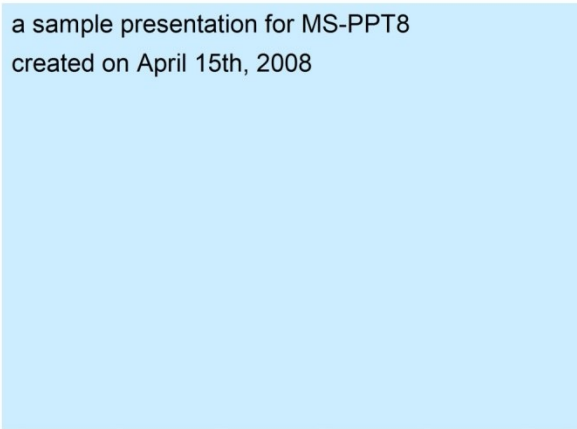
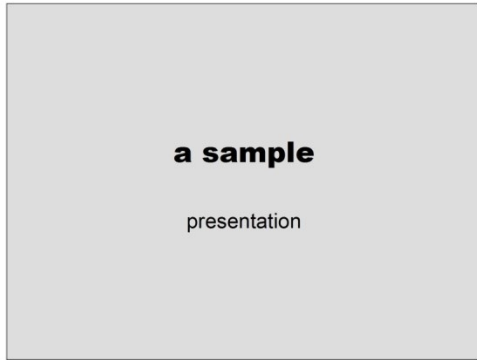

Figure 10: Presentation slide 6



1

Figure 11: Notes slide 1

the weather

- a sunny day
- the blue sky
- some green grass

day in and day out
a story of the weather
outside the window

2

Figure 12: Notes slide 2

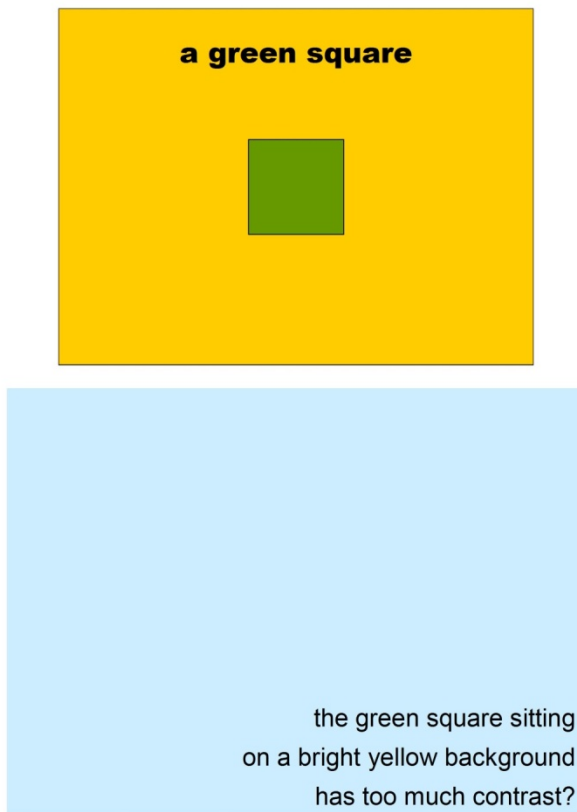

3

Figure 13: Notes slide 3

a hungry bear



the bear is hungry
the bear is wet
the bear is cold
birds are full and dry

a hungry brown bear
fishing in the flowing stream
birds stand vigilant

4

Figure 14: Notes slide 4



in all, how much fruit
can someone possibly eat
a whole pie, i guess

5

Figure 15: Notes slide 5

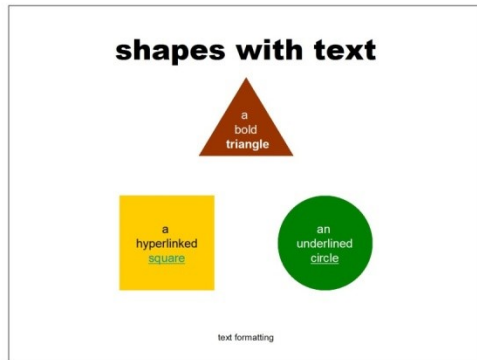

geometric shapes
are filled brightly with colors
with text for effect

6

Figure 16: Notes slide 6



Figure 17: Main master slide

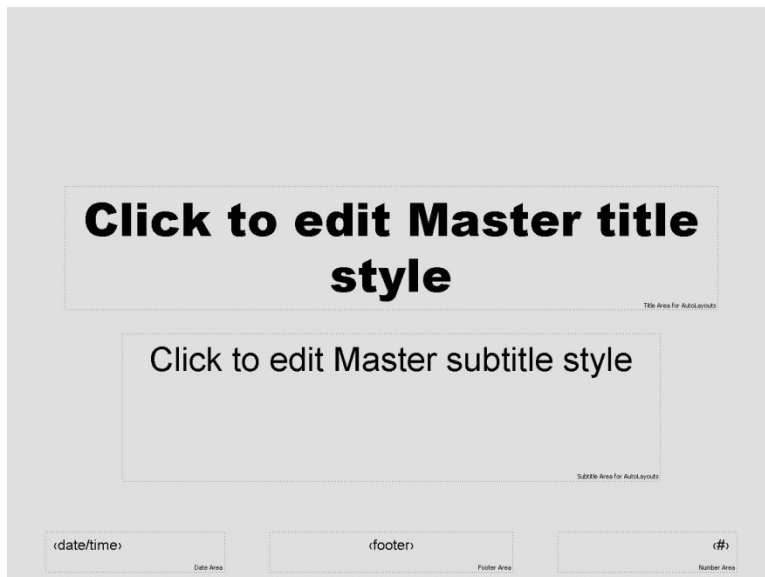

Figure 18: Title master slide

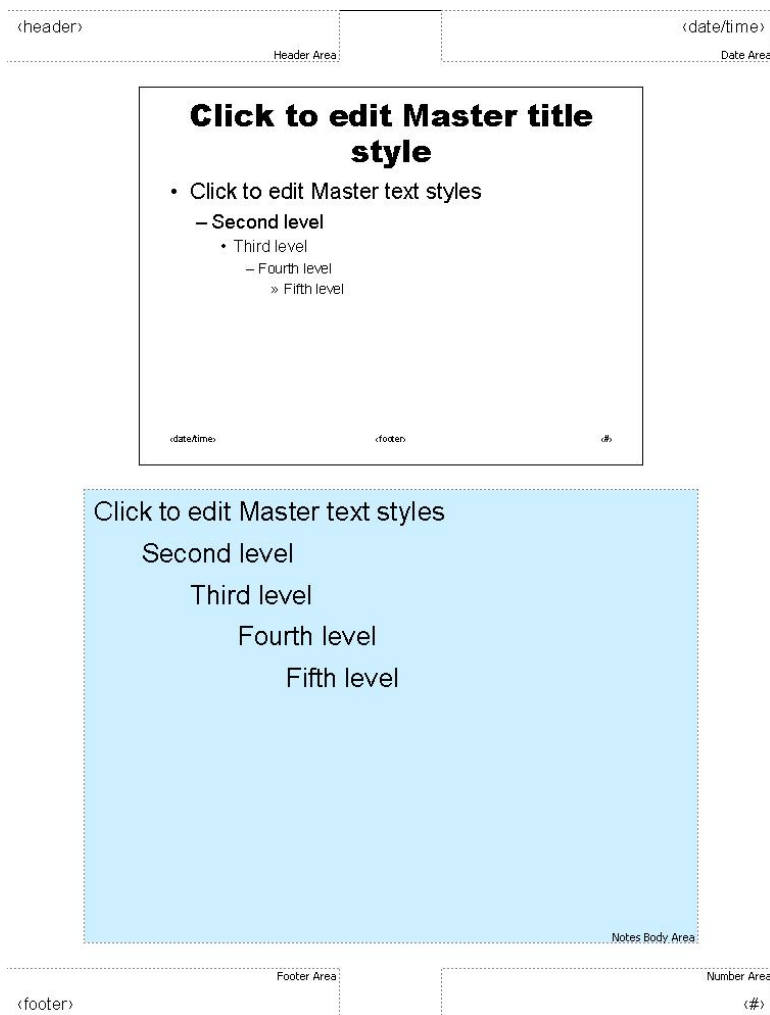

Figure 19: Notes master slide

The sample presentation was authored in two sessions. The first session created a **main master slide**, a **title master slide**, six **presentation slides**, and associated **notes slides** for five of the six presentation slides. The second session deleted the presentation slide without an associated notes slide, changed the content on presentation slide 3, and added presentation slide 6 and an associated notes slide.

The preceding figures will be further explained in the sections that follow.

3.2 File Structure

This section provides an example of how to construct the **persist object directory** for the file. Correctly constructing the persist object directory is the first step in finding the rest of the **presentation** content in the file—**main master slides**, **notes master slide**, **handout master slide**, **presentation slides**, **notes slides**, embedded or linked **OLE object** storages, and the **VBA project** storage. Because new **user edits** can simply be appended to the existing stream contents, the process for constructing the persist object directory needs to be carefully followed to ensure that the most recent version of a **persist object** is used and older versions are ignored.

Construction of the persist object directory begins with parsing the **CurrentUserAtom** record (section [2.3.2](#)). The child-record hierarchy of the **CurrentUserAtom** record is shown expanded in the following table.

Offset	Size	Structure	Value
00000000	005F	CurrentUserAtom - currentUserAtom	
00000000	0008	RecordHeader - rh	
00000008	0004	unsigned integer - size	0x00000014
0000000C	0004	unsigned integer - headerToken	0xE391C05F
00000010	0004	unsigned integer - offsetToCurrentEdit	0x00008290
00000014	0002	unsigned integer - lenUserName	0x0015
00000016	0002	unsigned integer - docFileVersion	0x03F4
00000018	0001	unsigned integer - majorVersion	0x03
00000019	0001	unsigned integer - minorVersion	0x00
0000001A	0002	unsigned integer - unused	0x0000
0000001C	0015	array of bytes - ansiUserName	Microsoft Corporation
00000031	0004	unsigned integer - relVersion	0x00000008
00000035	002A	array of bytes - unicodeUserName	Microsoft Corporation

Figure 20: CurrentUserAtom child-record hierarchy

offsetToCurrentEdit: 0x00008290 specifies the offset, in bytes, from the beginning of the **PowerPoint Document Stream** (section [2.1.2](#)) to the **UserEditAtom** record (section [2.3.3](#)) for the most recent user edit.

The **UserEditAtom** record specified by the **offsetToCurrentEdit** field in the previous table is shown expanded in the following table.

Offset	Size	Structure	Value
00008290	0024	UserEditAtom	
00008290	0008	RecordHeader - rh	
00008298	0004	unsigned integer - lastSlideIdRef	0x00000100
0000829C	16 bits	unsigned integer - version	0x1FE9
0000829C	8 bits	unsigned integer - minorVersion	0x00
0000829C	8 bits	unsigned integer - majorVersion	0x03
000082A0	0004	unsigned integer - offsetLastEdit	0x00005C45
000082A4	0004	unsigned integer - offsetPersistDirectory	0x0000826C
000082A8	0004	unsigned integer - docPersistIdRef	0x00000001
000082AC	0004	unsigned integer - persistIdSeed	0x00000014

Offset	Size	Structure	Value
000082B0	0002	ViewTypeEnum - lastView	0x0001
000082B2	0002	unsigned integer - unused	0x31C5

Figure 21: UserEditAtom child-record hierarchy for the most recent user edit

offsetLastEdit: 0x00005C45 specifies the offset, in bytes, from the beginning of the **PowerPoint Document Stream** to the **UserEditAtom** record for the previous user edit.

offsetPersistDirectory: 0x0000826C specifies the offset, in bytes, from the beginning of the **PowerPoint Document Stream** to the **PersistDirectoryAtom** record (section [2.3.4](#)) for the most recent user edit.

The **PersistDirectoryAtom** record specified by the **offsetPersistDirectory** field in the previous table titled "UserEditAtom child-record hierarchy for the most recent user edit" is shown expanded in the following table.

Offset	Size	Structure	Value
0000826C	0024	PersistDirectoryAtom	
0000826C	0008	RecordHeader - rh	
00008274	0008	PersistDirectoryEntry - persistDirEntry[0]	
00008274	20 bits	unsigned integer - persistId	0x00001
00008274	12 bits	unsigned integer - cPersist	0x001
00008278	0004	PersistOffsetEntry - persistOffset[0]	0x00005C69
0000827C	0008	PersistDirectoryEntry - persistDirEntry[1]	
0000827C	20 bits	unsigned integer - persistId	0x00006
0000827C	12 bits	unsigned integer - cPersist	0x001
00008280	0004	PersistOffsetEntry - persistOffset[0]	0x00006964
00008284	000C	PersistDirectoryEntry - persistDirEntry[2]	
00008284	20 bits	unsigned integer - persistId	0x00013
00008284	12 bits	unsigned integer - cPersist	0x002
00008288	0004	PersistOffsetEntry - persistOffset[0]	0x00007AF6
0000828C	0004	PersistOffsetEntry - persistOffset[1]	0x00007FE3

Figure 22: PersistDirectoryAtom child-record hierarchy for the most recent user edit

persistDirEntry[0].persistId: 0x00001 specifies the starting **persist object identifier** for the **PersistOffsetEntry** entries (section 2.3.6) that follow.

persistDirEntry[0].cPersist: 0x001 specifies the count of **PersistOffsetEntry** entries that follow.

persistDirEntry[0].persistOffset[0]: 0x00005C69 specifies the stream offset for the persist object with persist object identifier 0x00001.

persistDirEntry[1].persistId: 0x00006 specifies the starting persist object identifier for the **PersistOffsetEntry** entries that follow.

persistDirEntry[1].cPersist: 0x001 specifies the count of **PersistOffsetEntry** entries that follow.

persistDirEntry[1].persistOffset[0]: 0x00006964 specifies the stream offset for the persist object with persist object identifier 0x00006.

persistDirEntry[2].persistId: 0x00013 specifies the starting persist object identifier for the **PersistOffsetEntry** entries that follow.

persistDirEntry[2].cPersist: 0x002 specifies the count of **PersistOffsetEntry** entries that follow.

persistDirEntry[2].persistOffset[0]: 0x00007AF6 specifies the stream offset for the persist object with persist object identifier 0x00013.

persistDirEntry[2].persistOffset[1]: 0x00007FE3 specifies the stream offset for the persist object with persist object identifier 0x00014.

The partial persist object directory constructed after parsing the first **PersistDirectoryAtom** record is summarized in the following table.

Persist object identifier	Persist object stream offset
0x00001	0x00005C69
0x00006	0x00006964
0x00013	0x00007AF6
0x00014	0x00007FE3

The **UserEditAtom** record specified by the **offsetLastEdit** field in the previous table titled "UserEditAtom child-record hierarchy for the most recent user edit" is shown expanded in the following table.

Offset	Size	Structure	Value
00005C45	0024	UserEditAtom	
00005C45	0008	RecordHeader - rh	
00005C4D	0004	unsigned integer - lastSlideIdRef	0x00000104
00005C51	16 bits	unsigned integer - version	0x1FE9
00005C51	8 bits	unsigned integer - minorVersion	0x00
00005C51	8 bits	unsigned integer - majorVersion	0x03
00005C55	0004	unsigned integer - offsetLastEdit	0x00000000
00005C59	0004	unsigned integer - offsetPersistDirectory	0x00005BF1
00005C5D	0004	unsigned integer - docPersistIdRef	0x00000001
00005C61	0004	unsigned integer - persistIdSeed	0x00000012
00005C65	0002	ViewTypeEnum - lastView	0x000F
00005C67	0002	unsigned integer - unused	0x31C5

Figure 23: UserEditAtom child-record hierarchy for the previous user edit

offsetLastEdit: 0x00000000 specifies that no further user edits exist.

offsetPersistDirectory: 0x00005BF1 specifies the offset, in bytes, from the beginning of the **PowerPoint Document Stream** to the **PersistDirectoryAtom** record for this previous user edit.

The **PersistDirectoryAtom** record specified by the **offsetPersistDirectory** field in the previous table is shown expanded in the following table.

Offset	Size	Structure	Value
00005BF1	0054	PersistDirectoryAtom	
00005BF1	0008	RecordHeader - rh	
00005BF9	0028	PersistDirectoryEntry - persistDirEntry[0]	
00005BF9	20 bits	unsigned integer - persistId	0x00001
00005BF9	12 bits	unsigned integer - cPersist	0x009
00005BFD	0004	PersistOffsetEntry - persistOffset[0]	0x00000000
00005C01	0004	PersistOffsetEntry - persistOffset[1]	0x00000CC5
00005C05	0004	PersistOffsetEntry - persistOffset[2]	0x00001671
00005C09	0004	PersistOffsetEntry - persistOffset[3]	0x000021C8
00005C0D	0004	PersistOffsetEntry - persistOffset[4]	0x000023F4
00005C11	0004	PersistOffsetEntry - persistOffset[5]	0x000030CD
00005C15	0004	PersistOffsetEntry - persistOffset[6]	0x00004D69
00005C19	0004	PersistOffsetEntry - persistOffset[7]	0x000037B5
00005C1D	0004	PersistOffsetEntry - persistOffset[8]	0x00003E83
00005C21	0008	PersistDirectoryEntry - persistDirEntry[1]	
00005C21	20 bits	unsigned integer - persistId	0x0000B
00005C21	12 bits	unsigned integer - cPersist	0x001
00005C25	0004	PersistOffsetEntry - persistOffset[0]	0x00001B98
00005C29	001C	PersistDirectoryEntry - persistDirEntry[2]	
00005C29	20 bits	unsigned integer - persistId	0x0000D
00005C29	12 bits	unsigned integer - cPersist	0x006
00005C2D	0004	PersistOffsetEntry - persistOffset[0]	0x000040CB
00005C31	0004	PersistOffsetEntry - persistOffset[1]	0x00004319
00005C35	0004	PersistOffsetEntry - persistOffset[2]	0x000045D4
00005C39	0004	PersistOffsetEntry - persistOffset[3]	0x00004873
00005C3D	0004	PersistOffsetEntry - persistOffset[4]	0x00004B22
00005C41	0004	PersistOffsetEntry - persistOffset[5]	0x00002E81

Figure 24: PersistDirectoryAtom child-record hierarchy for the previous user edit

persistDirEntry[0].persistId: 0x00001 specifies the starting persist object identifier for the **PersistOffsetEntry** entries that follow.

persistDirEntry[0].cPersist: 0x009 specifies the count of **PersistOffsetEntry** entries that follow.

persistDirEntry[0].persistOffset[0]: 0x00000000 specifies the stream offset for the persist object with persist object identifier 0x00001. However, because the persist object identifier 0x00001 already appears in the first table in this section, this stream offset is ignored.

persistDirEntry[0].persistOffset[1]: 0x00000CC5 specifies the stream offset for the persist object with persist object identifier 0x00002.

persistDirEntry[0].persistOffset[2]: 0x00001671 specifies the stream offset for the persist object with persist object identifier 0x00003.

persistDirEntry[0].persistOffset[3]: 0x000021C8 specifies the stream offset for the persist object with persist object identifier 0x00004.

persistDirEntry[0].persistOffset[4]: 0x000023F4 specifies the stream offset for the persist object with persist object identifier 0x00005.

persistDirEntry[0].persistOffset[5]: 0x000030CD specifies the stream offset for the persist object with persist object identifier 0x00006. However, because the persist object identifier 0x00006 already appears in the first table in this section, this stream offset is ignored.

persistDirEntry[0].persistOffset[6]: 0x00004D69 specifies the stream offset for the persist object with persist object identifier 0x00007.

persistDirEntry[0].persistOffset[7]: 0x000037B5 specifies the stream offset for the persist object with persist object identifier 0x00008.

persistDirEntry[0].persistOffset[8]: 0x00003E83 specifies the stream offset for the persist object with persist object identifier 0x00009.

persistDirEntry[1].persistId: 0x0000B specifies the starting persist object identifier for the **PersistOffsetEntry** entries that follow.

persistDirEntry[1].cPersist: 0x001 specifies the count of **PersistOffsetEntry** entries that follow.

persistDirEntry[1].persistOffset[0]: 0x00001B98 specifies the stream offset for the persist object with persist object identifier 0x0000B.

persistDirEntry[2].persistId: 0x0000D specifies the starting persist object identifier for the **PersistOffsetEntry** entries that follow.

persistDirEntry[2].cPersist: 0x006 specifies the count of **PersistOffsetEntry** entries that follow.

persistDirEntry[2].persistOffset[0]: 0x000040CB specifies the stream offset for the persist object with persist object identifier 0x0000D.

persistDirEntry[2].persistOffset[1]: 0x00004319 specifies the stream offset for the persist object with persist object identifier 0x0000E.

persistDirEntry[2].persistOffset[2]: 0x000045D4 specifies the stream offset for the persist object with persist object identifier 0x0000F.

persistDirEntry[2].persistOffset[3]: 0x00004873 specifies the stream offset for the persist object with persist object identifier 0x00010.

persistDirEntry[2].persistOffset[4]: 0x00004B22 specifies the stream offset for the persist object with persist object identifier 0x00011.

persistDirEntry[2].persistOffset[5]: 0x00002E81 specifies the stream offset for the persist object with persist object identifier 0x00012.

The complete persist object directory constructed after parsing all **PersistDirectoryAtom** records is summarized in the following table.

Persist object identifier	Persist object stream offset
0x00001	0x00005C69
0x00002	0x00000CC5
0x00003	0x00001671
0x00004	0x000021C8
0x00005	0x000023F4
0x00006	0x00006964
0x00007	0x00004D69
0x00008	0x000037B5
0x00009	0x00003E83
0x0000B	0x00001B98
0x0000D	0x000040CB
0x0000E	0x00004319
0x0000F	0x000045D4
0x00010	0x00004873
0x00011	0x00004B22
0x00012	0x00002E81
0x00013	0x00007AF6
0x00014	0x00007FE3

3.3 Persist Objects

The **PowerPoint Document Stream** (section [2.1.2](#)) is fundamentally a sequence of **container records** and **atom records** that represent **persist objects**, the **PersistDirectoryAtom** records (section [2.3.4](#)) that comprise the **persist object directory**, and the **UserEditAtom** records (section [2.3.3](#)) that identify the content comprising each **user edit**. The specific top-level record sequence for the sample presentation is shown in the following table.

Offset	Size	Structure
00000000	82B4	Stream - PowerPoint Document
00000000	0CC5	A: DocumentContainer
00000CC5	09AC	B: MainMasterContainer
00001671	0527	C: SlideContainer

Offset	Size	Structure
00001B98	0630	D: NotesContainer
000021C8	022C	E: SlideContainer
000023F4	0A8D	F: SlideContainer
00002E81	024C	G: SlideContainer
000030CD	06E8	H: SlideContainer
000037B5	06CE	I: SlideContainer
00003E83	0248	J: SlideContainer
000040CB	024E	K: NotesContainer
00004319	02BB	L: NotesContainer
000045D4	029F	M: NotesContainer
00004873	02AF	N: NotesContainer
00004B22	0247	O: NotesContainer
00004D69	0E88	P: ExOleObjStg
00005BF1	0054	Q: PersistDirectoryAtom
00005C45	0024	R: UserEditAtom
00005C69	0CFB	S: DocumentContainer
00006964	1192	T: SlideContainer
00007AF6	04ED	U: SlideContainer
00007FE3	0289	V: NotesContainer
0000826C	0024	W: PersistDirectoryAtom
00008290	0024	X: UserEditAtom

Figure 25: Top-level record sequence in the PowerPoint Document Stream from sample.ppt

For each record in the previous table, the type of the record and its offset from the beginning of the **PowerPoint Document Stream** are listed. The atom records are: **ExOleObjStg** (section 2.10.34), **PersistDirectoryAtom** and **UserEditAtom**. The rest are container records. The letter labels are used to identify specific records in the text that follows.

The first user edit comprises records labeled A through R and the second user edit comprises records labeled S through X. By cross-referencing the previous table with the output from the second table in section 3.2, some dead records can be immediately identified, because their offsets do not appear in the second table in section 3.2. Specifically, **DocumentContainer** (section 2.4.1) record A is a dead record and is superseded by record S; **SlideContainer** (section 2.5.1) record H is also a dead record and is superseded by record T. Although **SlideContainer** record G is referenced by the persist object directory shown in the second table in section 3.2, further parsing of the **slideList** field of the **DocumentContainer** record S determines that no **SlidePersistAtom** (section 2.4.14.5) child-record has a **persistIdRef** field equal to 0x00000012. For more information about how the records from the previous table are associated with the slide images as shown in figures titled "Presentation slide 1" through "Notes master slide" in section 3.1, see the Slides Example (section 3.5).

3.4 Outline Text

The outline text can be displayed visually, as shown in the figure titled "Outline text" in section 3.1. The records used to construct the outline text are found inside the **SlideListWithTextContainer** record (section 2.4.14.3) contained within the **DocumentContainer** record (section 2.4.1). The child-record hierarchy of the **DocumentContainer** record S from the table titled "Top-level record sequence in the PowerPoint Document Stream from sample.ppt" in section 3.3 is shown expanded in the following table.

Offset	Size	Structure
00005C69	0CFB	DocumentContainer
00005C69	0008	RecordHeader - rh
00005C71	0030	E: DocumentAtom - documentAtom
00005CA1	0152	F: ExObjListContainer - exObjList
00005DF3	016A	DocumentTextInfoContainer - documentTextInfo
00005F5D	01FC	DrawingGroupContainer - drawingGroup
00006159	0040	A: MasterListWithTextContainer - masterList
00006199	04D7	D: DocInfoListContainer - docInfoList
00006670	0014	SlideHeadersFootersContainer - slideHF
00006684	0014	NotesHeadersFootersContainer - notesHF
00006698	0214	B: SlideListWithTextContainer - slideList
000068AC	00B0	C: NotesListWithTextContainer - notesList
0000695C	0008	EndDocumentAtom - endDocumentAtom

Figure 26: DocumentContainer child-record hierarchy

The child-record hierarchy of the **SlideListWithTextContainer** (section 2.4.14.3) record B from the previous table is shown expanded in the following table.

Offset	Size	Structure
00006698	0214	SlideListWithTextContainer - slideList
00006698	0008	RecordHeader - rh
000066A0	001C	SlidePersistAtom - case of RT_SlidePersistAtom
000066BC	000C	A: TextHeaderAtom - case of RT_TextHeaderAtom
000066C8	0010	B: TextBytesAtom - case of RT_TextBytesAtom
000066D8	000C	C: TextHeaderAtom - case of RT_TextHeaderAtom
000066E4	0014	D: TextBytesAtom - case of RT_TextBytesAtom
000066F8	001C	SlidePersistAtom - case of RT_SlidePersistAtom
00006714	000C	E: TextHeaderAtom - case of RT_TextHeaderAtom
00006720	0013	F: TextBytesAtom - case of RT_TextBytesAtom

Offset	Size	Structure
00006733	000C	G : TextHeaderAtom - case of RT_TextHeaderAtom
0000673F	0031	H : TextBytesAtom - case of RT_TextBytesAtom
00006770	0022	StyleTextPropAtom - case of RT_StyleTextPropAtom
00006792	001C	SlidePersistAtom - case of RT_SlidePersistAtom
000067AE	000C	I : TextHeaderAtom - case of RT_TextHeaderAtom
000067BA	0016	J : TextBytesAtom - case of RT_TextBytesAtom
000067D0	000C	TextHeaderAtom - case of RT_TextHeaderAtom
000067DC	0012	TextSpecialInfoAtom - case of RT_TextSpecialInfoAtom
000067EE	001C	SlidePersistAtom - case of RT_SlidePersistAtom
0000680A	000C	K : TextHeaderAtom - case of RT_TextHeaderAtom
00006816	0015	L : TextBytesAtom - case of RT_TextBytesAtom
0000682B	001C	SlidePersistAtom - case of RT_SlidePersistAtom
00006847	000C	M : TextHeaderAtom - case of RT_TextHeaderAtom
00006853	0019	N : TextBytesAtom - case of RT_TextBytesAtom
0000686C	001C	SlidePersistAtom - case of RT_SlidePersistAtom
00006888	000C	O : TextHeaderAtom - case of RT_TextHeaderAtom
00006894	0018	P : TextBytesAtom - case of RT_TextBytesAtom

Figure 27: SlideListWithTextContainer child-record hierarchy

The character content of the outline text is derived from the TextBytesAtom records labeled B, D, F, H, J, L, N, and P in the previous table titled "SlideListWithTextContainer child-record hierarchy". The TextHeaderAtom records labeled A, C, E, G, I, K, M, and O that precede the TextBytesAtom records indicate the type of text content as specified by the **textType** field and the [TextTypeEnum](#). These values can be used to organize the text into logical outline levels, where title **placeholder shape** text is a top-level outline item and body placeholder shape text is a subordinate outline item.

The detailed structures of records A through P in the previous table titled "SlideListWithTextContainer child-record hierarchy" are shown in the following tables. Non-printable character content in TextBytesAtom records has been replaced with "\t", "\n", "\v", or "\r" where applicable.

The first line of the outline text as shown in the figure titled "Outline text" in section 3.1 is derived from records A and B, which are shown expanded in the following tables.

Offset	Size	Structure	Value
000066BC	000C	A : TextHeaderAtom - case of RT_TextHeaderAtom	
000066BC	0008	RecordHeader - rh	
000066BC	4 bits	unsigned integer - recVer	0x0
000066BC	12 bits	unsigned integer - recInstance	0x000
000066BE	0002	RecordType - recType	0x0F9F

Offset	Size	Structure	Value
000066C0	0004	unsigned integer - recLen	0x00000004
000066C4	0004	TextTypeEnum - textType	0x00000006

Figure 28: Outline TextHeaderAtom record A

textType: 0x00000006 specifies that the following character content in the **textBytes** field of the following table represents the center title placeholder shape text.

Offset	Size	Structure	Value
000066C8	0010	B: TextBytesAtom - case of RT_TextBytesAtom	
000066C8	0008	RecordHeader - rh	
000066C8	4 bits	unsigned integer - recVer	0x0
000066C8	12 bits	unsigned integer - recInstance	0x000
000066CA	0002	RecordType - recType	0x0FA8
000066CC	0004	unsigned integer - recLen	0x00000008
000066D0	0008	array of bytes - textBytes	a sample

Figure 29: Outline TextBytesAtom record B

textBytes: "a sample" specifies the center title placeholder shape text.

The second line of the outline text as shown in the figure titled "Outline text" in section 3.1 is derived from records C and D, which are shown expanded in the following tables.

Offset	Size	Structure	Value
000066D8	000C	C: TextHeaderAtom - case of RT_TextHeaderAtom	
000066D8	0008	RecordHeader - rh	
000066D8	4 bits	unsigned integer - recVer	0x0
000066D8	12 bits	unsigned integer - recInstance	0x001
000066DA	0002	RecordType - recType	0x0F9F
000066DC	0004	unsigned integer - recLen	0x00000004
000066E0	0004	TextTypeEnum - textType	0x00000005

Figure 30: Outline TextHeaderAtom record C

textType: 0x00000005 specifies that the following character content in the **textBytes** field of the following table represents the center body placeholder shape text.

Offset	Size	Structure	Value
000066E4	0014	D: TextBytesAtom - case of RT_TextBytesAtom	
000066E4	0008	RecordHeader - rh	
000066E4	4 bits	unsigned integer - recVer	0x0

Offset	Size	Structure	Value
000066E4	12 bits	unsigned integer - recInstance	0x000
000066E6	0002	RecordType - recType	0x0FA8
000066E8	0004	unsigned integer - recLen	0x0000000C
000066EC	000C	array of bytes - textBytes	presentation

Figure 31: Outline TextBytesAtom record D

textBytes: "presentation" specifies the center body placeholder shape text.

The third line of the outline text as shown in the figure titled "Outline text" in section 3.1 is derived from records E and F, which are shown expanded in the following tables.

Offset	Size	Structure	Value
00006714	000C	E: TextHeaderAtom - case of RT_TextHeaderAtom	
00006714	0008	RecordHeader - rh	
00006714	4 bits	unsigned integer - recVer	0x0
00006714	12 bits	unsigned integer - recInstance	0x000
00006716	0002	RecordType - recType	0x0F9F
00006718	0004	unsigned integer - recLen	0x00000004
0000671C	0004	TextTypeEnum - textType	0x00000000

Figure 32: Outline TextHeaderAtom record E

textType: 0x00000000 specifies that the following character content in the **textBytes** field of the following table represents the title placeholder shape text.

Offset	Size	Structure	Value
00006720	0013	F: TextBytesAtom - case of RT_TextBytesAtom	
00006720	0008	RecordHeader - rh	
00006720	4 bits	unsigned integer - recVer	0x0
00006720	12 bits	unsigned integer - recInstance	0x000
00006722	0002	RecordType - recType	0x0FA8
00006724	0004	unsigned integer - recLen	0x0000000B
00006728	000B	array of bytes - textBytes	the weather

Figure 33: Outline TextBytesAtom record F

textBytes: "the weather" specifies the title placeholder shape text.

Lines four through six of the outline text as shown in the figure titled "Outline text" in section 3.1 are derived from records G and H, which are shown expanded in the following tables.

Offset	Size	Structure	Value
00006733	000C	G: TextHeaderAtom - case of RT_TextHeaderAtom	
00006733	0008	RecordHeader - rh	
00006733	4 bits	unsigned integer - recVer	0x0
00006733	12 bits	unsigned integer - recInstance	0x001
00006735	0002	RecordType - recType	0x0F9F
00006737	0004	unsigned integer - recLen	0x00000004
0000673B	0004	TextTypeEnum - textType	0x00000001

Figure 34: Outline TextHeaderAtom record G

textType: 0x00000001 specifies that the following character content in the **textBytes** field of the following table represents the body placeholder shape text.

Offset	Size	Structure	Value
0000673F	0031	H: TextBytesAtom - case of RT_TextBytesAtom	
0000673F	0008	RecordHeader - rh	
0000673F	4 bits	unsigned integer - recVer	0x0
0000673F	12 bits	unsigned integer - recInstance	0x000
00006741	0002	RecordType - recType	0x0FA8
00006743	0004	unsigned integer - recLen	0x00000029
00006747	0029	array of bytes - textBytes	a sunny day\rthe blue sky\rsome green grass

Figure 35: Outline TextBytesAtom record H

textBytes: "a sunny day\rthe blue sky\rsome green grass" specifies the body placeholder shape text. Each line break in the text, shown as "\r", is displayed as a separate outline item shown in the figure titled "Outline text" in section 3.1.

Line seven of the outline text as shown in the figure titled "Outline text" in section 3.1 is derived from records I and J, which are shown expanded in the following tables.

Offset	Size	Structure	Value
000067AE	000C	I: TextHeaderAtom - case of RT_TextHeaderAtom	
000067AE	0008	RecordHeader - rh	
000067AE	4 bits	unsigned integer - recVer	0x0
000067AE	12 bits	unsigned integer - recInstance	0x000
000067B0	0002	RecordType - recType	0x0F9F
000067B2	0004	unsigned integer - recLen	0x00000004
000067B6	0004	TextTypeEnum - textType	0x00000000

Figure 36: Outline TextHeaderAtom record I

textType: 0x00000000 specifies that the following character content in the **textBytes** field of the following table represents the title placeholder shape text.

Offset	Size	Structure	Value
000067BA	0016	J: TextBytesAtom - case of RT_TextBytesAtom	
000067BA	0008	RecordHeader - rh	
000067BA	4 bits	unsigned integer - recVer	0x0
000067BA	12 bits	unsigned integer - recInstance	0x000
000067BC	0002	RecordType - recType	0x0FA8
000067BE	0004	unsigned integer - recLen	0x0000000E
000067C2	000E	array of bytes - textBytes	a green square

Figure 37: Outline TextBytesAtom record J

textBytes: "a green square" specifies the title placeholder shape text.

Line eight of the outline text as shown in the figure titled "Outline text" in section 3.1 is derived from records K and L, which are shown expanded in the following tables.

Offset	Size	Structure	Value
0000680A	000C	K: TextHeaderAtom - case of RT_TextHeaderAtom	
0000680A	0008	RecordHeader - rh	
0000680A	4 bits	unsigned integer - recVer	0x0
0000680A	12 bits	unsigned integer - recInstance	0x000
0000680C	0002	RecordType - recType	0x0F9F
0000680E	0004	unsigned integer - recLen	0x00000004
00006812	0004	TextTypeEnum - textType	0x00000000

Figure 38: Outline TextHeaderAtom record K

textType: 0x00000000 specifies that the following character content in the **textBytes** field of the following table represents the title placeholder shape text.

Offset	Size	Structure	Value
00006816	0015	L: TextBytesAtom - case of RT_TextBytesAtom	
00006816	0008	RecordHeader - rh	
00006816	4 bits	unsigned integer - recVer	0x0
00006816	12 bits	unsigned integer - recInstance	0x000
00006818	0002	RecordType - recType	0x0FA8
0000681A	0004	unsigned integer - recLen	0x0000000D
0000681E	000D	array of bytes - textBytes	a hungry bear

Figure 39: Outline TextBytesAtom record L

textBytes: "a hungry bear" specifies the title placeholder shape text.

Line nine of the outline text as shown in the figure titled "Outline text" in section 3.1 is derived from records M and N, which are shown expanded in the following tables.

Offset	Size	Structure	Value
00006847	000C	M: TextHeaderAtom - case of RT_TextHeaderAtom	
00006847	0008	RecordHeader - rh	
00006847	4 bits	unsigned integer - recVer	0x0
00006847	12 bits	unsigned integer - recInstance	0x000
00006849	0002	RecordType - recType	0x0F9F
0000684B	0004	unsigned integer - recLen	0x00000004
0000684F	0004	TextTypeEnum - textType	0x00000000

Figure 40: Outline TextHeaderAtom record M

textType: 0x00000000 specifies that the following character content in the **textBytes** field of the following table represents the title placeholder shape text.

Offset	Size	Structure	Value
00006853	0019	N: TextBytesAtom - case of RT_TextBytesAtom	
00006853	0008	RecordHeader - rh	
00006853	4 bits	unsigned integer - recVer	0x0
00006853	12 bits	unsigned integer - recInstance	0x000
00006855	0002	RecordType - recType	0x0FA8
00006857	0004	unsigned integer - recLen	0x00000011
0000685B	0011	array of bytes - textBytes	a fruit pie chart

Figure 41: Outline TextBytesAtom record N

textBytes: "a fruit pie chart" specifies the title placeholder shape text.

The last line of the outline text as shown in the figure titled "Outline text" in section 3.1 is derived from records O and P, which are shown expanded in the following tables.

Offset	Size	Structure	Value
00006888	000C	O: TextHeaderAtom - case of RT_TextHeaderAtom	
00006888	0008	RecordHeader - rh	
00006888	4 bits	unsigned integer - recVer	0x0
00006888	12 bits	unsigned integer - recInstance	0x000
0000688A	0002	RecordType - recType	0x0F9F
0000688C	0004	unsigned integer - recLen	0x00000004

Offset	Size	Structure	Value
00006890	0004	TextTypeEnum - textType	0x00000000

Figure 42: Outline TextHeaderAtom record O

textType: 0x00000000 specifies that the following character content in the **textBytes** field of the following table represents the title placeholder shape text.

Offset	Size	Structure	Value
00006894	0018	P: TextBytesAtom - case of RT_TextBytesAtom	
00006894	0008	RecordHeader - rh	
00006894	4 bits	unsigned integer - recVer	0x0
00006894	12 bits	unsigned integer - recInstance	0x000
00006896	0002	RecordType - recType	0x0FA8
00006898	0004	unsigned integer - recLen	0x00000010
0000689C	0010	array of bytes - textBytes	shapes with text

Figure 43: Outline TextBytesAtom record P

textBytes: "shapes with text" specifies the title placeholder shape text.

For more information about how the outline text formatting as shown in the figure titled "Outline text" in section 3.1, for example bullet points, font face, and font size, is derived, see the [Text Example](#) section.

3.5 Slides

The following sections provide examples of a **main master slide**, a **title master slide**, a **notes master slide**, **presentation slides**, and **notes slides**.

3.5.1 Master Slides

This example explains how to locate the **main master slide**, the **title master slide**, and the **notes master slide**.

The main master slide and title master slide are found by means of the **MasterPersistAtom** records (section [2.4.14.2](#)) contained within the **MasterListWithTextContainer** record (section [2.4.14.1](#)). The child-record hierarchy of the **MasterListWithTextContainer** record A from the table titled "DocumentContainer child-record hierarchy" in section [3.4](#) is shown expanded in the following table.

Offset	Size	Structure
00006159	0040	A: MasterListWithTextContainer - masterList
00006159	0008	RecordHeader - rh
00006161	001C	B: MasterPersistAtom - masterPersistAtom
0000617D	001C	C: MasterPersistAtom - masterPersistAtom

Figure 44: MasterListWithTextContainer record A child-record hierarchy

The child-record hierarchy of the **MasterPersistAtom** record B from previous table is shown expanded in the following table.

Offset	Size	Structure	Value
00006161	001C	B: MasterPersistAtom - masterPersistAtom	
00006161	0008	RecordHeader - rh	
00006169	0004	PersistIdRef - persistIdRef	0x00000002
0000616D	2 bits	unsigned integer - reserved1	0x0
0000616D	1 bit	bit - fNonOutlineData	0x0
0000616D	29 bits	unsigned integer - reserved2	0x00000000
00006171	0004	signed integer - reserved3	0x00000000
00006175	0004	MasterId - masterId	0x80000000
00006179	0004	unsigned integer - reserved4	0x00000000

Figure 45: MasterPersistAtom record B child-record hierarchy

persistIdRef: 0x00000002 specifies the value to look up in the **persist object directory**, shown in the last table in section 3.2, to find the **persist object** stream offset 0x00000CC5. This offset matches the offset for the **MainMasterContainer** (section 2.5.3) record B in the table titled "Top-level record sequence in the PowerPoint Document Stream from sample.ppt" in section 3.3. This **MainMasterContainer** record represents the main master slide as shown in figure titled "Main master slide" in section 3.1.

The child-record hierarchy of the **MasterPersistAtom** record C from the previous table titled "MasterListWithTextContainer record A child-record hierarchy" is shown expanded in the following table.

Offset	Size	Structure	Value
0000617D	001C	C: MasterPersistAtom - masterPersistAtom	
0000617D	0008	RecordHeader - rh	
00006185	0004	PersistIdRef - persistIdRef	0x00000003
00006189	2 bits	unsigned integer - reserved1	0x0
00006189	1 bit	bit - fNonOutlineData	0x0
00006189	29 bits	unsigned integer - reserved2	0x00000000
0000618D	0004	signed integer - reserved3	0x00000000
00006191	0004	MasterId - masterId	0x80000001
00006195	0004	unsigned integer - reserved4	0x00000000

Figure 46: MasterPersistAtom record C child-record hierarchy

persistIdRef: 0x00000003 specifies the value to look up in the **persist object directory**, shown in the last table in section 3.2, to find the **persist object** stream offset 0x00001671. This offset matches the offset for the **SlideContainer** (section 2.5.1) the record C in the table titled "Top-level record sequence in the PowerPoint Document Stream from sample.ppt" in section 3.3. This

SlideContainer record represents the title master slide as shown in figure titled "Title master slide" in section 3.1.

The notes master slide is found by means of the **DocumentAtom** record (section 2.4.2) contained within the **DocumentContainer** record (section 2.4.1). The **DocumentAtom** record E from the table titled "DocumentContainer child-record hierarchy" in section 3.4 is shown expanded in the following table.

Offset	Size	Structure	Value
00005C71	0030	E: DocumentAtom - documentAtom	
00005C71	0008	RecordHeader - rh	
00005C79	0008	PointStruct - slideSize	
00005C81	0008	PointStruct - notesSize	
00005C89	0008	RatioStruct - serverZoom	
00005C91	0004	PersistIdRef - notesMasterPersistIdRef	0x0000000B
00005C95	0004	PersistIdRef - handoutMasterPersistIdRef	0x00000000
00005C99	0002	unsigned integer - firstSlideNumber	0x0001
00005C9B	0002	SlideSizeEnum - slideSizeType	0x0000
00005C9D	0001	bool1 - fSaveWithFonts	0x00
00005C9E	0001	bool1 - fOmitTitlePlace	0x00
00005C9F	0001	bool1 - fRightToLeft	0x00
00005CA0	0001	bool1 - fShowComments	0x01

Figure 47: DocumentAtom record E child-record hierarchy

notesMasterPersistIdRef: 0x0000000B specifies the value to look up in the persist object directory, shown in the last table in section 3.2, to find the persist object stream offset 0x00001B98. This offset matches the offset for the **NotesContainer** (section 2.5.6) record D in section 3.3. This **NotesContainer** record (section 2.5.6) represents the notes master slide as shown in figure titled "Notes master slide" in section 3.1.

3.5.2 Presentation Slides

The **presentation slides** are found by means of the **SlidePersistAtom** records (section 2.4.14.5) contained within the **SlideListWithTextContainer** record (section 2.4.14.3). The child-record hierarchy of the **SlideListWithTextContainer** (section 2.4.14.3) record B from the table titled "DocumentContainer child-record hierarchy" in section 3.4 is shown expanded in the following table.

Offset	Size	Structure
00006698	0214	SlideListWithTextContainer - slideList
00006698	0008	RecordHeader - rh
000066A0	001C	A: SlidePersistAtom - case of RT_SlidePersistAtom
000066BC	000C	TextHeaderAtom - case of RT_TextHeaderAtom

Offset	Size	Structure
000066C8	0010	TextBytesAtom - case of RT_TextBytesAtom
000066D8	000C	TextHeaderAtom - case of RT_TextHeaderAtom
000066E4	0014	TextBytesAtom - case of RT_TextBytesAtom
000066F8	001C	B : SlidePersistAtom - case of RT_SlidePersistAtom
00006714	000C	TextHeaderAtom - case of RT_TextHeaderAtom
00006720	0013	TextBytesAtom - case of RT_TextBytesAtom
00006733	000C	TextHeaderAtom - case of RT_TextHeaderAtom
0000673F	0031	TextBytesAtom - case of RT_TextBytesAtom
00006770	0022	StyleTextPropAtom - case of RT_StyleTextPropAtom
00006792	001C	C : SlidePersistAtom - case of RT_SlidePersistAtom
000067AE	000C	TextHeaderAtom - case of RT_TextHeaderAtom
000067BA	0016	TextBytesAtom - case of RT_TextBytesAtom
000067D0	000C	TextHeaderAtom - case of RT_TextHeaderAtom
000067DC	0012	TextSpecialInfoAtom - case of RT_TextSpecialInfoAtom
000067EE	001C	D : SlidePersistAtom - case of RT_SlidePersistAtom
0000680A	000C	TextHeaderAtom - case of RT_TextHeaderAtom
00006816	0015	TextBytesAtom - case of RT_TextBytesAtom
0000682B	001C	E : SlidePersistAtom - case of RT_SlidePersistAtom
00006847	000C	TextHeaderAtom - case of RT_TextHeaderAtom
00006853	0019	TextBytesAtom - case of RT_TextBytesAtom
0000686C	001C	F : SlidePersistAtom - case of RT_SlidePersistAtom
00006888	000C	TextHeaderAtom - case of RT_TextHeaderAtom
00006894	0018	TextBytesAtom - case of RT_TextBytesAtom

Figure 48: SlideListWithTextContainer child-record hierarchy

The child-record hierarchy of the **SlidePersistAtom** record A from the previous table is shown expanded in the following table.

Offset	Size	Structure	Value
000066A0	001C	A : SlidePersistAtom - case of RT_SlidePersistAtom	
000066A0	0008	RecordHeader - rh	
000066A8	0004	PersistIdRef - persistIdRef	0x00000004
000066AC	1 bit	bit - reserved1	0x0
000066AC	1 bit	bit - fShouldCollapse	0x0

Offset	Size	Structure	Value
000066AC	1 bit	bit - fNonOutlineData	0x1
000066AC	29 bits	unsigned integer - reserved2	0x00000000
000066B0	0004	signed integer - cTexts	0x00000002
000066B4	0004	SlideId - slideId	0x00000100
000066B8	0004	unsigned integer - reserved3	0x00000000

Figure 49: SlidePersistAtom record A child-record hierarchy

persistIdRef: 0x00000004 specifies the value to look up in the **persist object directory**, shown in the last table in section 3.2, to find the **persist object** stream offset 0x000021C8. This offset matches the offset for the **SlideContainer** (section 2.5.1) record E in the table titled "Top-level record sequence in the PowerPoint Document Stream from sample.ppt" in section 3.3. This **SlideContainer** record represents the first presentation slide as shown in figure titled "Presentation slide 1" in section 3.1.

The child-record hierarchy of **SlideContainer** record E from the table titled "Top-level record sequence in the PowerPoint Document Stream from sample.ppt" in section 3.3 is shown expanded in the following table.

Offset	Size	Structure	Value
000021C8	022C	E: SlideContainer	
000021C8	0008	RecordHeader - rh	
000021D0	0020	SlideAtom - slideAtom	
000021D0	0008	RecordHeader - rh	
000021D8	0004	SlideLayoutType - geom	0x00000000
000021DC	0001	PlaceholderEnum - pt	0x0F
000021DD	0001	PlaceholderEnum - pt	0x10
000021DE	0001	PlaceholderEnum - pt	0x00
000021DF	0001	PlaceholderEnum - pt	0x00
000021E0	0001	PlaceholderEnum - pt	0x00
000021E1	0001	PlaceholderEnum - pt	0x00
000021E2	0001	PlaceholderEnum - pt	0x00
000021E3	0001	PlaceholderEnum - pt	0x00
000021E4	0004	MasterIdRef - masterIdRef	0x80000001
000021E8	0004	NotesIdRef - notesIdRef	0x00000105
000021EC	0002	SlideFlags - slideFlags	
000021EC	1 bit	bit - fMasterObjects	0x1
000021EC	1 bit	bit - fMasterScheme	0x1

Offset	Size	Structure	Value
000021EC	1 bit	bit - fMasterBackground	0x1
000021EC	13 bits	unsigned integer - reserved	0x0000
000021EE	0002	unsigned integer - unused	0x3014
000021F0	019C	DrawingContainer - drawing	
0000238C	0028	SlideSchemeColorSchemeAtom - slideSchemeColorSchemeAtom	
000023B4	0040	SlideProgTagsContainer - slideProgTagsContainer	

Figure 50: SlideContainer record E child-record hierarchy

slideAtom.masterIdRef: 0x80000001 specifies a reference to the **masterId** field in the table titled "MasterPersistAtom record C child-record hierarchy" in section 3.5.1, the **MasterPersistAtom** (section 2.4.14.2) for the **title master slide**. This specifies that this presentation slide follows the title master slide.

slideAtom.slideFlags.fMasterBackground: 0x0001 specifies that this presentation slide will inherit the background from the title master slide as shown in figure titled "Title master slide" in section 3.1.

The child-record hierarchy of the **SlidePersistAtom** record B from the table titled "SlideListWithTextContainer child-record hierarchy" in this section is shown expanded in the following table.

Offset	Size	Structure	Value
000066F8	001C	B: SlidePersistAtom - case of RT_SlidePersistAtom	
000066F8	0008	RecordHeader - rh	
00006700	0004	PersistIdRef - persistIdRef	0x00000005
00006704	1 bit	bit - reserved1	0x0
00006704	1 bit	bit - fShouldCollapse	0x0
00006704	1 bit	bit - fNonOutlineData	0x1
00006704	29 bits	unsigned integer - reserved2	0x00000000
00006708	0004	signed integer - cTexts	0x00000002
0000670C	0004	SlideId - slideId	0x00000101
00006710	0004	unsigned integer - reserved3	0x00000000

Figure 51: SlidePersistAtom record B child-record hierarchy

persistIdRef: 0x00000005 specifies the value to look up in the persist object directory, shown in the last table in section 3.2, to find the persist object stream offset 0x000023F4. This offset matches the offset for the **SlideContainer** (section 2.5.1) record F in the table titled "Top-level record sequence in the PowerPoint Document Stream from sample.ppt" in section 3.3. This **SlideContainer** record represents the second presentation slide as shown in figure titled "Presentation slide 2" in section 3.1.

The child-record hierarchy of **SlideContainer** record F from the table titled "Top-level record sequence in the PowerPoint Document Stream from sample.ppt" in section 3.3 is shown expanded in the following table.

Offset	Size	Structure	Value
000023F4	0A8D	F : SlideContainer	
000023F4	0008	RecordHeader - rh	
000023FC	0020	SlideAtom - slideAtom	
000023FC	0008	RecordHeader - rh	
00002404	0004	SlideLayoutType - geom	0x00000001
00002408	0001	PlaceholderEnum - pt	0x0D
00002409	0001	PlaceholderEnum - pt	0x0E
0000240A	0001	PlaceholderEnum - pt	0x00
0000240B	0001	PlaceholderEnum - pt	0x00
0000240C	0001	PlaceholderEnum - pt	0x00
0000240D	0001	PlaceholderEnum - pt	0x00
0000240E	0001	PlaceholderEnum - pt	0x00
0000240F	0001	PlaceholderEnum - pt	0x00
00002410	0004	unsigned integer - masterIdRef	0x80000000
00002414	0004	unsigned integer - notesIdRef	0x00000104
00002418	0002	SlideFlags - slideFlags	
00002418	1 bit	bit - fMasterObjects	0x1
00002418	1 bit	bit - fMasterScheme	0x1
00002418	1 bit	bit - fMasterBackground	0x1
00002418	13 bits	unsigned integer - reserved	0x0000
0000241A	0002	unsigned integer - unused	0x3014
0000241C	01C8	DrawingContainer - drawing	
000025E4	0028	SlideSchemeColorSchemeAtom - slideSchemeColorSchemeAtom	
0000260C	0875	A : SlideProgTagsContainer - slideProgTagsContainer	

Figure 52: SlideContainer record F child-record hierarchy

slideAtom.masterIdRef: 0x80000000 specifies a reference to the **masterId** field in the table titled "MasterPersistAtom record B child-record hierarchy" in section 3.5.1, the **MasterPersistAtom** for the **main master slide**. This specifies that this presentation slide follows the main master slide.

slideAtom.slideFlags.fMasterBackground: 0x0001 specifies this presentation slide will inherit the background from the main master slide as shown in figure titled "Main master slide" in section 3.1.

The child-record hierarchy of the **SlidePersistAtom** record C from the table titled "SlideListWithTextContainer child-record hierarchy" in this section is shown expanded in the following table.

Offset	Size	Structure	Value
00006792	001C	C: SlidePersistAtom - case of RT_SlidePersistAtom	
00006792	0008	RecordHeader - rh	
0000679A	0004	PersistIdRef - persistIdRef	0x00000006
0000679E	1 bit	bit - reserved1	0x0
0000679E	1 bit	bit - fShouldCollapse	0x0
0000679E	1 bit	bit - fNonOutlineData	0x1
0000679E	29 bits	unsigned integer - reserved2	0x00000000
000067A2	0004	signed integer - cTexts	0x00000002
000067A6	0004	SlideId - slideId	0x00000102
000067AA	0004	unsigned integer - reserved3	0x00000000

Figure 53: SlidePersistAtom record C child-record hierarchy

persistIdRef: 0x00000006 specifies the value to look up in the persist object directory, shown in the last table in section 3.2, to find the persist object stream offset 0x00006964. This offset matches the offset for the **SlideContainer** (section 2.5.1) record T in the table titled "Top-level record sequence in the PowerPoint Document Stream from sample.ppt" in section 3.3. This **SlideContainer** record represents the third presentation slide as shown in figure titled "Presentation slide 3" in section 3.1.

The child-record hierarchy of **SlideContainer** record T from the table titled "Top-level record sequence in the PowerPoint Document Stream from sample.ppt" in section 3.3 is shown expanded in the following table.

Offset	Size	Structure	Value
00006964	1192	T: SlideContainer	
00006964	0008	RecordHeader - rh	
0000696C	0020	SlideAtom - slideAtom	
0000696C	0008	RecordHeader - rh	
00006974	0004	SlideLayoutType - geom	0x00000001
00006978	0001	PlaceholderEnum - pt	0x0D
00006979	0001	PlaceholderEnum - pt	0x0E
0000697A	0001	PlaceholderEnum - pt	0x00
0000697B	0001	PlaceholderEnum - pt	0x00
0000697C	0001	PlaceholderEnum - pt	0x00
0000697D	0001	PlaceholderEnum - pt	0x00

Offset	Size	Structure	Value
0000697E	0001	PlaceholderEnum - pt	0x00
0000697F	0001	PlaceholderEnum - pt	0x00
00006980	0004	MasterIdRef - masterIdRef	0x80000000
00006984	0004	NotesIdRef - notesIdRef	0x00000103
00006988	0002	SlideFlags - slideFlags	
00006988	1 bit	bit - fMasterObjects	0x1
00006988	1 bit	bit - fMasterScheme	0x1
00006988	1 bit	bit - fMasterBackground	0x0
00006988	13 bits	unsigned integer - reserved	0x0000
0000698A	0002	unsigned integer - unused	0x3014
0000698C	020E	DrawingContainer - drawing	
00006B9A	0028	SlideSchemeColorSchemeAtom - slideSchemeColorSchemeAtom	
00006BC2	0F34	SlideProgTagsContainer - slideProgTagsContainer	

Figure 54: SlideContainer record T child-record hierarchy

slideAtom.masterIdRef: 0x80000000 specifies a reference to the **masterId** field in the table titled "MasterPersistAtom record B child-record hierarchy" in section 3.5.1, the **MasterPersistAtom** for the main master slide. This specifies that this presentation slide follows the main master slide.

slideAtom.slideFlags.fMasterBackground: 0x0000 specifies this slide does not inherit the background from the main master slide and provides its own background as shown in figure titled "Presentation slide 3" in section 3.1.

The child-record hierarchy of the **SlidePersistAtom** record D from the table titled "SlideListWithTextContainer child-record hierarchy" in this section is shown expanded in the following table.

Offset	Size	Structure	Value
000067EE	001C	D: SlidePersistAtom - case of RT_SlidePersistAtom	
000067EE	0008	RecordHeader - rh	
000067F6	0004	PersistIdRef - persistIdRef	0x00000008
000067FA	1 bit	bit - reserved1	0x0
000067FA	1 bit	bit - fShouldCollapse	0x0
000067FA	1 bit	bit - fNonOutlineData	0x1
000067FA	29 bits	unsigned integer - reserved2	0x00000000
000067FE	0004	signed integer - cTexts	0x00000001
00006802	0004	SlideId - slideId	0x00000103

Offset	Size	Structure	Value
00006806	0004	unsigned integer - reserved3	0x00000000

Figure 55: SlidePersistAtom record D child-record hierarchy

persistIdRef: 0x00000008 specifies the value to look up in the persist object directory, shown in the last table in section 3.2, to find the persist object stream offset 0x000037B5. This offset matches the offset for the **SlideContainer** (section 2.5.1) record I in the table titled "Top-level record sequence in the PowerPoint Document Stream from sample.ppt" in section 3.3. This **SlideContainer** record represents the fourth presentation slide as shown in figure titled "Presentation slide 4" in section 3.1.

The child-record hierarchy of **SlideContainer** record I from the table titled "Top-level record sequence in the PowerPoint Document Stream from sample.ppt" in section 3.3 is shown expanded in the following table.

Offset	Size	Structure	Value
000037B5	06CE	I: SlideContainer	
000037B5	0008	RecordHeader - rh	
000037BD	0020	SlideAtom - slideAtom	
000037BD	0008	RecordHeader - rh	
000037C5	0004	SlideLayoutType - geom	0x00000001
000037C9	0001	PlaceholderEnum - pt	0x0D
000037CA	0001	PlaceholderEnum - pt	0x13
000037CB	0001	PlaceholderEnum - pt	0x00
000037CC	0001	PlaceholderEnum - pt	0x00
000037CD	0001	PlaceholderEnum - pt	0x00
000037CE	0001	PlaceholderEnum - pt	0x00
000037CF	0001	PlaceholderEnum - pt	0x00
000037D0	0001	PlaceholderEnum - pt	0x00
000037D1	0004	MasterIdRef - masterIdRef	0x80000000
000037D5	0004	NotesIdRef - notesIdRef	0x00000102
000037D9	0002	SlideFlags - slideFlags	
000037D9	1 bit	bit - fMasterObjects	0x1
000037D9	1 bit	bit - fMasterScheme	0x1
000037D9	1 bit	bit - fMasterBackground	0x1
000037D9	13 bits	unsigned integer - reserved	0x0000
000037DB	0002	unsigned integer - unused	0x3014
000037DD	01BA	DrawingContainer - drawing	

Offset	Size	Structure	Value
00003997	0028	SlideSchemeColorSchemeAtom - slideSchemeColorSchemeAtom	
000039BF	04C4	SlideProgTagsContainer - slideProgTagsContainer	

Figure 56: SlideContainer record I child-record hierarchy

slideAtom.masterIdRef: 0x80000000 specifies a reference to the **masterId** field in the table titled "MasterPersistAtom record B child-record hierarchy" in section 3.5.1, the **MasterPersistAtom** for the main master slide. This specifies that this presentation slide follows the main master slide.

slideAtom.slideFlags.fMasterBackground: 0x0001 specifies that this presentation slide will inherit the background from the main master slide as shown in figure titled "Main master slide" in section 3.1.

The child-record hierarchy of the **SlidePersistAtom** record E from the table titled "SlideListWithTextContainer child-record hierarchy" in this section is shown expanded in the following table.

Offset	Size	Structure	Value
0000682B	001C	E: SlidePersistAtom - case of RT_SlidePersistAtom	
0000682B	0008	RecordHeader - rh	
00006833	0004	PersistIdRef - persistIdRef	0x00000009
00006837	1 bit	bit - reserved1	0x0
00006837	1 bit	bit - fShouldCollapse	0x0
00006837	1 bit	bit - fNonOutlineData	0x1
00006837	29 bits	unsigned integer - reserved2	0x00000000
0000683B	0004	signed integer - cTexts	0x00000001
0000683F	0004	SlideId - slideId	0x00000104
00006843	0004	unsigned integer - reserved3	0x00000000

Figure 57: SlidePersistAtom record E child-record hierarchy

persistIdRef: 0x00000009 specifies the value to look up in the persist object directory, shown in the last table in section 3.2, to find the persist object stream offset 0x00003E83. This offset matches the offset for the **SlideContainer** (section 2.5.1) record J in the table titled "Top-level record sequence in the PowerPoint Document Stream from sample.ppt" in section 3.3. This **SlideContainer** record represents the fifth presentation slide as shown in figure titled "Presentation slide 5" in section 3.1.

The child-record hierarchy of **SlideContainer** record J from the table titled "Top-level record sequence in the PowerPoint Document Stream from sample.ppt" in section 3.3 is shown expanded in the following table.

Offset	Size	Structure	Value
00003E83	0248	J: SlideContainer	
00003E83	0008	RecordHeader - rh	

Offset	Size	Structure	Value
00003E8B	0020	SlideAtom - slideAtom	
00003E8B	0008	RecordHeader - rh	
00003E93	0004	SlideLayoutType - geom	0x00000001
00003E97	0001	PlaceholderEnum - pt	0x0D
00003E98	0001	PlaceholderEnum - pt	0x14
00003E99	0001	PlaceholderEnum - pt	0x00
00003E9A	0001	PlaceholderEnum - pt	0x00
00003E9B	0001	PlaceholderEnum - pt	0x00
00003E9C	0001	PlaceholderEnum - pt	0x00
00003E9D	0001	PlaceholderEnum - pt	0x00
00003E9E	0001	PlaceholderEnum - pt	0x00
00003E9F	0004	MasterIdRef - masterIdRef	0x80000000
00003EA3	0004	NotesIdRef - notesIdRef	0x00000101
00003EA7	0002	SlideFlags - slideFlags	
00003EA7	1 bit	bit - fMasterObjects	0x1
00003EA7	1 bit	bit - fMasterScheme	0x1
00003EA7	1 bit	bit - fMasterBackground	0x1
00003EA7	13 bits	unsigned integer - reserved	0x0000
00003EA9	0002	unsigned integer - unused	0x3014
00003EAB	01B8	A : DrawingContainer - drawing	
00004063	0028	SlideSchemeColorSchemeAtom - slideSchemeColorSchemeAtom	
0000408B	0040	SlideProgTagsContainer - slideProgTagsContainer	

Figure 58: SlideContainer record J child-record hierarchy

slideAtom.masterIdRef: 0x80000000 specifies a reference to the **masterId** field in the table titled "MasterPersistAtom record B child-record hierarchy" in section 3.5.1, the **MasterPersistAtom** for the main master slide. This specifies that this presentation slide follows the main master slide.

slideAtom.slideFlags.fMasterBackground: 0x0001 specifies that this presentation slide will inherit the background from the main master slide as shown in figure titled "Main master slide" in section 3.1.

The child-record hierarchy of the **SlidePersistAtom** record F from the table titled "SlideListWithTextContainer child-record hierarchy" in this section is shown expanded in the following table.

Offset	Size	Structure	Value
0000686C	001C	F: SlidePersistAtom - case of RT_SlidePersistAtom	
0000686C	0008	RecordHeader - rh	
00006874	0004	PersistIdRef - persistIdRef	0x00000013
00006878	1 bit	bit - reserved1	0x0
00006878	1 bit	bit - fShouldCollapse	0x0
00006878	1 bit	bit - fNonOutlineData	0x1
00006878	29 bits	unsigned integer - reserved2	0x00000000
0000687C	0004	signed integer - cTexts	0x00000001
00006880	0004	SlideId - slideId	0x00000105
00006884	0004	unsigned integer - reserved3	0x00000000

Figure 59: SlidePersistAtom record F child-record hierarchy

persistIdRef: 0x00000013 specifies the value to look up in the persist object directory, shown in the last table in section 3.2, to find the persist object stream offset 0x00007AF6. This offset matches the offset for the **SlideContainer** (section 2.5.1) record U in the table titled "Top-level record sequence in the PowerPoint Document Stream from sample.ppt" in section 3.3. This represents the sixth and final presentation slide as shown in figure titled "Presentation slide 6" in section 3.1.

The child-record hierarchy of **SlideContainer** record U from the table titled "Top-level record sequence in the PowerPoint Document Stream from sample.ppt" in section 3.3 is shown expanded in the following table.

Offset	Size	Structure	Value
00007AF6	04ED	U: SlideContainer	
00007AF6	0008	RecordHeader - rh	
00007AFE	0020	SlideAtom - slideAtom	
00007AFE	0008	RecordHeader - rh	
00007B06	0004	SlideLayoutType - geom	0x00000007
00007B0A	0001	PlaceholderEnum - pt	0x0D
00007B0B	0001	PlaceholderEnum - pt	0x00
00007B0C	0001	PlaceholderEnum - pt	0x00
00007B0D	0001	PlaceholderEnum - pt	0x00
00007B0E	0001	PlaceholderEnum - pt	0x00
00007B0F	0001	PlaceholderEnum - pt	0x00
00007B10	0001	PlaceholderEnum - pt	0x00
00007B11	0001	PlaceholderEnum - pt	0x00
00007B12	0004	MasterIdRef - masterIdRef	0x80000000

Offset	Size	Structure	Value
00007B16	0004	NotesIdRef - notesIdRef	0x00000106
00007B1A	0002	SlideFlags - slideFlags	
00007B1A	1 bit	bit - fMasterObjects	0x1
00007B1A	1 bit	bit - fMasterScheme	0x1
00007B1A	1 bit	bit - fMasterBackground	0x1
00007B1A	13 bits	unsigned integer - reserved	0x0000
00007B1C	0002	unsigned integer - unused	0x3014
00007B1E	003A	B: PerSlideHeadersFootersContainer - perSlideHFContainer	
00007B58	0423	A: DrawingContainer - drawing	
00007F7B	0028	SlideSchemeColorSchemeAtom - slideSchemeColorSchemeAtom	
00007FA3	0040	SlideProgTagsContainer - slideProgTagsContainer	

Figure 60: SlideContainer record U child-record hierarchy

slideAtom.masterIdRef: 0x80000000 specifies a reference to the **masterId** field in the table titled "MasterPersistAtom record B child-record hierarchy" in section 3.5.1, the **MasterPersistAtom** for the main master slide. This specifies that this presentation slide follows the main master slide.

slideAtom.slideFlags.fMasterBackground: 0x0001 specifies that this presentation slide will inherit the background from the main master slide as shown in figure titled "Main master slide" in section 3.1.

3.5.3 Notes Slides

The **notes slides** are found by means of the **NotesPersistAtom** records (section 2.4.14.7) contained within the **NotesListWithTextContainer** record (section 2.4.14.6). Unlike in the previous example, where the order of the **SlidePersistAtom** records (section 2.4.14.5) contained within the **SlideListWithTextContainer** record (section 2.4.14.3) determines the order of the **presentation slides**, the order of the **NotesPersistAtom** records is not meaningful. A notes slide is associated with its presentation slide by means of the **slideIdRef** field in the **NotesContainer** record (section 2.5.6).

The child-record hierarchy of the **NotesListWithTextContainer** record C from the table titled "DocumentContainer child-record hierarchy" in section 3.4 is shown expanded in the following table.

Offset	Size	Structure
000068AC	00B0	NotesListWithTextContainer - notesList
000068AC	0008	RecordHeader - rh
000068B4	001C	A: NotesPersistAtom - notesPersistAtom
000068D0	001C	B: NotesPersistAtom - notesPersistAtom
000068EC	001C	C: NotesPersistAtom - notesPersistAtom
00006908	001C	D: NotesPersistAtom - notesPersistAtom
00006924	001C	E: NotesPersistAtom - notesPersistAtom

Offset	Size	Structure
00006940	001C	F: NotesPersistAtom - notesPersistAtom

Figure 61: NotesListWithTextContainer child-record hierarchy

The child-record hierarchy of the **NotesPersistAtom** record A from the previous table is shown expanded in the following table.

Offset	Size	Structure	Value
000068B4	001C	A: NotesPersistAtom - notesPersistAtom	
000068B4	0008	RecordHeader - rh	
000068BC	0004	PersistIdRef - persistIdRef	0x0000000D
000068C0	2 bits	unsigned integer - reserved1	0x0
000068C0	1 bit	bit - fNonOutlineData	0x0
000068C0	29 bits	unsigned integer - reserved2	0x00000000
000068C4	0004	signed integer - reserved3	0x00000000
000068C8	0004	NotesId - notesId	0x00000101
000068CC	0004	unsigned integer - reserved4	0x00000000

Figure 62: NotesPersistAtom record A child-record hierarchy

persistIdRef: 0x0000000D specifies the value to look up in the **persist object directory**, shown in the last in section 3.2, to find the **persist object** stream offset 0x000040CB. This offset matches the offset for the **NotesContainer** (section 2.5.6) record K in the table titled "Top-level record sequence in the PowerPoint Document Stream from sample.ppt" in section 3.3.

The child-record hierarchy of the **NotesContainer** (section 2.5.6) record K from the table titled "Top-level record sequence in the PowerPoint Document Stream from sample.ppt" in section 3.3 is shown expanded in the following table.

Offset	Size	Structure	Value
000040CB	024E	K: NotesContainer	
000040CB	0008	RecordHeader - rh	
000040D3	0010	NotesAtom - notesAtom	
000040D3	0008	RecordHeader - rh	
000040DB	0004	SlideIdRef - slideIdRef	0x00000104
000040DF	0002	SlideFlags - slideFlags	
000040E3	01CE	DrawingContainer - drawing	
000042B1	0028	SlideSchemeColorSchemeAtom - slideSchemeColorSchemeAtom	
000042D9	0040	SlideProgTagsContainer - slideProgTagsContainer	

Figure 63: NotesContainer record K child-record hierarchy

notesAtom.slideIdRef: 0x00000104 specifies a reference to the **slideId** field in the table titled "SlidePersistAtom record E child-record hierarchy" in section 3.5.2, the **SlidePersistAtom** for the fifth presentation slide. This **NotesContainer** record (section 2.5.6) represents the fifth notes slide as shown in figure titled "Notes slide 5" in section 3.1.

The child-record hierarchy of the **NotesPersistAtom** record B from the table titled "NotesListWithTextContainer child-record hierarchy" in this section is shown expanded in the following table.

Offset	Size	Structure	Value
000068D0	001C	B: NotesPersistAtom - notesPersistAtom	
000068D0	0008	RecordHeader - rh	
000068D8	0004	PersistIdRef - persistIdRef	0x0000000E
000068DC	2 bits	unsigned integer - reserved1	0x0
000068DC	1 bit	bit - fNonOutlineData	0x0
000068DC	29 bits	unsigned integer - reserved2	0x00000000
000068E0	0004	signed integer - reserved3	0x00000000
000068E4	0004	NotesId - notesId	0x00000102
000068E8	0004	unsigned integer - reserved4	0x00000000

Figure 64: NotesPersistAtom record B child-record hierarchy

persistIdRef: 0x0000000E specifies the value to look up in the persist object directory, shown in the last table in section 3.2, to find the persist object stream offset 0x00004319. This offset matches the offset for the **NotesContainer** (section 2.5.6) record L in the table titled "Top-level record sequence in the PowerPoint Document Stream from sample.ppt" in section 3.3.

The child-record hierarchy of the **NotesContainer** (section 2.5.6) record L from the table titled "Top-level record sequence in the PowerPoint Document Stream from sample.ppt" in section 3.3 is shown expanded in the following table.

Offset	Size	Structure	Value
00004319	02BB	L: NotesContainer	
00004319	0008	RecordHeader - rh	
00004321	0010	NotesAtom - notesAtom	
00004321	0008	RecordHeader - rh	
00004329	0004	SlideIdRef - slideIdRef	0x00000103
0000432D	0002	SlideFlags - slideFlags	
00004331	023B	DrawingContainer - drawing	
0000456C	0028	SlideSchemeColorSchemeAtom - slideSchemeColorSchemeAtom	
00004594	0040	SlideProgTagsContainer - slideProgTagsContainer	

Figure 65: NotesContainer record L child-record hierarchy

notesAtom.slideIdRef: 0x00000103 specifies a reference to the **slideId** field in the table titled "SlidePersistAtom record D child-record hierarchy" in section 3.5.2, the **SlidePersistAtom** for the fourth presentation slide. This **NotesContainer** record (section 2.5.6) represents the fourth notes slide as shown in figure titled "Notes slide 4" in section 3.1.

The child-record hierarchy of the **NotesPersistAtom** record C from the table titled "NotesListWithTextContainer child-record hierarchy" in this section is shown expanded in the following table.

Offset	Size	Structure	Value
000068EC	001C	C: NotesPersistAtom - notesPersistAtom	
000068EC	0008	RecordHeader - rh	
000068F4	0004	PersistIdRef - persistIdRef	0x0000000F
000068F8	2 bits	unsigned integer - reserved1	0x0
000068F8	1 bit	bit - fNonOutlineData	0x0
000068F8	29 bits	unsigned integer - reserved2	0x00000000
000068FC	0004	signed integer - reserved3	0x00000000
00006900	0004	NotesId - notesId	0x00000103
00006904	0004	unsigned integer - reserved4	0x00000000

Figure 66: NotesPersistAtom record C child-record hierarchy

persistIdRef: 0x0000000F specifies the value to look up in the persist object directory, shown in the last table in section 3.2, to find the persist object stream offset 0x000045D4. This offset matches the offset for the **NotesContainer** (section 2.5.6) record M in the table titled "Top-level record sequence in the PowerPoint Document Stream from sample.ppt" in section 3.3.

The child-record hierarchy of the **NotesContainer** (section 2.5.6) record M from the table titled "Top-level record sequence in the PowerPoint Document Stream from sample.ppt" in section 3.3 is shown expanded in the following table.

Offset	Size	Structure	Value
000045D4	029F	M: NotesContainer	
000045D4	0008	RecordHeader - rh	
000045DC	0010	NotesAtom - notesAtom	
000045DC	0008	RecordHeader - rh	
000045E4	0004	SlideIdRef - slideIdRef	0x00000102
000045E8	0002	SlideFlags - slideFlags	
000045EC	021F	DrawingContainer - drawing	
0000480B	0028	SlideSchemeColorSchemeAtom - slideSchemeColorSchemeAtom	
00004833	0040	SlideProgTagsContainer - slideProgTagsContainer	

Figure 67: NotesContainer record M child-record hierarchy

notesAtom.slideIdRef: 0x00000102 specifies a reference to the **slideId** field in the table titled "SlidePersistAtom record C child-record hierarchy" in section 3.5.2, the **SlidePersistAtom** for the third presentation slide. This **NotesContainer** record (section 2.5.6) represents the third notes slide as shown in figure titled "Notes slide 3" in section 3.1.

The child-record hierarchy of the **NotesPersistAtom** record D from the table titled "NotesListWithTextContainer child-record hierarchy" in this section is shown expanded in the following table.

Offset	Size	Structure	Value
00006908	001C	D: NotesPersistAtom - notesPersistAtom	
00006908	0008	RecordHeader - rh	
00006910	0004	PersistIdRef - persistIdRef	0x00000010
00006914	2 bits	unsigned integer - reserved1	0x0
00006914	1 bit	bit - fNonOutlineData	0x0
00006914	29 bits	unsigned integer - reserved2	0x00000000
00006918	0004	signed integer - reserved3	0x00000000
0000691C	0004	NotesId - notesId	0x00000104
00006920	0004	unsigned integer - reserved4	0x00000000

Figure 68: NotesPersistAtom record D child-record hierarchy

persistIdRef: 0x00000010 specifies the value to look up in the persist object directory, shown in the last table in section 3.2, to find the persist object stream offset 0x00004873. This offset matches the offset for the **NotesContainer** (section 2.5.6) record N in the table titled "Top-level record sequence in the PowerPoint Document Stream from sample.ppt" in section 3.3.

The child-record hierarchy of the **NotesContainer** (section 2.5.6) record N from the table titled "Top-level record sequence in the PowerPoint Document Stream from sample.ppt" in section 3.3 is shown expanded in the following table.

Offset	Size	Structure	Value
00004873	02AF	N: NotesContainer	
00004873	0008	RecordHeader - rh	
0000487B	0010	NotesAtom - notesAtom	
0000487B	0008	RecordHeader - rh	
00004883	0004	SlideIdRef - slideIdRef	0x00000101
00004887	0002	SlideFlags - slideFlags	
0000488B	022F	DrawingContainer - drawing	
00004ABA	0028	SlideSchemeColorSchemeAtom - slideSchemeColorSchemeAtom	
00004AE2	0040	SlideProgTagsContainer - slideProgTagsContainer	

Figure 69: NotesContainer record N child-record hierarchy

notesAtom.slideIdRef: 0x00000101 specifies a reference to the **slideId** field in the table titled "SlidePersistAtom record A child-record hierarchy" in section 3.5.2, the **SlidePersistAtom** for the second presentation slide. This **NotesContainer** record (section 2.5.6) represents the second notes slide as shown in figure titled "Notes slide 2" in section 3.1.

The child-record hierarchy of the **NotesPersistAtom** record E from the table titled "NotesListWithTextContainer child-record hierarchy" in this section is shown expanded in the following table.

Offset	Size	Structure	Value
00006924	001C	E: NotesPersistAtom - notesPersistAtom	
00006924	0008	RecordHeader - rh	
0000692C	0004	PersistIdRef - persistIdRef	0x00000011
00006930	2 bits	unsigned integer - reserved1	0x0
00006930	1 bit	bit - fNonOutlineData	0x0
00006930	29 bits	unsigned integer - reserved2	0x00000000
00006934	0004	signed integer - reserved3	0x00000000
00006938	0004	NotesId - notesId	0x00000105
0000693C	0004	unsigned integer - reserved4	0x00000000

Figure 70: NotesPersistAtom record E child-record hierarchy

persistIdRef: 0x00000011 specifies the value to look up in the persist object directory, shown in the last table in section 3.2, to find the persist object stream offset 0x00004B22. This offset matches the offset for the **NotesContainer** (section 2.5.6) record O in the table titled "Top-level record sequence in the PowerPoint Document Stream from sample.ppt" in section 3.3.

The child-record hierarchy of the **NotesContainer** (section 2.5.6) record O from the table titled "Top-level record sequence in the PowerPoint Document Stream from sample.ppt" in section 3.3 is shown expanded in the following table.

Offset	Size	Structure	Value
00004B22	0247	O: NotesContainer	
00004B22	0008	RecordHeader - rh	
00004B2A	0010	NotesAtom - notesAtom	
00004B2A	0008	RecordHeader - rh	
00004B32	0004	SlideIdRef - slideIdRef	0x00000100
00004B36	0002	SlideFlags - slideFlags	
00004B3A	01C7	DrawingContainer - drawing	
00004D01	0028	SlideSchemeColorSchemeAtom - slideSchemeColorSchemeAtom	
00004D29	0040	SlideProgTagsContainer - slideProgTagsContainer	

Figure 71: NotesContainer record O child-record hierarchy

notesAtom.slideIdRef: 0x00000100 specifies a reference to the **slideId** field in the table titled "SlidePersistAtom record A child-record hierarchy" in section 3.5.2, the **SlidePersistAtom** for the first presentation slide. This **NotesContainer** record (section 2.5.6) represents the first notes slide as shown in figure titled "Notes slide 1" in section 3.1.

The child-record hierarchy of the **NotesPersistAtom** record F from the table titled "NotesListWithTextContainer child-record hierarchy" in this section is shown expanded in the following table.

Offset	Size	Structure	Value
00006940	001C	F: NotesPersistAtom - notesPersistAtom	
00006940	0008	RecordHeader - rh	
00006948	0004	PersistIdRef - persistIdRef	0x00000014
0000694C	2 bits	unsigned integer - reserved1	0x0
0000694C	1 bit	bit - fNonOutlineData	0x0
0000694C	29 bits	unsigned integer - reserved2	0x00000000
00006950	0004	signed integer - reserved3	0x00000000
00006954	0004	NotesId - notesId	0x00000106
00006958	0004	unsigned integer - reserved4	0x00000000

Figure 72: NotesPersistAtom record F child-record hierarchy

persistIdRef: 0x00000014 specifies the value to look up in the persist object directory, shown in the last table in section 3.2, to find the persist object stream offset 0x00007FE3. This offset matches the offset for the **NotesContainer** (section 2.5.6) record V in the table titled "Top-level record sequence in the PowerPoint Document Stream from sample.ppt" in section 3.3.

The child-record hierarchy of the **NotesContainer** (section 2.5.6) record V from the table titled "Top-level record sequence in the PowerPoint Document Stream from sample.ppt" in section 3.3 is shown expanded in the following table.

Offset	Size	Structure	Value
00007FE3	0289	V: NotesContainer	
00007FE3	0008	RecordHeader - rh	
00007FEB	0010	NotesAtom - notesAtom	
00007FEB	0008	RecordHeader - rh	
00007FF3	0004	SlideIdRef - slideIdRef	0x00000105
00007FF7	0002	SlideFlags - slideFlags	
00007FFB	0209	DrawingContainer - drawing	
00008204	0028	SlideSchemeColorSchemeAtom - slideSchemeColorSchemeAtom	
0000822C	0040	SlideProgTagsContainer - slideProgTagsContainer	

Figure 73: NotesContainer record V child-record hierarchy

notesAtom.slideIdRef: 0x00000105 specifies a reference to the **slideId** field in the table titled "SlidePersistAtom record F child-record hierarchy" in section 3.5.2, the **SlidePersistAtom** for the sixth presentation slide. This **NotesContainer** record (section 2.5.6) represents the sixth notes slide as shown in figure titled "Notes slide 6" in section 3.1.

3.6 Programmable Tags

This file format allows for the storage of **programmable tags** at three levels—on the document itself, on each **slide**, and on each **shape**. While the primary purpose of programmable tags is to provide a mechanism for a third-party **VBA add-in** to persist opaque data in the file, they are also used as a way for a later version of PowerPoint to store new records in the file that will be safely ignored and preserved by an earlier version. The following sections show an example of this extension mechanism on the document and slide-levels.

3.6.1 Document Programmable Tags

Document-level **programmable tags** are found inside the **DocProgTagsContainer** record (section 2.4.23.1) contained within the **DocInfoListContainer** record (section 2.4.4). The **DocInfoListContainer** record D from the table titled "DocumentContainer child-record hierarchy" in section 3.4 is shown expanded in the following table.

Offset	Size	Structure
00006199	04D7	DocInfoListContainer - docInfoList
00006199	0008	RecordHeader - rh
000061A1	0024	NormalViewSetInfoContainer - case of RT_NormalViewSetInfo9
000061C5	00AF	SlideViewInfoInstance - case of RT_SlideViewInfo
00006274	0044	NotesTextViewInfoContainer - case of RT_NotesTextViewInfo9
000062B8	001C	VBAInfoContainer - case of RT_VbaInfo
000062D4	006F	SlideViewInfoInstance - case of RT_SlideViewInfo
00006343	0044	SorterViewInfoContainer - case of RT_SorterViewInfo
00006387	0044	OutlineViewInfoContainer - case of RT_OutlineViewInfo
000063CB	02A5	A: DocProgTagsContainer - case of RT_ProgTags

Figure 74: DocInfoListContainer child-record hierarchy

The **DocProgTagsContainer** record A from the previous table is shown expanded in the following table.

Offset	Size	Structure	Value
000063CB	02A5	DocProgTagsContainer - case of RT_ProgTags	
000063CB	0008	RecordHeader - rh	
000063D3	0038	A: DocProgBinaryTagContainer - case of RT_ProgBinaryTag	
000063D3	0008	RecordHeader - rh	
000063D3	4 bits	unsigned integer - recVer	0xF

Offset	Size	Structure	Value
000063D3	12 bits	unsigned integer - recInstance	0x000
000063D5	0002	RecordType - recType	0x138A
000063D7	0004	unsigned integer - recLen	0x00000030
000063DB	0030	B: PP10DocBinaryTagExtension - case of ___PPT10	
0000640B	0265	C: DocProgBinaryTagContainer - case of RT_ProgBinaryTag	
0000640B	0008	RecordHeader - rh	
0000640B	4 bits	unsigned integer - recVer	0xF
0000640B	12 bits	unsigned integer - recInstance	0x000
0000640D	0002	RecordType - recType	0x138A
0000640F	0004	unsigned integer - recLen	0x0000025D
00006413	025D	D: PP9DocBinaryTagExtension - case of ___PPT9	

Figure 75: DocProgTagsContainer child-record hierarchy

The **DocProgTagsContainer** record shown in the previous table has two programmable tags, represented by records labeled A and C, both of which store binary data as specified by the 0x138A value for their **rh.recType** fields.

The PP2.4.23.6DocBinaryTagExtension record B from the previous table is shown expanded in the following table.

Offset	Size	Structure	Value
000063DB	0030	B: PP10DocBinaryTagExtension - case of ___PPT10	
000063DB	0008	RecordHeader - rh	
000063DB	4 bits	unsigned integer - recVer	0x0
000063DB	12 bits	unsigned integer - recInstance	0x000
000063DD	0002	RecordType - recType	0x0FBA
000063DF	0004	unsigned integer - recLen	0x00000010
000063E3	0010	PrintableUnicodeString - tagName	___PPT10
000063F3	0008	RecordHeader - rhData	
000063F3	4 bits	unsigned integer - recVer	0x0
000063F3	12 bits	unsigned integer - recInstance	0x000
000063F5	0002	RecordType - recType	0x138B
000063F7	0004	unsigned integer - recLen	0x00000010
000063FB	0010	GridSpacing10Atom - gridSpacingAtom	

Figure 76: PP10DocBinaryTagExtension child-record hierarchy

Most records that have a **RecordHeader** structure (section 2.3.1) as the first field are either an **atom record** or a **container record**. However, the PP2.4.23.6DocBinaryTagExtension record is not a single atom record, but rather a pair of atom records and has two **RecordHeader** structures identified by the **rh** and **rhData** fields.

rh: The value of the **rh.recLen** field is 0x00000010 and specifies the size of all subsequent fields until the next **RecordHeader** structure.

tagName: "___PPT10" specifies that the binary tag data following the **rhData** field is as specified by the PP2.4.23.6DocBinaryTagExtension record.

rhData: The value of the **rhData.recVer** field is 0x0. Generally when the **recVer** field of a **RecordHeader** structure is not equal to 0xF, it indicates that the record that contains the **RecordHeader** structure is an atom record. However, in this context, **rhData** behaves more like a **RecordHeader** structure found as the first field of a container record, because following it are more atom records and container records, specifically a GridSpacing2.4.21.1Atom record. Accordingly, the value of the **rhData.recLen** field is 0x00000010 and specifies the size of all subsequent records to be included as part of the PP2.4.23.6DocBinaryTagExtension record.

The PP2.4.23.5DocBinaryTagExtension record D from the table titled "DocProgTagsContainer child-record hierarchy" in this section is shown expanded in the following table.

Offset	Size	Structure	Value
00006413	025D	D: PP9DocBinaryTagExtension - case of ___PPT9	
00006413	0008	RecordHeader - rh	
00006413	4 bits	unsigned integer - recVer	0x0
00006413	12 bits	unsigned integer - recInstance	0x000
00006415	0002	RecordType - recType	0x0FBA
00006417	0004	unsigned integer - recLen	0x0000000E
0000641B	000E	PrintableUnicodeString - tagName	___PPT9
00006429	0008	RecordHeader - rhData	
00006429	4 bits	unsigned integer - recVer	0x0
00006429	12 bits	unsigned integer - recInstance	0x000
0000642B	0002	RecordType - recType	0x138B
0000642D	0004	unsigned integer - recLen	0x0000023F
00006431	01F1	BlipCollection9Container - blipCollectionContainer	
00006622	0020	ExHyperlink9Container - exHyperlinkContainer	
00006642	002E	OutlineTextProps9Container - outlineTextPropsContainer	

Figure 77: PP9DocBinaryTagExtension child-record hierarchy

Most records that have a **RecordHeader** structure as the first field are either an atom record or a container record. However, the PP2.4.23.5DocBinaryTagExtension record is not a single atom record, but rather a pair of atom records and has two **RecordHeader** structures identified by the **rh** and **rhData** fields.

rh: The value of the **rh.recLen** field is 0x0000000E and specifies the size of all subsequent fields until the next **RecordHeader** structure.

tagName: "____PPT9" specifies that the binary tag data following the **rhData** is as specified by the PP2.4.23.5DocBinaryTagExtension record.

rhData: The value of the **rhData.recVer** field is 0x0. Generally when the **recVer** field of a **RecordHeader** structure is not equal to 0xF, it indicates that the record that contains the **RecordHeader** structure is an atom record. However, in this context, **rhData** behaves more like a **RecordHeader** structure found as the first field of a container record, because following it are more atom records and container records, specifically a **BlipCollection9Container** record (section 2.9.72), a ExHyperlink2.10.21Container record, and a OutlineTextProps2.9.60Container record. Accordingly, the value of the **rhData.recLen** field is 0x0000023F and specifies the size of all subsequent records to be included as part of the PP2.4.23.5DocBinaryTagExtension record.

3.6.2 Slide Programmable Tags

Slide-level **programmable tags** are found inside the **SlideContainer** record (section 2.5.1). The [SlideProgTagsContainer](#) record A from the table titled "SlidePersistAtom record F child-record hierarchy" in section 3.5.2 is shown expanded in the following table.

Offset	Size	Structure	Value
0000260C	0875	SlideProgTagsContainer - slideProgTagsContainer	
0000260C	0008	RecordHeader - rh	
00002614	086D	A: SlideProgBinaryTagContainer - case of RT_ProgBinaryTag	
00002614	0008	RecordHeader - rh	
00002614	4 bits	unsigned integer - recVer	0xF
00002614	12 bits	unsigned integer - recInstance	0x000
00002616	0002	RecordType - recType	0x138A
00002618	0004	unsigned integer - recLen	0x00000865
0000261C	0865	B: PP10SlideBinaryTagExtension - case of ____PPT10	
0000261C	0008	C: RecordHeader - rh	
0000261C	4 bits	unsigned integer - recVer	0x0
0000261C	12 bits	unsigned integer - recInstance	0x000
0000261E	0002	RecordType - recType	0x0FBA
00002620	0004	unsigned integer - recLen	0x00000010
00002624	0010	PrintableUnicodeString - tagName	____PPT10
00002634	0008	RecordHeader - rhData	
00002634	4 bits	unsigned integer - recVer	0x0
00002634	12 bits	unsigned integer - recInstance	0x000
00002636	0002	RecordType - recType	0x138B
00002638	0004	unsigned integer - recLen	0x00000845

Offset	Size	Structure	Value
0000263C	0010	SlideTime10Atom - slideTimeAtom	
0000264C	000C	HashCode10Atom - hashCodeAtom	
00002658	07E9	D: ExtTimeNodeContainer - extTimeNodeContainer	
00002E41	0040	BuildListContainer - buildListContainer	

Figure 78: SlideProgTagsContainer child-record hierarchy

The SlideProgTagsContainer record shown in the previous table has one programmable tag, represented by the record A, which stores binary data as specified by the 0x138A value for its **rh.recType** fields.

The contents of the programmable tag are shown by record B. Most records that have a **RecordHeader** structure (section 2.3.1) as the first field are either an **atom record** or a **container record**. However, the PP2.5.24SlideBinaryTagExtension record B is not a single atom record, but rather a pair of atom records and has two **RecordHeader** structures identified by the **rh** and **rhData** fields.

case of RT_ProgBinaryTag.case of ___PPT10.rh: The value of the **rh.recLen** field of the **RecordHeader** structure C is 0x00000010 and specifies the size of all subsequent fields until the next **RecordHeader** structure.

case of RT_ProgBinaryTag.case of ___PPT10.tagName: "___PPT10" specifies that the binary tag data following the **rhData** field is as specified by the PP2.5.24SlideBinaryTagExtension record.

case of RT_ProgBinaryTag.case of ___PPT10.rhData: The value of the **rhData.recVer** field is 0x0. Generally when the **recVer** field of a **RecordHeader** structure is not equal to 0xF, it indicates that the record that contains the **RecordHeader** structure is an atom record. However, in this context, **rhData** behaves more like a **RecordHeader** structure found as the first field of a container record, because following it are more atom records and container records, specifically a SlideTime2.5.31Atom record, a HashCode2.8.3Atom record, an **ExtTimeNodeContainer** record (section 2.8.15), and a BuildListContainer record. Accordingly, the value of the **rhData.recLen** field is 0x00000845 and specifies the size of all subsequent records to be included as part of the PP2.5.24SlideBinaryTagExtension record.

3.7 Animation

The following sections provide examples of text animation and shape animation. The animation in each example is synchronized with a timing tree that is a six-level tree of **time nodes**. The first level is the root of the tree, which is stored inside the [PP10SlideBinaryTagExtension](#) record.

3.7.1 Text Animation

This example explains the timing tree of the text animation used on **presentation slide 2** as shown in figure titled "Presentation slide 2" in section [3.1](#). The animation displays one bullet item of paragraph every time the mouse is clicked. In total, three paragraphs that are not displayed at first are displayed, using animation.

The timing tree of the text animation is found inside the [PP2.5.24SlideBinaryTagExtension](#) record. The **ExtTimeNodeContainer** (section [2.8.15](#)) record D from the table titled "SlideProgTagsContainer child-record hierarchy" in section [3.6.2](#) is shown expanded in the following table.

Offset	Size	Structure	Value
00002658	07E9	ExtTimeNodeContainer - extTimeNodeContainer	

Offset	Size	Structure	Value
00002658	0008	RecordHeader - rh	
00002660	0028	A: TimeNodeAtom - timeNodeAtom	
00002688	0015	TimePropertyList4TimeNodeContainer - timePropertyList	
00002688	0008	RecordHeader - rh	
00002690	000D	TimeEffectNodeType - case of TL_TPID_EffectNodeType	
00002690	0008	RecordHeader - rh	
00002698	0001	TimeVariantTypeEnum - type	0x01
00002699	0004	signed integer - effectNodeType	0x00000009
0000269D	07A4	B: ExtTimeNodeContainer - case of RT_TimeExtTimeNodeContainer	

Figure 79: First-level ExtTimeNodeContainer child-record hierarchy

timePropertyList.case of TL_TPID_EffectNodeType.effectNodeType: 0x00000009 specifies that this **time node** is the root of the timing tree.

The child-record hierarchy of the TimeNodeAtom record A from the previous table is shown expanded in the following table.

Offset	Size	Structure	Value
00002660	0028	A: TimeNodeAtom - timeNodeAtom	
00002660	0008	RecordHeader - rh	
00002668	0004	unsigned integer - reserved1	0x00000000
0000266C	0004	unsigned integer - restart	0x00000003
00002670	0004	TimeNodeTypeEnum - type	0x00000000
00002674	0004	unsigned integer - fill	0x00000000
00002678	0004	signed integer - reserved2	0x00000000
0000267C	0001	unsigned integer - reserved3	0x00
00002680	0004	signed integer - duration	0xFFFFFFFF
00002684	1 bit	bit - fFillProperty	0x0
00002684	1 bit	bit - fRestartProperty	0x1
00002684	1 bit	bit - reserved4	0x0
00002684	1 bit	bit - fGroupingTypeProperty	0x0
00002684	1 bit	bit - fDurationProperty	0x1
00002684	27 bits	unsigned integer - reserved5	0x00000000

Figure 80: TimeNodeAtom record A child-record hierarchy

restart: 0x00000003 specifies that this time node will never restart.

type: 0x00000000 specifies that this time node is a parallel time node, which allows all of its child nodes to start at the same time.

fill: 0x00000000 specifies that the animated properties are reset to their original values after the time node becomes inactive.

duration: 0xFFFFFFFF specifies that the duration of the time node is infinite, and that its actual duration is determined by the durations of its child nodes.

The child-record hierarchy of the **ExtTimeNodeContainer** record B from the first table titled "First-level ExtTimeNodeContainer child-record hierarchy" in this section is shown expanded in the following table.

Offset	Size	Structure	Value
0000269D	07A4	ExtTimeNodeContainer - case of RT_TimeExtTimeNodeContainer	
0000269D	0008	RecordHeader - rh	
000026A5	0028	A: TimeNodeAtom - timeNodeAtom	
000026CD	0015	TimePropertyList4TimeNodeContainer - timePropertyList	
000026CD	0008	RecordHeader - rh	
000026D5	000D	TimeEffectNodeType - case of TL_TPID_EffectNodeType	
000026D5	0008	RecordHeader - rh	
000026DD	0001	TimeVariantTypeEnum - type	0x01
000026DE	0004	signed integer - effectNodeType	0x00000004
000026E2	001C	B: TimeSequenceDataAtom - timeSequenceDataAtom	
000026FE	0034	C: TimeConditionContainer - timeCondition	
00002732	0034	D: TimeConditionContainer - timeCondition	
00002766	0249	E: ExtTimeNodeContainer - case of RT_TimeExtTimeNodeContainer	
000029AF	0249	F: ExtTimeNodeContainer - case of RT_TimeExtTimeNodeContainer	
00002BF8	0249	G: ExtTimeNodeContainer - case of RT_TimeExtTimeNodeContainer	

Figure 81: Second-level ExtTimeNodeContainer child-record hierarchy

The **TimeConditionContainer** (section 2.8.75) record C specifies the **time condition** of starting the next child time node, while the **TimeConditionContainer** record D specifies the time condition of starting the previous child time node.

The **ExtTimeNodeContainer** records E, F, and G are three child nodes of this time node. Each of them specifies the animation of one paragraph. Because these records are very similar, only the record E will be explained in this example.

timePropertyList.case of TL_TPID_EffectNodeType.effectNodeType: 0x00000004 specifies that this time node is the main sequential time node.

The child-record hierarchy of the TimeNodeAtom record A from the previous table is shown expanded in the following table.

Offset	Size	Structure	Value
000026A5	0028	A: TimeNodeAtom - timeNodeAtom	
000026A5	0008	RecordHeader - rh	
000026AD	0004	unsigned integer - reserved1	0x00000000
000026B1	0004	unsigned integer - restart	0x00000000
000026B5	0004	TimeNodeTypeEnum - type	0x00000001
000026B9	0004	unsigned integer - fill	0x00000000
000026BD	0004	signed integer - reserved2	0x00000000
000026C1	0001	unsigned integer - reserved3	0x00
000026C5	0004	signed integer - duration	0xFFFFFFFF
000026C9	1 bit	bit - fFillProperty	0x0
000026C9	1 bit	bit - fRestartProperty	0x0
000026C9	1 bit	bit - reserved4	0x0
000026C9	1 bit	bit - fGroupingTypeProperty	0x1
000026C9	1 bit	bit - fDurationProperty	0x1
000026C9	27 bits	unsigned integer - reserved5	0x00000000

Figure 82: TimeNodeAtom record A child-record hierarchy in the second-level ExtTimeNodeContainer

type: 0x00000001 specifies that this time node is a sequential time node.

The child-record hierarchy of the TimeSequenceDataAtom record B from the table titled "Second-level ExtTimeNodeContainer child-record hierarchy" in section [3.7.2](#) is shown expanded in the following table.

Offset	Size	Structure	Value
000026E2	001C	B: TimeSequenceDataAtom - timeSequenceDataAtom	
000026E2	0008	RecordHeader - rh	
000026EA	0004	unsigned integer - concurrency	0x00000001
000026EE	0004	unsigned integer - nextAction	0x00000001
000026F2	0004	unsigned integer - previousAction	0x00000000
000026F6	0004	unsigned integer - reserved1	0x00000000
000026FA	1 bit	bit - fConcurrencyPropertyUsed	0x1
000026FA	1 bit	bit - fNextActionPropertyUsed	0x1
000026FA	1 bit	bit - fPreviousActionPropertyUsed	0x0
000026FA	29 bits	unsigned integer - reserved2	0x00000000

Figure 83: TimeSequenceDataAtom record B child-record hierarchy

concurrency: 0x00000001 specifies that the next child time node can be activated after the current child is activated and that the time condition in the **TimeConditionContainer** record C from the table titled "Second-level ExtTimeNodeContainer child-record hierarchy" in section 3.7.2 are met.

nextAction: 0x00000001 specifies that the current child time node traverses forward to its natural end time before traversing to the next child.

previousAction: 0x00000000 specifies that no actions are performed before traversing back to the previous child time node.

The child-record hierarchy of the **TimeConditionContainer** record C from the table titled "Second-level ExtTimeNodeContainer child-record hierarchy" in section 3.7.2 is shown expanded in the following table.

Offset	Size	Structure	Value
000026FE	0034	C: TimeConditionContainer - timeCondition	
000026FE	0008	RecordHeader - rh	
00002706	0018	TimeConditionAtom - conditionAtom	
00002706	0008	RecordHeader - rh	
0000270E	0004	TriggerObjectEnum - triggerObject	0x00000001
00002712	0004	unsigned integer - triggerEvent	0x00000009
00002716	0004	unsigned integer - id	0x00000000
0000271A	0004	signed integer - delay	0x00000000
0000271E	0014	ClientVisualElementContainer - visualElement	
0000271E	0008	RecordHeader - rh	
00002726	000C	VisualElementAtom - visualElementAtom	
00002726	000C	VisualPageAtom - case of RT_VisualPageAtom	
00002726	0008	RecordHeader - rh	
0000272E	0004	TimeVisualElementEnum - type	0x00000001

Figure 84: TimeConditionContainer record C child-record hierarchy in the second-level ExtTimeNodeContainer

The **TimeConditionContainer** specifies the time condition that triggers the next child time node.

conditionAtom.triggerObject: 0x00000001 specifies that the target that participates in the evaluation of time condition is an object as specified in the **timeCondition.visualElement** field.

conditionAtom.triggerEvent: 0x00000009 specifies that if the OnNext event occurs on the target, the time condition is true. The OnNext event can be triggered by a mouse click on the presentation slide.

conditionAtom.id: 0x00000000 specifies that the target is the presentation slide.

conditionAtom.delay: 0x00000000 specifies that there is no offset time applied to when the time condition becomes true.

visualElement.visualElementAtom.case of RT_VisualPageAtom.type: 0x00000001 specifies that the target of the time condition is a presentation slide.

The child-record hierarchy of the **TimeConditionContainer** record D from the table titled "Second-level ExtTimeNodeContainer child-record hierarchy" in section 3.7.2 is shown expanded in the following table.

Offset	Size	Structure	Value
00002732	0034	D: TimeConditionContainer - timeCondition	
00002732	0008	RecordHeader - rh	
0000273A	0018	TimeConditionAtom - conditionAtom	
0000273A	0008	RecordHeader - rh	
00002742	0004	TriggerObjectEnum - triggerObject	0x00000001
00002746	0004	unsigned integer - triggerEvent	0x0000000A
0000274A	0004	unsigned integer - id	0x00000000
0000274E	0004	signed integer - delay	0x00000000
00002752	0014	ClientVisualElementContainer - visualElement	
00002752	0008	RecordHeader - rh	
0000275A	000C	VisualElementAtom - visualElementAtom	
0000275A	000C	VisualPageAtom - case of RT_VisualPageAtom	
0000275A	0008	RecordHeader - rh	
00002762	0004	TimeVisualElementEnum - type	0x00000001

Figure 85: TimeConditionContainer record D child-record hierarchy in the second-level ExtTimeNodeContainer

The **TimeConditionContainer** specifies the time condition that triggers the previous child time node. The only difference between the **TimeConditionContainer** record C from the table titled "Second-level ExtTimeNodeContainer child-record hierarchy" in section 3.7.2 and the **TimeConditionContainer** record D from the table titled "Second-level ExtTimeNodeContainer child-record hierarchy" in section 3.7.2 is the **timeCondition.conditionAtom.triggerEvent** field.

conditionAtom.triggerEvent: 0x0000000A specifies that if the OnPrev event occurs on the target, the time condition is true.

The child-record hierarchy of the **ExtTimeNodeContainer** record E from the table titled "Second-level ExtTimeNodeContainer child-record hierarchy" in section 3.7.2 is shown expanded in the following table.

Offset	Size	Structure
00002766	0249	ExtTimeNodeContainer - case of RT_TimeExtTimeNodeContainer
00002766	0008	RecordHeader - rh
0000276E	0028	A: TimeNodeAtom - timeNodeAtom
00002796	0008	B: TimePropertyList4TimeNodeContainer - timePropertyList
00002796	0008	RecordHeader - rh

Offset	Size	Structure
0000279E	0020	C: TimeConditionContainer - timeCondition
000027BE	01F1	D: ExtTimeNodeContainer - case of RT_TimeExtTimeNodeContainer

Figure 86: Third-level ExtTimeNodeContainer child-record hierarchy

The **TimePropertyList4TimeNodeContainer** (section 2.8.18) record B is an empty list.

The child-record hierarchy of the TimeNodeAtom record A from the previous table is shown expanded in the following table.

Offset	Size	Structure	Value
0000276E	0028	A: TimeNodeAtom - timeNodeAtom	
0000276E	0008	RecordHeader - rh	
00002776	0004	unsigned integer - reserved1	0x00000000
0000277A	0004	unsigned integer - restart	0x00000000
0000277E	0004	TimeNodeTypeEnum - type	0x00000000
00002782	0004	unsigned integer - fill	0x00000003
00002786	0004	signed integer - reserved2	0x00000000
0000278A	0001	unsigned integer - reserved3	0x00
0000278E	0004	signed integer - duration	0x00000000
00002792	1 bit	bit - fFillProperty	0x1
00002792	1 bit	bit - fRestartProperty	0x0
00002792	1 bit	bit - reserved4	0x0
00002792	1 bit	bit - fGroupingTypeProperty	0x0
00002792	1 bit	bit - fDurationProperty	0x0
00002792	27 bits	unsigned integer - reserved5	0x00000000

Figure 87: TimeNodeAtom record A child-record hierarchy in the third-level ExtTimeNodeContainer

fill: 0x00000003 specifies that the properties remain at their ending values while the parent time node at the second level is still running or holding.

duration: 0x00000000 specifies that the duration of the time node is not specified, and that its actual duration is determined by the latest end time of any of its child nodes.

The child-record hierarchy of the **TimeConditionContainer** record C from the first table titled "Third-level ExtTimeNodeContainer child-record hierarchy" in section 3.7.2 is shown expanded in the following table.

Offset	Size	Structure	Value
0000279E	0020	C: TimeConditionContainer - timeCondition	
0000279E	0008	RecordHeader - rh	

Offset	Size	Structure	Value
000027A6	0018	TimeConditionAtom - conditionAtom	
000027A6	0008	RecordHeader - rh	
000027AE	0004	TriggerObjectEnum - triggerObject	0x00000000
000027B2	0004	unsigned integer - triggerEvent	0x00000000
000027B6	0004	unsigned integer - id	0x00000000
000027BA	0004	signed integer - delay	0xFFFFFFFF

Figure 88: TimeConditionContainer record C child-record hierarchy in the third-level ExtTimeNodeContainer

The value of the **conditionAtom.delay** field is 0xFFFFFFFF and specifies an infinite value, which implies that no delay is defined. The value of the **conditionAtom.triggerObject** field and the value of the **conditionAtom.triggerEvent** field are both 0x00000000, which specifies no condition for this time node, which implies that the evaluation of the time condition always returns true.

The child-record hierarchy of the **ExtTimeNodeContainer** record D from the first table titled "Third-level ExtTimeNodeContainer child-record hierarchy" in section 3.7.2 is shown expanded in the following table.

Offset	Size	Structure	Value
000027BE	01F1	ExtTimeNodeContainer - case of RT_TimeExtTimeNodeContainer	
000027BE	0008	RecordHeader - rh	
000027C6	0028	A: TimeNodeAtom - timeNodeAtom	
000027EE	0008	TimePropertyList4TimeNodeContainer - timePropertyList	
000027EE	0008	RecordHeader - rh	
000027F6	0020	B: TimeConditionContainer - timeCondition	
000027F6	0008	RecordHeader - rh	
000027FE	0018	TimeConditionAtom - conditionAtom	
000027FE	0008	RecordHeader - rh	
00002806	0004	TriggerObjectEnum - triggerObject	0x00000000
0000280A	0004	unsigned integer - triggerEvent	0x00000000
0000280E	0004	unsigned integer - id	0x00000000
00002812	0004	signed integer - delay	0x00000000
00002816	0199	C: ExtTimeNodeContainer - case of RT_TimeExtTimeNodeContainer	

Figure 89: Fourth-level ExtTimeNodeContainer child-record hierarchy

The values of the **conditionAtom.triggerObject** field and the **conditionAtom.triggerEvent** field in the **TimeConditionContainer** record B are both 0x00000000, which specifies no condition for this time node and implies that the evaluation of the time condition always returns true.

The child-record hierarchy of the TimeNodeAtom record A from the previous table is shown expanded in the following table.

Offset	Size	Structure	Value
000027C6	0028	A: TimeNodeAtom - timeNodeAtom	
000027C6	0008	RecordHeader - rh	
000027CE	0004	unsigned integer - reserved1	0x00000000
000027D2	0004	unsigned integer - restart	0x00000000
000027D6	0004	TimeNodeTypeEnum - type	0x00000000
000027DA	0004	unsigned integer - fill	0x00000003
000027DE	0004	signed integer - reserved2	0x00000000
000027E2	0001	unsigned integer - reserved3	0x00
000027E6	0004	signed integer - duration	0x00000000
000027EA	1 bit	bit - fFillProperty	0x1
000027EA	1 bit	bit - fRestartProperty	0x0
000027EA	1 bit	bit - reserved4	0x0
000027EA	1 bit	bit - fGroupingTypeProperty	0x0
000027EA	1 bit	bit - fDurationProperty	0x0
000027EA	27 bits	unsigned integer - reserved5	0x00000000

Figure 90: TimeNodeAtom record A child-record hierarchy in the fourth-level ExtTimeNodeContainer

fill: 0x00000003 specifies that the properties remain at their ending values while the parent time node at the third level is still running or holding.

The child-record hierarchy of the **ExtTimeNodeContainer** record C from the table titled "Fourth-level ExtTimeNodeContainer child-record hierarchy" in section 3.7.2 is shown expanded in the following table.

Offset	Size	Structure	Value
00002816	0199	ExtTimeNodeContainer - case of RT_TimeExtTimeNodeContainer	
00002816	0008	RecordHeader - rh	
0000281E	0028	A: TimeNodeAtom - timeNodeAtom	
00002846	0049	B: TimePropertyList4TimeNodeContainer - timePropertyList	
0000288F	0020	C: TimeConditionContainer - timeCondition	
0000288F	0008	RecordHeader - rh	
00002897	0018	TimeConditionAtom - conditionAtom	
00002897	0008	RecordHeader - rh	

Offset	Size	Structure	Value
0000289F	0004	TriggerObjectEnum - triggerObject	0x00000000
000028A3	0004	unsigned integer - triggerEvent	0x00000000
000028A7	0004	unsigned integer - id	0x00000000
000028AB	0004	signed integer - delay	0x00000000
000028AF	0100	D: ExtTimeNodeContainer - case of RT_TimeExtTimeNodeContainer	

Figure 91: Fifth-level ExtTimeNodeContainer child-record hierarchy

This time node specifies the appear animation effect that makes the paragraph display during a **slide show**.

The values of the **conditionAtom.triggerObject** field and the **conditionAtom.triggerEvent** field in the **TimeConditionContainer** record C are both 0x00000000, which specifies no condition for this time node and implies that the evaluation of the time condition always returns true.

The child-record hierarchy of the TimeNodeAtom record A from the previous table is shown expanded in the following table.

Offset	Size	Structure	Value
0000281E	0028	A: TimeNodeAtom - timeNodeAtom	
0000281E	0008	RecordHeader - rh	
00002826	0004	unsigned integer - reserved1	0x00000000
0000282A	0004	unsigned integer - restart	0x00000000
0000282E	0004	TimeNodeTypeEnum - type	0x00000000
00002832	0004	unsigned integer - fill	0x00000003
00002836	0004	signed integer - reserved2	0x00000000
0000283A	0001	unsigned integer - reserved3	0x00
0000283E	0004	signed integer - duration	0x00000000
00002842	1 bit	bit - fFillProperty	0x1
00002842	1 bit	bit - fRestartProperty	0x0
00002842	1 bit	bit - reserved4	0x0
00002842	1 bit	bit - fGroupingTypeProperty	0x0
00002842	1 bit	bit - fDurationProperty	0x0
00002842	27 bits	unsigned integer - reserved5	0x00000000

Figure 92: TimeNodeAtom record A child-record hierarchy in the fifth-level ExtTimeNodeContainer

fill: 0x00000003 specifies that the properties remain at their ending values while the parent time node at the fourth level is still running or holding.

The child-record hierarchy of the **TimePropertyList4TimeNodeContainer** record B from the table titled "Fifth-level ExtTimeNodeContainer child-record hierarchy" in this section is shown expanded in the following table.

Offset	Size	Structure	Value
00002846	0049	B: TimePropertyList4TimeNodeContainer - timePropertyList	
00002846	0008	RecordHeader - rh	
0000284E	000D	TimeEffectNodeType - case of TL_TPID_EffectNodeType	
0000284E	0008	RecordHeader - rh	
00002856	0001	TimeVariantTypeEnum - type	0x01
00002857	0004	signed integer - effectNodeType	0x00000001
0000285B	000D	TimeEffectID - case of TL_TPID_EffectID	
0000285B	0008	RecordHeader - rh	
00002863	0001	TimeVariantTypeEnum - type	0x01
00002864	0004	signed integer - effectID	0x00000001
00002868	000D	TimeVariantInt - case of TL_TPID_EffectDir	
00002868	0008	RecordHeader - rh	
00002870	0001	TimeVariantTypeEnum - type	0x01
00002871	0004	signed integer - intValue	0x00000000
00002875	000D	TimeEffectType - case of TL_TPID_EffectType	
00002875	0008	RecordHeader - rh	
0000287D	0001	TimeVariantTypeEnum - type	0x01
0000287E	0004	signed integer - effectType	0x00000001
00002882	000D	TimeGroupID - case of TL_TPID_GroupID	
00002882	0008	RecordHeader - rh	
0000288A	0001	TimeVariantTypeEnum - type	0x01
0000288B	0004	signed integer - groupID	0x00000000

Figure 93: TimePropertyList4TimeNodeContainer record B child-record hierarchy in the fifth-level ExtTimeNodeContainer

case of TL_TPID_EffectNodeType.effectNodeType: 0x00000001 specifies that this time node is for a click effect.

case of TL_TPID_EffectID.effectID: 0x00000001 specifies the identifier of the animation effect applied to the paragraphs, which specifies the appear animation effect.

case of TL_TPID_EffectDir.intValue: 0x00000000 specifies no direction for the animation effect.

case of TL_TPID_EffectType.effectType: 0x00000001 specifies that the animation effect is an entrance effect.

case of TL_TPID_GroupID.groupID: 0x00000000 specifies the **build identifier** of the animation effect.

The child-record hierarchy of the **ExtTimeNodeContainer** record D from the table titled "Fifth-level ExtTimeNodeContainer child-record hierarchy" in this section is shown expanded in the following table. This is the only animation behavior of the appear animation effect.

Offset	Size	Structure	Value
000028AF	0100	ExtTimeNodeContainer - case of RT_TimeExtTimeNodeContainer	
000028AF	0008	RecordHeader - rh	
000028B7	0028	A: TimeNodeAtom - timeNodeAtom	
000028DF	0008	B: TimePropertyList4TimeNodeContainer - timePropertyList	
000028DF	0008	RecordHeader - rh	
000028E7	00A8	C: TimeSetBehaviorContainer - timeSetBehavior	
0000298F	0020	D: TimeConditionContainer - timeCondition	
0000298F	0008	RecordHeader - rh	
00002997	0018	TimeConditionAtom - conditionAtom	
00002997	0008	RecordHeader - rh	
0000299F	0004	TriggerObjectEnum - triggerObject	0x00000000
000029A3	0004	unsigned integer - triggerEvent	0x00000000
000029A7	0004	unsigned integer - id	0x00000000
000029AB	0004	signed integer - delay	0x00000000

Figure 94: Sixth-level ExtTimeNodeContainer child-record hierarchy

The values of the **conditionAtom.triggerObject** field and the **conditionAtom.triggerEvent** field in the **TimeConditionContainer** record D are both 0x00000000, which specifies no condition for this time node and implies that the evaluation of the time condition always returns true.

The **TimePropertyList4TimeNodeContainer** record B is an empty list.

The child-record hierarchy of the TimeNodeAtom record A from the previous table is shown expanded in the following table.

Offset	Size	Structure	Value
000028B7	0028	A: TimeNodeAtom - timeNodeAtom	
000028B7	0008	RecordHeader - rh	
000028BF	0004	unsigned integer - reserved1	0x00000000
000028C3	0004	unsigned integer - restart	0x00000000
000028C7	0004	TimeNodeTypeEnum - type	0x00000003
000028CB	0004	unsigned integer - fill	0x00000003
000028CF	0004	signed integer - reserved2	0x00000000

Offset	Size	Structure	Value
000028D3	0001	unsigned integer - reserved3	0x00
000028D7	0004	signed integer - duration	0x00000001
000028DB	1 bit	bit - fFillProperty	0x1
000028DB	1 bit	bit - fRestartProperty	0x0
000028DB	1 bit	bit - reserved4	0x0
000028DB	1 bit	bit - fGroupingTypeProperty	0x1
000028DB	1 bit	bit - fDurationProperty	0x1
000028DB	27 bits	unsigned integer - reserved5	0x00000000

Figure 95: TimeNodeAtom record A child-record hierarchy in the sixth-level ExtTimeNodeContainer

type: 0x00000003 specifies that this time node is a behavior time node that contains a behavior.

fill: 0x00000003 specifies that the properties remain at their ending values while the parent time node at the fourth level is still running or holding.

duration: 0x00000001 specifies that the duration of this time node is 0.001 seconds.

The child-record hierarchy of the **TimeSetBehaviorContainer** (section 2.8.69) record C from the table titled "Sixth-level ExtTimeNodeContainer child-record hierarchy" in this section is shown expanded in the following table.

Offset	Size	Structure	Value
000028E7	00A8	TimeSetBehaviorContainer - timeSetBehavior	
000028E7	0008	RecordHeader - rh	
000028EF	0010	TimeSetBehaviorAtom - setBehaviorAtom	
000028EF	0008	RecordHeader - rh	
000028EF	1 bit	bit - fToPropertyUsed	0x1
000028EF	1 bit	bit - fValueTypePropertyUsed	0x0
000028EF	30 bits	unsigned integer - reserved	0x00000000
000028FB	0004	TimeAnimateBehaviorValueTypeEnum - valueType	0x00000001
000028FF	0019	TimeVariantString - varTo	
000028FF	0008	RecordHeader - rh	
00002907	0001	TimeVariantTypeEnum - type	0x03
00002908	0010	array of bytes - stringValue	visible
00002918	0077	A: TimeBehaviorContainer - behavior	

Figure 96: Child-record hierarchy of TimeSetBehaviorContainer in the sixth-level ExtTimeNodeContainer

This set behavior assigns a specified value to the property as specified in the **timeSetBehavior.varTo.stringValue** field.

setBehaviorAtom.valueType: 0x00000001 specifies that the type of the property value is a number.

varTo.stringValue: "visible" specifies the preset value that will be assigned to the property that controls the visibility of the target object. After this value is set, the target object appears in the slide show.

The child-record hierarchy of the **TimeBehaviorContainer** (section 2.8.34) record A from the previous table is shown expanded in the following table.

Offset	Size	Structure	Value
00002918	0077	TimeBehaviorContainer - behavior	
00002918	0008	RecordHeader - rh	
00002920	0018	A: TimeBehaviorAtom - behaviorAtom	
00002938	0033	B: TimeStringListContainer - stringList	
00002938	0008	RecordHeader - rh	
00002940	002B	TimeVariantString - string	
00002940	0008	RecordHeader - rh	
00002948	0001	TimeVariantTypeEnum - type	0x03
00002949	0022	array of bytes - stringValue	style.visibility
0000296B	0024	C: ClientVisualElementContainer - clientVisualElement	
0000296B	0008	RecordHeader - rh	
00002973	001C	VisualElementAtom - visualElementAtom	
00002973	001C	VisualShapeOrSoundAtom - case of RT_VisualShapeAtom	
00002973	001C	VisualShapeAtom - case of TL_ET_ShapeType	
00002973	001C	VisualShapeGeneralAtom - default_case	
00002973	0008	RecordHeader - rh	
0000297B	0004	TimeVisualElementEnum - type	0x00000002
0000297F	0004	ElementTypeEnum - refType	0x00000001
00002983	0004	unsigned integer - shapeIdRef	0x00000C03
00002987	0004	signed integer - data1	0x00000000
0000298B	0004	signed integer - data2	0x0000000C

Figure 97: Child-record hierarchy of TimeBehaviorContainer

stringList.string.stringValue: "style.visibility" specifies the property to which a value is assigned. This property controls the visibility of the target object.

clientVisualElement.visualElementAtom.case of RT_VisualShapeAtom.case of TL_ET_ShapeType.default_case.type: 0x00000002 specifies that the animation is applied to a specified range of text in the **shape**.

clientVisualElement.visualElementAtom.case of RT_VisualShapeAtom.case of TL_ET_ShapeType.default_case.refType: 0x00000001 specifies that the animation target is a part of the shape that contains the three paragraphs.

clientVisualElement.visualElementAtom.case of RT_VisualShapeAtom.case of TL_ET_ShapeType.default_case.shapeIdRef: 0x00000C03 specifies the **shape identifier** of the shape that contains the three paragraphs.

clientVisualElement.visualElementAtom.case of RT_VisualShapeAtom.case of TL_ET_ShapeType.default_case.data1: 0x00000000 specifies the character index of the beginning of the paragraph to be animated.

clientVisualElement.visualElementAtom.case of RT_VisualShapeAtom.case of TL_ET_ShapeType.default_case.data2: 0x0000000C specifies the character index of the end of the paragraph to be animated.

The child-record hierarchy of the TimeBehaviorAtom record A from the previous table is shown expanded in the following table.

Offset	Size	Structure	Value
00002920	0018	A: TimeBehaviorAtom - behaviorAtom	
00002920	0008	RecordHeader - rh	
00002920	1 bit	bit - fAdditivePropertyUsed	0x0
00002920	1 bit	bit - reserved1	0x0
00002920	1 bit	bit - fAttributeNamesPropertyUsed	0x1
00002920	1 bit	bit - reserved2	0x0
00002920	28 bits	unsigned integer - reserved3	0x00000000
0000292C	0004	unsigned integer - behaviorAdditive	0x00000000
00002930	0004	signed integer - behaviorAccumulate	0x00000000
00002934	0004	signed integer - behaviorTransform	0x00000000

Figure 98: TimeBehaviorAtom record A child-record hierarchy

behaviorAdditive: 0x00000000 specifies that the animated value replaces the original value of the property to be animated.

behaviorAccumulate: 0x00000000 specifies that no accumulation between repeating animations occurs.

behaviorTransform: 0x00000000 specifies that the animation animates a property of the target object.

3.7.2 Shape Animation

This example explains the timing tree of the **shape** animations for the green square on **presentation slide** 3 as shown in figure titled "Presentation slide 3" in section [3.1](#). The effects include a fly-in

animation effect, a spin animation effect, and a sink-down animation effect. These three animation effects are triggered one after the other by successive mouse clicks.

The timing tree of the shape animation is found inside the [PP2.5.24SlideBinaryTagExtension](#) record. For example, the **ExtTimeNodeContainer** (section [2.8.15](#)) record D from the table titled "SlideProgTagsContainer child-record hierarchy" in section [3.6.2](#) is the root of the timing tree for presentation slide 2. The **ExtTimeNodeContainer** record shown expanded in the following table is similarly the root of the timing tree for presentation slide 3.

Offset	Size	Structure	Value
00006C0E	0E38	ExtTimeNodeContainer - extTimeNodeContainer	
00006C0E	0008	RecordHeader - rh	
00006C16	0028	A: TimeNodeAtom - timeNodeAtom	
00006C3E	0015	TimePropertyList4TimeNodeContainer - timePropertyList	
00006C3E	0008	RecordHeader - rh	
00006C46	000D	TimeVariant4TimeNode - rec	
00006C46	000D	TimeEffectNodeType - case of TL_TPID_EffectNodeType	
00006C46	000D	TimeVariantInt - effectNodeType0	
00006C46	0008	RecordHeader - rh	
00006C4E	0001	TimeVariantTypeEnum - type	0x01
00006C4F	0004	signed integer - effectNodeType	0x00000009
00006C53	0DF3	B: ExtTimeNodeContainer - case of RT_TimeExtTimeNodeContainer	

Figure 99: First-level ExtTimeNodeContainer child-record hierarchy

timePropertyList.rec.case of TL_TPID_EffectNodeType.effectNodeType0.effectNodeType:
0x00000009 specifies that this **time node** is the root of the timing tree.

The TimeNodeAtom record A is similar to the TimeNodeAtom record, as specified in the table titled "TimeNodeAtom record A child-record hierarchy" in section [3.7.1](#).

The child-record hierarchy of the **ExtTimeNodeContainer** record B from the previous table is shown expanded in the following table.

Offset	Size	Structure	Value
00006C53	0DF3	ExtTimeNodeContainer - case of RT_TimeExtTimeNodeContainer	
00006C53	0008	RecordHeader - rh	
00006C5B	0028	A: TimeNodeAtom - timeNodeAtom	
00006C83	0015	TimePropertyList4TimeNodeContainer - timePropertyList	
00006C83	0008	RecordHeader - rh	
00006C8B	000D	TimeEffectNodeType - case of TL_TPID_EffectNodeType	
00006C8B	0008	RecordHeader - rh	

Offset	Size	Structure	Value
00006C93	0001	TimeVariantTypeEnum - type	0x01
00006C94	0004	signed integer - effectNodeType	0x00000004
00006C98	001C	B: TimeSequenceDataAtom - timeSequenceDataAtom	
00006CB4	0034	C: TimeConditionContainer - timeCondition	
00006CE8	0034	D: TimeConditionContainer - timeCondition	
00006D1C	0483	E: ExtTimeNodeContainer - case of RT_TimeExtTimeNodeContainer	
0000719F	022E	F: ExtTimeNodeContainer - case of RT_TimeExtTimeNodeContainer	
000073CD	0679	G: ExtTimeNodeContainer - case of RT_TimeExtTimeNodeContainer	

Figure 100: Second-level ExtTimeNodeContainer child-record hierarchy

As a second-level time node, the **ExtTimeNodeContainer** record shown in the preceding table serves a similar purpose in the timing tree as does the **ExtTimeNodeContainer** record shown in the table titled "Second-level ExtTimeNodeContainer child-record hierarchy" in this section. Consequently many of the child-records are likewise similar. The TimeNodeAtom record A specifies the timing attributes of this time node and is similar to the TimeNodeAtom record, as specified in the table titled "TimeNodeAtom record A child-record hierarchy in the second-level ExtTimeNodeContainer" in section 3.7.1. The TimeSequenceDataAtom record B specifies how to activate the child time nodes E, F, and G, sequentially and is similar to the TimeSequenceDataAtom record, as specified in the table titled "TimeSequenceDataAtom record B child-record hierarchy" in section 3.7.1. The **TimeConditionContainer** (section 2.8.75) record C specifies the **time condition** to activate the next child time node and is similar to the **TimeConditionContainer** record, as specified in the table titled "TimeConditionContainer record C child-record hierarchy in the second-level ExtTimeNodeContainer" in section 3.7.1. The **TimeConditionContainer** record D specifies the time condition required to activate the previous child time node and is similar to the **TimeConditionContainer** record as specified in the table titled "TimeConditionContainer record D child-record hierarchy in the second-level ExtTimeNodeContainer" in section 3.7.1.

timePropertyList.case of TL_TPID_EffectNodeType.effectNodeType: 0x00000004 specifies that this time node is the main sequential time node.

The child-record hierarchy of the **ExtTimeNodeContainer** record E from the previous table is shown expanded in the following table. This time node contains the fly-in animation.

Offset	Size	Structure	Value
00006D1C	0483	ExtTimeNodeContainer - case of RT_TimeExtTimeNodeContainer	
00006D1C	0008	RecordHeader - rh	
00006D24	0028	A: TimeNodeAtom - timeNodeAtom	
00006D4C	0008	B: TimePropertyList4TimeNodeContainer - timePropertyList	
00006D4C	0008	RecordHeader - rh	
00006D54	0020	C: TimeConditionContainer - timeCondition	
00006D54	0008	RecordHeader - rh	
00006D5C	0018	TimeConditionAtom - conditionAtom	

Offset	Size	Structure	Value
00006D5C	0008	RecordHeader - rh	
00006D64	0004	TriggerObjectEnum - triggerObject	0x00000000
00006D68	0004	unsigned integer - triggerEvent	0x00000000
00006D6C	0004	unsigned integer - id	0x00000000
00006D70	0004	signed integer - delay	0xFFFFFFFF
00006D74	042B	D: ExtTimeNodeContainer - case of RT_TimeExtTimeNodeContainer	

Figure 101: Third-level ExtTimeNodeContainer child-record hierarchy

The TimeNodeAtom record A specifies the timing attributes of this time node and is similar to the TimeNodeAtom record, as specified in the table titled "TimeNodeAtom record A child-record hierarchy in the third-level ExtTimeNodeContainer" in section 3.7.1. The

TimePropertyList4TimeNodeContainer (section 2.8.18) record B is an empty list.

The value of the **conditionAtom.delay** field in the **TimeConditionContainer** record C is 0xFFFFFFFF, which specifies an infinite value and implies that no delay is defined. The value of the **conditionAtom.triggerObject** field and the value of the **conditionAtom.triggerEvent** field in the **TimeConditionContainer** record C are both 0x00000000, which specifies no time condition for this time node and implies that the evaluation of the time condition always returns true.

The child-record hierarchy of the **ExtTimeNodeContainer** record D from the previous table is shown expanded in the following table.

Offset	Size	Structure	Value
00006D74	042B	ExtTimeNodeContainer - case of RT_TimeExtTimeNodeContainer	
00006D74	0008	RecordHeader - rh	
00006D7C	0028	A: TimeNodeAtom - timeNodeAtom	
00006DA4	0008	TimePropertyList4TimeNodeContainer - timePropertyList	
00006DA4	0008	RecordHeader - rh	
00006DAC	0020	TimeConditionContainer - timeCondition	
00006DAC	0008	RecordHeader - rh	
00006DB4	0018	TimeConditionAtom - conditionAtom	
00006DB4	0008	RecordHeader - rh	
00006DBC	0004	TriggerObjectEnum - triggerObject	0x00000000
00006DC0	0004	unsigned integer - triggerEvent	0x00000000
00006DC4	0004	unsigned integer - id	0x00000000
00006DC8	0004	signed integer - delay	0x00000000
00006DCC	03D3	B: ExtTimeNodeContainer - case of RT_TimeExtTimeNodeContainer	

Figure 102: Fourth-level ExtTimeNodeContainer child-record hierarchy

The TimeNodeAtom record A is similar to the TimeNodeAtom record A, as specified in the table titled "TimeNodeAtom record A child-record hierarchy in the fourth-level ExtTimeNodeContainer" in section 3.7.1.

The child-record hierarchy of the **ExtTimeNodeContainer** record B from the previous table is shown expanded in the following table.

Offset	Size	Structure	Value
00006DCC	03D3	ExtTimeNodeContainer - case of RT_TimeExtTimeNodeContainer	
00006DCC	0008	RecordHeader - rh	
00006DD4	0028	A: TimeNodeAtom - timeNodeAtom	
00006DFC	0049	B: TimePropertyList4TimeNodeContainer - timePropertyList	
00006E45	0020	TimeConditionContainer - timeCondition	
00006E45	0008	RecordHeader - rh	
00006E4D	0018	TimeConditionAtom - conditionAtom	
00006E4D	0008	RecordHeader - rh	
00006E55	0004	TriggerObjectEnum - triggerObject	0x00000000
00006E59	0004	unsigned integer - triggerEvent	0x00000000
00006E5D	0004	unsigned integer - id	0x00000000
00006E61	0004	signed integer - delay	0x00000000
00006E65	0100	C: ExtTimeNodeContainer - case of RT_TimeExtTimeNodeContainer	
00006F65	0119	D: ExtTimeNodeContainer - case of RT_TimeExtTimeNodeContainer	
0000707E	0121	E: ExtTimeNodeContainer - case of RT_TimeExtTimeNodeContainer	

Figure 103: Fifth-level ExtTimeNodeContainer child-record hierarchy

The **ExtTimeNodeContainer** record C contains a set behavior, while the **ExtTimeNodeContainer** records D and E contain two generic animations. These three animation behaviors form the fly-in animation that is triggered by the first mouse click.

The child-record hierarchy of the TimeNodeAtom record A from the previous table is shown expanded in the following table.

Offset	Size	Structure	Value
00006DD4	0028	A: TimeNodeAtom - timeNodeAtom	
00006DD4	0008	RecordHeader - rh	
00006DDC	0004	unsigned integer - reserved1	0x00000000
00006DE0	0004	unsigned integer - restart	0x00000000
00006DE4	0004	TimeNodeTypeEnum - type	0x00000000
00006DE8	0004	unsigned integer - fill	0x00000003

Offset	Size	Structure	Value
00006DEC	0004	signed integer - reserved2	0x00000000
00006DF0	0001	unsigned integer - reserved3	0x00
00006DF4	0004	signed integer - duration	0x00000000
00006DF8	1 bit	bit - fFillProperty	0x1
00006DF8	1 bit	bit - fRestartProperty	0x0
00006DF8	1 bit	bit - reserved4	0x0
00006DF8	1 bit	bit - fGroupingTypeProperty	0x0
00006DF8	1 bit	bit - fDurationProperty	0x0
00006DF8	27 bits	unsigned integer - reserved5	0x00000000

Figure 104: TimeNodeAtom record A child-record hierarchy in the fifth-level ExtTimeNodeContainer

fill: 0x00000003 specifies that the properties remain at their ending values while the parent time node at the fourth level is still running or holding.

duration: 0x00000000 specifies that the duration of this time node depends on its child nodes.

The child-record hierarchy of the **TimePropertyList2.8.18TimeNodeContainer** record B from the first table titled "Fifth-level ExtTimeNodeContainer child-record hierarchy" in this section is shown expanded in the following table.

Offset	Size	Structure	Value
00006DFC	0049	B: TimePropertyList4TimeNodeContainer - timePropertyList	
00006DFC	0008	RecordHeader - rh	
00006E04	000D	TimeEffectNodeType - case of TL_TPID_EffectNodeType	
00006E04	0008	RecordHeader - rh	
00006E0C	0001	TimeVariantTypeEnum - type	0x01
00006E0D	0004	signed integer - effectNodeType	0x00000001
00006E11	000D	TimeEffectID - case of TL_TPID_EffectID	
00006E11	0008	RecordHeader - rh	
00006E19	0001	TimeVariantTypeEnum - type	0x01
00006E1A	0004	signed integer - effectID	0x00000002
00006E1E	000D	TimeVariantInt - case of TL_TPID_EffectDir	
00006E26	0001	TimeVariantTypeEnum - type	0x01
00006E27	0004	signed integer - intValue	0x00000004
00006E2B	000D	TimeEffectType - case of TL_TPID_EffectType	
00006E2B	0008	RecordHeader - rh	

Offset	Size	Structure	Value
00006E33	0001	TimeVariantTypeEnum - type	0x01
00006E34	0004	signed integer - effectType	0x00000001
00006E38	000D	TimeGroupID - case of TL_TPID_GroupID	
00006E38	0008	RecordHeader - rh	
00006E40	0001	TimeVariantTypeEnum - type	0x01
00006E41	0004	signed integer - groupID	0x00000001

Figure 105: Child-record hierarchy of TimePropertyList4TimeNodeContainer in the fifth-level ExtTimeNodeContainer

case of TL_TPID_EffectNodeType.effectNodeType: 0x00000001 specifies that this time node is for a click effect.

case of TL_TPID_EffectID.effectID: 0x00000002 specifies the identifier of the fly-in animation effect.

case of TL_TPID_EffectDir.intValue: 0x00000004 specifies that the direction of the fly-in animation is from bottom up.

case of TL_TPID_EffectType.effectType: 0x00000001 specifies that the fly-in animation is an entrance effect.

case of TL_TPID_GroupID.groupID: 0x00000001 specifies the **build identifier** of the fly-in animation.

The child-record hierarchy of the **ExtTimeNodeContainer** record C from the first table titled "Fifth-level ExtTimeNodeContainer child-record hierarchy" in this section is shown expanded in the following table.

Offset	Size	Structure	Value
00006E65	0100	ExtTimeNodeContainer - case of RT_TimeExtTimeNodeContainer	
00006E65	0008	RecordHeader - rh	
00006E6D	0028	A: TimeNodeAtom - timeNodeAtom	
00006E95	0008	TimePropertyList4TimeNodeContainer - timePropertyList	
00006E95	0008	RecordHeader - rh	
00006E9D	00A8	B: TimeSetBehaviorContainer - timeSetBehavior	
00006F45	0020	TimeConditionContainer - timeCondition	
00006F45	0008	RecordHeader - rh	
00006F4D	0018	TimeConditionAtom - conditionAtom	
00006F4D	0008	RecordHeader - rh	
00006F55	0004	TriggerObjectEnum - triggerObject	0x00000000
00006F59	0004	unsigned integer - triggerEvent	0x00000000
00006F5D	0004	unsigned integer - id	0x00000000

Offset	Size	Structure	Value
00006F61	0004	signed integer - delay	0x00000000

Figure 106: The first sixth-level ExtTimeNodeContainer child-record hierarchy

This time node contains a set behavior that sets the "style.visibility" property of the shape to "visible", to make the shape visible in the **slide show**. It is very similar to the time node specified in the table titled "Sixth-level ExtTimeNodeContainer child-record hierarchy" in section 3.7.1. The TimeNodeAtom record A is similar to the TimeNodeAtom record specified in the table titled "TimeNodeAtom record A child-record hierarchy in the sixth-level ExtTimeNodeContainer" in section 3.7.1, while the **TimeSetBehaviorContainer** (section 2.8.69) record B is similar to the **TimeSetBehaviorContainer** specified in the table titled "Child-record hierarchy of TimeSetBehaviorContainer in the sixth-level ExtTimeNodeContainer" in section 3.7.1. The **timePropertyList** field is an empty list, and the **timeCondition** field specifies that the evaluation of the time condition always returns true.

The child-record hierarchy of the **ExtTimeNodeContainer** record D from the first table titled "Fifth-level ExtTimeNodeContainer child-record hierarchy" in this section is shown expanded in the following table.

Offset	Size	Structure	Value
00006F65	0119	ExtTimeNodeContainer - case of RT_TimeExtTimeNodeContainer	
00006F65	0008	RecordHeader - rh	
00006F6D	0028	TimeNodeAtom - timeNodeAtom	
00006F6D	0008	RecordHeader - rh	
00006F75	0004	unsigned integer - reserved1	0x00000000
00006F79	0004	unsigned integer - restart	0x00000000
00006F7D	0004	TimeNodeTypeEnum - type	0x00000003
00006F81	0004	unsigned integer - fill	0x00000003
00006F85	0004	signed integer - reserved2	0x00000000
00006F89	0001	unsigned integer - reserved3	0x00
00006F8D	0004	signed integer - duration	0x000001F4
00006F91	1 bit	bit - fFillProperty	0x1
00006F91	1 bit	bit - fRestartProperty	0x0
00006F91	1 bit	bit - reserved4	0x0
00006F91	1 bit	bit - fGroupingTypeProperty	0x1
00006F91	1 bit	bit - fDurationProperty	0x1
00006F91	27 bits	unsigned integer - reserved5	0x00000000
00006F95	0008	TimePropertyList4TimeNodeContainer - timePropertyList	
00006F95	0008	RecordHeader - rh	
00006F9D	00E1	A: TimeAnimateBehaviorContainer - timeAnimateBehavior	

Figure 107: The second sixth-level ExtTimeNodeContainer child-record hierarchy

This time node contains a generic behavior that animates the position of the shape in the horizontal axis.

timeNodeAtom.type: 0x00000003 specifies that this time node is a behavior time node that contains a behavior.

timeNodeAtom.fill: 0x00000003 specifies that the properties remain at their ending values while the parent time node at the fourth level is still running or holding.

timeNodeAtom.duration: 0x000001F4 specifies that the duration of this time node is 0.5 seconds.

The child-record hierarchy of the **TimeAnimateBehaviorContainer** (section 2.8.29) record A from the previous table is shown expanded in the following table.

Offset	Size	Structure	Value
00006F9D	00E1	TimeAnimateBehaviorContainer - timeAnimateBehavior	
00006F9D	0008	RecordHeader - rh	
00006FA5	0014	TimeAnimateBehaviorAtom - animateBehaviorAtom	
00006FA5	0008	RecordHeader - rh	
00006FAD	0004	unsigned integer - calcMode	0x00000001
00006FB1	1 bit	bit - fByPropertyUsed	0x0
00006FB1	1 bit	bit - fFromPropertyUsed	0x0
00006FB1	1 bit	bit - fToPropertyUsed	0x0
00006FB1	1 bit	bit - fCalcModePropertyUsed	0x1
00006FB1	1 bit	bit - fAnimationValuesPropertyUsed	0x1
00006FB1	1 bit	bit - fValueTypePropertyUsed	0x1
00006FB1	26 bits	unsigned integer - reserved	0x00000000
00006FB5	0004	TimeAnimateBehaviorValueTypeEnum - valueType	0x00000001
00006FB9	0064	A: TimeAnimationValueListContainer - animateValueList	
0000701D	0061	B: TimeBehaviorContainer - behavior	

Figure 108: TimeAnimateBehaviorContainer child-record hierarchy in the sixth-level ExtTimeNodeContainer

animateBehaviorAtom.calcMode: 0x00000001 specifies that the animated value of the property is calculated by linear interpolation.

animateBehaviorAtom.valueType: 0x00000001 specifies that the property value is a number.

The child-record hierarchy of the **TimeAnimationValueListContainer** (section 2.8.31) record A from the previous table is shown expanded in the following table.

Offset	Size	Structure	Value
00006FB9	0064	TimeAnimationValueListContainer - animateValueList	
00006FB9	0008	RecordHeader - rh	

Offset	Size	Structure	Value
00006FC1	002E	A: TimeAnimationValueListEntry - timeAnimValueListEntry[0]	
00006FC1	000C	TimeAnimationValueAtom - timeAnimationValueAtom	
00006FC1	0008	RecordHeader - rh	
00006FC9	0004	signed integer - time	0x00000000
00006FCD	0017	TimeVariantString - case of TL_TVT_String	
00006FCD	0008	RecordHeader - rh	
00006FD5	0001	TimeVariantTypeEnum - type	0x03
00006FD6	000E	array of bytes - stringValue	#ppt_x
00006FE4	000B	TimeVariantString - varFormula	
00006FE4	0008	RecordHeader - rh	
00006FEC	0001	TimeVariantTypeEnum - type	0x03
00006FED	0002	array of bytes - stringValue	
00006FEF	002E	B: TimeAnimationValueListEntry - timeAnimValueListEntry[1]	
00006FEF	000C	TimeAnimationValueAtom - timeAnimationValueAtom	
00006FEF	0008	RecordHeader - rh	
00006FF7	0004	signed integer - time	0x000003E8
00006FFB	0017	TimeVariantString - case of TL_TVT_String	
00006FFB	0008	RecordHeader - rh	
00007003	0001	TimeVariantTypeEnum - type	0x03
00007004	000E	array of bytes - stringValue	#ppt_x
00007012	000B	TimeVariantString - varFormula	
00007012	0008	RecordHeader - rh	
0000701A	0001	TimeVariantTypeEnum - type	0x03
0000701B	0002	array of bytes - stringValue	

Figure 109: TimeAnimationValueListContainer child-record hierarchy

The **TimeAnimationValueListContainer** record specifies two key points of the animation. The **TimeAnimationValueListEntry** record A specifies the beginning point, while the **TimeAnimationValueListEntry** record B specifies the endpoint.

timeAnimValueListEntry[0].timeAnimationValueAtom.time: 0x00000000 specifies that the first key point is the starting point of the animation.

timeAnimValueListEntry[0].case of TL_TVT_String.stringValue: "#ppt_x" specifies the formula that is used to calculate the property value at time 0x00000000. The value of this formula is the original value of the position of the shape on the horizontal axis.

timeAnimValueListEntry[1].timeAnimationValueAtom.time: 0x000003E8 specifies that the second key point is the endpoint of the animation.

timeAnimValueListEntry[1].case of TL_TVT_String.stringValue: "#ppt_x" specifies the formula that is used to calculate the property value at time 0x000003E8. The value of this formula is the original value of the position of the shape on the horizontal axis.

Because the values at the two key points are identical and equal to the original value of the position on the horizontal axis, the shape does not change its position on the horizontal axis during the fly-in animation.

The child-record hierarchy of the **TimeBehaviorContainer** (section 2.8.34) record B from the first table titled "TimeAnimateBehaviorContainer child-record hierarchy in the sixth-level ExtTimeNodeContainer" in this section is shown expanded in the following table.

Offset	Size	Structure	Value
0000701D	0061	TimeBehaviorContainer - behavior	
0000701D	0008	RecordHeader - rh	
00007025	0018	A: TimeBehaviorAtom - behaviorAtom	
0000703D	001D	B: TimeStringListContainer - stringList	
0000703D	0008	RecordHeader - rh	
00007045	0015	TimeVariantString - string	
00007045	0008	RecordHeader - rh	
0000704D	0001	TimeVariantTypeEnum - type	0x03
0000704E	000C	array of bytes - stringValue	ppt_x
0000705A	0024	C: ClientVisualElementContainer - clientVisualElement	
0000705A	0008	RecordHeader - rh	
00007062	001C	VisualElementAtom - visualElementAtom	
00007062	001C	VisualShapeOrSoundAtom - case of RT_VisualShapeAtom	
00007062	001C	VisualShapeAtom - case of TL_ET_ShapeType	
00007062	001C	VisualShapeGeneralAtom - default_case	
00007062	0008	RecordHeader - rh	
0000706A	0004	TimeVisualElementEnum - type	0x00000000
0000706E	0004	ElementTypeEnum - refType	0x00000001
00007072	0004	unsigned integer - shapeIdRef	0x00001404
00007076	0004	signed integer - data1	0xFFFFFFFF
0000707A	0004	signed integer - data2	0xFFFFFFFF

Figure 110: TimeBehaviorContainer child-record hierarchy

The **TimeStringListContainer** (section 2.8.36) record B specifies the properties to be animated.

stringList.string.stringValue: "ppt_x" specifies that the property to be animated is the position of the shape on the horizontal axis.

clientVisualElement.visualElementAtom.case of RT_VisualShapeAtom.case of TL_ET_ShapeType.default_case.type: 0x00000000 specifies that the animation is applied to the shape.

clientVisualElement.visualElementAtom.case of RT_VisualShapeAtom.case of TL_ET_ShapeType.default_case.refType: 0x00000001 specifies that the animation target is the shape.

clientVisualElement.visualElementAtom.case of RT_VisualShapeAtom.case of TL_ET_ShapeType.default_case.shapeIdRef: 0x00001404 specifies the **shape identifier** of the target shape.

The child-record hierarchy of the TimeBehaviorAtom record A from the previous table is shown expanded in the following table.

Offset	Size	Structure	Value
00007025	0018	A: TimeBehaviorAtom - behaviorAtom	
00007025	0008	RecordHeader - rh	
00007025	1 bit	bit - fAdditivePropertyUsed	0x1
00007025	1 bit	bit - reserved1	0x0
00007025	1 bit	bit - fAttributeNamesPropertyUsed	0x1
00007025	1 bit	bit - reserved2	0x0
00007025	28 bits	unsigned integer - reserved3	0x00000000
00007031	0004	unsigned integer - behaviorAdditive	0x00000000
00007035	0004	signed integer - behaviorAccumulate	0x00000000
00007039	0004	signed integer - behaviorTransform	0x00000000

Figure 111: TimeBehaviorAtom record A child-record hierarchy

behaviorAdditive: 0x00000000 specifies that the animated value replaces the original value of the property being animated.

behaviorAccumulate: 0x00000000 specifies that no accumulation between repeating animations occurs.

behaviorTransform: 0x00000000 specifies that the animation animates a property of the target object.

The child-record hierarchy of the **ExtTimeNodeContainer** record E from the first table titled "Fifth-level ExtTimeNodeContainer child-record hierarchy" in this section is shown expanded in the following table.

Offset	Size	Structure	Value
0000707E	0121	ExtTimeNodeContainer - case of RT_TimeExtTimeNodeContainer	
0000707E	0008	RecordHeader - rh	
00007086	0028	TimeNodeAtom - timeNodeAtom	

Offset	Size	Structure	Value
00007086	0008	RecordHeader - rh	
0000708E	0004	unsigned integer - reserved1	0x00000000
00007092	0004	unsigned integer - restart	0x00000000
00007096	0004	TimeNodeTypeEnum - type	0x00000003
0000709A	0004	unsigned integer - fill	0x00000003
0000709E	0004	signed integer - reserved2	0x00000000
000070A2	0001	unsigned integer - reserved3	0x00
000070A6	0004	signed integer - duration	0x000001F4
000070AA	1 bit	bit - fFillProperty	0x1
000070AA	1 bit	bit - fRestartProperty	0x0
000070AA	1 bit	bit - reserved4	0x0
000070AA	1 bit	bit - fGroupingTypeProperty	0x1
000070AA	1 bit	bit - fDurationProperty	0x1
000070AA	27 bits	unsigned integer - reserved5	0x00000000
000070AE	0008	TimePropertyList4TimeNodeContainer - timePropertyList	
000070AE	0008	RecordHeader - rh	
000070B6	00E9	A: TimeAnimateBehaviorContainer - timeAnimateBehavior	

Figure 112: The third sixth-level ExtTimeNodeContainer child-record hierarchy

This time node contains a generic behavior that animates the position of the shape on the vertical axis.

timeNodeAtom.duration: 0x000001F4 specifies that the duration of this time node is 0.5 seconds.

The child-record hierarchy of the **TimeAnimateBehaviorContainer** (section 2.8.29) record A from the previous table is shown expanded in the following table.

Offset	Size	Structure	Value
000070B6	00E9	TimeAnimateBehaviorContainer - timeAnimateBehavior	
000070B6	0008	RecordHeader - rh	
000070BE	0014	TimeAnimateBehaviorAtom - animateBehaviorAtom	
000070BE	0008	RecordHeader - rh	
000070C6	0004	unsigned integer - calcMode	0x00000001
000070CA	0004	unsigned integer - fByPropertyUsed	0x00000000
000070CA	0004	unsigned integer - fFromPropertyUsed	0x00000000
000070CA	0004	unsigned integer - fToPropertyUsed	0x00000000

Offset	Size	Structure	Value
000070CA	0004	unsigned integer - fCalcModePropertyUsed	0x00000001
000070CA	0004	unsigned integer - fAnimationValuesPropertyUsed	0x00000001
000070CA	0004	unsigned integer - fValueTypePropertyUsed	0x00000001
000070CA	0004	unsigned integer - reserved	0x00000000
000070CE	0004	TimeAnimateBehaviorValueTypeEnum - valueType	0x00000001
000070D2	006C	A: TimeAnimationValueListContainer - animateValueList	
0000713E	0061	B: TimeBehaviorContainer - behavior	

Figure 113: TimeAnimateBehaviorContainer child-record hierarchy in the sixth-level ExtTimeNodeContainer

animateBehaviorAtom.calcMode: 0x00000001 specifies that the animated value of the property is calculated by linear interpolation.

animateBehaviorAtom.valueType: 0x00000001 specifies that the property value is a number.

The child-record hierarchy of the **TimeAnimationValueListContainer** record A from the previous table is shown expanded in the following table.

Offset	Size	Structure	Value
000070D2	006C	TimeAnimationValueListContainer - animateValueList	
000070D2	0008	RecordHeader - rh	
000070DA	0036	A: TimeAnimationValueListEntry - timeAnimValueListEntry[0]	
000070DA	000C	TimeAnimationValueAtom - timeAnimationValueAtom	
000070DA	0008	RecordHeader - rh	
000070E2	0004	signed integer - time	0x00000000
000070E6	001F	TimeVariantString - case of TL_TVT_String	
000070E6	0008	RecordHeader - rh	
000070EE	0001	TimeVariantTypeEnum - type	0x03
000070EF	0016	array of bytes - stringValue	1+#ppt_h/2
00007105	000B	TimeVariantString - varFormula	
00007105	0008	RecordHeader - rh	
0000710D	0001	TimeVariantTypeEnum - type	0x03
0000710E	0002	array of bytes - stringValue	
00007110	002E	B: TimeAnimationValueListEntry - timeAnimValueListEntry[1]	
00007110	000C	TimeAnimationValueAtom - timeAnimationValueAtom	
00007110	0008	RecordHeader - rh	

Offset	Size	Structure	Value
00007118	0004	signed integer - time	0x000003E8
0000711C	0017	TimeVariantString - case of TL_TVT_String	
0000711C	0008	RecordHeader - rh	
00007124	0001	TimeVariantTypeEnum - type	0x03
00007125	000E	array of bytes - stringValue	#ppt_y
00007133	000B	TimeVariantString - varFormula	
00007133	0008	RecordHeader - rh	
0000713B	0001	TimeVariantTypeEnum - type	0x03
0000713C	0002	array of bytes - stringValue	

Figure 114: Child-record hierarchy of TimeAnimationValueListContainer

The **TimeAnimationValueListContainer** record specifies two key points of the animation. The **TimeAnimationValueListEntry** record A specifies the starting point, while the **TimeAnimationValueListEntry** record B specifies the endpoint.

timeAnimValueListEntry[0].timeAnimationValueAtom.time: 0x00000000 specifies that the first key point is the starting point of the animation.

timeAnimValueListEntry[0].case of TL_TVT_String.stringValue: "1+#ppt_h/2" specifies the formula that is used to calculate the property value at time 0x00000000. The value of this formula is the position that is just under the bottom of the slide show, which makes the shape hidden.

timeAnimValueListEntry[1].timeAnimationValueAtom.time: 0x000003E8 specifies that the second key point is the endpoint of the animation.

timeAnimValueListEntry[1].case of TL_TVT_String.stringValue: "#ppt_y" specifies the formula that is used to calculate the property value at time 0x000003E8. The value of this formula is the original value of the position of the shape on the vertical axis.

The two key points specify that the shape moves from the bottom of the slide show to its original position.

The child-record hierarchy of the **TimeBehaviorContainer** record B from the second table titled "TimeAnimateBehaviorContainer child-record hierarchy in the sixth-level ExtTimeNodeContainer" in this section is shown expanded in the following table.

Offset	Size	Structure	Value
0000713E	0061	TimeBehaviorContainer - behavior	
0000713E	0008	RecordHeader - rh	
00007146	0018	A: TimeBehaviorAtom - behaviorAtom	
0000715E	001D	B: TimeStringListContainer - stringList	
0000715E	0008	RecordHeader - rh	
00007166	0015	TimeVariantString - string	
00007166	0008	RecordHeader - rh	

Offset	Size	Structure	Value
0000716E	0001	TimeVariantTypeEnum - type	0x03
0000716F	000C	array of bytes - stringValue	ppt_y
0000717B	0024	C: ClientVisualElementContainer - clientVisualElement	
0000717B	0008	RecordHeader - rh	
00007183	001C	VisualElementAtom - visualElementAtom	
00007183	001C	VisualShapeOrSoundAtom - case of RT_VisualShapeAtom	
00007183	001C	VisualShapeAtom - case of TL_ET_ShapeType	
00007183	001C	VisualShapeGeneralAtom - default_case	
00007183	0008	RecordHeader - rh	
0000718B	0004	TimeVisualElementEnum - type	0x00000000
0000718F	0004	ElementTypeEnum - refType	0x00000001
00007193	0004	unsigned integer - shapeIdRef	0x00001404
00007197	0004	signed integer - data1	0xFFFFFFFF
0000719B	0004	signed integer - data2	0xFFFFFFFF

Figure 115: Child-record hierarchy of TimeBehaviorContainer

The TimeBehaviorAtom record A is similar to the TimeBehaviorAtom record specified in the second table titled "TimeBehaviorAtom record A child-record hierarchy" in this section. The **TimeStringListContainer** record B specifies the properties to be animated. The **ClientVisualElementContainer** (section 2.8.44) record B specifies that the target object of the animation is the shape.

stringList.string.stringValue: "ppt_y" specifies that the property to be animated is the position of the shape on the vertical axis.

The child-record hierarchy of the **ExtTimeNodeContainer** record F from the table titled "Second-level ExtTimeNodeContainer child-record hierarchy" in this section is shown expanded in the following table. This time node contains the spin animation effect.

Offset	Size	Structure
0000719F	022E	A: ExtTimeNodeContainer - case of RT_TimeExtTimeNodeContainer
0000719F	0008	RecordHeader - rh
000071A7	0028	TimeNodeAtom - timeNodeAtom
000071CF	0008	TimePropertyList4TimeNodeContainer - timePropertyList
000071D7	0020	TimeConditionContainer - timeCondition
000071F7	01D6	B: ExtTimeNodeContainer - case of RT_TimeExtTimeNodeContainer
000071F7	0008	RecordHeader - rh
000071FF	0028	TimeNodeAtom - timeNodeAtom

Offset	Size	Structure
00007227	0008	TimePropertyList4TimeNodeContainer - timePropertyList
0000722F	0020	TimeConditionContainer - timeCondition
0000724F	017E	C: ExtTimeNodeContainer - case of RT_TimeExtTimeNodeContainer

Figure 116: Third-level and fourth-level ExtTimeNodeContainer child-record hierarchies

The **ExtTimeNodeContainer** record A is similar to the **ExtTimeNodeContainer** record as specified in the second table titled "Third-level ExtTimeNodeContainer child-record hierarchy" in this section, while the **ExtTimeNodeContainer** record B is similar to the **ExtTimeNodeContainer** record as specified in the table titled "Fourth-level ExtTimeNodeContainer child-record hierarchy" in this section.

The child-record hierarchy of the **ExtTimeNodeContainer** record C from the previous table is shown expanded in the following table.

Offset	Size	Structure	Value
0000724F	017E	ExtTimeNodeContainer - case of RT_TimeExtTimeNodeContainer	
0000724F	0008	RecordHeader - rh	
00007257	0028	A: TimeNodeAtom - timeNodeAtom	
0000727F	0049	B: TimePropertyList4TimeNodeContainer - timePropertyList	
000072C8	0020	TimeConditionContainer - timeCondition	
000072E8	0010	C: TimeModifierAtom - timeModifierAtom[0]	
000072E8	0008	RecordHeader - rh	
000072F0	0004	TimeModifierEnum - type	0x00000003
000072F4	0004	unsigned integer - value	0x00000000
000072F8	0010	D: TimeModifierAtom - timeModifierAtom[1]	
000072F8	0008	RecordHeader - rh	
00007300	0004	TimeModifierEnum - type	0x00000004
00007304	0004	unsigned integer - value	0x00000000
00007308	0010	E: TimeModifierAtom - timeModifierAtom[2]	
00007308	0008	RecordHeader - rh	
00007310	0004	TimeModifierEnum - type	0x00000005
00007314	0004	unsigned integer - value	0x00000000
00007318	00B5	F: ExtTimeNodeContainer - case of RT_TimeExtTimeNodeContainer	

Figure 117: Fifth-level ExtTimeNodeContainer child-record hierarchy

This time node specifies the spin animation effect. The TimeNodeAtom record A is similar to the TimeNodeAtom as specified in the table titled "TimeNodeAtom record A child-record hierarchy in the fifth-level ExtTimeNodeContainer" in this section. The TimeModifierAtom records C, D, and E specify the acceleration, the deceleration, and the automatic reverse attribute of this time node, respectively. The **ExtTimeNodeContainer** record F is the only child time node and contains a rotation behavior.

timeModifierAtom[0].type: 0x00000003 specifies that the **timeModifierAtom[0].value** field defines the acceleration of the spin animation effect.

timeModifierAtom[0].value: 0x00000000 specifies no acceleration of the spin animation effect.

timeModifierAtom[1].type: 0x00000004 specifies that the **timeModifierAtom[1].value** field defines the deceleration of the spin animation effect.

timeModifierAtom[1].value: 0x00000000 specifies no deceleration of the spin animation effect.

timeModifierAtom[2].type: 0x00000005 specifies that the **timeModifierAtom[2].value** field defines whether the spin animation effect automatically reverse.

timeModifierAtom[2].value: 0x00000000 specifies that the spin animation does not automatically reverse.

The child-record hierarchy of the **TimePropertyList2.8.18TimeNodeContainer** record B from the previous table is shown expanded in the following table.

Offset	Size	Structure	Value
0000727F	0049	B: TimePropertyList4TimeNodeContainer - timePropertyList	
0000727F	0008	RecordHeader - rh	
00007287	000D	TimeEffectNodeType - case of TL_TPID_EffectNodeType	
00007287	0008	RecordHeader - rh	
0000728F	0001	TimeVariantTypeEnum - type	0x01
00007290	0004	signed integer - effectNodeType	0x00000001
00007294	000D	TimeEffectID - case of TL_TPID_EffectID	
00007294	0008	RecordHeader - rh	
0000729C	0001	TimeVariantTypeEnum - type	0x01
0000729D	0004	signed integer - effectID	0x00000008
000072A1	000D	TimeVariantInt - case of TL_TPID_EffectDir	
000072A1	0008	RecordHeader - rh	
000072A9	0001	TimeVariantTypeEnum - type	0x01
000072AA	0004	signed integer - intValue	0x00000000
000072AE	000D	TimeEffectType - case of TL_TPID_EffectType	
000072AE	0008	RecordHeader - rh	
000072B6	0001	TimeVariantTypeEnum - type	0x01
000072B7	0004	signed integer - effectType	0x00000003
000072BB	000D	TimeGroupID - case of TL_TPID_GroupID	
000072BB	0008	RecordHeader - rh	
000072C3	0001	TimeVariantTypeEnum - type	0x01

Offset	Size	Structure	Value
000072C4	0004	signed integer - groupID	0x00000000

Figure 118: TimePropertyList4TimeNodeContainer record B child-record hierarchy in the fifth-level ExtTimeNodeContainer

case of TL_TPID_EffectNodeType.effectNodeType: 0x00000001 specifies that this time node is for a click effect.

case of TL_TPID_EffectID.effectID: 0x00000008 specifies the identifier of the spin animation effect.

case of TL_TPID_EffectDir.intValue: 0x00000000 specifies that the direction of the spin animation is clockwise.

case of TL_TPID_EffectType.effectType: 0x00000003 specifies that the spin animation effect is an emphasis effect.

case of TL_TPID_GroupID.groupID: 0x00000000 specifies the build identifier for this spin animation effect.

The child-record hierarchy of the **ExtTimeNodeContainer** record F from the second table titled "Fifth-level ExtTimeNodeContainer child-record hierarchy" in this section is shown expanded in the following table. It contains the rotation behavior that specifies how the shape spins.

Offset	Size	Structure	Value
00007318	00B5	ExtTimeNodeContainer - case of RT_TimeExtTimeNodeContainer	
00007318	0008	RecordHeader - rh	
00007320	0028	TimeNodeAtom - timeNodeAtom	
00007320	0008	RecordHeader - rh	
00007328	0004	unsigned integer - reserved1	0x00000000
0000732C	0004	unsigned integer - restart	0x00000000
00007330	0004	TimeNodeTypeEnum - type	0x00000003
00007334	0004	unsigned integer - fill	0x00000003
00007338	0004	signed integer - reserved2	0x00000000
0000733C	0001	unsigned integer - reserved3	0x00
00007340	0004	signed integer - duration	0x000007D0
00007344	1 bit	bit - fFillProperty	0x1
00007344	1 bit	bit - fRestartProperty	0x0
00007344	1 bit	bit - reserved4	0x0
00007344	1 bit	bit - fGroupingTypeProperty	0x1
00007344	1 bit	bit - fDurationProperty	0x1
00007344	27 bits	unsigned integer - reserved5	0x00000000
00007348	0008	TimePropertyList4TimeNodeContainer - timePropertyList	

Offset	Size	Structure	Value
00007348	0008	RecordHeader - rh	
00007350	007D	A: TimeRotationBehaviorContainer - timeRotationBehavior	

Figure 119: Sixth-level ExtTimeNodeContainer child-record hierarchy

timeNodeAtom.duration: 0x000007D0 specifies that the duration of the animation is 2.0 seconds.

The child-record hierarchy of the **TimeRotationBehaviorContainer** (section 2.8.65) record A from the previous table is shown expanded in the following table.

Offset	Size	Structure	Value
00007350	007D	TimeRotationBehaviorContainer - timeRotationBehavior	
00007350	0008	RecordHeader - rh	
00007358	001C	TimeRotationBehaviorAtom - rotationBehaviorAtom	
00007358	0008	RecordHeader - rh	
00007358	1 bit	bit - fByPropertyUsed	0x1
00007358	1 bit	bit - fFromPropertyUsed	0x0
00007358	1 bit	bit - fToPropertyUsed	0x0
00007358	1 bit	bit - fDirectionPropertyUsed	0x0
00007358	28 bits	unsigned integer - reserved	0x00000000
00007364	0004	Float - fBy	360
00007368	0004	Float - fFrom	0
0000736C	0004	Float - fTo	360
00007370	0004	TimeRotationBehaviorDirectionEnum - rotationDirection	0x00000000
00007374	0059	A: TimeBehaviorContainer - behavior	

Figure 120: TimeRotationBehaviorContainer child-record hierarchy in the sixth-level ExtTimeNodeContainer

rotationBehaviorAtom.fBy: 360 specifies that the shape rotates 360 degrees.

rotationBehaviorAtom.fFrom: 0 specifies that the rotation starts from the original angle.

rotationBehaviorAtom.fTo: 360 specifies that the shape rotates 360 degrees.

rotationBehaviorAtom.rotationDirection: 0x00000000 specifies that the rotation is clockwise.

The child-record hierarchy of the **TimeBehaviorContainer** record A from the previous table is shown expanded in the following table.

Offset	Size	Structure	Value
00007374	0059	TimeBehaviorContainer - behavior	
00007374	0008	RecordHeader - rh	

Offset	Size	Structure	Value
0000737C	0018	A: TimeBehaviorAtom - behaviorAtom	
00007394	0015	TimeStringListContainer - stringList	
00007394	0008	RecordHeader - rh	
0000739C	000D	TimeVariantString - string	
0000739C	0008	RecordHeader - rh	
000073A4	0001	TimeVariantTypeEnum - type	0x03
000073A5	0004	array of bytes - stringValue	r
000073A9	0024	B: ClientVisualElementContainer - clientVisualElement	
000073A9	0008	RecordHeader - rh	
000073B1	001C	VisualElementAtom - visualElementAtom	
000073B1	001C	VisualShapeOrSoundAtom - case of RT_VisualShapeAtom	
000073B1	001C	VisualShapeAtom - case of TL_ET_ShapeType	
000073B1	001C	VisualShapeGeneralAtom - default_case	
000073B1	0008	RecordHeader - rh	
000073B9	0004	TimeVisualElementEnum - type	0x00000000
000073BD	0004	ElementTypeEnum - refType	0x00000001
000073C1	0004	unsigned integer - shapeIdRef	0x00001404
000073C5	0004	signed integer - data1	0xFFFFFFFF
000073C9	0004	signed integer - data2	0xFFFFFFFF

Figure 121: TimeBehaviorContainer child-record hierarchy

The TimeBehaviorAtom record A is similar to the TimeBehaviorAtom as specified in the second table titled "TimeBehaviorAtom record A child-record hierarchy" in this section. The **ClientVisualElementContainer** record B specifies that the target is the shape, and it is similar to the **ClientVisualElementContainer** record as specified in the first table titled "TimeBehaviorContainer child-record hierarchy" in this section.

stringList.stringValue: "r" specifies that the property to be animated is the rotation angle of the shape.

The child-record hierarchy of the **ExtTimeNodeContainer** record G from the table titled "Second-level ExtTimeNodeContainer child-record hierarchy" in this section is shown expanded in the following table. This time node contains the sink-down animation.

Offset	Size	Structure
000073CD	0679	A: ExtTimeNodeContainer - case of RT_TimeExtTimeNodeContainer
000073CD	0008	RecordHeader - rh
000073D5	0028	TimeNodeAtom - timeNodeAtom

Offset	Size	Structure
000073FD	0008	TimePropertyList4TimeNodeContainer - timePropertyList
00007405	0020	TimeConditionContainer - timeCondition
00007425	0621	B: ExtTimeNodeContainer - case of RT_TimeExtTimeNodeContainer
00007425	0008	RecordHeader - rh
0000742D	0028	TimeNodeAtom - timeNodeAtom
00007455	0008	TimePropertyList4TimeNodeContainer - timePropertyList
0000745D	0020	TimeConditionContainer - timeCondition
0000747D	05C9	C: ExtTimeNodeContainer - case of RT_TimeExtTimeNodeContainer

Figure 122: Third-level and fourth-level ExtTimeNodeContainer child-record hierarchies

The **ExtTimeNodeContainer** record A is similar to the **ExtTimeNodeContainer** record as specified in the second table titled "Third-level ExtTimeNodeContainer child-record hierarchy" in this section, while the **ExtTimeNodeContainer** record B is similar to the **ExtTimeNodeContainer** record as specified in the table titled "Fourth-level ExtTimeNodeContainer child-record hierarchy" in this section.

The child-record hierarchy of the **ExtTimeNodeContainer** record C from the previous table is shown expanded in the following table.

Offset	Size	Structure
0000747D	05C9	ExtTimeNodeContainer - case of RT_TimeExtTimeNodeContainer
0000747D	0008	RecordHeader - rh
00007485	0028	A: TimeNodeAtom - timeNodeAtom
000074AD	0049	B: TimePropertyList4TimeNodeContainer - timePropertyList
000074F6	0020	TimeConditionContainer - timeCondition
00007516	00A7	C: ExtTimeNodeContainer - case of RT_TimeExtTimeNodeContainer
000075BD	0115	D: ExtTimeNodeContainer - case of RT_TimeExtTimeNodeContainer
000076D2	012D	E: ExtTimeNodeContainer - case of RT_TimeExtTimeNodeContainer
000077FF	0149	F: ExtTimeNodeContainer - case of RT_TimeExtTimeNodeContainer
00007948	00FE	G: ExtTimeNodeContainer - case of RT_TimeExtTimeNodeContainer

Figure 123: Fifth-level ExtTimeNodeContainer child-record hierarchy

This time node specifies the sink-down animation effect. The TimeNodeAtom record A is similar to the TimeNodeAtom as specified in the table titled "TimeNodeAtom record A child-record hierarchy in the fifth-level ExtTimeNodeContainer" in this section. The **ExtTimeNodeContainer** record C contains an effect behavior to fade the shape. The **ExtTimeNodeContainer** records C, D, E, and F contain generic behaviors to move the shape out of the slide show. The **ExtTimeNodeContainer** record G contains a set behavior to make the shape invisible at the end.

The child-record hierarchy of the **TimePropertyList2.8.18TimeNodeContainer** record B from the previous table is shown expanded in the following table.

Offset	Size	Structure	Value
000074AD	0049	B: TimePropertyList4TimeNodeContainer - timePropertyList	
000074AD	0008	RecordHeader - rh	
000074B5	000D	TimeEffectNodeType - case of TL_TPID_EffectNodeType	
000074B5	0008	RecordHeader - rh	
000074BD	0001	TimeVariantTypeEnum - type	0x01
000074BE	0004	signed integer - effectNodeType	0x00000001
000074C2	000D	TimeEffectID - case of TL_TPID_EffectID	
000074C2	0008	RecordHeader - rh	
000074CA	0001	TimeVariantTypeEnum - type	0x01
000074CB	0004	signed integer - effectID	0x00000025
000074CF	000D	TimeVariantInt - case of TL_TPID_EffectDir	
000074CF	0008	RecordHeader - rh	
000074D7	0001	TimeVariantTypeEnum - type	0x01
000074D8	0004	signed integer - intValue	0x00000000
000074DC	000D	TimeEffectType - case of TL_TPID_EffectType	
000074DC	0008	RecordHeader - rh	
000074E4	0001	TimeVariantTypeEnum - type	0x01
000074E5	0004	signed integer - effectType	0x00000002
000074E9	000D	TimeGroupID - case of TL_TPID_GroupID	
000074E9	0008	RecordHeader - rh	
000074F1	0001	TimeVariantTypeEnum - type	0x01
000074F2	0004	signed integer - groupID	0x00000002

Figure 124: TimePropertyList4TimeNodeContainer record B child-record hierarchy in the fifth-level ExtTimeNodeContainer

case of TL_TPID_EffectID.effectID: 0x00000025 specifies the identifier of this sink-down animation effect.

case of TL_TPID_EffectDir.intValue: 0x00000000 specifies no direction for this sink-down animation effect.

case of TL_TPID_EffectType.effectType: 0x00000002 specifies that this sink-down animation effect is an exit effect.

case of TL_TPID_GroupID.groupID: 0x00000002 specifies the build identifier of the sink-down animation effect.

The child-record hierarchy of the **ExtTimeNodeContainer** record C from the third table titled "Fifth-level ExtTimeNodeContainer child-record hierarchy" in this section is shown expanded in the following table. It contains an effect behavior to fade out the shape.

Offset	Size	Structure	Value
00007516	00A7	ExtTimeNodeContainer - case of RT_TimeExtTimeNodeContainer	
00007516	0008	RecordHeader - rh	
0000751E	0028	TimeNodeAtom - timeNodeAtom	
0000751E	0008	RecordHeader - rh	
00007526	0004	unsigned integer - reserved1	0x00000000
0000752A	0004	unsigned integer - restart	0x00000000
0000752E	0004	TimeNodeTypeEnum - type	0x00000003
00007532	0004	unsigned integer - fill	0x00000000
00007536	0004	signed integer - reserved2	0x00000000
0000753A	0001	unsigned integer - reserved3	0x00
0000753E	0004	signed integer - duration	0x000003E8
00007542	1 bit	bit - fFillProperty	0x0
00007542	1 bit	bit - fRestartProperty	0x0
00007542	1 bit	bit - reserved4	0x0
00007542	1 bit	bit - fGroupingTypeProperty	0x1
00007542	1 bit	bit - fDurationProperty	0x1
00007542	27 bits	unsigned integer - reserved5	0x00000000
00007546	0008	TimePropertyList4TimeNodeContainer - timePropertyList	
00007546	0008	RecordHeader - rh	
0000754E	006F	A: TimeEffectBehaviorContainer - timeEffectBehavior	

Figure 125: The first sixth-level ExtTimeNodeContainer child-record hierarchy

timeNodeAtom.fill: 0x00000000 specifies that the animated values of the property remain at their ending values while the parent time node at the fifth level is still running or holding.

timeNodeAtom.duration: 0x000003E8 specifies that the duration of the effect animation is 1.0 seconds.

The child-record hierarchy of the **TimeEffectBehaviorContainer** (section 2.8.61) record A from the previous table is shown expanded in the following table.

Offset	Size	Structure	Value
0000754E	006F	TimeEffectBehaviorContainer - timeEffectBehavior	
0000754E	0008	RecordHeader - rh	
00007556	0010	TimeEffectBehaviorAtom - effectBehaviorAtom	
00007556	0008	RecordHeader - rh	

Offset	Size	Structure	Value
00007556	1 bit	bit - fTransitionPropertyUsed	0x1
00007556	1 bit	bit - fTypePropertyUsed	0x1
00007556	1 bit	bit - fProgressPropertyUsed	0x0
00007556	1 bit	bit - fRuntimeContextObsolete	0x0
00007556	28 bits	unsigned integer - reserved	0x0000000
00007562	0004	unsigned integer - effectTransition	0x00000001
00007566	0013	TimeVariantString - varType	
00007566	0008	RecordHeader - rh	
0000756E	0001	TimeVariantTypeEnum - type	0x03
0000756F	000A	array of bytes - stringValue	fade
00007579	0044	A: TimeBehaviorContainer - behavior	

Figure 126: TimeEffectBehaviorContainer child-record hierarchy

effectBehaviorAtom.effectTransition: 0x00000001 specifies that the animation behavior fades out the shape.

varType.stringValue: "fade" specifies that the effect behavior is a fade effect.

The child-record hierarchy of the **TimeBehaviorContainer** record A from the previous table is shown expanded in the following table.

Offset	Size	Structure	Value
00007579	0044	TimeBehaviorContainer - behavior	
00007579	0008	RecordHeader - rh	
00007581	0018	A: TimeBehaviorAtom - behaviorAtom	
00007581	0008	RecordHeader - rh	
00007581	0004	unsigned integer - fAdditivePropertyUsed	0x00000000
00007581	0004	unsigned integer - reserved1	0x00000000
00007581	0004	unsigned integer - fAttributeNamesPropertyUsed	0x00000000
00007581	0004	unsigned integer - reserved2	0x00000000
00007581	0004	unsigned integer - reserved3	0x00000000
0000758D	0004	unsigned integer - behaviorAdditive	0x00000000
00007591	0004	signed integer - behaviorAccumulate	0x00000000
00007595	0004	signed integer - behaviorTransform	0x00000000
00007599	0024	B: ClientVisualElementContainer - clientVisualElement	
00007599	0008	RecordHeader - rh	

Offset	Size	Structure	Value
000075A1	001C	VisualElementAtom - visualElementAtom	
000075A1	001C	VisualShapeOrSoundAtom - case of RT_VisualShapeAtom	
000075A1	001C	VisualShapeAtom - case of TL_ET_ShapeType	
000075A1	001C	VisualShapeGeneralAtom - default_case	
000075A1	0008	RecordHeader - rh	
000075A9	0004	TimeVisualElementEnum - type	0x00000000
000075AD	0004	ElementTypeEnum - refType	0x00000001
000075B1	0004	unsigned integer - shapeIdRef	0x00001404
000075B5	0004	signed integer - data1	0xFFFFFFFF
000075B9	0004	signed integer - data2	0xFFFFFFFF

Figure 127: TimeBehaviorContainer child-record hierarchy

The TimeBehaviorAtom record A is similar to the TimeBehaviorAtom record as specified in the second table titled "TimeBehaviorAtom record A child-record hierarchy" in this section. The **ClientVisualElementContainer** record B specifies that the target of the animation is the shape.

The child-record hierarchy of the **ExtTimeNodeContainer** record F from the third table titled "Fifth-level ExtTimeNodeContainer child-record hierarchy" in this section is shown expanded in the following table.

Offset	Size	Structure	Value
000075BD	0115	ExtTimeNodeContainer - case of RT_TimeExtTimeNodeContainer	
000075BD	0008	RecordHeader - rh	
000075C5	0028	TimeNodeAtom - timeNodeAtom	
000075C5	0008	RecordHeader - rh	
000075CD	0004	unsigned integer - reserved1	0x00000000
000075D1	0004	unsigned integer - restart	0x00000000
000075D5	0004	TimeNodeTypeEnum - type	0x00000003
000075D9	0004	unsigned integer - fill	0x00000000
000075DD	0004	signed integer - reserved2	0x00000000
000075E1	0001	unsigned integer - reserved3	0x00
000075E5	0004	signed integer - duration	0x000003E8
000075E9	1 bit	bit - fFillProperty	0x1
000075E9	1 bit	bit - fRestartProperty	0x0
000075E9	1 bit	bit - reserved4	0x0
000075E9	1 bit	bit - fGroupingTypeProperty	0x1

Offset	Size	Structure	Value
000075E9	1 bit	bit - fDurationProperty	0x1
000075E9	27 bits	unsigned integer - reserved5	0x00000000
000075ED	0008	TimePropertyList4TimeNodeContainer - timePropertyList	
000075ED	0008	RecordHeader - rh	
000075F5	00DD	A: TimeAnimateBehaviorContainer - timeAnimateBehavior	

Figure 128: The second sixth-level ExtTimeNodeContainer child-record hierarchy

This time node contains a generic behavior that animates the position of the shape on the horizontal axis.

timeNodeAtom.duration: 0x000003E8 specifies that the duration of this time node is 1.0 seconds.

The child-record hierarchy of the **TimeAnimateBehaviorContainer** (section 2.8.29) record A from the previous table is shown expanded in the following table.

Offset	Size	Structure	Value
000075F5	00DD	TimeAnimateBehaviorContainer - timeAnimateBehavior	
000075F5	0008	RecordHeader - rh	
000075FD	0014	TimeAnimateBehaviorAtom - animateBehaviorAtom	
000075FD	0008	RecordHeader - rh	
00007605	0004	unsigned integer - calcMode	0x00000001
00007609	0004	unsigned integer - fByPropertyUsed	0x00000000
00007609	0004	unsigned integer - fFromPropertyUsed	0x00000000
00007609	0004	unsigned integer - fToPropertyUsed	0x00000000
00007609	0004	unsigned integer - fCalcModePropertyUsed	0x00000001
00007609	0004	unsigned integer - fAnimationValuesPropertyUsed	0x00000001
00007609	0004	unsigned integer - fValueTypePropertyUsed	0x00000001
00007609	0004	unsigned integer - reserved	0x00000000
0000760D	0004	TimeAnimateBehaviorValueTypeEnum - valueType	0x00000001
00007611	0060	A: TimeAnimationValueListContainer - animateValueList	
00007671	0061	B: TimeBehaviorContainer - behavior	

Figure 129: TimeAnimateBehaviorContainer child-record hierarchy in the sixth-level ExtTimeNodeContainer

animateBehaviorAtom.calcMode: 0x00000001 specifies that the animated value of the property is calculated by linear interpolation.

The child-record hierarchy of the **TimeAnimationValueListContainer** record A from the previous table is shown expanded in the following table.

Offset	Size	Structure	Value
00007611	0060	TimeAnimationValueListContainer - animateValueList	
00007611	0008	RecordHeader - rh	
00007619	002C	A: TimeAnimationValueListEntry - timeAnimValueListEntry[0]	
00007619	000C	TimeAnimationValueAtom - timeAnimationValueAtom	
00007619	0008	RecordHeader - rh	
00007621	0004	signed integer - time	0x00000000
00007625	0015	TimeVariantString - case of TL_TVT_String	
00007625	0008	RecordHeader - rh	
0000762D	0001	TimeVariantTypeEnum - type	0x03
0000762E	000C	array of bytes - stringValue	ppt_x
0000763A	000B	TimeVariantString - varFormula	
0000763A	0008	RecordHeader - rh	
00007642	0001	TimeVariantTypeEnum - type	0x03
00007643	0002	array of bytes - stringValue	
00007645	002C	B: TimeAnimationValueListEntry - timeAnimValueListEntry[1]	
00007645	000C	TimeAnimationValueAtom - timeAnimationValueAtom	
00007645	0008	RecordHeader - rh	
0000764D	0004	signed integer - time	0x000003E8
00007651	0015	TimeVariantString - case of TL_TVT_String	
00007651	0008	RecordHeader - rh	
00007659	0001	TimeVariantTypeEnum - type	0x03
0000765A	000C	array of bytes - stringValue	ppt_x
00007666	000B	TimeVariantString - varFormula	
00007666	0008	RecordHeader - rh	
0000766E	0001	TimeVariantTypeEnum - type	0x03
0000766F	0002	array of bytes - stringValue	

Figure 130: Child-record hierarchy of TimeAnimationValueListContainer

The **TimeAnimationValueListContainer** (section 2.8.31) record specifies two key points of the animation. The TimeAnimationValueListEntry record A specifies the starting point, while the TimeAnimationValueListEntry record B specifies the endpoint.

timeAnimValueListEntry[0].timeAnimationValueAtom.time: 0x00000000 specifies that the first key point is the starting point of the animation.

timeAnimValueListEntry[0].case of TL_TVT_String.stringValue: "ppt_x" specifies the formula that is used to calculate the property value at time 0x00000000. The value of this formula is the original value of the position of the shape on the horizontal axis.

timeAnimValueListEntry[1].timeAnimationValueAtom.time: 0x000003E8 specifies that the second key point is the endpoint of the animation.

timeAnimValueListEntry[1].case of TL_TVT_String.stringValue: "ppt_x" specifies the formula that is used to calculate the property value at time 0x000003E8. The value of this formula is the original value of the position of the shape on the horizontal axis.

Because the values at the two key points are identical and equal to the original value of the position on the horizontal axis, the shape does not change position on the horizontal axis during the sink-down animation.

The child-record hierarchy of the **TimeBehaviorContainer** record B from the third table titled "TimeAnimateBehaviorContainer child-record hierarchy in the sixth-level ExtTimeNodeContainer" in this section is shown expanded in the following table.

Offset	Size	Structure	Value
00007671	0061	TimeBehaviorContainer - behavior	
00007671	0008	RecordHeader - rh	
00007679	0018	A: TimeBehaviorAtom - behaviorAtom	
00007679	0008	RecordHeader - rh	
00007679	1 bit	bit - fAdditivePropertyUsed	0x0
00007679	1 bit	bit - reserved1	0x0
00007679	1 bit	bit - fAttributeNamesPropertyUsed	0x1
00007679	1 bit	bit - reserved2	0x0
00007679	28 bits	unsigned integer - reserved3	0x00000000
00007685	0004	unsigned integer - behaviorAdditive	0x00000000
00007689	0004	signed integer - behaviorAccumulate	0x00000000
0000768D	0004	signed integer - behaviorTransform	0x00000000
00007691	001D	TimeStringListContainer - stringList	
00007691	0008	RecordHeader - rh	
00007699	0015	TimeVariantString - string	
00007699	0008	RecordHeader - rh	
000076A1	0001	TimeVariantTypeEnum - type	0x03
000076A2	000C	array of bytes - stringValue	ppt_x
000076AE	0024	B: ClientVisualElementContainer - clientVisualElement	

Figure 131: Child-record hierarchy of TimeBehaviorContainer

The TimeBehaviorAtom record A is similar to the record as specified in the second table titled "TimeBehaviorAtom record A child-record hierarchy" in this section. The

ClientVisualElementContainer (section 2.8.44) record B specifies that the target of the animation is the shape.

stringList.string.stringValue: "ppt_x" specifies that the property to be animated is the position of the shape on the horizontal axis.

The child-record hierarchy of the **ExtTimeNodeContainer** record G from the third table titled "Fifth-level ExtTimeNodeContainer child-record hierarchy" in this section is shown expanded in the following table.

Offset	Size	Structure	Value
000076D2	012D	ExtTimeNodeContainer - case of RT_TimeExtTimeNodeContainer	
000076D2	0008	RecordHeader - rh	
000076DA	0028	A: TimeNodeAtom - timeNodeAtom	
00007702	0008	TimePropertyList4TimeNodeContainer - timePropertyList	
00007702	0008	RecordHeader - rh	
0000770A	00E5	B: TimeAnimateBehaviorContainer - timeAnimateBehavior	
000077EF	0010	C: TimeModifierAtom - timeModifierAtom	
000077EF	0008	RecordHeader - rh	
000077F7	0004	TimeModifierEnum - type	0x00000004
000077FB	0004	unsigned integer - value	0x3F800000

Figure 132: The third sixth-level ExtTimeNodeContainer child-record hierarchy

This time node contains a generic behavior that animates the position of the shape on the vertical axis. The TimeModifierAtom record C specifies the deceleration attribute that the animation will use.

timeModifierAtom.type: 0x00000004 specifies that the **timeModifierAtom.value** field defines the deceleration of the generic behavior as specified in the **TimeAnimateBehaviorContainer** (section 2.8.29) record B.

timeModifierAtom.value: 0x3F800000 specifies that the deceleration of the behavior occurs during the entire length of the animation.

The child-record hierarchy of the TimeNodeAtom record A from the previous table is shown expanded in the following table.

Offset	Size	Structure	Value
000076DA	0028	A: TimeNodeAtom - timeNodeAtom	
000076DA	0008	RecordHeader - rh	
000076E2	0004	unsigned integer - reserved1	0x00000000
000076E6	0004	unsigned integer - restart	0x00000000
000076EA	0004	TimeNodeTypeEnum - type	0x00000003
000076EE	0004	unsigned integer - fill	0x00000000
000076F2	0004	signed integer - reserved2	0x00000000

Offset	Size	Structure	Value
000076F6	0001	unsigned integer - reserved3	0x00
000076FA	0004	signed integer - duration	0x00000064
000076FE	1 bit	bit - fFillProperty	0x1
000076FE	1 bit	bit - fRestartProperty	0x0
000076FE	1 bit	bit - reserved4	0x0
000076FE	1 bit	bit - fGroupingTypeProperty	0x1
000076FE	1 bit	bit - fDurationProperty	0x1
000076FE	27 bits	unsigned integer - reserved5	0x00000000

Figure 133: TimeNodeAtom record A child-record hierarchy in the sixth-level ExtTimeNodeContainer

duration: 0x00000064 specifies that the duration of the animation is 0.1 seconds.

The child-record hierarchy of the **TimeAnimateBehaviorContainer** (section 2.8.29) record B from the second table titled "The third sixth-level ExtTimeNodeContainer child-record hierarchy" in this section is shown expanded in the following table.

Offset	Size	Structure	Value
0000770A	00E5	TimeAnimateBehaviorContainer - timeAnimateBehavior	
0000770A	0008	RecordHeader - rh	
00007712	0014	A: TimeAnimateBehaviorAtom - animateBehaviorAtom	
00007712	0008	RecordHeader - rh	
0000771A	0004	unsigned integer - calcMode	0x00000001
0000771E	0004	unsigned integer - fByPropertyUsed	0x00000000
0000771E	0004	unsigned integer - fFromPropertyUsed	0x00000000
0000771E	0004	unsigned integer - fToPropertyUsed	0x00000000
0000771E	0004	unsigned integer - fCalcModePropertyUsed	0x00000001
0000771E	0004	unsigned integer - fAnimationValuesPropertyUsed	0x00000001
0000771E	0004	unsigned integer - fValueTypePropertyUsed	0x00000001
0000771E	0004	unsigned integer - reserved	0x00000000
00007722	0004	TimeAnimateBehaviorValueTypeEnum - valueType	0x00000001
00007726	0068	B: TimeAnimationValueListContainer - animateValueList	
0000778E	0061	C: TimeBehaviorContainer - behavior	

Figure 134: TimeAnimateBehaviorContainer child-record hierarchy in the sixth-level ExtTimeNodeContainer

The TimeAnimateBehaviorAtom record A is similar to the TimeAnimateBehaviorAtom record as specified in the third table titled "TimeAnimateBehaviorContainer child-record hierarchy in the sixth-level ExtTimeNodeContainer" in this section.

The child-record hierarchy of the **TimeAnimationValueListContainer** (section 2.8.31) record B from the fourth table titled "TimeAnimateBehaviorContainer child-record hierarchy in the sixth-level ExtTimeNodeContainer" in this section is shown expanded in the following table.

Offset	Size	Structure	Value
00007726	0068	TimeAnimationValueListContainer - animateValueList	
00007726	0008	RecordHeader - rh	
0000772E	002C	A: TimeAnimationValueListEntry - timeAnimValueListEntry[0]	
0000772E	000C	TimeAnimationValueAtom - timeAnimationValueAtom	
0000772E	0008	RecordHeader - rh	
00007736	0004	signed integer - time	0x00000000
0000773A	0015	TimeVariantString - case of TL_TVT_String	
0000773A	0008	RecordHeader - rh	
00007742	0001	TimeVariantTypeEnum - type	0x03
00007743	000C	array of bytes - stringValue	ppt_y
0000774F	000B	TimeVariantString - varFormula	
0000774F	0008	RecordHeader - rh	
00007757	0001	TimeVariantTypeEnum - type	0x03
00007758	0002	array of bytes - stringValue	
0000775A	0034	B: TimeAnimationValueListEntry - timeAnimValueListEntry[1]	
0000775A	000C	TimeAnimationValueAtom - timeAnimationValueAtom	
0000775A	0008	RecordHeader - rh	
00007762	0004	signed integer - time	0x000003E8
00007766	001D	TimeVariantString - case of TL_TVT_String	
00007766	0008	RecordHeader - rh	
0000776E	0001	TimeVariantTypeEnum - type	0x03
0000776F	0014	array of bytes - stringValue	ppt_y-.03
00007783	000B	TimeVariantString - varFormula	
00007783	0008	RecordHeader - rh	
0000778B	0001	TimeVariantTypeEnum - type	0x03
0000778C	0002	array of bytes - stringValue	

Figure 135: TimeAnimationValueListContainer child-record hierarchy

timeAnimValueListEntry[0].timeAnimationValueAtom.time: 0x00000000 specifies that the first key point is the starting point of the animation.

timeAnimValueListEntry[0].case of TL_TVT_String.stringValue: "ppt_y" specifies the formula that is used to calculate the property value at time 0x00000000. The value of this formula is the original value of the position of the shape on the vertical axis.

timeAnimValueListEntry[1].timeAnimationValueAtom.time: 0x000003E8 specifies that the second key point is the endpoint of the animation.

timeAnimValueListEntry[1].case of TL_TVT_String.stringValue: "ppt_y-.03" specifies the formula that is used to calculate the property value at time 0x000003E8. The value of this formula moves the shape above its original position by a small amount in the vertical direction.

The child-record hierarchy of the **TimeBehaviorContainer** record C from the fourth table titled "TimeAnimateBehaviorContainer child-record hierarchy in the sixth-level ExtTimeNodeContainer" in s section is shown expanded in the following table.

Offset	Size	Structure	Value
0000778E	0061	TimeBehaviorContainer - behavior	
0000778E	0008	RecordHeader - rh	
00007796	0018	A: TimeBehaviorAtom - behaviorAtom	
00007796	0008	RecordHeader - rh	
00007796	1 bit	bit - fAdditivePropertyUsed	0x0
00007796	1 bit	bit - reserved1	0x0
00007796	1 bit	bit - fAttributeNamesPropertyUsed	0x1
00007796	1 bit	bit - reserved2	0x0
00007796	28 bits	unsigned integer - reserved3	0x00000000
000077A2	0004	unsigned integer - behaviorAdditive	0x00000000
000077A6	0004	signed integer - behaviorAccumulate	0x00000000
000077AA	0004	signed integer - behaviorTransform	0x00000000
000077AE	001D	TimeStringListContainer - stringList	
000077AE	0008	RecordHeader - rh	
000077B6	0015	TimeVariantString - string	
000077B6	0008	RecordHeader - rh	
000077BE	0001	TimeVariantTypeEnum - type	0x03
000077BF	000C	array of bytes - stringValue	ppt_y
000077CB	0024	B: ClientVisualElementContainer - clientVisualElement	

Figure 23: TimeBehaviorContainer child-record hierarchy

The TimeBehaviorAtom record A is similar to the TimeBehaviorAtom record as specified in the second table titled "TimeBehaviorAtom record A child-record hierarchy" in this section. The **ClientVisualElementContainer** record B specifies that the target of the animation is the shape.

stringList.string.stringValue: "ppt_y" specifies that the property to be animated is the position of the shape on the vertical axis.

The child-record hierarchy of the **ExtTimeNodeContainer** record F from the third table titled "Fifth-level ExtTimeNodeContainer child-record hierarchy" in this section is shown expanded in the following table.

Offset	Size	Structure	Value
000077FF	0149	ExtTimeNodeContainer - case of RT_TimeExtTimeNodeContainer	
000077FF	0008	RecordHeader - rh	
00007807	0028	A: TimeNodeAtom - timeNodeAtom	
0000782F	0008	B: TimePropertyList4TimeNodeContainer - timePropertyList	
00007837	00E1	C: TimeAnimateBehaviorContainer - timeAnimateBehavior	
00007918	0020	D: TimeConditionContainer - timeCondition	
00007918	0008	RecordHeader - rh	
00007920	0018	TimeConditionAtom - conditionAtom	
00007920	0008	RecordHeader - rh	
00007928	0004	TriggerObjectEnum - triggerObject	0x00000000
0000792C	0004	unsigned integer - triggerEvent	0x00000000
00007930	0004	unsigned integer - id	0x00000000
00007934	0004	signed integer - delay	0x00000064
00007938	0010	E: TimeModifierAtom - timeModifierAtom	
00007938	0008	RecordHeader - rh	
00007940	0004	TimeModifierEnum - type	0x00000003
00007944	0004	unsigned integer - value	0x3F800000

Figure 137: The fourth sixth-level ExtTimeNodeContainer child-record hierarchy

This time node contains a generic behavior that animates the position of the shape on the vertical axis. The **TimeConditionContainer** record D specifies that this behavior is deferred until the behaviors contained in the **ExtTimeNodeContainer** records F and G from the third table titled "Fifth-level ExtTimeNodeContainer child-record hierarchy" in this section start. The **TimePropertyList4TimeNodeContainer** record B is similar to the **TimePropertyList4TimeNodeContainer** record as specified in the second table titled "The third sixth-level ExtTimeNodeContainer child-record hierarchy" in this section.

timeCondition.conditionAtom.delay: 0x00000064 specifies that this time node is delayed 0.1 seconds after its parent time node at the fifth level is activated.

timeModifierAtom.type: 0x00000003 specifies that the **timeModifierAtom.value** field defines the acceleration of the rotation animation.

timeModifierAtom.value: 0x3F800000 specifies the acceleration occurs over the entire duration of the behavior.

The child-record hierarchy of the TimeNodeAtom record A from the previous table is shown expanded in the following table.

Offset	Size	Structure	Value
00007807	0028	A: TimeNodeAtom - timeNodeAtom	
00007807	0008	RecordHeader - rh	
0000780F	0004	unsigned integer - reserved1	0x00000000
00007813	0004	unsigned integer - restart	0x00000000
00007817	0004	TimeNodeTypeEnum - type	0x00000003
0000781B	0004	unsigned integer - fill	0x00000000
0000781F	0004	signed integer - reserved2	0x00000000
00007823	0001	unsigned integer - reserved3	0x00
00007827	0004	signed integer - duration	0x00000384
0000782B	1 bit	bit - fFillProperty	0x1
0000782B	1 bit	bit - fRestartProperty	0x0
0000782B	1 bit	bit - reserved4	0x0
0000782B	1 bit	bit - fGroupingTypeProperty	0x1
0000782B	1 bit	bit - fDurationProperty	0x1
0000782B	27 bits	unsigned integer - reserved5	0x00000000

Figure 138: TimeNodeAtom record A child-record hierarchy in the sixth-level ExtTimeNodeContainer

duration: 0x00000384 specifies that the duration of this time node is 0.9 seconds.

The child-record hierarchy of the **TimeAnimateBehaviorContainer** (section 2.8.29) record C from the table titled "The fourth sixth-level ExtTimeNodeContainer child-record hierarchy" in this section is shown expanded in the following table.

Offset	Size	Structure	Value
00007837	00E1	TimeAnimateBehaviorContainer - timeAnimateBehavior	
00007837	0008	RecordHeader - rh	
0000783F	0014	A: TimeAnimateBehaviorAtom - animateBehaviorAtom	
0000783F	0008	RecordHeader - rh	
00007847	0004	unsigned integer - calcMode	0x00000001
0000784B	1 bit	bit - fByPropertyUsed	0x0
0000784B	1 bit	bit - fFromPropertyUsed	0x0
0000784B	1 bit	bit - fToPropertyUsed	0x0
0000784B	1 bit	bit - fCalcModePropertyUsed	0x1

Offset	Size	Structure	Value
0000784B	1 bit	bit - fAnimationValuesPropertyUsed	0x1
0000784B	1 bit	bit - fValueTypePropertyUsed	0x1
0000784B	26 bits	unsigned integer - reserved	0x00000000
0000784F	0004	TimeAnimateBehaviorValueTypeEnum - valueType	0x00000001
00007853	0064	B: TimeAnimationValueListContainer - animateValueList	
000078B7	0061	C: TimeBehaviorContainer - behavior	

Figure 139: TimeAnimateBehaviorContainer child-record hierarchy in the sixth-level ExtTimeNodeContainer

The TimeAnimateBehaviorAtom record A is similar to the TimeAnimateBehaviorAtom record as specified in the third table titled "TimeAnimateBehaviorContainer child-record hierarchy in the sixth-level ExtTimeNodeContainer" in this section.

The child-record hierarchy of the **TimeAnimationValueListContainer** (section 2.8.31) record B from the previous table is shown expanded in the following table.

Offset	Size	Structure	Value
00007853	0064	TimeAnimationValueListContainer - animateValueList	
00007853	0008	RecordHeader - rh	
0000785B	002C	A: TimeAnimationValueListEntry - timeAnimValueListEntry[0]	
0000785B	000C	TimeAnimationValueAtom - timeAnimationValueAtom	
0000785B	0008	RecordHeader - rh	
00007863	0004	signed integer - time	0x00000000
00007867	0015	TimeVariantString - case of TL_TVT_String	
00007867	0008	RecordHeader - rh	
0000786F	0001	TimeVariantTypeEnum - type	0x03
00007870	000C	array of bytes - stringValue	ppt_y
0000787C	000B	TimeVariantString - varFormula	
0000787C	0008	RecordHeader - rh	
00007884	0001	TimeVariantTypeEnum - type	0x03
00007885	0002	array of bytes - stringValue	
00007887	0030	B: TimeAnimationValueListEntry - timeAnimValueListEntry[1]	
00007887	000C	TimeAnimationValueAtom - timeAnimationValueAtom	
00007887	0008	RecordHeader - rh	
0000788F	0004	signed integer - time	0x000003E8
00007893	0019	TimeVariantString - case of TL_TVT_String	

Offset	Size	Structure	Value
00007893	0008	RecordHeader - rh	
0000789B	0001	TimeVariantTypeEnum - type	0x03
0000789C	0010	array of bytes - stringValue	ppt_y+1
000078AC	000B	TimeVariantString - varFormula	
000078AC	0008	RecordHeader - rh	
000078B4	0001	TimeVariantTypeEnum - type	0x03
000078B5	0002	array of bytes - stringValue	

Figure 140: TimeAnimationValueListContainer child-record hierarchy

The **TimeAnimationValueListContainer** record (section 2.8.31) specifies two key points of the animation. The TimeAnimationValueListEntry record A specifies the starting point, while the TimeAnimationValueListEntry record B specifies the endpoint.

timeAnimValueListEntry[0].timeAnimationValueAtom.time: 0x00000000 specifies that the first key point is the starting point of the animation.

timeAnimValueListEntry[0].case of TL_TVT_String.stringValue: "ppt_y" specifies the formula that is used to calculate the property value at time 0x00000000. The value of this formula is the original value of the position of the shape on the vertical axis.

timeAnimValueListEntry[1].timeAnimationValueAtom.time: 0x000003E8 specifies that the second key point is the endpoint of the animation.

timeAnimValueListEntry[1].case of TL_TVT_String.stringValue: "ppt_y+1" specifies the formula that is used to calculate the property value at time 0x000003E8. The value of this formula makes sure that the shape is moved beneath the bottom of slide show where the shape is invisible.

This behavior moves the shape from its original position to a position beneath the slide show so that the shape is invisible.

The child-record hierarchy of the **TimeBehaviorContainer** record C from the fifth table titled "TimeAnimateBehaviorContainer child-record hierarchy in the sixth-level ExtTimeNodeContainer" in this section is shown expanded in the following table.

Offset	Size	Structure	Value
000078B7	0061	TimeBehaviorContainer - behavior	
000078B7	0008	RecordHeader - rh	
000078BF	0018	A: TimeBehaviorAtom - behaviorAtom	
000078BF	0008	RecordHeader - rh	
000078BF	0004	unsigned integer - fAdditivePropertyUsed	0x00000000
000078BF	0004	unsigned integer - reserved1	0x00000000
000078BF	0004	unsigned integer - fAttributeNamesPropertyUsed	0x00000001
000078BF	0004	unsigned integer - reserved2	0x00000000
000078BF	0004	unsigned integer - reserved3	0x00000000

Offset	Size	Structure	Value
000078CB	0004	unsigned integer - behaviorAdditive	0x00000000
000078CF	0004	signed integer - behaviorAccumulate	0x00000000
000078D3	0004	signed integer - behaviorTransform	0x00000000
000078D7	001D	TimeStringListContainer - stringList	
000078D7	0008	RecordHeader - rh	
000078DF	0015	TimeVariantString - string	
000078DF	0008	RecordHeader - rh	
000078E7	0001	TimeVariantTypeEnum - type	0x03
000078E8	000C	array of bytes - stringValue	ppt_y
000078F4	0024	B: ClientVisualElementContainer - clientVisualElement	

Figure 141: Child-record hierarchy of TimeBehaviorContainer

The TimeBehaviorAtom record A is similar to the TimeBehaviorAtom record as specified in the second table titled "TimeBehaviorAtom record A child-record hierarchy" in this section. The **ClientVisualElementContainer** record B specifies that the target of the animation is the shape.

stringList.string.stringValue: "ppt_y" specifies that the property to be animated is the position of the shape on the vertical axis.

The child-record hierarchy of the **ExtTimeNodeContainer** record G from the third table titled "Fifth-level ExtTimeNodeContainer child-record hierarchy" in this section is shown expanded in the following table.

Offset	Size	Structure	Value
00007948	00FE	ExtTimeNodeContainer - case of RT_TimeExtTimeNodeContainer	
00007948	0008	RecordHeader - rh	
00007950	0028	A: TimeNodeAtom - timeNodeAtom	
00007978	0008	B: TimePropertyList4TimeNodeContainer - timePropertyList	
00007980	00A6	C: TimeSetBehaviorContainer - timeSetBehavior	
00007A26	0020	D: TimeConditionContainer - timeCondition	
00007A26	0008	RecordHeader - rh	
00007A2E	0018	TimeConditionAtom - conditionAtom	
00007A2E	0008	RecordHeader - rh	
00007A36	0004	TriggerObjectEnum - triggerObject	0x00000000
00007A3A	0004	unsigned integer - triggerEvent	0x00000000
00007A3E	0004	unsigned integer - id	0x00000000
00007A42	0004	signed integer - delay	0x000003E7

Figure 142: The fifth sixth-level ExtTimeNodeContainer child-record hierarchy

This time node contains a set behavior that hides the shape. The TimeNodeAtom record A is similar to the record specified in the second table titled "TimeNodeAtom record A child-record hierarchy in the sixth-level ExtTimeNodeContainer" in this section. The **TimePropertyList4TimeNodeContainer** record B is similar to the **TimePropertyList4TimeNodeContainer** record as specified in the second table titled "The second sixth-level ExtTimeNodeContainer child-record hierarchy" in this section. The **TimeConditionContainer** record D specifies that this behavior is deferred until the last millisecond.

timeCondition.conditionAtom.delay: 0x000003E7 specifies that this time node will start 0.999 seconds after the parent time node at the fifth level is activated.

The child-record hierarchy of the **TimeSetBehaviorContainer** record C from the previous table is shown expanded in the following table.

Offset	Size	Structure	Value
00007980	00A6	TimeSetBehaviorContainer - timeSetBehavior	
00007980	0008	RecordHeader - rh	
00007988	0010	A: TimeSetBehaviorAtom - setBehaviorAtom	
00007988	0008	RecordHeader - rh	
00007988	0004	unsigned integer - fToPropertyUsed	0x00000001
00007988	0004	unsigned integer - fValueTypePropertyUsed	0x00000000
00007988	0004	unsigned integer - reserved	0x00000000
00007994	0004	TimeAnimateBehaviorValueTypeEnum - valueType	0x00000001
00007998	0017	TimeVariantString - varTo	
00007998	0008	RecordHeader - rh	
000079A0	0001	TimeVariantTypeEnum - type	0x03
000079A1	000E	array of bytes - stringValue	hidden
000079AF	0077	B: TimeBehaviorContainer - behavior	

Figure 143: TimeSetBehaviorContainer child-record hierarchy in the sixth-level ExtTimeNodeContainer

The TimeSetBehaviorAtom record A is similar to the TimeSetBehaviorAtom record as specified in the table titled "Child-record hierarchy of TimeSetBehaviorContainer in the sixth-level ExtTimeNodeContainer" in section 3.7.1.

varTo.stringValue: "hidden" specifies that the shape is invisible.

The child-record hierarchy of the **TimeBehaviorContainer** record B from the previous table is shown expanded in the following table.

Offset	Size	Structure	Value
000079AF	0077	TimeBehaviorContainer - behavior	
000079AF	0008	RecordHeader - rh	
000079B7	0018	A: TimeBehaviorAtom - behaviorAtom	
000079B7	0008	RecordHeader - rh	

Offset	Size	Structure	Value
000079B7	1 bit	bit - fAdditivePropertyUsed	0x0
000079B7	1 bit	bit - reserved1	0x0
000079B7	1 bit	bit - fAttributeNamesPropertyUsed	0x1
000079B7	1 bit	bit - reserved2	0x0
000079B7	28 bits	unsigned integer - reserved3	0x0000000
000079C3	0004	unsigned integer - behaviorAdditive	0x00000000
000079C7	0004	signed integer - behaviorAccumulate	0x00000000
000079CB	0004	signed integer - behaviorTransform	0x00000000
000079CF	0033	TimeStringListContainer - stringList	
000079CF	0008	RecordHeader - rh	
000079D7	002B	TimeVariantString - string	
000079D7	0008	RecordHeader - rh	
000079DF	0001	TimeVariantTypeEnum - type	0x03
000079E0	0022	array of bytes - stringValue	style.visibility
00007A02	0024	B : ClientVisualElementContainer - clientVisualElement	

Figure 144: TimeBehaviorContainer child-record hierarchy

The TimeBehaviorAtom record A is similar to the TimeBehaviorAtom record as specified in the second table titled "TimeBehaviorAtom record A child-record hierarchy" in this section. The **ClientVisualElementContainer** record B specifies that the target of the animation is the shape.

stringList.string.stringValue: "style.visibility" specifies the property to be animated that controls the visibility of the shape.

3.8 Shape Client Data

The following sections provide examples of a **shape** anchor, a **placeholder shape**, a shape text body, an **OLE object**, and an external video.

3.8.1 Shape Anchor

This example shows how to locate the **shape** anchor for the title **placeholder shape** on **presentation slide** 6 as shown in figure titled "Presentation slide 6" in section [3.1](#).

The child-record hierarchy of the **DrawingContainer** (section [2.5.13](#)) record A from the table titled "SlideContainer record U child-record hierarchy" in section [3.5.2](#) is shown expanded in the following table.

Offset	Size	Structure
00007B58	0423	DrawingContainer - drawing
00007B58	0008	RecordHeader - rh

Offset	Size	Structure
00007B60	041B	OfficeArtDgContainer - OfficeArtDg
00007B60	0008	OfficeArtRecordHeader - rh
00007B68	0010	OfficeArtFDG - drawingData
00007B78	03B3	OfficeArtSpgrContainer - groupShape
00007B78	0008	OfficeArtRecordHeader - rh
00007B80	0030	OfficeArtSpContainer - case of msofbtSpContainer
00007BB0	0080	A: OfficeArtSpContainer - case of msofbtSpContainer
00007C30	0109	B: OfficeArtSpContainer - case of msofbtSpContainer
00007D39	00F7	C: OfficeArtSpContainer - case of msofbtSpContainer
00007E30	00FB	D: OfficeArtSpContainer - case of msofbtSpContainer
00007F2B	0050	OfficeArtSpContainer - shape

Figure 145: DrawingContainer child-record hierarchy

The child-record hierarchy of the **OfficeArtSpContainer** ([\[MS-ODRAW\]](#) section 2.2.14) record A from the previous table is shown expanded in the following table.

Offset	Size	Structure
00007BB0	0080	OfficeArtSpContainer - case of msofbtSpContainer
00007BB0	0008	OfficeArtRecordHeader - rh
00007BB8	0010	OfficeArtFSP - shapeProp
00007BC8	002C	OfficeArtFOPT - shapePrimaryOptions
00007BF4	0010	A: OfficeArtClientAnchor - clientAnchor
00007C04	0018	B: OfficeArtClientData - clientData
00007C1C	0014	C: OfficeArtClientTextbox - clientTextbox

Figure 146: OfficeArtSpContainer child-record hierarchy

The child-record hierarchy of the OfficeArtClientAnchor record A from the previous table is shown expanded in the following table.

Offset	Size	Structure	Value
00007BF4	0010	A: OfficeArtClientAnchor - clientAnchor	
00007BF4	0008	OfficeArtRecordHeader - rh	
00007BF4	4 bits	unsigned integer - recVer	0x0
00007BF4	12 bits	unsigned integer - recInstance	0x000
00007BF6	0002	unsigned integer - recType	0xF010
00007BF8	0004	unsigned integer - recLen	0x00000008

Offset	Size	Structure	Value
00007BFC	0008	OfficeArtClientAnchorData - clientAnchorData	
00007BFC	0008	SmallRectStruct - case of 0x00000008	
00007BFC	0002	signed integer - top	0x00AD
00007BFE	0002	signed integer - left	0x0120
00007C00	0002	signed integer - right	0x1560
00007C02	0002	signed integer - bottom	0x037D

Figure 147: OfficeArtClientAnchor record A child-record hierarchy

rh.recLen: 0x00000008 specifies that a SmallRectStruct record is contained in **clientAnchorData**.

clientAnchorData.case of 0x00000008.top: 0x00AD specifies the minimum y-value of the rectangle.

clientAnchorData.case of 0x00000008.left: 0x0120 specifies the minimum x-value of the rectangle.

clientAnchorData.case of 0x00000008.right: 0x1560 specifies the maximum x-value of the rectangle.

clientAnchorData.case of 0x00000008.bottom: 0x037D specifies the maximum y-value of the rectangle.

3.8.2 Shape Placeholder

This example shows how to locate the title **placeholder shape** on **presentation slide 6** as shown in figure titled "Presentation slide 6" in section [3.1](#).

The child-record hierarchy of the [OfficeArtClientData](#) record B from the second table titled "OfficeArtSpContainer child-record hierarchy" in section [3.8.1](#) is shown expanded in the following table.

Offset	Size	Structure	Value
00007C04	0018	B: OfficeArtClientData - clientData	
00007C04	0008	OfficeArtRecordHeader - rh	
00007C0C	0010	PlaceholderAtom - placeholderAtom	
00007C0C	0008	RecordHeader - rh	
00007C14	0004	signed integer - position	0x00000000
00007C18	0001	PlaceholderEnum - placementId	0x0D
00007C19	0001	PlaceholderSize - size	0x00

Figure 148: OfficeArtClientData record B child-record hierarchy

placeholderAtom.position: 0x00000000 specifies the identifier for the **placeholder shape**.

placeholderAtom.placementId: 0x0D specifies that this placeholder shape is a title text placeholder shape.

The child-record hierarchy of the [OfficeArtClientTextbox](#) record C from the second table titled "OfficeArtSpContainer child-record hierarchy" in section 3.8.1 is shown expanded in the following table.

Offset	Size	Structure	Value
00007C1C	0014	C: OfficeArtClientTextbox - clientTextbox	
00007C1C	0008	OfficeArtRecordHeader - rh	
00007C24	000C	OutlineTextRefAtom - case of RT_OutlineTextRefAtom	
00007C24	0008	RecordHeader - rh	
00007C24	4 bits	unsigned integer - recVer	0x0
00007C24	12 bits	unsigned integer - recInstance	0x000
00007C26	0002	RecordType - recType	0x0F9E
00007C28	0004	unsigned integer - recLen	0x00000004
00007C2C	0004	signed integer - index	0x00000000

Figure 149: OfficeArtClientTextbox child-record hierarchy

case of RT_OutlineTextRefAtom: specifies a reference to text contained in the **SlideListWithTextContainer** record (section [2.4.14.3](#)).

case of RT_OutlineTextRefAtom.index: 0x00000000 specifies the index into the sequence of the [TextHeaderAtom](#) records that follows the slide persist record. This specifies record O in the table titled "SlideListWithTextContainer child-record hierarchy" in section [3.4](#). The table titled "OutlineTextBytesAtom record O" in section 3.4 shows record O expanded. The contained text "shapes with text" is specified by record P in the table titled "SlideListWithTextContainer child-record hierarchy" in section 3.4, and is shown expanded in the table titled "OutlineTextBytesAtom record P" in section 3.4.

3.8.3 Shape Text

This example shows how to locate the text of the triangle **shape** on **presentation slide 6** as shown in figure titled "Presentation slide 6" in section [3.1](#).

The child-record hierarchy of the **OfficeArtSpContainer** ([\[MS-ODRAW\]](#) section 2.2.14) record C from the table titled "DrawingContainer child-record hierarchy" in section [3.8.1](#) is shown expanded in the following table.

Offset	Size	Structure
00007D39	00F7	OfficeArtSpContainer - case of msofptSpContainer
00007D39	0008	OfficeArtRecordHeader - rh
00007D41	0010	OfficeArtFSP - shapeProp
00007D51	0044	OfficeArtFOPT - shapePrimaryOptions
00007D95	000E	OfficeArtTertiaryFOPT - shapeTertiaryOptions
00007DA3	0010	OfficeArtClientAnchor - clientAnchor
00007DB3	007D	A: OfficeArtClientTextbox - clientTextbox

Figure 24: OfficeArtSpContainer child-record hierarchy

The child-record hierarchy of the OfficeArtClientTextbox record A from the previous table is shown expanded in the following table.

Offset	Size	Structure	Value
00007DB3	007D	OfficeArtClientTextbox - clientTextbox	
00007DB3	0008	OfficeArtRecordHeader - rh	
00007DB3	4 bits	unsigned integer - recVer	0xF
00007DB3	12 bits	unsigned integer - recInstance	0x000
00007DB5	0002	unsigned integer - recType	0xF00D
00007DB7	0004	unsigned integer - recLen	0x00000075
00007DBB	000C	A: TextHeaderAtom - case of RT_TextHeaderAtom	
00007DC7	0019	B: TextBytesAtom - case of RT_TextBytesAtom	
00007DE0	0050	StyleTextPropAtom - case of RT_StyleTextPropAtom	

Figure 25: OfficeArtClientTextbox child-record hierarchy

The child-record hierarchy of the TextHeaderAtom record A from the previous table is shown expanded in the following table.

Offset	Size	Structure	Value
00007DBB	000C	A: TextHeaderAtom - case of RT_TextHeaderAtom	
00007DBB	0008	RecordHeader - rh	
00007DBB	4 bits	unsigned integer - recVer	0x0
00007DBB	12 bits	unsigned integer - recInstance	0x000
00007DBD	0002	RecordType - recType	0x0F9F
00007DBF	0004	unsigned integer - recLen	0x00000004
00007DC3	0004	TextTypeEnum - textType	0x00000004

Figure 26: TextHeaderAtom record A child-record hierarchy

textType: 0x00000004 specifies that the body of text is type Tx_TYPE_OTHER.

The child-record hierarchy of the TextBytesAtom record B from the table titled "OfficeArtClientTextbox child-record hierarchy" in this section is shown expanded in the following table.

Offset	Size	Structure	Value
00007DC7	0019	B: TextBytesAtom - case of RT_TextBytesAtom	
00007DC7	0008	RecordHeader - rh	
00007DC7	4 bits	unsigned integer - recVer	0x0
00007DC7	12 bits	unsigned integer - recInstance	0x000

Offset	Size	Structure	Value
00007DC9	0002	RecordType - recType	0x0FA8
00007DCB	0004	unsigned integer - recLen	0x00000011
00007DCF	0011	array of bytes - textBytes	a \vbold\v triangle

Figure 27: TextBytesAtom record B child-record hierarchy

textBytes: "a \vbold\v triangle" specifies the characters of the text body.

3.8.4 OLE Object

This example shows how to locate the pie chart on **presentation slide 5** as shown in figure titled "Presentation slide 5" in section [3.1](#).

The child-record hierarchy of the **DrawingContainer** (section [2.5.13](#)) record A from the table titled "SlideContainer record J child-record hierarchy" in section [3.5.2](#) is shown expanded in the following table.

Offset	Size	Structure
00003EAB	01B8	DrawingContainer - drawing
00003EAB	0008	RecordHeader - rh
00003EB3	01B0	OfficeArtDgContainer - OfficeArtDg
00003EB3	0008	OfficeArtRecordHeader - rh
00003EBB	0010	OfficeArtFDG - drawingData
00003ECB	0148	OfficeArtSpgrContainer - groupShape
00003ECB	0008	OfficeArtRecordHeader - rh
00003ED3	0030	OfficeArtSpContainer - case of msofbtSpContainer
00003F03	007A	OfficeArtSpContainer - case of msofbtSpContainer
00003F7D	0096	A: OfficeArtSpContainer - case of msofbtSpContainer
00004013	0050	OfficeArtSpContainer - shape

Figure 28: OfficeArtSpContainer child-record hierarchy

The child-record hierarchy of the **OfficeArtSpContainer** ([\[MS-ODRAW\]](#) section 2.2.14) record A from the previous table is shown expanded in the following table.

Offset	Size	Structure
00003F7D	0096	OfficeArtSpContainer - case of msofbtSpContainer
00003F7D	0008	OfficeArtRecordHeader - rh
00003F85	0010	OfficeArtFSP - shapeProp
00003F95	004A	OfficeArtFOPT - shapePrimaryOptions
00003FDF	0010	OfficeArtClientAnchor - clientAnchor

Offset	Size	Structure
00003FEF	0024	A: OfficeArtClientData - clientData

Figure 29: OfficeArtSpContainer child-record hierarchy

The child-record hierarchy of the **OfficeArtClientData** (section 2.7.3) record A from the previous table is shown expanded in the following table.

Offset	Size	Structure	Value
00003FEF	0024	A: OfficeArtClientData - clientData	
00003FEF	0008	OfficeArtRecordHeader - rh	
00003FF7	000C	ExObjRefAtom - exObjRefAtom	
00003FF7	0008	RecordHeader - rh	
00003FFF	0004	unsigned integer - exObjIdRef	0x00000014
00004003	0010	PlaceholderAtom - placeholderAtom	

Figure 30: OfficeArtClientData record A child-record hierarchy

exObjRefAtom.exObjIdRef: 0x00000014 specifies the identifier reference to the **external object** in the **ExObjListContainer** record (section [2.10.1](#)) at the document level.

The child-record hierarchy of the **ExObjListContainer** record F from the table titled "DocumentContainer child-record hierarchy" in section [3.4](#) is shown expanded in the following table.

Offset	Size	Structure	Value
00005CA1	0152	ExObjListContainer - exObjList	
00005CA1	0008	RecordHeader - rh	
00005CA9	000C	ExObjListAtom - exObjListAtom	
00005CB5	00A2	ExOleEmbedContainer - case of RT_ExternalOleEmbed	
00005CB5	0008	RecordHeader - rh	
00005CB5	4 bits	unsigned integer - recVer	0xF
00005CB5	12 bits	unsigned integer - recInstance	0x000
00005CB7	0002	RecordType - recType	0x0FCC
00005CB9	0004	unsigned integer - recLen	0x0000009A
00005CBD	0010	A: ExOleEmbedAtom - exOleEmbedAtom	
00005CCD	0020	B: ExOleObjAtom - exOleObjAtom	
00005CED	0012	C: MenuNameAtom - menuNameAtom	
00005CFF	0026	D: ProgIDAtom - progIdAtom	
00005D25	0032	E: ClipboardNameAtom - clipboardNameAtom	
00005D57	003E	F: ExMCIMovieContainer - case of RT_ExternalMciMovie	

Offset	Size	Structure	Value
00005D95	005E	H: ExHyperlinkContainer - case of RT_ExternalHyperlink	

Figure 31: ExObjListContainer child-record hierarchy

The child-record hierarchy of the ExOleEmbedAtom record A from the previous table is shown expanded in the following table.

Offset	Size	Structure	Value
00005CBD	0010	A: ExOleEmbedAtom - exOleEmbedAtom	
00005CBD	0008	RecordHeader - rh	
00005CC5	0004	ExColorFollowEnum - exColorFollow	0x00000001
00005CC9	0001	unsigned integer - fCantLockServer	0x00
00005CCA	0001	unsigned integer - fNoSizeToServer	0x00
00005CCB	0001	unsigned integer - fIsTable	0x00

Figure 32: ExOleEmbedAtom record A child-record hierarchy

exColorFollow: 0x00000001 specifies that the **OLE object** follows the **color scheme**.

fCantLockServer: 0x00 specifies that the **OLE** server can be locked.

fNoSizeToServer: 0x00 specifies that sending dimensions to the OLE server is required.

fIsTable: 0x00 specifies that the OLE object is not a table.

The child-record hierarchy of the **ExOleObjAtom** (section 2.10.12) record B from the table titled "ExObjListContainer child-record hierarchy" in this section is shown expanded in the following table.

Offset	Size	Structure	Value
00005CCD	0020	B: ExOleObjAtom - exOleObjAtom	
00005CCD	0008	RecordHeader - rh	
00005CD5	0004	DataViewAspectEnum - drawAspect	0x00000001
00005CD9	0004	ExOleObjTypeEnum - type	0x00000000
00005CDD	0004	unsigned integer - exObjId	0x00000014
00005CE1	0004	ExOleObjSubTypeEnum - subType	0x00000004
00005CE5	0004	PersistIdRef - persistIdRef	0x00000007
00005CE9	0004	BOOL - unused	0x00139600

Figure 33: ExOleObjAtom record B child-record hierarchy

drawAspect: 0x00000001 specifies that it is preferable to display the OLE object as an embedded object inside of the container document.

type: 0x00000000 specifies that this OLE object is serialized and saved with the document.

exObjId: 0x00000014 specifies the identifier of this OLE object.

subType: 0x00000004 specifies that the OLE object is created by ProgID "MSGraph.Chart" or "MSGraph".

persistIdRef: 0x00000007 specifies the value to look up in the **persist object directory**, shown in the second table in section 3.2, to find the **persist object** stream offset 0x00004D69. This offset matches the offset for the **ExOleObjStg** (section 2.10.34) record P in the table titled "Top-level record sequence in the PowerPoint Document Stream from sample.ppt" in section 3.3. This **ExOleObjStg** record represents the OLE object as shown in figure titled "Presentation slide 5" in section 3.1.

The child-record hierarchy of the **ExOleObjStg** record P from the table titled "Top-level record sequence in the PowerPoint Document Stream from sample.ppt" in section 3.3 is shown expanded in the following table.

Offset	Size	Structure	Value
00004D69	0E88	P: ExOleObjStg	
00004D69	0E88	ExOleObjStgCompressedAtom - case of 1	
00004D69	0008	RecordHeader - rh	
00004D69	4 bits	unsigned integer - recVer	0x0
00004D69	12 bits	unsigned integer - recInstance	0x001
00004D6B	0002	RecordType - recType	0x1011
00004D6D	0004	unsigned integer - recLen	0x00000E80
00004D71	0004	unsigned integer - decompressedSize	0x00006A00
00004D75	0E7C	array of bytes - oleStgCompressed	78 9C ED 5C 7B 70 94 D5 15 ...

Figure 34: ExOleObjStg record P child-record hierarchy

case of 1.rh.recInstance: 0x001 specifies that this is an ExOleObjStgCompressedAtom record.

case of 1.decompressedSize: 0x00006A00 specifies that the storage length is 0x00006A00 bytes after decompression.

case of 1.oleStgCompressed: 78 9C ED 5C 7B 70 94 D5 15 ... specifies the array data of the compressed OLE object.

The child-record hierarchy of the MenuNameAtom record C from the table titled "ExObjListContainer child-record hierarchy" in this section is shown expanded in the following table.

Offset	Size	Structure	Value
00005CED	0012	C: MenuNameAtom - menuNameAtom	
00005CED	0008	RecordHeader - rh	
00005CED	4 bits	unsigned integer - recVer	0x0
00005CED	12 bits	unsigned integer - recInstance	0x001
00005CEF	0002	RecordType - recType	0x0FBA
00005CF1	0004	unsigned integer - recLen	0x0000000A
00005CF5	000A	PrintableUnicodeString - menuName	Chart

Figure 35: MenuNameAtom record C child-record hierarchy

menuName: "Chart" specifies the short name of the OLE object.

The child-record hierarchy of the ProgIDAtom record D from the table titled "ExObjListContainer child-record hierarchy" in this section is shown expanded in the following table.

Offset	Size	Structure	Value
00005CFF	0026	D: ProgIDAtom - progIdAtom	
00005CFF	0008	RecordHeader - rh	
00005CFF	4 bits	unsigned integer - recVer	0x0
00005CFF	12 bits	unsigned integer - recInstance	0x002
00005D01	0002	RecordType - recType	0x0FBA
00005D03	0004	unsigned integer - recLen	0x0000001E
00005D07	001E	PrintableUnicodeString - progId	MSGraph.Chart.8

Figure 36: ProgIDAtom record D child-record hierarchy

progId: "MSGraph.Chart.8" specifies the **ProgID** of the OLE object.

The child-record hierarchy of the ClipboardNameAtom record E from the table titled "ExObjListContainer child-record hierarchy" in this section is shown expanded in the following table.

Offset	Size	Structure	Value
00005D25	0032	E: ClipboardNameAtom - clipboardNameAtom	
00005D25	0008	RecordHeader - rh	
00005D25	4 bits	unsigned integer - recVer	0x0
00005D25	12 bits	unsigned integer - recInstance	0x003
00005D27	0002	RecordType - recType	0x0FBA
00005D29	0004	unsigned integer - recLen	0x0000002A
00005D2D	002A	PrintableUnicodeString - clipboardName	Microsoft Graph Chart

Figure 37: ClipboardNameAtom record E child-record hierarchy

clipboardName: "Microsoft Graph Chart" specifies the long name of the OLE object.

3.8.5 External Video

This example shows how to locate the external video object on **presentation slide 4** as shown in figure titled "Presentation slide 4" in section [3.1](#).

The child-record hierarchy of the **DrawingContainer** (section [2.5.13](#)) record A from the table titled "SlideContainer record I child-record hierarchy" in section [3.5.2](#) is shown expanded in the following table.

Offset	Size	Structure
000037DD	01BA	DrawingContainer - drawing

Offset	Size	Structure
000037DD	0008	RecordHeader - rh
000037E5	01B2	OfficeArtDgContainer - OfficeArtDg
000037E5	0008	OfficeArtRecordHeader - rh
000037ED	0010	OfficeArtFDG - drawingData
000037FD	014A	OfficeArtSpgrContainer - groupShape
000037FD	0008	OfficeArtRecordHeader - rh
00003805	0030	OfficeArtSpContainer - case of msofbtSpContainer
00003835	007A	A: OfficeArtSpContainer - case of msofbtSpContainer
000038AF	0098	OfficeArtSpContainer - case of msofbtSpContainer
00003947	0050	OfficeArtSpContainer - shape

Figure 38: DrawingContainer child-record hierarchy

The child-record hierarchy of the OfficeArtSpContainer ([\[MS-ODRAW\]](#) section 2.2.14) record A from the previous table is shown expanded in the following table.

Offset	Size	Structure	Value
000038AF	0098	A: OfficeArtSpContainer - case of msofbtSpContainer	
000038AF	0008	OfficeArtRecordHeader - rh	
000038B7	0010	OfficeArtFSP - shapeProp	
000038C7	002C	OfficeArtFOPT - shapePrimaryOptions	
000038F3	0010	OfficeArtClientAnchor - clientAnchor	
00003903	0044	OfficeArtClientData - clientData	
00003903	0008	OfficeArtRecordHeader - rh	
0000390B	000C	ExObjRefAtom - exObjRefAtom	
0000390B	0008	RecordHeader - rh	
00003913	0004	unsigned integer - exObjIdRef	0x0000001B
00003917	0020	MouseClickedInteractiveInfoContainer - mouseClickedInteractiveInfo	
00003937	0010	PlaceholderAtom - placeholderAtom	

Figure 39: OfficeArtSpContainer record A child-record hierarchy

clientData.exObjRefAtom.exObjIdRef: 0x0000001B specifies a reference to an **external object** with **exObjId** value 0x0000001B in the **ExObjListContainer** record (section [2.10.1](#)) at the document level.

The **ExObjListContainer** record is shown as record F in the table titled "DocumentContainer child-record hierarchy" in section [3.4](#), and is shown expanded in the table titled "ExObjListContainer child-record hierarchy" in this section. The child-record hierarchy of [ExMCIMovieContainer](#) record H is shown expanded in the following table.

Offset	Size	Structure	Value
00005D57	003E	H: ExMCIMovieContainer - case of RT_ExternalMciMovie	
00005D57	0008	RecordHeader - rh	
00005D57	4 bits	unsigned integer - recVer	0xF
00005D57	12 bits	unsigned integer - recInstance	0x000
00005D59	0002	RecordType - recType	0x1007
00005D5B	0004	unsigned integer - recLen	0x00000036
00005D5F	0036	ExVideoContainer - exVideo	
00005D5F	0008	RecordHeader - rh	
00005D67	0010	ExMediaAtom - exMediaAtom	
00005D67	0008	RecordHeader - rh	
00005D6F	0004	unsigned integer - exObjId	0x0000001B
00005D73	0002	unsigned integer - fLoop	0x0000
00005D73	0002	unsigned integer - fRewind	0x0000
00005D73	0002	unsigned integer - fNarration	0x0000
00005D73	0002	unsigned integer - reserved	0x0000
00005D77	001E	UncOrLocalPathAtom - videoFilePathAtom	
00005D77	0008	RecordHeader - rh	
00005D7F	0016	UncOrLocalPath - path	C:\Bear.wmv

Figure 40: ExMCIMovieContainer record H child-record hierarchy

exVideo.exMediaAtom.exObjId: 0x0000001B specifies the identifier of the external object. It matches the value of the **exObjRefAtom.exObjIdRef** field in the table titled "OfficeArtSpContainer record A child-record hierarchy" in this section.

exVideo.exMediaAtom.fLoop: 0x0000 specifies that the video data is not repeated continuously.

exVideo.exMediaAtom.fRewind: 0x0000 specifies that the video data is not rewound after playing.

exVideo.exMediaAtom.fNarration: 0x0000 specifies that the video data is not recorded narration for the **slide show**.

exVideo.videoFilePathAtom.path: "C:\Bear.wmv" specifies the local path string to the video file.

3.9 Text

The following sections provide examples of paragraph-level text formatting, character-level text formatting, interactive text, and text metacharacters.

3.9.1 Paragraph Formatting

Paragraph-level formatting is stored separately from the text characters.

The most basic paragraph-level formatting for a body of text is specified in the [StyleTextPropAtom](#) record. The following sample shows a section of the **SlideListWithTextContainer** record (section [2.4.14.3](#)) pertaining to **presentation slide** 1 and presentation slide 2. (The complete hierarchy of the **SlideListWithTextContainer** record is shown in the table titled "SlideListWithTextContainer child-record hierarchy" in section [3.4](#).)

Offset	Size	Structure	Value
000066A0	001C	SlidePersistAtom - case of RT_SlidePersistAtom A	
000066BC	000C	TextHeaderAtom - case of RT_TextHeaderAtom A	
000066C8	0010	TextBytesAtom - case of RT_TextBytesAtom A	
000066D8	000C	TextHeaderAtom - case of RT_TextHeaderAtom B	
000066E4	0014	TextBytesAtom - case of RT_TextBytesAtom B	
000066F8	001C	SlidePersistAtom - case of RT_SlidePersistAtom B	
00006714	000C	TextHeaderAtom - case of RT_TextHeaderAtom C	
00006714	0008	RecordHeader - rh	
00006714	4 bits	unsigned integer - recVer	0x0
00006714	12 bits	unsigned integer - recInstance	0x000
00006716	0002	RecordType - recType	0x0F9F
00006718	0004	unsigned integer - recLen	0x00000004
00006720	0013	TextBytesAtom - case of RT_TextBytesAtom C	
00006720	0008	RecordHeader - rh	
00006728	000B	array of bytes - textBytes	the weather
00006733	000C	TextHeaderAtom - case of RT_TextHeaderAtom D	
00006733	0008	RecordHeader - rh	
00006733	4 bits	unsigned integer - recVer	0x0
00006733	12 bits	unsigned integer - recInstance	0x001
00006735	0002	RecordType - recType	0x0F9F
00006737	0004	unsigned integer - recLen	0x00000004
0000673B	0004	TextTypeEnum - textType	0x00000001
0000673F	0031	TextBytesAtom - case of RT_TextBytesAtom D	
0000673F	0008	RecordHeader - rh	
0000673F	4 bits	unsigned integer - recVer	0x0
0000673F	12 bits	unsigned integer - recInstance	0x000

Offset	Size	Structure	Value
00006741	0002	RecordType - recType	0x0FA8
00006743	0004	unsigned integer - recLen	0x00000029
00006747	0029	array of bytes - textBytes	a sunny day\rthe blue sky\rsome green grass
00006770	0022	A: StyleTextPropAtom - styleTextPropAtom	

Figure 41: Basic paragraph-level formatting for placeholder text

The preceding sample shows how the text and basic paragraph-level formatting for the content placeholder on presentation slide 2 of the sample presentation are specified.

case of RT_SlidePersistAtom B: The second **SlidePersistAtom** record (section 2.4.14.5) in the **SlideListWithTextContainer** record specifies presentation slide 2. The records that follow specify the text for placeholders on this slide.

case of RT_TextHeaderAtom C: Specifies the title **placeholder shape**. The **rh.recInstance** value of 0x000 specifies that this text is the first text body on presentation slide 2.

case of RT_TextHeaderAtom D: Specifies a new body of text. The **rh.recInstance** value of 0x001 specifies that this text is the second text body for presentation slide 2. The records that follow specify additional properties for this text body.

case of RT_TextHeaderAtom D.textType: 0x00000001 specifies that the text type is **Tx_TYPE_BODY**, the body placeholder shape text.

case of RT_TextBytesAtom D: Specifies the characters of the text. The quantity of characters specified is 41. Therefore, the length of the text is 42 because of the terminating line break character.

styleTextPropAtom: Specifies the text formatting.

The child-record hierarchy of the StyleTextPropAtom record A from the previous table is shown expanded in the following table.

Offset	Size	Structure
00006770	0022	StyleTextPropAtom - case of RT_StyleTextPropAtom
00006770	0008	RecordHeader - rh
00006778	0012	A: TextPFRun - textPFRun
0000678A	0008	TextCFRun - textCFRun

Figure 42: StyleTextPropAtom child-record hierarchy

textPFRun: Specifies the paragraph-level formatting for a single range of text. There is only one TextPFRun in the StyleTextPropAtom record because all of the individual bulleted paragraphs share the same paragraph-level properties.

The child-record hierarchy of the TextPFRun record A from the previous table is shown expanded in the following table.

Offset	Size	Structure	Value
00006778	0012	TextPFRun - textPFRun	

Offset	Size	Structure	Value
00006778	0004	unsigned integer - count	0x0000002A
0000677C	0002	unsigned integer - indentLevel	0x0000
0000677E	000C	TextPFException - pf	
0000677E	0004	A: PFMasks - masks	
00006782	0002	B: BulletFlags - bulletFlags	
00006784	0002	signed integer - bulletSize	0x0032
00006786	0004	ColorIndexStruct - bulletColor	

Figure 43: TextPFRun child-record hierarchy

count: 0x0000002A specifies that **textPFRun** applies to 42 characters.

indentLevel: 0x0000 specifies the indent level of the paragraphs.

pf: Specifies the basic paragraph-level formatting options for this run.

pf.masks: Specifies which fields of **pf** exist or are valid.

pf.bulletFlags: Specifies whether the run has certain paragraph-level properties. This field exists because **masks.bulletHasSize** is set. The **masks** field is expanded in the following table.

pf.bulletSize: 0x0032 specifies the bullet size. This field exists because **masks.bulletSize** is set.

pf.bulletColor: Specifies the bullet color. This field exists because **masks.bulletColor** is set.

The child-record hierarchy of the PFMasks record A from the table titled "TextPFRun child-record hierarchy" in this section is shown expanded in the following table.

Offset	Size	Structure	Value
0000677E	0004	PFMasks - masks	
0000677E	1 bit	unsigned integer - hasBullet	0x0
0000677E	1 bit	unsigned integer - bulletHasFont	0x0
0000677E	1 bit	unsigned integer - bulletHasColor	0x0
0000677E	1 bit	unsigned integer - bulletHasSize	0x1
0000677E	1 bit	unsigned integer - bulletFont	0x0
0000677E	1 bit	unsigned integer - bulletColor	0x1
0000677E	1 bit	unsigned integer - bulletSize	0x1
0000677E	1 bit	unsigned integer - bulletChar	0x0
0000677E	1 bit	unsigned integer - leftMargin	0x0
0000677E	1 bit	unsigned integer - unused	0x0
0000677E	1 bit	unsigned integer - indent	0x0
0000677E	1 bit	unsigned integer - align	0x0

Offset	Size	Structure	Value
0000677E	1 bit	unsigned integer - lineSpacing	0x0
0000677E	1 bit	unsigned integer - spaceBefore	0x0
0000677E	1 bit	unsigned integer - spaceAfter	0x0
0000677E	1 bit	unsigned integer - defaultTabSize	0x0
0000677E	1 bit	unsigned integer - fontAlign	0x0
0000677E	1 bit	unsigned integer - charWrap	0x0
0000677E	1 bit	unsigned integer - wordWrap	0x0
0000677E	1 bit	unsigned integer - overflow	0x0
0000677E	1 bit	unsigned integer - tabStops	0x0
0000677E	1 bit	unsigned integer - textDirection	0x0
0000677E	1 bit	unsigned integer - reserved1	0x0
0000677E	1 bit	unsigned integer - bulletBlip	0x0
0000677E	1 bit	unsigned integer - bulletScheme	0x0
0000677E	1 bit	unsigned integer - bulletHasScheme	0x0
0000677E	6 bits	unsigned integer - reserved2	0x00

Figure 44: PFMasks contents

bulletHasSize: 0x00000001 specifies that the **bulletFlags** field of the TextPFException shown in the table titled "TextPFRun child-record hierarchy" in this section exists.

bulletColor: 0x00000001 specifies that the **bulletColor** field of the TextPFException shown in the table titled "TextPFRun child-record hierarchy" in this section exists.

bulletSize: 0x00000001 specifies that the **bulletSize** field of the TextPFException shown in the table titled "TextPFRun child-record hierarchy" in this section exists.

The child-record hierarchy of the BulletFlags record B from the table titled "TextPFRun child-record hierarchy" in this section is shown expanded in the following table.

Offset	Size	Structure	Value
00006782	0002	BulletFlags - bulletFlags	
00006782	1 bit	unsigned integer - fHasBullet	0x1
00006782	1 bit	unsigned integer - fBulletHasFont	0x0
00006782	1 bit	unsigned integer - fBulletHasColor	0x0
00006782	1 bit	unsigned integer - fBulletHasSize	0x1
00006782	12 bits	unsigned integer - reserved	0x000

Figure 45: BulletFlags contents

fHasBullet: 0x0001 specifies that a bullet exists.

fBulletHasSize: 0x0001 specifies that the **bulletSize** field of the TextPFException shown in the table titled "TextPFRun child-record hierarchy" in this section is valid.

The following example shows how additional paragraph-level formatting is specified. The following [OutlineTextProps2.9.61Entry](#) record is located in the [OutlineTextProps2.9.60Container](#) record contained in the [PP2.4.23.5DocBinaryTagExtension](#) record shown in the table titled "PP9DocBinaryTagExtension child-record hierarchy" in section [3.6.1](#).

Offset	Size	Structure	Value
0000664A	0026	OutlineTextProps9Entry - outlineTextProps9Entry	
0000664A	0010	OutlineTextPropsHeaderExAtom - outlineTextHeaderAtom	
0000664A	0008	RecordHeader - rh	
0000664A	4 bits	unsigned integer - recVer	0x0
0000664A	12 bits	unsigned integer - recInstance	0x001
0000664C	0002	RecordType - recType	0x0FAF
0000664E	0004	unsigned integer - recLen	0x00000008
00006652	0004	SlideIdRef - slideIdRef	0x00000101
00006656	0004	TextTypeEnum - txType	0x00000001
0000665A	0016	StyleTextProp9Atom - styleTextProp9Atom	
0000665A	0008	RecordHeader - rh	
00006662	000E	StyleTextProp9 - styleTextProps9	
00006662	0006	TextPFException9 - pf9	
00006662	0004	PFMasks - masks	
00006666	0002	signed integer - bulletBlipRef	0x0000
00006668	0004	TextCFException9 - cf9	
0000666C	0004	TextSIException - si	

Figure 46: An OutlineTextProps9Entry that contains the additional paragraph-level properties for the content placeholder on presentation slide 2

The OutlineTextPropsHeaderExAtom specifies the corresponding text to which this formatting applies. The **rh.recInstance** field of the OutlineTextPropsHeaderExAtom along with the **slideIdRef** and **txType** fields are sufficient to find the corresponding text specified by a TextHeaderAtom record contained in the **SlideListWithTextContainer** record.

The OutlineTextProps2.9.61Entry contains one StyleTextProp2.9.67Atom because there is only one run in the text. This is the case because all bits of the **fontStyle.pp9rt** fields of all [TextCFException](#) records contained in the TextCFRun records are equal. Therefore, the TextPFException2.9.26, TextCFException2.9.17, and TextSIException apply to the entire text. The TextCFException2.9.17 specifies that there is a custom graphical bullet for this placeholder.

outlineTextHeaderAtom.rh.recInstance: 0x001 specifies that these additional properties apply to the second text body for the presentation slide specified by the **slideIdRef** field.

outlineTextHeaderAtom.slideIdRef: 0x00000101 specifies the presentation slide that contains the text that has additional paragraph-level properties.

outlineTextHeaderAtom.txType: 0x00000001 specifies the type of text. This matches the **txType** field of the TextHeaderAtom shown in the table titled "Basic paragraph-level formatting for placeholder text" in this section.

styleTextProp9Atom: Specifies the additional paragraph-level properties.

styleTextProp9Atom.styleTextProps9.pf9.bulletBlipRef: 0x0000 specifies the picture to use as the bullet symbol.

3.9.2 Character Formatting

This example shows how character-level formatting is specified for the green circular shape on **presentation slide 6** as shown in figure titled "Presentation slide 6" in section [3.1](#).

The text of the **shape** is specified in an [OfficeArtClientTextbox](#) record. The child-record hierarchy of the **OfficeArtSpContainer** ([\[MS-ODRAW\]](#) section 2.2.14) record D from the table titled "DrawingContainer child-record hierarchy" in section [3.8.1](#) is shown expanded in the following table.

Offset	Size	Structure	Value
00007E30	00FB	OfficeArtSpContainer - case of msofptSpContainer	
00007E30	0008	OfficeArtRecordHeader - rh	
00007E38	0010	OfficeArtFSP - shapeProp	
00007E48	0044	OfficeArtFOPT - shapePrimaryOptions	
00007E8C	000E	OfficeArtTertiaryFOPT - shapeTertiaryOptions	
00007E9A	0010	OfficeArtClientAnchor - clientAnchor	
00007EAA	0081	OfficeArtClientTextbox - clientTextbox	
00007EAA	0008	OfficeArtRecordHeader - rh	
00007EB2	000C	TextHeaderAtom - case of RT_TextHeaderAtom	
00007EBE	001D	TextBytesAtom - case of RT_TextBytesAtom	
00007EBE	0008	RecordHeader - rh	
00007EBE	4 bits	unsigned integer - recVer	0x0
00007EBE	12 bits	unsigned integer - recInstance	0x000
00007EC0	0002	RecordType - recType	0x0FA8
00007EC2	0004	unsigned integer - recLen	0x00000015
00007EC6	0015	array of bytes - textBytes	an \runderlined\rcircle
00007EDB	0050	StyleTextPropAtom - case of RT_StyleTextPropAtom	
00007EDB	0008	RecordHeader - rh	
00007EE3	000C	TextPFRun - textPFRun	
00007EEF	000E	A: TextCFRun - TextCFRun A	
00007EFD	0010	B: TextCFRun - TextCFRun B	

Offset	Size	Structure	Value
00007F0D	000E	C: TextCFRun - TextCFRun C	
00007F1B	0010	D: TextCFRun - TextCFRun D	

Figure 47: OfficeArtSpContainer child-record hierarchy

clientTextbox.case of RT_TextBytesAtom.rh.recLen: 0x00000015 specifies that the length of the corresponding text body is 22 because of the terminating line break character.

clientTextbox.case of RT_TextBytesAtom.textBytes: "an \runderlined\rrcircle" specifies the content of the text.

The basic character-level formatting is specified by four TextCFRun structures contained in the StyleTextPropAtom record that follows the TextBytesAtom record.

The child-record hierarchy of the TextCFRun record A from the previous table is shown expanded in the following table. The offset of the first TextCFRun depends on the paragraph-level formatting. When all TextPFRun records are read, the character-level formatting begins.

Offset	Size	Structure	Value
00007EEF	000E	A: TextCFRun - textCFRun	
00007EEF	0004	unsigned integer - count	0x00000002
00007EF3	000A	TextCFException - cf	
00007EF3	0004	CFMasks - masks	
00007EF3	1 bit	unsigned integer - bold	0x0
00007EF3	1 bit	unsigned integer - italic	0x0
00007EF3	1 bit	unsigned integer - underline	0x0
00007EF3	1 bit	unsigned integer - unused1	0x0
00007EF3	1 bit	unsigned integer - shadow	0x0
00007EF3	1 bit	unsigned integer - fehint	0x0
00007EF3	1 bit	unsigned integer - unused2	0x0
00007EF3	1 bit	unsigned integer - kumi	0x0
00007EF3	1 bit	unsigned integer - unused3	0x0
00007EF3	1 bit	unsigned integer - emboss	0x0
00007EF3	4 bits	unsigned integer - fHasStyle	0x0
00007EF3	2 bits	unsigned integer - unused4	0x0
00007EF3	1 bit	unsigned integer - typeface	0x0
00007EF3	1 bit	unsigned integer - size	0x0
00007EF3	1 bit	unsigned integer - color	0x1
00007EF3	1 bit	unsigned integer - position	0x0

Offset	Size	Structure	Value
00007EF3	1 bit	unsigned integer - pp10ext	0x0
00007EF3	1 bit	unsigned integer - oldEATypeface	0x0
00007EF3	1 bit	unsigned integer - ansiTypeface	0x1
00007EF3	1 bit	unsigned integer - symbolTypeface	0x0
00007EF3	1 bit	unsigned integer - newEATypeface	0x0
00007EF3	1 bit	unsigned integer - csTypeface	0x0
00007EF3	1 bit	unsigned integer - pp11ext	0x0
00007EF3	5 bits	unsigned integer - reserved	0x00
00007EF7	0002	unsigned integer - ansiFontRef	0x0000
00007EF9	0004	ColorIndexStruct - color	

Figure 48: TextCFRun record A child-record hierarchy

This TextCFRun specifies only the font and font color for the first two characters, "an". The **fontStyle** field does not exist, because none of the bits of the CFMasks record that determine the existence of **fontStyle** are set.

count: 0x00000002 specifies that these character-level formatting options apply to two characters. The corresponding characters are "an".

cf.masks.color: 0x0001 specifies that **cf.color** exists.

cf.masks.ansiTypeface: 0x0001 specifies that **cf.ansiFontRef** exists.

cf.ansiFontRef: 0x0000 specifies the font. This field exists because **cf.masks.ansiTypeface** is set.

cf.color: Specifies the color of the font. This field exists because **cf.masks.color** is set.

So far, the sum of the **count** field of the TextCFRun records is 2.

The child-record hierarchy of the TextCFRun record B from the table titled "OfficeArtSpContainer child-record hierarchy" in this section is shown expanded in the following table.

Offset	Size	Structure	Value
00007EFD	0010	B: TextCFRun - textCFRun	
00007EFD	0004	unsigned integer - count	0x00000002
00007F01	000C	TextCFException - cf	
00007F01	0004	CFMasks - masks	
00007F01	1 bit	unsigned integer - bold	0x0
00007F01	1 bit	unsigned integer - italic	0x0
00007F01	1 bit	unsigned integer - underline	0x1
00007F01	1 bit	unsigned integer - unused1	0x0
00007F01	1 bit	unsigned integer - shadow	0x0

Offset	Size	Structure	Value
00007F01	1 bit	unsigned integer - fehint	0x0
00007F01	1 bit	unsigned integer - unused2	0x0
00007F01	1 bit	unsigned integer - kumi	0x0
00007F01	1 bit	unsigned integer - unused3	0x0
00007F01	1 bit	unsigned integer - emboss	0x0
00007F01	4 bits	unsigned integer - fHasStyle	0x0
00007F01	2 bits	unsigned integer - unused4	0x0
00007F01	1 bit	unsigned integer - typeface	0x0
00007F01	1 bit	unsigned integer - size	0x0
00007F01	1 bit	unsigned integer - color	0x1
00007F01	1 bit	unsigned integer - position	0x0
00007F01	1 bit	unsigned integer - pp10ext	0x0
00007F01	1 bit	unsigned integer - oldEATypeface	0x0
00007F01	1 bit	unsigned integer - ansiTypeface	0x1
00007F01	1 bit	unsigned integer - symbolTypeface	0x0
00007F01	1 bit	unsigned integer - newEATypeface	0x0
00007F01	1 bit	unsigned integer - csTypeface	0x0
00007F01	1 bit	unsigned integer - pp11ext	0x0
00007F01	5 bits	unsigned integer - reserved	0x00
00007F05	0002	CFStyle - fontStyle	
00007F05	1 bit	unsigned integer - bold	0x0
00007F05	1 bit	unsigned integer - italic	0x0
00007F05	1 bit	unsigned integer - underline	0x1
00007F05	1 bit	unsigned integer - unused1	0x0
00007F05	1 bit	unsigned integer - shadow	0x0
00007F05	1 bit	unsigned integer - fehint	0x0
00007F05	1 bit	unsigned integer - unused2	0x0
00007F05	1 bit	unsigned integer - kumi	0x0
00007F05	1 bit	unsigned integer - unused3	0x0
00007F05	1 bit	unsigned integer - emboss	0x0
00007F05	4 bits	unsigned integer - pp9rt	0x0

Offset	Size	Structure	Value
00007F05	2 bits	unsigned integer - unused4	0x0
00007F07	0002	unsigned integer - ansiFontRef	0x0000
00007F09	0004	ColorIndexStruct - color	

Figure 49: TextCFRun B child-record hierarchy

count: 0x00000002 specifies that these character-level formatting options apply to the next 2 characters, " \r".

cf.masks.underline: 0x0001 specifies that **cf.fontStyle** exists and that **cf.fontStyle.underline** is valid.

cf.fontStyle: Specifies styling options. This field exists because **cf.masks.underline** is set.

cf.fontStyle.underline: 0x0001 specifies that the text is underlined.

So far, the sum of the **count** field of the TextCFRun records is 4.

The child-record hierarchy of the TextCFRun record C from the table titled "OfficeArtSpContainer child-record hierarchy" in this section is shown expanded in the following table.

Offset	Size	Structure	Value
00007F0D	000E	C: TextCFRun - textCFRun	
00007F0D	0004	unsigned integer - count	0x0000000B
00007F11	000A	TextCFException - cf	
00007F11	0004	CFMasks - masks	
00007F11	1 bit	unsigned integer - bold	0x0
00007F11	1 bit	unsigned integer - italic	0x0
00007F11	1 bit	unsigned integer - underline	0x0
00007F11	1 bit	unsigned integer - unused1	0x0
00007F11	1 bit	unsigned integer - shadow	0x0
00007F11	1 bit	unsigned integer - fehint	0x0
00007F11	1 bit	unsigned integer - unused2	0x0
00007F11	1 bit	unsigned integer - kumi	0x0
00007F11	1 bit	unsigned integer - unused3	0x0
00007F11	1 bit	unsigned integer - emboss	0x0
00007F11	4 bits	unsigned integer - fHasStyle	0x0
00007F11	2 bits	unsigned integer - unused4	0x0
00007F11	1 bit	unsigned integer - typeface	0x0
00007F11	1 bit	unsigned integer - size	0x0

Offset	Size	Structure	Value
00007F11	1 bit	unsigned integer - color	0x1
00007F11	1 bit	unsigned integer - position	0x0
00007F11	1 bit	unsigned integer - pp10ext	0x0
00007F11	1 bit	unsigned integer - oldEATypeface	0x0
00007F11	1 bit	unsigned integer - ansiTypeface	0x1
00007F11	1 bit	unsigned integer - symbolTypeface	0x0
00007F11	1 bit	unsigned integer - newEATypeface	0x0
00007F11	1 bit	unsigned integer - csTypeface	0x0
00007F11	1 bit	unsigned integer - pp11ext	0x0
00007F11	5 bits	unsigned integer - reserved	0x00
00007F15	0002	unsigned integer - ansiFontRef	0x0000
00007F17	0004	ColorIndexStruct - color	

Figure 50: TextCFRun C child-record hierarchy

The **fontStyle** field does not exist because none of the first 16 bits of the CFMasks record is set.

count: 0x0000000B specifies that these character-level properties apply to the next 11 characters, "underlined\r".

cf.masks.underline: 0x0000 specifies that the **underline** field of **fontStyle**, which does not exist in this TextCFRun, would not be valid.

So far, the sum of the **count** field of the TextCFRun records is 15.

The child-record hierarchy of the TextCFRun record D from the table titled "OfficeArtSpContainer child-record hierarchy" in this section is shown expanded in the following table.

Offset	Size	Structure	Value
00007F1B	0010	D: TextCFRun - textCFRun	
00007F1B	0004	unsigned integer - count	0x00000007
00007F1F	000C	TextCFException - cf	
00007F1F	0004	CFMasks - masks	
00007F1F	1 bit	unsigned integer - bold	0x0
00007F1F	1 bit	unsigned integer - italic	0x0
00007F1F	1 bit	unsigned integer - underline	0x1
00007F1F	1 bit	unsigned integer - unused1	0x0
00007F1F	1 bit	unsigned integer - shadow	0x0
00007F1F	1 bit	unsigned integer - fehint	0x0

Offset	Size	Structure	Value
00007F1F	1 bit	unsigned integer - unused2	0x0
00007F1F	1 bit	unsigned integer - kumi	0x0
00007F1F	1 bit	unsigned integer - unused3	0x0
00007F1F	1 bit	unsigned integer - emboss	0x0
00007F1F	4 bits	unsigned integer - fHasStyle	0x0
00007F1F	2 bits	unsigned integer - unused4	0x0
00007F1F	1 bit	unsigned integer - typeface	0x0
00007F1F	1 bit	unsigned integer - size	0x0
00007F1F	1 bit	unsigned integer - color	0x1
00007F1F	1 bit	unsigned integer - position	0x0
00007F1F	1 bit	unsigned integer - pp10ext	0x0
00007F1F	1 bit	unsigned integer - oldEATypeface	0x0
00007F1F	1 bit	unsigned integer - ansiTypeface	0x1
00007F1F	1 bit	unsigned integer - symbolTypeface	0x0
00007F1F	1 bit	unsigned integer - newEATypeface	0x0
00007F1F	1 bit	unsigned integer - csTypeface	0x0
00007F1F	1 bit	unsigned integer - pp11ext	0x0
00007F1F	5 bits	unsigned integer - reserved	0x00
00007F23	0002	CFStyle - fontStyle	
00007F23	1 bit	unsigned integer - bold	0x0
00007F23	1 bit	unsigned integer - italic	0x0
00007F23	1 bit	unsigned integer - underline	0x1
00007F23	1 bit	unsigned integer - unused1	0x0
00007F23	1 bit	unsigned integer - shadow	0x0
00007F23	1 bit	unsigned integer - fehint	0x0
00007F23	1 bit	unsigned integer - unused2	0x0
00007F23	1 bit	unsigned integer - kumi	0x0
00007F23	1 bit	unsigned integer - unused3	0x0
00007F23	1 bit	unsigned integer - emboss	0x0
00007F23	4 bits	unsigned integer - pp9rt	0x0
00007F23	2 bits	unsigned integer - unused4	0x0

Offset	Size	Structure	Value
00007F25	0002	unsigned integer - ansiFontRef	0x0000
00007F27	0004	ColorIndexStruct - color	

Figure 51: TextCFRun D child-record hierarchy

count: 0x00000007 specifies that these character-level properties apply to the next 7 characters, "circle" and the terminating '\n'. Note that the terminating '\n' is not included in the preceding TextBytesAtom shown in the table titled "OfficeArtSpContainer child-record hierarchy" in this section.

cf.masks.underline: 0x0001 specifies that **cf.fontStyle** exists and that **cf.fontStyle.underline** is valid.

cf.fontStyle: Specifies character-level styling.

cf.fontStyle.underline: 0x0001 specifies that the text is underlined.

So far, the sum of the **count** field of the TextCFRun text structures is 22. Because the sum of the **count** field is the length of the text, this TextCFRun record is the final TextCFRun record.

3.9.3 TextInteractiveInfo

This example shows how the hyperlink is specified for the yellow square on **presentation slide 6** as shown in figure titled "Presentation slide 6" in section [3.1](#).

The clickable text hyperlink is specified by an [MouseClickedInteractiveInfoContainer](#) record and a [MouseClickedTextInteractiveInfoAtom](#) record following the [TextHeaderAtom](#) record, the characters of the text, and the formatting.

The child-record hierarchy of the **OfficeArtSpContainer** ([\[MS-ODRAW\]](#) section 2.2.14) record B from the table titled "DrawingContainer child-record hierarchy" in section [3.8.1](#) is shown expanded in the following table.

Offset	Size	Structure	Value
00007C30	0109	OfficeArtSpContainer - case of msobftSpContainer	
00007C30	0008	OfficeArtRecordHeader - rh	
00007C38	0010	OfficeArtFSP - shapeProp	
00007C48	0044	OfficeArtFOPT - shapePrimaryOptions	
00007C8C	000E	OfficeArtTertiaryFOPT - shapeTertiaryOptions	
00007C9A	0010	OfficeArtClientAnchor - clientAnchor	
00007CAA	008F	OfficeArtClientTextbox - clientTextbox	
00007CAA	0008	OfficeArtRecordHeader - rh	
00007CB2	000C	TextHeaderAtom - case of RT_TextHeaderAtom	
00007CBE	001D	TextBytesAtom - case of RT_TextBytesAtom	
00007CBE	0008	RecordHeader - rh	
00007CC6	0015	array of bytes - textBytes	a \rhyperlinked\rsquare

Offset	Size	Structure	Value
00007CDB	002E	StyleTextPropAtom - case of RT_StyleTextPropAtom	
00007D09	0020	A: MouseClickInteractiveInfoContainer - mouseClickInteractiveInfoContainer	
00007D29	0010	B: MouseClickTextInteractiveInfoAtom - mouseClickTextInteractiveInfoAtom	

Figure 52: OfficeArtSpContainer child-record hierarchy

The child-record hierarchy of the MouseClickInteractiveInfoContainer record A from the previous table is shown expanded in the following table.

Offset	Size	Structure	Value
00007D09	0020	MouseClickInteractiveInfoContainer - mouseClickInteractiveInfoContainer	
00007D09	0008	RecordHeader - rh	
00007D09	4 bits	unsigned integer - recVer	0xF
00007D09	12 bits	unsigned integer - recInstance	0x000
00007D0B	0002	RecordType - recType	0x0FF2
00007D0D	0004	unsigned integer - recLen	0x00000018
00007D11	0018	InteractiveInfoAtom - interactiveInfoAtom	
00007D11	0008	RecordHeader - rh	
00007D11	4 bits	unsigned integer - recVer	0x0
00007D11	12 bits	unsigned integer - recInstance	0x000
00007D13	0002	RecordType - recType	0x0FF3
00007D15	0004	unsigned integer - recLen	0x00000010
00007D19	0004	unsigned integer - soundIdRef	0x00000000
00007D1D	0004	unsigned integer - exHyperlinkIdRef	0x0000001C
00007D21	0001	InteractiveInfoActionEnum - action	0x04
00007D22	0001	OLEVerbEnum - oleVerb	0x00
00007D23	0001	InteractiveInfoJumpEnum - jump	0x00
00007D24	1 bit	bit - fAnimated	0x0
00007D24	1 bit	bit - fStopSound	0x0
00007D24	1 bit	bit - fCustomShowReturn	0x0
00007D24	1 bit	bit - fVisited	0x0
00007D24	4 bits	unsigned integer - reserved	0x0
00007D25	0001	LinkToEnum - hyperlinkType	0x08

Figure 53: MouseClickInteractiveInfoContainer child-record hierarchy

interactiveInfoAtom.exHyperlinkIdRef: 0x0000001C specifies the identifier of the hyperlink that is the target of this interactive portion of text.

The child-record hierarchy of the `MouseClickedTextInteractiveInfoAtom` record B from the table titled "OfficeArtSpContainer child-record hierarchy" in this section is shown expanded in the following table.

Offset	Size	Structure	Value
00007D29	0010	MouseClickedTextInteractiveInfoAtom - mouseClickTextInteractiveInfoAtom	
00007D29	0008	RecordHeader - rh	
00007D29	4 bits	unsigned integer - recVer	0x0
00007D29	12 bits	unsigned integer - recInstance	0x000
00007D2B	0002	RecordType - recType	0x0FDF
00007D2D	0004	unsigned integer - recLen	0x00000008
00007D31	0008	TextRange - range	
00007D31	0004	signed integer - begin	0x0000000F
00007D35	0004	signed integer - end	0x00000015

Figure 54: MouseClickTextInteractiveInfoAtom child-record hierarchy

range.begin: 0x0000000F specifies the zero-based index of the first character, the 's', to which this hyperlink applies.

range.end: 0x00000015 specifies the zero-based index of the last character, the 'e', to which this hyperlink applies.

An [ExHyperlinkContainer](#) record exists for each hyperlink referenced in the document. The following `ExHyperlinkContainer` record is the one referenced in the preceding sample of the yellow square.

The child-record hierarchy of the `ExHyperlinkContainer` record H from the table titled "ExObjListContainer child-record hierarchy" in section [3.8.4](#) is shown expanded in the following table.

Offset	Size	Structure	Value
00005D95	005E	ExHyperlinkContainer - case of RT_ExternalHyperlink	
00005D95	0008	RecordHeader - rh	
00005D9D	000C	ExHyperlinkAtom - exHyperlinkAtom	
00005D9D	0008	RecordHeader - rh	
00005DA5	0004	unsigned integer - exHyperlinkId	0x0000001C
00005DA9	0014	FriendlyNameAtom - friendlyNameAtom	
00005DA9	0008	RecordHeader - rh	
00005DB1	000C	array of bytes - friendlyName	square
00005DBD	0036	TargetAtom - targetAtom	
00005DBD	0008	RecordHeader - rh	

Offset	Size	Structure	Value
00005DC5	002E	array of bytes - target	http://www.contoso.com/

Figure 55: ExHyperlinkContainer child-record hierarchy

The **exHyperlinkAtom.exHyperlinkId** field matches the **exHyperlinkIdRef** field of the InteractiveInfoAtom record shown in the table titled "MouseClickedInteractiveInfoContainer child-record hierarchy" in this section.

targetAtom: Specifies the target of the hyperlink. In this case, it is the external Web site located at <http://www.contoso.com/>.

3.9.4 Metacharacter

The following example shows how a footer metacharacter is specified on [presentation slide 6](#).

The following diagram shows the context of a footer placeholder on the [main master slide](#).

The child-record hierarchy of the **MainMasterContainer** (section [2.5.3](#)) record B from the table titled "Top-level record sequence in the PowerPoint Document Stream from sample.ppt" in section [3.3](#) is shown expanded in the following table.

Offset	Size	Structure
00000CC5	09AC	MainMasterContainer - case of RT_MainMaster
00000CC5	0008	RecordHeader - rh
00000CCD	0020	SlideAtom - slideAtom
00000CED	0028	SchemeListElementColorSchemeAtom - schemeListElementColorSchemeAtom
00000D15	0028	SchemeListElementColorSchemeAtom - schemeListElementColorSchemeAtom
00000D3D	0028	SchemeListElementColorSchemeAtom - schemeListElementColorSchemeAtom
00000D65	0028	SchemeListElementColorSchemeAtom - schemeListElementColorSchemeAtom
00000D8D	0028	SchemeListElementColorSchemeAtom - schemeListElementColorSchemeAtom
00000DB5	0028	SchemeListElementColorSchemeAtom - schemeListElementColorSchemeAtom
00000DDD	0028	SchemeListElementColorSchemeAtom - schemeListElementColorSchemeAtom
00000E05	0028	SchemeListElementColorSchemeAtom - schemeListElementColorSchemeAtom
00000E2D	0028	SchemeListElementColorSchemeAtom - schemeListElementColorSchemeAtom
00000E55	0028	SchemeListElementColorSchemeAtom - schemeListElementColorSchemeAtom
00000E7D	0028	SchemeListElementColorSchemeAtom - schemeListElementColorSchemeAtom
00000EA5	0028	SchemeListElementColorSchemeAtom - schemeListElementColorSchemeAtom
00000ECD	0046	TextMasterStyleAtom - textMasterStyleAtom
00000F13	0084	TextMasterStyleAtom - textMasterStyleAtom
00000F97	0076	TextMasterStyleAtom - textMasterStyleAtom
0000100D	005A	TextMasterStyleAtom - textMasterStyleAtom

Offset	Size	Structure
00001067	0014	TextMasterStyleAtom - textMasterStyleAtom
0000107B	0046	TextMasterStyleAtom - textMasterStyleAtom
000010C1	0046	TextMasterStyleAtom - textMasterStyleAtom
00001107	04DE	DrawingContainer - drawing
00001107	0008	RecordHeader - rh
0000110F	04D6	OfficeArtDgContainer - OfficeArtDg
0000110F	0008	OfficeArtRecordHeader - rh
00001117	0010	OfficeArtFDG - drawingData
00001127	046E	A: OfficeArtSpgrContainer - groupShape
00001595	0050	OfficeArtSpContainer - shape
000015E5	0028	SlideSchemeColorSchemeAtom - slideSchemeColorSchemeAtom
0000160D	0040	SlideProgTagsContainer - slideProgTagsContainer
0000164D	0024	TemplateNameAtom - templateNameAtom

Figure 56: MainMasterContainer child-record hierarchy

The child-record hierarchy of the **OfficeArtSpgrContainer** record A from the previous table is shown expanded in the following table.

Offset	Size	Structure
00001127	046E	OfficeArtSpgrContainer - groupShape
00001127	0008	OfficeArtRecordHeader - rh
0000112F	0030	OfficeArtSpContainer - case of msofbtSpContainer
0000115F	00DA	OfficeArtSpContainer - case of msofbtSpContainer
00001239	011E	OfficeArtSpContainer - case of msofbtSpContainer
00001357	00BE	OfficeArtSpContainer - case of msofbtSpContainer
00001415	00C0	OfficeArtSpContainer - case of msofbtSpContainer
00001415	0008	OfficeArtRecordHeader - rh
0000141D	0010	OfficeArtFSP - shapeProp
0000142D	0038	OfficeArtFOPT - shapePrimaryOptions
00001465	0010	OfficeArtClientAnchor - clientAnchor
00001475	0018	OfficeArtClientData - clientData
0000148D	0048	A: OfficeArtClientTextbox - clientTextbox
000014D5	00C0	OfficeArtSpContainer - case of msofbtSpContainer

Figure 57: OfficeArtSpgrContainer child-record hierarchy

The child-record hierarchy of the OfficeArtClientTextbox record A from the previous table is shown expanded in the following table.

Offset	Size	Structure	Value
0000148D	0048	OfficeArtClientTextbox - clientTextbox	
0000148D	0008	OfficeArtRecordHeader - rh	
00001495	000C	TextHeaderAtom - case of RT_TextHeaderAtom	
00001495	0008	RecordHeader - rh	
0000149D	0004	TextTypeEnum - textType	0x00000004
000014A1	000A	TextCharsAtom - case of RT_TextCharsAtom	
000014A1	0008	RecordHeader - rh	
000014A9	0002	array of bytes - textChars	*
000014AB	001E	StyleTextPropAtom - case of RT_StyleTextPropAtom	
000014AB	0008	RecordHeader - rh	
000014B3	000C	TextPFRun - textPFRun	
000014BF	000A	TextCFRun - textCFRun	
000014BF	0004	unsigned integer - count	0x00000002
000014C3	0006	TextCFException - cf	
000014C9	000C	FooterMCAAtom - case of RT_FooterMetaCharAtom	
000014C9	0008	RecordHeader - rh	
000014D1	0004	signed integer - position	0x00000000

Figure 58: OfficeArtClientTextbox record A child-record hierarchy

case of RT_TextHeaderAtom.textType: 0x00000004 specifies that this text is of type Tx_TYPE_OTHER.

case of RT_TextCharsAtom.textChars: "*" is only used as a placeholder in this context.

case of RT_FooterMetaCharAtom.position: 0x00000000 specifies that a footer metacharacter exists as the first character in the placeholder.

The main master slide specified by the **MainMasterContainer** record is the main master slide for presentation slide 6. When presentation slide 6 contains a [FooterAtom](#) record, the text specified by the FooterAtom is placed into the shape specified by the OfficeArtClientTextBox on the main master slide.

Slide-level footer information is contained in the [PerSlideHeadersFootersContainer](#) record contained in the **SlideContainer** (section [2.5.1](#)) for presentation slide 6.

The child-record hierarchy of the PerSlideHeadersFootersContainer record B from the table titled "SlideContainer record U child-record hierarchy" in section [3.5.2](#) is shown expanded in the following table.

Offset	Size	Structure
00007B1E	003A	PerSlideHeadersFootersContainer - perSlideHeadersFootersContainer

Offset	Size	Structure
00007B1E	0008	RecordHeader - rh
00007B26	000C	A: HeadersFootersAtom - hfAtom
00007B32	0026	B: FooterAtom - footerAtom

Figure 59: PerSlideHeadersFooterContainer child-record hierarchy

The child-record hierarchy of the HeadersFootersAtom record A from this section is shown expanded in the following table.

Offset	Size	Structure	Value
00007B26	000C	A: HeadersFootersAtom - hfAtom	
00007B26	0008	RecordHeader - rh	
00007B2E	0002	signed integer - formatId	0x000D
00007B30	1 bit	unsigned integer - fHasDate	0x0
00007B30	1 bit	unsigned integer - fHasTodayDate	0x0
00007B30	1 bit	unsigned integer - fHasUserDate	0x1
00007B30	1 bit	unsigned integer - fHasSlideNumber	0x0
00007B30	1 bit	unsigned integer - fHasHeader	0x0
00007B30	1 bit	unsigned integer - fHasFooter	0x1
00007B30	10 bits	unsigned integer - reserved	0x000

Figure 60: HeaderFootersAtom record A child-record hierarchy

fHasFooter: 0x0001 specifies that this slide should show the footer.

The child-record hierarchy of the FooterAtom record B from this section is shown expanded in the following table.

Offset	Size	Structure	Value
00007B32	0026	B: FooterAtom - footerAtom	
00007B32	0008	RecordHeader - rh	
00007B32	4 bits	unsigned integer - recVer	0x0
00007B32	12 bits	unsigned integer - recInstance	0x002
00007B34	0002	RecordType - recType	0x0FBA
00007B36	0004	unsigned integer - recLen	0x0000001E
00007B3A	001E	array of bytes - footer	text formatting

Figure 61: FooterAtom record B child-record hierarchy

footer: "text formatting" specifies the characters to display for the footer metacharacter when it appears on this slide.

4 Security Considerations

For **encrypted documents**, the block number 0 is reused for every field of an **OfficeArtBStoreContainerFileBlock** record (described in [\[MS-ODRAW\]](#) section 2.2.22) within the **Pictures Stream**.

Additional security considerations for encrypted documents are described in [\[MS-OFFCRYPTO\]](#) section 4.1.3.2.

See the **CryptSession10Container** record (section [2.3.7](#)) for more information about how to encrypt and decrypt encrypted documents.

5 Appendix A: Product Behavior

The information in this specification is applicable to the following Microsoft products or supplemental software. References to product versions include updates to those products.

- Microsoft PowerPoint 97
- Microsoft PowerPoint 2000
- Microsoft PowerPoint 2002
- Microsoft Office PowerPoint 2003
- Microsoft Office PowerPoint 2007
- Microsoft PowerPoint 2010
- Microsoft PowerPoint 2013
- Microsoft PowerPoint 2016

Exceptions, if any, are noted in this section. If an update version, service pack or Knowledge Base (KB) number appears with a product name, the behavior changed in that update. The new behavior also applies to subsequent updates unless otherwise specified. If a product edition appears with the product version, behavior is different in that product edition.

Unless otherwise specified, any statement of optional behavior in this specification that is prescribed using the terms "SHOULD" or "SHOULD NOT" implies product behavior in accordance with the SHOULD or SHOULD NOT prescription. Unless otherwise specified, the term "MAY" implies that the product does not follow the prescription.

[<1> Section 2.1.2](#): PowerPoint 2000, PowerPoint 2002, Office PowerPoint 2003, Office PowerPoint 2007, PowerPoint 2010, and PowerPoint 2013 preserve unknown records found in the following records: **DocumentContainer** (section [2.4.1](#)), **DrawingContainer** (section [2.5.13](#)), **DrawingGroupContainer** (section [2.4.3](#)), **OfficeArtClientData** (section [2.7.3](#)), **ExControlContainer** (section [2.10.10](#)), **ExOleEmbedContainer** (section [2.10.27](#)), **ExOleLinkContainer** (section [2.10.29](#)), **HandoutContainer** (section [2.5.8](#)), **Kinsoku9Container** (section [2.9.6](#)), **KinsokuContainer** (section [2.9.2](#)), **MainMasterContainer** (section [2.5.3](#)), **MasterListWithTextContainer** (section [2.4.14.1](#)), **NamedShowsContainer** (section [2.6.2](#)), **NormalViewSetInfoContainer** (section [2.4.21.2](#)), **NotesContainer** (section [2.5.6](#)), **NotesListWithTextContainer** (section [2.4.14.6](#)), **NotesViewInfoContainer** (section [2.4.21.12](#)), **SubEffectContainer** (section [2.8.16](#)), **SlideContainer** (section [2.5.1](#)), **SlideListWithTextContainer** (section [2.4.14.3](#)), and **SlideViewInfoContainer** (section [2.4.21.9](#)).

PowerPoint 2002, Office PowerPoint 2003, Office PowerPoint 2007, PowerPoint 2010, and PowerPoint 2013 additionally preserve unknown records found in the following records:

ClientVisualElementContainer (section [2.8.44](#)), **ExtTimeNodeContainer** (section [2.8.15](#)), **TimeAnimateBehaviorContainer** (section [2.8.29](#)), **TimeAnimationValueListContainer** (section [2.8.31](#)), **TimeBehaviorContainer** (section [2.8.34](#)), **TimeColorBehaviorContainer** (section [2.8.52](#)), **TimeCommandBehaviorContainer** (section [2.8.71](#)), **TimeConditionContainer** (section [2.8.75](#)), **TimeEffectBehaviorContainer** (section [2.8.61](#)), **TimeMotionBehaviorContainer** (section [2.8.63](#)), **TimePropertyList4TimeNodeContainer** (section [2.8.18](#)), **TimeRotationBehaviorContainer** (section [2.8.65](#)), **TimeScaleBehaviorContainer** (section [2.8.67](#)), **TimeSetBehaviorContainer** (section [2.8.69](#)), and **TimeStringListContainer** (section [2.8.36](#)).

[<2> Section 2.1.5](#): PowerPoint 2002, Office PowerPoint 2003, Office PowerPoint 2007, PowerPoint 2010, and PowerPoint 2013 create this stream for encrypted documents, but the contents of the stream will be empty.

<3> [Section 2.1.7](#): PowerPoint 97 and PowerPoint 2000 always omit and ignore this storage, because these versions do not support signatures. PowerPoint 2002 and Office PowerPoint 2003 also omit and ignore this storage and instead use the "_signatures" stream.

<4> [Section 2.1.9](#): PowerPoint 97 and PowerPoint 2000 always omit and ignore this stream, because these versions do not support signatures. PowerPoint 2002 and Office PowerPoint 2003 do not omit this stream.

<5> [Section 2.2.3](#): The object models in PowerPoint 97, PowerPoint 2000, PowerPoint 2002, and Office PowerPoint 2003 allow bullet sizes to be specified as percentages outside the range of 25 to 400, inclusive.

<6> [Section 2.3.2](#): PowerPoint 2002 uses the **headerToken** 0xE391C05F for **encrypted documents**.

<7> [Section 2.3.2](#): PowerPoint 2000 initially used the value 0x00000009 to indicate to PowerPoint 97 that a file contained multiple main master slides and therefore could not be opened by PowerPoint 97. PowerPoint 97 was subsequently updated to add support for reading files with multiple main master slides, and PowerPoint 2000 was later updated to stop writing 0x00000009 to indicate the presence of multiple master slides.

<8> [Section 2.3.2](#): PowerPoint 97 omits this field.

<9> [Section 2.3.3](#): PowerPoint 97, PowerPoint 2000, PowerPoint 2002, Office PowerPoint 2003, Office PowerPoint 2007, PowerPoint 2010, and PowerPoint 2013 write the minor build version of powerpnt.exe to this field.

<10> [Section 2.3.3](#): PowerPoint 97 and PowerPoint 2000 will always omit this field because they do not support opening or creating encrypted documents.

<11> [Section 2.3.7](#): PowerPoint 2002 writes 0xE391C05F to the **headerToken** field for an encrypted document.

<12> [Section 2.4.15.2](#): PowerPoint 97 behaves unpredictably if **formatId** is 0x000D; PowerPoint 2000, PowerPoint 2002, Office PowerPoint 2003, Office PowerPoint 2007, PowerPoint 2010, and PowerPoint 2013 interpret it as 0x0000 instead.

<13> [Section 2.4.16.5](#): PowerPoint 97, PowerPoint 2000, PowerPoint 2002, Office PowerPoint 2003, Office PowerPoint 2007, PowerPoint 2010, and PowerPoint 2013 store the file extension of the source sound file initially embedded. Regardless of the file extension, only **WAV** and **AIFF** audio files are supported by these versions for playback.

<14> [Section 2.4.17.1](#): Only PowerPoint 2000 fully supports the **BroadcastDocInfo9Container** record. PowerPoint 2002 supports a subset of this record necessary for archiving a presentation broadcast.

<15> [Section 2.4.23.1](#): PowerPoint 97 sets this field to 0x001.

<16> [Section 2.4.23.4](#): PowerPoint 97 ignores this record.

<17> [Section 2.4.23.4](#): PowerPoint 97 and PowerPoint 2000 ignore this record.

<18> [Section 2.4.23.4](#): PowerPoint 97, PowerPoint 2000 and PowerPoint 2002 ignore this record.

<19> [Section 2.4.23.4](#): PowerPoint 97, PowerPoint 2000, PowerPoint 2002, and Office PowerPoint 2003 ignore this record.

<20> [Section 2.4.23.5](#): PowerPoint 2000 and PowerPoint 2002 do not ignore this field.

<21> [Section 2.4.23.5](#): PowerPoint 2000 does not ignore this field.

- [<22> Section 2.4.23.5](#): PowerPoint 2000 does not ignore this field.
- [<23> Section 2.4.23.5](#): PowerPoint 2000 and PowerPoint 2002 do not ignore this field.
- [<24> Section 2.4.23.6](#): PowerPoint 2002 and Office PowerPoint 2003 do not ignore this field.
- [<25> Section 2.4.23.6](#): PowerPoint 2002 and Office PowerPoint 2003 do not omit this field when the document contains embedded reviewer documents.
- [<26> Section 2.4.23.6](#): PowerPoint 2002 and Office PowerPoint 2003 do not ignore this field.
- [<27> Section 2.4.23.6](#): PowerPoint 2002 and Office PowerPoint 2003 do not omit this field when the document contains embedded reviewer documents.
- [<28> Section 2.4.23.6](#): PowerPoint 2002 and Office PowerPoint 2003 do not ignore this field.
- [<29> Section 2.4.23.6](#): PowerPoint 2002 and Office PowerPoint 2003 do not omit this field when the document contains embedded reviewer documents.
- [<30> Section 2.4.23.8](#): Office PowerPoint 2007, PowerPoint 2010, and PowerPoint 2013 do not omit this field.
- [<31> Section 2.5.1](#): Office PowerPoint 2007, PowerPoint 2010, and PowerPoint 2013 do not preserve this field.
- [<32> Section 2.5.1](#): Office PowerPoint 2007, PowerPoint 2010, and PowerPoint 2013 do not ignore this field.
- [<33> Section 2.5.1](#): PowerPoint 97 does not preserve this field.
- [<34> Section 2.5.1](#): Office PowerPoint 2007, PowerPoint 2010, and PowerPoint 2013 do not preserve this record.
- [<35> Section 2.5.2](#): Office PowerPoint 2007, PowerPoint 2010, and PowerPoint 2013 do not ignore this record.
- [<36> Section 2.5.2](#): PowerPoint 97 does not preserve this record.
- [<37> Section 2.5.2](#): Office PowerPoint 2007, PowerPoint 2010, and PowerPoint 2013 do not ignore this record.
- [<38> Section 2.5.2](#): PowerPoint 97 does not preserve this record.
- [<39> Section 2.5.2](#): Office PowerPoint 2007, PowerPoint 2010, and PowerPoint 2013 do not ignore this record.
- [<40> Section 2.5.2](#): PowerPoint 97 does not preserve this record.
- [<41> Section 2.5.2](#): Office PowerPoint 2007, PowerPoint 2010, and PowerPoint 2013 do not ignore this record.
- [<42> Section 2.5.2](#): PowerPoint 97 does not preserve this record.
- [<43> Section 2.5.2](#): Office PowerPoint 2007, PowerPoint 2010, and PowerPoint 2013 do not ignore this record.
- [<44> Section 2.5.2](#): PowerPoint 97 does not preserve this record.
- [<45> Section 2.5.2](#): Office PowerPoint 2007, PowerPoint 2010, and PowerPoint 2013 do not ignore this record.
- [<46> Section 2.5.2](#): PowerPoint 97 does not preserve this record.

[<47> Section 2.5.2](#): Office PowerPoint 2007, PowerPoint 2010, and PowerPoint 2013 do not ignore this record.

[<48> Section 2.5.2](#): PowerPoint 97 does not preserve this record.

[<49> Section 2.5.3](#): Office PowerPoint 2007, PowerPoint 2010, and PowerPoint 2013 do not ignore this field.

[<50> Section 2.5.3](#): PowerPoint 97 does not preserve this field.

[<51> Section 2.5.3](#): Office PowerPoint 2007, PowerPoint 2010, and PowerPoint 2013 do not preserve this field.

[<52> Section 2.5.3](#): Office PowerPoint 2007, PowerPoint 2010, and PowerPoint 2013 do not preserve this field.

[<53> Section 2.5.4](#): Office PowerPoint 2007, PowerPoint 2010, and PowerPoint 2013 do not ignore this record.

[<54> Section 2.5.4](#): PowerPoint 97 does not preserve this record.

[<55> Section 2.5.4](#): Office PowerPoint 2007, PowerPoint 2010, and PowerPoint 2013 do not ignore this record.

[<56> Section 2.5.4](#): PowerPoint 97 does not preserve this record.

[<57> Section 2.5.4](#): Office PowerPoint 2007, PowerPoint 2010, and PowerPoint 2013 do not ignore this record.

[<58> Section 2.5.4](#): PowerPoint 97 does not preserve this record.

[<59> Section 2.5.4](#): Office PowerPoint 2007, PowerPoint 2010, and PowerPoint 2013 do not ignore this record.

[<60> Section 2.5.4](#): PowerPoint 97 does not preserve this record.

[<61> Section 2.5.4](#): Office PowerPoint 2007, PowerPoint 2010, and PowerPoint 2013 do not ignore this record.

[<62> Section 2.5.4](#): PowerPoint 97 does not preserve this record.

[<63> Section 2.5.4](#): Office PowerPoint 2007, PowerPoint 2010, and PowerPoint 2013 do not ignore this record.

[<64> Section 2.5.4](#): PowerPoint 97 does not preserve this record.

[<65> Section 2.5.4](#): Office PowerPoint 2007, PowerPoint 2010, and PowerPoint 2013 do not ignore this record.

[<66> Section 2.5.4](#): PowerPoint 97 does not preserve this record.

[<67> Section 2.5.4](#): Office PowerPoint 2007, PowerPoint 2010, and PowerPoint 2013 do not ignore this record.

[<68> Section 2.5.4](#): PowerPoint 97 does not preserve this record.

[<69> Section 2.5.6](#): Office PowerPoint 2007, PowerPoint 2010, and PowerPoint 2013 do not preserve this record.

[<70> Section 2.5.7](#): Office PowerPoint 2007, PowerPoint 2010, and PowerPoint 2013 do not ignore this record.

- [<71> Section 2.5.7](#): PowerPoint 97 does not preserve this record.
- [<72> Section 2.5.7](#): Office PowerPoint 2007, PowerPoint 2010, and PowerPoint 2013 do not ignore this record.
- [<73> Section 2.5.7](#): PowerPoint 97 does not preserve this record.
- [<74> Section 2.5.7](#): Office PowerPoint 2007, PowerPoint 2010, and PowerPoint 2013 do not ignore this record.
- [<75> Section 2.5.7](#): PowerPoint 97 does not preserve this record.
- [<76> Section 2.5.8](#): Office PowerPoint 2007, PowerPoint 2010, and PowerPoint 2013 do not preserve this record.
- [<77> Section 2.5.9](#): Office PowerPoint 2007, PowerPoint 2010, and PowerPoint 2013 do not ignore this record.
- [<78> Section 2.5.9](#): PowerPoint 97 does not preserve this record.
- [<79> Section 2.5.9](#): Office PowerPoint 2007, PowerPoint 2010, and PowerPoint 2013 do not ignore this record.
- [<80> Section 2.5.9](#): PowerPoint 97 does not preserve this record.
- [<81> Section 2.5.22](#): PowerPoint 97 ignores this record.
- [<82> Section 2.5.22](#): PowerPoint 97 and PowerPoint 2000 ignore this record.
- [<83> Section 2.5.22](#): PowerPoint 97, PowerPoint 2000, PowerPoint 2002, and Office PowerPoint 2003 ignore this record.
- [<84> Section 2.5.24](#): PowerPoint 2002 and Office PowerPoint 2003 do not ignore this field.
- [<85> Section 2.5.24](#): PowerPoint 2002 and Office PowerPoint 2003 do not omit this field when the document contains embedded reviewer documents.
- [<86> Section 2.5.24](#): PowerPoint 2002 and Office PowerPoint 2003 do not ignore this field.
- [<87> Section 2.5.24](#): PowerPoint 2002 and Office PowerPoint 2003 do not omit this field when the document contains embedded reviewer documents.
- [<88> Section 2.7.4](#): Office PowerPoint 2007, PowerPoint 2010, and PowerPoint 2013 do not ignore this record.
- [<89> Section 2.7.4](#): PowerPoint 97 does not preserve this record.
- [<90> Section 2.7.4](#): Office PowerPoint 2007, PowerPoint 2010, and PowerPoint 2013 do not ignore this record.
- [<91> Section 2.7.4](#): PowerPoint 97 does not preserve this record.
- [<92> Section 2.7.4](#): Office PowerPoint 2007, PowerPoint 2010, and PowerPoint 2013 do not ignore this record.
- [<93> Section 2.7.4](#): PowerPoint 97 does not preserve this record.
- [<94> Section 2.7.4](#): Office PowerPoint 2007, PowerPoint 2010, and PowerPoint 2013 do not ignore this record.
- [<95> Section 2.7.4](#): PowerPoint 97 does not preserve this record.

- [<96> Section 2.7.6](#): PowerPoint 97 and PowerPoint 2000 ignore this field.
- [<97> Section 2.7.9](#): PowerPoint 97, PowerPoint 2000, PowerPoint 2002 and Office PowerPoint 2003 do not ignore this flag.
- [<98> Section 2.7.9](#): PowerPoint 97, PowerPoint 2000, PowerPoint 2002 and Office PowerPoint 2003 do not ignore this flag.
- [<99> Section 2.7.14](#): PowerPoint 97 sets this field to 0x001 or 0x002.
- [<100> Section 2.7.17](#): PowerPoint 97 ignores this record.
- [<101> Section 2.7.17](#): PowerPoint 97 and PowerPoint 2000 ignore this record.
- [<102> Section 2.7.17](#): PowerPoint 97, PowerPoint 2000 and PowerPoint 2002 ignore this record.
- [<103> Section 2.8.1](#): PowerPoint 97 and PowerPoint 2000 do not ignore this field. PowerPoint 2002, Office PowerPoint 2003, Office PowerPoint 2007, PowerPoint 2010, and PowerPoint 2013 do not ignore this field if an animation hash computed as specified in the [HashCode10Atom](#) record does not match the value stored in the HashCode10Atom record itself. If the two hashes do match, the contents of this field are ignored in favor of the contents of the **ExtTimeNodeContainer** record contained by the **SlideContainer** (section 2.5.1) or **MainMasterContainer** (section 2.5.3) record that contains this **AnimationInfoContainer** record. If the two hashes do not match, the contents of the **ExtTimeNodeContainer** record are instead ignored in favor of the contents of the **AnimationInfoAtom** records.
- [<104> Section 2.8.2](#): If this field is -1, PowerPoint 97 and PowerPoint 2000 play the animation for this shape before all other shapes; PowerPoint 2002, Office PowerPoint 2003, Office PowerPoint 2007, PowerPoint 2010, and PowerPoint 2013 ignore the animation for the shape.
- [<105> Section 2.8.2](#): PowerPoint 2002 and Office PowerPoint 2003 always write out 0x00.
- [<106> Section 2.8.10](#): Office PowerPoint 2007, PowerPoint 2010, and PowerPoint 2013 set this value as less than or equal to 0x00000009.
- [<107> Section 2.9.53](#): PowerPoint 97, PowerPoint 2000, PowerPoint 2002, Office PowerPoint 2003, Office PowerPoint 2007, PowerPoint 2010, and PowerPoint 2013 ignore this record when **end – begin** is greater than or equal to 256.
- [<108> Section 2.10.28](#): PowerPoint 2000 writes other positive values besides 0x01. All values not equal to 0x00 are interpreted as 0x01.
- [<109> Section 2.10.28](#): PowerPoint 97 does not ignore this field.
- [<110> Section 2.11.13](#): Prior to SP1, Office PowerPoint 2007 set this field to 0xF.
- [<111> Section 2.11.21](#): PowerPoint 97 does not preserve this record.
- [<112> Section 2.11.21](#): Office PowerPoint 2007, PowerPoint 2010, and PowerPoint 2013 do not omit this record.
- [<113> Section 2.13.11](#): Office PowerPoint 2007, PowerPoint 2010, and PowerPoint 2013 use **ExOleSub_Visio**; PowerPoint 97, PowerPoint 2000, PowerPoint 2002, Office PowerPoint 2003 use **ExOleSub_Default** for **ProgID Visio.Drawing**.
- [<114> Section 2.13.11](#): Office PowerPoint 2007 starting with SP2, PowerPoint 2010, and PowerPoint 2013 use **ExOleSub_WordODF**. PowerPoint 97, PowerPoint 2000, PowerPoint 2002, Office PowerPoint 2003 use **ExOleSub_Default** for **ProgID Word.OpenDocumentText**.

<115> [Section 2.13.11](#): Office PowerPoint 2007 starting with SP2, PowerPoint 2010, and PowerPoint 2013 use **ExOleSub_ExcelODF**. PowerPoint 97, PowerPoint 2000, PowerPoint 2002, Office PowerPoint 2003 use **ExOleSub_Default** for **ProgID Excel.OpenDocumentSpreadsheet**.

<116> [Section 2.13.11](#): Office PowerPoint 2007 starting with SP2, PowerPoint 2010, and PowerPoint 2013 use **ExOleSub_PPTODF**. PowerPoint 97, PowerPoint 2000, PowerPoint 2002, Office PowerPoint 2003 use **ExOleSub_Default** for **ProgID PowerPoint.OpenDocumentPresentation**.

6 Change Tracking

This section identifies changes that were made to this document since the last release. Changes are classified as Major, Minor, or None.

The revision class **Major** means that the technical content in the document was significantly revised. Major changes affect protocol interoperability or implementation. Examples of major changes are:

- A document revision that incorporates changes to interoperability requirements.
- A document revision that captures changes to protocol functionality.

The revision class **Minor** means that the meaning of the technical content was clarified. Minor changes do not affect protocol interoperability or implementation. Examples of minor changes are updates to clarify ambiguity at the sentence, paragraph, or table level.

The revision class **None** means that no new technical changes were introduced. Minor editorial and formatting changes may have been made, but the relevant technical content is identical to the last released version.

The changes made to this document are listed in the following table. For more information, please contact dochelp@microsoft.com.

Section	Description	Revision class
2.1.2 PowerPoint Document Stream	Updated usage of normative term for container record.	Minor
2.4.18.1 HTMLDocInfo9Atom	Updated the lowercase version of normative term for outputType.	Minor
2.4.18.5 HTMLPublishInfoAtom	Updated the lowercase version of normative term for outputType.	Minor
2.7.8 PlaceholderAtom	Updated the lowercase version of normative term for PT_MasterHeader.	Minor
2.8.32 TimeAnimationValueListEntry	Updated the lowercase version of normative term.	Minor
2.9.10 FontEntityAtom	Updated the lowercase version of normative term.	Minor
2.9.25 PFWrapFlags	Updated the lowercase version of normative term.	Minor
2.13.5 ColorModeEnum	Updated the lowercase version of normative term.	Minor
2.13.24 RecordType	Updated type name for RoundTripShapeCheckSumForCL12Atom.	Minor
3.9.4 Metacharacter	Updated the lowercase version of normative term for fHasFooter.	Minor

7 Index

A

[AnimAfterEffectEnum enumeration](#) 460

Animation

[behavior types](#) 23

[builds](#) 24

[conditional properties](#) 23

[examples](#) 541

[timeline](#) 23

[Animation example](#) 541

[Animation examples](#) 541

[Animation overview](#) 23

Animation type

[AnimationInfoAtom](#) 214

[AnimationInfoContainer](#) 213

[BuildAtom](#) 227

[BuildListContainer](#) 225

[BuildListSubContainer](#) 225

[ChartBuildAtom](#) 231

[ChartBuildContainer](#) 230

[ClientVisualElementContainer](#) 279

[DiagramBuildAtom](#) 232

[DiagramBuildContainer](#) 232

[ExtTimeNodeContainer](#) 233

[HashCode10Atom](#) 223

[HSLColorBy](#) 287

[IndexSchemeColor](#) 289

[LevelInfoAtom](#) 229

[ParaBuildAtom](#) 227

[ParaBuildContainer](#) 226

[ParaBuildLevel](#) 229

[RGBColor](#) 288

[RGBColorBy](#) 287

[SubEffectContainer](#) 237

[TimeAnimateBehaviorAtom](#) 264

[TimeAnimateBehaviorContainer](#) 262

[TimeAnimateColor](#) 288

[TimeAnimateColorBy](#) 286

[TimeAnimationValueAtom](#) 269

[TimeAnimationValueListContainer](#) 266

[TimeAnimationValueListEntry](#) 266

[TimeBehaviorAtom](#) 271

[TimeBehaviorContainer](#) 270

[TimeColorBehaviorAtom](#) 285

[TimeColorBehaviorContainer](#) 284

[TimeColorBehaviorPropertyUsedFlag](#) 286

[TimeColorDirection](#) 276

[TimeColorModel](#) 275

[TimeCommandBehaviorAtom](#) 329

[TimeCommandBehaviorContainer](#) 327

[TimeConditionAtom](#) 333

[TimeConditionContainer](#) 333

[TimeDisplayType](#) 242

[TimeEffectBehaviorAtom](#) 294

[TimeEffectBehaviorContainer](#) 289

[TimeEffectID](#) 245

[TimeEffectNodeType](#) 261

[TimeEffectType](#) 258

[TimeEventFilter](#) 260

[TimeGroupID](#) 260

[TimeIterateDataAtom](#) 329

[TimeMasterRelType](#) 243

[TimeModifierAtom](#) 335

[TimeMotionBehaviorAtom](#) 297

[TimeMotionBehaviorContainer](#) 295

[TimeNodeAtom](#) 239

[TimeNodeTimeFilter](#) 259

[TimeOverride](#) 276

[TimePointsTypes](#) 278

[TimePropertyList4TimeBehavior](#) 273

[TimePropertyList4TimeNodeContainer](#) 240

[TimeRotationBehaviorAtom](#) 299

[TimeRotationBehaviorContainer](#) 299

[TimeRuntimeContext](#) 277

[TimeScaleBehaviorAtom](#) 301

[TimeScaleBehaviorContainer](#) 301

[TimeSequenceDataAtom](#) 331

[TimeSetBehaviorAtom](#) 326

[TimeSetBehaviorContainer](#) 303

[TimeStringListContainer](#) 272

[TimeSubType](#) 244

[TimeVariant](#) 335

[TimeVariant4Behavior](#) 274

[TimeVariant4TimeNode](#) 241

[TimeVariantBool](#) 336

[TimeVariantFloat](#) 337

[TimeVariantInt](#) 336

[TimeVariantString](#) 338

[VisualElementAtom](#) 280

[VisualPageAtom](#) 280

[VisualShapeAtom](#) 282

[VisualShapeChartElementAtom](#) 282

[VisualShapeGeneralAtom](#) 283

[VisualShapeOrSoundAtom](#) 281

[VisualSoundAtom](#) 281

[AnimationInfoAtom animation type](#) 214

[AnimationInfoContainer animation type](#) 213

[AnimBuildTypeEnum enumeration](#) 460

[Applicability](#) 27

[AuthorNameAtom comment author type](#) 97

B

Basic type

[BlipRef](#) 33

[bool1](#) 33

[BulletSize](#) 33

[char2](#) 33

[ExHyperlinkId](#) 33

[ExHyperlinkIdRef](#) 34

[ExObjId](#) 34

[ExObjIdRef](#) 34

[FileOrDirNameFragment](#) 34

[FontIndexRef](#) 34

[FontIndexRef10](#) 34

[HttpUri](#) 34

[IndentLevel](#) 34

[MachineName](#) 35

[MarginOrIndent](#) 35

[MasterId](#) 35

[MasterIdRef](#) 35

[NotesId](#) 35

[NotesIdRef](#) 35
[ParaSpacing](#) 35
[PersistIdRef](#) 36
[PrintableAnsiString](#) 36
[PrintableUnicodeString](#) 36
[SlideId](#) 36
[SlideIdRef](#) 37
[SmartTagIndex](#) 37
[SoundIdRef](#) 37
[TabCrLfPrintableUnicodeString](#) 37
[TabSize](#) 37
[TextPosition](#) 37
[TxLCID](#) 38
[UncOrLocalPath](#) 38
[UncPath](#) 38
[UncPathOrHttpUrl](#) 38
[UnicodeString](#) 38
[Utf8UnicodeString](#) 38
[BCArchiveDirAtom broadcast type](#) 82
[BCAsdFileNameAtom broadcast type](#) 89
[BCBroadcastDateTimeAtom broadcast type](#) 88
[BCChatUrlAtom broadcast type](#) 82
[BCContactAtom broadcast type](#) 79
[BCDescriptionAtom broadcast type](#) 78
[BCEmailAddressAtom broadcast type](#) 80
[BCEmailNameAtom broadcast type](#) 81
[BCEntryIDAtom broadcast type](#) 90
[BCNetShowFilesBaseDirAtom broadcast type](#) 83
[BCNetShowFilesDirAtom broadcast type](#) 84
[BCNetShowServerNameAtom broadcast type](#) 84
[BCPptFilesBaseDirAtom broadcast type](#) 85
[BCPptFilesBaseUrlAtom broadcast type](#) 86
[BCPptFilesDirAtom broadcast type](#) 86
[BCPresentationNameAtom broadcast type](#) 88
[BCRexServerNameAtom broadcast type](#) 80
[BCSpeakerAtom broadcast type](#) 78
[BCTitleAtom broadcast type](#) 77
[BCUserNameAtom broadcast type](#) 87
[Behavior types in animation](#) 23
[BinaryTagDataBlob type](#) 455
[BlipCollection9Container text type](#) 398
[BlipEntityAtom text type](#) 398
[BlipRef basic type](#) 33
[BookmarkCollectionContainer summary info type](#) 137
[BookmarkEntityAtom summary info type](#) 139
[BookmarkEntityAtomContainer summary info type](#) 138
[BookmarkSeedAtom summary info type](#) 137
[BookmarkValueAtom summary info type](#) 140
[bool1 basic type](#) 33
 Broadcast type
 [BCArchiveDirAtom](#) 82
 [BCAsdFileNameAtom](#) 89
 [BCBroadcastDateTimeAtom](#) 88
 [BCChatUrlAtom](#) 82
 [BCContactAtom](#) 79
 [BCDescriptionAtom](#) 78
 [BCEmailAddressAtom](#) 80
 [BCEmailNameAtom](#) 81
 [BCEntryIDAtom](#) 90
 [BCNetShowFilesBaseDirAtom](#) 83
 [BCNetShowFilesDirAtom](#) 84
 [BCNetShowServerNameAtom](#) 84
 [BCPptFilesBaseDirAtom](#) 85
 [BCPptFilesBaseUrlAtom](#) 86

[BCPptFilesDirAtom](#) 86
[BCPresentationNameAtom](#) 88
[BCRexServerNameAtom](#) 80
[BCSpeakerAtom](#) 78
[BCTitleAtom](#) 77
[BCUserNameAtom](#) 87
[BroadcastDocInfo9Container](#) 74
[BroadcastDocInfoAtom](#) 90
[BroadcastDocInfo9Container broadcast type](#) 74
[BroadcastDocInfoAtom broadcast type](#) 90
[Build order in animation](#) 24
[BuildAtom animation type](#) 227
[BuildListContainer animation type](#) 225
[BuildListSubContainer animation type](#) 225
[BuildTypeEnum enumeration](#) 461
[BulletFlags text type](#) 357
[BulletSize basic type](#) 33
[Byte ordering](#) 26

C

[CFMasks text type](#) 350
[CFStyle text type](#) 351
[Change tracking](#) 633
[char2 basic type](#) 33
[Character formatting example](#) 611
[ChartBuildAtom animation type](#) 231
[ChartBuildContainer animation type](#) 230
[ChartBuildEnum enumeration](#) 462
[ClientVisualElementContainer animation type](#) 279
[ClipboardNameAtom external object type](#) 414
[ColorIndexStruct structure](#) 456
[ColorModeEnum enumeration](#) 463
[ColorStruct structure](#) 456
 Comment author type
 [AuthorNameAtom](#) 97
 [CommentIndex10Atom](#) 98
 [CommentIndex10Container](#) 96
[Comment10Atom slide type](#) 177
[Comment10AuthorAtom slide type](#) 175
[Comment10AuthorInitialAtom slide type](#) 176
[Comment10Container slide type](#) 174
[Comment10TextAtom slide type](#) 176
[CommentIndex10Atom comment author type](#) 98
[CommentIndex10Container comment author type](#) 96
[Conditional properties](#) 23
[ConditionEnum enumeration](#) 463
[CopyrightAtom summary info type](#) 135
[CryptSession10Container file structure](#) 44
[current user stream](#) 28
[CurrentUserAtom file structure](#) 39
[custom XML data storage](#) 32

D

[DateTimeMCAtom text type](#) 378
[DateTimeStruct structure](#) 457
[DefaultRulerAtom text type](#) 361
 Details
 [AnimAfterEffectEnum enumeration](#) 460
 [AnimationInfoAtom animation type](#) 214
 [AnimationInfoContainer animation type](#) 213
 [AnimBuildTypeEnum enumeration](#) 460
 [AuthorNameAtom comment author type](#) 97
 [BCArchiveDirAtom broadcast type](#) 82

[BCAsdFileNameAtom broadcast type](#) 89
[BCBroadcastDateTimeAtom broadcast type](#) 88
[BCChatUrlAtom broadcast type](#) 82
[BCContactAtom broadcast type](#) 79
[BCDescriptionAtom broadcast type](#) 78
[BCEmailAddressAtom broadcast type](#) 80
[BCEmailNameAtom broadcast type](#) 81
[BCEntryIDAtom broadcast type](#) 90
[BCNetShowFilesBaseDirAtom broadcast type](#) 83
[BCNetShowFilesDirAtom broadcast type](#) 84
[BCNetShowServerNameAtom broadcast type](#) 84
[BCPptFilesBaseDirAtom broadcast type](#) 85
[BCPptFilesBaseUrlAtom broadcast type](#) 86
[BCPptFilesDirAtom broadcast type](#) 86
[BCPresentationNameAtom broadcast type](#) 88
[BCRexServerNameAtom broadcast type](#) 80
[BCSpeakerAtom broadcast type](#) 78
[BCTitleAtom broadcast type](#) 77
[BCUserNameAtom broadcast type](#) 87
[BinaryTagDataBlob type](#) 455
[BlipCollection9Container text type](#) 398
[BlipEntityAtom text type](#) 398
[BlipRef basic type](#) 33
[BookmarkCollectionContainer summary info type](#) 137
[BookmarkEntityAtom summary info type](#) 139
[BookmarkEntityAtomContainer summary info type](#) 138
[BookmarkSeedAtom summary info type](#) 137
[BookmarkValueAtom summary info type](#) 140
[bool1 basic type](#) 33
[BroadcastDocInfo9Container broadcast type](#) 74
[BroadcastDocInfoAtom broadcast type](#) 90
[BuildAtom animation type](#) 227
[BuildListContainer animation type](#) 225
[BuildListSubContainer animation type](#) 225
[BuildTypeEnum enumeration](#) 461
[BulletFlags text type](#) 357
[BulletSize basic type](#) 33
[CFMasks text type](#) 350
[CFStyle text type](#) 351
[char2 basic type](#) 33
[ChartBuildAtom animation type](#) 231
[ChartBuildContainer animation type](#) 230
[ChartBuildEnum enumeration](#) 462
[ClientVisualElementContainer animation type](#) 279
[ClipboardNameAtom external object type](#) 414
[ColorIndexStruct structure](#) 456
[ColorModeEnum enumeration](#) 463
[ColorStruct structure](#) 456
[Comment10Atom slide type](#) 177
[Comment10AuthorAtom slide type](#) 175
[Comment10AuthorInitialAtom slide type](#) 176
[Comment10Container slide type](#) 174
[Comment10TextAtom slide type](#) 176
[CommentIndex10Atom comment author type](#) 98
[CommentIndex10Container comment author type](#) 96
[ConditionEnum enumeration](#) 463
[CopyrightAtom summary info type](#) 135
[CryptSession10Container file structure](#) 44
[current user stream](#) 28
[CurrentUserAtom file structure](#) 39
[custom XML data storage](#) 32
[DateTimeMCAtom text type](#) 378
[DateTimeStruct structure](#) 457
[DefaultRulerAtom text type](#) 361
[DiagramBuildAtom animation type](#) 232
[DiagramBuildContainer animation type](#) 232
[DiagramBuildEnum enumeration](#) 463
[DiffRecordHeaders document comparison type](#) 103
[DiffTree10Container document comparison type](#) 101
[DiffTypeEnum enumeration](#) 464
[digital signature storage](#) 32
[DocDiff10Container document comparison type](#) 104
[DocInfoListContainer document type](#) 51
[DocInfoListSubContainerOrAtom document type](#) 51
[DocProgBinaryTagContainer document tag info type](#) 141
[DocProgBinaryTagSubContainerOrAtom document tag info type](#) 142
[DocProgTagsContainer document tag info type](#) 140
[DocProgTagsSubContainerOrAtom document tag info type](#) 141
[DocRoutingSlipAtom type](#) 433
[DocRoutingSlipString type](#) 435
[DocToolBarStates10Atom document comparison type](#) 98
[document summary information stream](#) 32
[DocumentAtom document type](#) 48
[DocumentContainer document type](#) 45
[DocumentTextInfoContainer text type](#) 338
[DrawingContainer slide type](#) 165
[DrawingGroupContainer document type](#) 50
[ElementTypeEnum enumeration](#) 465
[encrypted summary information stream](#) 32
[EndDocumentAtom document type](#) 57
[EnvelopeData9Atom type](#) 436
[EnvelopeFlags9Atom type](#) 436
[ExAviMovieContainer external object type](#) 406
[ExCDAudioAtom external object type](#) 409
[ExCDAudioContainer external object type](#) 408
[ExColorFollowEnum enumeration](#) 465
[ExControlAtom external object type](#) 411
[ExControlContainer external object type](#) 410
[ExControlStg external object type](#) 430
[ExControlStgCompressedAtom external object type](#) 430
[ExControlStgUncompressedAtom external object type](#) 430
[ExHyperlink9Container external object type](#) 418
[ExHyperlinkAtom external object type](#) 415
[ExHyperlinkContainer external object type](#) 414
[ExHyperlinkFlagsAtom external object type](#) 420
[ExHyperlinkId basic type](#) 33
[ExHyperlinkIdRef basic type](#) 34
[ExHyperlinkRefAtom external object type](#) 419
[ExMCI MovieContainer external object type](#) 420
[ExMediaAtom external object type](#) 407
[ExMIDIAudioContainer external object type](#) 421
[ExObjId basic type](#) 34
[ExObjIdRef basic type](#) 34
[ExObjListAtom external object type](#) 405
[ExObjListContainer external object type](#) 404
[ExObjListSubContainer external object type](#) 405
[ExObjRefAtom shape type](#) 201
[ExOleEmbedAtom external object type](#) 423
[ExOleEmbedContainer external object type](#) 422

[ExOleLinkAtom external object type](#) 425
[ExOleLinkContainer external object type](#) 424
[ExOleObjAtom external object type](#) 412
[ExOleObjStg external object type](#) 428
[ExOleObjStgCompressedAtom external object type](#) 429
[ExOleObjStgUncompressedAtom external object type](#) 428
[ExOleObjSubTypeEnum enumeration](#) 465
[ExOleObjTypeEnum enumeration](#) 466
[ExternalObjectDiffContainer document comparison type](#) 119
[ExtTimeNodeContainer animation type](#) 233
[ExVideoContainer external object type](#) 406
[ExWAVAudioEmbeddedAtom external object type](#) 427
[ExWAVAudioEmbeddedContainer external object type](#) 426
[ExWAVAudioLinkContainer external object type](#) 427
[file stream structure](#) 28
[FileNameAtom publish type](#) 94
[FileOrDirNameFragment basic type](#) 34
[FilterPrivacyFlags10Atom document type](#) 54
[FontCollection10Container text type](#) 347
[FontCollectionContainer text type](#) 345
[FontCollectionEntry text type](#) 345
[FontEmbedDataBlob type](#) 437
[FontEmbedFlags10Atom text type](#) 348
[FontEntityAtom text type](#) 346
[FontIndexRef basic type](#) 34
[FontIndexRef10 basic type](#) 34
[FooterAtom header/footer type](#) 67
[FooterMCAAtom text type](#) 377
[FriendlyNameAtom external object type](#) 416
[GenericDateMCAAtom text type](#) 385
[GridSpacing10Atom view info type](#) 124
[GuideAtom view info type](#) 132
[HandoutContainer slide type](#) 157
[HandoutRoundTripAtom slide type](#) 158
[HashCode10Atom animation type](#) 223
[HeaderAtom header/footer type](#) 66
[HeaderFooterDiffContainer document comparison type](#) 106
[HeaderMCAAtom text type](#) 377
[HeadersFootersAtom header/footer type](#) 65
[HSLColorBy animation type](#) 287
[HTMLDocInfo9Atom publish type](#) 92
[HTMLPublishInfo9Container publish type](#) 93
[HTMLPublishInfoAtom publish type](#) 95
[HttpUrl basic type](#) 34
[IndentLevel basic type](#) 34
[IndexSchemeColor animation type](#) 289
[InteractiveInfoActionEnum enumeration](#) 466
[InteractiveInfoAtom slide show type](#) 195
[InteractiveInfoDiffContainer document comparison type](#) 120
[InteractiveInfoInstance slide show type](#) 194
[InteractiveInfoJumpEnum enumeration](#) 467
[KeywordsAtom summary info type](#) 135
[Kinsoku9Atom text type](#) 343
[Kinsoku9Container text type](#) 342
[KinsokuAtom text type](#) 341
[KinsokuContainer text type](#) 340
[KinsokuFollowingAtom text type](#) 342
[KinsokuLeadingAtom text type](#) 341
[LevelInfoAtom animation type](#) 229
[LinkedShape10Atom slide type](#) 181
[LinkedSlide10Atom slide type](#) 179
[LinkToEnum enumeration](#) 467
[LocationAtom external object type](#) 417
[MachineName basic type](#) 35
[MacroNameAtom slide show type](#) 196
[MainMasterContainer slide type](#) 152
[MainMasterDiffContainer document comparison type](#) 110
[MarginOrIndent basic type](#) 35
[MasterId basic type](#) 35
[MasterIdRef basic type](#) 35
[MasterListDiff10ChildContainer document comparison type](#) 110
[MasterListDiffContainer document comparison type](#) 109
[MasterListWithTextContainer slide list type](#) 58
[MasterOrSlideContainer slide type](#) 155
[MasterPersistAtom slide list type](#) 59
[MasterTextPropAtom text type](#) 403
[MasterTextPropRun text type](#) 403
[MenuNameAtom external object type](#) 413
[MetafileBlob type](#) 437
[ModifyPasswordAtom document type](#) 53
[MouseClickedInteractiveInfoContainer slide show type](#) 194
[MouseClickedTextInteractiveInfoAtom text type](#) 388
[MouseOverInteractiveInfoContainer slide show type](#) 195
[MouseOverTextInteractiveInfoAtom text type](#) 389
[NamedShowAtom publish type](#) 95
[NamedShowContainer slide show type](#) 185
[NamedShowDiffContainer document comparison type](#) 107
[NamedShowListDiffContainer document comparison type](#) 106
[NamedShowNameAtom slide show type](#) 185
[NamedShowsContainer slide show type](#) 184
[NamedShowSlidesAtom slide show type](#) 186
[NormalViewSetBarStates enumeration](#) 468
[NormalViewSetInfoAtom view info type](#) 125
[NormalViewSetInfoContainer view info type](#) 124
[NotesAtom slide type](#) 164
[NotesContainer slide type](#) 156
[NotesDiffContainer document comparison type](#) 123
[NotesHeadersFootersContainer header/footer type](#) 67
[NotesId basic type](#) 35
[NotesIdRef basic type](#) 35
[NotesListWithTextContainer slide list type](#) 62
[NotesPersistAtom slide list type](#) 63
[NotesRoundTripAtom slide type](#) 157
[NotesTextViewInfoContainer view info type](#) 127
[NotesViewInfoContainer view info type](#) 133
[NoZoomViewInfoAtom view info type](#) 129
[OfficeArtClientAnchor shape type](#) 197
[OfficeArtClientAnchorData shape type](#) 198
[OfficeArtClientData shape type](#) 198
[OfficeArtClientTextbox text type](#) 400
[OLEVerbEnum enumeration](#) 468
[OutlineTextProps10Container text type](#) 392
[OutlineTextProps10Entry text type](#) 392
[OutlineTextProps11Container text type](#) 393

[OutlineTextProps11Entry text type](#) 393
[OutlineTextProps9Container text type](#) 390
[OutlineTextProps9Entry text type](#) 391
[OutlineTextPropsHeaderExAtom text type](#) 391
[OutlineTextRefAtom text type](#) 402
[OutlineViewInfoContainer view info type](#) 129
[ParaBuildAtom animation type](#) 227
[ParaBuildContainer animation type](#) 226
[ParaBuildEnum enumeration](#) 468
[ParaBuildLevel animation type](#) 229
[ParaSpacing basic type](#) 35
[PersistDirectoryAtom file structure](#) 42
[PersistDirectoryEntry file structure](#) 43
[PersistIdRef basic type](#) 36
[PersistOffsetEntry file structure](#) 43
[PerSlideHeadersFootersContainer slide type](#) 167
[PFMasks text type](#) 356
[PFWrapFlags text type](#) 359
[PhotoAlbumFrameShapeEnum enumeration](#) 469
[PhotoAlbumInfo10Atom document type](#) 54
[PhotoAlbumLayoutEnum enumeration](#) 469
[PlaceholderAtom shape type](#) 202
[PlaceholderEnum enumeration](#) 470
[PlaceholderSize enumeration](#) 471
[PointStruct structure](#) 458
[PowerPoint document stream](#) 28
[PP10DocBinaryTagExtension document tag info type](#) 145
[PP10ShapeBinaryTagExtension shape type](#) 211
[PP10SlideBinaryTagExtension slide type](#) 172
[PP11DocBinaryTagExtension document tag info type](#) 148
[PP11ShapeBinaryTagExtension shape type](#) 212
[PP12DocBinaryTagExtension document tag info type](#) 149
[PP12SlideBinaryTagExtension slide type](#) 182
[PP9DocBinaryTagExtension document tag info type](#) 142
[PP9ShapeBinaryTagExtension shape type](#) 210
[PP9SlideBinaryTagExtension slide type](#) 171
[PresAdvisorFlags9Atom document type](#) 52
[PrintableAnsiString basic type](#) 36
[PrintableUnicodeString basic type](#) 36
[PrintOptionsAtom document type](#) 57
[PrintWhatEnum enumeration](#) 471
[ProgIDAtom external object type](#) 413
[ProgStringTagContainer type](#) 453
[RatioStruct structure](#) 458
[RecolorEntry shape type](#) 206
[RecolorEntryBrush shape type](#) 207
[RecolorEntryColor shape type](#) 207
[RecolorEntryVariant shape type](#) 207
[RecolorInfoAtom shape type](#) 204
[RecolorInfoDiffContainer document comparison type](#) 118
[RecordHeader file structure](#) 39
[RecordType enumeration](#) 471
[RectStruct structure](#) 458
[ReviewerNameAtom document comparison type](#) 102
[RGBColor animation type](#) 288
[RGBColorBy animation type](#) 287
[RoundTripAnimationAtom type](#) 438
[RoundTripAnimationHashAtom type](#) 439
[RoundTripColorMappingAtom type](#) 440
[RoundTripCompositeMasterId12Atom type](#) 440
[RoundTripContentMasterId12Atom type](#) 441
[RoundTripContentMasterInfo12Atom type](#) 442
[RoundTripCustomTableStyles12Atom type](#) 442
[RoundTripDocFlags12Atom type](#) 443
[RoundTripHeaderFooterDefaults12Atom type](#) 443
[RoundTripHFPlaceholder12Atom type](#) 444
[RoundTripMainMasterRecord slide type](#) 155
[RoundTripNewPlaceholderId12Atom type](#) 445
[RoundTripNotesMasterTextStyles12Atom type](#) 445
[RoundTripOArtTextStyles12Atom type](#) 446
[RoundTripOriginalMainMasterId12Atom type](#) 446
[RoundTripShapeChecksumForCustomLayouts12Atom type](#) 447
[RoundTripShapeId12Atom type](#) 448
[RoundTripSlideRecord slide type](#) 152
[RoundTripSlideSyncInfo12Container type](#) 448
[RoundTripThemeAtom type](#) 451
[RTFDateTimeMCAtom text type](#) 385
[ScalingStruct structure](#) 459
[SchemeListElementColorSchemeAtom slide type](#) 166
[ScreenTipAtom external object type](#) 419
[ServerIdAtom type](#) 449
[ShapeClientRoundtripDataSubContainerOrAtom shape type](#) 200
[ShapeDiffContainer document comparison type](#) 114
[ShapeFlags10Atom shape type](#) 201
[ShapeFlagsAtom shape type](#) 200
[ShapeListDiffContainer document comparison type](#) 114
[ShapeProgBinaryTagContainer shape type](#) 209
[ShapeProgBinaryTagSubContainerOrAtom shape type](#) 210
[ShapeProgTagsContainer shape type](#) 209
[ShapeProgTagsSubContainerOrAtom shape type](#) 209
[signatures stream](#) 33
[SlideAtom slide type](#) 159
[SlideContainer slide type](#) 150
[SlideDiffContainer document comparison type](#) 111
[SlideFlags slide type](#) 164
[SlideFlags10Atom slide type](#) 178
[SlideHeadersFootersContainer header/footer type](#) 64
[SlideId basic type](#) 36
[SlideIdRef basic type](#) 37
[SlideLayoutType enumeration](#) 481
[SlideLibUrlAtom type](#) 450
[SlideListDiffContainer document comparison type](#) 108
[SlideListEntry10Atom document comparison type](#) 100
[SlideListTable10Container document comparison type](#) 99
[SlideListTableSize10Atom document comparison type](#) 100
[SlideListWithTextContainer slide list type](#) 59
[SlideListWithTextSubContainerOrAtom slide list type](#) 60
[SlideNameAtom slide type](#) 168
[SlideNumberMCAtom text type](#) 376
[SlidePersistAtom slide list type](#) 61

[SlideProgBinaryTagContainer slide type](#) 170
[SlideProgBinaryTagSubContainerOrAtom slide type](#) 170
[SlideProgTagsContainer slide type](#) 169
[SlideProgTagsSubContainerOrAtom slide type](#) 170
[SlideSchemeColorSchemeAtom slide type](#) 166
[SlideShowDiffContainer document comparison type](#) 122
[SlideShowDocInfoAtom slide show type](#) 183
[SlideShowSlideInfoAtom slide show type](#) 187
[SlideSizeEnum enumeration](#) 482
[SlideSyncInfoAtom12 type](#) 450
[SlideTime10Atom slide type](#) 178
[SlideViewInfoAtom view info type](#) 132
[SlideViewInfoContainer view info type](#) 131
[SlideViewInfoInstance view info type](#) 131
[SmallRectStruct structure](#) 459
[SmartTagIndex basic type](#) 37
[SmartTags text type](#) 366
[SmartTagStore11Container type](#) 452
[SorterViewInfoContainer view info type](#) 134
[SoundBuiltinIdAtom sound type](#) 73
[SoundCollectionAtom sound type](#) 69
[SoundCollectionContainer sound type](#) 68
[SoundContainer sound type](#) 70
[SoundDataBlob type](#) 452
[SoundExtensionAtom sound type](#) 71
[SoundIdAtom sound type](#) 72
[SoundIdRef basic type](#) 37
[SoundNameAtom sound type](#) 71
[SpellingFlags text type](#) 366
[storage structure](#) 28
[StyleTextProp10Atom text type](#) 396
[StyleTextProp11 text type](#) 397
[StyleTextProp11Atom text type](#) 396
[StyleTextProp9 text type](#) 395
[StyleTextProp9Atom text type](#) 394
[StyleTextPropAtom text type](#) 374
[SubEffectContainer animation type](#) 237
[summary information stream](#) 32
[SummaryContainer summary info type](#) 136
[TabCrLfPrintableUnicodeString basic type](#) 37
[TableDiffContainer document comparison type](#) 121
[TableListDiffContainer document comparison type](#) 120
[TabSize basic type](#) 37
[TabStop text type](#) 358
[TabStops text type](#) 358
[TagNameAtom type](#) 454
[TagValueAtom type](#) 454
[TargetAtom external object type](#) 417
[TemplateNameAtom slide type](#) 168
[TextAlignmentEnum enumeration](#) 482
[TextAutoNumberScheme text type](#) 360
[TextAutoNumberSchemeEnum enumeration](#) 483
[TextBookmarkAtom text type](#) 386
[TextBuildSubEffectEnum enumeration](#) 485
[TextBytesAtom text type](#) 373
[TextCFException text type](#) 349
[TextCFException10 text type](#) 353
[TextCFException9 text type](#) 352
[TextCFExceptionAtom text type](#) ([section 2.9.13](#) 348, [section 2.9.19](#) 354)
[TextCFRun text type](#) 376
[TextCharsAtom text type](#) 373
[TextClientDataSubContainerOrAtom text type](#) 401
[TextDefaults10Atom text type](#) 400
[TextDefaults9Atom text type](#) 399
[TextDiffContainer document comparison type](#) 117
[TextDirectionEnum enumeration](#) 485
[TextFontAlignmentEnum enumeration](#) 485
[TextHeaderAtom text type](#) 371
[TextInteractiveInfoInstance text type](#) 388
[TextMasterStyle10Atom text type](#) 370
[TextMasterStyle10Levels text type](#) 371
[TextMasterStyle9Atom text type](#) 368
[TextMasterStyle9Level text type](#) 369
[TextMasterStyleAtom text type](#) 366
[TextMasterStyleLevel text type](#) 368
[TextPFException text type](#) 354
[TextPFException9 text type](#) 359
[TextPFRun text type](#) 375
[TextPosition basic type](#) 37
[TextRange text type](#) 389
[TextRuler text type](#) 362
[TextRulerAtom text type](#) 361
[TextSIException text type](#) 364
[TextSIExceptionAtom text type](#) 364
[TextSIRun text type](#) 387
[TextSpecialInfoAtom text type](#) 387
[TextTabTypeEnum enumeration](#) 485
[TextTypeEnum enumeration](#) 486
[TimeAnimateBehaviorAtom animation type](#) 264
[TimeAnimateBehaviorContainer animation type](#) 262
[TimeAnimateBehaviorValueTypeEnum enumeration](#) 486
[TimeAnimateColor animation type](#) 288
[TimeAnimateColorBy animation type](#) 286
[TimeAnimationValueAtom animation type](#) 269
[TimeAnimationValueListContainer animation type](#) 266
[TimeAnimationValueListEntry animation type](#) 266
[TimeBehaviorAtom animation type](#) 271
[TimeBehaviorContainer animation type](#) 270
[TimeColorBehaviorAtom animation type](#) 285
[TimeColorBehaviorContainer animation type](#) 284
[TimeColorBehaviorPropertyUsedFlag animation type](#) 286
[TimeColorDirection animation type](#) 276
[TimeColorModel animation type](#) 275
[TimeCommandBehaviorAtom animation type](#) 329
[TimeCommandBehaviorContainer animation type](#) 327
[TimeCommandBehaviorTypeEnum enumeration](#) 486
[TimeConditionAtom animation type](#) 333
[TimeConditionContainer animation type](#) 333
[TimeDisplayType animation type](#) 242
[TimeEffectBehaviorAtom animation type](#) 294
[TimeEffectBehaviorContainer animation type](#) 289
[TimeEffectID animation type](#) 245
[TimeEffectNodeType animation type](#) 261
[TimeEffectType animation type](#) 258
[TimeEventFilter animation type](#) 260
[TimeGroupID animation type](#) 260
[TimeIterateDataAtom animation type](#) 329
[TimeMasterRelType animation type](#) 243
[TimeModifierAtom animation type](#) 335
[TimeMotionBehaviorAtom animation type](#) 297

[TimeMotionBehaviorContainer animation type](#) 295
[TimeNodeAtom animation type](#) 239
[TimeNodeTimeFilter animation type](#) 259
[TimeNodeTypeEnum enumeration](#) 487
[TimeOverride animation type](#) 276
[TimePointsTypes animation type](#) 278
[TimePropertyID4TimeBehavior enumeration](#) 487
[TimePropertyID4TimeNode enumeration](#) 487
[TimePropertyList4TimeBehavior animation type](#) 273
[TimePropertyList4TimeNodeContainer animation type](#) 240
[TimeRotationBehaviorAtom animation type](#) 299
[TimeRotationBehaviorContainer animation type](#) 299
[TimeRuntimeContext animation type](#) 277
[TimeScaleBehaviorAtom animation type](#) 301
[TimeScaleBehaviorContainer animation type](#) 301
[TimeSequenceDataAtom animation type](#) 331
[TimeSetBehaviorAtom animation type](#) 326
[TimeSetBehaviorContainer animation type](#) 303
[TimeStringListContainer animation type](#) 272
[TimeSubType animation type](#) 244
[TimeVariant animation type](#) 335
[TimeVariant4Behavior animation type](#) 274
[TimeVariant4TimeNode animation type](#) 241
[TimeVariantBool animation type](#) 336
[TimeVariantFloat animation type](#) 337
[TimeVariantInt animation type](#) 336
[TimeVariantString animation type](#) 338
[TimeVariantTypeEnum enumeration](#) 488
[TimeVisualElementEnum enumeration](#) 488
[TmsfTimeStruct structure](#) 459
[TriggerObjectEnum enumeration](#) 489
[TxLCID basic type](#) 38
[UncOrLocalPath basic type](#) 38
[UncOrLocalPathAtom external object type](#) 408
[UncPath basic type](#) 38
[UncPathOrHttpUrl basic type](#) 38
[UnicodeString basic type](#) 38
[UnknownBinaryTag type](#) 455
[UserDataAtom header/footer type](#) 65
[UserEditAtom file structure](#) 41
[Utf8UnicodeString basic type](#) 38
[VBAInfoAtom document type](#) 56
[VBAInfoContainer document type](#) 55
[VbaProjectStg external object type](#) 431
[VbaProjectStgCompressedAtom external object type](#) 432
[VbaProjectStgUncompressedAtom external object type](#) 431
[ViewTypeEnum enumeration](#) 489
[VisualElementAtom animation type](#) 280
[VisualPageAtom animation type](#) 280
[VisualShapeAtom animation type](#) 282
[VisualShapeChartElementAtom animation type](#) 282
[VisualShapeGeneralAtom animation type](#) 283
[VisualShapeOrSoundAtom animation type](#) 281
[VisualSoundAtom animation type](#) 281
[WebFrameColorsEnum enumeration](#) 490
[WebOutputEnum enumeration](#) 490
[WideColorStruct structure](#) 457
[ZoomViewInfoAtom view info type](#) 127
[DetailSpPictures stream](#) 32
[DiagramBuildAtom animation type](#) 232
[DiagramBuildContainer animation type](#) 232
[DiagramBuildEnum enumeration](#) 463
[DiffRecordHeaders document comparison type](#) 103
[DiffTree10Container document comparison type](#) 101
[DiffTypeEnum enumeration](#) 464
[Digital signature storage](#) 32
[DocDiff10Container document comparison type](#) 104
[DocInfoListContainer document type](#) 51
[DocInfoListSubContainerOrAtom document type](#) 51
[DocProgBinaryTagContainer document tag info type](#) 141
[DocProgBinaryTagSubContainerOrAtom document tag info type](#) 142
[DocProgTagsContainer document tag info type](#) 140
[DocProgTagsSubContainerOrAtom document tag info type](#) 141
[DocRoutingSlipAtom type](#) 433
[DocRoutingSlipString type](#) 435
[DocToolBarStates10Atom document comparison type](#) 98
[Document comparison type](#)
[DiffRecordHeaders](#) 103
[DiffTree10Container](#) 101
[DocDiff10Container](#) 104
[DocToolBarStates10Atom](#) 98
[ExternalObjectDiffContainer](#) 119
[HeaderFooterDiffContainer](#) 106
[InteractiveInfoDiffContainer](#) 120
[MainMasterDiffContainer](#) 110
[MasterListDiff10ChildContainer](#) 110
[MasterListDiffContainer](#) 109
[NamedShowDiffContainer](#) 107
[NamedShowListDiffContainer](#) 106
[NotesDiffContainer](#) 123
[RecolorInfoDiffContainer](#) 118
[ReviewerNameAtom](#) 102
[ShapeDiffContainer](#) 114
[ShapeListDiffContainer](#) 114
[SlideDiffContainer](#) 111
[SlideListDiffContainer](#) 108
[SlideListEntry10Atom](#) 100
[SlideListTable10Container](#) 99
[SlideListTableSize10Atom](#) 100
[SlideShowDiffContainer](#) 122
[TableDiffContainer](#) 121
[TableListDiffContainer](#) 120
[TextDiffContainer](#) 117
[Document programmable tag example](#) 537
[Document summary information stream](#) 32
[Document tag info type](#)
[DocProgBinaryTagContainer](#) 141
[DocProgBinaryTagSubContainerOrAtom](#) 142
[DocProgTagsContainer](#) 140
[DocProgTagsSubContainerOrAtom](#) 141
[PP10DocBinaryTagExtension](#) 145
[PP11DocBinaryTagExtension](#) 148
[PP12DocBinaryTagExtension](#) 149
[PP9DocBinaryTagExtension](#) 142
[Document type](#)
[AtomContainer](#) 48
[DocInfoListContainer](#) 51
[DocInfoListSubContainerOrAtom](#) 51
[DocumentContainer](#) 45
[DrawingGroupContainer](#) 50
[EndDocumentAtom](#) 57

[FilterPrivacyFlags10Atom](#) 54
[ModifyPasswordAtom](#) 53
[PhotoAlbumInfo10Atom](#) 54
[PresAdvisorFlags9Atom](#) 52
[PrintOptionsAtom](#) 57
[VBAInfoAtom](#) 56
[VBAInfoContainer](#) 55
[DocumentAtom document type](#) 48
[DocumentContainer document type](#) 45
[DocumentTextInfoContainer text type](#) 338
[DrawingContainer slide type](#) 165
[DrawingGroupContainer document type](#) 50

E

[ElementTypeEnum enumeration](#) 465
[Encrypted summary information stream](#) 32
[EndDocumentAtom document type](#) 57
Enumeration
[AnimAfterEffectEnum](#) 460
[AnimBuildTypeEnum](#) 460
[BuildTypeEnum](#) 461
[ChartBuildEnum](#) 462
[ColorModeEnum](#) 463
[ConditionEnum](#) 463
[DiagramBuildEnum](#) 463
[DiffTypeEnum](#) 464
[ElementTypeEnum](#) 465
[ExColorFollowEnum](#) 465
[ExOleObjSubTypeEnum](#) 465
[ExOleObjTypeEnum](#) 466
[InteractiveInfoActionEnum](#) 466
[InteractiveInfoJumpEnum](#) 467
[LinkToEnum](#) 467
[NormalViewSetBarStates](#) 468
[OLEVerbEnum](#) 468
[ParaBuildEnum](#) 468
[PhotoAlbumFrameShapeEnum](#) 469
[PhotoAlbumLayoutEnum](#) 469
[PlaceholderEnum](#) 470
[PlaceholderSize](#) 471
[PrintWhatEnum](#) 471
[RecordType](#) 471
[SlideLayoutType](#) 481
[SlideSizeEnum](#) ([section 2.13.26](#) 482, [section 2.13.27](#) 482)
[TextAutoNumberSchemeEnum](#) 483
[TextBuildSubEffectEnum](#) 485
[TextDirectionEnum](#) 485
[TextFontAlignmentEnum](#) 485
[TextTabTypeEnum](#) 485
[TextTypeEnum](#) 486
[TimeAnimateBehaviorValueTypeEnum](#) 486
[TimeCommandBehaviorTypeEnum](#) 486
[TimeNodeTypeEnum](#) 487
[TimePropertyID4TimeBehavior](#) ([section 2.13.37](#) 487, [section 2.13.38](#) 487)
[TimeVariantTypeEnum](#) 488
[TimeVisualElementEnum](#) 488
[TriggerObjectEnum](#) 489
[ViewTypeEnum](#) 489
[WebFrameColorsEnum](#) 490
[WebOutputEnum](#) 490
[EnvelopeData9Atom type](#) 436
[EnvelopeFlags9Atom type](#) 436

Examples

[Animation](#) 541
[character formatting](#) 611
[document programmable tag](#) 537
[external video](#) 603
[File Structure](#) 502
[Introduction](#) 491
[master slide](#) 517
[metacharacter formatting](#) 621
[notes slide](#) 530
[OLE object](#) 599
[Outline Text](#) 510
[overview](#) 491
[paragraph formatting](#) 605
[Persist Objects](#) 508
[presentation slide](#) 519
[Programmable Tags](#) 537
[shape anchor](#) 594
[shape animation](#) 555
[Shape Client Data](#) 594
[shape placeholder](#) 596
[shape text](#) 597
[slide programmable tag](#) 540
[Slides](#) 517
[Text](#) 605
[text animation](#) 541
[TextInteractiveInfo](#) 618
[ExAviMovieContainer external object type](#) 406
[ExCDAudioAtom external object type](#) 409
[ExCDAudioContainer external object type](#) 408
[ExColorFollowEnum enumeration](#) 465
[ExControlAtom external object type](#) 411
[ExControlContainer external object type](#) 410
[ExControlStg external object type](#) 430
[ExControlStgCompressedAtom external object type](#) 430
[ExControlStgUncompressedAtom external object type](#) 430
[ExHyperlink9Container external object type](#) 418
[ExHyperlinkAtom external object type](#) 415
[ExHyperlinkContainer external object type](#) 414
[ExHyperlinkFlagsAtom external object type](#) 420
[ExHyperlinkId basic type](#) 33
[ExHyperlinkIdRef basic type](#) 34
[ExHyperlinkRefAtom external object type](#) 419
[ExMCIMovieContainer external object type](#) 420
[ExMediaAtom external object type](#) 407
[ExMIDIAudioContainer external object type](#) 421
[ExObjId basic type](#) 34
[ExObjIdRef basic type](#) 34
[ExObjListAtom external object type](#) 405
[ExObjListContainer external object type](#) 404
[ExObjListSubContainer external object type](#) 405
[ExObjRefAtom shape type](#) 201
[ExOleEmbedAtom external object type](#) 423
[ExOleEmbedContainer external object type](#) 422
[ExOleLinkAtom external object type](#) 425
[ExOleLinkContainer external object type](#) 424
[ExOleObjAtom external object type](#) 412
[ExOleObjStg external object type](#) 428
[ExOleObjStgCompressedAtom external object type](#) 429
[ExOleObjStgUncompressedAtom external object type](#) 428
[ExOleObjSubTypeEnum enumeration](#) 465

[ExOleObjTypeEnum enumeration](#) 466
 External object type
 [BinaryTagDataBlob type](#) 455
 [ClipboardNameAtom](#) 414
 [DocRoutingSlipAtom type](#) 433
 [DocRoutingSlipString type](#) 435
 [EnvelopeData9Atom type](#) 436
 [EnvelopeFlags9Atom type](#) 436
 [ExAviMovieContainer](#) 406
 [ExCDAudioAtom](#) 409
 [ExCDAudioContainer](#) 408
 [ExControlAtom](#) 411
 [ExControlContainer](#) 410
 [ExControlStg](#) 430
 [ExControlStgCompressedAtom](#) 430
 [ExControlStgUncompressedAtom](#) 430
 [ExHyperlink9Container](#) 418
 [ExHyperlinkAtom](#) 415
 [ExHyperlinkContainer](#) 414
 [ExHyperlinkFlagsAtom](#) 420
 [ExHyperlinkRefAtom](#) 419
 [ExMCIMovieContainer](#) 420
 [ExMediaAtom](#) 407
 [ExMIDIAudioContainer](#) 421
 [ExObjListAtom](#) 405
 [ExObjListContainer](#) 404
 [ExObjListSubContainer](#) 405
 [ExOleEmbedAtom](#) 423
 [ExOleEmbedContainer](#) 422
 [ExOleLinkAtom](#) 425
 [ExOleLinkContainer](#) 424
 [ExOleObjAtom](#) 412
 [ExOleObjStg](#) 428
 [ExOleObjStgCompressedAtom](#) 429
 [ExOleObjStgUncompressedAtom](#) 428
 [ExVideoContainer](#) 406
 [ExWAVAudioEmbeddedAtom](#) 427
 [ExWAVAudioEmbeddedContainer](#) 426
 [ExWAVAudioLinkContainer](#) 427
 [FontEmbedDataBlob type](#) 437
 [FriendlyNameAtom](#) 416
 [LocationAtom](#) 417
 [MenuNameAtom](#) 413
 [MetafileBlob type](#) 437
 [ProgIDAtom](#) 413
 [ProgStringTagContainer type](#) 453
 [RoundTripAnimationAtom type](#) 438
 [RoundTripAnimationHashAtom type](#) 439
 [RoundTripColorMappingAtom type](#) 440
 [RoundTripCompositeMasterId12Atom type](#) 440
 [RoundTripContentMasterId12Atom type](#) 441
 [RoundTripContentMasterInfo12Atom type](#) 442
 [RoundTripCustomTableStyles12Atom type](#) 442
 [RoundTripDocFlags12Atom type](#) 443
 [RoundTripHeaderFooterDefaults12Atom type](#) 443
 [RoundTripHFPlaceholder12Atom type](#) 444
 [RoundTripNewPlaceholderId12Atom type](#) 445
 [RoundTripNotesMasterTextStyles12Atom type](#) 445
 [RoundTripOArtTextStyles12Atom type](#) 446
 [RoundTripOriginalMainMasterId12Atom type](#) 446
 [RoundTripShapeChecksumForCustomLayouts12Atom type](#) 447
 [RoundTripShapeId12Atom type](#) 448
 [RoundTripSlideSyncInfo12Container type](#) 448
 [RoundTripThemeAtom type](#) 451
 [ScreenTipAtom](#) 419
 [ServerIdAtom type](#) 449
 [SlideLibUrlAtom type](#) 450
 [SlideSyncInfoAtom12 type](#) 450
 [SmartTagStore11Container type](#) 452
 [SoundDataBlob type](#) 452
 [TagNameAtom type](#) 454
 [TagValueAtom type](#) 454
 [TargetAtom](#) 417
 [UncOrLocalPathAtom](#) 408
 [UnknownBinaryTag type](#) 455
 [VbaProjectStg](#) 431
 [VbaProjectStgCompressedAtom](#) 432
 [VbaProjectStgUncompressedAtom](#) 431
 [External objects overview](#) 22
 [External video example](#) 603
 [ExternalObjectDiffContainer document comparison type](#) 119
 [ExtTimeNodeContainer animation type](#) 233
 [ExVideoContainer external object type](#) 406
 [ExWAVAudioEmbeddedAtom external object type](#) 427
 [ExWAVAudioEmbeddedContainer external object type](#) 426
 [ExWAVAudioLinkContainer external object type](#) 427

F

[Fields - vendor-extensible](#) 27
 File storage
 [custom XML data](#) 32
 [digital signature](#) 32
 File stream
 [document summary information](#) 32
 [encrypted summary information](#) 32
 [signatures](#) 33
 [summary information](#) 32
 [file stream structure](#) 28
[File streams](#) 28
 [current user](#) 28
 [pictures](#) 32
 [PowerPoint document](#) 28
[File Structure example](#) 502
 File structure type
 [CryptSession10Container](#) 44
 [CurrentUserAtom](#) 39
 [PersistDirectoryAtom](#) 42
 [PersistDirectoryEntry](#) 43
 [PersistOffsetEntry](#) 43
 [RecordHeader](#) 39
 [UserEditAtom](#) 41
 [FileNameAtom publish type](#) 94
 [FileOrDirNameFragment basic type](#) 34
 [FilterPrivacyFlags10Atom document type](#) 54
 [FontCollection10Container text type](#) 347
 [FontCollectionContainer text type](#) 345
 [FontCollectionEntry text type](#) 345
 [FontEmbedDataBlob type](#) 437
 [FontEmbedFlags10Atom text type](#) 348
 [FontEntityAtom text type](#) 346
 [FontIndexRef basic type](#) 34
 [FontIndexRef10 basic type](#) 34
 [FooterAtom header/footer type](#) 67
 [FooterMCAAtom text type](#) 377

[FriendlyNameAtom external object type](#) 416

G

[GenericDateMCAAtom text type](#) 385
[Glossary](#) 15
[GridSpacing10Atom view info type](#) 124
[GuideAtom view info type](#) 132

H

[HandoutContainer slide type](#) 157
[HandoutRoundTripAtom slide type](#) 158
[HashCode10Atom animation type](#) 223
Header/footer type
 [FooterAtom](#) 67
 [HeaderAtom](#) 66
 [HeadersFootersAtom](#) 65
 [NotesHeadersFootersContainer](#) 67
 [SlideHeadersFootersContainer](#) 64
 [UserDataAtom](#) 65
[HeaderAtom header/footer type](#) 66
[HeaderFooterDiffContainer document comparison type](#) 106
[HeaderMCAAtom text type](#) 377
[HeadersFootersAtom header/footer type](#) 65
[HSLColorBy animation type](#) 287
[HTMLDocInfo9Atom publish type](#) 92
[HTMLPublishInfo9Container publish type](#) 93
[HTMLPublishInfoAtom publish type](#) 95
[HttpUrl basic type](#) 34

I

[Implementer - security considerations](#) 625
[IndentLevel basic type](#) 34
[IndexSchemeColor animation type](#) 289
[Informative references](#) 21
[InteractiveInfoActionEnum enumeration](#) 466
[InteractiveInfoAtom slide show type](#) 195
[InteractiveInfoDiffContainer document comparison type](#) 120
[InteractiveInfoInstance slide show type](#) 194
[InteractiveInfoJumpEnum enumeration](#) 467
[Introduction](#) 15
[Introduction example](#) 491

K

[KeywordsAtom summary info type](#) 135
[Kinsoku9Atom text type](#) 343
[Kinsoku9Container text type](#) 342
[KinsokuAtom text type](#) 341
[KinsokuContainer text type](#) 340
[KinsokuFollowingAtom text type](#) 342
[KinsokuLeadingAtom text type](#) 341

L

[LevelInfoAtom animation type](#) 229
[LinkedShape10Atom slide type](#) 181
[LinkedSlide10Atom slide type](#) 179
[LinkToEnum enumeration](#) 467
[Localization](#) 27

[LocationAtom external object type](#) 417

M

[MachineName basic type](#) 35
[MacroNameAtom slide show type](#) 196
[MainMasterContainer slide type](#) 152
[MainMasterDiffContainer document comparison type](#) 110
[MarginOrIndent basic type](#) 35
[Master slide example](#) 517
[MasterId basic type](#) 35
[MasterIdRef basic type](#) 35
[MasterListDiff10ChildContainer document comparison type](#) 110
[MasterListDiffContainer document comparison type](#) 109
[MasterListWithTextContainer slide list type](#) 58
[MasterOrSlideContainer slide type](#) 155
[MasterPersistAtom slide list type](#) 59
[MasterTextPropAtom text type](#) 403
[MasterTextPropRun text type](#) 403
[MenuNameAtom external object type](#) 413
[Metacharacter example](#) 621
[MetafileBlob type](#) 437
[ModifyPasswordAtom document type](#) 53
[MouseClickedInteractiveInfoContainer slide show type](#) 194
[MouseClickedTextInteractiveInfoAtom text type](#) 388
[MouseOverInteractiveInfoContainer slide show type](#) 195
[MouseOverTextInteractiveInfoAtom text type](#) 389

N

[Named show](#) 25
[NamedShowAtom publish type](#) 95
[NamedShowContainer slide show type](#) 185
[NamedShowDiffContainer document comparison type](#) 107
[NamedShowListDiffContainer document comparison type](#) 106
[NamedShowNameAtom slide show type](#) 185
[NamedShowsContainer slide show type](#) 184
[NamedShowSlidesAtom slide show type](#) 186
[NormalViewSetBarStates enumeration](#) 468
[NormalViewSetInfoAtom view info type](#) 125
[NormalViewSetInfoContainer view info type](#) 124
[Normative references](#) 20
[Notes slide example](#) 530
[NotesAtom slide type](#) 164
[NotesContainer slide type](#) 156
[NotesDiffContainer document comparison type](#) 123
[NotesHeadersFootersContainer header/footer type](#) 67
[NotesId basic type](#) 35
[NotesIdRef basic type](#) 35
[NotesListWithTextContainer slide list type](#) 62
[NotesPersistAtom slide list type](#) 63
[NotesRoundTripAtom slide type](#) 157
[NotesTextViewInfoContainer view info type](#) 127
[NotesViewInfoContainer view info type](#) 133
[NoZoomViewInfoAtom view info type](#) 129

O

[OfficeArtClientAnchor shape type](#) 197
[OfficeArtClientAnchorData shape type](#) 198
[OfficeArtClientData shape type](#) 198
[OfficeArtClientTextbox text type](#) 400
[OLE object example](#) 599
[OLEVerbEnum enumeration](#) 468
[Outline Text example](#) 510
[OutlineTextProps10Container text type](#) 392
[OutlineTextProps10Entry text type](#) 392
[OutlineTextProps11Container text type](#) 393
[OutlineTextProps11Entry text type](#) 393
[OutlineTextProps9Container text type](#) 390
[OutlineTextProps9Entry text type](#) 391
[OutlineTextPropsHeaderExAtom text type](#) 391
[OutlineTextRefAtom text type](#) 402
[OutlineViewInfoContainer view info type](#) 129
 Overview
 [animation](#) 23
 [byte ordering](#) 26
 [external objects](#) 22
 [placeholder shapes](#) 22
 [presentation](#) 22
 [shapes](#) 22
 [slide show](#) 25
 [slides](#) 22

P

[ParaBuildAtom animation type](#) 227
[ParaBuildContainer animation type](#) 226
[ParaBuildEnum enumeration](#) 468
[ParaBuildLevel animation type](#) 229
[Paragraph formatting example](#) 605
[ParaSpacing basic type](#) 35
[Persist Objects example](#) 508
[PersistDirectoryAtom file structure](#) 42
[PersistDirectoryEntry file structure](#) 43
[PersistIdRef basic type](#) 36
[PersistOffsetEntry file structure](#) 43
[PerSlideHeadersFootersContainer slide type](#) 167
[PFMasks text type](#) 356
[PFWrapFlags text type](#) 359
[PhotoAlbumFrameShapeEnum enumeration](#) 469
[PhotoAlbumInfo10Atom document type](#) 54
[PhotoAlbumLayoutEnum enumeration](#) 469
[pictures stream](#) 32
[Placeholder shapes overview](#) 22
[PlaceholderAtom shape type](#) 202
[PlaceholderEnum enumeration](#) 470
[PlaceholderSize enumeration](#) 471
[PointStruct structure](#) 458
[PowerPoint document stream](#) 28
[PP10DocBinaryTagExtension document tag info type](#)
 145
[PP10ShapeBinaryTagExtension shape type](#) 211
[PP10SlideBinaryTagExtension slide type](#) 172
[PP11DocBinaryTagExtension document tag info type](#)
 148
[PP11ShapeBinaryTagExtension shape type](#) 212
[PP12DocBinaryTagExtension document tag info type](#)
 149
[PP12SlideBinaryTagExtension slide type](#) 182
[PP9DocBinaryTagExtension document tag info type](#)
 142
[PP9ShapeBinaryTagExtension shape type](#) 210
[PP9SlideBinaryTagExtension slide type](#) 171
[PresAdvisorFlags9Atom document type](#) 52
[Presentation overview](#) 22
[Presentation slide example](#) 519
[PrintableAnsiString basic type](#) 36
[PrintableUnicodeString basic type](#) 36
[PrintOptionsAtom document type](#) 57
[PrintWhatEnum enumeration](#) 471
[Product behavior](#) 626
[ProgIDAtom external object type](#) 413
 Programmable tags
 [examples](#) 537
[Programmable Tags example](#) 537
[Programmable tags examples](#) 537
[ProgStringTagContainer type](#) 453
 Publish type
 [FileNameAtom](#) 94
 [HTMLDocInfo9Atom](#) 92
 [HTMLPublishInfo9Container](#) 93
 [HTMLPublishInfoAtom](#) 95
 [NamedShowAtom](#) 95

R

[RatioStruct structure](#) 458
[RecolorEntry shape type](#) 206
[RecolorEntryBrush shape type](#) 207
[RecolorEntryColor shape type](#) 207
[RecolorEntryVariant shape type](#) 207
[RecolorInfoAtom shape type](#) 204
[RecolorInfoDiffContainer document comparison type](#)
 118
[RecordHeader file structure](#) 39
[RecordType enumeration](#) 471
[RectStruct structure](#) 458
[References](#) 20
 [informative](#) 21
 [normative](#) 20
[Relationship to protocols and other structures](#) 26
[ReviewerNameAtom document comparison type](#) 102
[RGBColor animation type](#) 288
[RGBColorBy animation type](#) 287
[RoundTripAnimationAtom type](#) 438
[RoundTripAnimationHashAtom type](#) 439
[RoundTripColorMappingAtom type](#) 440
[RoundTripCompositeMasterId12Atom type](#) 440
[RoundTripContentMasterId12Atom type](#) 441
[RoundTripContentMasterInfo12Atom type](#) 442
[RoundTripCustomTableStyles12Atom type](#) 442
[RoundTripDocFlags12Atom type](#) 443
[RoundTripHeaderFooterDefaults12Atom type](#) 443
[RoundTripHFPlaceholder12Atom type](#) 444
[RoundTripMainMasterRecord slide type](#) 155
[RoundTripNewPlaceholderId12Atom type](#) 445
[RoundTripNotesMasterTextStyles12Atom type](#) 445
[RoundTripOArtTextStyles12Atom type](#) 446
[RoundTripOriginalMainMasterId12Atom type](#) 446
[RoundTripShapeChecksumForCustomLayouts12Atom type](#) 447
[RoundTripShapeId12Atom type](#) 448
[RoundTripSlideRecord slide type](#) 152
[RoundTripSlideSyncInfo12Container type](#) 448
[RoundTripThemeAtom type](#) 451
[RTFDateTimeMCAtom text type](#) 385

S

- [ScalingStruct structure](#) 459
- [SchemeListElementColorSchemeAtom slide type](#) 166
- [ScreenTipAtom external object type](#) 419
- [Security - implementer considerations](#) 625
- [ServerIdAtom type](#) 449
- [Shape anchor example](#) 594
- [Shape animation example](#) 555
- Shape client data
 - [examples](#) 594
- [Shape Client Data example](#) 594
- [Shape client data examples](#) 594
- [Shape placeholder example](#) 596
- [Shape text example](#) 597
- Shape type
 - [ExObjRefAtom](#) 201
 - [OfficeArtClientAnchor](#) 197
 - [OfficeArtClientAnchorData](#) 198
 - [OfficeArtClientData](#) 198
 - [PlaceholderAtom](#) 202
 - [PP10ShapeBinaryTagExtension](#) 211
 - [PP11ShapeBinaryTagExtension](#) 212
 - [PP9ShapeBinaryTagExtension](#) 210
 - [RecolorEntry](#) 206
 - [RecolorEntryBrush](#) 207
 - [RecolorEntryColor](#) 207
 - [RecolorEntryVariant](#) 207
 - [RecolorInfoAtom](#) 204
 - [ShapeClientRoundtripDataSubContainerOrAtom](#) 200
 - [ShapeFlags10Atom](#) 201
 - [ShapeFlagsAtom](#) 200
 - [ShapeProgBinaryTagContainer](#) 209
 - [ShapeProgBinaryTagSubContainerOrAtom](#) 210
 - [ShapeProgTagsContainer](#) 209
 - [ShapeProgTagsSubContainerOrAtom](#) 209
- [ShapeClientRoundtripDataSubContainerOrAtom shape type](#) 200
- [ShapeDiffContainer document comparison type](#) 114
- [ShapeFlags10Atom shape type](#) 201
- [ShapeFlagsAtom shape type](#) 200
- [ShapeListDiffContainer document comparison type](#) 114
- [ShapeProgBinaryTagContainer shape type](#) 209
- [ShapeProgBinaryTagSubContainerOrAtom shape type](#) 210
- [ShapeProgTagsContainer shape type](#) 209
- [ShapeProgTagsSubContainerOrAtom shape type](#) 209
- [Shapes overview](#) 22
- [signatures stream](#) 33
- Slide list type
 - [MasterListWithTextContainer](#) 58
 - [MasterPersistAtom](#) 59
 - [NotesListWithTextContainer](#) 62
 - [NotesPersistAtom](#) 63
 - [SlideListWithTextContainer](#) 59
 - [SlideListWithTextSubContainerOrAtom](#) 60
 - [SlidePersistAtom](#) 61
- [Slide programmable tag example](#) 540
- Slide show
 - [named show](#) 25
 - [slide transitions](#) 25
- [Slide show overview](#) 25

- Slide show type
 - [InteractiveInfoAtom](#) 195
 - [InteractiveInfoInstance](#) 194
 - [MacroNameAtom](#) 196
 - [MouseClickedInteractiveInfoContainer](#) 194
 - [MouseOverInteractiveInfoContainer](#) 195
 - [NamedShowContainer](#) 185
 - [NamedShowNameAtom](#) 185
 - [NamedShowsContainer](#) 184
 - [NamedShowSlidesAtom](#) 186
 - [SlideShowDocInfoAtom](#) 183
 - [SlideShowSlideInfoAtom](#) 187
- [Slide transitions](#) 25
- Slide type
 - [Comment10Atom](#) 177
 - [Comment10AuthorAtom](#) 175
 - [Comment10AuthorInitialAtom](#) 176
 - [Comment10Container](#) 174
 - [Comment10TextAtom](#) 176
 - [DrawingContainer](#) 165
 - [HandoutContainer](#) 157
 - [HandoutRoundTripAtom](#) 158
 - [LinkedShape10Atom](#) 181
 - [LinkedSlide10Atom](#) 179
 - [MainMasterContainer](#) 152
 - [MasterOrSlideContainer](#) 155
 - [NotesAtom](#) 164
 - [NotesContainer](#) 156
 - [NotesRoundTripAtom](#) 157
 - [PerSlideHeadersFootersContainer](#) 167
 - [PP10SlideBinaryTagExtension](#) 172
 - [PP12SlideBinaryTagExtension](#) 182
 - [PP9SlideBinaryTagExtension](#) 171
 - [RoundTripMainMasterRecord](#) 155
 - [RoundTripSlideRecord](#) 152
 - [SchemeListElementColorSchemeAtom](#) 166
 - [SlideAtom](#) 159
 - [SlideContainer](#) 150
 - [SlideFlags](#) 164
 - [SlideFlags10Atom](#) 178
 - [SlideNameAtom](#) 168
 - [SlideProgBinaryTagContainer](#) 170
 - [SlideProgBinaryTagSubContainerOrAtom](#) 170
 - [SlideProgTagsContainer](#) 169
 - [SlideProgTagsSubContainerOrAtom](#) 170
 - [SlideSchemeColorSchemeAtom](#) 166
 - [SlideTime10Atom](#) 178
 - [TemplateNameAtom](#) 168
- [SlideAtom slide type](#) 159
- [SlideContainer slide type](#) 150
- [SlideDiffContainer document comparison type](#) 111
- [SlideFlags slide type](#) 164
- [SlideFlags10Atom slide type](#) 178
- [SlideHeadersFootersContainer header/footer type](#) 64
- [SlideId basic type](#) 36
- [SlideIdRef basic type](#) 37
- [SlideLayoutType enumeration](#) 481
- [SlideLibUrlAtom type](#) 450
- [SlideListDiffContainer document comparison type](#) 108
- [SlideListEntry10Atom document comparison type](#) 100
- [SlideListTable10Container document comparison type](#) 99

[SlideListTableSize10Atom document comparison type](#) 100
[SlideListWithTextContainer slide list type](#) 59
[SlideListWithTextSubContainerOrAtom slide list type](#) 60
[SlideNameAtom slide type](#) 168
[SlideNumberMCAtom text type](#) 376
[SlidePersistAtom slide list type](#) 61
[SlideProgBinaryTagContainer slide type](#) 170
[SlideProgBinaryTagSubContainerOrAtom slide type](#) 170
[SlideProgTagsContainer slide type](#) 169
[SlideProgTagsSubContainerOrAtom slide type](#) 170
Slides
 [examples](#) 517
[Slides example](#) 517
[Slides examples](#) 517
[Slides overview](#) 22
[SlideSchemeColorSchemeAtom slide type](#) 166
[SlideShowDiffContainer document comparison type](#) 122
[SlideShowDocInfoAtom slide show type](#) 183
[SlideShowSlideInfoAtom slide show type](#) 187
SlideSizeEnum enumeration ([section 2.13.26](#) 482, [section 2.13.27](#) 482)
[SlideSyncInfoAtom12 type](#) 450
[SlideTime10Atom slide type](#) 178
[SlideViewInfoAtom view info type](#) 132
[SlideViewInfoContainer view info type](#) 131
[SlideViewInfoInstance view info type](#) 131
[SmallRectStruct structure](#) 459
[SmartTagIndex basic type](#) 37
[SmartTags text type](#) 366
[SmartTagStore11Container type](#) 452
[SorterViewInfoContainer view info type](#) 134
Sound type
 [SoundBuiltinIdAtom](#) 73
 [SoundCollectionAtom](#) 69
 [SoundCollectionContainer](#) 68
 [SoundContainer](#) 70
 [SoundExtensionAtom](#) 71
 [SoundIdAtom](#) 72
 [SoundNameAtom](#) 71
[SoundBuiltinIdAtom sound type](#) 73
[SoundCollectionAtom sound type](#) 69
[SoundCollectionContainer sound type](#) 68
[SoundContainer sound type](#) 70
[SoundDataBlob type](#) 452
[SoundExtensionAtom sound type](#) 71
[SoundIdAtom sound type](#) 72
[SoundIdRef basic type](#) 37
[SoundNameAtom sound type](#) 71
[SpellingFlags text type](#) 366
[storage](#) 28
[Storages](#) 28
Structure
 [ColorIndexStruct](#) 456
 [ColorStruct](#) 456
 [DateTimeStruct](#) 457
 [file streams](#) 28
 [PointStruct](#) 458
 [RatioStruct](#) 458
 [RectStruct](#) 458
 [ScalingStruct](#) 459
 [SmallRectStruct](#) 459

[storages](#) 28
[TmsfTimeStruct](#) 459
[WideColorStruct](#) 457
[StyleTextProp10Atom text type](#) 396
[StyleTextProp11 text type](#) 397
[StyleTextProp11Atom text type](#) 396
[StyleTextProp9 text type](#) 395
[StyleTextProp9Atom text type](#) 394
[StyleTextPropAtom text type](#) 374
[SubEffectContainer animation type](#) 237
Summary info type
 [BookmarkCollectionContainer](#) 137
 [BookmarkEntityAtom](#) 139
 [BookmarkEntityAtomContainer](#) 138
 [BookmarkSeedAtom](#) 137
 [BookmarkValueAtom](#) 140
 [CopyrightAtom](#) 135
 [KeywordsAtom](#) 135
 [SummaryContainer](#) 136
[summary information stream](#) 32
[SummaryContainer summary info type](#) 136

T

[TabCrLfPrintableUnicodeString basic type](#) 37
[TableDiffContainer document comparison type](#) 121
[TableListDiffContainer document comparison type](#) 120
[TabSize basic type](#) 37
[TabStop text type](#) 358
[TabStops text type](#) 358
[TagNameAtom type](#) 454
[TagValueAtom type](#) 454
[TargetAtom external object type](#) 417
[TemplateNameAtom slide type](#) 168
Text
 [examples](#) 605
[Text animation example](#) 541
[Text example](#) 605
[Text examples](#) 605
Text type
 [BlipCollection9Container](#) 398
 [BlipEntityAtom](#) 398
 [BulletFlags](#) 357
 [CFMasks](#) 350
 [CFStyle](#) 351
 [DateTimeMCAtom](#) 378
 [DefaultRulerAtom](#) 361
 [DocumentTextInfoContainer](#) 338
 [FontCollection10Container](#) 347
 [FontCollectionContainer](#) 345
 [FontCollectionEntry](#) 345
 [FontEmbedFlags10Atom](#) 348
 [FontEntityAtom](#) 346
 [FooterMCAtom](#) 377
 [GenericDateMCAtom](#) 385
 [HeaderMCAtom](#) 377
 [Kinsoku9Atom](#) 343
 [Kinsoku9Container](#) 342
 [KinsokuAtom](#) 341
 [KinsokuContainer](#) 340
 [KinsokuFollowingAtom](#) 342
 [KinsokuLeadingAtom](#) 341
 [MasterTextPropAtom](#) 403
 [MasterTextPropRun](#) 403

[MouseClickedTextInteractiveInfoAtom](#) 388
[MouseOverTextInteractiveInfoAtom](#) 389
[OfficeArtClientTextbox](#) 400
[OutlineTextProps10Container](#) 392
[OutlineTextProps10Entry](#) 392
[OutlineTextProps11Container](#) 393
[OutlineTextProps11Entry](#) 393
[OutlineTextProps9Container](#) 390
[OutlineTextProps9Entry](#) 391
[OutlineTextPropsHeaderExAtom](#) 391
[OutlineTextRefAtom](#) 402
[PFMasks](#) 356
[PFWrapFlags](#) 359
[RTFDateTimeMCAtom](#) 385
[SlideNumberMCAtom](#) 376
[SmartTags](#) 366
[SpellingFlags](#) 366
[StyleTextProp10Atom](#) 396
[StyleTextProp11](#) 397
[StyleTextProp11Atom](#) 396
[StyleTextProp9](#) 395
[StyleTextProp9Atom](#) 394
[StyleTextPropAtom](#) 374
[TabStop](#) 358
[TabStops](#) 358
[TextAutoNumberScheme](#) 360
[TextBookmarkAtom](#) 386
[TextBytesAtom](#) 373
[TextCFException](#) 349
[TextCFException10](#) 353
[TextCFException9](#) 352
[TextCFExceptionAtom](#) ([section 2.9.13](#) 348, [section 2.9.19](#) 354)
[TextCFRun](#) 376
[TextCharsAtom](#) 373
[TextClientDataSubContainerOrAtom](#) 401
[TextDefaults10Atom](#) 400
[TextDefaults9Atom](#) 399
[TextHeaderAtom](#) 371
[TextInteractiveInfoInstance](#) 388
[TextMasterStyle10Atom](#) 370
[TextMasterStyle10Levels](#) 371
[TextMasterStyle9Atom](#) 368
[TextMasterStyle9Level](#) 369
[TextMasterStyleAtom](#) 366
[TextMasterStyleLevel](#) 368
[TextPFException](#) 354
[TextPFException9](#) 359
[TextPFRun](#) 375
[TextRange](#) 389
[TextRuler](#) 362
[TextRulerAtom](#) 361
[TextSIException](#) 364
[TextSIExceptionAtom](#) 364
[TextSIRun](#) 387
[TextSpecialInfoAtom](#) 387
[TextAutoNumberScheme text type](#) 360
[TextAutoNumberSchemeEnum enumeration](#) 483
[TextBookmarkAtom text type](#) 386
[TextBuildSubEffectEnum enumeration](#) 485
[TextBytesAtom text type](#) 373
[TextCFException text type](#) 349
[TextCFException10 text type](#) 353
[TextCFException9 text type](#) 352
[TextCFExceptionAtom text type](#) ([section 2.9.13](#) 348, [section 2.9.19](#) 354)
[TextCFRun text type](#) 376
[TextCharsAtom text type](#) 373
[TextClientDataSubContainerOrAtom text type](#) 401
[TextDefaults10Atom text type](#) 400
[TextDefaults9Atom text type](#) 399
[TextDiffContainer document comparison type](#) 117
[TextDirectionEnum enumeration](#) 485
[TextFontAlignmentEnum enumeration](#) 485
[TextHeaderAtom text type](#) 371
[TextInteractiveInfo example](#) 618
[TextInteractiveInfoInstance text type](#) 388
[TextMasterStyle10Atom text type](#) 370
[TextMasterStyle10Levels text type](#) 371
[TextMasterStyle9Atom text type](#) 368
[TextMasterStyle9Level text type](#) 369
[TextMasterStyleAtom text type](#) 366
[TextMasterStyleLevel text type](#) 368
[TextPFException text type](#) 354
[TextPFException9 text type](#) 359
[TextPFRun text type](#) 375
[TextPosition basic type](#) 37
[TextRange text type](#) 389
[TextRuler text type](#) 362
[TextRulerAtom text type](#) 361
[TextSIException text type](#) 364
[TextSIExceptionAtom text type](#) 364
[TextSIRun text type](#) 387
[TextSpecialInfoAtom text type](#) 387
[TextTabTypeEnum enumeration](#) 485
[TextTypeEnum enumeration](#) 486
[TimeAnimateBehaviorAtom animation type](#) 264
[TimeAnimateBehaviorContainer animation type](#) 262
[TimeAnimateBehaviorValueTypeEnum enumeration](#) 486
[TimeAnimateColor animation type](#) 288
[TimeAnimateColorBy animation type](#) 286
[TimeAnimationValueAtom animation type](#) 269
[TimeAnimationValueListContainer animation type](#) 266
[TimeAnimationValueListEntry animation type](#) 266
[TimeBehaviorAtom animation type](#) 271
[TimeBehaviorContainer animation type](#) 270
[TimeColorBehaviorAtom animation type](#) 285
[TimeColorBehaviorContainer animation type](#) 284
[TimeColorBehaviorPropertyUsedFlag animation type](#) 286
[TimeColorDirection animation type](#) 276
[TimeColorModel animation type](#) 275
[TimeCommandBehaviorAtom animation type](#) 329
[TimeCommandBehaviorContainer animation type](#) 327
[TimeCommandBehaviorTypeEnum enumeration](#) 486
[TimeConditionAtom animation type](#) 333
[TimeConditionContainer animation type](#) 333
[TimeDisplayType animation type](#) 242
[TimeEffectBehaviorAtom animation type](#) 294
[TimeEffectBehaviorContainer animation type](#) 289
[TimeEffectID animation type](#) 245
[TimeEffectNodeType animation type](#) 261
[TimeEffectType animation type](#) 258
[TimeEventFilter animation type](#) 260
[TimeGroupID animation type](#) 260
[TimeIterateDataAtom animation type](#) 329
[Timeline](#) 23

[TimeMasterRelType animation type](#) 243
[TimeModifierAtom animation type](#) 335
[TimeMotionBehaviorAtom animation type](#) 297
[TimeMotionBehaviorContainer animation type](#) 295
[TimeNodeAtom animation type](#) 239
[TimeNodeTimeFilter animation type](#) 259
[TimeNodeTypeEnum enumeration](#) 487
[TimeOverride animation type](#) 276
[TimePointsTypes animation type](#) 278
TimePropertyID4TimeBehavior enumeration ([section 2.13.37](#) 487, [section 2.13.38](#) 487)
[TimePropertyList4TimeBehavior animation type](#) 273
[TimePropertyList4TimeNodeContainer animation type](#) 240
[TimeRotationBehaviorAtom animation type](#) 299
[TimeRotationBehaviorContainer animation type](#) 299
[TimeRuntimeContext animation type](#) 277
[TimeScaleBehaviorAtom animation type](#) 301
[TimeScaleBehaviorContainer animation type](#) 301
[TimeSequenceDataAtom animation type](#) 331
[TimeSetBehaviorAtom animation type](#) 326
[TimeSetBehaviorContainer animation type](#) 303
[TimeStringListContainer animation type](#) 272
[TimeSubType animation type](#) 244
[TimeVariant animation type](#) 335
[TimeVariant4Behavior animation type](#) 274
[TimeVariant4TimeNode animation type](#) 241
[TimeVariantBool animation type](#) 336
[TimeVariantFloat animation type](#) 337
[TimeVariantInt animation type](#) 336
[TimeVariantString animation type](#) 338
[TimeVariantTypeEnum enumeration](#) 488
[TimeVisualElementEnum enumeration](#) 488
[TmsfTimeStruct structure](#) 459
[Tracking changes](#) 633
[TriggerObjectEnum enumeration](#) 489
[TxLCID basic type](#) 38

U

[UncOrLocalPath basic type](#) 38
[UncOrLocalPathAtom external object type](#) 408
[UncPath basic type](#) 38
[UncPathOrHttpUrl basic type](#) 38
[UnicodeString basic type](#) 38
[UnknownBinaryTag type](#) 455
[UserDataAtom header/footer type](#) 65
[UserEditAtom file structure](#) 41
[Utf8UnicodeString basic type](#) 38

V

[VBAInfoAtom document type](#) 56
[VBAInfoContainer document type](#) 55
[VbaProjectStg external object type](#) 431
[VbaProjectStgCompressedAtom external object type](#) 432
[VbaProjectStgUncompressedAtom external object type](#) 431
[Vendor-extensible fields](#) 27
[Versioning](#) 27
View info type
[GridSpacing10Atom](#) 124
[GuideAtom](#) 132
[NormalViewSetInfoAtom](#) 125

[NormalViewSetInfoContainer](#) 124
[NotesTextViewInfoContainer](#) 127
[NotesViewInfoContainer](#) 133
[NoZoomViewInfoAtom](#) 129
[OutlineViewInfoContainer](#) 129
[SlideViewInfoAtom](#) 132
[SlideViewInfoContainer](#) 131
[SlideViewInfoInstance](#) 131
[SorterViewInfoContainer](#) 134
[ZoomViewInfoAtom](#) 127
[ViewTypeEnum enumeration](#) 489
[VisualElementAtom animation type](#) 280
[VisualPageAtom animation type](#) 280
[VisualShapeAtom animation type](#) 282
[VisualShapeChartElementAtom animation type](#) 282
[VisualShapeGeneralAtom animation type](#) 283
[VisualShapeOrSoundAtom animation type](#) 281
[VisualSoundAtom animation type](#) 281

W

[WebFrameColorsEnum enumeration](#) 490
[WebOutputEnum enumeration](#) 490
[WideColorStruct structure](#) 457

Z

[ZoomViewInfoAtom view info type](#) 127