



**"Vega" 7nm Instruction Set
Architecture
*Reference Guide***

26-November-2019

Specification Agreement

This Specification Agreement (this "Agreement") is a legal agreement between Advanced Micro Devices, Inc. ("AMD") and "You" as the recipient of the attached AMD Specification (the "Specification"). If you are accessing the Specification as part of your performance of work for another party, you acknowledge that you have authority to bind such party to the terms and conditions of this Agreement. If you accessed the Specification by any means or otherwise use or provide Feedback (defined below) on the Specification, You agree to the terms and conditions set forth in this Agreement. If You do not agree to the terms and conditions set forth in this Agreement, you are not licensed to use the Specification; do not use, access or provide Feedback about the Specification. In consideration of Your use or access of the Specification (in whole or in part), the receipt and sufficiency of which are acknowledged, You agree as follows:

1. You may review the Specification only (a) as a reference to assist You in planning and designing Your product, service or technology ("Product") to interface with an AMD product in compliance with the requirements as set forth in the Specification and (b) to provide Feedback about the information disclosed in the Specification to AMD.
 2. Except as expressly set forth in Paragraph 1, all rights in and to the Specification are retained by AMD. This Agreement does not give You any rights under any AMD patents, copyrights, trademarks or other intellectual property rights. You may not (i) duplicate any part of the Specification; (ii) remove this Agreement or any notices from the Specification, or (iii) give any part of the Specification, or assign or otherwise provide Your rights under this Agreement, to anyone else.
 3. The Specification may contain preliminary information, errors, or inaccuracies, or may not include certain necessary information. Additionally, AMD reserves the right to discontinue or make changes to the Specification and its products at any time without notice. The Specification is provided entirely "AS IS." AMD MAKES NO WARRANTY OF ANY KIND AND DISCLAIMS ALL EXPRESS, IMPLIED AND STATUTORY WARRANTIES, INCLUDING BUT NOT LIMITED TO IMPLIED WARRANTIES OF MERCHANTABILITY, FITNESS FOR A PARTICULAR PURPOSE, NONINFRINGEMENT, TITLE OR THOSE WARRANTIES ARISING AS A COURSE OF DEALING OR CUSTOM OF TRADE. AMD SHALL NOT BE LIABLE FOR DIRECT, INDIRECT, CONSEQUENTIAL, SPECIAL, INCIDENTAL, PUNITIVE OR EXEMPLARY DAMAGES OF ANY KIND (INCLUDING LOSS OF BUSINESS, LOSS OF INFORMATION OR DATA, LOST PROFITS, LOSS OF CAPITAL, LOSS OF GOODWILL) REGARDLESS OF THE FORM OF ACTION WHETHER IN CONTRACT, TORT (INCLUDING NEGLIGENCE) AND STRICT PRODUCT LIABILITY OR OTHERWISE, EVEN IF ADVISED OF THE POSSIBILITY OF SUCH DAMAGES.
 4. Furthermore, AMD's products are not designed, intended, authorized or warranted for use as components in systems intended for surgical implant into the body, or in other applications intended to support or sustain life, or in any other application in which the failure of AMD's product could create a situation where personal injury, death, or severe property or environmental damage may occur.
 5. You have no obligation to give AMD any suggestions, comments or feedback ("Feedback") relating to the Specification. However, any Feedback You voluntarily provide may be used by AMD without restriction, fee or obligation of confidentiality. Accordingly, if You do give AMD Feedback on any version of the Specification, You agree AMD may freely use, reproduce, license, distribute, and otherwise commercialize Your Feedback in any product, as well as has the right to sublicense third parties to do the same. Further, You will not give AMD any Feedback that You may have reason to believe is (i) subject to any patent, copyright or other intellectual property claim or right of any third party; or (ii) subject to license terms which seek to require any product or intellectual property incorporating or derived from Feedback or any Product or other AMD intellectual property to be licensed to or otherwise provided to any third party.
 6. You shall adhere to all applicable U.S., European, and other export laws, including but not limited to the U.S. Export Administration Regulations ("EAR"), (15 C.F.R. Sections 730 through 774), and E.U. Council Regulation (EC) No 428/2009 of 5 May 2009. Further, pursuant to Section 740.6 of the EAR, You hereby certifies that, except pursuant to a license granted by the United States Department of Commerce Bureau of Industry and Security or as otherwise permitted pursuant to a License Exception under the U.S. Export Administration Regulations ("EAR"), You will not (1) export, re-export or release to a national of a country in Country Groups D:1, E:1 or E:2 any restricted technology, software, or source code You receive hereunder, or (2) export to Country Groups D:1, E:1 or E:2 the direct product of such technology or software, if such foreign produced direct product is subject to
-

national security controls as identified on the Commerce Control List (currently found in Supplement 1 to Part 774 of EAR). For the most current Country Group listings, or for additional information about the EAR or Your obligations under those regulations, please refer to the U.S. Bureau of Industry and Security's website at <http://www.bis.doc.gov/>.

7. If You are a part of the U.S. Government, then the Specification is provided with "RESTRICTED RIGHTS" as set forth in subparagraphs (c) (1) and (2) of the Commercial Computer Software-Restricted Rights clause at FAR 52.227-14 or subparagraph (c) (1)(ii) of the Rights in Technical Data and Computer Software clause at DFARS 252.277-7013, as applicable.
8. This Agreement is governed by the laws of the State of California without regard to its choice of law principles. Any dispute involving it must be brought in a court having jurisdiction of such dispute in Santa Clara County, California, and You waive any defenses and rights allowing the dispute to be litigated elsewhere. If any part of this agreement is unenforceable, it will be considered modified to the extent necessary to make it enforceable, and the remainder shall continue in effect. The failure of AMD to enforce any rights granted hereunder or to take action against You in the event of any breach hereunder shall not be deemed a waiver by AMD as to subsequent enforcement of rights or subsequent actions in the event of future breaches. This Agreement is the entire agreement between You and AMD concerning the Specification; it may be changed only by a written document signed by both You and an authorized representative of AMD.

DISCLAIMER

The information contained herein is for informational purposes only, and is subject to change without notice. While every precaution has been taken in the preparation of this document, it may contain technical inaccuracies, omissions and typographical errors, and AMD is under no obligation to update or otherwise correct this information. Advanced Micro Devices, Inc. makes no representations or warranties with respect to the accuracy or completeness of the contents of this document, and assumes no liability of any kind, including the implied warranties of noninfringement, merchantability or fitness for particular purposes, with respect to the operation or use of AMD hardware, software or other products described herein. No license, including implied or arising by estoppel, to any intellectual property rights is granted by this document. Terms and limitations applicable to the purchase or use of AMD's products are as set forth in a signed agreement between the parties or in AMD's Standard Terms and Conditions of Sale.

AMD, the AMD Arrow logo, and combinations thereof are trademarks of Advanced Micro Devices, Inc. Other product names used in this publication are for identification purposes only and may be trademarks of their respective companies.

© 2018-2019 Advanced Micro Devices, Inc. All rights reserved.



Advanced Micro Devices, Inc.

2485 Augustine Drive

Santa Clara, CA, 95054

www.amd.com

Contents

Preface	1
About This Document	1
Audience	1
Organization	1
Conventions	2
Related Documents	2
New Features of "Vega" 7nm Devices	2
New Instructions	3
Contact Information	3
1. Introduction	5
1.1. Terminology	6
2. Program Organization	8
2.1. Compute Shaders	8
2.2. Data Sharing	9
2.2.1. Local Data Share (LDS)	9
2.2.2. Global Data Share (GDS)	10
2.3. Device Memory	10
3. Kernel State	11
3.1. State Overview	11
3.2. Program Counter (PC)	12
3.3. EXECute Mask	12
3.4. Status registers	13
3.5. Mode register	14
3.6. GPRs and LDS	15
3.6.1. Out-of-Range behavior	16
3.6.2. SGPR Allocation and storage	17
3.6.3. SGPR Alignment	17
3.6.4. VGPR Allocation and Alignment	17
3.6.5. LDS Allocation and Clamping	17
3.7. M# Memory Descriptor	18
3.8. SCC: Scalar Condition code	18
3.9. Vector Compares: VCC and VCCZ	18
3.10. Trap and Exception registers	19
3.10.1. Trap Status register	20
3.11. Memory Violations	21
4. Program Flow Control	22
4.1. Program Control	22
4.2. Branching	22
4.3. Workgroups	23
4.4. Data Dependency Resolution	23

4.5. Manually Inserted Wait States (NOPs)	24
4.6. Arbitrary Divergent Control Flow	26
5. Scalar ALU Operations	28
5.1. SALU Instruction Formats	28
5.2. Scalar ALU Operands	28
5.3. Scalar Condition Code (SCC)	31
5.4. Integer Arithmetic Instructions	31
5.5. Conditional Instructions	32
5.6. Comparison Instructions	32
5.7. Bit-Wise Instructions	32
5.8. Access Instructions	34
6. Vector ALU Operations	36
6.1. Microcode Encodings	36
6.2. Operands	37
6.2.1. Instruction Inputs	37
6.2.2. Instruction Outputs	38
6.2.3. Out-of-Range GPRs	40
6.3. Instructions	40
6.4. Denormalized and Rounding Modes	42
6.5. ALU Clamp Bit Usage	43
6.6. VGPR Indexing	43
6.6.1. Indexing Instructions	43
6.6.2. Specific Cases	44
6.7. Packed Math	45
7. Scalar Memory Operations	46
7.1. Microcode Encoding	46
7.2. Operations	47
7.2.1. S_LOAD_DWORD, S_STORE_DWORD	47
7.2.2. Scalar Atomic Operations	48
7.2.3. S_DCACHE_INV, S_DCACHE_WB	49
7.2.4. S_MEMTIME	49
7.2.5. S_MEMREALTIME	49
7.3. Dependency Checking	49
7.4. Alignment and Bounds Checking	49
8. Vector Memory Operations	51
8.1. Vector Memory Buffer Instructions	51
8.1.1. Simplified Buffer Addressing	52
8.1.2. Buffer Instructions	52
8.1.3. VGPR Usage	54
8.1.4. Buffer Data	55
8.1.5. Buffer Addressing	56
8.1.6. 16-bit Memory Operations	61

8.1.7. Alignment	61
8.1.8. Buffer Resource	61
8.1.9. Memory Buffer Load to LDS	62
8.1.10. GLC Bit Explained	63
8.2. Vector Memory (VM) Image Instructions	64
8.2.1. Image Instructions	65
8.3. Image Opcodes with No Sampler	66
8.4. Image Opcodes with a Sampler	67
8.4.1. VGPR Usage	69
8.4.2. Image Resource	70
8.4.3. Image Sampler	72
8.4.4. Data Formats	73
8.4.5. Vector Memory Instruction Data Dependencies	74
9. Flat Memory Instructions	76
9.1. Flat Memory Instruction	76
9.2. Instructions	78
9.2.1. Ordering	78
9.2.2. Important Timing Consideration	78
9.3. Addressing	79
9.4. Global	79
9.5. Scratch	79
9.6. Memory Error Checking	80
9.7. Data	80
9.8. Scratch Space (Private)	81
10. Data Share Operations	82
10.1. Overview	82
10.2. Dataflow in Memory Hierarchy	83
10.3. LDS Access	83
10.3.1. LDS Direct Reads	84
10.3.2. LDS Parameter Reads	84
10.3.3. Data Share Indexed and Atomic Access	85
11. Exporting Pixel and Vertex Data	89
11.1. Microcode Encoding	89
11.2. Operations	90
11.2.1. Pixel Shader Exports	90
11.2.2. Vertex Shader Exports	90
11.3. Dependency Checking	90
12. Instructions	92
12.1. SOP2 Instructions	92
12.2. SOPK Instructions	97
12.3. SOP1 Instructions	99
12.4. SOPC Instructions	109

12.5. SOPP Instructions	110
12.5.1. Send Message	114
12.6. SMEM Instructions	114
12.7. VOP2 Instructions	122
12.7.1. VOP2 using VOP3 encoding	127
12.8. VOP1 Instructions	127
12.8.1. VOP1 using VOP3 encoding	141
12.9. VOPC Instructions	142
12.9.1. VOPC using VOP3A encoding	154
12.10. VOP3P Instructions	154
12.11. VINTERP Instructions	156
12.11.1. VINTERP using VOP3 encoding	157
12.12. VOP3A & VOP3B Instructions	157
12.13. LDS & GDS Instructions	176
12.13.1. DS_SWIZZLE_B32 Details	197
12.13.2. LDS Instruction Limitations	199
12.14. MUBUF Instructions	200
12.15. MTBUF Instructions	205
12.16. MIMG Instructions	206
12.17. EXPORT Instructions	211
12.18. FLAT, Scratch and Global Instructions	212
12.18.1. Flat Instructions	212
12.18.2. Scratch Instructions	216
12.18.3. Global Instructions	217
12.19. Instruction Limitations	221
12.19.1. DPP	221
12.19.2. SDWA	222
13. Microcode Formats	223
13.1. Scalar ALU and Control Formats	224
13.1.1. SOP2	225
13.1.2. SOPK	228
13.1.3. SOP1	230
13.1.4. SOPC	233
13.1.5. SOPP	235
13.2. Scalar Memory Format	237
13.2.1. SMEM	237
13.3. Vector ALU Formats	240
13.3.1. VOP2	240
13.3.2. VOP1	243
13.3.3. VOPC	247
13.3.4. VOP3A	256
13.3.5. VOP3B	261

13.3.6. VOP3P	263
13.3.7. SDWA	265
13.3.8. SDWAB	267
13.3.9. DPP	267
13.4. Vector Parameter Interpolation Format	269
13.4.1. VINTRP	269
13.5. LDS and GDS format	270
13.5.1. DS	270
13.6. Vector Memory Buffer Formats	275
13.6.1. MTBUF	275
13.6.2. MUBUF	277
13.7. Vector Memory Image Format	280
13.7.1. MIMG	280
13.8. Flat Formats	284
13.8.1. FLAT	285
13.8.2. GLOBAL	287
13.8.3. SCRATCH	289
13.9. Export Format	290
13.9.1. EXP	290

Preface

About This Document

This document describes the environment, organization and program state of AMD GCN "Vega" 7nm Generation devices. It details the instruction set and the microcode formats native to this family of processors that are accessible to programmers and compilers.

The document specifies the instructions (include the format of each type of instruction) and the relevant program state (including how the program state interacts with the instructions). Some instruction fields are mutually dependent; not all possible settings for all fields are legal. This document specifies the valid combinations.

The main purposes of this document are to:

1. Specify the language constructs and behavior, including the organization of each type of instruction in both text syntax and binary format.
2. Provide a reference of instruction operation that compiler writers can use to maximize performance of the processor.

Audience

This document is intended for programmers writing application and system software, including operating systems, compilers, loaders, linkers, device drivers, and system utilities. It assumes that programmers are writing compute-intensive parallel applications (streaming applications) and assumes an understanding of requisite programming practices.

Organization

This document begins with an overview of the AMD GCN processors' hardware and programming environment (Chapter 1).

Chapter 2 describes the organization of GCN programs.

Chapter 3 describes the program state that is maintained.

Chapter 4 describes the program flow.

Chapter 5 describes the scalar ALU operations.

Chapter 6 describes the vector ALU operations.

Chapter 7 describes the scalar memory operations.

Chapter 8 describes the vector memory operations.

Chapter 9 provides information about the flat memory instructions.

Chapter 10 describes the data share operations.

Chapter 11 describes exporting the parameters of pixel color and vertex shaders.

Chapter 12 describes instruction details, first by the microcode format to which they belong,

then in alphabetic order.

Finally, Chapter 13 provides a detailed specification of each microcode format.

Conventions

The following conventions are used in this document:

mono-spaced font	A filename, file path or code.
*	Any number of alphanumeric characters in the name of a code format, parameter, or instruction.
< >	Angle brackets denote streams.
[1,2)	A range that includes the left-most value (in this case, 1), but excludes the right-most value (in this case, 2).
[1,2]	A range that includes both the left-most and right-most values.
{x y}	One of the multiple options listed. In this case, X or Y.
0.0	A single-precision (32-bit) floating-point value.
1011b	A binary value, in this example a 4-bit value.
7:4	A bit range, from bit 7 to bit 4, inclusive. The high-order bit is shown first.
<i>italicized word or phrase</i>	The first use of a term or concept basic to the understanding of stream computing.

Related Documents

- Intermediate Language (IL) Reference Manual. Published by AMD.
- AMD Accelerated Parallel Processing OpenCL Programming Guide. Published by AMD.
- The OpenCL Specification. Published by Khronos Group. Aaftab Munshi, editor.
- OpenGL Programming Guide, at <http://www.glprogramming.com/red/>
- Microsoft DirectX Reference Website, at http://msdn.microsoft.com/archive/default.asp?url=/archive/en-us/directx9_c_Summer_04/directx/graphics/reference/reference.asp

New Features of "Vega" 7nm Devices

Summary of kernel instruction changes in Vega GPUs:

- New packed 16-bit math instructions.

V_PK_MAD_I16	V_PK_MUL_LO_U16	V_PK_ADD_I16	V_PK_SUB_I16
V_PK_LSHLREV_B16	V_PK_LSHRREV_B16	V_PK_ASHRREV_I16	V_PK_MAX_I16
V_PK_MIN_I16	V_PK_MAD_U16	V_PK_ADD_U16	V_PK_SUB_U16
V_PK_MAX_U16	V_PK_MIN_U16	V_PK_FMA_F16	V_PK_ADD_F16
V_PK_MUL_F16	V_PK_MIN_F16	V_PK_MAX_F16	V_MAD_MIX_F32
V_MAD_MIXLO_F16	V_MAD_MIXHI_F16	S_PACK_{LL, LH, HH}_B16_B32	

- TMA and TBA registers are stored one per VM-ID, not per draw or dispatch.
- Added Image operations support 16-bit address and data.
- Added Global and Scratch memory read/write operations.
 - Also added Scratch load/store to scalar memory.
- Added Scalar memory atomic instructions.
- MIMG Microcode format: removed the R128 bit.
- FLAT Microcode format: added an offset field.
- Removed V_MOVEREL instructions.
- Added control over arithmetic overflow for FP16 VALU operations.
- Modified bit packing of surface descriptors and samplers:
 - T#: removed heap, elem_size, last_array, interlaced, uservm_mode bits.
 - V#: removed mtype.
 - S#: removed astc_hdr field.

New Instructions

Vega 7nm includes the additional instructions listed below:

```
V_FMAC_F32
V_XNOR_B32
V_DOT2_F32_F16
V_DOT2_I32_I16
V_DOT2_U32_U16
V_DOT4_I32_I8
V_DOT4_U32_U8
V_DOT8_I32_I4
V_DOT8_U32_U4
```

Contact Information

For information concerning AMD Accelerated Parallel Processing developing, please see: developer.amd.com/ .

For information about developing with AMD Accelerated Parallel Processing, please see: developer.amd.com/appsdk .

We also have a growing community of AMD Accelerated Parallel Processing users. Come visit us at the AMD Accelerated Parallel Processing Developer Forum (<http://developer.amd.com/openclforum>) to find out what applications other users are trying on their AMD Accelerated Parallel Processing products.

Chapter 1. Introduction

The AMD GCN processor implements a parallel micro-architecture that provides an excellent platform not only for computer graphics applications but also for general-purpose data parallel applications. Data-intensive applications that require high bandwidth or are computationally intensive may be run on an AMD GCN processor.

The figure below shows a block diagram of the AMD GCN Vega Generation series processors

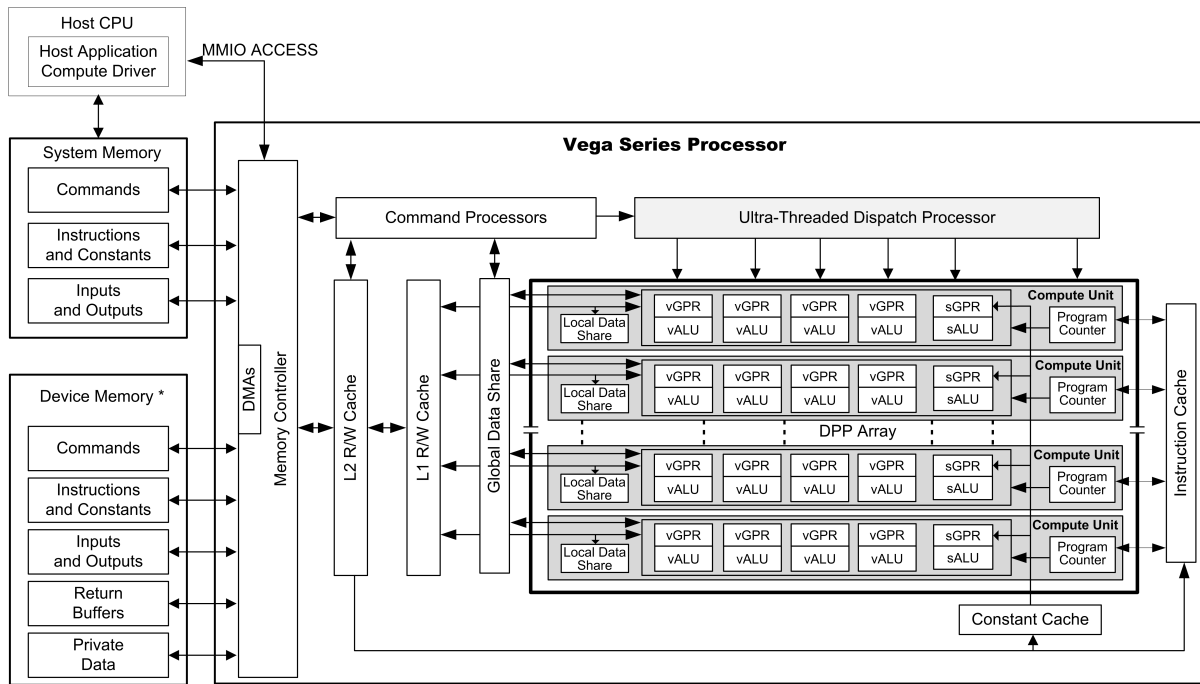

*Discrete GPU – Physical Device Memory; APU – Region of system for GPU direct access

Figure 1. AMD GCN Vega Generation Series Block Diagram

The GCN device includes a data-parallel processor (DPP) array, a command processor, a memory controller, and other logic (not shown). The GCN command processor reads commands that the host has written to memory-mapped GCN registers in the system-memory address space. The command processor sends hardware-generated interrupts to the host when the command is completed. The GCN memory controller has direct access to all GCN device memory and the host-specified areas of system memory. To satisfy read and write requests, the memory controller performs the functions of a direct-memory access (DMA) controller, including computing memory-address offsets based on the format of the requested data in memory. In the GCN environment, a complete application includes two parts:

- a program running on the host processor, and
- programs, called kernels, running on the GCN processor.

The GCN programs are controlled by host commands that

- set GCN internal base-address and other configuration registers,

- specify the data domain on which the GCN GPU is to operate,
- invalidate and flush caches on the GCN GPU, and
- cause the GCN GPU to begin execution of a program.

The GCN driver program runs on the host.

The DPP array is the heart of the GCN processor. The array is organized as a set of compute unit pipelines, each independent from the others, that operate in parallel on streams of floating-point or integer data. The compute unit pipelines can process data or, through the memory controller, transfer data to, or from, memory. Computation in a compute unit pipeline can be made conditional. Outputs written to memory can also be made conditional.

When it receives a request, the compute unit pipeline loads instructions and data from memory, begins execution, and continues until the end of the kernel. As kernels are running, the GCN hardware automatically fetches instructions from memory into on-chip caches; GCN software plays no role in this. GCN kernels can load data from off-chip memory into on-chip general-purpose registers (GPRs) and caches.

The AMD GCN devices can detect floating point exceptions and can generate interrupts. In particular, they detect IEEE floating-point exceptions in hardware; these can be recorded for post-execution analysis. The software interrupts shown in the previous figure from the command processor to the host represent hardware-generated interrupts for signaling command-completion and related management functions.

The GCN processor hides memory latency by keeping track of potentially hundreds of work-items in different stages of execution, and by overlapping compute operations with memory-access operations.

1.1. Terminology

Table 1. Basic Terms

Term	Description
GCN Processor	The Graphics Core Next shader processor is a scalar and vector ALU designed to run complex programs on behalf of a wavefront.
Dispatch	A dispatch launches a 1D, 2D, or 3D grid of work to the GCN processor array.
Workgroup	A workgroup is a collection of wavefronts that have the ability to synchronize with each other quickly; they also can share data through the Local Data Share.
Wavefront	A collection of 64 work-items that execute in parallel on a single GCN processor.
Work-item	A single element of work: one element from the dispatch grid, or in graphics a pixel or vertex.
Literal Constant	A 32-bit integer or float constant that is placed in the instruction stream.
Scalar ALU (SALU)	The scalar ALU operates on one value per wavefront and manages all control flow.

Term	Description
Vector ALU (VALU)	The vector ALU maintains Vector GPRs that are unique for each work item and execute arithmetic operations uniquely on each work-item.
Microcode format	The microcode format describes the bit patterns used to encode instructions. Each instruction is either 32 or 64 bits.
Instruction	An instruction is the basic unit of the kernel. Instructions include: vector ALU, scalar ALU, memory transfer, and control flow operations.
Quad	A quad is a 2x2 group of screen-aligned pixels. This is relevant for sampling texture maps.
Texture Sampler (S#)	A texture sampler is a 128-bit entity that describes how the vector memory system reads and samples (filters) a texture map.
Texture Resource (T#)	A texture resource descriptor describes an image in memory: address, data format, stride, etc.
Buffer Resource (V#)	A buffer resource descriptor describes a buffer in memory: address, data format, stride, etc.

Chapter 2. Program Organization

GCN kernels are programs executed by the GCN processor. Conceptually, the kernel is executed independently on every work-item, but in reality the GCN processor groups 64 work-items into a wavefront, which executes the kernel on all 64 work-items in one pass.

The GCN processor consists of:

- A scalar ALU, which operates on one value per wavefront (common to all work items).
- A vector ALU, which operates on unique values per work-item.
- Local data storage, which allows work-items within a workgroup to communicate and share data.
- Scalar memory, which can transfer data between SGPRs and memory through a cache.
- Vector memory, which can transfer data between VGPRs and memory, including sampling texture maps.

All kernel control flow is handled using scalar ALU instructions. This includes if/else, branches and looping. Scalar ALU (SALU) and memory instructions work on an entire wavefront and operate on up to two SGPRs, as well as literal constants.

Vector memory and ALU instructions operate on all work-items in the wavefront at one time. In order to support branching and conditional execute, every wavefront has an EXECute mask that determines which work-items are active at that moment, and which are dormant. Active work-items execute the vector instruction, and dormant ones treat the instruction as a NOP. The EXEC mask can be changed at any time by Scalar ALU instructions.

Vector ALU instructions can take up to three arguments, which can come from VGPRs, SGPRs, or literal constants that are part of the instruction stream. They operate on all work-items enabled by the EXEC mask. Vector compare and add with- carryout return a bit-per-work-item mask back to the SGPRs to indicate, per work-item, which had a "true" result from the compare or generated a carry-out.

Vector memory instructions transfer data between VGPRs and memory. Each work-item supplies its own memory address and supplies or receives unique data. These instructions are also subject to the EXEC mask.

2.1. Compute Shaders

Compute kernels (shaders) are generic programs that can run on the GCN processor, taking data from memory, processing it, and writing results back to memory. Compute kernels are created by a dispatch, which causes the GCN processors to run the kernel over all of the work-items in a 1D, 2D, or 3D grid of data. The GCN processor walks through this grid and generates wavefronts, which then run the compute kernel. Each work-item is initialized with its unique address (index) within the grid. Based on this index, the work-item computes the address of the

data it is required to work on and what to do with the results.

2.2. Data Sharing

The AMD GCN stream processors are designed to share data between different work-items. Data sharing can boost performance. The figure below shows the memory hierarchy that is available to each work-item.

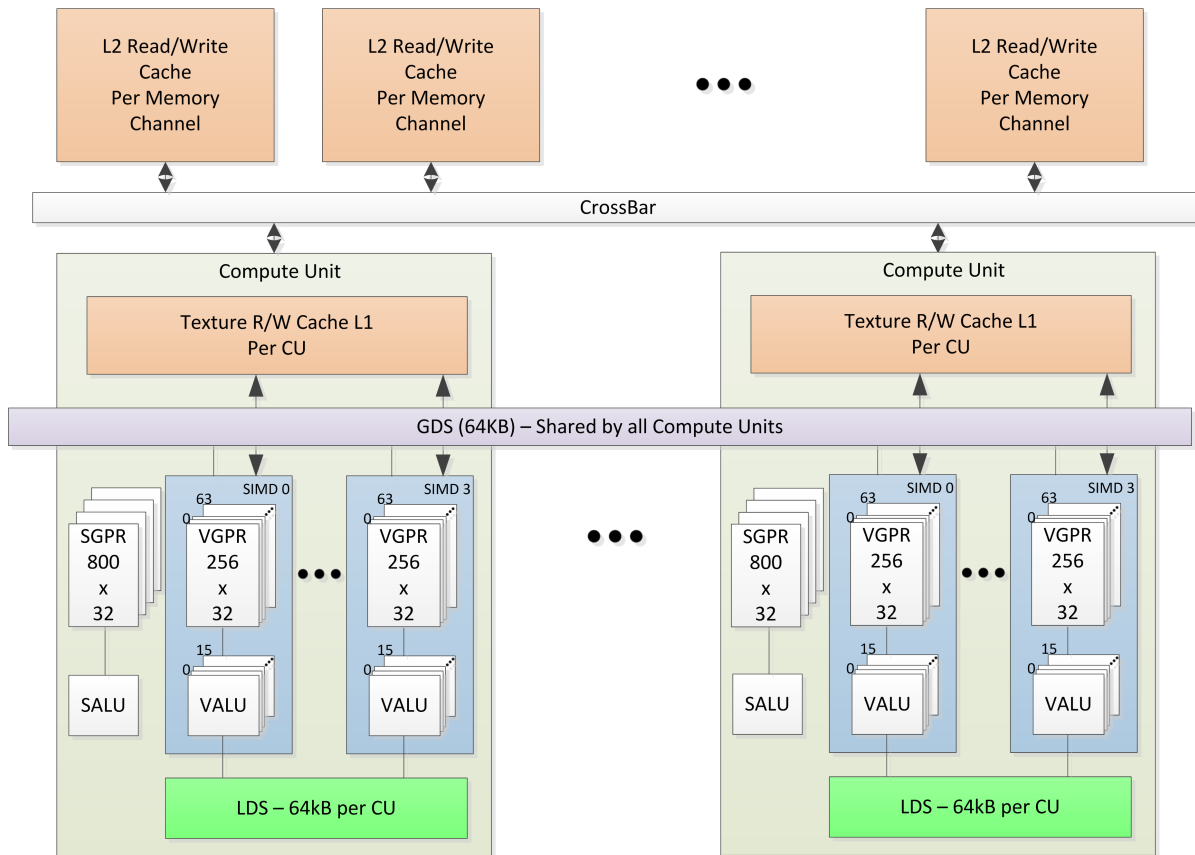

Figure 2. Shared Memory Hierarchy

2.2.1. Local Data Share (LDS)

Each compute unit has a 64 kB memory space that enables low-latency communication between work-items within a work-group, or the work-items within a wavefront; this is the local data share (LDS). This memory is configured with 32 banks, each with 512 entries of 4 bytes. The AMD GCN processors use a 64 kB local data share (LDS) memory for each compute unit; this enables 64 kB of low-latency bandwidth to the processing elements. The shared memory contains 32 integer atomic units to enable fast, unordered atomic operations. This memory can be used as a software cache for predictable re-use of data, a data exchange machine for the work-items of a work-group, or as a cooperative way to enable efficient access to off-chip memory.

2.2.2. Global Data Share (GDS)

The AMD GCN devices use a 64 kB global data share (GDS) memory that can be used by wavefronts of a kernel on all compute units. This memory provides 128 bytes per cycle of memory access to all the processing elements. The GDS is configured with 32 banks, each with 512 entries of 4 bytes each. It is designed to provide full access to any location for any processor. The shared memory contains 32 integer atomic units to enable fast, unordered atomic operations. This memory can be used as a software cache to store important control data for compute kernels, reduction operations, or a small global shared surface. Data can be preloaded from memory prior to kernel launch and written to memory after kernel completion. The GDS block contains support logic for unordered append/consume and domain launch ordered append/consume operations to buffers in memory. These dedicated circuits enable fast compaction of data or the creation of complex data structures in memory.

2.3. Device Memory

The AMD GCN devices offer several methods for access to off-chip memory from the processing elements (PE) within each compute unit. On the primary read path, the device consists of multiple channels of L2 read-only cache that provides data to an L1 cache for each compute unit. Specific cache-less load instructions can force data to be retrieved from device memory during an execution of a load clause. Load requests that overlap within the clause are cached with respect to each other. The output cache is formed by two levels of cache: the first for write-combining cache (collect scatter and store operations and combine them to provide good access patterns to memory); the second is a read/write cache with atomic units that lets each processing element complete unordered atomic accesses that return the initial value. Each processing element provides the destination address on which the atomic operation acts, the data to be used in the atomic operation, and a return address for the read/write atomic unit to store the pre-op value in memory. Each store or atomic operation can be set up to return an acknowledgment to the requesting PE upon write confirmation of the return value (pre-atomic op value at destination) being stored to device memory.

This acknowledgment has two purposes:

- enabling a PE to recover the pre-op value from an atomic operation by performing a cache-less load from its return address after receipt of the write confirmation acknowledgment, and
- enabling the system to maintain a relaxed consistency model.

Each scatter write from a given PE to a given memory channel maintains order. The acknowledgment enables one processing element to implement a fence to maintain serial consistency by ensuring all writes have been posted to memory prior to completing a subsequent write. In this manner, the system can maintain a relaxed consistency model between all parallel work-items operating on the system.

Chapter 3. Kernel State

This chapter describes the kernel states visible to the shader program.

3.1. State Overview

The table below shows all of the hardware states readable or writable by a shader program.

Table 2. Readable and Writable Hardware States

Abbrev.	Name	Size (bits)	Description
PC	Program Counter	48	Points to the memory address of the next shader instruction to execute.
V0-V255	VGPR	32	Vector general-purpose register.
S0-S103	SGPR	32	Scalar general-purpose register.
LDS	Local Data Share	64kB	Local data share is a scratch RAM with built-in arithmetic capabilities that allow data to be shared between threads in a workgroup.
EXEC	Execute Mask	64	A bit mask with one bit per thread, which is applied to vector instructions and controls that threads execute and that ignore the instruction.
EXECZ	EXEC is zero	1	A single bit flag indicating that the EXEC mask is all zeros.
VCC	Vector Condition Code	64	A bit mask with one bit per thread; it holds the result of a vector compare operation.
VCCZ	VCC is zero	1	A single bit-flag indicating that the VCC mask is all zeros.
SCC	Scalar Condition Code	1	Result from a scalar ALU comparison instruction.
FLAT_SCRATCH	Flat scratch address	64	The base address of scratch memory.
XNACK_MASK	Address translation failure.	64	Bit mask of threads that have failed their address translation.
STATUS	Status	32	Read-only shader status bits.
MODE	Mode	32	Writable shader mode bits.
M0	Memory Reg	32	A temporary register that has various uses, including GPR indexing and bounds checking.
TRAPSTS	Trap Status	32	Holds information about exceptions and pending traps.
TBA	Trap Base Address	64	Holds the pointer to the current trap handler program.

Abbrev.	Name	Size (bits)	Description
TMA	Trap Memory Address	64	Temporary register for shader operations. For example, can hold a pointer to memory used by the trap handler.
TTMP0-TTMP15	Trap Temporary SGPRs	32	16 SGPRs available only to the Trap Handler for temporary storage.
VMCNT	Vector memory instruction count	6	Counts the number of VMEM instructions issued but not yet completed.
EXPCNT	Export Count	3	Counts the number of Export and GDS instructions issued but not yet completed. Also counts VMEM writes that have not yet sent their write-data to the TC.
LGKMCNT	LDS, GDS, Constant and Message count	4	Counts the number of LDS, GDS, constant-fetch (scalar memory read), and message instructions issued but not yet completed.

3.2. Program Counter (PC)

The program counter (PC) is a byte address pointing to the next instruction to execute. When a wavefront is created, the PC is initialized to the first instruction in the program.

The PC interacts with three instructions: `S_GET_PC`, `S_SET_PC`, `S_SWAP_PC`. These transfer the PC to, and from, an even-aligned SGPR pair.

Branches jump to (`PC_of_the_instruction_after_the_branch + offset`). The shader program cannot directly read from, or write to, the PC. Branches, `GET_PC` and `SWAP_PC`, are PC-relative to the next instruction, not the current one. `S_TRAP` saves the PC of the `S_TRAP` instruction itself.

3.3. EXECute Mask

The Execute mask (64-bit) determines which threads in the vector are executed:

1 = execute, 0 = do not execute.

EXEC can be read from, and written to, through scalar instructions; it also can be written as a result of a vector-ALU compare. This mask affects vector-ALU, vector-memory, LDS, and export instructions. It does not affect scalar execution or branches.

A helper bit (EXECZ) can be used as a condition for branches to skip code when EXEC is zero.



This GPU does no optimization when EXEC = 0. The shader hardware executes every instruction, wasting instruction issue bandwidth. Use CBRANCH or VSKIP to rapidly skip over code when it is likely that the EXEC mask is zero.

3.4. Status registers

Status register fields can be read, but not written to, by the shader. These bits are initialized at wavefront-creation time. The table below lists and briefly describes the status register fields.

Table 3. Status Register Fields

Field	Bit Position	Description
SCC	1	Scalar condition code. Used as a carry-out bit. For a comparison instruction, this bit indicates failure or success. For logical operations, this is 1 if the result was non-zero.
SPI_PRIO	2:1	Wavefront priority set by the shader processor interpolator (SPI) when the wavefront is created. See the S_SETPRIO instruction (page 12-49) for details. 0 is lowest, 3 is highest priority.
WAVE_PRIO	4:3	Wavefront priority set by the shader program. See the S_SETPRIO instruction (page 12-49) for details.
PRIV	5	Privileged mode. Can only be active when in the trap handler. Gives write access to the TTMP, TMA, and TBA registers.
TRAP_EN	6	Indicates that a trap handler is present. When set to zero, traps are not taken.
TTRACE_EN	7	Indicates whether thread trace is enabled for this wavefront. If zero, also ignore any shader-generated (instruction) thread-trace data.
EXPORT_RDY	8	This status bit indicates if export buffer space has been allocated. The shader stalls any export instruction until this bit becomes 1. It is set to 1 when export buffer space has been allocated. Before a Pixel or Vertex shader can export, the hardware checks the state of this bit. If the bit is 1, export can be issued. If the bit is zero, the wavefront sleeps until space becomes available in the export buffer. Then, this bit is set to 1, and the wavefront resumes.
EXECZ	9	Exec mask is zero.
VCCZ	10	Vector condition code is zero.
IN_TG	11	Wavefront is a member of a work-group of more than one wavefront.
IN_BARRIER	12	Wavefront is waiting at a barrier.
HALT	13	Wavefront is halted or scheduled to halt. HALT can be set by the host through wavefront-control messages, or by the shader. This bit is ignored while in the trap handler (PRIV = 1); it also is ignored if a host-initiated trap is received (request to enter the trap handler).

Field	Bit Position	Description
TRAP	14	Wavefront is flagged to enter the trap handler as soon as possible.
TTRACE_CU_EN	15	Enables/disables thread trace for this compute unit (CU). This bit allows more than one CU to be outputting USERDATA (shader initiated writes to the thread-trace buffer). Note that wavefront data is only traced from one CU per shader array. Wavefront user data (instruction based) can be output if this bit is zero.
VALID	16	Wavefront is active (has been created and not yet ended).
ECC_ERR	17	An ECC error has occurred.
SKIP_EXPORT	18	For Vertex Shaders only. 1 = this shader is not allocated export buffer space; all export instructions are ignored (treated as NOPs). Formerly called VS_NO_ALLOC. Used for stream-out of multiple streams (multiple passes over the same VS), and for DS running in the VS stage for wavefronts that produced no primitives.
PERF_EN	19	Performance counters are enabled for this wavefront.
COND_DBG_USER	20	Conditional debug indicator for user mode
COND_DBG_SYS	21	Conditional debug indicator for system mode.
ALLOW_REPLAY	22	Indicates that ATC replay is enabled.
MUST_EXPORT	27	This wavefront is required to perform an export with Done=1 before terminating.

3.5. Mode register

Mode register fields can be read from, and written to, by the shader through scalar instructions. The table below lists and briefly describes the mode register fields.

Table 4. Mode Register Fields

Field	Bit Position	Description
FP_ROUND	3:0	[1:0] Single precision round mode. [3:2] Double/Half precision round mode. Round Modes: 0=nearest even, 1= +infinity, 2= -infinity, 3= toward zero.
FP_DENORM	7:4	[1:0] Single precision denormal mode. [3:2] Double/Half-precision denormal mode. Denorm modes: 0 = flush input and output denorms. 1 = allow input denorms, flush output denorms. 2 = flush input denorms, allow output denorms. 3 = allow input and output denorms.
DX10_CLAMP	8	Used by the vector ALU to force DX10-style treatment of NaNs: when set, clamp NaN to zero; otherwise, pass NaN through.

Field	Bit Position	Description
IEEE	9	Floating point opcodes that support exception flag gathering quiet and propagate signaling NaN inputs per IEEE 754-2008. Min_dx10 and max_dx10 become IEEE 754-2008 compliant due to signaling NaN propagation and quieting.
LOD_CLAMPED	10	Sticky bit indicating that one or more texture accesses had their LOD clamped.
DEBUG	11	Forces the wavefront to jump to the exception handler after each instruction is executed (but not after ENDPGM). Only works if TRAP_EN = 1.
EXCP_EN	18:12	Enable mask for exceptions. Enabled means if the exception occurs and TRAP_EN==1, a trap is taken. [12] : invalid. [13] : inputDenormal. [14] : float_div0. [15] : overflow. [16] : underflow. [17] : inexact. [18] : int_div0. [19] : address watch [20] : memory violation
FP16_OVFL	23	If set, an overflowed FP16 result is clamped to +/- MAX_FP16, regardless of round mode, while still preserving true INF values.
POPS_PACKER0	24	1 = this wave is associated with packer 0. User shader must set this to !PackerID from the POPS initialized SGPR (load_collision_waveID), or zero if not using POPS.
POPS_PACKER1	25	1 = this wave is associated with packer 1. User shader must set this to PackerID from the POPS initialized SGPR (load_collision_waveID), or zero if not using POPS.
DISABLE_PERF	26	1 = disable performance counting for this wave
GPR_IDX_EN	27	GPR index enable.
VSKIP	28	0 = normal operation. 1 = skip (do not execute) any vector instructions: valu, vmem, export, lds, gds. "Skipping" instructions occurs at high-speed (10 wavefronts per clock cycle can skip one instruction). This is much faster than issuing and discarding instructions.
CSP	31:29	Conditional branch stack pointer.

3.6. GPRs and LDS

This section describes how GPR and LDS space is allocated to a wavefront, as well as how out-of-range and misaligned accesses are handled.

3.6.1. Out-of-Range behavior

This section defines the behavior when a source or destination GPR or memory address is outside the legal range for a wavefront.

Out-of-range can occur through GPR-indexing or bad programming. It is illegal to index from one register type into another (for example: SGPRs into trap registers or inline constants). It is also illegal to index within inline constants.

The following describe the out-of-range behavior for various storage types.

- SGPRs
 - Source or destination out-of-range = (sgpr < 0 || (sgpr >= sgpr_size)).
 - Source out-of-range: returns the value of SGPR0 (not the value 0).
 - Destination out-of-range: instruction writes no SGPR result.
- VGPRs
 - Similar to SGPRs. It is illegal to index from SGPRs into VGPRs, or vice versa.
 - Out-of-range = (vgpr < 0 || (vgpr >= vgpr_size))
 - If a source VGPR is out of range, VGPR0 is used.
 - If a destination VGPR is out-of-range, the instruction is ignored (treated as an NOP).
- LDS
 - If the LDS-ADDRESS is out-of-range (addr < 0 or > (MIN(lds_size, m0))):
 - Writes out-of-range are discarded; it is undefined if SIZE is not a multiple of write-data-size.
 - Reads return the value zero.
 - If any source-VGPR is out-of-range, use the VGPR0 value is used.
 - If the dest-VGPR is out of range, nullify the instruction (issue with exec=0)
- Memory, LDS, and GDS: Reads and atomics with returns.
 - If any source VGPR or SGPR is out-of-range, the data value is undefined.
 - If any destination VGPR is out-of-range, the operation is nullified by issuing the instruction as if the EXEC mask were cleared to 0.
 - This out-of-range check must check all VGPRs that can be returned (for example: VDST to VDST+3 for a BUFFER_LOAD_DWORDx4).
 - This check must also include the extra PRT (partially resident texture) VGPR and nullify the fetch if this VGPR is out-of-range, no matter whether the texture system actually returns this value or not.
 - Atomic operations with out-of-range destination VGPRs are nullified: issued, but with exec mask of zero.

Instructions with multiple destinations (for example: V_ADDC): if any destination is out-of-range, no results are written.

3.6.2. SGPR Allocation and storage

A wavefront can be allocated 16 to 102 SGPRs, in units of 16 GPRs (Dwords). These are logically viewed as SGPRs 0-101. The VCC is physically stored as part of the wavefront's SGPRs in the highest numbered two SGPRs (SGPR 106 and 107; the source/destination VCC is an alias for those two SGPRs). When a trap handler is present, 16 additional SGPRs are reserved after VCC to hold the trap addresses, as well as saved-PC and trap-handler temps. These all are privileged (cannot be written to unless privilege is set). Note that if a wavefront allocates 16 SGPRs, 2 SGPRs are normally used as VCC, the remaining 14 are available to the shader. Shader hardware does not prevent use of all 16 SGPRs.

3.6.3. SGPR Alignment

Even-aligned SGPRs are required in the following cases.

- When 64-bit data is used. This is required for moves to/from 64-bit registers, including the PC.
- When scalar memory reads that the address-base comes from an SGPR-pair (either in SGPR).

Quad-alignment is required for the data-GPR when a scalar memory read returns four or more Dwords. When a 64-bit quantity is stored in SGPRs, the LSBs are in SGPR[n], and the MSBs are in SGPR[n+1].

3.6.4. VGPR Allocation and Alignment

VGPRs are allocated in groups of four Dwords. Operations using pairs of VGPRs (for example: double-floats) have no alignment restrictions. Physically, allocations of VGPRs can wrap around the VGPR memory pool.

3.6.5. LDS Allocation and Clamping

LDS is allocated per work-group or per-wavefront when work-groups are not in use. LDS space is allocated to a work-group or wavefront in contiguous blocks of 128 Dwords on 128-Dword alignment. LDS allocations do not wrap around the LDS storage. All accesses to LDS are restricted to the space allocated to that wavefront/work-group.

Clamping of LDS reads and writes is controlled by two size registers, which contain values for the size of the LDS space allocated by SPI to this wavefront or work-group, and a possibly smaller value specified in the LDS instruction (size is held in M0). The LDS operations use the smaller of these two sizes to determine how to clamp the read/write addresses.

3.7. M# Memory Descriptor

There is one 32-bit M# (M0) register per wavefront, which can be used for:

- Local Data Share (LDS)
 - Interpolation: holds { 1'b0, new_prim_mask[15:1], parameter_offset[15:0] } // in bytes
 - LDS direct-read offset and data type: { 13'b0, DataType[2:0], LDS_address[15:0] } // addr in bytes
 - LDS addressing for Memory/Vfetch → LDS: {16'h0, lds_offset[15:0]} // in bytes
- Global Data Share (GDS)
 - { base[15:0] , size[15:0] } // base and size are in bytes
- Indirect GPR addressing for both vector and scalar instructions. M0 is an unsigned index.
- Send-message value. EMIT/CUT use M0 and EXEC as the send-message data.

3.8. SCC: Scalar Condition code

Most scalar ALU instructions set the Scalar Condition Code (SCC) bit, indicating the result of the operation.

Compare operations: 1 = true
 Arithmetic operations: 1 = carry out
 Bit/logical operations: 1 = result was not zero
 Move: does not alter SCC

The SCC can be used as the carry-in for extended-precision integer arithmetic, as well as the selector for conditional moves and branches.

3.9. Vector Compares: VCC and VCCZ

Vector ALU comparisons set the Vector Condition Code (VCC) register (1=pass, 0=fail). Also, vector compares have the option of setting EXEC to the VCC value.

There is also a VCC summary bit (vccz) that is set to 1 when the VCC result is zero. This is useful for early-exit branch tests. VCC is also set for selected integer ALU operations (carry-out).

Vector compares have the option of writing the result to VCC (32-bit instruction encoding) or to any SGPR (64-bit instruction encoding). VCCZ is updated every time VCC is updated: vector compares and scalar writes to VCC.

The EXEC mask determines which threads execute an instruction. The VCC indicates which

executing threads passed the conditional test, or which threads generated a carry-out from an integer add or subtract.

$$V_CMP_* \Rightarrow VCC[n] = EXEC[n] \& (\text{test passed for thread}[n])$$

VCC is fully written; there are no partial mask updates.



VCC physically resides in the SGPR register file, so when an instruction sources VCC, that counts against the limit on the total number of SGPRs that can be sourced for a given instruction. VCC physically resides in the highest two user SGPRs.

Shader Hazard with VCC The user/compiler must prevent a scalar-ALU write to the SGPR holding VCC, immediately followed by a conditional branch using VCCZ. The hardware cannot detect this, and inserts the one required wait state (hardware does detect it when the SALU writes to VCC, it only fails to do this when the SALU instruction references the SGPRs that happen to hold VCC).

3.10. Trap and Exception registers

Each type of exception can be enabled or disabled independently by setting, or clearing, bits in the TRAPSTS register's EXCP_EN field. This section describes the registers which control and report kernel exceptions.

All Trap temporary SGPRs (TTMP*) are privileged for writes - they can be written only when in the trap handler (`status.priv = 1`). When not privileged, writes to these are ignored. TMA and TBA are read-only; they can be accessed through `S_GETREG_B32`.

When a trap is taken (either user initiated, exception or host initiated), the shader hardware generates an `S_TRAP` instruction. This loads trap information into a pair of SGPRs:

$$\{TTMP1, TTMP0\} = \{3'h0, pc_rewind[3:0], HT[0], trapID[7:0], PC[47:0]\}.$$

HT is set to one for host initiated traps, and zero for user traps (`s_trap`) or exceptions. `TRAP_ID` is zero for exceptions, or the user/host trapID for those traps. When the trap handler is entered, the PC of the faulting instruction will be: $(PC - PC_rewind * 4)$.

STATUS . TRAP_EN - This bit indicates to the shader whether or not a trap handler is present. When one is not present, traps are not taken, no matter whether they're floating point, user-, or host-initiated traps. When the trap handler is present, the wavefront uses an extra 16 SGPRs for trap processing. If `trap_en == 0`, all traps and exceptions are ignored, and `s_trap` is converted by hardware to NOP.

MODE . EXCP_EN[8:0] - Floating point exception enables. Defines which exceptions and events cause a trap.

Bit	Exception
0	Invalid
1	Input Denormal
2	Divide by zero
3	Overflow
4	Underflow
5	Inexact
6	Integer divide by zero
7	Address Watch - TC (L1) has witnessed a thread access to an 'address of interest'

3.10.1. Trap Status register

The trap status register records previously seen traps or exceptions. It can be read and written by the kernel.

Table 5. Exception Field Bits

Field	Bits	Description
EXCP	8:0	Status bits of which exceptions have occurred. These bits are sticky and accumulate results until the shader program clears them. These bits are accumulated regardless of the setting of EXCP_EN. These can be read or written without shader privilege. Bit Exception 0 invalid 1 Input Denormal 2 Divide by zero 3 overflow 4 underflow 5 inexact 6 integer divide by zero 7 address watch 8 memory violation
SAVECTX	10	A bit set by the host command indicating that this wave must jump to its trap handler and save its context. This bit must be cleared by the trap handler using S_SETREG. Note - a shader can set this bit to 1 to cause a save-context trap, and due to hardware latency the shader may execute up to 2 additional instructions before taking the trap.
ILLEGAL_INST	11	An illegal instruction has been detected.
ADDR_WATCH1-3	14:12	Indicates that address watch 1, 2, or 3 has been hit. Bit 12 is address watch 1; bit 13 is 2; bit 14 is 3.

Field	Bits	Description
EXCP_CYCLE	21:16	When a float exception occurs, this tells the trap handler on which cycle the exception occurred on. 0-3 for normal float operations, 0-7 for double float add, and 0-15 for double float muladd or transcendentals. This register records the cycle number of the first occurrence of an enabled (unmasked) exception. EXCP_CYCLE[1:0] Phase: threads 0-15 are in phase 0, 48-63 in phase 3. EXCP_CYCLE[3:2] Multi-slot pass. EXCP_CYCLE[5:4] Hybrid pass: used for machines running at lower rates.
DP_RATE	31:29	Determines how the shader interprets the TRAP_STS.cycle. Different Vector Shader Processors (VSP) process instructions at different rates.

3.11. Memory Violations

A Memory Violation is reported from:

- LDS alignment error.
- Memory read/write/atomic alignment error.
- Flat access where the address is invalid (does not fall in any aperture).
- Write to a read-only surface.
- GDS alignment or address range error.
- GWS operation aborted (semaphore or barrier not executed).

Memory violations are not reported for instruction or scalar-data accesses.

Memory Buffer to LDS does NOT return a memory violation if the LDS address is out of range, but masks off EXEC bits of threads that would go out of range.

When a memory access is in violation, the appropriate memory (LDS or TC) returns MEM_VIOL to the wave. This is stored in the wave's TRAPSTS.mem_viol bit. This bit is sticky, so once set to 1, it remains at 1 until the user clears it.

There is a corresponding exception enable bit (EXCP_EN.mem_viol). If this bit is set when the memory returns with a violation, the wave jumps to the trap handler.

Memory violations are not precise. The violation is reported when the LDS or TC processes the address; during this time, the wave may have processed many more instructions. When a mem_viol is reported, the Program Counter saved is that of the next instruction to execute; it has no relationship the faulting instruction.

Chapter 4. Program Flow Control

All program flow control is programmed using scalar ALU instructions. This includes loops, branches, subroutine calls, and traps. The program uses SGPRs to store branch conditions and loop counters. Constants can be fetched from the scalar constant cache directly into SGPRs.

4.1. Program Control

The instructions in the table below control the priority and termination of a shader program, as well as provide support for trap handlers.

Table 6. Control Instructions

Instructions	Description
S_ENDPGM	Terminates the wavefront. It can appear anywhere in the kernel and can appear multiple times.
S_ENDPGM_SAVED	Terminates the wavefront due to context save. It can appear anywhere in the kernel and can appear multiple times.
S_NOP	Does nothing; it can be repeated in hardware up to eight times.
S_TRAP	Jumps to the trap handler.
S_RFE	Returns from the trap handler
S_SETPRIO	Modifies the priority of this wavefront: 0=lowest, 3 = highest.
S_SLEEP	Causes the wavefront to sleep for 64 - 960 clock cycles.
S_SENDMSG	Sends a message (typically an interrupt) to the host CPU.

4.2. Branching

Branching is done using one of the following scalar ALU instructions.

Table 7. Branch Instructions

Instructions	Description
S_BRANCH	Unconditional branch.
S_CBRANCH_<test>	Conditional branch. Branch only if <test> is true. Tests are VCCZ, VCCNZ, EXECZ, EXECNZ, SCCZ, and SCCNZ.
S_CBRANCH_CDBGSYS	Conditional branch, taken if the COND_DBG_SYS status bit is set.
S_CBRANCH_CDBGUSER	Conditional branch, taken if the COND_DBG_USER status bit is set.
S_CBRANCH_CDBGSYS_AND_USER	Conditional branch, taken only if both COND_DBG_SYS and COND_DBG_USER are set.
S_SETPC	Directly set the PC from an SGPR pair.

Instructions	Description
S_SWAPPC	Swap the current PC with an address in an SGPR pair.
S_GETPC	Retrieve the current PC value (does not cause a branch).
S_CBRANCH_FORK and S_CBRANCH_JOIN	Conditional branch for complex branching.
S_SETVSKIP	Set a bit that causes all vector instructions to be ignored. Useful alternative to branching.
S_CALL_B64	Jump to a subroutine, and save return address. SGPR_pair = PC+4; PC = PC+4+SIMM16*4.

For conditional branches, the branch condition can be determined by either scalar or vector operations. A scalar compare operation sets the Scalar Condition Code (SCC), which then can be used as a conditional branch condition. Vector compare operations set the VCC mask, and VCCZ or VCCNZ then can be used to determine branching.

4.3. Workgroups

Work-groups are collections of wavefronts running on the same compute unit which can synchronize and share data. Up to 16 wavefronts (1024 work-items) can be combined into a work-group. When multiple wavefronts are in a workgroup, the S_BARRIER instruction can be used to force each wavefront to wait until all other wavefronts reach the same instruction; then, all wavefronts continue. Any wavefront can terminate early using S_ENDPGM, and the barrier is considered satisfied when the remaining live waves reach their barrier instruction.

4.4. Data Dependency Resolution

Shader hardware resolves most data dependencies, but a few cases must be explicitly handled by the shader program. In these cases, the program must insert S_WAITCNT instructions to ensure that previous operations have completed before continuing.

The shader has three counters that track the progress of issued instructions. S_WAITCNT waits for the values of these counters to be at, or below, specified values before continuing.

These allow the shader writer to schedule long-latency instructions, execute unrelated work, and specify when results of long-latency operations are needed.

Instructions of a given type return in order, but instructions of different types can complete out-of-order. For example, both GDS and LDS instructions use LGKM_cnt, but they can return out-of-order.

- VM_CNT: Vector memory count.
Determines when memory reads have returned data to VGPRs, or memory writes have

completed.

- Incremented every time a vector-memory read or write (MIMG, MUBUF, or MTBUF format) instruction is issued.
- Decremented for reads when the data has been written back to the VGPRs, and for writes when the data has been written to the L2 cache. Ordering: Memory reads and writes return in the order they were issued, including mixing reads and writes.
- LGKM_CNT: (LDS, GDS, (K)constant, (M)essage) Determines when one of these low-latency instructions have completed.
 - Incremented by 1 for every LDS or GDS instruction issued, as well as by Dword-count for scalar-memory reads. For example, s_memtime counts the same as an s_load_dwordx2.
 - Decremented by 1 for LDS/GDS reads or atomic-with-return when the data has been returned to VGPRs.
 - Incremented by 1 for each S_SENDMSG issued. Decremented by 1 when message is sent out.
 - Decremented by 1 for LDS/GDS writes when the data has been written to LDS/GDS.
 - Decremented by 1 for each Dword returned from the data-cache (SMEM).

Ordering:

- Instructions of different types are returned out-of-order.
- Instructions of the same type are returned in the order they were issued, except scalar-memory-reads, which can return out-of-order (in which case only S_WAITCNT 0 is the only legitimate value).
- EXP_CNT: VGPR-export count.
Determines when data has been read out of the VGPR and sent to GDS, at which time it is safe to overwrite the contents of that VGPR.
 - Incremented when an Export/GDS instruction is issued from the wavefront buffer.
 - Decremented for exports/GDS when the last cycle of the export instruction is granted and executed (VGPRs read out). Ordering
 - Exports are kept in order only within each export type (color/null, position, parameter cache).

4.5. Manually Inserted Wait States (NOPs)

The hardware does not check for the following dependencies; they must be resolved by inserting NOPs or independent instructions.

Table 8. Required Software-inserted Wait States

First Instruction	Second Instruction	Wait	Notes
S_SETREG <*>	S_GETREG <same reg>	2	
S_SETREG <*>	S_SETREG <same reg>	2	
SET_VSKIP	S_GETREG MODE	2	Reads VSKIP from MODE.

First Instruction	Second Instruction	Wait	Notes
S_SETREG MODE.vskip	any vector op	2	Requires two nops or non-vector instructions.
VALU that sets VCC or EXEC	VALU that uses EXECZ or VCCZ as a data source	5	
VALU writes SGPR/VCC (readlane, cmp, add/sub, div_scale)	V_{READ,WRITE}LANE using that SGPR/VCC as the lane select	4	
VALU writes VCC (including v_div_scale)	V_DIV_FMAS	4	
FLAT_STORE_X3 FLAT_STORE_X4 FLAT_ATOMIC_{F}CMPSWAP_X2 BUFFER_STORE_DWORD_X3 BUFFER_STORE_DWORD_X4 BUFFER_STORE_FORMAT_XYZ BUFFER_STORE_FORMAT_XYZW BUFFER_ATOMIC_{F}CMPSWAP_X2 IMAGE_STORE_* > 64 bits IMAGE_ATOMIC_{F}CMPSWAP > + 64bits	Write VGPRs holding writedata from those instructions.	1	BUFFER_STORE_* operations that use an SGPR for "offset" do not require any wait states. IMAGE_STORE_* and IMAGE_{F}CMPSWAP* ops with more than two DMASK bits set require this one wait state. Ops that use a 256-bit T# do not need a wait state.
VALU writes SGPR	VMEM reads that SGPR	5	Hardware assumes that there is no dependency here. If the VALU writes the SGPR that is used by a VMEM, the user must add five wait states.
SALU writes M0	GDS, S_SENDMSG or S_TTRACE_DATA	1	
VALU writes VGPR	VALU DPP reads that VGPR	2	
VALU writes EXEC	VALU DPP op	5	ALU does not forward EXEC to DPP.
Mixed use of VCC: alias vs SGPR# v_readlane, v_readfirstlane v_cmp v_add*/i/u v_sub*/i/u v_div_scale* (writes vcc)	VALU which reads VCC as a constant (not as a carry-in which is 0 wait states).	1	VCC can be accessed by name or by the logical SGPR which holds VCC. The data dependency check logic does not understand that these are the same register and do not prevent races.
S_SETREG TRAPSTS	RFE, RFE_restore	1	
SALU writes M0	LDS "add-TID" instruction, buffer_store_LDS_dword, scratch or global with LDS = 1, VINTERP or LDS_direct	1	
SALU writes M0	S_MOVEREL	1	

4.6. Arbitrary Divergent Control Flow

In the GCN architecture, conditional branches are handled in one of the following ways.

1. `S_CBRANCH` This case is used for simple control flow, where the decision to take a branch is based on a previous compare operation. This is the most common method for conditional branching.
2. `S_CBRANCH_I/G_FORK` and `S_CBRANCH_JOIN` This method, intended for complex, irreducible control flow graphs, is described in the rest of this section. The performance of this method is lower than that for `S_CBRANCH` on simple flow control; use it only when necessary.

Conditional Branch (CBR) graphs are grouped into self-contained code blocks, denoted by `FORK` at the entrance point, and `JOIN` and the exit point. The shader compiler must add these instructions into the code. This method uses a six-deep stack and requires three SGPRs for each fork/join block. Fork/Join blocks can be hierarchically nested to any depth (subject to SGPR requirements); they also can coexist with other conditional flow control or computed jumps.

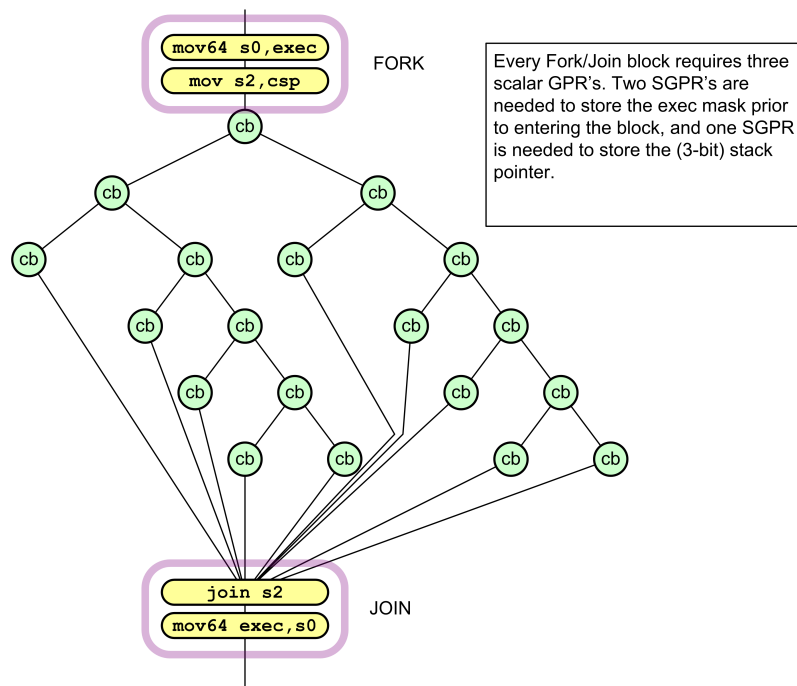

Figure 3. Example of Complex Control Flow Graph

The register requirements per wavefront are:

- `CSP [2:0]` - control stack pointer.
- Six stack entries of 128-bits each, stored in SGPRs: { `exec[63:0]`, `PC[47:2]` }

This method compares how many of the 64 threads go down the `PASS` path instead of the `FAIL` path; then, it selects the path with the fewer number of threads first. This means at most 50% of

the threads are active, and this limits the necessary stack depth to $\text{Log}264 = 6$.

The following pseudo-code shows the details of CBRANCH Fork and Join operations.

```

S_CBRANCH_G_FORK arg0, arg1
    // arg1 is an sgrpr-pair which holds 64bit (48bit) target address

S_CBRANCH_I_FORK arg0, #target_addr_offset[17:2]
    // target_addr_offset: 16b signed immediate offset

// PC: in this pseudo-code is pointing to the cbranch*_fork instruction
mask_pass = SGPR[arg0] & exec
mask_fail = ~SGPR[arg0] & exec

if (mask_pass == exec)
    I_FORK : PC += 4 + target_addr_offset
    G_FORK: PC = SGPR[arg1]
else if (mask_fail == exec)
    PC += 4
else if (bitcount(mask_fail) < bitcount(mask_pass))
    exec = mask_fail
    I_FORK : SGPR[CSP*4] = { (pc + 4 + target_addr_offset), mask_pass }
    G_FORK: SGPR[CSP*4] = { SGPR[arg1], mask_pass }
    CSP++
    PC += 4
else
    exec = mask_pass
    SGPR[CSP*4] = { (pc+4), mask_fail }
    CSP++
    I_FORK : PC += 4 + target_addr_offset
    G_FORK: PC = SGPR[arg1]

S_CBRANCH_JOIN arg0
if (CSP == SGPR[arg0]) // SGPR[arg0] holds the CSP value when the FORK started
    PC += 4 // this is the 2nd time to JOIN: continue with pgm
else
    CSP -- // this is the 1st time to JOIN: jump to other FORK path
    {PC, EXEC} = SGPR[CSP*4] // read 128-bits from 4 consecutive SGPRs

```

Chapter 5. Scalar ALU Operations

Scalar ALU (SALU) instructions operate on a single value per wavefront. These operations consist of 32-bit integer arithmetic and 32- or 64-bit bit-wise operations. The SALU also can perform operations directly on the Program Counter, allowing the program to create a call stack in SGPRs. Many operations also set the Scalar Condition Code bit (SCC) to indicate the result of a comparison, a carry-out, or whether the instruction result was zero.

5.1. SALU Instruction Formats

SALU instructions are encoded in one of five microcode formats, shown below:

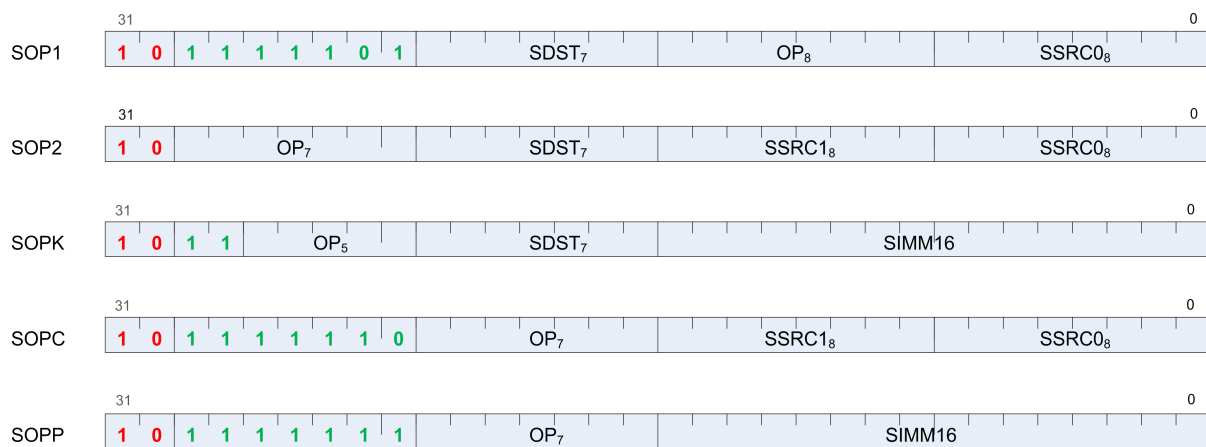

Each of these instruction formats uses some of these fields:

Field	Description
OP	Opcode: instruction to be executed.
SDST	Destination SGPR.
SSRC0	First source operand.
SSRC1	Second source operand.
SIMM16	Signed immediate 16-bit integer constant.

The lists of similar instructions sometimes use a condensed form using curly braces { } to express a list of possible names. For example, S_AND_{B32, B64} defines two legal instructions: S_AND_B32 and S_AND_B64.

5.2. Scalar ALU Operands

Valid operands of SALU instructions are:

- SGPRs, including trap temporary SGPRs.
- Mode register.
- Status register (read-only).
- M0 register.
- TrapSts register.
- EXEC mask.
- VCC mask.
- SCC.
- PC.
- Inline constants: integers from -16 to 64, and a some floating point values.
- VCCZ, EXECZ, and SCC.
- Hardware registers.
- 32-bit literal constant.

In the table below, 0-127 can be used as scalar sources or destinations; 128-255 can only be used as sources.

Table 9. Scalar Operands

	Code	Meaning	Description
Scalar Dest (7 bits)	0 - 101	SGPR 0 to 101	Scalar GPRs
	102	FLAT_SCR_LO	Holds the low Dword of the flat-scratch memory descriptor
	103	FLAT_SCR_HI	Holds the high Dword of the flat-scratch memory descriptor
	104	XNACK_MASK_LO	Holds the low Dword of the XNACK mask.
	105	XNACK_MASK_HI	Holds the high Dword of the XNACK mask.
	106	VCC_LO	Holds the low Dword of the vector condition code
	107	VCC_HI	Holds the high Dword of the vector condition code
	108-123	TTMP0 to TTMP15	Trap temps (privileged)
	124	M0	Holds the low Dword of the flat-scratch memory descriptor
	125	reserved	reserved
	126	EXEC_LO	Execute mask, low Dword
	127	EXEC_HI	Execute mask, high Dword
		128	0
	129-192	int 1 to 64	Positive integer values.
	193-208	int -1 to -16	Negative integer values.
	209-234	reserved	Unused.

	Code	Meaning	Description
	235	SHARED_BASE	Memory Aperture definition.
	236	SHARED_LIMIT	
	237	PRIVATE_BASE	
	238	PRIVATE_LIMIT	
	239	POPS_EXITING_WAVE_ID	Primitive Ordered Pixel Shading wave ID.
	240	0.5	single or double floats
	241	-0.5	
	242	1.0	
	243	-1.0	
	244	2.0	
	245	-2.0	
	246	4.0	
	247	-4.0	
	248	1.0 / (2 * PI)	
	249-250	reserved	unused
	251	VCCZ	{ zeros, VCCZ }
	252	EXECZ	{ zeros, EXECZ }
	253	SCC	{ zeros, SCC }
	254	reserved	unused
	255	Literal	constant 32-bit constant from instruction stream.

The SALU cannot use VGPRs or LDS. SALU instructions can use a 32-bit literal constant. This constant is part of the instruction stream and is available to all SALU microcode formats except SOPP and SOPK. Literal constants are used by setting the source instruction field to "literal" (255), and then the following instruction dword is used as the source value.

If any source SGPR is out-of-range, the value of SGPR0 is used instead.

If the destination SGPR is out-of-range, no SGPR is written with the result. However, SCC and possibly EXEC (if saveexec) will still be written.

If an instruction uses 64-bit data in SGPRs, the SGPR pair must be aligned to an even boundary. For example, it is legal to use SGPRs 2 and 3 or 8 and 9 (but not 11 and 12) to represent 64-bit data.

5.3. Scalar Condition Code (SCC)

The scalar condition code (SCC) is written as a result of executing most SALU instructions.

The SCC is set by many instructions:

- Compare operations: 1 = true.
- Arithmetic operations: 1 = carry out.
 - SCC = overflow for signed add and subtract operations. For add, overflow = both operands are of the same sign, and the MSB (sign bit) of the result is different than the sign of the operands. For subtract (AB), overflow = A and B have opposite signs and the resulting sign is not the same as the sign of A.
- Bit/logical operations: 1 = result was not zero.

5.4. Integer Arithmetic Instructions

This section describes the arithmetic operations supplied by the SALU. The table below shows the scalar integer arithmetic instructions:

Table 10. Integer Arithmetic Instructions

Instruction	Encoding	Sets SCC?	Operation
S_ADD_I32	SOP2	y	$D = S0 + S1$, SCC = overflow.
S_ADD_U32	SOP2	y	$D = S0 + S1$, SCC = carry out.
S_ADDC_U32	SOP2	y	$D = S0 + S1 + SCC$ = overflow.
S_SUB_I32	SOP2	y	$D = S0 - S1$, SCC = overflow.
S_SUB_U32	SOP2	y	$D = S0 - S1$, SCC = carry out.
S_SUBB_U32	SOP2	y	$D = S0 - S1 - SCC$ = carry out.
S_ABSDIFF_I32	SOP2	y	$D = \text{abs}(s1 - s2)$, SCC = result not zero.
S_MIN_I32 S_MIN_U32	SOP2	y	$D = (S0 < S1) ? S0 : S1$. SCC = 1 if S0 was min.
S_MAX_I32 S_MAX_U32	SOP2	y	$D = (S0 > S1) ? S0 : S1$. SCC = 1 if S0 was max.
S_MUL_I32	SOP2	n	$D = S0 * S1$. Low 32 bits of result.
S_ADDK_I32	SOPK	y	$D = D + \text{simm16}$, SCC = overflow. Sign extended version of simm16.
S_MULK_I32	SOPK	n	$D = D * \text{simm16}$. Return low 32bits. Sign extended version of simm16.
S_ABS_I32	SOP1	y	$D.i = \text{abs}(S0.i)$. SCC=result not zero.
S_SEXT_I32_I8	SOP1	n	$D = \{ 24\{S0[7]\}, S0[7:0] \}$.

Instruction	Encoding	Sets SCC?	Operation
S_SEXT_I32_I16	SOP1	n	$D = \{ 16\{S0[15]\}, S0[15:0] \}$.

5.5. Conditional Instructions

Conditional instructions use the SCC flag to determine whether to perform the operation, or (for CSELECT) which source operand to use.

Table 11. Conditional Instructions

Instruction	Encoding	Sets SCC?	Operation
S_CSELECT_{B32, B64}	SOP2	n	$D = SCC ? S0 : S1$.
S_CMOVK_I32	SOPK	n	if (SCC) $D = \text{signext}(\text{simm16})$.
S_CMOV_{B32,B64}	SOP1	n	if (SCC) $D = S0$, else NOP.

5.6. Comparison Instructions

These instructions compare two values and set the SCC to 1 if the comparison yielded a TRUE result.

Table 12. Conditional Instructions

Instruction	Encoding	Sets SCC?	Operation
S_CMP_EQ_U64, S_CMP_NE_U64	SOPC	y	Compare two 64-bit source values. $SCC = S0 <\text{cond}> S1$.
S_CMP_{EQ,NE,GT,GE,LE,LT} _{I32,U32}	SOPC	y	Compare two source values. $SCC = S0 <\text{cond}> S1$.
S_CMPK_{EQ,NE,GT,GE,LE,LT} _{I32,U32}	SOPK	y	Compare Dest SGPR to a constant. $SCC = DST <\text{cond}> \text{simm16}$. simm16 is zero-extended (U32) or sign-extended (I32).
S_BITCMP0_{B32,B64}	SOPC	y	Test for "is a bit zero". $SCC = !S0[S1]$.
S_BITCMP1_{B32,B64}	SOPC	y	Test for "is a bit one". $SCC = S0[S1]$.

5.7. Bit-Wise Instructions

Bit-wise instructions operate on 32- or 64-bit data without interpreting it has having a type. For bit-wise operations if noted in the table below, SCC is set if the result is nonzero.

Table 13. Bit-Wise Instructions

Instruction	Encoding	Sets SCC?	Operation
S_MOV_{B32,B64}	SOP1	n	D = S0
S_MOVK_I32	SOPK	n	D = signext(simm16)
{S_AND,S_OR,S_XOR}_{B32,B64}	SOP2	y	D = S0 & S1, S0 OR S1, S0 XOR S1
{S_ANDN2,S_ORN2}_{B32,B64}	SOP2	y	D = S0 & ~S1, S0 OR ~S1, S0 XOR ~S1,
{S_NAND,S_NOR,S_XNOR}_{B32,B64}	SOP2	y	D = ~(S0 & S1), ~(S0 OR S1), ~(S0 XOR S1)
S_LSHL_{B32,B64}	SOP2	y	D = S0 << S1[4:0], [5:0] for B64.
S_LSHR_{B32,B64}	SOP2	y	D = S0 >> S1[4:0], [5:0] for B64.
S_ASHR_{I32,I64}	SOP2	y	D = sext(S0 >> S1[4:0]) ([5:0] for I64).
S_BFM_{B32,B64}	SOP2	n	Bit field mask. D = ((1 << S0[4:0]) - 1) << S1[4:0].
S_BFE_U32, S_BFE_U64 S_BFE_I32, S_BFE_I64 (signed/unsigned)	SOP2	n	Bit Field Extract, then sign-extend result for I32/64 instructions. S0 = data, S1[5:0] = offset, S1[22:16]= width.
S_NOT_{B32,B64}	SOP1	y	D = ~S0.
S_WQM_{B32,B64}	SOP1	y	D = wholeQuadMode(S0). If any bit in a group of four is set to 1, set the resulting group of four bits all to 1.
S_QUADMASK_{B32,B64}	SOP1	y	D[0] = OR(S0[3:0]), D[1]=OR(S0[7:4]), etc.
S_BREV_{B32,B64}	SOP1	n	D = S0[0:31] are reverse bits.
S_BCNT0_I32_{B32,B64}	SOP1	y	D = CountZeroBits(S0).
S_BCNT1_I32_{B32,B64}	SOP1	y	D = CountOneBits(S0).
S_FF0_I32_{B32,B64}	SOP1	n	D = Bit position of first zero in S0 starting from LSB. -1 if not found.
S_FF1_I32_{B32,B64}	SOP1	n	D = Bit position of first one in S0 starting from LSB. -1 if not found.
S_FLBIT_I32_{B32,B64}	SOP1	n	Find last bit. D = the number of zeros before the first one starting from the MSB. Returns -1 if none.
S_FLBIT_I32 S_FLBIT_I32_I64	SOP1	n	Count how many bits in a row (from MSB to LSB) are the same as the sign bit. Return -1 if the input is zero or all 1's (-1). 32-bit pseudo-code: if (S0 == 0 S0 == -1) D = -1 else D = 0 for (I = 31 .. 0) if (S0[I] == S0[31]) D++ else break This opcode behaves the same as V_FFBH_I32.
S_BITSET0_{B32,B64}	SOP1	n	D[S0[4:0], [5:0] for B64] = 0

Instruction	Encoding	Sets SCC?	Operation
S_BITSET1_{B32,B64}	SOP1	n	D[S0[4:0], [5:0] for B64] = 1
S_{and,or,xor,andn2,orn2,nand,nor,xnor}_SAVEEXEC_B64	SOP1	y	Save the EXEC mask, then apply a bit-wise operation to it. D = EXEC EXEC = S0 <op> EXEC SCC = (exec != 0)
S_{ANDN{1,2}_WREXEC_B64	SOP1	y	N1: EXEC, D = ~S0 & EXEC N2: EXEC, D = S0 & ~EXEC Both D and EXEC get the same result. SCC = (result != 0).
S_MOVRELS_{B32,B64} S_MOVRELD_{B32,B64}	SOP1	n	Move a value into an SGPR relative to the value in M0. MOVERELS: D = SGPR[S0+M0] MOVERELD: SGPR[D+M0] = S0 Index must be even for 64. M0 is an unsigned index.

5.8. Access Instructions

These instructions access hardware internal registers.

Table 14. Hardware Internal Registers

Instruction	Encoding	Sets SCC?	Operation
S_GETREG_B32	SOPK*	n	Read a hardware register into the LSBs of D.
S_SETREG_B32	SOPK*	n	Write the LSBs of D into a hardware register. (Note that D is a source SGPR.) Must add an S_NOP between two consecutive S_SETREG to the same register.
S_SETREG_IMM32_B32	SOPK*	n	S_SETREG where 32-bit data comes from a literal constant (so this is a 64-bit instruction format).

The hardware register is specified in the DEST field of the instruction, using the values in the table above. Some bits of the DEST specify which register to read/write, but additional bits specify which bits in the specific register to read/write:

```
SIMM16 = {size[4:0], offset[4:0], hwRegId[5:0]}; offset is 0..31, size is 1..32.
```

Table 15. Hardware Register Values

Code	Register	Description
0	reserved	
1	MODE	R/W.

Code	Register	Description
2	STATUS	Read only.
3	TRAPSTS	R/W.
4	HW_ID	Read only. Debug only.
5	GPR_ALLOC	Read only. {sgpr_size, sgpr_base, vgpr_size, vgpr_base }.
6	LDS_ALLOC	Read only. {lds_size, lds_base}.
7	IB_STS	Read only. {valu_cnt, lgkm_cnt, exp_cnt, vm_cnt}.
8 - 15		reserved.
16	TBA_LO	Trap base address register [31:0].
17	TBA_HI	Trap base address register [47:32].
18	TMA_LO	Trap memory address register [31:0].
19	TMA_HI	Trap memory address register [47:32].

Table 16. IB_STS

Code	Register	Description
VM_CNT	23:22, 3:0	Number of VMEM instructions issued but not yet returned.
EXP_CNT	6:4	Number of Exports issued but have not yet read their data from VGPRs.
LGKM_CNT	11:8	LDS, GDS, Constant-memory and Message instructions issued-but-not-completed count.
VALU_CNT	14:12	Number of VALU instructions outstanding for this wavefront.

Table 17. GPR_ALLOC

Code	Register	Description
VGPR_BASE	5:0	Physical address of first VGPR assigned to this wavefront, as [7:2]
VGPR_SIZE	13:8	Number of VGPRs assigned to this wavefront, as [7:2]. 0=4 VGPRs, 1=8 VGPRs, etc.
SGPR_BASE	21:16	Physical address of first SGPR assigned to this wavefront, as [7:3].
SGPR_SIZE	27:24	Number of SGPRs assigned to this wave, as [7:3]. 0=8 SGPRs, 1=16 SGPRs, etc.

Table 18. LDS_ALLOC

Code	Register	Description
LDS_BASE	7:0	Physical address of first LDS location assigned to this wavefront, in units of 64 Dwords.
LDS_SIZE	20:12	Amount of LDS space assigned to this wavefront, in units of 64 Dwords.

Chapter 6. Vector ALU Operations

Vector ALU instructions (VALU) perform an arithmetic or logical operation on data for each of 64 threads and write results back to VGPRs, SGPRs or the EXEC mask.

Parameter interpolation is a mixed VALU and LDS instruction, and is described in the Data Share chapter.

6.1. Microcode Encodings

Most VALU instructions are available in two encodings: VOP3 which uses 64-bits of instruction, and one of three 32-bit encodings that offer a restricted set of capabilities. A few instructions are only available in the VOP3 encoding. The only instructions that cannot use the VOP3 format are the parameter interpolation instructions.

When an instruction is available in two microcode formats, it is up to the user to decide which to use. It is recommended to use the 32-bit encoding whenever possible.

The microcode encodings are shown below.

VOP2 is for instructions with two inputs and a single vector destination. Instructions that have a carry-out implicitly write the carry-out to the VCC register.

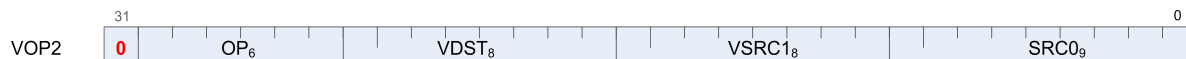

VOP1 is for instructions with no inputs or a single input and one destination.



VOPC is for comparison instructions.

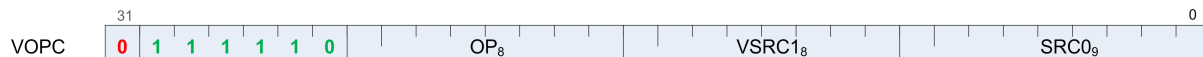

VINTRP is for parameter interpolation instructions.



VOP3 is for instructions with up to three inputs, input modifiers (negate and absolute value), and output modifiers. There are two forms of VOP3: one which uses a scalar destination field (used only for div_scale, integer add and subtract); this is designated VOP3b. All other instructions use the common form, designated VOP3a.

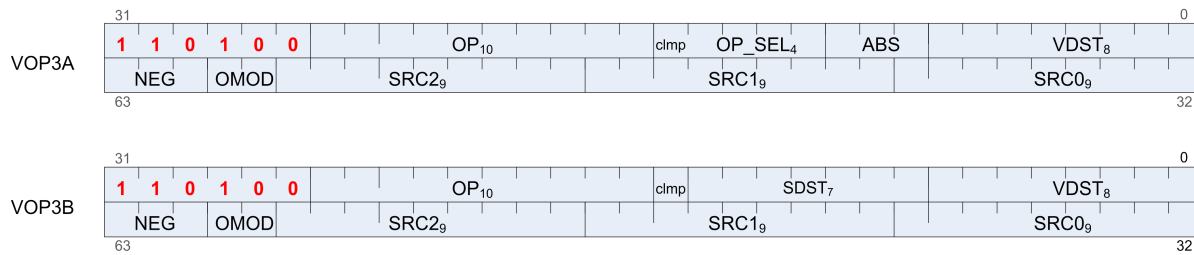

Any of the 32-bit microcode formats may use a 32-bit literal constant, but not VOP3.

VOP3P is for instructions that use "packed math": They perform the operation on a pair of input values that are packed into the high and low 16-bits of each operand; the two 16-bit results are written to a single VGPR as two packed values.

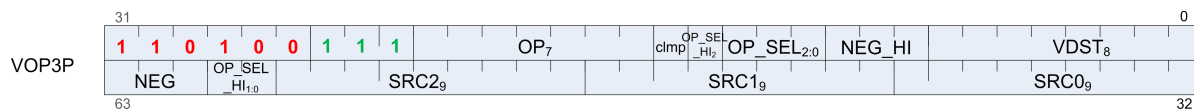

6.2. Operands

All VALU instructions take at least one input operand (except V_NOP and V_CLREXCP). The data-size of the operands is explicitly defined in the name of the instruction. For example, V_MAD_F32 operates on 32-bit floating point data.

6.2.1. Instruction Inputs

VALU instructions can use any of the following sources for input, subject to restrictions listed below:

- VGPRs.
- SGPRs.
- Inline constants - constant selected by a specific VSRC value.
- Literal constant - 32-bit value in the instruction stream. When a literal constant is used with a 64bit instruction, the literal is expanded to 64 bits by: padding the LSBs with zeros for floats, padding the MSBs with zeros for unsigned ints, and by sign-extending signed ints.
- LDS direct data read.
- M0.
- EXEC mask.

Limitations

- At most one SGPR can be read per instruction, but the value can be used for more than one operand.
- At most one literal constant can be used, and only when an SGPR or M0 is not used as a source.

- Only SRC0 can use LDS_DIRECT (see Chapter 10, "Data Share Operations").

Specific Cases for Constants

VALU "ADDC", "SUBB" and CNDMASK all implicitly use an SGPR value (VCC), so these instructions cannot use an additional SGPR or literal constant.

Instructions using the VOP3 form and also using floating-point inputs have the option of applying absolute value (ABS field) or negate (NEG field) to any of the input operands.

Literal Expansion to 64 bits

Literal constants are 32-bits, but they can be used as sources which normally require 64-bit data:

- 64 bit float: the lower 32-bit are padded with zero.
- 64-bit unsigned integer: zero extended to 64 bits
- 64-bit signed integer: sign extended to 64 bits

6.2.2. Instruction Outputs

VALU instructions typically write their results to VGPRs specified in the VDST field of the microcode word. A thread only writes a result if the associated bit in the EXEC mask is set to 1.

All V_CMPX instructions write the result of their comparison (one bit per thread) to both an SGPR (or VCC) and the EXEC mask.

Instructions producing a carry-out (integer add and subtract) write their result to VCC when used in the VOP2 form, and to an arbitrary SGPR-pair when used in the VOP3 form.

When the VOP3 form is used, instructions with a floating-point result can apply an output modifier (OMOD field) that multiplies the result by: 0.5, 1.0, 2.0 or 4.0. Optionally, the result can be clamped (CLAMP field) to the range [0.0, +1.0].

In the table below, all codes can be used when the vector source is nine bits; codes 0 to 255 can be the scalar source if it is eight bits; codes 0 to 127 can be the scalar source if it is seven bits; and codes 256 to 511 can be the vector source or destination.

Table 19. Instruction Operands

Value	Name	Description
0-101	SGPR	0 .. 101
102	FLATSCR_LO	Flat Scratch[31:0].

Value	Name	Description
103	FLATSCR_HI	Flat Scratch[63:32].
104	XNACK_MASK_LO	
105	XNACK_MASK_HI	
106	VCC_LO	vcc[31:0].
107	VCC_HI	vcc[63:32].
108-123	TTMP0 to TTMP 15	Trap handler temps (privileged).
124	M0	
125	reserved	
126	EXEC_LO	exec[31:0].
127	EXEC_HI	exec[63:32].
128	0	
129-192	int 1.. 64	Integer inline constants.
193-208	int -1 .. -16	
209-234	reserved	Unused.
235	SHARED_BASE	Memory Aperture definition.
236	SHARED_LIMIT	
237	PRIVATE_BASE	
238	PRIVATE_LIMIT	
239	POPS_EXITING_WAVE_ID	Primitive Ordered Pixel Shading wave ID.
240	0.5	Single, double, or half-precision inline floats. 1/(2*PI) is 0.15915494. The exact value used is: half: 0x3118 single: 0x3e22f983 double: 0x3fc45f306dc9c882
241	-0.5	
242	1.0	
243	-1.0	
244	2.0	
245	-2.0	
246	4.0	
247	-4.0	
248	1/(2*PI)	
249	SDWA	Sub Dword Address (only valid as Source-0)
250	DPP	DPP over 16 lanes (only valid as Source-0)
251	VCCZ	{ zeros, VCCZ }
252	EXECZ	{ zeros, EXECZ }
253	SCC	{ zeros, SCC }

Value	Name	Description
254	LDS direct	Use LDS direct read to supply 32-bit value Vector-alu instructions only.
255	Literal	constant 32-bit constant from instruction stream.
256-511	VGPR	0 .. 255

6.2.3. Out-of-Range GPRs

When a source VGPR is out-of-range, the instruction uses as input the value from VGPR0.

When the destination GPR is out-of-range, the instruction executes but does not write the results.

6.3. Instructions

The table below lists the complete VALU instruction set by microcode encoding, except for VOP3P instructions which are listed in a later section.

Table 20. VALU Instruction Set

VOP3	VOP3 - 1-2 operand opcodes	VOP2	VOP1
V_MAD_LEGACY_F32	V_ADD_F64	V_ADD_{ F16, F32, U16, U32 }	V_NOP
V_MAD_{ F16, I16, U16, F32 }	V_MUL_F64	V_SUB_{ F16, F32, U16, U32 }	V_MOV_B32
V_MAD_LEGACY_{F16, U16, I16 }	V_MIN_F64	V_SUBREV_{ F16, F32, U16, U32 }	
V_MAD_I32_I24	V_MAX_F64	V_ADD_CO_U32	V_READFIRSTLANE_B32
V_MAD_U32_U24	V_LDEXP_F64	V_SUB_CO_U32	V_CVT_F32_{I32, U32, F16, F64 }
V_CUBEID_F32	V_MUL_LO_U32	V_SUBREV_CO_U32	V_CVT_{I32, U32, F16, F64}_F32
V_CUBESC_F32	V_MUL_HI_{I32, U32 }	V_ADDC_U32	V_CVT_{I32, U32}_F64
V_CUBETC_F32	V_LSHLREV_B64	V_SUBB_U32	V_CVT_F64_{I32, U32 }
V_CUBEMA_F32	V_LSHRREV_B64	V_SUBBREV_U32	V_CVT_F32_UBYTE{0, 1, 2, 3}
V_BFE_{U32, I32 }	V_ASHRREV_I64	V_MUL_LEGACY_F32	V_CVT_F16_{U16, I16 }
V_FMA_{ F16, F32, F64 }	V_LDEXP_F32	V_MUL_{F16, F32 }	V_CVT_RPI_I32_F32
V_FMA_LEGACY_F16	V_READLANE_B32	V_MUL_I32_I24	V_CVT_FLR_I32_F32

VOP3	VOP3 - 1-2 operand opcodes	VOP2	VOP1
V_BFI_B32	V_WRITELANE_B32	V_MUL_HI_I32_I24	V_CVT_OFF_F32_I4
V_LERP_U8	V_BCNT_U32_B32	V_MUL_U32_U24	V_FRACT_{ F16, F32, F64}
V_ALIGNBIT_B32	V_MBCNT_LO_U32_B32	V_MUL_HI_U32_U24	V_TRUNC_{ F16, F32, F64}
V_ALIGNBYTE_B32	V_MBCNT_HI_U32_B32	V_MIN_{ F16, U16, I16, F32, I32, U32}	V_CEIL_{ F16, F32, F64}
V_MIN3_{F32, I32, U32}	V_CVT_PKACCUM_U8_F32	V_MAX_{ F16, U16, I16, F32, I32, U32}	V_RNDNE_{ F16, F32, F64}
V_MAX3_{F32, I32, U32}	V_CVT_PKNORM_I16_F32	V_LSHRREV_{ B16, B32}	V_FLOOR_{ F16, F32, F64}
V_MED3_{F32, I32, U32}	V_CVT_PKNORM_U16_F32	V_ASHRREV_{I16, I32}	V_EXP_{ F16, F32}
V_SAD_{U8, HI_U8, U16, U32}	V_CVT_PKRTZ_F16_F32	V_LSHLREV_{ B16, B32}	V_LOG_{ F16, F32}
V_CVT_PK_U8_F32	V_CVT_PK_U16_U32	V_AND_B32	V_RCP_{ F16, F32, F64}
V_DIV_FIXUP_{ F16, F32, F64}	V_CVT_PK_I16_I32	V_OR_B32	V_RCP_IFLAG_F32
V_DIV_FIXUP_LEGACY_F16	V_MAC_LEGACY_F32	V_XOR_B32	V_RSQ_{ F16, F32, F64}
V_DIV_SCALE_{F32, F64}	V_BFM_B32	V_MAC_{ F16, F32}	V_SQRT_{ F16, F32, F64}
V_DIV_FMAS_{F32, F64}	V_INTERP_P1_F32	V_MADMK_{ F16, F32}	V_SIN_{ F16, F32}
V_MSAD_U8	V_INTERP_P2_F32	V_MADAK_{ F16, F32}	V_COS_{ F16, F32}
V_QSAD_PK_U16_U8	V_INTERP_MOV_F32	V_CNDMASK_B32	V_NOT_B32
V_MQSAD_PK_U16_U8	V_INTERP_P1LL_F16	V_LDEXP_F16	V_BFREV_B32
V_MQSAD_PK_U32_U8	V_INTERP_P1LV_F16	MUL_LO_U16	V_FFBH_{U32, I32}
V_TRIG_PREOP_F64	V_INTERP_P2_F16		V_FFB_L_B32
V_MAD_{U64_U32, I64_I32}	V_INTERP_P2_LEGACY_F16		V_FREXP_EXP_I32_F64
	V_CVT_PKNORM_I16_F16		V_FREXP_MANT_{ F16, F32, 64}
	V_CVT_PKNORM_U16_F16		V_FREXP_EXP_I32_F32
	V_MAD_U32_U16		V_FREXP_EXP_I16_F16
	V_MAD_I32_I16		V_CLREXCP
	V_XAD_U32		V_MOV_FED_B32
	V_MIN3_{F16, I16, U16}		V_CVT_NORM_I16_F16
	V_MAX3_{F16, I16, U16}		V_CVT_NORM_U16_F16

VOP3	VOP3 - 1-2 operand opcodes	VOP2	VOP1
	V_MED3_{F16, I16, U16}		V_SAT_PK_U8_I16
	V_CVT_PKNORM_{I16_F16, U16_F16}		V_WRITELANE_REGWR
	V_READLANE_REGRD_B32		V_SWAP_B32
	V_PACK_B32_F16		V_SCREEN_PARTITION_4SE_B32

The next table lists the compare instructions.

Table 21. VALU Instruction Set

Op	Formats	Functions	Result
V_CMP	I16, I32, I64, U16, U32, U64	F, LT, EQ, LE, GT, LG, GE, T	Write VCC..
V_CMPX			Write VCC and exec.
V_CMP	F16, F32, F64	F, LT, EQ, LE, GT, LG, GE, T, O, U, NGE, NLG, NGT, NLE, NEQ, NLT (o = total order, u = unordered, N = NaN or normal compare)	Write VCC.
V_CMPX			Write VCC and exec.
V_CMP_CLASS	F16, F32, F64	Test for one of: signaling-NaN, quiet-NaN, positive or negative: infinity, normal, subnormal, zero.	Write VCC.
V_CMPX_CLASS			Write VCC and exec.

6.4. Denormalized and Rounding Modes

The shader program has explicit control over the rounding mode applied and the handling of denormalized inputs and results. The MODE register is set using the S_SETREG instruction; it has separate bits for controlling the behavior of single and double-precision floating-point numbers.

Table 22. Round and Denormal Modes

Field	Bit Position	Description
FP_ROUND	3:0	[1:0] Single-precision round mode. [3:2] Double/Half-precision round mode. Round Modes: 0=nearest even; 1= +infinity; 2= -infinity, 3= toward zero.

Field	Bit Position	Description
FP_DENORM	7:4	[5:4] Single-precision denormal mode. [7:6] Double/Half-precision denormal mode. Denormal modes: 0 = Flush input and output denorms. 1 = Allow input denorms, flush output denorms. 2 = Flush input denorms, allow output denorms. 3 = Allow input and output denorms.

6.5. ALU Clamp Bit Usage

In GCN Vega Generation, the meaning of the "Clamp" bit in the VALU instructions has changed. For V_CMP instructions, setting the clamp bit to 1 indicates that the compare signals if a floating point exception occurs. For integer operations, it clamps the result to the largest and smallest representable value. For floating point operations, it clamps the result to the range: [0.0, 1.0].

6.6. VGPR Indexing

VGPR Indexing allows a value stored in the M0 register to act as an index into the VGPRs either for the source or destination registers in VALU instructions.

6.6.1. Indexing Instructions

The table below describes the instructions which enable, disable and control VGPR indexing.

Table 23. VGPR Indexing Instructions

Instruction	Encoding	Sets SCC?	Operation
S_SET_GPR_IDX_OFF	SOPP	N	Disable VGPR indexing mode. Sets: mode.gpr_idx_en = 0.
S_SET_GPR_IDX_ON	SOPC	N	Enable VGPR indexing, and set the index value and mode from an SGPR. mode.gpr_idx_en = 1 M0[7:0] = S0.u[7:0] M0[15:12] = SIMM4
S_SET_GPR_IDX_IDX	SOP1	N	Set the VGPR index value: M0[7:0] = S0.u[7:0]
S_SET_GPR_IDX_MODE	SOPP	N	Change the VGPR indexing mode, which is stored in M0[15:12]. M0[15:12] = SIMM4

Indexing is enabled and disabled by a bit in the MODE register: gpr_idx_en. When enabled, two fields from M0 are used to determine the index value and what it applies to:

- M0[7:0] holds the unsigned index value, added to selected source or destination VGPR addresses.
- M0[15:12] holds a four-bit mask indicating to which source or destination the index is applied.
 - M0[15] = dest_enable.
 - M0[14] = src2_enable.
 - M0[13] = src1_enable.
 - M0[12] = src0_enable.

Indexing only works on VGPR source and destinations, not on inline constants or SGPRs. It is illegal for the index attempt to address VGPRs that are out of range.

6.6.2. Specific Cases

This section describes how VGPR indexing is applied to instructions that use source and destination registers in unusual ways. The table below shows which M0 bits control indexing of the sources and destination registers for these instructions.

Instruction	Microcode Encodes	VALU Receives	M0[15] (dst)	M0[15] (s2)	M0[15] (s1)	M0[12] (s0)
v_readlane	sdst = src0, SS1		x	x	x	src0
v_readfirstlane	sdst = func(src0)		x	x	x	src0
v_writelane	dst = func(ss0, ss1)		dst	x	x	x
v_mac_*	dst = src0 * src1 + dst	mad: dst, src0, src1, src2	dst, s2	x	src1	src0
v_madak	dst = src0 * src1 + imm	mad: dst, src0, src1, src2	dst	x	src1	src0
v_madm	dst = S0 * imm + src1	mad: dst, src0, src1, src2	dst	src2	x	src0
v_*sh*_rev	dst = S1 << S0	<shift> (src1, src0)	dst	x	src1	src0
v_cvt_pkaccum	uses dst as src2		dst, s2	x	src1	src0
SDWA (dest preserve, sub-Dword mask)	uses dst as src2 for read-mod-write			dst, s2		

where:

src= vector source

SS = scalar source

dst = vector destination

sdst = scalar destination

6.7. Packed Math

Vega adds support for **packed math**, which performs operations on two 16-bit values within a Dword as if they were separate threads. For example, a packed add of $V0=V1+V2$ is really two separate adds: adding the low 16 bits of each Dword and storing the result in the low 16 bits of $V0$, and adding the high halves.

Packed math uses the instructions below and the microcode format "VOP3P". This format adds `op_sel` and `neg` fields for both the low and high operands, and removes `ABS` and `OMOD`.

Packed Math Opcodes:

V_PK_MAD_I16	V_PK_MUL_LO_U16	V_PK_ADD_I16	V_PK_SUB_I16
V_PK_LSHLREV_B16	V_PK_LSHRREV_B16	V_PK_ASHRREV_I16	V_PK_MAX_I16
V_PK_MIN_I16	V_PK_MAD_U16	V_PK_ADD_U16	V_PK_SUB_U16
V_PK_MAX_U16	V_PK_MIN_U16	V_PK_FMA_F16	V_PK_ADD_F16
V_PK_MUL_F16	V_PK_MIN_F16	V_PK_MAX_F16	V_MAD_MIX_F32



V_MAD_MIX_* are not packed math, but perform a single MAD operation on a mixture of 16- and 32-bit inputs. They are listed here because they use the VOP3P encoding.

Chapter 7. Scalar Memory Operations

Scalar Memory Read (SMEM) instructions allow a shader program to load data from memory into SGPRs through the Scalar Data Cache, or write data from SGPRs to memory through the Scalar Data Cache. Instructions can read from 1 to 16 Dwords, or write 1 to 4 Dwords at a time. Data is read directly into SGPRs without any format conversion.

The scalar unit reads and writes consecutive Dwords between memory and the SGPRs. This is intended primarily for loading ALU constants and for indirect T#/S# lookup. No data formatting is supported, nor is byte or short data.

7.1. Microcode Encoding

Scalar memory read, write and atomic instructions are encoded using the SMEM microcode format.



The fields are described in the table below:

Table 24. SMEM Encoding Field Descriptions

Field	Size	Description
OP	8	Opcode.
IMM	1	Determines how the OFFSET field is interpreted. IMM=1 : Offset is a 20-bit unsigned byte offset to the address. IMM=0 : Offset[6:0] specifies an SGPR or M0 which provides an unsigned byte offset. STORE and ATOMIC instructions cannot use an SGPR: only imm or M0.
GLC	1	Globally Coherent. For loads, controls L1 cache policy: 0=hit_lru, 1=miss_evict. For stores, controls L1 cache bypass: 0=write-combine, 1=write-thru. For atomics, "1" indicates that the atomic returns the pre-op value.
SDATA	7	SGPRs to return read data to, or to source write-data from. Reads of two Dwords must have an even SDST-sgpr. Reads of four or more Dwords must have their DST-gpr aligned to a multiple of 4. SDATA must be: SGPR or VCC. Not: exec or m0.
SBASE	6	SGPR-pair (SBASE has an implied LSB of zero) which provides a base address, or for BUFFER instructions, a set of 4 SGPRs (4-sgpr aligned) which hold the resource constant. For BUFFER instructions, the only resource fields used are: base, stride, num_records.
OFFSET	20	An unsigned byte offset, or the address of an SGPR holding the offset. Writes and atomics: M0 or immediate only, not SGPR.
NV	1	Non-volatile.

Field	Size	Description
SOE	1	Scalar Offset Enable.

7.2. Operations

7.2.1. S_LOAD_DWORD, S_STORE_DWORD

These instructions load 1-16 Dwords or store 1-4 Dwords between SGPRs and memory. The data in SGPRs is specified in SDATA, and the address is composed of the SBASE, OFFSET, and SOFFSET fields.

Scalar Memory Addressing

S_LOAD / S_STORE / S_DACHE_DISCARD:

$$\text{ADDR} = \text{SGPR}[\text{base}] + \text{inst_offset} + \{ \text{M0 or SGPR}[\text{offset}] \text{ or zero } \}$$

S_SCRATCH_LOAD / S_SCRATCH_STORE:

$$\text{ADDR} = \text{SGPR}[\text{base}] + \text{inst_offset} + \{ \text{M0 or SGPR}[\text{offset}] \text{ or zero } \} * 64$$

Use of offset fields:

IMM	SOFFSET_EN (SOE)	Address
0	0	SGPR[base] + (SGPR[offset] or M0)
0	1	SGPR[base] + (SGPR[soffset] or M0)
1	0	SGPR[base] + inst_offset
1	1	SGPR[base] + inst_offset + (SGPR[soffset] or M0)

All components of the address (base, offset, inst_offset, M0) are in bytes, but the two LSBs are ignored and treated as if they were zero. S_DCACHE_DISCARD ignores the six LSBs to make the address 64-byte-aligned.

It is illegal and undefined if the inst_offset is negative and the resulting (inst_offset + (M0 or SGPR[offset])) is negative.

Scalar access to private space must either use a buffer constant or manually convert the address:

$$\text{Addr} = \text{Addr} - \text{private_base} + \text{private_base_addr} + \text{scratch_baseOffset_for_this_wave}$$

"Hidden private base" is not available to the shader through hardware: It must be preloaded into an SGPR or made available through a constant buffer. This is equivalent to what the driver must do to calculate the base address from scratch for buffer constants.

A scalar instruction must not overwrite its own source registers because the possibility of the instruction being replayed due to an ATC XNACK. Similarly, instructions in scalar memory clauses must not overwrite the sources of any of the instructions in the clause. A clause is defined as a string of memory instructions of the same type. A clause is broken by any non-memory instruction.

Atomics are a different case because they are naturally aligned and they must be in a single-instruction clause. By definition, an atomic that returns the pre-op value overwrites its data source, which is acceptable.

Reads/Writes/Atomics using Buffer Constant

Buffer constant fields used: `base_address`, `stride`, `num_records`, `NV`. Other fields are ignored.

Scalar memory read/write does not support "swizzled" buffers. **Stride** is used only for memory address bounds checking, not for computing the address to access.

The SMEM supplies only a SBASE address (byte) and an offset (byte or Dword). Any "index * stride" must be calculated manually in shader code and added to the offset prior to the SMEM.

The two LSBs of `V#.base` and of the final address are ignored to force Dword alignment.

```
"m_*" components come from the buffer constant (V#):
offset      = IMM ? OFFSET : SGPR[OFFSET]
m_base      = { SGPR[SBASE * 2 + 1][15:0], SGPR[SBASE] }
m_stride    = SGPR[SBASE * 2 + 1][31:16]
m_num_records = SGPR[SBASE * 2 + 2]
m_size      = (m_stride == 0) ? 1 : m_num_records
m_addr      = (SGPR[SBASE * 2] + offset) & ~0x3
SGPR[SDST] = read_Dword_from_dcache(m_base, offset, m_size)
```

If more than 1 dword is being read, it is returned to `SDST+1`, `SDST+2`, etc, and the offset is incremented by 4 bytes per DWORD.

7.2.2. Scalar Atomic Operations

The scalar memory unit supports the same set of memory atomics as the vector memory unit. Addressing is the same as for scalar memory loads and stores. Like the vector memory

atomics, scalar atomic operations can return the "pre-operation value" to the SDATA SGPRs. This is enabled by setting the microcode GLC bit to 1.

7.2.3. S_DCACHE_INV, S_DCACHE_WB

This instruction invalidates, or does a "write back" of dirty data, for the entire data cache. It does not return anything to SDST.

7.2.4. S_MEMTIME

This instruction reads a 64-bit clock counter into a pair of SGPRs: SDST and SDST+1.

7.2.5. S_MEMREALTIME

This instruction reads a 64-bit "real time-counter" and returns the value into a pair of SGPRs: SDST and SDST+1. The time value is from a clock for which the frequency is constant (not affected by power modes or core clock frequency changes).

7.3. Dependency Checking

Scalar memory reads and writes can return data out-of-order from how they were issued; they can return partial results at different times when the read crosses two cache lines. The shader program uses the LGKM_CNT counter to determine when the data has been returned to the SDST SGPRs. This is done as follows.

- LGKM_CNT is incremented by 1 for every fetch of a single Dword.
- LGKM_CNT is incremented by 2 for every fetch of two or more Dwords.
- LGKM_CNT is decremented by an equal amount when each instruction completes.

Because the instructions can return out-of-order, the only sensible way to use this counter is to implement S_WAITCNT 0; this imposes a wait for all data to return from previous SMEMs before continuing.

7.4. Alignment and Bounds Checking

SDST

The value of SDST must be even for fetches of two Dwords (including S_MEMTIME), or a multiple of four for larger fetches. If this rule is not followed, invalid data can result. If SDST is out-of-range, the instruction is not executed.

SBASE

The value of SBASE must be even for S_BUFFER_LOAD (specifying the address of an SGPR which is a multiple of four). If SBASE is out-of-range, the value from SGPR0 is used.

OFFSET

The value of OFFSET has no alignment restrictions.

Memory Address : If the memory address is out-of-range (clamped), the operation is not performed for any Dwords that are out-of-range.

Chapter 8. Vector Memory Operations

Vector Memory (VMEM) instructions read or write one piece of data separately for each work-item in a wavefront into, or out of, VGPRs. This is in contrast to Scalar Memory instructions, which move a single piece of data that is shared by all threads in the wavefront. All Vector Memory (VM) operations are processed by the texture cache system (level 1 and level 2 caches).

Software initiates a load, store or atomic operation through the texture cache through one of three types of VMEM instructions:

- MTBUF: Memory typed-buffer operations.
- MUBUF: Memory untyped-buffer operations.
- MIMG: Memory image operations.

The instruction defines which VGPR(s) supply the addresses for the operation, which VGPRs supply or receive data from the operation, and a series of SGPRs that contain the memory buffer descriptor (V# or T#). Also, MIMG operations supply a texture sampler from a series of four SGPRs; this sampler defines texel filtering operations to be performed on data read from the image.

8.1. Vector Memory Buffer Instructions

Vector-memory (VM) operations transfer data between the VGPRs and buffer objects in memory through the texture cache (TC). **Vector** means that one or more piece of data is transferred uniquely for every thread in the wavefront, in contrast to scalar memory reads, which transfer only one value that is shared by all threads in the wavefront.

Buffer reads have the option of returning data to VGPRs or directly into LDS.

Examples of buffer objects are vertex buffers, raw buffers, stream-out buffers, and structured buffers.

Buffer objects support both homogeneous and heterogeneous data, but no filtering of read-data (no samplers). Buffer instructions are divided into two groups:

- MUBUF: Untyped buffer objects.
 - Data format is specified in the resource constant.
 - Load, store, atomic operations, with or without data format conversion.
- MTBUF: Typed buffer objects.
 - Data format is specified in the instruction.
 - The only operations are Load and Store, both with data format conversion.

Atomic operations take data from VGPRs and combine them arithmetically with data already in

memory. Optionally, the value that was in memory before the operation took place can be returned to the shader.

All VM operations use a buffer resource constant (V#) which is a 128-bit value in SGPRs. This constant is sent to the texture cache when the instruction is executed. This constant defines the address and characteristics of the buffer in memory. Typically, these constants are fetched from memory using scalar memory reads prior to executing VM instructions, but these constants also can be generated within the shader.

8.1.1. Simplified Buffer Addressing

The equation below shows how the hardware calculates the memory address for a buffer access.

$$ADDR = \underset{V\#}{Base} + \underset{SGPR}{baseOffset} + \underset{Instr}{Inst_offset} + \underset{VGPR}{Voffset} + \underset{V\#}{Stride} * (\underset{VGPR}{Vindex} + \underset{0..63}{TID})$$

Voffset is ignored when instruction bit "OFFEN" == 0

Vindex is ignored when instruction bit "IDXEN" == 0

TID is a constant value (0..63) unique to each thread in the wave. It is ignored when resource bit ADD_TID_ENABLE == 0

8.1.2. Buffer Instructions

Buffer instructions (MTBUF and MUBUF) allow the shader program to read from, and write to, linear buffers in memory. These operations can operate on data as small as one byte, and up to four Dwords per work-item. Atomic arithmetic operations are provided that can operate on the data values in memory and, optionally, return the value that was in memory before the arithmetic operation was performed.

The D16 instruction variants convert the results to packed 16-bit values. For example, BUFFER_LOAD_FORMAT_D16_XYZW will write two VGPRs.

Table 25. Buffer Instructions

Instruction	Description
MTBUF Instructions	
TBUFFER_LOAD_FORMAT_{x,xy,xyz,xyzw} TBUFFER_STORE_FORMAT_{x,xy,xyz,xyzw}	Read from, or write to, a typed buffer object. Also used for a vertex fetch.
MUBUF Instructions	
BUFFER_LOAD_FORMAT_{x,xy,xyz,xyzw} BUFFER_STORE_FORMAT_{x,xy,xyz,xyzw} BUFFER_LOAD_<size> BUFFER_STORE_<size>	Read to, or write from, an untyped buffer object. <size> = byte, ubyte, short, ushort, Dword, Dwordx2, Dwordx3, Dwordx4 BUFFER_ATOMIC_<op> BUFFER_ATOMIC_<op>_x2

Table 26. Microcode Formats

Field	Bit Size	Description
OP	4 7	MTBUF: Opcode for Typed buffer instructions. MUBUF: Opcode for Untyped buffer instructions.
VADDR	8	Address of VGPR to supply first component of address (offset or index). When both index and offset are used, index is in the first VGPR, offset in the second.
VDATA	8	Address of VGPR to supply first component of write data or receive first component of read-data.
SOFFSET	8	SGPR to supply unsigned byte offset. Must be an SGPR, M0, or inline constant.
SRSRC	5	Specifies which SGPR supplies T# (resource constant) in four or eight consecutive SGPRs. This field is missing the two LSBs of the SGPR address, since this address must be aligned to a multiple of four SGPRs.
DFMT	4	Data Format of data in memory buffer: 0 invalid 1 8 2 16 3 8_8 4 32 5 16_16 6 10_11_11 7 11_11_10 8 10_10_10_2 9 2_10_10_10 10 8_8_8_8 11 32_32 12 16_16_16_16 13 32_32_32 14 32_32_32_32 15 reserved
NFMT	3	Numeric format of data in memory: 0 unorm 1 snorm 2 uscaled 3 sscaled 4 uint 5 sint 6 reserved 7 float
OFFSET	12	Unsigned byte offset.
OFFEN	1	1 = Supply an offset from VGPR (VADDR). 0 = Do not (offset = 0).
IDXEN	1	1 = Supply an index from VGPR (VADDR). 0 = Do not (index = 0).

Field	Bit Size	Description
GLC	1	Globally Coherent. Controls how reads and writes are handled by the L1 texture cache. READ GLC = 0 Reads can hit on the L1 and persist across wavefronts GLC = 1 Reads miss the L1 and force fetch to L2. No L1 persistence across waves. WRITE GLC = 0 Writes miss the L1, write through to L2, and persist in L1 across wavefronts. GLC = 1 Writes miss the L1, write through to L2. No persistence across wavefronts. ATOMIC GLC = 0 Previous data value is not returned. No L1 persistence across wavefronts. GLC = 1 Previous data value is returned. No L1 persistence across wavefronts. Note: GLC means "return pre-op value" for atomics.
SLC	1	System Level Coherent. When set, accesses are forced to miss in level 2 texture cache and are coherent with system memory.
TFE	1	Texel Fail Enable for PRT (partially resident textures). When set to 1, fetch can return a NACK that causes a VGPR write into DST+1 (first GPR after all fetch-dest GPRs).
LDS	1	MUBUF-ONLY: 0 = Return read-data to VGPRs. 1 = Return read-data to LDS instead of VGPRs.

8.1.3. VGPR Usage

VGPRs supply address and write-data; also, they can be the destination for return data (the other option is LDS).

Address

Zero, one or two VGPRs are used, depending of the offset-enable (OFFEN) and index-enable (IDXEN) in the instruction word, as shown in the table below:

Table 27. Address VGPRs

IDXEN	OFFEN	VGPRn	VGPRn+1
0	0	nothing	
0	1	uint offset	
1	0	uint index	
1	1	uint index	uint offset

Write Data : N consecutive VGPRs, starting at VDATA. The data format specified in the instruction word (NFMT, DFMT for MTBUF, or encoded in the opcode field for MUBUF) determines how many Dwords to write.

Read Data : Same as writes. Data is returned to consecutive GPRs.

Read Data Format : Read data is 32 bits, based on the data format in the instruction or resource. Float or normalized data is returned as floats; integer formats are returned as integers (signed or unsigned, same type as the memory storage format). Memory reads of data in

memory that is 32 or 64 bits do not undergo any format conversion.

Atomics with Return : Data is read out of the VGPR(s) starting at VDATA to supply to the atomic operation. If the atomic returns a value to VGPRs, that data is returned to those same VGPRs starting at VDATA.

8.1.4. Buffer Data

The amount and type of data that is read or written is controlled by the following: data-format (dfmt), numeric-format (nfmt), destination-component-selects (dst_sel), and the opcode. Dfmt and nfmt can come from the resource, instruction fields, or the opcode itself. Dst_sel comes from the resource, but is ignored for many operations.

Table 28. Buffer Instructions

Instruction	Data Format	Num Format	DST SEL
TBUFFER_LOAD_FORMAT_*	instruction	instruction	identity
TBUFFER_STORE_FORMAT_*	instruction	instruction	identity
BUFFER_LOAD_<type>	derived	derived	identity
BUFFER_STORE_<type>	derived	derived	identity
BUFFER_LOAD_FORMAT_*	resource	resource	resource
BUFFER_STORE_FORMAT_*	resource	resource	resource
BUFFER_ATOMIC_*	derived	derived	identity

Instruction : The instruction’s dfmt and nfmt fields are used instead of the resource’s fields.

Data format derived : The data format is derived from the opcode and ignores the resource definition. For example, buffer_load_ubyte sets the data-format to 8 and number-format to uint.



The resource’s data format must not be INVALID; that format has specific meaning (unbound resource), and for that case the data format is not replaced by the instruction’s implied data format.

DST_SEL identity : Depending on the number of components in the data-format, this is: X000, XY00, XYZ0, or XYZW.

The MTBUF derives the data format from the instruction. The MUBUF BUFFER_LOAD_FORMAT and BUFFER_STORE_FORMAT instructions use dst_sel from the resource; other MUBUF instructions derive data-format from the instruction itself.

D16 Instructions : Load-format and store-format instructions also come in a "d16" variant. For stores, each 32-bit VGPR holds two 16-bit data elements that are passed to the texture unit. This texture unit converts them to the texture format before writing to memory. For loads, data

returned from the texture unit is converted to 16 bits, and a pair of data are stored in each 32-bit VGPR (LSBs first, then MSBs). Control over int vs. float is controlled by NFMT.

8.1.5. Buffer Addressing

A **buffer** is a data structure in memory that is addressed with an **index** and an **offset**. The index points to a particular record of size **stride** bytes, and the offset is the byte-offset within the record. The **stride** comes from the resource, the index from a VGPR (or zero), and the offset from an SGPR or VGPR and also from the instruction itself.

Table 29. BUFFER Instruction Fields for Addressing

Field	Size	Description
inst_offset	12	Literal byte offset from the instruction.
inst_idxen	1	Boolean: get index from VGPR when true, or no index when false.
inst_offen	1	Boolean: get offset from VGPR when true, or no offset when false. Note that inst_offset is present, regardless of this bit.

The "element size" for a buffer instruction is the amount of data the instruction transfers. It is determined by the DFMT field for MTBUF instructions, or from the opcode for MUBUF instructions. It can be 1, 2, 4, 8, or 16 bytes.

Table 30. V# Buffer Resource Constant Fields for Addressing

Field	Size	Description
const_base	48	Base address, in bytes, of the buffer resource.
const_stride	14 or 18	Stride of the record in bytes (0 to 16,383 bytes, or 0 to 262,143 bytes). Normally 14 bits, but is extended to 18-bits when: const_add_tid_enable = true used with MUBUF instructions which are not format types (or cache invalidate/WB). This is extension intended for use with scratch (private) buffers. <div style="border: 1px solid #ccc; padding: 10px; margin: 10px 0;"> <pre> If (const_add_tid_enable && MUBUF-non-format instr.) const_stride [17:0] = { V#.DFMT[3:0], V#.const_stride[13:0] } else const_stride is 14 bits: {4'b0, V#.const_stride[13:0]} </pre> </div>
const_num_records	32	Number of records in the buffer. In units of Bytes for raw buffers, units of Stride for structured buffers, and ignored for private (scratch) buffers. In units of: (inst_idxen == 1) ? Bytes : Stride

Field	Size	Description
const_add_tid_enable	1	Boolean. Add thread_ID within the wavefront to the index when true.
const_swizzle_enable	1	Boolean. Indicates that the surface is swizzled when true.
const_element_size	2	Used only when const_swizzle_en = true. Number of contiguous bytes of a record for a given index (2, 4, 8, or 16 bytes). Must be >= the maximum element size in the structure. const_stride must be an integer multiple of const_element_size.
const_index_stride	2	Used only when const_swizzle_en = true. Number of contiguous indices for a single element (of const_element_size) before switching to the next element. There are 8, 16, 32, or 64 indices.

Table 31. Address Components from GPRs

Field	Size	Description
SGPR_offset	32	An unsigned byte-offset to the address. Comes from an SGPR or M0.
VGPR_offset	32	An optional unsigned byte-offset. It is per-thread, and comes from a VGPR.
VGPR_index	32	An optional index value. It is per-thread and comes from a VGPR.

The final buffer memory address is composed of three parts:

- the base address from the buffer resource (V#),
- the offset from the SGPR, and
- a buffer-offset that is calculated differently, depending on whether the buffer is linearly addressed (a simple Array-of-Structures calculation) or is swizzled.

Address Calculation for a Linear Buffer

$$\text{ADDRESS} = \text{const_base} + \text{sgpr_offset} + \text{buffer_offset}$$

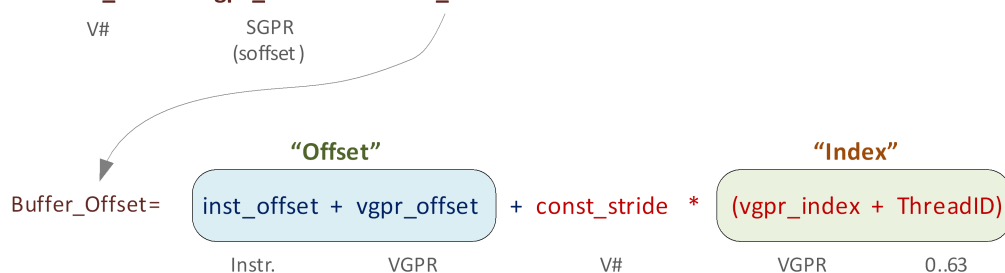

Full equations:

$$\text{Index} = (\text{inst_idxen} ? \text{vgpr_index} : 0) + (\text{const_add_tid_enable} ? \text{thread_id}[5:0] : 0)$$

$$\text{Offset} = (\text{inst_offen} ? \text{vgpr_offset} : 0) + \text{inst_offset}$$

Figure 4. Address Calculation for a Linear Buffer

Range Checking

Addresses can be checked to see if they are in or out of range. When an address is out of range, reads will return zero, and writes and atomics will be dropped. The address range check algorithm depends on the buffer type.

Private (Scratch) Buffer

Used when: `AddTID==1 && IdxEn==0`
For this buffer, there is no range checking.

Raw Buffer

Used when: `AddTID==0 && SWizzleEn==0 && IdxEn==0`
Out of Range if: `(InstOffset + (OffEN ? vgpr_offset : 0)) >= NumRecords`

Structured Buffer

Used when: `AddTID==0 && Stride!=0 && IdxEn==1`
Out of Range if: `Index(vgpr) >= NumRecords`

Notes:

1. Reads that go out-of-range return zero (except for components with `V#.dst_sel = SEL_1` that return 1).
2. Writes that are out-of-range do not write anything.
3. Load/store-format-* instruction and atomics are range-checked "all or nothing" - either entirely in or out.
4. Load/store-Dword-x{2,3,4} and range-check per component.

Swizzled Buffer Addressing

Swizzled addressing rearranges the data in the buffer and can help provide improved cache locality for arrays of structures. Swizzled addressing also requires Dword-aligned accesses. A single fetch instruction cannot attempt to fetch a unit larger than `const-element-size`. The buffer's `STRIDE` must be a multiple of `element_size`.

```
Index = (inst_idxen ? vgpr_index : 0) +
        (const_add_tid_enable ? thread_id[5:0] : 0)

Offset = (inst_offen ? vgpr_offset : 0) + inst_offset

index_msb = index / const_index_stride
index_lsb = index % const_index_stride
offset_msb = offset / const_element_size
offset_lsb = offset % const_element_size

buffer_offset = (index_msb * const_stride + offset_msb *
                const_element_size) * const_index_stride + index_lsb *
                const_element_size + offset_lsb

Final Address = const_base + sgpr_offset + buffer_offset
```

Remember that the "sgpr_offset" is not a part of the "offset" term in the above equations.

Original Buffer

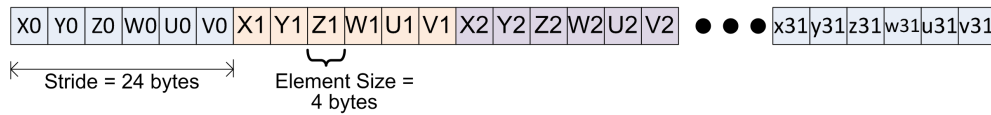

Swizzled Buffer

`const_index_stride = 8` // how many consecutive indices to group together
`const_element_size = 4 bytes` // the size of a single element, in bytes

`index_msb = index / const_index_stride`
`index_lsb = index % const_index_stride`
`offset_msb = offset / const_element_size`
`offset_lsb = offset % const_element_size`

$$\text{Buffer_offset} = (\text{index_msb} * \text{const_stride} + \text{offset_msb} * \text{const_element_size}) * \text{const_index_stride} + \text{index_lsb} * \text{const_element_size} + \text{offset_lsb}$$

which simplifies to...

$$\text{Buffer_offset} = (\text{index}/8 * \text{const_stride} + (\text{offset}/4)*4) * 8 + \text{index}\%8 * 4 + \text{offset}\%4$$

Note that because we are dealing with dwords, offset%4 is always == 0.

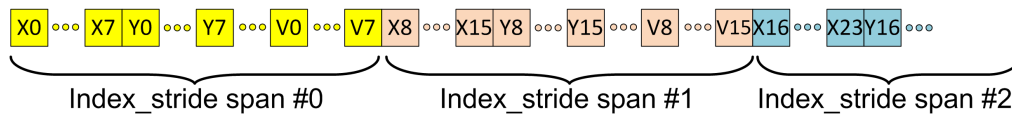

If the const_element_size had been 8 :

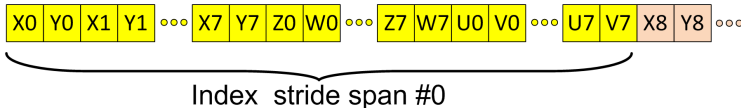

An alternate way to visualize Swizzled Buffers

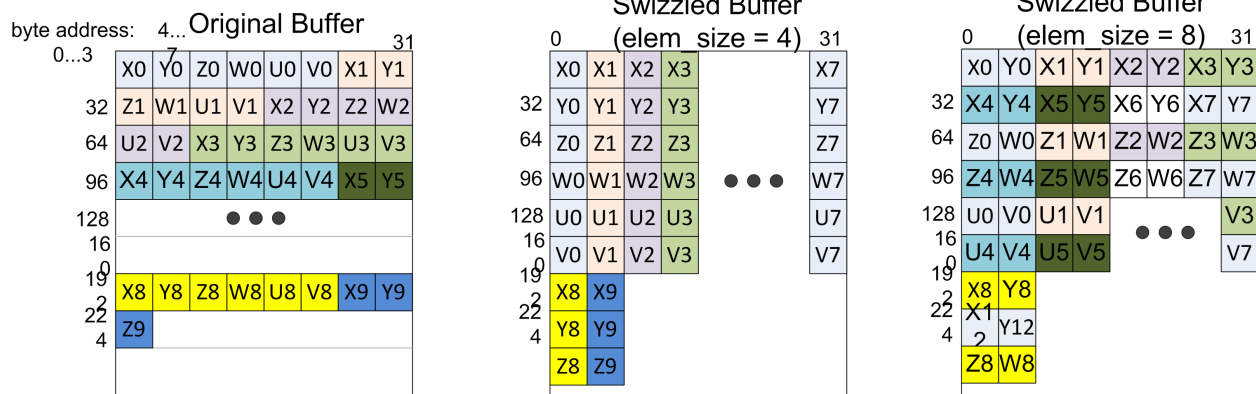

Figure 5. Example of Buffer Swizzling

Proposed Use Cases for Swizzled Addressing

Here are few proposed uses of swizzled addressing in common graphics buffers.

Table 32. Swizzled Buffer Use Cases

	DX11 Raw Uav OpenCL Buffer Object	Dx11 Structured (literal offset)	Dx11 Structured (gpr offset)	Scratch	Ring / stream-out	Const Buffer
inst_vgpr_offset_en	T	F	T	T	T	T
inst_vgpr_index_en	F	T	T	F	F	F
const_stride	na	<api>	<api>	scratchSize	na	na
const_add_tid_enable	F	F	F	T	T	F
const_buffer_swizzle	F	T	T	T	F	F
const_elem_size	na	4	4	4 or 16	na	4
const_index_stride	na	16	16	64		

8.1.6. 16-bit Memory Operations

The D16 buffer instructions allow a kernel to load or store just 16 bits per work item between VGPRs and memory. There are two variants of these instructions:

- D16 loads data into or stores data from the lower 16 bits of a VGPR.
- D16_HI loads data into or stores data from the upper 16 bits of a VGPR.

For example, BUFFER_LOAD_UBYTE_D16 reads a byte per work-item from memory, converts it to a 16-bit integer, then loads it into the lower 16 bits of the data VGPR.

8.1.7. Alignment

For Dword or larger reads or writes, the two LSBs of the byte-address are ignored, thus forcing Dword alignment.

8.1.8. Buffer Resource

The buffer resource describes the location of a buffer in memory and the format of the data in the buffer. It is specified in four consecutive SGPRs (four aligned SGPRs) and sent to the texture cache with each buffer instruction.

The table below details the fields that make up the buffer resource descriptor.

Table 33. Buffer Resource Descriptor

Bits	Size	Name	Description
47:0	48	Base address	Byte address.
61:48	14	Stride	Bytes 0 to 16383
62	1	Cache swizzle	Buffer access. Optionally, swizzle texture cache TC L1 cache banks.
63	1	Swizzle enable	Swizzle AOS according to stride, index_stride, and element_size, else linear (stride * index + offset).
95:64	32	Num_records	In units of stride or bytes.
98:96	3	Dst_sel_x	Destination channel select: 0=0, 1=1, 4=R, 5=G, 6=B, 7=A
101:99	3	Dst_sel_y	
104:102	3	Dst_sel_z	
107:105	3	Dst_sel_w	
110:108	3	Num format	Numeric data type (float, int, ...). See instruction encoding for values.
114:111	4	Data format	Number of fields and size of each field. See instruction encoding for values. For MUBUF instructions with ADD_TID_EN = 1. This field holds Stride [17:14].
115	1	User VM Enable	Resource is mapped via tiled pool / heap.
116	1	User VM mode	Unmapped behavior: 0: null (return 0 / drop write); 1:invalid (results in error)
118:117	2	Index stride	8, 16, 32, or 64. Used for swizzled buffer addressing.
119	1	Add tid enable	Add thread ID to the index for to calculate the address.
122:120	3	RSVD	Reserved. Must be set to zero.
123	1	NV	Non-volatile (0=volatile)
125:124	2	RSVD	Reserved. Must be set to zero.
127:126	2	Type	Value == 0 for buffer. Overlaps upper two bits of four-bit TYPE field in 128-bit T# resource.

A resource set to all zeros acts as an unbound texture or buffer (return 0,0,0,0).

8.1.9. Memory Buffer Load to LDS

The MUBUF instruction format allows reading data from a memory buffer directly into LDS without passing through VGPRs. This is supported for the following subset of MUBUF instructions.

- BUFFER_LOAD_{ubyte, sbyte, ushort, sshort, dword, format_x}.
- It is illegal to set the instruction's TFE bit for loads to LDS.

LDS_offset = 16-bit unsigned byte offset from M0[15:0].
 Mem_offset = 32-bit unsigned byte offset from an SGPR (the SOFFSET SGPR).
 idx_vgpr = index value from a VGPR (located at VADDR). (Zero if idxen=0.)
 off_vgpr = offset value from a VGPR (located at VADDR or VADDR+1). (Zero if offen=0.)

The figure below shows the components of the LDS and memory address calculation:

$$\text{LDS_ADDR} = \text{LDSbase} + \text{LDS_offset} + \text{inst_offset} + (\text{TIDinWave} * 4)$$

HW-Alloc
M0[15:0]
Instr.
0..63
bytes-per-dword

$$\text{MEM_ADDR} = \text{Base} + \text{mem_offset} + \text{inst_offset} + \text{off_vgpr} + \text{stride} * (\text{idx_vgpr} + \text{TIDinWave})$$

T#
SGPR (soffset)
Instr.
VGPR
T#
VGPR
0..63

Zero – no vgpr
4 bytes
Zero

TIDinWave is only added if the resource (T#) has the ADD_TID_ENABLE field set to 1, whereas LDS adds it. The MEM_ADDR M# is in the VDATA field; it specifies M0.

Clamping Rules

Memory address clamping follows the same rules as any other buffer fetch. LDS address clamping: the return data must not be written outside the LDS space allocated to this wave.

- Set the active-mask to limit buffer reads to those threads that return data to a legal LDS location.
- The LDSbase (alloc) is in units of 32 Dwords, as is LDSsize.
- M0[15:0] is in bytes.

8.1.10. GLC Bit Explained

The GLC bit means different things for loads, stores, and atomic ops.

GLC Meaning for Loads

- For GLC==0
 - The load can read data from the GPU L1.
 - Typically, all loads (except load-acquire) use GLC==0.
- For GLC==1
 - The load intentionally misses the GPU L1 and reads from L2. If there was a line in the GPU L1 that matched, it is invalidated; L2 is reread.

- NOTE: L2 is not re-read for every work-item in the same wave-front for a single load instruction. For example: `b=uav[N+tid]` // assume this is a byte read w/ `glc==1` and N is aligned to 64B In the above op, the first Tid of the wavefront brings in the line from L2 or beyond, and all 63 of the other Tids read from same 64 B cache line in the L1.

GLC Meaning for Stores

- For `GLC==0` This causes a write-combine across work-items of the wavefront store op; dirtied lines are written to the L2 automatically.
 - If the store operation dirtied all bytes of the 64 B line, it is left clean and valid in the L1; subsequent accesses to the cache are allowed to hit on this cache line.
 - Else do not leave write-combined lines in L1.
- For `GLC==1` Same as `GLC==0`, except the write-combined lines are not left in the line, even if all bytes are dirtied.

Atomics

- For `GLC == 0` No return data (this is "write-only" atomic op).
- For `GLC == 1` Returns previous value in memory (before the atomic operation).

8.2. Vector Memory (VM) Image Instructions

Vector Memory (VM) operations transfer data between the VGPRs and memory through the texture cache (TC). Vector means the transfer of one or more pieces of data uniquely for every work-item in the wavefront. This is in contrast to scalar memory reads, which transfer only one value that is shared by all work-items in the wavefront.

Examples of image objects are texture maps and typed surfaces.

Image objects are accessed using from one to four dimensional addresses; they are composed of homogeneous data of one to four elements. These image objects are read from, or written to, using `IMAGE_*` or `SAMPLE_*` instructions, all of which use the MIMG instruction format. `IMAGE_LOAD` instructions read an element from the image buffer directly into VGPRs, and `SAMPLE` instructions use sampler constants (`S#`) and apply filtering to the data after it is read. `IMAGE_ATOMIC` instructions combine data from VGPRs with data already in memory, and optionally return the value that was in memory before the operation.

All VM operations use an image resource constant (`T#`) that is a 256-bit value in SGPRs. This constant is sent to the texture cache when the instruction is executed. This constant defines the address, data format, and characteristics of the surface in memory. Some image instructions also use a sampler constant that is a 128-bit constant in SGPRs. Typically, these constants are fetched from memory using scalar memory reads prior to executing VM instructions, but these constants can also be generated within the shader.

Texture fetch instructions have a data mask (`DMASK`) field. `DMASK` specifies how many data

components it receives. If DMASK is less than the number of components in the texture, the texture unit only sends DMASK components, starting with R, then G, B, and A. if DMASK specifies more than the texture format specifies, the shader receives zero for the missing components.

8.2.1. Image Instructions

This section describes the image instruction set, and the microcode fields available to those instructions.

Table 34. Image Instructions

MIMG	Description
SAMPLE_*	Read and filter data from a image object.
IMAGE_LOAD_<op>	Read data from an image object using one of the following: image_load, image_load_mip, image_load_{pck, pck_sgn, mip_pck, mip_pck_sgn}.
IMAGE_STORE IMAGE_STORE_MIP	Store data to an image object. Store data to a specific mipmap level.
IMAGE_ATOMIC_<op>	Image atomic operation, which is one of the following: swap, cmpswap, add, sub, rsub, {u,s}{min,max}, and, or, xor, inc, dec, fcmpswap, fmin, fmax.

Table 35. Instruction Fields

Field	Bit Size	Description
OP	7	Opcode.
VADDR	8	Address of VGPR to supply first component of address.
VDATA	8	Address of VGPR to supply first component of write data or receive first component of read-data.
SSAMP	5	SGPR to supply S# (sampler constant) in four consecutive SGPRs. Missing two LSBs of SGPR-address since must be aligned to a multiple of four SGPRs.
SRSRC	5	SGPR to supply T# (resource constant) in four or eight consecutive SGPRs. Missing two LSBs of SGPR-address since must be aligned to a multiple of four SGPRs.
UNRM	1	Force address to be un-normalized regardless of T#. Must be set to 1 for image stores and atomics.
DA	1	Shader declared an array resource to be used with this fetch. When 1, the shader provides an array-index with the instruction. When 0, no array index is provided.
DMASK	4	Data VGPR enable mask: one to four consecutive VGPRs. Reads: defines which components are returned. 0 = red, 1 = green, 2 = blue, 3 = alpha Writes: defines which components are written with data from VGPRs (missing components get 0). Enabled components come from consecutive VGPRs. For example: DMASK=1001: Red is in VGPRn and alpha in VGPRn+1. For D16 writes, DMASK is used only as a word count: each bit represents 16 bits of data to be written, starting at the LSBs of VADDR, the MSBs, VADDR+1, etc. Bit position is ignored.

Field	Bit Size	Description
GLC	1	Globally Coherent. Controls how reads and writes are handled by the L1 texture cache. READ: GLC = 0 Reads can hit on the L1 and persist across waves. GLC = 1 Reads miss the L1 and force fetch to L2. No L1 persistence across waves. WRITE: GLC = 0 Writes miss the L1, write through to L2, and persist in L1 across wavefronts. GLC = 1 Writes miss the L1, write through to L2. No persistence across wavefronts. ATOMIC: GLC = 0 Previous data value is not returned. No L1 persistence across wavefronts. GLC = 1 Previous data value is returned. No L1 persistence across wavefronts.
SLC	1	System Level Coherent. When set, accesses are forced to miss in level 2 texture cache and are coherent with system memory.
TFE	1	Texel Fail Enable for PRT (partially resident textures). When set, a fetch can return a NACK, which causes a VGPR write into DST+1 (first GPR after all fetch-dest GPRs).
LWE	1	LOD Warning Enable. When set to 1, a texture fetch may return "LOD_CLAMPED = 1".
A16	1	Address components are 16-bits (instead of the usual 32 bits). When set, all address components are 16 bits (packed into two per Dword), except: Texel offsets (three 6-bit uint packed into one Dword). PCF reference (for _C instructions). Address components are 16-bit uint for image ops without sampler; 16-bit float with sampler.
D16	1	VGPR-Data-16bit. On loads, convert data in memory to 16-bit format before storing it in VGPRs. For stores, convert 16-bit data in VGPRs to 32 bits before going to memory. Whether the data is treated as float or int is decided by NFMT. Allowed only with these opcodes: IMAGE_SAMPLE* IMAGE_GATHER4*, but not GATHER4H_PCK IMAGE_LOAD IMAGE_LOAD_MIP IMAGE_STORE IMAGE_STORE_MIP

8.3. Image Opcodes with No Sampler

For image opcodes with no sampler, all VGPR address values are taken as uint. For cubemaps, $\text{face_id} = \text{slice} * 6 + \text{face}$.

The table below shows the contents of address VGPRs for the various image opcodes.

Table 36. Image Opcodes with No Sampler

Image Opcode (Resource w/o Sampler)	Acnt	dim	VGPRn	VGPRn+1	VGPRn+2	VGPRn+3
get_resinfo	0	Any	mipid			

Image Opcode (Resource w/o Sampler)	Acnt	dim	VGPRn	VGPRn+1	VGPRn+2	VGPRn+3
load / store / atomics	0	1D	x			
	1	1D Array	x	slice		
	1	2D	x	y		
	2	2D MSAA	x	y	fragid	
	2	2D Array	x	y	slice	
	3	2D Array MSAA	x	y	slice	fragid
	2	3D	x	y	z	
	2	Cube	x	y	face_id	
load_mip / store_mip	1	1D	x	mipid		
	2	1D Array	x	slice	mipid	
	2	2D	x	y	mipid	
	3	2D Array	x	y	slice	mipid
	3	3D	x	y	z	mipid
	3	Cube	x	y	face_id	mipid

8.4. Image Opcodes with a Sampler

For image opcodes with a sampler, all VGPR address values are taken as float. For cubemaps, $face_id = slice * 8 + face$.

Certain sample and gather opcodes require additional values from VGPRs beyond what is shown. These values are: offset, bias, z-compare, and gradients.

Table 37. Image Opcodes with Sampler

Image Opcode (w/ Sampler)	Acnt	dim	VGPRn	VGPRn+1	VGPRn+2	VGPRn+3
sample	0	1D	x			
	1	1D Array	x	slice		
	1	2D	x	y		
	2	2D interlaced	x	y	field	
	2	2D Array	x	y	slice	
	2	3D	x	y	z	
	2	Cube	x	y	face_id	

Image Opcode (w/ Sampler)	Acnt	dim	VGPRn	VGPRn+1	VGPRn+2	VGPRn+3
sample_l	1	1D	x	lod		
	2	1D Array	x	slice	lod	
	2	2D	x	y	lod	
	3	2D interlaced	x	y	field	lod
	3	2D Array	x	y	slice	lod
	3	3D	x	y	z	lod
	3	Cube	x	y	face_id	lod
sample_cl	1	1D	x	clamp		
	2	1D Array	x	slice	clamp	
	2	2D	x	y	clamp	
	3	2D interlaced	x	y	field	clamp
	3	2D Array	x	y	slice	clamp
	3	3D	x	y	z	clamp
	3	Cube	x	y	face_id	clamp
gather4	1	2D	x	y		
	2	2D interlaced	x	y	field	
	2	2D Array	x	y	slice	
	2	Cube	x	y	face_id	
gather4_l	2	2D	x	y	lod	
	3	2D interlaced	x	y	field	lod
	3	2D Array	x	y	slice	lod
	3	Cube	x	y	face_id	lod
gather4_cl	2	2D	x	y	clamp	
	3	2D interlaced	x	y	field	clamp
	3	2D Array	x	y	slice	clamp
	3	Cube	x	y	face_id	clamp

1. Sample includes sample, sample_d, sample_b, sample_lz, sample_c, sample_c_d, sample_c_b, sample_c_lz, and getlod.
2. Sample_l includes sample_l and sample_c_l.
3. Sample_cl includes sample_cl, sample_d_cl, sample_b_cl, sample_c_cl, sample_c_d_cl, and sample_c_b_cl.
4. Gather4 includes gather4, gather4_lz, gather4_c, and gather4_c_lz.

The table below lists and briefly describes the legal suffixes for image instructions:

Table 38. Sample Instruction Suffix Key

Suffix	Meaning	Extra Addresses	Description
_L	LOD	-	LOD is used instead of TA computed LOD.
_B	LOD BIAS	1: lod bias	Add this BIAS to the LOD TA computes.
_CL	LOD CLAMP	-	Clamp the LOD to be no larger than this value.
_D	Derivative	2,4 or 6: slopes	Send dx/dv, dx/dy, etc. slopes to TA for it to used in LOD computation.
_CD	Coarse Derivative		Send dx/dv, dx/dy, etc. slopes to TA for it to used in LOD computation.
_LZ	Level 0	-	Force use of MIP level 0.
_C	PCF	1: z-comp	Percentage closer filtering.
_O	Offset	1: offsets	Send X, Y, Z integer offsets (packed into 1 Dword) to offset XYZ address.

8.4.1. VGPR Usage

Address: The address consists of up to four parts:

{ offset } { bias } { z-compare } { derivative } { body }

These are all packed into consecutive VGPRs.

- Offset: SAMPLE*O*, GATHER*O*
One Dword of offset_xyz. The offsets are six-bit signed integers: X=[5:0], Y=[13:8], and Z=[21:16].
- Bias: SAMPLE*B*, GATHER*B*. One Dword float.
- Z-compare: SAMPLE*C*, GATHER*C*. One Dword.
- Derivatives (sample_d, sample_cd): 2, 4, or 6 Dwords, packed one Dword per derivative as:

Image Dim	Vgpr N	N+1	N+2	N+3	N+4	N+5
1D	DX/DH	DX/DV	-	-	-	-
2D	DX/DH	DY/DH	DX/DV	DY/DV	-	-
3D	DX/DH	DY/DH	DZ/DH	DX/DV	DY/DV	DZ/DV

- Body: One to four Dwords, as defined by the table: [\[Image Opcodes with Sampler\]](#) Address components are X,Y,Z,W with X in VGPR_M, Y in VGPR_M+1, etc. The number of components in "body" is the value of the ACNT field in the table, plus one.
- Data: Written from, or returned to, one to four consecutive VGPRs. The amount of data read

or written is determined by the DMASK field of the instruction.

- Reads: DMASK specifies which elements of the resource are returned to consecutive VGPRs. The texture system reads data from memory and based on the data format expands it to a canonical RGBA form, filling in zero or one for missing components. Then, DMASK is applied, and only those components selected are returned to the shader.
- Writes: When writing an image object, it is only possible to write an entire element (all components), not just individual components. The components come from consecutive VGPRs, and the texture system fills in the value zero for any missing components of the image's data format; it ignores any values that are not part of the stored data format. For example, if the DMASK=1001, the shader sends Red from VGPR_N, and Alpha from VGPR_N+1, to the texture unit. If the image object is RGB, the texel is overwritten with Red from the VGPR_N, Green and Blue set to zero, and Alpha from the shader ignored.
- Atomics: Image atomic operations are supported only on 32- and 64-bit-per pixel surfaces. The surface data format is specified in the resource constant. Atomic operations treat the element as a single component of 32- or 64-bits. For atomic operations, DMASK is set to the number of VGPRs (Dwords) to send to the texture unit. DMASK legal values for atomic image operations: no other values of DMASK are legal.
 - 0x1 = 32-bit atomics except cmpswap.
 - 0x3 = 32-bit atomic cmpswap.
 - 0x3 = 64-bit atomics except cmpswap.
 - 0xf = 64-bit atomic cmpswap.
- Atomics with Return: Data is read out of the VGPR(s), starting at VDATA, to supply to the atomic operation. If the atomic returns a value to VGPRs, that data is returned to those same VGPRs starting at VDATA.
- D16 Instructions: Load-format and store-format instructions also come in a "d16" variant. For stores, each 32-bit VGPR holds two 16-bit data elements that are passed to the texture unit. The texture unit converts them to the texture format before writing to memory. For loads, data returned from the texture unit is converted to 16 bits, and a pair of data are stored in each 32- bit VGPR (LSBs first, then MSBs). The DMASK bit represents individual 16- bit elements; so, when DMASK=0011 for an image-load, two 16-bit components are loaded into a single 32-bit VGPR.

8.4.2. Image Resource

The image resource (also referred to as T#) defines the location of the image buffer in memory, its dimensions, tiling, and data format. These resources are stored in four or eight consecutive SGPRs and are read by MIMG instructions.

Table 39. Image Resource Definition

Bits	Size	Name	Comments
128-bit Resource: 1D-tex, 2d-tex, 2d-msaa (multi-sample auto-aliasing)			
39:0	40	base address	256-byte aligned. Also used for fmask-ptr.
51:40	12	min lod	4.8 (four uint bits, eight fraction bits) format.

Bits	Size	Name	Comments
57:52	6	data format	Number of comps, number of bits/comp.
61:58	4	num format	Numeric format.
62	1	NV	Non-volatile (0=volatile)
77:64	14	width	width-1 of mip0 in texels
91:78	14	height	height-1 of mip0 in texels
94:92	3	perf modulation	Scales sampler's perf_z, perf_mip, aniso_bias, lod_bias_sec.
98:96	3	dst_sel_x	0 = 0, 1 = 1, 4 = R, 5 = G, 6 = B, 7 = A.
101:99	3	dst_sel_y	
104:102	3	dst_sel_z	
107:105	3	dst_sel_w	
111:108	4	base level	largest mip level in the resource view. For msaa, set to zero.
115:112	4	last level	For msaa, holds number of samples
120:116	5	Tiling index	Lookuptable: 32 x 16 bank_width[2], bank_height[2], num_banks[2], tile_split[2], macro_tile_aspect[2], micro_tile_mode[2], array_mode[4].
127:124	4	type	0 = buf, 8 = 1d, 9 = 2d, 10 = 3d, 11 = cube, 12 = 1d-array, 13 = 2d-array, 14 = 2d-msaa, 15 = 2d-msaa-array. 1-7 are reserved.
256-bit Resource: 1d-array, 2d-array, 3d, cubemap, MSAA			
140:128	13	depth	depth-1 of mip0 for 3d map
156:141	16	pitch	In texel units.
159:157	3	border color swizzle	Specifies the channel ordering for border color independent of the T# dst_sel fields. 0=xyzw, 1=xwyz, 2=wqyx, 3=wxyz, 4=zyxw, 5=yxwz
176:173	4	Array Pitch	array pitch for quilts, encoded as: trunc(log2(array_pitch))+1
184:177	8	meta data address	bits[47:40]
185	1	meta_linear	forces metadata surface to be linear
186	1	meta_pipe_aligned	maintain pipe alignment in metadata addressing
187	1	meta_rb_aligned	maintain RB alignment in metadata addressing
191:188	4	Max Mip	Resource mipLevel-1. Describes the resource, as opposed to base_level and last_level, which describes the resource view. For MSAA, holds log2(number of samples).
203:192	12	min LOD warn	Feedback trigger for LOD, in U4.8 format.
211:204	8	counter bank ID	PRT counter ID
212	1	LOD hardware count enable	PRT hardware counter enable
213	1	Compression Enable	enable delta color compression

Bits	Size	Name	Comments
214	1	Alpha is on MSB	Set to 1 if the surface's component swap is not reversed (DCC)
215	1	Color Transform	Auto=0, none=1 (DCC)
255:216	40	Meta Data Address	Upper bits of meta-data address (DCC) [47:8]

All image resource view descriptors (T#'s) are written by the driver as 256 bits.

The MIMG-format instructions have a DeclareArray (DA) bit that reflects whether the shader was expecting an array-texture or simple texture to be bound. When DA is zero, the hardware does not send an array index to the texture cache. If the texture map was indexed, the hardware supplies an index value of zero. Indices sent for non-indexed texture maps are ignored.

8.4.3. Image Sampler

The sampler resource (also referred to as S#) defines what operations to perform on texture map data read by **sample** instructions. These are primarily address clamping and filter options. Sampler resources are defined in four consecutive SGPRs and are supplied to the texture cache with every sample instruction.

Table 40. Image Sampler Definition

Bits	Size	Name	Description
2:0	3	clamp x	Clamp/wrap mode.
5:3	3	clamp y	
8:6	3	clamp z	
11:9	3	max aniso ratio	
14:12	3	depth compare func	
15	1	force unnormalized	Force address cords to be unorm.
18:16	3	aniso threshold	
19	1	mc coord trunc	
20	1	force degamma	
26:21	6	aniso bias	u1.5.
27	1	trunc coord	
28	1	disable cube wrap	
30:29	2	filter_mode	Normal lerp, min, or max filter.
31	1	compat_mode	1 = new mode; 0 = legacy
43:32	12	min lod	u4.8.
55:44	12	max lod	u4.8.

Bits	Size	Name	Description
59:56	4	perf_mip	
63:60	4	perf z	
77:64	14	lod bias	s5.8.
83:78	6	lod bias sec	s1.4.
85:84	2	xy mag filter	Magnification filter.
87:86	2	xy min filter	Minification filter.
89:88	2	z filter	
91:90	2	mip filter	
92	1	mip_point_preclamp	When mipfilter = point, add 0.5 before clamping.
93	1	disable_lsb_ceil	Disable ceiling logic in filter (rounds up).
94	1	Filter_Prec_Fix	
95	1	Aniso_override	Disable Aniso filtering if base_level = last_level
107:96	12	border color ptr	
125:108	18	unused	
127:126	2	border color type	Opaque-black, transparent-black, white, use border color ptr.

8.4.4. Data Formats

Data formats 0-15 are available to buffer resources, and all formats are available to image formats. The table below details all the data formats that can be used by image and buffer resources.

(VMCNT).

This is explained in the section: [Data Dependency Resolution](#)

Chapter 9. Flat Memory Instructions

Flat Memory instructions read, or write, one piece of data into, or out of, VGPRs; they do this separately for each work-item in a wavefront. Unlike buffer or image instructions, Flat instructions do not use a resource constant to define the base address of a surface. Instead, Flat instructions use a single flat address from the VGPR; this addresses memory as a single flat memory space. This memory space includes video memory, system memory, LDS memory, and scratch (private) memory. It does not include GDS memory. Parts of the flat memory space may not map to any real memory, and accessing these regions generates a memory-violation error. The determination of the memory space to which an address maps is controlled by a set of "memory aperture" base and size registers.

9.1. Flat Memory Instruction

Flat memory instructions let the kernel read or write data in memory, or perform atomic operations on data already in memory. These operations occur through the texture L2 cache. The instruction declares which VGPR holds the address (either 32- or 64-bit, depending on the memory configuration), the VGPR which sends and the VGPR which receives data. Flat instructions also use M0 as described in the table below:

Table 41. Flat, Global and Scratch Microcode Formats

Field	Bit Size	Description
OP	7	Opcode. Can be Flat, Scratch or Global instruction. See next table.
ADDR	8	VGPR which holds the address. For 64-bit addresses, ADDR has the LSBs, and ADDR+1 has the MSBs.
DATA	8	VGPR which holds the first Dword of data. Instructions can use 0-4 Dwords.
VDST	8	VGPR destination for data returned to the kernel, either from LOADs or Atomics with GLC=1 (return pre-op value).
SLC	1	System Level Coherent. Used in conjunction with GLC to determine cache policies.
GLC	1	Global Level Coherent. For Atomics, GLC: 1 means return pre-op value, 0 means do not return pre-op value.
SEG	2	Memory Segment: 0=FLAT, 1=SCRATCH, 2=GLOBAL, 3=reserved.
LDS	1	When set, data is moved between LDS and memory instead of VGPRs and memory. For Global and Scratch only; must be zero for Flat.
NV	1	Non-volatile. When set, the read/write is operating on non-volatile memory.
OFFSET	13	Address offset. Scratch, Global: 13-bit signed byte offset. Flat: 12-bit unsigned offset (MSB is ignored).

Field	Bit Size	Description
SADDR	7	Scalar SGPR that provides an offset address. To disable, set this field to 0x7F. Meaning of this field is different for Scratch and Global: Flat: Unused. Scratch: Use an SGPR (instead of VGPR) for the address. Global: Use the SGPR to provide a base address; the VGPR provides a 32-bit offset.
M0	16	Implied use of M0 for SCRATCH and GLOBAL only when LDS=1. Provides the LDS address-offset.

Table 42. Flat, Global and Scratch Opcodes

Flat Opcodes	Global Opcodes	Scratch Opcodes
FLAT	GLOBAL	SCRATCH
FLAT_LOAD_UBYTE	GLOBAL_LOAD_UBYTE	SCRATCH_LOAD_UBYTE
FLAT_LOAD_UBYTE_D16	GLOBAL_LOAD_UBYTE_D16	SCRATCH_LOAD_UBYTE_D16
FLAT_LOAD_UBYTE_D16_HI	GLOBAL_LOAD_UBYTE_D16_HI	SCRATCH_LOAD_UBYTE_D16_HI
FLAT_LOAD_SBYTE	GLOBAL_LOAD_SBYTE	SCRATCH_LOAD_SBYTE
FLAT_LOAD_SBYTE_D16	GLOBAL_LOAD_SBYTE_D16	SCRATCH_LOAD_SBYTE_D16
FLAT_LOAD_SBYTE_D16_HI	GLOBAL_LOAD_SBYTE_D16_HI	SCRATCH_LOAD_SBYTE_D16_HI
FLAT_LOAD_USHORT	GLOBAL_LOAD_USHORT	SCRATCH_LOAD_USHORT
FLAT_LOAD_SSHORT	GLOBAL_LOAD_SSHORT	SCRATCH_LOAD_SSHORT
FLAT_LOAD_SHORT_D16	GLOBAL_LOAD_SHORT_D16	SCRATCH_LOAD_SHORT_D16
FLAT_LOAD_SHORT_D16_HI	GLOBAL_LOAD_SHORT_D16_HI	SCRATCH_LOAD_SHORT_D16_HI
FLAT_LOAD_DWORD	GLOBAL_LOAD_DWORD	SCRATCH_LOAD_DWORD
FLAT_LOAD_DWORDX2	GLOBAL_LOAD_DWORDX2	SCRATCH_LOAD_DWORDX2
FLAT_LOAD_DWORDX3	GLOBAL_LOAD_DWORDX3	SCRATCH_LOAD_DWORDX3
FLAT_LOAD_DWORDX4	GLOBAL_LOAD_DWORDX4	SCRATCH_LOAD_DWORDX4
FLAT_STORE_BYTE	GLOBAL_STORE_BYTE	SCRATCH_STORE_BYTE
FLAT_STORE_BYTE_D16_HI	GLOBAL_STORE_BYTE_D16_HI	SCRATCH_STORE_BYTE_D16_HI
FLAT_STORE_SHORT	GLOBAL_STORE_SHORT	SCRATCH_STORE_SHORT
FLAT_STORE_SHORT_D16_HI	GLOBAL_STORE_SHORT_D16_HI	SCRATCH_STORE_SHORT_D16_HI
FLAT_STORE_DWORD	GLOBAL_STORE_DWORD	SCRATCH_STORE_DWORD
FLAT_STORE_DWORDX2	GLOBAL_STORE_DWORDX2	SCRATCH_STORE_DWORDX2
FLAT_STORE_DWORDX3	GLOBAL_STORE_DWORDX3	SCRATCH_STORE_DWORDX3
FLAT_STORE_DWORDX4	GLOBAL_STORE_DWORDX4	SCRATCH_STORE_DWORDX4
FLAT_ATOMIC_SWAP	GLOBAL_ATOMIC_SWAP	none
FLAT_ATOMIC_CMPSWAP	GLOBAL_ATOMIC_CMPSWAP	none

Flat Opcodes	Global Opcodes	Scratch Opcodes
FLAT_ATOMIC_ADD	GLOBAL_ATOMIC_ADD	none
FLAT_ATOMIC_SUB	GLOBAL_ATOMIC_SUB	none
FLAT_ATOMIC_SMIN	GLOBAL_ATOMIC_SMIN	none
FLAT_ATOMIC_UMIN	GLOBAL_ATOMIC_UMIN	none
FLAT_ATOMIC_SMAX	GLOBAL_ATOMIC_SMAX	none
FLAT_ATOMIC_UMAX	GLOBAL_ATOMIC_UMAX	none
FLAT_ATOMIC_AND	GLOBAL_ATOMIC_AND	none
FLAT_ATOMIC_OR	GLOBAL_ATOMIC_OR	none
FLAT_ATOMIC_XOR	GLOBAL_ATOMIC_XOR	none
FLAT_ATOMIC_INC	GLOBAL_ATOMIC_INC	none
FLAT_ATOMIC_DEC	GLOBAL_ATOMIC_DEC	none

The atomic instructions above are also available in "_X2" versions (64-bit).

9.2. Instructions

The FLAT instruction set is nearly identical to the Buffer instruction set, but without the FORMAT reads and writes. Unlike Buffer instructions, FLAT instructions cannot return data directly to LDS, but only to VGPRs.

FLAT instructions do not use a resource constant (V#) or sampler (S#); however, they do require a SGPR-pair to hold scratch-space information in case any threads' address resolves to scratch space. See the Scratch section for details.

Internally, FLAT instruction are executed as both an LDS and a Buffer instruction; so, they increment both VM_CNT and LGKM_CNT and are not considered done until both have been decremented. There is no way beforehand to determine whether a FLAT instruction uses only LDS or TA memory space.

9.2.1. Ordering

Flat instructions can complete out of order with each other. If one flat instruction finds all of its data in Texture cache, and the next finds all of its data in LDS, the second instruction might complete first. If the two fetches return data to the same VGPR, the result are unknown.

9.2.2. Important Timing Consideration

Since the data for a FLAT load can come from either LDS or the texture cache, and because these units have different latencies, there is a potential race condition with respect to the

VM_CNT and LGKM_CNT counters. Because of this, the only sensible S_WAITCNT value to use after FLAT instructions is zero.

9.3. Addressing

FLAT instructions support both 64- and 32-bit addressing. The address size is set using a mode register (PTR32), and a local copy of the value is stored per wave.

The addresses for the aperture check differ in 32- and 64-bit mode; however, this is not covered here.

64-bit addresses are stored with the LSBs in the VGPR at ADDR, and the MSBs in the VGPR at ADDR+1.

For scratch space, the texture unit takes the address from the VGPR and does the following.

```
Address = VGPR[addr] + TID_in_wave * Size
          - private aperture base (in SH_MEM_BASES)
          + offset (from flat_scratch)
```

9.4. Global

Global instructions are similar to Flat instructions, but the programmer must ensure that no threads access LDS space; thus, no LDS bandwidth is used by global instructions.

Global instructions offer two types of addressing:

- Memory_addr = VGPR-address + instruction offset.
- Memory_addr = SGPR-address + VGPR-offset + instruction offset.

The size of the address component is dependent on ADDRESS_MODE: 32-bits or 64-bit pointers. The VGPR-offset is 32 bits.

These instructions also allow direct data movement between LDS and memory without going through VGPRs.

Since these instructions do not access LDS, only VM_CNT is used, not LGKM_CNT. If a global instruction does attempt to access LDS, the instruction returns MEM_VIOL.

9.5. Scratch

Scratch instructions are similar to Flat, but the programmer must ensure that no threads access LDS space, and the memory space is swizzled. Thus, no LDS bandwidth is used by scratch

instructions.

Scratch instructions also support multi-Dword access and mis-aligned access (although mis-aligned is slower).

Scratch instructions use the following addressing:

- $\text{Memory_addr} = \text{flat_scratch.addr} + \text{swizzle}(\text{V/SGPR_offset} + \text{inst_offset}, \text{threadID})$
- The offset can come from either an SGPR or a VGPR, and is a 32-bit unsigned byte.

The size of the address component is dependent on the ADDRESS_MODE: 32-bits or 64-bit pointers. The VGPR-offset is 32 bits.

These instructions also allow direct data movement between LDS and memory without going through VGPRs.

Since these instructions do not access LDS, only VM_CNT is used, not LGKM_CNT. It is not possible for a Scratch instruction to access LDS; thus, no error or aperture checking is done.

9.6. Memory Error Checking

Both TA and LDS can report that an error occurred due to a bad address. This can occur for the following reasons:

- invalid address (outside any aperture)
- write to read-only surface
- misaligned data
- out-of-range address:
 - LDS access with an address outside the range: $[0, \text{MIN}(M0, \text{LDS_SIZE})-1]$
 - Scratch access with an address outside the range: $[0, \text{scratch-size}-1]$

The policy for threads with bad addresses is: writes outside this range do not write a value, and reads return zero.

Addressing errors from either LDS or TA are returned on their respective "instruction done" busses as MEM_VIOL. This sets the wave's MEM_VIOL TrapStatus bit and causes an exception (trap) if the corresponding EXCPEN bit is set.

9.7. Data

FLAT instructions can use zero to four consecutive Dwords of data in VGPRs and/or memory. The DATA field determines which VGPR(s) supply source data (if any), and the VDST VGPRs hold return data (if any). No data-format conversion is done.

9.8. Scratch Space (Private)

Scratch (thread-private memory) is an area of memory defined by the aperture registers. When an address falls in scratch space, additional address computation is automatically performed by the hardware. The kernel must provide additional information for this computation to occur in the form of the FLAT_SCRATCH register.

The FLAT_SCRATCH address is automatically sent with every FLAT request.

FLAT_SCRATCH is a 64-bit, byte address. The shader composes the value by adding together two separate values: the base address, which can be passed in via an initialized SGPR, or perhaps through a constant buffer, and the per-wave allocation offset (also initialized in an SGPR).

Chapter 10. Data Share Operations

Local data share (LDS) is a very low-latency, RAM scratchpad for temporary data with at least one order of magnitude higher effective bandwidth than direct, uncached global memory. It permits sharing of data between work-items in a work-group, as well as holding parameters for pixel shader parameter interpolation. Unlike read-only caches, the LDS permits high-speed write-to-read re-use of the memory space (gather/read/load and scatter/write/store operations).

10.1. Overview

The figure below shows the conceptual framework of the LDS is integration into the memory of AMD GPUs using OpenCL.

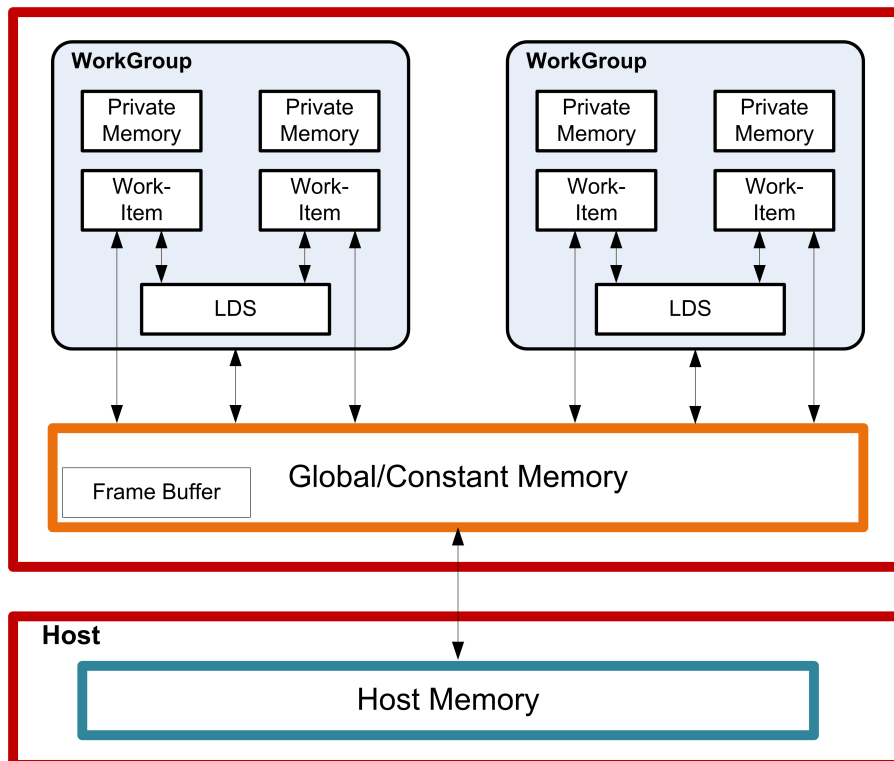

Figure 6. High-Level Memory Configuration

Physically located on-chip, directly next to the ALUs, the LDS is approximately one order of magnitude faster than global memory (assuming no bank conflicts).

There are 64 kB memory per compute unit, segmented into 32 of 512 Dwords. Each bank is a 256x32 two-port RAM (1R/1W per clock cycle). Dwords are placed in the banks serially, but all banks can execute a store or load simultaneously. One work-group can request up to 64 kB memory. Reads across wavefront are dispatched over four cycles in waterfall.

The high bandwidth of the LDS memory is achieved not only through its proximity to the ALUs, but also through simultaneous access to its memory banks. Thus, it is possible to concurrently

execute 32 write or read instructions, each nominally 32-bits; extended instructions, read2/write2, can be 64-bits each. If, however, more than one access attempt is made to the same bank at the same time, a bank conflict occurs. In this case, for indexed and atomic operations, hardware prevents the attempted concurrent accesses to the same bank by turning them into serial accesses. This decreases the effective bandwidth of the LDS. For maximum throughput (optimal efficiency), therefore, it is important to avoid bank conflicts. A knowledge of request scheduling and address mapping is key to achieving this.

10.2. Dataflow in Memory Hierarchy

The figure below is a conceptual diagram of the dataflow within the memory structure.

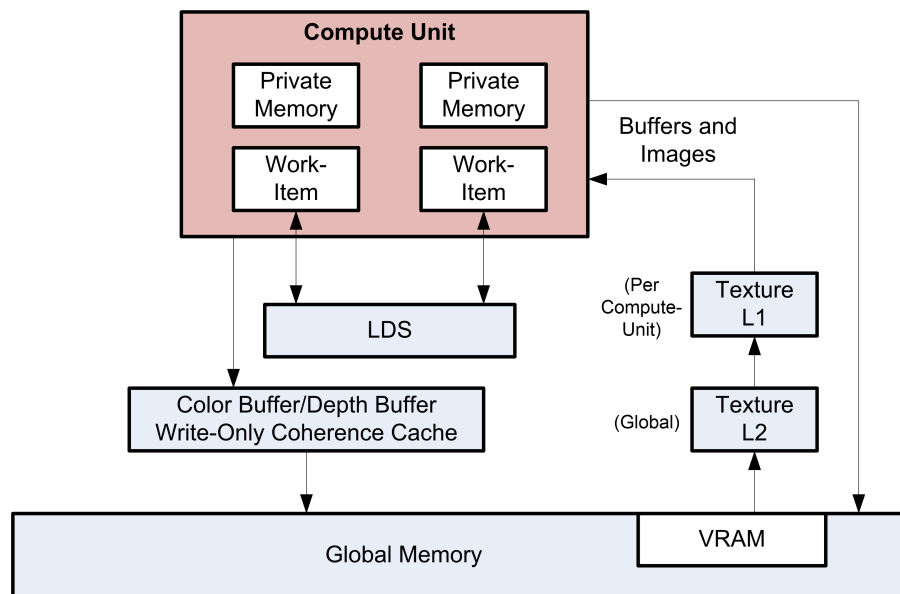

To load data into LDS from global memory, it is read from global memory and placed into the work-item's registers; then, a store is performed to LDS. Similarly, to store data into global memory, data is read from LDS and placed into the workitem's registers, then placed into global memory. To make effective use of the LDS, an algorithm must perform many operations on what is transferred between global memory and LDS. It also is possible to load data from a memory buffer directly into LDS, bypassing VGPRs.

LDS atomics are performed in the LDS hardware. (Thus, although ALUs are not directly used for these operations, latency is incurred by the LDS executing this function.)

10.3. LDS Access

The LDS is accessed in one of three ways:

- Direct Read
- Parameter Read

- Indexed or Atomic

The following subsections describe these methods.

10.3.1. LDS Direct Reads

Direct reads are only available in LDS, not in GDS.

LDS Direct reads occur in vector ALU (VALU) instructions and allow the LDS to supply a single DWORD value which is broadcast to all threads in the wavefront and is used as the SRC0 input to the ALU operations. A VALU instruction indicates that input is to be supplied by LDS by using the LDS_DIRECT for the SRC0 field.

The LDS address and data-type of the data to be read from LDS comes from the M0 register:

```
LDS_addr = M0[15:0] (byte address and must be Dword aligned)
DataType = M0[18:16]
    0 unsigned byte
    1 unsigned short
    2 Dword
    3 unused
    4 signed byte
    5 signed short
```

10.3.2. LDS Parameter Reads

Parameter reads are only available in LDS, not in GDS.

Pixel shaders use LDS to read vertex parameter values; the pixel shader then interpolates them to find the per-pixel parameter values. LDS parameter reads occur when the following opcodes are used.

- V_INTERP_P1_F32 D = P10 * S + P0 Parameter interpolation, first step.
- V_INTERP_P2_F32D = P20 * S + DParameter interpolation, second step.
- V_INTERP_MOV_F32D = {P10,P20,P0}[S]Parameter load.

The typical parameter interpolation operations involves reading three parameters: P0, P10, and P20, and using the two barycentric coordinates, I and J, to determine the final per-pixel value:

$$\text{Final value} = P0 + P10 * I + P20 * J$$

Parameter interpolation instructions indicate the parameter attribute number (0 to 32) and the component number (0=x, 1=y, 2=z and 3=w).

Table 43. Parameter Instruction Fields

Field	Size	Description
VDST	8	Destination VGPR. Also acts as source for v_interp_p2_f32.
OP	2	Opcode: 0: v_interp_p1_f32 VDST = P10 * VSRC + P0 1: v_interp_p2_f32 VDST = P20 * VSRC + VDST 2: v_interp_mov_f32 VDST = (P0, P10 or P20 selected by VSRC[1:0]) P0, P10 and P20 are parameter values read from LDS
ATTR	6	Attribute number: 0 to 32.
ATTRCHAN	2	0=X, 1=Y, 2=Z, 3=W
VSRC	8	Source VGPR supplies interpolation "I" or "J" value. For OP==v_interp_mov_f32: 0=P10, 1=P20, 2=P0. VSRC must not be the same register as VDST because 16-bank LDS chips implement v_interp_p1 as a macro of two instructions.
(M0)	32	Use of the M0 register is automatic. M0 must contain: { 1'b0, new_prim_mask[15:1], lds_param_offset[15:0] }

Parameter interpolation and parameter move instructions must initialize the M0 register before using it. The lds_param_offset[15:0] is an address offset from the beginning of LDS storage allocated to this wavefront to where parameters begin in LDS memory for this wavefront. The new_prim_mask is a 15-bit mask with one bit per quad; a one in this mask indicates that this quad begins a new primitive, a zero indicates it uses the same primitive as the previous quad. The mask is 15 bits, not 16, since the first quad in a wavefront begins a new primitive and so it is not included in the mask.

10.3.3. Data Share Indexed and Atomic Access

Both LDS and GDS can perform indexed and atomic data share operations. For brevity, "LDS" is used in the text below and, except where noted, also applies to GDS.

Indexed and atomic operations supply a unique address per work-item from the VGPRs to the LDS, and supply or return unique data per work-item back to VGPRs. Due to the internal banked structure of LDS, operations can complete in as little as two cycles, or take as many 64 cycles, depending upon the number of bank conflicts (addresses that map to the same memory bank).

Indexed operations are simple LDS load and store operations that read data from, and return data to, VGPRs.

Atomic operations are arithmetic operations that combine data from VGPRs and data in LDS, and write the result back to LDS. Atomic operations have the option of returning the LDS "pre-op" value to VGPRs.

The table below lists and briefly describes the LDS instruction fields.

Table 44. LDS Instruction Fields

Field	Size	Description
OP	7	LDS opcode.
GDS	1	0 = LDS, 1 = GDS.
OFFSET0	8	Immediate offset, in bytes. Instructions with one address combine the offset fields into a single 16-bit unsigned offset: {offset1, offset0}. Instructions with two addresses (for example: READ2) use the offsets separately as two 8-bit unsigned offsets. DS_*_SRC2_* ops treat the offset as a 16-bit signed Dword offset.
OFFSET1	8	
VDST	8	VGPR to which result is written: either from LDS-load or atomic return value.
ADDR	8	VGPR that supplies the byte address offset.
DATA0	8	VGPR that supplies first data source.
DATA1	8	VGPR that supplies second data source.

All LDS operations require that M0 be initialized prior to use. M0 contains a size value that can be used to restrict access to a subset of the allocated LDS range. If no clamping is wanted, set M0 to 0xFFFFFFFF.

Table 45. LDS Indexed Load/Store

Load / Store	Description
DS_READ_{B32,B64,B96,B128,U8,I8,U16,I16}	Read one value per thread; sign extend to Dword, if signed.
DS_READ2_{B32,B64}	Read two values at unique addresses.
DS_READ2ST64_{B32,B64}	Read 2 values at unique addresses; offset *= 64.
DS_WRITE_{B32,B64,B96,B128,B8,B16}	Write one value.
DS_WRITE2_{B32,B64}	Write two values.
DS_WRITE2ST64_{B32,B64}	Write two values, offset *= 64.
DS_WRXCHG2_RTN_{B32,B64}	Exchange GPR with LDS-memory.
DS_WRXCHG2ST64_RTN_{B32,B64}	Exchange GPR with LDS-memory; offset *= 64.
DS_PERMUTE_B32	Forward permute. Does not write any LDS memory. LDS[dst] = src0 returnVal = LDS[thread_id] where thread_id is 0..63.
DS_BPERMUTE_B32	Backward permute. Does not actually write any LDS memory. LDS[thread_id] = src0 where thread_id is 0..63, and returnVal = LDS[dst].

Single Address Instructions

```
LDS_Addr = LDS_BASE + VGPR[ADDR] + {InstrOffset1, InstrOffset0}
```

Double Address Instructions

```
LDS_Addr0 = LDS_BASE + VGPR[ADDR] + InstrOffset0*ADJ +
LDS_Addr1 = LDS_BASE + VGPR[ADDR] + InstrOffset1*ADJ
Where ADJ = 4 for 8, 16 and 32-bit data types; and ADJ = 8 for 64-bit.
```

Note that LDS_ADDR1 is used only for READ2*, WRITE2*, and WREXCHG2*.

M0[15:0] provides the size in bytes for this access. The size sent to LDS is MIN(M0, LDS_SIZE), where LDS_SIZE is the amount of LDS space allocated by the shader processor interpolator, SPI, at the time the wavefront was created.

The address comes from VGPR, and both ADDR and InstrOffset are byte addresses.

At the time of wavefront creation, LDS_BASE is assigned to the physical LDS region owned by this wavefront or work-group.

Specify only one address by setting both offsets to the same value. This causes only one read or write to occur and uses only the first DATA0.

SRC2 Ops The ds_<op>_src2_<type> opcodes are different. These operands perform an atomic operation on 2 operands from the LDS memory: one is viewed as the data and the other is the second source operand and the final destination. The addressing for these can operate in two different modes depending on the MSB of offset1[7]: If it is 0, the offset for the data term is derived by the offset fields as a SIGNED dword offset:

```
LDS_Addr0 = LDS_BASE + VGPR(ADDR) + SIGNEXTEND(InstrOffset1[6:0], InstrOffset0) << 2 // data
term
LDS_Addr1 = LDS_BASE + VGPR(ADDR) // second source and final destination
address
```

If the bit is 1, the offset for the data term becomes per thread and is a SIGNED dword offset derived from the msbs read from the VGPR for the index. The addressing becomes:

```
LDS_Addr0 = LDS_BASE + VGPR(ADDR)[16:0] + SIGNEXTEND(VGPR(ADDR)[31:17]) << 2 // data term
LDS_Addr1 = LDS_BASE + VGPR(ADDR)[16:0] // second source and final destination address
```

LDS Atomic Ops DS_<atomicOp> OP, GDS=0, OFFSET0, OFFSET1, VDST, ADDR, Data0, Data1

Data size is encoded in atomicOp: byte, word, Dword, or double.

$$\text{LDS_Addr0} = \text{LDS_BASE} + \text{VGPR}[\text{ADDR}] + \{\text{InstrOffset1}, \text{InstrOffset0}\}$$

ADDR is a Dword address. VGPRs 0,1 and dst are double-GPRs for doubles data.

VGPR data sources can only be VGPRs or constant values, not SGPRs.

Chapter 11. Exporting Pixel and Vertex Data

The export instruction copies pixel or vertex shader data from VGPRs into a dedicated output buffer. The export instruction outputs the following types of data.

- Vertex Position
- Vertex Parameter
- Pixel color
- Pixel depth (Z)

11.1. Microcode Encoding

The export instruction uses the EXP microcode format.

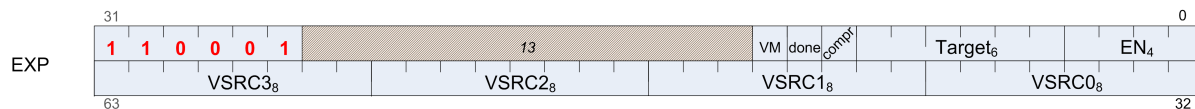

Table 46. EXP Encoding Field Descriptions

Field	Size	Description
VM	1	Valid Mask. When set to 1, this indicates that the EXEC mask represents the valid-mask for this wavefront. It can be sent multiple times per shader (the final value is used), but must be sent at least once per pixel shader.
DONE	1	This is the final pixel shader or vertex-position export of the program. Used only for pixel and position exports. Set to zero for parameters.
COMPR	1	Compressed data. When set, indicates that the data being exported is 16-bits per component rather than the usual 32-bit.
TARGET	6	Indicates type of data exported. 0..7 MRT 0..7 8 Z 9 Null (no data) 12-15 Position 0..3 32-63 Param 0..31
EN	4	COMPR==1 : export half-Dword enable. Valid values are: 0x0,3,C,F. [0] enables VSRC0 : R,G from one VGPR [2] enables VSRC1 : B,A from one VGPR COMPR==0 : [0-3] = enables for VSRC0..3. EN can be zero (used when exporting only valid mask to NULL target).

Field	Size	Description
VSRC3	8	VGPR from which to read data.
VSRC2	8	Pos & Param: vsrc0=X, 1=Y, 2=Z, 3=W MRT: vsrc0=R, 1=G, 2=B, 3=A
VSRC1	8	
VSRC0	8	

11.2. Operations

11.2.1. Pixel Shader Exports

Export instructions copy color data to the MRTs. Data has four components (R, G, B, A). Optionally, export instructions also output depth (Z) data.

Every pixel shader must have at least one export instruction. The last export instruction executed must have the DONE bit set to one.

The EXEC mask is applied to all exports. Only pixels with the corresponding EXEC bit set to 1 export data to the output buffer. Results from multiple exports are accumulated in the output buffer.

At least one export must have the VM bit set to 1. This export, in addition to copying data to the color or depth output buffer, also informs the color buffer which pixels are valid and which have been discarded. The value of the EXEC mask communicates the pixel valid mask. If multiple exports are sent with VM set to 1, the mask from the final export is used. If the shader program wants to only update the valid mask but not send any new data, the program can do an export to the NULL target.

11.2.2. Vertex Shader Exports

The vertex shader uses export instructions to output vertex position data and vertex parameter data to the output buffer. This data is passed on to subsequent pixel shaders.

Every vertex shader must output at least one position vector (x, y, z; w is optional) to the POS0 target. The last position export must have the DONE bit set to 1. A vertex shader can export zero or more parameters. For enhanced performance, output all position data as early as possible in the vertex shader.

11.3. Dependency Checking

Export instructions are executed by the hardware in two phases. First, the instruction is selected to be executed, and EXPCNT is incremented by 1. At this time, the hardware requests the use

of internal busses needed to complete the instruction.

When access to the bus is granted, the EXEC mask is read and the VGPR data sent out. After the last of the VGPR data is sent, the EXPCNT counter is decremented by 1.

Use S_WAITCNT on EXPCNT to prevent the shader program from overwriting EXEC or the VGPRs holding the data to be exported before the export operation has completed.

Multiple export instructions can be outstanding at one time. Exports of the same type (for example: position) are completed in order, but exports of different types can be completed out of order.

If the STATUS register's SKIP_EXPORT bit is set to one, the hardware treats all EXPORT instructions as if they were NOPs.

Chapter 12. Instructions

This chapter lists, and provides descriptions for, all instructions in the GCN Vega Generation environment. Instructions are grouped according to their format.

Instruction suffixes have the following definitions:

- B32 Bitfield (untyped data) 32-bit
- B64 Bitfield (untyped data) 64-bit
- F16 floating-point 16-bit
- F32 floating-point 32-bit (IEEE 754 single-precision float)
- F64 floating-point 64-bit (IEEE 754 double-precision float)
- I8 signed 8-bit integer
- I16 signed 16-bit integer
- I32 signed 32-bit integer
- I64 signed 64-bit integer
- U16 unsigned 16-bit integer
- U32 unsigned 32-bit integer
- U64 unsigned 64-bit integer

If an instruction has two suffixes (for example, `_I32_F32`), the first suffix indicates the destination type, the second the source type.

The following abbreviations are used in instruction definitions:

- D = destination
- U = unsigned integer
- S = source
- SCC = scalar condition code
- I = signed integer
- B = bitfield

Note: `.u` or `.i` specifies to interpret the argument as an unsigned or signed float.

Note: Rounding and Denormal modes apply to all floating-point operations unless otherwise specified in the instruction description.

12.1. SOP2 Instructions



Instructions in this format may use a 32-bit literal constant which occurs immediately after the instruction.

Opcode	Name	Description
0	S_ADD_U32	$D.u = S0.u + S1.u;$ $SCC = (S0.u + S1.u \geq 0x100000000ULL ? 1 : 0).$ // unsigned overflow/carry-out, S_ADDC_U32
1	S_SUB_U32	$D.u = S0.u - S1.u;$ $SCC = (S1.u > S0.u ? 1 : 0).$ // unsigned overflow or carry-out for S_SUBB_U32.
2	S_ADD_I32	$D.i = S0.i + S1.i;$ $SCC = (S0.u[31] == S1.u[31] \&\& S0.u[31] != D.u[31]).$ // signed overflow. This opcode is not suitable for use with S_ADDC_U32 for implementing 64-bit operations.
3	S_SUB_I32	$D.i = S0.i - S1.i;$ $SCC = (S0.u[31] != S1.u[31] \&\& S0.u[31] != D.u[31]).$ // signed overflow. This opcode is not suitable for use with S_SUBB_U32 for implementing 64-bit operations.
4	S_ADDC_U32	$D.u = S0.u + S1.u + SCC;$ $SCC = (S0.u + S1.u + SCC \geq 0x100000000ULL ? 1 : 0).$ // unsigned overflow.
5	S_SUBB_U32	$D.u = S0.u - S1.u - SCC;$ $SCC = (S1.u + SCC > S0.u ? 1 : 0).$ // unsigned overflow.
6	S_MIN_I32	$D.i = (S0.i < S1.i) ? S0.i : S1.i;$ $SCC = (S0.i < S1.i).$
7	S_MIN_U32	$D.u = (S0.u < S1.u) ? S0.u : S1.u;$ $SCC = (S0.u < S1.u).$
8	S_MAX_I32	$D.i = (S0.i > S1.i) ? S0.i : S1.i;$ $SCC = (S0.i > S1.i).$
9	S_MAX_U32	$D.u = (S0.u > S1.u) ? S0.u : S1.u;$ $SCC = (S0.u > S1.u).$
10	S_CSELECT_B32	$D.u = SCC ? S0.u : S1.u.$ Conditional select.
11	S_CSELECT_B64	$D.u64 = SCC ? S0.u64 : S1.u64.$ Conditional select.
12	S_AND_B32	$D = S0 \& S1;$ $SCC = (D != 0).$

Opcode	Name	Description
13	S_AND_B64	$D = S0 \& S1;$ $SCC = (D \neq 0).$
14	S_OR_B32	$D = S0 \mid S1;$ $SCC = (D \neq 0).$
15	S_OR_B64	$D = S0 \mid S1;$ $SCC = (D \neq 0).$
16	S_XOR_B32	$D = S0 \wedge S1;$ $SCC = (D \neq 0).$
17	S_XOR_B64	$D = S0 \wedge S1;$ $SCC = (D \neq 0).$
18	S_ANDN2_B32	$D = S0 \& \sim S1;$ $SCC = (D \neq 0).$
19	S_ANDN2_B64	$D = S0 \& \sim S1;$ $SCC = (D \neq 0).$
20	S_ORN2_B32	$D = S0 \mid \sim S1;$ $SCC = (D \neq 0).$
21	S_ORN2_B64	$D = S0 \mid \sim S1;$ $SCC = (D \neq 0).$
22	S_NAND_B32	$D = \sim(S0 \& S1);$ $SCC = (D \neq 0).$
23	S_NAND_B64	$D = \sim(S0 \& S1);$ $SCC = (D \neq 0).$
24	S_NOR_B32	$D = \sim(S0 \mid S1);$ $SCC = (D \neq 0).$
25	S_NOR_B64	$D = \sim(S0 \mid S1);$ $SCC = (D \neq 0).$
26	S_XNOR_B32	$D = \sim(S0 \wedge S1);$ $SCC = (D \neq 0).$
27	S_XNOR_B64	$D = \sim(S0 \wedge S1);$ $SCC = (D \neq 0).$
28	S_LSHL_B32	$D.u = S0.u \ll S1.u[4:0];$ $SCC = (D.u \neq 0).$
29	S_LSHL_B64	$D.u64 = S0.u64 \ll S1.u[5:0];$ $SCC = (D.u64 \neq 0).$
30	S_LSHR_B32	$D.u = S0.u \gg S1.u[4:0];$ $SCC = (D.u \neq 0).$
31	S_LSHR_B64	$D.u64 = S0.u64 \gg S1.u[5:0];$ $SCC = (D.u64 \neq 0).$

Opcode	Name	Description
32	S_ASHR_I32	$D.i = \text{signext}(S0.i) \gg S1.u[4:0];$ $SCC = (D.i \neq 0).$
33	S_ASHR_I64	$D.i64 = \text{signext}(S0.i64) \gg S1.u[5:0];$ $SCC = (D.i64 \neq 0).$
34	S_BFM_B32	$D.u = ((1 \ll S0.u[4:0]) - 1) \ll S1.u[4:0].$ Bitfield mask.
35	S_BFM_B64	$D.u64 = ((1ULL \ll S0.u[5:0]) - 1) \ll S1.u[5:0].$ Bitfield mask.
36	S_MUL_I32	$D.i = S0.i * S1.i.$
37	S_BFE_U32	$D.u = (S0.u \gg S1.u[4:0]) \& ((1 \ll S1.u[22:16]) - 1);$ $SCC = (D.u \neq 0).$ Bit field extract. S0 is Data, S1[4:0] is field offset, S1[22:16] is field width.
38	S_BFE_I32	$D.i = \text{signext}((S0.i \gg S1.u[4:0]) \& ((1 \ll S1.u[22:16]) - 1));$ $SCC = (D.i \neq 0).$ Bit field extract. S0 is Data, S1[4:0] is field offset, S1[22:16] is field width.
39	S_BFE_U64	$D.u64 = (S0.u64 \gg S1.u[5:0]) \& ((1 \ll S1.u[22:16]) - 1);$ $SCC = (D.u64 \neq 0).$ Bit field extract. S0 is Data, S1[5:0] is field offset, S1[22:16] is field width.
40	S_BFE_I64	$D.i64 = \text{signext}((S0.i64 \gg S1.u[5:0]) \& ((1 \ll S1.u[22:16]) - 1));$ $SCC = (D.i64 \neq 0).$ Bit field extract. S0 is Data, S1[5:0] is field offset, S1[22:16] is field width.

Opcode	Name	Description
41	S_CBRANCH_G_FOR K	<pre> mask_pass = S0.u64 & EXEC; mask_fail = ~S0.u64 & EXEC; if(mask_pass == EXEC) then PC = S1.u64; elseif(mask_fail == EXEC) then PC += 4; elseif(bitcount(mask_fail) < bitcount(mask_pass)) EXEC = mask_fail; SGPR[CSP*4] = { S1.u64, mask_pass }; CSP += 1; PC += 4; else EXEC = mask_pass; SGPR[CSP*4] = { PC + 4, mask_fail }; CSP += 1; PC = S1.u64; endif. </pre> <p>Conditional branch using branch-stack. S0 = compare mask(vcc or any sgpr) and S1 = 64-bit byte address of target instruction. See also S_CBRANCH_JOIN.</p>
42	S_ABSDIFF_I32	<pre> D.i = S0.i - S1.i; if(D.i < 0) then D.i = -D.i; endif; SCC = (D.i != 0). </pre> <p>Compute the absolute value of difference between two values.</p> <p>Examples:</p> <pre> S_ABSDIFF_I32(0x00000002, 0x00000005) => 0x00000003 S_ABSDIFF_I32(0xffffffff, 0x00000000) => 0x00000001 S_ABSDIFF_I32(0x80000000, 0x00000000) => 0x80000000 // </pre> <p>Note: result is negative!</p> <pre> S_ABSDIFF_I32(0x80000000, 0x00000001) => 0x7fffffff S_ABSDIFF_I32(0x80000000, 0xffffffff) => 0x7fffffff S_ABSDIFF_I32(0x80000000, 0xfffffffef) => 0x7ffffffe </pre>
43	S_RFE_RESTORE_B 64	<pre> PRIV = 0; PC = S0.u64. </pre> <p>Return from exception handler and continue. This instruction may only be used within a trap handler.</p> <p>This instruction is provided for compatibility with older ASICs. New shader code must use S_RFE_B64. The second argument is ignored.</p>
44	S_MUL_HI_U32	<pre> D.u = (S0.u * S1.u) >> 32. </pre>
45	S_MUL_HI_I32	<pre> D.i = (S0.i * S1.i) >> 32. </pre>

Opcode	Name	Description
46	S_LSHL1_ADD_U32	$D.u = (S0.u \ll 1) + S1.u;$ $SCC = (((S0.u \ll 1) + S1.u) \geq 0x100000000ULL ? 1 : 0).$ // unsigned overflow.
47	S_LSHL2_ADD_U32	$D.u = (S0.u \ll 2) + S1.u;$ $SCC = (((S0.u \ll 2) + S1.u) \geq 0x100000000ULL ? 1 : 0).$ // unsigned overflow.
48	S_LSHL3_ADD_U32	$D.u = (S0.u \ll 3) + S1.u;$ $SCC = (((S0.u \ll 3) + S1.u) \geq 0x100000000ULL ? 1 : 0).$ // unsigned overflow.
49	S_LSHL4_ADD_U32	$D.u = (S0.u \ll 4) + S1.u;$ $SCC = (((S0.u \ll 4) + S1.u) \geq 0x100000000ULL ? 1 : 0).$ // unsigned overflow.
50	S_PACK_LL_B32_B16	$D.u[31:0] = \{ S1.u[15:0], S0.u[15:0] \}.$
51	S_PACK_LH_B32_B16	$D.u[31:0] = \{ S1.u[31:16], S0.u[15:0] \}.$
52	S_PACK_HH_B32_B16	$D.u[31:0] = \{ S1.u[31:16], S0.u[31:16] \}.$

12.2. SOPK Instructions



Instructions in this format may use a 32-bit literal constant which occurs immediately after the instruction.

Opcode	Name	Description
0	S_MOVK_I32	$D.i = \text{signext}(\text{SIMM16}).$ Sign extension from a 16-bit constant.
1	S_CMOVK_I32	if(SCC) then $D.i = \text{signext}(\text{SIMM16});$ endif. Conditional move with sign extension.
2	S_CMPK_EQ_I32	$SCC = (S0.i == \text{signext}(\text{SIMM16})).$
3	S_CMPK_LG_I32	$SCC = (S0.i != \text{signext}(\text{SIMM16})).$
4	S_CMPK_GT_I32	$SCC = (S0.i > \text{signext}(\text{SIMM16})).$
5	S_CMPK_GE_I32	$SCC = (S0.i \geq \text{signext}(\text{SIMM16})).$
6	S_CMPK_LT_I32	$SCC = (S0.i < \text{signext}(\text{SIMM16})).$

Opcode	Name	Description
7	S_CMPK_LE_I32	SCC = (S0.i <= signext(SIMM16)).
8	S_CMPK_EQ_U32	SCC = (S0.u == SIMM16).
9	S_CMPK_LG_U32	SCC = (S0.u != SIMM16).
10	S_CMPK_GT_U32	SCC = (S0.u > SIMM16).
11	S_CMPK_GE_U32	SCC = (S0.u >= SIMM16).
12	S_CMPK_LT_U32	SCC = (S0.u < SIMM16).
13	S_CMPK_LE_U32	SCC = (S0.u <= SIMM16).
14	S_ADDK_I32	<pre> tmp = D.i; // save value so we can check sign bits for overflow later. D.i = D.i + signext(SIMM16); SCC = (tmp[31] == SIMM16[15] && tmp[31] != D.i[31]). // signed overflow. </pre>
15	S_MULK_I32	D.i = D.i * signext(SIMM16).
16	S_CBRANCH_I_FOR K	<pre> mask_pass = S0.u64 & EXEC; mask_fail = ~S0.u64 & EXEC; target_addr = PC + signext(SIMM16 * 4) + 4; if(mask_pass == EXEC) PC = target_addr; elseif(mask_fail == EXEC) PC += 4; elseif(bitcount(mask_fail) < bitcount(mask_pass)) EXEC = mask_fail; SGPR[CSP*4] = { target_addr, mask_pass }; CSP += 1; PC += 4; else EXEC = mask_pass; SGPR[CSP*4] = { PC + 4, mask_fail }; CSP += 1; PC = target_addr; endif. </pre> <p>Conditional branch using branch-stack. S0 = compare mask(vcc or any sgpr), and SIMM16 = signed DWORD branch offset relative to next instruction. See also S_CBRANCH_JOIN.</p>
17	S_GETREG_B32	<p>D.u = hardware-reg. Read some or all of a hardware register into the LSBs of D.</p> <p>SIMM16 = {size[4:0], offset[4:0], hwRegId[5:0]}; offset is 0..31, size is 1..32.</p>

Opcode	Name	Description
18	S_SETREG_B32	hardware-reg = S0.u. Write some or all of the LSBs of D into a hardware register. SIMM16 = {size[4:0], offset[4:0], hwRegId[5:0]}; offset is 0..31, size is 1..32.
20	S_SETREG_IMM32_B32	Write some or all of the LSBs of IMM32 into a hardware register; this instruction requires a 32-bit literal constant. SIMM16 = {size[4:0], offset[4:0], hwRegId[5:0]}; offset is 0..31, size is 1..32.
21	S_CALL_B64	D.u64 = PC + 4; PC = PC + signext(SIMM16 * 4) + 4. Implements a short call, where the return address (the next instruction after the S_CALL_B64) is saved to D. Long calls should consider S_SWAPPC_B64 instead. Note that this instruction is always 4 bytes.

12.3. SOP1 Instructions



Instructions in this format may use a 32-bit literal constant which occurs immediately after the instruction.

Opcode	Name	Description
0	S_MOV_B32	D.u = S0.u.
1	S_MOV_B64	D.u64 = S0.u64.
2	S_CMOV_B32	if(SCC) then D.u = S0.u; endif. Conditional move.
3	S_CMOV_B64	if(SCC) then D.u64 = S0.u64; endif. Conditional move.
4	S_NOT_B32	D = ~S0; SCC = (D != 0). Bitwise negation.

Opcode	Name	Description
5	S_NOT_B64	<p>D = ~S0; SCC = (D != 0).</p> <p>Bitwise negation.</p>
6	S_WQM_B32	<pre> for i in 0 ... opcode_size_in_bits - 1 do D[i] = (S0[(i & ~3):(i 3)] != 0); endfor; SCC = (D != 0). </pre> <p>Computes whole quad mode for an active/valid mask. If any pixel in a quad is active, all pixels of the quad are marked active.</p>
7	S_WQM_B64	<pre> for i in 0 ... opcode_size_in_bits - 1 do D[i] = (S0[(i & ~3):(i 3)] != 0); endfor; SCC = (D != 0). </pre> <p>Computes whole quad mode for an active/valid mask. If any pixel in a quad is active, all pixels of the quad are marked active.</p>
8	S_BREV_B32	<p>D.u[31:0] = S0.u[0:31].</p> <p>Reverse bits.</p>
9	S_BREV_B64	<p>D.u64[63:0] = S0.u64[0:63].</p> <p>Reverse bits.</p>
10	S_BCNT0_I32_B32	<p>D = 0;</p> <pre> for i in 0 ... opcode_size_in_bits - 1 do D += (S0[i] == 0 ? 1 : 0) endfor; SCC = (D != 0). </pre> <p>Examples:</p> <p>S_BCNT0_I32_B32(0x00000000) => 32 S_BCNT0_I32_B32(0xcccccccc) => 16 S_BCNT0_I32_B32(0xffffffff) => 0</p>
11	S_BCNT0_I32_B64	<p>D = 0;</p> <pre> for i in 0 ... opcode_size_in_bits - 1 do D += (S0[i] == 0 ? 1 : 0) endfor; SCC = (D != 0). </pre> <p>Examples:</p> <p>S_BCNT0_I32_B32(0x00000000) => 32 S_BCNT0_I32_B32(0xcccccccc) => 16 S_BCNT0_I32_B32(0xffffffff) => 0</p>

Opcode	Name	Description
12	S_BCNT1_I32_B32	<pre> D = 0; for i in 0 ... opcode_size_in_bits - 1 do D += (S0[i] == 1 ? 1 : 0) endfor; SCC = (D != 0). Examples: S_BCNT1_I32_B32(0x00000000) => 0 S_BCNT1_I32_B32(0xcccccccc) => 16 S_BCNT1_I32_B32(0xffffffff) => 32 </pre>
13	S_BCNT1_I32_B64	<pre> D = 0; for i in 0 ... opcode_size_in_bits - 1 do D += (S0[i] == 1 ? 1 : 0) endfor; SCC = (D != 0). Examples: S_BCNT1_I32_B32(0x00000000) => 0 S_BCNT1_I32_B32(0xcccccccc) => 16 S_BCNT1_I32_B32(0xffffffff) => 32 </pre>
14	S_FF0_I32_B32	<pre> D.i = -1; // Set if no zeros are found for i in 0 ... opcode_size_in_bits - 1 do // Search from LSB if S0[i] == 0 then D.i = i; break for; endif; endfor. Returns the bit position of the first zero from the LSB, or -1 if there are no zeros. Examples: S_FF0_I32_B32(0xaaaaaaaa) => 0 S_FF0_I32_B32(0x55555555) => 1 S_FF0_I32_B32(0x00000000) => 0 S_FF0_I32_B32(0xffffffff) => 0xffffffff S_FF0_I32_B32(0xfffeffff) => 16 </pre>

Opcode	Name	Description
15	S_FF0_I32_B64	<p>D.i = -1; // Set if no zeros are found for i in 0 ... opcode_size_in_bits - 1 do // Search from LSB if S0[i] == 0 then D.i = i; break for; endif; endfor.</p> <p>Returns the bit position of the first zero from the LSB, or -1 if there are no zeros.</p> <p>Examples: S_FF0_I32_B32(0xaaaaaaaa) => 0 S_FF0_I32_B32(0x55555555) => 1 S_FF0_I32_B32(0x00000000) => 0 S_FF0_I32_B32(0xffffffff) => 0xffffffff S_FF0_I32_B32(0xfffeffff) => 16</p>
16	S_FF1_I32_B32	<p>D.i = -1; // Set if no ones are found for i in 0 ... opcode_size_in_bits - 1 do // Search from LSB if S0[i] == 1 then D.i = i; break for; endif; endfor.</p> <p>Returns the bit position of the first one from the LSB, or -1 if there are no ones.</p> <p>Examples: S_FF1_I32_B32(0xaaaaaaaa) => 1 S_FF1_I32_B32(0x55555555) => 0 S_FF1_I32_B32(0x00000000) => 0xffffffff S_FF1_I32_B32(0xffffffff) => 0 S_FF1_I32_B32(0x00010000) => 16</p>

Opcode	Name	Description
17	S_FF1_I32_B64	<pre> D.i = -1; // Set if no ones are found for i in 0 ... opcode_size_in_bits - 1 do // Search from LSB if S0[i] == 1 then D.i = i; break for; endif; endfor. </pre> <p>Returns the bit position of the first one from the LSB, or -1 if there are no ones.</p> <p>Examples:</p> <pre> S_FF1_I32_B32(0xaaaaaaaa) => 1 S_FF1_I32_B32(0x55555555) => 0 S_FF1_I32_B32(0x00000000) => 0xffffffff S_FF1_I32_B32(0xffffffff) => 0 S_FF1_I32_B32(0x00010000) => 16 </pre>
18	S_FLBIT_I32_B32	<pre> D.i = -1; // Set if no ones are found for i in 0 ... opcode_size_in_bits - 1 do // Note: search is from the MSB if S0[opcode_size_in_bits - 1 - i] == 1 then D.i = i; break for; endif; endfor. </pre> <p>Counts how many zeros before the first one starting from the MSB. Returns -1 if there are no ones.</p> <p>Examples:</p> <pre> S_FLBIT_I32_B32(0x00000000) => 0xffffffff S_FLBIT_I32_B32(0x0000cccc) => 16 S_FLBIT_I32_B32(0xffff3333) => 0 S_FLBIT_I32_B32(0x7fffffff) => 1 S_FLBIT_I32_B32(0x80000000) => 0 S_FLBIT_I32_B32(0xffffffff) => 0 </pre>

Opcode	Name	Description
19	S_FLBIT_I32_B64	<pre> D.i = -1; // Set if no ones are found for i in 0 ... opcode_size_in_bits - 1 do // Note: search is from the MSB if S0[opcode_size_in_bits - 1 - i] == 1 then D.i = i; break for; endif; endfor. </pre> <p>Counts how many zeros before the first one starting from the MSB. Returns -1 if there are no ones.</p> <p>Examples:</p> <pre> S_FLBIT_I32_B32(0x00000000) => 0xffffffff S_FLBIT_I32_B32(0x0000cccc) => 16 S_FLBIT_I32_B32(0xffff3333) => 0 S_FLBIT_I32_B32(0x7fffffff) => 1 S_FLBIT_I32_B32(0x80000000) => 0 S_FLBIT_I32_B32(0xffffffff) => 0 </pre>
20	S_FLBIT_I32	<pre> D.i = -1; // Set if all bits are the same for i in 1 ... opcode_size_in_bits - 1 do // Note: search is from the MSB if S0[opcode_size_in_bits - 1 - i] != S0[opcode_size_in_bits - 1] then D.i = i; break for; endif; endfor. </pre> <p>Counts how many bits in a row (from MSB to LSB) are the same as the sign bit. Returns -1 if all bits are the same.</p> <p>Examples:</p> <pre> S_FLBIT_I32(0x00000000) => 0xffffffff S_FLBIT_I32(0x0000cccc) => 16 S_FLBIT_I32(0xffff3333) => 16 S_FLBIT_I32(0x7fffffff) => 1 S_FLBIT_I32(0x80000000) => 1 S_FLBIT_I32(0xffffffff) => 0xffffffff </pre>

Opcode	Name	Description
21	S_FLBIT_I32_I64	<pre>D.i = -1; // Set if all bits are the same for i in 1 ... opcode_size_in_bits - 1 do // Note: search is from the MSB if S0[opcode_size_in_bits - 1 - i] != S0[opcode_size_in_bits - 1] then D.i = i; break for; endif; endfor.</pre> <p>Counts how many bits in a row (from MSB to LSB) are the same as the sign bit. Returns -1 if all bits are the same.</p> <p>Examples:</p> <pre>S_FLBIT_I32(0x00000000) => 0xffffffff S_FLBIT_I32(0x0000cccc) => 16 S_FLBIT_I32(0xffff3333) => 16 S_FLBIT_I32(0x7fffffff) => 1 S_FLBIT_I32(0x80000000) => 1 S_FLBIT_I32(0xffffffff) => 0xffffffff</pre>
22	S_SEXT_I32_I8	<p>D.i = signext(S0.i[7:0]).</p> <p>Sign extension.</p>
23	S_SEXT_I32_I16	<p>D.i = signext(S0.i[15:0]).</p> <p>Sign extension.</p>
24	S_BITSET0_B32	D.u[S0.u[4:0]] = 0.
25	S_BITSET0_B64	D.u64[S0.u[5:0]] = 0.
26	S_BITSET1_B32	D.u[S0.u[4:0]] = 1.
27	S_BITSET1_B64	D.u64[S0.u[5:0]] = 1.
28	S_GETPC_B64	<p>D.u64 = PC + 4.</p> <p>Destination receives the byte address of the next instruction. Note that this instruction is always 4 bytes.</p>
29	S_SETPC_B64	<p>PC = S0.u64.</p> <p>S0.u64 is a byte address of the instruction to jump to.</p>
30	S_SWAPPC_B64	<p>D.u64 = PC + 4;</p> <p>PC = S0.u64.</p> <p>S0.u64 is a byte address of the instruction to jump to. Destination receives the byte address of the instruction immediately following the SWAPPC instruction. Note that this instruction is always 4 bytes.</p>

Opcode	Name	Description
31	S_RFE_B64	<pre> PRIV = 0; PC = S0.u64. Return from exception handler and continue. This instruction may only be used within a trap handler. </pre>
32	S_AND_SAVEEXEC_B64	<pre> D.u64 = EXEC; EXEC = S0.u64 & EXEC; SCC = (EXEC != 0). </pre>
33	S_OR_SAVEEXEC_B64	<pre> D.u64 = EXEC; EXEC = S0.u64 EXEC; SCC = (EXEC != 0). </pre>
34	S_XOR_SAVEEXEC_B64	<pre> D.u64 = EXEC; EXEC = S0.u64 ^ EXEC; SCC = (EXEC != 0). </pre>
35	S_ANDN2_SAVEEXEC_B64	<pre> D.u64 = EXEC; EXEC = S0.u64 & ~EXEC; SCC = (EXEC != 0). </pre>
36	S_ORN2_SAVEEXEC_B64	<pre> D.u64 = EXEC; EXEC = S0.u64 ~EXEC; SCC = (EXEC != 0). </pre>
37	S_NAND_SAVEEXEC_B64	<pre> D.u64 = EXEC; EXEC = ~(S0.u64 & EXEC); SCC = (EXEC != 0). </pre>
38	S_NOR_SAVEEXEC_B64	<pre> D.u64 = EXEC; EXEC = ~(S0.u64 EXEC); SCC = (EXEC != 0). </pre>
39	S_XNOR_SAVEEXEC_B64	<pre> D.u64 = EXEC; EXEC = ~(S0.u64 ^ EXEC); SCC = (EXEC != 0). </pre>
40	S_QUADMASK_B32	<pre> D = 0; for i in 0 ... (opcode_size_in_bits / 4) - 1 do D[i] = (S0[i * 4 + 3:i * 4] != 0); endfor; SCC = (D != 0). Reduce a pixel mask to a quad mask. To perform the inverse operation see S_BITREPLICATE_B64_B32. </pre>

Opcode	Name	Description
41	S_QUADMASK_B64	<pre>D = 0; for i in 0 ... (opcode_size_in_bits / 4) - 1 do D[i] = (S0[i * 4 + 3:i * 4] != 0); endfor; SCC = (D != 0).</pre> <p>Reduce a pixel mask to a quad mask. To perform the inverse operation see S_BITREPLICATE_B64_B32.</p>
42	S_MOVRELS_B32	<pre>addr = SGPR address appearing in instruction SRC0 field; addr += M0.u; D.u = SGPR[addr].u.</pre> <p>Move from a relative source address. For example, the following instruction sequence will perform a move <code>s5 <== s17</code>:</p> <pre>s_mov_b32 m0, 10 s_movrels_b32 s5, s7</pre>
43	S_MOVRELS_B64	<pre>addr = SGPR address appearing in instruction SRC0 field; addr += M0.u; D.u64 = SGPR[addr].u64.</pre> <p>Move from a relative source address. The index in <code>M0.u</code> must be even for this operation.</p>
44	S_MOVRELD_B32	<pre>addr = SGPR address appearing in instruction DST field; addr += M0.u; SGPR[addr].u = S0.u.</pre> <p>Move to a relative destination address. For example, the following instruction sequence will perform a move <code>s15 <== s7</code>:</p> <pre>s_mov_b32 m0, 10 s_movreld_b32 s5, s7</pre>
45	S_MOVRELD_B64	<pre>addr = SGPR address appearing in instruction DST field; addr += M0.u; SGPR[addr].u64 = S0.u64.</pre> <p>Move to a relative destination address. The index in <code>M0.u</code> must be even for this operation.</p>
46	S_CBRANCH_JOIN	<pre>saved_csp = S0.u; if(CSP == saved_csp) then PC += 4; // Second time to JOIN: continue with program. else CSP -= 1; // First time to JOIN; jump to other FORK path. {PC, EXEC} = SGPR[CSP * 4]; // Read 128 bits from 4 consecutive SGPRs. endif.</pre> <p>Conditional branch join point (end of conditional branch block). <code>S0</code> is saved CSP value. See S_CBRANCH_G_FORK and S_CBRANCH_I_FORK for related instructions.</p>

Opcode	Name	Description
48	S_ABS_I32	$D.i = (S.i < 0 ? -S.i : S.i);$ $SCC = (D.i \neq 0).$ Integer absolute value. Examples: $S_ABS_I32(0x00000001) \Rightarrow 0x00000001$ $S_ABS_I32(0x7fffffff) \Rightarrow 0x7fffffff$ $S_ABS_I32(0x80000000) \Rightarrow 0x80000000$ // Note this is negative! $S_ABS_I32(0x80000001) \Rightarrow 0x7fffffff$ $S_ABS_I32(0x80000002) \Rightarrow 0x7ffffffe$ $S_ABS_I32(0xffffffff) \Rightarrow 0x00000001$
50	S_SET_GPR_IDX_ID X	$M0[7:0] = S0.u[7:0].$ Modify the index used in vector GPR indexing. S_SET_GPR_IDX_ON, S_SET_GPR_IDX_OFF, S_SET_GPR_IDX_MODE and S_SET_GPR_IDX_IDX are related instructions.
51	S_ANDN1_SAVEEXEC_C_B64	$D.u64 = EXEC;$ $EXEC = \sim S0.u64 \& EXEC;$ $SCC = (EXEC \neq 0).$
52	S_ORN1_SAVEEXEC_B64	$D.u64 = EXEC;$ $EXEC = \sim S0.u64 EXEC;$ $SCC = (EXEC \neq 0).$
53	S_ANDN1_WREXEC_B64	$EXEC = \sim S0.u64 \& EXEC;$ $D.u64 = EXEC;$ $SCC = (EXEC \neq 0).$
54	S_ANDN2_WREXEC_B64	$EXEC = S0.u64 \& \sim EXEC;$ $D.u64 = EXEC;$ $SCC = (EXEC \neq 0).$
55	S_BITREPLICATE_B64_B32	<pre> for i in 0 ... 31 do D.u64[i * 2 + 0] = S0.u32[i] D.u64[i * 2 + 1] = S0.u32[i] endfor. </pre> <p>Replicate the low 32 bits of S0 by 'doubling' each bit.</p> <p>This opcode can be used to convert a quad mask into a pixel mask; given quad mask in s0, the following sequence will produce a pixel mask in s1:</p> <pre> s_bitreplicate_b64 s1, s0 s_bitreplicate_b64 s1, s1 </pre> <p>To perform the inverse operation see S_QUADMASK_B64.</p>

12.4. SOPC Instructions



Instructions in this format may use a 32-bit literal constant which occurs immediately after the instruction.

Opcode	Name	Description
0	S_CMP_EQ_I32	$SCC = (S0 == S1).$ Note that S_CMP_EQ_I32 and S_CMP_EQ_U32 are identical opcodes, but both are provided for symmetry.
1	S_CMP_LG_I32	$SCC = (S0 != S1).$ Note that S_CMP_LG_I32 and S_CMP_LG_U32 are identical opcodes, but both are provided for symmetry.
2	S_CMP_GT_I32	$SCC = (S0.i > S1.i).$
3	S_CMP_GE_I32	$SCC = (S0.i >= S1.i).$
4	S_CMP_LT_I32	$SCC = (S0.i < S1.i).$
5	S_CMP_LE_I32	$SCC = (S0.i <= S1.i).$
6	S_CMP_EQ_U32	$SCC = (S0 == S1).$ Note that S_CMP_EQ_I32 and S_CMP_EQ_U32 are identical opcodes, but both are provided for symmetry.
7	S_CMP_LG_U32	$SCC = (S0 != S1).$ Note that S_CMP_LG_I32 and S_CMP_LG_U32 are identical opcodes, but both are provided for symmetry.
8	S_CMP_GT_U32	$SCC = (S0.u > S1.u).$
9	S_CMP_GE_U32	$SCC = (S0.u >= S1.u).$
10	S_CMP_LT_U32	$SCC = (S0.u < S1.u).$
11	S_CMP_LE_U32	$SCC = (S0.u <= S1.u).$
12	S_BITCMP0_B32	$SCC = (S0.u[S1.u[4:0]] == 0).$
13	S_BITCMP1_B32	$SCC = (S0.u[S1.u[4:0]] == 1).$
14	S_BITCMP0_B64	$SCC = (S0.u64[S1.u[5:0]] == 0).$
15	S_BITCMP1_B64	$SCC = (S0.u64[S1.u[5:0]] == 1).$

Opcode	Name	Description
16	S_SETVSKIP	<p>VSKIP = S0.u[S1.u[4:0]].</p> <p>Enables and disables VSKIP mode. When VSKIP is enabled, no VOP*/M*BUF/MIMG/DS/FLAT/EXP instructions are issued. Note that VSKIPped memory instructions do not manipulate the waitcnt counters; as a result, if you have outstanding memory requests you may want to issue S_WAITCNT 0 prior to enabling VSKIP, otherwise you'll need to be careful not to count VSKIPped instructions in your waitcnt calculations.</p> <p>Examples:</p> <pre>s_setvskip 1, 0 // Enable vskip mode. s_setvskip 0, 0 // Disable vskip mode.</pre>
17	S_SET_GPR_IDX_ON	<pre>MODE.gpr_idx_en = 1; M0[7:0] = S0.u[7:0]; M0[15:12] = SIMM4; // this is the direct content of S1 field // Remaining bits of M0 are unmodified.</pre> <p>Enable GPR indexing mode. Vector operations after this will perform relative GPR addressing based on the contents of M0. The structure SQ_M0_GPR_IDX_WORD may be used to decode M0. The raw contents of the S1 field are read and used to set the enable bits. S1[0] = VSRC0_REL, S1[1] = VSRC1_REL, S1[2] = VSRC2_REL and S1[3] = VDST_REL.</p> <p>S_SET_GPR_IDX_ON, S_SET_GPR_IDX_OFF, S_SET_GPR_IDX_MODE and S_SET_GPR_IDX_IDX are related instructions.</p>
18	S_CMP_EQ_U64	<p>SCC = (S0.i64 == S1.i64).</p>
19	S_CMP_LG_U64	<p>SCC = (S0.i64 != S1.i64).</p>

12.5. SOPP Instructions



Opcode	Name	Description
0	S_NOP	<p>Do nothing. Repeat NOP 1..16 times based on SIMM16[3:0] -- 0x0 = 1 time, 0xf = 16 times. This instruction may be used to introduce wait states to resolve hazards. Compare with S_SLEEP.</p>
1	S_ENDPGM	<p>End of program; terminate wavefront. The hardware implicitly executes S_WAITCNT 0 before executing this instruction. See S_ENDPGM_SAVED for the context-switch version of this instruction and S_ENDPGM_ORDERED_PS_DONE for the POPS critical region version of this instruction.</p>

Opcode	Name	Description
2	S_BRANCH	<p>PC = PC + signext(SIMM16 * 4) + 4. // short jump.</p> <p>For a long jump, use S_SETPC_B64.</p>
3	S_WAKEUP	<p>Allow a wave to 'ping' all the other waves in its threadgroup to force them to wake up immediately from an S_SLEEP instruction. The ping is ignored if the waves are not sleeping. This allows for efficient polling on a memory location. The waves which are polling can sit in a long S_SLEEP between memory reads, but the wave which writes the value can tell them all to wake up early now that the data is available. This is useful for fBarrier implementations (speedup). This method is also safe from races because if any wave misses the ping, everything still works fine (waves which missed it just complete their normal S_SLEEP).</p> <p>If the wave executing S_WAKEUP is in a threadgroup (in_tg set), then it will wake up all waves associated with the same threadgroup ID. Otherwise, S_WAKEUP is treated as an S_NOP.</p>
4	S_CBRANCH_SCC0	<pre>if(SCC == 0) then PC = PC + signext(SIMM16 * 4) + 4; endif.</pre>
5	S_CBRANCH_SCC1	<pre>if(SCC == 1) then PC = PC + signext(SIMM16 * 4) + 4; endif.</pre>
6	S_CBRANCH_VCCZ	<pre>if(VCC == 0) then PC = PC + signext(SIMM16 * 4) + 4; endif.</pre>
7	S_CBRANCH_VCCNZ	<pre>if(VCC != 0) then PC = PC + signext(SIMM16 * 4) + 4; endif.</pre>
8	S_CBRANCH_EXECZ	<pre>if(EXEC == 0) then PC = PC + signext(SIMM16 * 4) + 4; endif.</pre>
9	S_CBRANCH_EXECNZ	<pre>if(EXEC != 0) then PC = PC + signext(SIMM16 * 4) + 4; endif.</pre>
10	S_BARRIER	<p>Synchronize waves within a threadgroup. If not all waves of the threadgroup have been created yet, waits for entire group before proceeding. If some waves in the threadgroup have already terminated, this waits on only the surviving waves. Barriers are legal inside trap handlers.</p>
11	S_SETKILL	<p>Set KILL bit to value of SIMM16[0]. Used primarily for debugging kill wave host command behavior.</p>

Opcode	Name	Description
12	S_WAITCNT	<p>Wait for the counts of outstanding lds, vector-memory and export/vmem-write-data to be at or below the specified levels.</p> <p>SIMM16[3:0] = vmcount (vector memory operations) lower bits [3:0],</p> <p>SIMM16[6:4] = export/mem-write-data count,</p> <p>SIMM16[11:8] = LGKM_cnt (scalar-mem/GDS/LDS count),</p> <p>SIMM16[15:14] = vmcount (vector memory operations) upper bits [5:4],</p>
13	S_SETHALT	<p>Set HALT bit to value of SIMM16[0]; 1 = halt, 0 = resume. The halt flag is ignored while PRIV == 1 (inside trap handlers) but the shader will halt immediately after the handler returns if HALT is still set at that time.</p>
14	S_SLEEP	<p>Cause a wave to sleep for (64 * SIMM16[6:0] + 1..64) clocks. The exact amount of delay is approximate. Compare with S_NOP.</p>
15	S_SETPRIO	<p>User settable wave priority is set to SIMM16[1:0]. 0 = lowest, 3 = highest. The overall wave priority is {SPIPrio[1:0] + UserPrio[1:0], WaveAge[3:0]}.</p>
16	S_SENDMSG	<p>Send a message upstream to VGT or the interrupt handler. SIMM16[9:0] contains the message type.</p>
17	S_SENDMSGHALT	<p>Send a message and then HALT the wavefront; see S_SENDMSG for details.</p>
18	S_TRAP	<p>TrapID = SIMM16[7:0];</p> <p>Wait for all instructions to complete;</p> <p>{TTMP1, TTMP0} = {3'h0, PCRewind[3:0], HT[0], TrapID[7:0], PC[47:0]};</p> <p>PC = TBA; // trap base address</p> <p>PRIV = 1.</p> <p>Enter the trap handler. This instruction may be generated internally as well in response to a host trap (HT = 1) or an exception. TrapID 0 is reserved for hardware use and should not be used in a shader-generated trap.</p>
19	S_ICACHE_INV	<p>Invalidate entire L1 instruction cache.</p> <p>You must have 16 separate S_NOP instructions or a jump/branch instruction after this instruction to ensure the SQ instruction buffer is purged.</p> <p>NOTE: The number of S_NOPs required depends on the size of the shader instruction buffer, which in current generations is 16 DWORDs long. Older architectures had a 12 DWORD instruction buffer and in those architectures, 12 S_NOP instructions were sufficient.</p>

Opcode	Name	Description
20	S_INCPERFLEVEL	Increment performance counter specified in SIMM16[3:0] by 1.
21	S_DECPERFLEVEL	Decrement performance counter specified in SIMM16[3:0] by 1.
22	S_TTRACEDATA	Send M0 as user data to the thread trace stream.
23	S_CBRANCH_CDBGSYS	<pre> if(conditional_debug_system != 0) then PC = PC + signext(SIMM16 * 4) + 4; endif. </pre>
24	S_CBRANCH_CDBGUSER	<pre> if(conditional_debug_user != 0) then PC = PC + signext(SIMM16 * 4) + 4; endif. </pre>
25	S_CBRANCH_CDBGSYS_OR_USER	<pre> if(conditional_debug_system conditional_debug_user) then PC = PC + signext(SIMM16 * 4) + 4; endif. </pre>
26	S_CBRANCH_CDBGSYS_AND_USER	<pre> if(conditional_debug_system && conditional_debug_user) then PC = PC + signext(SIMM16 * 4) + 4; endif. </pre>
27	S_ENDPGM_SAVED	End of program; signal that a wave has been saved by the context-switch trap handler and terminate wavefront. The hardware implicitly executes S_WAITCNT 0 before executing this instruction. See S_ENDPGM for additional variants.
28	S_SET_GPR_IDX_OFF	<p>MODE.gpr_idx_en = 0.</p> <p>Clear GPR indexing mode. Vector operations after this will not perform relative GPR addressing regardless of the contents of M0. This instruction does not modify M0.</p> <p>S_SET_GPR_IDX_ON, S_SET_GPR_IDX_OFF, S_SET_GPR_IDX_MODE and S_SET_GPR_IDX_IDX are related instructions.</p>
29	S_SET_GPR_IDX_MODE	<p>M0[15:12] = SIMM16[3:0].</p> <p>Modify the mode used for vector GPR indexing. The raw contents of the source field are read and used to set the enable bits. SIMM16[0] = VSRC0_REL, SIMM16[1] = VSRC1_REL, SIMM16[2] = VSRC2_REL and SIMM16[3] = VDST_REL.</p> <p>S_SET_GPR_IDX_ON, S_SET_GPR_IDX_OFF, S_SET_GPR_IDX_MODE and S_SET_GPR_IDX_IDX are related instructions.</p>
30	S_ENDPGM_ORDERED_PS_DONE	End of program; signal that a wave has exited its POPS critical section and terminate wavefront. The hardware implicitly executes S_WAITCNT 0 before executing this instruction. This instruction is an optimization that combines S_SENDMSG(MSG_ORDERED_PS_DONE) and S_ENDPGM; there may be cases where you still need to send the message separately, in which case you can end the shader with a normal S_ENDPGM instruction. See S_ENDPGM for additional variants.

12.5.1. Send Message

The S_SENDMSG instruction encodes the message type in M0, and can also send data from the SIMM16 field and in some cases from EXEC.

Message	SIMM16[3:0]	SIMM16[6:4]	Payload
none	0	-	illegal
GS	2	0=nop, 1=cut, 2=emit, 3=emit-cut	GS output. M0[4:0]=gs-waveID, SIMM[9:8] = stream-id
GS-done	3		
save wave	4	-	used in context switching
Stall Wave Gen	5	-	stop new wave generation
Halt Waves	6	-	halt all running waves of this vmid
Ordered PS Done	7	-	POPS ordered section done
Early Prim Dealloc	8	-	Deallocate primitives. This message is optional. EXEC[N*12+10:N*12] = number of verts to deallocate from buffer N (N=0..3). Exec[58:48] = number of vertices to deallocate.
GS alloc req	9	-	Request GS space in parameter cache. M0[9:0] = number of vertices

12.6. SMEM Instructions



Opcode	Name	Description
0	S_LOAD_DWORD	Read 1 dword from scalar data cache. If the offset is specified as an SGPR, the SGPR contains an UNSIGNED BYTE offset (the 2 LSBs are ignored). If the offset is specified as an immediate 21-bit constant, the constant is a SIGNED BYTE offset.
1	S_LOAD_DWORDX2	Read 2 dwords from scalar data cache. See S_LOAD_DWORD for details on the offset input.
2	S_LOAD_DWORDX4	Read 4 dwords from scalar data cache. See S_LOAD_DWORD for details on the offset input.
3	S_LOAD_DWORDX8	Read 8 dwords from scalar data cache. See S_LOAD_DWORD for details on the offset input.
4	S_LOAD_DWORDX16	Read 16 dwords from scalar data cache. See S_LOAD_DWORD for details on the offset input.

Opcode	Name	Description
5	S_SCRATCH_LOAD_DWORD	Read 1 dword from scalar data cache. If the offset is specified as an SGPR, the SGPR contains an UNSIGNED 64-byte offset, consistent with other scratch operations. If the offset is specified as an immediate 21-bit constant, the constant is a SIGNED BYTE offset.
6	S_SCRATCH_LOAD_DWORDX2	Read 2 dwords from scalar data cache. See S_SCRATCH_LOAD_DWORD for details on the offset input.
7	S_SCRATCH_LOAD_DWORDX4	Read 4 dwords from scalar data cache. See S_SCRATCH_LOAD_DWORD for details on the offset input.
8	S_BUFFER_LOAD_DWORD	Read 1 dword from scalar data cache. See S_LOAD_DWORD for details on the offset input.
9	S_BUFFER_LOAD_DWORDX2	Read 2 dwords from scalar data cache. See S_LOAD_DWORD for details on the offset input.
10	S_BUFFER_LOAD_DWORDX4	Read 4 dwords from scalar data cache. See S_LOAD_DWORD for details on the offset input.
11	S_BUFFER_LOAD_DWORDX8	Read 8 dwords from scalar data cache. See S_LOAD_DWORD for details on the offset input.
12	S_BUFFER_LOAD_DWORDX16	Read 16 dwords from scalar data cache. See S_LOAD_DWORD for details on the offset input.
16	S_STORE_DWORD	Write 1 dword to scalar data cache. If the offset is specified as an SGPR, the SGPR contains an UNSIGNED BYTE offset (the 2 LSBs are ignored). If the offset is specified as an immediate 21-bit constant, the constant is an SIGNED BYTE offset.
17	S_STORE_DWORDX2	Write 2 dwords to scalar data cache. See S_STORE_DWORD for details on the offset input.
18	S_STORE_DWORDX4	Write 4 dwords to scalar data cache. See S_STORE_DWORD for details on the offset input.
21	S_SCRATCH_STORE_DWORD	Write 1 dword from scalar data cache. If the offset is specified as an SGPR, the SGPR contains an UNSIGNED 64-byte offset, consistent with other scratch operations. If the offset is specified as an immediate 21-bit constant, the constant is a SIGNED BYTE offset.
22	S_SCRATCH_STORE_DWORDX2	Write 2 dwords from scalar data cache. See S_SCRATCH_STORE_DWORD for details on the offset input.
23	S_SCRATCH_STORE_DWORDX4	Write 4 dwords from scalar data cache. See S_SCRATCH_STORE_DWORD for details on the offset input.
24	S_BUFFER_STORE_DWORD	Write 1 dword to scalar data cache. See S_STORE_DWORD for details on the offset input.
25	S_BUFFER_STORE_DWORDX2	Write 2 dwords to scalar data cache. See S_STORE_DWORD for details on the offset input.

Opcode	Name	Description
26	S_BUFFER_STORE_DWORD_X4	Write 4 dwords to scalar data cache. See S_STORE_DWORD for details on the offset input.
32	S_DCACHE_INV	Invalidate the scalar data cache.
33	S_DCACHE_WB	Write back dirty data in the scalar data cache.
34	S_DCACHE_INV_VOL	Invalidate the scalar data cache volatile lines.
35	S_DCACHE_WB_VOL	Write back dirty data in the scalar data cache volatile lines.
36	S_MEMTIME	Return current 64-bit timestamp.
37	S_MEMREALTIME	Return current 64-bit RTC.
38	S_ATC_PROBE	Probe or prefetch an address into the SQC data cache.
39	S_ATC_PROBE_BUFFER	Probe or prefetch an address into the SQC data cache.
40	S_DCACHE_DISCARD	Discard one dirty scalar data cache line. A cache line is 64 bytes. Normally, dirty cachelines (one which have been written by the shader) are written back to memory, but this instruction allows the shader to invalidate and not write back cachelines which it has previously written. This is a performance optimization to be used when the shader knows it no longer needs that data. Address is calculated the same as S_STORE_DWORD, except the 6 LSBs are ignored to get the 64 byte aligned address. LGKM count is incremented by 1 for this opcode.
41	S_DCACHE_DISCARD_X2	Discard two consecutive dirty scalar data cache lines. A cache line is 64 bytes. Normally, dirty cachelines (one which have been written by the shader) are written back to memory, but this instruction allows the shader to invalidate and not write back cachelines which it has previously written. This is a performance optimization to be used when the shader knows it no longer needs that data. Address is calculated the same as S_STORE_DWORD, except the 6 LSBs are ignored to get the 64 byte aligned address. LGKM count is incremented by 2 for this opcode.
64	S_BUFFER_ATOMIC_SWAP	<pre>// 32bit tmp = MEM[ADDR]; MEM[ADDR] = DATA; RETURN_DATA = tmp.</pre>
65	S_BUFFER_ATOMIC_CMPSWAP	<pre>// 32bit tmp = MEM[ADDR]; src = DATA[0]; cmp = DATA[1]; MEM[ADDR] = (tmp == cmp) ? src : tmp; RETURN_DATA[0] = tmp.</pre>

Opcode	Name	Description
66	S_BUFFER_ATOMIC_ADD	<pre>// 32bit tmp = MEM[ADDR]; MEM[ADDR] += DATA; RETURN_DATA = tmp.</pre>
67	S_BUFFER_ATOMIC_SUB	<pre>// 32bit tmp = MEM[ADDR]; MEM[ADDR] -= DATA; RETURN_DATA = tmp.</pre>
68	S_BUFFER_ATOMIC_SMIN	<pre>// 32bit tmp = MEM[ADDR]; MEM[ADDR] = (DATA < tmp) ? DATA : tmp; // signed compare RETURN_DATA = tmp.</pre>
69	S_BUFFER_ATOMIC_UMIN	<pre>// 32bit tmp = MEM[ADDR]; MEM[ADDR] = (DATA < tmp) ? DATA : tmp; // unsigned compare RETURN_DATA = tmp.</pre>
70	S_BUFFER_ATOMIC_SMAX	<pre>// 32bit tmp = MEM[ADDR]; MEM[ADDR] = (DATA > tmp) ? DATA : tmp; // signed compare RETURN_DATA = tmp.</pre>
71	S_BUFFER_ATOMIC_UMAX	<pre>// 32bit tmp = MEM[ADDR]; MEM[ADDR] = (DATA > tmp) ? DATA : tmp; // unsigned compare RETURN_DATA = tmp.</pre>
72	S_BUFFER_ATOMIC_AND	<pre>// 32bit tmp = MEM[ADDR]; MEM[ADDR] &= DATA; RETURN_DATA = tmp.</pre>
73	S_BUFFER_ATOMIC_OR	<pre>// 32bit tmp = MEM[ADDR]; MEM[ADDR] = DATA; RETURN_DATA = tmp.</pre>
74	S_BUFFER_ATOMIC_XOR	<pre>// 32bit tmp = MEM[ADDR]; MEM[ADDR] ^= DATA; RETURN_DATA = tmp.</pre>
75	S_BUFFER_ATOMIC_INC	<pre>// 32bit tmp = MEM[ADDR]; MEM[ADDR] = (tmp >= DATA) ? 0 : tmp + 1; // unsigned compare RETURN_DATA = tmp.</pre>

Opcode	Name	Description
76	S_BUFFER_ATOMIC_DEC	<pre>// 32bit tmp = MEM[ADDR]; MEM[ADDR] = (tmp == 0 tmp > DATA) ? DATA : tmp - 1; // unsigned compare RETURN_DATA = tmp.</pre>
96	S_BUFFER_ATOMIC_SWAP_X2	<pre>// 64bit tmp = MEM[ADDR]; MEM[ADDR] = DATA[0:1]; RETURN_DATA[0:1] = tmp.</pre>
97	S_BUFFER_ATOMIC_CMPSWAP_X2	<pre>// 64bit tmp = MEM[ADDR]; src = DATA[0:1]; cmp = DATA[2:3]; MEM[ADDR] = (tmp == cmp) ? src : tmp; RETURN_DATA[0:1] = tmp.</pre>
98	S_BUFFER_ATOMIC_ADD_X2	<pre>// 64bit tmp = MEM[ADDR]; MEM[ADDR] += DATA[0:1]; RETURN_DATA[0:1] = tmp.</pre>
99	S_BUFFER_ATOMIC_SUB_X2	<pre>// 64bit tmp = MEM[ADDR]; MEM[ADDR] -= DATA[0:1]; RETURN_DATA[0:1] = tmp.</pre>
100	S_BUFFER_ATOMIC_SMIN_X2	<pre>// 64bit tmp = MEM[ADDR]; MEM[ADDR] -= (DATA[0:1] < tmp) ? DATA[0:1] : tmp; // signed compare RETURN_DATA[0:1] = tmp.</pre>
101	S_BUFFER_ATOMIC_UMIN_X2	<pre>// 64bit tmp = MEM[ADDR]; MEM[ADDR] -= (DATA[0:1] < tmp) ? DATA[0:1] : tmp; // unsigned compare RETURN_DATA[0:1] = tmp.</pre>
102	S_BUFFER_ATOMIC_SMAX_X2	<pre>// 64bit tmp = MEM[ADDR]; MEM[ADDR] -= (DATA[0:1] > tmp) ? DATA[0:1] : tmp; // signed compare RETURN_DATA[0:1] = tmp.</pre>
103	S_BUFFER_ATOMIC_UMAX_X2	<pre>// 64bit tmp = MEM[ADDR]; MEM[ADDR] -= (DATA[0:1] > tmp) ? DATA[0:1] : tmp; // unsigned compare RETURN_DATA[0:1] = tmp.</pre>

Opcode	Name	Description
104	S_BUFFER_ATOMIC_AND_X2	<pre>// 64bit tmp = MEM[ADDR]; MEM[ADDR] &= DATA[0:1]; RETURN_DATA[0:1] = tmp.</pre>
105	S_BUFFER_ATOMIC_OR_X2	<pre>// 64bit tmp = MEM[ADDR]; MEM[ADDR] = DATA[0:1]; RETURN_DATA[0:1] = tmp.</pre>
106	S_BUFFER_ATOMIC_XOR_X2	<pre>// 64bit tmp = MEM[ADDR]; MEM[ADDR] ^= DATA[0:1]; RETURN_DATA[0:1] = tmp.</pre>
107	S_BUFFER_ATOMIC_INC_X2	<pre>// 64bit tmp = MEM[ADDR]; MEM[ADDR] = (tmp >= DATA[0:1]) ? 0 : tmp + 1; // unsigned compare RETURN_DATA[0:1] = tmp.</pre>
108	S_BUFFER_ATOMIC_DEC_X2	<pre>// 64bit tmp = MEM[ADDR]; MEM[ADDR] = (tmp == 0 tmp > DATA[0:1]) ? DATA[0:1] : tmp - 1; // unsigned compare RETURN_DATA[0:1] = tmp.</pre>
128	S_ATOMIC_SWAP	<pre>// 32bit tmp = MEM[ADDR]; MEM[ADDR] = DATA; RETURN_DATA = tmp.</pre>
129	S_ATOMIC_CMPSWAP	<pre>// 32bit tmp = MEM[ADDR]; src = DATA[0]; cmp = DATA[1]; MEM[ADDR] = (tmp == cmp) ? src : tmp; RETURN_DATA[0] = tmp.</pre>
130	S_ATOMIC_ADD	<pre>// 32bit tmp = MEM[ADDR]; MEM[ADDR] += DATA; RETURN_DATA = tmp.</pre>
131	S_ATOMIC_SUB	<pre>// 32bit tmp = MEM[ADDR]; MEM[ADDR] -= DATA; RETURN_DATA = tmp.</pre>
132	S_ATOMIC_SMIN	<pre>// 32bit tmp = MEM[ADDR]; MEM[ADDR] = (DATA < tmp) ? DATA : tmp; // signed compare RETURN_DATA = tmp.</pre>

Opcode	Name	Description
133	S_ATOMIC_UMIN	<pre>// 32bit tmp = MEM[ADDR]; MEM[ADDR] = (DATA < tmp) ? DATA : tmp; // unsigned compare RETURN_DATA = tmp.</pre>
134	S_ATOMIC_SMAX	<pre>// 32bit tmp = MEM[ADDR]; MEM[ADDR] = (DATA > tmp) ? DATA : tmp; // signed compare RETURN_DATA = tmp.</pre>
135	S_ATOMIC_UMAX	<pre>// 32bit tmp = MEM[ADDR]; MEM[ADDR] = (DATA > tmp) ? DATA : tmp; // unsigned compare RETURN_DATA = tmp.</pre>
136	S_ATOMIC_AND	<pre>// 32bit tmp = MEM[ADDR]; MEM[ADDR] &= DATA; RETURN_DATA = tmp.</pre>
137	S_ATOMIC_OR	<pre>// 32bit tmp = MEM[ADDR]; MEM[ADDR] = DATA; RETURN_DATA = tmp.</pre>
138	S_ATOMIC_XOR	<pre>// 32bit tmp = MEM[ADDR]; MEM[ADDR] ^= DATA; RETURN_DATA = tmp.</pre>
139	S_ATOMIC_INC	<pre>// 32bit tmp = MEM[ADDR]; MEM[ADDR] = (tmp >= DATA) ? 0 : tmp + 1; // unsigned compare RETURN_DATA = tmp.</pre>
140	S_ATOMIC_DEC	<pre>// 32bit tmp = MEM[ADDR]; MEM[ADDR] = (tmp == 0 tmp > DATA) ? DATA : tmp - 1; // unsigned compare RETURN_DATA = tmp.</pre>
160	S_ATOMIC_SWAP_X2	<pre>// 64bit tmp = MEM[ADDR]; MEM[ADDR] = DATA[0:1]; RETURN_DATA[0:1] = tmp.</pre>
161	S_ATOMIC_CMPSWAP_X2	<pre>// 64bit tmp = MEM[ADDR]; src = DATA[0:1]; cmp = DATA[2:3]; MEM[ADDR] = (tmp == cmp) ? src : tmp; RETURN_DATA[0:1] = tmp.</pre>

Opcode	Name	Description
162	S_ATOMIC_ADD_X2	<pre>// 64bit tmp = MEM[ADDR]; MEM[ADDR] += DATA[0:1]; RETURN_DATA[0:1] = tmp.</pre>
163	S_ATOMIC_SUB_X2	<pre>// 64bit tmp = MEM[ADDR]; MEM[ADDR] -= DATA[0:1]; RETURN_DATA[0:1] = tmp.</pre>
164	S_ATOMIC_SMIN_X2	<pre>// 64bit tmp = MEM[ADDR]; MEM[ADDR] -= (DATA[0:1] < tmp) ? DATA[0:1] : tmp; // signed compare RETURN_DATA[0:1] = tmp.</pre>
165	S_ATOMIC_UMIN_X2	<pre>// 64bit tmp = MEM[ADDR]; MEM[ADDR] -= (DATA[0:1] < tmp) ? DATA[0:1] : tmp; // unsigned compare RETURN_DATA[0:1] = tmp.</pre>
166	S_ATOMIC_SMAX_X2	<pre>// 64bit tmp = MEM[ADDR]; MEM[ADDR] -= (DATA[0:1] > tmp) ? DATA[0:1] : tmp; // signed compare RETURN_DATA[0:1] = tmp.</pre>
167	S_ATOMIC_UMAX_X2	<pre>// 64bit tmp = MEM[ADDR]; MEM[ADDR] -= (DATA[0:1] > tmp) ? DATA[0:1] : tmp; // unsigned compare RETURN_DATA[0:1] = tmp.</pre>
168	S_ATOMIC_AND_X2	<pre>// 64bit tmp = MEM[ADDR]; MEM[ADDR] &= DATA[0:1]; RETURN_DATA[0:1] = tmp.</pre>
169	S_ATOMIC_OR_X2	<pre>// 64bit tmp = MEM[ADDR]; MEM[ADDR] = DATA[0:1]; RETURN_DATA[0:1] = tmp.</pre>
170	S_ATOMIC_XOR_X2	<pre>// 64bit tmp = MEM[ADDR]; MEM[ADDR] ^= DATA[0:1]; RETURN_DATA[0:1] = tmp.</pre>
171	S_ATOMIC_INC_X2	<pre>// 64bit tmp = MEM[ADDR]; MEM[ADDR] = (tmp >= DATA[0:1]) ? 0 : tmp + 1; // unsigned compare RETURN_DATA[0:1] = tmp.</pre>

Opcode	Name	Description
172	S_ATOMIC_DEC_X2	<pre>// 64bit tmp = MEM[ADDR]; MEM[ADDR] = (tmp == 0 tmp > DATA[0:1]) ? DATA[0:1] : tmp - 1; // unsigned compare RETURN_DATA[0:1] = tmp.</pre>

12.7. VOP2 Instructions



Instructions in this format may use a 32-bit literal constant, DPP or SDWA which occurs immediately after the instruction.

Opcode	Name	Description
0	V_CNDMASK_B32	$D.u = (VCC[threadId] ? S1.u : S0.u).$ Conditional mask on each thread. In VOP3 the VCC source may be a scalar GPR specified in S2.u.
1	V_ADD_F32	$D.f = S0.f + S1.f.$ 0.5ULP precision, denormals are supported.
2	V_SUB_F32	$D.f = S0.f - S1.f.$
3	V_SUBREV_F32	$D.f = S1.f - S0.f.$
4	V_MUL_LEGACY_F32	$D.f = S0.f * S1.f.$ // DX9 rules, 0.0*x = 0.0
5	V_MUL_F32	$D.f = S0.f * S1.f.$ 0.5ULP precision, denormals are supported.
6	V_MUL_I32_I24	$D.i = S0.i[23:0] * S1.i[23:0].$
7	V_MUL_HI_I32_I24	$D.i = (S0.i[23:0] * S1.i[23:0]) >> 32.$
8	V_MUL_U32_U24	$D.u = S0.u[23:0] * S1.u[23:0].$
9	V_MUL_HI_U32_U24	$D.i = (S0.u[23:0] * S1.u[23:0]) >> 32.$

Opcode	Name	Description
10	V_MIN_F32	<pre> if (IEEE_MODE && S0.f == sNaN) D.f = Quiet(S0.f); else if (IEEE_MODE && S1.f == sNaN) D.f = Quiet(S1.f); else if (S0.f == NaN) D.f = S1.f; else if (S1.f == NaN) D.f = S0.f; else if (S0.f == +0.0 && S1.f == -0.0) D.f = S1.f; else if (S0.f == -0.0 && S1.f == +0.0) D.f = S0.f; else // Note: there's no IEEE special case here like there is for V_MAX_F32. D.f = (S0.f < S1.f ? S0.f : S1.f); endif. </pre>
11	V_MAX_F32	<pre> if (IEEE_MODE && S0.f == sNaN) D.f = Quiet(S0.f); else if (IEEE_MODE && S1.f == sNaN) D.f = Quiet(S1.f); else if (S0.f == NaN) D.f = S1.f; else if (S1.f == NaN) D.f = S0.f; else if (S0.f == +0.0 && S1.f == -0.0) D.f = S0.f; else if (S0.f == -0.0 && S1.f == +0.0) D.f = S1.f; else if (IEEE_MODE) D.f = (S0.f >= S1.f ? S0.f : S1.f); else D.f = (S0.f > S1.f ? S0.f : S1.f); endif. </pre>
12	V_MIN_I32	D.i = (S0.i < S1.i ? S0.i : S1.i).
13	V_MAX_I32	D.i = (S0.i >= S1.i ? S0.i : S1.i).
14	V_MIN_U32	D.u = (S0.u < S1.u ? S0.u : S1.u).
15	V_MAX_U32	D.u = (S0.u >= S1.u ? S0.u : S1.u).
16	V_LSHRREV_B32	D.u = S1.u >> S0.u[4:0].
17	V_ASHRREV_I32	D.i = signext(S1.i) >> S0.i[4:0].
18	V_LSHLREV_B32	D.u = S1.u << S0.u[4:0].
19	V_AND_B32	D.u = S0.u & S1.u.
		Input and output modifiers not supported.

Opcode	Name	Description
20	V_OR_B32	$D.u = S0.u \mid S1.u.$ Input and output modifiers not supported.
21	V_XOR_B32	$D.u = S0.u \wedge S1.u.$ Input and output modifiers not supported.
22	V_MAC_F32	$D.f = S0.f * S1.f + D.f.$
23	V_MADMK_F32	$D.f = S0.f * K + S1.f.$ // K is a 32-bit literal constant. This opcode cannot use the VOP3 encoding and cannot use input/output modifiers.
24	V_MADAK_F32	$D.f = S0.f * S1.f + K.$ // K is a 32-bit literal constant. This opcode cannot use the VOP3 encoding and cannot use input/output modifiers.
25	V_ADD_CO_U32	$D.u = S0.u + S1.u;$ $VCC[threadId] = (S0.u + S1.u \geq 0x100000000ULL ? 1 : 0).$ // VCC is an UNSIGNED overflow/carry-out for V_ADDCO_U32. In VOP3 the VCC destination may be an arbitrary SGPR-pair.
26	V_SUB_CO_U32	$D.u = S0.u - S1.u;$ $VCC[threadId] = (S1.u > S0.u ? 1 : 0).$ // VCC is an UNSIGNED overflow/carry-out for V_SUBCO_U32. In VOP3 the VCC destination may be an arbitrary SGPR-pair.
27	V_SUBREV_CO_U32	$D.u = S1.u - S0.u;$ $VCC[threadId] = (S0.u > S1.u ? 1 : 0).$ // VCC is an UNSIGNED overflow/carry-out for V_SUBCO_U32. In VOP3 the VCC destination may be an arbitrary SGPR-pair.
28	V_ADDC_CO_U32	$D.u = S0.u + S1.u + VCC[threadId];$ $VCC[threadId] = (S0.u + S1.u + VCC[threadId] \geq 0x100000000ULL ? 1 : 0).$ // VCC is an UNSIGNED overflow. In VOP3 the VCC destination may be an arbitrary SGPR-pair, and the VCC source comes from the SGPR-pair at S2.u.
29	V_SUBB_CO_U32	$D.u = S0.u - S1.u - VCC[threadId];$ $VCC[threadId] = (S1.u + VCC[threadId] > S0.u ? 1 : 0).$ // VCC is an UNSIGNED overflow. In VOP3 the VCC destination may be an arbitrary SGPR-pair, and the VCC source comes from the SGPR-pair at S2.u.

Opcode	Name	Description
30	V_SUBBREV_CO_U32	$D.u = S1.u - S0.u - VCC[threadId];$ $VCC[threadId] = (S1.u + VCC[threadId] > S0.u ? 1 : 0).$ // VCC is an UNSIGNED overflow. In VOP3 the VCC destination may be an arbitrary SGPR-pair, and the VCC source comes from the SGPR-pair at S2.u.
31	V_ADD_F16	$D.f16 = S0.f16 + S1.f16.$ Supports denormals, round mode, exception flags, saturation. 0.5ULP precision, denormals are supported.
32	V_SUB_F16	$D.f16 = S0.f16 - S1.f16.$ Supports denormals, round mode, exception flags, saturation.
33	V_SUBREV_F16	$D.f16 = S1.f16 - S0.f16.$ Supports denormals, round mode, exception flags, saturation.
34	V_MUL_F16	$D.f16 = S0.f16 * S1.f16.$ Supports denormals, round mode, exception flags, saturation. 0.5ULP precision, denormals are supported.
35	V_MAC_F16	$D.f16 = S0.f16 * S1.f16 + D.f16.$ Supports round mode, exception flags, saturation.
36	V_MADMK_F16	$D.f16 = S0.f16 * K.f16 + S1.f16.$ // K is a 16-bit literal constant stored in the following literal DWORD. This opcode cannot use the VOP3 encoding and cannot use input/output modifiers. Supports round mode, exception flags, saturation.
37	V_MADAK_F16	$D.f16 = S0.f16 * S1.f16 + K.f16.$ // K is a 16-bit literal constant stored in the following literal DWORD. This opcode cannot use the VOP3 encoding and cannot use input/output modifiers. Supports round mode, exception flags, saturation.
38	V_ADD_U16	$D.u16 = S0.u16 + S1.u16.$ Supports saturation (unsigned 16-bit integer domain).
39	V_SUB_U16	$D.u16 = S0.u16 - S1.u16.$ Supports saturation (unsigned 16-bit integer domain).
40	V_SUBREV_U16	$D.u16 = S1.u16 - S0.u16.$ Supports saturation (unsigned 16-bit integer domain).

Opcode	Name	Description
41	V_MUL_LO_U16	$D.u16 = S0.u16 * S1.u16.$ Supports saturation (unsigned 16-bit integer domain).
42	V_LSHLREV_B16	$D.u[15:0] = S1.u[15:0] \ll S0.u[3:0].$
43	V_LSHRREV_B16	$D.u[15:0] = S1.u[15:0] \gg S0.u[3:0].$
44	V_ASHRREV_I16	$D.i[15:0] = \text{signext}(S1.i[15:0]) \gg S0.i[3:0].$
45	V_MAX_F16	<pre> if (IEEE_MODE && S0.f16 == sNaN) D.f16 = Quiet(S0.f16); else if (IEEE_MODE && S1.f16 == sNaN) D.f16 = Quiet(S1.f16); else if (S0.f16 == NaN) D.f16 = S1.f16; else if (S1.f16 == NaN) D.f16 = S0.f16; else if (S0.f16 == +0.0 && S1.f16 == -0.0) D.f16 = S0.f16; else if (S0.f16 == -0.0 && S1.f16 == +0.0) D.f16 = S1.f16; else if (IEEE_MODE) D.f16 = (S0.f16 >= S1.f16 ? S0.f16 : S1.f16); else D.f16 = (S0.f16 > S1.f16 ? S0.f16 : S1.f16); endif. </pre> <p>IEEE compliant. Supports denormals, round mode, exception flags, saturation.</p>
46	V_MIN_F16	<pre> if (IEEE_MODE && S0.f16 == sNaN) D.f16 = Quiet(S0.f16); else if (IEEE_MODE && S1.f16 == sNaN) D.f16 = Quiet(S1.f16); else if (S0.f16 == NaN) D.f16 = S1.f16; else if (S1.f16 == NaN) D.f16 = S0.f16; else if (S0.f16 == +0.0 && S1.f16 == -0.0) D.f16 = S1.f16; else if (S0.f16 == -0.0 && S1.f16 == +0.0) D.f16 = S0.f16; else // Note: there's no IEEE special case here like there is // for V_MAX_F16. D.f16 = (S0.f16 < S1.f16 ? S0.f16 : S1.f16); endif. </pre> <p>IEEE compliant. Supports denormals, round mode, exception flags, saturation.</p>
47	V_MAX_U16	$D.u16 = (S0.u16 >= S1.u16 ? S0.u16 : S1.u16).$

Opcode	Name	Description
48	V_MAX_I16	$D.i16 = (S0.i16 \geq S1.i16 ? S0.i16 : S1.i16).$
49	V_MIN_U16	$D.u16 = (S0.u16 < S1.u16 ? S0.u16 : S1.u16).$
50	V_MIN_I16	$D.i16 = (S0.i16 < S1.i16 ? S0.i16 : S1.i16).$
51	V_LDEXP_F16	$D.f16 = S0.f16 * (2 ** S1.i16).$ Note that the S1 has a format of f16 since floating point literal constants are interpreted as 16 bit value for this opcode
52	V_ADD_U32	$D.u = S0.u + S1.u.$
53	V_SUB_U32	$D.u = S0.u - S1.u.$
54	V_SUBREV_U32	$D.u = S1.u - S0.u.$
59	V_FMAC_F32	$D.f32 = S0.f32 * S1.f32 + D.f32.$ VOP2 version of V_FMA_F32 with 3rd src VGPR address is the vDst.
61	V_XNOR_B32	$D.b32 = S0.b32 \text{ XNOR } S1.b32.$

12.7.1. VOP2 using VOP3 encoding

Instructions in this format may also be encoded as VOP3. This allows access to the extra control bits (e.g. ABS, OMOD) in exchange for not being able to use a literal constant. The VOP3 opcode is: VOP2 opcode + 0x100.

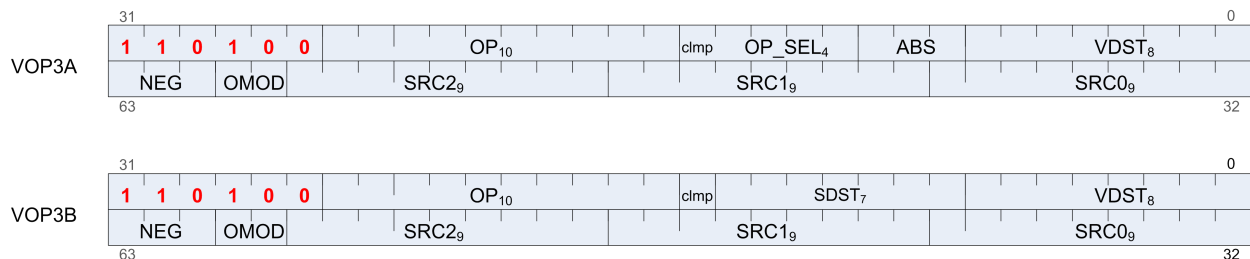

12.8. VOP1 Instructions

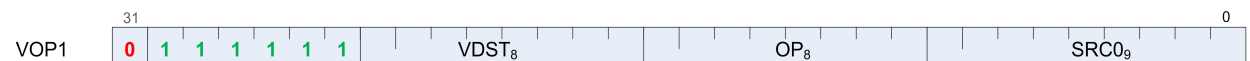

Instructions in this format may use a 32-bit literal constant, DPP or SDWA which occurs immediately after the instruction.

Opcode	Name	Description
0	V_NOP	Do nothing.

Opcode	Name	Description
1	V_MOV_B32	<p>$D.u = S0.u.$</p> <p>Input and output modifiers not supported; this is an untyped operation.</p>
2	V_READFIRSTLANE_B32	<p>Copy one VGPR value to one SGPR. D = SGPR destination, S0 = source data (VGPR# or M0 for lds direct access), Lane# = FindFirst1fromLSB(exec) (Lane# = 0 if exec is zero). Ignores exec mask for the access.</p> <p>Input and output modifiers not supported; this is an untyped operation.</p>
3	V_CVT_I32_F64	<p>$D.i = (int)S0.d.$</p> <p>0.5ULP accuracy, out-of-range floating point values (including infinity) saturate. NaN is converted to 0.</p> <p>Generation of the INEXACT exception is controlled by the CLAMP bit. INEXACT exceptions are enabled for this conversion iff CLAMP == 1.</p>
4	V_CVT_F64_I32	<p>$D.d = (double)S0.i.$</p> <p>0ULP accuracy.</p>
5	V_CVT_F32_I32	<p>$D.f = (float)S0.i.$</p> <p>0.5ULP accuracy.</p>
6	V_CVT_F32_U32	<p>$D.f = (float)S0.u.$</p> <p>0.5ULP accuracy.</p>
7	V_CVT_U32_F32	<p>$D.u = (unsigned)S0.f.$</p> <p>1ULP accuracy, out-of-range floating point values (including infinity) saturate. NaN is converted to 0.</p> <p>Generation of the INEXACT exception is controlled by the CLAMP bit. INEXACT exceptions are enabled for this conversion iff CLAMP == 1.</p>
8	V_CVT_I32_F32	<p>$D.i = (int)S0.f.$</p> <p>1ULP accuracy, out-of-range floating point values (including infinity) saturate. NaN is converted to 0.</p> <p>Generation of the INEXACT exception is controlled by the CLAMP bit. INEXACT exceptions are enabled for this conversion iff CLAMP == 1.</p>

Opcode	Name	Description
10	V_CVT_F16_F32	$D.f16 = flt32_to_flt16(S0.f).$ 0.5ULP accuracy, supports input modifiers and creates FP16 denormals when appropriate.
11	V_CVT_F32_F16	$D.f = flt16_to_flt32(S0.f16).$ 0ULP accuracy, FP16 denormal inputs are accepted.
12	V_CVT_RPI_I32_F32	$D.i = (int)floor(S0.f + 0.5).$ 0.5ULP accuracy, denormals are supported.
13	V_CVT_FLR_I32_F32	$D.i = (int)floor(S0.f).$ 1ULP accuracy, denormals are supported.
14	V_CVT_OFF_F32_I4	4-bit signed int to 32-bit float. Used for interpolation in shader. S0 Result 1000 -0.5f 1001 -0.4375f 1010 -0.375f 1011 -0.3125f 1100 -0.25f 1101 -0.1875f 1110 -0.125f 1111 -0.0625f 0000 0.0f 0001 0.0625f 0010 0.125f 0011 0.1875f 0100 0.25f 0101 0.3125f 0110 0.375f 0111 0.4375f
15	V_CVT_F32_F64	$D.f = (float)S0.d.$ 0.5ULP accuracy, denormals are supported.
16	V_CVT_F64_F32	$D.d = (double)S0.f.$ 0ULP accuracy, denormals are supported.
17	V_CVT_F32_UBYTE0	$D.f = (float)(S0.u[7:0]).$
18	V_CVT_F32_UBYTE1	$D.f = (float)(S0.u[15:8]).$
19	V_CVT_F32_UBYTE2	$D.f = (float)(S0.u[23:16]).$
20	V_CVT_F32_UBYTE3	$D.f = (float)(S0.u[31:24]).$

Opcode	Name	Description
21	V_CVT_U32_F64	<p>$D.u = (\text{unsigned})S0.d.$</p> <p>0.5ULP accuracy, out-of-range floating point values (including infinity) saturate. NaN is converted to 0.</p> <p>Generation of the INEXACT exception is controlled by the CLAMP bit. INEXACT exceptions are enabled for this conversion iff CLAMP == 1.</p>
22	V_CVT_F64_U32	<p>$D.d = (\text{double})S0.u.$</p> <p>0ULP accuracy.</p>
23	V_TRUNC_F64	<p>$D.d = \text{trunc}(S0.d).$</p> <p>Return integer part of $S0.d$, round-to-zero semantics.</p>
24	V_CEIL_F64	<p>$D.d = \text{trunc}(S0.d);$ $\text{if}(S0.d > 0.0 \ \&\& \ S0.d \neq D.d) \ \text{then}$ $\quad D.d += 1.0;$ endif.</p> <p>Round up to next whole integer.</p>
25	V_RNDNE_F64	<p>$D.d = \text{floor}(S0.d + 0.5);$ $\text{if}(\text{floor}(S0.d) \ \text{is even} \ \&\& \ \text{fract}(S0.d) == 0.5) \ \text{then}$ $\quad D.d -= 1.0;$ endif.</p> <p>Round-to-nearest-even semantics.</p>
26	V_FLOOR_F64	<p>$D.d = \text{trunc}(S0.d);$ $\text{if}(S0.d < 0.0 \ \&\& \ S0.d \neq D.d) \ \text{then}$ $\quad D.d += -1.0;$ endif.</p> <p>Round down to previous whole integer.</p>
27	V_FRACT_F32	<p>$D.f = S0.f + -\text{floor}(S0.f).$</p> <p>Return fractional portion of a number. 0.5ULP accuracy, denormals are accepted.</p>
28	V_TRUNC_F32	<p>$D.f = \text{trunc}(S0.f).$</p> <p>Return integer part of $S0.f$, round-to-zero semantics.</p>
29	V_CEIL_F32	<p>$D.f = \text{trunc}(S0.f);$ $\text{if}(S0.f > 0.0 \ \&\& \ S0.f \neq D.f) \ \text{then}$ $\quad D.f += 1.0;$ endif.</p> <p>Round up to next whole integer.</p>

Opcode	Name	Description
30	V_RNDNE_F32	<pre>D.f = floor(S0.f + 0.5); if(floor(S0.f) is even && fract(S0.f) == 0.5) then D.f -= 1.0; endif.</pre> <p>Round-to-nearest-even semantics.</p>
31	V_FLOOR_F32	<pre>D.f = trunc(S0.f); if(S0.f < 0.0 && S0.f != D.f) then D.f += -1.0; endif.</pre> <p>Round down to previous whole integer.</p>
32	V_EXP_F32	<p>D.f = pow(2.0, S0.f).</p> <p>Base 2 exponentiation. 1ULP accuracy, denormals are flushed.</p> <p>Examples:</p> <pre>V_EXP_F32(0xff800000) => 0x00000000 // exp(-INF) = 0 V_EXP_F32(0x80000000) => 0x3f800000 // exp(-0.0) = 1 V_EXP_F32(0x7f800000) => 0x7f800000 // exp(+INF) = +INF</pre>
33	V_LOG_F32	<p>D.f = log2(S0.f).</p> <p>Base 2 logarithm. 1ULP accuracy, denormals are flushed.</p> <p>Examples:</p> <pre>V_LOG_F32(0xff800000) => 0xffc00000 // log(-INF) = NAN V_LOG_F32(0xbf800000) => 0xffc00000 // log(-1.0) = NAN V_LOG_F32(0x80000000) => 0xff800000 // log(-0.0) = -INF V_LOG_F32(0x00000000) => 0xff800000 // log(+0.0) = -INF V_LOG_F32(0x3f800000) => 0x00000000 // log(+1.0) = 0 V_LOG_F32(0x7f800000) => 0x7f800000 // log(+INF) = +INF</pre>
34	V_RCP_F32	<p>D.f = 1.0 / S0.f.</p> <p>Reciprocal with IEEE rules and 1ULP accuracy. Accuracy converges to < 0.5ULP when using the Newton-Raphson method and 2 FMA operations. Denormals are flushed.</p> <p>Examples:</p> <pre>V_RCP_F32(0xff800000) => 0x80000000 // rcp(-INF) = -0 V_RCP_F32(0xc0000000) => 0xbf000000 // rcp(-2.0) = -0.5 V_RCP_F32(0x80000000) => 0xff800000 // rcp(-0.0) = -INF V_RCP_F32(0x00000000) => 0x7f800000 // rcp(+0.0) = +INF V_RCP_F32(0x7f800000) => 0x00000000 // rcp(+INF) = +0</pre>

Opcode	Name	Description
35	V_RCP_IFLAG_F32	<p>$D.f = 1.0 / S0.f.$</p> <p>Reciprocal intended for integer division, can raise integer DIV_BY_ZERO exception but cannot raise floating-point exceptions. To be used in an integer reciprocal macro by the compiler with one of the following sequences:</p> <p>Unsigned: CVT_F32_U32 RCP_IFLAG_F32 MUL_F32 (2**32 - 1) CVT_U32_F32</p> <p>Signed: CVT_F32_I32 RCP_IFLAG_F32 MUL_F32 (2**31 - 1) CVT_I32_F32</p>
36	V_RSQ_F32	<p>$D.f = 1.0 / \text{sqrt}(S0.f).$</p> <p>Reciprocal square root with IEEE rules. 1ULP accuracy, denormals are flushed.</p> <p>Examples: V_RSQ_F32(0xff800000) => 0xffc00000 // rsq(-INF) = NAN V_RSQ_F32(0x80000000) => 0xff800000 // rsq(-0.0) = -INF V_RSQ_F32(0x00000000) => 0x7f800000 // rsq(+0.0) = +INF V_RSQ_F32(0x40800000) => 0x3f000000 // rsq(+4.0) = +0.5 V_RSQ_F32(0x7f800000) => 0x00000000 // rsq(+INF) = +0</p>
37	V_RCP_F64	<p>$D.d = 1.0 / S0.d.$</p> <p>Reciprocal with IEEE rules and perhaps not the accuracy you were hoping for -- (2**29)ULP accuracy. On the upside, denormals are supported.</p>
38	V_RSQ_F64	<p>$D.f16 = 1.0 / \text{sqrt}(S0.f16).$</p> <p>Reciprocal square root with IEEE rules and perhaps not the accuracy you were hoping for -- (2**29)ULP accuracy. On the upside, denormals are supported.</p>

Opcode	Name	Description
39	V_SQRT_F32	<p>$D.f = \text{sqrt}(S0.f).$</p> <p>Square root. 1ULP accuracy, denormals are flushed.</p> <p>Examples:</p> <pre>V_SQRT_F32(0xff800000) => 0xffc00000 // sqrt(-INF) = NAN V_SQRT_F32(0x80000000) => 0x80000000 // sqrt(-0.0) = -0 V_SQRT_F32(0x00000000) => 0x00000000 // sqrt(+0.0) = +0 V_SQRT_F32(0x40800000) => 0x40000000 // sqrt(+4.0) = +2.0 V_SQRT_F32(0x7f800000) => 0x7f800000 // sqrt(+INF) = +INF</pre>
40	V_SQRT_F64	<p>$D.d = \text{sqrt}(S0.d).$</p> <p>Square root with perhaps not the accuracy you were hoping for -- (2**29)ULP accuracy. On the upside, denormals are supported.</p>
41	V_SIN_F32	<p>$D.f = \text{sin}(S0.f * 2 * \text{PI}).$</p> <p>Trigonometric sine. Denormals are supported.</p> <p>Examples:</p> <pre>V_SIN_F32(0xff800000) => 0xffc00000 // sin(-INF) = NAN V_SIN_F32(0xff7fffff) => 0x00000000 // -MaxFloat, finite V_SIN_F32(0x80000000) => 0x80000000 // sin(-0.0) = -0 V_SIN_F32(0x3e800000) => 0x3f800000 // sin(0.25) = 1 V_SIN_F32(0x7f800000) => 0xffc00000 // sin(+INF) = NAN</pre>
42	V_COS_F32	<p>$D.f = \text{cos}(S0.f * 2 * \text{PI}).$</p> <p>Trigonometric cosine. Denormals are supported.</p> <p>Examples:</p> <pre>V_COS_F32(0xff800000) => 0xffc00000 // cos(-INF) = NAN V_COS_F32(0xff7fffff) => 0x3f800000 // -MaxFloat, finite V_COS_F32(0x80000000) => 0x3f800000 // cos(-0.0) = 1 V_COS_F32(0x3e800000) => 0x00000000 // cos(0.25) = 0 V_COS_F32(0x7f800000) => 0xffc00000 // cos(+INF) = NAN</pre>
43	V_NOT_B32	<p>$D.u = \sim S0.u.$</p> <p>Bitwise negation. Input and output modifiers not supported.</p>
44	V_BFREV_B32	<p>$D.u[31:0] = S0.u[0:31].$</p> <p>Bitfield reverse. Input and output modifiers not supported.</p>

Opcode	Name	Description
45	V_FFBH_U32	<pre> D.i = -1; // Set if no ones are found for i in 0 ... 31 do // Note: search is from the MSB if S0.u[31 - i] == 1 then D.i = i; break for; endif; endfor. </pre> <p>Counts how many zeros before the first one starting from the MSB. Returns -1 if there are no ones.</p> <p>Examples:</p> <pre> V_FFBH_U32(0x00000000) => 0xffffffff V_FFBH_U32(0x800000ff) => 0 V_FFBH_U32(0x100000ff) => 3 V_FFBH_U32(0x0000ffff) => 16 V_FFBH_U32(0x00000001) => 31 </pre>
46	V_FFBL_B32	<pre> D.i = -1; // Set if no ones are found for i in 0 ... 31 do // Search from LSB if S0.u[i] == 1 then D.i = i; break for; endif; endfor. </pre> <p>Returns the bit position of the first one from the LSB, or -1 if there are no ones.</p> <p>Examples:</p> <pre> V_FFBL_B32(0x00000000) => 0xffffffff V_FFBL_B32(0xff000001) => 0 V_FFBL_B32(0xff000008) => 3 V_FFBL_B32(0xffff0000) => 16 V_FFBL_B32(0x80000000) => 31 </pre>

Opcode	Name	Description
47	V_FFBH_I32	<pre> D.i = -1; // Set if all bits are the same for i in 1 ... 31 do // Note: search is from the MSB if S0.i[31 - i] != S0.i[31] then D.i = i; break for; endif; endfor. </pre> <p>Counts how many bits in a row (from MSB to LSB) are the same as the sign bit. Returns -1 if all bits are the same.</p> <p>Examples:</p> <pre> V_FFBH_I32(0x00000000) => 0xffffffff V_FFBH_I32(0x40000000) => 1 V_FFBH_I32(0x80000000) => 1 V_FFBH_I32(0xffffffff) => 4 V_FFBH_I32(0xffff0000) => 16 V_FFBH_I32(0xfffffff0) => 31 V_FFBH_I32(0xffffffff) => 0xffffffff </pre>
48	V_FREXP_EXP_I32_F64	<pre> if(S0.d == +-INF S0.d == NAN) then D.i = 0; else D.i = TwosComplement(Exponent(S0.d) - 1023 + 1); endif. </pre> <p>Returns exponent of single precision float input, such that $S0.d = \text{significand} * (2 ** \text{exponent})$. See also V_FREXP_MANT_F64, which returns the significand. See the C library function <code>frexp()</code> for more information.</p>
49	V_FREXP_MANT_F64	<pre> if(S0.d == +-INF S0.d == NAN) then D.d = S0.d; else D.d = Mantissa(S0.d); endif. </pre> <p>Result range is in $(-1.0, -0.5][0.5, 1.0)$ in typical cases. Returns binary significand of double precision float input, such that $S0.d = \text{significand} * (2 ** \text{exponent})$. See also V_FREXP_EXP_I32_F64, which returns integer exponent. See the C library function <code>frexp()</code> for more information.</p>
50	V_FRACT_F64	<pre> D.d = S0.d + -floor(S0.d). </pre> <p>Return fractional portion of a number. 0.5ULP accuracy, denormals are accepted.</p>

Opcode	Name	Description
51	V_FREXP_EXP_I32_F32	<pre> if(S0.f == +-INF S0.f == NAN) then D.i = 0; else D.i = TwosComplement(Exponent(S0.f) - 127 + 1); endif. </pre> <p>Returns exponent of single precision float input, such that $S0.f = \text{significand} * (2 ** \text{exponent})$. See also V_FREXP_MANT_F32, which returns the significand. See the C library function <code>frexp()</code> for more information.</p>
52	V_FREXP_MANT_F32	<pre> if(S0.f == +-INF S0.f == NAN) then D.f = S0.f; else D.f = Mantissa(S0.f); endif. </pre> <p>Result range is in $(-1.0, -0.5][0.5, 1.0)$ in typical cases. Returns binary significand of single precision float input, such that $S0.f = \text{significand} * (2 ** \text{exponent})$. See also V_FREXP_EXP_I32_F32, which returns integer exponent. See the C library function <code>frexp()</code> for more information.</p>
53	V_CLREXCP	Clear wave's exception state in SIMD (SP).

Opcode	Name	Description
55	V_SCREEN_PARTITION_4SE_B32	<p>$D.u = TABLE[S0.u[7:0]]$.</p> <p>TABLE:</p> <pre> 0x1, 0x3, 0x7, 0xf, 0x5, 0xf, 0xf, 0xf, 0x7, 0xf, 0xf, 0xf, 0xf, 0xf, 0xf, 0xf, 0xf, 0x2, 0x6, 0xe, 0xf, 0xa, 0xf, 0xf, 0xf, 0xb, 0xf, 0xf, 0xf, 0xf, 0xf, 0xf, 0xd, 0xf, 0x4, 0xc, 0xf, 0xf, 0x5, 0xf, 0xf, 0xf, 0xd, 0xf, 0xf, 0xf, 0xf, 0xf, 0x9, 0xb, 0xf, 0x8, 0xf, 0xf, 0xf, 0xa, 0xf, 0xf, 0xf, 0xe, 0xf, 0xf, 0xf, 0xf, 0xf, 0xf, 0xf, 0xf, 0x4, 0xc, 0xd, 0xf, 0x6, 0xf, 0xf, 0xf, 0xe, 0xf, 0xf, 0xf, 0xf, 0xf, 0xf, 0xf, 0xf, 0x8, 0x9, 0xb, 0xf, 0x9, 0x9, 0xf, 0xf, 0xd, 0xf, 0xf, 0xf, 0xf, 0xf, 0xf, 0x7, 0xf, 0x1, 0x3, 0xf, 0xf, 0x9, 0xf, 0xf, 0xf, 0xb, 0xf, 0xf, 0xf, 0xf, 0xf, 0x6, 0xe, 0xf, 0x2, 0x6, 0xf, 0xf, 0x6, 0xf, 0xf, 0xf, 0xf, 0xb, 0xf, 0xf, 0xf, 0xf, 0xf, 0xf, 0xf, 0x2, 0x3, 0xb, 0xf, 0xa, 0xf, 0xf, 0xf, 0xf, 0x7, 0xf, 0xf, 0xf, 0xf, 0xf, 0xf, 0xf, 0x1, 0x9, 0xd, 0xf, 0x5, 0xf, 0xf, 0xf, 0xf, 0xe, 0xf, 0xf, 0xf, 0xf, 0xf, 0xf, 0xe, 0xf, 0x8, 0xc, 0xf, 0xf, 0xa, 0xf, 0xf, 0xf, 0xf, 0xd, 0xf, 0xf, 0xf, 0xf, 0x6, 0x7, 0xf, 0x4, 0xf, 0xf, 0xf, 0xf, 0x9, 0xf, 0xf, 0xf, 0xd, 0xf, 0xf, 0xf, 0xf, 0xf, 0xf, 0xf, 0x8, 0xc, 0xe, 0xf, 0xf, 0x6, 0x6, 0xf, 0xf, 0xe, 0xf, 0xf, 0xf, 0xf, 0xf, 0xf, 0xf, 0xf, 0x4, 0x6, 0x7, 0xf, 0xf, 0x6, 0xf, 0xf, 0xf, 0x7, 0xf, 0xf, 0xf, 0xf, 0xf, 0xb, 0xf, 0x2, 0x3, 0x9, 0xf, 0xf, 0x9, 0xf, 0xf, 0xf, 0xb, 0xf, 0xf, 0xf, 0xf, 0x9, 0xd, 0xf, 0x1 </pre> <p>4SE version of LUT instruction for screen partitioning/filtering. This opcode is intended to accelerate screen partitioning in the 4SE case only. 2SE and 1SE cases use normal ALU instructions.</p> <p>This opcode returns a 4-bit bitmask indicating which SE backends are covered by a rectangle from (x_min, y_min) to (x_max, y_max). With 32-pixel tiles the SE for (x, y) is given by $\{ x[5] \wedge y[6], y[5] \wedge x[6] \}$. Using this formula we can determine which SEs are covered by a larger rectangle.</p> <p>The primitive shader must perform the following operation before the opcode is called.</p> <ol style="list-style-type: none"> 1. Compute the bounding box of the primitive (x_min, y_min) (upper left) and (x_max, y_max) (lower right), in pixels. 2. Check for any extents that do not need to use the opcode ---

Opcode	Name	Description
57	V_CVT_F16_U16	<p>$D.f16 = \text{uint16_to_flt16}(S.u16).$</p> <p>0.5ULP accuracy, supports denormals, rounding, exception flags and saturation.</p>
58	V_CVT_F16_I16	<p>$D.f16 = \text{int16_to_flt16}(S.i16).$</p> <p>0.5ULP accuracy, supports denormals, rounding, exception flags and saturation.</p>
59	V_CVT_U16_F16	<p>$D.u16 = \text{flt16_to_uint16}(S.f16).$</p> <p>1ULP accuracy, supports rounding, exception flags and saturation. FP16 denormals are accepted. Conversion is done with truncation.</p> <p>Generation of the INEXACT exception is controlled by the CLAMP bit. INEXACT exceptions are enabled for this conversion iff CLAMP == 1.</p>
60	V_CVT_I16_F16	<p>$D.i16 = \text{flt16_to_int16}(S.f16).$</p> <p>1ULP accuracy, supports rounding, exception flags and saturation. FP16 denormals are accepted. Conversion is done with truncation.</p> <p>Generation of the INEXACT exception is controlled by the CLAMP bit. INEXACT exceptions are enabled for this conversion iff CLAMP == 1.</p>
61	V_RCP_F16	<p>$D.f16 = 1.0 / S0.f16.$</p> <p>Reciprocal with IEEE rules and 0.51ULP accuracy.</p> <p>Examples:</p> <pre>V_RCP_F16(0xfc00) => 0x8000 // rcp(-INF) = -0 V_RCP_F16(0xc000) => 0xb800 // rcp(-2.0) = -0.5 V_RCP_F16(0x8000) => 0xfc00 // rcp(-0.0) = -INF V_RCP_F16(0x0000) => 0x7c00 // rcp(+0.0) = +INF V_RCP_F16(0x7c00) => 0x0000 // rcp(+INF) = +0</pre>
62	V_SQRT_F16	<p>$D.f16 = \text{sqrt}(S0.f16).$</p> <p>Square root. 0.51ULP accuracy, denormals are supported.</p> <p>Examples:</p> <pre>V_SQRT_F16(0xfc00) => 0xfe00 // sqrt(-INF) = NAN V_SQRT_F16(0x8000) => 0x8000 // sqrt(-0.0) = -0 V_SQRT_F16(0x0000) => 0x0000 // sqrt(+0.0) = +0 V_SQRT_F16(0x4400) => 0x4000 // sqrt(+4.0) = +2.0 V_SQRT_F16(0x7c00) => 0x7c00 // sqrt(+INF) = +INF</pre>

Opcode	Name	Description
63	V_RSQ_F16	<p>$D.f16 = 1.0 / \text{sqrt}(S0.f16).$</p> <p>Reciprocal square root with IEEE rules. 0.51ULP accuracy, denormals are supported.</p> <p>Examples:</p> <pre>V_RSQ_F16(0xfc00) => 0xfe00 // rsq(-INF) = NAN V_RSQ_F16(0x8000) => 0xfc00 // rsq(-0.0) = -INF V_RSQ_F16(0x0000) => 0x7c00 // rsq(+0.0) = +INF V_RSQ_F16(0x4400) => 0x3800 // rsq(+4.0) = +0.5 V_RSQ_F16(0x7c00) => 0x0000 // rsq(+INF) = +0</pre>
64	V_LOG_F16	<p>$D.f16 = \log_2(S0.f).$</p> <p>Base 2 logarithm. 0.51ULP accuracy, denormals are supported.</p> <p>Examples:</p> <pre>V_LOG_F16(0xfc00) => 0xfe00 // log(-INF) = NAN V_LOG_F16(0xbc00) => 0xfe00 // log(-1.0) = NAN V_LOG_F16(0x8000) => 0xfc00 // log(-0.0) = -INF V_LOG_F16(0x0000) => 0xfc00 // log(+0.0) = -INF V_LOG_F16(0x3c00) => 0x0000 // log(+1.0) = 0 V_LOG_F16(0x7c00) => 0x7c00 // log(+INF) = +INF</pre>
65	V_EXP_F16	<p>$D.f16 = \text{pow}(2.0, S0.f16).$</p> <p>Base 2 exponentiation. 0.51ULP accuracy, denormals are supported.</p> <p>Examples:</p> <pre>V_EXP_F16(0xfc00) => 0x0000 // exp(-INF) = 0 V_EXP_F16(0x8000) => 0x3c00 // exp(-0.0) = 1 V_EXP_F16(0x7c00) => 0x7c00 // exp(+INF) = +INF</pre>
66	V_FREXP_MANT_F16	<pre>if(S0.f16 == +-INF S0.f16 == NAN) then D.f16 = S0.f16; else D.f16 = Mantissa(S0.f16); endif.</pre> <p>Result range is in (-1.0,-0.5][0.5,1.0) in typical cases. Returns binary significand of half precision float input, such that $S0.f16 = \text{significand} * (2 ** \text{exponent})$. See also V_FREXP_EXP_I16_F16, which returns integer exponent. See the C library function frexp() for more information.</p>

Opcode	Name	Description
67	V_FREXP_EXP_I16_F16	<pre> if(S0.f16 == +-INF S0.f16 == NAN) then D.i = 0; else D.i = TwosComplement(Exponent(S0.f16) - 15 + 1); endif. </pre> <p>Returns exponent of half precision float input, such that $S0.f16 = \text{significand} * (2 ** \text{exponent})$. See also V_FREXP_MANT_F16, which returns the significand. See the C library function <code>frexp()</code> for more information.</p>
68	V_FLOOR_F16	<pre> D.f16 = trunc(S0.f16); if(S0.f16 < 0.0f && S0.f16 != D.f16) then D.f16 -= 1.0; endif. </pre> <p>Round down to previous whole integer.</p>
69	V_CEIL_F16	<pre> D.f16 = trunc(S0.f16); if(S0.f16 > 0.0f && S0.f16 != D.f16) then D.f16 += 1.0; endif. </pre> <p>Round up to next whole integer.</p>
70	V_TRUNC_F16	<pre> D.f16 = trunc(S0.f16). </pre> <p>Return integer part of $S0.f16$, round-to-zero semantics.</p>
71	V_RNDNE_F16	<pre> D.f16 = floor(S0.f16 + 0.5); if(floor(S0.f16) is even && fract(S0.f16) == 0.5) then D.f16 -= 1.0; endif. </pre> <p>Round-to-nearest-even semantics.</p>
72	V_FRACT_F16	<pre> D.f16 = S0.f16 + -floor(S0.f16). </pre> <p>Return fractional portion of a number. 0.5ULP accuracy, denormals are accepted.</p>
73	V_SIN_F16	<pre> D.f16 = sin(S0.f16 * 2 * PI). </pre> <p>Trigonometric sine. Denormals are supported.</p> <p>Examples:</p> <pre> V_SIN_F16(0xfc00) => 0xfe00 // sin(-INF) = NAN V_SIN_F16(0xfbff) => 0x0000 // Most negative finite FP16 V_SIN_F16(0x8000) => 0x8000 // sin(-0.0) = -0 V_SIN_F16(0x3400) => 0x3c00 // sin(0.25) = 1 V_SIN_F16(0x7bff) => 0x0000 // Most positive finite FP16 V_SIN_F16(0x7c00) => 0xfe00 // sin(+INF) = NAN </pre>

Opcode	Name	Description
74	V_COS_F16	$D.f16 = \cos(S0.f16 * 2 * \text{PI})$. Trigonometric cosine. Denormals are supported. Examples: $V_COS_F16(0xfc00) \Rightarrow 0xfe00$ // $\cos(-\text{INF}) = \text{NAN}$ $V_COS_F16(0xfbff) \Rightarrow 0x3c00$ // Most negative finite FP16 $V_COS_F16(0x8000) \Rightarrow 0x3c00$ // $\cos(-0.0) = 1$ $V_COS_F16(0x3400) \Rightarrow 0x0000$ // $\cos(0.25) = 0$ $V_COS_F16(0x7bff) \Rightarrow 0x3c00$ // Most positive finite FP16 $V_COS_F16(0x7c00) \Rightarrow 0xfe00$ // $\cos(+\text{INF}) = \text{NAN}$
75	V_EXP_LEGACY_F32	$D.f = \text{pow}(2.0, S0.f)$. Power with legacy semantics.
76	V_LOG_LEGACY_F32	$D.f = \log_2(S0.f)$. Base 2 logarithm with legacy semantics.
77	V_CVT_NORM_I16_F16	$D.i16 = \text{flt16_to_snorm16}(S.f16)$. 0.5ULP accuracy, supports rounding, exception flags and saturation, denormals are supported.
78	V_CVT_NORM_U16_F16	$D.u16 = \text{flt16_to_unorm16}(S.f16)$. 0.5ULP accuracy, supports rounding, exception flags and saturation, denormals are supported.
79	V_SAT_PK_U8_I16	$D.u32 = \{16'b0, \text{sat8}(S.u[31:16]), \text{sat8}(S.u[15:0])\}$.
81	V_SWAP_B32	$\text{tmp} = D.u;$ $D.u = S0.u;$ $S0.u = \text{tmp}.$ Swap operands. Input and output modifiers not supported; this is an untyped operation.

12.8.1. VOP1 using VOP3 encoding

Instructions in this format may also be encoded as VOP3. This allows access to the extra control bits (e.g. ABS, OMOD) in exchange for not being able to use a literal constant. The VOP3 opcode is: VOP2 opcode + 0x140.

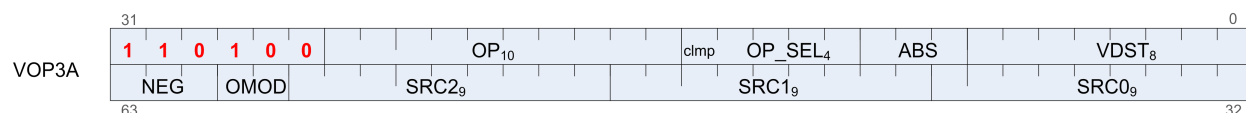

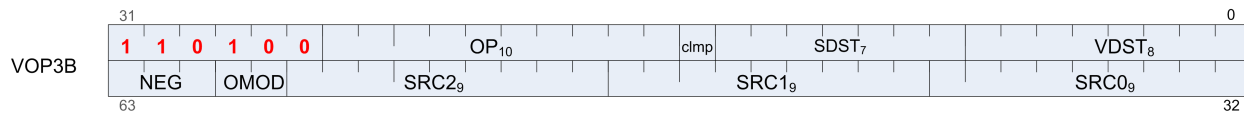

12.9. VOPC Instructions

The bitfield map for VOPC is:



where:

SRC0 = First operand for instruction.

VSRC1 = Second operand for instruction.

OP = Instructions.

All VOPC instructions can alternatively be encoded in the VOP3A format.

Compare instructions perform the same compare operation on each lane (workItem or thread) using that lane's private data, and producing a 1 bit result per lane into VCC or EXEC.

Instructions in this format may use a 32-bit literal constant which occurs immediately after the instruction.

Most compare instructions fall into one of two categories:

- Those which can use one of 16 compare operations (floating point types). "{COMPF}"
- Those which can use one of 8 compare operations (integer types). "{COMPI}"

The opcode number is such that for these the opcode number can be calculated from a base opcode number for the data type, plus an offset for the specific compare operation.

Table 47. Instructions with Sixteen Compare Operations

Compare Operation	Opcode Offset	Description
F	0	D.u = 0
LT	1	D.u = (S0 < S1)
EQ	2	D.u = (S0 == S1)
LE	3	D.u = (S0 <= S1)
GT	4	D.u = (S0 > S1)
LG	5	D.u = (S0 <> S1)
GE	6	D.u = (S0 >= S1)
O	7	D.u = (!isNaN(S0) && !isNaN(S1))

Compare Operation	Opcode Offset	Description
U	8	D.u = (!isNaN(S0) !isNaN(S1))
NGE	9	D.u = !(S0 >= S1)
NLG	10	D.u = !(S0 <> S1)
NGT	11	D.u = !(S0 > S1)
NLE	12	D.u = !(S0 <= S1)
NEQ	13	D.u = !(S0 == S1)
NLT	14	D.u = !(S0 < S1)
TRU	15	D.u = 1

Table 48. Instructions with Sixteen Compare Operations

Instruction	Description	Hex Range
V_CMP_{COMPF}_F16	16-bit float compare.	0x20 to 0x2F
V_CMPX_{COMPF}_F16	16-bit float compare. Also writes EXEC.	0x30 to 0x3F
V_CMP_{COMPF}_F32	32-bit float compare.	0x40 to 0x4F
V_CMPX_{COMPF}_F32	32-bit float compare. Also writes EXEC.	0x50 to 0x5F
V_CMPS_{COMPF}_F64	64-bit float compare.	0x60 to 0x6F
V_CMPSX_{COMPF}_F64	64-bit float compare. Also writes EXEC.	0x70 to 0x7F

Table 49. Instructions with Sixteen Compare Operations

Compare Operation	Opcode Offset	Description
F	0	D.u = 0
LT	1	D.u = (S0 < S1)
EQ	2	D.u = (S0 == S1)
LE	3	D.u = (S0 <= S1)
GT	4	D.u = (S0 > S1)
LG	5	D.u = (S0 <> S1)
GE	6	D.u = (S0 >= S1)
TRU	7	D.u = 1

Table 50. Instructions with Eight Compare Operations

Instruction	Description	Hex Range
V_CMP_{COMPI}_I16	16-bit signed integer compare.	0xA0 - 0xA7
V_CMP_{COMPI}_U16	16-bit signed integer compare. Also writes EXEC.	0xA8 - 0xAF
V_CMPX_{COMPI}_I16	16-bit unsigned integer compare.	0xB0 - 0xB7

Instruction	Description	Hex Range
V_CMPX_{COMPI}_U16	16-bit unsigned integer compare. Also writes EXEC.	0xB8 - 0xBF
V_CMP_{COMPI}_I32	32-bit signed integer compare.	0xC0 - 0xC7
V_CMP_{COMPI}_U32	32-bit signed integer compare. Also writes EXEC.	0xC8 - 0xCF
V_CMPX_{COMPI}_I32	32-bit unsigned integer compare.	0xD0 - 0xD7
V_CMPX_{COMPI}_U32	32-bit unsigned integer compare. Also writes EXEC.	0xD8 - 0xDF
V_CMP_{COMPI}_I64	64-bit signed integer compare.	0xE0 - 0xE7
V_CMP_{COMPI}_U64	64-bit signed integer compare. Also writes EXEC.	0xE8 - 0xEF
V_CMPX_{COMPI}_I64	64-bit unsigned integer compare.	0xF0 - 0xF7
V_CMPX_{COMPI}_U64	64-bit unsigned integer compare. Also writes EXEC.	0xF8 - 0xFF

Table 51. VOPC Compare Opcodes

Opcode	Name	Description
16	V_CMP_CLASS_F32	<p>VCC = IEEE numeric class function specified in S1.u, performed on S0.f</p> <p>The function reports true if the floating point value is <i>*any*</i> of the numeric types selected in S1.u according to the following list:</p> <ul style="list-style-type: none"> S1.u[0] -- value is a signaling NaN. S1.u[1] -- value is a quiet NaN. S1.u[2] -- value is negative infinity. S1.u[3] -- value is a negative normal value. S1.u[4] -- value is a negative denormal value. S1.u[5] -- value is negative zero. S1.u[6] -- value is positive zero. S1.u[7] -- value is a positive denormal value. S1.u[8] -- value is a positive normal value. S1.u[9] -- value is positive infinity.

Opcode	Name	Description
17	V_CMPX_CLASS_F32	<p>EXEC = VCC = IEEE numeric class function specified in S1.u, performed on S0.f</p> <p>The function reports true if the floating point value is <i>any*</i> of the numeric types selected in S1.u according to the following list:</p> <p>S1.u[0] -- value is a signaling NaN. S1.u[1] -- value is a quiet NaN. S1.u[2] -- value is negative infinity. S1.u[3] -- value is a negative normal value. S1.u[4] -- value is a negative denormal value. S1.u[5] -- value is negative zero. S1.u[6] -- value is positive zero. S1.u[7] -- value is a positive denormal value. S1.u[8] -- value is a positive normal value. S1.u[9] -- value is positive infinity.</p>
18	V_CMP_CLASS_F64	<p>VCC = IEEE numeric class function specified in S1.u, performed on S0.d</p> <p>The function reports true if the floating point value is <i>any*</i> of the numeric types selected in S1.u according to the following list:</p> <p>S1.u[0] -- value is a signaling NaN. S1.u[1] -- value is a quiet NaN. S1.u[2] -- value is negative infinity. S1.u[3] -- value is a negative normal value. S1.u[4] -- value is a negative denormal value. S1.u[5] -- value is negative zero. S1.u[6] -- value is positive zero. S1.u[7] -- value is a positive denormal value. S1.u[8] -- value is a positive normal value. S1.u[9] -- value is positive infinity.</p>

Opcode	Name	Description
19	V_CMPX_CLASS_F64	<p>EXEC = VCC = IEEE numeric class function specified in S1.u, performed on S0.d</p> <p>The function reports true if the floating point value is <i>*any*</i> of the numeric types selected in S1.u according to the following list:</p> <p>S1.u[0] -- value is a signaling NaN. S1.u[1] -- value is a quiet NaN. S1.u[2] -- value is negative infinity. S1.u[3] -- value is a negative normal value. S1.u[4] -- value is a negative denormal value. S1.u[5] -- value is negative zero. S1.u[6] -- value is positive zero. S1.u[7] -- value is a positive denormal value. S1.u[8] -- value is a positive normal value. S1.u[9] -- value is positive infinity.</p>
20	V_CMP_CLASS_F16	<p>VCC = IEEE numeric class function specified in S1.u, performed on S0.f16.</p> <p>Note that the S1 has a format of f16 since floating point literal constants are interpreted as 16 bit value for this opcode</p> <p>The function reports true if the floating point value is <i>*any*</i> of the numeric types selected in S1.u according to the following list:</p> <p>S1.u[0] -- value is a signaling NaN. S1.u[1] -- value is a quiet NaN. S1.u[2] -- value is negative infinity. S1.u[3] -- value is a negative normal value. S1.u[4] -- value is a negative denormal value. S1.u[5] -- value is negative zero. S1.u[6] -- value is positive zero. S1.u[7] -- value is a positive denormal value. S1.u[8] -- value is a positive normal value. S1.u[9] -- value is positive infinity.</p>

Opcode	Name	Description
21	V_CMPX_CLASS_F16	<p>EXEC = VCC = IEEE numeric class function specified in S1.u, performed on S0.f16</p> <p>Note that the S1 has a format of f16 since floating point literal constants are interpreted as 16 bit value for this opcode</p> <p>The function reports true if the floating point value is <i>*any*</i> of the numeric types selected in S1.u according to the following list:</p> <p>S1.u[0] -- value is a signaling NaN. S1.u[1] -- value is a quiet NaN. S1.u[2] -- value is negative infinity. S1.u[3] -- value is a negative normal value. S1.u[4] -- value is a negative denormal value. S1.u[5] -- value is negative zero. S1.u[6] -- value is positive zero. S1.u[7] -- value is a positive denormal value. S1.u[8] -- value is a positive normal value. S1.u[9] -- value is positive infinity.</p>
32	V_CMP_F_F16	D.u64[threadId] = 0.
33	V_CMP_LT_F16	D.u64[threadId] = (S0 < S1).
34	V_CMP_EQ_F16	D.u64[threadId] = (S0 == S1).
35	V_CMP_LE_F16	D.u64[threadId] = (S0 <= S1).
36	V_CMP_GT_F16	D.u64[threadId] = (S0 > S1).
37	V_CMP_LG_F16	D.u64[threadId] = (S0 <> S1).
38	V_CMP_GE_F16	D.u64[threadId] = (S0 >= S1).
39	V_CMP_O_F16	D.u64[threadId] = (!isNan(S0) && !isNan(S1)).
40	V_CMP_U_F16	D.u64[threadId] = (isNan(S0) isNan(S1)).
41	V_CMP_NGE_F16	D.u64[threadId] = !(S0 >= S1) // With NAN inputs this is not the same operation as <.
42	V_CMP_NLG_F16	D.u64[threadId] = !(S0 <> S1) // With NAN inputs this is not the same operation as ==.
43	V_CMP_NGT_F16	D.u64[threadId] = !(S0 > S1) // With NAN inputs this is not the same operation as <=.
44	V_CMP_NLE_F16	D.u64[threadId] = !(S0 <= S1) // With NAN inputs this is not the same operation as >.
45	V_CMP_NEQ_F16	D.u64[threadId] = !(S0 == S1) // With NAN inputs this is not the same operation as !=.
46	V_CMP_NLT_F16	D.u64[threadId] = !(S0 < S1) // With NAN inputs this is not the same operation as >=.
47	V_CMP_TRU_F16	D.u64[threadId] = 1.

Opcode	Name	Description
48	V_CMPX_F_F16	EXEC[threadId] = D.u64[threadId] = 0.
49	V_CMPX_LT_F16	EXEC[threadId] = D.u64[threadId] = (S0 < S1).
50	V_CMPX_EQ_F16	EXEC[threadId] = D.u64[threadId] = (S0 == S1).
51	V_CMPX_LE_F16	EXEC[threadId] = D.u64[threadId] = (S0 <= S1).
52	V_CMPX_GT_F16	EXEC[threadId] = D.u64[threadId] = (S0 > S1).
53	V_CMPX_LG_F16	EXEC[threadId] = D.u64[threadId] = (S0 <> S1).
54	V_CMPX_GE_F16	EXEC[threadId] = D.u64[threadId] = (S0 >= S1).
55	V_CMPX_O_F16	EXEC[threadId] = D.u64[threadId] = (!isNan(S0) && !isNan(S1)).
56	V_CMPX_U_F16	EXEC[threadId] = D.u64[threadId] = (isNan(S0) isNan(S1)).
57	V_CMPX_NGE_F16	EXEC[threadId] = D.u64[threadId] = !(S0 >= S1) // With NAN inputs this is not the same operation as <.
58	V_CMPX_NLG_F16	EXEC[threadId] = D.u64[threadId] = !(S0 <> S1) // With NAN inputs this is not the same operation as ==.
59	V_CMPX_NGT_F16	EXEC[threadId] = D.u64[threadId] = !(S0 > S1) // With NAN inputs this is not the same operation as <=.
60	V_CMPX_NLE_F16	EXEC[threadId] = D.u64[threadId] = !(S0 <= S1) // With NAN inputs this is not the same operation as >.
61	V_CMPX_NEQ_F16	EXEC[threadId] = D.u64[threadId] = !(S0 == S1) // With NAN inputs this is not the same operation as !=.
62	V_CMPX_NLT_F16	EXEC[threadId] = D.u64[threadId] = !(S0 < S1) // With NAN inputs this is not the same operation as >=.
63	V_CMPX_TRU_F16	EXEC[threadId] = D.u64[threadId] = 1.
64	V_CMP_F_F32	D.u64[threadId] = 0.
65	V_CMP_LT_F32	D.u64[threadId] = (S0 < S1).
66	V_CMP_EQ_F32	D.u64[threadId] = (S0 == S1).
67	V_CMP_LE_F32	D.u64[threadId] = (S0 <= S1).
68	V_CMP_GT_F32	D.u64[threadId] = (S0 > S1).
69	V_CMP_LG_F32	D.u64[threadId] = (S0 <> S1).
70	V_CMP_GE_F32	D.u64[threadId] = (S0 >= S1).
71	V_CMP_O_F32	D.u64[threadId] = (!isNan(S0) && !isNan(S1)).
72	V_CMP_U_F32	D.u64[threadId] = (isNan(S0) isNan(S1)).
73	V_CMP_NGE_F32	D.u64[threadId] = !(S0 >= S1) // With NAN inputs this is not the same operation as <.
74	V_CMP_NLG_F32	D.u64[threadId] = !(S0 <> S1) // With NAN inputs this is not the same operation as ==.

Opcode	Name	Description
75	V_CMP_NGT_F32	D.u64[threadId] = !(S0 > S1) // With NAN inputs this is not the same operation as <=.
76	V_CMP_NLE_F32	D.u64[threadId] = !(S0 <= S1) // With NAN inputs this is not the same operation as >.
77	V_CMP_NEQ_F32	D.u64[threadId] = !(S0 == S1) // With NAN inputs this is not the same operation as !=.
78	V_CMP_NLT_F32	D.u64[threadId] = !(S0 < S1) // With NAN inputs this is not the same operation as >=.
79	V_CMP_TRU_F32	D.u64[threadId] = 1.
80	V_CMPX_F_F32	EXEC[threadId] = D.u64[threadId] = 0.
81	V_CMPX_LT_F32	EXEC[threadId] = D.u64[threadId] = (S0 < S1).
82	V_CMPX_EQ_F32	EXEC[threadId] = D.u64[threadId] = (S0 == S1).
83	V_CMPX_LE_F32	EXEC[threadId] = D.u64[threadId] = (S0 <= S1).
84	V_CMPX_GT_F32	EXEC[threadId] = D.u64[threadId] = (S0 > S1).
85	V_CMPX_LG_F32	EXEC[threadId] = D.u64[threadId] = (S0 <> S1).
86	V_CMPX_GE_F32	EXEC[threadId] = D.u64[threadId] = (S0 >= S1).
87	V_CMPX_O_F32	EXEC[threadId] = D.u64[threadId] = (!isNan(S0) && !isNan(S1)).
88	V_CMPX_U_F32	EXEC[threadId] = D.u64[threadId] = (isNan(S0) isNan(S1)).
89	V_CMPX_NGE_F32	EXEC[threadId] = D.u64[threadId] = !(S0 >= S1) // With NAN inputs this is not the same operation as <.
90	V_CMPX_NLG_F32	EXEC[threadId] = D.u64[threadId] = !(S0 <> S1) // With NAN inputs this is not the same operation as ==.
91	V_CMPX_NGT_F32	EXEC[threadId] = D.u64[threadId] = !(S0 > S1) // With NAN inputs this is not the same operation as <=.
92	V_CMPX_NLE_F32	EXEC[threadId] = D.u64[threadId] = !(S0 <= S1) // With NAN inputs this is not the same operation as >.
93	V_CMPX_NEQ_F32	EXEC[threadId] = D.u64[threadId] = !(S0 == S1) // With NAN inputs this is not the same operation as !=.
94	V_CMPX_NLT_F32	EXEC[threadId] = D.u64[threadId] = !(S0 < S1) // With NAN inputs this is not the same operation as >=.
95	V_CMPX_TRU_F32	EXEC[threadId] = D.u64[threadId] = 1.
96	V_CMP_F_F64	D.u64[threadId] = 0.
97	V_CMP_LT_F64	D.u64[threadId] = (S0 < S1).
98	V_CMP_EQ_F64	D.u64[threadId] = (S0 == S1).
99	V_CMP_LE_F64	D.u64[threadId] = (S0 <= S1).

Opcode	Name	Description
100	V_CMP_GT_F64	$D.u64[threadId] = (S0 > S1).$
101	V_CMP_LG_F64	$D.u64[threadId] = (S0 <> S1).$
102	V_CMP_GE_F64	$D.u64[threadId] = (S0 >= S1).$
103	V_CMP_O_F64	$D.u64[threadId] = (!isNan(S0) \&\& !isNan(S1)).$
104	V_CMP_U_F64	$D.u64[threadId] = (isNan(S0) \ \ isNan(S1)).$
105	V_CMP_NGE_F64	$D.u64[threadId] = !(S0 >= S1)$ // With NAN inputs this is not the same operation as $<$.
106	V_CMP_NLG_F64	$D.u64[threadId] = !(S0 <> S1)$ // With NAN inputs this is not the same operation as $=$.
107	V_CMP_NGT_F64	$D.u64[threadId] = !(S0 > S1)$ // With NAN inputs this is not the same operation as $<=$.
108	V_CMP_NLE_F64	$D.u64[threadId] = !(S0 <= S1)$ // With NAN inputs this is not the same operation as $>$.
109	V_CMP_NEQ_F64	$D.u64[threadId] = !(S0 == S1)$ // With NAN inputs this is not the same operation as $!=$.
110	V_CMP_NLT_F64	$D.u64[threadId] = !(S0 < S1)$ // With NAN inputs this is not the same operation as $>=$.
111	V_CMP_TRU_F64	$D.u64[threadId] = 1.$
112	V_CMPX_F_F64	$EXEC[threadId] = D.u64[threadId] = 0.$
113	V_CMPX_LT_F64	$EXEC[threadId] = D.u64[threadId] = (S0 < S1).$
114	V_CMPX_EQ_F64	$EXEC[threadId] = D.u64[threadId] = (S0 == S1).$
115	V_CMPX_LE_F64	$EXEC[threadId] = D.u64[threadId] = (S0 <= S1).$
116	V_CMPX_GT_F64	$EXEC[threadId] = D.u64[threadId] = (S0 > S1).$
117	V_CMPX_LG_F64	$EXEC[threadId] = D.u64[threadId] = (S0 <> S1).$
118	V_CMPX_GE_F64	$EXEC[threadId] = D.u64[threadId] = (S0 >= S1).$
119	V_CMPX_O_F64	$EXEC[threadId] = D.u64[threadId] = (!isNan(S0) \&\& !isNan(S1)).$
120	V_CMPX_U_F64	$EXEC[threadId] = D.u64[threadId] = (isNan(S0) \ \ isNan(S1)).$
121	V_CMPX_NGE_F64	$EXEC[threadId] = D.u64[threadId] = !(S0 >= S1)$ // With NAN inputs this is not the same operation as $<$.
122	V_CMPX_NLG_F64	$EXEC[threadId] = D.u64[threadId] = !(S0 <> S1)$ // With NAN inputs this is not the same operation as $=$.
123	V_CMPX_NGT_F64	$EXEC[threadId] = D.u64[threadId] = !(S0 > S1)$ // With NAN inputs this is not the same operation as $<=$.
124	V_CMPX_NLE_F64	$EXEC[threadId] = D.u64[threadId] = !(S0 <= S1)$ // With NAN inputs this is not the same operation as $>$.

Opcode	Name	Description
125	V_CMPX_NEQ_F64	EXEC[threadId] = D.u64[threadId] = !(S0 == S1) // With NAN inputs this is not the same operation as !=.
126	V_CMPX_NLT_F64	EXEC[threadId] = D.u64[threadId] = !(S0 < S1) // With NAN inputs this is not the same operation as >=.
127	V_CMPX_TRU_F64	EXEC[threadId] = D.u64[threadId] = 1.
160	V_CMP_F_I16	D.u64[threadId] = 0.
161	V_CMP_LT_I16	D.u64[threadId] = (S0 < S1).
162	V_CMP_EQ_I16	D.u64[threadId] = (S0 == S1).
163	V_CMP_LE_I16	D.u64[threadId] = (S0 <= S1).
164	V_CMP_GT_I16	D.u64[threadId] = (S0 > S1).
165	V_CMP_NE_I16	D.u64[threadId] = (S0 <> S1).
166	V_CMP_GE_I16	D.u64[threadId] = (S0 >= S1).
167	V_CMP_T_I16	D.u64[threadId] = 1.
168	V_CMP_F_U16	D.u64[threadId] = 0.
169	V_CMP_LT_U16	D.u64[threadId] = (S0 < S1).
170	V_CMP_EQ_U16	D.u64[threadId] = (S0 == S1).
171	V_CMP_LE_U16	D.u64[threadId] = (S0 <= S1).
172	V_CMP_GT_U16	D.u64[threadId] = (S0 > S1).
173	V_CMP_NE_U16	D.u64[threadId] = (S0 <> S1).
174	V_CMP_GE_U16	D.u64[threadId] = (S0 >= S1).
175	V_CMP_T_U16	D.u64[threadId] = 1.
176	V_CMPX_F_I16	EXEC[threadId] = D.u64[threadId] = 0.
177	V_CMPX_LT_I16	EXEC[threadId] = D.u64[threadId] = (S0 < S1).
178	V_CMPX_EQ_I16	EXEC[threadId] = D.u64[threadId] = (S0 == S1).
179	V_CMPX_LE_I16	EXEC[threadId] = D.u64[threadId] = (S0 <= S1).
180	V_CMPX_GT_I16	EXEC[threadId] = D.u64[threadId] = (S0 > S1).
181	V_CMPX_NE_I16	EXEC[threadId] = D.u64[threadId] = (S0 <> S1).
182	V_CMPX_GE_I16	EXEC[threadId] = D.u64[threadId] = (S0 >= S1).
183	V_CMPX_T_I16	EXEC[threadId] = D.u64[threadId] = 1.
184	V_CMPX_F_U16	EXEC[threadId] = D.u64[threadId] = 0.
185	V_CMPX_LT_U16	EXEC[threadId] = D.u64[threadId] = (S0 < S1).
186	V_CMPX_EQ_U16	EXEC[threadId] = D.u64[threadId] = (S0 == S1).
187	V_CMPX_LE_U16	EXEC[threadId] = D.u64[threadId] = (S0 <= S1).

Opcode	Name	Description
188	V_CMPX_GT_U16	EXEC[threadId] = D.u64[threadId] = (S0 > S1).
189	V_CMPX_NE_U16	EXEC[threadId] = D.u64[threadId] = (S0 <> S1).
190	V_CMPX_GE_U16	EXEC[threadId] = D.u64[threadId] = (S0 >= S1).
191	V_CMPX_T_U16	EXEC[threadId] = D.u64[threadId] = 1.
192	V_CMP_F_I32	D.u64[threadId] = 0.
193	V_CMP_LT_I32	D.u64[threadId] = (S0 < S1).
194	V_CMP_EQ_I32	D.u64[threadId] = (S0 == S1).
195	V_CMP_LE_I32	D.u64[threadId] = (S0 <= S1).
196	V_CMP_GT_I32	D.u64[threadId] = (S0 > S1).
197	V_CMP_NE_I32	D.u64[threadId] = (S0 <> S1).
198	V_CMP_GE_I32	D.u64[threadId] = (S0 >= S1).
199	V_CMP_T_I32	D.u64[threadId] = 1.
200	V_CMP_F_U32	D.u64[threadId] = 0.
201	V_CMP_LT_U32	D.u64[threadId] = (S0 < S1).
202	V_CMP_EQ_U32	D.u64[threadId] = (S0 == S1).
203	V_CMP_LE_U32	D.u64[threadId] = (S0 <= S1).
204	V_CMP_GT_U32	D.u64[threadId] = (S0 > S1).
205	V_CMP_NE_U32	D.u64[threadId] = (S0 <> S1).
206	V_CMP_GE_U32	D.u64[threadId] = (S0 >= S1).
207	V_CMP_T_U32	D.u64[threadId] = 1.
208	V_CMPX_F_I32	EXEC[threadId] = D.u64[threadId] = 0.
209	V_CMPX_LT_I32	EXEC[threadId] = D.u64[threadId] = (S0 < S1).
210	V_CMPX_EQ_I32	EXEC[threadId] = D.u64[threadId] = (S0 == S1).
211	V_CMPX_LE_I32	EXEC[threadId] = D.u64[threadId] = (S0 <= S1).
212	V_CMPX_GT_I32	EXEC[threadId] = D.u64[threadId] = (S0 > S1).
213	V_CMPX_NE_I32	EXEC[threadId] = D.u64[threadId] = (S0 <> S1).
214	V_CMPX_GE_I32	EXEC[threadId] = D.u64[threadId] = (S0 >= S1).
215	V_CMPX_T_I32	EXEC[threadId] = D.u64[threadId] = 1.
216	V_CMPX_F_U32	EXEC[threadId] = D.u64[threadId] = 0.
217	V_CMPX_LT_U32	EXEC[threadId] = D.u64[threadId] = (S0 < S1).
218	V_CMPX_EQ_U32	EXEC[threadId] = D.u64[threadId] = (S0 == S1).
219	V_CMPX_LE_U32	EXEC[threadId] = D.u64[threadId] = (S0 <= S1).

Opcode	Name	Description
220	V_CMPX_GT_U32	EXEC[threadId] = D.u64[threadId] = (S0 > S1).
221	V_CMPX_NE_U32	EXEC[threadId] = D.u64[threadId] = (S0 <> S1).
222	V_CMPX_GE_U32	EXEC[threadId] = D.u64[threadId] = (S0 >= S1).
223	V_CMPX_T_U32	EXEC[threadId] = D.u64[threadId] = 1.
224	V_CMP_F_I64	D.u64[threadId] = 0.
225	V_CMP_LT_I64	D.u64[threadId] = (S0 < S1).
226	V_CMP_EQ_I64	D.u64[threadId] = (S0 == S1).
227	V_CMP_LE_I64	D.u64[threadId] = (S0 <= S1).
228	V_CMP_GT_I64	D.u64[threadId] = (S0 > S1).
229	V_CMP_NE_I64	D.u64[threadId] = (S0 <> S1).
230	V_CMP_GE_I64	D.u64[threadId] = (S0 >= S1).
231	V_CMP_T_I64	D.u64[threadId] = 1.
232	V_CMP_F_U64	D.u64[threadId] = 0.
233	V_CMP_LT_U64	D.u64[threadId] = (S0 < S1).
234	V_CMP_EQ_U64	D.u64[threadId] = (S0 == S1).
235	V_CMP_LE_U64	D.u64[threadId] = (S0 <= S1).
236	V_CMP_GT_U64	D.u64[threadId] = (S0 > S1).
237	V_CMP_NE_U64	D.u64[threadId] = (S0 <> S1).
238	V_CMP_GE_U64	D.u64[threadId] = (S0 >= S1).
239	V_CMP_T_U64	D.u64[threadId] = 1.
240	V_CMPX_F_I64	EXEC[threadId] = D.u64[threadId] = 0.
241	V_CMPX_LT_I64	EXEC[threadId] = D.u64[threadId] = (S0 < S1).
242	V_CMPX_EQ_I64	EXEC[threadId] = D.u64[threadId] = (S0 == S1).
243	V_CMPX_LE_I64	EXEC[threadId] = D.u64[threadId] = (S0 <= S1).
244	V_CMPX_GT_I64	EXEC[threadId] = D.u64[threadId] = (S0 > S1).
245	V_CMPX_NE_I64	EXEC[threadId] = D.u64[threadId] = (S0 <> S1).
246	V_CMPX_GE_I64	EXEC[threadId] = D.u64[threadId] = (S0 >= S1).
247	V_CMPX_T_I64	EXEC[threadId] = D.u64[threadId] = 1.
248	V_CMPX_F_U64	EXEC[threadId] = D.u64[threadId] = 0.
249	V_CMPX_LT_U64	EXEC[threadId] = D.u64[threadId] = (S0 < S1).
250	V_CMPX_EQ_U64	EXEC[threadId] = D.u64[threadId] = (S0 == S1).
251	V_CMPX_LE_U64	EXEC[threadId] = D.u64[threadId] = (S0 <= S1).

Opcode	Name	Description
252	V_CMPX_GT_U64	EXEC[threadId] = D.u64[threadId] = (S0 > S1).
253	V_CMPX_NE_U64	EXEC[threadId] = D.u64[threadId] = (S0 <> S1).
254	V_CMPX_GE_U64	EXEC[threadId] = D.u64[threadId] = (S0 >= S1).
255	V_CMPX_T_U64	EXEC[threadId] = D.u64[threadId] = 1.

12.9.1. VOPC using VOP3A encoding

Instructions in this format may also be encoded as VOP3A. This allows access to the extra control bits (e.g. ABS, OMOD) in exchange for not being able to use a literal constant. The VOP3 opcode is: VOP2 opcode + 0x000.

When the CLAMP microcode bit is set to 1, these compare instructions signal an exception when either of the inputs is NaN. When CLAMP is set to zero, NaN does not signal an exception. The second eight VOPC instructions have {OP8} embedded in them. This refers to each of the compare operations listed below.

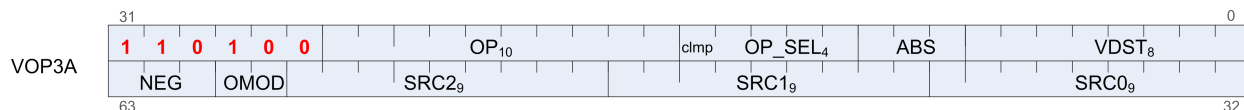

where:

- VDST = Destination for instruction in the VGPR.
- ABS = Floating-point absolute value.
- CLMP = Clamp output.
- OP = Instructions.
- SRC0 = First operand for instruction.
- SRC1 = Second operand for instruction.
- SRC2 = Third operand for instruction. Unused in VOPC instructions.
- OMOD = Output modifier for instruction. Unused in VOPC instructions.
- NEG = Floating-point negation.

12.10. VOP3P Instructions

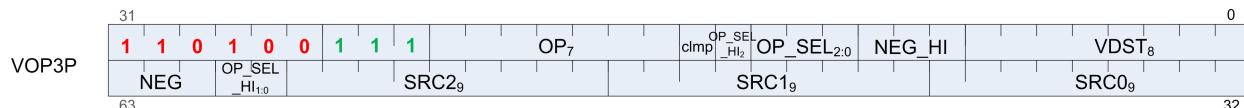

Opcode	Name	Description
0	V_PK_MAD_I16	D.i[31:16] = S0.i[31:16] * S1.i[31:16] + S2.i[31:16] . D.i[15:0] = S0.i[15:0] * S1.i[15:0] + S2.i[15:0] .

Opcode	Name	Description
1	V_PK_MUL_LO_U16	$D.u[31:16] = S0.u[31:16] * S1.u[31:16]$. $D.u[15:0] = S0.u[15:0] * S1.u[15:0]$.
2	V_PK_ADD_I16	$D.i[31:16] = S0.i[31:16] + S1.i[31:16]$. $D.i[15:0] = S0.i[15:0] + S1.i[15:0]$.
3	V_PK_SUB_I16	$D.i[31:16] = S0.i[31:16] - S1.i[31:16]$. $D.i[15:0] = S0.i[15:0] - S1.i[15:0]$.
4	V_PK_LSHLREV_B16	$D.u[31:16] = S1.u[31:16] \ll S0.u[19:16]$. $D.u[15:0] = S1.u[15:0] \ll S0.u[3:0]$.
5	V_PK_LSHRREV_B16	$D.u[31:16] = S1.u[31:16] \gg S0.u[19:16]$. $D.u[15:0] = S1.u[15:0] \gg S0.u[3:0]$.
6	V_PK_ASHRREV_I16	$D.i[31:16] = S1.i[31:16] \gg S0.i[19:16]$. $D.i[15:0] = S1.i[15:0] \gg S0.i[3:0]$.
7	V_PK_MAX_I16	$D.i[31:16] = (S0.i[31:16] \geq S1.i[31:16]) ? S0.i[31:16] : S1.i[31:16]$. $D.i[15:0] = (S0.i[15:0] \geq S1.i[15:0]) ? S0.i[15:0] : S1.i[15:0]$.
8	V_PK_MIN_I16	$D.i[31:16] = (S0.i[31:16] < S1.i[31:16]) ? S0.i[31:16] : S1.i[31:16]$. $D.i[15:0] = (S0.i[15:0] < S1.i[15:0]) ? S0.i[15:0] : S1.i[15:0]$
9	V_PK_MAD_U16	$D.u[31:16] = S0.u[31:16] * S1.u[31:16] + S2.u[31:16]$. $D.u[15:0] = S0.u[15:0] * S1.u[15:0] + S2.u[15:0]$.
10	V_PK_ADD_U16	$D.u[31:16] = S0.u[31:16] + S1.u[31:16]$. $D.u[15:0] = S0.u[15:0] + S1.u[15:0]$.
11	V_PK_SUB_U16	$D.u[31:16] = S0.u[31:16] - S1.u[31:16]$. $D.u[15:0] = S0.u[15:0] - S1.u[15:0]$.
12	V_PK_MAX_U16	$D.u[31:16] = (S0.u[31:16] \geq S1.u[31:16]) ? S0.u[31:16] : S1.u[31:16]$. $D.u[15:0] = (S0.u[15:0] \geq S1.u[15:0]) ? S0.u[15:0] : S1.u[15:0]$.
13	V_PK_MIN_U16	$D.u[31:16] = (S0.u[31:16] < S1.u[31:16]) ? S0.u[31:16] : S1.u[31:16]$. $D.u[15:0] = (S0.u[15:0] < S1.u[15:0]) ? S0.u[15:0] : S1.u[15:0]$.
14	V_PK_FMA_F16	$D.f[31:16] = S0.f[31:16] * S1.f[31:16] + S2.f[31:16]$. $D.f[15:0] = S0.f[15:0] * S1.f[15:0] + S2.f[15:0]$. Fused half-precision multiply add.
15	V_PK_ADD_F16	$D.f[31:16] = S0.f[31:16] + S1.f[31:16]$. $D.f[15:0] = S0.f[15:0] + S1.f[15:0]$.
16	V_PK_MUL_F16	$D.f[31:16] = S0.f[31:16] * S1.f[31:16]$. $D.f[15:0] = S0.f[15:0] * S1.f[15:0]$.
17	V_PK_MIN_F16	$D.f[31:16] = \min(S0.f[31:16], S1.f[31:16])$. $D.f[15:0] = \min(S0.f[15:0], S1.u[15:0])$.

Opcode	Name	Description
18	V_PK_MAX_F16	$D.f[31:16] = \max(S0.f[31:16], S1.f[31:16])$. $D.f[15:0] = \max(S0.f[15:0], S1.f[15:0])$.
32	V_MAD_MIX_F32	$D.f[31:0] = S0.f * S1.f + S2.f$. Size and location of S0, S1 and S2 controlled by OPSEL: 0=src[31:0], 1=src[31:0], 2=src[15:0], 3=src[31:16]. Also, for MAD_MIX, the NEG_HI field acts instead as an absolute-value modifier.
33	V_MAD_MIXLO_F16	$D.f[15:0] = S0.f * S1.f + S2.f$. Size and location of S0, S1 and S2 controlled by OPSEL: 0=src[31:0], 1=src[31:0], 2=src[15:0], 3=src[31:16]. Also, for MAD_MIX, the NEG_HI field acts instead as an absolute-value modifier.
34	V_MAD_MIXHI_F16	$D.f[31:16] = S0.f * S1.f + S2.f$. Size and location of S0, S1 and S2 controlled by OPSEL: 0=src[31:0], 1=src[31:0], 2=src[15:0], 3=src[31:16]. Also, for MAD_MIX, the NEG_HI field acts instead as an absolute-value modifier.
35	V_DOT2_F32_F16	$D.f32 = S0.f16[0] * S1.f16[0] + S0.f16[1] * S1.f16[1] + S2.f32$
38	V_DOT2_I32_I16	$D.i32 = S0.i16[0] * S1.i16[0] + S0.i16[1] * S1.i16[1] + S2.i32$
39	V_DOT2_U32_U16	$D.u32 = S0.u16[0] * S1.u16[0] + S0.u16[1] * S1.u16[1] + S2.u32$
40	V_DOT4_I32_I8	$D.i32 = S0.i8[0] * S1.i8[0] + S0.i8[1] * S1.i8[1] + S0.i8[2] * S1.i8[2] + S0.i8[3] * S1.i8[3] + S2.i32$
41	V_DOT4_U32_U8	$D.u32 = S0.u8[0] * S1.u8[0] + S0.u8[1] * S1.u8[1] + S0.u8[2] * S1.u8[2] + S0.u8[3] * S1.u8[3] + S2.u32$
42	V_DOT8_I32_I4	$D.i32 = S0.i4[0] * S1.i4[0] + S0.i4[1] * S1.i4[1] + S0.i4[2] * S1.i4[2] + S0.i4[3] * S1.i4[3] + S0.i4[4] * S1.i4[4] + S0.i4[5] * S1.i4[5] + S0.i4[6] * S1.i4[6] + S0.i4[7] * S1.i4[7] + S2.i32$
43	V_DOT8_U32_U4	$D.u32 = S0.u4[0] * S1.u4[0] + S0.u4[1] * S1.u4[1] + S0.u4[2] * S1.u4[2] + S0.u4[3] * S1.u4[3] + S0.u4[4] * S1.u4[4] + S0.u4[5] * S1.u4[5] + S0.u4[6] * S1.u4[6] + S0.u4[7] * S1.u4[7] + S2.u32$

12.11. VINTERP Instructions



Opcode	Name	Description
0	V_INTERP_P1_F32	$D.f = P10 * S.f + P0.$ Parameter interpolation. CAUTION: when in HALF_LDS mode, D must not be the same GPR as S; if $D == S$ then data corruption will occur. NOTE: In textual representations the I/J VGPR is the first source and the attribute is the second source; however in the VOP3 encoding the attribute is stored in the src0 field and the VGPR is stored in the src1 field.
1	V_INTERP_P2_F32	$D.f = P20 * S.f + D.f.$ Parameter interpolation. NOTE: In textual representations the I/J VGPR is the first source and the attribute is the second source; however in the VOP3 encoding the attribute is stored in the src0 field and the VGPR is stored in the src1 field.
2	V_INTERP_MOV_F32	$D.f = \{P10, P20, P0\}[S.u].$ Parameter load. Used for custom interpolation in the shader.

12.11.1. VINTERP using VOP3 encoding

Instructions in this format may also be encoded as VOP3A. This allows access to the extra control bits (e.g. ABS, OMOD) in exchange for not being able to use a literal constant. The VOP3 opcode is: VOP2 opcode + 0x270.

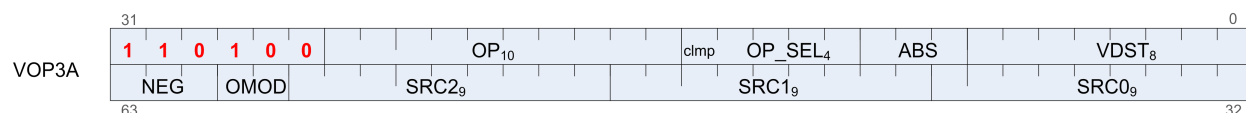

12.12. VOP3A & VOP3B Instructions

VOP3 instructions use one of two encodings:

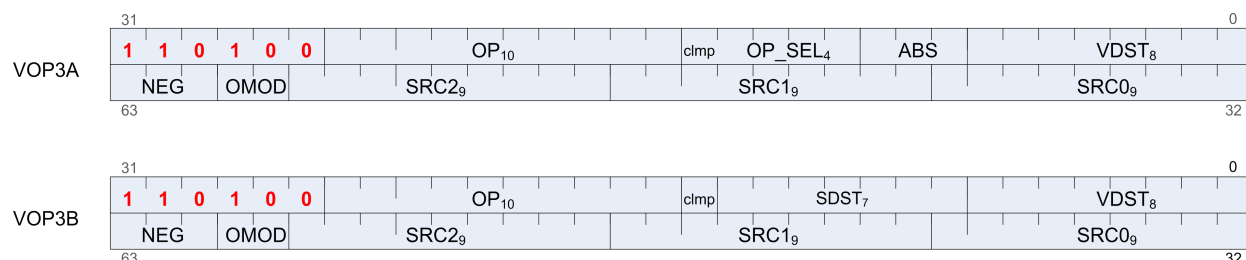

VOP3B this encoding allows specifying a unique scalar destination, and is used only for:

- V_ADD_CO_U32
- V_SUB_CO_U32
- V_SUBREV_CO_U32
- V_ADDC_CO_U32
- V_SUBB_CO_U32
- V_SUBBREV_CO_U32
- V_DIV_SCALE_F32
- V_DIV_SCALE_F64
- V_MAD_U64_U32
- V_MAD_I64_I32

VOP3A all other VALU instructions use this encoding

Opcode	Name	Description
448	V_MAD_LEGACY_F32	$D.f = S0.f * S1.f + S2.f.$ // DX9 rules, $0.0 * x = 0.0$
449	V_MAD_F32	$D.f = S0.f * S1.f + S2.f.$ 1ULP accuracy, denormals are flushed.
450	V_MAD_I32_I24	$D.i = S0.i[23:0] * S1.i[23:0] + S2.i.$
451	V_MAD_U32_U24	$D.u = S0.u[23:0] * S1.u[23:0] + S2.u.$
452	V_CUBEID_F32	$D.f =$ cubemap face ID ($\{0.0, 1.0, \dots, 5.0\}$). XYZ coordinate is given in $(S0.f, S1.f, S2.f)$. Cubemap Face ID determination. Result is a floating point face ID. $S0.f = x$ $S1.f = y$ $S2.f = z$ If $(Abs(S2.f) \geq Abs(S0.f) \ \&\& \ Abs(S2.f) \geq Abs(S1.f))$ If $(S2.f < 0)$ $D.f = 5.0$ Else $D.f = 4.0$ Else if $(Abs(S1.f) \geq Abs(S0.f))$ If $(S1.f < 0)$ $D.f = 3.0$ Else $D.f = 2.0$ Else If $(S0.f < 0)$ $D.f = 1.0$ Else $D.f = 0.0$

Opcode	Name	Description
453	V_CUBESC_F32	<p>D.f = cubemap S coordinate. XYZ coordinate is given in (S0.f, S1.f, S2.f).</p> <p>S0.f = x S1.f = y S2.f = z</p> <p>If (Abs(S2.f) >= Abs(S0.f) && Abs(S2.f) >= Abs(S1.f)) If (S2.f < 0) D.f = -S0.f Else D.f = S0.f</p> <p>Else if (Abs(S1.f) >= Abs(S0.f)) D.f = S0.f</p> <p>Else If (S0.f < 0) D.f = S2.f Else D.f = -S2.f</p>
454	V_CUBETC_F32	<p>D.f = cubemap T coordinate. XYZ coordinate is given in (S0.f, S1.f, S2.f).</p> <p>S0.f = x S1.f = y S2.f = z</p> <p>If (Abs(S2.f) >= Abs(S0.f) && Abs(S2.f) >= Abs(S1.f)) D.f = -S1.f</p> <p>Else if (Abs(S1.f) >= Abs(S0.f)) If (S1.f < 0) D.f = -S2.f Else D.f = S2.f</p> <p>Else D.f = -S1.f</p>
455	V_CUBEMA_F32	<p>D.f = 2.0 * cubemap major axis. XYZ coordinate is given in (S0.f, S1.f, S2.f).</p> <p>S0.f = x S1.f = y S2.f = z</p> <p>If (Abs(S2.f) >= Abs(S0.f) && Abs(S2.f) >= Abs(S1.f)) D.f = 2.0*S2.f</p> <p>Else if (Abs(S1.f) >= Abs(S0.f)) D.f = 2.0 * S1.f</p> <p>Else D.f = 2.0 * S0.f</p>
456	V_BFE_U32	<p>D.u = (S0.u >> S1.u[4:0]) & ((1 << S2.u[4:0]) - 1).</p> <p>Bitfield extract with S0 = data, S1 = field_offset, S2 = field_width.</p>
457	V_BFE_I32	<p>D.i = (S0.i >> S1.u[4:0]) & ((1 << S2.u[4:0]) - 1).</p> <p>Bitfield extract with S0 = data, S1 = field_offset, S2 = field_width.</p>
458	V_BFI_B32	<p>D.u = (S0.u & S1.u) (~S0.u & S2.u).</p> <p>Bitfield insert.</p>

Opcode	Name	Description
459	V_FMA_F32	$D.f = S0.f * S1.f + S2.f.$ Fused single precision multiply add. 0.5ULP accuracy, denormals are supported.
460	V_FMA_F64	$D.d = S0.d * S1.d + S2.d.$ Fused double precision multiply add. 0.5ULP precision, denormals are supported.
461	V_LERP_U8	$D.u = ((S0.u[31:24] + S1.u[31:24] + S2.u[24]) >> 1) << 24$ $D.u += ((S0.u[23:16] + S1.u[23:16] + S2.u[16]) >> 1) << 16;$ $D.u += ((S0.u[15:8] + S1.u[15:8] + S2.u[8]) >> 1) << 8;$ $D.u += ((S0.u[7:0] + S1.u[7:0] + S2.u[0]) >> 1).$ Unsigned 8-bit pixel average on packed unsigned bytes (linear interpolation). S2 acts as a round mode; if set, 0.5 rounds up, otherwise 0.5 truncates.
462	V_ALIGNBIT_B32	$D.u = (\{S0, S1\} >> S2.u[4:0]) \& 0xffffffff.$
463	V_ALIGNBYTE_B32	$D.u = (\{S0, S1\} >> (8*S2.u[4:0])) \& 0xffffffff.$
464	V_MIN3_F32	$D.f = V_MIN_F32(V_MIN_F32(S0.f, S1.f), S2.f).$
465	V_MIN3_I32	$D.i = V_MIN_I32(V_MIN_I32(S0.i, S1.i), S2.i).$
466	V_MIN3_U32	$D.u = V_MIN_U32(V_MIN_U32(S0.u, S1.u), S2.u).$
467	V_MAX3_F32	$D.f = V_MAX_F32(V_MAX_F32(S0.f, S1.f), S2.f).$
468	V_MAX3_I32	$D.i = V_MAX_I32(V_MAX_I32(S0.i, S1.i), S2.i).$
469	V_MAX3_U32	$D.u = V_MAX_U32(V_MAX_U32(S0.u, S1.u), S2.u).$
470	V_MED3_F32	<pre> if (isNan(S0.f) isNan(S1.f) isNan(S2.f)) D.f = V_MIN3_F32(S0.f, S1.f, S2.f); else if (V_MAX3_F32(S0.f, S1.f, S2.f) == S0.f) D.f = V_MAX_F32(S1.f, S2.f); else if (V_MAX3_F32(S0.f, S1.f, S2.f) == S1.f) D.f = V_MAX_F32(S0.f, S2.f); else D.f = V_MAX_F32(S0.f, S1.f); endif. </pre>
471	V_MED3_I32	<pre> if (V_MAX3_I32(S0.i, S1.i, S2.i) == S0.i) D.i = V_MAX_I32(S1.i, S2.i); else if (V_MAX3_I32(S0.i, S1.i, S2.i) == S1.i) D.i = V_MAX_I32(S0.i, S2.i); else D.i = V_MAX_I32(S0.i, S1.i); endif. </pre>

Opcode	Name	Description
472	V_MED3_U32	<pre> if (V_MAX3_U32(S0.u, S1.u, S2.u) == S0.u) D.u = V_MAX_U32(S1.u, S2.u); else if (V_MAX3_U32(S0.u, S1.u, S2.u) == S1.u) D.u = V_MAX_U32(S0.u, S2.u); else D.u = V_MAX_U32(S0.u, S1.u); endif. </pre>
473	V_SAD_U8	<pre> D.u = abs(S0.i[31:24] - S1.i[31:24]); D.u += abs(S0.i[23:16] - S1.i[23:16]); D.u += abs(S0.i[15:8] - S1.i[15:8]); D.u += abs(S0.i[7:0] - S1.i[7:0]) + S2.u. </pre> <p>Sum of absolute differences with accumulation, overflow into upper bits is allowed.</p>
474	V_SAD_HI_U8	<pre> D.u = (SAD_U8(S0, S1, 0) << 16) + S2.u. </pre> <p>Sum of absolute differences with accumulation, overflow is lost.</p>
475	V_SAD_U16	<pre> D.u = abs(S0.i[31:16] - S1.i[31:16]) + abs(S0.i[15:0] - S1.i[15:0]) + S2.u. </pre> <p>Word SAD with accumulation.</p>
476	V_SAD_U32	<pre> D.u = abs(S0.i - S1.i) + S2.u. </pre> <p>Dword SAD with accumulation.</p>
477	V_CVT_PK_U8_F32	<pre> D.u = (S2.u & ~(0xff << (8 * S1.u[1:0]))); D.u = D.u ((flt32_to_uint8(S0.f) & 0xff) << (8 * S1.u[1:0])). </pre> <p>Convert floating point value S0 to 8-bit unsigned integer and pack the result into byte S1 of dword S2.</p>

Opcode	Name	Description
478	V_DIV_FIXUP_F32	<pre> sign_out = sign(S1.f)^sign(S2.f); if (S2.f == NAN) D.f = Quiet(S2.f); else if (S1.f == NAN) D.f = Quiet(S1.f); else if (S1.f == S2.f == 0) // 0/0 D.f = 0xffc0_0000; else if (abs(S1.f) == abs(S2.f) == +-INF) // inf/inf D.f = 0xffc0_0000; else if (S1.f == 0 abs(S2.f) == +-INF) // x/0, or inf/y D.f = sign_out ? -INF : +INF; else if (abs(S1.f) == +-INF S2.f == 0) // x/inf, 0/y D.f = sign_out ? -0 : 0; else if ((exponent(S2.f) - exponent(S1.f)) < -150) D.f = sign_out ? -underflow : underflow; else if (exponent(S1.f) == 255) D.f = sign_out ? -overflow : overflow; else D.f = sign_out ? -abs(S0.f) : abs(S0.f); endif. Single precision division fixup. S0 = Quotient, S1 = Denominator, S2 = Numerator. Given a numerator, denominator, and quotient from a divide, this opcode will detect and apply special case numerics, touching up the quotient if necessary. This opcode also generates invalid, denorm and divide by zero exceptions caused by the division. </pre>

Opcode	Name	Description
479	V_DIV_FIXUP_F64	<pre> sign_out = sign(S1.d)^sign(S2.d); if (S2.d == NAN) D.d = Quiet(S2.d); else if (S1.d == NAN) D.d = Quiet(S1.d); else if (S1.d == S2.d == 0) // 0/0 D.d = 0xfff8_0000_0000_0000; else if (abs(S1.d) == abs(S2.d) == +-INF) // inf/inf D.d = 0xfff8_0000_0000_0000; else if (S1.d == 0 abs(S2.d) == +-INF) // x/0, or inf/y D.d = sign_out ? -INF : +INF; else if (abs(S1.d) == +-INF S2.d == 0) // x/inf, 0/y D.d = sign_out ? -0 : 0; else if ((exponent(S2.d) - exponent(S1.d)) < -1075) D.d = sign_out ? -underflow : underflow; else if (exponent(S1.d) == 2047) D.d = sign_out ? -overflow : overflow; else D.d = sign_out ? -abs(S0.d) : abs(S0.d); endif. Double precision division fixup. S0 = Quotient, S1 = Denominator, S2 = Numerator. Given a numerator, denominator, and quotient from a divide, this opcode will detect and apply special case numerics, touching up the quotient if necessary. This opcode also generates invalid, denorm and divide by zero exceptions caused by the division. </pre>

Opcode	Name	Description
480	V_DIV_SCALE_F32	<pre> VCC = 0; if (S2.f == 0 S1.f == 0) D.f = NAN else if (exponent(S2.f) - exponent(S1.f) >= 96) // N/D near MAX_FLOAT VCC = 1; if (S0.f == S1.f) // Only scale the denominator D.f = ldexp(S0.f, 64); end if else if (S1.f == DENORM) D.f = ldexp(S0.f, 64); else if (1 / S1.f == DENORM && S2.f / S1.f == DENORM) VCC = 1; if (S0.f == S1.f) // Only scale the denominator D.f = ldexp(S0.f, 64); end if else if (1 / S1.f == DENORM) D.f = ldexp(S0.f, -64); else if (S2.f / S1.f == DENORM) VCC = 1; if (S0.f == S2.f) // Only scale the numerator D.f = ldexp(S0.f, 64); end if else if (exponent(S2.f) <= 23) // Numerator is tiny D.f = ldexp(S0.f, 64); end if. </pre> <p>Single precision division pre-scale. S0 = Input to scale (either denominator or numerator), S1 = Denominator, S2 = Numerator.</p> <p>Given a numerator and denominator, this opcode will appropriately scale inputs for division to avoid subnormal terms during Newton-Raphson correction algorithm. S0 must be the same value as either S1 or S2.</p> <p>This opcode produces a VCC flag for post-scaling of the quotient (using V_DIV_FMAS_F32).</p>

Opcode	Name	Description
481	V_DIV_SCALE_F64	<pre> VCC = 0; if (S2.d == 0 S1.d == 0) D.d = NAN else if (exponent(S2.d) - exponent(S1.d) >= 768) // N/D near MAX_FLOAT VCC = 1; if (S0.d == S1.d) // Only scale the denominator D.d = ldexp(S0.d, 128); end if else if (S1.d == DENORM) D.d = ldexp(S0.d, 128); else if (1 / S1.d == DENORM && S2.d / S1.d == DENORM) VCC = 1; if (S0.d == S1.d) // Only scale the denominator D.d = ldexp(S0.d, 128); end if else if (1 / S1.d == DENORM) D.d = ldexp(S0.d, -128); else if (S2.d / S1.d==DENORM) VCC = 1; if (S0.d == S2.d) // Only scale the numerator D.d = ldexp(S0.d, 128); end if else if (exponent(S2.d) <= 53) // Numerator is tiny D.d = ldexp(S0.d, 128); end if. </pre> <p>Double precision division pre-scale. S0 = Input to scale (either denominator or numerator), S1 = Denominator, S2 = Numerator.</p> <p>Given a numerator and denominator, this opcode will appropriately scale inputs for division to avoid subnormal terms during Newton-Raphson correction algorithm. S0 must be the same value as either S1 or S2.</p> <p>This opcode produces a VCC flag for post-scaling of the quotient (using V_DIV_FMAS_F64).</p>

Opcode	Name	Description
482	V_DIV_FMAS_F32	<pre> if (VCC[threadId]) D.f = 2**32 * (S0.f * S1.f + S2.f); else D.f = S0.f * S1.f + S2.f; end if. </pre> <p>Single precision FMA with fused scale.</p> <p>This opcode performs a standard Fused Multiply-Add operation and will conditionally scale the resulting exponent if VCC is set.</p> <p>Input denormals are not flushed, but output flushing is allowed.</p>
483	V_DIV_FMAS_F64	<pre> if (VCC[threadId]) D.d = 2**64 * (S0.d * S1.d + S2.d); else D.d = S0.d * S1.d + S2.d; end if. </pre> <p>Double precision FMA with fused scale.</p> <p>This opcode performs a standard Fused Multiply-Add operation and will conditionally scale the resulting exponent if VCC is set.</p> <p>Input denormals are not flushed, but output flushing is allowed.</p>
484	V_MSAD_U8	D.u = Masked Byte SAD with accum_lo(S0.u, S1.u, S2.u).
485	V_QSAD_PK_U16_U8	D.u = Quad-Byte SAD with 16-bit packed accum_lo/hi(S0.u[63:0], S1.u[31:0], S2.u[63:0])
486	V_MQSAD_PK_U16_U8	D.u = Masked Quad-Byte SAD with 16-bit packed accum_lo/hi(S0.u[63:0], S1.u[31:0], S2.u[63:0])
487	V_MQSAD_U32_U8	D.u128 = Masked Quad-Byte SAD with 32-bit accum_lo/hi(S0.u[63:0], S1.u[31:0], S2.u[127:0])
488	V_MAD_U64_U32	{vcc_out,D.u64} = S0.u32 * S1.u32 + S2.u64.
489	V_MAD_I64_I32	{vcc_out,D.i64} = S0.i32 * S1.i32 + S2.i64.
490	V_MAD_LEGACY_F16	<p>D.f16 = S0.f16 * S1.f16 + S2.f16.</p> <p>Supports round mode, exception flags, saturation.</p> <p>If op_sel[3] is 0 Result is written to 16 LSBs of destination VGPR and hi 16 bits are written as 0 (this is different from V_MAD_F16).</p> <p>If op_sel[3] is 1 Result is written to 16 MSBs of destination VGPR and lo 16 bits are preserved.</p>

Opcode	Name	Description
491	V_MAD_LEGACY_U16	$D.u16 = S0.u16 * S1.u16 + S2.u16.$ <p>Supports saturation (unsigned 16-bit integer domain).</p> <p>If op_sel[3] is 0 Result is written to 16 LSBs of destination VGPR and hi 16 bits are written as 0 (this is different from V_MAD_U16).</p> <p>If op_sel[3] is 1 Result is written to 16 MSBs of destination VGPR and lo 16 bits are preserved.</p>
492	V_MAD_LEGACY_I16	$D.i16 = S0.i16 * S1.i16 + S2.i16.$ <p>Supports saturation (signed 16-bit integer domain).</p> <p>If op_sel[3] is 0 Result is written to 16 LSBs of destination VGPR and hi 16 bits are written as 0 (this is different from V_MAD_I16).</p> <p>If op_sel[3] is 1 Result is written to 16 MSBs of destination VGPR and lo 16 bits are preserved.</p>
493	V_PERM_B32	$D.u[31:24] = \text{byte_permute}(\{S0.u, S1.u\}, S2.u[31:24]);$ $D.u[23:16] = \text{byte_permute}(\{S0.u, S1.u\}, S2.u[23:16]);$ $D.u[15:8] = \text{byte_permute}(\{S0.u, S1.u\}, S2.u[15:8]);$ $D.u[7:0] = \text{byte_permute}(\{S0.u, S1.u\}, S2.u[7:0]);$ <pre> byte permute(byte in[8], byte sel) { if(sel>=13) then return 0xff; elsif(sel==12) then return 0x00; elsif(sel==11) then return in[7][7] * 0xff; elsif(sel==10) then return in[5][7] * 0xff; elsif(sel==9) then return in[3][7] * 0xff; elsif(sel==8) then return in[1][7] * 0xff; else return in[sel]; } </pre> <p>Byte permute.</p>
494	V_FMA_LEGACY_F16	$D.f16 = S0.f16 * S1.f16 + S2.f16.$ <p>Fused half precision multiply add.</p>

Opcode	Name	Description
495	V_DIV_FIXUP_LEGACY_F16	<pre> sign_out = sign(S1.f16)^sign(S2.f16); if (S2.f16 == NAN) D.f16 = Quiet(S2.f16); else if (S1.f16 == NAN) D.f16 = Quiet(S1.f16); else if (S1.f16 == S2.f16 == 0) // 0/0 D.f16 = 0xfe00; else if (abs(S1.f16) == abs(S2.f16) == +-INF) // inf/inf D.f16 = 0xfe00; else if (S1.f16 ==0 abs(S2.f16) == +-INF) // x/0, or inf/y D.f16 = sign_out ? -INF : +INF; else if (abs(S1.f16) == +-INF S2.f16 == 0) // x/inf, 0/y D.f16 = sign_out ? -0 : 0; else D.f16 = sign_out ? -abs(S0.f16) : abs(S0.f16); end if. Half precision division fixup. S0 = Quotient, S1 = Denominator, S2 = Numerator. Given a numerator, denominator, and quotient from a divide, this opcode will detect and apply special case numerics, touching up the quotient if necessary. This opcode also generates invalid, denorm and divide by zero exceptions caused by the division. </pre>
496	V_CVT_PKACCUM_U8_F32	<pre> byte = S1.u[1:0]; bit = byte * 8; D.u[bit+7:bit] = flt32_to_uint8(S0.f). Pack converted value of S0.f into byte S1 of the destination. Note: this opcode uses src_c to pass destination in as a source. </pre>
497	V_MAD_U32_U16	<pre> D.u32 = S0.u16 * S1.u16 + S2.u32. </pre>
498	V_MAD_I32_I16	<pre> D.i32 = S0.i16 * S1.i16 + S2.i32. </pre>
499	V_XAD_U32	<pre> D.u32 = (S0.u32 ^ S1.u32) + S2.u32. No carryin/carryout and no saturation. This opcode exists to accelerate the SHA256 hash algorithm. </pre>
500	V_MIN3_F16	<pre> D.f16 = V_MIN_F16(V_MIN_F16(S0.f16, S1.f16), S2.f16). </pre>
501	V_MIN3_I16	<pre> D.i16 = V_MIN_I16(V_MIN_I16(S0.i16, S1.i16), S2.i16). </pre>
502	V_MIN3_U16	<pre> D.u16 = V_MIN_U16(V_MIN_U16(S0.u16, S1.u16), S2.u16). </pre>
503	V_MAX3_F16	<pre> D.f16 = V_MAX_F16(V_MAX_F16(S0.f16, S1.f16), S2.f16). </pre>
504	V_MAX3_I16	<pre> D.i16 = V_MAX_I16(V_MAX_I16(S0.i16, S1.i16), S2.i16). </pre>

Opcode	Name	Description
505	V_MAX3_U16	$D.u16 = V_MAX_U16(V_MAX_U16(S0.u16, S1.u16), S2.u16).$
506	V_MED3_F16	<pre> if (isNaN(S0.f16) isNaN(S1.f16) isNaN(S2.f16)) D.f16 = V_MIN3_F16(S0.f16, S1.f16, S2.f16); else if (V_MAX3_F16(S0.f16, S1.f16, S2.f16) == S0.f16) D.f16 = V_MAX_F16(S1.f16, S2.f16); else if (V_MAX3_F16(S0.f16, S1.f16, S2.f16) == S1.f16) D.f16 = V_MAX_F16(S0.f16, S2.f16); else D.f16 = V_MAX_F16(S0.f16, S1.f16); endif. </pre>
507	V_MED3_I16	<pre> if (V_MAX3_I16(S0.i16, S1.i16, S2.i16) == S0.i16) D.i16 = V_MAX_I16(S1.i16, S2.i16); else if (V_MAX3_I16(S0.i16, S1.i16, S2.i16) == S1.i16) D.i16 = V_MAX_I16(S0.i16, S2.i16); else D.i16 = V_MAX_I16(S0.i16, S1.i16); endif. </pre>
508	V_MED3_U16	<pre> if (V_MAX3_U16(S0.u16, S1.u16, S2.u16) == S0.u16) D.u16 = V_MAX_U16(S1.u16, S2.u16); else if (V_MAX3_U16(S0.u16, S1.u16, S2.u16) == S1.u16) D.u16 = V_MAX_U16(S0.u16, S2.u16); else D.u16 = V_MAX_U16(S0.u16, S1.u16); endif. </pre>
509	V_LSHL_ADD_U32	$D.u = (S0.u \ll S1.u[4:0]) + S2.u.$
510	V_ADD_LSHL_U32	$D.u = (S0.u + S1.u) \ll S2.u[4:0].$
511	V_ADD3_U32	$D.u = S0.u + S1.u + S2.u.$
512	V_LSHL_OR_B32	$D.u = (S0.u \ll S1.u[4:0]) S2.u.$
513	V_AND_OR_B32	$D.u = (S0.u \& S1.u) S2.u.$
514	V_OR3_B32	$D.u = S0.u S1.u S2.u.$
515	V_MAD_F16	<p>$D.f16 = S0.f16 * S1.f16 + S2.f16.$</p> <p>Supports round mode, exception flags, saturation. 1ULP accuracy, denormals are flushed.</p> <p>If op_sel[3] is 0 Result is written to 16 LSBs of destination VGPR and hi 16 bits are preserved.</p> <p>If op_sel[3] is 1 Result is written to 16 MSBs of destination VGPR and lo 16 bits are preserved.</p>

Opcode	Name	Description
516	V_MAD_U16	$D.u16 = S0.u16 * S1.u16 + S2.u16.$ <p>Supports saturation (unsigned 16-bit integer domain).</p> <p>If op_sel[3] is 0 Result is written to 16 LSBs of destination VGPR and hi 16 bits are preserved.</p> <p>If op_sel[3] is 1 Result is written to 16 MSBs of destination VGPR and lo 16 bits are preserved.</p>
517	V_MAD_I16	$D.i16 = S0.i16 * S1.i16 + S2.i16.$ <p>Supports saturation (signed 16-bit integer domain).</p> <p>If op_sel[3] is 0 Result is written to 16 LSBs of destination VGPR and hi 16 bits are preserved.</p> <p>If op_sel[3] is 1 Result is written to 16 MSBs of destination VGPR and lo 16 bits are preserved.</p>
518	V_FMA_F16	$D.f16 = S0.f16 * S1.f16 + S2.f16.$ <p>Fused half precision multiply add. 0.5ULP accuracy, denormals are supported.</p> <p>If op_sel[3] is 0 Result is written to 16 LSBs of destination VGPR and hi 16 bits are preserved.</p> <p>If op_sel[3] is 1 Result is written to 16 MSBs of destination VGPR and lo 16 bits are preserved.</p>

Opcode	Name	Description
519	V_DIV_FIXUP_F16	<pre> sign_out = sign(S1.f16)^sign(S2.f16); if (S2.f16 == NAN) D.f16 = Quiet(S2.f16); else if (S1.f16 == NAN) D.f16 = Quiet(S1.f16); else if (S1.f16 == S2.f16 == 0) // 0/0 D.f16 = 0xfe00; else if (abs(S1.f16) == abs(S2.f16) == +-INF) // inf/inf D.f16 = 0xfe00; else if (S1.f16 ==0 abs(S2.f16) == +-INF) // x/0, or inf/y D.f16 = sign_out ? -INF : +INF; else if (abs(S1.f16) == +-INF S2.f16 == 0) // x/inf, 0/y D.f16 = sign_out ? -0 : 0; else D.f16 = sign_out ? -abs(S0.f16) : abs(S0.f16); end if. Half precision division fixup. S0 = Quotient, S1 = Denominator, S2 = Numerator. Given a numerator, denominator, and quotient from a divide, this opcode will detect and apply special case numerics, touching up the quotient if necessary. This opcode also generates invalid, denorm and divide by zero exceptions caused by the division. If op_sel[3] is 0 Result is written to 16 LSBs of destination VGPR and hi 16 bits are preserved. If op_sel[3] is 1 Result is written to 16 MSBs of destination VGPR and lo 16 bits are preserved. </pre>
628	V_INTERP_P1LL_F16	<pre> D.f32 = P10.f16 * S0.f32 + P0.f16. `LL' stands for `two LDS arguments'. attr_word selects the high or low half 16 bits of each LDS dword accessed. This opcode is available for 32-bank LDS only. NOTE: In textual representations the I/J VGPR is the first source and the attribute is the second source; however in the VOP3 encoding the attribute is stored in the src0 field and the VGPR is stored in the src1 field. </pre>

Opcode	Name	Description
629	V_INTERP_P1LV_F16	$D.f32 = P10.f16 * S0.f32 + (S2.u32 \gg (\text{attr_word} * 16)).f16.$ <p>`LV' stands for `One LDS and one VGPR argument'. S2 holds two parameters, attr_word selects the high or low word of the VGPR for this calculation, as well as the high or low half of the LDS data. Meant for use with 16-bank LDS.</p> <p>NOTE: In textual representations the I/J VGPR is the first source and the attribute is the second source; however in the VOP3 encoding the attribute is stored in the src0 field and the VGPR is stored in the src1 field.</p>
630	V_INTERP_P2_LEGACY_F16	$D.f16 = P20.f16 * S0.f32 + S2.f32.$ <p>Final computation. attr_word selects LDS high or low 16bits. Used for both 16- and 32-bank LDS. Result is written to the 16 LSBs of the destination VGPR.</p> <p>NOTE: In textual representations the I/J VGPR is the first source and the attribute is the second source; however in the VOP3 encoding the attribute is stored in the src0 field and the VGPR is stored in the src1 field.</p>
631	V_INTERP_P2_F16	$D.f16 = P20.f16 * S0.f32 + S2.f32.$ <p>Final computation. attr_word selects LDS high or low 16bits. Used for both 16- and 32-bank LDS.</p> <p>NOTE: In textual representations the I/J VGPR is the first source and the attribute is the second source; however in the VOP3 encoding the attribute is stored in the src0 field and the VGPR is stored in the src1 field.</p> <p>If op_sel[3] is 0 Result is written to 16 LSBs of destination VGPR and hi 16 bits are preserved. If op_sel[3] is 1 Result is written to 16 MSBs of destination VGPR and lo 16 bits are preserved.</p>
640	V_ADD_F64	$D.d = S0.d + S1.d.$ <p>0.5ULP precision, denormals are supported.</p>
641	V_MUL_F64	$D.d = S0.d * S1.d.$ <p>0.5ULP precision, denormals are supported.</p>

Opcode	Name	Description
642	V_MIN_F64	<pre> if (IEEE_MODE && S0.d == sNaN) D.d = Quiet(S0.d); else if (IEEE_MODE && S1.d == sNaN) D.d = Quiet(S1.d); else if (S0.d == NaN) D.d = S1.d; else if (S1.d == NaN) D.d = S0.d; else if (S0.d == +0.0 && S1.d == -0.0) D.d = S1.d; else if (S0.d == -0.0 && S1.d == +0.0) D.d = S0.d; else // Note: there's no IEEE special case here like there is for V_MAX_F64. D.d = (S0.d < S1.d ? S0.d : S1.d); endif. </pre>
643	V_MAX_F64	<pre> if (IEEE_MODE && S0.d == sNaN) D.d = Quiet(S0.d); else if (IEEE_MODE && S1.d == sNaN) D.d = Quiet(S1.d); else if (S0.d == NaN) D.d = S1.d; else if (S1.d == NaN) D.d = S0.d; else if (S0.d == +0.0 && S1.d == -0.0) D.d = S0.d; else if (S0.d == -0.0 && S1.d == +0.0) D.d = S1.d; else if (IEEE_MODE) D.d = (S0.d >= S1.d ? S0.d : S1.d); else D.d = (S0.d > S1.d ? S0.d : S1.d); endif. </pre>
644	V_LDEXP_F64	D.d = S0.d * (2 ** S1.i).
645	V_MUL_LO_U32	D.u = S0.u * S1.u.
646	V_MUL_HI_U32	D.u = (S0.u * S1.u) >> 32.
647	V_MUL_HI_I32	D.i = (S0.i * S1.i) >> 32.
648	V_LDEXP_F32	D.f = S0.f * (2 ** S1.i).
649	V_READLANE_B32	<p>Copy one VGPR value to one SGPR. D = SGPR-dest, S0 = Source Data (VGPR# or M0(lds-direct)), S1 = Lane Select (SGPR or M0). Ignores exec mask.</p> <p>Input and output modifiers not supported; this is an untyped operation.</p>

Opcode	Name	Description
650	V_WRITELANE_B32	<p>Write value into one VGPR in one lane. D = VGPR-dest, S0 = Source Data (sgpr, m0, exec or constants), S1 = Lane Select (SGPR or M0). Ignores exec mask.</p> <p>Input and output modifiers not supported; this is an untyped operation.</p>
651	V_BCNT_U32_B32	<pre>D.u = 0; for i in 0 ... 31 do D.u += (S0.u[i] == 1 ? 1 : 0); endfor.</pre> <p>Bit count.</p>
652	V_MBCNT_LO_U32_B32	<pre>ThreadMask = (1LL << ThreadPosition) - 1; MaskedValue = (S0.u & ThreadMask[31:0]); D.u = S1.u; for i in 0 ... 31 do D.u += (MaskedValue[i] == 1 ? 1 : 0); endfor.</pre> <p>Masked bit count, ThreadPosition is the position of this thread in the wavefront (in 0..63). See also V_MBCNT_HI_U32_B32.</p>
653	V_MBCNT_HI_U32_B32	<pre>ThreadMask = (1LL << ThreadPosition) - 1; MaskedValue = (S0.u & ThreadMask[63:32]); D.u = S1.u; for i in 0 ... 31 do D.u += (MaskedValue[i] == 1 ? 1 : 0); endfor.</pre> <p>Masked bit count, ThreadPosition is the position of this thread in the wavefront (in 0..63). See also V_MBCNT_LO_U32_B32.</p> <p>Example to compute each thread's position in 0..63:</p> <pre>v_mbcnt_lo_u32_b32 v0, -1, 0 v_mbcnt_hi_u32_b32 v0, -1, v0 // v0 now contains ThreadPosition</pre>
655	V_LSHLREV_B64	D.u64 = S1.u64 << S0.u[5:0].
656	V_LSHRREV_B64	D.u64 = S1.u64 >> S0.u[5:0].
657	V_ASHRREV_I64	D.u64 = signext(S1.u64) >> S0.u[5:0].

Opcode	Name	Description
658	V_TRIG_PREOP_F64	<pre> shift = S1.u * 53; if exponent(S0.d) > 1077 then shift += exponent(S0.d) - 1077; endif result = (double) ((2/PI[1200:0] << shift) & 0x1ffffff_ffffffff); scale = (-53 - shift); if exponent(S0.d) >= 1968 then scale += 128; endif D.d = ldexp(result, scale). </pre> <p>Look Up 2/PI (S0.d) with segment select S1.u[4:0]. This operation returns an aligned, double precision segment of 2/PI needed to do range reduction on S0.d (double-precision value). Multiple segments can be specified through S1.u[4:0]. Rounding uses round-to-zero. Large inputs (exp > 1968) are scaled to avoid loss of precision through denormalization.</p>
659	V_BFM_B32	$D.u = ((1 \ll S0.u[4:0]) - 1) \ll S1.u[4:0].$ <p>Bitfield modify. S0 is the bitfield width and S1 is the bitfield offset.</p>
660	V_CVT_PKNORM_I16_F32	$D = \{(snorm)S1.f, (snorm)S0.f\}.$
661	V_CVT_PKNORM_U16_F32	$D = \{(unorm)S1.f, (unorm)S0.f\}.$
662	V_CVT_PKRTZ_F16_F32	$D = \{flt32_to_flt16(S1.f), flt32_to_flt16(S0.f)\}.$ <p>// Round-toward-zero regardless of current round mode setting in hardware.</p> <p>This opcode is intended for use with 16-bit compressed exports. See V_CVT_F16_F32 for a version that respects the current rounding mode.</p>
663	V_CVT_PK_U16_U32	$D = \{uint32_to_uint16(S1.u), uint32_to_uint16(S0.u)\}.$
664	V_CVT_PK_I16_I32	$D = \{int32_to_int16(S1.i), int32_to_int16(S0.i)\}.$
665	V_CVT_PKNORM_I16_F16	$D = \{(snorm)S1.f16, (snorm)S0.f16\}.$
666	V_CVT_PKNORM_U16_F16	$D = \{(unorm)S1.f16, (unorm)S0.f16\}.$
668	V_ADD_I32	$D.i = S0.i + S1.i.$ <p>Supports saturation (signed 32-bit integer domain).</p>
669	V_SUB_I32	$D.i = S0.i - S1.i.$ <p>Supports saturation (signed 32-bit integer domain).</p>

Opcode	Name	Description
670	V_ADD_I16	$D.i16 = S0.i16 + S1.i16.$ Supports saturation (signed 16-bit integer domain).
671	V_SUB_I16	$D.i16 = S0.i16 - S1.i16.$ Supports saturation (signed 16-bit integer domain).
672	V_PACK_B32_F16	$D[31:16].f16 = S1.f16;$ $D[15:0].f16 = S0.f16.$

12.13. LDS & GDS Instructions

This suite of instructions operates on data stored within the data share memory. The instructions transfer data between VGPRs and data share memory.

The bitfield map for the LDS/GDS is:

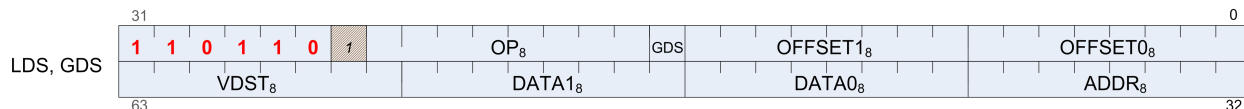

where:

OFFSET0 = Unsigned byte offset added to the address from the ADDR VGPR.

OFFSET1 = Unsigned byte offset added to the address from the ADDR VGPR.

GDS = Set if GDS, cleared if LDS.

OP = DS instructions.

ADDR = Source LDS address VGPR 0 - 255.

DATA0 = Source data0 VGPR 0 - 255.

DATA1 = Source data1 VGPR 0 - 255.

VDST = Destination VGPR 0- 255.



All instructions with RTN in the name return the value that was in memory before the operation was performed.

Opcode	Name	Description
0	DS_ADD_U32	<code>// 32bit</code> <code>tmp = MEM[ADDR];</code> <code>MEM[ADDR] += DATA;</code> <code>RETURN_DATA = tmp.</code>
1	DS_SUB_U32	<code>// 32bit</code> <code>tmp = MEM[ADDR];</code> <code>MEM[ADDR] -= DATA;</code> <code>RETURN_DATA = tmp.</code>

Opcode	Name	Description
2	DS_RSUB_U32	<pre>// 32bit tmp = MEM[ADDR]; MEM[ADDR] = DATA - MEM[ADDR]; RETURN_DATA = tmp.</pre> <p>Subtraction with reversed operands.</p>
3	DS_INC_U32	<pre>// 32bit tmp = MEM[ADDR]; MEM[ADDR] = (tmp >= DATA) ? 0 : tmp + 1; // unsigned compare RETURN_DATA = tmp.</pre>
4	DS_DEC_U32	<pre>// 32bit tmp = MEM[ADDR]; MEM[ADDR] = (tmp == 0 tmp > DATA) ? DATA : tmp - 1; // unsigned compare RETURN_DATA = tmp.</pre>
5	DS_MIN_I32	<pre>// 32bit tmp = MEM[ADDR]; MEM[ADDR] = (DATA < tmp) ? DATA : tmp; // signed compare RETURN_DATA = tmp.</pre>
6	DS_MAX_I32	<pre>// 32bit tmp = MEM[ADDR]; MEM[ADDR] = (DATA > tmp) ? DATA : tmp; // signed compare RETURN_DATA = tmp.</pre>
7	DS_MIN_U32	<pre>// 32bit tmp = MEM[ADDR]; MEM[ADDR] = (DATA < tmp) ? DATA : tmp; // unsigned compare RETURN_DATA = tmp.</pre>
8	DS_MAX_U32	<pre>// 32bit tmp = MEM[ADDR]; MEM[ADDR] = (DATA > tmp) ? DATA : tmp; // unsigned compare RETURN_DATA = tmp.</pre>
9	DS_AND_B32	<pre>// 32bit tmp = MEM[ADDR]; MEM[ADDR] &= DATA; RETURN_DATA = tmp.</pre>
10	DS_OR_B32	<pre>// 32bit tmp = MEM[ADDR]; MEM[ADDR] = DATA; RETURN_DATA = tmp.</pre>
11	DS_XOR_B32	<pre>// 32bit tmp = MEM[ADDR]; MEM[ADDR] ^= DATA; RETURN_DATA = tmp.</pre>

Opcode	Name	Description
12	DS_MSKOR_B32	<pre>// 32bit tmp = MEM[ADDR]; MEM[ADDR] = (MEM[ADDR] & ~DATA) DATA2; RETURN_DATA = tmp.</pre> <p>Masked dword OR, D0 contains the mask and D1 contains the new value.</p>
13	DS_WRITE_B32	<pre>// 32bit MEM[ADDR] = DATA.</pre> <p>Write dword.</p>
14	DS_WRITE2_B32	<pre>// 32bit MEM[ADDR_BASE + OFFSET0 * 4] = DATA; MEM[ADDR_BASE + OFFSET1 * 4] = DATA2.</pre> <p>Write 2 dwords.</p>
15	DS_WRITE2ST64_B32	<pre>// 32bit MEM[ADDR_BASE + OFFSET0 * 4 * 64] = DATA; MEM[ADDR_BASE + OFFSET1 * 4 * 64] = DATA2.</pre> <p>Write 2 dwords.</p>
16	DS_CMPST_B32	<pre>// 32bit tmp = MEM[ADDR]; src = DATA2; cmp = DATA; MEM[ADDR] = (tmp == cmp) ? src : tmp; RETURN_DATA[0] = tmp.</pre> <p>Compare and store. Caution, the order of src and cmp are the <i>opposite</i> of the BUFFER_ATOMIC_CMPSWAP opcode.</p>
17	DS_CMPST_F32	<pre>// 32bit tmp = MEM[ADDR]; src = DATA2; cmp = DATA; MEM[ADDR] = (tmp == cmp) ? src : tmp; RETURN_DATA[0] = tmp.</pre> <p>Floating point compare and store that handles NaN/INF/denormal values.</p>
18	DS_MIN_F32	<pre>// 32bit tmp = MEM[ADDR]; src = DATA; cmp = DATA2; MEM[ADDR] = (cmp < tmp) ? src : tmp.</pre> <p>Floating point minimum that handles NaN/INF/denormal values.</p>

Opcode	Name	Description
19	DS_MAX_F32	<pre>// 32bit tmp = MEM[ADDR]; src = DATA; cmp = DATA2; MEM[ADDR] = (tmp > cmp) ? src : tmp.</pre> <p>Floating point maximum that handles NaN/INF/denormal values.</p>
20	DS_NOP	Do nothing.
21	DS_ADD_F32	<pre>// 32bit tmp = MEM[ADDR]; MEM[ADDR] += DATA; RETURN_DATA = tmp.</pre> <p>Floating point add that handles NaN/INF/denormal values.</p>
29	DS_WRITE_ADDTID_B32	<pre>// 32bit MEM[ADDR_BASE + OFFSET + M0.OFFSET + TID*4] = DATA.</pre> <p>Write dword.</p>
30	DS_WRITE_B8	<pre>MEM[ADDR] = DATA[7:0].</pre> <p>Byte write.</p>
31	DS_WRITE_B16	<pre>MEM[ADDR] = DATA[15:0].</pre> <p>Short write.</p>
32	DS_ADD_RTN_U32	<pre>// 32bit tmp = MEM[ADDR]; MEM[ADDR] += DATA; RETURN_DATA = tmp.</pre>
33	DS_SUB_RTN_U32	<pre>// 32bit tmp = MEM[ADDR]; MEM[ADDR] -= DATA; RETURN_DATA = tmp.</pre>
34	DS_RSUB_RTN_U32	<pre>// 32bit tmp = MEM[ADDR]; MEM[ADDR] = DATA - MEM[ADDR]; RETURN_DATA = tmp.</pre> <p>Subtraction with reversed operands.</p>
35	DS_INC_RTN_U32	<pre>// 32bit tmp = MEM[ADDR]; MEM[ADDR] = (tmp >= DATA) ? 0 : tmp + 1; // unsigned compare RETURN_DATA = tmp.</pre>

Opcode	Name	Description
36	DS_DEC_RTN_U32	<pre>// 32bit tmp = MEM[ADDR]; MEM[ADDR] = (tmp == 0 tmp > DATA) ? DATA : tmp - 1; // unsigned compare RETURN_DATA = tmp.</pre>
37	DS_MIN_RTN_I32	<pre>// 32bit tmp = MEM[ADDR]; MEM[ADDR] = (DATA < tmp) ? DATA : tmp; // signed compare RETURN_DATA = tmp.</pre>
38	DS_MAX_RTN_I32	<pre>// 32bit tmp = MEM[ADDR]; MEM[ADDR] = (DATA > tmp) ? DATA : tmp; // signed compare RETURN_DATA = tmp.</pre>
39	DS_MIN_RTN_U32	<pre>// 32bit tmp = MEM[ADDR]; MEM[ADDR] = (DATA < tmp) ? DATA : tmp; // unsigned compare RETURN_DATA = tmp.</pre>
40	DS_MAX_RTN_U32	<pre>// 32bit tmp = MEM[ADDR]; MEM[ADDR] = (DATA > tmp) ? DATA : tmp; // unsigned compare RETURN_DATA = tmp.</pre>
41	DS_AND_RTN_B32	<pre>// 32bit tmp = MEM[ADDR]; MEM[ADDR] &= DATA; RETURN_DATA = tmp.</pre>
42	DS_OR_RTN_B32	<pre>// 32bit tmp = MEM[ADDR]; MEM[ADDR] = DATA; RETURN_DATA = tmp.</pre>
43	DS_XOR_RTN_B32	<pre>// 32bit tmp = MEM[ADDR]; MEM[ADDR] ^= DATA; RETURN_DATA = tmp.</pre>
44	DS_MSKOR_RTN_B32	<pre>// 32bit tmp = MEM[ADDR]; MEM[ADDR] = (MEM[ADDR] & ~DATA) DATA2; RETURN_DATA = tmp.</pre> <p>Masked dword OR, D0 contains the mask and D1 contains the new value.</p>
45	DS_WRXCHG_RTN_B32	<pre>tmp = MEM[ADDR]; MEM[ADDR] = DATA; RETURN_DATA = tmp.</pre> <p>Write-exchange operation.</p>

Opcode	Name	Description
46	DS_WRXCHG2_RTN_B32	Write-exchange 2 separate dwords.
47	DS_WRXCHG2ST64_RT N_B32	Write-exchange 2 separate dwords with a stride of 64 dwords.
48	DS_CMPST_RTN_B32	<pre>// 32bit tmp = MEM[ADDR]; src = DATA2; cmp = DATA; MEM[ADDR] = (tmp == cmp) ? src : tmp; RETURN_DATA[0] = tmp.</pre> <p>Compare and store. Caution, the order of src and cmp are the <i>opposite</i> of the BUFFER_ATOMIC_CMPSWAP opcode.</p>
49	DS_CMPST_RTN_F32	<pre>// 32bit tmp = MEM[ADDR]; src = DATA2; cmp = DATA; MEM[ADDR] = (tmp == cmp) ? src : tmp; RETURN_DATA[0] = tmp.</pre> <p>Floating point compare and store that handles NaN/INF/denormal values.</p>
50	DS_MIN_RTN_F32	<pre>// 32bit tmp = MEM[ADDR]; src = DATA; cmp = DATA2; MEM[ADDR] = (cmp < tmp) ? src : tmp.</pre> <p>Floating point minimum that handles NaN/INF/denormal values.</p>
51	DS_MAX_RTN_F32	<pre>// 32bit tmp = MEM[ADDR]; src = DATA; cmp = DATA2; MEM[ADDR] = (tmp > cmp) ? src : tmp.</pre> <p>Floating point maximum that handles NaN/INF/denormal values.</p>
52	DS_WRAP_RTN_B32	<pre>tmp = MEM[ADDR]; MEM[ADDR] = (tmp >= DATA) ? tmp - DATA : tmp + DATA2; RETURN_DATA = tmp.</pre>
53	DS_ADD_RTN_F32	<pre>// 32bit tmp = MEM[ADDR]; MEM[ADDR] += DATA; RETURN_DATA = tmp.</pre> <p>Floating point add that handles NaN/INF/denormal values.</p>

Opcode	Name	Description
54	DS_READ_B32	$RETURN_DATA = MEM[ADDR].$ Dword read.
55	DS_READ2_B32	$RETURN_DATA[0] = MEM[ADDR_BASE + OFFSET0 * 4];$ $RETURN_DATA[1] = MEM[ADDR_BASE + OFFSET1 * 4].$ Read 2 dwords.
56	DS_READ2ST64_B32	$RETURN_DATA[0] = MEM[ADDR_BASE + OFFSET0 * 4 * 64];$ $RETURN_DATA[1] = MEM[ADDR_BASE + OFFSET1 * 4 * 64].$ Read 2 dwords.
57	DS_READ_I8	$RETURN_DATA = \text{signext}(MEM[ADDR][7:0]).$ Signed byte read.
58	DS_READ_U8	$RETURN_DATA = \{24'h0, MEM[ADDR][7:0]\}.$ Unsigned byte read.
59	DS_READ_I16	$RETURN_DATA = \text{signext}(MEM[ADDR][15:0]).$ Signed short read.
60	DS_READ_U16	$RETURN_DATA = \{16'h0, MEM[ADDR][15:0]\}.$ Unsigned short read.
61	DS_SWIZZLE_B32	Dword swizzle, no data is written to LDS memory. See next section for details.

Opcode	Name	Description
62	DS_PERMUTE_B32	<pre data-bbox="623 191 1398 852"> // VGPR[index][thread_id] is the VGPR RAM // VDST, ADDR and DATA0 are from the microcode DS encoding tmp[0..63] = 0 for i in 0..63 do // If a source thread is disabled, it will not propagate data. next if !EXEC[i] // ADDR needs to be divided by 4. // High-order bits are ignored. dst_lane = floor((VGPR[ADDR][i] + OFFSET) / 4) mod 64 tmp[dst_lane] = VGPR[DATA0][i] endfor // Copy data into destination VGPRs. If multiple sources // select the same destination thread, the highest-numbered // source thread wins. for i in 0..63 do next if !EXEC[i] VGPR[VDST][i] = tmp[i] endfor </pre> <p data-bbox="623 894 1398 1020">Forward permute. This does not access LDS memory and may be called even if no LDS memory is allocated to the wave. It uses LDS hardware to implement an arbitrary swizzle across threads in a wavefront.</p> <p data-bbox="623 1062 1398 1125">Note the address passed in is the thread ID multiplied by 4. This is due to a limitation in the DS hardware design.</p> <p data-bbox="623 1167 1398 1230">If multiple sources map to the same destination lane, standard LDS arbitration rules determine which write wins.</p> <p data-bbox="623 1272 943 1293">See also DS_BPERMUTE_B32.</p> <p data-bbox="623 1335 1154 1356">Examples (simplified 4-thread wavefronts):</p> <pre data-bbox="623 1398 984 1524"> VGPR[SRC0] = { A, B, C, D } VGPR[ADDR] = { 0, 0, 12, 4 } EXEC = 0xF, OFFSET = 0 VGPR[VDST] := { B, D, 0, C } </pre> <pre data-bbox="623 1566 984 1692"> VGPR[SRC0] = { A, B, C, D } VGPR[ADDR] = { 0, 0, 12, 4 } EXEC = 0xA, OFFSET = 0 VGPR[VDST] := { -, D, -, 0 } </pre>

Opcode	Name	Description
63	DS_BPERMUTE_B32	<pre> // VGPR[index][thread_id] is the VGPR RAM // VDST, ADDR and DATA0 are from the microcode DS encoding tmp[0..63] = 0 for i in 0..63 do // ADDR needs to be divided by 4. // High-order bits are ignored. src_lane = floor((VGPR[ADDR][i] + OFFSET) / 4) mod 64 // EXEC is applied to the source VGPR reads. next if !EXEC[src_lane] tmp[i] = VGPR[DATA0][src_lane] endfor // Copy data into destination VGPRs. Some source // data may be broadcast to multiple lanes. for i in 0..63 do next if !EXEC[i] VGPR[VDST][i] = tmp[i] endfor </pre> <p>Backward permute. This does not access LDS memory and may be called even if no LDS memory is allocated to the wave. It uses LDS hardware to implement an arbitrary swizzle across threads in a wavefront.</p> <p>Note the address passed in is the thread ID multiplied by 4. This is due to a limitation in the DS hardware design.</p> <p>Note that EXEC mask is applied to both VGPR read and write. If src_lane selects a disabled thread, zero will be returned.</p> <p>See also DS_PERMUTE_B32.</p> <p>Examples (simplified 4-thread wavefronts):</p> <pre> VGPR[SRC0] = { A, B, C, D } VGPR[ADDR] = { 0, 0, 12, 4 } EXEC = 0xF, OFFSET = 0 VGPR[VDST] := { A, A, D, B } VGPR[SRC0] = { A, B, C, D } VGPR[ADDR] = { 0, 0, 12, 4 } EXEC = 0xA, OFFSET = 0 VGPR[VDST] := { -, 0, -, B } </pre>
64	DS_ADD_U64	<pre> // 64bit tmp = MEM[ADDR]; MEM[ADDR] += DATA[0:1]; RETURN_DATA[0:1] = tmp. </pre>
65	DS_SUB_U64	<pre> // 64bit tmp = MEM[ADDR]; MEM[ADDR] -= DATA[0:1]; RETURN_DATA[0:1] = tmp. </pre>

Opcode	Name	Description
66	DS_RSUB_U64	<pre>// 64bit tmp = MEM[ADDR]; MEM[ADDR] = DATA - MEM[ADDR]; RETURN_DATA = tmp.</pre> <p>Subtraction with reversed operands.</p>
67	DS_INC_U64	<pre>// 64bit tmp = MEM[ADDR]; MEM[ADDR] = (tmp >= DATA[0:1]) ? 0 : tmp + 1; // unsigned compare RETURN_DATA[0:1] = tmp.</pre>
68	DS_DEC_U64	<pre>// 64bit tmp = MEM[ADDR]; MEM[ADDR] = (tmp == 0 tmp > DATA[0:1]) ? DATA[0:1] : tmp - 1; // unsigned compare RETURN_DATA[0:1] = tmp.</pre>
69	DS_MIN_I64	<pre>// 64bit tmp = MEM[ADDR]; MEM[ADDR] -= (DATA[0:1] < tmp) ? DATA[0:1] : tmp; // signed compare RETURN_DATA[0:1] = tmp.</pre>
70	DS_MAX_I64	<pre>// 64bit tmp = MEM[ADDR]; MEM[ADDR] -= (DATA[0:1] > tmp) ? DATA[0:1] : tmp; // signed compare RETURN_DATA[0:1] = tmp.</pre>
71	DS_MIN_U64	<pre>// 64bit tmp = MEM[ADDR]; MEM[ADDR] -= (DATA[0:1] < tmp) ? DATA[0:1] : tmp; // unsigned compare RETURN_DATA[0:1] = tmp.</pre>
72	DS_MAX_U64	<pre>// 64bit tmp = MEM[ADDR]; MEM[ADDR] -= (DATA[0:1] > tmp) ? DATA[0:1] : tmp; // unsigned compare RETURN_DATA[0:1] = tmp.</pre>
73	DS_AND_B64	<pre>// 64bit tmp = MEM[ADDR]; MEM[ADDR] &= DATA[0:1]; RETURN_DATA[0:1] = tmp.</pre>
74	DS_OR_B64	<pre>// 64bit tmp = MEM[ADDR]; MEM[ADDR] = DATA[0:1]; RETURN_DATA[0:1] = tmp.</pre>

Opcode	Name	Description
75	DS_XOR_B64	<pre>// 64bit tmp = MEM[ADDR]; MEM[ADDR] ^= DATA[0:1]; RETURN_DATA[0:1] = tmp.</pre>
76	DS_MSKOR_B64	<pre>// 64bit tmp = MEM[ADDR]; MEM[ADDR] = (MEM[ADDR] & ~DATA) DATA2; RETURN_DATA = tmp.</pre> <p>Masked dword OR, D0 contains the mask and D1 contains the new value.</p>
77	DS_WRITE_B64	<pre>// 64bit MEM[ADDR] = DATA.</pre> <p>Write qword.</p>
78	DS_WRITE2_B64	<pre>// 64bit MEM[ADDR_BASE + OFFSET0 * 8] = DATA; MEM[ADDR_BASE + OFFSET1 * 8] = DATA2.</pre> <p>Write 2 qwords.</p>
79	DS_WRITE2ST64_B64	<pre>// 64bit MEM[ADDR_BASE + OFFSET0 * 8 * 64] = DATA; MEM[ADDR_BASE + OFFSET1 * 8 * 64] = DATA2.</pre> <p>Write 2 qwords.</p>
80	DS_CMPST_B64	<pre>// 64bit tmp = MEM[ADDR]; src = DATA2; cmp = DATA; MEM[ADDR] = (tmp == cmp) ? src : tmp; RETURN_DATA[0] = tmp.</pre> <p>Compare and store. Caution, the order of src and cmp are the <i>opposite</i> of the BUFFER_ATOMIC_CMPSWAP_X2 opcode.</p>
81	DS_CMPST_F64	<pre>// 64bit tmp = MEM[ADDR]; src = DATA2; cmp = DATA; MEM[ADDR] = (tmp == cmp) ? src : tmp; RETURN_DATA[0] = tmp.</pre> <p>Floating point compare and store that handles NaN/INF/denormal values.</p>

Opcode	Name	Description
82	DS_MIN_F64	<pre>// 64bit tmp = MEM[ADDR]; src = DATA; cmp = DATA2; MEM[ADDR] = (cmp < tmp) ? src : tmp.</pre> <p>Floating point minimum that handles NaN/INF/denormal values.</p>
83	DS_MAX_F64	<pre>// 64bit tmp = MEM[ADDR]; src = DATA; cmp = DATA2; MEM[ADDR] = (tmp > cmp) ? src : tmp.</pre> <p>Floating point maximum that handles NaN/INF/denormal values.</p>
84	DS_WRITE_B8_D16_HI	<p>MEM[ADDR] = DATA[23:16].</p> <p>Byte write in to high word.</p>
85	DS_WRITE_B16_D16_HI	<p>MEM[ADDR] = DATA[31:16].</p> <p>Short write in to high word.</p>
86	DS_READ_U8_D16	<p>RETURN_DATA[15:0] = {8'h0, MEM[ADDR][7:0]}.</p> <p>Unsigned byte read with masked return to lower word.</p>
87	DS_READ_U8_D16_HI	<p>RETURN_DATA[31:16] = {8'h0, MEM[ADDR][7:0]}.</p> <p>Unsigned byte read with masked return to upper word.</p>
88	DS_READ_I8_D16	<p>RETURN_DATA[15:0] = signext(MEM[ADDR][7:0]).</p> <p>Signed byte read with masked return to lower word.</p>
89	DS_READ_I8_D16_HI	<p>RETURN_DATA[31:16] = signext(MEM[ADDR][7:0]).</p> <p>Signed byte read with masked return to upper word.</p>
90	DS_READ_U16_D16	<p>RETURN_DATA[15:0] = MEM[ADDR][15:0].</p> <p>Unsigned short read with masked return to lower word.</p>
91	DS_READ_U16_D16_HI	<p>RETURN_DATA[31:0] = MEM[ADDR][15:0].</p> <p>Unsigned short read with masked return to upper word.</p>
96	DS_ADD_RTN_U64	<pre>// 64bit tmp = MEM[ADDR]; MEM[ADDR] += DATA[0:1]; RETURN_DATA[0:1] = tmp.</pre>

Opcode	Name	Description
97	DS_SUB_RTN_U64	<pre>// 64bit tmp = MEM[ADDR]; MEM[ADDR] -= DATA[0:1]; RETURN_DATA[0:1] = tmp.</pre>
98	DS_RSUB_RTN_U64	<pre>// 64bit tmp = MEM[ADDR]; MEM[ADDR] = DATA - MEM[ADDR]; RETURN_DATA = tmp.</pre> <p>Subtraction with reversed operands.</p>
99	DS_INC_RTN_U64	<pre>// 64bit tmp = MEM[ADDR]; MEM[ADDR] = (tmp >= DATA[0:1]) ? 0 : tmp + 1; // unsigned compare RETURN_DATA[0:1] = tmp.</pre>
100	DS_DEC_RTN_U64	<pre>// 64bit tmp = MEM[ADDR]; MEM[ADDR] = (tmp == 0 tmp > DATA[0:1]) ? DATA[0:1] : tmp - 1; // unsigned compare RETURN_DATA[0:1] = tmp.</pre>
101	DS_MIN_RTN_I64	<pre>// 64bit tmp = MEM[ADDR]; MEM[ADDR] -= (DATA[0:1] < tmp) ? DATA[0:1] : tmp; // signed compare RETURN_DATA[0:1] = tmp.</pre>
102	DS_MAX_RTN_I64	<pre>// 64bit tmp = MEM[ADDR]; MEM[ADDR] -= (DATA[0:1] > tmp) ? DATA[0:1] : tmp; // signed compare RETURN_DATA[0:1] = tmp.</pre>
103	DS_MIN_RTN_U64	<pre>// 64bit tmp = MEM[ADDR]; MEM[ADDR] -= (DATA[0:1] < tmp) ? DATA[0:1] : tmp; // unsigned compare RETURN_DATA[0:1] = tmp.</pre>
104	DS_MAX_RTN_U64	<pre>// 64bit tmp = MEM[ADDR]; MEM[ADDR] -= (DATA[0:1] > tmp) ? DATA[0:1] : tmp; // unsigned compare RETURN_DATA[0:1] = tmp.</pre>
105	DS_AND_RTN_B64	<pre>// 64bit tmp = MEM[ADDR]; MEM[ADDR] &= DATA[0:1]; RETURN_DATA[0:1] = tmp.</pre>

Opcode	Name	Description
106	DS_OR_RTN_B64	<pre>// 64bit tmp = MEM[ADDR]; MEM[ADDR] = DATA[0:1]; RETURN_DATA[0:1] = tmp.</pre>
107	DS_XOR_RTN_B64	<pre>// 64bit tmp = MEM[ADDR]; MEM[ADDR] ^= DATA[0:1]; RETURN_DATA[0:1] = tmp.</pre>
108	DS_MSKOR_RTN_B64	<pre>// 64bit tmp = MEM[ADDR]; MEM[ADDR] = (MEM[ADDR] & ~DATA) DATA2; RETURN_DATA = tmp.</pre> <p>Masked dword OR, D0 contains the mask and D1 contains the new value.</p>
109	DS_WRXCHG_RTN_B64	<pre>tmp = MEM[ADDR]; MEM[ADDR] = DATA; RETURN_DATA = tmp.</pre> <p>Write-exchange operation.</p>
110	DS_WRXCHG2_RTN_B64	Write-exchange 2 separate qwords.
111	DS_WRXCHG2ST64_RTN_B64	Write-exchange 2 qwords with a stride of 64 qwords.
112	DS_CMPST_RTN_B64	<pre>// 64bit tmp = MEM[ADDR]; src = DATA2; cmp = DATA; MEM[ADDR] = (tmp == cmp) ? src : tmp; RETURN_DATA[0] = tmp.</pre> <p>Compare and store. Caution, the order of src and cmp are the <i>opposite</i> of the BUFFER_ATOMIC_CMPSWAP_X2 opcode.</p>
113	DS_CMPST_RTN_F64	<pre>// 64bit tmp = MEM[ADDR]; src = DATA2; cmp = DATA; MEM[ADDR] = (tmp == cmp) ? src : tmp; RETURN_DATA[0] = tmp.</pre> <p>Floating point compare and store that handles NaN/INF/denormal values.</p>

Opcode	Name	Description
114	DS_MIN_RTN_F64	<pre>// 64bit tmp = MEM[ADDR]; src = DATA; cmp = DATA2; MEM[ADDR] = (cmp < tmp) ? src : tmp.</pre> <p>Floating point minimum that handles NaN/INF/denormal values.</p>
115	DS_MAX_RTN_F64	<pre>// 64bit tmp = MEM[ADDR]; src = DATA; cmp = DATA2; MEM[ADDR] = (tmp > cmp) ? src : tmp.</pre> <p>Floating point maximum that handles NaN/INF/denormal values.</p>
118	DS_READ_B64	<p>RETURN_DATA = MEM[ADDR].</p> <p>Read 1 qword.</p>
119	DS_READ2_B64	<p>RETURN_DATA[0] = MEM[ADDR_BASE + OFFSET0 * 8]; RETURN_DATA[1] = MEM[ADDR_BASE + OFFSET1 * 8].</p> <p>Read 2 qwords.</p>
120	DS_READ2ST64_B64	<p>RETURN_DATA[0] = MEM[ADDR_BASE + OFFSET0 * 8 * 64]; RETURN_DATA[1] = MEM[ADDR_BASE + OFFSET1 * 8 * 64].</p> <p>Read 2 qwords.</p>
126	DS_CONDXCHG32_RTN_B64	Conditional write exchange.
128	DS_ADD_SRC2_U32	<pre>//32bit A = ADDR_BASE; B = A + 4*(offset1[7] ? {A[31],A[31:17]} : {offset1[6],offset1[6:0],offset0}); MEM[A] = MEM[A] + MEM[B].</pre>
129	DS_SUB_SRC2_U32	<pre>//32bit A = ADDR_BASE; B = A + 4*(offset1[7] ? {A[31],A[31:17]} : {offset1[6],offset1[6:0],offset0}); MEM[A] = MEM[A] - MEM[B].</pre>
130	DS_RSUB_SRC2_U32	<pre>//32bit A = ADDR_BASE; B = A + 4*(offset1[7] ? {A[31],A[31:17]} : {offset1[6],offset1[6:0],offset0}); MEM[A] = MEM[B] - MEM[A].</pre>

Opcode	Name	Description
131	DS_INC_SRC2_U32	<pre>//32bit A = ADDR_BASE; B = A + 4*(offset1[7] ? {A[31],A[31:17]} : {offset1[6],offset1[6:0],offset0}); MEM[A] = (MEM[A] >= MEM[B] ? 0 : MEM[A] + 1).</pre>
132	DS_DEC_SRC2_U32	<pre>//32bit A = ADDR_BASE; B = A + 4*(offset1[7] ? {A[31],A[31:17]} : {offset1[6],offset1[6:0],offset0}); MEM[A] = (MEM[A] == 0 MEM[A] > MEM[B] ? MEM[B] : MEM[A] - 1).</pre> <p>Uint decrement.</p>
133	DS_MIN_SRC2_I32	<pre>//32bit A = ADDR_BASE; B = A + 4*(offset1[7] ? {A[31],A[31:17]} : {offset1[6],offset1[6:0],offset0}); MEM[A] = min(MEM[A], MEM[B]).</pre>
134	DS_MAX_SRC2_I32	<pre>//32bit A = ADDR_BASE; B = A + 4*(offset1[7] ? {A[31],A[31:17]} : {offset1[6],offset1[6:0],offset0}); MEM[A] = max(MEM[A], MEM[B]).</pre>
135	DS_MIN_SRC2_U32	<pre>//32bit A = ADDR_BASE; B = A + 4*(offset1[7] ? {A[31],A[31:17]} : {offset1[6],offset1[6:0],offset0}); MEM[A] = min(MEM[A], MEM[B]).</pre>
136	DS_MAX_SRC2_U32	<pre>//32bit A = ADDR_BASE; B = A + 4*(offset1[7] ? {A[31],A[31:17]} : {offset1[6],offset1[6:0],offset0}); MEM[A] = max(MEM[A], MEM[B]).</pre>
137	DS_AND_SRC2_B32	<pre>//32bit A = ADDR_BASE; B = A + 4*(offset1[7] ? {A[31],A[31:17]} : {offset1[6],offset1[6:0],offset0}); MEM[A] = MEM[A] & MEM[B].</pre>
138	DS_OR_SRC2_B32	<pre>//32bit A = ADDR_BASE; B = A + 4*(offset1[7] ? {A[31],A[31:17]} : {offset1[6],offset1[6:0],offset0}); MEM[A] = MEM[A] MEM[B].</pre>

Opcode	Name	Description
139	DS_XOR_SRC2_B32	<pre>//32bit A = ADDR_BASE; B = A + 4*(offset1[7] ? {A[31],A[31:17]} : {offset1[6],offset1[6:0],offset0}); MEM[A] = MEM[A] ^ MEM[B].</pre>
141	DS_WRITE_SRC2_B32	<pre>//32bit A = ADDR_BASE; B = A + 4*(offset1[7] ? {A[31],A[31:17]} : {offset1[6],offset1[6:0],offset0}); MEM[A] = MEM[B]. Write dword.</pre>
146	DS_MIN_SRC2_F32	<pre>//32bit A = ADDR_BASE; B = A + 4*(offset1[7] ? {A[31],A[31:17]} : {offset1[6],offset1[6:0],offset0}); MEM[A] = (MEM[B] < MEM[A]) ? MEM[B] : MEM[A]. Float, handles NaN/INF/denorm.</pre>
147	DS_MAX_SRC2_F32	<pre>//32bit A = ADDR_BASE; B = A + 4*(offset1[7] ? {A[31],A[31:17]} : {offset1[6],offset1[6:0],offset0}); MEM[A] = (MEM[B] > MEM[A]) ? MEM[B] : MEM[A]. Float, handles NaN/INF/denorm.</pre>
149	DS_ADD_SRC2_F32	<pre>//32bit A = ADDR_BASE; B = A + 4*(offset1[7] ? {A[31],A[31:17]} : {offset1[6],offset1[6:0],offset0}); MEM[A] = MEM[B] + MEM[A]. Float, handles NaN/INF/denorm.</pre>
152	DS_GWS_SEMA_RELEASE_ALL	<p>GDS Only: The GWS resource (rid) indicated will process this opcode by updating the counter and labeling the specified resource as a semaphore.</p> <pre>// Determine the GWS resource to work on rid[5:0] = SH_SX_EXPCMD.gds_base[5:0] + offset0[5:0]; // Incr the state counter of the resource state.counter[rid] = state.wave_in_queue; state.type = SEMAPHORE; return rd_done; //release calling wave</pre> <p>This action will release ALL queued waves; it Will have no effect if no waves are present.</p>

Opcode	Name	Description
153	DS_GWS_INIT	<p>GDS Only: Initialize a barrier or semaphore resource.</p> <pre> // Determine the GWS resource to work on rid[5:0] = SH_SX_EXPCMD.gds_base[5:0] + offset0[5:0]; // Get the value to use in init index = find_first_valid(vector mask) value = DATA[thread: index] // Set the state of the resource state.counter[rid] = lsb(value); //limit #waves state.flag[rid] = 0; return rd_done; //release calling wave </pre>
154	DS_GWS_SEMA_V	<p>GDS Only: The GWS resource indicated will process this opcode by updating the counter and labeling the resource as a semaphore.</p> <pre> //Determine the GWS resource to work on rid[5:0] = SH_SX_EXPCMD.gds_base[5:0] + offset0[5:0]; //Incr the state counter of the resource state.counter[rid] += 1; state.type = SEMAPHORE; return rd_done; //release calling wave </pre> <p>This action will release one waved if any are queued in this resource.</p>
155	DS_GWS_SEMA_BR	<p>GDS Only: The GWS resource indicated will process this opcode by updating the counter by the bulk release delivered count and labeling the resource as a semaphore.</p> <pre> //Determine the GWS resource to work on rid[5:0] = SH_SX_EXPCMD.gds_base[5:0] + offset0[5:0]; index = find first valid (vector mask) count = DATA[thread: index]; //Add count to the resource state counter state.counter[rid] += count; state.type = SEMAPHORE; return rd_done; //release calling wave </pre> <p>This action will release count number of waves, immediately if queued, or as they arrive from the noted resource.</p>

Opcode	Name	Description
156	DS_GWS_SEMA_P	<p>GDS Only: The GWS resource indicated will process this opcode by queueing it until counter enables a release and then decrementing the counter of the resource as a semaphore.</p> <pre>//Determine the GWS resource to work on rid[5:0] = SH_SX_EXPCMD.gds_base[5:0] + offset0[5:0]; state.type = SEMAPHORE; ENQUEUE until(state[rid].counter > 0) state[rid].counter -= 1; return rd_done;</pre>
157	DS_GWS_BARRIER	<p>GDS Only: The GWS resource indicated will process this opcode by queueing it until barrier is satisfied. The number of waves needed is passed in as DATA of first valid thread.</p> <pre>//Determine the GWS resource to work on rid[5:0] = SH_SX_EXPCMD.gds_base[5:0] + OFFSET0[5:0]; index = find first valid (vector mask); value = DATA[thread: index]; // Input Decision Machine state.type[rid] = BARRIER; if(state[rid].counter <= 0) then thread[rid].flag = state[rid].flag; ENQUEUE; state[rid].flag = !state.flag; state[rid].counter = value; return rd_done; else state[rid].counter -= 1; thread.flag = state[rid].flag; ENQUEUE; endif.</pre> <p>Since the waves deliver the count for the next barrier, this function can have a different size barrier for each occurrence.</p> <pre>// Release Machine if(state.type == BARRIER) then if(state.flag != thread.flag) then return rd_done; endif; endif.</pre>
182	DS_READ_ADDTID_B32	<p>RETURN_DATA = MEM[ADDR_BASE + OFFSET + M0.OFFSET + TID*4].</p> <p>Dword read.</p>
189	DS_CONSUME	<p>LDS & GDS. Subtract (count_bits(exec_mask)) from the value stored in DS memory at (M0.base + instr_offset). Return the pre-operation value to VGPRs.</p>

Opcode	Name	Description
190	DS_APPEND	LDS & GDS. Add (count_bits(exec_mask)) to the value stored in DS memory at (M0.base + instr_offset). Return the pre-operation value to VGPRs.
191	DS_ORDERED_COUNT	GDS-only. Add (count_bits(exec_mask)) to one of 4 dedicated ordered-count counters (aka 'packers'). Additional bits of instr.offset field are overloaded to hold packer-id, 'last'.
192	DS_ADD_SRC2_U64	<pre>//64bit A = ADDR_BASE; B = A + 4*(offset1[7] ? {A[31],A[31:17]} : {offset1[6],offset1[6:0],offset0}); MEM[A] = MEM[A] + MEM[B].</pre>
193	DS_SUB_SRC2_U64	<pre>//64bit A = ADDR_BASE; B = A + 4*(offset1[7] ? {A[31],A[31:17]} : {offset1[6],offset1[6:0],offset0}); MEM[A] = MEM[A] - MEM[B].</pre>
194	DS_RSUB_SRC2_U64	<pre>//64bit A = ADDR_BASE; B = A + 4*(offset1[7] ? {A[31],A[31:17]} : {offset1[6],offset1[6:0],offset0}); MEM[A] = MEM[B] - MEM[A].</pre>
195	DS_INC_SRC2_U64	<pre>//64bit A = ADDR_BASE; B = A + 4*(offset1[7] ? {A[31],A[31:17]} : {offset1[6],offset1[6:0],offset0}); MEM[A] = (MEM[A] >= MEM[B] ? 0 : MEM[A] + 1).</pre>
196	DS_DEC_SRC2_U64	<pre>//64bit A = ADDR_BASE; B = A + 4*(offset1[7] ? {A[31],A[31:17]} : {offset1[6],offset1[6:0],offset0}); MEM[A] = (MEM[A] == 0 MEM[A] > MEM[B] ? MEM[B] : MEM[A] - 1). Uint decrement.</pre>
197	DS_MIN_SRC2_I64	<pre>//64bit A = ADDR_BASE; B = A + 4*(offset1[7] ? {A[31],A[31:17]} : {offset1[6],offset1[6:0],offset0}); MEM[A] = min(MEM[A], MEM[B]).</pre>
198	DS_MAX_SRC2_I64	<pre>//64bit A = ADDR_BASE; B = A + 4*(offset1[7] ? {A[31],A[31:17]} : {offset1[6],offset1[6:0],offset0}); MEM[A] = max(MEM[A], MEM[B]).</pre>

Opcode	Name	Description
199	DS_MIN_SRC2_U64	<pre>//64bit A = ADDR_BASE; B = A + 4*(offset1[7] ? {A[31],A[31:17]} : {offset1[6],offset1[6:0],offset0}); MEM[A] = min(MEM[A], MEM[B]).</pre>
200	DS_MAX_SRC2_U64	<pre>//64bit A = ADDR_BASE; B = A + 4*(offset1[7] ? {A[31],A[31:17]} : {offset1[6],offset1[6:0],offset0}); MEM[A] = max(MEM[A], MEM[B]).</pre>
201	DS_AND_SRC2_B64	<pre>//64bit A = ADDR_BASE; B = A + 4*(offset1[7] ? {A[31],A[31:17]} : {offset1[6],offset1[6:0],offset0}); MEM[A] = MEM[A] & MEM[B].</pre>
202	DS_OR_SRC2_B64	<pre>//64bit A = ADDR_BASE; B = A + 4*(offset1[7] ? {A[31],A[31:17]} : {offset1[6],offset1[6:0],offset0}); MEM[A] = MEM[A] MEM[B].</pre>
203	DS_XOR_SRC2_B64	<pre>//64bit A = ADDR_BASE; B = A + 4*(offset1[7] ? {A[31],A[31:17]} : {offset1[6],offset1[6:0],offset0}); MEM[A] = MEM[A] ^ MEM[B].</pre>
205	DS_WRITE_SRC2_B64	<pre>//64bit A = ADDR_BASE; B = A + 4*(offset1[7] ? {A[31],A[31:17]} : {offset1[6],offset1[6:0],offset0}); MEM[A] = MEM[B]. Write qword.</pre>
210	DS_MIN_SRC2_F64	<pre>//64bit A = ADDR_BASE; B = A + 4*(offset1[7] ? {A[31],A[31:17]} : {offset1[6],offset1[6:0],offset0}); MEM[A] = (MEM[B] < MEM[A]) ? MEM[B] : MEM[A]. Float, handles NaN/INF/denorm.</pre>
211	DS_MAX_SRC2_F64	<pre>//64bit A = ADDR_BASE; B = A + 4*(offset1[7] ? {A[31],A[31:17]} : {offset1[6],offset1[6:0],offset0}); MEM[A] = (MEM[B] > MEM[A]) ? MEM[B] : MEM[A]. Float, handles NaN/INF/denorm.</pre>

Opcode	Name	Description
222	DS_WRITE_B96	$\{MEM[ADDR + 8], MEM[ADDR + 4], MEM[ADDR]\} = DATA[95:0]$. Tri-dword write.
223	DS_WRITE_B128	$\{MEM[ADDR + 12], MEM[ADDR + 8], MEM[ADDR + 4], MEM[ADDR]\} = DATA[127:0]$. Quad-dword write.
254	DS_READ_B96	Tri-dword read.
255	DS_READ_B128	Quad-dword read.

12.13.1. DS_SWIZZLE_B32 Details

Dword swizzle, no data is written to LDS memory.
 Swizzles input thread data based on offset mask and returns; note does not read or write the DS memory banks.
 Note that reading from an invalid thread results in 0x0.
 This opcode supports two special modes, FFT and rotate, plus two basic modes which swizzle in groups of 4 or 32 consecutive threads.
 The FFT mode (offset $\geq 0xe000$) swizzles the input based on offset[4:0] to support FFT calculation. Example swizzles using input {1, 2, ... 20} are:
 Offset[4:0]: Swizzle
 0x00: {1, 11, 9, 19, 5, 15, d, 1d, 3, 13, b, 1b, 7, 17, f, 1f, 2, 12, a, 1a, 6, 16, e, 1e, 4, 14, c, 1c, 8, 18, 10, 20}
 0x10: {1, 9, 5, d, 3, b, 7, f, 2, a, 6, e, 4, c, 8, 10, 11, 19, 15, 1d, 13, 1b, 17, 1f, 12, 1a, 16, 1e, 14, 1c, 18, 20}
 0x1f: No swizzle
 The rotate mode (offset $\geq 0xc000$ and offset $< 0xe000$) rotates the input either left (offset[10] == 0) or right (offset[10] == 1) a number of threads equal to offset[9:5]. The rotate mode also uses a mask value which can alter the rotate result. For example, mask == 1 will swap the odd threads across every other even thread (rotate left), or even threads across every other odd thread (rotate right).
 Offset[9:5]: Swizzle
 0x01, mask=0, rotate left:
 {2, 3, 4, 5, 6, 7, 8, 9, a, b, c, d, e, f, 10, 11, 12, 13, 14, 15, 16, 17, 18, 19, 1a, 1b, 1c, 1d, 1e, 1f, 20, 1}
 0x01, mask=0, rotate right:
 {20, 1, 2, 3, 4, 5, 6, 7, 8, 9, a, b, c, d, e, f, 10, 11, 12, 13, 14, 15, 16, 17, 18, 19, 1a, 1b, 1c, 1d, 1e, 1f}
 0x01, mask=1, rotate left:
 {2, 1, 4, 7, 6, 5, 8, b, a, 9, c, f, e, d, 10, 13, 12, 11, 14, 17, 16, 15, 18, 1b, 1a, 19, 1c, 1f, 1e, 1d, 20, 3}
 0x01, mask=1, rotate right:
 {1e, 1, 4, 3, 2, 5, 8, 7, 6, 9, c, b, a, d, 10, f, e, 11, 14, 13, 12, 15, 18, 17, 16, 19, 1c, 1b, 1a, 1d, 20, 1f}
 If offset $< 0xc000$, one of the basic swizzle modes is used based on offset[15]. If offset[15] == 1, groups of 4 consecutive threads are swizzled together. If offset[15] == 0, all 32 threads are swizzled together. The first basic swizzle mode (when offset[15] == 1) allows full data sharing between a group of 4 consecutive threads. Any thread within the group of 4 can get data from any other thread within the group of 4, specified by the corresponding offset bits --- [1:0] for the first thread, [3:2] for the second thread, [5:4] for the third thread, [7:6] for the fourth thread. Note that the offset bits apply to all groups of 4 within a wavefront; thus if offset[1:0] == 1, then thread0 will grab thread1, thread4 will grab thread5, etc.
 The second basic swizzle mode (when offset[15] == 0) allows limited data sharing between 32 consecutive threads. In this case, the offset is used to specify a 5-bit xor-mask, 5-bit or-

mask, and 5-bit and-mask used to generate a thread mapping. Note that the offset bits apply to each group of 32 within a wavefront. The details of the thread mapping are listed below. Some example usages:

```
SWAPX16 : xor_mask = 0x10, or_mask = 0x00, and_mask = 0x1f
SWAPX8  : xor_mask = 0x08, or_mask = 0x00, and_mask = 0x1f
SWAPX4  : xor_mask = 0x04, or_mask = 0x00, and_mask = 0x1f
SWAPX2  : xor_mask = 0x02, or_mask = 0x00, and_mask = 0x1f
SWAPX1  : xor_mask = 0x01, or_mask = 0x00, and_mask = 0x1f
REVERSEX32 : xor_mask = 0x1f, or_mask = 0x00, and_mask = 0x1f
REVERSEX16 : xor_mask = 0x0f, or_mask = 0x00, and_mask = 0x1f
REVERSEX8  : xor_mask = 0x07, or_mask = 0x00, and_mask = 0x1f
REVERSEX4  : xor_mask = 0x03, or_mask = 0x00, and_mask = 0x1f
REVERSEX2  : xor_mask = 0x01, or_mask = 0x00, and_mask = 0x1f
BCASTX32 : xor_mask = 0x00, or_mask = thread, and_mask = 0x00
BCASTX16 : xor_mask = 0x00, or_mask = thread, and_mask = 0x10
BCASTX8   : xor_mask = 0x00, or_mask = thread, and_mask = 0x18
BCASTX4   : xor_mask = 0x00, or_mask = thread, and_mask = 0x1c
BCASTX2   : xor_mask = 0x00, or_mask = thread, and_mask = 0x1e
```

Pseudocode follows:

```
offset = offset1:offset0;
```

```

if (offset >= 0xe000) {
    // FFT decomposition
    mask = offset[4:0];
    for (i = 0; i < 64; i++) {
        j = reverse_bits(i & 0x1f);
        j = (j >> count_ones(mask));
        j |= (i & mask);
        j |= i & 0x20;
        thread_out[i] = thread_valid[j] ? thread_in[j] : 0;
    }
} else if (offset >= 0xc000) {
    // rotate
    rotate = offset[9:5];
    mask = offset[4:0];
    if (offset[10]) {
        rotate = -rotate;
    }
    for (i = 0; i < 64; i++) {
        j = (i & mask) | ((i + rotate) & ~mask);
        j |= i & 0x20;
        thread_out[i] = thread_valid[j] ? thread_in[j] : 0;
    }
} else if (offset[15]) {
    // full data sharing within 4 consecutive threads
    for (i = 0; i < 64; i+=4) {
        thread_out[i+0] = thread_valid[i+offset[1:0]]?thread_in[i+offset[1:0]]:0;
        thread_out[i+1] = thread_valid[i+offset[3:2]]?thread_in[i+offset[3:2]]:0;
        thread_out[i+2] = thread_valid[i+offset[5:4]]?thread_in[i+offset[5:4]]:0;
        thread_out[i+3] = thread_valid[i+offset[7:6]]?thread_in[i+offset[7:6]]:0;
    }
} else { // offset[15] == 0
    // limited data sharing within 32 consecutive threads
    xor_mask = offset[14:10];
    or_mask = offset[9:5];
    and_mask = offset[4:0];
    for (i = 0; i < 64; i++) {
        j = (((i & 0x1f) & and_mask) | or_mask) ^ xor_mask;
        j |= (i & 0x20); // which group of 32
        thread_out[i] = thread_valid[j] ? thread_in[j] : 0;
    }
}
}

```

12.13.2. LDS Instruction Limitations

Some of the DS instructions are available only to GDS, not LDS. These are:

- DS_GWS_SEMA_RELEASE_ALL
- DS_GWS_INIT
- DS_GWS_SEMA_V
- DS_GWS_SEMA_BR

- DS_GWS_SEMA_P
- DS_GWS_BARRIER
- DS_ORDERED_COUNT

12.14. MUBUF Instructions

The bitfield map of the MUBUF format is:

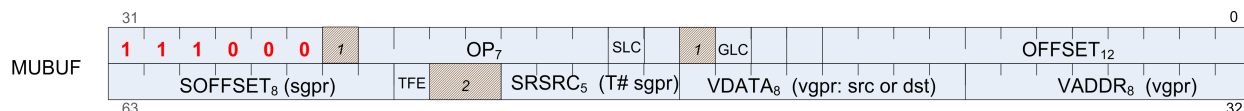

where:

OFFSET = Unsigned immediate byte offset.
 OFFEN = Send offset either as VADDR or as zero..
 IDXEN = Send index either as VADDR or as zero.
 GLC = Global coherency.
 ADDR64 = Buffer address of 64 bits.
 LDS = Data read from/written to LDS or VGPR.
 OP = Opcode instructions.
 VADDR = VGPR address source.
 VDATA = Destination vector GPR.
 SRSRC = Scalar GPR that specifies resource constant.
 SLC = System level coherent.
 TFE = Texture fail enable.
 SOFFSET = Byte offset added to the memory address of an SGPR.

Opcode	Name	Description
0	BUFFER_LOAD_FORMAT_X	Untyped buffer load 1 dword with format conversion.
1	BUFFER_LOAD_FORMAT_XY	Untyped buffer load 2 dwords with format conversion.
2	BUFFER_LOAD_FORMAT_XYZ	Untyped buffer load 3 dwords with format conversion.
3	BUFFER_LOAD_FORMAT_XYZW	Untyped buffer load 4 dwords with format conversion.
4	BUFFER_STORE_FORMAT_X	Untyped buffer store 1 dword with format conversion.
5	BUFFER_STORE_FORMAT_XY	Untyped buffer store 2 dwords with format conversion.
6	BUFFER_STORE_FORMAT_XYZ	Untyped buffer store 3 dwords with format conversion.
7	BUFFER_STORE_FORMAT_XYZW	Untyped buffer store 4 dwords with format conversion.
8	BUFFER_LOAD_FORMAT_D16_X	Untyped buffer load 1 dword with format conversion. D0[15:0] = {8'h0, MEM[ADDR]}.
9	BUFFER_LOAD_FORMAT_D16_XY	Untyped buffer load 1 dword with format conversion.
10	BUFFER_LOAD_FORMAT_D16_XYZ	Untyped buffer load 2 dwords with format conversion.

Opcode	Name	Description
11	BUFFER_LOAD_FORMAT_D16_XYZW	Untyped buffer load 2 dwords with format conversion.
12	BUFFER_STORE_FORMAT_D16_X	Untyped buffer store 1 dword with format conversion.
13	BUFFER_STORE_FORMAT_D16_XY	Untyped buffer store 1 dword with format conversion.
14	BUFFER_STORE_FORMAT_D16_XYZ	Untyped buffer store 2 dwords with format conversion.
15	BUFFER_STORE_FORMAT_D16_XYZW	Untyped buffer store 2 dwords with format conversion.
16	BUFFER_LOAD_UBYTE	Untyped buffer load unsigned byte (zero extend to VGPR destination).
17	BUFFER_LOAD_SBYTE	Untyped buffer load signed byte (sign extend to VGPR destination).
18	BUFFER_LOAD_USHORT	Untyped buffer load unsigned short (zero extend to VGPR destination).
19	BUFFER_LOAD_SSHORT	Untyped buffer load signed short (sign extend to VGPR destination).
20	BUFFER_LOAD_DWORD	Untyped buffer load dword.
21	BUFFER_LOAD_DWORDX2	Untyped buffer load 2 dwords.
22	BUFFER_LOAD_DWORDX3	Untyped buffer load 3 dwords.
23	BUFFER_LOAD_DWORDX4	Untyped buffer load 4 dwords.
24	BUFFER_STORE_BYTE	Untyped buffer store byte. Stores S0[7:0].
25	BUFFER_STORE_BYTE_D16_HI	Untyped buffer store byte. Stores S0[23:16].
26	BUFFER_STORE_SHORT	Untyped buffer store short. Stores S0[15:0].
27	BUFFER_STORE_SHORT_D16_HI	Untyped buffer store short. Stores S0[31:16].
28	BUFFER_STORE_DWORD	Untyped buffer store dword.
29	BUFFER_STORE_DWORDX2	Untyped buffer store 2 dwords.
30	BUFFER_STORE_DWORDX3	Untyped buffer store 3 dwords.
31	BUFFER_STORE_DWORDX4	Untyped buffer store 4 dwords.
32	BUFFER_LOAD_UBYTE_D16	D0[15:0] = {8'h0, MEM[ADDR]}. Untyped buffer load unsigned byte.
33	BUFFER_LOAD_UBYTE_D16_HI	D0[31:16] = {8'h0, MEM[ADDR]}. Untyped buffer load unsigned byte.

Opcode	Name	Description
34	BUFFER_LOAD_SBYTE_D16	$D0[15:0] = \{8'h0, MEM[ADDR]\}.$ Untyped buffer load signed byte.
35	BUFFER_LOAD_SBYTE_D16_HI	$D0[31:16] = \{8'h0, MEM[ADDR]\}.$ Untyped buffer load signed byte.
36	BUFFER_LOAD_SHORT_D16	$D0[15:0] = MEM[ADDR].$ Untyped buffer load short.
37	BUFFER_LOAD_SHORT_D16_HI	$D0[31:16] = MEM[ADDR].$ Untyped buffer load short.
38	BUFFER_LOAD_FORMAT_D16_HI_X	$D0[31:16] = MEM[ADDR].$ Untyped buffer load 1 dword with format conversion.
39	BUFFER_STORE_FORMAT_D16_HI_X	Untyped buffer store 1 dword with format conversion.
61	BUFFER_STORE_LDS_DWORD	Store one DWORD from LDS memory to system memory without utilizing VGPRs.
62	BUFFER_WBINVL1	Write back and invalidate the shader L1. Returns ACK to shader.
63	BUFFER_WBINVL1_VOL	Write back and invalidate the shader L1 only for lines that are marked volatile. Returns ACK to shader.
64	BUFFER_ATOMIC_SWAP	<pre>// 32bit tmp = MEM[ADDR]; MEM[ADDR] = DATA; RETURN_DATA = tmp.</pre>
65	BUFFER_ATOMIC_CMPSWAP	<pre>// 32bit tmp = MEM[ADDR]; src = DATA[0]; cmp = DATA[1]; MEM[ADDR] = (tmp == cmp) ? src : tmp; RETURN_DATA[0] = tmp.</pre>
66	BUFFER_ATOMIC_ADD	<pre>// 32bit tmp = MEM[ADDR]; MEM[ADDR] += DATA; RETURN_DATA = tmp.</pre>
67	BUFFER_ATOMIC_SUB	<pre>// 32bit tmp = MEM[ADDR]; MEM[ADDR] -= DATA; RETURN_DATA = tmp.</pre>

Opcode	Name	Description
68	BUFFER_ATOMIC_SMIN	<pre>// 32bit tmp = MEM[ADDR]; MEM[ADDR] = (DATA < tmp) ? DATA : tmp; // signed compare RETURN_DATA = tmp.</pre>
69	BUFFER_ATOMIC_UMIN	<pre>// 32bit tmp = MEM[ADDR]; MEM[ADDR] = (DATA < tmp) ? DATA : tmp; // unsigned compare RETURN_DATA = tmp.</pre>
70	BUFFER_ATOMIC_SMAX	<pre>// 32bit tmp = MEM[ADDR]; MEM[ADDR] = (DATA > tmp) ? DATA : tmp; // signed compare RETURN_DATA = tmp.</pre>
71	BUFFER_ATOMIC_UMAX	<pre>// 32bit tmp = MEM[ADDR]; MEM[ADDR] = (DATA > tmp) ? DATA : tmp; // unsigned compare RETURN_DATA = tmp.</pre>
72	BUFFER_ATOMIC_AND	<pre>// 32bit tmp = MEM[ADDR]; MEM[ADDR] &= DATA; RETURN_DATA = tmp.</pre>
73	BUFFER_ATOMIC_OR	<pre>// 32bit tmp = MEM[ADDR]; MEM[ADDR] = DATA; RETURN_DATA = tmp.</pre>
74	BUFFER_ATOMIC_XOR	<pre>// 32bit tmp = MEM[ADDR]; MEM[ADDR] ^= DATA; RETURN_DATA = tmp.</pre>
75	BUFFER_ATOMIC_INC	<pre>// 32bit tmp = MEM[ADDR]; MEM[ADDR] = (tmp >= DATA) ? 0 : tmp + 1; // unsigned compare RETURN_DATA = tmp.</pre>
76	BUFFER_ATOMIC_DEC	<pre>// 32bit tmp = MEM[ADDR]; MEM[ADDR] = (tmp == 0 tmp > DATA) ? DATA : tmp - 1; // unsigned compare RETURN_DATA = tmp.</pre>

Opcode	Name	Description
96	BUFFER_ATOMIC_SWAP_X2	<pre>// 64bit tmp = MEM[ADDR]; MEM[ADDR] = DATA[0:1]; RETURN_DATA[0:1] = tmp.</pre>
97	BUFFER_ATOMIC_CMPSWAP_X2	<pre>// 64bit tmp = MEM[ADDR]; src = DATA[0:1]; cmp = DATA[2:3]; MEM[ADDR] = (tmp == cmp) ? src : tmp; RETURN_DATA[0:1] = tmp.</pre>
98	BUFFER_ATOMIC_ADD_X2	<pre>// 64bit tmp = MEM[ADDR]; MEM[ADDR] += DATA[0:1]; RETURN_DATA[0:1] = tmp.</pre>
99	BUFFER_ATOMIC_SUB_X2	<pre>// 64bit tmp = MEM[ADDR]; MEM[ADDR] -= DATA[0:1]; RETURN_DATA[0:1] = tmp.</pre>
100	BUFFER_ATOMIC_SMIN_X2	<pre>// 64bit tmp = MEM[ADDR]; MEM[ADDR] -= (DATA[0:1] < tmp) ? DATA[0:1] : tmp; // signed compare RETURN_DATA[0:1] = tmp.</pre>
101	BUFFER_ATOMIC_UMIN_X2	<pre>// 64bit tmp = MEM[ADDR]; MEM[ADDR] -= (DATA[0:1] < tmp) ? DATA[0:1] : tmp; // unsigned compare RETURN_DATA[0:1] = tmp.</pre>
102	BUFFER_ATOMIC_SMAX_X2	<pre>// 64bit tmp = MEM[ADDR]; MEM[ADDR] -= (DATA[0:1] > tmp) ? DATA[0:1] : tmp; // signed compare RETURN_DATA[0:1] = tmp.</pre>
103	BUFFER_ATOMIC_UMAX_X2	<pre>// 64bit tmp = MEM[ADDR]; MEM[ADDR] -= (DATA[0:1] > tmp) ? DATA[0:1] : tmp; // unsigned compare RETURN_DATA[0:1] = tmp.</pre>
104	BUFFER_ATOMIC_AND_X2	<pre>// 64bit tmp = MEM[ADDR]; MEM[ADDR] &= DATA[0:1]; RETURN_DATA[0:1] = tmp.</pre>

Opcode	Name	Description
105	BUFFER_ATOMIC_OR_X2	// 64bit tmp = MEM[ADDR]; MEM[ADDR] = DATA[0:1]; RETURN_DATA[0:1] = tmp.
106	BUFFER_ATOMIC_XOR_X2	// 64bit tmp = MEM[ADDR]; MEM[ADDR] ^= DATA[0:1]; RETURN_DATA[0:1] = tmp.
107	BUFFER_ATOMIC_INC_X2	// 64bit tmp = MEM[ADDR]; MEM[ADDR] = (tmp >= DATA[0:1]) ? 0 : tmp + 1; // unsigned compare RETURN_DATA[0:1] = tmp.
108	BUFFER_ATOMIC_DEC_X2	// 64bit tmp = MEM[ADDR]; MEM[ADDR] = (tmp == 0 tmp > DATA[0:1]) ? DATA[0:1] : tmp - 1; // unsigned compare RETURN_DATA[0:1] = tmp.

12.15. MTBUF Instructions

The bitfield map of the MTBUF format is:



where:

- OFFSET = Unsigned immediate byte offset.
- OFFEN = Send offset either as VADDR or as zero.
- IDXEN = Send index either as VADDR or as zero.
- GLC = Global coherency.
- ADDR64 = Buffer address of 64 bits.
- OP = Opcode instructions.
- DFMT = Data format for typed buffer.
- NFMT = Number format for typed buffer.
- VADDR = VGPR address source.
- VDATA = Vector GPR for read/write result.
- SRSRC = Scalar GPR that specifies resource constant.
- SOFFSET = Unsigned byte offset from an SGPR.

Opcode	Name	Description
0	TBUFFER_LOAD_FORMAT_X	Typed buffer load 1 dword with format conversion.

Opcode	Name	Description
1	TBUFFER_LOAD_FORMAT_XY	Typed buffer load 2 dwords with format conversion.
2	TBUFFER_LOAD_FORMAT_XYZ	Typed buffer load 3 dwords with format conversion.
3	TBUFFER_LOAD_FORMAT_XYZW	Typed buffer load 4 dwords with format conversion.
4	TBUFFER_STORE_FORMAT_X	Typed buffer store 1 dword with format conversion.
5	TBUFFER_STORE_FORMAT_XY	Typed buffer store 2 dwords with format conversion.
6	TBUFFER_STORE_FORMAT_XYZ	Typed buffer store 3 dwords with format conversion.
7	TBUFFER_STORE_FORMAT_XYZW	Typed buffer store 4 dwords with format conversion.
8	TBUFFER_LOAD_FORMAT_D16_X	Typed buffer load 1 dword with format conversion.
9	TBUFFER_LOAD_FORMAT_D16_XY	Typed buffer load 1 dword with format conversion.
10	TBUFFER_LOAD_FORMAT_D16_XYZ	Typed buffer load 2 dwords with format conversion.
11	TBUFFER_LOAD_FORMAT_D16_XYZW	Typed buffer load 2 dwords with format conversion.
12	TBUFFER_STORE_FORMAT_D16_X	Typed buffer store 1 dword with format conversion.
13	TBUFFER_STORE_FORMAT_D16_XY	Typed buffer store 1 dword with format conversion.
14	TBUFFER_STORE_FORMAT_D16_XYZ	Typed buffer store 2 dwords with format conversion.
15	TBUFFER_STORE_FORMAT_D16_XYZW	Typed buffer store 2 dwords with format conversion.

12.16. MIMG Instructions

The bitfield map of the MIMG format is:

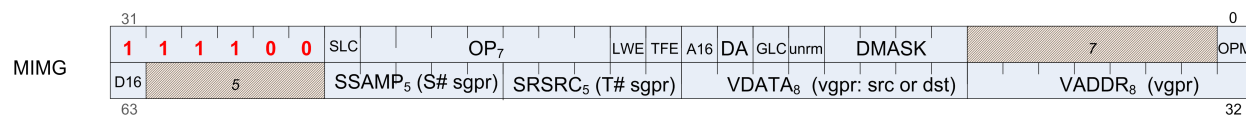

where:

- DMASK = Enable mask for image read/write data components.
- UNRM = Force address to be unnormalized.
- GLC = Global coherency.
- DA = Declare an array.
- A16 = Texture address component size.
- TFE = Texture fail enable.
- LWE = LOD warning enable.
- OP = Opcode instructions.
- SLC = System level coherent.
- VADDR = VGPR address source.
- VDATA = Vector GPR for read/write result.
- SRSRC = Scalar GPR that specifies resource constant.
- SSAMP = Scalar GPR that specifies sampler constant.
- D16 = Data in VGPRs is 16 bits, not 32 bits.

Opcode	Name	Description
0	IMAGE_LOAD	Image memory load with format conversion specified in T#. No sampler.
1	IMAGE_LOAD_MIP	Image memory load with user-supplied mip level. No sampler.
2	IMAGE_LOAD_PCK	Image memory load with no format conversion. No sampler.
3	IMAGE_LOAD_PCK_SGN	Image memory load with with no format conversion and sign extension. No sampler.
4	IMAGE_LOAD_MIP_PCK	Image memory load with user-supplied mip level, no format conversion. No sampler.
5	IMAGE_LOAD_MIP_PCK_SGN	Image memory load with user-supplied mip level, no format conversion and with sign extension. No sampler.
8	IMAGE_STORE	Image memory store with format conversion specified in T#. No sampler.
9	IMAGE_STORE_MIP	Image memory store with format conversion specified in T# to user specified mip level. No sampler.
10	IMAGE_STORE_PCK	Image memory store of packed data without format conversion . No sampler.
11	IMAGE_STORE_MIP_PCK	Image memory store of packed data without format conversion to user-supplied mip level. No sampler.
14	IMAGE_GET_RESINFO	return resource info for a given mip level specified in the address vgpr. No sampler. Returns 4 integer values into VGPRs 3-0: {num_mip_levels, depth, height, width}.
16	IMAGE_ATOMIC_SWAP	<pre>// 32bit tmp = MEM[ADDR]; MEM[ADDR] = DATA; RETURN_DATA = tmp.</pre>

Opcode	Name	Description
17	IMAGE_ATOMIC_CMPSWAP	<pre>// 32bit tmp = MEM[ADDR]; src = DATA[0]; cmp = DATA[1]; MEM[ADDR] = (tmp == cmp) ? src : tmp; RETURN_DATA[0] = tmp.</pre>
18	IMAGE_ATOMIC_ADD	<pre>// 32bit tmp = MEM[ADDR]; MEM[ADDR] += DATA; RETURN_DATA = tmp.</pre>
19	IMAGE_ATOMIC_SUB	<pre>// 32bit tmp = MEM[ADDR]; MEM[ADDR] -= DATA; RETURN_DATA = tmp.</pre>
20	IMAGE_ATOMIC_SMIN	<pre>// 32bit tmp = MEM[ADDR]; MEM[ADDR] = (DATA < tmp) ? DATA : tmp; // signed compare RETURN_DATA = tmp.</pre>
21	IMAGE_ATOMIC_UMIN	<pre>// 32bit tmp = MEM[ADDR]; MEM[ADDR] = (DATA < tmp) ? DATA : tmp; // unsigned compare RETURN_DATA = tmp.</pre>
22	IMAGE_ATOMIC_SMAX	<pre>// 32bit tmp = MEM[ADDR]; MEM[ADDR] = (DATA > tmp) ? DATA : tmp; // signed compare RETURN_DATA = tmp.</pre>
23	IMAGE_ATOMIC_UMAX	<pre>// 32bit tmp = MEM[ADDR]; MEM[ADDR] = (DATA > tmp) ? DATA : tmp; // unsigned compare RETURN_DATA = tmp.</pre>
24	IMAGE_ATOMIC_AND	<pre>// 32bit tmp = MEM[ADDR]; MEM[ADDR] &= DATA; RETURN_DATA = tmp.</pre>
25	IMAGE_ATOMIC_OR	<pre>// 32bit tmp = MEM[ADDR]; MEM[ADDR] = DATA; RETURN_DATA = tmp.</pre>
26	IMAGE_ATOMIC_XOR	<pre>// 32bit tmp = MEM[ADDR]; MEM[ADDR] ^= DATA; RETURN_DATA = tmp.</pre>

Opcode	Name	Description
27	IMAGE_ATOMIC_INC	<pre>// 32bit tmp = MEM[ADDR]; MEM[ADDR] = (tmp >= DATA) ? 0 : tmp + 1; // unsigned compare RETURN_DATA = tmp.</pre>
28	IMAGE_ATOMIC_DEC	<pre>// 32bit tmp = MEM[ADDR]; MEM[ADDR] = (tmp == 0 tmp > DATA) ? DATA : tmp - 1; // unsigned compare RETURN_DATA = tmp.</pre>
32	IMAGE_SAMPLE	sample texture map.
33	IMAGE_SAMPLE_CL	sample texture map, with LOD clamp specified in shader.
34	IMAGE_SAMPLE_D	sample texture map, with user derivatives
35	IMAGE_SAMPLE_D_CL	sample texture map, with LOD clamp specified in shader, with user derivatives.
36	IMAGE_SAMPLE_L	sample texture map, with user LOD.
37	IMAGE_SAMPLE_B	sample texture map, with lod bias.
38	IMAGE_SAMPLE_B_CL	sample texture map, with LOD clamp specified in shader, with lod bias.
39	IMAGE_SAMPLE_LZ	sample texture map, from level 0.
40	IMAGE_SAMPLE_C	sample texture map, with PCF.
41	IMAGE_SAMPLE_C_CL	SAMPLE_C, with LOD clamp specified in shader.
42	IMAGE_SAMPLE_C_D	SAMPLE_C, with user derivatives.
43	IMAGE_SAMPLE_C_D_CL	SAMPLE_C, with LOD clamp specified in shader, with user derivatives.
44	IMAGE_SAMPLE_C_L	SAMPLE_C, with user LOD.
45	IMAGE_SAMPLE_C_B	SAMPLE_C, with lod bias.
46	IMAGE_SAMPLE_C_B_CL	SAMPLE_C, with LOD clamp specified in shader, with lod bias.
47	IMAGE_SAMPLE_C_LZ	SAMPLE_C, from level 0.
48	IMAGE_SAMPLE_O	sample texture map, with user offsets.
49	IMAGE_SAMPLE_CL_O	SAMPLE_0 with LOD clamp specified in shader.
50	IMAGE_SAMPLE_D_O	SAMPLE_0, with user derivatives.
51	IMAGE_SAMPLE_D_CL_O	SAMPLE_0, with LOD clamp specified in shader, with user derivatives.
52	IMAGE_SAMPLE_L_O	SAMPLE_0, with user LOD.
53	IMAGE_SAMPLE_B_O	SAMPLE_0, with lod bias.

Opcode	Name	Description
54	IMAGE_SAMPLE_B_CL_O	SAMPLE_0, with LOD clamp specified in shader, with lod bias.
55	IMAGE_SAMPLE_LZ_O	SAMPLE_0, from level 0.
56	IMAGE_SAMPLE_C_O	SAMPLE_C with user specified offsets.
57	IMAGE_SAMPLE_C_CL_O	SAMPLE_C_0, with LOD clamp specified in shader.
58	IMAGE_SAMPLE_C_D_O	SAMPLE_C_0, with user derivatives.
59	IMAGE_SAMPLE_C_D_CL_O	SAMPLE_C_0, with LOD clamp specified in shader, with user derivatives.
60	IMAGE_SAMPLE_C_L_O	SAMPLE_C_0, with user LOD.
61	IMAGE_SAMPLE_C_B_O	SAMPLE_C_0, with lod bias.
62	IMAGE_SAMPLE_C_B_CL_O	SAMPLE_C_0, with LOD clamp specified in shader, with lod bias.
63	IMAGE_SAMPLE_C_LZ_O	SAMPLE_C_0, from level 0.
64	IMAGE_GATHER4	gather 4 single component elements (2x2).
65	IMAGE_GATHER4_CL	gather 4 single component elements (2x2) with user LOD clamp.
66	IMAGE_GATHER4H	Same as Gather4, but fetches one component per texel, from a 4x1 group of texels.
68	IMAGE_GATHER4_L	gather 4 single component elements (2x2) with user LOD.
69	IMAGE_GATHER4_B	gather 4 single component elements (2x2) with user bias.
70	IMAGE_GATHER4_B_CL	gather 4 single component elements (2x2) with user bias and clamp.
71	IMAGE_GATHER4_LZ	gather 4 single component elements (2x2) at level 0.
72	IMAGE_GATHER4_C	gather 4 single component elements (2x2) with PCF.
73	IMAGE_GATHER4_C_CL	gather 4 single component elements (2x2) with user LOD clamp and PCF.
74	IMAGE_GATHER4H_PCK	Same as GATHER4H, but fetched elements are treated as a single component and packed into GPR(s).
75	IMAGE_GATHER8H_PCK	Simliar to GATHER4H_PCK, but packs eight elements from a 8x1 group of texels.
76	IMAGE_GATHER4_C_L	gather 4 single component elements (2x2) with user LOD and PCF.
77	IMAGE_GATHER4_C_B	gather 4 single component elements (2x2) with user bias and PCF.
78	IMAGE_GATHER4_C_B_CL	gather 4 single component elements (2x2) with user bias, clamp and PCF.

Opcode	Name	Description
79	IMAGE_GATHER4_C_LZ	gather 4 single component elements (2x2) at level 0, with PCF.
80	IMAGE_GATHER4_O	GATHER4, with user offsets.
81	IMAGE_GATHER4_CL_O	GATHER4_CL, with user offsets.
84	IMAGE_GATHER4_L_O	GATHER4_L, with user offsets.
85	IMAGE_GATHER4_B_O	GATHER4_B, with user offsets.
86	IMAGE_GATHER4_B_CL_O	GATHER4_B_CL, with user offsets.
87	IMAGE_GATHER4_LZ_O	GATHER4_LZ, with user offsets.
88	IMAGE_GATHER4_C_O	GATHER4_C, with user offsets.
89	IMAGE_GATHER4_C_CL_O	GATHER4_C_CL, with user offsets.
92	IMAGE_GATHER4_C_L_O	GATHER4_C_L, with user offsets.
93	IMAGE_GATHER4_C_B_O	GATHER4_B, with user offsets.
94	IMAGE_GATHER4_C_B_CL_O	GATHER4_B_CL, with user offsets.
95	IMAGE_GATHER4_C_LZ_O	GATHER4_C_LZ, with user offsets.
96	IMAGE_GET_LOD	Return calculated LOD. Vdata gets 2 32bit integer values: { rawLOD, clampedLOD }.
104	IMAGE_SAMPLE_CD	sample texture map, with user derivatives (LOD per quad)
105	IMAGE_SAMPLE_CD_CL	sample texture map, with LOD clamp specified in shader, with user derivatives (LOD per quad).
106	IMAGE_SAMPLE_C_CD	SAMPLE_C, with user derivatives (LOD per quad).
107	IMAGE_SAMPLE_C_CD_CL	SAMPLE_C, with LOD clamp specified in shader, with user derivatives (LOD per quad).
108	IMAGE_SAMPLE_CD_O	SAMPLE_0, with user derivatives (LOD per quad).
109	IMAGE_SAMPLE_CD_CL_O	SAMPLE_0, with LOD clamp specified in shader, with user derivatives (LOD per quad).
110	IMAGE_SAMPLE_C_CD_O	SAMPLE_C_0, with user derivatives (LOD per quad).
111	IMAGE_SAMPLE_C_CD_CL_O	SAMPLE_C_0, with LOD clamp specified in shader, with user derivatives (LOD per quad).

12.17. EXPORT Instructions

Transfer vertex position, vertex parameter, pixel color, or pixel depth information to the output buffer. Every pixel shader must do at least one export to a color, depth or NULL target with the VM bit set to 1. This communicates the pixel-valid mask to the color and depth buffers. Every pixel does only one of the above export types with the DONE bit set to 1. Vertex shaders must do one or more position exports, and at least one parameter export. The final position export

must have the DONE bit set to 1.

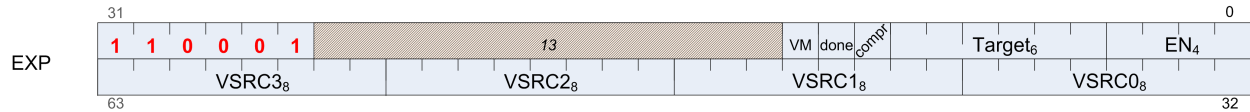

12.18. FLAT, Scratch and Global Instructions

The bitfield map of the FLAT format is:

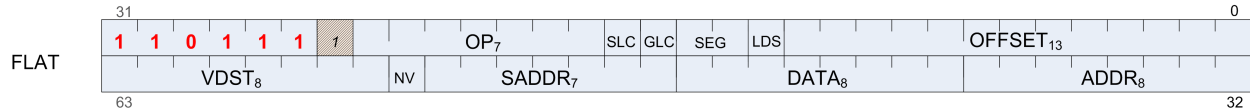

where:

- GLC = Global coherency.
- SLC = System level coherency.
- OP = Opcode instructions.
- ADDR = Source of flat address VGPR.
- DATA = Source data.
- VDST = Destination VGPR.
- NV = Access to non-volatile memory.
- SADDR = SGPR holding address or offset
- SEG = Instruction type: Flat, Scratch, or Global
- LDS = Data is transferred between LDS and Memory, not VGPRs.
- OFFSET = Immediate address byte-offset.

12.18.1. Flat Instructions

Flat instructions look at the per-workitem address and determine for each work item if the target memory address is in global, private or scratch memory.

Opcode	Name	Description
16	FLAT_LOAD_UBYTE	Untyped buffer load unsigned byte (zero extend to VGPR destination).
17	FLAT_LOAD_SBYTE	Untyped buffer load signed byte (sign extend to VGPR destination).
18	FLAT_LOAD_USHORT	Untyped buffer load unsigned short (zero extend to VGPR destination).
19	FLAT_LOAD_SSHORT	Untyped buffer load signed short (sign extend to VGPR destination).
20	FLAT_LOAD_DWORD	Untyped buffer load dword.
21	FLAT_LOAD_DWORDX2	Untyped buffer load 2 dwords.

Opcode	Name	Description
22	FLAT_LOAD_DWORDX3	Untyped buffer load 3 dwords.
23	FLAT_LOAD_DWORDX4	Untyped buffer load 4 dwords.
24	FLAT_STORE_BYTE	Untyped buffer store byte. Stores S0[7:0].
25	FLAT_STORE_BYTE_D16_HI	Untyped buffer store byte. Stores S0[23:16].
26	FLAT_STORE_SHORT	Untyped buffer store short. Stores S0[15:0].
27	FLAT_STORE_SHORT_D16_HI	Untyped buffer store short. Stores S0[31:16].
28	FLAT_STORE_DWORD	Untyped buffer store dword.
29	FLAT_STORE_DWORDX2	Untyped buffer store 2 dwords.
30	FLAT_STORE_DWORDX3	Untyped buffer store 3 dwords.
31	FLAT_STORE_DWORDX4	Untyped buffer store 4 dwords.
32	FLAT_LOAD_UBYTE_D16	D0[15:0] = {8'h0, MEM[ADDR]}. Untyped buffer load unsigned byte.
33	FLAT_LOAD_UBYTE_D16_HI	D0[31:16] = {8'h0, MEM[ADDR]}. Untyped buffer load unsigned byte.
34	FLAT_LOAD_SBYTE_D16	D0[15:0] = {8'h0, MEM[ADDR]}. Untyped buffer load signed byte.
35	FLAT_LOAD_SBYTE_D16_HI	D0[31:16] = {8'h0, MEM[ADDR]}. Untyped buffer load signed byte.
36	FLAT_LOAD_SHORT_D16	D0[15:0] = MEM[ADDR]. Untyped buffer load short.
37	FLAT_LOAD_SHORT_D16_HI	D0[31:16] = MEM[ADDR]. Untyped buffer load short.
64	FLAT_ATOMIC_SWAP	// 32bit tmp = MEM[ADDR]; MEM[ADDR] = DATA; RETURN_DATA = tmp.
65	FLAT_ATOMIC_CMPSWAP	// 32bit tmp = MEM[ADDR]; src = DATA[0]; cmp = DATA[1]; MEM[ADDR] = (tmp == cmp) ? src : tmp; RETURN_DATA[0] = tmp.

Opcode	Name	Description
66	FLAT_ATOMIC_ADD	<pre>// 32bit tmp = MEM[ADDR]; MEM[ADDR] += DATA; RETURN_DATA = tmp.</pre>
67	FLAT_ATOMIC_SUB	<pre>// 32bit tmp = MEM[ADDR]; MEM[ADDR] -= DATA; RETURN_DATA = tmp.</pre>
68	FLAT_ATOMIC_SMIN	<pre>// 32bit tmp = MEM[ADDR]; MEM[ADDR] = (DATA < tmp) ? DATA : tmp; // signed compare RETURN_DATA = tmp.</pre>
69	FLAT_ATOMIC_UMIN	<pre>// 32bit tmp = MEM[ADDR]; MEM[ADDR] = (DATA < tmp) ? DATA : tmp; // unsigned compare RETURN_DATA = tmp.</pre>
70	FLAT_ATOMIC_SMAX	<pre>// 32bit tmp = MEM[ADDR]; MEM[ADDR] = (DATA > tmp) ? DATA : tmp; // signed compare RETURN_DATA = tmp.</pre>
71	FLAT_ATOMIC_UMAX	<pre>// 32bit tmp = MEM[ADDR]; MEM[ADDR] = (DATA > tmp) ? DATA : tmp; // unsigned compare RETURN_DATA = tmp.</pre>
72	FLAT_ATOMIC_AND	<pre>// 32bit tmp = MEM[ADDR]; MEM[ADDR] &= DATA; RETURN_DATA = tmp.</pre>
73	FLAT_ATOMIC_OR	<pre>// 32bit tmp = MEM[ADDR]; MEM[ADDR] = DATA; RETURN_DATA = tmp.</pre>
74	FLAT_ATOMIC_XOR	<pre>// 32bit tmp = MEM[ADDR]; MEM[ADDR] ^= DATA; RETURN_DATA = tmp.</pre>
75	FLAT_ATOMIC_INC	<pre>// 32bit tmp = MEM[ADDR]; MEM[ADDR] = (tmp >= DATA) ? 0 : tmp + 1; // unsigned compare RETURN_DATA = tmp.</pre>

Opcode	Name	Description
76	FLAT_ATOMIC_DEC	<pre>// 32bit tmp = MEM[ADDR]; MEM[ADDR] = (tmp == 0 tmp > DATA) ? DATA : tmp - 1; // unsigned compare RETURN_DATA = tmp.</pre>
96	FLAT_ATOMIC_SWAP_X2	<pre>// 64bit tmp = MEM[ADDR]; MEM[ADDR] = DATA[0:1]; RETURN_DATA[0:1] = tmp.</pre>
97	FLAT_ATOMIC_CMPSWAP_X2	<pre>// 64bit tmp = MEM[ADDR]; src = DATA[0:1]; cmp = DATA[2:3]; MEM[ADDR] = (tmp == cmp) ? src : tmp; RETURN_DATA[0:1] = tmp.</pre>
98	FLAT_ATOMIC_ADD_X2	<pre>// 64bit tmp = MEM[ADDR]; MEM[ADDR] += DATA[0:1]; RETURN_DATA[0:1] = tmp.</pre>
99	FLAT_ATOMIC_SUB_X2	<pre>// 64bit tmp = MEM[ADDR]; MEM[ADDR] -= DATA[0:1]; RETURN_DATA[0:1] = tmp.</pre>
100	FLAT_ATOMIC_SMIN_X2	<pre>// 64bit tmp = MEM[ADDR]; MEM[ADDR] -= (DATA[0:1] < tmp) ? DATA[0:1] : tmp; // signed compare RETURN_DATA[0:1] = tmp.</pre>
101	FLAT_ATOMIC_UMIN_X2	<pre>// 64bit tmp = MEM[ADDR]; MEM[ADDR] -= (DATA[0:1] < tmp) ? DATA[0:1] : tmp; // unsigned compare RETURN_DATA[0:1] = tmp.</pre>
102	FLAT_ATOMIC_SMAX_X2	<pre>// 64bit tmp = MEM[ADDR]; MEM[ADDR] -= (DATA[0:1] > tmp) ? DATA[0:1] : tmp; // signed compare RETURN_DATA[0:1] = tmp.</pre>
103	FLAT_ATOMIC_UMAX_X2	<pre>// 64bit tmp = MEM[ADDR]; MEM[ADDR] -= (DATA[0:1] > tmp) ? DATA[0:1] : tmp; // unsigned compare RETURN_DATA[0:1] = tmp.</pre>

Opcode	Name	Description
104	FLAT_ATOMIC_AND_X2	<pre>// 64bit tmp = MEM[ADDR]; MEM[ADDR] &= DATA[0:1]; RETURN_DATA[0:1] = tmp.</pre>
105	FLAT_ATOMIC_OR_X2	<pre>// 64bit tmp = MEM[ADDR]; MEM[ADDR] = DATA[0:1]; RETURN_DATA[0:1] = tmp.</pre>
106	FLAT_ATOMIC_XOR_X2	<pre>// 64bit tmp = MEM[ADDR]; MEM[ADDR] ^= DATA[0:1]; RETURN_DATA[0:1] = tmp.</pre>
107	FLAT_ATOMIC_INC_X2	<pre>// 64bit tmp = MEM[ADDR]; MEM[ADDR] = (tmp >= DATA[0:1]) ? 0 : tmp + 1; // unsigned compare RETURN_DATA[0:1] = tmp.</pre>
108	FLAT_ATOMIC_DEC_X2	<pre>// 64bit tmp = MEM[ADDR]; MEM[ADDR] = (tmp == 0 tmp > DATA[0:1]) ? DATA[0:1] : tmp - 1; // unsigned compare RETURN_DATA[0:1] = tmp.</pre>

12.18.2. Scratch Instructions

Scratch instructions are like Flat, but assume all workitem addresses fall in scratch (private) space.

Opcode	Name	Description
16	SCRATCH_LOAD_UBYTE	Untyped buffer load unsigned byte (zero extend to VGPR destination).
17	SCRATCH_LOAD_SBYTE	Untyped buffer load signed byte (sign extend to VGPR destination).
18	SCRATCH_LOAD_USHORT	Untyped buffer load unsigned short (zero extend to VGPR destination).
19	SCRATCH_LOAD_SSHORT	Untyped buffer load signed short (sign extend to VGPR destination).
20	SCRATCH_LOAD_DWORD	Untyped buffer load dword.
21	SCRATCH_LOAD_DWORDX2	Untyped buffer load 2 dwords.
22	SCRATCH_LOAD_DWORDX3	Untyped buffer load 3 dwords.
23	SCRATCH_LOAD_DWORDX4	Untyped buffer load 4 dwords.

Opcode	Name	Description
24	SCRATCH_STORE_BYTE	Untyped buffer store byte. Stores S0[7:0].
25	SCRATCH_STORE_BYTE_D16_HI	Untyped buffer store byte. Stores S0[23:16].
26	SCRATCH_STORE_SHORT	Untyped buffer store short. Stores S0[15:0].
27	SCRATCH_STORE_SHORT_D16_HI	Untyped buffer store short. Stores S0[31:16].
28	SCRATCH_STORE_DWORD	Untyped buffer store dword.
29	SCRATCH_STORE_DWORDX2	Untyped buffer store 2 dwords.
30	SCRATCH_STORE_DWORDX3	Untyped buffer store 3 dwords.
31	SCRATCH_STORE_DWORDX4	Untyped buffer store 4 dwords.
32	SCRATCH_LOAD_UBYTE_D16	D0[15:0] = {8'h0, MEM[ADDR]}. Untyped buffer load unsigned byte.
33	SCRATCH_LOAD_UBYTE_D16_HI	D0[31:16] = {8'h0, MEM[ADDR]}. Untyped buffer load unsigned byte.
34	SCRATCH_LOAD_SBYTE_D16	D0[15:0] = {8'h0, MEM[ADDR]}. Untyped buffer load signed byte.
35	SCRATCH_LOAD_SBYTE_D16_HI	D0[31:16] = {8'h0, MEM[ADDR]}. Untyped buffer load signed byte.
36	SCRATCH_LOAD_SHORT_D16	D0[15:0] = MEM[ADDR]. Untyped buffer load short.
37	SCRATCH_LOAD_SHORT_D16_HI	D0[31:16] = MEM[ADDR]. Untyped buffer load short.

12.18.3. Global Instructions

Global instructions are like Flat, but assume all workitem addresses fall in global memory space.

Opcode	Name	Description
16	GLOBAL_LOAD_UBYTE	Untyped buffer load unsigned byte (zero extend to VGPR destination).
17	GLOBAL_LOAD_SBYTE	Untyped buffer load signed byte (sign extend to VGPR destination).
18	GLOBAL_LOAD_USHORT	Untyped buffer load unsigned short (zero extend to VGPR destination).

Opcode	Name	Description
19	GLOBAL_LOAD_SSHORT	Untyped buffer load signed short (sign extend to VGPR destination).
20	GLOBAL_LOAD_DWORD	Untyped buffer load dword.
21	GLOBAL_LOAD_DWORDX2	Untyped buffer load 2 dwords.
22	GLOBAL_LOAD_DWORDX3	Untyped buffer load 3 dwords.
23	GLOBAL_LOAD_DWORDX4	Untyped buffer load 4 dwords.
24	GLOBAL_STORE_BYTE	Untyped buffer store byte. Stores S0[7:0].
25	GLOBAL_STORE_BYTE_D16_HI	Untyped buffer store byte. Stores S0[23:16].
26	GLOBAL_STORE_SHORT	Untyped buffer store short. Stores S0[15:0].
27	GLOBAL_STORE_SHORT_D16_HI	Untyped buffer store short. Stores S0[31:16].
28	GLOBAL_STORE_DWORD	Untyped buffer store dword.
29	GLOBAL_STORE_DWORDX2	Untyped buffer store 2 dwords.
30	GLOBAL_STORE_DWORDX3	Untyped buffer store 3 dwords.
31	GLOBAL_STORE_DWORDX4	Untyped buffer store 4 dwords.
32	GLOBAL_LOAD_UBYTE_D16	D0[15:0] = {8'h0, MEM[ADDR]}. Untyped buffer load unsigned byte.
33	GLOBAL_LOAD_UBYTE_D16_HI	D0[31:16] = {8'h0, MEM[ADDR]}. Untyped buffer load unsigned byte.
34	GLOBAL_LOAD_SBYTE_D16	D0[15:0] = {8'h0, MEM[ADDR]}. Untyped buffer load signed byte.
35	GLOBAL_LOAD_SBYTE_D16_HI	D0[31:16] = {8'h0, MEM[ADDR]}. Untyped buffer load signed byte.
36	GLOBAL_LOAD_SHORT_D16	D0[15:0] = MEM[ADDR]. Untyped buffer load short.
37	GLOBAL_LOAD_SHORT_D16_HI	D0[31:16] = MEM[ADDR]. Untyped buffer load short.
64	GLOBAL_ATOMIC_SWAP	// 32bit tmp = MEM[ADDR]; MEM[ADDR] = DATA; RETURN_DATA = tmp.

Opcode	Name	Description
65	GLOBAL_ATOMIC_CMPSWAP	<pre>// 32bit tmp = MEM[ADDR]; src = DATA[0]; cmp = DATA[1]; MEM[ADDR] = (tmp == cmp) ? src : tmp; RETURN_DATA[0] = tmp.</pre>
66	GLOBAL_ATOMIC_ADD	<pre>// 32bit tmp = MEM[ADDR]; MEM[ADDR] += DATA; RETURN_DATA = tmp.</pre>
67	GLOBAL_ATOMIC_SUB	<pre>// 32bit tmp = MEM[ADDR]; MEM[ADDR] -= DATA; RETURN_DATA = tmp.</pre>
68	GLOBAL_ATOMIC_SMIN	<pre>// 32bit tmp = MEM[ADDR]; MEM[ADDR] = (DATA < tmp) ? DATA : tmp; // signed compare RETURN_DATA = tmp.</pre>
69	GLOBAL_ATOMIC_UMIN	<pre>// 32bit tmp = MEM[ADDR]; MEM[ADDR] = (DATA < tmp) ? DATA : tmp; // unsigned compare RETURN_DATA = tmp.</pre>
70	GLOBAL_ATOMIC_SMAX	<pre>// 32bit tmp = MEM[ADDR]; MEM[ADDR] = (DATA > tmp) ? DATA : tmp; // signed compare RETURN_DATA = tmp.</pre>
71	GLOBAL_ATOMIC_UMAX	<pre>// 32bit tmp = MEM[ADDR]; MEM[ADDR] = (DATA > tmp) ? DATA : tmp; // unsigned compare RETURN_DATA = tmp.</pre>
72	GLOBAL_ATOMIC_AND	<pre>// 32bit tmp = MEM[ADDR]; MEM[ADDR] &= DATA; RETURN_DATA = tmp.</pre>
73	GLOBAL_ATOMIC_OR	<pre>// 32bit tmp = MEM[ADDR]; MEM[ADDR] = DATA; RETURN_DATA = tmp.</pre>
74	GLOBAL_ATOMIC_XOR	<pre>// 32bit tmp = MEM[ADDR]; MEM[ADDR] ^= DATA; RETURN_DATA = tmp.</pre>

Opcode	Name	Description
75	GLOBAL_ATOMIC_INC	<pre>// 32bit tmp = MEM[ADDR]; MEM[ADDR] = (tmp >= DATA) ? 0 : tmp + 1; // unsigned compare RETURN_DATA = tmp.</pre>
76	GLOBAL_ATOMIC_DEC	<pre>// 32bit tmp = MEM[ADDR]; MEM[ADDR] = (tmp == 0 tmp > DATA) ? DATA : tmp - 1; // unsigned compare RETURN_DATA = tmp.</pre>
96	GLOBAL_ATOMIC_SWAP_X2	<pre>// 64bit tmp = MEM[ADDR]; MEM[ADDR] = DATA[0:1]; RETURN_DATA[0:1] = tmp.</pre>
97	GLOBAL_ATOMIC_CMPSWAP_X2	<pre>// 64bit tmp = MEM[ADDR]; src = DATA[0:1]; cmp = DATA[2:3]; MEM[ADDR] = (tmp == cmp) ? src : tmp; RETURN_DATA[0:1] = tmp.</pre>
98	GLOBAL_ATOMIC_ADD_X2	<pre>// 64bit tmp = MEM[ADDR]; MEM[ADDR] += DATA[0:1]; RETURN_DATA[0:1] = tmp.</pre>
99	GLOBAL_ATOMIC_SUB_X2	<pre>// 64bit tmp = MEM[ADDR]; MEM[ADDR] -= DATA[0:1]; RETURN_DATA[0:1] = tmp.</pre>
100	GLOBAL_ATOMIC_SMIN_X2	<pre>// 64bit tmp = MEM[ADDR]; MEM[ADDR] -= (DATA[0:1] < tmp) ? DATA[0:1] : tmp; // signed compare RETURN_DATA[0:1] = tmp.</pre>
101	GLOBAL_ATOMIC_UMIN_X2	<pre>// 64bit tmp = MEM[ADDR]; MEM[ADDR] -= (DATA[0:1] < tmp) ? DATA[0:1] : tmp; // unsigned compare RETURN_DATA[0:1] = tmp.</pre>
102	GLOBAL_ATOMIC_SMAX_X2	<pre>// 64bit tmp = MEM[ADDR]; MEM[ADDR] -= (DATA[0:1] > tmp) ? DATA[0:1] : tmp; // signed compare RETURN_DATA[0:1] = tmp.</pre>

Opcode	Name	Description
103	GLOBAL_ATOMIC_UMAX_X2	<pre>// 64bit tmp = MEM[ADDR]; MEM[ADDR] -= (DATA[0:1] > tmp) ? DATA[0:1] : tmp; // unsigned compare RETURN_DATA[0:1] = tmp.</pre>
104	GLOBAL_ATOMIC_AND_X2	<pre>// 64bit tmp = MEM[ADDR]; MEM[ADDR] &= DATA[0:1]; RETURN_DATA[0:1] = tmp.</pre>
105	GLOBAL_ATOMIC_OR_X2	<pre>// 64bit tmp = MEM[ADDR]; MEM[ADDR] = DATA[0:1]; RETURN_DATA[0:1] = tmp.</pre>
106	GLOBAL_ATOMIC_XOR_X2	<pre>// 64bit tmp = MEM[ADDR]; MEM[ADDR] ^= DATA[0:1]; RETURN_DATA[0:1] = tmp.</pre>
107	GLOBAL_ATOMIC_INC_X2	<pre>// 64bit tmp = MEM[ADDR]; MEM[ADDR] = (tmp >= DATA[0:1]) ? 0 : tmp + 1; // unsigned compare RETURN_DATA[0:1] = tmp.</pre>
108	GLOBAL_ATOMIC_DEC_X2	<pre>// 64bit tmp = MEM[ADDR]; MEM[ADDR] = (tmp == 0 tmp > DATA[0:1]) ? DATA[0:1] : tmp - 1; // unsigned compare RETURN_DATA[0:1] = tmp.</pre>

12.19. Instruction Limitations

12.19.1. DPP

The following instructions cannot use DPP:

- V_MADMK_F32
- V_MADAK_F32
- V_MADMK_F16
- V_MADAK_F16
- V_READFIRSTLANE_B32
- V_CVT_I32_F64
- V_CVT_F64_I32
- V_CVT_F32_F64

- V_CVT_F64_F32
- V_CVT_U32_F64
- V_CVT_F64_U32
- V_TRUNC_F64
- V_CEIL_F64
- V_RNDNE_F64
- V_FLOOR_F64
- V_RCP_F64
- V_RSQ_F64
- V_SQRT_F64
- V_FREXP_EXP_I32_F64
- V_FREXP_MANT_F64
- V_FRACT_F64
- V_CLREXCP
- V_SWAP_B32
- V_CMP_CLASS_F64
- V_CMPX_CLASS_F64
- V_CMP_*_F64
- V_CMPX_*_F64
- V_CMP_*_I64
- V_CMP_*_U64
- V_CMPX_*_I64
- V_CMPX_*_U64

12.19.2. SDWA

The following instructions cannot use SDWA:

- V_MAC_F32
- V_MADMK_F32
- V_MADAK_F32
- V_MAC_F16
- V_MADMK_F16
- V_MADAK_F16
- V_FMAC_F32
- V_READFIRSTLANE_B32
- V_CLREXCP
- V_SWAP_B32

Chapter 13. Microcode Formats

This section specifies the microcode formats. The definitions can be used to simplify compilation by providing standard templates and enumeration names for the various instruction formats.

Endian Order - The GCN architecture addresses memory and registers using littleendian byte-ordering and bit-ordering. Multi-byte values are stored with their least-significant (low-order) byte (LSB) at the lowest byte address, and they are illustrated with their LSB at the right side. Byte values are stored with their least-significant (low-order) bit (lsb) at the lowest bit address, and they are illustrated with their lsb at the right side.

The table below summarizes the microcode formats and their widths. The sections that follow provide details

Table 52. Summary of Microcode Formats

Microcode Formats	Reference	Width (bits)
Scalar ALU and Control Formats		
SOP2	SOP2	32
SOP1	SOP1	
SOPK	SOPK	
SOPP	SOPP	
SOPC	SOPC	
Scalar Memory Format		
SMEM	SMEM	64
Vector ALU Format		
VOP1	VOP1	32
VOP2	VOP2	32
VOPC	VOPC	32
VOP3A	VOP3A	64
VOP3B	VOP3B	64
VOP3P	VOP3P	64
DPP	DPP	32
SDWA	VOP2	32
Vector Parameter Interpolation Format		
VINTRP	VINTRP	32
LDS/GDS Format		
DS	DS	64

Microcode Formats	Reference	Width (bits)
Vector Memory Buffer Formats		
MTBUF	[MTUBF]	64
MUBUF	MUBUF	64
Vector Memory Image Format		
MIMG	MIMG	64
Export Format		
EXP	EXP	64
Flat Formats		
FLAT	FLAT	64
GLOBAL	GLOBAL	64
SCRATCH	SCRATCH	64

The field-definition tables that accompany the descriptions in the sections below use the following notation.

- int(2) - A two-bit field that specifies an unsigned integer value.
- enum(7) - A seven-bit field that specifies an enumerated set of values (in this case, a set of up to 27 values). The number of valid values can be less than the maximum.

The default value of all fields is zero. Any bitfield not identified is assumed to be reserved.

Instruction Suffixes

Most instructions include a suffix which indicates the data type the instruction handles. This suffix may also include a number which indicate the size of the data.

For example: "F32" indicates "32-bit floating point data", or "B16" is "16-bit binary data".

- B = binary
- F = floating point
- U = unsigned integer
- S = signed integer

When more than one data-type specifier occurs in an instruction, the last one is the result type and size, and the earlier one(s) is/are input data type and size.

13.1. Scalar ALU and Control Formats

13.1.1. SOP2

Scalar format with Two inputs, one output

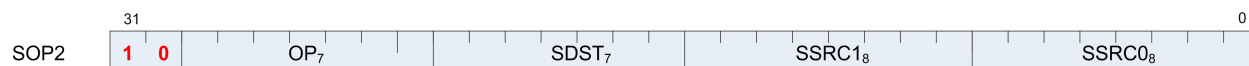

Format SOP2

Description This is a scalar instruction with two inputs and one output. Can be followed by a 32-bit literal constant.

Table 53. SOP2 Fields

Field Name	Bits	Format or Description
SSRC0	[7:0]	Source 0. First operand for the instruction.
	0 - 101	SGPR0 to SGPR101: Scalar general-purpose registers.
	102	FLAT_SCRATCH_LO.
	103	FLAT_SCRATCH_HI.
	104	XNACK_MASK_LO.
	105	XNACK_MASK_HI.
	106	VCC_LO: vcc[31:0].
	107	VCC_HI: vcc[63:32].
	108-123	TTMP0 - TTMP15: Trap handler temporary register.
	124	M0. Memory register 0.
	125	Reserved
	126	EXEC_LO: exec[31:0].
	127	EXEC_HI: exec[63:32].
	128	0.
	129-192	Signed integer 1 to 64.
	193-208	Signed integer -1 to -16.
	209-234	Reserved.
	235	SHARED_BASE (Memory Aperture definition).
	236	SHARED_LIMIT (Memory Aperture definition).
	237	PRIVATE_BASE (Memory Aperture definition).
	238	PRIVATE_LIMIT (Memory Aperture definition).
	239	POPS_EXITING_WAVE_ID .
	240	0.5.
	241	-0.5.
	242	1.0.
	243	-1.0.
	244	2.0.
	245	-2.0.
	246	4.0.
	247	-4.0.
	248	1/(2*PI).
	249 - 250	Reserved.
251	VCCZ.	
252	EXECZ.	
253	SCC.	
254	Reserved.	
255	Literal constant.	
SSRC1	[15:8]	Second scalar source operand. Same codes as SSRC0, above.
SDST	[22:16]	Scalar destination. Same codes as SSRC0, above except only codes 0-127 are valid.
OP	[29:23]	See Opcode table below.
ENCODING	[31:30]	Must be: 10

Table 54. SOP2 Opcodes

Opcode #	Name
0	S_ADD_U32

Opcode #	Name
1	S_SUB_U32
2	S_ADD_I32
3	S_SUB_I32
4	S_ADDC_U32
5	S_SUBB_U32
6	S_MIN_I32
7	S_MIN_U32
8	S_MAX_I32
9	S_MAX_U32
10	S_CSELECT_B32
11	S_CSELECT_B64
12	S_AND_B32
13	S_AND_B64
14	S_OR_B32
15	S_OR_B64
16	S_XOR_B32
17	S_XOR_B64
18	S_ANDN2_B32
19	S_ANDN2_B64
20	S_ORN2_B32
21	S_ORN2_B64
22	S_NAND_B32
23	S_NAND_B64
24	S_NOR_B32
25	S_NOR_B64
26	S_XNOR_B32
27	S_XNOR_B64
28	S_LSHL_B32
29	S_LSHL_B64
30	S_LSHR_B32
31	S_LSHR_B64
32	S_ASHR_I32
33	S_ASHR_I64

Opcode #	Name
34	S_BFM_B32
35	S_BFM_B64
36	S_MUL_I32
37	S_BFE_U32
38	S_BFE_I32
39	S_BFE_U64
40	S_BFE_I64
41	S_CBRANCH_G_FORK
42	S_ABSDIFF_I32
43	S_RFE_RESTORE_B64
44	S_MUL_HI_U32
45	S_MUL_HI_I32
46	S_LSHL1_ADD_U32
47	S_LSHL2_ADD_U32
48	S_LSHL3_ADD_U32
49	S_LSHL4_ADD_U32
50	S_PACK_LL_B32_B16
51	S_PACK_LH_B32_B16
52	S_PACK_HH_B32_B16

13.1.2. SOPK



Format SOPK

Description This is a scalar instruction with one 16-bit signed immediate (SIMM16) input and a single destination. Instructions which take 2 inputs use the destination as the second input.

Table 55. SOPK Fields

Field Name	Bits	Format or Description
SIMM16	[15:0]	Signed immediate 16-bit value.

Field Name	Bits	Format or Description
SDST	[22:16] 0 - 101 102 103 104 105 106 107 108-123 124 125 126 127	Scalar destination, and can provide second source operand. SGPR0 to SGPR101: Scalar general-purpose registers. FLAT_SCRATCH_LO. FLAT_SCRATCH_HI. XNACK_MASK_LO. XNACK_MASK_HI. VCC_LO: vcc[31:0]. VCC_HI: vcc[63:32]. TTMP0 - TTMP15: Trap handler temporary register. M0. Memory register 0. Reserved EXEC_LO: exec[31:0]. EXEC_HI: exec[63:32].
OP	[27:23]	See Opcode table below.
ENCODING	[31:28]	Must be: 1011

Table 56. SOPK Opcodes

Opcode #	Name
0	S_MOVK_I32
1	S_CMOVK_I32
2	S_CMPK_EQ_I32
3	S_CMPK_LG_I32
4	S_CMPK_GT_I32
5	S_CMPK_GE_I32
6	S_CMPK_LT_I32
7	S_CMPK_LE_I32
8	S_CMPK_EQ_U32
9	S_CMPK_LG_U32
10	S_CMPK_GT_U32
11	S_CMPK_GE_U32
12	S_CMPK_LT_U32
13	S_CMPK_LE_U32
14	S_ADDK_I32
15	S_MULK_I32
16	S_CBRANCH_I_FORK
17	S_GETREG_B32
18	S_SETREG_B32
20	S_SETREG_IMM32_B32

Opcode #	Name
21	S_CALL_B64

13.1.3. SOP1



Format SOP1

Description This is a scalar instruction with two inputs and one output. Can be followed by a 32-bit literal constant.

Table 57. SOP1 Fields

Field Name	Bits	Format or Description
SSRC0	[7:0]	Source 0. First operand for the instruction.
	0 - 101	SGPR0 to SGPR101: Scalar general-purpose registers.
	102	FLAT_SCRATCH_LO.
	103	FLAT_SCRATCH_HI.
	104	XNACK_MASK_LO.
	105	XNACK_MASK_HI.
	106	VCC_LO: vcc[31:0].
	107	VCC_HI: vcc[63:32].
	108-123	TTMP0 - TTMP15: Trap handler temporary register.
	124	M0. Memory register 0.
	125	Reserved
	126	EXEC_LO: exec[31:0].
	127	EXEC_HI: exec[63:32].
	128	0.
	129-192	Signed integer 1 to 64.
	193-208	Signed integer -1 to -16.
	209-234	Reserved.
	235	SHARED_BASE (Memory Aperture definition).
	236	SHARED_LIMIT (Memory Aperture definition).
	237	PRIVATE_BASE (Memory Aperture definition).
	238	PRIVATE_LIMIT (Memory Aperture definition).
	239	POPS_EXITING_WAVE_ID .
	240	0.5.
	241	-0.5.
	242	1.0.
	243	-1.0.
	244	2.0.
	245	-2.0.
	246	4.0.
	247	-4.0.
	248	1/(2*PI).
	249 - 250	Reserved.
251	VCCZ.	
252	EXECZ.	
253	SCC.	
254	Reserved.	
255	Literal constant.	
OP	[15:8]	See Opcode table below.
SDST	[22:16]	Scalar destination. Same codes as SSRC0, above except only codes 0-127 are valid.
ENCODING	[31:23]	Must be: 10_1111101

Table 58. SOP1 Opcodes

Opcode #	Name
0	S_MOV_B32
1	S_MOV_B64
2	S_CMOV_B32

Opcode #	Name
3	S_CMOV_B64
4	S_NOT_B32
5	S_NOT_B64
6	S_WQM_B32
7	S_WQM_B64
8	S_BREV_B32
9	S_BREV_B64
10	S_BCNT0_I32_B32
11	S_BCNT0_I32_B64
12	S_BCNT1_I32_B32
13	S_BCNT1_I32_B64
14	S_FF0_I32_B32
15	S_FF0_I32_B64
16	S_FF1_I32_B32
17	S_FF1_I32_B64
18	S_FLBIT_I32_B32
19	S_FLBIT_I32_B64
20	S_FLBIT_I32
21	S_FLBIT_I32_I64
22	S_SEXT_I32_I8
23	S_SEXT_I32_I16
24	S_BITSET0_B32
25	S_BITSET0_B64
26	S_BITSET1_B32
27	S_BITSET1_B64
28	S_GETPC_B64
29	S_SETPC_B64
30	S_SWAPPC_B64
31	S_RFE_B64
32	S_AND_SAVEEXEC_B64
33	S_OR_SAVEEXEC_B64
34	S_XOR_SAVEEXEC_B64
35	S_ANDN2_SAVEEXEC_B64

Opcode #	Name
36	S_ORN2_SAVEEXEC_B64
37	S_NAND_SAVEEXEC_B64
38	S_NOR_SAVEEXEC_B64
39	S_XNOR_SAVEEXEC_B64
40	S_QUADMASK_B32
41	S_QUADMASK_B64
42	S_MOVRELS_B32
43	S_MOVRELS_B64
44	S_MOVRELD_B32
45	S_MOVRELD_B64
46	S_CBRANCH_JOIN
48	S_ABS_I32
50	S_SET_GPR_IDX_IDX
51	S_ANDN1_SAVEEXEC_B64
52	S_ORN1_SAVEEXEC_B64
53	S_ANDN1_WREXEC_B64
54	S_ANDN2_WREXEC_B64
55	S_BITREPLICATE_B64_B32

13.1.4. SOPC



Format SOPC

Description This is a scalar instruction with two inputs which are compared and produce SCC as a result. Can be followed by a 32-bit literal constant.

Table 59. SOPC Fields

Field Name	Bits	Format or Description
SSRC0	[7:0]	Source 0. First operand for the instruction.
	0 - 101	SGPR0 to SGPR101: Scalar general-purpose registers.
	102	FLAT_SCRATCH_LO.
	103	FLAT_SCRATCH_HI.
	104	XNACK_MASK_LO.
	105	XNACK_MASK_HI.
	106	VCC_LO: vcc[31:0].
	107	VCC_HI: vcc[63:32].
	108-123	TTMP0 - TTMP15: Trap handler temporary register.
	124	M0. Memory register 0.
	125	Reserved
	126	EXEC_LO: exec[31:0].
	127	EXEC_HI: exec[63:32].
	128	0.
	129-192	Signed integer 1 to 64.
	193-208	Signed integer -1 to -16.
	209-234	Reserved.
	235	SHARED_BASE (Memory Aperture definition).
	236	SHARED_LIMIT (Memory Aperture definition).
	237	PRIVATE_BASE (Memory Aperture definition).
	238	PRIVATE_LIMIT (Memory Aperture definition).
	239	POPS_EXITING_WAVE_ID .
	240	0.5.
	241	-0.5.
	242	1.0.
	243	-1.0.
	244	2.0.
	245	-2.0.
	246	4.0.
	247	-4.0.
	248	1/(2*PI).
	249 - 250	Reserved.
251	VCCZ.	
252	EXECZ.	
253	SCC.	
254	Reserved.	
255	Literal constant.	
SSRC1	[15:8]	Second scalar source operand. Same codes as SSRC0, above.
OP	[22:16]	See Opcode table below.
ENCODING	[31:23]	Must be: 10_1111110

Table 60. SOPC Opcodes

Opcode #	Name
0	S_CMP_EQ_I32
1	S_CMP_LG_I32
2	S_CMP_GT_I32

Opcode #	Name
3	S_CMP_GE_I32
4	S_CMP_LT_I32
5	S_CMP_LE_I32
6	S_CMP_EQ_U32
7	S_CMP_LG_U32
8	S_CMP_GT_U32
9	S_CMP_GE_U32
10	S_CMP_LT_U32
11	S_CMP_LE_U32
12	S_BITCMP0_B32
13	S_BITCMP1_B32
14	S_BITCMP0_B64
15	S_BITCMP1_B64
16	S_SETVSKIP
17	S_SET_GPR_IDX_ON
18	S_CMP_EQ_U64
19	S_CMP_LG_U64

13.1.5. SOPP



Format SOPP

Description This is a scalar instruction with one 16-bit signed immediate (SIMM16) input.

Table 61. SOPP Fields

Field Name	Bits	Format or Description
SIMM16	[15:0]	Signed immediate 16-bit value.
OP	[22:16]	See Opcode table below.
ENCODING	[31:23]	Must be: 10_111111

Table 62. SOPP Opcodes

Opcode #	Name
0	S_NOP
1	S_ENDPGM
2	S_BRANCH
3	S_WAKEUP
4	S_CBRANCH_SCC0
5	S_CBRANCH_SCC1
6	S_CBRANCH_VCCZ
7	S_CBRANCH_VCCNZ
8	S_CBRANCH_EXECZ
9	S_CBRANCH_EXECNZ
10	S_BARRIER
11	S_SETKILL
12	S_WAITCNT
13	S_SETHALT
14	S_SLEEP
15	S_SETPRIO
16	S_SENDMSG
17	S_SENDMSGHALT
18	S_TRAP
19	S_ICACHE_INV
20	S_INCPERFLEVEL
21	S_DECPERFLEVEL
22	S_TTRACEDATA
23	S_CBRANCH_CDBGSYS
24	S_CBRANCH_CDBGUSER
25	S_CBRANCH_CDBGSYS_OR_USER
26	S_CBRANCH_CDBGSYS_AND_USER
27	S_ENDPGM_SAVED
28	S_SET_GPR_IDX_OFF
29	S_SET_GPR_IDX_MODE
30	S_ENDPGM_ORDERED_PS_DONE

13.2. Scalar Memory Format

13.2.1. SMEM



Format SMEM

Description Scalar Memory data load/store

Table 63. SMEM Fields

Field Name	Bits	Format or Description
SBASE	[5:0]	SGPR-pair which provides base address or SGPR-quad which provides V#. (LSB of SGPR address is omitted).
SDATA	[12:6]	SGPR which provides write data or accepts return data.
SOE	[14]	Scalar offset enable.
NV	[15]	Non-volatile
GLC	[16]	Globally memory Coherent. Force bypass of L1 cache, or for atomics, cause pre-op value to be returned.
IMM	[17]	Immediate enable.
OP	[25:18]	See Opcode table below.
ENCODING	[31:26]	Must be: 110000
OFFSET	[52:32]	An immediate signed byte offset, or the address of an SGPR holding the unsigned byte offset. Signed offsets only work with S_LOAD/STORE.
SOFFSET	[63:57]	SGPR offset. Used only when SOFFSET_EN = 1 May only specify an SGPR or M0.

Table 64. SMEM Opcodes

Opcode #	Name
0	S_LOAD_DWORD
1	S_LOAD_DWORDX2
2	S_LOAD_DWORDX4
3	S_LOAD_DWORDX8
4	S_LOAD_DWORDX16
5	S_SCRATCH_LOAD_DWORD
6	S_SCRATCH_LOAD_DWORDX2

Opcode #	Name
7	S_SCRATCH_LOAD_DWORDX4
8	S_BUFFER_LOAD_DWORD
9	S_BUFFER_LOAD_DWORDX2
10	S_BUFFER_LOAD_DWORDX4
11	S_BUFFER_LOAD_DWORDX8
12	S_BUFFER_LOAD_DWORDX16
16	S_STORE_DWORD
17	S_STORE_DWORDX2
18	S_STORE_DWORDX4
21	S_SCRATCH_STORE_DWORD
22	S_SCRATCH_STORE_DWORDX2
23	S_SCRATCH_STORE_DWORDX4
24	S_BUFFER_STORE_DWORD
25	S_BUFFER_STORE_DWORDX2
26	S_BUFFER_STORE_DWORDX4
32	S_DCACHE_INV
33	S_DCACHE_WB
34	S_DCACHE_INV_VOL
35	S_DCACHE_WB_VOL
36	S_MEMTIME
37	S_MEMREALTIME
38	S_ATC_PROBE
39	S_ATC_PROBE_BUFFER
40	S_DCACHE_DISCARD
41	S_DCACHE_DISCARD_X2
64	S_BUFFER_ATOMIC_SWAP
65	S_BUFFER_ATOMIC_CMPSWAP
66	S_BUFFER_ATOMIC_ADD
67	S_BUFFER_ATOMIC_SUB
68	S_BUFFER_ATOMIC_SMIN
69	S_BUFFER_ATOMIC_UMIN
70	S_BUFFER_ATOMIC_SMAX
71	S_BUFFER_ATOMIC_UMAX

Opcode #	Name
72	S_BUFFER_ATOMIC_AND
73	S_BUFFER_ATOMIC_OR
74	S_BUFFER_ATOMIC_XOR
75	S_BUFFER_ATOMIC_INC
76	S_BUFFER_ATOMIC_DEC
96	S_BUFFER_ATOMIC_SWAP_X2
97	S_BUFFER_ATOMIC_CMPSWAP_X2
98	S_BUFFER_ATOMIC_ADD_X2
99	S_BUFFER_ATOMIC_SUB_X2
100	S_BUFFER_ATOMIC_SMIN_X2
101	S_BUFFER_ATOMIC_UMIN_X2
102	S_BUFFER_ATOMIC_SMAX_X2
103	S_BUFFER_ATOMIC_UMAX_X2
104	S_BUFFER_ATOMIC_AND_X2
105	S_BUFFER_ATOMIC_OR_X2
106	S_BUFFER_ATOMIC_XOR_X2
107	S_BUFFER_ATOMIC_INC_X2
108	S_BUFFER_ATOMIC_DEC_X2
128	S_ATOMIC_SWAP
129	S_ATOMIC_CMPSWAP
130	S_ATOMIC_ADD
131	S_ATOMIC_SUB
132	S_ATOMIC_SMIN
133	S_ATOMIC_UMIN
134	S_ATOMIC_SMAX
135	S_ATOMIC_UMAX
136	S_ATOMIC_AND
137	S_ATOMIC_OR
138	S_ATOMIC_XOR
139	S_ATOMIC_INC
140	S_ATOMIC_DEC
160	S_ATOMIC_SWAP_X2
161	S_ATOMIC_CMPSWAP_X2

Opcode #	Name
162	S_ATOMIC_ADD_X2
163	S_ATOMIC_SUB_X2
164	S_ATOMIC_SMIN_X2
165	S_ATOMIC_UMIN_X2
166	S_ATOMIC_SMAX_X2
167	S_ATOMIC_UMAX_X2
168	S_ATOMIC_AND_X2
169	S_ATOMIC_OR_X2
170	S_ATOMIC_XOR_X2
171	S_ATOMIC_INC_X2
172	S_ATOMIC_DEC_X2

13.3. Vector ALU Formats

13.3.1. VOP2



Format VOP2

Description Vector ALU format with two operands

Table 65. VOP2 Fields

Field Name	Bits	Format or Description
SRC0	[8:0]	Source 0. First operand for the instruction.
	0 - 101	SGPR0 to SGPR101: Scalar general-purpose registers.
	102	FLAT_SCRATCH_LO.
	103	FLAT_SCRATCH_HI.
	104	XNACK_MASK_LO.
	105	XNACK_MASK_HI.
	106	VCC_LO: vcc[31:0].
	107	VCC_HI: vcc[63:32].
	108-123	TTMP0 - TTMP15: Trap handler temporary register.
	124	M0. Memory register 0.
	125	Reserved
	126	EXEC_LO: exec[31:0].
	127	EXEC_HI: exec[63:32].
	128	0.
	129-192	Signed integer 1 to 64.
	193-208	Signed integer -1 to -16.
	209-234	Reserved.
	235	SHARED_BASE (Memory Aperture definition).
	236	SHARED_LIMIT (Memory Aperture definition).
	237	PRIVATE_BASE (Memory Aperture definition).
	238	PRIVATE_LIMIT (Memory Aperture definition).
	239	POPS_EXITING_WAVE_ID .
	240	0.5.
	241	-0.5.
	242	1.0.
	243	-1.0.
	244	2.0.
	245	-2.0.
	246	4.0.
	247	-4.0.
	248	1/(2*PI).
	249	SDWA
	250	DPP
	251	VCCZ.
252	EXECZ.	
253	SCC.	
254	Reserved.	
255	Literal constant.	
256 - 511	VGPR 0 - 255	
VSRC1	[16:9]	VGPR which provides the second operand.
VDST	[24:17]	Destination VGPR.
OP	[30:25]	See Opcode table below.
ENCODING	[31]	Must be: 0

Table 66. VOP2 Opcodes

Opcode #	Name
0	V_CNDMASK_B32

Opcode #	Name
1	V_ADD_F32
2	V_SUB_F32
3	V_SUBREV_F32
4	V_MUL_LEGACY_F32
5	V_MUL_F32
6	V_MUL_I32_I24
7	V_MUL_HI_I32_I24
8	V_MUL_U32_U24
9	V_MUL_HI_U32_U24
10	V_MIN_F32
11	V_MAX_F32
12	V_MIN_I32
13	V_MAX_I32
14	V_MIN_U32
15	V_MAX_U32
16	V_LSHRREV_B32
17	V_ASHRREV_I32
18	V_LSHLREV_B32
19	V_AND_B32
20	V_OR_B32
21	V_XOR_B32
22	V_MAC_F32
23	V_MADMK_F32
24	V_MADAK_F32
25	V_ADD_CO_U32
26	V_SUB_CO_U32
27	V_SUBREV_CO_U32
28	V_ADDC_CO_U32
29	V_SUBB_CO_U32
30	V_SUBBREV_CO_U32
31	V_ADD_F16
32	V_SUB_F16
33	V_SUBREV_F16

Opcode #	Name
34	V_MUL_F16
35	V_MAC_F16
36	V_MADMK_F16
37	V_MADAK_F16
38	V_ADD_U16
39	V_SUB_U16
40	V_SUBREV_U16
41	V_MUL_LO_U16
42	V_LSHLREV_B16
43	V_LSHRREV_B16
44	V_ASHRREV_I16
45	V_MAX_F16
46	V_MIN_F16
47	V_MAX_U16
48	V_MAX_I16
49	V_MIN_U16
50	V_MIN_I16
51	V_LDEXP_F16
52	V_ADD_U32
53	V_SUB_U32
54	V_SUBREV_U32
59	V_FMAC_F32
61	V_XNOR_B32

13.3.2. VOP1

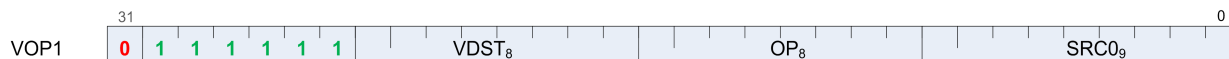

Format VOP1

Description Vector ALU format with one operand

Table 67. VOP1 Fields

Field Name	Bits	Format or Description
SRC0	[8:0]	Source 0. First operand for the instruction.
	0 - 101	SGPR0 to SGPR101: Scalar general-purpose registers.
	102	FLAT_SCRATCH_LO.
	103	FLAT_SCRATCH_HI.
	104	XNACK_MASK_LO.
	105	XNACK_MASK_HI.
	106	VCC_LO: vcc[31:0].
	107	VCC_HI: vcc[63:32].
	108-123	TTMP0 - TTMP15: Trap handler temporary register.
	124	M0. Memory register 0.
	125	Reserved
	126	EXEC_LO: exec[31:0].
	127	EXEC_HI: exec[63:32].
	128	0.
	129-192	Signed integer 1 to 64.
	193-208	Signed integer -1 to -16.
	209-234	Reserved.
	235	SHARED_BASE (Memory Aperture definition).
	236	SHARED_LIMIT (Memory Aperture definition).
	237	PRIVATE_BASE (Memory Aperture definition).
	238	PRIVATE_LIMIT (Memory Aperture definition).
	239	POPS_EXITING_WAVE_ID .
	240	0.5.
	241	-0.5.
	242	1.0.
	243	-1.0.
	244	2.0.
	245	-2.0.
	246	4.0.
	247	-4.0.
	248	1/(2*PI).
	249	SDWA
	250	DPP
	251	VCCZ.
252	EXECZ.	
253	SCC.	
254	Reserved.	
255	Literal constant.	
256 - 511	VGPR 0 - 255	
OP	[16:9]	See Opcode table below.
VDST	[24:17]	Destination VGPR.
ENCODING	[31:25]	Must be: 0_111111

Table 68. VOP1 Opcodes

Opcode #	Name
0	V_NOP
1	V_MOV_B32

Opcode #	Name
2	V_READFIRSTLANE_B32
3	V_CVT_I32_F64
4	V_CVT_F64_I32
5	V_CVT_F32_I32
6	V_CVT_F32_U32
7	V_CVT_U32_F32
8	V_CVT_I32_F32
10	V_CVT_F16_F32
11	V_CVT_F32_F16
12	V_CVT_RPI_I32_F32
13	V_CVT_FLR_I32_F32
14	V_CVT_OFF_F32_I4
15	V_CVT_F32_F64
16	V_CVT_F64_F32
17	V_CVT_F32_UBYTE0
18	V_CVT_F32_UBYTE1
19	V_CVT_F32_UBYTE2
20	V_CVT_F32_UBYTE3
21	V_CVT_U32_F64
22	V_CVT_F64_U32
23	V_TRUNC_F64
24	V_CEIL_F64
25	V_RNDNE_F64
26	V_FLOOR_F64
27	V_FRACT_F32
28	V_TRUNC_F32
29	V_CEIL_F32
30	V_RNDNE_F32
31	V_FLOOR_F32
32	V_EXP_F32
33	V_LOG_F32
34	V_RCP_F32
35	V_RCP_IFLAG_F32

Opcode #	Name
36	V_RSQ_F32
37	V_RCP_F64
38	V_RSQ_F64
39	V_SQRT_F32
40	V_SQRT_F64
41	V_SIN_F32
42	V_COS_F32
43	V_NOT_B32
44	V_BFREVB32
45	V_FFBH_U32
46	V_FFBL_B32
47	V_FFBH_I32
48	V_FREXP_EXP_I32_F64
49	V_FREXP_MANT_F64
50	V_FRACT_F64
51	V_FREXP_EXP_I32_F32
52	V_FREXP_MANT_F32
53	V_CLREXCP
55	V_SCREEN_PARTITION_4SE_B32
57	V_CVT_F16_U16
58	V_CVT_F16_I16
59	V_CVT_U16_F16
60	V_CVT_I16_F16
61	V_RCP_F16
62	V_SQRT_F16
63	V_RSQ_F16
64	V_LOG_F16
65	V_EXP_F16
66	V_FREXP_MANT_F16
67	V_FREXP_EXP_I16_F16
68	V_FLOOR_F16
69	V_CEIL_F16
70	V_TRUNC_F16

Opcode #	Name
71	V_RNDNE_F16
72	V_FRACT_F16
73	V_SIN_F16
74	V_COS_F16
75	V_EXP_LEGACY_F32
76	V_LOG_LEGACY_F32
77	V_CVT_NORM_I16_F16
78	V_CVT_NORM_U16_F16
79	V_SAT_PK_U8_I16
81	V_SWAP_B32

13.3.3. VOPC



Format VOPC

Description Vector instruction taking two inputs and producing a comparison result. Can be followed by a 32-bit literal constant. Vector Comparison operations are divided into three groups:

- those which can use any one of 16 comparison operations,
- those which can use any one of 8, and
- those which have only a single comparison operation.

The final opcode number is determined by adding the base for the opcode family plus the offset from the compare op. Every compare instruction writes a result to VCC (for VOPC) or an SGPR (for VOP3). Additionally, every compare instruction has a variant that also writes to the EXEC mask. The destination of the compare result is VCC when encoded using the VOPC format, and can be an arbitrary SGPR when encoded in the VOP3 format.

Comparison Operations

Table 69. Comparison Operations

Compare Operation	Opcode Offset	Description
Sixteen Compare Operations (OP16)		
F	0	D.u = 0

Compare Operation	Opcode Offset	Description
LT	1	D.u = (S0 < S1)
EQ	2	D.u = (S0 == S1)
LE	3	D.u = (S0 <= S1)
GT	4	D.u = (S0 > S1)
LG	5	D.u = (S0 <> S1)
GE	6	D.u = (S0 >= S1)
O	7	D.u = (!isNaN(S0) && isNaN(S1))
U	8	D.u = (!isNaN(S0) isNaN(S1))
NGE	9	D.u = !(S0 >= S1)
NLG	10	D.u = !(S0 <> S1)
NGT	11	D.u = !(S0 > S1)
NLE	12	D.u = !(S0 <= S1)
NEQ	13	D.u = !(S0 == S1)
NLT	14	D.u = !(S0 < S1)
TRU	15	D.u = 1
Eight Compare Operations (OP8)		
F	0	D.u = 0
LT	1	D.u = (S0 < S1)
EQ	2	D.u = (S0 == S1)
LE	3	D.u = (S0 <= S1)
GT	4	D.u = (S0 > S1)
LG	5	D.u = (S0 <> S1)
GE	6	D.u = (S0 >= S1)
TRU	7	D.u = 1

Table 70. VOPC Fields

Field Name	Bits	Format or Description
SRC0	[8:0]	Source 0. First operand for the instruction.
	0 - 101	SGPR0 to SGPR101: Scalar general-purpose registers.
	102	FLAT_SCRATCH_LO.
	103	FLAT_SCRATCH_HI.
	104	XNACK_MASK_LO.
	105	XNACK_MASK_HI.
	106	VCC_LO: vcc[31:0].
	107	VCC_HI: vcc[63:32].
	108-123	TTMP0 - TTMP15: Trap handler temporary register.
	124	M0. Memory register 0.
	125	Reserved
	126	EXEC_LO: exec[31:0].
	127	EXEC_HI: exec[63:32].
	128	0.
	129-192	Signed integer 1 to 64.
	193-208	Signed integer -1 to -16.
	209-234	Reserved.
	235	SHARED_BASE (Memory Aperture definition).
	236	SHARED_LIMIT (Memory Aperture definition).
	237	PRIVATE_BASE (Memory Aperture definition).
	238	PRIVATE_LIMIT (Memory Aperture definition).
	239	POPS_EXITING_WAVE_ID .
	240	0.5.
	241	-0.5.
	242	1.0.
	243	-1.0.
	244	2.0.
	245	-2.0.
	246	4.0.
	247	-4.0.
	248	1/(2*PI).
	249	SDWA
	250	DPP
	251	VCCZ.
252	EXECZ.	
253	SCC.	
254	Reserved.	
255	Literal constant.	
256 - 511	VGPR 0 - 255	
VSRC1	[16:9]	VGPR which provides the second operand.
OP	[24:17]	See Opcode table below.
ENCODING	[31:25]	Must be: 0_111110

Table 71. VOPC Opcodes

Opcode #	Name
16	V_CMP_CLASS_F32
17	V_CMPX_CLASS_F32

Opcode #	Name
18	V_CMP_CLASS_F64
19	V_CMPX_CLASS_F64
20	V_CMP_CLASS_F16
21	V_CMPX_CLASS_F16
32	V_CMP_F_F16
33	V_CMP_LT_F16
34	V_CMP_EQ_F16
35	V_CMP_LE_F16
36	V_CMP_GT_F16
37	V_CMP_LG_F16
38	V_CMP_GE_F16
39	V_CMP_O_F16
40	V_CMP_U_F16
41	V_CMP_NGE_F16
42	V_CMP_NLG_F16
43	V_CMP_NGT_F16
44	V_CMP_NLE_F16
45	V_CMP_NEQ_F16
46	V_CMP_NLT_F16
47	V_CMP_TRU_F16
48	V_CMPX_F_F16
49	V_CMPX_LT_F16
50	V_CMPX_EQ_F16
51	V_CMPX_LE_F16
52	V_CMPX_GT_F16
53	V_CMPX_LG_F16
54	V_CMPX_GE_F16
55	V_CMPX_O_F16
56	V_CMPX_U_F16
57	V_CMPX_NGE_F16
58	V_CMPX_NLG_F16
59	V_CMPX_NGT_F16
60	V_CMPX_NLE_F16

Opcode #	Name
61	V_CMPX_NEQ_F16
62	V_CMPX_NLT_F16
63	V_CMPX_TRU_F16
64	V_CMP_F_F32
65	V_CMP_LT_F32
66	V_CMP_EQ_F32
67	V_CMP_LE_F32
68	V_CMP_GT_F32
69	V_CMP_LG_F32
70	V_CMP_GE_F32
71	V_CMP_O_F32
72	V_CMP_U_F32
73	V_CMP_NGE_F32
74	V_CMP_NLG_F32
75	V_CMP_NGT_F32
76	V_CMP_NLE_F32
77	V_CMP_NEQ_F32
78	V_CMP_NLT_F32
79	V_CMP_TRU_F32
80	V_CMPX_F_F32
81	V_CMPX_LT_F32
82	V_CMPX_EQ_F32
83	V_CMPX_LE_F32
84	V_CMPX_GT_F32
85	V_CMPX_LG_F32
86	V_CMPX_GE_F32
87	V_CMPX_O_F32
88	V_CMPX_U_F32
89	V_CMPX_NGE_F32
90	V_CMPX_NLG_F32
91	V_CMPX_NGT_F32
92	V_CMPX_NLE_F32
93	V_CMPX_NEQ_F32

Opcode #	Name
94	V_CMPX_NLT_F32
95	V_CMPX_TRU_F32
96	V_CMP_F_F64
97	V_CMP_LT_F64
98	V_CMP_EQ_F64
99	V_CMP_LE_F64
100	V_CMP_GT_F64
101	V_CMP_LG_F64
102	V_CMP_GE_F64
103	V_CMP_O_F64
104	V_CMP_U_F64
105	V_CMP_NGE_F64
106	V_CMP_NLG_F64
107	V_CMP_NGT_F64
108	V_CMP_NLE_F64
109	V_CMP_NEQ_F64
110	V_CMP_NLT_F64
111	V_CMP_TRU_F64
112	V_CMPX_F_F64
113	V_CMPX_LT_F64
114	V_CMPX_EQ_F64
115	V_CMPX_LE_F64
116	V_CMPX_GT_F64
117	V_CMPX_LG_F64
118	V_CMPX_GE_F64
119	V_CMPX_O_F64
120	V_CMPX_U_F64
121	V_CMPX_NGE_F64
122	V_CMPX_NLG_F64
123	V_CMPX_NGT_F64
124	V_CMPX_NLE_F64
125	V_CMPX_NEQ_F64
126	V_CMPX_NLT_F64

Opcode #	Name
127	V_CMPX_TRU_F64
160	V_CMP_F_I16
161	V_CMP_LT_I16
162	V_CMP_EQ_I16
163	V_CMP_LE_I16
164	V_CMP_GT_I16
165	V_CMP_NE_I16
166	V_CMP_GE_I16
167	V_CMP_T_I16
168	V_CMP_F_U16
169	V_CMP_LT_U16
170	V_CMP_EQ_U16
171	V_CMP_LE_U16
172	V_CMP_GT_U16
173	V_CMP_NE_U16
174	V_CMP_GE_U16
175	V_CMP_T_U16
176	V_CMPX_F_I16
177	V_CMPX_LT_I16
178	V_CMPX_EQ_I16
179	V_CMPX_LE_I16
180	V_CMPX_GT_I16
181	V_CMPX_NE_I16
182	V_CMPX_GE_I16
183	V_CMPX_T_I16
184	V_CMPX_F_U16
185	V_CMPX_LT_U16
186	V_CMPX_EQ_U16
187	V_CMPX_LE_U16
188	V_CMPX_GT_U16
189	V_CMPX_NE_U16
190	V_CMPX_GE_U16
191	V_CMPX_T_U16

Opcode #	Name
192	V_CMP_F_I32
193	V_CMP_LT_I32
194	V_CMP_EQ_I32
195	V_CMP_LE_I32
196	V_CMP_GT_I32
197	V_CMP_NE_I32
198	V_CMP_GE_I32
199	V_CMP_T_I32
200	V_CMP_F_U32
201	V_CMP_LT_U32
202	V_CMP_EQ_U32
203	V_CMP_LE_U32
204	V_CMP_GT_U32
205	V_CMP_NE_U32
206	V_CMP_GE_U32
207	V_CMP_T_U32
208	V_CMPX_F_I32
209	V_CMPX_LT_I32
210	V_CMPX_EQ_I32
211	V_CMPX_LE_I32
212	V_CMPX_GT_I32
213	V_CMPX_NE_I32
214	V_CMPX_GE_I32
215	V_CMPX_T_I32
216	V_CMPX_F_U32
217	V_CMPX_LT_U32
218	V_CMPX_EQ_U32
219	V_CMPX_LE_U32
220	V_CMPX_GT_U32
221	V_CMPX_NE_U32
222	V_CMPX_GE_U32
223	V_CMPX_T_U32
224	V_CMP_F_I64

Opcode #	Name
225	V_CMP_LT_I64
226	V_CMP_EQ_I64
227	V_CMP_LE_I64
228	V_CMP_GT_I64
229	V_CMP_NE_I64
230	V_CMP_GE_I64
231	V_CMP_T_I64
232	V_CMP_F_U64
233	V_CMP_LT_U64
234	V_CMP_EQ_U64
235	V_CMP_LE_U64
236	V_CMP_GT_U64
237	V_CMP_NE_U64
238	V_CMP_GE_U64
239	V_CMP_T_U64
240	V_CMPX_F_I64
241	V_CMPX_LT_I64
242	V_CMPX_EQ_I64
243	V_CMPX_LE_I64
244	V_CMPX_GT_I64
245	V_CMPX_NE_I64
246	V_CMPX_GE_I64
247	V_CMPX_T_I64
248	V_CMPX_F_U64
249	V_CMPX_LT_U64
250	V_CMPX_EQ_U64
251	V_CMPX_LE_U64
252	V_CMPX_GT_U64
253	V_CMPX_NE_U64
254	V_CMPX_GE_U64
255	V_CMPX_T_U64

13.3.4. VOP3A

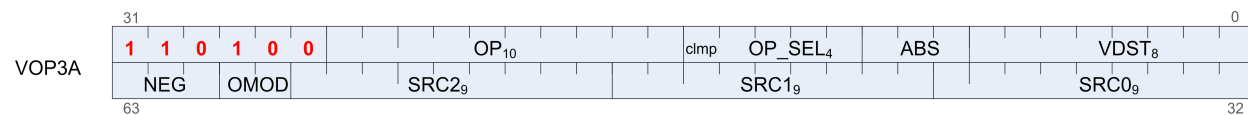

Format VOP3A

Description Vector ALU format with three operands

Table 72. VOP3A Fields

Field Name	Bits	Format or Description
VDST	[7:0]	Destination VGPR
ABS	[10:8]	Absolute value of input. [8] = src0, [9] = src1, [10] = src2
OPSEL	[14:11]	Operand select for 16-bit data. 0 = select low half, 1 = select high half. [11] = src0, [12] = src1, [13] = src2, [14] = dest.
CLMP	[15]	Clamp output
OP	[25:16]	Opcode. See next table.
ENCODING	[31:26]	Must be: 110100

Field Name	Bits	Format or Description
SRC0	[40:32]	Source 0. First operand for the instruction.
	0 - 101	SGPR0 to SGPR101: Scalar general-purpose registers.
	102	FLAT_SCRATCH_LO.
	103	FLAT_SCRATCH_HI.
	104	XNACK_MASK_LO.
	105	XNACK_MASK_HI.
	106	VCC_LO: vcc[31:0].
	107	VCC_HI: vcc[63:32].
	108-123	TTMP0 - TTMP15: Trap handler temporary register.
	124	M0. Memory register 0.
	125	Reserved
	126	EXEC_LO: exec[31:0].
	127	EXEC_HI: exec[63:32].
	128	0.
	129-192	Signed integer 1 to 64.
	193-208	Signed integer -1 to -16.
	209-234	Reserved.
	235	SHARED_BASE (Memory Aperture definition).
	236	SHARED_LIMIT (Memory Aperture definition).
	237	PRIVATE_BASE (Memory Aperture definition).
	238	PRIVATE_LIMIT (Memory Aperture definition).
	239	POPS_EXITING_WAVE_ID .
	240	0.5.
	241	-0.5.
	242	1.0.
	243	-1.0.
	244	2.0.
	245	-2.0.
	246	4.0.
	247	-4.0.
	248	1/(2*PI).
	249	SDWA
	250	DPP
	251	VCCZ.
252	EXECZ.	
253	SCC.	
254	Reserved.	
255	Literal constant.	
256 - 511	VGPR 0 - 255	
SRC1	[49:41]	Second input operand. Same options as SRC0.
SRC2	[58:50]	Third input operand. Same options as SRC0.
OMOD	[60:59]	Output Modifier: 0=none, 1=*2, 2=*4, 3=div-2
NEG	[63:61]	Negate input. [61] = src0, [62] = src1, [63] = src2

Table 73. VOP3A Opcodes

Opcode #	Name
448	V_MAD_LEGACY_F32

Opcode #	Name
449	V_MAD_F32
450	V_MAD_I32_I24
451	V_MAD_U32_U24
452	V_CUBEID_F32
453	V_CUBESC_F32
454	V_CUBETC_F32
455	V_CUBEMA_F32
456	V_BFE_U32
457	V_BFE_I32
458	V_BFI_B32
459	V_FMA_F32
460	V_FMA_F64
461	V_LERP_U8
462	V_ALIGNBIT_B32
463	V_ALIGNBYTE_B32
464	V_MIN3_F32
465	V_MIN3_I32
466	V_MIN3_U32
467	V_MAX3_F32
468	V_MAX3_I32
469	V_MAX3_U32
470	V_MED3_F32
471	V_MED3_I32
472	V_MED3_U32
473	V_SAD_U8
474	V_SAD_HI_U8
475	V_SAD_U16
476	V_SAD_U32
477	V_CVT_PK_U8_F32
478	V_DIV_FIXUP_F32
479	V_DIV_FIXUP_F64
482	V_DIV_FMAS_F32
483	V_DIV_FMAS_F64

Opcode #	Name
484	V_MSAD_U8
485	V_QSAD_PK_U16_U8
486	V_MQSAD_PK_U16_U8
487	V_MQSAD_U32_U8
490	V_MAD_LEGACY_F16
491	V_MAD_LEGACY_U16
492	V_MAD_LEGACY_I16
493	V_PERM_B32
494	V_FMA_LEGACY_F16
495	V_DIV_FIXUP_LEGACY_F16
496	V_CVT_PKACCUM_U8_F32
497	V_MAD_U32_U16
498	V_MAD_I32_I16
499	V_XAD_U32
500	V_MIN3_F16
501	V_MIN3_I16
502	V_MIN3_U16
503	V_MAX3_F16
504	V_MAX3_I16
505	V_MAX3_U16
506	V_MED3_F16
507	V_MED3_I16
508	V_MED3_U16
509	V_LSHL_ADD_U32
510	V_ADD_LSHL_U32
511	V_ADD3_U32
512	V_LSHL_OR_B32
513	V_AND_OR_B32
514	V_OR3_B32
515	V_MAD_F16
516	V_MAD_U16
517	V_MAD_I16
518	V_FMA_F16

Opcode #	Name
519	V_DIV_FIXUP_F16
628	V_INTERP_P1LL_F16
629	V_INTERP_P1LV_F16
630	V_INTERP_P2_LEGACY_F16
631	V_INTERP_P2_F16
640	V_ADD_F64
641	V_MUL_F64
642	V_MIN_F64
643	V_MAX_F64
644	V_LDEXP_F64
645	V_MUL_LO_U32
646	V_MUL_HI_U32
647	V_MUL_HI_I32
648	V_LDEXP_F32
649	V_READLANE_B32
650	V_WRITELANE_B32
651	V_BCNT_U32_B32
652	V_MBCNT_LO_U32_B32
653	V_MBCNT_HI_U32_B32
655	V_LSHLREV_B64
656	V_LSHRREV_B64
657	V_ASHRREV_I64
658	V_TRIG_PREOP_F64
659	V_BFM_B32
660	V_CVT_PKNORM_I16_F32
661	V_CVT_PKNORM_U16_F32
662	V_CVT_PKRTZ_F16_F32
663	V_CVT_PK_U16_U32
664	V_CVT_PK_I16_I32
665	V_CVT_PKNORM_I16_F16
666	V_CVT_PKNORM_U16_F16
668	V_ADD_I32
669	V_SUB_I32

Opcode #	Name
670	V_ADD_I16
671	V_SUB_I16
672	V_PACK_B32_F16

13.3.5. VOP3B

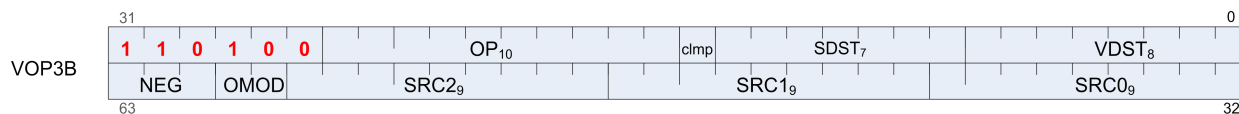

Format VOP3B

Description Vector ALU format with three operands and a scalar result. This encoding is used only for a few opcodes.

This encoding allows specifying a unique scalar destination, and is used only for the opcodes listed below. All other opcodes use VOP3A.

- V_ADD_CO_U32
- V_SUB_CO_U32
- V_SUBREV_CO_U32
- V_ADDC_CO_U32
- V_SUBB_CO_U32
- V_SUBBREV_CO_U32
- V_DIV_SCALE_F32
- V_DIV_SCALE_F64
- V_MAD_U64_U32
- V_MAD_I64_I32

Table 74. VOP3B Fields

Field Name	Bits	Format or Description
VDST	[7:0]	Destination VGPR
SDST	[14:8]	Scalar destination
CLMP	[15]	Clamp result
OP	[25:16]	Opcode. see next table.
ENCODING	[31:26]	Must be: 110100

Field Name	Bits	Format or Description
SRC0	[40:32]	Source 0. First operand for the instruction.
	0 - 101	SGPR0 to SGPR101: Scalar general-purpose registers.
	102	FLAT_SCRATCH_LO.
	103	FLAT_SCRATCH_HI.
	104	XNACK_MASK_LO.
	105	XNACK_MASK_HI.
	106	VCC_LO: vcc[31:0].
	107	VCC_HI: vcc[63:32].
	108-123	TTMP0 - TTMP15: Trap handler temporary register.
	124	M0. Memory register 0.
	125	Reserved
	126	EXEC_LO: exec[31:0].
	127	EXEC_HI: exec[63:32].
	128	0.
	129-192	Signed integer 1 to 64.
	193-208	Signed integer -1 to -16.
	209-234	Reserved.
	235	SHARED_BASE (Memory Aperture definition).
	236	SHARED_LIMIT (Memory Aperture definition).
	237	PRIVATE_BASE (Memory Aperture definition).
	238	PRIVATE_LIMIT (Memory Aperture definition).
	239	POPS_EXITING_WAVE_ID .
	240	0.5.
	241	-0.5.
	242	1.0.
	243	-1.0.
	244	2.0.
	245	-2.0.
	246	4.0.
	247	-4.0.
	248	1/(2*PI).
	249	SDWA
	250	DPP
	251	VCCZ.
252	EXECZ.	
253	SCC.	
254	Reserved.	
255	Literal constant.	
256 - 511	VGPR 0 - 255	
SRC1	[49:41]	Second input operand. Same options as SRC0.
SRC2	[58:50]	Third input operand. Same options as SRC0.
OMOD	[60:59]	Output Modifier: 0=none, 1=*2, 2=*4, 3=div-2
NEG	[63:61]	Negate input. [61] = src0, [62] = src1, [63] = src2

Table 75. VOP3B Opcodes

Opcode #	Name
480	V_DIV_SCALE_F32

Opcode #	Name
481	V_DIV_SCALE_F64
488	V_MAD_U64_U32
489	V_MAD_I64_I32

13.3.6. VOP3P

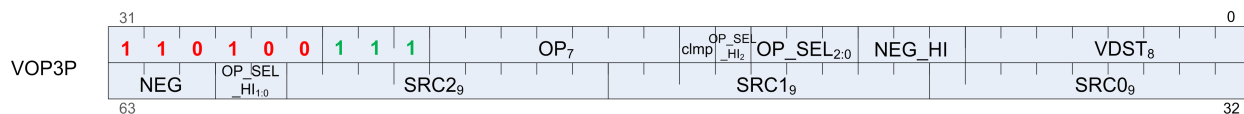

Format VOP3P

Description Vector ALU format taking one, two or three pairs of 16 bit inputs and producing two 16-bit outputs (packed into 1 dword).

Table 76. VOP3P Fields

Field Name	Bits	Format or Description
VDST	[7:0]	Destination VGPR
NEG_HI	[10:8]	Negate sources 0,1,2 of the high 16-bits.
OPSEL	[13:11]	Select low or high for low sources 0=[11], 1=[12], 2=[13].
OPSEL_HI2	[14]	Select low or high for high sources 0=[14], 1=[60], 2=[59].
CLMP	[15]	1 = clamp result.
OP	[22:16]	Opcode. see next table.
ENCODING	[31:24]	Must be: 11010011

Field Name	Bits	Format or Description
SRC0	[40:32]	Source 0. First operand for the instruction.
	0 - 101	SGPR0 to SGPR101: Scalar general-purpose registers.
	102	FLAT_SCRATCH_LO.
	103	FLAT_SCRATCH_HI.
	104	XNACK_MASK_LO.
	105	XNACK_MASK_HI.
	106	VCC_LO: vcc[31:0].
	107	VCC_HI: vcc[63:32].
	108-123	TTMP0 - TTMP15: Trap handler temporary register.
	124	M0. Memory register 0.
	125	Reserved
	126	EXEC_LO: exec[31:0].
	127	EXEC_HI: exec[63:32].
	128	0.
	129-192	Signed integer 1 to 64.
	193-208	Signed integer -1 to -16.
	209-234	Reserved.
	235	SHARED_BASE (Memory Aperture definition).
	236	SHARED_LIMIT (Memory Aperture definition).
	237	PRIVATE_BASE (Memory Aperture definition).
	238	PRIVATE_LIMIT (Memory Aperture definition).
	239	POPS_EXITING_WAVE_ID .
	240	0.5.
	241	-0.5.
	242	1.0.
	243	-1.0.
	244	2.0.
	245	-2.0.
	246	4.0.
	247	-4.0.
	248	1/(2*PI).
	249	SDWA
	250	DPP
	251	VCCZ.
252	EXECZ.	
253	SCC.	
254	Reserved.	
255	Literal constant.	
256 - 511	VGPR 0 - 255	
SRC1	[49:41]	Second input operand. Same options as SRC0.
SRC2	[58:50]	Third input operand. Same options as SRC0.
OPSEL_HI	[60:59]	See OP_SEL_HI2.
NEG	[63:61]	Negate input for low 16-bits of sources. [61] = src0, [62] = src1, [63] = src2

Table 77. VOP3P Opcodes

Opcode #	Name
0	V_PK_MAD_I16

Opcode #	Name
1	V_PK_MUL_LO_U16
2	V_PK_ADD_I16
3	V_PK_SUB_I16
4	V_PK_LSHLREV_B16
5	V_PK_LSHRREV_B16
6	V_PK_ASHRREV_I16
7	V_PK_MAX_I16
8	V_PK_MIN_I16
9	V_PK_MAD_U16
10	V_PK_ADD_U16
11	V_PK_SUB_U16
12	V_PK_MAX_U16
13	V_PK_MIN_U16
14	V_PK_FMA_F16
15	V_PK_ADD_F16
16	V_PK_MUL_F16
17	V_PK_MIN_F16
18	V_PK_MAX_F16
32	V_MAD_MIX_F32
33	V_MAD_MIXLO_F16
34	V_MAD_MIXHI_F16
35	V_DOT2_F32_F16
38	V_DOT2_I32_I16
39	V_DOT2_U32_U16
40	V_DOT4_I32_I8
41	V_DOT4_U32_U8
42	V_DOT8_I32_I4
43	V_DOT8_U32_U4

13.3.7. SDWA

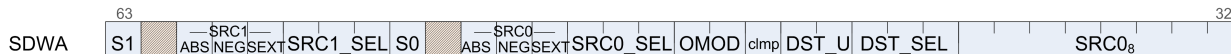

Format SDWA

Description Sub-Dword Addressing. This is a second dword which can follow VOP1 or VOP2 instructions (in place of a literal constant) to control selection of sub-dword (16-bit) operands. Use of SDWA is indicated by assigning the SRC0 field to SDWA, and then the actual VGPR used as source-zero is determined in SDWA instruction word.

Table 78. SDWA Fields

Field Name	Bits	Format or Description
SRC0	[39:32]	Real SRC0 operand (VGPR).
DST_SEL	[42:40]	Select the data destination: 0 = data[7:0] 1 = data[15:8] 2 = data[23:16] 3 = data[31:24] 4 = data[15:0] 5 = data[31:16] 6 = data[31:0] 7 = reserved
DST_U	[44:43]	Destination format: what do with the bits in the VGPR that are not selected by DST_SEL: 0 = pad with zeros + 1 = sign extend upper / zero lower 2 = preserve (don't modify) 3 = reserved
CLMP	[45]	1 = clamp result
OMOD	[47:46]	Output modifiers (see VOP3). [46] = low half, [47] = high half
SRC0_SEL	[50:48]	Source 0 select. Same options as DST_SEL.
SRC0_SEXT	[51]	Sign extend modifier for source 0.
SRC0_NEG	[52]	1 = negate source 0.
SRC0_ABS	[53]	1 = Absolute value of source 0.
S0	[55]	0 = source 0 is VGPR, 1 = is SGPR.
SRC1_SEL	[58:56]	Same options as SRC0_SEL.
SRC1_SEXT	[59]	Sign extend modifier for source 1.
SRC1_NEG	[60]	1 = negate source 1.
SRC1_ABS	[61]	1 = Absolute value of source 1.
S1	[63]	0 = source 1 is VGPR, 1 = is SGPR.

13.3.8. SDWAB

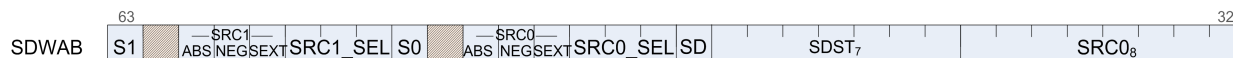

Format SDWAB

Description Sub-Dword Addressing. This is a second dword which can follow VOPC instructions (in place of a literal constant) to control selection of sub-dword (16-bit) operands. Use of SDWA is indicated by assigning the SRC0 field to SDWA, and then the actual VGPR used as source-zero is determined in SDWA instruction word. This version has a scalar destination.

Table 79. SDWAB Fields

Field Name	Bits	Format or Description
SRC0	[39:32]	Real SRC0 operand (VGPR).
SDST	[46:40]	Scalar GPR destination.
SD	[47]	Scalar destination type: 0 = VCC, 1 = normal SGPR.
SRC0_SEL	[50:48]	Source 0 select. Same options as DST_SEL.
SRC0_SEXT	[51]	Sign extend modifier for source 0.
SRC0_NEG	[52]	1 = negate source 0.
SRC0_ABS	[53]	1 = Absolute value of source 0.
S0	[55]	0 = source 0 is VGPR, 1 = is SGPR.
SRC1_SEL	[58:56]	Same options as SRC0_SEL.
SRC1_SEXT	[59]	Sign extend modifier for source 1.
SRC1_NEG	[60]	1 = negate source 1.
SRC1_ABS	[61]	1 = Absolute value of source 1.
S1	[63]	0 = source 1 is VGPR, 1 = is SGPR.

13.3.9. DPP



Format DPP

Description Data Parallel Primitives. This is a second dword which can follow VOP1, VOP2 or VOPC instructions (in place of a literal constant) to control selection of data from other lanes.

Table 80. DPP Fields

Field Name	Bits	Format or Description
SRC0	[39:32]	Real SRC0 operand (VGPR).
DPP_CTRL	[48:40]	See next table: "DPP_CTRL Enumeration"
BC	[51]	Bounds Control: 0 = do not write when source is out of range, 1 = write.
SRC0_NEG	[52]	1 = negate source 0.
SRC0_ABS	[53]	1 = Absolute value of source 0.
SRC1_NEG	[54]	1 = negate source 1.
SRC1_ABS	[55]	1 = Absolute value of source 1.
BANK_MASK	[59:56]	Bank Mask Applies to the VGPR destination write only, does not impact the thread mask when fetching source VGPR data. 27==0: lanes[12:15, 28:31, 44:47, 60:63] are disabled 26==0: lanes[8:11, 24:27, 40:43, 56:59] are disabled 25==0: lanes[4:7, 20:23, 36:39, 52:55] are disabled 24==0: lanes[0:3, 16:19, 32:35, 48:51] are disabled Notice: the term "bank" here is not the same as we used for the VGPR bank.
ROW_MASK	[63:60]	Row Mask Applies to the VGPR destination write only, does not impact the thread mask when fetching source VGPR data. 31==0: lanes[63:48] are disabled (wave 64 only) 30==0: lanes[47:32] are disabled (wave 64 only) 29==0: lanes[31:16] are disabled 28==0: lanes[15:0] are disabled

Table 81. DPP_CTRL Enumeration

DPP_Cntl Enumeration	Hex Value	Function	Description
DPP_QUAD_PERM*	000-0FF	$\text{pix}[n].\text{srca} = \text{pix}[(n \& 0x3c) + \text{dpp_cntl}[n\%4*2+1 : n\%4*2]].\text{srca}$	Permute of four threads.
DPP_UNUSED	100	Undefined	Reserved.
DPP_ROW_SL*	101-10F	if $(n \& 0xf) < (16 - \text{cntl}[3:0])$ $\text{pix}[n].\text{srca} = \text{pix}[n + \text{cntl}[3:0]].\text{srca}$ else use bound_cntl	Row shift left by 1-15 threads.
DPP_ROW_SR*	111-11F	if $((n \& 0xf) \geq \text{cntl}[3:0])$ $\text{pix}[n].\text{srca} = \text{pix}[n - \text{cntl}[3:0]].\text{srca}$ else use bound_cntl	Row shift right by 1-15 threads.
DPP_ROW_RR*	121-12F	if $((n \& 0xf) \geq \text{cntl}[3:0])$ $\text{pix}[n].\text{srca} = \text{pix}[n - \text{cntl}[3:0]].\text{srca}$ else $\text{pix}[n].\text{srca} = \text{pix}[n + 16 - \text{cntl}[3:0]].\text{srca}$	Row rotate right by 1-15 threads.
DPP_WF_SL1*	130	if $(n < 63)$ $\text{pix}[n].\text{srca} = \text{pix}[n+1].\text{srca}$ else use bound_cntl	Wavefront left shift by 1 thread.

DPP_Cntl Enumeration	Hex Value	Function	Description
DPP_WF_RL1*	134	if (n<63) pix[n].srca = pix[n+1].srca else pix[n].srca = pix[0].srca	Wavefront left rotate by 1 thread.
DPP_WF_SR1*	138	if (n>0) pix[n].srca = pix[n-1].srca else use bound_cntl	Wavefront right shift by 1 thread.
DPP_WF_RR1*	13C	if (n>0) pix[n].srca = pix[n-1].srca else pix[n].srca = pix[63].srca	Wavefront right rotate by 1 thread.
DPP_ROW_MIRR OR*	140	pix[n].srca = pix[15-(n&f)].srca	Mirror threads within row.
DPP_ROW_HALF_MIRROR*	141	pix[n].srca = pix[7-(n&7)].srca	Mirror threads within row (8 threads).
DPP_ROW_BCA ST15*	142	if (n>15) pix[n].srca = pix[n & 0x30 - 1].srca	Broadcast 15th thread of each row to next row.
DPP_ROW_BCA ST31*	143	if (n>31) pix[n].srca = pix[n & 0x20 - 1].srca	Broadcast thread 31 to rows 2 and 3.

13.4. Vector Parameter Interpolation Format

13.4.1. VINTRP



Format VINTRP

Description Vector Parameter Interpolation.
 These opcodes perform parameter interpolation using vertex data in pixel shaders.

Table 82. VINTRP Fields

Field Name	Bits	Format or Description
VSRC	[7:0]	SRC0 operand (VGPR).
ATTR_CHAN	[9:8]	Attribute channel: 0=X, 1=Y, 2=Z, 3=W
ATTR	[15:10]	Attribute number: 0 - 32.
OP	[17:16]	Opcode: 0: v_interp_p1_f32 : VDST = P10 * VSRC + P0 1: v_interp_p2_f32: VDST = P20 * VSRC + VDST 2: v_interp_mov_f32: VDST = (P0, P10 or P20 selected by VSRC[1:0])
VDST	[25:18]	Destination VGPR

Field Name	Bits	Format or Description
ENCODING	[31:26]	Must be: 110101



VSRC must be different from VDST.

13.5. LDS and GDS format

13.5.1. DS

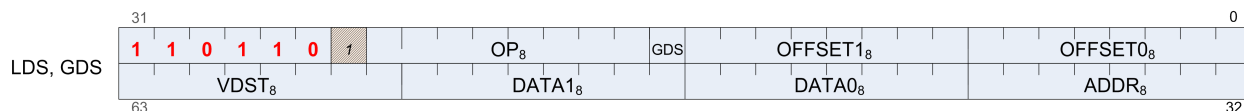

Format LDS and GDS

Description Local and Global Data Sharing instructions

Table 83. DS Fields

Field Name	Bits	Format or Description
OFFSET0	[7:0]	First address offset
OFFSET1	[15:8]	Second address offset. For some opcodes this is concatenated with OFFSET0.
GDS	[16]	1=GDS, 0=LDS operation.
OP	[24:17]	See Opcode table below.
ENCODING	[31:26]	Must be: 110110
ADDR	[39:32]	VGPR which supplies the address.
DATA0	[47:40]	First data VGPR.
DATA1	[55:48]	Second data VGPR.
VDST	[63:56]	Destination VGPR when results returned to VGPRs.

Table 84. DS Opcodes

Opcode #	Name
0	DS_ADD_U32
1	DS_SUB_U32
2	DS_RSUB_U32
3	DS_INC_U32
4	DS_DEC_U32

Opcode #	Name
5	DS_MIN_I32
6	DS_MAX_I32
7	DS_MIN_U32
8	DS_MAX_U32
9	DS_AND_B32
10	DS_OR_B32
11	DS_XOR_B32
12	DS_MSKOR_B32
13	DS_WRITE_B32
14	DS_WRITE2_B32
15	DS_WRITE2ST64_B32
16	DS_CMPST_B32
17	DS_CMPST_F32
18	DS_MIN_F32
19	DS_MAX_F32
20	DS_NOP
21	DS_ADD_F32
29	DS_WRITE_ADDTID_B32
30	DS_WRITE_B8
31	DS_WRITE_B16
32	DS_ADD_RTN_U32
33	DS_SUB_RTN_U32
34	DS_RSUB_RTN_U32
35	DS_INC_RTN_U32
36	DS_DEC_RTN_U32
37	DS_MIN_RTN_I32
38	DS_MAX_RTN_I32
39	DS_MIN_RTN_U32
40	DS_MAX_RTN_U32
41	DS_AND_RTN_B32
42	DS_OR_RTN_B32
43	DS_XOR_RTN_B32
44	DS_MSKOR_RTN_B32

Opcode #	Name
45	DS_WRXCHG_RTN_B32
46	DS_WRXCHG2_RTN_B32
47	DS_WRXCHG2ST64_RTN_B32
48	DS_CMPST_RTN_B32
49	DS_CMPST_RTN_F32
50	DS_MIN_RTN_F32
51	DS_MAX_RTN_F32
52	DS_WRAP_RTN_B32
53	DS_ADD_RTN_F32
54	DS_READ_B32
55	DS_READ2_B32
56	DS_READ2ST64_B32
57	DS_READ_I8
58	DS_READ_U8
59	DS_READ_I16
60	DS_READ_U16
61	DS_SWIZZLE_B32
62	DS_PERMUTE_B32
63	DS_BPERMUTE_B32
64	DS_ADD_U64
65	DS_SUB_U64
66	DS_RSUB_U64
67	DS_INC_U64
68	DS_DEC_U64
69	DS_MIN_I64
70	DS_MAX_I64
71	DS_MIN_U64
72	DS_MAX_U64
73	DS_AND_B64
74	DS_OR_B64
75	DS_XOR_B64
76	DS_MSKOR_B64
77	DS_WRITE_B64

Opcode #	Name
78	DS_WRITE2_B64
79	DS_WRITE2ST64_B64
80	DS_CMPST_B64
81	DS_CMPST_F64
82	DS_MIN_F64
83	DS_MAX_F64
84	DS_WRITE_B8_D16_HI
85	DS_WRITE_B16_D16_HI
86	DS_READ_U8_D16
87	DS_READ_U8_D16_HI
88	DS_READ_I8_D16
89	DS_READ_I8_D16_HI
90	DS_READ_U16_D16
91	DS_READ_U16_D16_HI
96	DS_ADD_RTN_U64
97	DS_SUB_RTN_U64
98	DS_RSUB_RTN_U64
99	DS_INC_RTN_U64
100	DS_DEC_RTN_U64
101	DS_MIN_RTN_I64
102	DS_MAX_RTN_I64
103	DS_MIN_RTN_U64
104	DS_MAX_RTN_U64
105	DS_AND_RTN_B64
106	DS_OR_RTN_B64
107	DS_XOR_RTN_B64
108	DS_MSKOR_RTN_B64
109	DS_WRXCHG_RTN_B64
110	DS_WRXCHG2_RTN_B64
111	DS_WRXCHG2ST64_RTN_B64
112	DS_CMPST_RTN_B64
113	DS_CMPST_RTN_F64
114	DS_MIN_RTN_F64

Opcode #	Name
115	DS_MAX_RTN_F64
118	DS_READ_B64
119	DS_READ2_B64
120	DS_READ2ST64_B64
126	DS_CONDXCHG32_RTN_B64
128	DS_ADD_SRC2_U32
129	DS_SUB_SRC2_U32
130	DS_RSUB_SRC2_U32
131	DS_INC_SRC2_U32
132	DS_DEC_SRC2_U32
133	DS_MIN_SRC2_I32
134	DS_MAX_SRC2_I32
135	DS_MIN_SRC2_U32
136	DS_MAX_SRC2_U32
137	DS_AND_SRC2_B32
138	DS_OR_SRC2_B32
139	DS_XOR_SRC2_B32
141	DS_WRITE_SRC2_B32
146	DS_MIN_SRC2_F32
147	DS_MAX_SRC2_F32
149	DS_ADD_SRC2_F32
152	DS_GWS_SEMA_RELEASE_ALL
153	DS_GWS_INIT
154	DS_GWS_SEMA_V
155	DS_GWS_SEMA_BR
156	DS_GWS_SEMA_P
157	DS_GWS_BARRIER
182	DS_READ_ADDTID_B32
189	DS_CONSUME
190	DS_APPEND
191	DS_ORDERED_COUNT
192	DS_ADD_SRC2_U64
193	DS_SUB_SRC2_U64

Opcode #	Name
194	DS_RSUB_SRC2_U64
195	DS_INC_SRC2_U64
196	DS_DEC_SRC2_U64
197	DS_MIN_SRC2_I64
198	DS_MAX_SRC2_I64
199	DS_MIN_SRC2_U64
200	DS_MAX_SRC2_U64
201	DS_AND_SRC2_B64
202	DS_OR_SRC2_B64
203	DS_XOR_SRC2_B64
205	DS_WRITE_SRC2_B64
210	DS_MIN_SRC2_F64
211	DS_MAX_SRC2_F64
222	DS_WRITE_B96
223	DS_WRITE_B128
254	DS_READ_B96
255	DS_READ_B128

13.6. Vector Memory Buffer Formats

There are two memory buffer instruction formats:

MTBUF

typed buffer access (data type is defined by the instruction)

MUBUF

untyped buffer access (data type is defined by the buffer / resource-constant)

13.6.1. MTBUF

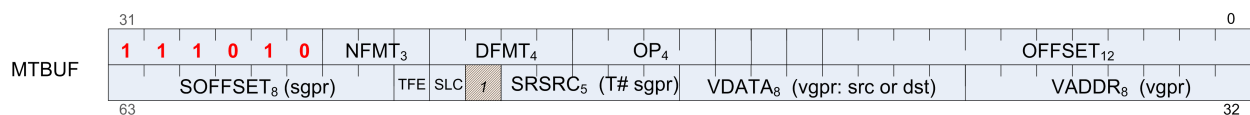

Format MTBUF

Description Memory Typed-Buffer Instructions

Table 85. MTBUF Fields

Field Name	Bits	Format or Description
OFFSET	[11:0]	Address offset, unsigned byte.
OFFEN	[12]	1 = enable offset VGPR, 0 = use zero for address offset
IDXEN	[13]	1 = enable index VGPR, 0 = use zero for address index
GLC	[14]	0 = normal, 1 = globally coherent (bypass L0 cache) or for atomics, return pre-op value to VGPR.
OP	[18:15]	Opcode. See table below.
DFMT	22:19	Data Format of data in memory buffer: 0 invalid 1 8 2 16 3 8_8 4 32 5 16_16 6 10_11_11 8 10_10_10_2 9 2_10_10_10 10 8_8_8_8 11 32_32 12 16_16_16_16 13 32_32_32 14 32_32_32_32
NFMT	25:23	Numeric format of data in memory: 0 unorm 1 snorm 2 uscaled 3 sscaled 4 uint 5 sint 6 reserved 7 float
ENCODING	[31:26]	Must be: 111010
VADDR	[39:32]	Address of VGPR to supply first component of address (offset or index). When both index and offset are used, index is in the first VGPR and offset in the second.
VDATA	[47:40]	Address of VGPR to supply first component of write data or receive first component of read-data.
SRSRC	[52:48]	SGPR to supply V# (resource constant) in 4 or 8 consecutive SGPRs. It is missing 2 LSB's of SGPR-address since must be aligned to 4.
SLC	[54]	System level coherent: bypass L2 cache.
TFE	[55]	Partially resident texture, texture fail enable.

Field Name	Bits	Format or Description
SOFFSET	[63:56]	Address offset, unsigned byte.

Table 86. MTBUF Opcodes

Opcode #	Name
0	TBUFFER_LOAD_FORMAT_X
1	TBUFFER_LOAD_FORMAT_XY
2	TBUFFER_LOAD_FORMAT_XYZ
3	TBUFFER_LOAD_FORMAT_XYZW
4	TBUFFER_STORE_FORMAT_X
5	TBUFFER_STORE_FORMAT_XY
6	TBUFFER_STORE_FORMAT_XYZ
7	TBUFFER_STORE_FORMAT_XYZW
8	TBUFFER_LOAD_FORMAT_D16_X
9	TBUFFER_LOAD_FORMAT_D16_XY
10	TBUFFER_LOAD_FORMAT_D16_XYZ
11	TBUFFER_LOAD_FORMAT_D16_XYZW
12	TBUFFER_STORE_FORMAT_D16_X
13	TBUFFER_STORE_FORMAT_D16_XY
14	TBUFFER_STORE_FORMAT_D16_XYZ
15	TBUFFER_STORE_FORMAT_D16_XYZW

13.6.2. MUBUF



Format MUBUF

Description Memory Untyped-Buffer Instructions

Table 87. MUBUF Fields

Field Name	Bits	Format or Description
OFFSET	[11:0]	Address offset, unsigned byte.
OFFEN	[12]	1 = enable offset VGPR, 0 = use zero for address offset

Field Name	Bits	Format or Description
IDXEN	[13]	1 = enable index VGPR, 0 = use zero for address index
GLC	[14]	0 = normal, 1 = globally coherent (bypass L0 cache) or for atomics, return pre-op value to VGPR.
LDS	[16]	0 = normal, 1 = transfer data between LDS and memory instead of VGPRs and memory.
SLC	[17]	System level coherent: bypass L2 cache.
OP	[24:18]	Opcode. See table below.
ENCODING	[31:26]	Must be: 111000
VADDR	[39:32]	Address of VGPR to supply first component of address (offset or index). When both index and offset are used, index is in the first VGPR and offset in the second.
VDATA	[47:40]	Address of VGPR to supply first component of write data or receive first component of read-data.
SRSRC	[52:48]	SGPR to supply V# (resource constant) in 4 or 8 consecutive SGPRs. It is missing 2 LSB's of SGPR-address since must be aligned to 4.
TFE	[55]	Partially resident texture, texture fail enable.
SOFFSET	[63:56]	Address offset, unsigned byte.

Table 88. MUBUF Opcodes

Opcode #	Name
0	BUFFER_LOAD_FORMAT_X
1	BUFFER_LOAD_FORMAT_XY
2	BUFFER_LOAD_FORMAT_XYZ
3	BUFFER_LOAD_FORMAT_XYZW
4	BUFFER_STORE_FORMAT_X
5	BUFFER_STORE_FORMAT_XY
6	BUFFER_STORE_FORMAT_XYZ
7	BUFFER_STORE_FORMAT_XYZW
8	BUFFER_LOAD_FORMAT_D16_X
9	BUFFER_LOAD_FORMAT_D16_XY
10	BUFFER_LOAD_FORMAT_D16_XYZ
11	BUFFER_LOAD_FORMAT_D16_XYZW
12	BUFFER_STORE_FORMAT_D16_X
13	BUFFER_STORE_FORMAT_D16_XY
14	BUFFER_STORE_FORMAT_D16_XYZ

Opcode #	Name
15	BUFFER_STORE_FORMAT_D16_XYZW
16	BUFFER_LOAD_UBYTE
17	BUFFER_LOAD_SBYTE
18	BUFFER_LOAD_USHORT
19	BUFFER_LOAD_SSHORT
20	BUFFER_LOAD_DWORD
21	BUFFER_LOAD_DWORDX2
22	BUFFER_LOAD_DWORDX3
23	BUFFER_LOAD_DWORDX4
24	BUFFER_STORE_BYTE
25	BUFFER_STORE_BYTE_D16_HI
26	BUFFER_STORE_SHORT
27	BUFFER_STORE_SHORT_D16_HI
28	BUFFER_STORE_DWORD
29	BUFFER_STORE_DWORDX2
30	BUFFER_STORE_DWORDX3
31	BUFFER_STORE_DWORDX4
32	BUFFER_LOAD_UBYTE_D16
33	BUFFER_LOAD_UBYTE_D16_HI
34	BUFFER_LOAD_SBYTE_D16
35	BUFFER_LOAD_SBYTE_D16_HI
36	BUFFER_LOAD_SHORT_D16
37	BUFFER_LOAD_SHORT_D16_HI
38	BUFFER_LOAD_FORMAT_D16_HI_X
39	BUFFER_STORE_FORMAT_D16_HI_X
61	BUFFER_STORE_LDS_DWORD
62	BUFFER_WBINVL1
63	BUFFER_WBINVL1_VOL
64	BUFFER_ATOMIC_SWAP
65	BUFFER_ATOMIC_CMPSWAP
66	BUFFER_ATOMIC_ADD
67	BUFFER_ATOMIC_SUB
68	BUFFER_ATOMIC_SMIN

Opcode #	Name
69	BUFFER_ATOMIC_UMIN
70	BUFFER_ATOMIC_SMAX
71	BUFFER_ATOMIC_UMAX
72	BUFFER_ATOMIC_AND
73	BUFFER_ATOMIC_OR
74	BUFFER_ATOMIC_XOR
75	BUFFER_ATOMIC_INC
76	BUFFER_ATOMIC_DEC
96	BUFFER_ATOMIC_SWAP_X2
97	BUFFER_ATOMIC_CMPSWAP_X2
98	BUFFER_ATOMIC_ADD_X2
99	BUFFER_ATOMIC_SUB_X2
100	BUFFER_ATOMIC_SMIN_X2
101	BUFFER_ATOMIC_UMIN_X2
102	BUFFER_ATOMIC_SMAX_X2
103	BUFFER_ATOMIC_UMAX_X2
104	BUFFER_ATOMIC_AND_X2
105	BUFFER_ATOMIC_OR_X2
106	BUFFER_ATOMIC_XOR_X2
107	BUFFER_ATOMIC_INC_X2
108	BUFFER_ATOMIC_DEC_X2

13.7. Vector Memory Image Format

13.7.1. MIMG

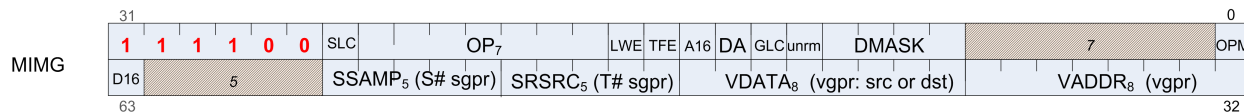

Format MIMG

Description Memory Image Instructions

Table 89. MIMG Fields

Field Name	Bits	Format or Description
DMASK	[11:8]	Data VGPR enable mask: 1 .. 4 consecutive VGPRs Reads: defines which components are returned: 0=red,1=green,2=blue,3=alpha Writes: defines which components are written with data from VGPRs (missing components get 0). Enabled components come from consecutive VGPRs. E.G. dmask=1001 : Red is in VGPRn and alpha in VGPRn+1. For D16 writes, DMASK is only used as a word count: each bit represents 16 bits of data to be written starting at the LSB's of VDATA, then MSBs, then VDATA+1 etc. Bit position is ignored.
UNRM	[12]	Force address to be un-normalized. Must be set to 1 for Image stores & atomics.
GLC	[13]	0 = normal, 1 = globally coherent (bypass L0 cache) or for atomics, return pre-op value to VGPR.
DA	[14]	Declare an Array. 1 Kernel has declared this resource to be an array of texture maps. 0 Kernel has declared this resource to be a single texture map.
A16	[15]	Address components are 16-bits (instead of the usual 32 bits). When set, all address components are 16 bits (packed into 2 per dword), except: Texel offsets (3 6bit UINT packed into 1 dword) PCF reference (for "_C" instructions) Address components are 16b uint for image ops without sampler; 16b float with sampler.
TFE	[16]	Partially resident texture, texture fail enable.
LWE	[17]	LOD Warning Enable. When set to 1, a texture fetch may return "LOD_CLAMPED = 1".
OP	[0],[24:18]	Opcode. See table below. (combine bits zero and 18-24 to form opcode).
SLC	[25]	System level coherent: bypass L2 cache.
ENCODING	[31:26]	Must be: 111100
VADDR	[39:32]	Address of VGPR to supply first component of address (offset or index). When both index and offset are used, index is in the first VGPR and offset in the second.
VDATA	[47:40]	Address of VGPR to supply first component of write data or receive first component of read-data.
SRSRC	[52:48]	SGPR to supply V# (resource constant) in 4 or 8 consecutive SGPRs. It is missing 2 LSB's of SGPR-address since must be aligned to 4.
SSAMP	[57:53]	SGPR to supply V# (resource constant) in 4 or 8 consecutive SGPRs. It is missing 2 LSB's of SGPR-address since must be aligned to 4.
D16	[63]	Address offset, unsigned byte.

Table 90. MIMG Opcodes

Opcode #	Name
0	IMAGE_LOAD
1	IMAGE_LOAD_MIP
2	IMAGE_LOAD_PCK
3	IMAGE_LOAD_PCK_SGN
4	IMAGE_LOAD_MIP_PCK
5	IMAGE_LOAD_MIP_PCK_SGN
8	IMAGE_STORE
9	IMAGE_STORE_MIP
10	IMAGE_STORE_PCK
11	IMAGE_STORE_MIP_PCK
14	IMAGE_GET_RESINFO
16	IMAGE_ATOMIC_SWAP
17	IMAGE_ATOMIC_CMPSWAP
18	IMAGE_ATOMIC_ADD
19	IMAGE_ATOMIC_SUB
20	IMAGE_ATOMIC_SMIN
21	IMAGE_ATOMIC_UMIN
22	IMAGE_ATOMIC_SMAX
23	IMAGE_ATOMIC_UMAX
24	IMAGE_ATOMIC_AND
25	IMAGE_ATOMIC_OR
26	IMAGE_ATOMIC_XOR
27	IMAGE_ATOMIC_INC
28	IMAGE_ATOMIC_DEC
32	IMAGE_SAMPLE
33	IMAGE_SAMPLE_CL
34	IMAGE_SAMPLE_D
35	IMAGE_SAMPLE_D_CL
36	IMAGE_SAMPLE_L
37	IMAGE_SAMPLE_B
38	IMAGE_SAMPLE_B_CL
39	IMAGE_SAMPLE_LZ
40	IMAGE_SAMPLE_C

Opcode #	Name
41	IMAGE_SAMPLE_C_CL
42	IMAGE_SAMPLE_C_D
43	IMAGE_SAMPLE_C_D_CL
44	IMAGE_SAMPLE_C_L
45	IMAGE_SAMPLE_C_B
46	IMAGE_SAMPLE_C_B_CL
47	IMAGE_SAMPLE_C_LZ
48	IMAGE_SAMPLE_O
49	IMAGE_SAMPLE_CL_O
50	IMAGE_SAMPLE_D_O
51	IMAGE_SAMPLE_D_CL_O
52	IMAGE_SAMPLE_L_O
53	IMAGE_SAMPLE_B_O
54	IMAGE_SAMPLE_B_CL_O
55	IMAGE_SAMPLE_LZ_O
56	IMAGE_SAMPLE_C_O
57	IMAGE_SAMPLE_C_CL_O
58	IMAGE_SAMPLE_C_D_O
59	IMAGE_SAMPLE_C_D_CL_O
60	IMAGE_SAMPLE_C_L_O
61	IMAGE_SAMPLE_C_B_O
62	IMAGE_SAMPLE_C_B_CL_O
63	IMAGE_SAMPLE_C_LZ_O
64	IMAGE_GATHER4
65	IMAGE_GATHER4_CL
66	IMAGE_GATHER4H
68	IMAGE_GATHER4_L
69	IMAGE_GATHER4_B
70	IMAGE_GATHER4_B_CL
71	IMAGE_GATHER4_LZ
72	IMAGE_GATHER4_C
73	IMAGE_GATHER4_C_CL
74	IMAGE_GATHER4H_PCK

Opcode #	Name
75	IMAGE_GATHER8H_PCK
76	IMAGE_GATHER4_C_L
77	IMAGE_GATHER4_C_B
78	IMAGE_GATHER4_C_B_CL
79	IMAGE_GATHER4_C_LZ
80	IMAGE_GATHER4_O
81	IMAGE_GATHER4_CL_O
84	IMAGE_GATHER4_L_O
85	IMAGE_GATHER4_B_O
86	IMAGE_GATHER4_B_CL_O
87	IMAGE_GATHER4_LZ_O
88	IMAGE_GATHER4_C_O
89	IMAGE_GATHER4_C_CL_O
92	IMAGE_GATHER4_C_L_O
93	IMAGE_GATHER4_C_B_O
94	IMAGE_GATHER4_C_B_CL_O
95	IMAGE_GATHER4_C_LZ_O
96	IMAGE_GET_LOD
104	IMAGE_SAMPLE_CD
105	IMAGE_SAMPLE_CD_CL
106	IMAGE_SAMPLE_C_CD
107	IMAGE_SAMPLE_C_CD_CL
108	IMAGE_SAMPLE_CD_O
109	IMAGE_SAMPLE_CD_CL_O
110	IMAGE_SAMPLE_C_CD_O
111	IMAGE_SAMPLE_C_CD_CL_O

13.8. Flat Formats

Flat memory instruction come in three versions: FLAT:: memory address (per work-item) may be in global memory, scratch (private) memory or shared memory (LDS) GLOBAL:: same as FLAT, but assumes all memory addresses are global memory. SCRATCH:: same as FLAT, but assumes all memory addresses are scratch (private) memory.

The microcode format is identical for each, and only the value of the SEG (segment) field differs.

13.8.1. FLAT

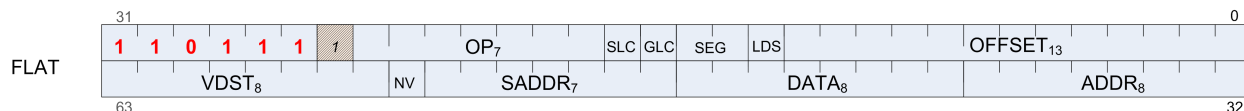

Format FLAT

Description FLAT Memory Access

Table 91. FLAT Fields

Field Name	Bits	Format or Description
OFFSET	[12:0]	Address offset Scratch, Global: 13-bit signed byte offset FLAT: 12-bit unsigned offset (MSB is ignored)
LDS	[13]	0 = normal, 1 = transfer data between LDS and memory instead of VGPRs and memory.
SEG	[15:14]	Memory Segment (instruction type): 0 = flat, 1 = scratch, 2 = global.
GLC	[16]	0 = normal, 1 = globally coherent (bypass L0 cache) or for atomics, return pre-op value to VGPR.
SLC	[17]	System level coherent: bypass L2 cache.
OP	[24:18]	Opcode. See tables below for FLAT, SCRATCH and GLOBAL opcodes.
ENCODING	[31:26]	Must be: 110111
ADDR	[39:32]	VGPR which holds address or offset. For 64-bit addresses, ADDR has the LSB's and ADDR+1 has the MSBs. For offset a single VGPR has a 32 bit unsigned offset. For FLAT_*: specifies an address. For GLOBAL_* and SCRATCH_* when SADDR is 0x7f: specifies an address. For GLOBAL_* and SCRATCH_* when SADDR is not 0x7f: specifies an offset.
DATA	[47:40]	VGPR which supplies data.
SADDR	[54:48]	Scalar SGPR which provides an address of offset (unsigned). Set this field to 0x7f to disable use. Meaning of this field is different for Scratch and Global: FLAT: Unused Scratch: use an SGPR for the address instead of a VGPR Global: use the SGPR to provide a base address and the VGPR provides a 32-bit byte offset.
NV	[55]	Non-Volatile.
VDST	[63:56]	Destination VGPR for data returned from memory to VGPRs.

Table 92. FLAT Opcodes

Opcode #	Name
16	FLAT_LOAD_UBYTE
17	FLAT_LOAD_SBYTE
18	FLAT_LOAD_USHORT
19	FLAT_LOAD_SSHORT
20	FLAT_LOAD_DWORD
21	FLAT_LOAD_DWORDX2
22	FLAT_LOAD_DWORDX3
23	FLAT_LOAD_DWORDX4
24	FLAT_STORE_BYTE
25	FLAT_STORE_BYTE_D16_HI
26	FLAT_STORE_SHORT
27	FLAT_STORE_SHORT_D16_HI
28	FLAT_STORE_DWORD
29	FLAT_STORE_DWORDX2
30	FLAT_STORE_DWORDX3
31	FLAT_STORE_DWORDX4
32	FLAT_LOAD_UBYTE_D16
33	FLAT_LOAD_UBYTE_D16_HI
34	FLAT_LOAD_SBYTE_D16
35	FLAT_LOAD_SBYTE_D16_HI
36	FLAT_LOAD_SHORT_D16
37	FLAT_LOAD_SHORT_D16_HI
64	FLAT_ATOMIC_SWAP
65	FLAT_ATOMIC_CMPSWAP
66	FLAT_ATOMIC_ADD
67	FLAT_ATOMIC_SUB
68	FLAT_ATOMIC_SMIN
69	FLAT_ATOMIC_UMIN
70	FLAT_ATOMIC_SMAX
71	FLAT_ATOMIC_UMAX
72	FLAT_ATOMIC_AND
73	FLAT_ATOMIC_OR

Opcode #	Name
74	FLAT_ATOMIC_XOR
75	FLAT_ATOMIC_INC
76	FLAT_ATOMIC_DEC
96	FLAT_ATOMIC_SWAP_X2
97	FLAT_ATOMIC_CMPSWAP_X2
98	FLAT_ATOMIC_ADD_X2
99	FLAT_ATOMIC_SUB_X2
100	FLAT_ATOMIC_SMIN_X2
101	FLAT_ATOMIC_UMIN_X2
102	FLAT_ATOMIC_SMAX_X2
103	FLAT_ATOMIC_UMAX_X2
104	FLAT_ATOMIC_AND_X2
105	FLAT_ATOMIC_OR_X2
106	FLAT_ATOMIC_XOR_X2
107	FLAT_ATOMIC_INC_X2
108	FLAT_ATOMIC_DEC_X2

13.8.2. GLOBAL

Table 93. GLOBAL Opcodes

Opcode #	Name
16	GLOBAL_LOAD_UBYTE
17	GLOBAL_LOAD_SBYTE
18	GLOBAL_LOAD_USHORT
19	GLOBAL_LOAD_SSHORT
20	GLOBAL_LOAD_DWORD
21	GLOBAL_LOAD_DWORDX2
22	GLOBAL_LOAD_DWORDX3
23	GLOBAL_LOAD_DWORDX4
24	GLOBAL_STORE_BYTE
25	GLOBAL_STORE_BYTE_D16_HI
26	GLOBAL_STORE_SHORT
27	GLOBAL_STORE_SHORT_D16_HI

Opcode #	Name
28	GLOBAL_STORE_DWORD
29	GLOBAL_STORE_DWORDX2
30	GLOBAL_STORE_DWORDX3
31	GLOBAL_STORE_DWORDX4
32	GLOBAL_LOAD_UBYTE_D16
33	GLOBAL_LOAD_UBYTE_D16_HI
34	GLOBAL_LOAD_SBYTE_D16
35	GLOBAL_LOAD_SBYTE_D16_HI
36	GLOBAL_LOAD_SHORT_D16
37	GLOBAL_LOAD_SHORT_D16_HI
64	GLOBAL_ATOMIC_SWAP
65	GLOBAL_ATOMIC_CMPSWAP
66	GLOBAL_ATOMIC_ADD
67	GLOBAL_ATOMIC_SUB
68	GLOBAL_ATOMIC_SMIN
69	GLOBAL_ATOMIC_UMIN
70	GLOBAL_ATOMIC_SMAX
71	GLOBAL_ATOMIC_UMAX
72	GLOBAL_ATOMIC_AND
73	GLOBAL_ATOMIC_OR
74	GLOBAL_ATOMIC_XOR
75	GLOBAL_ATOMIC_INC
76	GLOBAL_ATOMIC_DEC
96	GLOBAL_ATOMIC_SWAP_X2
97	GLOBAL_ATOMIC_CMPSWAP_X2
98	GLOBAL_ATOMIC_ADD_X2
99	GLOBAL_ATOMIC_SUB_X2
100	GLOBAL_ATOMIC_SMIN_X2
101	GLOBAL_ATOMIC_UMIN_X2
102	GLOBAL_ATOMIC_SMAX_X2
103	GLOBAL_ATOMIC_UMAX_X2
104	GLOBAL_ATOMIC_AND_X2
105	GLOBAL_ATOMIC_OR_X2

Opcode #	Name
106	GLOBAL_ATOMIC_XOR_X2
107	GLOBAL_ATOMIC_INC_X2
108	GLOBAL_ATOMIC_DEC_X2

13.8.3. SCRATCH

Table 94. SCRATCH Opcodes

Opcode #	Name
16	SCRATCH_LOAD_UBYTE
17	SCRATCH_LOAD_SBYTE
18	SCRATCH_LOAD_USHORT
19	SCRATCH_LOAD_SSHORT
20	SCRATCH_LOAD_DWORD
21	SCRATCH_LOAD_DWORDX2
22	SCRATCH_LOAD_DWORDX3
23	SCRATCH_LOAD_DWORDX4
24	SCRATCH_STORE_BYTE
25	SCRATCH_STORE_BYTE_D16_HI
26	SCRATCH_STORE_SHORT
27	SCRATCH_STORE_SHORT_D16_HI
28	SCRATCH_STORE_DWORD
29	SCRATCH_STORE_DWORDX2
30	SCRATCH_STORE_DWORDX3
31	SCRATCH_STORE_DWORDX4
32	SCRATCH_LOAD_UBYTE_D16
33	SCRATCH_LOAD_UBYTE_D16_HI
34	SCRATCH_LOAD_SBYTE_D16
35	SCRATCH_LOAD_SBYTE_D16_HI
36	SCRATCH_LOAD_SHORT_D16
37	SCRATCH_LOAD_SHORT_D16_HI

13.9. Export Format

13.9.1. EXP



Format EXP

Description EXPORT instructions

The export format has only a single opcode, "EXPORT".

Table 95. EXP Fields

Field Name	Bits	Format or Description
EN	[3:0]	COMPR==1: export half-dword enable. Valid values are: 0x0,3,c,f [0] enables VSRC0 : R,G from one VGPR (R in low bits, G high) [2] enables VSRC1 : B,A from one VGPR (B in low bits, A high) COMPR==0: [0-3] = enables for VSRC0..3. EN may be zero only for "NULL Pixel Shader" exports (used when exporting only valid mask to NULL target).
TARGET	[9:4]	Export destination: 0-7: MRT 0..7 8: Z 9: Null pixel shader export (no data) 12-15: Position 0..3 32-63: Parameter 0..31
COMPR	[10]	Indicates that data is float-16/short/byte (compressed). Data is written to consecutive components (rgba or xyzw).
DONE	[11]	Indicates that this is the last export from the shader. Used only for Position and Pixel/color data.
VM	[12]	1 = the exec mask IS the valid mask for this export. Can be sent multiple times, must be sent at least once per pixel shader. This bit is only used for Pixel Shaders.
ENCODING	[31:26]	Must be: 110001
VSRC0	[39:32]	VGPR for source 0.
VSRC1	[47:40]	VGPR for source 1.
VSRC2	[55:48]	VGPR for source 2.
VSRC3	[63:56]	VGPR for source 3.